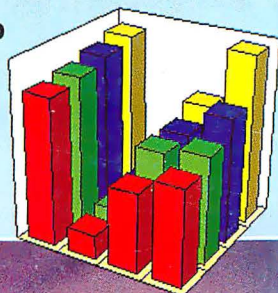


# BYTE

A MCGRAW-HILL PUBLICATION

## GRAPHICAL SPREADSHEETS

BYTE Lab  
Product  
Report  
Page 222



Top Portables and Pointing Devices for

# Windows on the Road

**Del! Color Notebook Breaks  
\$4000 Price Barrier**

**C++ Wars:  
Borland vs. Microsoft**

**Is NetWare Lite  
Too Lite?**

**Breakthroughs  
in Memory  
and Storage** Page 160



\$3.50 U.S.A./\$4.50 IN CANADA  
0360-5230



Gateway Cafe  
Dee Dee

D

*Special*

# Gateway 2000 - Now Serving PCs With Free Application Software!



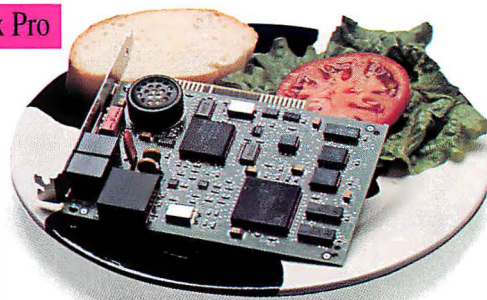
*Special*

All kinds of new things are cookin' for you at Gateway 2000.

We have a brand-new application software buffet. When you buy a Gateway 2000 system, you get to choose one free software package from a smorgasbord of offerings.

There's a new fax/modem card on the menu, too. It's the Gateway TelePath – a 14,400 bps modem with full fax capability. The card comes with WinFax Pro and Crosstalk for Windows, plus a free CompuServe trial membership, all for \$195.

If you have an appetite for savory new video options, we have 'em. We're introducing the Gateway 2000 Crystal



Scan 1572FS – a 15-inch flat, square, non-interlaced color monitor with front controls. And the Graphics Ultra, ATI's sizzling graphics accelerator, is now on the menu at Gateway 2000.

Of course we're still serving your old favorites – the hottest PCs at the best prices on the market. We have seven great systems in our main course selections, from a 286/16 to a 486/33 EISA.

Browse through our other ad in *BYTE* for all the details about what's new from Gateway 2000. When you get the scoop, the decision to buy a Gateway will be easy as pie.



 **GATEWAY2000**  
"You've got a friend in the business."

8 0 0 - 5 2 3 - 2 0 0 0

610 Gateway Drive • N. Sioux City, SD 57049 • 605-232-2000 • Fax 605-232-2023

*Special*

# Where Can You Get The Best Byte For Your Buck?



Sometimes sharing will  
slow you down.



Now there's a LaserJet fast enough and smart enough to keep the whole group happy. The HP LaserJet III Si printer. A 17ppm powerhouse designed for high volume. And multiple users.

With the LaserJet III Si, your users are up to speed the moment they give the "print" command. HP's RISC-based formatter yields fast results. Even on the most complex documents.

The LaserJet III Si meets the needs of your shared workgroups with a new standard for I/O performance. HP's optional interface cards allow your network to transfer data up to 25 times faster than a typical parallel connection. Once you slide a card into the back of the printer, the LaserJet III Si is ready to go. Anywhere on your network. Anywhere your users need it.

#### **Speed**

- 17ppm
- RISC-based formatter

#### **Paper Handling**

- Two 500-sheet input trays
- 500-sheet output tray
- Optional two-sided printing
- Optional envelope feeder

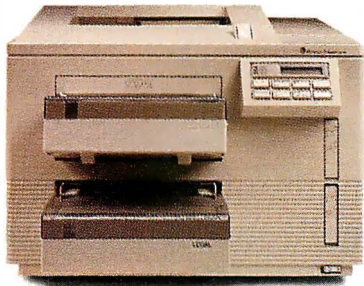
#### **Networking**

- Optional Novell, Microsoft® LAN Manager, IBM LAN Server, 3 COM, EtherTalk, LocalTalk
- Serial/Centronics (standard)

#### **Languages**

- PCL5, optional Adobe PostScript

And sometimes it'll  
get you there faster. The 17ppm  
LaserJet III Si printer.



And since every workgroup has special needs, this versatile LaserJet printer offers a range of paper-handling features. Software-selectable language switching between PCL5 and optional Adobe® PostScript®. And the best 300 dpi print quality available. With HP's exclusive REt and microfine toner.

For all its capabilities, the LaserJet III Si is priced at just

\$5,495\*. So if you're ready to satisfy the whole workgroup, call **1-800-752-0900, Ext. 2134** for more information and the name of your nearest authorized HP dealer.

**LaserJet Printers**



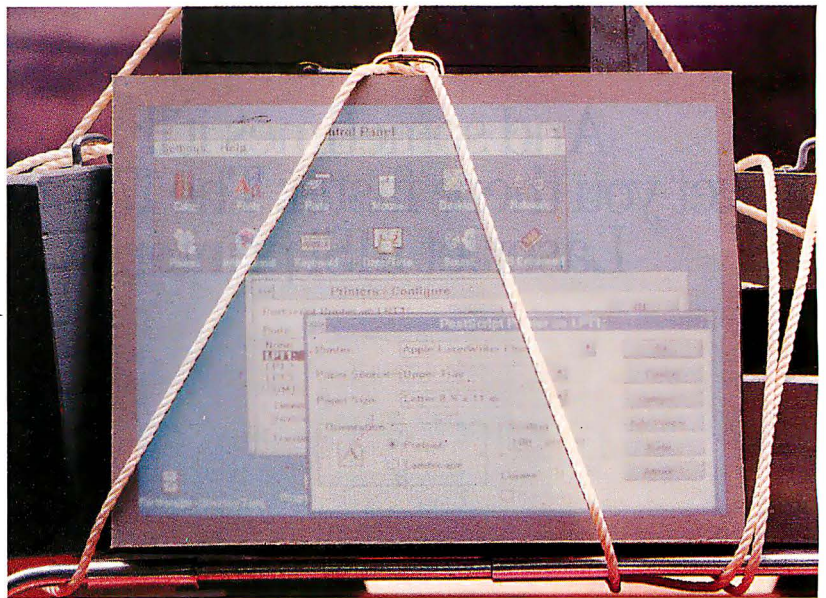
**HEWLETT  
PACKARD**

## COVER STORY

### SOLUTIONS FOCUS

## Windows on the Road

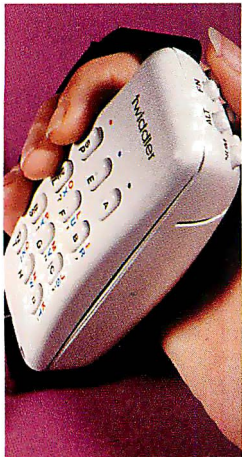
PAGE 208



## NEWS

- 23 MICROBYTES**  
As the 32-bit, scalable Windows NT inches closer to reality, Novell is clearly concerned about the long term. The solution: Novell is throwing in its lot with Unix.
- 36 FIRST IMPRESSIONS**  
**A New Unix Standard**  
Hewlett-Packard again sets a standard for workstation price and performance.
- 39 FIRST IMPRESSIONS**  
**Battle of the Heavyweights**  
The C market leaders slug it out.
- 42 Dell System 325NC,**  
a color notebook that destroys the \$5000 barrier

Twiddler, a typing alternative that fits in your hand



**System Sleuth Professional 4.0 and WinSleuth Professional 2.0,** advanced system diagnostics keep up with technology

**Bravado,** Truevision's new live video/VGA card

**Grammatik V for DOS,** it sports interesting new features but won't cause corporate wordsmiths to fear for their jobs

- 58 WHAT'S NEW**  
Mobius gives you the Mirage IPS system for Unix; Xircorn connects you to Token Ring; and more.

## FEATURES

- 122 Software Without Walls**  
Distributed object management systems can fuse diverse distributed applications and data into seamless information systems.
- 131 System Bus or System Bottleneck?**  
The 32-bit EISA and Micro Channel buses are not living up to their potential.
- 145 The Birth of the Microprocessor**  
On the twentieth anniversary of its introduction, a retrospective.
- 155 Classic Languages, Part 6: BASIC**  
Despite its educational roots, this language has become the most widespread and most commonly used on microcomputers.

## STATE OF THE ART

- 160 MEMORY AND STORAGE ADVANCES**  
**Overview: Scaling the Memory Pyramid**  
Memory and mass-storage subsystems traditionally lag behind the theoretical performance limits of CPUs. Systems designers are minimizing the performance penalty by organizing storage in a hierarchy of speed and capacity.
- 175 What to Stash in a Cache**  
Today, caching is a must for high performance. Now, the questions are: What type, and how big?
- 183 Storage Management**  
A new class of products eases the burden of the LAN administrator's job.
- 195 Embedded Intelligence**  
Demands for higher storage performance are being answered by disk designers: They're adding intelligence to drives to boost speed and accuracy.
- 204 Resource Guide: Storage for Networks**





- 208 SOLUTIONS FOCUS**  
**Windows on the Road**  
The BYTE Lab tests portable systems and pointing devices with a flair for Windows.
- 222 BYTE Lab Product Report: Captains of Crunch**  
The top spreadsheet programs for DOS, Windows, and the Mac.
- 240 Raising the Ceiling: Nine Memory Managers for Today's Processors**  
Nine products that make more memory available to your DOS programs.
- 246 NetWare Grows Lean, Not Mean**  
NetWare Lite 1.0 earns high marks for simplicity and interoperability with server-based NetWare.
- 251 Swift Programming for Windows, in Windows**  
QuickC for Windows brings GUI integration to Windows program development.
- 253 Apple Reinvents the Notebook**  
Apple's lightweight notebook computers are heavy-duty champs.
- 257 WordPerfect for Windows**  
The big-selling word processor is finally running under Windows. Has it been worth the wait?
- 259 REVIEWER'S NOTEBOOK**  
SoftNode brings a different kind of NetWare to the Mac, Stacker 2.0 squeezes out space, and Telebit's tiny modem blazes.



HANDS ON

- 261 SOME ASSEMBLY REQUIRED**  
**Tapping into Sockets**  
Use TCP/IP sockets to write portable client/server applications.
- 269 UNDER THE HOOD**  
**Enhancing Laser-Printer Resolution**  
How to make a laser printer act like a phototypesetter.
- 279 SOFTWARE CORNER**  
**Network Sleuth**  
Network utilities for the Mac and PC; an E-mail utility for Unix.
- 281 BEYOND DOS**  
**32-bit Windows Today**  
*by Martin Heller*  
Watcom and MetaWare deliver 32-bit Windows programming toolkits.
- 287 NETWORKS**  
**LAN Analyzers Move to AI**  
*by Barry Nance*  
AI is redefining the role of LAN analyzers.
- 291 THE UNIX /bin**  
**X Hits the Spot**  
*by David Fiedler*  
Setting up your PC Unix for the X Window System.
- 295 MACINATIONS**  
**Managing Mac Upgrades**  
*by Don Crabb*  
Don works up some Mac hardware upgrade strategies.
- 303 ASK BYTE**  
The best number crunchers; Windows environment space problems; PC-to-Mac connectivity; and other issues.

- 93 USER'S COLUMN**  
**Interrupts and Big Cats**  
*by Jerry Pournelle*  
Jerry configures a new 486 computer.
- 109 BUSINESS CONNECTION**  
**Windows Moves Out**  
*by Wayne Rash Jr.*  
Better notebook computers make traveling with Windows a workable proposition.
- 115 ROUNDTABLE**  
**The Future of Pen Computing**  
Pen software developers and systems designers debate the future of pen computing.
- 362 PRINT QUEUE**  
**Mirror Worlds**  
David Gelernter's *Mirror Worlds* puts the universe in a shoebox.
- 364 STOP BIT**  
**Infoglut at Your Fingertips**  
All the information search-and-retrieval services still remain islands to themselves.
- 10 EDITORIAL**  
Sending a Message to Congress
- 14 LETTERS**  
Reader reactions to OS/2 2.0 and other issues.

READER SERVICE

- 360** Editorial Index by Company
- 357** Alphabetical Index to Advertisers
- 358** Index to Advertisers by Product Category
- Inquiry Reply Cards: 355

PROGRAM LISTINGS

- From BIX: Join "listings/frombyte92"
- From Demolink: See ad on page 361
- On disk: See ad on page 297

INSIDE BYTE

File Edit Worksheet

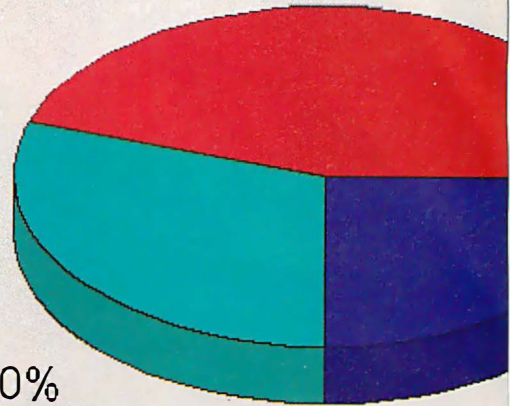
(C0) [W12]

A:E10 @SUM(B

	A	B
9		
10	Revenues	\$1,260,000
11	Costs	\$850,000
12	Profit	\$410,000

# Market Share

45.0%



30.0%

## Buy a ZEOS. Get a Bundle!

Now, Lotus 1-2-3 for Windows and Ami Pro 2.0 are included with every ZEOS Windows system. Details inside!



1-2-3 for Windows



Amipro



WinRIX-DCS





## EVERY ZEOS WINDOWS SYSTEM ALSO INCLUDES LOTUS 1-2-3 FOR WINDOWS PLUS AMI PRO 2.0!

Upgradable. High performance. Low cost. Unbelievable? Believe it! Because now ZEOS® gives it all to you in one complete package.

Harnessing the ZEOS power and value you want is easy. Simply pick your processor, then your package and your price. Package #1 gets you up and running for a *very* reasonable price. Then you can add even more options *and* savings with Packages 2, 3 or 4 and receive VGA, additional memory, a larger drive and more. Not only that, but you'll also receive *Windows 3.0*, *Lotus 1-2-3 for Windows*, Lotus' great new word processor *Ami Pro 2.0*, *Microsoft DOS 5.0* *plus* a genuine Microsoft Mouse. Nobody gives you this combination of hardware and software. It's exclusively yours, exclusively from ZEOS!

# ZEOS® Upgrad



### FANTASTIC PERFORMANCE.

When we first sat down to design these new systems, we wanted computers that would *blow the doors off* anything else out there. Plus, we wanted you to be able to upgrade from one CPU to another as your computing requirements changed, *without having to buy an entirely new system*. The results?

Incredibly low cost, high performance systems so very advanced you can move freely from the '386 family of processors to the latest '486s all without a moment's hesitation.

Choose from either high speed '386-25 and 33MHz systems, either cached or non-cached, plus the '486SX and '486-33 MHz with or without a secondary cache. Whichever you choose you know that as your computing requirements change, your processing power can change as well.

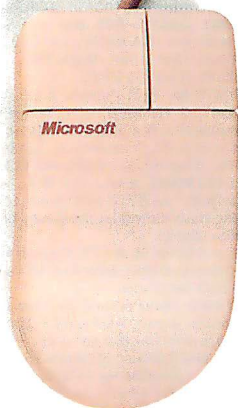
### ROOM TO EXPAND. POWER TOO.

ZEOS gives you everything you need *now* plus room to expand in the future. We've freed two normally occupied expansion slots by placing our high speed IDE hard drive and floppy drive interfaces right on the main board. Then we put the high speed serial, parallel and game ports on the motherboard too. The result?

Eight expansion slots, seven of which are available for your future use! And another important expansion feature: our *300 watt power supply*. All the pure clean power you need right now, *plus* plenty of power for the future.

What about space? Your new ZEOS Space-Saver case comes complete with *seven drive bays*. Yes, it's actually smaller than many cases offering only five drive bays!

**BEST VALUE!**



**EXTRA COOLING MEANS LONGER LIFE.**

Each ZEOS system includes not one but *two whisper quiet cooling fans*. Why? Because whether you expand your system or not, the cooler it runs, the longer it will last.

And every ZEOS system is *UL® Listed*. This listing means your entire system (not just the power supply) has met the stringent safety requirements of Underwriters Laboratories. We believe UL listings say a lot about quality. And UL safety listings are

# ables & Lotus!

something most of our competitors don't (or can't) provide. At ZEOS, quality and safety are important to us. *You* are important to us.

**24-HOUR-A-DAY TOLL-FREE TECHNICAL SUPPORT!**

Most of our competitors still offer only part time technical support. Yet for the last two years ZEOS technicians have been helping customers just like you — *24 hours a day, 365 days a year*. Add to that our 30-Day Absolute Satisfaction Money-Back Guarantee, One Full Year Limited Warranty and our Express Replacement Policy, and we know you're going to be very satisfied. We don't just say it. *We guarantee it.*

**ORDER YOUR OWN ZEOS TODAY!**

Selecting your new ZEOS system is easy. Choose from any of the money-saving packages shown here. Or let your friendly and knowledgeable ZEOS Systems Consultant help you configure exactly what you want from our huge selection of upgrades and options. Buying your new ZEOS system is perhaps the best purchasing decision you'll ever make!

Simply pick up the phone and give us a call toll free at 800-423-5891.

**ORDER NOW TOLL FREE: 800-423-5891 AND DON'T FORGET THE OPTIONS!**

Because every ZEOS system is custom-built, you can choose from a huge selection of hard drives, video packages and many other options. On-site service is available too. Call 800-423-5891 for details.



**ZEOS SYSTEMS— A FEW EXPERT OPINIONS:**

*PC Magazine*, "Out of 104 machines from 58 companies...For Overall Excellence we selected ZEOS International..."

*InfoWorld*, "We find the ZEOS '386 an excellent value. Speed: Excellent. Compatibility: Excellent. Value: Excellent."

*Government Computer News*, "Arguably the fastest MS-DOS and OS/2 micro in the world!"

*PC Magazine*, Editor's Choice, "The ZEOS blows away every other computer...a smart choice."

**ZEOS SYSTEMS. A SMART CHOICE INDEED!**

**ORDER NOW TOLL FREE 800-423-5891**

TAKE YOUR PICK!

# Choose From 4 Great Money Saving Packages.

## Or Specify Your Own Custom Configuration!

### ZEOS COMPLETE SYSTEM PACKAGE #1

Start with the processor and speed of your choice then add plenty of future upgradability!

- 1MB of high speed RAM, expandable to a system total of 32MB right on the motherboard.
- Ultra-fast 42MB IDE hard drive with its own cache.
- 1.2MB or 1.44MB Teac® floppy drive.
- ZEOS 14" flat screen Hi-Res amber monitor with Tilt & Swivel.
- Shadow RAM and EMS.
- ZEOS/RS 101 SpaceSaver keyboard.
- Two serial, one parallel and one game port built right on the motherboard.
- 7-16, 1-8 bit expansion slots. 80387 math coprocessor support for '386 systems.
- Rugged ZEOS SpaceSaver case with twin cooling fans for added reliability.
- Seven drive bays and our custom 300 watt power supply for your future expansion!
- Includes ZEOS 24-hour-a-day toll free Technical Support and Customer Satisfaction Package. Yes!

### INCREDIBLE UPGRADE PACKAGE #2

We take Package #1 and upgrade your Editor's Choice system to include:

- 2 full Megabytes of rip-roaring high speed RAM.
- Our 107MB IDE hard drive with cache.
- Both the Teac 1.2MB and 1.44MB floppy drives. Top quality drives!
- The awesome Diamond SpeedStar HiColor VGA graphics card complete with 1MB DRAM.
- ZEOS 14" Hi Res VGA Mono Monitor with Tilt & Swivel.
- Lotus 1-2-3 Windows, Ami Pro 2.0, Microsoft Windows, DOS 5.0 plus a genuine Microsoft Mouse!

### ASTOUNDING UPGRADE PACKAGE #3

Add even more memory, a larger drive. And more savings!

- 4 full Megabytes of high speed RAM.
- 130MB IDE hard drive with built-in cache.
- Both Teac floppies—the 1.2MB and 1.44!
- The Diamond HiColor VGA card with 1MB DRAM.
- ZEOS 14" High Res 1024 x 768 non-interlaced VGA Color Monitor with Tilt & Swivel.
- Lotus 1-2-3 for Windows, Ami Pro 2.0, Microsoft Windows, DOS 5.0 plus a Microsoft Mouse!

### THE ULTIMATE UPGRADE PACKAGE #4

Now, memory goes to 8MB and the drive to 210 MB. The ultimate power user's dream machine. Fantastic!

- 8 full Megabytes of ultra high speed RAM.
- 210MB IDE hard drive with its own built-in cache.
- Both Teac floppies!
- The Diamond HiColor VGA card with 1MB DRAM.
- ZEOS 14" High Res 1024 x 768 non-interlaced VGA Color Monitor with Tilt & Swivel.
- Lotus 1-2-3 for Windows, Ami Pro 2.0, Microsoft Windows, DOS 5.0 plus a Microsoft Mouse!

#### PACKAGES 2, 3 & 4 INCLUDE LOTUS BUNDLE!

	Pkg. #1	Pkg. #2	Pkg. #3	Pkg. #4
<b>386-25</b>	\$1395	\$1895	\$2395	\$2895
<b>386-33</b>	\$1495	\$1995	\$2495	\$2995
<b>486SX-20</b>	\$1595	\$2095	\$2595	\$3095
<b>486-33</b>	\$1795	\$2295	\$2795	\$3295

Add \$200 to any price for a 128K cache.

### Lotus Software Bundle!

**For a limited time only, order any ZEOS Windows system (like packages 2, 3 and 4 above) and we will also include Lotus 1-2-3 for Windows and Ami Pro 2.0— at no additional charge!**

**ORDER NOW TOLL FREE  
800-423-5891**

FAX Orders:  
612-633-1325  
TDD Orders:  
800-228-5389

Outside US  
and Canada:  
612-633-6131

MasterCard, VISA,  
Am Exp, Discover, Z-Card and COD.  
GSA# GSA00K91AGS5176

Open 24 Hours a Day, 365 Days a Year!



# INSIDE **BYTE**

## BYTE Topic Index and Author Guide

This index helps you find articles that contain information on each of the listed topics. (The topic list changes each month.) Combined with the table of contents (page 4) and the Editorial Index by Company (page 360), you can identify articles by type, subject, title, author, or product discussed.

<b>ANALYZERS</b> 287	<b>FPU</b> 303	<b>OBJECT-ORIENTED PROGRAMMING</b> 39, 122	<b>AUTHORS</b>
<b>BASIC</b> 155	<b>FREEWARE/SHAREWARE</b> 279	<b>PEN PC</b> 115	Allen, Dennis 10
<b>BUSES</b> 131		<b>PRINTERS</b> 269, 303	Andrews, D. L. 23
<b>BUSINESS</b> 78	<b>HALFTONES</b> 269	<b>PROGRAMMING</b> 39, 74	Apiki, Steve 214
<b>C/C++</b> 39, 251	<b>HISTORY</b> 145	<b>SCSI</b> 195	Appleby, Doris 155
<b>CACHE</b> 175	<b>HOLOGRAPHY</b> 168	<b>SPREADSHEETS</b> 222	Baran, Nicholas 115, 257
<b>CHIPS</b> 145	<b>IMAGING</b> 269	<b>STORAGE</b> 160, 183, 195, 204	Bricklin, Dan 115
<b>COMPRESSION</b> 259	<b>KEYBOARDS</b> 51	<b>TCP</b> 261	Christianson, Tim 195
<b>CONTROLLERS</b> 195	<b>LAPTOPS/NOTEBOOKS/PORTABLES</b> 42, 109, 208, 253	<b>TELECOMMUNICATIONS</b> 70, 72, 259	Côté, Raymond GA 222, 261
<b>DBMS</b> 362, 364	<b>MACINTOSH</b> 253, 295	<b>UNIX</b> 23, 36, 58, 261, 291, 303	Crabb, Don 295
<b>DIAGNOSTIC</b> 51	<b>MEMORY/MEMORY MANAGEMENT</b> 240, 281	<b>UTILITIES</b> 54, 93	Dao, Jeff 115
<b>DIGITIZERS</b> 58	<b>MICROPROCESSORS</b> 93, 145	<b>VIDEO</b> 52	Dulaney, Ken 115
<b>DISK ARRAYS</b> 204	<b>MOUSE</b> 208	<b>WINDOWS</b> 74, 109, 208, 251, 257, 281	Edwards, David L. 222
		<b>WORD PROCESSING</b> 257	Eglowstein, Howard 115, 208
<b>FLOPTICAL</b> 166	<b>NETWORKS/NETWORK MANAGEMENT</b> 23, 122, 183, 246, 259, 261, 287	<b>WORKSTATIONS</b> 36	Faggin, Federico 145
<b>486</b> 93		<b>X WINDOW SYSTEM</b> 291	Faizullabhoj, Danial 195

# BYTE

**EDITOR IN CHIEF**  
Dennis Allen

**EXECUTIVE EDITORS**

New York: Rich Malloy  
Peterborough: Michael Nadeau

**MANAGING EDITOR**  
Anne Fischer Lent

**ASSISTANT MANAGING EDITOR**  
Lauren A. Stickler

**NEWS**

New York:  
News Editor: Andrew Reinhardt

**Peterborough:**

Sr. Ed., *New Products*: Stan Miastkowski  
*News Editors, What's New*: Martha Hicks, Carol Swartz, Amanda Waterfield  
*Microbytes*: D. L. Andrews

**San Francisco/West Coast:**

Bureau Chief: Kenneth M. Sheldon  
Sr. News Editor: Owen Linderholm  
Editorial Assistant: Barbara J. Caravello  
UK/Europe: Bureau Chief: Andrew Redfern

**BYTE LAB**

Technical Director: Rick Grehan  
Technical Editors: Stephen Apiki, D. Barker, Alan Joch, Tom Yager  
Testing Editors/Engineers: Raymond GA Côté, Stanford Diehl, Howard Eglowstein, Stanley Wszola  
Lab Assistant: Selinda Chiquoine

**STATE OF THE ART/FEATURES**

Senior Editor: John W. Donovan  
Technical Editors: Janet J. Barron, Robert M. Ryan, Ben Smith

**SENIOR TECHNICAL EDITORS, AT LARGE**

Tom Thompson, Jon Udell

**COLUMNS**

Senior Editor: Robert Mitchell

**SPECIAL PROJECTS**

Senior Editor: Gene Smarte

**ASSOCIATE TECHNICAL EDITORS**

Ellen Bingham, Susan Colwell, Jeff Edmonds, Tom Kevan, Cathy Kingery, Margaret A. Richard, Warren Williamson

**SENIOR CONTRIBUTING EDITOR**

Jerry Pournelle

**CONTRIBUTING EDITORS**

Don Crabb, David Fiedler, Martin Heller, Hugh Kenner, Wayne Rash Jr.

**CONSULTING EDITORS**

Roger C. Alford, Jonathan Amsterdam, Nicholas Baran, Laurence H. Loeb, Trevor Marshall, Mark J. Minasi, Barry Nance, Dick Pountain, Phillip Robinson, Jane Morrill Tazelaar, Ellen Ullman, Peter Wayne

**EDITORIAL ASSISTANTS**

Office Manager: Peggy Dunham  
Assistants: Linda C. Ryan, June Sheldon

**DESIGN**

Director: Nancy Rice  
Associate Director: Joseph A. Gallagher  
Designer: Jan Muller  
Assistant Designer: Rebecca Magill

**PRODUCTION AND FINANCE**

Director: Claudia Flowers

**PRODUCTION**

Director: David M. Cohen  
Production Manager: David R. Anderson  
Senior Editorial Production Coordinator: Virginia Reardon  
Editorial Production Coordinator: Barbara Busenbark  
Systems Manager: Sherry Fiske  
Applications Manager: Donna Sweeney  
Typesetter: Christa Patterson  
Creative Services Mgr: Susan Kingsbury  
Production Artist: Lillian J. Wise  
Advertising Services Manager: Linda Fluhr  
Senior Advertising Services Representative: Lyda Clark  
Advertising Services Representatives: Dale J. Christensen, Karen Cilley, Rod Holden  
Advertising Services Assistant: Roxanne Hollenbeck  
Quality Control Manager: Wai-Chiu Li  
Operations Assistant: Christine Tourgee

**FINANCE**

Business Manager: Kenneth A. King  
Assistants: Marilyn Parker, Diane Henry, JoAnn Walter, Jeanne Gatcombe, Jaime Huber, Agnes Perry

**MARKETING AND PLANNING**

Director: L. Bradley Browne  
Administrative Assistant: Carol Cochran  
Marketing Communications Manager: Pamela Petrakos  
Public Relations Mgr: Dawn Matthews  
Asst. Promotion Manager: Lisa Jo Steiner  
Marketing Art Dir.: Stephanie Warnesky  
Associate Art Director: Sharon Price  
Market Research Manager: Julie Perron  
Copyrights Manager: Faith Kluntz  
Reader Service: Cynthia Sands  
Marketing Assistant: Carol Sanchioni

**CIRCULATION**

Director: Glyn Standen  
Subscriptions Manager: Paul Ruess  
Assistant Manager: Pam Wilder  
Subscriptions Assistant: Holly Zilling  
Newsstand Manager: Vicki Weston  
Assistant Manager: Karen Desroches  
Back Issues: Louise Menegus  
Direct Accounts Coordinator: Ellen Dunbar

**PUBLISHER**

Ronald W. Evans

Publisher's Assistant: Donna Nordlund

**ADVERTISING SALES**

National Sales Manager:  
Jennifer L. Bartel (214) 701-8496

**NEW ENGLAND**

Daniel D. Savage (617) 860-6344

**EAST COAST**

Kim Norris (212) 512-2645  
Ariane Casey (212) 512-2368

**SOUTHEAST**

John Schilin (404) 843-4782

**MIDWEST**

Kurt Kelley (312) 616-3328

**SOUTHWEST, ROCKY MOUNTAIN**

(214) 701-8496

**SOUTH PACIFIC**

Ron Cordek (714) 753-8140  
Alan ElFaye (213) 480-5243

**NORTH PACIFIC**

Bill McAfee (408) 879-0381  
Roy J. Kops (415) 954-9728  
Leslie Hupp (408) 879-0381

**INSIDE ADVERTISING SALES**

Director: Liz Coyman (603) 924-2518  
Assists.: Susan Monkton, Vivian Bernier

**NATIONAL ADVERTISING SALES**

Mary Ann Goulding (603) 924-2664  
Patricia Payne (603) 924-2654  
Jon Sawyer (603) 924-2665  
Barry Echavarria (603) 924-2574

**THE BUYER'S MART (1x2)**

Joseph Mabe (603) 924-2656

**HARDWARE/SOFTWARE SHOWCASE**

Ellen Perham (603) 924-2598  
Mark Stone (603) 924-2695

**REGIONAL ADVERTISING SECTIONS**

Brian Higgins (603) 924-2651  
Barry Echavarria (603) 924-2574  
Larry Levine (603) 924-2637

**BYTE DECK**

Ed Ware (603) 924-2596

**EURO-DECK**

James Bail (603) 924-2533

**INTERNATIONAL ADVERTISING SALES STAFF**

See listing on page 359.

**PERSONNEL**

Human Resources Admin.: Patricia Burke  
Assistant: Fran Wozniak  
Receptionist: Beverly Goss

**HOW TO CONTACT THE EDITORS**

We welcome your questions, comments, complaints, kudos, and submissions.

**MAIN OFFICE:** One Phoenix Mill Lane, Peterborough, NH 03458, (603) 924-9281.  
**WEST COAST:** 425 Battery St., San Francisco, CA 94111, (415) 954-9718; 15635 Alton Pkwy., Suite 290, Irvine, CA 92718, (714) 753-6140.

**NEW YORK:** 1221 Avenue of the Americas, New York, NY 10020, (212) 512-3175.

**UK/EUROPE:** Wimbledon Bridge House, One Hartfield Rd., Wimbledon, London SW19 3RU, England, 011-44-81-543-1234.

**ELECTRONIC MAIL:** On BIX, send to "editors." All BYTE editors and columnists also have individual mailboxes on BIX for easy access.

**MCI:** 250-0135 BYTE Magazine. Many editors also have individual MCI addresses in their own name.

**OTHERS:** Many editors also are reachable through uunet, AppleLink, CompuServe, and numerous other services.

**U.S. fax:** Editorial: (603) 924-2550

Advertising: (603) 924-7507

**U.K. fax:** 011-44-81-540-3833

**SUBMISSIONS**

**Authors:** We welcome article proposals and submissions. Unacceptable manuscripts will be returned if accompanied by sufficient return postage. Not responsible for lost manuscripts or photos.

**Vendors:** We welcome news of your new products; please call the News department or the BYTE Lab at the earliest possible date. We cannot be responsible for unsolicited product samples.

**SUBSCRIPTION CUSTOMER SERVICE**

**Inside U.S. (800) 232-BYTE;** outside U.S. (800) 426-7676. For a new subscription—(800) 257-9402 U.S. only, or write to BYTE Subscription Dept., P.O. Box 555, Hightstown, NJ 08520. Subscriptions are \$29.95 for one year, \$54.95 for two years, and \$74.95 for three years in the U.S. and its possessions. In Canada and Mexico, \$34.95 for one year, \$64.95 for two years, \$87.95 for three years. In Europe, £29 (U.S. \$50) for fast surface delivery, £41 (U.S. \$70) for air delivery. Non-European countries U.S. \$50 for surface mail, or U.S. \$75 for air mail. Single copy price is \$3.50 in the U.S. and its possessions, \$4.50 in Canada. Foreign subscriptions and sales should be remitted in U.S. funds drawn on a U.S. bank. Please allow six to eight weeks for delivery of first issue.

**PHOTOCOPY PERMISSION:**

Where necessary, permission is granted by the copyright owner for those registered with the Copyright Clearance Center (CCC), 27 Congress St., Salem, MA 01970, to photocopy any article herein for personal or internal reference use only for the flat fee of \$1.50 per copy of the article or any part thereof. Correspondence and payment should be sent directly to the CCC, 27 Congress St., Salem, MA 01970. Specify ISSN 0380-5280/92, \$1.50. Copying done for other than personal or internal reference use without the permission of McGraw-Hill, Inc., is prohibited. Requests for special permission or bulk orders should be addressed to the publisher. BYTE is available in microform from University Microfilms International, 300 North Zeeb Rd., Dept. PR, Ann Arbor, MI 48106, or 18 Bedford Row, Dept. PR, London WC1R 4EJ, U.K.

Copyright © 1992 by McGraw-Hill, Inc. All rights reserved. BYTE and BIX are registered trademarks of McGraw-Hill, Inc. Trademark registered in the United States Patent and Trademark Office.

 Member  
Audit Bureau of Circulation

**BIX** BYTE INFORMATION EXCHANGE

**MANAGING EDITOR**

Tony Lockwood

**MICROBYTES DAILY**

Coordinator: D. L. Andrews  
Rich Malloy New York,  
Nicholas Baran Sandpoint, ID,  
Laurence H. Loeb Wallingford, CT,  
Rick Cook Phoenix, AZ,  
Stephen Banker Washington, DC,  
David Reed Lexington, KY,  
Andrew Reinhardt New York

**DEMOLINK**

BYTE program listings are available at (617) 861-9767 (set modem at 8-1-N, 2400 or 1200 bps). Enter Demolink.

**EXCHANGE EDITORS**

Amiga Exchange: Joanne Dow;  
Entertainment and Leisure Exchange:  
Rich Taylor;  
IBM Exchange: Barry Nance;  
Macintosh Exchange: Laurence H. Loeb;  
Programmers Exchange: Bill Nicholls;  
Professionals Exchange: David Reed;  
Tojerry Exchange: Jerry Pournelle;  
Writers Exchange: Wayne Rash Jr.

**DIRECTOR**

Stephen M. Laliberte

**BUSINESS AND MARKETING**

Secretary: Patricia Bausum  
Marketing Services Coordinator:  
Denise A. Greene  
Billing Services Coordinators:  
Tammy Burgess, Donna Healy  
Editorial Assistant: Brian Warnock

**TECHNOLOGY**

Programmer/Analyst: John Spadafora  
Systems Consultant: Gary Kendall

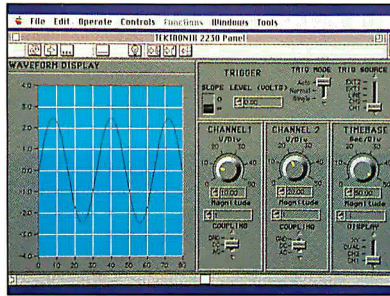
BIX, the "BYTE Information Exchange," is a worldwide, low-cost, on-line information service featuring industry news, downloadable software, powerful electronic mail, previews of upcoming BYTE articles, the full text of published issues of BYTE, and source and/or executable code for BYTE benchmarks and noncommercial software mentioned in feature articles. BIX also offers unmatched "conferences" on virtually every computer-related topic imaginable, where you can share information with thousands of other computer pros. To subscribe via modem, set your communications software to full duplex, 7 bits, even parity, 1 stop bit, and then call 800-225-4129; in MA, call (617) 861-9767. International, call NU1310690157800. Then hit the Enter/Return key and enter "BIX" when asked to log in; then enter "BIX.VILLE" when asked for a name. For current fees and more information, call (800) 227-2983 or (603) 924-7681 on voice phone.

**OFFICERS OF MCGRAW-HILL, INC.:**

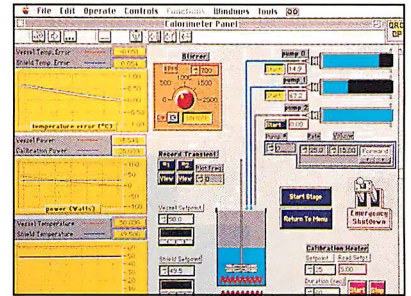
Chairman, President and Chief Executive Officer: Joseph L. Dionne, Executive Vice President, General Counsel and Secretary: Robert N. Landes, Executive Vice President: Walter D. Serwatka, Senior Vice President, Treasury Operations: Frank D. Penglase, Executive Vice President and Chief Financial Officer: Robert J. Bahash, Executive Vice President, Administration: Thomas J. Sullivan, Senior Vice President, Corporate Affairs, and Executive Assistant to the Chairman: Mary A. Cooper, Senior Vice President, Editorial: Ralph R. Schulz.



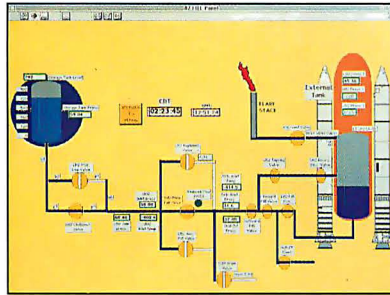
Automated Test



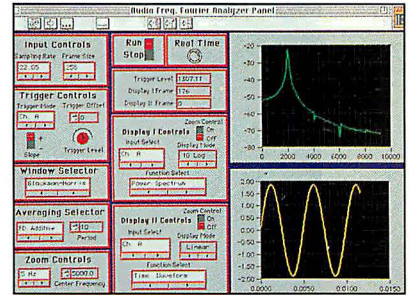
Analytical Chemistry



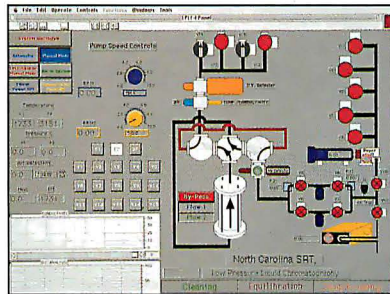
Process Control



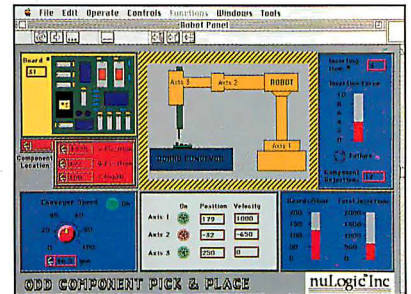
Audio and Vibration



Chromatography



Manufacturing and Production



```

20 REM *****
30 OPEN "dev1" FOR OUTPUT AS #1
40 OPEN "dev1" FOR INPUT AS #2
50 REM *****
60 PRINT #1,"clear 1"
70 PRINT #1,"local lockout"
80 PRINT #1,"output 1:in? yml: wkt gdf:"
90 REM *****
100 PRINT #1,"trigger 1"
110 PRINT #1,"center 1"
120 INPUT #2,AS:RS
130 REM *****
140 PRINT #1,"output 1:dat encl:acc:curv?"
150 PRINT #1,"center 1"
160 INPUT #2,AS:PS
170 REM *****
180 PRINT #1,"spoll 1"
190 INPUT #2,SPB:

```

You can automate your system with 30-year old technology, or . . .

# BRING IT TO LIFE WITH LABVIEW® 2



While PC users wrestle with cryptic text-based programming languages, Macintosh users are getting the job done with LabVIEW 2, the most celebrated application software for data acquisition and instrument control. It recently won the MacUser Magazine Editors' Choice Award. Five years ago, LabVIEW introduced the combination of front panel interfaces and graphical programming. Today, engineers and scientists around the world use LabVIEW 2 and the Macintosh for a broad spectrum of applications.

Unlike other graphical packages, LabVIEW 2 does not sacrifice power and flexibility for ease of use. With LabVIEW 2, you create front panel user interfaces and import pictures to customize your panels. Then you quickly build block diagram programs and add your own blocks to expand upon our libraries. Yet your virtual instruments run as quickly as compiled C programs. Call us to find out how you can bring your system to life with LabVIEW 2.

For a free LabVIEW 2 Demo disk, call:  
 (512) 794-0100 or  
 (800) 433-3488  
 (U.S. and Canada)



International Branch Offices: Australia [03] 879 9422, Denmark [45] 76 73 22, France [1] 48 65 33 70, Germany [089] 714 5093, Italy [02] 4830 1892, Japan [03] 3788 1921, Netherlands [01720] 45761, Norway [03] 846 866, Spain [908] 604 304, Switzerland [056] 45 58 80, U.K. [0635] 523 545.  
 Product names listed are trademarks of their respective manufacturers. Company names listed are trademarks or trade names of their respective companies.  
 ©Copyright 1991 National Instruments Corporation. All rights reserved.

LARGER DISPLAY AREA FOR  
BIGGER IMAGES



BRIGHTER SCREENS FOR  
SHARP, CRISP IMAGES

NON-INTERLACED, FLICKER-FREE  
DISPLAY FOR LESS EYE STRAIN

**WISHES DO COME TRUE.** And at MAG Innovation™ our new MX-Series color monitors are making a number of wishes come true.

These advanced displays are great for all types of applications, particularly Microsoft® Windows.

**4 MODELS TO CHOOSE FROM.** With a variety of sizes and tubes to select from, there's an MX display just right for you. The

MX15F and MX17F make use of the latest flat square tube technology to offer distortion-free images, while the

MX14S and MX17S utilize proven Trinitron® tubes.

**LARGER DISPLAY AREA.** Every MX-Series monitor uses advanced overscan technology to provide an

edge-to-edge active display area that dwarfs displays of comparable size by as much as 36 percent!

**HIGH-RESOLUTION.** MX monitors offer the highest resolution you can find in any display of comparable size. In fact, at 1280 x 1024 non-interlaced, the MX15F displays four times the information available with standard VGA. That means more windows on the screen...more information...more productivity!



**BUILT-IN MICROPROCESSOR.** Each MX-Series display has its own microprocessor that can adjust the display format

WISHES  
GRANTED.

BUILT-IN MICROPROCESSOR FOR  
AUTOMATIC CONFIGURATION

A WINDOWS<sup>®</sup> WISH LIST.  
INTRODUCING THE ULTIMATE  
WINDOWS DISPLAYS.

HIGH-RESOLUTION FOR MORE  
WORK SPACE

*automatically to work with almost any of the available video standards. So whether you're changing a video mode or upgrading a video card, the MX display will adjust automatically. And, if you do make adjustments, you only do it once. An MX display never forgets.*



**SHARPER, BRIGHTER IMAGES.** *By incorporating an Invar Shadow Mask into the MX15F and MX17F, we've achieved 30 percent more brightness without sacrificing sharp, crisp focus. And when combined with our high-resolution and fast-refresh rate, that 30 percent more brightness truly creates an image to wish for.*

**LISTEN TO THE EXPERTS.** *Don't just take our word for it. We're partial. Read PC Magazine's "Editors' Choice" for July 1991. They said of the MX15F... "clearly the best." Or listen to PC World (12/91) rave about the MX17F... "so great that it defies comparison."*

**WISHES DO COME TRUE.** *The next time you go window shopping to look at Windows displays check out an MX monitor.*

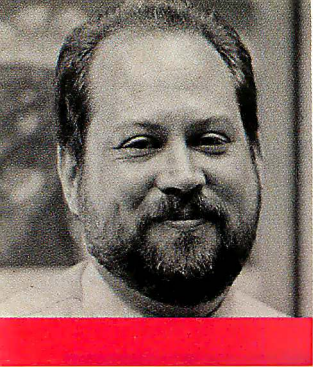
*For more information on how to make your wishes come true, call us now at 1-800/827-3998, or contact us at our corporate headquarters:*

*4392 Corporate Center Drive, Los Alamitos, CA 90720. Tel: 714/827-3998. Fax: 714/827-5522.*

©1992, MAG Innovation. All rights reserved. MAG Innovation and its logo are trademarks of MAG Innovation. Microsoft and Windows are registered trademarks of Microsoft Corp. Trinitron is a registered trademark of SONY Corp.



Circle 260 on Inquiry Card (RESELLERS: 261).



## EDITORIAL

DENNIS  
ALLEN

# SENDING A MESSAGE TO CONGRESS

**A**n election year in the U.S. means two things—one good, the other bad. The good thing is that to get reelected, Congress has to actually do something. The bad thing is that that something may not be very good. We ought to be concerned about the latter.

Consider, for example, how trade-protection measures would affect the computer industry. For a long time, Congress has had a hankering to help out the semiconductor manufacturers in the U.S. You probably remember all those news stories about how Japanese firms have flooded the market with cheap memory chips and how U.S. firms cannot compete against the “dump-

ing” of such low-cost chips on the market.

On the one hand, it would appear that restricting imports of memory chips would help U.S. memory makers, therefore protecting the industry and jobs. On the other hand, any kind of restriction would cause prices to skyrocket, and higher memory prices would mean higher prices for systems—a complete reversal of the current trend toward commodity pricing.

Think about it this way: Just a few short years ago, there was a shortage of memory chips, and prices were naturally high. They were high enough, in fact, that a typical system came with only 1 MB of RAM—scarcely enough to run, say, Microsoft Windows or any demanding application.

It took a big drop in memory prices to spur manufacturers to produce 2-, 4-, or even 8-MB systems for less than \$3000, and we’ve all capitalized from that. More to the point, we’ve bought more-powerful computers that let us run more-powerful—and more-demanding—software applications so we can better do our jobs. Now that’s a competitive edge, and it’s one that Congress seems willing to forfeit.

After years of promises and predictions of how personal computers would improve everyone’s productivity, we find ourselves at the threshold of realizing that goal. Almost as though it happened overnight, although it didn’t, we finally have user interfaces that actually make applications easy. We have applications that can use graphics as well as they can use text and numbers. We have operating-system platforms that let us run several applications at once. All of this came about because memory chips have been cheap and plentiful, and now, just as

we’re ready to cross the ubiquitous productivity threshold, Congress wants to slam the door.

For a moment, think about all that you could do if you had more memory in your present system. You could run more concurrent applications so that they could “talk” to one another and exchange data. You could run a larger disk cache to speed up those applications. You could run a more powerful operating system. Simply put, you could do your job better.

The benefits of having more memory go far beyond the obvious. Software developers, for example, are eager to write the gigantic programs necessary for enterprise-wide computing. And companies are raring to implement those programs so that their entire operations can work more efficiently.

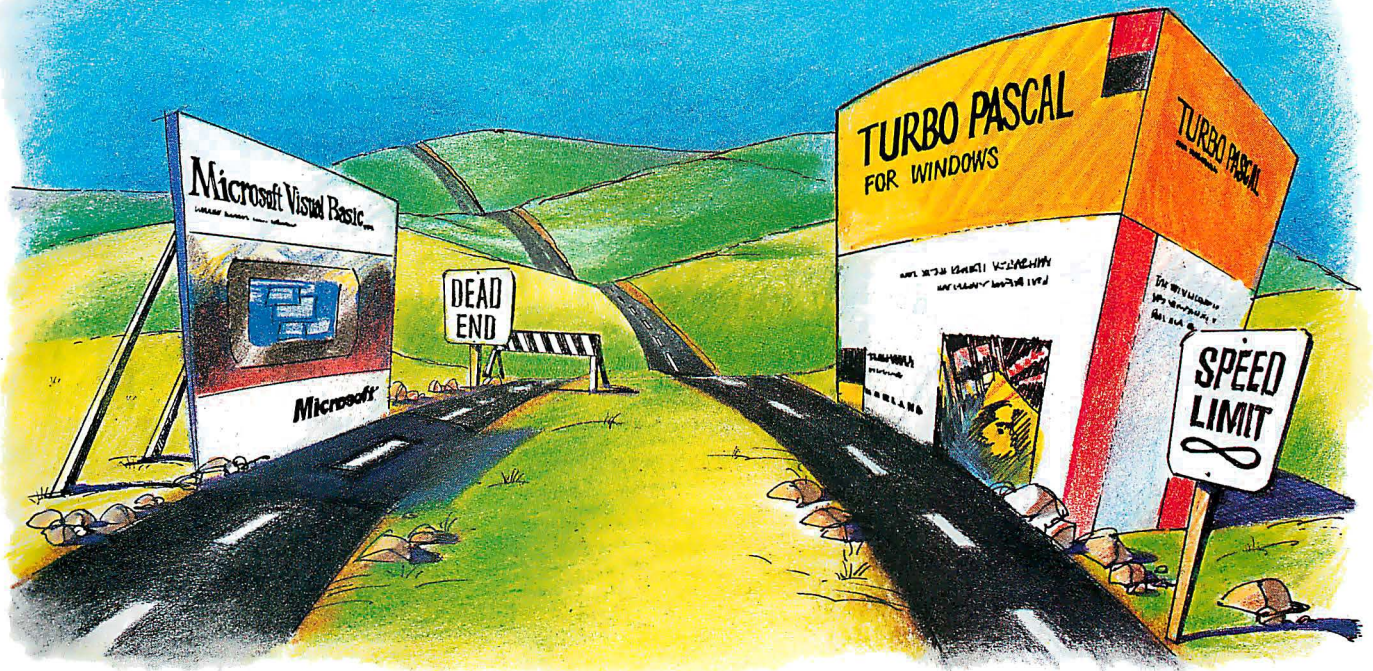
Enacting protectionist measures for memory chips will halt the forward momentum of the computer market and the computer industry. Such action would stall future developments—in both software and hardware—simply because high memory prices would mean that the average computer system would have a relatively small amount of memory. In short, we would all have to spend a little more on computers to do a little less.

You get the picture. With lots of inexpensive memory, we become more productive individually and as entire companies, and that increased productivity translates into nationwide competitiveness. Does that competitiveness mean jobs? Perhaps, but I’ll leave that to the Labor Department to say. One thing for sure, though, is that if trade restrictions are applied, cheap and plentiful memory is not possible.

That’s less than desirable, and it’s nearly intolerable. At best, it may only be shortsighted. At worst, it’s just plain stupid. Trade protections rarely make sense. Moreover, Congress doesn’t seem to think that voters look beyond the short-term benefits that they promise. Of course, it’s not the first time that Congress has been wrong.

Fortunately, when Congress is wrong, folks can say so at the voting booth on election day. But why wait until then? By that time, the damage will have been done. The better solution is to write a letter to your congressperson. Contrary to what you may have heard, they’re starved for feedback from folks like you. If you’re too busy to write a letter, just tear out this page, sign it, and mail it. Either way, they’ll get the message.

—Dennis Allen  
Editor in Chief  
(BIX name “dallen”)



# Borland's Turbo Pascal for Windows

## What you need to go the distance

Turbo Pascal® for Windows is the easy way to get into Windows application development *and* go as far as you want. Because Turbo Pascal for Windows gives you *twice*

	Visual Basic	Turbo Pascal for Windows
Visual interface editing	Yes	Yes
Object-oriented language	No	Yes
Compiled	No	Yes
Built-in assembler	No	Yes
Extensible	No <sup>(1)</sup>	Yes
Create DLLs	No	Yes
Reference to API	No	Yes
Resource compiler	No	Yes
Help compiler	No	Yes
Speed (Sieve)	20.21 sec.	1.65 sec.
Space (Sieve)	5429 bytes <sup>(2)</sup>	1156 bytes

<sup>(1)</sup>Visual Basic can only be extended by writing Dynamic Link Libraries in C, C++ or Pascal.  
<sup>(2)</sup>Visual Basic requires a runtime Dynamic Link Library of 272K.

*Turbo Pascal for Windows comes with everything you could possibly want for writing Windows applications easily.*

the features of Visual Basic in a faster, more efficient package. So you'll never run out of horsepower!

With Turbo Pascal for Windows you can instantly create a functional Windows interface *without programming*, using the included Resource Toolkit. And you can write your first Windows program in just *five* lines of code.

### The objects of Windows development

Turbo Pascal for Windows comes with a complete library of prewritten program building blocks called objects. To create a program, simply select the objects you want from the included ObjectWindows™ library, place them in your application, and off you go. Before you know it, you've created your first Windows program complete with overlapping Windows, pull-down menus and dialog boxes!

### Get the critics' choice!

Turbo Pascal for Windows goes the distance with the critics, too! David Gerrold in *PC Techniques* (July-August 1991) says, "If I had to pick one killer 'app' for Windows, I'd pick Turbo Pascal for Windows." *Windows and OS/2 Magazine* states, "The speed of the compiler is a pleasure to experience." (Sept. 1991). *InfoWorld* proclaims, "Turbo Pascal sets the standard for Windows programming. The ObjectWindows library makes (it) extremely easy to use." (June 3, 1991).

Now you can get Turbo Pascal for Windows for only \$99<sup>95</sup> from Borland (after a \$25 manufacturer's rebate\*).

**\$99<sup>95</sup>**  
 Limited time offer

### REPORT CARD

### INFO WORLD

### Turbo Pascal for Windows

VERSION 1.0



Criterion	Score
<b>Performance</b>	
Programming environment	Excellent
Language extensions	Excellent
Debugging	Excellent
OOP implementation	Excellent
<b>Documentation</b>	
Ease of learning	Very Good
Ease of use	Excellent
<b>Error handling</b>	
Support	Very Good
Support policies	Very Good
Technical support	Excellent
<b>Value</b>	
<b>Final score</b>	<b>9.1</b>

*Turbo Pascal for Windows received one of the highest scores ever in InfoWorld, outperforming Visual Basic.*

That's \$150 off the suggested retail price and half the price of Visual Basic!† So why limit your Windows development when you can go as far as you want?

Turbo Pascal for Windows. The easy way to go the distance.

See your dealer today, or call 1-800-331-0877, Dept. 5471, now!

# BORLAND

The Leader in Object-Oriented Programming

\*Offer good until May 15, 1992. †Rebate also available from your local dealer. Dealer prices may vary. Copyright © 1992 Borland International, Inc. All rights reserved. Turbo Pascal and ObjectWindows are trademarks of Borland International, Inc. BI 14328

Circle 28 on Inquiry Card (RESELLERS: 29).

# THE PINN

**TYPE: 3.5" OPTICAL**  
**CAPACITY: 128 MB**  
**SIZE: 6.75"(H) X 2.125"(W) X 8.25"(L)**  
**MOUNTING: VERTICAL OR HORIZONTAL**

**The Pinnacle.** The top. The leader in optical storage. Since 1988, Pinnacle's been the world's leader in optical storage solutions, shipping more systems than any other company.

**Introducing** the Pinnacle Micro REO-130S rewritable optical drive featuring the new Sony 3.5" mechanism. With its 38 msec access time, the REO-130S is the perfect storage solution for personal computing, desktop publishing, multimedia, data distribution and backup.

Company	Per Disk Price	Per Disk Capacity	Price For 5 Disks	Capacity Of 5 Disks	Drive Price
Pinnacle Micro REO-130S	\$ 79	128 MB	\$ 395	640 MB	\$1995
Imago Bernoulli® 90	229	90 MB	1145	450 MB	1149
Syquest™ (PLI) 88	229	88 MB	1190	440 MB	1199

**Pricing advantage** over Bernoulli® and Syquest™. Pinnacle's REO-130S offers a lower cost per megabyte compared to its magnetic storage competition. Users now need fewer disks while getting more storage capacity at a lower price.

Trademark Owners: REO-130S of Pinnacle Micro, Inc.; PLI of Peripheral Land, Inc.; Syquest of Syquest Corp. Registered Owners: Bernoulli of Imago; Pricing acquired directly from manufacturers on 11-5-91.

 **800-553-7070**

19 Technology • Irvine CA 92718 • In CA (714) 727-3300 • Fax (714) 727-1913

# ACLE.



**Optical Technology** has distinct advantages over the Bernoulli® and Syquest™ technology. Since optical drives use laser technology to store information there is no chance of head crashes. 3.5" optical has a much smaller footprint than 5.25" magnetic but holds 40% more data.

**Reliability** of optical media is 15 years (shelf life) - that's 3 times longer than Bernoulli® and Syquest™ magnetic disks. Since the 3.5" cartridges are removable, optical remains the most secure way of storing your data into the future.

**Media Standards** for 3.5" optical disks have both ISO and ANSI standards to support the technology, while Bernoulli® and Syquest™ have none. Each 3.5" disk can be recognized in any 3.5" ISO/ANSI standard optical drive.

**The Pinnacle Advantage** is clear. Pinnacle Micro dominates the optical storage industry by offering the largest selection of 3.5" and 5.25" optical drives and disk changers. Interface kits are available for MAC, SUN, DEC, IBM and compatibles. The Pinnacle. Your next storage system. Circle 98 on Inquiry Card (RESELLERS: 99).

**PINNACLE MICRO**  
THE OPTICAL STORAGE COMPANY

# LETTERS

## Waiting for OS/2

Regarding "The Public Speaks on OS/2 vs. Windows" (November 1991), Microsoft has claimed that "the market has spoken" by choosing Windows. This is nonsense. The market has no way of knowing what it wants until products are available for purchase. The market was never offered 32-bit OS/2 2.0. If Microsoft needed to abandon something in favor of Windows 3.0, there was 16-bit OS/2 1.x, which never had much to recommend it and was rejected by the market.

Microsoft has claimed that Windows 3.x is better for the market than OS/2 2.0 would have been because it requires less-expensive hardware. This too is nonsense. No one buys a 286 machine these days, except as a minimal DOS box. Everyone is buying 386SX, 386, and 486 machines, and Windows 3.x wants as much from these as OS/2 2.0 would have, but it gives back much less functionality and performance.

For years we were told we were moving out of DOS, and then suddenly we were told to stay put and get bigger Windows instead. I hope the IBM version of OS/2 2.0 succeeds, if only to spite Microsoft.

Jim Howard  
Project City, CA

What Ellen Ullman says in the December 1991 Roundtable ("What's Wrong with Unix?") is true: DOS is a "retrofit kludge." We deserve something better. When I try to generate a report in Quicken with Desqview installed, I get an "Insufficient memory" message. I have to remove Desqview to generate the report. Sure, this is just a bug. It's also a pain.

I'm pinning my hopes on OS/2 at this point and praying that IBM finally gets it out the door and that it spawns many applications.

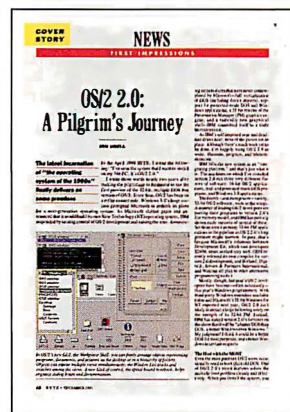
Bill Romaine  
Acton, MA

With the real OS/2 just around the corner ("OS/2 2.0: A Pilgrim's Journey," December 1991), it is ironic that Microsoft Windows has both hindered and helped OS/2: hindered, because Windows derailed OS/2's development program; helped, because until Windows, the GUI was going nowhere on the PC. Windows binary compatibility made OS/2 unnecessarily fat and delayed it even more, but this helps, because Windows capability will be what sells OS/2.

I intend to run OS/2, and I intend to program for it.

**WE WANT TO HEAR FROM YOU.** Please double-space your letter on one side of the page and include your name and address. Letters two pages in length or under have a better chance of being published in their entirety. Address correspondence to Letters Editor, BYTE, One Phoenix Mill Lane, Peterborough, NH 03458. You can also send letters via BIXmail c/o "editors."

Your letter will be read, but because of the large volume of mail we receive, we cannot guarantee publication. We also reserve the right to edit letters. It takes about four months from the time we receive a letter until we publish it.



But I am not pleased that it is four years late. Nothing has held back the industry more than the Microsoft/IBM bundle of OS/2. I'll never forgive IBM for wasting time on 16-bit OS/2. And I'll never forgive Microsoft for abandoning OS/2 altogether. BYTE editor Michael Nadeau is correct (see "Why Windows Needs OS/2," December 1991). The coming battle between Microsoft's Windows NT and IBM's OS/2 2.0 is a boon to consumers. However, it's not the really interesting spectacle. More interesting will be the emergence of 64-bit operating systems as Intel rolls out—as it must—its

64-bit 80x86 chip.

Will we see another bungle from the operating-systems giants, or will they react correctly next time?

John Kominek  
Markham, Ontario, Canada

I'm often bemused by the preponderance of pro-Big Blue proclamations that stream forth from your pages. I just finished laughing at Michael Nadeau's editorial ("Why Windows Needs OS/2") and Jon Udell's "OS/2 2.0: A Pilgrim's Journey" (December 1991). I laughed not because the writing was particularly humorous, but because these authors still [don't understand]. How many postponements [of OS/2 2.0] have there been? The deadline for OS/2 2.0 was December 31, 1991. Yesterday I read of IBM's planned March 1992 release of the product. Ha! IBM couldn't produce a viable package with Microsoft, and IBM won't be able to do it without Microsoft.

I'm almost ready to wager that by March IBM will proclaim some wonderful new breakthrough technology that can't be ignored and that will be developed by IBM's crack OS/2 2.0 team. And of course OS/2 2.0 will then be ready by May 1995 or soon thereafter, so users shouldn't switch to Windows!

John Caporale  
West Chester, PA

## High-Level Praise

I am very glad to see your six-part series by Doris Appleby on higher-level languages ("Classic Languages," beginning in September 1991). We read much about C these days, but higher-level languages offer enormous advantages to applications software developers as well as to maintenance programmers.

One advantage is that these programs are written in a fashion similar to the way people think and thus are very readable. Another advantage is that these programs can be transported from a platform manufactured by one vendor to a platform made by a different vendor, providing that both vendors have conformed to the appropriate standards. In addition, the error-handling routines for the higher-level languages are very sophisticated and accurate. I have yet to see competent error-reporting routines for C.

C should be used to create operating systems, drivers, compilers, linkers, and interrupt handlers. For



C developers

# Imagine:



## interface development & screen management in a utopian environment!

In the perfect world, you probably wouldn't choose to spend excessive time and energy (read: any) sweating the interface to satisfy the constantly changing whims of your end-users. Of course, the perfect world probably wouldn't have end-users.

But the real world does.

And the more ridiculous they get (difficult, picky, and fickle) about the way they want their screens to look and function, the more miserable *you* get.

Because every little "adjustment" they demand means that you have to go back and do huge hunks of work all over again. And again. And again. Frankly, it's amazing you haven't strangled anyone yet.

### Vermont Views™

We can end your end-user nightmares by eliminating the aggravations of coding — and recoding — perfect C language interfaces. Instead, we let you create interfaces interactively, with our powerful, intuitive, menu-driven Designer.

With Designer, you create working prototypes by playing *directly* with your screens. Pull-downs, pop-ups, choice lists, data entry forms, borders, sizes... all that stuff. Just peruse, choose, and voilà!

Changes? Easy! New details? No problem! Whole new approaches? Go for it!

It's all made possible by an incredibly extensive library of 586 tested, debugged, reliable functions. Which means *every screen you create* can look and function distinctively, uniquely, and precisely the way

Circle 132 on Inquiry Card.

you want it to (and no one *ever* has to know you didn't spend days doing it all from scratch).

Once your screens are done, the prototypes become the actual applications. *No double coding* (it's a *really* nice touch). And — get this — they're all portable to DOS (with minor code modifications) and completely portable among UNIX, SCO UNIX, XENIX, and VMS. With *no* code modifications!

It also doesn't hurt that we give you the fastest screen updates in the business. How fast? Don't bother reaching for the Twinkies. *That's* how fast.

But perhaps most importantly, Vermont Views is a *mature* product. We have great documentation, and superb tech support. And we've been helping developers like you do the improbable since 1984.

Which leads us to this fundamental question: Why are you still letting your end-users whack your fragile head against their hard, heartless walls?

Join our thousands and thousands of happy, healthy customers. Take that big step towards developer's dreamland.

**Demo paradise  
for yourself. Free.  
Call 1-800-848-1248** US & Can.

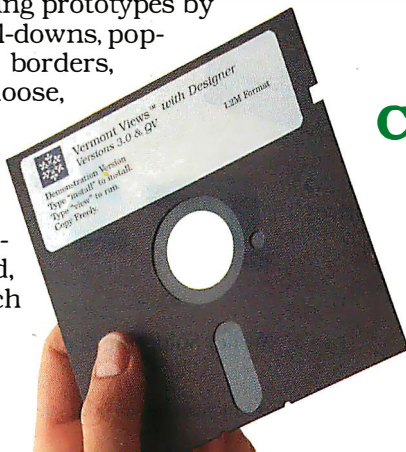
(Please mention "Offer 276")



Vermont  
Creative  
Software

Pinnacle Meadows, Richford, VT USA 05476  
(802) 848-7731, fax (802) 848-3502

©1991 Vermont Creative Software

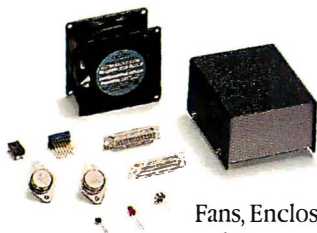


# NATURAL

## A Wider Vista of Reliable Electronic



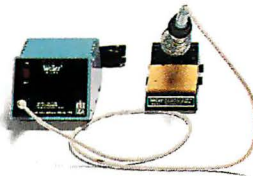
*South Sister, Middle Sister, and Broken Top Mountains  
- Oregon Cascades*



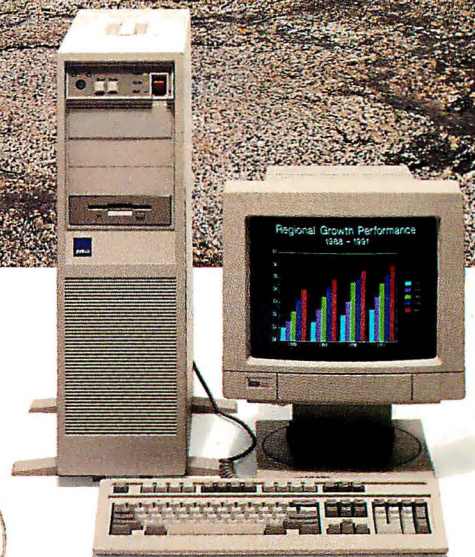
Fans, Enclosures,  
and Components



Toshiba 1.44MB 3.5"  
Floppy Disk Drives



Weller Soldering Stations



Jameco 8088, 80286 and 80386  
Computer Kits

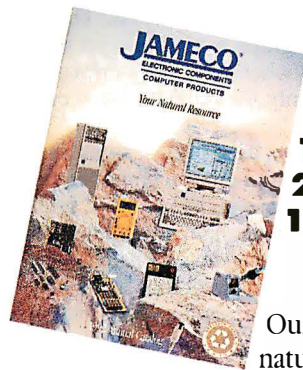
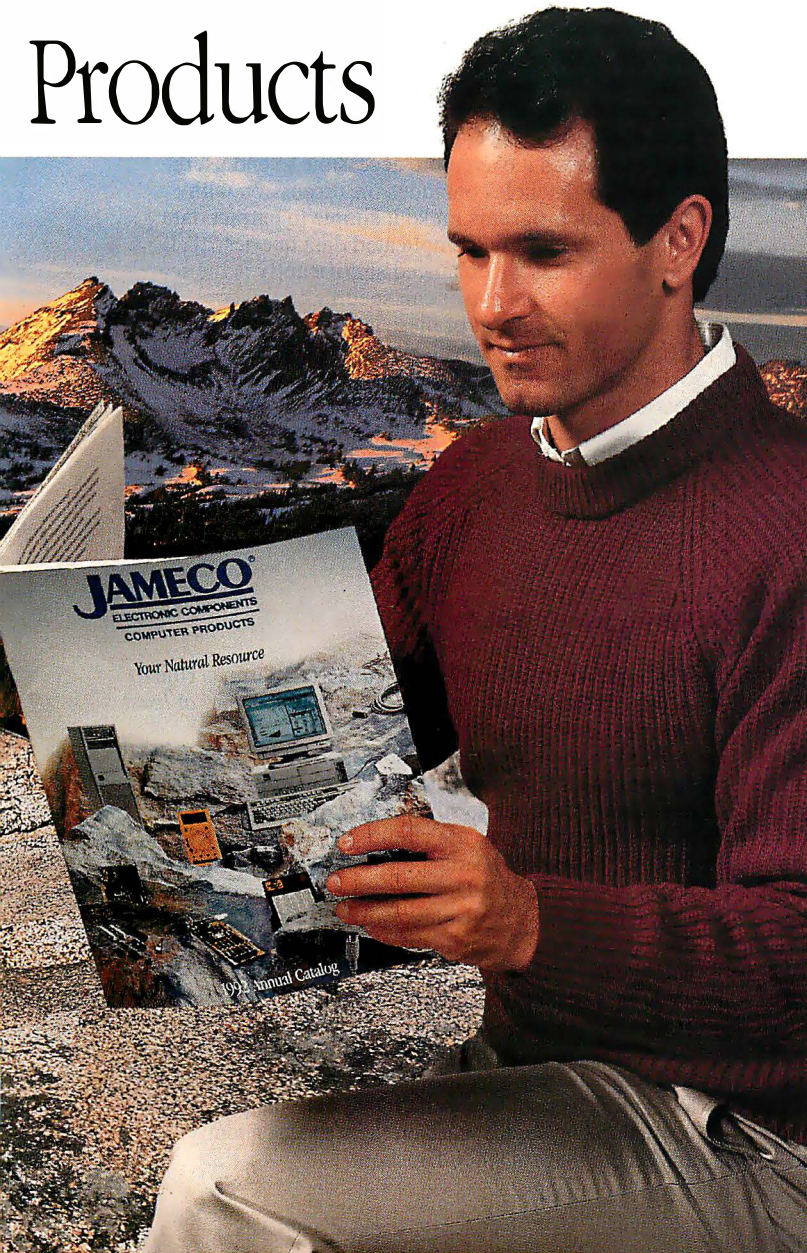


Please refer to  
Mail Key 1  
when ordering

Terms: Prices are subject to change without notice. Items subject to availability and prior sale. Complete list of terms/warranties is available upon request.

# RESOURCE.

## Products

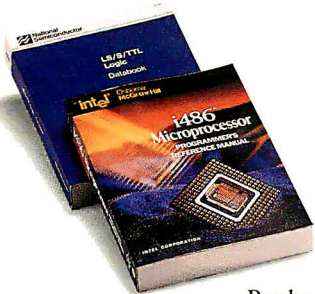


**Get Your Free  
Jameco Catalog  
Today. Call Our  
24-Hour Hotline  
1-800-831-4242**

Our catalog is a natural resource for all your computer and electronic product needs. You'll find over 4000 different items in this easy-to-use source book. Whether you want the latest computer kit, computer upgrade component, or accessory.... integrated circuits, test and measurement equipment or a special technology book, you'll find it at the most competitive price. And this wide selection is backed by our record of assured quality and solid customer support.

For 16 years, Jameco has been the resource of choice for large and small businesses, schools and universities, government, and individuals. And we make buying as natural as one phone call. Use our 24-hour order processing, toll-free 800 number and fax, BBS access and expedited shipping.

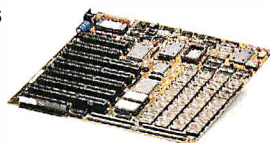
Let us become your natural resource today. Call now for our latest catalog. When you're ready, shop by phone or stop by our catalog-store/headquarters located in Belmont, CA, serving Silicon Valley and the Stanford Technology Park area.



Books



Integrated Circuits  
and RAM Modules



Jameco 16MHz  
80386SX Motherboards

**JAMECO**<sup>®</sup>  
ELECTRONIC COMPONENTS  
COMPUTER PRODUCTS

1355 Shoreway Road, Belmont, CA 94002  
1-800-831-4242 (415) 592-8097  
FAX: 1-800-237-6948

**Circle 71 on Inquiry Card.**

applications, though, the higher-level languages are by far the better choice.

Leonard M. De Ball  
*Glen Ellyn, IL*

## Defining Interoperability

What a wonderful article "Integrating Distributed Information" (November 1991) is. The opening line of the second paragraph is so subtle yet so incredibly important: "Everywhere you look, information hides within data, waiting only for the right set of circumstances to reveal itself."

In Ontario, road crews used to post signs ahead of major construction listing a contract number and completion date for the work. New signs include a brief descriptive message regarding the work, along with the completion date. What a wonderful change. The original signs were a great example of data, and the new signs are a great example of information. Until the new signs came, everyone considered the old signs to be informative because they had information written on them. Ah! Not anymore. Now someone has shown us what information really is, and we can see that there is in fact a difference between data and information.

Kevin Stumpf  
*Kitchener, Ontario, Canada*

It's obvious from reading "Interoperability: The Unfulfilled Promise" (November 1991) that interoperability has become more important as more and more corporate data is distributed off mainframes onto desktop systems. But I am left wondering whether the quest for interoperability may stem from a failure to adequately distinguish between the nature of data typically kept on small computers and that residing on larger systems.

Consider an IBM 3090 mainframe handling data and global data processing. A centralized MIS bureaucracy might dream of linking a local database of clients maintained by the New York office with local client databases kept by field offices, all of which might very well be sitting on some combination of minicomputers, Macs, and PCs. Even if a field office harbors data seemingly equivalent in structure to that independently gathered in New York, there is no guarantee that the data is equally meaningful, since there is not likely to be any commonly defined protocols for collecting the data. For these and other reasons, desktop-resident data is often valuable only at this localized or "micro" level.

Ultimately, "noninteroperative" computing seems to entail redefining what constitutes legitimate and valuable data processing. We should be careful not to obviate the economies obtained in the desktop revolution by demanding that small systems be defined merely as distributed versions of mainframe technology, as the quest for interoperability seems to tacitly demand.

Keith E. Risler  
*London, Ontario, Canada*

There is an error in "Transparent Data Exchange" (November 1991) and a few possible misconceptions. AutoImport is not on the market. Tangent Group acquired the technology and, after evaluating what the market needed, developed refinements to serve two differ-

ent computing environments: PC file server and mixed platform. Avenue is adapted to the PC file-server environment and Catapult to the multiplatform environment.

Steven J. Vaughan-Nichols comments, "It isn't transparent, but at least it's easy." If this means that you can't get Lotus data when you're in dBase, transparently, it's accurate. With Avenue and Catapult, the PC user can choose a keyword that will initiate action on host data. The user needs no knowledge of host operations to get host data. The mask capability refines data access further and makes it even more accessible to end users.

Vaughan-Nichols concludes the discussion with "while both programs make it simple to extract data ranges, they can't do complicated data queries. . . ." One of the areas we enhanced significantly is the search capabilities so that a user can specify criteria or values to select data. Several of these can be put back to back to sift through multiple levels of data.

Overall, the tone and direction of the whole special section were informative and interesting. We applaud your efforts at cutting through the glitz with the knife of practicality.

Posy Gering  
*Tangent Group, Inc.*  
*Bothell, WA*

## Revise Jerry's Rule?

I would like to extend Jerry Pournelle's famous rule to this: "One person, at least one processor, and at least one mass-storage unit."

There is the ugly new phenomenon of diskless workstations, which provide end users with processors but deny them the space to store work unless the network and the central server are running. This reduces the local CPU to the level of a smart terminal, with all the drawbacks of one main CPU.

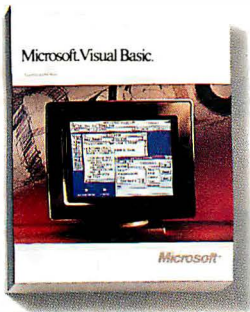
The network with diskless workstations is as unproductive as a mainframe network. The local workstations will use the server for any dumb I/O and will stay idle when they need information and the server is overloaded or down. The same justification to get rid of the old mainframe will appear in this type of network. The users will have (as they have now) the right claim that with local mass storage they can unload only the pieces of information they need, work on them independently, and upload them again when finished.

Ze'ev Atlas  
*Teaneck, NJ*

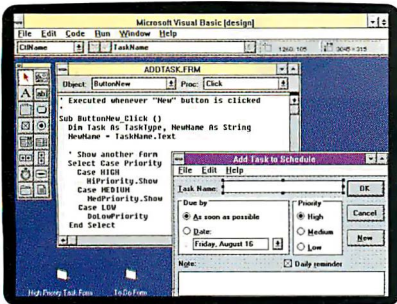
*I'll give some thought to the modification: One user, at least one CPU, and nowadays, yes, at least one mass-storage device. —Jerry Pournelle*

## FIX

LANFax Redirector ("Network Fax Servers Come of Age (Slowly)," December 1991) is stand-alone software that supports industry-standard fax boards. We inadvertently described it as a hardware/software bundle. ■



# A powerful Windows system that lets you develop powerful Windows apps.



Graphical forms and a robust programming language combine to create powerful Windows-based applications.

With the Microsoft® Visual Basic™ programming system, you can have it both ways.

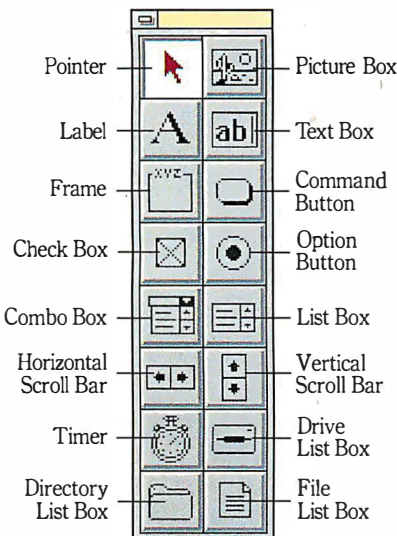
Start with a robust, structured language, one of the fastest compilers around, and an interactive source-level debugger. All tightly integrated in a programming system that's extensible via direct calls to the Windows API or other dynamic-link libraries (DLLs), and even new types of controls.

Of course, all that power can be put to good use.

Namely, remarkably powerful applications. Any app you create can have a graphical interface that includes multiple windows, drag and drop, and all standard Windows controls. Not to mention dynamic data exchange (DDE) for interoperability with other Windows applications.

The result? You can produce any kind of Windows application—each one a compiled, distributable .EXE file.

So call us at (800) 541-1261, Dept. V68. We'll be glad to tell you more about the system that has it all.



Visual design tools provide a graphical way to create graphical applications.

© 1991 Microsoft Corporation. All rights reserved. Printed in the U.S.A. For more information inside the 50 United States, call (800) 541-1261, Dept. V68. Customers in Canada, call (800) 563-9048. Outside the U.S. and Canada, call (206) 936-8661. Microsoft and the Microsoft logo are registered trademarks and Windows and Visual Basic are trademarks of Microsoft Corporation.

## PROGRAMMER'S CHOICE

### Key Features

- Fast, full-featured programming language.
- Create .EXE files with no royalty or run-time fee.
- Visual design tools for click-and-drag development of graphical applications.
- Sophisticated Windows-based applications can include all standard Windows controls, multiple windows, dialogs, custom menus, drag and drop, and programmatic graphics.
- Paste-link and programmable dynamic data exchange (DDE).
- Support for dynamic-link libraries (DLLs).
- Online, context-sensitive Help.
- Detailed online tutorial.
- Sample code and full-featured example applications.
- Incorporate bitmap graphics, metafiles, and icons.
- Sophisticated debugging tools.



WINNER

At the 1991 Spring Comdex/Windows World, the editors of BYTE judged Visual Basic the "Best of Show." In the July 1991 issue of BYTE, Editor-in-chief Fred Langa called Visual Basic "a milestone product."

**Microsoft®**

# Soon, Eight Hours Computing Will



## AMD Introduces The World's First 386 Microprocessor With 3-Volt Technology.

Two standard dry-cell batteries. There's really nothing special about them. Aside from the fact that they can run a powerful, portable 386 computer for a full eight hours. Provided, of course, that portable is built around a low-voltage Am386™ microprocessor.

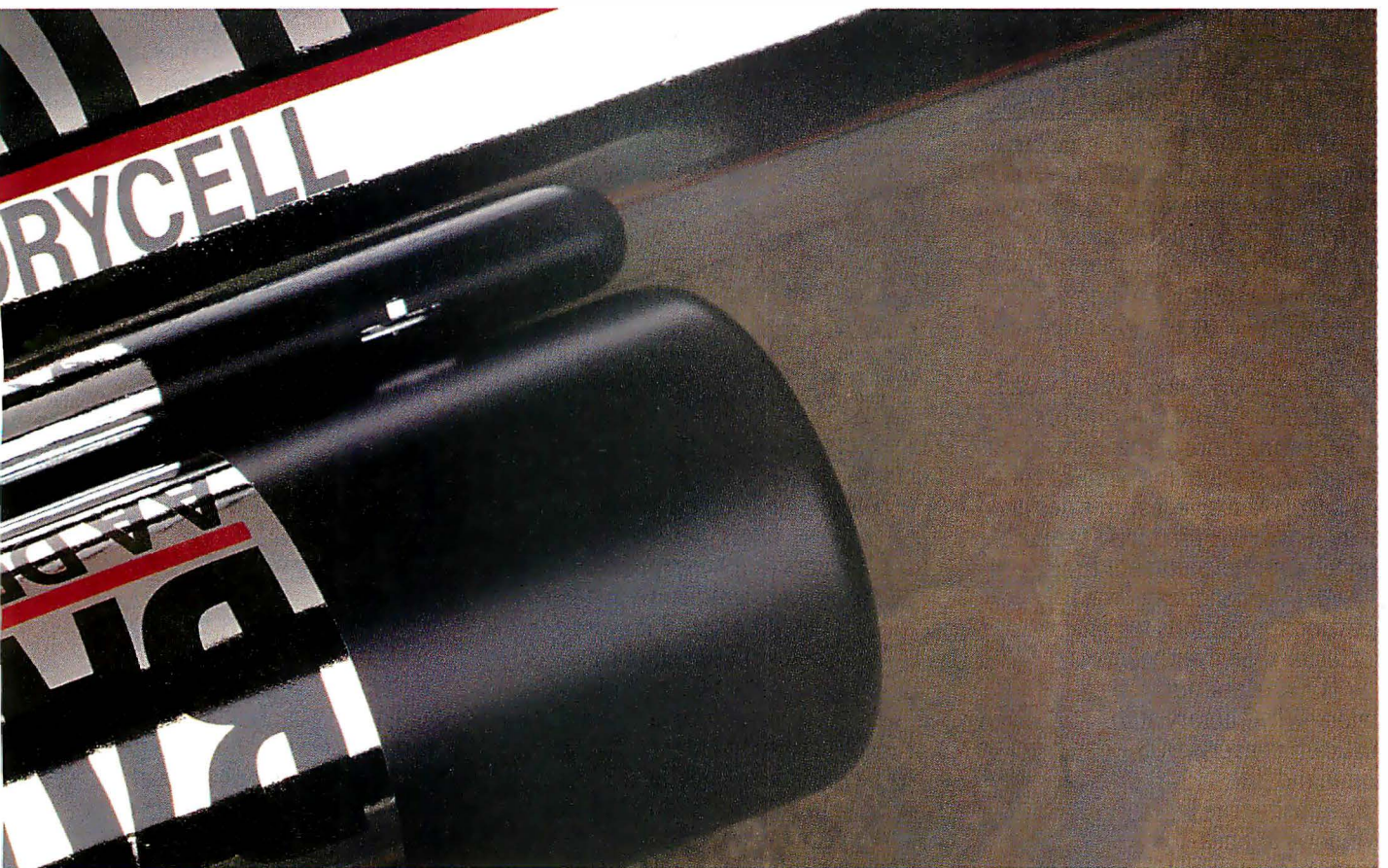


*The 25MHz: DXLV and the 25MHz: SXLV are available in POFP packaging.*

Thanks to the low-voltage Am386 microprocessors, laptop, palmtop and notebook computer designs will become smaller, lighter, and more powerful than ever before.

With battery life of up to eight hours or more. That's a full day's worth of 386 performance—the per-

# urs Of Portable Look Like This.



formance you need to run sophisticated applications like Windows™ 3.0.

And rest assured, the low-voltage Am386 microprocessors are proven compatible and comply fully with JEDEC standards for low-power, 3-volt computing. We can even supply you with the 3-volt EPROMs your systems will need. Other 3-volt system logic is also readily available.

For more information on the low-voltage

Am386 microprocessors call AMD today at **1-800-222-9323**. You'll never look at dry-cell batteries the same way again.



**Advanced Micro Devices**

*"We're Not Your Competition."™*

# C++ PLUS.

## ONLY ZORTECH™ C++ OFFERS A TRUE MULTI-PLATFORM COMPILER AND MUCH MORE.

When it comes to building larger, more complex applications, C++ is the language of choice. And now with Zortech C++, Symantec presents the only C++ compiler that provides professional tools for Windows,™ DOS and OS/2 in a single, integrated package.

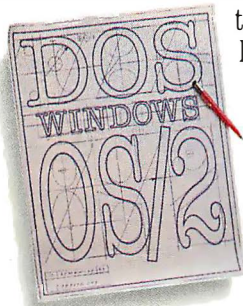
Zortech C++ goes well beyond the other C++ and C compilers by delivering more of the tools serious programmers demand—plus a collection of exclusive features designed to increase your productivity and reduce your development time.

All of which means you'll get your applications to market faster than ever before.

For starters, our unique WINCLibrary automatically converts DOS command line programs to true Windows applications. And you won't need to switch development systems, because you'll have the flexibility of moving to different platforms.

Zortech C++ even includes royalty-free 32-bit and 16-bit DOS extenders, for the cost-effective development of programs with advanced memory requirements.

And since Zortech C++ provides absolutely everything you need



*Zortech C++ dramatically cuts your multi-platform development time by supporting the complete range of PC architectures.*

to edit, compile, link and debug any Windows application, you won't need to buy the Microsoft Windows SDK. We've also added a help compiler and engine, a resource compiler, Windows header

files and libraries, and printed SDK documentation.

For unmatched performance, Zortech C++ offers globally optimizing compilers that boost program speed and significantly reduce program size. So regardless of the platform, Zortech C++ delivers performance and security where it matters... in your finished application.

In fact, as the safest choice you can make, Zortech C++ ensures total C++ and ANSI C compatibility. It's also supported by leading third-party utilities, libraries and other tools. That's probably why more and more corporations are moving to Zortech C++ for their application development.

## UPGRADE TO ZORTECH C++ FOR JUST \$199.

There's never been a better time to take advantage of the world's first multiple-platform C++ compiler.

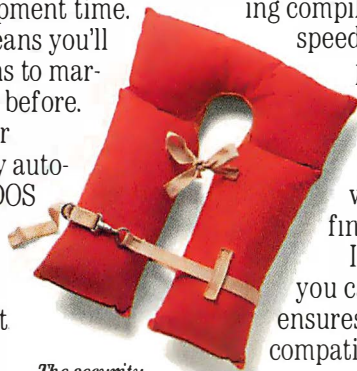
Because, for just \$199, users of Borland C++ and Microsoft C can now upgrade to Zortech C++ For Windows, DOS & OS/2—that's a savings of \$500!\*

And if your applications require even greater numerics support, pick up the Zortech C++ Science and Engineering Edition (which offers everything from the Windows, DOS and OS/2 version, along with the M++ array language extension, IEEE-754 and NCEG 91-015 numerical support, and much more).

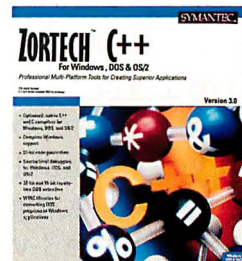


*Zortech's industrial-strength compiler breaks through the DOS 640K barrier, enabling you to develop programs of up to 16MB and beyond.*

Either way, you'll get unmatched Zortech quality backed by Symantec's outstanding service and support. So visit your dealer or call us at 1-800-228-4122, Ext. 804Y for more information about Zortech C++ and our competitive upgrade offer.



*The security of one compiler across multiple platforms has never been more essential. With Zortech C++, developing applications has never been easier or more efficient.*



\*Promotion ends March 31, 1992. Offer good in the US and Canada only. In Canada, call 1-800-465-2266. For more information in Europe, call 3171-353111. In Australia, call 61 2 879-6577. Everywhere else, call 408-252-3570. © 1991 Symantec Corporation. All rights reserved. Zortech is a trademark of Symantec Corporation. All other brand or product names mentioned are trademarks or registered trademarks of their respective holders.



# NEWS

## MICROBYTES

### Novell Gets Serious About Unix

**N**ovell might be justified in thinking that NetWare will dominate for years to come. But as Microsoft's 32-bit, scalable Windows NT (New Technology) operating system inches closer to reality, it's clear that Novell is concerned about the long term. Windows NT, with its integral networking capabilities, could obviate the need for NetWare. The solution: Novell is throwing in its lot with Unix.

Long the dominant client/server network operating system for the world of DOS-based PCs, Novell's NetWare is now being moved over to Unix through partnerships with Hewlett-Packard and the Unix Systems Laboratories (USL). In the past, Novell's Portable NetWare for Unix provided a subset of NetWare's full capabilities and incomplete connectivity between Unix and DOS. Now NetWare will be tightly integrated with Unix. One benefit: The difficulties of integrating LANs based on TCP/IP and Sun Microsystems' Network File System protocol with NetWare will become transparent.

The deal between HP and Novell will finally bring NetWare to a RISC-based Unix environment. The two companies plan to work together to port NetWare onto HP's Precision Architecture-RISC architecture, which is the basis for the blisteringly fast Series 700 workstations and servers. The software is expected to be available sometime in 1993. Darrell Miller, Novell's executive vice president of marketing and services, said that the two companies decided to support PA-RISC because of its speed and that producing a native version of NetWare will allow NetWare loadable modules to run.

The deal with USL may prove to be more strategically significant, since it could open up the whole Unix world, not just HP's corner of the market, to Novell. Novell and USL will form a joint venture called Univel in San Jose, California. Univel's mission will be to create a standard implementation of NetWare for USL's Unix System V release 4.0. Univel's products—the first of which will reportedly be available in the first half of this year—will arrive first for Intel-architecture machines. Other possible platforms include Advanced Computing Environment and SPARC machines.

The USL deal may have more to do with battling Microsoft than with integrating heterogeneous LANs. The announcement sheds light on why Novell invested in USL last year: Novell wants to hold onto the Intel-based market, and if that means jumping to Unix, so be it. Says Rikki Kirzner, a senior analyst at Dataquest, NetWare could become to Unix what LAN Manager is to OS/2 and Windows NT. Unfortunately for users, a protracted battle between Windows NT and Unix could further postpone the era of truly transparent interoperability.

—Owen Linderholm and Andy Reinhardt

### Clarion and Jensen & Partners to Merge

**C**larion Software (Pompano Beach, FL), developer of database applications development tools for DOS-based PCs, and London-based Jensen & Partners International, developer of the TopSpeed language products, have announced an intent to merge. Clarion's flagship product, the Clarion Professional Developer, will be integrated with JPI's tools, which include optimizing compilers, link tech-

nology, and an interactive debugger. The two companies had already planned to include JPI's compiler/linker technology in the Clarion Professional Developer 3.0, scheduled to ship this month.

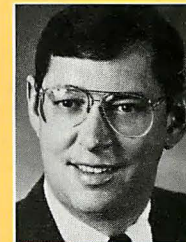
To accomplish the merger, Clarion stock will be issued to JPI stockholders. JPI's development staff will remain in London under the name TopSpeed Institute.

—D. L. Andrews

### NANOBYTES

The most intriguing and puzzling aspect of Novell and USL's Univel deal is that the partners hinted that they may produce the long-rumored **Unix Lite**, a scaled-down version of the operating system that would be shrink-wrapped for the desktop. USL has been thought to be developing this technology with **Compaq**, but now it will apparently fall to Univel. Compaq's role is unknown at this time. Robert Kavner, chairman of USL, said the software will appear this year. □

**Bruce Barrington**, Clarion Software's chairman and chief engineer, said his company's merger with



Jensen & Partners International "allows us to offer the best in languages together with the best in database technology. Until now, the database developer's choice has been

C for speed or either Clarion, dBase, Paradox, or Clipper for programming ease. Now Clarion can offer the same speed and compactness as a C program." □

**Ray Noorda**, Novell's CEO, has a different view on corporate stockholders. "During our operations, we think of the **customer first, employees second, and shareholders third**," he said at the time of the Hewlett-Packard and USL announcements. Noorda's approach contrasts sharply with the business model that puts shareholders first. Novell shareholders aren't doing too badly: Novell reported **record revenues** for 1991 of \$640.1 million, up 29 percent from \$497.5 million in 1990, and profits of \$162.5 million, or \$1.10 per share, up 72 percent from 1990's \$94.3 million net. □

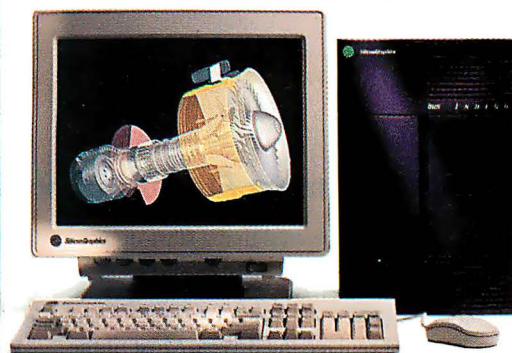
# IRIS Indigo. An excellent example



IRIS Indigo delivers 30 MIPS, 4.2 MFLOPS, 26 SPECmarks, CD-quality audio, 8-24 bit color, ACE-compatibility, and comes complete with color monitor, keyboard and mouse.

Copyright ©1991 Silicon Graphics, Inc. Silicon Graphics, the Silicon Graphics logo and IRIS are registered trademarks, and IRIS Indigo is a trademark of Silicon Graphics, Inc. All other registered and unregistered trademarks are the sole property of their respective owners.

IRIS INDIGO • RISC/PC



of smaller, faster, cheaper, better.

Desktop, RISC/PC, under  
\$10,000 ... Silicon Graphics.

It was bound to happen.

We've taken everything we've learned about visual computing and built it into powerful systems that everyone can afford – the IRIS Indigo™ family.

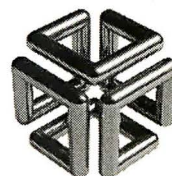
They pack the hot power of workstations and glide by at the cool price of PCs. And they're remarkably versatile – going from conceptual design to manufacturing – from fast 2D drafting through solids modeling – all with our powerful, renowned graphics.

They're standards-based machines with all the hooks and connections to fit easily with other systems. And with a starting price under \$10,000, they bring unprecedented graphics power to more desks for less money.

But don't just take our word for it. *Systems Integration* magazine says IRIS Indigo has, "the best price/performance ratio we've seen on a workstation – or any product for that matter." And they've been given both the *BYTE* Award of Distinction and a *Digital Review* Editor's Choice award.

See them for yourself. Get our free 20-page full-color capabilities brochure, and find out where to check out the IRIS Indigo family as well as our full line of servers and supercomputers.

Call 1 (800) 800-7441. Ext.17



**SiliconGraphics®**  
Computer Systems



## Apple Admits Floppy Drive Problem

**A**pple has admitted that a start-up production glitch has affected the floppy drives in the new portable PowerBook 140s and 170s to the point where the company must replace the drives. Most of the failures have been in the drives in the 140 model.

The internal floppy drives on some early production runs fail to operate unless screen brightness is turned down all the way, which makes the machine far less

useful. "We made a production change before the holidays that adds shielding to the floppy drive, and that seems to eliminate the problem," an Apple representative said. "We are fixing the affected drives under warranty at no charge to the consumer and encourage those with problems to call the Apple Customer Assistance Center at (800) 776-2333 to find their nearest service location."

—Larry Loeb

## IBM's Multimedia Development Kit Acknowledges Two Worlds

**I**BM is supporting the formats of two different multimedia platforms with the beta release of its 32-bit Multimedia Presentation Manager/2 Development Kit. The prerelease MPM/2, available from the company's operation in Boca Raton, Florida, is priced at \$100 and provides developers with early access to documentation, tools, and code samples for the Multimedia Extensions to OS/2 2.0.

Mark Tempelmeyer, IBM's manager of multimedia system software, acknowledges the importance of standards in the growth of multimedia and says that the MPM/2 extensions support standards such as the Media Control Interface (MCI) command set and the Resource Interchange File Format (RIFF), which are part of the multimedia extensions to Windows 3.0. IBM belongs to the Interactive Multimedia Association instead of the Multimedia Marketing Council, an organization created by Microsoft, Tandy, and others to promote the Multimedia PC (MPC) standard. Other IMA members include Apple, Sony, and Philips.

By supporting command sets, formats, and functions such as MCI and RIFF, IBM

gives the nod to both organizations' platforms. The MCI command set controls multimedia hardware in an MPC, and the RIFF structure can incorporate other formats developed independently of RIFF, such as a Windows metafile or a Windows device-independent bit-map file.

The IMA's definition of the minimum system necessary to run multimedia applications differs from that of the MPC standard. The MPC standard, while not preclusive of full-motion video, does not specifically address it. The IMA specification addresses NTSC and PAL video.

Tempelmeyer describes the main difference between IBM's and Microsoft's offerings as synchronization. He states that because the IBM multimedia product is built on top of a true multitasking operating system, it provides additional functions that are used to synchronize multiple data streams, such as audio and video. For example, a stereo output device, such as the Sound Blaster Pro, can play two independent data streams, one on each channel, and be assured of keeping them synchronous with each other.

—Matt Trask

## Microsoft Takes Another Step Toward NT

**M**icrosoft's second prerelease version of the Microsoft Windows 32-Bit Development Kit includes code to develop for and run on Mips RISC and Intel systems, marking the first time the company has released tools for a non-Intel-based platform.

A Microsoft spokesperson said that the Development Kit has been released to about 100 select software developers and corporate customers.

The kit includes an integrated LAN Man-

ager client/server and the tools to develop 32-bit applications for Windows. Microsoft's official position on Windows NT is that it will transform Windows into a Microsoft LAN Manager server platform, adding a fourth server platform to the three—OS/2, Unix, and VMS—that LAN Manager currently supports. To develop code for both Mips platforms, you have to develop on a Mips R4000-based machine.

—D. L. Andrews

## NANOBYTES

How will Microsoft's forthcoming Windows NT operating system compare to Unix? According to Microsoft chairman and CEO



Bill Gates, NT pretty much *is* Unix. With its **Posix standard compliance**, Gates claims NT will be as compatible with the leading versions of Unix as they

are with each other. The advantage of NT, Gates says, is that it will sell millions of units, more than any flavor of Unix. He also said that Microsoft may offer a limited voice-recognition capability for Windows this year. □

Starting next month, **Intel** will cut prices of its 386 processors by as much as **35 percent**. It will also increase research and capital spending this year. The company says that the cuts are inspired by competition from AMD and that Intel will concentrate on generating revenue from its 486 chips and 386SL chips for notebooks. In the same month that Intel revealed the looming 386 price cuts, AMD CEO Jerry Sanders said in a teleconference for financial analysts that AMD will ship a 486 product for revenue this year. □

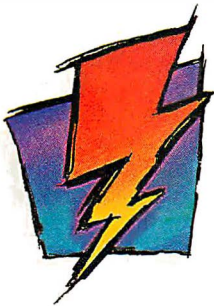
Live from Merrimack, New Hampshire, it's Desktop Direct from DEC. That's right, DEC is in the midst of a "multimillion dollar push" to start selling systems such as the 386SX, 16-MHz-based DECstation 316SX, 486SX-based DECpc 433 Graphics Power Package, and the 486SX-based DECpc 433 Graphic Power Plus Package at prices as low as 50 percent of the list price. Resellers and value-added resellers can take advantage of the offers. For more information, call (800) 722-9332. A DEC representative said that the offers won't apply for SCO Unix systems. "Unix variations are a much more intense technical environment," he said. □

# Unprecedented 32-Bit Programming Power in a Single Package: WATCOM C8.5/386

Limited-time  
Introductory offer  
**\$795**  
Regular price: \$995  
Suggested retail prices.  
Dealers may sell for less.

## WATCOM C8.5/386 Optimizing Compiler and Tools includes:

- ❑ **Royalty-free 32-bit DOS Extender**
- ❑ **True 32-bit Windows GUI Application Kit**
- ❑ **Fast, Tight, Reliable 32-bit Code Optimizer**
- ❑ **Licensed Microsoft Windows SDK Components**
- ❑ **Interactive Source-Level Debugger**
- ❑ **Execution Profiler**



MICROSOFT  
WINDOWS  
Version 3.0 Corporate Product



September 13, 1988  
Watcom C, Version 6.5



WATCOM C7.0  
1989



## Highlights

**100% ANSI and SAA compatible:** C8.5/386 passes all Plum Hall Validation Suite tests.  
**Comprehensive tool set** includes a debugger, linker, profiler and much more. **Microsoft extensions** simplify porting of 16-bit source.  
**DOS extenders** supported include Phar Lap, Rational and Ergo.  
**Extensive third party** support includes products to help with windowing, communications, C++ development and graphics.  
**AutoCAD ADS** development and debugging support.

## DOS Extender Features

C8.5/386 includes **DOS/4GW**, a 32-bit DOS extender developed by Rational Systems and based on the industry-leading technology of DOS/16M. Key features include:

- **Royalty-free runtime license**
- **Virtual memory support up to 32Mb**
- **25K real mode memory footprint**
- **DPMI support** (DOS, Windows DOS Box, etc.)
- **VCPI and XMS** (himem.sys) compatible

## 32-bit Windows Kit

Develop and debug true 32-bit GUI applications and 32-bit DLL's. Using 32-bit addressing, GUI applications can exploit the flat memory model to overcome inherent Windows memory constraints. Straightforward memory allocation makes Windows application development easier. Key components include:

- **Supervisor** for executing 32-bit applications and DLL's under Windows
- **Debugger** for 32-bit applications and DLL's under Windows
- **Licensed Microsoft SDK components**
- **Access to Windows API** from 32-bit code through special libraries
- **387 math co-processor emulation**
- **32-bit C library** for Windows

## WATCOM C8.5/386

• 100% ANSI C Optimizing Compiler  
**Tools set components:**  
• Protected-mode version of Compiler  
• Royalty-free DOS Extender with VMM support  
• Licensed Components of the Microsoft Windows SDK  
• Interactive Source-Level Debugger  
• Linker  
• Protected-mode version of Linker  
• Profiler  
• Object Code Librarian  
• Object Code Disassembler  
• MAKE Facility  
• Patch Facility  
• Object Module Convert Utility  
• Windows Supervisor  
• Bind Facility for Windows Applications  
• 386 Run-time library object code  
• Special 32-bit libraries for Windows API  
• 386 Graphics Library for Extended DOS applications  
• 386 Run-time libraries for Windows

## Also available:

### WATCOM FORTRAN 77/386

Includes 100% ANSI FORTRAN optimizing compiler and all tool set components listed above for C8.5/386.

## Platforms

### Host environments:

DOS, Extended DOS, Windows DOS box, OS/2 1.1 or later

### Target environments:

Extended DOS, Windows, Windows DOS box, AutoCAD ADS, embedded systems

Novell's *Network C for NLM's* includes C8.5/386

Price: \$995

**1-800-265-4555**

# WATCOM

415 Phillip Street, Waterloo, Ontario, Canada  
N2L 3X2 Tel. (519) 886-3700 Fax (519) 747-4971

WATCOM C and Lightning Device are trademarks of WATCOM Systems Inc. DOS/4G and DOS/16M are trademarks of Rational Systems Inc. Other trademarks are the properties of their respective owners. © Copyright 1991 WATCOM Products Inc.

## Vendors Announce Electronic-Imaging Standard

**A** new standard for the graphics and imaging world promises to make it easy to directly import captured images into applications and to simplify developers' support of the many input devices on the market. Many of the companies that are involved in electronic-image processing have jointly defined a standard programming interface, called CLASP (Connecting Link for Applications and Source Peripherals), so that developers won't have to program a set of drivers for each scanner or digital camera on the market.

The computer-imaging world relies on two capabilities: the conversion of images among different file formats and the ability to capture images electronically from an input device (e.g., a scanner). Although a standard doesn't exist for image formats, most applications now support a small range of preferred image formats. Because most graphics-related applications can convert among these formats, the image-format problem is at least manageable.

Unfortunately, except for the forthcoming CLASP standard, the industry hasn't agreed on a way to import images. Thus, every application that wants to bring in an image must provide its own extensive set of drivers to support every possible input device; otherwise, the application has to

rely on using a separate image-capture program to import the image in one of several possible file formats. The latter solution is inelegant for the user, the former is laborious for the programmer, and neither helps if you just want to directly scan an image into the company newsletter.

CLASP is designed to address all these problems. The standard CLASP application programming interface (API) will let applications use one set of device drivers that will support all compliant peripherals. When applications such as PageMaker support CLASP, you will be able to select a menu item to acquire an image, capture the image using your scanner, and paste it directly into a document without leaving your application.

This set of standards is being finalized. The preliminary name of CLASP is likely to change soon to TWAIN, which one observer said means Toolkit Without An Important Name. Whatever the name, the standard has the support of leading hardware and software companies, improving its chances of becoming widely adopted.

CLASP is a multiple-platform and multiple-device API. It is initially targeted for the Mac and Windows environments. OS/2 and the X Window System may follow.

—Owen Linderholm

## Lotus Not Consolidating DOS Spreadsheets... for Now

**S**ources outside of Lotus Development have told BYTE that two factions are at war within Lotus over how to deal with the DOS spreadsheets. Recognizing that the bifurcation causes market confusion, some people argue that Lotus 1-2-3 release 3.1 should be eliminated—especially since its level of functionality is supplied by 1-2-3 for Windows—and 2.3 should be enhanced to better compete with Quattro Pro. Release 2.3 runs on XT-class machines, so if it were eliminated, Lotus would have no low-end offering.

Other people apparently believe that Lotus needs to keep both products, at least until the Windows version gains popularity and more XTs are retired. Rewriting 2.3's assembly language code to provide better memory management and allow multiple-page spreadsheets is said to be an enormous task, so keeping 3.1 alive for 386-class users may make more sense in the short term.

The release 3.0 architecture, which is the

basis for all of Lotus's non-DOS implementations of 1-2-3, has proven very successful and portable. But the old 2.x architecture keeps hanging around—and it apparently makes up 55 percent to 60 percent of new DOS spreadsheet sales—so this is a problem Lotus will have for a long time.

Lotus asserts that it is not combining its two DOS-based spreadsheets into a single product—or at least not now. A Lotus spokesperson said, "Both products play a significant role. We're not combining these products."

According to Lotus, 1-2-3 release 3.1 now accounts for 40 percent to 45 percent of the company's worldwide sales in the DOS spreadsheet market. Lotus is now working on new versions of both products, a spokesperson said, and although the company had considered consolidating the products in the past, a consolidation is "not in the cards in the near future."

—Andy Reinhardt

## NANOBYTES

A manufacturer active in the Mac II market is now shipping a touch-screen for the Mac. **Edmark** (Redmond, WA) has redesigned its \$335 TouchWindow to work with Mac monitors via the Mac's Apple Desktop Bus port. You can use the Mac's mouse concurrently with the TouchWindow.

The TouchWindow works with any Mac application and lets you use your finger to access pull-down menus, make selections, move objects, and draw. The screen is attached to a Mac monitor with adhesive strips. You can remove the screen from the monitor and use it as a stand-alone graphics tablet. Edmark recently began shipping a version for PC compatibles. An Amiga version is due this summer. □

Rear Admiral Grace Murray Hopper, 85, a pioneer in the development of computers, coinventor of the COBOL programming language, and the Navy's oldest serving officer, died in January at her home in Arlington, Virginia, of a heart attack.

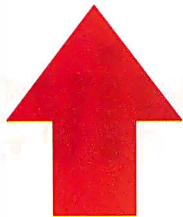
Hopper, a graduate of Vassar with a master's degree and doctorate in mathematics from Yale, joined the Navy in 1943. She was the first programmer on the world's first large-scale digital computer, the Navy's Mark I. She continued as a programmer on subsequent wartime Navy computers.

Following World War II, Hopper transferred to the Naval Reserve but continued her work in computers. She was recalled to active duty in the Navy following her retirement from the reserves and was kept on active duty for the next 20 years through a series of congressional and presidential orders.

In 1991, Hopper was awarded the National Medal of Technology by President Bush. She was known for her contrary lifestyle. Her office at the Navy Data Automation Command featured a clock that ran backward. Until her death, Hopper was a senior consultant for DEC. She was also a contributor to BYTE. She will be missed. □

**NEC introduces  
a 486 series  
that has  
a built-in survival  
instinct.**





*Next time you need a mission-critical PC or network server, here's something you might want to think about: NEC is one of a handful of companies that have received the Deming Award, the highest honor bestowed in the quality assurance field, on five separate occasions.*

## **NEC's new PowerMate Express Series. A lesson in survival and security.**

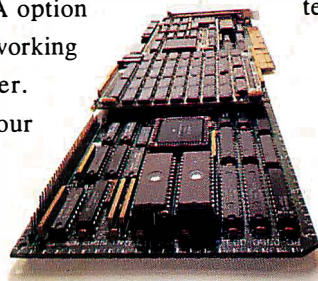
Imagine a line of affordable 486 PCs and towers that is completely modular and upgradable.

Now imagine how secure you'd feel in your decision to purchase such a system. A system that would not only meet your needs today, but also adapt to changing technologies.

### **We adapt to your environment.**

With NEC's new PowerMate® Express™ Series, you get total subsystem modularity and scalability, including CPU, memory, video, disk subsystems, and EISA option slots at no extra cost. All working in balance with each other. And flexible enough for your particular needs.

An easy-open chassis design, featuring thumb screws and snap-in device rails, gives you convenient access to all internal subsystems. Standard SIMM sockets—16 of



them—provide for easy, inexpensive memory expansion.

You can add an MIS-preferred EISA SCSI host adaptor. And choose from three video options—Base VGA, 1024 VGA, even BITBLT EVGA for graphics-intensive applications.

In short, you can configure your system exactly the way you want it.

### **128-bit memory path gives us quicker reflexes.**

Instead of the traditional 32-bit memory path, our PCs have one that's four times as wide, guaranteeing you 0-wait state performance even at faster processor speeds. Giving you the ability to handle data-intensive applications or networking demands with ease.

### **Our best feature hasn't been invented yet.**

Perhaps the best feature of the PowerMate Express Series is its ability to reduce the possibility of your system becoming obsolete soon after you buy it.







Our CPU scalability starts at 486SX/20 for only \$2,999\* and goes up through 486SX/25, 486/33, and beyond.

All at affordable prices.

What's more, our modular systems are ready for the next generation of Intel® microprocessors, and adaptable to new developments in video and memory technologies.

### We can take the heat.

We've given each of our PCs generous power supplies to handle even the most power-hungry components. As well as a three- or four-fan array, to enable your system to keep cool—and keep working—under any amount of pressure.

### Proof that a well-balanced system is a weapon.

Scalability. And balance. In the end, that's what distinguishes our

486 computers from others in their class.

Just look at a side-by-side comparison of our features versus COMPAQ's and AST's.


We think it's further proof that investing in a PowerMate Express Series PC or tower could very well be one of the best decisions you'll ever make.

A decision that will help you survive in today's business environment. And tomorrow's.

Desktops:	NEC PowerMate Express Desktops	COMPAQ Deskpro™ Series	AST Premium II Series	Advantage
Towers:	PowerMate Express Towers	Systempro™/LI Series	Premium SE 433 Series	Advantage
1. # SIMM sockets standard	16	4	4	NEC
	16	4	4	NEC
2. Maximum RAM capacity	64	64	80	AST
	112	64	80	NEC
3. Internal hard-drive storage capacity	2.7GB	1GB	420MB	NEC
	4GB	4GB	2.9GB	Tie
4. Power supply	285W	240W	167W	NEC
	388W	355W	300W	NEC
5. Internal fans	3	1	1	NEC
	4	2	2	NEC
6. Snap-in devices slots	Yes	No	No	NEC
	Yes	No	No	NEC

Data based on manufacturer-supplied specifications.

For more information, call 1-800-NEC-INFO (in Canada, 1-800-343-4418), or NEC FastFacts at 1-800-366-0476, #XPRESS (977377), for immediate literature.

Because  is the way you want to go.

# NEC

## Poqet Computer Licenses Nestor Handwriting-Recognition Software

**P**oqet Computer has licensed the NestorWriter handwriting-recognition software from Nestor (Providence, RI) for use in pen-based products now under development by Poqet. NestorWriter software operates with DOS 3.3 or higher, which allows integration of current DOS-based applications and offers a stable platform for new applications development.

In addition to a user interface and handwriting recognition, Nestor and Poqet are developing a complete application programming interface (API) toolkit that third-party developers can use to create pen-centric DOS applications. The software will include mouse emulation and electronic ink for signature capture and for the creation of bit-mapped images. A Nestor representative said that with the toolkit, developers will add pen-recognition capabilities to their DOS applications through pop-up, pen-input windows.

The licensing of NestorWriter is part of Poqet's strategy to provide a portable platform to users while offering flexibility to

programmers so that they can develop DOS-based, vertical applications, as opposed to developing for data-collection devices that are based on proprietary operating systems. NestorWriter and the Nestor pen user interface are designed to provide robust pen-computing functionality in all classes of pen-based computers, including 16-bit (using 8088/286 architecture) and 32-bit computers.

Nestor says you can use its handwriting-recognition engine in applications developed for situations where careful handprinting of characters is not practical. NestorWriter combines handwriting-recognition accuracy for first-time users with on-the-fly learning capabilities that adapt to a user's handwriting style, Nestor says.

The Nestor/Poqet API toolkit is available to developers direct from Poqet. The Poqet deal is nonexclusive, and Nestor is discussing similar agreements with other hardware manufacturers, according to a Nestor spokesperson.

—D. L. Andrews

## IBM's Kuehler Promotes Partnering Efforts

**I**n a meeting with securities analysts to explain IBM's recently announced restructuring plan, president Jack Kuehler promoted the company's growing effort to form alliances with leading partners, saying the business model IBM used in the 1960s and 1970s is now "a strategy for extinction."

Kuehler explained why IBM has sought to work with companies such as Apple, Motorola, Intel, and Siemens-Nixdorf. "We can leverage each other's core competencies," he said. "We can share the expense and risk of these steep investments."

Despite IBM's huge size, he noted, its 50,000 worldwide competitors "collectively have far more money, capital, and talent than we could ever muster."

Through its joint venture with Siemens, IBM is sharing 16-Mb memory-chip production and 64-Mb chip development. Kuehler also said that IBM is working on a 256-Mb chip. The partnership between Display Technologies and Toshiba will produce active-matrix color displays. The Motorola and Intel partnerships will produce new IBM RISC and 80x86 CPUs.

—Andy Reinhardt

## SAS Institute Favors Windows over DOS

**S**AS Institute, maker of the widely used statistics package, is contemplating abandoning further enhancements of its DOS product. According to spokeswoman Hilary Yeo, the company will release a Windows 3.0 version of its software in June and will then encourage PC users to move to the Windows- and OS/2-based versions of the package. SAS will continue to license and support the DOS versions, but the company is not likely to continue enhancing them.

SAS says that it's moving to Windows in response to customer demand. However, many statistics-software users are in academic settings, where money for hardware is scarce.

Graduate students and instructors won't relish having to buy a 386 to get a new version of SAS, but vendors can't be expected to carry DOS forever. Benign neglect of the DOS platform is probably inevitable over time. ■

—Ellen Ullman

## NANOBYTES

IBM plans to introduce new notebooks, laptops, and high-end servers early in the year, company

president Jack Kuehler said.

"In software, we have clearly put our reputation on the line," he said, referring to OS/2 2.0. The operating system was delivered in late December



"to customers who want to roll out code early," and it will ship commercially in March, as previously stated. IBM will "build volumes as aggressively as possible," he said. Kuehler also said that the object-oriented Taligent operating system IBM is codeveloping with Apple is slated to ship in 1994. Previously, estimates had ranged as late as 1995. He also said that IBM does not see uses of RISC CPUs confined to the computer industry. "Consumer electronics, for example, is not out of the question." □

Not long after Kuehler made those comments, Apple chairman and CEO John Sculley said that Apple will introduce **consumer-specific versions of its low-end Mac products** in the U.S. during the second half of 1992. The company also plans to introduce two lines of CD-ROM-based desktop multimedia Macs: one for the consumer channel and the other for the company's traditional PC channel, Sculley said. These CD-ROM systems will be based on System 7.0 and QuickTime multimedia technology. They should ship in time for the 1992 Christmas season. □

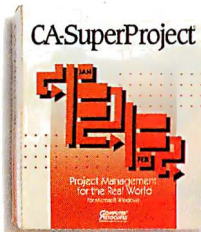
IBM is internally showing **Mac applications running under OS/2**. The technology to implement this latest feature is coming out of the Taligent group, a source said. IBM could neither confirm nor deny the existence of such technology, and the source said it wasn't clear how it was being accomplished. ■

# Introducing Power Windows For Project Managers.

*The #1 Rated Project Manager Now Comes With Windows.*

Power changes people.

Especially project managers.

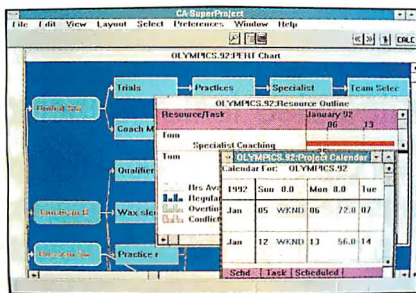


They're working smarter and faster with new CA-SuperProject® For Windows. It's the world's most advanced, efficient and reliable project management software—and now it's

incredibly easy to use.

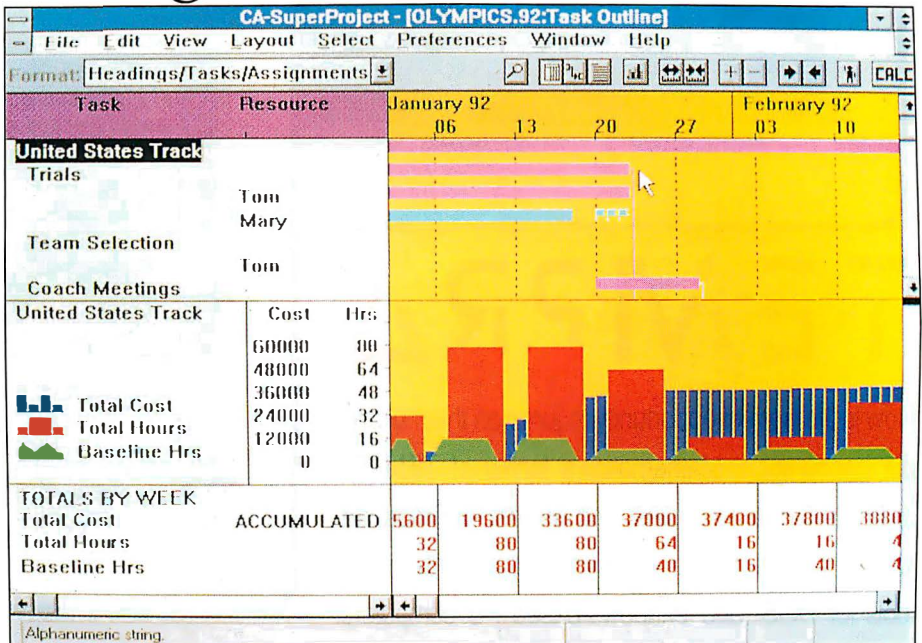
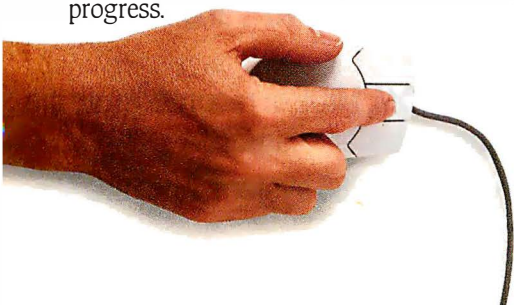
Total power is yours with just a few mouse clicks. Create and edit projects. Specify resources, task types and durations.

Define integrated sub-projects. Build top-down hierarchies and task-



Report the status of your project with detailed Gantt, PERT, WBS and Cost/Resource charts.

dependency relations. Link multiple projects together for cross-project leveling. Perform extensive "what-if" analysis, revising schedules as projects progress.



*Manage with power, using tools for sophisticated planning, comprehensive resource management, tracking and controlling.*

You can bet your career on its advanced and efficient scheduling algorithms.

A recent study of the five leading project managers proved it. Each was

first in 214 working days—leaving Microsoft Project, Timeline 4.0, Project Workbench and Project Scheduler in the dust.

There's also a wide array of state-of-the-art graphics and detailed reporting tools to help bring your projects to life.

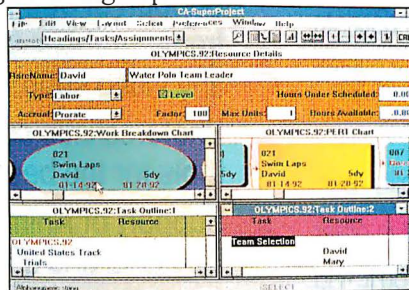
For your free Demo Disk, call 1-800-CALL-CAI. Call today.

And find out what our power windows can do for you.



## CA-SuperProject® For Windows

© Computer Associates International, Inc., 1 Computer Associates Plaza, Islandia, NY 11788-7000. All product names referenced herein are trademarks of their respective companies.



*Show multiple views of the same project or different projects simultaneously.*

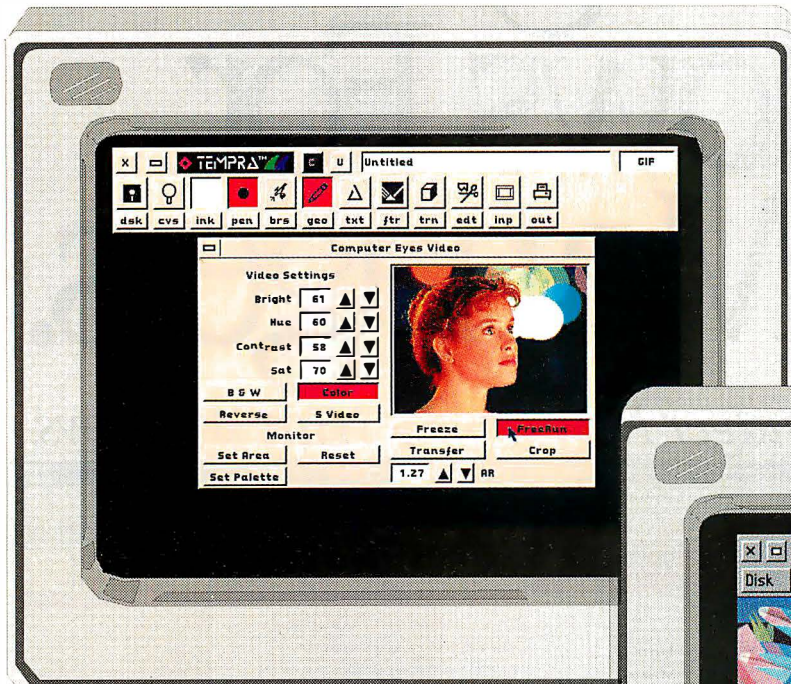
assigned the same project, but the finish dates varied by as much as five months. CA-SuperProject For Windows finished

Circle 40 on Inquiry Card.

CAPTURE ♦ PAINT ♦ EDIT ♦ SCAN ♦ PRINT ♦ PRESENT

*What is Tempra?*

# The Only Complete, Affordable Multimedia Solution!



## TEMPRA™

Now is the perfect opportunity to jump on the multimedia bandwagon. Mathematica's family of TEMPRA products forms the fastest and easiest, yet most advanced and affordable, color imaging and multimedia tools for DOS- and Windows-based PC computers. TEMPRA's revolutionary graphic user interface makes the products incredibly easy to learn and use.

Scan, edit, create, capture, paint and print images in **TEMPRA PRO** and **TEMPRA GIF** — up to 16.7 million vibrant colors! Then import your images and video into **TEMPRA SHOW** to produce dynamic presentations with audio, animation, and sophisticated wipes.

Our TEMPRA products provide the functionality, performance, and sophisticated paint tools found in other products costing more than \$2000. Plus, you'll find unparalleled speed with our **TEMPRA turbo charger** add-on feature, which brings 32-bit power to graphics and imaging — use your 386/486 to the fullest now!

### TEMPRA's powerful integrated features include:

- ♦ Intuitive GUI with a variety of adjustable paint tools, including airbrush, pens, geometry shapes, text, mask, tranformation, filters, color swap, and color protection.
- ♦ Support of ComputerEyes/RT™ — real-time, 24-bit video frame grabber for capturing high-quality images from any video source in 1/30th of a second.
- ♦ Photorealistic scanning and printing, including special tools for the best quality image.
- ♦ Support of Animator™, Animator Pro™, and 3D Studio™ flick (.FLI and .FLC) files.
- ♦ Audio support from CD-ROM, MIDI, or recorded onto the hard drive with a Sound Blaster™ card.
- ♦ Fast enough to run on even a 286 system. And on a 486, fasten your seat belts!

# The *Complete* Solution

"Go Tempra"  
on CompuServe

	The Solution	Draw Programs		Image Programs		Paint Programs	
	Mathematica, Inc. TEMPRA	Corel CorelDRAW	Micrografx Designer	Micrografx Picture Publisher	Aldus PhotoStyler	RIX WinRIX	ZSoft Paintbrush
Drawing Effects	72	13	8	64	10	64	8
Drawing Styles							
Arc	16	N/A	4	N/A	N/A	N/A	N/A
Circle	12	4	8	3	N/A	N/A	4
Curve (Parabola)	8	N/A	1	N/A	N/A	N/A	N/A
Ellipse	8	4	8	3	N/A	8	4
Freehand	3	3	4	2	2	4	3
Irregular Polygon	2	N/A	2	3	N/A	N/A	8
Line	7	7	6	2	4	8	6
Parallelogram	4	N/A	N/A	N/A	N/A	N/A	N/A
Rectangle	12	4	8	3	N/A	8	4
Regular Polygon	24	N/A	N/A	N/A	N/A	N/A	N/A
Spline (Bezier)	2	3	3	N/A	N/A	N/A	3
Square	12	4	8	3	N/A	N/A	4
Load/Display Times							
42K PCX	:03	:39	:11	:36	:05	:13	:05
330K TIFF	:04	:18	:14	:47	:05	:17	:06
289K Uncomp. TGA	:03	N/A	N/A	:45	:05	:16	:07
708K Comp. TGA	:06	N/A	N/A	N/A	N/A	N/A	:17
Image Formats							
!IM	✓	N/A	N/A	N/A	N/A	N/A	N/A
GIF	✓	N/A	N/A	✓	✓	✓	✓
PCX	✓	✓	✓	✓	✓	✓	✓
PTN	✓	N/A	N/A	N/A	N/A	N/A	N/A
TGA	✓	N/A	N/A	uncompressed	uncompressed	✓	✓
TIF	✓	✓	✓	✓	✓	✓	✓
WIN	✓	N/A	N/A	N/A	N/A	N/A	N/A
Hardware							
Batch Printing	✓	✓	✓	N/A	N/A	N/A	N/A
Scanners	✓	N/A	N/A	✓	✓	✓	✓
Video Capture	✓	N/A	N/A	N/A	N/A	N/A	N/A
B/W Printing	✓	✓	✓	✓	✓	✓	✓
Sierra HiColor VGA	✓	✓	✓	✓	✓	✓	✓
Color Models							
CMYK	✓	✓	✓	✓	✓	✓	N/A
RGB	✓	✓	✓	✓	✓	✓	✓
HLS	✓	N/A	✓	✓	✓	N/A	✓
HSV	✓	✓	N/A	✓	✓	✓	N/A
Environments							
DOS	✓	N/A	N/A	N/A	N/A	N/A	N/A
Windows 3.0	✓	✓	✓	✓	✓	✓	✓
Multimedia/Authoring	✓	N/A	N/A	N/A	N/A	N/A	N/A
Audio Support	✓	N/A	N/A	N/A	N/A	N/A	N/A
Suggested List Price	\$149 — \$495	\$695	\$695	\$695	\$795	\$495	\$495

All tests were performed on an Orchid Technology Privilege 386-33 with 8MB RAM and a Conner 200MB HDD. Windows applications were tested in 386 enhanced mode with no other tasks running. TEMPRA is a trademark of Mathematica, Inc. All other products are trademarks of their respective owners. TEMPRA speeds clocked before turbo charger feature. Copyright 1991 by Gary A. Klein. All Rights Reserved.

"Mathematica's Tempra 24-bit paint program was another winner, providing unparalleled editing speed."  
*Adam Osborn*  
*NewMedia*,  
*November/December 1991*

"A top-flight painting/photo retouching program with amazing capabilities. Video speed, even for 24-bit color files, is remarkable. Highly recommended."  
*Susan Glinert-Stevens*  
*PC Sources*, *November 1991*

"Tempra Pro has some very powerful features. The package's color manipulation and control are hard to beat. Overall, Tempra Pro is an excellent graphics editor that's very easy to use and quite powerful. You will find it possible to create and edit images whether you are a beginner or a professional."  
*Marc Greenfield*  
*Computer Buying World*,  
*November 1991*

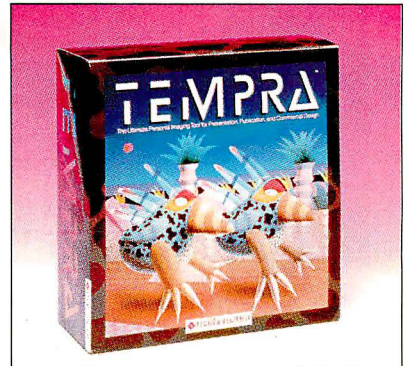
"Tempra really stands out when working with true-color images. The output from Tempra is excellent. Overall Tempra is a good program. Those who work with full-color images — and any of the supported color scanners — may find it a valuable tool. And the ability to work with video input offers interesting possibilities."  
*Leonard Hyre*  
*PCM*, *November 1991*

"Tempra gets our nod for PC-based programs. It's the least expensive of the lot and handles a variety of image formats."  
*Tom Thompson*  
*BYTE Magazine*, *June 1991*



**mathematica**  
INCORPORATED

402 S. Kentucky Ave., Lakeland, FL 33801  
813-682-1128 • Fax 813-686-5969  
**1-800-852-MATH**



Circle 262 on Inquiry Card (RESELLERS: 263).

# A New Unix Standard

BEN SMITH

## The HP/Apollo 710 and 705 are small, elegant, inexpensive, and fast systems

Hewlett-Packard/Apollo has introduced two new members to its 9000 Series 700: 710 and 705. These low-priced personal workstations use the PA-RISC processor, the fastest RISC processor being shipped for the workstation market. Although they have a low price, these are not low-end machines: The 710 lists for \$9490, but it runs at 50 MHz and yields a BYTE Unix index of 4.6 (see the table), which means that it is more than four times as fast as a comparable Sun Microsystems Sparcstation IPC.

Hewlett-Packard/Apollo has introduced two new members to its 9000 Series 700: 710 and 705. These low-priced personal workstations use the PA-RISC processor, the fastest RISC processor being shipped for the workstation market. Although they have a low price, these are not low-end machines: The 710 lists for



The new HP/Apollo workstations are enclosed in a small, trim case. The CPU can stand on edge (as shown) or sit flat on your desk.

The BYTE Unix index is a suite of tests that evaluate Unix workstation performance on integers, floating-point math, operating system, disk access, and system loading. We have not yet tested the low-end HP/Apollo 705, but we estimate that its index would be approximately 3.5. The 705 runs at 35 MHz and lists for \$4990.

### Keeping the Packaging Lean

These machines are enclosed in a simple 16 $\frac{1}{4}$ - by 14 $\frac{1}{4}$ - by 3-inch case. They include both thick- and thin-wire Ethernet connections, a parallel port, two serial ports, and a SCSI-2 connector. You can save yourself some desk space by setting the CPU case on edge by attaching the feet that are provided. The 710 has an 8-bit frame buffer that provides 256 simultaneous colors to either a 19-inch (1280- by 1024-pixel, 72-Hz) display or a 16-inch (1024- by 768-pixel, 75-Hz) display. A 19-inch gray-scale monitor is also available.

The minimum systems are diskless and come with 16 MB of 80-nanosecond RAM, 32 KB of instruction cache memory, and 64 KB of data cache memory. The RAM can be built up to 64 MB. The maximum internal hard drive storage is 840 MB. The maximum external hard drive is 9.45 gigabytes.

### The RISCs of Battle

The high performance of the 9000 Series 700 machines is primarily due to the PA-RISC central processor. The Unix workstation market has turned into a battleground for competing designs. Sun's SPARC design has dominated the workstation market for years, and it will probably continue to do so for many more years because Sun licenses the SPARC design for only a token sum.

IBM's RISC System/6000 brought it from being the most laughable RISC manufacturer (the IBM RT) to one of the most feared (see "Sizzling RISC Systems from IBM," April 1990 BYTE). For at least a year, the RISC System/6000 was the performance leader among workstations. But, despite tens of millions of dollars invested in setting up its marketing and distribution, it still does not dominate the market. With HP/Apollo's introduction of the 720 last year, IBM lost the performance lead as well.

Other notable RISC designs are the Motorola 88000, which doesn't look like it will ever be popular for workstations, and

the Mips processors, which are used in its own machines as well as DEC's RISC workstations and the most recent designs from Sony. The newest Mips processor, the R4000, is a full 64-bit processor and is integral to the Unix plans of the Advanced Computing Environment consortium.

Targeted markets for the 710 and 705 workstations include both the technical and commercial worlds. HP/Apollo has established itself as a valuable source for computer-aided drafting and design workstations. The introduction of the 710 and 705 may well attract members of the commercial world, who need the high resolution and performance for electronic publishing, information management, and group/project-oriented networking.

Already, Lotus 1-2-3, WordPerfect, Wingz, Oracle, Informix, Ingres, Sybase, and the most popular electronic publishing and multimedia packages run on these new machines. When HP/Apollo introduced the 720, there was already a huge repository of software that runs on the PA-RISC minicomputers and the HP-UX operating system. The number and kinds of applications that run on the workstation's design and flavor of Unix are important considerations in evaluating RISC workstations.

### Power Shift

HP/Apollo's marketing phrase, "Power Shift," is fitting. With the kind of performance that the 710 offers at the price that it does, the competition is finding itself in a frightening race for the affections of the budget-conscious workstation buyer.

For all but intensive graphics applications, the 710 is more power than a single user needs. It is perfectly feasible and very practical to add an X-terminal to the configuration.

HP/Apollo claims that the 710 can generate 950,000 three-dimensional vectors per second. This is nearly twice the performance of any comparably priced competitor's workstation. Even with 3-D surface rendering, this workstation is no slouch. As with the Iris Indigo, 3-D graphics operations are done without a graphics pipeline coprocessor.

The HP/Apollo 700 line has leapt forward with the software that makes 3-D surface rendering practical on the low-end graphics workstations: the PowerShade libraries and software, which includes Wavefront Technologies' Personal Visualizer. The libraries include operations for all the basic 3-D rendering problems as

BYTE LAB BENCHMARKS			
<i>The 710's average score of 4.6 makes it more than four times as fast as a Sun Sparcstation IPC.</i>			
Test	Baseline	Result	Index
Arithmetic (type = double)	2541.7	21,255.5	8.4
Dhrystone 2 without register variables	22,366.3	84,850.8	3.8
Excel throughput	16.5	74.2	4.5
File copy (30 seconds)	179.0	1237.0	6.9
Pipe-based context switching	1318.5	1500.4	1.1
Shell scripts (eight concurrent)	4.0	11.0	2.8
Sum of six items			27.5
Average			4.6

well as adding haze- and ray-tracing.

If the low end of the 9000 Series 700 doesn't have enough power for your hefty graphics applications, you might consider the 750. It has larger caches and can be expanded to 384 MB of RAM and 2.6 gigabytes of internal hard drive storage. But if all you want is more disk space and another PA-RISC processor, you may need only one of the new low-cost 9000 Series 700 servers.

### Choice Computing

I used the 710 as my personal workstation for a month. I did this to become familiar with the machine and also because it gave me the nicest working environment with which to connect to the BYTE network. Yes, the X Window System applications are snappy, but with HP's Vue application and window manager (built on OSF/Motif), my screen's multiwindowed world is also elegant.

Computing is no longer in the Stone Age, and there is no reason why we should be so Spartan as to remain with ugly and difficult computing environments. Add HP's quality and design to the power of Unix computing and its network, and you have a comfortable and productive world in which to work. If you're in the market for a desktop workstation for general use, the 710 and 705 have the best price and performance, without sacrificing quality and good looks. ■

*Ben Smith is a BYTE technical editor, a former database consultant, and the author of UNIX Step by Step (Howard W. Sams, 1990). You can reach him on BIX as "bensmith."*

## THE FACTS

### HP/Apollo 705 and 710

705 (35 MHz)

19-inch 8-bit gray scale, diskless, \$4990

710 (50 MHz)

19-inch 8-bit gray scale, diskless, \$9490

16-inch 8-bit color, diskless, \$11,490

19-inch 8-bit color, diskless, \$13,990

Optional:

210-MB internal hard drive, \$2000

420-MB internal hard drive, \$2500

Series 700 servers:

720 with 32 MB of RAM, 840-MB hard drive, \$23,440

750 with 64 MB of RAM, 1.3-gigabyte hard drive, CD-ROM, 4-mm DAT backup, \$57,190

750 CRX-24Z

19-inch 24-bit color, 32 MB of RAM, 1.3-gigabyte internal hard drive, graphics coprocessor, and PowerShade, \$63,190

Hewlett-Packard/Apollo  
270 Billerica Rd.

Chelmsford, MA 01824

(508) 256-6600

fax: (508) 256-4862

**Circle 1219 on Inquiry Card.**

# WARNING! FAST WINDOWS AHEAD

Fasten your  
seat belt and  
snap in the new  
**Hercules Graphics  
Station GOLD!**

Windows *acceleration* plus:

- 32,768 colors
- Graphics processor
- High resolution
- High refresh rates
- VRAM
- DRAM (optional)

**\$495**



## Hercules Graphics Station GOLD

High-speed, true color Windows . . .  
and much more!

**Call 1-800-532-0600 for details.**

© Copyright 1991 Hercules Computer Technology, Inc., 921 Parker Street, Berkeley, CA 94710. 510-540-8000. Hercules is a registered trademark and Hercules Graphics Station GOLD is a trademark of Hercules Computer Technology, Inc. All other product names are trademarks of their respective owners, who are not associated with Hercules.

Circle 62 on Inquiry Card.

World Class  
Windows  
Performance.

**Hercules**



# Battle of the Heavyweights

MARTIN HELLER

## The release of Microsoft C/C++ 7.0 sets up a challenge with Borland C++ 3.0 for the hearts and minds of serious developers

environments that work well in a DOS box under enhanced-mode Windows. They each have command-line compilers, linkers, make utilities, debuggers and profilers for DOS and Windows programs, and Windows resource editors. Both have class libraries for building Windows applications, and both have container classes for DOS.

Yet these are different products. Borland includes a Windows integrated environment, a class library for building DOS applications, custom controls for Windows, and an assembler—for \$749. Microsoft includes extra compiler and linker options: automatic function in-lining, function packaging, and p-code generation—for \$495. (Microsoft sells separately a Windows integrated environment, QuickC for Windows, and Microsoft Macro Assembler.)

On my left, weighing in at 28 MB on disk and 3200 pages of documentation: Borland C++ 3.0 with Application Frameworks. (Crowd cheers.) On my right, weighing in at 20 MB on disk and 5800 pages of documentation (with a 500-page index): Microsoft C/C++ 7.0. (Crowd cheers again.)

These two contenders come to you compiling C and C++ code. Both target DOS and Windows applications. They each use a DOS Protected Mode Interface server to work in protected mode. Both have DOS integrated

Borland C++ 3.0 (BCC) requires 2.5 MB of RAM and a 286 processor to produce Windows applications. Microsoft C/C++ 7.0 (MSC) requires 4 MB of RAM and a 386 processor. The standard developer's machine is probably a 33-MHz 486 with 8 MB of RAM, so Microsoft isn't excluding too much of its real market. If you're still developing with an old AT, you now have an excuse to get a real computer.

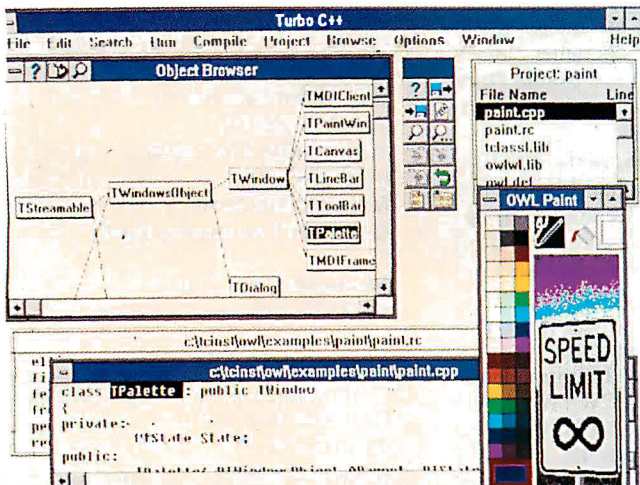
## Compiler Performance

For years, BCC had the reputation of compiling quickly to get poorly optimized code; MSC had the reputation of compiling slowly to get well-optimized code. Neither stereotype holds any longer. Both products now compile quickly and produce optimized code. In both cases, you can trade compilation time for generated code quality.

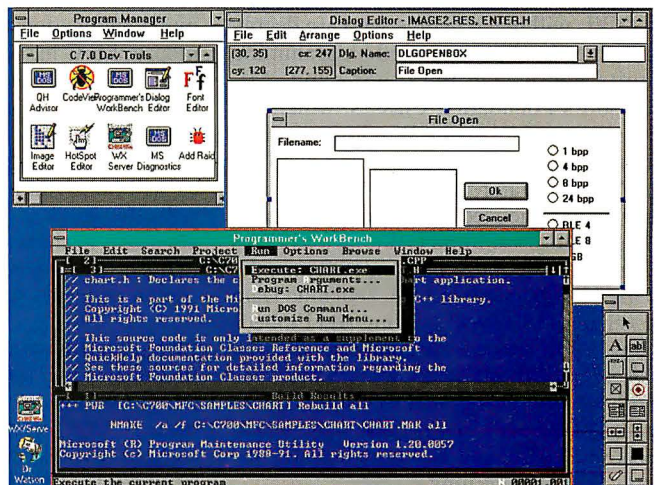
The table shows the preliminary Dhrystone benchmark results. I used a 25-MHz computer with memory and disk caching. Microsoft's new maximum in-lining coupled with global optimization worked magic on the Dhrystone benchmark—a major plus for Microsoft.

The Sieve of Eratosthenes benchmark results I obtained show Borland slightly ahead. There isn't much that can be optimized in the Sieve code. The results in the large model were similar, but not identical, to the results in the small model.

I also timed a complete reconstruction of Image2, a moderate-size Windows application. Clearly, MSC has closed the C compilation speed gap, even when I let



Borland C++ 3.0 with Application Frameworks is fine-tuned for developing Windows applications.



With the release of Microsoft C/C++ 7.0, Microsoft has finally entered the C++ fray.

### PRELIMINARY DHRYSTONE RESULTS

The results indicate a major plus for Microsoft.

Compiler	Switches	Run time (seconds)	.EXE size (bytes)	Text size (bytes)
MSC C/C++ 7.0 Large model	/Oxaz /Ob2/Gs	3.6	8305	1516
	/Oxaz /Ob2	5.1	14,895	2018
	/Gs /AL/Osae /Gs	7.1	7729	898
Borland C++ 3.0 Large model	-O2 -Z -A - ms	6.9	7624	1089
	-O2 -Z -A - ml	8.8	9298	1229
	-O1 -Z -A - ms	8.6	7640	1001

BCC use precompiled headers. When optimizing, the two compilers take the same amount of time and produce code of similar speed, but the MSC executable file is smaller. When quick-compiling, MSC now works faster than BCC. MSC's p-code option produces smaller code than any other option, but it is also much slower code than any other option.

#### C++ and Class Libraries

MSC has an implementation of C++ 2.1 as described in the *Annotated Reference Manual*, plus experimental exception-handling extensions. BCC has a C++ implementation that mirrors CFRONT 3.0, including template extensions. BCC has additional extensions known as dynamic dispatch virtual tables to support message-response functions in the ObjectWindows Library, Borland's application framework for Windows. Because of these extensions, you can't use OWL with any C++ compiler other than BCC.

OWL will make people who are deeply involved in object-oriented programming quite happy. On the other hand, Microsoft's Foundation Classes, which basically encapsulate the Windows application programming interface and keep the API nomenclature, make it relatively easy for an experienced Windows program to migrate to C++. I find OWL nice as far as it goes, but it doesn't cover, for example, Graphics Device Interface, Dynamic Data Exchange, or Object Linking and Embedding. MFC, while it constitutes a very thin layer on top of the Windows API that does little abstraction in and of itself, covers most of the API in a regular way, and it lets you easily add functionality and abstraction by inheriting classes.

MFC seems to have less overhead than OWL. Consider the size of a "Hello, World" application. HELLOAPP.EXE

built with MFC is 14,901 bytes long; HELLOAPP.EXE built with OWL is 114,693 bytes long. No, I didn't make a mistake: A minimum OWL application is over 100 KB on disk, because pretty much the whole library links in. Microsoft, on the other hand, was able to make its MFC classes more granular and to let its linker exclude unreferenced packaged functions. Packaged functions include, by default, all C++ member functions. The big gain here is excluding unnecessary member functions from the executable image.

This isn't as bad as it seems, because not all that baggage gets into memory. The RAM footprint of the MFC HELLOAPP is 18 KB; the RAM footprint of the OWL HELLOAPP is 28 KB. I'd like to see Borland enhance its compiler and linker to reduce the .EXE file size.

Microsoft has no equivalent to Borland's Turbo Vision application framework for DOS, which offers a lot of capability and makes it easy to build DOS character-mode applications that use menus and a mouse. MFC has some container classes and utility classes that are usable from DOS, but the major thrust of MFC is to aid Windows developers.

If you're targeting DOS, Borland's classes will help you more than Microsoft's will. But don't expect TV and OWL applications to share source code: While the two Borland application frameworks use similar concepts, they're incompatible.

#### Integrated Environments

BCC offers two integrated environments: BC (DOS-hosted) and TCW (Windows-hosted). MSC offers one DOS-hosted integrated environment, PWB. BC and PWB let you get at the full functionality of their compilers; TCW doesn't. TCW and PWB have browsers; BC doesn't. I like working completely within Windows, which

leads me to favor TCW. But it's frustrating that I can't do maximum optimization from TCW. PWB (which is much improved from previous incarnations) at least lets me do everything from one place—including launching Windows applications from a DOS box, thanks to some new technology—but I wish Microsoft had done a real Windows-hosted environment.

Borland's Resource Workshop is a fine tool for Windows developers that is similar to Mac ResEdit. MSC now comes with the basic set of resource-editing tools from the Windows Software Development Kit. Borland's TDW debugger now supports hardware breakpoints; Microsoft's CVW has speed and size improvements, and it fully supports C++ and p-code. Borland's WinSight is a neat message-monitoring utility. Microsoft Link can now build huge overlaid DOS programs.

I could go on at length discussing other new features; both packages have many. The bottom line is that both MSC 7.0 and BCC 3.0 will serve the needs of professional Windows and DOS applications developers who work in C or C++. There was no knockout; the fight has to be scored on points, and you're the judge. ■

*Martin Heller develops software and writes about computers. He can be reached on BIX as "mheller."*

### THE FACTS

**Borland C++ 3.0 with Application Frameworks**  
\$749

**Borland International, Inc.**  
1800 Green Hills Rd.  
P.O. Box 660001  
Scotts Valley, CA 95066  
(408) 438-8400  
fax: (408) 438-8696  
**Circle 1211 on Inquiry Card.**

**Microsoft C/C++ 7.0**  
\$495

**Microsoft Corp.**  
1 Microsoft Way  
Redmond, WA 98052  
(800) 426-9400  
(206) 882-8080  
fax: (206) 883-8101  
**Circle 1212 on Inquiry Card.**

Acer believes there is room for a different kind of computer company. One that not only offers everything from entry level PCs to 200 person UNIX™ networks, but designs them to grow when you do. Advance when technology does. And work as hard for your money as you do.

For example, Acer invented ChipUp.™ A breakthrough technology that allows you to upgrade a

Today, just about *everyone* can use a computer. That's why we make a *computer* for just about *everyone*.

386SX system to a 486 simply by adding a new chip. It's like buying a new

computer for the price of a single chip.

For people on the go, the Acer AnyWare™ notebook computers pack the power and features of machines



5 times their size—for prices that are less than most other notebooks. There's a full range of high-performance, low-cost models to choose from.

We can also make a lot of people happy all at once. Our 64-bit bus, multiprocessor AcerFrame™ file servers bring minicomputer performance to your desktop. And they're backed by our 10 years of experience in UNIX systems.

We invite you to see the complete range of Acer computers, including our affordable AcerMate™ line. And ask about our wide selection of AcerView™ monitors, laser printers, keyboards and other peripherals.

Call 1-800-SEE-ACER and tell us exactly what

you need. And then we'll give you exactly what you want.



Acer, the Acer logo, ChipUp, AcerAnyWare, AcerFrame, AcerMate and AcerView are registered trademarks of Acer Inc. and Acer America Corp. UNIX is a registered trademark of AT&T Bell Labs.

Circle 10 on Inquiry Card (RESELLERS: 11).

## Dell Delivers Color Computing Without a Price Penalty

It seems like manufacturers have been showing portable computers with color screens at trade shows for years. In fact, they have, starting with those so-called technology demonstrations a very long time ago. Some color portables have been available, but at eyebrow-raising and wallet-clearing prices that hovered around the five-figure area. No, thank you.

The major problem has been the availability of color flat-panel displays. Finally, color LCD screens that can run off battery power are becoming available in quantity, and that means that those long-awaited color notebook computers will soon appear.

After months of promises from a number of major players, the first color notebook I've been able to keep for a while and test arrived on my desk at the very end of 1991. The Dell System 325NC shows just how quickly you can get used to having color in your briefcase. What's surprising is the bottom line. Dell has brought a full-power color notebook to market for not much more than a comparably equipped unit with a monochrome screen: \$3999.

The 325NC weighs in at a respectable 7 pounds and measures 8½ by 11 by 2½ inches. That's a little heavier and a bit thicker than your garden-variety monochrome notebook, but this is one loaded notebook computer. It's based on Intel's 25-MHz 386SL (low-power) processor, but more about that later.

The display on the 325NC is a 9½-inch diagonal passive-matrix triple-supertwist nematic LCD that displays 16 colors in standard VGA (640- by 480-pixel) resolution. It can also display 256 colors, although in CGA (320- by 200-pixel) resolution.

Active-matrix displays are considerably brighter than passive-matrix displays. Active-matrix displays also use much more power and are more expensive.

I'd never worked with a passive-matrix display before, and I was at first a bit disappointed. The image isn't as bright as I'd like it, and the colors are on the muted side. But this isn't, after all, a desktop VGA display. It didn't take long for me to get used to it, and the more I used it,



the more I liked it. I soon realized how important the color factor is with the applications that I use regularly—especially in Windows.

Of course, a color display deserves a high-powered and high-quality system to go along with it, and the rest of the 325NC is no slouch. It's obviously designed from the ground up as a cohesive whole. Dell has come a long way from its roots as a purveyor of me-too clones.

Today's notebook computers are designed to use battery power conservatively. The 25-MHz 386SL that's the heart of the 325NC is state of the art for today's notebooks. It's crammed with power-saving features, including sleep and suspend/resume modes. Dell has added more: custom firmware and a custom application-specific IC whose entire purpose is power management.

The 325NC has yet another state-of-the-art feature: A nickel-metal-hydride battery lasts longer and doesn't have the "memory effect" that nickel-cadmium batteries are infamous for (i.e., delivering less power the more times they're recharged).

The end result of all this engineering is a system that will run for an average of about 3 hours on a charge. Some notebooks with monochrome displays don't do as well.

As far as other system features are concerned, the 325NC comes standard with 4 MB of RAM (expandable to 12 MB), a 60- or 80-MB hard drive, a 3½-inch 1.44-

MB floppy drive, and the usual assortment of ports, including PS/2 mouse and keyboard connectors. Options include a 2400-bps modem and a 9600-bps data/fax modem.

The 85-key keyboard has a solid big-system feel. Its layout is becoming standard for today's crop of notebooks. Because a pointing device of some sort is a necessity in today's Windows-centric world, the 325NC comes standard with the Microsoft Ballpoint mouse, which is actually a miniature trackball. It's not the smallest pointing device that's available for portable computers, but I have found it to be one of the best. I use one with the notebook computer that I own.

On the performance front, the 325NC is impressive. I ran the

BYTE Lab benchmarks and found that the 325NC compared favorably with others in its class. This is a machine that's comfortable for even computation-heavy applications, especially if you pop in the optional 387SX math coprocessor.

Dell's aggressive pricing strategy will give the demand for color notebooks a much-needed kick in the pants and will make competitors very nervous, especially those known for premium prices. With its \$3999 price tag, the question of whether you need a color notebook almost becomes moot. Color adds a new dimension to portable computing, and when you can get it for virtually the same price as a comparable monochrome unit, what are you waiting for?

—Stan Miastkowski

### THE FACTS

**Dell System 325NC**  
\$3999; with 80-MB hard drive,  
\$4299

**Dell Computer Corp.**  
9505 Arboretum Blvd.  
Austin, TX 78759  
(800) 426-5150  
(512) 338-4400  
fax: (512) 343-3312

**Circle 1213 on Inquiry Card.**

Come On In.

Gateway Cafe



# Serving PCs



And Yours  
Of Free

What comes to mind when you picture the classic 50's diner? Good food and plenty of it. Great service. And the price on the check is remarkably affordable.

When you buy a personal computer from Gateway 2000, the experience has its similarities. You get a solid quality, high-performance computer that comes fully loaded with all the

# With The Works!



Choice  
Software!

features you want. The service is unsurpassed anywhere. And the price you pay is also remarkably affordable.

Go ahead and browse through the Gateway Cafe menu. We serve a wide selection of the freshest items in the PC industry. You're sure to find something that will appeal to your taste and budget.



**GATEWAY2000**

*"You've got a friend in the business."*

# Gateway Cafe

## Specials

### Introducing The Gateway TelePath

For \$195, you get the Gateway TelePath – a new custom-designed V.32bis modem with full fax capability plus WinFax Pro,<sup>™</sup> Crosstalk<sup>®</sup> for Windows<sup>™</sup> and a free trial membership with CompuServe.<sup>®</sup> Anywhere else you'd pay more for the software alone!

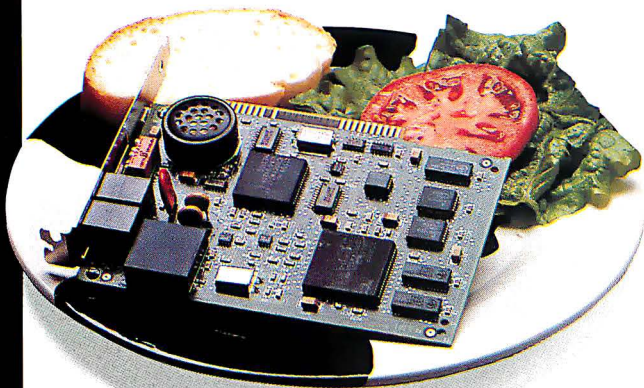
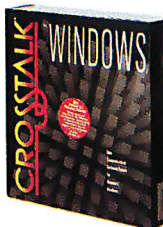
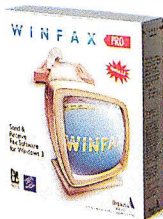
Gateway 2000's engineers designed this internal modem and fax card to incorporate everything our customers were hungry for in the arena of PC communications.

*Speed.* The Gateway TelePath modem operates up to 14,400 bps. The Gateway TelePath send/receive fax runs at 9,600 bps.

*Compatibility.* The 14,400 bps modem is compatible with the standard AT command set and can be used with almost any compatible software. With the Gateway TelePath fax, you can send to or receive from any Group 3 or earlier fax machine using Class 1 or Class 2 commands.

- Fax mode: V.17, V.29, and V.27ter
- Data mode: (try to find one we don't support!) V.32bis, V.32, V.22bis, V.22, V.21, Bell 212A and 103, V.42 and MNP 2-4 error correction, V.42bis/MNP 5 data compression

*Price.* You'll find comparable fax/modem packages can cost in excess of \$500 not including the software. At \$195, the Gateway TelePath price is very easy to swallow.



## Side Orders

### New Video Options For Your PC

#### The 15-Inch Crystal Scan 1572FS

It's bigger, but that's just one of the improvements we've made to the 15-inch Crystal Scan 1572FS. The new flat, square, non-glare screen reduces distortion around the corners and provides an edge-to-edge display area. The refresh rate is higher, 72 Hz, for added image stability and flicker-free display. Dot pitch is 0.28mm. We've also moved the fine tuning controls to the front of the monitor for easy access.

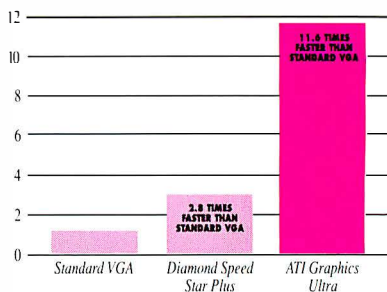


The Crystal Scan 1572FS is an option with 386DX and 486 systems for an additional \$195. Availability is limited.

#### The ATI<sup>®</sup> Graphics Accelerator

You're really cookin' when you run a Gateway 2000 system with ATI's graphics accelerator, the Graphics Ultra. ATI achieves a quantum leap in performance by using a highly optimized graphics coprocessor on the Graphics Ultra card. The 1024 x 768 mode is fully compatible with IBM<sup>®</sup> 8514, VGA, Super VGA and previous IBM graphics standards, which makes it easy to install applications using the standard video drivers.

The ATI Graphics Ultra video card is standard with the 486-33 system, optional with 386DX and 486 systems. The street price of this card is over \$500, but with the purchase of a Gateway 2000 system, you can upgrade to it for \$150!



Figures computed on a 486/33 and provided by ATI Technologies Inc.

Peripherals are sold only with the purchase of a system. If you already own a Gateway 2000 computer, you can buy peripherals separately.



# Gateway Cafe

Desserts

Desserts

## New On The Menu: Choose One Software Option Free With Your PC!

With the purchase of any Gateway 2000 386SX, 386DX or 486 computer system, you now receive your choice of free application software. Pick one from the seven application options in our software buffet. We'll install one software option on your hard drive, optimally configured for your system and Windows, and provide you with the master diskettes and manuals – absolutely free.

You can also buy additional software at extremely competitive prices, or choose from other popular applications not listed here. Ask your sales person for the details.

### Option #1

#### Microsoft® Excel for Windows™ 3.0

- A powerful graphical spreadsheet program
- Includes online help for Lotus® 1-2-3® users
- PC Magazine's Editor's Choice

Retail value: \$495. Discount value: \$300+. Can be yours free with a Gateway 2000 PC!

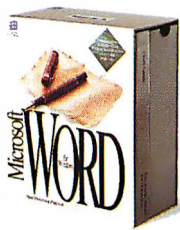


### Option #2

#### Microsoft Word for Windows™ 2.0

- Best selling word processor for Windows
- New version 2.0 adds spectacular refinements
- Includes online help for WordPerfect® users

Retail value: \$495. Discount value: \$300+. Can be yours free with a Gateway 2000 PC!



### Option #3

#### Microsoft PowerPoint for Windows™ 2.0

- Easy-to-use desktop presentations program
- Creates high-quality overheads and 35mm slides

Retail value: \$495. Discount value: \$300+. Can be yours free with a Gateway 2000 PC!



### Option #4

#### The Paradox® 3.5

- Award-winning database management program
- From Borland®, the leader in database and programming software

Retail value: \$695. Discount value: \$500+. Can be yours free with a Gateway 2000 PC!



### Option #5

#### The Entrepreneur Pack

Includes Microsoft's Works™, Publisher™ and Money™, the latest versions, and an

Entertainment Pack, all

for Windows, plus TurboTax for Windows® from ChipSoft

- Works integrates a word processor, spreadsheet, database and more into one easy-to-use program

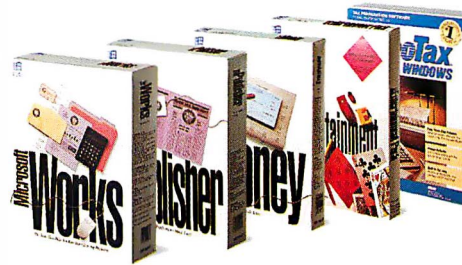
- Publisher has page layout tools to create publications

- Money helps you control your finances by writing checks, setting budgets, tracking expenses

- Entertainment Pack, eight games including Tetris®

- TurboTax is an easy-to-use tax preparation program with online help for understanding IRS rules

Retail value: \$607. Discount value: \$400+. Can be yours free with a Gateway 2000 PC!



# Gateway Cafe

## Desserts

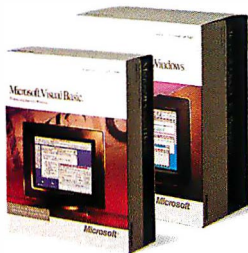
## Main Course

### Option #6

#### **The Windows Programmer Pack**

Includes Microsoft's QuickC for Windows,<sup>™</sup> Visual Basic for Windows,<sup>™</sup> Windows Control Development Kit,<sup>™</sup> MS Windows Help Compiler<sup>™</sup> and MS Windows Programmer's Online Reference<sup>™</sup>

■ Everything you need to create programs for Windows. You can't buy all of these tools in one package elsewhere, but this option can be yours free with a Gateway 2000 PC!



### Option #7

#### **Microsoft Project for Windows<sup>™</sup> 3.0**

- Flexible and easy project management program
- Includes interactive online tutorial
- PC Magazine calls it the best program in its category

Retail value: \$695. Discount value: \$425+. Can be yours free with a Gateway 2000 PC!



If the free software packages offered here don't suit your needs, we have others that are very competitively priced. For example, if you'd rather get Microsoft Office,<sup>™</sup> which includes Word for Windows, Excel and PowerPoint, you can upgrade to it. Office retails for \$750, with a discount value of \$499. It can be yours for only \$175 with a Gateway 2000 PC. Ask your sales representative for details.

*This offer includes the identical applications contained in retail packages but will not include the retail box. You get a complete set of diskettes and manuals, shrink-wrapped and packaged in a Gateway 2000 box.*



## There's A PC Here That's Just What You're Looking For

Gateway 2000 computer systems – the meat and potatoes of our menu – come with all the trimmings at no extra charge. All systems have plenty of RAM, two diskette drives, fast and reliable hard drives, 16-bit VGA graphics, color monitors and the 124-key programmable AnyKey<sup>™</sup> keyboard. We use only the highest quality components in our systems. Every model includes MS DOS 5.0, and 386SX, 386DX and 486 models come with Windows 3.0 and a Microsoft mouse.

Substitutions are welcome! We custom build each Gateway 2000 system to your specifications.

### 286 And 386SX Systems

Gateway 2000's 286 and 386SX systems come in a compact, mini desktop model. To give you plenty of room for expansion



in a small footprint system, we integrated the diskette drive controller, the video chip set and the I/O card on the motherboard, leaving five 16-bit slots open in the standard configuration.

The mini desktop models have a standard mouse port (PS/2 compatible), leaving two serial ports open. RAM on these systems is expandable to 16MB on the motherboard. The Western Digital<sup>®</sup> IDE hard drives feature a 32K read-look-ahead cache buffer. All mini desktop models have Quadtel<sup>®</sup> BIOS and 200 watt power supplies.



*The 124-key AnyKey keyboard comes standard with all Gateway 2000 systems.*

# Gateway Cafe

Main Course

Main Course

## Hungry For

### 386DX Systems

The 386 systems have a true 32-bit memory bus and more expansion capability. We start with a genuine Intel® 80386 microprocessor on a Micronics® motherboard. We add a generous portion of RAM – 4MB expandable to a system total of 64MB. Put in 64K of cache RAM on the 386/33 for a nice performance boost. Add IDE hard drives from Western Digital. Then give them Diamond Speedstar Plus™ 16-bit VGA graphics cards with 1MB RAM, non-interlaced 14-inch Crystal Scan 1024 x 768 color monitors, Phoenix™ BIOS, a Weitek socket on the 33 and 200 watt power supplies. That's the basic recipe for these tried-and-true, workhorse computers.

Both systems have a 32-bit slot open in the standard configuration for RAM expansion. The motherboard has a total of one 32-bit and seven 16-bit slots, with one 32-bit and five 16-bit expansion slots available in the advertised configuration. Gateway's 386DX and 486 systems come in a desktop model that is roomy and easily accessible.

A floor-standing tower model is an option for an additional \$100.



### 486 Systems

Gateway 2000's 486 systems run on the real McCoy – an Intel 80486 processor with built-in math coprocessor and 8K instruction cache. The 486/33 has a Micronics® motherboard, while the motherboard for the EISA system is custom-manufactured for Gateway 2000. RAM is expandable to a system total of 64MB. Both systems also have an external cache to further increase performance: the ISA system includes 64K; the EISA PC has 128K.

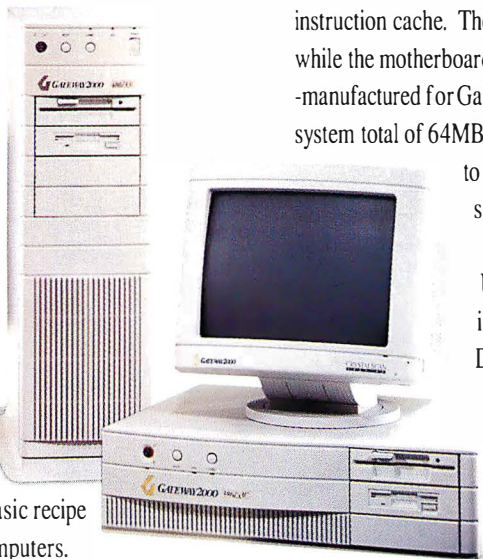
New on the 486/33 is the ATI® Graphics Ultra, which is the fastest video card by far in its class. The EISA model includes a Diamond Speedstar Plus, which is also a high-performance video card.

Both systems come with 1MB video RAM.

The 486/33 has eight 16-bit slots on the motherboard, six available in the standard configuration. The EISA machine has eight 32-bit EISA slots on the system board. You have five 32-bit EISA slots open in our standard configuration.

The 486/33 has Phoenix BIOS, while the 486/33 EISA uses Award® BIOS. Both systems come with Weitek sockets and 200 watt power supplies.

*Please refer to the back page of this ad for system configurations and prices.*



# Gateway Cafe

## 16 MHZ 286

- 80286 Processor
- 2MB RAM
- 1.2MB 5.25" Drive
- 1.44MB 3.5" Drive
- 40MB 17ms IDE Drive with 32K Cache
- 16-Bit VGA with 512K
- 14" Crystal Scan 1024 Color VGA Monitor
- 1 Parallel/2 Serial Ports
- 1 PS/2 Mouse Port
- 124-Key AnyKey™ Keyboard
- MS DOS® 5.0

**\$1345**



## 16 MHZ 386SX

- Intel® 80386SX Processor
- 2MB RAM
- 1.2MB 5.25" Drive
- 1.44MB 3.5" Drive
- 40MB 17ms IDE Drive with 32K Cache
- 16-Bit VGA with 512K
- 14" Crystal Scan 1024 Color VGA Monitor
- 1 Parallel/2 Serial Ports
- 1 PS/2 Mouse Port
- 124-Key AnyKey Keyboard
- Microsoft® Mouse
- MS DOS 5.0
- MS Windows™ 3.0
- Choice of Application Software

**\$1445**

## 20 MHZ 386SX

- Intel 80386SX Processor
- 32K Cache RAM
- 4MB RAM
- 1.2MB 5.25" Drive
- 1.44MB 3.5" Drive
- 80MB 17ms IDE Drive with 32K Cache
- 16-Bit VGA with 512K
- 14" Crystal Scan 1024 Color VGA Monitor
- 1 Parallel/2 Serial Ports
- 1 PS/2 Mouse Port
- 124-Key AnyKey Keyboard
- Microsoft Mouse
- MS DOS 5.0
- MS Windows 3.0
- Choice of Application Software

**\$1745**



## 25 MHZ 386

- Intel 80386 Processor
- 4MB RAM
- 1.2MB 5.25" Drive
- 1.44MB 3.5" Drive
- 80MB 17ms IDE Drive with 32K Cache
- 16-Bit VGA with 1MB
- 14" Crystal Scan 1024NI Color VGA Monitor
- 1 Parallel/2 Serial Ports
- 124-Key AnyKey Keyboard
- Microsoft Mouse
- MS DOS 5.0
- MS Windows 3.0
- Choice of Application Software

**\$1895**

## BEST BUYS

- Get our 33 MHz 386 system, same configuration as listed, with a 120MB IDE hard drive instead of the 200MB drive.

**\$2145**

- Same features as our 33 MHz 486 system except this machine has 4MB RAM instead of 8, and a 120MB IDE hard drive instead of the 200MB drive in our standard configuration.

**\$2495**

## 33 MHZ 386

- Intel 80386 Processor
- 64K Cache RAM
- 4MB RAM
- 1.2MB 5.25" Drive
- 1.44MB 3.5" Drive
- 200MB 15ms IDE Drive with 64K Multi-Segmented Cache
- 16-Bit VGA with 1MB
- 14" Crystal Scan 1024NI Color VGA Monitor
- 1 Parallel/2 Serial Ports
- 124-Key AnyKey Keyboard
- Microsoft Mouse
- MS DOS 5.0
- MS Windows 3.0
- Choice of Application Software

**\$2395**



## 33 MHZ 486

- Intel 80486 Processor
- 64K Cache RAM
- 8MB RAM
- 1.2MB 5.25" Drive
- 1.44MB 3.5" Drive
- 200MB 15ms IDE Drive with 64K Multi-Segmented Cache
- ATI Ultra VGA with 1MB
- 14" Crystal Scan 1024NI Color VGA Monitor
- 1 Parallel/2 Serial Ports
- 124-Key AnyKey Keyboard
- Microsoft Mouse
- MS DOS 5.0
- MS Windows 3.0
- Choice of Application Software

**\$2945**



## 33 MHZ 486 EISA

- Intel 80486 Processor
- 128K Cache RAM
- 8MB RAM
- 1.2MB 5.25" Drive
- 1.44MB 3.5" Drive
- 340MB 15ms SCSI Drive with 128K Multi-Segmented Cache
- 32-Bit EISA SCSI Controller
- 16-Bit VGA with 1MB
- 14" Crystal Scan 1024NI Color VGA Monitor
- 1 Parallel/2 Serial Ports
- 124-Key AnyKey Keyboard
- Microsoft Mouse
- MS DOS 5.0
- MS Windows 3.0
- Choice of Application Software

**\$3895**



### INCLUDED WITH EVERY SYSTEM:



- One-year warranty • 30-day money-back guarantee
- Lifetime toll-free technical support • Free on-site service to most locations • Free bulletin board technical support
- C.O.D. terms and major credit cards honored • Net 30-day credit terms and leasing options available to qualified commercial customers

Sales Hours: 7am-10pm Weekdays, 9am-4pm Saturdays (CST)  
Service Hours: 6am-Midnight Weekdays, 9am-2pm Saturdays (CST)  
All prices are subject to change. Prices do not include shipping.



8 0 0 - 5 2 3 - 2 0 0 0

610 Gateway Drive • N. Sioux City, SD 57049 • 605-232-2000 • Fax 605-232-2023

### Twiddling at My Computer

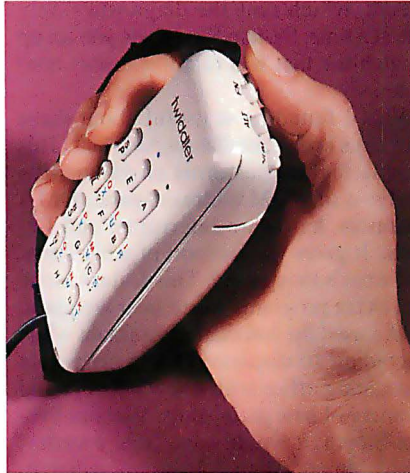
The first time I saw the Twiddler, I was enchanted. An alternative input device that is both keyboard and mouse, the Twiddler fit my hand comfortably, secured by the adjustable Velcro and nylon strap.

Ergonomically designed for right- or left-handed use, the 5-inch-long Twiddler is equipped with a 6-foot cord and is capable of working as far as 50 feet away from laptop and desktop computers with an extension cable, a definite advantage when giving presentations.

The Twiddler has three rows of miniature oval keys on the front surface. Each row is designated by a color: red signifying the left row, blue the middle row, and green the right row. An oval pattern of small round buttons on the top back curve of the Twiddler provides thumb control of Alt, Control, Shift, function, and number keys, as well as control of the unit's mouse capabilities.

The 12 finger keys on the front of the unit emulate a 101-key keyboard via chord keying. You press and release one or more keys at a time, with each combination generating a unique character or command. You can create your own key chords for words and groups of words that you use frequently.

The mouse pointer in the Twiddler is



based on an electrolytic tilt sensor that is sealed inside the device. By pressing the mouse button on the top of the unit and pointing with your index finger in the direction you want the device to tilt, you control the cursor on the screen.

The people at Handykey promise that most of us can learn the alphabet on the Twiddler in about 3 minutes and will master the device in about 10 days. I was doubtful that I would be able to claim such victories. But sure enough, when I started to use the device, I quickly found myself

THE FACTS

**Twiddler**  
\$199

*System requirements:*  
DOS 3.1 or higher, Windows 3.0 or higher; keyboard and serial ports.

Handykey Corp.  
141 Mount Sinai Ave.  
Mount Sinai, NY 11766  
(800) 638-2352  
(516) 474-4405  
fax: (516) 474-3760  
**Circle 1214 on Inquiry Card.**

remembering not only the alphabet, but also the preprogrammed macros. By the third time I picked up the Twiddler, my finger memory was beginning to kick in, and I was automatically able to press the proper chords for letters and words that require key combinations.

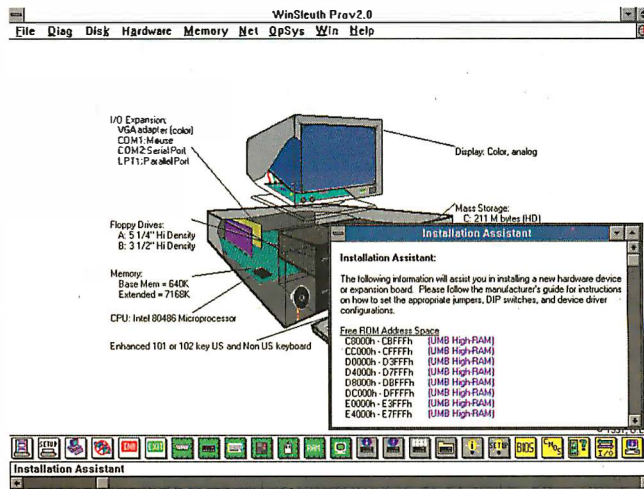
Each time I used the Twiddler, I noticed a bit more control over my hand, so I was able to type faster and more accurately. Twiddling my way through my work is an appealing alternative.

—Carol J. Swartz

### New Sleuths Delve Deep

Let's face it: A "standard" PC simply doesn't exist. Take here at BYTE, for example. Besides a few standard add-ins, each editor has a custom-configured system, with parts and pieces from a variety of manufacturers. Diagnosing pesky problems or installing peripherals and add-ins in this bewildering hodgepodge can be a nightmare.

Diagnostic utilities are designed to help. Several products are available, each updated on a regular basis to keep up with the march of technology. In the past, we've given Darina's System Sleuth a so-so rating. But the release of **System Sleuth Professional 4.0** and **WinSleuth Professional 2.0** has changed my opinion. These products—one for plain-vanilla DOS and one



for Windows—are cutting-edge utilities that ferret out even the most annoying intermittent problems.

The latest incarnations of System Sleuth

and WinSleuth are fully redesigned and expanded from their prior versions. Both are similar in their abilities. They're designed to diagnose problems and help with installations. There are, however, some intriguing differences. WinSleuth has all the abilities of System Sleuth, but because it is a Windows utility, it's graphics-oriented. Also, because of the underlying technical complexity of the Windows environment (and the probability of more esoteric things going wrong), it has many more features. There's a bewildering array of icons,

whose features are thankfully available on those ubiquitous pull-down menus.

I simply don't have the room to cover all the features of WinSleuth. What I found

particularly interesting was a "tune-up" option that made specific recommendations on how to change my WIN.INI and SYSTEM.INI files for maximum performance. And no other diagnostic program offers the wealth of Windows-specific information that WinSleuth does. You can look at the details of Windows memory management, descriptor tables, and even lists of exception handlers and Windows tasks.

System Sleuth, the plain-vanilla DOS version, offers a wealth of similar features (sans the Windows-specific ones of WinSleuth). It shows you virtually everything that you'd ever want to know (and more) about your system. There's excruciating detail about disks, memory, adapters, and hardware. It's all wrapped up in a new and easier-to-use interface with drop-down menus.

Both versions of the program offer exhaustive diagnostics for all system components, from the hard drive to RAM. This

is one area where the non-Windows version has a distinct advantage. Unlike WinSleuth, which runs the diagnostics only one at a time, System Sleuth lets you set up a batch file that will run diagnostics continuously.

What I found most useful about these programs is the Installation Assistant. This unique feature performs an exhaustive analysis of ROM address space, DMA channels, hardware interrupts, and I/O ports. It gives you a report of what's free and what's being used. This feature alone makes the programs worth their weight in gold. I used the Installation Assistant while upgrading 10 disparate PCs in my wife's accounting office with a new network and a variety of new peripherals. Without System Sleuth, it would have been a veritable nightmare. With it, I was immediately able to set jumpers on add-in boards.

Either System Sleuth Professional 4.0 or WinSleuth Professional 2.0 is one of the few programs that I consider absolutely

and positively necessary on my PC. One of them should be on yours, too.

—Stan Miastkowski

### THE FACTS

**System Sleuth Professional 4.0**  
**WinSleuth Professional 2.0**  
\$169 each

*System requirements:*

System Sleuth Professional: IBM PC, AT, PS/2, or compatible.  
WinSleuth Professional: Any system running Windows 3.0 or 3.1.

Dariana, Inc.

7439 La Palma Ave., Suite 278  
Buena Park, CA 90620  
(714) 562-5777  
fax: (714) 994-7401

**Circle 1215 on Inquiry Card.**

## Truevision's Bravado

**T** ruevision, one of the veterans of the computer video gear business, has thrown its hat into a new ring: video in a window/video overlay. Truevision's **Bravado** board takes in video from an external source (e.g., a camcorder, VCR, or laser disc player) and shows that video in a window on a computer display. The video can also be overlaid with computer-generated graphics. Boards in this class are frequently used for interactive multimedia applications, but they have other uses as well, ranging from video editing to stock market watching.

I brought a prerelease Bravado board into BYTE's Multimedia Lab for a spin. Bravado combines, on a single full-length board, all the features I can imagine wanting in a video-in-a-window product. And, true to Truevision's style, Bravado does more than it has to. It incorporates a full-featured VGA adapter (based on the Tseng Laboratories ET4000 chip set), eliminating the problem of interfacing to existing VGA cards, simplifying installation, and freeing up a slot in the bargain.

Bravado's other twist is that you can cascade multiple Bravado boards to pro-



vide access to multiple video sources. On the video-in-a-window side, Bravado does its duty: real-time video in a scalable window, with accompanying audio. It can handle NTSC or PAL signals, and it can save and load "frozen" video and other images to and from disk.

The board is simple to install. One DIP switch sets its port address. A RAM buffer is used to process the real-time video, but its address is set through software (as it should be). Once the board is installed, you simply plug your VGA or Super VGA monitor into the standard 15-pin connector and route your incoming video and stereo or mono audio through a sturdy ca-

ble set that attaches to a 25-pin external connector. The cable set includes a headphone jack. Bravado's on-board amplifier will drive a pair of headphones or small speakers. Internally, Bravado is equipped with a VGA feature connector, a cascade connector, and fittings for an alluded-to compression board, which is not yet available.

I tested Bravado with a prerelease set of software drivers and applications. Bravado's software is built to run under Windows 3.0. Even at the

prerelease stage, the entire installation

### THE FACTS

**Bravado**  
with 8-bit VGA, \$1295; with 16-bit  
VGA and options, \$1495

Truevision, Inc.  
7340 Shadeland Station  
Indianapolis, IN 46256  
(317) 841-0332  
fax: (317) 576-7700

**Circle 1216 on Inquiry Card.**

# COREL SCSI!

*The Complete SCSI Solution for Personal Computers!*

**Everything you need in one package!**

- ▶ **CoreISCSI Host Adapter & Cable**
- ▶ **CoreIDRIVER Software for SCSI Devices**
- ▶ **Videotape Guide for Ease of Installation**
- ▶ **100's of Devices Supported**

For the exciting world of multimedia, you need more storage space, faster access and more peripherals, but your computer has limited expansion slots. The high performance solution is CoreISCSI which provides the fastest universal interface (up to 10MB / sec.) for up to seven peripherals using a single card!

No additional software is needed because CoreISCSI supports hundreds of devices.

And CoreISCSI is multi-platform, with support for DOS, OS/2, Windows and Novell NetWare.

Available in 16 bit, 8 bit, and MCA versions.

*Multimedia - ready.*



**THE BEST WAY TO CONNECT PC PERIPHERALS!**

Circle 43 on Inquiry Card.

 **COREL**

1-800-836-SCSI  
FAX: (613) 728-9790  
CDN TEL: (613) 728-8200

process was automated, and a thorough testing program was included. The Windows drivers set the on-board VGA to run at resolutions of 640 by 400 pixels, 640 by 480 pixels, or 800 by 600 pixels in 256 colors. The 1024-by-768-pixel mode supports 16 colors only (the VGA component is equipped with 512 KB of memory). It's worth noting that the 256-color display modes are compatible with the Multimedia Extensions for Windows.

The lone Windows application, Brava-

do Control, wasn't quite complete, but it gave me a good feel for what the board can do. The application consists mostly of a real-time video window that can be changed to any size and a set of menus that lets you fiddle with various video and audio adjustments. The program also includes a simple "remote-control" dialog box that has the ability to control a small assortment of video devices through the PC's serial ports.

While the software wasn't quite fin-

ished, the Bravado board itself proved quite robust. It put up sharp, stable video and crisp true-color still images. When this board hits the streets, the key to its success will be the quality of its supporting software. Having chosen Windows, Truevision is duty-bound to provide a Media Control Interface driver for applications to hook into. That's yet to come, but after my first brush with Bravado, I came away impressed.

—Tom Yager

## A New Generation of Grammar-Checking Technology

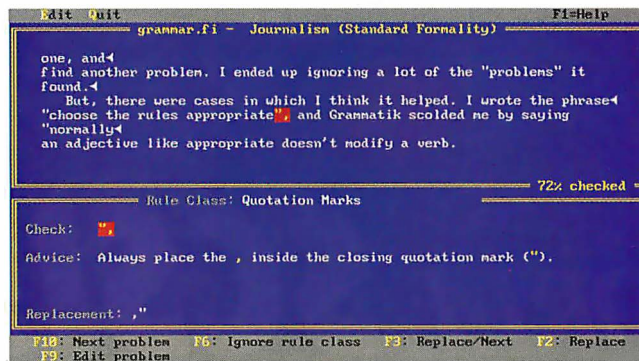
**W**hile Grammatik has always been an interesting product and a leader in the field of grammar checkers, **Grammatik V for DOS** is a significant upgrade.

With this new version, Reference Software introduces the industry's first paragraph-level checking that tells you when you've used the same word too often. Another unique feature is access to 10 customized writing styles, each with three levels of formality.

Grammatik V uses a new parsing engine to analyze sentences. The engine is integrated with the first root-based dictionary and spelling checker. The dictionary and parsing engine use 96 grammatical attributes (e.g., parts of speech) to analyze sentences—more than twice the number used by Grammatik IV. Sixty rule classes of grammar, according to Reference Software, add thousands of rules that help identify complex writing problems, such as subject and verb or pronoun agreement errors. Version V also suggests replacements for many more grammatical errors.

The program works with 25 word processors and is hot-key-accessible within WordPerfect, WordStar, Microsoft Word, Professional Write, PFS:First Choice, and XyWrite III Plus.

When running Grammatik in interactive mode, it pauses at each writing problem and awaits your response. It displays the current writing problem highlighted in the paragraph, displays the rule class for the writing problem, offers advice for correcting the problem, suggests a replacement word or phrase, and gives you optional commands for responding. The easiest way to correct an error is by choosing the Replacement command. By press-



abbreviations. So the only useful spelling checker is one that, like Grammatik V, can be taught.

Another problem I've had with spelling and grammar checkers is that they always think they know best. In some cases, I think the rules of writing should be a bit more flexible. Grammatik V addresses this as well, by letting you ignore the rules or corrections it throws at you.

ing the F2 key when you see Replacement in the advice window, Grammatik replaces the highlighted error with its suggested replacement.

Grammatik also has a Learn Word command. This puts a word into its spelling dictionary. I always have a hard time checking spelling in technical material because the spelling checker doesn't "know" what I think are common acronyms and

All the added features in Grammatik V are well and good, but the beta copy I tested wasn't as proficient as I would have liked. In one case, it read my use of *it's* incorrectly and told me to use *its*. I'm glad that I knew better. In a few other instances, it actually went backward to find problems. It would identify a problem at the end of a sentence, jump to the beginning of that sentence or a previous one, and find another problem. I ended up ignoring many of the "problems" it found. But there were cases in which I think it helped.

What I like best about the program are the statistics. It rated this First Impression a 54 in the Flesch Reading Ease. That's "fairly difficult" to read and indicates about a tenth-grade reading level. It also gave me a Fog Index of 13, indicating the approximate grade level a reader must have achieved to understand this First Impression.

In conclusion, assuming the problems I encountered will be resolved by the time the software is released, Grammatik V could be must-have software for every person who writes. It did clean up my typos and helped with some grammatical construction. I find all that worth \$99. ■

—Anne Fischer Lent

### THE FACTS

#### Grammatik V for DOS \$99

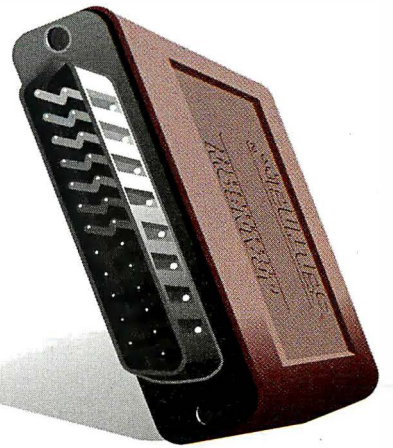
System requirements:  
IBM AT or compatible with DOS  
3.0 or higher, 640 KB of RAM, and  
a hard drive.

Reference Software International  
330 Townsend St., Suite 119  
San Francisco, CA 94107  
(800) 872-9933  
(415) 541-0222  
fax: (415) 541-0509

Circle 1218 on Inquiry Card.



# Why do they call it a dongle?



He wasn't famous. He didn't drive a fancy car, but dressed in his favorite Comdex T-shirt and faded blue jeans, he set out to change the course of the computer software industry. Quite a task for a lonely software developer.

Sitting in front of his computer, drinking pots of coffee and smoking cartons of cigarettes, he'd write pages of code.

It took time. Years in fact. But he did it. He wrote the most powerful computer program in the world. Now came the hard part. Selling it.


## The Most Powerful Program in the World

Determined to make those long years pay off, he called on every distributor, VAR and dealer in the world. He drove from Beantown to San Diego. Flew from Dublin to Borneo. Everyone loved the program.

So he sold a few. Only a few.

Back in Boston he waited. After a long year

with only 13 orders he set out to see what happened. As he drove across the

 country and flew around the world he discovered everyone knew about his program. Everyone had it too.

## The Global Marketplace

From Paris to Prague, his program was everywhere in Europe. When he got off the plane in Hong Kong he found his program stacked to the ceiling in every computer store. Amazed in disbelief, he bought a hundred cartons of cigarettes and a hundred pounds of Indonesian coffee and flew back to Boston.

Beaten, battered and bruised he went back to the drawing board. This time he would really change the face of the software industry. He would develop a device that would prevent unauthorized distribution of software programs.

## Call It What You Like

He developed a hardware key. His peers applauded his efforts. Finally, a solid solution for revenue protection.

But he didn't know what to call it. He thought of naming it after an exotic place he visited in his travels. Madagascar was a bit too long, though.

"Name it after you, Don!", urged his peers. So he did. Soon everyone was calling the key a dongle, after Don Gall — the lonely software developer who did what he had to do.

## You've Come A Long Way, Baby

Today, dongles are different. Fact is, they've come a long way. Leading the industry with security solutions, Rainbow Technologies has changed the face of hardware keys. They work with multiple applications, are programmable and network versions control concurrent usage. And they're always transparent to the end-user.

## Sentinel Family from Rainbow

Truth is, more and more developers are using keys. And the Sentinel Family is the most widely used in the world. In fact, over 6,000

developers use Sentinel from Rainbow. Why? They are simply the most effective, reliable and easy to implement keys on the market.

Learn more about securing your software and how keys provide developers with extra value. Call for a free copy of "The Sentinel Guide to Securing Software." And see just how easy it is to

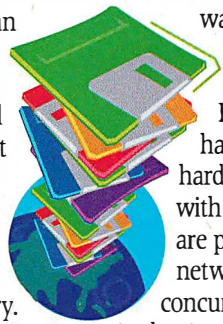
install a hardware key into your application in just minutes. Try it with our low cost Sentinel Evaluation Kit. Order one for your DOS, OS/2, Windows, Macintosh or UNIX based application.

And remember, when you need a dongle, you need Sentinel — the only dongle Don Gall would use.

CALL  
**800/852-8569**

FOR YOUR FREE GUIDE  
TO SECURING SOFTWARE

**SENTINEL**  
Securing the future of software



**Some call it a dongle. Those who know, call it Sentinel.**

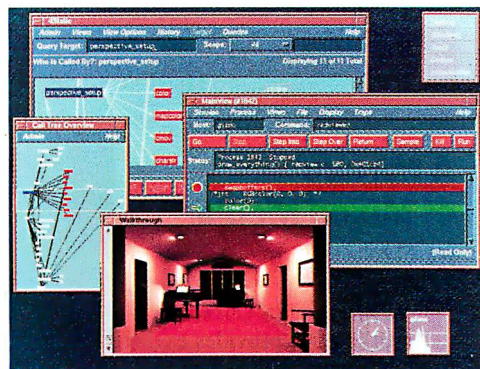


9292 JERONIMO ROAD, IRVINE, CALIFORNIA 92718 • 714/454-2100 • fax 714/454-8557  
International offices are located in the United Kingdom, Germany and France.

Circle 110 on Inquiry Card (RESELLERS: 111).

A man in a light-colored sweater is leaning over a desk, with his arms outstretched in a gesture of surprise or excitement. The scene is lit with a strong blue light, creating a dramatic and futuristic atmosphere. The desk has some papers on it, and a chair is visible in the foreground. A black banner with white text is overlaid on the image.

**Finally, a CASE platform that moves**



## CASEVision and IRIS Indigo—CASE like you've never seen it before.

You've known us as the company that builds hot graphics machines. Now we've taken that vision and applied it to CASE.

The result: we've created an intuitive, visual interface that reflects the way programmers think.

We've also included an entire suite of the most advanced and fastest C, C++ and FORTRAN programming, compiling, debugging and analysis tools available today — designed for large, multiple-language, and even multi-processing applications.

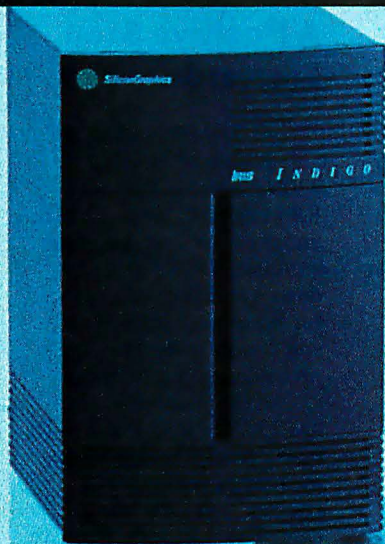
Put all this on any of our award-winning IRIS Indigo™ RISC/PCs, and you've got the ultimate software development platform.

Where you go with all that power is completely up to you.

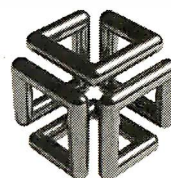
See for yourself. Get our CASEVision™ and IRIS Indigo literature package and find out where to check them out in person.

Call 1 (800) 800-7441. Ext.12

through code the way you do.



IRIS Indigo delivers 30 MIPS, 4.2 MFLOPS, 26 SPECmarks, CD-quality audio, 8-24 bit color, ACF-compatibility, and comes complete with color monitor, keyboard and mouse. Copyright ©1991 Silicon Graphics, Inc. Silicon Graphics, the Silicon Graphics logo and IRIS are registered trademarks, and CASEVision and IRIS Indigo are trademarks of Silicon Graphics, Inc. All other registered and unregistered trademarks are the sole property of their respective owners.



**SiliconGraphics®**  
Computer Systems

### A Mirage of Mixed Media in Color

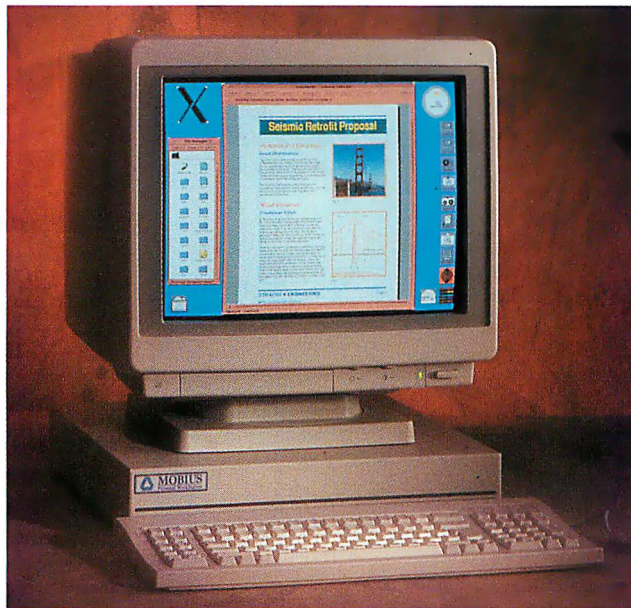
The Mirage IPS Unix workstation provides expandability and Next-like multimedia features. The SPARC-based workstation is built around the 25-MHz LSI chip set.

Available in diskless and disk versions, the Mirage IPS ships with Solaris 1.0 and 8 MB of RAM (expandable to 64 MB). It features a Weitek FPU, a Sparcstation chassis with three SBus slots and room for three internal drives, and a 17-inch flat-screen color display with noninterlaced 1151-by-900-pixel resolution and 256 colors. Also included are an Ethernet port, a SCSI-2 port, two serial ports, and a sound port. The Mirage IPS with disk is preconfigured with a 340-MB hard drive. **Price:** Diskless version, \$4990; disk version, \$6990. **Contact:** Mobius Computer Corp., 5635 West Las Positas, Building 4-410, Pleasanton, CA 94588, (800) 662-4871 or (510) 460-5252; fax (510) 460-5249. **Circle 1271 on Inquiry Card.**

### Notebook Carries a New Tempo

The Everex Tempo Carrier notebook features the KeyMouse pointing device and a minimum of 2 MB of RAM in its 5½ pounds. The 20-MHz 386SX unit includes a 3½-inch floppy drive and a 40- or 80-MB hard drive.

Designed into the notebook, the KeyMouse uses the J key as a pointer controller, giving you multidirectional control when you apply pressure on the edges of



*The Mirage IPS offers object-oriented mixed-media capabilities.*

the key. For times when you prefer to use a mouse, Everex bundles its 400-dpi two-button mouse with the unit. The backlit VGA LCD screen has resolutions of up to 640 by 480 pixels with 32 shades of gray. Ports are available for an external VGA monitor, serial and parallel devices, and an external keyboard. The Tempo Carrier has an internal expansion slot for a 9600-/2400-bps fax/modem and power-on password protection. Its RAM is expandable to 8 MB, and the notebook ships with DOS 5.0 and Windows 3.0. **Price:** Starts at \$2795. **Contact:** Everex Systems, Inc., 48431 Milmont Dr., Fremont, CA 94538, (800) 821-0806 or (510) 498-1111. **Circle 1272 on Inquiry Card.**

### A Positive Step Forward

The 25-MHz 386SX PC Positive 320N and 320ND notebooks have RAM expandable to 10 MB and ports for external color monitors. DOS 5.0, Windows 3.0, Microsoft Works for Windows, and a Microsoft Productivity Pack are preloaded on the hard disk.

The PC Positive 320N has 2 MB of RAM, a 40-MB hard drive, a 3½-inch floppy drive, a mouse, an AC adapter, and a carrying case. The deluxe PC Positive 320ND comes with 4 MB of RAM, a 60-MB hard drive, a 9600-/2400-bps fax/modem, and an extra battery. The 9-inch paper-white backlit LCD screens have a 640-by-480-pixel resolution with 32 shades of gray. Each 6½-pound machine has a standby feature to extend battery life to 3½ hours. Options include an expansion system that lets you add a hard drive, a CD-ROM drive, or other device. **Price:** PC Positive 320N,

\$1799.99; PC Positive 320ND, \$2399.99. **Contact:** Positive Corp., 9174 Deering Ave., Chatsworth, CA 91311, (818) 341-5400; fax (818) 718-2938. **Circle 1273 on Inquiry Card.**

### A Workstation in Modules

Designed for high-volume network computing, the Netmate modular workstation offers a built-in upgrade path via its interchangeable daughtercards. The cards plug into the motherboard, letting you change the CPU from the basic 20-MHz 16-/32-bit 386SX to a 20-MHz 32-bit 486SX or 25-MHz 32-bit 486 processor.

The diskless workstations have upgrades for floppy and hard drive configurations and include video capabilities for graphics-intensive applications. Netmate uses the Tseng Labs ET4000 graphics processor and runs in Super VGA with 800-by-600-pixel resolution at 16 colors with 256 KB of video RAM; interlaced or noninterlaced mode is selectable at setup. You can add 768 KB of video RAM to the main logic board for 1024-by-768-pixel resolution in 256 colors. Features include 2 MB of 80-ns RAM, 8 KB of on-chip cache memory in the 486SX and 486 units, and an on-chip math coprocessor in the 486 model. **Price:** Diskless models from \$1699 to \$2999. **Contact:** Datamedia Corp., 20 Trafalgar Sq., Nashua, NH 03063, (603) 886-1570. **Circle 1274 on Inquiry Card.**

### Bring Hi-Fi Sound to Your Computer

**F**or those of you who compose music on your computer, use it for multimedia presentations, or do MIDI or voice synthesizing on it, the Bose RoomMate Computer Monitor may fit right into your scheme of things. Incorporating Bose's HVC driver and proprietary distortion-limiting circuitry for a full range of digital output, the speaker includes a built-in amplifier and active equalization circuitry. The unit provides stereo or mono high-fidelity sound, depending on the sound chip in your computer. Magnetically shielded, the 6- by 6- by 9-inch speaker includes built-in volume control.

**Price:** \$339 a pair.  
**Contact:** Bose Corp., The Mountain, Framingham, MA 01701, (508) 879-7330; fax (508) 872-6541.  
**Circle 1275 on Inquiry Card.**

### A Laser Printer with RISC

**M**annesmann Tally's MT908 laser printer's enhanced resolution technology gives the illusion of higher than 300-dpi resolution. Combining Hewlett-Packard LaserJet III compatibility with RISC processing performance, the printer uses the company's Enhanced Edge Technology to provide smooth edges for type and graphics in all sizes.

Able to print at 8 ppm,



*The Bose RoomMate Computer Monitor unlocks your computer's sound.*

the MT908 has a RISC controller featuring an Intel 80960 32-bit 16-MHz processor. The printer's standard memory is 1 MB, expandable to 5 MB, and 1- and 2-MB upgrade modules are available. The MT908 has eight scalable LaserJet III fonts, 14 resident bit-mapped fonts, and HPGL/2 for shading and filling of fonts and graphics. An optional PostScript-compatible interpreter is available as a daughterboard that plugs into the controller.

**Price:** \$1995; upgrades, \$230 to \$599.

**Contact:** Mannesmann Tally Corp., 8301 South 180th St., Kent, WA 98032, (206) 251-5500; fax (206) 251-5520.

**Circle 1276 on Inquiry Card.**

### Magneto-Optical Drive for the Mac

**T**he DataPak MO/128 3½-inch magneto-optical drive for the Macintosh features 128 MB of storage on a removable, rewritable

optical disk cartridge the size of a 3½-inch floppy disk. The drive has an average access time of about 30 ms.

Available as an internal drive and in an external configuration, the DataPak MO/128 meets ISO/ANSI standards for 3½-inch optical technology. The external drive is compatible with all Mac computers and includes external SCSI termination; push-button SCSI ID selection; software utilities for formatting, partitioning, and diagnostics; and compatibility with System 7.0. The internal configuration is designed for the Mac Quadra 900 and includes a mounting kit with the necessary installation hardware.

**Price:** External drive, \$1795; internal drive, \$1495; cartridge, \$129.

**Contact:** Mass Microsystems, 810 West Maude Ave., Sunnyvale, CA 94086, (408) 522-1200; fax (408) 733-5499.

**Circle 1277 on Inquiry Card.**

### Fast Backup on a SCSI Minicartridge

**A** 3½-inch SCSI minicartridge tape backup system, the Excel 560 backs up 560 MB of uncompressed data or more than 1 gigabyte of compressed data at 32 MB per minute. The Excel 560's data burst rate exceeds 4 MBps, and it has a sustained user data transfer rate of 567 KBps.

Available in internal and external models, the Excel 560 conforms to the QIC-121 SCSI specification. Downward compatible with current QIC standards, the system is also compatible with major network operating systems.

**Price:** Internal, \$1579; external, \$1729.

**Contact:** Everex Systems, Inc., 48431 Milmont Dr., Fremont, CA 94538, (800) 628-3837.

**Circle 1278 on Inquiry Card.**

### High-Capacity Removable Drives

**C**onsisting of four models, the Passport XL removable hard drives for PCs and Macs provide 52, 105, 120, and 240 MB of storage in an internal or external configuration.

The drives provide access times as fast as 9 ms, seek times as low as 17 ms, and a sustained data transfer rate of 1.4 MBps. Quantum uses its proprietary DisCache technology in the drives, which have from 64 KB to 256 KB of RAM, depending on configuration.

**Price:** \$918 to \$1897.

**Contact:** Quantum Corp., 500 McCarthy Blvd., Milpitas, CA 95035, (408) 894-4000; fax (408) 894-3205.

**Circle 1279 on Inquiry Card.**

### Direct Capture to Display

The FG-15XX family of video capture boards for ISA-bus PCs offers direct capture to VGA display in extended modes. The video digitizers' VGA support includes pass-through of VGA, extended VGA, and Super VGA signals. The monochrome models support 256 levels of gray; the color models support 32,768 colors.

Resolution choices on the FG-15XX boards are 512 by 512, 640 by 480, or 768 by 512 pixels. You can capture images in 1/30 second and display them directly from the capture card in real time on a multisync monitor or transfer them to your video card and display them in modes with up to 1024-by-768-pixel resolution. Other features include 1-KB by 24-bit output lookup tables, a four-channel multiplexer, and external capture and event control. The monochrome versions also have two memory pages. Software support includes compatibility with TARGA, TIFF, and PCX files.

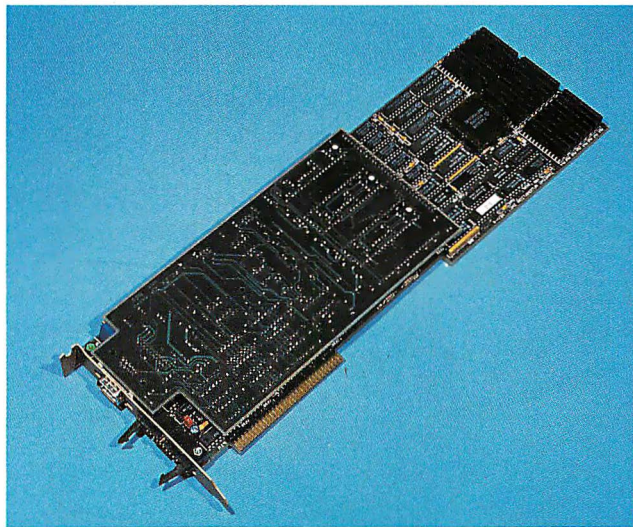
**Price:** \$895 to \$1295.

**Contact:** Imaging Automation, Inc., 7 Henry Clay Dr., Merrimack, NH 03054, (603) 598-3400; fax (603) 598-3422.

**Circle 1280 on Inquiry Card.**

### SCSI Caching Controller

The TenTime Controller TNT-6000 32-bit SCSI caching controller uses the Motorola MC68340 integrated processor with built-in 32-bit DMA for an average access time of 0.2 ms. The controller's cache is expandable to 80 MB. Other features include compatibility



*Import images for VGA display with the FG-15XX video digitizer.*

with the WD1003 protocol, support for SCSI-1 and -2 devices, an RS-232 test port, and compatibility with ISA and EISA systems. Options include disk mirroring and Columbia Data Products drivers and software.

**Price:** With 0.5 MB of cache, \$995.

**Contact:** Laura Technologies, Inc., 3212 South Fair Lane, Tempe, AZ 85282, (602) 438-0889; fax (602) 438-9222.

**Circle 1281 on Inquiry Card.**

### Data Compression for a Notebook

The HardPak data-compression system from Ceram increases hard drive performance by as much as 25 percent and drive capacity by as much as 50 percent, Ceram claims. The board fits into a single 8- or 16-bit ISA or EISA PC expansion slot, including most notebooks and laptops.

Built with Ceram's proprietary CRM1000 high-

speed solid-state data compression/decompression engine, the HardPak provides 32 KB of on-board write-through disk cache, which increases to 96 KB after compression. Requiring no modification to your machine's configuration, the HardPak features a user-selectable system address to eliminate potential conflicts with other devices. HardPak, which works with DOS and Windows, is transparent to most programs.

**Price:** \$98.

**Contact:** Ceram, Inc., 2260 Executive Cir., Colorado Springs, CO 80906, (800) 237-8600 or (719) 540-8500; fax (719) 540-8855.

**Circle 1282 on Inquiry Card.**

### Audio I/O and DSP Together

The AT-DSP2200 DSP accelerator board gives you 25 MFLOPS of processing power. Based on the AT&T WEDSP32C chip, the board is a dedicated numerical computation engine.

The AT-DSP2200 has two channels of 16-bit analog

input with 64× oversampling delta-sigma modulating A/D converters and built-in antialiasing filters. With a 92-dB signal-to-noise ratio, -95-dB total harmonic distortion, and ±0.015 amplitude flatness, the board can acquire signals with extremely high accuracy without introducing noise, National says. Additionally, the board has an RTSI serial-data bus interface, flexible triggering through the software on the WEDSP32C chip, and on-chip DMA.

**Price:** Starts at \$2495.

**Contact:** National Instruments Corp., 6504 Bridge Point Pkwy., Austin, TX 78730, (800) 433-3488 or (512) 794-0100; fax (512) 794-8411.

**Circle 1283 on Inquiry Card.**

### Internal Hard Drives for Macs

The DiamondDrive Internal hard drives from Mass Microsystems are configured for the Mac II, IIci, IIx, IIcx, and Quadra 700 and 900 computers. With drive mechanisms manufactured by Maxtor, the drives have storage capacities of 120, 210, 320, and 510 MB. Data transfer rates to and from the media reach 2 MBps; data rates to and from the buffer are as high as 5 MBps. Average access times range from 12 ms for the 510-MB drive to 15 ms for the other three drives.

**Price:** \$849 to \$2899.

**Contact:** Mass Microsystems, Inc., 810 West Maude Ave., Sunnyvale, CA 94086, (408) 522-1200; fax (408) 733-5499.

**Circle 1284 on Inquiry Card.**

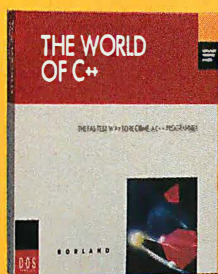
# BORLAND Spring Shower of Savings!

## The World of C++

The World of C++, an instructional video course, is the fastest way to become a C++ programmer. With 21 easy lessons, all aspects of the C++ language are presented in a clear logical order. Applicable to any AT&T 2.0-compatible C++ compiler/translator for DOS, Windows, OS/2 Macintosh or UNIX. C++ made easy so get started today!

List: \$100

FAX<sub>cetera</sub> # 1861-0021



**CALL!**

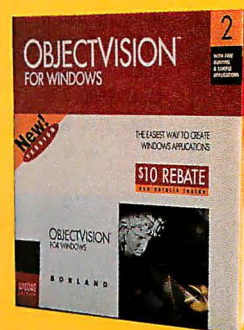
## OBJECTVISION 2.0

The easiest way to create Windows Applications. You simply draw your interface, add logic, and connect to your data - *all without knowing anything about programming*. ObjectVision that combines popular features from spreadsheets, databases, forms products and front-ends, into an easy-to-use WYSIWYG application tool for all Windows users and developers.

List: \$150

**\$95**

FAX<sub>cetera</sub> # 1861-0018



## BORLAND C++ 3.0

With full support for ANSI C and C++ 2.1, a powerful global optimizer, templates, and enhanced performance, Borland C++ is the best and most productive system available for code creation in either the Windows or DOS environments.

Create Windows applications easily from within Windows with the Windows IDE that includes a graphical class browser with speed bars for quick access to common functions. The WinScope utility tracks Windows messages to make debugging easier, and Resource Workshop allows you to visually draw Windows resources. Also includes Turbo Debugger, Assembler and Turbo Profiler.

List: \$495

FAX<sub>cetera</sub> # 1861-0016



**\$299**

## dBASE IV

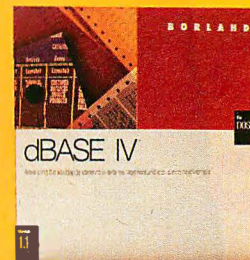
The worldwide standard in data management and application development. More than 3 million users. Now with BORLAND support.

List \$795

**\$499**

FAX<sub>cetera</sub> # 2660-0001

**New!! Version 1.5**



Programmer's  
Paradise



**800-445-7899**

TURN THE PAGE...  
WE HAVE THOUSANDS OF  
PRODUCTS TO CHOOSE FROM!



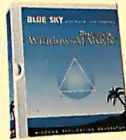
# DEVELOPERS - Your

*Developers, we're here to serve you. Programmer's Paradise offers the world's largest selection of software development tools and utilities at guaranteed low prices. If you don't see what you want call us anyway. And don't forget to ask for our comprehensive catalog.*

## WindowsMAKER Professional

The fastest way to create Windows applications in C. Generates the Windows .EXE with fully commented source and production files. No royalties. Point and click to define user interface. Preview your design to instantly test look and feel. Make changes on the fly without compiling. Custom code is preserved during code generation. Supports C++. True Visual Programming in C.

List: \$995 Ours: \$795  
FAXcetera #2602-0003



### 386/486 Development

Intel 386/486 C Code Builder	489
Lahey EM/32 w/OS 386	1089
LPI Basic 386	CALL
PharLap 386 Dos Extender	435
WATCOM C8.5/386	579
Zortech C++ Devel. 3.0	CALL

### Assembly/Disassembly

DIS DOC Professional	209
MS Macro Assembler 6.0	99
Spontaneous Assembly	169
Turbo Debugger & Tools	105

### C/C++ Compilers

Borland C++	299
& Application Frameworks	499
LPI C++	CALL
Microsoft C/C++ 7.0	299
MS QuickC for Windows	125
Turbo C++	69
w/TurboVision	139

### C-Application Generators

CASE-W Corporate	899
dANALYST GOLD	CALL
WindowsMAKER Prof.	795

### C Communications

BreakOut II	189
C Async Manager	139
Essential Comm	259
Greenleaf CommLib	287
Greenleaf ViewComm	319
SilverComm C Async	215

## Dan Bricklin's Demo II

Experience for yourself why 30,000 people have made Demo II 3.0 the leading tool for producing program prototypes, demonstrations, and tutorials.

Demonstrate commercial software to potential customers without shipping live software. Produce effective tutorials that interactively teach products. Create Computer Based Training for a fraction of the cost of dedicated CBT authoring software.

List: \$249 Ours: \$215  
FAXcetera # 0233-0003



### C File Management

AccSys for dBASE	349
Btrieve	359
Code Base 4.5	225
c-tree Plus	459
Essential Btree	159
Faircom SQL Server	399
Toolbox, Prof. Edition	899
Toolbox, Special Edition	569

### C General Libraries

/*resident_C*/4.0	195
C TOOLS PLUS	105
C Utility Library	195
Dolphin C Toolkit	105
Greenleaf Functions	175
Greenleaf SuperFunc.	235
Turbo C TOOLS	105
WKS Library	165

## DataBoss 3.5

Rational DBMS application generator used to develop complete database applications with menus, forms, pick lists, memo windows, reports and more. Includes sophisticated screen painter, field definition template, WYSIWYG report designer, modifiable skeletal files and generator engine which generates structured "C" or Pascal source code. Source code included for all libraries.

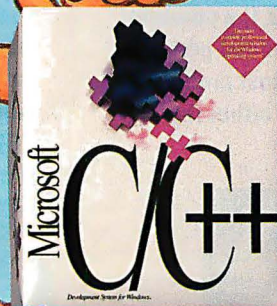
List: \$695 Ours: \$579  
FAXcetera #3758-0001



## Product of the Month: Microsoft C/C++ 7.0

It's Here!! The complete solution for creating Windows applications. Microsoft Foundation Classes help you make a smooth transition to the increased productivity of object-oriented programming, while you generate fast, tight code. Microsoft C/C++ is a complete implementation of the AT&T C++ version 2.1 specification, allowing you to integrate C++ classes into your existing C applications.

List: \$495 Ours: \$299  
FAXcetera #1269-0014



### C Screens

C Worthy	399
Greenleaf Data Windows	315
Vermont Views	415
Vitamin C	285

### C- Additional Products

C-Doc	165
MKS LEX & YACC	195
PC Lint	105

### C++ Libraries/Utilities

BrieforC++	CALL
C++Views	415
Codebase ++	225
Greenleaf Comm C++	285
ObjectGraphics	CALL
Object Manager	265
Object Professional for C++	195
Rogue Wave Math.h++	175
Rogue Wave Tools.h++	175
Win++	225

International: 908-389-9228  
Customer Service: 908-389-9229

Canada: 800-445-7899  
Fax: 908-389-9227

Programmer's

800-445-7899



# software source!

## Database Development

Parion Professional	525
Zipper	521
DataBoss 3.5	579
BASE IV	CALL
BASE IV Devel. Edition	845
dxPro	489
dxPro Distribution Kit	CALL
Paradox 3.5	525
4E Database Library	279
4R Code Generator	169
4R Report Writer	219
4y What!	49
4ilverClip/Fox SPCS	215

## Pascal

Topaz	89
Turbo Pascal for Windows	169
Turbo Pascal Professional	209
Turbo Professional	99
<b>Prototyping</b>	
Dan Bricklin's Demo II	215
ShowPartner F/X	355
<b>Version Control</b>	
MKS RCS	CALL
PVCS Config. Builder	199
PVCS Version Manager	479
TLIB	109

## Utilities

386MAX	69
After Dark	29
Bar Code Library	319
Blue MAX	89
HJAAK	139
Hold Everything	159
INSTALIT	135
Label Master	399
MKS Toolkit	199
Norton Anti-Virus	99
Norton Commander	99
Norton Utilities 6.0	129
Opt-Tech Sort/Merge	119
PC Tools Deluxe 7.0	115
SpinRite II	69
Stork Installation	CALL
SUNSHOW Image Library	CALL
UpShot	139

## WindowsTeach Professional

The fastest and easiest way to learn Windows programming is here now. Learn to program Windows with SDK or Borland C++ using this interactive and graphic self-paced tutorial. Zoom in/out and walk-through 21 source code lessons in C for the key components of Windows. See clear multi-level explanations of how Windows programs work.



List: \$123      Ours: CALL  
FAXcetera #1798-0002

## After Dark™

NEW! Save your screen with over 40 incredible displays. 2.0 features 5 brand new displays, digital sound, true color graphics, wall zapper (instantly turns an After Dark display into Wallpaper), network password support, new fish, and MultiModule! Also, DOS blanking to black and password protection.



List: \$50      Ours: \$29  
FAXcetera #3025-0001

### GUARANTEED BEST PRICES\*

Should you see one of these products listed at a lower price in another ad in this magazine, **CALL US!** We'll match the price, and still offer our same quality service and support!

#### Terms of offer:

- \* Offer good through March 31, 1992
- \* Applicable to pricing on current versions of software listed.
- \* March issue prices only.
- \* Offer does not apply towards obvious errors in competitors' ads.
- \* Subject to same terms and conditions

## Debuggers

Multiscope Debugger	CALL
Periscope Debuggers	CALL

## Editors

Brief	199
Multi Edit	89
Multi Edit Professional	139
Quick Editor	154
Text Plus	115

## FORTRAN

SheyF77L	535
MS FORTRAN	299
WATCOM FORTRAN 77/8.5	449

## Windows Development

Actor Professional	399
CASE-W	435
CASE-W Corporate	839
CODEPAD for Windows	95
dBFAST/Windows	CALL
Distinct TCP/IP for Windows	445
MEWEL	259
ObjectVision	95
Smalltalk/Windows	395
ToolBook	329
WindowsMAKER Professional	795
Windows Teach Professional	CALL
Whitewater Resource Toolkit	CALL

## WATCOM C8.5/386

Develop and debug 32-bit applications for extended DOS and Windows with the most complete 32-bit C development package available. Includes the royalty-free DOS/4GW DOS extender by Rational Systems, components from MS Windows SDK, compiler, linker, debugger, profiler, run-time compatibility with WATCOM FORTRAN 77/386 V8.5 plus numerous development tools. Supports other industry standard 32-bit DOS extenders. Create ADS Applications for AutoCAD or for embedded systems development.



List: \$795      Ours: \$579  
FAXcetera #1683-0001

## Graphic Libraries

Baby Driver II	229
BLACKHAWK dGT	259
Essential Graphics GUI	219
Essential Graphics Kernel	149
raf/Drive Plus Dev.	269
Graphics-MENU	189
FX Effects 2.0	179
FX Graphics	179
FX Text 2.0	125
alo Professional	279
CON-TOOLS	119
Genuet	259
SUNSHOW Products	CALL
3L 2D, 3D	CALL
Actor Image Library	179

## Linkers/Profilers

Linker - NEW VERSION!	CALL
Link86 Plus	335
TLINK/Plus	355

### Phone Orders

Mon-Fri 8:30 AM-7PM EST, Sat 9:30-2:30 EST. We accept MC, Visa, AMEX. Domestic shipments, please add \$5 per item for shipping/handling (UPS ground). Domestic COD shipments, please add \$3. Rush service available.

**Mail or FAX / International Orders/ Domestic Purchase Orders** Phone number required.

**Returns** Subject to \$25 processing charge.

**FAXcetera (908) 389-8173** Call from your FAX telephone and follow the instructions to receive more information on the products featured above!

**Corporate Accounts** Call CORISOFT, our corporate sales division. Ask about volume purchase agreements.

\* All prices subject to change without notice.

Circle 76 on Inquiry Card.

Paradise

800-445-7899

CORPORATE (CORISOFT): 800 422-6507

800-445-7899



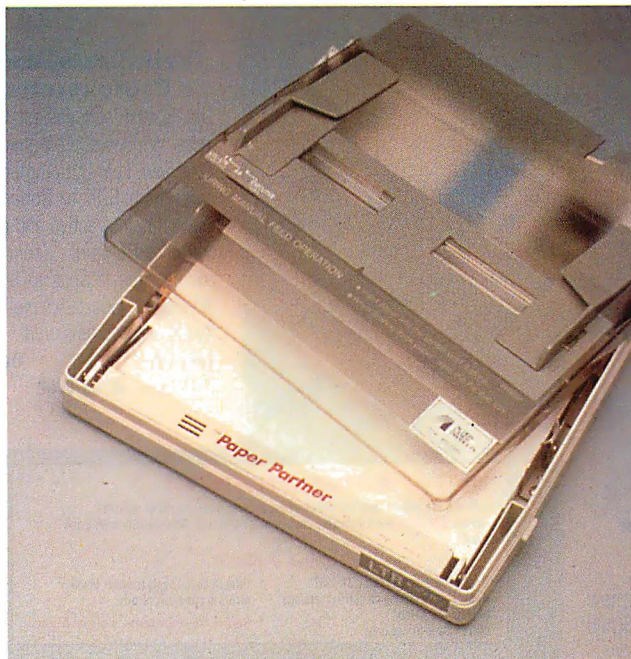
### At the Beep, Refill the Tray

**T**he self-contained and self-powered Paper Partner lets you know when your Hewlett-Packard or Apple LaserWriter printer has run out of paper. Compact and easy to install, the electromechanical device fits into the paper tray. Its nickel-plated contact and sensor arm, which rests on the paper, starts signaling when it touches the bottom metal plate of the tray and continues to beep until the tray has been refilled.

**Price:** \$69.95.

**Contact:** Action Laser Products, 1440 South State College Blvd., Suite 3D, Anaheim, CA 92806, (800) 289-1983 or (714) 491-1983; fax (714) 491-0501.

**Circle 1285 on Inquiry Card.**



*The Paper Partner tells you when your printer is out of paper.*

CA 91320, (800) 854-7600 or (805) 499-5751; fax (805) 498-8306.

**Circle 1286 on Inquiry Card.**

### 66 Fonts in a Cartridge

**T**he latest of Computer Peripherals' JetWare font cartridges, the DeskJet cartridge provides 66 high-resolution fonts for Hewlett-Packard DeskJet 500 ink-jet printers. The cartridge includes CG Times, Univers, Brush Script, and Dom Casual typefaces.

When you plug the cartridge into the DeskJet 500 printer, the printer drivers are automatically installed in the application, giving you access to the font sets, each of which supports as many as 15 symbol sets, including European languages. DeskJet ships with a complete set of drivers for word processing and desktop publishing software such as Windows 3.0 and WordPerfect 5.1.

**Price:** \$149.

**Contact:** Computer Peripherals, Inc., 667 Rancho Conejo Blvd., Newbury Park,

### Network Cable Tester

**T**he DX40A Network Cable Tester instantly checks the integrity of any twisted-pair cable wired for Ethernet, 10Base-T, or AT&T 258A applications. After you plug in both cable ends, the unit displays the test results via four two-color LEDs that show whether the cable is wired according to the standard. By combining two units, you can test unshielded twisted-pair wire that has already been installed. The cable tester operates from an internal 9-V alkaline battery.

**Price:** \$39.95.

**Contact:** L-com, Inc., 1755 Osgood St., North Andover, MA 01845, (508) 682-6936.

**Circle 1287 on Inquiry Card.**

### PC-Compatible Temperature Logger

**C**reate detailed temperature charts on your PC with just a few keystrokes using the XR220 Pocket Logger and software. A four-channel pocket-size temperature recorder, the XR220 can record up to 32,256 time-based temperature readings over a time span of less than a day or more than 2 years. The Pocket Logger software lets you transfer the recorded data to your PC. The logger's circuitry protects against signal noise.

**Price:** Starter kit with an XR220 Pocket Logger, Pocket Logger software, PC interface cable, and temperature probe, \$595; logger only, \$495.

**Contact:** Pace Scientific, P.O. Box 10069, Charlotte, NC 28212, (704) 568-3691; fax (704) 568-0278.

**Circle 1288 on Inquiry Card.**

### A Digitizer the Size of a Mouse Pad

**B**illed as the world's smallest digitizer, the AceCat 5- by 5-inch tablet takes up less space than a normal-size mouse pad and weighs only 1½ pounds. Designed with ergonomics in mind, the AceCat gives you the freedom to sit, stand, or even recline while using it.

The AceCat includes four drivers: AADI, for Autodesk applications; Ace96, with a utility file for setting tablet parameters for applications that support a larger tablet; a mouse driver; and a Windows driver. You also get a two-button stylus pen.

**Price:** \$129.

**Contact:** AceCAD, 8 Harris Court, Building A-100, Monterey, CA 93940, (800) 676-4223 or (408) 655-1900; fax (408) 655-1919.

**Circle 1289 on Inquiry Card.**

### Measure Electromagnetic Fields

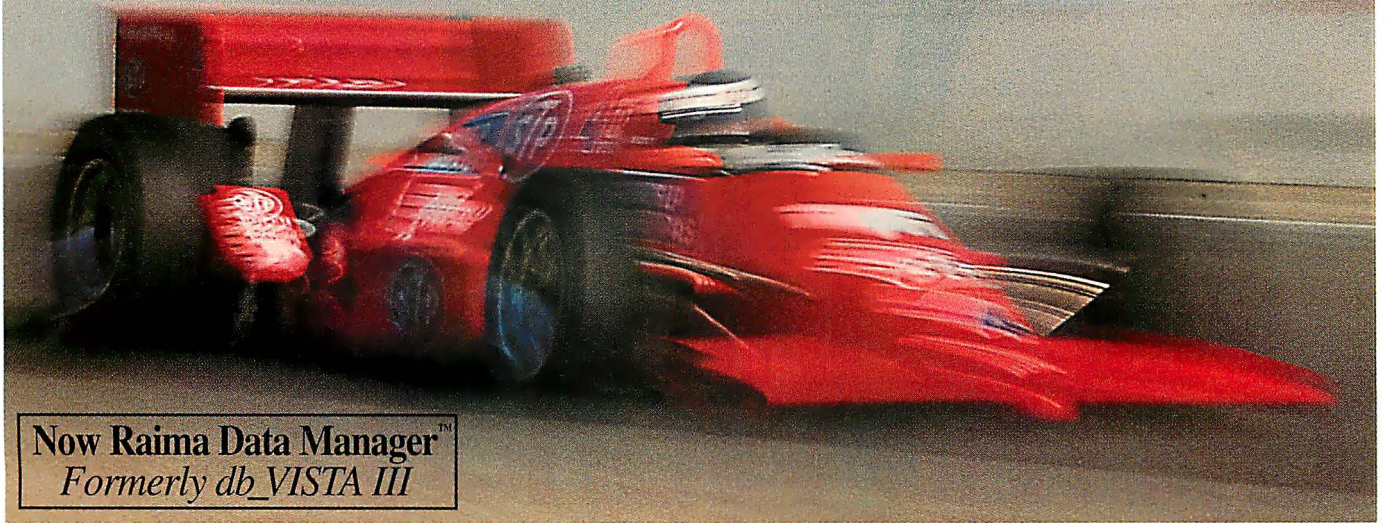
**A** field radiation monitor that measures potentially hazardous electromagnetic radiation generated by AC power lines, transformers, video display terminals, lamp ballasts, and related products, Walker's MF-5D Portable Fluxmeter measures from the gamma level up to 200 kilogauss. Incorporating an instrument, a sensor, and a cable, the fluxmeter has a frequency response range from DC up to 100 kHz.

**Price:** \$1753; coils, \$283 to \$600.

**Contact:** Walker Scientific, Inc., Rockdale St., Worcester, MA 01606, (800) 962-4638 or (508) 852-3674; fax (508) 856-9931.

**Circle 1290 on Inquiry Card.**

# Raima Database Engine Captures Fortune 500 With Record Speed



Now Raima Data Manager™  
Formerly db\_VISTA III

## Accelerated Database Performance

Compared to conventional relational databases, retrieval of records can be 10—20—even 50 times faster with Raima Data Manager from Raima Corporation.

## Propelling The Biggest Names In Business

Companies like General Motors, Hewlett-Packard, IBM, Eastman Kodak, Rockwell and others are using Raima Data Manager in their competitive environments. Today's most critical, most demanding applications demand the high performance of Raima Data Manager.

## Powerfully Efficient Leading-Edge Technology

Raima's combined technology merges the flexibility of relational databases with the lightning speed and efficient

**Raima Data Manager™**  
*The High Performance DBMS*

### Specifications

Relational B-tree indexing. Network data model. Relational SQL query and report writer. Single & multi-user. Automatic recovery. Built-in referential integrity. Supports: VMS, QNX, ULTRIX, UNIX System V, Berkeley 4.2, AIX, SunOS, SCO, MS DOS, MS Windows, and OS/2. Most C Compilers and LANs supported.

Raima Corporation 3245 146th Place S.E., Bellevue, WA 98007 USA (206)747-5570 Fax: (206)747-1991  
International Distributors: Australia: 61 2 419 7177 Belgium: 32 2 734 9818 Finland: 358 080405350 France: 33 1 46 09 27 84 Germany: 49 7022 34077; 49 214 91051 Italy: 39 49 829 1285  
Japan: 81 33 865 2140 Mexico: 52 83 49 53 00 The Netherlands: 31 2159 46814 Norway: 47 2 38 48 88 Singapore: 65 334 0061 Sweden: 46 13 111 588 Switzerland: 41 64 517475  
Taiwan: 886 2 552 3277 United Kingdom: 44 992 500919 Copyright ©1992 Raima Corporation, All rights reserved. Photo: Dale LaFollette

storage of the network model. With the program written entirely in C, you can "fine-tune" the Raima Data Manager engine for optimum performance in any application.

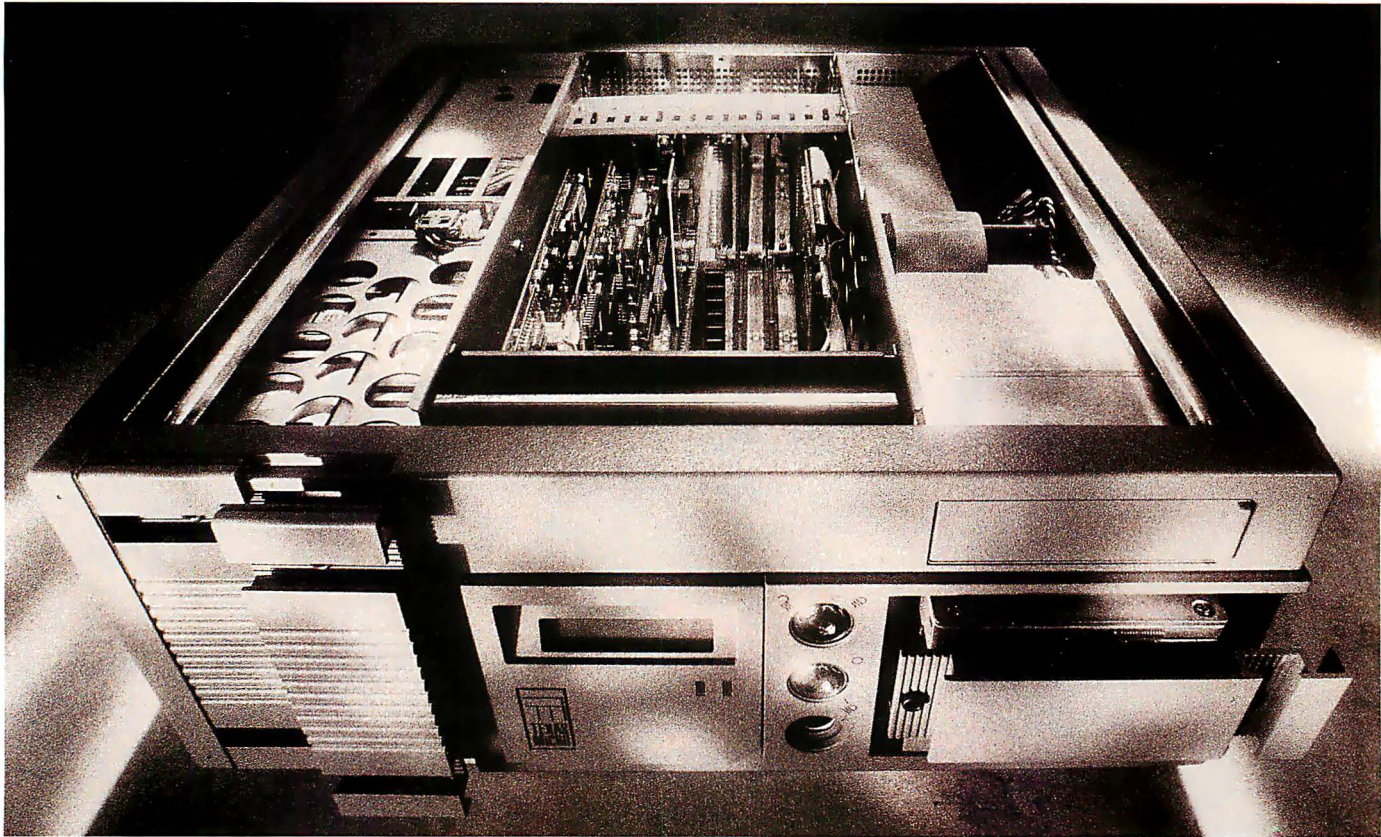
## Put Yourself In Fast Company

Give yourself the competitive edge of Raima Data Manager:

- Speed—faster access to data
- Portability—supports most environments
- Royalty-free—increase your profits
- Source code availability—total programming flexibility
- Full Raima support services—including training

Whether you're writing a stand-alone DOS application, or one for UNIX accessing thousands of records, Raima Data Manager will put your application on the fast track. Race to the phone and call for more information!

In the U.S. or Canada, call: **1-800-DB-RAIMA**  
In Washington state or international, call: **(206)747-5570**



# Inside Information On The World's First Fault Tolerant PC.

## INTRODUCING THE FAULT TOLERANT PC

FROM TEXAS MICRO. If you're the kind of person who absolutely has to protect your data and applications, your PC has arrived.

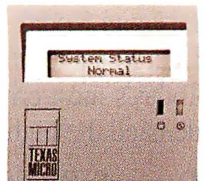
It will save you from head crashes. It will save you from blackouts and user errors. It will save you from dust, heat, vibration, bad sectors, power fluctuations, bumps and bruises.

It thrives where ordinary PCs knuckle under. It's the pit bull of PC-dom. It's the FTSA™ PC from Texas Micro, and it redefines fault tolerance.

## THE FTSA PC IS BUILT FAULT TOLERANT

FROM THE GROUND UP. It's not another PC with add-ons. Instead, the FTSA PC is based on Texas Micro's own Fault Tolerant System Architecture™, which operates at the BIOS level, creating an umbrella of fault tolerance ordinary PCs can't begin to compete with.

Each component is part of a synergistic unit, directed by a specialized, DOS-compatible BIOS. This makes FTSA transparently



The diagnostic system keeps you apprised of power, data and component status.

# For Complete Inside Information, Place This Card Inside Your Mailbox.

For free information about the FTSA PC, send in this card; FAX this card to 1-713-933-1029; or for immediate attention, call 1-800-627-8700.

I PURCHASE COMPUTERS FOR:

Internal company use  Resale  Both

I AM INTERESTED IN FAULT TOLERANCE FOR:  Stand alone PC

Network server  Both

APPLICATIONS YOU ARE RUNNING: \_\_\_\_\_  
\_\_\_\_\_

DO YOU CURRENTLY HAVE ANY FAULT TOLERANT PROTECTION?

Yes  No

IF YES:  UPS  Disk mirroring  Redundant power

Other \_\_\_\_\_

PROCESSOR:  386  386 SX  486  Other

CONFIGURATION:  Desktop  Rackmount  Tower

IMPORTANT SPECIFICATIONS:  Data security  Industrial

System availability  Power management

Other \_\_\_\_\_

PURCHASE TIMEFRAME:  30 days  60 days  1 year

NAME \_\_\_\_\_

TITLE \_\_\_\_\_

COMPANY \_\_\_\_\_

PHONE \_\_\_\_\_

FAX \_\_\_\_\_

ADDRESS \_\_\_\_\_

CITY \_\_\_\_\_

STATE \_\_\_\_\_ ZIP \_\_\_\_\_

B392

# Resellers, Give Yourself The Inside Track To PC Fault Tolerance.

Texas Micro has reseller programs and incentives that will interest you. Simply mail this card, FAX it to 1-713-933-1029 or call 1-800-627-8700.

I AM A/AN:  OEM  VAR  Systems Integrator

Other \_\_\_\_\_

ON WHAT APPLICATIONS DO YOU PRIMARILY FOCUS? \_\_\_\_\_  
\_\_\_\_\_

I AM INTERESTED IN FAULT TOLERANCE FOR:  Stand alone PC

Network server  Both

DO YOU CURRENTLY PROVIDE FAULT TOLERANT SOLUTIONS?

Yes  No

IF YES:  UPS  Disk mirroring  Redundant power

Other \_\_\_\_\_

DO YOU WORK WITH A SPECIFIC PC BRAND TO CREATE FAULT

TOLERANT SOLUTIONS?  Yes  No

NAME \_\_\_\_\_

TITLE \_\_\_\_\_

COMPANY \_\_\_\_\_

PHONE \_\_\_\_\_

FAX \_\_\_\_\_

ADDRESS \_\_\_\_\_

CITY \_\_\_\_\_

STATE \_\_\_\_\_ ZIP \_\_\_\_\_

BR392



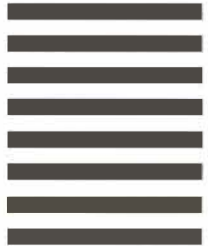
NO POSTAGE  
NECESSARY  
IF MAILED  
IN THE  
UNITED STATES

**BUSINESS REPLY MAIL**  
FIRST-CLASS MAIL      PERMIT NO. 2484      HOUSTON, TX

POSTAGE WILL BE PAID BY ADDRESSEE



TEXAS MICRO  
10618 ROCKLEY RD.  
HOUSTON, TX 77099-9986



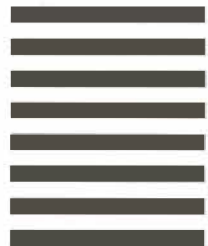
NO POSTAGE  
NECESSARY  
IF MAILED  
IN THE  
UNITED STATES

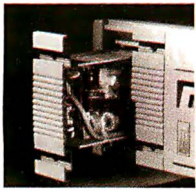
**BUSINESS REPLY MAIL**  
FIRST-CLASS MAIL      PERMIT NO. 2484      HOUSTON, TX

POSTAGE WILL BE PAID BY ADDRESSEE



TEXAS MICRO  
10618 ROCKLEY RD.  
HOUSTON, TX 77099-9986



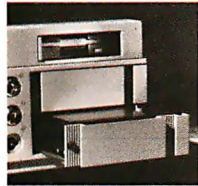


The FTSA PC has two externally removable power supplies with a built-in backup battery.

adaptable, giving it numerous ways to detect and correct system faults, without user intervention. The result is a level of intelligent data and system protection never before achieved in PCs. And FTSA does it

all without sacrificing performance.

THE FTSA PC IS FIERCELY PROTECTIVE OF YOUR DATA. With selective component redundancy and monitoring, FTSA virtually guarantees data integrity. FTSA begins with a data-mirroring disk array, which is supplemented by sophisticated auditing and archiving systems that make your data impervious to system crashes and corruption.



A disk array mirrors data to protect you from head crashes.

Employing a unique strategy called "data change auditing," FTSA keeps bit-level records of every data transaction to the disk. This allows you to roll back the record to any point in time and reconstruct lost files, even if you deleted them.

To further protect data and applications, FTSA allows you to easily program special "save" commands that execute during any shutdown sequence. Should system shutdown become imminent, FTSA will automatically write all data to the hard drives and exit your applications safely.

THE FTSA PC KEEPS YOU UP AND RUNNING. This makes it ideal for mission-critical applications and workgroup LANs. In fact, FTSA provides a fault tolerant solution for LANtastic and NetWare Lite right out of the box.

Should normal power fail, FTSA has a built-in battery backup to keep you on-line long enough to secure a safe shutdown. The disk array virtually

eliminates downtime due to hard disk crashes.

Every component is monitored and regulated by a coprocessor-driven diagnostic system that provides early indications in English of any impending problem, such as disk wear, power fluctuations and potential component failure.

FTSA has several cabinet configurations to conform to different environmental specifications—from desktops to industrial sites.

FTSA LETS YOU POP IT AND SWAP IT. The FTSA PC's modular design and passive backplane give you plug-and-play access to every major component, including CPU and option cards, which reduces

Mean Time To Repair to under 10 minutes. And gives you complete CPU upgradability.

THE BIGGEST BREAKTHROUGH IS THE PRICE.

FTSA truly stands alone. In fact, to match its fault tolerance, you'd have to spend 5 to 10 times more and get a minicomputer. No wonder the FTSA PC was awarded Best Desktop PC at Comdex by Byte Magazine.



Winner

Detailed information about the FTSA PC and our free "Guide to Fault Tolerant Computing" are just a phone call away. Find out today how you can benefit from a PC that has inner strength.



FTSA Desktop

FTSA Micro-tower

FTSA Rackmount

- 8-slot passive backplane
- 386/486 upgradable CPUs
- SCSI hard drives from 80-525 MB
- 1.44 MB floppy
- Up to 1024x768
- Redundant power supplies
- Built-in backup batteries



**Get An Insider's Look At The FTSA PC. Call 1-800-627-8700.**



### Get a Grip on Token Ring

**F**eaturing Xircom's Tractor Grip for one-handed installation, the Pocket Token Ring Adapter II is software switchable, letting you connect your laptop or desktop computer to a 16- or 4-Mbps Token Ring network. Preconfigured with SmartRing software (developed by Xircom and Madge Networks), the adapter connects to your PC's parallel port and is available for use with shielded or unshielded twisted-pair wiring. The unit has top-panel diagnostic lights.

**Price:** \$845.

**Contact:** Xircom, 26025 Mureau Rd., Calabasas, CA 91302, (818) 878-7600; fax (818) 878-7630.

**Circle 1291 on Inquiry Card.**

### V.42 Power in Your Pocket

**T**he Practical Pocket Modem (PM2400PPM) V.42 SendFax from Practical Peripherals puts in a pocket-size package a full-function 2400-bps data modem with 9600-bps fax transmission capabilities. The data modem supports V.42 error correction and V.42bis data compression. Powered by a plug-in



*The lightweight Practical Pocket Modem V.42 SendFax does heavy-duty faxing.*



*The software-switchable Pocket Token Ring Adapter II links laptops to LANs.*

wall power pack or a nickel-cadmium battery pack—both are included—the PM2400PPM V.42 SendFax weighs 4 ounces and measures 2 1/4 by 3 by 3/4 inch. The unit is compatible with all Group 3 fax systems as well as with the Hayes Smartmodem. Menu-driven Quick Link II fax communications software comes with the modem.

**Price:** \$299.

**Contact:** Practical Peripherals, 31245 La Baya Dr., Westlake Village, CA 91362, (818) 706-0333; fax (818) 706-2474.

**Circle 1292 on Inquiry Card.**

### Wire Converter

**T**he 10305 Ethernet external 10Base-T Media Attachment Unit enables integrators to convert existing coaxial or autonomous unit interface wiring to 10Base-T via the AUI port. The 10305's ability to detect collisions or cabling malfunctions maintains the network's integrity. The MAU fea-

tures a diagnostic LED that indicates link, jabber, and reversed polarity and uses standard unshielded twisted-pair and shielded twisted-pair wire.

**Price:** \$100.

**Contact:** Network Interface Corp., 15019 West 95th St., Lenexa, KS 66215, (800) 343-2853 or (913) 894-2277; fax (913) 894-0226.

**Circle 1293 on Inquiry Card.**

### Dove Flies to PCs

**D**oveFax for DOS supports the Class 1 fax/modem standard in its 9600-bps fax/2400-bps data modem. Featuring full background send and receive capability, call grouping and scheduling, and customizable cover pages, DoveFax for DOS automatically updates logs of incoming and outgoing faxes.

The fax driver in DoveFax for DOS loads into expanded memory, providing immediate access to the software's capabilities; pop-up DOS application support lets you fax directly from your applications. MNP level 5

data correction and compression are included in the software.

**Price:** \$299.

**Contact:** Dove Computer Corp., 1200 North 23rd St., Wilmington, NC 28405, (919) 763-7918; fax (919) 251-9441.

**Circle 1294 on Inquiry Card.**

### Da Vinci eMail Upgraded

**D**a Vinci eMail 2.0 for DOS offers increased power and modularity via its open systems architecture, which provides a set of application programming interfaces that let you customize the product as well as develop third-party gateways. In the open systems design, the core code of the product is connected to transmission, directory, storage, and network operating-system services.

Features new with version 2.0 include folders for organizing and archiving received mail, message storage that automatically recovers and reuses space from deleted messages, enhanced user directories, an edit menu with a spelling checker, display in 43- or 50-row mode, and MHS support. Da Vinci eMail 2.0 is fully compatible with earlier versions.

**Price:** 10-user starter pack, \$295.

**Contact:** Da Vinci Systems Corp., P.O. Box 17449, Raleigh, NC 27619, (800) 328-4624 or (919) 881-4320; fax (919) 787-3550.

**Circle 1295 on Inquiry Card.**





**JIM POWELL**

*Texas Instruments,*

*Manager of Distributed Information Services*

*Products: LAN Manager, SQL Server,  
Windows, Microsoft Excel*

*Servers Installed: 12 mainframes,  
3,500 minicomputers, 500 PC servers*

*PC Workstations: 40,000*

*Business Purposes: Marketing, finance, administration,  
manufacturing and office automation.*

# Texas Instruments' top executives get to the bottom line instantly with Microsoft client-server computing.

Every business wants to know the bottom line. Thanks to Microsoft's client-server computing solution, Texas Instruments' upper management sees it instantly. Right on their own PCs.

---

**"PEOPLE DON'T JUST WANT ACCESS TO DATA. THEY WANT TO CREATE IT, CHANGE IT AND MAKE IT THEIR OWN."**

---

They can also track inventory, monitor sales, check raw material prices and find other information needed to make decisions.

And that's how Jim Powell likes it. Because as Texas Instruments' Manager of Distributed Information Services, it's his job to provide his co-workers with the computer support they need. And with Microsoft client-server computing, his job is a lot easier.

Two years ago, a lot of people at Texas Instruments found the mainframes difficult to use and inflexible.

So Jim started to look at possible solutions. He wanted to find a system that would utilize their existing equipment, allow MIS to rapidly develop applications, and provide the end users with an easy-to-use interface.

He discovered Microsoft client-server computing was just what Texas Instruments needed.

The Windows<sup>®</sup> environment was placed on the desktops and Microsoft<sup>®</sup> LAN Manager and SQL Server were integrated into the system.

There were dividends right away.

Jim's group was able to quickly develop client-server applications, like the executive decision support system. Which means the users didn't have to wait forever to get the computer support they

---

**"NOW I CAN PUT APPLICATIONS INTO THE HANDS OF PEOPLE THAT WOULDN'T HAVE GOTTEN THEM OTHERWISE."**

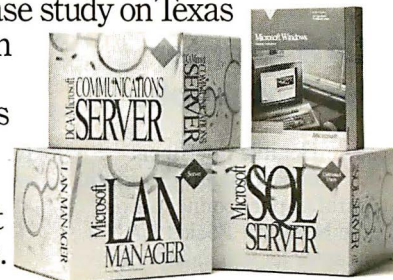
---

needed. And with Windows, the information on the mainframes was easier to access.

Simply put, Jim was able to get the right information, to the right people, the right way.

If you'd like a case study on Texas

Instruments' migration to Microsoft's client-server solution, call us at (800) 992-3675, Dept. X32. We'll tell you how you can profit from their experience.



## **Microsoft<sup>®</sup>**

### Document Manager Scans and Captures

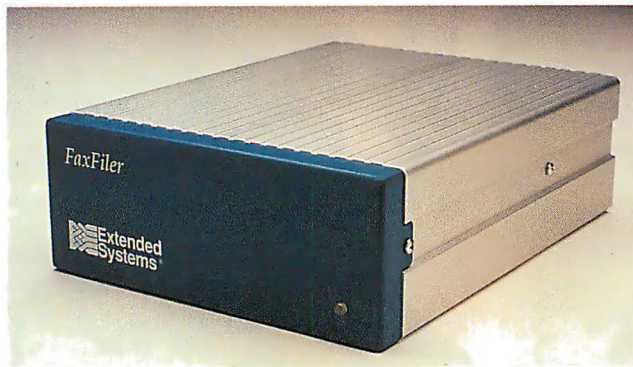
**F**axFiler has gained additional duties. Now able to give your fax machine the capability to scan documents and capture fax images to your PC, FaxFiler can still send and receive faxes and manage fax documents in a database file. The components FaxScan, which only scans, and FaxCapture, which only scans and captures, are also available separately.

Compatible with DOS and packaged with Windows 3.0, FaxFiler enables you to use your existing fax machine as a hard-copy input device to your PC fax card without requiring an additional phone line. You can save fax documents to your hard disk in standard formats for viewing later, resending, or editing, and you can save images in TIFF. FaxFiler automatically captures incoming and outgoing faxes in DOS and Windows and simultaneously receives fax documents at your computer system and fax machine.

**Price:** \$695; FaxScan, \$395; FaxCapture, \$495.  
**Contact:** Extended Systems, 6123 North Meeker Ave., Boise, ID 83704, (800) 235-7576 or (406) 587-7575; fax (208) 377-1906.  
**Circle 1296 on Inquiry Card.**

### LAN Adapter for Notebooks

**A** flexible intelligent cable and a lightweight parallel port connector on the NotePort Pocket LAN adapter let you easily join your notebook computer to a network. Supplied with connections for 10Base-T and coaxial Ethernet



Scan and capture images to a PC with the newest FaxFiler.

LANs, the NotePort connects to the notebook's parallel port and automatically senses the cabling interface that you select.

The NotePort integrates its power supply into its 3½-by 5½-by 1½-inch form. Preconfigured with NetWare software drivers, the unit's one-step installation procedure enables you to quickly link up to your LAN.

**Price:** \$395.  
**Contact:** Kodiak Technology, 1338 Ridder Park Dr., San Jose, CA 95131, (408) 441-6900; fax (408) 441-1273.

**Circle 1297 on Inquiry Card.**

### Token Ring Host Module

**T**he Model 3505A UTP Host Module addresses problems that can occur with unshielded twisted-pair (UTP) wiring at high speeds, such as network signal distortion and near-end cross talk. The module provides retiming at each Token Ring hub port, simplifying installation and configuration management, as well as providing consis-

tently reliable network performance, according to SynOptics.

When installed in a SynOptics System 3000 intelligent hub, the Model 3505A supports as many as 132 Token Ring stations as far away as 100 meters from the hub, using the UTP wiring found in most buildings. Compatible with SynOptics' Model 3505 UTP Token Ring Host Module, the Model 3505A can be connected to the 3505 module in a single ring or hub.

**Price:** \$2095.  
**Contact:** SynOptics Communications, Inc., 4401 Great American Pkwy., Santa Clara, CA 95052, (408) 988-2400; fax (408) 988-5525.  
**Circle 1298 on Inquiry Card.**

### X Server for Microsoft Windows

**T**he Xoftware for Windows X Window System server lets you work in Windows 3.0 or 3.1 to cut and paste between X and Microsoft Windows applications. Using Windows as a local window manager, you can configure icons to start specific network-based X applications that have the look and feel of Windows.

You can start X applications in Xoftware's single- or

multiple-window mode, and you can configure the Xoftware for Windows server for your preferred X start-up mode, such as XDMCP, telnet, rsh, rexec, or passive. As a Windows user, you can transparently access X-based Unix and VAX applications, integrating the environments as you work.

**Price:** \$495.  
**Contact:** AGE Logic, Inc., 9985 Pacific Heights Blvd., Suite 200, San Diego, CA 92121, (619) 455-8600; fax (619) 597-6030.

**Circle 1299 on Inquiry Card.**

### A New Network Archivist

**V**ersion 2.0d of the Network Archivist extends the software's intelligent storage management features. The new version has a prioritized list of tapes to use when full system, volume, or disk restores are requested, and it recommends the tape sequence that will ensure the fastest restores. This extension ensures that the volume or system is restored to its original state.

Other new features include the ability to restart a restore if the restore operation is aborted and the TNARECOV utility, which can run unattended restores. Additionally, export operations now record all NetWare security, rights, and attribute information.

**Price:** \$995; upgrades available.  
**Contact:** Palindrome Corp., 850 East Diehl Rd., Naperville, IL 60563, (708) 505-3300; fax (708) 505-7917.

**Circle 1351 on Inquiry Card.**

# RISC FREE!

**NEW!**  
• 4860 FrameBuffer with  
ADI/860 for AutoCAD rel.11  
• 4860 FrameBuffer support with  
RenderSTARTII/860 and CADART/860  
• 4860 AutoCAD workstations from \$4995.  
AutoCAD is a trademark of AutoDESK Inc. RenderSTARTII/860 is a trademark of Modern Medium

## Free i860™ Processor and i860/APX Software!

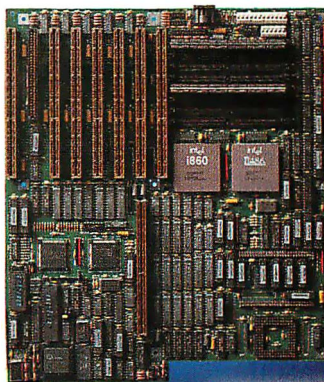
By now, you've probably heard about our industry-first 4860™ MotherBoard that packs the power of the Intel 80486 CPU with the Intel 80860 RISC processor (i486™ + i860 = 4860).

What you haven't heard is that, for a limited time, when you buy a 4860 MotherBoard with 8MB of RAM, Hauppauge will give you an i860 RISC processor and the i860/APX operating system at no additional cost.

Why *give* you this capability? Because you'll enjoy a level of processor performance never before seen in a PC. Our bet is that you'll be so impressed, you'll come back for more!

**A PC Revolution:** In the PC environment, the 4860 is a 486-based MotherBoard with the new EISA I/O bus. It runs over 2 times faster than 386 computers and delivers mainframe power for applications including CAD, LAN and desktop publishing. This board is fully compatible with DOS, IBM's OS/2, Novell Netware and SCO UNIX. What's more, Hauppauge's 4860 supports up to 64 MBytes of memory *without* a RAM expansion board.

**RISC-Y Business:** The i860 processor is ideal in complex applications, performing up to 25 million floating-point operations per second. It adds to the power of the 486, so you can run rings around ordinary PCs.



By adapting Intel's APX (Attached Processor Executive) software to our 4860 MotherBoard, we've created a way to exploit the power of the i860 to give you *practical* multiprocessing. In fact, i860/APX provides a base for entirely new applications made possible by the advent of the i860 RISC processor.

**Technical Features:** 25 or 33MHZ 486/860 • 4 Mbytes of high speed RAM expandable to 64 Mbytes shared between i486 and i860 processors  
• Socket for optional Intel Turbo Cache 485™ and Weitek 4167 • 8 EISA I/O slots • 64-bit expansion slot for optional high-speed graphic frame buffer • 1 parallel, 2 serial ports and a built-in PS/2-style mouse port.

Enjoy a RISC-free investment. Our 4860 MotherBoard is designed with the world's highest performing microprocessors. So you can have the world's highest performing PCs and workstations.

For more information, call 1-800-443-6284.

Hauppauge Computer Works, Inc.  
91 Cabot Court  
Hauppauge, New York 11788  
Telephone: 516-434-1600  
Fax: 516-434-3198  
In Europe (49) 2161-17063  
In Australia: (7) 262-3122  
In England: 071-378-7309



Hall 6  
Booth D51

**Hauppauge!**

Available at your local computer dealer.

## C++ Upgrades from Borland

The release of Turbo C++ for Windows and C++ and Application Frameworks 3.0 further establishes Borland in the Windows development market. The two applications development and maintenance products feature Borland's object-oriented C++.

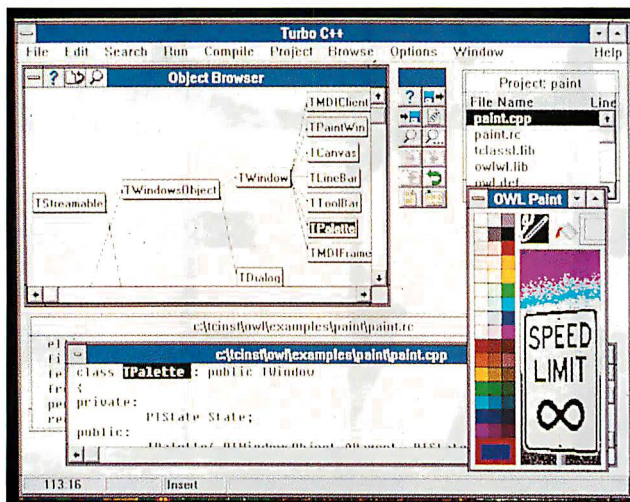
Turbo C++ for Windows offers a GUI development environment with visual programming tools and a library that enables DOS-based C and C++ programs to run in Windows. Turbo C++'s ObjectWindows framework provides built-in objects, and Resource Workshop lets you create Windows resources such as icons, fonts, and bit-mapped graphics without writing code.

C++ and Application Frameworks 3.0 includes all the programming tools provided in Borland C++ 3.0, plus the ObjectWindows and TurboVision applications frameworks. The frameworks let you define a standard user interface for your operating system by providing interface building blocks, fundamental data structures, and support for object-oriented programming.

**Price:** Turbo C++ for Windows, \$149.95; C++ and Application Frameworks 3.0, \$749.

**Contact:** Borland International, P.O. Box 660001, Scotts Valley, CA 95066, (408) 438-8400; fax (408) 439-9343.

**Circle 1300 on Inquiry Card.**



*Turbo C++'s ObjectBrowser lets you visually browse through class hierarchies, functions, and variables.*

## Expert-System Shell Features Ease of Use

Mentor's everyday syntax, automatic menu creation, and development features simplify the task of creating your own expert applications, according to its developer. The program lets you use backward and forward chaining, a procedural language, and object-based reasoning to build applications with multiple knowledge bases. Mentor features interfaces to Lotus 1-2-3, dBase, and ASCII files, and it can interface with files written in C, assembly, FORTRAN, and Pascal.

The program is available in two versions. The personal version lets you develop and run expert applications on a single PC running DOS; the developer's version lets you develop and distribute your applications to other PCs. Mentor is not currently network compatible.

**Price:** Personal version, \$495; developer's version, \$1495.

**Contact:** Icarus Corp., 1 Central Plaza, 11300 Rock-

ville Pike, Rockville, MD 20852, (301) 881-9350; fax (301) 881-2542.

**Circle 1301 on Inquiry Card.**

## A System 7.0 FORTRAN Compiler

Language Systems FORTRAN 3.0 is the first System 7.0-savvy compiler language for the Macintosh operating system, according to its developer. LSF lets you compile applications that include such System 7.0 features as Publish/Subscribe and Apple events. Enhancements to the compiler include 68040 code generation, advanced debugging, and Cray pointers.

LSF's interface to the Mac Edition manager lets you Publish a data file and Subscribe to graphing or spreadsheet applications with automatic data updating.

**Price:** \$495.

**Contact:** Language Systems Corp., 441 Carlisle Dr., Herndon, VA 22070,

(703) 478-0181; fax (703) 689-9593.

**Circle 1302 on Inquiry Card.**

## ART-IM Comes to Windows and Unix

The ART-IM knowledge-based system development tool is available now in Windows and Unix versions. ART-IM/Windows 2.5 and ART-IM/Unix 2.5 use Inference's Case-Based Reasoning technology, which lets you construct knowledge bases from case histories and access those histories when similar situations occur. According to Inference, CBR speeds up development of applications that incorporate experience-based advice, such as help desks and engineering design systems.

In addition to CBR, ART-IM includes rule-based reasoning, procedural programming, and hypothetical reasoning with consistency management. The program supports integration with external databases and provides automatic conversion of external data into ART-IM knowledge-base objects.

ART-IM/Windows supports the environment's Dynamic Data Exchange with applications such as spreadsheets, word processors, and databases. The Unix version features an on-line tutorial and provides support for Sun-4 Sparcstation, HP 9000, IBM RISC System/6000, and other Unix platforms.

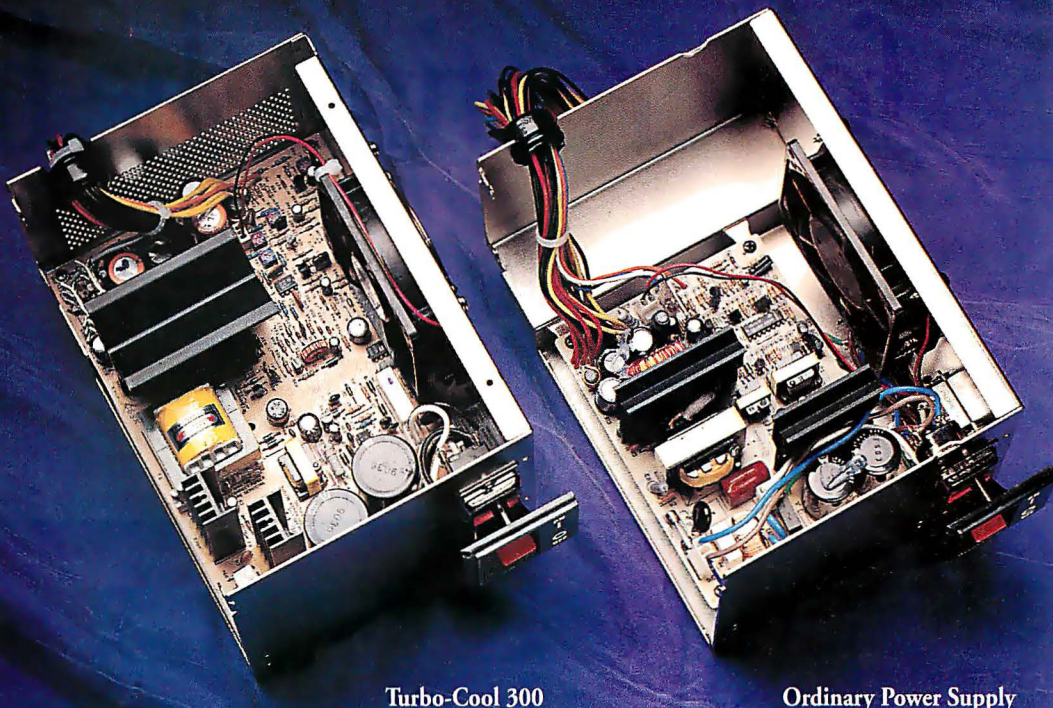
**Price:** Windows version, \$8000; Unix versions, \$12,500 and up.

**Contact:** Inference Corp., 550 North Continental Blvd., El Segundo, CA 90245, (213) 322-0200; fax (213) 322-3242.

**Circle 1303 on Inquiry Card.**

# LOOK AT THE INSIDE STORY ON POWER SUPPLIES.

*What power supply is inside your computer? If you are like most people, you don't know, and frankly, don't care. But, because your computer's power supply is a critical system component, what you don't know, may hurt you. An inferior power supply can cause interference, rebooting, hard drive errors, and other nasty hard-to-track problems. So why take chances? Call the power supply specialists at PC Power and Cooling today.*



Turbo-Cool 300

Ordinary Power Supply

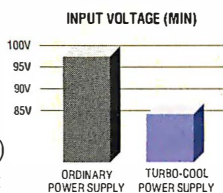
## HERE ARE TEN GREAT REASONS TO SELECT THE INDUSTRY'S BEST, THE TURBO-COOL™ 300 AND TURBO-COOL™ 450.

### 1. 50% TO 100% MORE POWER

The more power, the better! Our high-capacity units start drive motors with ease, run cooler, last longer, and allow for future expansion.

### 2. BUILT-IN LINE CONDITIONING

Turbo-Cool power supplies won't skip a beat when the line voltage sags. Their wide input range (85-135V, 170-270V) and heavy-duty input components protect your PC and its data from sags, surges and spikes.



### 3. FCC-B AND VDE-B LINE FILTER

A dual-stage EMI filter keeps electrical noise well below agency standards.

### 4. INDEPENDENT REGULATION

Turbo-Cool's superior independent-regulation design keeps output voltage tolerances 20 times tighter than that of an ordinary

power supply. This exceptional stability improves hard drive reliability during critical access periods.

### 5. ULTRA-CLEAN DC OUTPUT

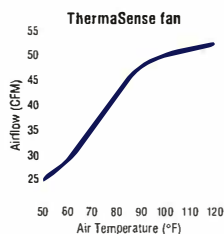
A dual-stage output filter ensures that sensitive computer chips receive pure, low-ripple power.

### 6. PROTECTION CIRCUITRY

Our units offer the most complete protection from dangerous overvoltage, overcurrent, and short circuit conditions.

### 7. THERMASENSE™ COOLING FAN

The Turbo-Cool 300 features ThermaSense, our high-capacity, thermostatically-controlled, variable-speed fan. It's ideal! High-performance systems operate up to 35° cooler while standard ones run as much as 75% quieter.



### 8. UL/CSA/TUV APPROVALS

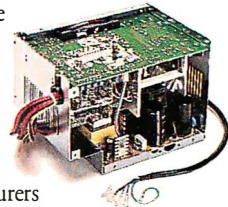
Our high-capacity units are safety approved by not only UL, but also by Canada's CSA and Germany's strict TUV.

### 9. TWO-YEAR WARRANTY

Turbo-Cools are designed and tested for MTBFs of over 100,000 hours. They come with a no-hassle 2-year warranty and a 30-day money-back guarantee.

### 10. GREAT VALUE

Loaded with premium features, a Turbo-Cool power supply will upgrade the performance of your PC or LAN file server at a retail cost of only 55¢ to 80¢ per watt. You'll be powered by a unit that is popular with award-winning PC manufacturers and recommended by experts such as the PC Magazine Advisor!



Turbo-Cool 450

**PC POWER & COOLING, INC.**

5995 Avenida Encinas, Carlsbad, CA 92008 • (619) 931-5700 • (800) 722-6555 • Fax (619) 931-6988

Circle 93 on Inquiry Card (RESELLERS: 94).

# We never dreamed for creating the best PC

Object-oriented, event-driven operation means that you get the benefits of a Graphic User Interface (GUI) on your DOS PCs, and code that's reusable from application to application.

FoxPro 2.0 is the state-of-the-database-art, an object-oriented, event-driven DBMS that runs in DOS to protect your information systems investments.

Rushmore query optimization is unique to FoxPro and gets your answers as much as hundreds of times faster than competitive products.

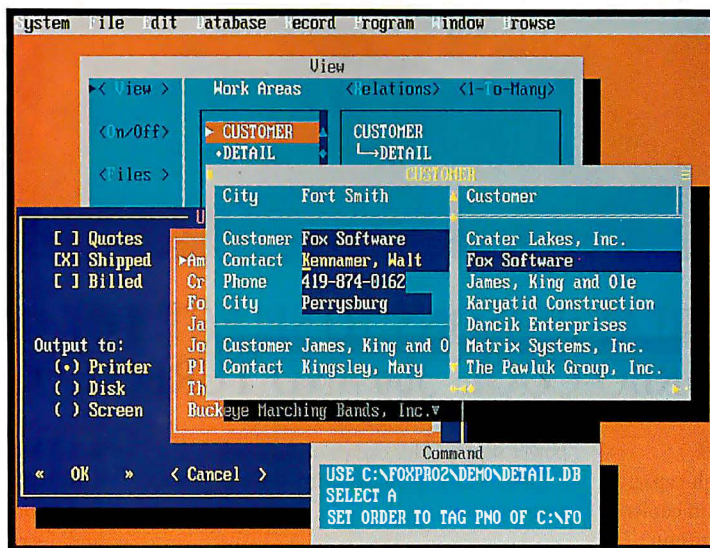
4GL Tools (Fourth Generation Language) simplify the creation of Mac-like applications on your DOS PCs, using keyboard shortcuts or a mouse.

Event-driven operation allows you to work with any number of resizable, scrollable windows, get to all of your data all of the time.

Optional Distribution Kit creates stand-alone .EXE files for distributing your applications.

Application Program Interface (API) links to external libraries written in C or assembler. Third-parties are currently developing communications, client/server access and other packages. (Optional Library Construction Kit available.)

Applications you write in FoxPro 2.0 can exchange data with our FoxBASE+/Mac on a LAN today, will run virtually unchanged under our Windows, Mac and UNIX versions currently in development (no release date yet).



For users, the View window makes it easy to work with multiple tables of data, RQBE (Relational Query By Example) simplifies the creation of business queries.

FoxPro 2.0 runs your industry-standard dBASE programs today, lets you build on your current systems for your needs tomorrow.

Response to FoxPro 2.0 has been overwhelmingly favorable.

And that's the problem: the response has been overwhelming.

We're hearing of callers being on hold for 20 minutes or longer!

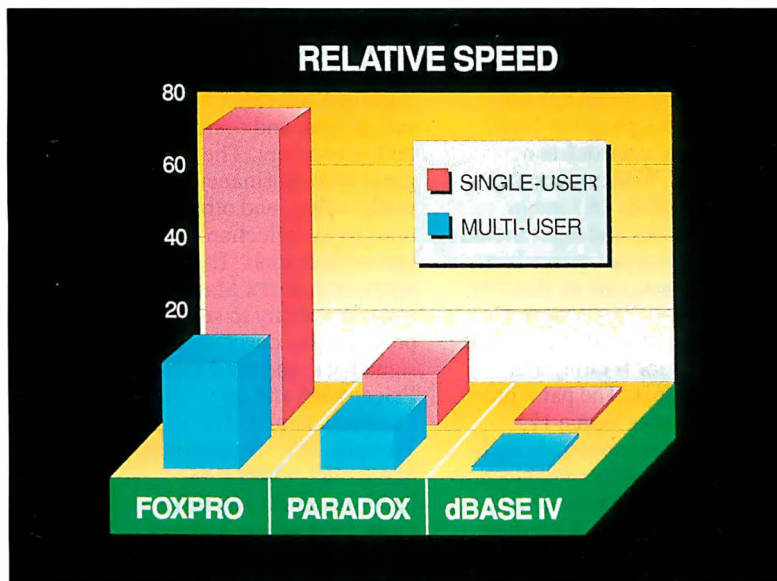
And this in spite of ramping up our support months in advance of the release.

Well, we're adding another 40 phone lines and hiring more people. And if that's not enough, we'll add even more.

In the meantime, we'd like to say

# we'd be apologizing database in the world.

*Results from an extensive suite of query tests independently performed by Micro Endeavors, Inc. and published in the 8/91 issue of Data Based Advisor.*



*FoxPro 2.0 is far faster than the other PC database management systems and raw compilers like Clipper, both single-user and on a LAN.*

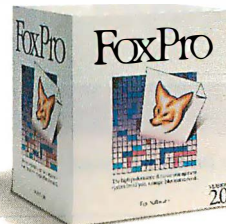
“Thanks” to the tens of thousands of you who put up with the wait, and “Sorry” to those who didn’t.

But please try again. We think we’ve got things under control now.

And FoxPro 2.0 really is worth the wait.

**Call 1-800-837-FOX2 or 419-874-0162 again.**

**(We believe we’ve fixed it.)**



Query benchmark tests performed by Micro Endeavors, Inc. (215) 449-4680. FoxPro and FoxBASE+/Mac are trademarks of Fox Holdings Inc.; other products and services are not. © Fox Holdings Inc. 1991.

**Circle 56 on Inquiry Card.**

### See Your Act Contacts Geographically

**M**apLinX-for-Act merges digital mapping technology with the Act PC contact-tracking database to display your contact data geographically. The add-on software lets you search for contacts on your map and then import that contact information to Act, where you can use the data to do such things as form proposals and compile totals. MapLinX uses ZIP codes to view and select contact regions.

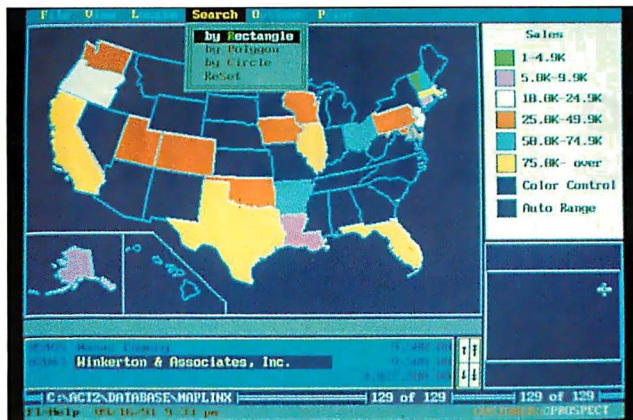
**Price:** Without ZIP code boundaries, \$99; with boundaries, \$399.

**Contact:** MapLinX Corp., 801 Presidential Dr., Richardson, TX 75081, (214) 231-1400; fax (214) 783-9072.

**Circle 1304 on Inquiry Card.**

### Unix Graphics, Mail, and More

**W**ith release 2.0, the Aster\*x office integration system offers improvements to its GUI and word



MapLinX's color mapping capabilities let you associate particular shades with contact, sales, or other information.

processing, graphics, spreadsheet, and mail capabilities. The program runs on eight Unix platforms.

Aster\*x's tool bar lets you access program functions and user-defined macros. Word processing tools provide 16 foreign dictionaries and eight thesauri, and you can merge live foreign text into an Aster\*x document. The program's graphics capabilities include support for rotating and scaling text. The paint program comes with a 125-color palette and tools such as fill, brighten, and blend. Aster\*x 2.0's built-in file formats include X bit-map,

Windows bit-map, and Amiga IFF ILBM. The spreadsheet now lets you drag and drop column widths, highlight individual cells or cell groups, and search for text or numbers. The program adds 46 financial, math, string, and other functions to its collection of spreadsheet tools. Enhancements to Aster\*x Mail include the ability to select preferred fax cover sheets, signatures, and mail format.

**Price:** \$695 and up.  
**Contact:** Applix, Inc., 112 Turnpike Rd., Westborough, MA 01581, (508) 870-0300; fax (508) 366-9313.  
**Circle 1305 on Inquiry Card.**

### Project Management with Motif GUI

**R**unning in the HP-UX environment, AutoPlan offers graphical project management to users of HP 9000 workstations. AutoPlan lets you produce bar charts and histograms that illustrate project schedules, resources, costs, and rela-

tionships within your work. The program uses the Motif GUI and features full WYSIWYG.

AutoPlan is available as a stand-alone product or encapsulated in Digital Tools' SoftBench software development environment. AutoPlan is also available for Sun-3 and Sun-4 Sparcstations, the DECstation series, and IBM RISC System/6000 workstations.

**Price:** Node-lock version, \$1495; floating-user version, \$2995 per license.

**Contact:** Digital Tools, Inc., 18900 Stevens Creek Blvd., Cupertino, CA 95014, (408) 366-6920; fax (408) 446-2140.

**Circle 1306 on Inquiry Card.**

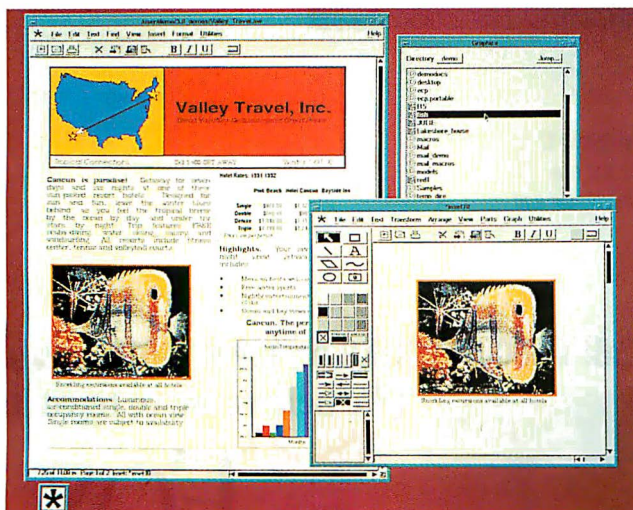
### Forecast Like a Pro

**F**orecast Pro Batch uses univariate techniques such as exponential smoothing and simple moving average to forecast unlimited numbers of items automatically. FPB 1.1 develops exception reports, monitors for forecast bias, and offers an evaluation option, which lets you withhold data from the end of your series so that you can compare the forecasts to actual values.

You can import and export data between FPB and Lotus 1-2-3, ASCII files, or Structured Query Language databases. The company also offers a 500-item version of the program.

**Price:** Standard version, \$3995; 500 version, \$1995.  
**Contact:** Business Forecast Systems, 68 Leonard St., Belmont, MA 02178, (617) 484-5050; fax (617) 484-9219.

**Circle 1307 on Inquiry Card.**



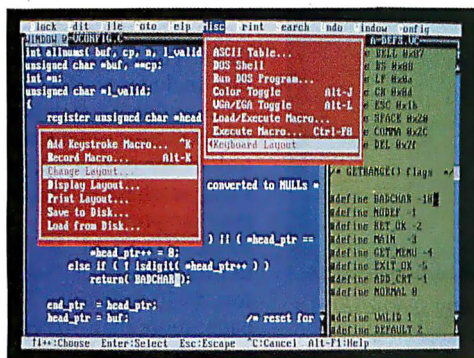
You can add audio attachments and video images to your Aster\*x documents.



# The new multi-mode VEDIT PLUS is the only text editor you will ever need!

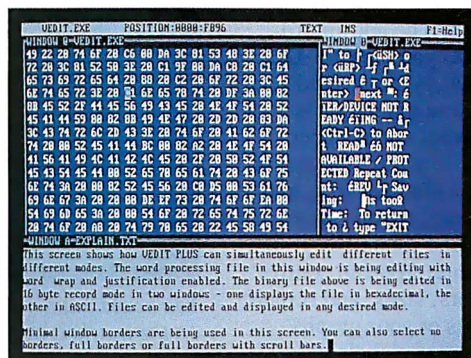
**The most powerful text editor for program development and text processing**

- Drop-down menus, mouse support
- Columnar blocks, regular expressions, undo
- Also VEDIT for \$69, VEDIT Jr. for \$29



**The fastest text editor for mainframe, CD ROM and other huge files**

- Edit up to 2 Gigabyte text, binary, mainframe files
- Edit in ASCII, EBCDIC or Hexadecimal
- Emulate Wordstar, Word Perfect, Brief, vi, others



The new VEDIT PLUS is today's finest programmer's editor. Small (80K) and lightning fast, it is written entirely in assembly language. VEDIT PLUS is the only programmer's editor that can edit any text or binary file you will ever encounter.

Incredibly, VEDIT is over 20 times faster than other editors on just a 3 megabyte file. When editing multi-megabyte files, only VEDIT has the speed to get the job done.

Benchmarks in 3 Meg File	VEDIT	Brief	Sage
Save and continue	52 sec	3:52 min	1:47 min
Load, modify, save, exit	21 sec	49 sec	1:38 min
Block-column copy (40x200)	2 sec	30 sec	2 sec
Delete one column in file	9:58 min	1:50 hour	1:03 hour
60,000 search & replace	3:18min	1:44 hour	1:32 hour

The extensive compiler support runs popular compilers and also your favorite linkers, debuggers and Make from within VEDIT. It even integrates tools from different vendors. When shelling to DOS, VEDIT swaps itself and TSRs out of memory, giving you as much as 620K of available memory for compiling the biggest programs. Only VEDIT gives you the advantages of a powerful editor with the convenience of an integrated environment.

VEDIT PLUS has every advanced feature you might expect. Simultaneously edit numerous files, split the screen into windows, search/replace with regular expressions. Automatic indent, block indent, parentheses matching and block operations by character, line, file or column speed program development. Word wrap, paragraph formatting, justification, centering and many printing options are ideal for text processing.

VEDIT PLUS has the most powerful macro programming language of any editor. It eliminates repetitive editing tasks and lets you create your own editing functions. It includes testing, branching, looping, user prompts, keyboard input, string and numeric variables, complete control over windows plus access to hardware interrupts, memory and I/O ports. Source level debugging helps you develop new macros quickly and easily.

Until now, few PC text editors could even begin to handle huge mainframe, CD ROM, postscript, plotter output and other multi-megabyte files. The new VEDIT PLUS, with its unique virtual memory management, handles them all effortlessly.

Edit in ASCII, EBCDIC or Hexadecimal modes, or split the screen for any combination of modes. File modes support DOS text, UNIX text, binary and many fixed length record formats.



An intuitive user interface with drop down menus, hot keys, mouse support, optional scroll bars, context sensitive help, point and shoot file selection, 1000 level undo and unlimited keystroke macros make VEDIT PLUS easy to use, easy to learn. And it can emulate the keystrokes of almost any editor you already know.

Everything in VEDIT PLUS is configurable. The keyboard layout, the screen colors, the way control characters, long lines and window borders are displayed, and much more, is all configured with easy to use menus.

Confidently order your copy of VEDIT PLUS today; it comes with a 30 day money-back guarantee. VEDIT has been the choice of 100,000 programmers, writers and engineers since 1980.

VEDIT PLUS - DOS single user license: \$185; DOS network 5 user license: \$295; UNIX/XENIX, QNX, FlexOS/IBM 4680 single CPU license: \$285. Site license pricing is available.

## 24-Hour Bulletin Board

A fully functional demo version of VEDIT PLUS and a shareware version of VEDIT Jr. are available on our BBS at 1-313-996-1304.

Toll Free: 1-800-45-VEDIT (1-800-458-3348)  
 Telephone: (313) 996-1300, Fax: (313) 996-1308  
 Mail: P.O. Box 1586, Ann Arbor, MI 48106

VEDIT is a registered trademark of Greenview Data, Inc. Brief is a trademark of Solution Systems. Sage Professional Editor is a trademark of Intersolv.

Circle 39 on Inquiry Card.

# Greenview Data

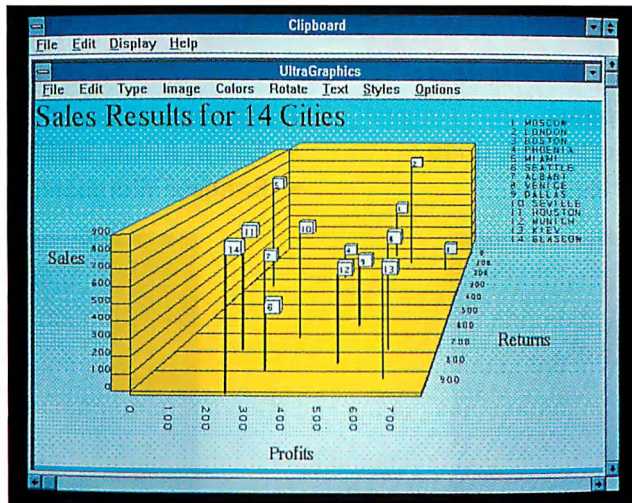
### Add Graphs to Spreadsheets

According to its developer, UltraGraphics lets users of most spreadsheets design sophisticated graphs and charts within their application. The add-in program lets you create 3-D bar, line, pyramid, and  $x,y,z$  graphs and other charts within your spreadsheet. Many UltraGraphics charts feature unlimited rows and value ranges. You can stretch and rotate any graph you create. You can control the colors, sizes, and screen positions of your graphs. The program labels your graphs automatically.

Intex claims that, in addition to being compatible with every major spreadsheet published in recent years, UltraGraphics lets you import graphs to word processing programs. The PC-based program supports PIC, PCX, and WMF file formats, among others. **Price:** \$245.

**Contact:** Intex Solutions, Inc., 35 Highland Cir., Needham, MA 02194, (617) 449-6222; fax (617) 444-2318.

**Circle 1308 on Inquiry Card.**



You could import this 3-D scatter graph into any spreadsheet on the market, according to Intex Solutions.

### Multiple View Functions for Sun and Windows

The Windows version of AutoVue lets you view, print, plot, and manage CAD drawing files in such formats as AutoCAD DWG, HPGL, and Generic CADD. You can also view scanned raster files. AutoVue-Sun lets you view and print over a dozen file formats, and you can convert files from

AutoVue's supported formats to DXF, HPGL, and other file formats.

**Price:** Windows version, \$250; Sun version, \$695.

**Contact:** Cimmetry Systems, Inc., 1430 Massachusetts Ave., Suite 306, Cambridge, MA 02138, (800) 361-1904 or (514) 735-3219; fax (514) 735-6440.

**Circle 1309 on Inquiry Card.**

### Capture Your Windows Screens

The latest incarnation of Pizazz Plus features a Windows screen-capture function, which you can use to save full-screen or selected Windows. Pizazz Plus 3.0 also features conversion capabilities for more than 20 graphics file formats, including PCX and TIF. You can print your Pizazz Plus images on over 400 printers, including the Hewlett-Packard DeskJet 500C. **Price:** \$149.

**Contact:** Application Techniques, Inc., 10 Lomar Park Dr., Pepperell, MA 01463, (508) 433-5201; fax (508) 433-8466.

**Circle 1310 on Inquiry Card.**

### Typeface Library on CD-ROM

The CD-ROM version of Bitstream's Typeface Library for the Macintosh is available in PostScript Type 1 format and includes a selection of TrueType fonts. The Type Treasury disc includes six free typefaces and lets you preview its 1000-plus typefaces. To unlock the typefaces, you must purchase access codes over the phone.

**Price:** CD-ROM, \$69; up to three typefaces, \$49 each; four to 10 typefaces, \$40 each; more than 10 typefaces, \$35 each.

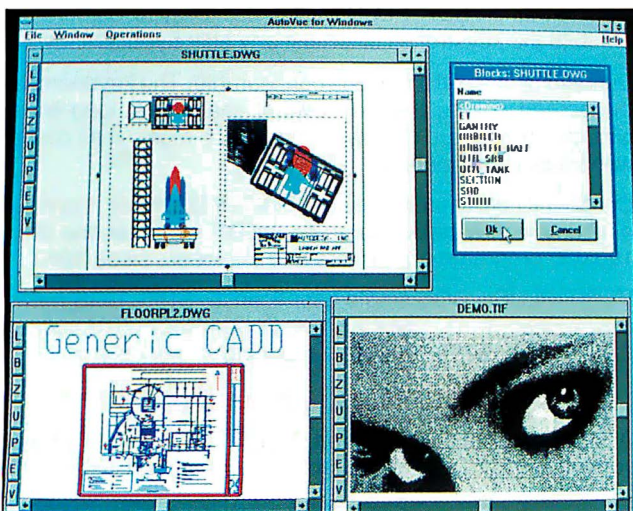
**Contact:** Bitstream, Inc., 215 First St., Cambridge, MA 02142, (617) 497-6222; fax (617) 868-4732. **Circle 1311 on Inquiry Card.**

### Turn Documents into Perfect Presentations

Perfect Presentations 2.0 lets you create charts and graphs from within WordPerfect 5.1. You can use the Desmond International add-in to design pie, bar, line, area, and scatter graphs within your WordPerfect documents. Perfect Presentations imports data from Lotus 1-2-3 worksheet files for direct integration within your presentation. Perfect Presentations works with the DOS version of WordPerfect 5.1. **Price:** \$95.

**Contact:** Desmond International, Inc., 99 High St., Suite 3001, Boston, MA 02110, (617) 338-9650; fax (617) 338-2752.

**Circle 1312 on Inquiry Card.**



AutoVue lets you open as many windows as your memory will allow.

**BEFORE YOU KNOW IT,  
THERE'LL BE A  
PORTABLE COMPUTER  
THAT'S ACTUALLY  
BETTER THAN A DESKTOP.**

# SEE WHAT WE MEAN?

You've dreamed about a computer like this.

One that would have power and display capabilities equal to, or greater than, the desktop computer you're using now.

One you could take along to all of those different places you need to work.

One you wouldn't need a furniture dolly to move.

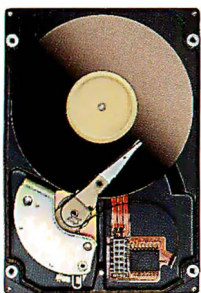
And here it is.

The Toshiba T6400.

With dimensions of 15.4" W x 10.5" D x 3.3" H (4.1" H with the color screen), it's small enough to fit in a briefcase.

With a spirited clock speed of

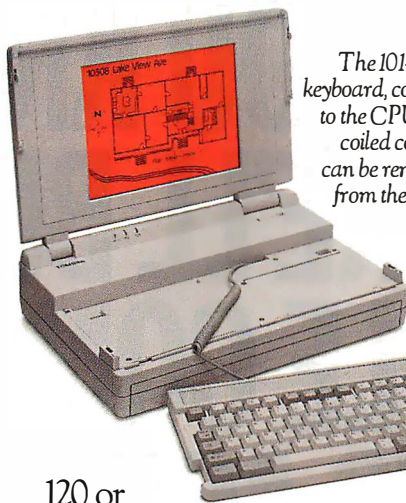
*In addition to a 1.44MB floppy drive, you can choose a 120 or 200MB hard disk.*



33 MHz, a powerful 486 DX microprocessor, 8K internal cache and full 32-bit architecture, it's big enough to handle all those jobs normally performed in an impressive office building.

And if a combination like that doesn't make the T6400 portable better than the desktop computer you're currently using, we'll eat our collective hat.

This remarkable machine comes equipped with an internal 1.44MB, 3½" floppy drive and a



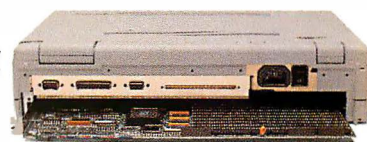
*The 101-key keyboard, connected to the CPU by a coiled cord, can be removed from the case.*

120 or 200MB hard disk. Plus 4MB RAM, expandable to 20MB. (Try finding any application that needs more memory than that.)

There's also a full-length, IBM-compatible, 16-bit expansion slot so you can take full advantage of your network card, SCSI controller or any of a myriad of other special purpose cards.

For even more expandability the T6400 comes complete with a 150-pin expansion port for

direct input/output to the CPU, enabling you to connect storage and communications devices. Plus an internal dedicated



*The AC-powered T6400 has full desktop expandability, including an IBM-compatible, 16-bit expansion slot.*

modem slot, as well as built-in parallel, serial, mouse and SuperVGA video ports.

Depending on your particular needs, you can choose one of two display screens.

A state-of-the-art active matrix SuperVGA color display with Thin Film Transistor technology, to deliver a higher quality image than you can get with most desktop monitors, and capable of displaying 256 simultaneous colors at 640 x 480 resolution.

Or a gas plasma display featuring 16 gray scales, also at 640 x 480 resolution, and a 100:1 contrast ratio—seven times the contrast of standard LCD displays, with ten times the display speed.

Both have a diagonal measure of 10.4" and provide simultaneous viewing capability with external SuperVGA displays.

To complete the T6400's amazing metamorphosis from desktop to portable, we took a 101-key keyboard



with full-size keys and key spacing, separate numeric keypad and eight dedicated cursor control keys, and nestled it into a compact 11.7 lb. package (12.9 lbs. with color screen). Then attached it to the CPU with a coiled cord, so you can remove

it and use it on your lap (or other convenient surface).

Now, having read all of the above, you'd probably welcome more information on the T6400. If so, call us at 1-800-457-7777.

The more you learn about our products the more you'll come to

understand the Toshiba philosophy: that portables are the future of personal computing.

Of course, with the introduction of the T6400 portable, it's a future that's already here.

In Touch with Tomorrow  
**TOSHIBA**

Circle 131 on Inquiry Card.

### Dadisp 3.0 for Two New Platforms

**D**adisp now runs on the Next workstation and on Hewlett-Packard's HP Apollo 700 workstation. Version 3.0 of the scientific-data-analysis program performs mathematical problem solving, what-if speculation, graphical analysis of sampled information, conversion of data from graphical windows into numbers, and other analytical functions.

Dadisp performs data acquisition with A/D boards, and the program can exchange data with instruments using the IEEE-488 (Hewlett-Packard Interface Bus/general-purpose interface bus) protocol.

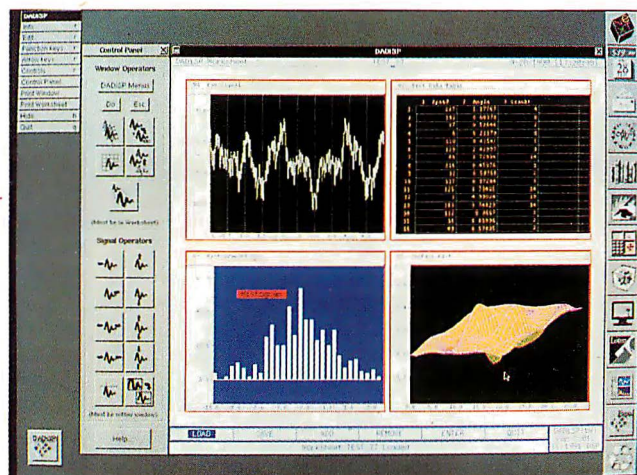
**Price:** Next version, \$4495; HP Apollo 700 version, \$895 to \$6995.

**Contact:** DSP Development Corp., 1 Kendall Sq., Cambridge, MA 02139, (617) 577-1133; fax (617) 577-8211.

**Circle 1313 on Inquiry Card.**

### For Chico Solver, Math Is No Problem

**V**ersion 2.3 of Chico Solver can process unlimited numbers of equations within a system, according to the developer, and can run up to 100 times faster than its predecessor. The numerical-modeling software lets you build large equation systems that include multiple files containing function definitions, algebraic equations, or differential equations.



*Dadisp can be used for laboratory research, electronic testing, and physiological data analysis.*

You can also automatically isolate and reorder separable equation sets, optimize any parameters used in equations or function definitions, and directly enter differential equations as a means of defining new functions. Chico Solver now provides such features as on-screen color controls, more detailed result and error messages, and graphics options that include scaling, labeling, and grid lines.

According to the company, Chico Solver has the ability to solve equation systems faster than larger mathematical programs such as MathCAD and Mathematica. Applications for Chico Solver include the design of systems within mechanical, chemical, automotive, and aerospace industries.

**Price:** \$399.

**Contact:** Chico Software Co., P.O. Box 5174, Chico, CA 95927, (916) 342-3279; fax (916) 893-1050.

**Circle 1314 on Inquiry Card.**

### SPREAD THE WORD

*Please address new product information to New Products Editors, BYTE, One Phoenix Mill Lane, Peterborough, NH 03458. Better yet, use your modem and mail new product information to the microbytes.hw or microbytes.sw conferences on BIX. Please send the product description, price, ship date, and an address and telephone number where readers can get more information.*

other applications via PCX, TIF, WPG, and other file filters.

**Price:** \$395.

**Contact:** MicroMath Scientific Software, P.O. Box 21550, Salt Lake City, UT 84121, (801) 943-0290; fax (801) 943-0299.

**Circle 1315 on Inquiry Card.**

### Analyze Data from Different Platforms

**C**ross-platform data analysis and reporting are now available for users of Windows, Unix, or Macintosh systems. CrossTarget (formerly called Power Search and available only for the Mac) lets you merge corporate data from disparate databases and platforms, transform it into a graph or spreadsheet-style chart, and analyze it.

You can use CrossTarget to merge and analyze up to 1 million records, including sales, statistical, and personnel information, from relational and nonrelational databases.

You can purchase the program's three modules individually or as a group. Builder compresses, indexes, and stores data; Data Integrator merges database information for transformation by Builder; and the Diver tool lets you spontaneously examine trends and leads throughout your data.

**Price:** Stand-alone versions, \$1000 to \$8000; per client/server station, \$1500 to \$4500.

**Contact:** Dimensional Insight, Inc., 99 South Bedford St., Burlington, MA 01803, (617) 229-9111; fax (617) 229-9113.

**Circle 1316 on Inquiry Card.**

### A High-Speed Model Solver

**D**iffeq with Fitting, MicroMath's program for performing least-squares parameter estimation with differential equations, saves you time in experimentation and verification, according to the developer. The product provides goodness-of-fit statistics and on-line graphics to show whether or not your results are satisfactory.

Diffeq with Fitting offers eight methods of solving models and four plotting styles. Least-squares parameter estimation methods include Powell's method and optional prefitting simplex method.

You can import and export data between Diffeq and Lotus 1-2-3, dBase, ASCII, and other data files. The program provides a plot editor with axis control, eight fonts, and drawing tools. You are able to export your charts to

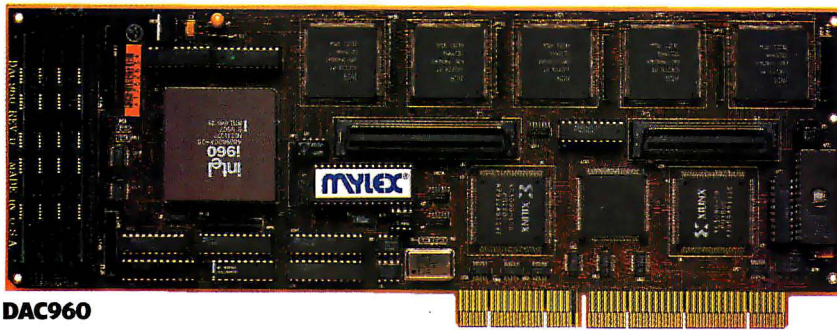
**When It Comes  
To EISA,  
Only Mylex  
Delivers  
The Complete  
Solution.**



▶ See our new products at CeBIT '92! Hall 8 EG, Stand B40 ◀

# SCSI Host Adapters

NEW

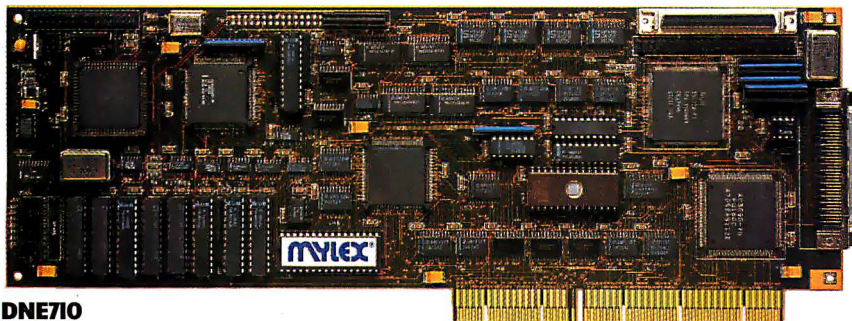


**DAC960**

**EISA Multi-Channel SCSI-2 Host Adapter**® (Available to OEMs only)

- ▶ Five SCSI-2 (fast and wide) channels— each channel supports up to 20 MB/s peak throughput
- ▶ Intel i960CA RISC processor; up to 64MB of write-back cache
- ▶ Striping with built-in support for various RAID levels
- ▶ Disconnect/reconnect, scatter/gather, command queuing, duplexing, mirroring and spanning
- ▶ Fault tolerance features include automatic drive failure detection, hot replacement and transparent rebuild

NEW



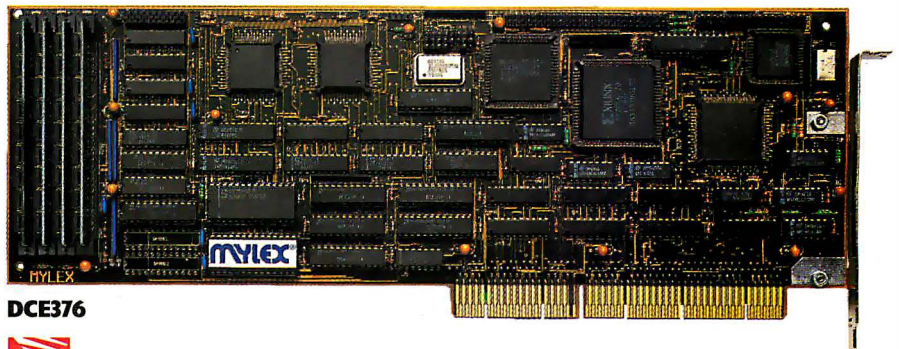
**DNE710**

**EISA SCSI-2 Host Adapter**®

- ▶ Fast SCSI-2 providing 10MB/s peak throughput
- ▶ EISA bus-master transfer rates up to 33MB/s
- ▶ Support for all popular SCSI devices
- ▶ Disconnect/reconnect, scatter/gather, synchronous drive support, duplexing and mirroring
- ▶ DOS, OS/2, Unix, NetWare

**EISA SCSI Host Adapter**

- ▶ Intel 80376; up to 8MB cache
- ▶ EISA bus-master transfer rate up to 33MB/s
- ▶ Disconnect/reconnect, scatter/gather, mirroring, duplexing and tape backup
- ▶ DOS, OS/2, UNIX, SCO UNIX, NetWare, Windows 3.0



**DCE376**

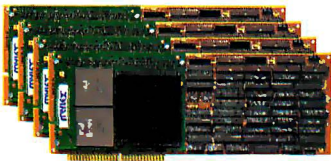




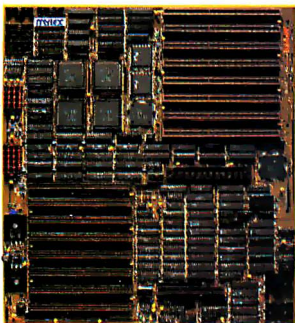
# Multiprocessing System

- ▶ 64-bit 267MB/s fully symmetric multiprocessing bus
- ▶ Four 486 50MHz CPUs with up to 512KB write-back cache
- ▶ EISA bus for high-performance I/O
- ▶ Up to 512MB of ECC memory
- ▶ Fully scalable and field upgradable
- ▶ All EISA peripherals available from Mylex; Mylex BIOS
- ▶ UNIX V4, Novell NetWare 286/386, SCO MPX, MS-DOS, Windows 3.0 and LAN Manager supported

Available Q2, 1992



CPU Board



EISA Bus Interface Backplane



Multiprocessor Interrupt Controller

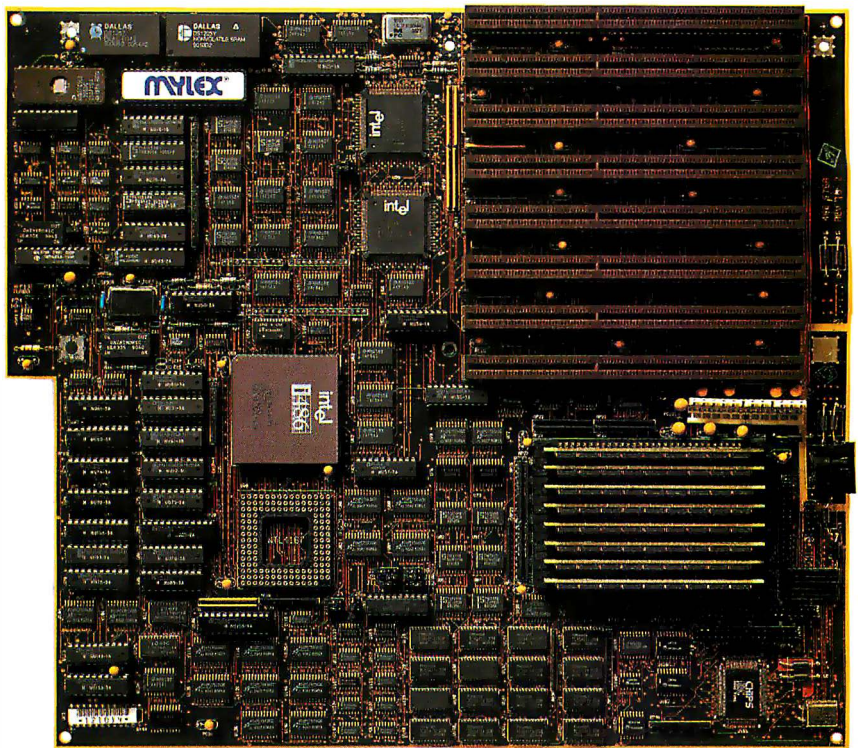


ECC Memory Controller

# System Boards

## EISA 486 System Board

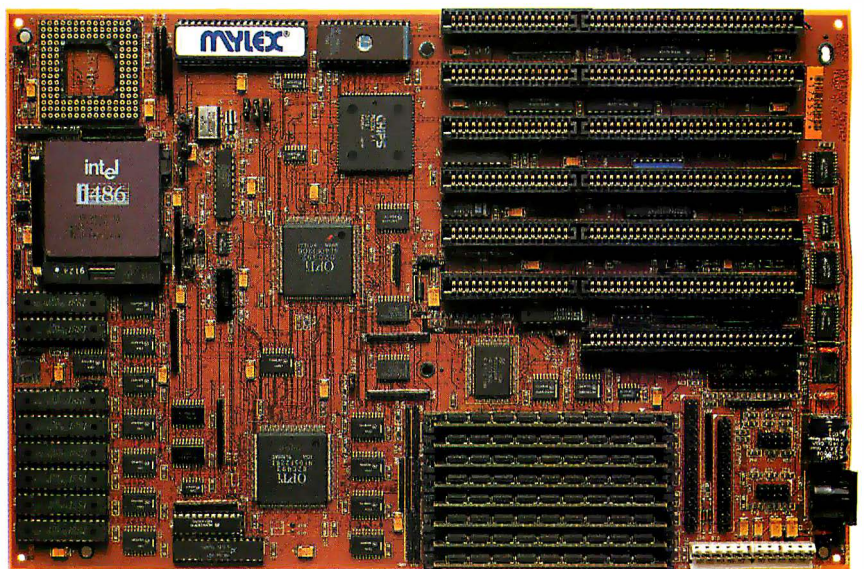
- ▶ 486DX 33/50MHz
- ▶ 14.5 MIPS performance
- ▶ 128KB of external write-back cache
- ▶ 8 EISA bus slots
- ▶ Integrated I/O— IDE, floppy, parallel, serial and PS2 mouse ports
- ▶ Weitek 4167 socket
- ▶ Surface mount design
- ▶ Mylex BIOS



MNE486

## ISA 486 System Board

- ▶ 486DX 33/50MHz
- ▶ 14.9 MIPS performance at 33MHz
- ▶ 64 or 256KB of external write-back cache
- ▶ 7 ISA bus slots
- ▶ On-board I/O— IDE, floppy, parallel and two serial ports
- ▶ Weitek 4167 socket
- ▶ Surface mount design
- ▶ Mylex BIOS



MDI486

\* Available March, 1992

\*\* Available Q2, 1992

# Mylex Has You Covered Worldwide.

For more information on Mylex products, please call your closest distributor or contact us at 1-800-77-MYLEX or 1-510-796-6100. Or, fax the domestic sales department at 1-510-745-8016 and international sales at 1-510-745-7521.

## U.S. Distributors

Ingram/Micro D  
Tel: 1-800-456-8000  
Merisel  
Tel: 1-800-637-4735

## Canada

Sidus Systems, Inc.  
▶ Thornhill, Ontario  
Tel: 416-882-1600  
Fax: 416-882-2429  
▶ Ottawa, Ontario  
Tel: 613-749-2443  
Fax: 613-749-3850  
▶ Vancouver, BC  
Tel: 604-322-1711  
Fax: 604-322-1722  
▶ St. Laurent, Quebec  
Tel: 514-731-9050  
Fax: 514-731-1069

## Australia/ New Zealand

Computa Vision  
▶ Melbourne  
Tel: 613-877-2700  
Fax: 613-877-2614  
▶ Sydney  
Tel: 612-957-3477  
Fax: 612-957-2866  
Lingo Computer  
Systems Ltd.  
Tel: 649-3079-025  
Fax: 649-3079-026  
IPC New Zealand  
Tel: 649-79-7052  
Fax: 649-3076-412

## Europe

Austria:  
Astco  
Tel: 43-1-330-7941  
Fax: 43-1-330-79412  
Belgium:  
Celem Computers  
Tel: 32-41-67-64-34  
Fax: 32-41-67-65-15  
Datatech-S. Service  
Systems  
Tel: 32-3-326-32-37  
Fax: 32-3-326-32-96

## Denmark:

Delfi Technology A/S  
Tel: 45-44-99-09-00  
Fax: 45-44-99-09-46

## Finland:

Mikrolog OY Ltd.  
Tel: 358-0-804-611  
Fax: 358-0-803-6617

## France:

Dymag  
Tel: 33-1-30-21-50-69  
Fax: 33-1-30-21-17-86

## Nucleus

Tel: 33-1-69-07-61-99  
Fax: 33-1-69-07-82-23

## Polywell Computers

Tel: 33-1-49-63-32-88  
Fax: 33-1-48-61-18-26

## Germany:

Interquad Computer  
Tel: 49-6104-6999-0  
Fax: 49-6104-6558-2

## Lobster Computer

Tel: 49-30-618-40-80  
Fax: 49-30-618-80-95

## Geva Datentechnik GmbH

Tel: 49-2404-5500-0  
Fax: 49-2404-5500-99

## Greece:

Digital Technology  
Hellas  
Tel: 30-1-9514-944  
Fax: 30-1-956-7631

## Hungary:

Pentacomp  
Tel: 36-1-182-0385  
Fax: 36-1-182-0385

## Italy:

Jen Elettronica  
Tel: 39-733-224-012  
Fax: 39-733-224-035

## Norway:

Jotronics A/S  
Tel: 47-4-66-37-91  
Fax: 47-4-66-66-40

## Plus Data

Tel: 47-4-55-50-22  
Fax: 47-4-55-21-61

## Spain:

Galileo Ingenieria Y  
Servicios  
Tel: 34-22-200-200  
Fax: 34-22-202-882

## Sweden:

Gluggstorps  
Argenturer AB  
Tel: 46-418-500-15  
Fax: 46-418-504-72

## Shelif Elektronik AB

Tel: 46-8-32-26-09  
Fax: 46-8-31-56-19

## Switzerland:

Paradigm Computer  
Peripherals  
Tel: 41-56-95-15-55  
Fax: 41-56-95-15-05

## The Netherlands:

Geveke Electronics  
Tel: 31-20-62-31-740  
Fax: 31-20-586-1568

## Hazecamp

Computers B.V.  
Tel: 31-15-141-979  
Fax: 31-15-136-401

## United Kingdom:

ADC  
Tel: 44-203-715-858  
Fax: 44-203-714-462

## Ideal Hardware

Tel: 44-81-390-1211  
Fax: 44-81-399-4382  
Westbase Technology  
Tel: 44-291-430-567  
Fax: 44-291-430-484

## Yugoslavia:

Drzavna Zalozba  
Slovenije  
Tel: 38-61-211-626  
Fax: 38-61-215-675

## NIL Systems Integration

Tel: 38-61-372-809  
Fax: 38-61-372-809

## The Middle East

### Egypt:

Metra Computers  
Tel: 202-3474783  
Fax: 202-3610475

### Iran:

Information Center  
Technology/  
Kanoon Informtic  
Tel: 98-21-241326  
Fax: 98-21-228837

### Saudi Arabia:

Electrical and Electronic  
Contracting Co.  
Tel: 966-2-6690221  
Fax: 966-2-6690225

### Turkey:

Karma Bilgisayar Sanayi  
Tel: 90-1-1740068  
Fax: 90-1-1730535

## Pacific Rim

### Hong Kong:

Madihurst Limited  
Tel: 852-529-0356  
Fax: 852-866-2691

### Quest Computer

Tel: 852-548-9129  
Fax: 852-858-0045

### Korea:

Harsper Technology, Inc.  
Tel: 822-578-2477  
Fax: 822-578-6955

### Singapore:

Pet Computers Service  
PTE LTD.  
Tel: 65-296-7222  
Fax: 65-296-1293

## South America

### Argentina:

Centro Instrumental  
Tel: 54-41-66616  
Fax: 54-41-24-4763

### Brazil:

Quantum Computadores  
Tel: 55-11-212-4644  
Fax: 55-11-212-2934

## Mylex Corporation

34551 Ardenwood Blvd., Fremont, CA 94555-3607

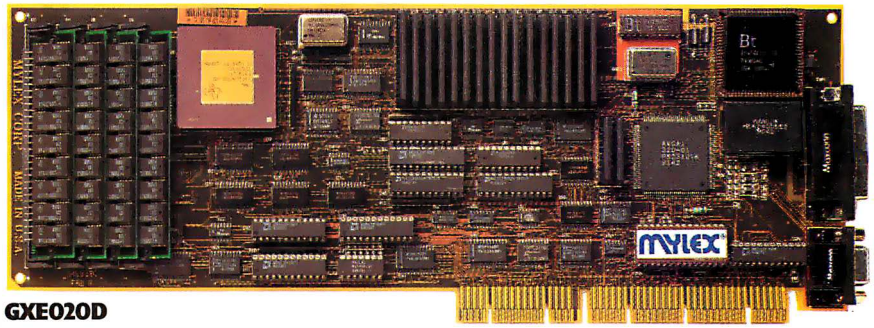
© 1992, Mylex Corporation. Specifications subject to change without notice. The Intel Inside Logo is a trademark of Intel Corporation. All trademarks are the property of their respective holders.



# Graphics Controllers

## EISA Graphics Controller\*\*

- ▶ TI34020 40MHz graphics processor
- ▶ 1600 x 1200 non-interlaced resolution
- ▶ 8 bit-planes for 256 simultaneous colors
- ▶ TIGA 2.05 compatibility
- ▶ VGA on-board
- ▶ Drivers for AutoCAD, X-Window and Windows 3.0

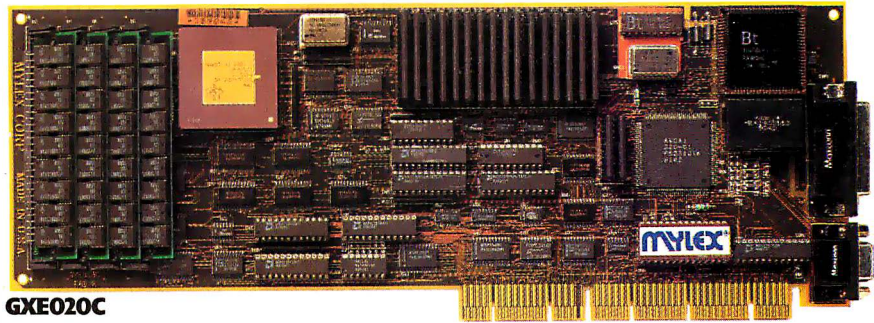


GXE020D

NEW

## EISA Graphics Controller

- ▶ TI34020 32MHz graphics processor
- ▶ 1280 x 1024 non-interlaced resolution
- ▶ 8 bit-planes for 256 simultaneous colors
- ▶ TIGA 2.05 compatibility
- ▶ VGA on-board\*
- ▶ Drivers for AutoCAD, X-Window and Windows 3.0



GXE020C

NEW

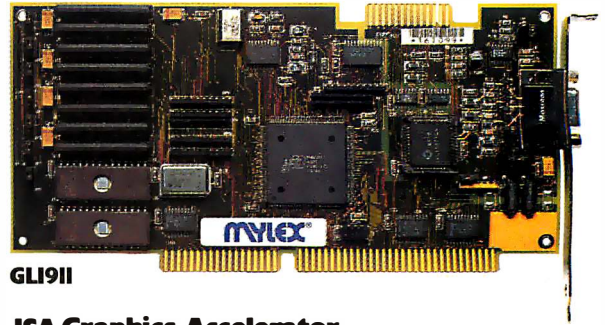


GLE911

## EISA Graphics Accelerator\*\*

- ▶ S3 graphics accelerator
- ▶ EISA bus data transfers
- ▶ 1280 x 960 x 16 or 1024 x 768 x 256 resolution
- ▶ 100% VGA compatible
- ▶ Drivers for Windows 3.0, GEM 3.1, Ventura, AutoCAD and many more

NEW

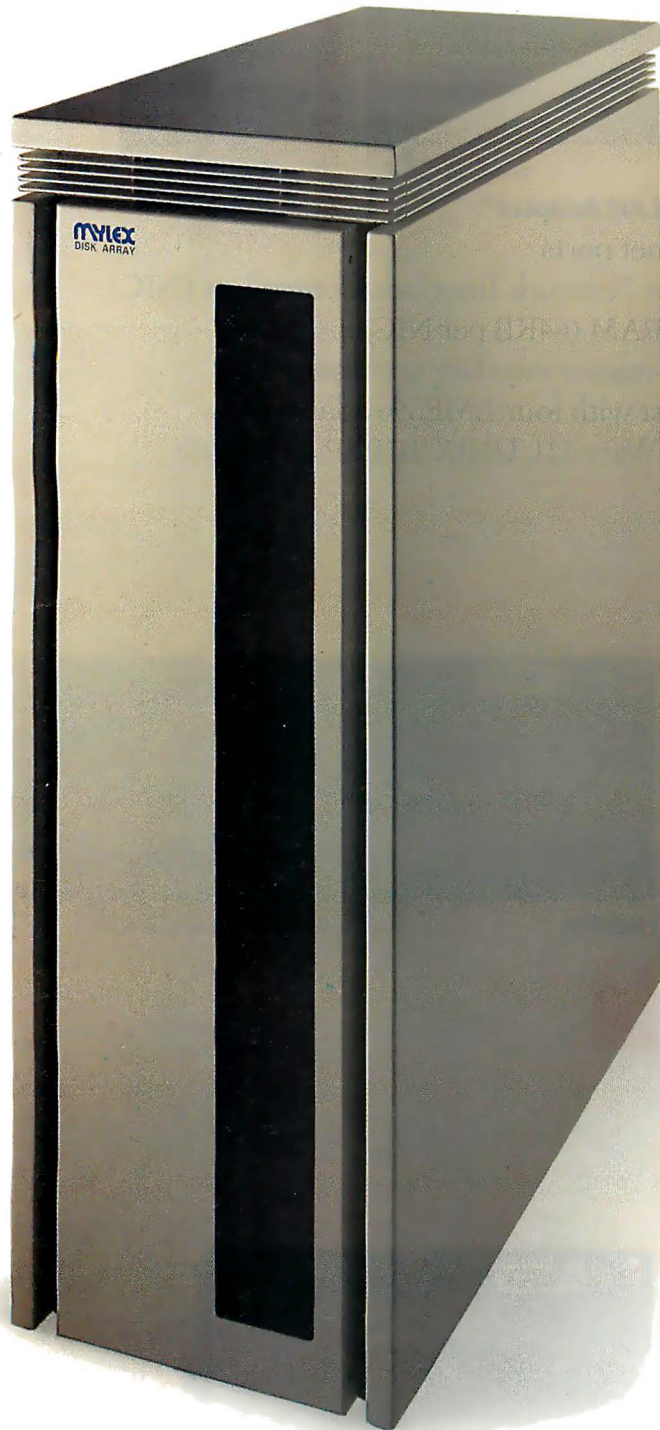


GLI911

## ISA Graphics Accelerator

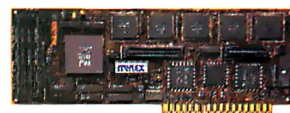
- ▶ S3 graphics accelerator
- ▶ ISA bus data transfers
- ▶ 1024 x 768 x 256 resolution
- ▶ 100% VGA compatible
- ▶ Drivers for Windows 3.0, GEM 3.1, Ventura, AutoCAD and many more

# Disk Array Subsystem



- ▶ Fastest disk array subsystem on the market— includes disk array enclosure, controller, host adapter and software
- ▶ Five SCSI-2 (fast and wide) channels— each channel supports up to 20MB/s peak throughput
- ▶ EISA host adapter uses Intel i960CA 32-bit RISC processor
- ▶ Up to 64MB of write-back cache
- ▶ Modular support for single-ended or differential SCSI channels
- ▶ Flash EPROMs for easy firmware field upgrades
- ▶ Striping with built-in support for various RAID levels
- ▶ Disconnect/reconnect with full multi-threading, scatter/gather, command queuing, duplexing, mirroring and spanning
- ▶ Fault tolerance features include automatic drive failure detection, hot replacement and transparent rebuild

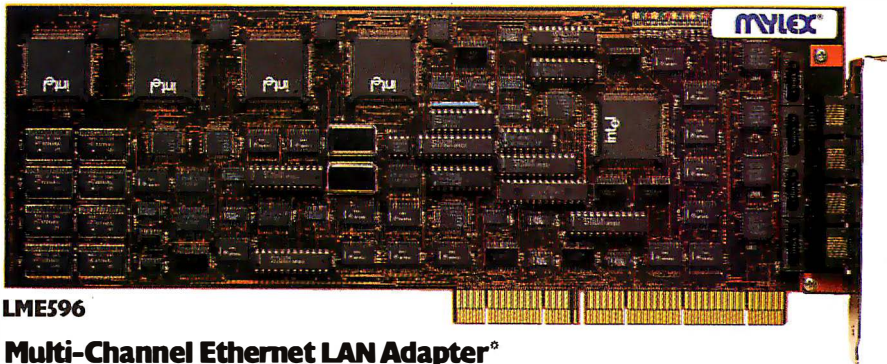
Available March, 1992



DAC960 Host Adapter

# Ethernet LAN Adapters

**NEW**



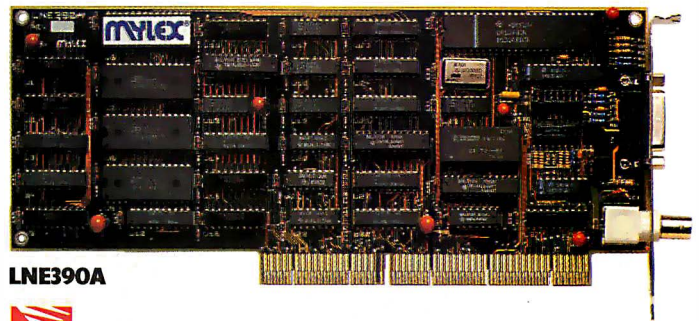
**LME596**

## **Multi-Channel Ethernet LAN Adapter<sup>®</sup>**

- ▶ Four 10Base-T Ethernet ports
- ▶ Four Intel 82596 32-bit Network Interface Controllers (NIC)
- ▶ 256KB dual-ported SRAM (64KB per NIC)
- ▶ Intel 82355 EISA bus-master interface controller
- ▶ Up to 16 ports per host with four LME596 adapters
- ▶ Supports Novell NetWare 3.11, UNIX TCP/IP and NDIS

## **EISA Ethernet LAN Adapter**

- ▶ DP8390 Network Interface Controller
- ▶ EISA shared-memory transfer rates up to 16MB/s
- ▶ Support for both thick- and thin-Ethernet interfaces
- ▶ Novell certified
- ▶ Supports Novell NetWare 2.15, 2.2, 3.0, 3.1 and 3.11, UNIX TCP/IP and NDIS

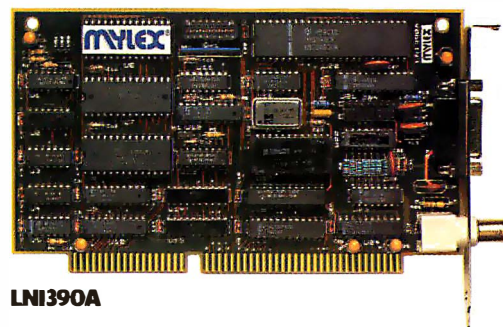


**LNE390A**



## **ISA Ethernet LAN Adapter**

- ▶ DP8390 Network Interface Controller
- ▶ Shared-memory transfer rates up to 2MB/s
- ▶ Support for both thick- and thin-Ethernet interfaces
- ▶ Supports Novell NetWare 2.15, 3.0, and 3.1 and UNIX



**LNI390A**

## Develop 32-bit Windows Applications

**T**he MetaWare Windows Application Development Kit lets you develop, debug, and run true 32-bit Windows applications. The ADK provides binder and make utilities, a 32-bit dynamic-link-library supervisor, MetaWare's Windows Supervisor, a debugger, a memory-configuration utility, and 32-bit libraries and header files. MetaWare reports that you can port 16-bit Windows applications without using a DOS extender.

The kit's user interface includes on-line help, resizable windows, scroll bars, pop-up and pull-down menus, a source window, and a control window. In addition to MetaWare's High C compiler, the ADK requires the Microsoft Windows Software Development Kit for application development.

**Price:** \$495; with High C compiler and source-level debugger, \$1095 and up.

**Contact:** MetaWare, Inc., 2161 Delaware Ave., Santa Cruz, CA 95060, (408) 429-6382; fax (408) 429-9273.

**Circle 1003 on Inquiry Card.**

## Develop and Port CAD Programs

**E**asier and less-expensive development of Windows-based CAD applications is the goal of CADvance 5.0. The program's CADvance Development Interface (CDI) lets you access the CADvance PC-CAD graphics and database routines as Windows dynamic link libraries. Once you de-



*According to MetaWare, you can use its debugger to debug 32-bit applications on your development machine without using an extra terminal or computer.*

velop your applications in the CADvance for Windows environment, you can port them to other Windows-based CAD platforms.

According to the developer, outside applications written in a standard Windows-supported language run with CADvance. The development tool can handle scanned images and vector information for linking with raster-based applications. CADvance's Visual Programming facility lets you build subroutines that call more complex CDI programs and generate CDI code. CADvance supports Windows' Object Linking and Embedding and Dynamic Data Exchange capabilities, and it provides two-way database links using standard database-file and Structured Query Language conventions.

CADvance 5.0 requires Borland's Quick C for Windows programming language.

**Price:** \$995.

**Contact:** ISICAD, Inc., 1920 West Corporate Way, P.O. Box 61022, Anaheim, CA 92803, (714) 533-8910; fax (714) 533-8642.

**Circle 1002 on Inquiry Card.**

## A Windows FORTRAN Compiler

**V**ersion 2.60 of FTN77 FORTRAN compilers for 386- and 486-based PCs features a host of improvements. Most notable is FTN77's compatibility with Windows; the compiler will run under Windows in enhanced mode. FTN77 now features make and touch utilities, and the new text-windowing routines let you create drop shadows, title windows, and other effects in graphics mode.

**Price:** 386 version, \$1295; 486 version, \$1525.

**Contact:** OTG Systems, Inc., Suite 300, Rts. 106 and 374, P.O. Box 239, Clifford, PA 18413, (717) 222-9100; fax (717) 222-9103.

**Circle 1001 on Inquiry Card.**

## Edit Code Through Windows

**D**esigned from its inception to run efficiently in the Windows environment, Codewright lets Windows programmers edit code files without switching to DOS. According to its developer, Codewright's performance equals, and sometimes excels, the performance of DOS-based editors.

The program provides standard program-editing features (e.g., unlimited file and line sizes, unlimited undo and redo of changes, and multiple file/multiple window editing). Codewright also lets you compile, line, and debug your target program without leaving the editor. You can select and display or hide portions of the file text, and Codewright lets you highlight parts of the file you're editing in user-specified color for easy detection.

You can configure Codewright to meet your own preferences. The program's .INI file lets you select settings each time you run the file. For workgroups, you can configure Codewright differently for specific people or projects.

Codewright includes keymaps for Common User Access-compliant and Brief-compatible operation. You can modify the keymaps provided, or you can assign your own.

**Price:** \$249.

**Contact:** Premia Corp., 1075 Northwest Murray Blvd., Suite 268, Portland, OR 97229, (800) 547-9902 or (503) 647-9902; fax (503) 647-5423.

**Circle 1000 on Inquiry Card.**

## MacDraft: Not Just for Macs Anymore

**N**early identical to its Macintosh counterpart, MacDraft for Windows provides mainstream drawing and drafting tools with a focus on ease of use. The program is geared toward technical users who want to focus on their design without having to learn a great deal about how the software works.

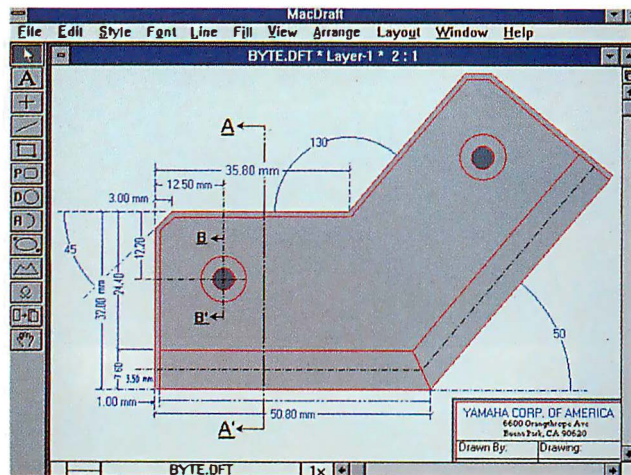
When drawing in MacDraft for Windows, your first task is to set a scale in either metric or English measurement units. Once you've defined your scale, the program keeps track of all component measurements, including angles, and lets you display line measurements at the line or in a legend. You can use the program's layering capabilities to create drawings in different scales and merge the layers to show areas of detail. Other drawing features include support for Bézier curves and splines, and you can create elliptical arcs with two keystrokes. You can also create and place circles in relation to three known points of intersection.

According to the developer, you can transfer your MacDraft files between Mac and Windows operating systems.

**Price:** \$495.

**Contact:** Innovative Data Design, Inc., 2280A Bates Ave., Suite A, Concord, CA 94520, (510) 680-6818; fax (510) 680-1165.

**Circle 1004 on Inquiry Card.**



*As you alter your MacDraft for Windows drawings, the program updates the dimension lines, area volumes, and angle measurements.*

## Analyze Your Equipment's Reliability

**T**he ECP Enhanced Component Stress Analysis program, an add-on to Powertronic's Reliability Prediction program, analyzes electronic, electrical, and electromechanical products in accordance with requirements outlined in NASA, Air Force, Naval Air Force, and Department of Defense documentation. ECP lets you lower the levels of acceptable equipment stress to improve reliability. You might perform this reduction process, known as *derating*, to establish different equipment-reliability requirements in different situations.

You can generate reports that include your equipment data and calculations (e.g., derated stress or temperature, worst-case stress, and minimum rating required). ECP features pull-down menus and context-sensitive help. You must use the Reliability Prediction program in conjunction with ECP.

**Price:** \$1000.

**Contact:** Powertronic Systems, Inc., P.O. Box 29109, New Orleans, LA 70189, (504) 254-0383; fax (504) 254-0393.

**Circle 1006 on Inquiry Card.**

## ISICAD: Now in a Window near You

**T**he release of ISICAD's CADvance for Windows brings you a design product rich in information-sharing tools. CADvance merges Windows features (e.g., Dynamic Data Exchange and Object Linking and Embedding) with the program's new open development architecture, which records activities such as drawing functions and automatically generates compatible code.

CADvance supports bit-map and scanned images, and it lets you combine raster and vector information within a single drawing. According to ISICAD, the

Windows version of the program retains speeds equal to those of DOS-based CAD packages.

**Price:** \$3495.

**Contact:** ISICAD, Inc., 1920 West Corporate Way, P.O. Box 61022, Anaheim, CA 92803, (714) 533-8910; fax (714) 533-8642.

**Circle 1005 on Inquiry Card.**

## Draw Contour Maps from Data Points

**W**ith Landview, you can turn 3-D coordinates into contour maps with as few as two commands. The Macintosh program uses the triangulated-irregular-network method of linearly interpolating imported data points into contour lines. You can import data from Landesign spreadsheet and other ASCII-based CAD programs and use that data as coordinate information. Once you've designed a contour map, you can export it as a PICT file for use in CAD applications.

Landview lets you control contour intervals and multiples and the base and highest contour values. You can display point and line labels with Northing, Easting, and elevation (x, y, z) orientation. Landview includes a zoom function, and it supports System 7.0 Balloon Help. According to its developer, future versions of the program will support volume calculations and terrain modeling.

**Price:** \$195 and up, depending on the configuration.

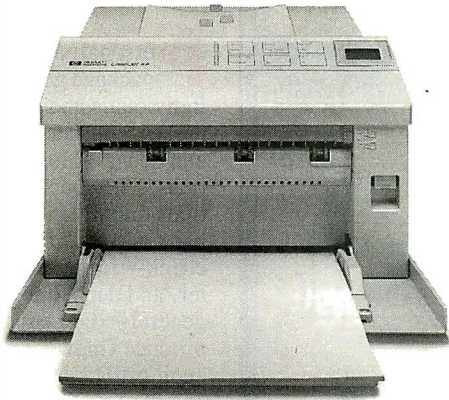
**Contact:** Compuneering, Inc., 113 McCabe Crescent, Thornhill, Ontario, Canada L4J 2S6, (416) 738-4601; fax (416) 738-5207.

**Circle 1007 on Inquiry Card.**



# Just OK.

HP LaserJet® IIP+



## \$1249

Printhead warranty: 1 year  
Conventional laser printhead  
14 fonts, 2 typefaces  
70-sheet paper tray  
Curved paper path  
Height: 8¼"

# Okidata OK!™

Okidata OL400



## \$999

Printhead warranty: 5 years  
Okidata-built LED printhead  
(no moving parts)  
17 fonts, 4 typefaces  
Fully compatible with HP  
Series II software emulation  
200-sheet paper tray  
Straight-line paper path -  
feeds envelopes, labels,  
heavy stock without jamming  
Low profile: 5 ½"

At \$999 list, there's no lower priced page printer on the market than the Okidata OL400.\* Yet it offers many features you won't find on the \$1249 LaserJet IIP+.

Our solid-state LED printhead, for example, has no moving parts. It's so reliable, it comes with a 5-year warranty - longest in the industry (plus 1 year parts and labor on the printer itself).

Okidata's simpler printhead costs less to manufacture, and results in a

simpler design overall - a major reason for the OL400's low cost. It also comes with more typefaces and fonts, and a high-capacity paper tray - all standard. And unlike the LaserJet, Okidata gives you your choice of parallel or serial interface.

And the OL400 has one more unique feature - the Okidata OK! It's our promise that every printer we sell will deliver not merely acceptable performance and good value, but

outstanding performance and exceptional value.

So before you settle for a page printer that's merely OK, visit your authorized Okidata dealer and ask about the printer that's Okidata OK! - the Okidata OL400.

For further information, please call 1 (800) OKI-DATA.  **OKIDATA OK!**

## We don't just design it to work. We design it to work wonders.™

\*Manufacturer's suggested retail price. Dealer prices may vary. HP and LaserJet are Reg. T.M. of the Hewlett-Packard Corporation. P.C. Magazine, 01/1990 issue. Okidata is a Reg. T.M. and Okidata OK! is a T.M. of OKI Electric Industry Co., LTD. "We don't just design it to work. We design it to work wonders" is a T.M. of OKI America Inc.

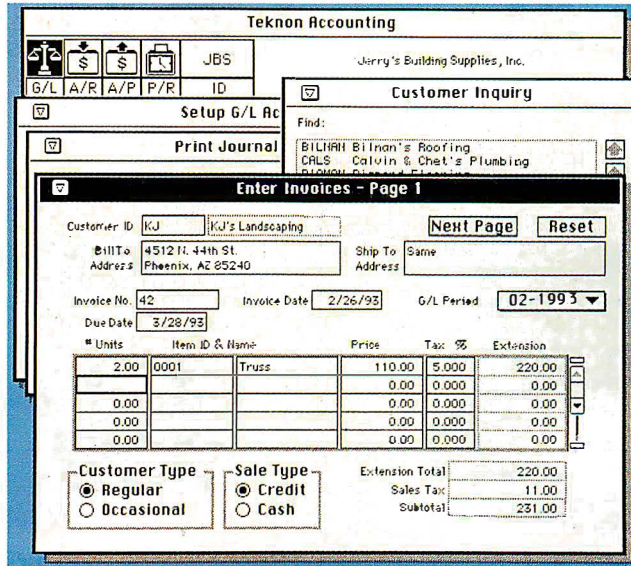
# NEWS

## WHAT'S NEW • ACCOUNTING

### Mac-Like Accounting for DOS

The developer of the atOnce accounting package for Macintosh systems now offers a DOS version of that program. Teknon Accounting, nearly identical to its Mac counterpart, features a graphical Open Look/Mac windowed interface.

Teknon Accounting provides general-ledger, accounts-receivable, accounts-payable, custom-financial-report, custom-form, budgeting, billing, and payroll modules. As you enter data into one module, all modules are updated instantly. You can work with an unlimited number of accounts, transactions, customers, and employees.



Teknon Accounting's interface matches its Mac counterpart's.

**Price:** \$149.  
**Contact:** Teknon Corp.,  
8603 East Royal Palm Rd.,  
Scottsdale, AZ 85258,

(800) 899-0876 or (602) 596-1500; fax (602) 483-8293.  
**Circle 1024 on Inquiry Card.**

### MIS Offers New Product for DOS

Personal, an accounting package geared toward individuals and small businesses, consists of checkbook and general-ledger functions. The checkbook functions maintain unlimited bank accounts and provide check-writing, check-register, and deposit tools. The general-ledger functions produce financial statements, audit trails, and journals, and they perform automatic updating of account data.

**Price:** \$29.95.  
**Contact:** Management Information Software, Inc.,  
3301 Gandy Blvd., Tampa, FL 33611, (813) 832-3449; fax (813) 831-1311.  
**Circle 1023 on Inquiry Card.**

# Breaking into WINDOWS has Never Been Easier

Introducing WinTRAN™, the object-oriented Windows™ development environment that lets you manipulate **named visual objects** instead of windows. Applications developed with WinTRAN contain from *one half to one tenth* the lines of code of Windows applications developed with other methods. And, WinTRAN applications are written in standard programming languages such as C, C++, or Pascal. Best yet, Windows applications developed with WinTRAN can be ported to other GUI environments such as OSF/Motif without change to user interface descriptions or code. Yes, its never been easier to break into Windows.

Call today for more information **1-800-257-4888**



**GUIDEWARE**  
CORPORATION

2483 Old Middlefield Way, Suite 224, Mountain View CA 94043

Windows is a trademark of Microsoft Corporation. WinTRAN is a trademark of Guideware Corporation.

# 486 33MHz Power!

PRICE  
INCLUDES  
GROUND  
SHIPPING IN  
CONTINENTAL  
U.S.



120MB HARD DRIVE  
4MB RAM, SUPERVGA

**\$2295.00**

**SHOPPER'S ADVISORY**— If you're finding yourself stuck in the confusing forest of computer dealers, you won't find many that can claim: 1) A Large National Customer Base, 2) Major Corporate Clients, 3) Retail/Mail Order and Wholesale business, 4) An Established Tradition of Customer Support. But WE CAN! Since 1984, we continue our commitment to providing the highest quality components and service at the best price. Stay on the cutting edge with Lucky Star International!

All LSI Professional Systems Are FCC Certified.

## 386SX/25 SuperVGA

105MB Hard Drive, 2MB RAM, SVGA, Dual Floppy

80386SX 25MHz CPU  
2MB RAM-Expandable to 16MB  
14" SuperVGA Color Monitor, .28mm dot  
512K Super VGA Card  
1.2MB and 1.44MB Floppy Disk Drives  
105MB IDE Hard Drive, 19ms  
Desktop Style Case, 101 Keyboard  
220W Switching Power Supply  
Serial, Parallel, and Game Ports  
Full 1 Year Limited Warranty-Parts and Labor

**\$1295.00**

## 286 and 386 SX

42MB Hard Drive, 1MB RAM, Mono Monitor

1MB RAM-Exp. to 4MB(286) or 8MB(SX)  
12" Monochrome TTL Monitor, 720x348 res.  
MonoGraphic Card, Hercules Compatible  
1.2MB Floppy Disk Drive  
42MB IDE Hard Drive, 28ms  
Desktop Style Case, 220W Switching PS  
Serial, Parallel, and Game Ports  
Full 1 Year Limited Warranty-Parts and Labor

**386SX/20**      **286/12**  
**\$845.00**      **\$645.00**

**386SX/16**      14" SuperVGA, 512K VRAM add \$350  
**\$795.00**      80MB Hard Drive, 19ms add \$100  
120MB Hard Drive, 19ms add \$200  
Memory Upgrade (per MB) add \$65

## 486/33 Features

80486 33MHZ 32 bit INTEL CPU  
4MB RAM-Expandable to 32MB  
Phoenix BIOS, 256K Static RAM Cache  
8 Expansion Slots (ISA 16 bit)  
14" SuperVGA Color Monitor, 1024x768, .28mm dot  
1MB VGA Card, resolves 1024x768 at 256 colors  
1.2 and 1.44 MB Floppy Disk Drives  
120MB IDE Hard Drive, 19ms  
Desktop Style Case (Tower Option Available)  
220W Switching Power Supply  
Serial, Parallel, and Game Ports  
MS-DOS 5.0, Serial Mouse included  
Full 1 Year Limited Warranty-Parts and Labor

EISA System, 32 bit Bus	add \$750	200MB IDE (19ms)	add \$250
(EISA has 7 32-bit slots, 1 16-bit slot)		336MB ESDI (16ms)	add \$1150
Non-Interlaced Video(.28 dot)	add \$90	760MB ESDI (14ms)	add \$1950
Sony 1304 (NI at .25 dot)	add \$450	ESD/EISA 32-bit Controller	add \$795



Tower System Option add \$100

## 386/33 Power System

120MB Hard Drive, 4MB RAM, SuperVGA

80386 33MHZ 32 bit CPU  
4MB RAM-Expandable to 32MB  
128K High Speed Static RAM Cache  
14" SuperVGA Color Monitor, 1024x768 (.28 dot)  
1MB Super VGA Card, 1024x768 at 256 colors  
1.2 and 1.44 MB Floppy Disk Drives  
120MB IDE Hard Drive, 19ms  
Desktop Style Case  
220W Switching Power Supply  
Serial, Parallel, and Game Ports  
MS-DOS 5.0, Serial Mouse included  
Full 1 Year Limited Warranty-Parts/Labor

Price Includes  
Shipping in  
Continental U.S.      **\$1795.00**

Non-Interlaced SVGA, .25mm dot (Sony tube) add \$350  
17" Non-Interlaced SVGA, .28mm dot      CALL  
20" Non-Interlaced SVGA      CALL  
Logitech Mouse and Windows 3.0 only \$75 with System



New! from **Mpact 386SX/20**  
**Notebook Computer**  
**\$1750.00**



- Compact 10"x12"x2", 7 pounds
- 60MB Hard Drive, 19ms access time
- 1MB RAM, expandable to 5MB
- 10" VGA LCD Display, 32 Grayscale
- 16Bit VGA, 512K Video RAM
- 1.44MB 3 1/2" Internal Floppy
- Serial/Parallel/Ext. Video Ports
- 3 Hour Battery, 50/60Hz AC Power

Locations Nationwide - Quality Service and Support Since 1984

# Lucky Computer Co.



## Retail Hours

Mon-Sat 9am-6pm  
Eastern/Central/Pacific Time

Sunday Noon-5pm  
Tukwila, WA  
Location ONLY

No CREDIT CARD SURCHARGE



## 1-800-966-5825

Mail Order  
(214)437-3251 FAX

Hours 9am-6pm  
Monday-Friday  
Central Time

### SOUTHWEST REGION

1701 Greenville Ave. #602      2132 N. Collins  
Richardson, TX 75081      Arlington, TX 76011  
(214)690-6110      (817)265-1883  
4151 Beltline Rd. #120      12110 Westheimer  
Addison, TX 75244      Houston, TX 77077  
(214)702-8588      (713)497-7887

### NORTHWEST REGION

10773 SW Bvtn.-Hills. Hwy      14220 NE 20th #D  
Beaverton, OR 97005      Bellevue, WA 98007  
(503)671-0961      (206)643-2673  
17338 Southcenter Pkwy.      **GREATER ATLANTA**  
Tukwila, WA 98188      5939 Jimmy Carter Blvd.  
(206)575-9060      Norcross, GA 30071  
(404)416-9605

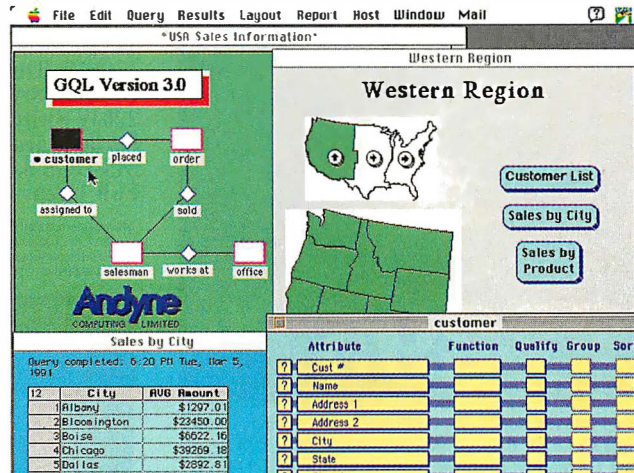
Copyright 1992 Lucky Computer Company. Lucky Star International, MS-DOS, Intel, Logitech, Micronics, Sony, View sonic, Conner, Teac and Microscience are trademarks of their respective companies. All Prices/Specifications subject to

Circle 562 on Inquiry Card (RESELLERS: 563).

### Share Mac and Windows Data with GQL

The Graphical Query Language line of ad-hoc Structured Query Language database query-and-reporting tools for Macintosh systems now branches out to Windows. You can develop your own data-analysis and reporting environments using the program's point-and-click WYSIWYG interface.

GQL for Windows lets Windows and Mac users share data from SQL databases. Optional administrative modules of GQL for Windows let select users develop query environments, perform data entry, and create new databases. Price: User version, \$350; administrative modules,



*GQL lets you store frequently used queries as Executive Buttons, which let you access information with automatic report generation, charts, data analysis, and integration with other applications.*

\$450 and up.  
**Contact:** Andyne Computing, Ltd., 552 Princess St., Second Floor, Kingston,

Ontario, Canada K7L 1C7,  
 (613) 548-4355; fax (613) 548-7801.  
**Circle 1030 on Inquiry Card.**

### Novice and Pro Tools

DataEase Personal for DOS provides a menu-driven interface, the Query-By-Example reporting facility, and other functions for developing applications.

DataEase 4.5 lets professional users migrate applications to an on-line distributed database environment. Version 4.5 runs OS/2 and DOS, and it lets you add client-server access to multiple Structured Query Language database engines. Price: DataEase Personal, \$99; DataEase 4.5, \$795; SQL Connect, \$495.

**Contact:** DataEase International, Inc., 7 Cambridge Dr., Trumbull, CT 06611, (800) 243-5123 or (203) 374-8000; fax (203) 365-2317.  
**Circle 1029 on Inquiry Card.**

## Let Gpf write the GUI you design

Using the powerful point and click visual programming environment of Gpf\*, you can prototype, test and generate a complete OS/2 PM GUI in a few hours or days rather than the weeks or months required to hand code the same design. Even a relatively simple GUI can require writing thousands of lines of code, but with Gpf you simply draw your user interface on the screen. The integrated dialogue editor of Gpf permits actions and context sensitive help to be linked to controls as you create them. Gpf then generates error free ANSI C complete with embedded SQL statements.

Gpf is optimized to take full advantage of OS/2 PM, the most powerful and robust GUI system available. Since Gpf code directly accesses the PM API, there is no run time module to distribute with your application and no added overhead or royalties.

Gpf keeps the entire design definition in one file. This means single point maintenance for easy update and archiving. From this file Gpf generates the C source file as well as .H, .RC, .IPF, DEF, .IDS, .MAK, etc..

#### Gpf supports:

- Simple and direct linkage of the interface to program logic, built in or user defined functions.
- Direct association of help screens with controls, and complete integration into the PM Help Presentation Facility.
- Flexible use of Presentation objects (fonts, colors, etc.) with controls and windows (client area and frame).
- Simple inclusion of bitmaps for use on About screens, user buttons, and menu or pull-down entries.
- Automatic embedded SQL statements to read OS/2 DataBase Manager tables, directly into combo or list boxes.
- Multi-thread programming.
- Multiple source file generation.
- Automatic creation of controls that scale with window size.
- Inclusion of user defined controls

#### Try us out.

Order Gpf today for just \$995.<sup>99</sup>  
 Call Gpf Systems Inc. at:  
 (203) 873-3300 or (800) 831-0017 - fax (203) 873-3302. Free demo software available  
 P.O. Box 414, 30 Falls Rd., Moodus, CT 06469

\* GUI Programming Facility



### Pro and Personal Versions of RapidTax for PC

**R**apidTax Professional is geared to getting the professional accountant through tax season quickly and easily. You can load any form with a single key-stroke and share data among forms, schedules, and state returns. RapidTax features a what-if form-filing capability; an auto-save feature; an audit detector; an on-line manual; and a client organizer, billing module, and checklist. You can receive RapidTax program updates and technical support via the included communication software and your modem. DacEasy offers electronic filing software, 23 state modules, and Refund Anticipation Loan software.

The personal version of RapidTax lets you choose between an interview style of data entry or a direct-form style of entry. The program offers time- and money-saving tax tips and a built-in tutorial. State modules are available from DacEasy. **Price:** Professional version, \$699.95; professional-version state modules, \$199 each; personal version, \$49.95; personal-version state modules, \$29.95 each. **Contact:** DacEasy, Inc., 17950 Preston Rd., Suite 800, Dallas, TX 75252, (800) 877-8088; fax (214) 248-1239.

**Circle 1011 on Inquiry Card.**

### Federal and State Preparation for the PC

**T**he 1991 version of Personal Tax Edge lets you work on multiple tax forms simultaneously. The program's windowing capabil-

7.	Wages, salaries, tips, etc.	(Wks)	7.	58,837
8a	Taxable interest income	(If over \$400—Schedule B)	8a	3,458
b	Tax			
9.	Div			718
10.	Tax			2,698
11.	Ali			398
12.	Bus			19,487
13.	Cap			972
14.	Cap			
15.	Oth			
16a	IRA			
17a	Pen			
18.	Pen			11,577
19.	Far			
20.	Une			
21a	Soc			
22.	Oth			
23.	Tot			98,849

1991 Tax Interview Form 1040

Line 9.  
If you received more than \$400 in dividend income, you must complete Schedule B. If you received dividend income of \$400 or less you may report it here without completing Schedule B. You should enter an amount here ONLY if you have dividend income of \$400 or LESS. If Schedule B is filed, these amounts will be set by Schedule B.

Dividend Amount: 718

Bal. Due: 738

J. Taxpayer

Form 1040 [PgUp] Input, Over [PgDn] Calculated

*RapidTax Personal's interview approach walks you through your return step-by-step and steers you away from answering unnecessary questions.*

ity lets you work on one form and switch among others as you wish. Tax Edge's cross-reference feature shows you the list of forms and subtotals that make up the total of a specific line item.

The DOS-based program is a two-part set that consists of planning and final-filing versions. State return modules are available for all states requiring returns except Hawaii.

Other features of Tax Edge include pull-down menus, a glossary of tax terms, enhanced on-line help, a comparison chart of U.S. averages, and alternative-filing comparison tools. The program provides instructions for the nearly 40 tax forms, and it prints your return in an IRS-approved format.

**Price:** Personal Tax Edge, \$49; state modules, \$49 each.

**Contact:** Parsons Technology, 1 Parsons Dr., P.O. Box 100, Hiawatha, IA 52233, (319) 395-9626; fax (319) 395-0217.

**Circle 1008 on Inquiry Card.**

### EasyTax Offers Helpful Hints

**E**asyTax for 1991 includes all IRS-approved forms, worksheets, and schedules. EasyTax provides on-screen help that explains the tax return process and offers tips to lower your tax bill. You can print replications of IRS tax forms or take advantage of the electronic-filing option. The developer offers state filing modules for 24 states.

EasyTax lets you import data from Quicken, Lotus 1-2-3, and other programs. The form-linking feature updates data in worksheets, forms, and schedules as you change information in one area. You can do what-if projections to determine your best tax alternative, and the DOS-based package warns you if your return's content might spark an IRS audit. **Price:** \$79.95.

**Contact:** Timeworks, Inc., 625 Academy Dr., Northbrook, IL 60062, (708) 559-1300; fax (708) 559-1399.

**Circle 1009 on Inquiry Card.**

### ChipSoft Offers a Bundle of Tax Packages

**T**urboTax, available for DOS and Windows, walks you through the preparation of your tax return in a question-and-answer process. The program features specialized help topics that advise you on the implications of personal issues or answer questions on income, payment, and expense categories.

You can import data from Quicken or any spreadsheet directly into TurboTax, according to the developer. This year's version of the program features enhanced depreciation capabilities, and you can automatically flow amortization amounts to the appropriate line of your return. TurboTax does a final review of your return, highlighting unusual itemized deductions, audit flags, and year-round tax deadlines.

MacInTax alerts you to changes in tax laws and to the program itself. The System 7.0-compliant package features automatic form, schedule, and worksheet linkage. A state version of TurboTax is available for all 44 states that have income taxes; MacInTax offers 15 state packages.

**Price:** TurboTax, \$79.95; TurboTax for Windows and MacInTax, \$99.95; TurboTax state modules, \$49.95 each; Windows and Mac state modules, \$69.95. **Contact:** ChipSoft, Inc., 6330 Nancy Ridge Dr., Suite 103, San Diego, CA 92121, (619) 458-8722; fax (800) 755-1040.

**Circle 1010 on Inquiry Card.**

# NEWS

WHAT'S NEW • MULTIMEDIA

## The CD Gallery: Facts, Music, and More

The CD Gallery, an NEC CD-ROM drive and seven CD-ROM software titles, is available for PC and Macintosh systems. In addition to the disk-reading hardware, both versions include interface software, speakers, and headphones.

Both PC and Mac disk sets include the New Grolier Electronic Encyclopedia and The Time Table of History. The PC version comes with such titles as The Time Magazine Almanac and National Geographic Mammals: A Multimedia Encyclopedia. Mac users get Warner New Media and Time magazine's Desert Storm. Price: \$699 to \$1229, de-



NEC's CD Gallery lets you access the Los Angeles visitors' travel guide, which is offered as part of the Great Cities of the World disk for PCs.

pending on the CD-ROM drive and the system interface. Contact: NEC Technol-

ogies, Inc., 1255 Michael Dr., Wood Dale, IL 60191, (708) 860-9500. Circle 1027 on Inquiry Card.

## A Business Directory on a Disk

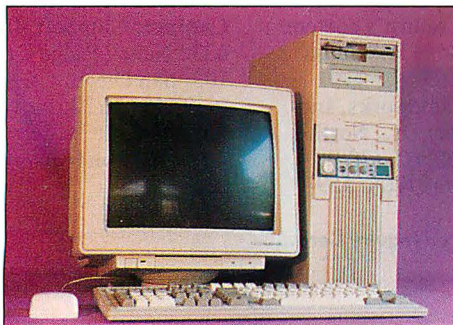
Nynex Fast Track, the consumer and business telephone directory, is now available as a nine-disk set that lets you access directory information by name, address, telephone number, or ZIP code for more than 77 million listings. You can purchase Fast Track in any number of regional combinations. The directory will be updated quarterly. Price: \$125 to \$7995, depending on configuration. Contact: Nynex Information Technologies Co., 100 Church St., Ninth Floor, New York, NY 10007, (800) 338-0646 or (212) 513-9735. Circle 1028 on Inquiry Card.

## AIM FOR THE BEST

### 386SX-16 or 25MHz

- AMI BIOS
- 2MB Ram (Expands to 16MB)
- 80 MB IDE Hard Drive
- Mini-Tower Case
- 1.2MB 5.25" Floppy Drive
- 101 Key Tactile Keyboard
- 2 Serial, 1 Parallel, 1 Game Port
- S. VGA Card (1024x768-256 Color)
- S. VGA Monitor (1024x768 .28dot)
- MS-DOS 5.0
- Windows 3.0 and Mouse
- FCC Class B
- FCC Class B

\$1375/1425



### 386-33 or 40 MHz

- AMI BIOS
- 64K Write Back Cache
- 4MB Ram (Expands to 32MB)
- 120MB IDE Hard Drive
- Middle-Tower Case
- 1.2MB 5.25" Floppy Drive
- 1.44MB 3.5" Floppy Drive
- 101 Key Tactile Keyboard
- 2 Serial, 1 Parallel, 1 Game Port
- Orchard ProDesigner IIs 32K Color
- 14" Non-interlaced Monitor 1024x768 72Hz Refresh .28 dp
- MS-DOS 5.0
- Windows 3.0 and Mouse
- FCC Class B

\$1975/2025

### 486-33 MHz

- AMI BIOS
- 256K Write Back Cache
- 4MB Ram (Expands to 32MB)
- 120MB IDE Hard Drive
- Middle-Tower Case
- 1.2MB 5.25" Floppy Drive
- 1.44MB 3.5" Floppy Drive
- 101 Key Tactile Keyboard
- 2 Serial, 1 Parallel, 1 Game Port
- Orchard ProDesigner IIs 32K Color
- 14" Non-interlaced Monitor 1024x768 72Hz Refresh .28 dp
- MS-DOS 5.0
- Windows 3.0 and Mouse
- FCC Class B

\$2455

DOS 5.0 & Windows 3.0 Installation .....\$35  
OS/2 Installation .....\$75

## AIMS Information Systems

780 Montague Expwy #303, San Jose, CA 95131  
Tel: 408-456-0111 Fax: 408-456-0818

California	Utah
408-456-0111	801-278-8400
Idaho	Montana
208-467-5357	406-449-4499

# FREE PRODUCT INFORMATION

Mail Your Completed Card Today. For Quicker Response, Fax to 1-413-637-4343!

Circle the numbers on Inquiry Card which correspond to inquiry numbers assigned to items of interest to you.

Check all the appropriate answers to questions "A" through "E".

Print Your name and address and mail, or fax to 1-413-637-4343

Fill out this coupon carefully. PLEASE PRINT.

NAME \_\_\_\_\_  
TITLE \_\_\_\_\_  
COMPANY \_\_\_\_\_  
ADDRESS \_\_\_\_\_  
CITY \_\_\_\_\_ STATE \_\_\_\_\_ ZIP \_\_\_\_\_  
( ) ( )  
PHONE \_\_\_\_\_ FAX \_\_\_\_\_

A. What is your primary job function/principal area of responsibility? (Check one.)

- 1  MIS/DP  
2  Programmer/Systems Analyst  
3  Administration/Management  
4  Sales/Marketing  
5  Engineer/Scientist  
6  Other

B. What is your level of management responsibility?

- 7  Senior-level  
8  Middle-level  
9  Professional

C. Are you a reseller (VAR, VAD, Dealer, Consultant)?

- 10  Yes  
11  No

D. What operating systems are you currently using? (Check all that apply.)

- 12  PC/MS DOS  
13  DOS + Windows  
14  OS/2  
15  UNIX  
16  MacOS  
17  VAX/VMS

E. For how many people do you influence the purchase of hardware or software?

- 18  1-25  
19  26-50  
20  51-99  
21  100 or more

Please send me one year of BYTE Magazine for \$24.95 and bill me. Offer valid in U.S. and possessions only.

MARCH  
IRSD03C

**Inquiry Numbers 1-493**

1 2 3 4 5 6 7 8 9 10 11 12 13 14 15 16 17  
18 19 20 21 22 23 24 25 26 27 28 29 30 31 32 33 34  
35 36 37 38 39 40 41 42 43 44 45 46 47 48 49 50 51  
52 53 54 55 56 57 58 59 60 61 62 63 64 65 66 67 68  
69 70 71 72 73 74 75 76 77 78 79 80 81 82 83 84 85  
86 87 88 89 90 91 92 93 94 95 96 97 98 99 100 101 102  
103 104 105 106 107 108 109 110 111 112 113 114 115 116 117 118 119  
120 121 122 123 124 125 126 127 128 129 130 131 132 133 134 135 136  
137 138 139 140 141 142 143 144 145 146 147 148 149 150 151 152 153  
154 155 156 157 158 159 160 161 162 163 164 165 166 167 168 169 170  
171 172 173 174 175 176 177 178 179 180 181 182 183 184 185 186 187  
188 189 190 191 192 193 194 195 196 197 198 199 200 201 202 203 204  
205 206 207 208 209 210 211 212 213 214 215 216 217 218 219 220 221  
222 223 224 225 226 227 228 229 230 231 232 233 234 235 236 237 238  
239 240 241 242 243 244 245 246 247 248 249 250 251 252 253 254 255  
256 257 258 259 260 261 262 263 264 265 266 267 268 269 270 271 272  
273 274 275 276 277 278 279 280 281 282 283 284 285 286 287 288 289  
290 291 292 293 294 295 296 297 298 299 300 301 302 303 304 305 306  
307 308 309 310 311 312 313 314 315 316 317 318 319 320 321 322 323  
324 325 326 327 328 329 330 331 332 333 334 335 336 337 338 339 340  
341 342 343 344 345 346 347 348 349 350 351 352 353 354 355 356 357  
358 359 360 361 362 363 364 365 366 367 368 369 370 371 372 373 374  
375 376 377 378 379 380 381 382 383 384 385 386 387 388 389 390 391  
392 393 394 395 396 397 398 399 400 401 402 403 404 405 406 407 408  
409 410 411 412 413 414 415 416 417 418 419 420 421 422 423 424 425  
426 427 428 429 430 431 432 433 434 435 436 437 438 439 440 441 442  
443 444 445 446 447 448 449 450 451 452 453 454 455 456 457 458 459  
460 461 462 463 464 465 466 467 468 469 470 471 472 473 474 475 476  
477 478 479 480 481 482 483 484 485 486 487 488 489 490 491 492 493

**Inquiry Numbers 494-986**

494 495 496 497 498 499 500 501 502 503 504 505 506 507 508 509 510  
511 512 513 514 515 516 517 518 519 520 521 522 523 524 525 526 527  
528 529 530 531 532 533 534 535 536 537 538 539 540 541 542 543 544  
545 546 547 548 549 550 551 552 553 554 555 556 557 558 559 560 561  
562 563 564 565 566 567 568 569 570 571 572 573 574 575 576 577 578  
579 580 581 582 583 584 585 586 587 588 589 590 591 592 593 594 595  
596 597 598 599 600 601 602 603 604 605 606 607 608 609 610 611 612  
613 614 615 616 617 618 619 620 621 622 623 624 625 626 627 628 629  
630 631 632 633 634 635 636 637 638 639 640 641 642 643 644 645 646  
647 648 649 650 651 652 653 654 655 656 657 658 659 660 661 662 663  
664 665 666 667 668 669 670 671 672 673 674 675 676 677 678 679 680  
681 682 683 684 685 686 687 688 689 690 691 692 693 694 695 696 697  
698 699 700 701 702 703 704 705 706 707 708 709 710 711 712 713 714  
715 716 717 718 719 720 721 722 723 724 725 726 727 728 729 730 731  
732 733 734 735 736 737 738 739 740 741 742 743 744 745 746 747 748  
749 750 751 752 753 754 755 756 757 758 759 760 761 762 763 764 765  
766 767 768 769 770 771 772 773 774 775 776 777 778 779 780 781 782  
783 784 785 786 787 788 789 790 791 792 793 794 795 796 797 798 799  
800 801 802 803 804 805 806 807 808 809 810 811 812 813 814 815 816  
817 818 819 820 821 822 823 824 825 826 827 828 829 830 831 832 833  
834 835 836 837 838 839 840 841 842 843 844 845 846 847 848 849 850  
851 852 853 854 855 856 857 858 859 860 861 862 863 864 865 866 867  
868 869 870 871 872 873 874 875 876 877 878 879 880 881 882 883 884  
885 886 887 888 889 890 891 892 893 894 895 896 897 898 899 900 901  
902 903 904 905 906 907 908 909 910 911 912 913 914 915 916 917 918  
919 920 921 922 923 924 925 926 927 928 929 930 931 932 933 934 935  
936 937 938 939 940 941 942 943 944 945 946 947 948 949 950 951 952  
953 954 955 956 957 958 959 960 961 962 963 964 965 966 967 968 969  
970 971 972 973 974 975 976 977 978 979 980 981 982 983 984 985 986

**Inquiry Numbers 987-1479**

987 988 989 990 991 992 993 994 995 996 997 998 999 1000 1001 1002 1003  
1004 1005 1006 1007 1008 1009 1010 1011 1012 1013 1014 1015 1016 1017 1018 1019 1020  
1021 1022 1023 1024 1025 1026 1027 1028 1029 1030 1031 1032 1033 1034 1035 1036 1037  
1038 1039 1040 1041 1042 1043 1044 1045 1046 1047 1048 1049 1050 1051 1052 1053 1054  
1055 1056 1057 1058 1059 1060 1061 1062 1063 1064 1065 1066 1067 1068 1069 1070 1071  
1072 1073 1074 1075 1076 1077 1078 1079 1080 1081 1082 1083 1084 1085 1086 1087 1088  
1089 1090 1091 1092 1093 1094 1095 1096 1097 1098 1099 1100 1101 1102 1103 1104 1105  
1106 1107 1108 1109 1110 1111 1112 1113 1114 1115 1116 1117 1118 1119 1120 1121 1122  
1123 1124 1125 1126 1127 1128 1129 1130 1131 1132 1133 1134 1135 1136 1137 1138 1139  
1140 1141 1142 1143 1144 1145 1146 1147 1148 1149 1150 1151 1152 1153 1154 1155 1156  
1157 1158 1159 1160 1161 1162 1163 1164 1165 1166 1167 1168 1169 1170 1171 1172 1173  
1174 1175 1176 1177 1178 1179 1180 1181 1182 1183 1184 1185 1186 1187 1188 1189 1190  
1191 1192 1193 1194 1195 1196 1197 1198 1199 1200 1201 1202 1203 1204 1205 1206 1207  
1208 1209 1210 1211 1212 1213 1214 1215 1216 1217 1218 1219 1220 1221 1222 1223 1224  
1225 1226 1227 1228 1229 1230 1231 1232 1233 1234 1235 1236 1237 1238 1239 1240 1241  
1242 1243 1244 1245 1246 1247 1248 1249 1250 1251 1252 1253 1254 1255 1256 1257 1258  
1259 1260 1261 1262 1263 1264 1265 1266 1267 1268 1269 1270 1271 1272 1273 1274 1275  
1276 1277 1278 1279 1280 1281 1282 1283 1284 1285 1286 1287 1288 1289 1290 1291 1292  
1293 1294 1295 1296 1297 1298 1299 1300 1301 1302 1303 1304 1305 1306 1307 1308 1309  
1310 1311 1312 1313 1314 1315 1316 1317 1318 1319 1320 1321 1322 1323 1324 1325 1326  
1327 1328 1329 1330 1331 1332 1333 1334 1335 1336 1337 1338 1339 1340 1341 1342 1343  
1344 1345 1346 1347 1348 1349 1350 1351 1352 1353 1354 1355 1356 1357 1358 1359 1360  
1361 1362 1363 1364 1365 1366 1367 1368 1369 1370 1371 1372 1373 1374 1375 1376 1377  
1378 1379 1380 1381 1382 1383 1384 1385 1386 1387 1388 1389 1390 1391 1392 1393 1394  
1395 1396 1397 1398 1399 1400 1401 1402 1403 1404 1405 1406 1407 1408 1409 1410 1411  
1412 1413 1414 1415 1416 1417 1418 1419 1420 1421 1422 1423 1424 1425 1426 1427 1428  
1429 1430 1431 1432 1433 1434 1435 1436 1437 1438 1439 1440 1441 1442 1443 1444 1445  
1446 1447 1448 1449 1450 1451 1452 1453 1454 1455 1456 1457 1458 1459 1460 1461 1462  
1463 1464 1465 1466 1467 1468 1469 1470 1471 1472 1473 1474 1475 1476 1477 1478 1479



NO POSTAGE  
NECESSARY  
IF MAILED  
IN THE  
UNITED STATES

**BUSINESS REPLY MAIL**  
FIRST CLASS MAIL PERMIT NO. 176 PITTSFIELD, MA

POSTAGE WILL BE PAID BY ADDRESSEE

# BYTE

READER SERVICE  
PO Box 5110  
Pittsfield, MA 01203-9926  
USA



# FREE PRODUCT INFORMATION

Mail Your Completed Card Today. For Quicker Response, Fax to 1-413-637-4343!

1. Circle the numbers on Inquiry Card which correspond to inquiry numbers assigned to items of interest to you.

2. Check all the appropriate answers to questions "A" through "E".

3. Print Your name and address and mail, or fax to 1-413-637-4343



NO POSTAGE  
NECESSARY  
IF MAILED  
IN THE  
UNITED STATES

## BUSINESS REPLY MAIL

FIRST CLASS MAIL PERMIT NO. 176 PITTSFIELD, MA

POSTAGE WILL BE PAID BY ADDRESSEE

# BYTE

**READER SERVICE**  
PO Box 5110  
Pittsfield, MA 01203-9926  
USA



Fill out this coupon carefully. PLEASE PRINT.

NAME \_\_\_\_\_  
TITLE \_\_\_\_\_  
COMPANY \_\_\_\_\_  
ADDRESS \_\_\_\_\_  
CITY \_\_\_\_\_ STATE \_\_\_\_\_ ZIP \_\_\_\_\_  
PHONE \_\_\_\_\_ FAX \_\_\_\_\_

**A. What is your primary job function/principal area of responsibility? (Check one.)**

- 1  MIS/DP  
2  Programmer/Systems Analyst  
3  Administration/Management  
4  Sales/Marketing  
5  Engineer/Scientist  
6  Other

**B. What is your level of management responsibility?**

- 7  Senior-level  
8  Middle-level  
9  Professional

**C. Are you a reseller (VAR, VAD, Dealer, Consultant)?**

- 10  Yes  
11  No

**D. What operating systems are you currently using? (Check all that apply.)**

- 12  PC/MS-DOS  
13  DOS + Windows  
14  OS/2  
15  UNIX  
16  MacOS  
17  VAX/VMS

**E. For how many people do you influence the purchase of hardware or software?**

- 18  1-25  
19  26-50  
20  51-99  
21  100 or more

Please send me one year of BYTE Magazine for \$24.95 and bill me. Offer valid in U.S. and possessions only.

MARCH  
IRSD03C

**Inquiry Numbers 1-493**

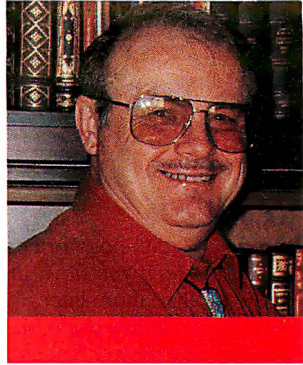
1 2 3 4 5 6 7 8 9 10 11 12 13 14 15 16 17  
18 19 20 21 22 23 24 25 26 27 28 29 30 31 32 33 34  
35 36 37 38 39 40 41 42 43 44 45 46 47 48 49 50 51  
52 53 54 55 56 57 58 59 60 61 62 63 64 65 66 67 68  
69 70 71 72 73 74 75 76 77 78 79 80 81 82 83 84 85  
86 87 88 89 90 91 92 93 94 95 96 97 98 99 100 101 102  
103 104 105 106 107 108 109 110 111 112 113 114 115 116 117 118 119  
120 121 122 123 124 125 126 127 128 129 130 131 132 133 134 135 136  
137 138 139 140 141 142 143 144 145 146 147 148 149 150 151 152 153  
154 155 156 157 158 159 160 161 162 163 164 165 166 167 168 169 170  
171 172 173 174 175 176 177 178 179 180 181 182 183 184 185 186 187  
188 189 190 191 192 193 194 195 196 197 198 199 200 201 202 203 204  
205 206 207 208 209 210 211 212 213 214 215 216 217 218 219 220 221  
222 223 224 225 226 227 228 229 230 231 232 233 234 235 236 237 238  
239 240 241 242 243 244 245 246 247 248 249 250 251 252 253 254 255  
256 257 258 259 260 261 262 263 264 265 266 267 268 269 270 271 272  
273 274 275 276 277 278 279 280 281 282 283 284 285 286 287 288 289  
290 291 292 293 294 295 296 297 298 299 300 301 302 303 304 305 306  
307 308 309 310 311 312 313 314 315 316 317 318 319 320 321 322 323  
324 325 326 327 328 329 330 331 332 333 334 335 336 337 338 339 340  
341 342 343 344 345 346 347 348 349 350 351 352 353 354 355 356 357  
358 359 360 361 362 363 364 365 366 367 368 369 370 371 372 373 374  
375 376 377 378 379 380 381 382 383 384 385 386 387 388 389 390 391  
392 393 394 395 396 397 398 399 400 401 402 403 404 405 406 407 408  
409 410 411 412 413 414 415 416 417 418 419 420 421 422 423 424 425  
426 427 428 429 430 431 432 433 434 435 436 437 438 439 440 441 442  
443 444 445 446 447 448 449 450 451 452 453 454 455 456 457 458 459  
460 461 462 463 464 465 466 467 468 469 470 471 472 473 474 475 476  
477 478 479 480 481 482 483 484 485 486 487 488 489 490 491 492 493

**Inquiry Numbers 494-986**

494 495 496 497 498 499 500 501 502 503 504 505 506 507 508 509 510  
511 512 513 514 515 516 517 518 519 520 521 522 523 524 525 526 527  
528 529 530 531 532 533 534 535 536 537 538 539 540 541 542 543 544  
545 546 547 548 549 550 551 552 553 554 555 556 557 558 559 560 561  
562 563 564 565 566 567 568 569 570 571 572 573 574 575 576 577 578  
579 580 581 582 583 584 585 586 587 588 589 590 591 592 593 594 595  
596 597 598 599 600 601 602 603 604 605 606 607 608 609 610 611 612  
613 614 615 616 617 618 619 620 621 622 623 624 625 626 627 628 629  
630 631 632 633 634 635 636 637 638 639 640 641 642 643 644 645 646  
647 648 649 650 651 652 653 654 655 656 657 658 659 660 661 662 663  
664 665 666 667 668 669 670 671 672 673 674 675 676 677 678 679 680  
681 682 683 684 685 686 687 688 689 690 691 692 693 694 695 696 697  
698 699 700 701 702 703 704 705 706 707 708 709 710 711 712 713 714  
715 716 717 718 719 720 721 722 723 724 725 726 727 728 729 730 731  
732 733 734 735 736 737 738 739 740 741 742 743 744 745 746 747 748  
749 750 751 752 753 754 755 756 757 758 759 760 761 762 763 764 765  
766 767 768 769 770 771 772 773 774 775 776 777 778 779 780 781 782  
783 784 785 786 787 788 789 790 791 792 793 794 795 796 797 798 799  
800 801 802 803 804 805 806 807 808 809 810 811 812 813 814 815 816  
817 818 819 820 821 822 823 824 825 826 827 828 829 830 831 832 833  
834 835 836 837 838 839 840 841 842 843 844 845 846 847 848 849 850  
851 852 853 854 855 856 857 858 859 860 861 862 863 864 865 866 867  
868 869 870 871 872 873 874 875 876 877 878 879 880 881 882 883 884  
885 886 887 888 889 890 891 892 893 894 895 896 897 898 899 900 901  
902 903 904 905 906 907 908 909 910 911 912 913 914 915 916 917 918  
919 920 921 922 923 924 925 926 927 928 929 930 931 932 933 934 935  
936 937 938 939 940 941 942 943 944 945 946 947 948 949 950 951 952  
953 954 955 956 957 958 959 960 961 962 963 964 965 966 967 968 969  
970 971 972 973 974 975 976 977 978 979 980 981 982 983 984 985 986

987 988 989 990 991 992 993 994 995 996 997 998 999 1000 1001 1002 1003  
1004 1005 1006 1007 1008 1009 1010 1011 1012 1013 1014 1015 1016 1017 1018 1019 1020  
1021 1022 1023 1024 1025 1026 1027 1028 1029 1030 1031 1032 1033 1034 1035 1036 1037  
1038 1039 1040 1041 1042 1043 1044 1045 1046 1047 1048 1049 1050 1051 1052 1053 1054  
1055 1056 1057 1058 1059 1060 1061 1062 1063 1064 1065 1066 1067 1068 1069 1070 1071  
1072 1073 1074 1075 1076 1077 1078 1079 1080 1081 1082 1083 1084 1085 1086 1087 1088  
1089 1090 1091 1092 1093 1094 1095 1096 1097 1098 1099 1100 1101 1102 1103 1104 1105  
1106 1107 1108 1109 1110 1111 1112 1113 1114 1115 1116 1117 1118 1119 1120 1121 1122  
1123 1124 1125 1126 1127 1128 1129 1130 1131 1132 1133 1134 1135 1136 1137 1138 1139  
1140 1141 1142 1143 1144 1145 1146 1147 1148 1149 1150 1151 1152 1153 1154 1155 1156  
1157 1158 1159 1160 1161 1162 1163 1164 1165 1166 1167 1168 1169 1170 1171 1172 1173  
1174 1175 1176 1177 1178 1179 1180 1181 1182 1183 1184 1185 1186 1187 1188 1189 1190  
1191 1192 1193 1194 1195 1196 1197 1198 1199 1200 1201 1202 1203 1204 1205 1206 1207  
1208 1209 1210 1211 1212 1213 1214 1215 1216 1217 1218 1219 1220 1221 1222 1223 1224  
1225 1226 1227 1228 1229 1230 1231 1232 1233 1234 1235 1236 1237 1238 1239 1240 1241  
1242 1243 1244 1245 1246 1247 1248 1249 1250 1251 1252 1253 1254 1255 1256 1257 1258  
1259 1260 1261 1262 1263 1264 1265 1266 1267 1268 1269 1270 1271 1272 1273 1274 1275  
1276 1277 1278 1279 1280 1281 1282 1283 1284 1285 1286 1287 1288 1289 1290 1291 1292  
1293 1294 1295 1296 1297 1298 1299 1300 1301 1302 1303 1304 1305 1306 1307 1308 1309  
1310 1311 1312 1313 1314 1315 1316 1317 1318 1319 1320 1321 1322 1323 1324 1325 1326  
1327 1328 1329 1330 1331 1332 1333 1334 1335 1336 1337 1338 1339 1340 1341 1342 1343  
1344 1345 1346 1347 1348 1349 1350 1351 1352 1353 1354 1355 1356 1357 1358 1359 1360  
1361 1362 1363 1364 1365 1366 1367 1368 1369 1370 1371 1372 1373 1374 1375 1376 1377  
1378 1379 1380 1381 1382 1383 1384 1385 1386 1387 1388 1389 1390 1391 1392 1393 1394  
1395 1396 1397 1398 1399 1400 1401 1402 1403 1404 1405 1406 1407 1408 1409 1410 1411  
1412 1413 1414 1415 1416 1417 1418 1419 1420 1421 1422 1423 1424 1425 1426 1427 1428  
1429 1430 1431 1432 1433 1434 1435 1436 1437 1438 1439 1440 1441 1442 1443 1444 1445  
1446 1447 1448 1449 1450 1451 1452 1453 1454 1455 1456 1457 1458 1459 1460 1461 1462  
1463 1464 1465 1466 1467 1468 1469 1470 1471 1472 1473 1474 1475 1476 1477 1478 1479





JERRY  
POURNELLE

## INTERRUPTS AND BIG CATS

**N**ietzsche says that which does not kill us makes us stronger. This month seemed designed to demonstrate that to me, but all's well that ends well...

My Cheetah 386/25 is one of the first ones they made. Indeed, I got it when 386 chips were rare, and I had to wheedle a 25-MHz 386/387 chip set out of Intel, since Cheetah couldn't get any for me. The system was assembled by Larry Aldridge, and it was my main system from the day I got it until a couple of weeks ago. During that time, it was turned off only when I went on trips and the innumerable times we changed one or another peripheral board.

We also loaded it up: CD-ROM drive, tape drive, LAN card, Perceptive Solutions drive controller with 4 MB of on-board cache memory, dual hard drives—you name it, and we put it in there. In all that time, I had no real problems with it; indeed, that machine was so reliable that although I have had a Cheetah Gold 486/33 for months, I continued to use the 386/25, relegating the 486 to the status of a network server.

Two weeks ago I set up Norton Commander to go look at my MCI Mail, and I went for a hike in the local hills. When I got back, the screen was blank, and there was no power light on the machine. I thought at first that the housekeeper had turned the machine off, but no, the switch was on. But the fan wasn't on, and the drives were not spinning.

This seemed odd. My writing machines are powered from a Clary uninterruptible power supply, and it was working just fine as always.

I flipped the power switch off and back on. The power light came on for about a second and went off again. No question about it, I had a problem. I opened up the machine and thought about it. My first thought was a short of some kind, possibly on one of the boards. First thing, then, was to pull out the drive controller board. With its 4 MB of memory, it uses more power than anything else. Sure enough, it made a difference: now, when I flipped the power switch, it stayed on for almost 2 seconds before going dead.

Next step was to unplug everything. When I did that, the power supply would run fine; but as soon as I put a load on it, it died. Not much question, then, that the problem was the power supply. I had a 200-watt Turbo-Cool power supply from PC Power & Cooling. In fact, all my Cheetah systems have Turbo-Cool power supplies; that was the only kind Larry Aldridge recommended. A quick call to my son Alex confirmed my theory.

Alex also pointed out that when we added all the peripherals and extra drives we'd loaded that 200-W supply right up to its capacity and beyond—and that apparently it had failed gracefully, not smoking any boards on the way out. A lot of power supplies do terrible damage as they die, but we never heard of a Turbo-Cool doing that.

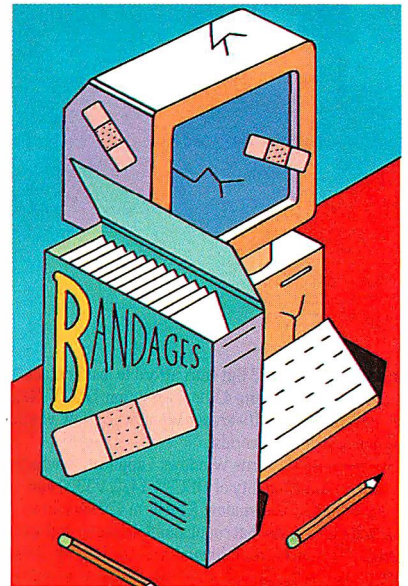
I had Alex order me a new 300-W Turbo-Cool. It was too late for them to get it out that day, so it would be at least two days before I could fix my Cheetah 386. Unfortunately, I had a lot of work to do, and there was no way I could afford to take two days off. I had to have a machine. Of course, I have several systems in the other room. I could go use one of them. I could even use Roberta's Gateway, which works just fine. But I didn't like either idea much: my desk and chair are set up pretty well to take care of my back, and I really hate to work away from my desk.

### Cheetah Gold 486/33

The obvious thing to do was to use this as an opportunity to upgrade to the Cheetah Gold 486/33. I'd have to do that one day anyway. There are getting to be just too many nifty programs that require Windows, and while my old Cheetah 386/25 with 4 MB of RAM was plenty adequate for DOS and Desqview, it would be only marginally so for Windows. With Windows, you want about 8 MB of memory, and a 486/25 is none too fast; a 486/33 is much better.

I know there are people who despise Windows because it won't run on their older hardware, and I sympathize. I have stayed with Desqview this past year because I didn't like the Windows performance on my 386/25. That's ironic because Desqview is itself hardware-sensitive. It will work with a 286, but it's sure better with a 386. I was also wrong: a 386/25 is plenty fast enough for Windows, especially if it is run with an intelligent controller, like one from Distributed Processing

**Configuring a new machine is always a learning experience**



Technology or Perceptive Solutions, *provided you have the right video card*. On that, more later.

In any event, the Gold 486/33 has a fast Perceptive Solutions controller with 4 MB of on-board cache memory and a big 800-MB Siemens hard drive. Cheetah systems run clean without glitches and are among the best development systems available; this one is easily the best machine in the house. Moreover, it was already set up with Artisoft's LANtastic and had the

Palindrome digital audiotape backup and Network Archivist software installed. I figured that changing over would never be easier.

I was almost right.

First things first. As it happened, I had used the network to copy everything from the Cheetah 386 to the 486 just the night before in a routine backup. I had done almost no work in the morning before my hike, so the only thing that could be lost was whatever the 386 had picked up from

MCI Mail; and since MCI Mail keeps all your messages for a couple of days, I could even check that out. All I'd have to do, then, would be to move the 486 in under my desk and connect it to my Zenith Flat Technology Monitor and my Northgate OmniKey keyboard. Then I'd have to mess about installing QEMM 6.0 and Desqview and getting them right, but everything else should have been fine. Once that was done, I could install Windows.

There was one little problem. When I'd start up the Gold 486/33, it would try to load the mouse driver, but the mouse software wouldn't load. Instead, I'd get a message that the interrupt jumper was missing. That hadn't been a problem for a network server that doesn't need a mouse, but it sure was for a machine that I was setting up to run Windows. Still, how long could it take to run down that problem?

It turned out to eat nearly a day.

The Gold 486/33 originally had a video card that was fast enough, but it wouldn't work with the network. The video card grabbed all the high memory it could find and wouldn't let go, so the network had no place to operate. I replaced it with a Sota Technology video card—a fairly *old* Sota card.

Like the ATI Technologies video cards, the Sota cards have the capability of letting you connect a bus mouse to the card, thus saving either a serial port or a slot for a bus mouse card. Unlike the ATI card, you can buy the Sota card without the mouse port and mouse. On the other hand, ATI has aggressive pricing policies, so you're not paying much for the mouse you get with their board.

On the gripping hand, the mouse drivers that come with the ATI video card aren't much good. But you can use Logitech or Microsoft mouse drivers, which are.

In any event, I had a serial mouse connected to COM2. I removed that, found a bus mouse, and tried to enable it with the Sota card. No joy. As I said, this was an older card. And I figured that while it worked just fine with a 486/25, its bus mouse port just couldn't keep up with the 486/33. OK, use the DIP switch to disable the bus mouse entirely and go back to COM2.

That didn't work, either. In desperation, I got out an older video card, one with no mouse port, and tried that: the mouse still wouldn't work. This time, though, I got an error message regarding interrupt request processing. That led me to look at the *other* cards in the system—and, lo, I found that the LANtastic network card was set by default to use IRQ 3, which is in fact COM2. All I had to do, then, was tell LANtastic to use one of the higher-order

# Move to Windows, stay with the VAX.™



Considering Windows? But can't afford to lose contact with your host? KEAterm 420 is the solution: DEC VT420 terminal emulation software for Windows 3. Now, you can have the best of both worlds!

KEAterm 420 is a true Windows 3 application which provides the functionality of DEC's VT420, VT320 and VT220 terminals in a window. KEAterm 420 version 2 gives you the features that count: multiple pages, multiple sessions, file transfer, multilingual support (English, French and German), script language and DDE support as well as network connections. Using the familiar Windows interface, KEAterm makes it easy to move between servers, hosts and PC applications. With KEAterm, you can do it easier, do it faster, do it better!

To tie it all together, use KEA's network connection

software: KEAlink LAT, KEAlink TCP/IP, and KEAlink IPX for concurrently connecting to your Novell network and your VAX or UNIX host. To eliminate keyboard remapping, select KEA's *PowerStation* VT layout keyboard to plug into your PC. And if you're a DOS or UNIX user, KEA Systems offers the ZSTEM family of VT graphics and text emulation software for desktops running DOS or UNIX.

For superior PC-VAX-UNIX connectivity, call today!

**KEA Systems Ltd.**  
**Orders:** 1-800-663-8702  
**Telephone:** (604) 431-0727  
**Fax:** (604) 431-0818



## VT Emulation Under Windows

KEA Systems Ltd., 3738 North Fraser Way, Unit 101, Burnaby, BC, Canada V5J 5G1.

The KEA logo, KEAterm, KEAlink, ZSTEM and PowerStation are trademarks of KEA Systems Ltd. All other brand and product names are trademarks or registered trademarks of their respective holders. Copyright © KEA SYSTEMS LTD. 1991. All rights reserved.

# We asked LaserJet III users what they wanted in a font cartridge.

**They told us to stuff it.**

*The Complete Font Library Cartridge. Stuffed with every font you'll ever need for your LaserJet III.*

Let's face it. People who use a LaserJet III printer are demanding. After all, that's why they chose a LaserJet III in the first place. So we weren't at all surprised when they told us to stuff it—our font cartridge that is.

You see, we realize that the one or two resident typefaces in the LaserJet III, IIID, IIIP, and IIISi, just don't fulfill the needs of users who create a wide variety of documents. Each message you send is different. So each should be dressed in fonts that clearly deliver that message. And that's why you need The Complete Font Library Cartridge.

Each of its 51 different typestyles is fully scalable. So you can choose a point size as big as 999.75, as small as .25, or just about any point size in between.

And with our custom printer drivers, the cartridge can be used with popular software applications like Windows 2.X/3.0, Word 5.0/5.5, and Ventura Publisher 2.0/3.0 as well as software that includes Autofont support.

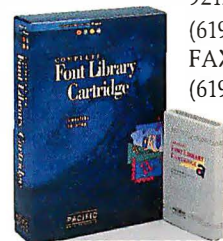
So get all the fonts you'll ever need for your LaserJet III in one cartridge for only \$399. You won't even need additional printer memory.

For more information on the Complete Font Library Cartridge or for a dealer near you, contact: Pacific Data Products at 9125 Rehco Rd, San Diego, CA

92121  
(619) 597-4660  
FAX  
(619) 552-0889.



CG Century Schoolbook, **Bold, Italic, Bold Italic**  
CG Palacio, **Bold, Italic, Bold Italic**  
ITC Souvenir Light, **Demi, Light Italic, Demi Italic**  
Univers Medium Condensed, **Bold, Medium Italic, Bold Italic**  
Antique Olive, **Bold, Italic, Compact**  
Stymie Medium, **Bold, Medium Italic, Bold Italic**  
ITC Zapf Dingbats   
Shannon Book, **Bold, Oblique, Extra Bold**  
CG Bodoni Book, **Bold, Book Italic, Bold Italic**  
CG Omega, **Bold, Italic, Bold Italic**  
ITC Bengulat Book, **Bold, Book Italic, Bold Italic**  
ITC Bookman Light, **Demi, Light Italic, Demi Italic**  
Garamond Antiqua, **Halbfett, Kursiv, Kursiv Halbfett**  
Cooper Black  
Letraset Revue Light



**PACIFIC**  
DATA PRODUCTS

Complete Font Library Cartridge is a trademark of Pacific Data Products, Inc. LaserJet is a registered trademark of Hewlett-Packard Co. Scalable type outlines are licensed from Agfa Corporation. All other company, product and typeface names are trademarks or registered trademarks of the company or manufacturer respectively.  
EUROPEAN OFFICES: Geneva Tel (41) 22.41.26.50, Fax (41) 22.41.06.82, France Tel (33) 1 39 23 20 00, Fax (33) 1 39 63 31 20, U.K. Tel (44) 442 23 74 74, Fax (44) 442 23 65 40  
© 1991 Pacific Data Products, Inc.



STANDARD IRQS FOR PC COMPATIBLES

*Installing a new bus mouse often requires stealing an IRQ from some other device.*

IRQ	Function	Remarks
0	System timer	Set by BIOS
1	Keyboard	Set by BIOS
2	Duplexed with IRQ 9	Hard drive on XT
3	COM2 or COM4	Serial port
4	COM1 or COM3	Serial port
5	LPT2	Second parallel port
6	Floppy drive	
7	LPT1	Usual printer port
8	Real-time clock	
9	VGA; duplexed with IRQ 2	
10	Not assigned	
11	Not assigned	
12	Usually not assigned	
13	Coprocessor	
14	Hard drive	
15	Usually not assigned	Sometimes second hard drive

interrupts—LANtastic sets that in software, and I chose IRQ 15—and the Great Mouse Puzzle was solved.

**The IRQ Lesson**

At that point, I could use either the serial mouse on COM2 or the bus mouse connected through the Sota video card. Sota uses the Logitech Mouse Chip, which runs Logitech or Microsoft mice with the Microsoft Windows mouse drivers or whatever other drivers you like. The Sota card has jumpers that will let you set the mouse interrupt to IRQ 2, 3, 4, or 5, and I suspect that some of you would like that explained.

There has to be a way to tell the computer system that the mouse has done something. This is done with an IRQ. In an AT or PS/2, there are 16 of these, numbered 0 through 15. When the computer sees an interrupt flag, it stops what it's doing to process the interrupt by executing the instructions that its software tells it are associated with that IRQ. Some of these are built into the computer's BIOS. Others are loaded on boot-up. In particular, the mouse software driver will have instructions on what to do if a mouse event—a click or a mouse movement—interrupts the computer.

Now, which interrupt that will be depends on a number of factors. The information in the table comes from TouchStone Software's CheckIt, a very useful troubleshooting tool.

Of those, only IRQ 0 through 7 are available on 8-bit peripheral systems (i.e., the original PC and XT, or an 8-bit slot on an AT or a PS/2). That has had the un-

fortunate effect that many companies design cards that let you use only IRQ 2 through 5. This can cause real problems when you're trying to set up a high-end system.

If you assign IRQ 3 to the bus mouse, it will still disable the COM2 port, and if you try to use COM2, either the port or the mouse won't work. Indeed, if you assign IRQ 3 to the bus mouse and plug a serial mouse into COM2, that mouse can't work. What I tend to do is assign the bus mouse to IRQ 5, since I'm not likely to have two active parallel ports and I may need two serial ports.

Fortunately, Artisoft, Novell, and other companies are now designing their cards so you can use any IRQ from 2 through 15. I wish everyone else would.

Anyway, once I had the IRQ conflict resolved, it was a breeze. I just installed QEMM 6.0 and Desqview and let QEMM's Optimize program do its thing, and in no time, I had Desqview windows of 576 KB. I sure do like QEMM 6.0.

**Parallel Blues**

Next thing then was to transfer software from other systems. I've found that for temporary hookups the fastest and most convenient way to move lots of files around is to connect parallel port to parallel port with a yellow LapLink "designer" cable and use the new LapLink Pro. I've also found that I can use an Inmac blue cable with gender changer to extend the parallel-to-parallel distance up to about 20 feet without any problem.

This time, though, it didn't work. I had the Gold 486/33 connected to the Chee-

tah 486/25 Larry Niven uses, and LapLink Pro going on both, but the machines simply refused to acknowledge each other's existence. Very strange. Since I knew that Niven's 25-MHz machine could be connected parallel-port-to-parallel-port with other systems, logic dictated that I check out the 486/33's parallel port. The easiest way to do that was to connect it to the printer.

It wouldn't print. That told me what the problem was, but now what? I could hardly have a primary system that wouldn't print! I called Ron Sartore, the Cheetah's designer. He had no idea why it wouldn't print, but he suspected the little 3Com card. Cheetah computers don't have ports on the motherboard. Instead, they rely on a 3Com card, which has two serial ports and one parallel port. I checked the DIP switches on the 3Com card. They seemed all right, but it didn't work.

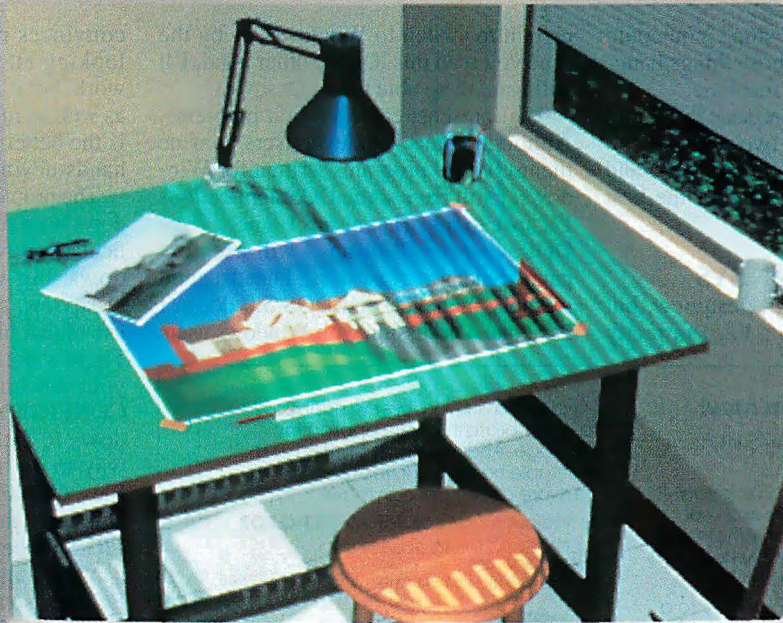
Fortunately, Alex had a spare parallel port card. I plugged it in and the printer worked, so I knew there was nothing wrong with the machine. I looked again at the 3Com card, and I made a discovery: the cable connector from the card to the DB-25 connector was in backward. It probably always had been. It hadn't hurt anything, but it sure wasn't going to work that way. Once that was turned around, the printer worked fine.

Once again, I connected the 486/33's parallel port to LapLink Pro—and it still didn't work. By now I was getting frustrated. I tried Alex's parallel card, and LapLink Pro worked fine. I again called Ron Sartore, from whom I learned something: the 3Com card has only an output parallel port. It's one-way. That was the original IBM PC specification!

I could have fixed that with a different I/O card, but I decided it didn't really matter. My setup has a cable from COM1 to the desktop, where I plug in the USRobotics Courier HST Dual modem, which, incidentally, I've used for more than a year without any glitches, hitches, or problems whatever. When I want to connect to LapLink Pro for file transfer from another machine, such as a laptop, it's easy to unplug the modem and plug in the LapLink Pro cable in its place.

On the other hand, I suspect that the lack of an input capability on my parallel port might cause problems if I were to use any of the software protected by a "dongle"—one of those gizmos that plug into your parallel port. It might not. Some of those dongles use the "out of paper" signal as input and don't need a full parallel input capability.

On the gripping hand, I generally don't use software protected that way, because if

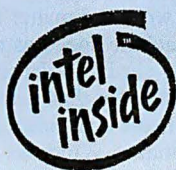


 DTK Computer

## DTK 486 drives high-performance software in PC Week Labs test.

When *PC Week's* editors asked PC Week Labs to test Autodesk's® Renderman™ software, a DTK i486™ computer was chosen to run the sophisticated, high-level shading software program. (The drawing shown above is representative of the high quality of Renderman™ output.)

It takes a lot of muscle to get the full benefits of Renderman's™ power; we build that muscle into every DTK i486™ system™.



We begin with Intel's® potent i486™ processor (with its built-in cache and floating-point coprocessor circuitry) and add a second-level 64KByte static Ram cache (expandable to 256KBytes) for even

more impressive productivity levels.

Add to these your choice of hard drives and controllers, a fast graphics card and a post-VGA high definition monitor, and you have a PC screamer that can handle even the toughest of jobs ... while still affordably-priced.

When power and dependability are important, DTK is the computer of choice of people who know. Perhaps it's time you considered a DTK i486™ for your next computer. Call one of the DTK branch offices below for the name of a reseller near you.



**The DTK 486 Family ■ 486-33 ISA ■ 486-33 EISA ■ 486-25 ISA ■ 486SX-20 ISA**



**DTK Computer Inc. A Reputation for Success.**

17700 Castleton Street, Suite 300 / City of Industry (Los Angeles), CA 91748 / (818) 810-8880 / FAX (818) 810-5233

Los Angeles  
(818) 810-0098

San Jose  
(408) 436-6363

Houston  
(713) 568-6688

Chicago  
(708) 593-3080

New York  
(908) 562-8800

Miami  
(305) 597-8888

Autodesk is a registered trademark and Renderman is a trademark of Autodesk Inc. The DTK Logo is a registered trademark of DTK Computer Inc. Intel is a registered trademark and the Intel Inside Logo and i486 are trademarks of Intel Corporation. Design and specifications subject to change without notice. ©1991. DTK Computer Inc.

Circle 53 on Inquiry Card.

I started, where would I stop? You could end up with a dozen of those things hanging off the back of your machine.

One day I'll probably replace the 3Com card with one that has a two-way parallel port. Meanwhile, it's no big problem, and the Gold 486/33 remains by far the best system in the house.

**Setting Up: BOOTCON.SYS**

I'm still operating under Desqview, but for reasons I'll get to in a bit, I'm pretty

certain to switch to Windows 3.1 by the time you read this. On the other hand, I'll still want to be able to use Desqview.

That presents configuration problems. Although some Windows users confine themselves to programs written for Windows, I still have some DOS applications I'll have to run. That means I'll need large DOS windows. It means I will need expanded memory. In a word, I need a good memory manager, and DOS 5.0 doesn't have one. Discussion with Windows users

convinces me that there are two worth looking at: 386Max and QEMM. Both work, but it's the consensus of colleagues as well as my experience that QEMM 6.0 is the better of the two. Certainly it's the hands-down choice for Desqview users.

The problem is that Desqview and Windows want different configurations. In particular, you want DOS=HIGH to run Windows, but you don't want it there for Desqview, since Desqview makes better use of that high memory space than DOS. There's nothing for it; you must reboot your machine and change to a different CONFIG.SYS when changing from Windows to Desqview and vice versa. One way to do that is to have two CONFIG files, CONFIG.DSV and CONFIG.WIN, and copy the appropriate one as CONFIG.SYS before you reboot.

You'll also want different AUTOEXEC files, so a batch file that copies the appropriate CONFIG and AUTOEXEC files would do the trick. Then, too, you might want CONFIG and AUTOEXEC files that produce big, clean systems with no TSR programs, and perhaps another pair that set up your system as a network server. Pretty soon, you'll have a dozen files and a complicated batch file just to handle configurations.

Fortunately, there's a better way to handle this. BOOTCON.SYS lets you set up as many as 26 CONFIG/AUTOEXEC files and choose the appropriate one on boot-up. It then gets out of the way. If you spend any time at all fooling with your system, you need a way to recover from disasters. Obviously, you keep a "panic" boot-up floppy disk, but you can save a lot of time if you also use BOOTCON. The new version works with DOS 5.0. Recommended.

**Sota Lightning VGA**

Making Windows work is a matter not as much of native machine speed as of the speed of the video card and drivers. A 386/33 will perform better than a 386SX/20, and a 486/33 is better than either. However, what really makes Windows seem agonizingly slow is the time it takes to repaint the screen, and that's a function of the speed of the video card. If you're trying to run Windows with an old, slow video card, forget it.

That all changes when you get a video card designed for Windows. Operations that used to take forever suddenly "just happen." If you're contemplating Windows, be very sure you have the right video card, or you'll find yourself disgusted.

Many good video cards are available. Of the ones I've tried, two are definitely good enough: the ATI Graphics Ultra and

**Put an end to software piracy!**

Meet the growing family of security keys from Software Security.

Each one a specialist at enforcing your license agreement in virtually any user environment you can think of. Whether it's DOS, UNIX, Macintosh or OS/2...whether it's a single user installation or a LAN.

Simply connect the appropriate key to a single user computer, or a non-dedicated file server in a network, and you control all access to your protected application.

Users, however, won't even know it's there. The keys are transparent and won't impact software functionality or the ability to make back up copies. Normal node and LAN operations are unaffected.

Simple. Unassuming. Ever vigilant. Easy to incorporate into your application package. And quite possibly the most profitable hardware investment a software developer can make.

To find out more, call: **1-800-333-0407**

IN CONNECTICUT CALL: 203-329-8870  
FAX 203-329-7428

EUROPE AND UK: +44 784 43 00 60



**SOFTWARE SECURITY**

1011 High Ridge Road  
Stamford, CT 06905

Proudly Made in the USA

**THE ULTIMATE PROTECTION FOR SOFTWARE PUBLISHERS**

All product names are trademarks or registered trademarks of their respective holders.





START OVER  
Imported EISA board  
has no tech support

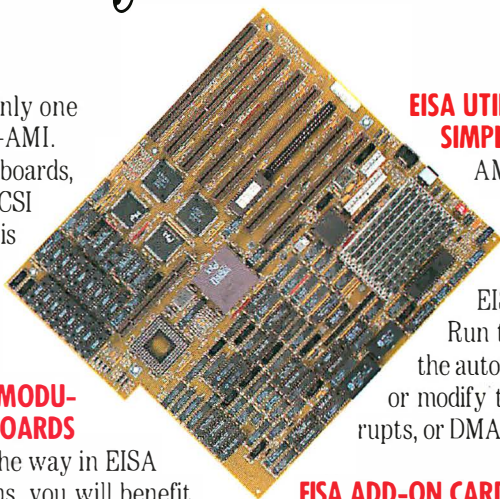
GO BACK 1 SPACE  
Discount board  
has compatibility  
problems

Now Available  
50 MHz

# AMI EISA

## The Only Game In Town

For EISA, there is only one player to consider—AMI. Whether it's motherboards, BIOS, utilities, or SCSI host adapters, AMI is the single source for advanced EISA technology.



### EISA UTILITIES MAKE THE JOB SIMPLE

AMI designed and developed the EISA Configuration Utility to make configuring EISA products a snap. Run the ECU and select the auto configuration option, or modify the I/O ports, interrupts, or DMA settings as you desire.

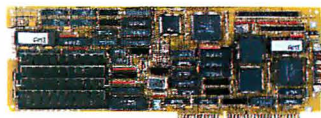
### ADVANCED EISA & MODULAR CPU MOTHERBOARDS

With AMI leading the way in EISA motherboard designs, you will benefit from bulletproof performance and proven reliability.

- EZ-Flex—A new modular CPU design offering easy upgrades to future technology.
- Enterprise II—A proven EISA performer, popular for critical applications.

### EISA ADD-ON CARDS

The Fast Disk EISA SCSI Host Adapter, with a combination of 16 MB cache, and intelligent



386SX I/O management, is the fastest SCSI host adapter on the market today. Look to AMI for other EISA cards in the near future.



### THE LEADING EISA BIOS

AMI is the world-wide standard for BIOS. AMI's EISA BIOS provides the reliability, compatibility, and features you desire. Plus, it's compatible with AMI's BIOS Configuration Utility, providing on-site customization for the Integrator or OEM.

### THE AMI DIFFERENCE

AMI's expertise covers the entire EISA environment. With research, engineering and support functions under one roof, AMI is unmatched in knowledge and support. Call AMI, and you will understand why AMI's "monopoly" on EISA makes it the only game in town.



Circle 14 on Inquiry Card  
(RESELLERS: 15).

SINGLE SOURCE TECHNOLOGY

AMERICAN MEGATRENDS, INC.  
800-U-BUY-AMI or 800-828-9264, 404-263-8181, fax 404-263-9381

START  
HERE

Cheap board fails in  
UNIX system

Select Dependable AMI  
EISA motherboards

No AMI  
EISA BIOS

Discount  
boards not  
worth the savings

Imported board  
proves unreliable

GO BACK 1 SPACE

Use AMI EISA for  
reliable network  
file server

MOVE AHEAD 2 SPACES

Slow SCSI  
interface  
ruins reputation

GO BACK 3 SPACES



Discount EISA boards  
have high failure rate

GO BACK 3 SPACES

Discount board has  
slow video speed

LOSE TURN

Use highly compatible  
AMI EISA BIOS

PROFITABLE PARKING

GO TO BANKRUPTCY

# About the only t can't contain is y



Imagine this.

A Windows™ database that can handle virtually any data type.

It's called Superbase® 4 from Software Publishing Corporation. With it, the development possibilities are, well, thought provoking.

Consider bar coding. The state of the art



in inventory control. Start thinking creatively and anything's fair game. A high-security prison, for example, uses Superbase 4 to handle the toughest inventory control problem anywhere. Keeping track of their prisoners.

Or how about video? Through DLL you can store still shots from a full-motion video camera. So you can monitor remote locations in real time.

Or grab key images from a previously recorded tape. A petrochemical facility, for example, uses

Superbase 4 to store camcorder images in a training file for new engineers.



Imagine, a free demo disk just by calling 1-800-336-8360, Operator 617.

Superbase is a registered trademark and Superbase 4 is a trademark of Software Publishing Corporation. Windows is a trademark of Microsoft Corporation. © 1991 Software Publishing Corporation, 3165 Kifer Road, Santa Clara, CA 95051.



# hing Superbase 4 our imagination.



What's more, any photographic or graphic image can be included in any

data file. So you can dress up product catalogs. Personnel records. Insurance claims files. Or anything else you can think of.



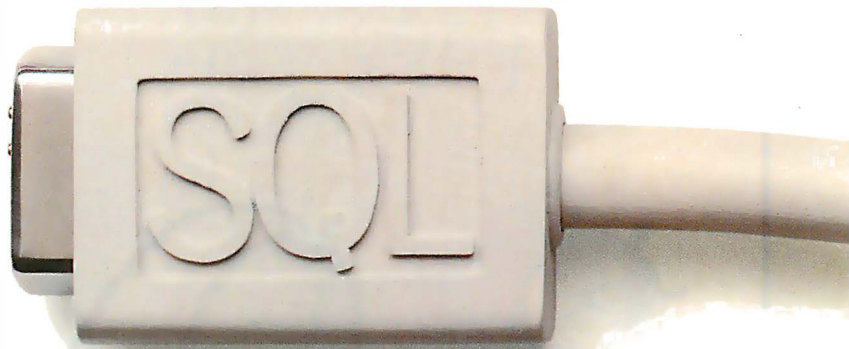
MICROSOFT  
WINDOWS  
Version 3.0 Compatible Product

And through DDE you can even pull in more familiar business accessories. Like maps, graphs, charts, and spreadsheets.

But don't think for a minute that this versatility comes at the expense of raw power. Superbase 4 is fast. It lets you include an unlimited number of characters in any text field. And supporting SQL, it easily connects with some formidable databases—SQL Server, Oracle, Sybase, dBase,

and DB2, among others.

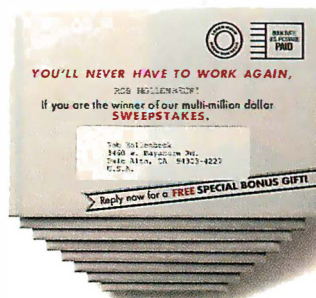
In fact, Superbase 4 already manages a direct mail database containing over one million records. It could handle a lot more.



A stock market ticker. A ticket sales network. You know, big stuff.

And our Data Management Language (DML) gives you unsurpassed ease and flexibility in customizing screens.

So it's no wonder Superbase 4 is the worldwide market leader in Windows databases. Just imagine what it can do for you.



**SPC** SOFTWARE  
PUBLISHING  
CORPORATION



the Sota Lightning VGA. Both are easy to install, work with most monitors, and come with good software for enhancing Windows. Both have mouse ports; the Graphics Ultra cannot be bought without the mouse port and mouse. I can recommend both cards. So far, I don't have any strong reason for choosing one over the other. More as I learn more, but if you want a good-enough VGA card for Windows, these two won't leave you disappointed. Installation of the Lightning VGA card

is simple enough. In my case, I left the hardware switches at their default settings and put in the card. I installed Windows 3.1 and watched it come up at its usual slow pace. Then I exited Windows, put the Sota installation disk in drive A, and typed INSTALL. The program prompts for the rest. When that was done, I typed WIN /D:X (the switch is so Windows 3.1 will work with QEMM). Windows came up *dramatically* faster, and everything works very well.

I've been impressed with Sota since I first saw the company off in a dark corner at Comdex some years ago. The Lightning VGA card works as well as I expected it to. Recommended.

**Samurai Avagio!**

As they say on the news, this is just in: a copy of the Avagio desktop publishing system, a floppy V.70 still video camera, some cables, and a copy of a newsletter featuring a color picture of me taken with that camera at the Silicon Northwest Press Reception at Comdex. I'm told not all of this is available in the U.S. just yet, but it will be. The results are impressive.

The Yashica Samurai is a still digital video camera that takes monochrome or color images that can then be transferred to your VCR and saved on tape or input into your computer through a video-capture card. The video pictures can be digitally manipulated and inserted into desktop publishing documents. The notion is that everyone knows how to use a camera, while everyone does not know how to use a scanner.

**Dycam**

The Dycam Model 1 digital still camera is monochrome only, but it requires no special equipment to get the images it takes from the camera into your PC or Mac. It comes with all the cable adapters and software that you'll need. There's also software you can port across to the camera to convert it from a flash system to "tripod"—meaning longer exposure for poor light conditions when you don't want flash.

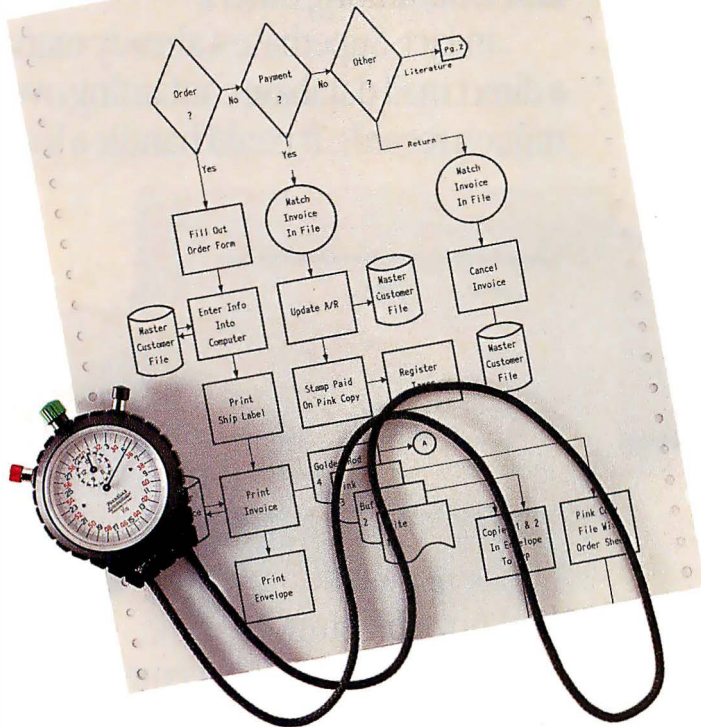
For PCs, the images come out as TIFF files. You can transform them from that in the usual way, and they'll feed nicely into newsletters or other desktop publications. They can also be incorporated into PowerPoint displays and output onto View Graphs.

You can operate the Dycam on its own, in which case it's about like any small camera with a 32-picture roll. After you take 32 pictures, you have to download them to clear the Dycam's memory. You can also operate the Dycam when it's attached to your computer—any PC or Mac with a serial port—in which case you can control it from the keyboard.

Now there is no question that the Yashica Samurai is more sophisticated, what with changeable recording disks (they're tiny floppy disks a bit like the rather unlamented Zenith microflop disks), zoom lenses, and suchlike. But the Dycam is less expensive and a great deal more portable.

The important thing to note here is that the images are digitized in the camera. This means you can take this camera, with

**BY HAND. OR BY NOON.**



**Flow Charting™ 3**

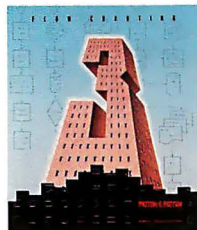
Now, even complex flowcharts that once took days to perfect can be presentation-perfect—in no time!

Quick to master and a snap to use, Patton & Patton's flowcharting software is the standard of both large and small businesses around the world—and is available through all major software dealers.

See your dealer today! Or, for a "live," interactive demo disk, call: **800-525-0082, ext. 1115.** International: 408-778-6557, ext. 1115.

Works on IBM & 100% compatible PC's, supports CGA/EGA/VGA and over 150 dot matrix and laser printers, with multiple print densities and 10 font sizes. **Creates multi-page charts, portrait or landscape, on most standard paper sizes.** Mouse or keyboard controlled.

IBM is a registered trademark of International Business Machines Corporation.



**PATTON & PATTON**  
Software Corporation

*Excellence in charting the flow of ideas!*

**14,400 bps DATA**  
**14,400 bps FAX**  
**Voice\***  
**Caller ID\***  
**5 Year Warranty**  
**\$399<sup>95</sup>**



# Are We Connecting Yet?

Introducing the amazing new SupraFAX-Modem™ V.32bis! On the fax side, it has 14,400 bps send and receive fax, Class 1 and 2 commands, and compatibility with the millions of Group 3 fax machines in use. On the data side, it connects at 300 to 14,400 bps and provides up to 57,600 bps throughput with V.42bis compression.



**Supra Corporation**

(It has MNP 2-5 and 10, too.) Plus its revolutionary display gives you 25 different status reports! And for just a little more, you can easily add caller ID and voice capabilities

later this year. In addition to the \$399<sup>95</sup> stand-alone version (without software), SupraFAXModems are available in Windows™, DOS™, and Macintosh™ packages.

9600 bps Version  
**\$299<sup>95</sup>**

**1-800-727-8647**

7101 Supra Drive S.W., Albany, OR 97321 USA • 503-967-2410 • Fax: 503-967-2401

\* Low-cost, user-installable Voice & Caller ID upgrades available Q2 '92.

All trademarks belong to their respective companies.

Circle 154 on Inquiry Card.



or without your laptop computer, to a library and use it instead of a scanner. Scanners don't connect to serial ports. The Dycam does, at up to 115,200 bps. Logitech has licensed the Dycam technology and is now shipping its own line of camera scanners and Logitech-developed software.

Look for further developments in this field, in both digital recording cameras like the Dycam and imaginative ways to integrate video camera images into your personal computer system.

**Sound Boards and Multimedia**

In the past year, the Brown-Wagh Sound Blaster Pro has become the de facto standard for multimedia systems. It's supported by nearly all the major software designers, including the game companies, which are currently the most important sources of sound for PC systems.

This made for a real problem for Media Vision's Pro Audio Spectrum. This card has nearly everything you'd want for multimedia: a joystick port; sound, in-

cluding a MIDI port for two-way connection to a MIDI connector box and thence to keyboards, synthesizers, and so forth; on-board FM synthesizers to generate 22 different voices; excellent software; stereo digital recording; and a SCSI port that should be able to control a CD-ROM or other SCSI device, saving you a slot.

All in all, it's a very good system. If you're going to use it to generate music, to work with Lotus Freelance to build presentations with sound effects and speech, or anything like that, I wouldn't hesitate to recommend it. The problem, though, is that Media Vision used a nonstandard digital-to-audio conversion. That nonstandard conversion means that many major games, and a lot of other multimedia software, simply don't work with it.

Fortunately, they're fixing that. I am assured that the new version (which should be out now) will be Sound Blaster-compatible and will feature the new OPL-3 sound chip. That's important because, I am told, the OPL-3 is good enough to blow everything else away. Stay tuned. We'll see. Mind you, I don't have the new version of the Pro Audio Spectrum, but assuming that it performs as promised, it's much needed: a board of near-Roland quality without Roland's price. Try it on digitized speech before you buy it, but with that stricture, recommended.

One final bit of news: Disney and Phoenix have signed a deal whereby the Disney sound system will be integrated into new versions of the Phoenix BIOS. After that, your PC will be able to talk to you about as well as the Mac does (i.e., digitized speech, which takes up lots of disk space but has good quality). Before long, your PC will be able to have Spock's voice say "That should prove interesting" when you reboot. . . .

**System 7.0 and Quadra 900**

We've temporarily dismantled the Mac IIfx to give its place to a new Quadra 900 running System 7.0. The result has brought about some minor problems. Apple has for years been warning software designers not to write self-modifying code, because the 68040 chip wouldn't allow that. Alas, a number of older programs do that or violate some other published system restriction, and thus won't work on the Quadra. In addition, many of the software-conversion filters for desktop publishing programs just didn't work properly with the Quadra and System 7.0.

This is all changing. New filters are available on BIX and other BBSes. Many companies are revising their software, and every month we get an upgrade of yet one more major program. As an example, the

**P E R I S C O P E**

**Professional Software and Hardware-Assisted Debuggers for 80386 & 80486 Systems**

**JUST RELEASED**

Model IV for 386SXs

OS/2 Driver Support

32-Bit Toolkit

Rent Model IV

Windows 3 Driver Support

**I**f you need a debugger but have no room left in the lower 640K of your 386™ or 486™ system, Periscope now has a new SOFTWARE-ONLY solution for you—Periscope/EM.

- Periscope/EM takes advantage of the extended memory you already have, rather than using any memory in the lower 640K.
- No runaway program can corrupt Periscope/EM because it's write-protected.
- You don't have to use a slot since there's no board to install.
- You can add an optional break-out switch to recover from crashes.
- Periscope/EM costs only \$295, half the cost of Periscope Model I, with most of the same functionality.

Periscope/EM requires 386MAX™ or BlueMAX™, version 5.11 or later; a 386 or 486 system with about 300K of extended memory; 32K of memory between 640K and one megabyte; DOS 3.0 or later.

**New Debugging Tools**

*"I needed a means to debug interrupt handlers where I could really see what was going on. The hardware trace buffer is great. I was able to debug code in 3 days that I have been trying to debug for months!"*

...writes Peg Sestrich with Prime Computer, on why she chose Periscope Model IV.

If you need more than your current software-based debugger gives you, Periscope Model IV, with these advanced NEW features, may be just what you're looking for:

- Supports 386 and 486 systems running up to 33MHz with its ICE-like capabilities.
- Real-time hardware trace buffer holds up to 16K CPU events.
- Enhanced analysis and display of trace buffer makes you more productive.
- Periscope/EM functionality, built-in at no extra cost, saves you money.

**Just call toll-free 800/722-7006 for details or to order.**

**The Periscope Company, Inc.**

1197 PEACHTREE ST.  
PLAZA LEVEL  
ATLANTA, GA 30361  
404-875-8080  
FAX 404-872-1973



Real-time Periscope Model IV, shown with new 33MHz board and 486 pod.

# Breaking the page barrier.



## The new TI microLaser Turbo™ printers. High-performance graphics at record speed.

Give yourself a breakthrough. The TI microLaser Turbos race through popular graphics software like Ventura Publisher® and Harvard Graphics faster than other printers.

How?

The Turbos' RISC-based 8220 controller with PostScript® software from Adobe® processes information from the PC faster. So you spend less time waiting for graphic output.

Now give yourself all this speed and

PostScript Level 2 with 35 scalable fonts. Superior paper handling that includes a 250-sheet paper drawer that slides *inside* the printer. Automatic switching between HP LaserJet®/PostScript modes and PC/Mac® interfaces†. And two of the smallest footprints you'll find.

Plus, you can break the page barrier without breaking your budget. Designed for personal printing, the 9ppm microLaser

Turbo starts at \$2,249\*. Ideal for shared printing, the 16ppm XL Turbo goes for \$3,649\*.

Quick. Dial the number below for the name of your nearest TI dealer. And break some speed records of your own.

**1-800-527-3500**



POSTSCRIPT

  
**TEXAS  
INSTRUMENTS**

newest version of Strategic Conquest, long our classic Mac war-game favorite, runs just fine. So does Microsoft Word and, now that we have the proper filters, Aldus PageMaker.

We also have a public domain program, available on BIX, that will automatically detect programs that won't work with the Quadra in 68040 mode and switch it to some mode that will work. Fair warning: after you have experienced the blazing speed of the Quadra in 68040 mode, you will really *hate* it when it slows down.

You'll hear more about the Quadra in times to come. All told, the transition has been relatively painless. The Quadra is a worthy successor to the IIfx. You'll love it.

The Quadra runs System 7.0, and it won't run any flavor of System 6.0. I don't regard that as a defect. We also have a Mac Classic II, which has replaced Richard's ancient Mac Plus. Richard is our number four son, who is at present an undergraduate at UCLA and the perfect user for testing computer systems. He grew up in Chaos Manor expecting to be able to use computers while refusing to learn anything at all about them. Given his choice of nearly any kind of computer, he chose a Mac. He loves System 7.0. Of my four sons, one uses a PC, two use a Mac, and Alex understands and uses both. Meanwhile, my wife publishes the L.A. Opera League newsletter on the Mac.

Later this spring—I think the June issue—I will devote a major part of the column to outfitting the Classic II: recommended hardware and software, including shareware and public domain utilities, all tested by Richard and his debate team. I'll also look into System 7.0 versus Windows.

### Knowledge Adventure

The short description of this program would be "a hypertext-linked general database." Knowledge Adventure is several megabytes of images and text arranged for browsing. Although this is a DOS product that runs just fine under Desqview, it has a Windows feel to it and requires a mouse. Ideally, you'd want VGA and a Sound Blaster, although it will work with EGA and no sound board.

The interface is fully GUI, and navigation is with mouse-clicks to self-explanatory icons. There are icons for music, architecture, science, and so forth. There is a time-scale bar ranging from 10 billion B.C. to the year A.D. 2000. There is a distance scale running from 100 miles to intergalactic. You can use the mouse to move around in time and space. Each stop brings up a different picture: Stonehenge, Albert Einstein, Orville Wright, Beethoven, Aristotle, Magellan, chariot races, *Apollo 11*,

and so on. Each picture has associated text. In addition, there are links, some obvious, some not: Einstein links to *The Atom at War*, which describes the destruction of Hiroshima and Nagasaki; that is linked with the zeppelin *Hindenburg*, which is linked to Orville Wright.

Many pictures have multiple links: click on the spacecraft in the picture of *Apollo 11* on the moon and you get one link, click on the stars behind the astronauts and you get another, and click on the astronauts and there's another yet.

I'd have killed for this when I was a kid. If you know a bright youngster with access to a computer, get this program, set it up, and get out of the way. From the touching story of how Beethoven, deaf, thought his Ninth Symphony a failure until his assistant turned him around to see the wildly cheering crowd, to the architectural details of the Hagia Sophia in Constantinople, Knowledge Adventure is full of the kind of trivia that I have always loved. It is limited: there are only eight items under the music icon, for example. On the other hand, they are making up new databases that can easily be integrated into the Knowledge Access engine.

I liked it a lot.

### Portable REXX

I haven't time to do this product from Kilowatt Software justice. The language is fully described in *The REXX Language: A Practical Approach to Programming* by Michael Cowlinshaw (Prentice-Hall, 1990, ISBN 0-13-780651-5), which is available from Kilowatt. REXX is an easily learned command language that some have described as a "superbatch language." It does file operations and math (including scientific math). It appends records to files, prints things on command, and generally functions as a software robot on your PC.

Amiga users consider REXX for the Amiga a secret weapon—with reason. If you like mucking about with your computer, you'll almost certainly like this.

### Crescent Tools

Crescent Software's QuickPak Professional BASIC tools are quite simply essential if you are going to do much programming in compiled BASIC for the PC. These routines either do things that the standard Microsoft BASIC compiler doesn't do or, because they're written in assembly language, do them much faster and more efficiently.

Now there's a QuickPak Professional for Windows. In my judgment, it has always been easier to write Windows programs in Visual Basic than in C, and the resulting code will be very nearly as efficient

and working long before the equivalent C program will be. Now Crescent makes that even easier. Highly recommended.

### Winding Down

As usual, I'm out of space long before I'm out of things to write about. There are a zillion new CD-ROMs. Get the catalogs from Quanta Press and the Bureau of Electronic Publishing for details. My favorites for the month are the Monarch Notes—all of them—from the Bureau and Apollo—everything about the U.S. moon missions—from Quanta.

I'm currently carrying the AT&T Safari laptop. More next month, but there's really a lot to like about the Safari. Moreover, it comes with the new Logitech TrackMan Portable trackball. Logitech's trackball for laptops beats the previous winner, the Microsoft Ball Pointer, and by quite a lot.

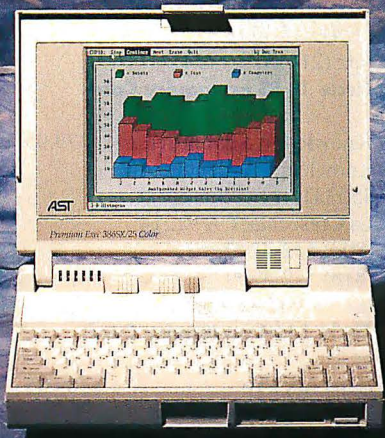
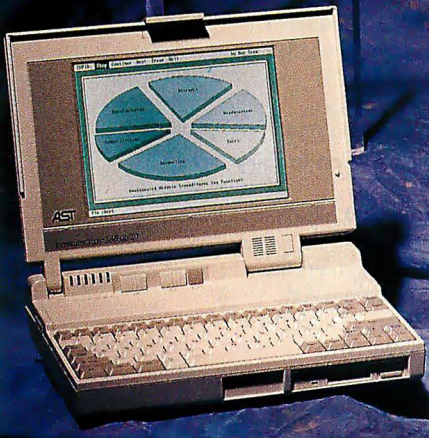
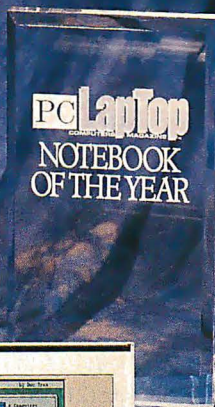
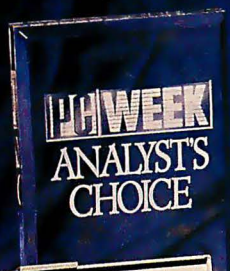
The shareware of the month, available from BIX (see the *ibm.utils* listings conference), is DISKMON. This is a small TSR that tells you all the error messages DOS sees but doesn't report to you. You'll be astonished the first time you run it. Developers need this.

The books of the month are Peggy Noonan's *What I Saw at the Revolution: A Political Life in the Reagan Era* (Ivy Books, 1991, ISBN 0-8041-0760-2), an interesting account of a remarkable young woman's years in the Reagan White House and one of the few such books that stays near the truth rather than trying to exaggerate the importance of the author; and Paul M. Kennedy's *Grand Strategies in War and Peace* (Yale University Press, 1991, ISBN 0-300-04944-7), a historical analysis of the present by the author of *The Rise and Fall of the Great Powers*. I don't always agree with either Kennedy or Noonan, but reading the two together is an insightful experience.

Next month, the annual Chaos Manor User's Awards, including the year's best in a number of hardware and software categories, and my annual orchid and onion parade. ■

*Jerry Pournelle holds a doctorate in psychology and is a science fiction writer who also earns a comfortable living writing about computers present and future. Jerry welcomes readers' comments and opinions. Send a self-addressed, stamped envelope to Jerry Pournelle, c/o BYTE, One Phoenix Mill Lane, Peterborough, NH 03458. Please put your address on the letter as well as on the envelope. Due to the high volume of letters, Jerry cannot guarantee a personal reply. You can also contact him on BIX as "jerry."*

# The "Notebook Of The Year" And Two Powerful Sequels.



Premium® Exec™ 386SX/20  
Model 43V

**New Lower Pricing!**

**\$2395**

20 MHz, 386SX Processing  
2 MB RAM, 40 MB Hard Drive  
VGA Monochrome Display  
With 32 Gray Shades

Premium Exec 386SX/25C  
Color Model 63V/4

**\$4995**

25 MHz, 386SX Processing  
4 MB RAM, 60 MB Hard Drive  
VGA Color Display  
With Up To 256 Colors

Premium Exec 386SX/25  
Model 63V/4

**New Lower Pricing!**

**\$2995**

25 MHz, 386SX Processing  
4 MB RAM, 60 MB Hard Drive  
VGA Monochrome Display  
With 32 Gray Shades

Only one year after its introduction, the Premium Exec 386SX/20 has become one of the most popular notebook computers today, with sales of more than 70,000 units and climbing.

And among industry experts, the Premium Exec 386SX/20 is winning such coveted awards as "Notebook of the Year," "Analyst's Choice," "Best Buy" and the "VIP Award."

So, you can be assured AST delivers the best combination of price, performance, quality and customer support on the market today.

And if you need a color display, or 25 MHz processing power, here are two more winners to meet your specific portable computing needs:

**Premium Exec 386SX/25 For Split-Second Processing** — When every minute counts, ask for this speed demon. It delivers super-fast 25 MHz speed to conquer any number of applications with ease. And at a cost comparable to other manufacturers' 20 MHz systems, AST's

Premium Exec 386SX/25 gives you a 25% increase in performance. Now that's value.

**Premium Exec 386SX/25C For Fabulous Color At A Fabulous Price** — Here's your chance to take advantage of a top-notch 256-color note-

**Backed By AST's Award-Winning Service And Toll-Free Support**

**For More Information On AST Products Call**

**1-800-876-4AST**

book with 25 MHz processing for only \$4995. Its bright, fast VGA display offers a resolution of 640 x 480, perfect for Windows-based software.

**Made In America To Stringent Quality Standards** — Designed and manufactured right here in the U.S., our Premium Exec notebooks offer state-of-the-art features and performance.

**Backed By Award-Winning AST Service and Support** — We're never out of touch. Whether you need to reach us by computer, telephone, mail, or even by FAX, you can count on AST for a full range of service and support programs. This includes ExeCare™, an optional program which guarantees your Premium Exec will be replaced within 24 hours.

**Ask For The "Notebook Of The Year"** — For the best all-around notebook computer, look to the experts. Their choice is unanimous — the Premium Exec. For more information, or the name of the dealer nearest you, call AST today at 1-800-876-4AST.



Prices are MSRP, dealer prices may vary. Awards: Notebook Of The Year, PC Laptop, December 1991; VIP, Portable Office, November 1991; Analyst's Choice, PC Week, April 1991; Best Buy, PC Magazine (British Edition), April 1991. AST markets products worldwide; outside of the United States and Canada call AST International on (714) 727-9292 or FAX to (714) 727-8585. AST, AST logo and Premium registered, Exec, ExeCare trademarks AST Research, Inc. Copyright © 1991 AST Research, Inc. All rights reserved.

ITEMS DISCUSSED

**Apollo CD-ROM** .....\$129  
 Quanta Press  
 2550 University Ave. W, Suite 245N  
 St. Paul, MN 55114  
 (612) 379-3956  
 fax: (612) 644-8811  
**Circle 1155 on Inquiry Card.**

**Avagio** .....\$149.95  
 Unison World Software  
 1321 Harbor Bay Pkwy.  
 Alameda, CA 94501  
 (800) 444-7553  
 (415) 748-6670  
 fax: (510) 748-6964  
**Circle 1156 on Inquiry Card.**

**BOOTCON.SYS** .....\$59.95  
 Modular Software Systems  
 115 West California Blvd., Suite 113  
 Pasadena, CA 91105  
 (818) 440-9104  
**Circle 1157 on Inquiry Card.**

**CheckIt 3.0** .....\$149  
 TouchStone Software Corp.  
 2130 Main St., Suite 25  
 Huntington Beach, CA 92648  
 (800) 531-0450  
 (714) 969-7746  
 fax: (714) 960-1886  
**Circle 1158 on Inquiry Card.**

**Cheetah Gold 486/33** .....\$7049.79  
 Cheetah International  
 1007 Elkton Dr.  
 Colorado Springs, CO 80907  
 (800) 243-3824  
 (719) 531-9339  
 fax: (719) 531-9388  
**Circle 1159 on Inquiry Card.**

**Desqview 2.4** .....\$129.95  
**Desqview/386 2.4** .....\$219.95  
**QEMM-386 6.0** .....\$99.95  
 Quarterdeck Office Systems  
 150 Pico Blvd.  
 Santa Monica, CA 90405  
 (800) 354-3222  
 (213) 392-9851  
 fax: (213) 399-3802  
**Circle 1160 on Inquiry Card.**

**Dycam Model 1** .....\$995  
 Dycam, Inc.  
 9588 Topanga Canyon Blvd.  
 Chatsworth, CA 91311  
 (818) 998-8008  
 fax: (818) 998-7951  
**Circle 1161 on Inquiry Card.**

**Graphics Ultra**  
 with 512 KB .....\$599  
 with 1 MB .....\$799  
 ATI Technologies, Inc.  
 3761 Victoria Park Ave.  
 Scarborough, Ontario,  
 Canada M1W 3S2  
 (416) 756-0718  
 fax: (416) 756-0720  
**Circle 1162 on Inquiry Card.**

**HyperStore 1600** .....\$650  
 Perceptive Solutions, Inc.  
 2700 Flora St.  
 Dallas, TX 75201  
 (800) 486-3278  
 (214) 954-1774  
 fax: (214) 953-1774  
**Circle 1163 on Inquiry Card.**

**Knowledge Adventure** .....\$79.95  
 Knowledge Adventure, Inc.  
 4502 Dyer St., Suite 100  
 La Crescenta, CA 91214  
 (800) 542-4240  
 (818) 542-4200  
 fax: (818) 542-4205  
**Circle 1164 on Inquiry Card.**

**LapLink Pro** .....\$169.95  
 Traveling Software, Inc.  
 18702 North Creek Pkwy.  
 Bothell, WA 98011  
 (800) 343-8080  
 (206) 483-8088  
 fax: (206) 487-1284  
**Circle 1165 on Inquiry Card.**

**Lightning VGA**  
 with 512 KB .....\$345  
 with 1 MB .....\$445  
 Sota Technology, Inc.  
 559 Weddell Dr.  
 Sunnyvale, CA 94089  
 (800) 933-7682  
 (408) 745-1111  
 fax: (408) 745-1640  
**Circle 1166 on Inquiry Card.**

**Monarch Notes CD-ROM** .....\$99  
 Bureau of Electronic Publishing  
 141 New Rd.  
 Parsippany, NJ 07054  
 (800) 828-4766  
 (201) 808-2700  
 fax: (201) 808-2676  
**Circle 1167 on Inquiry Card.**

**Portable REXX** .....\$69.95  
 with book .....\$94.95  
**REXX for Windows** .....\$109  
 with book .....\$134  
 Kilowatt Software  
 1945 Washington St., Suite 410  
 San Francisco, CA 94109  
 (800) 848-9474  
 (415) 346-7353  
**Circle 1168 on Inquiry Card.**

**Pro Audio Spectrum** .....\$389  
 Media Vision, Inc.  
 47221 Fremont Blvd.  
 Fremont, CA 94538  
 (800) 845-5870  
 (415) 770-8600  
 fax: (510) 770-9592  
**Circle 1169 on Inquiry Card.**

**Quadra 900** .....\$8499  
**System 7.0** .....\$99  
 Apple Computer, Inc.  
 20525 Mariani Ave.  
 Cupertino, CA 95014  
 (408) 996-1010  
**Circle 1170 on Inquiry Card.**

**QuickPak Professional for Windows** .....\$199  
 Crescent Software, Inc.  
 32 Seventy Acres  
 West Redding, CT 06896  
 (203) 438-5300  
 fax: (203) 431-4626  
**Circle 1171 on Inquiry Card.**

**TrackMan Portable** .....\$169  
 Logitech, Inc.  
 6505 Kaiser Dr.  
 Fremont, CA 94555  
 (800) 231-7717  
 (415) 795-8500  
**Circle 1172 on Inquiry Card.**

**Turbo-Cool 300** .....\$189  
 PC Power & Cooling, Inc.  
 5995 Avenida Encinas  
 Carlsbad, CA 92008  
 (800) 722-6555  
 (619) 931-5700  
 fax: (619) 931-6988  
**Circle 1173 on Inquiry Card.**



**CAN AN 8,000 LB. ELEPHANT  
OUTRUN THE GAZELLES?**



# STAND

## Introducing Desktop

At the risk of understatement, Desktop Direct from Digital is about to shake up the PC industry. Because we believe that a PC company should be low cost—but not lightweight.

We will deliver world class PCs—without proprietary surprises. Premier PC components and operating systems put together exactly the way *you* want them.

Because Desktop Direct doesn't think you should have to sacrifice choice for cost. And because the only PC standard we're interested in is yours. Give us your specs and we'll do it *your* way. At no extra charge.

Or, choose from a range of pre-configured PC packages at *amazing* prices. Not because it's easier for us, but because you asked for them—in focus groups, surveys, questionnaires and opinion polls.

So size us up. You'll be impressed by our open-minded philosophy towards service. For example, Desktop Direct from Digital offers Multivendor Service that includes Apple®, Intel, Microsoft, IBM® and Dell®.

In short, industry-leading Intel-Microsoft systems. Comprehensive support from a corporation you can count on. At prices that will start a stampede.

**Signed, sealed, delivered—and supported.** Whether you purchase our ready-to-run PCs or design your own, your system can be on its way to you within 48 hours of the receipt of your order. Already loaded with your choice of operating systems. And backed by a 30-day money-back guarantee.

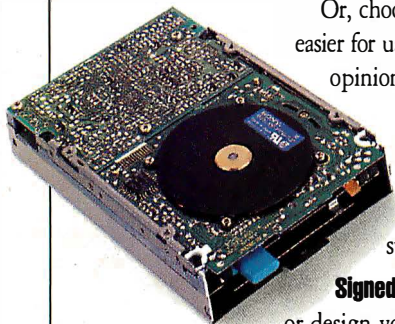
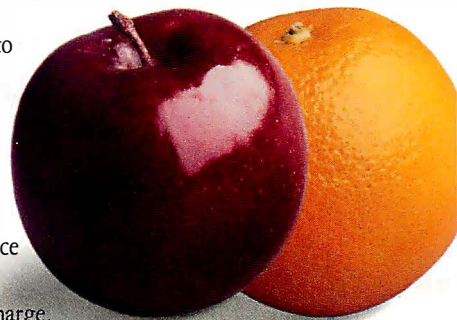
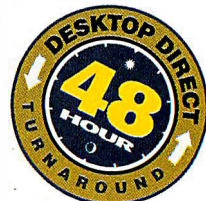
But that's just for starters. When you purchase a PC from Desktop Direct, you're backed by expert Digital Services personnel. Besides free on-site service with no fine print for a year after the purchase of a PC, our own 10,000 plus Digital Service Representatives can provide you with installation, systems integration and networking expertise.

**Open for business—your business.** Any techie will attest that our Intel i386 and i486 microprocessors are the best in the business. And any MIS manager will be happy that our standard bus architecture and expansion slots won't tie you to proprietary solutions. Because at Desktop Direct from Digital, "open systems" means just that: the ability to mix and match PC hardware and software to build information systems that meet business needs.

In fact, we've been meeting the stringent demands of big business for years. And that's great experience for your business. Put us to the test today.

- ✓ Free One Year On-Site Service with No Fine Print
- ✓ Free Technical Support Line
- ✓ Multivendor Support for Hardware and Software
- ✓ Free 24 Hour FAX Support
- ✓ Free Electronic Connection Modem Information
- ✓ Free Factory Installed Operating System
- ✓ Free Freight
- ✓ PC Training for the World Ahead

Call Desktop Direct from Digital  
**1-800 PC BY DEC (1-800-722-9332)**  
Please reference AHQ when you call.  
Mon-Fri 8:30am to 8:00pm (ET)



# BACK.

## Direct From Digital.

### Service

When your "help" key can't cut it, we can. Mon.-Fri. 8:30am to 8:00pm (ET) Our Technical Sales Representatives put you in touch with software specialists, programming professionals and hardware wizards. All with a single call.

### Networking

Digital. Need we say more? We don't just sell Novell Netware™, Microsoft LAN Manager™ or Digital PATHWORKS™—we offer our networking expertise in design, service and support.

### Operating Systems

DOS and Windows™ are a winning combination. They're pre-installed in our PCs—and ready to run your most important applications.

### Multivendor Support

Because in business, no PC is really a "stand-alone". We go the extra mile. Our Multivendor Support plan can consolidate your maintenance agreements and service contracts. We back the best names in the PC business: Intel. Microsoft®. Apple®. IBM®. Dell®. Ashton-Tate. Because we're about to make PC maintenance seamless. Now.

### Keyboard

The Digital Gold™ keyboard is available with some systems.

### SVGA

We're SVGA-ready, so you're set for the next generation of PC graphics. In the meantime you get crisp color or monochrome VGA graphics. And with the DECpc 433w special processor you'll have the fastest available pixel or coordinate-based graphics anywhere. That's right: the fastest.

### Price

Priced to compete and win, without sacrificing quality, compatibility or power. That's Desktop Direct from Digital.



### Standard bus

Someone once said, that best surprise is no surprise. Especially when it comes to PCs. No oddball bus architecture here. Just standard—and powerful—components and quality Digital engineering.

### Expansion

Start with a system that's lean and mean, and move up to more muscle when you're ready. Plug in up to 16MB of memory. Add fixed disks to the 3.5" and 5.25" storage bays. It's up to you.

### Microprocessors

Intel engineering sets the pace. And we keep you up to speed—from the sleek i386sx-based DECstation 316sx to the ultra-fast i486-based DECpc 433 Workstation.

**DESKTOP  
DIRECT  
from  
DIGITAL**

Taking PCs into the world ahead

**digital™**

# LEADER OF

## DECpc 320sx



Includes:

- Microprocessor: Intel i386 running at 20MHz
- Memory: 1MB, 80NS Memory Kit
- Storage: 52MB IDE Hard Disk Drive
- Resolution Mode: 1024 X 768 SVGA Adapter
- Display: 14" VGA Color Plus Monitor
- Keyboard: 101-key Keyboard
- Mouse: Mouse
- Operating Systems: MS-DOS 5.0 and MS-Windows 3.0

Special Package Price **\$1,899**

(DJ-PC443-03)

## DECpc 333c



Includes:

- Microprocessor: Intel i386 running at 33MHz
- Memory: 4MB, 80NS Memory Kit
- Storage: 52MB IDE Hard Disk Drive
- Resolution Mode: 1024 X 768 SVGA Adapter
- Display: 14" SVGA Color Monitor
- Keyboard: 101-key Keyboard
- Mouse: Mouse
- Operating Systems: MS-DOS 5.0 and MS-Windows 3.0

Special Package Price **\$3,199**

(DJ-PC463-06)

## DECpc 433 workstation



Includes:

- Microprocessor: Intel i486 running at 33MHz
- Memory: 8MB, 80NS Memory Kit
- Storage: 40MB IDE Hard Disk Drive
- Resolution Mode: 1280 X 1024 TIGA Adapter
- Display: 20" Color SVGA Monitor
- Keyboard: 101-key Keyboard
- Mouse: Three-button Logitech mouse
- Operating Systems: MS-DOS 5.0 and MS-Windows 3.0

Special Package Price **\$5,999**

(DJ-PCW10-BB)

# THE PACKS.

## DECpc 316sx



Includes:  
Microprocessor: Intel i386 running at 16MHz  
Memory: 1MB, 80NS Memory Kit  
Storage: 52MB IDE Hard Disk Drive  
Resolution Mode: 1024 X 768 SVGA Adapter  
Display: 14" VGA Color Plus Monitor  
Keyboard: 101-key Keyboard  
Mouse: Two-button mouse  
Operating Systems: MS-DOS 5.0 and MS-Windows 3.0

Special Package Price **\$1,799**

(DJ-PC444-03)

## DECpc 325c



Includes:  
Microprocessor: Intel i386 running at 25MHz  
Memory: 4MB, 80NS Memory Kit  
Storage: 52MB IDE Hard Disk Drive  
Resolution Mode: 1024 X 768 SVGA Adapter  
Display: 14" VGA Color Plus Monitor  
Keyboard: 101-key Keyboard  
Mouse: Two-button Mouse  
Operating Systems: MS-DOS 5.0 and MS-Windows 3.0

Special Package Price **\$2,949**

(DJ-PC462-04)

## DECpc 433 workstation



Includes:  
Microprocessor: Intel i486 running at 33MHz  
Memory: 8MB, 80NS Memory Kit  
Storage: 209MB SCSI Hard Disk Drive  
Resolution Mode: 1280 X 1024 TIGA Adapter  
Display: 20" Color SVGA Monitor  
Keyboard: 101-key Keyboard  
Mouse: Three-button Logitech mouse  
Operating Systems: MS-DOS 5.0 and MS-Windows 3.0

Special Package Price **\$6,699**

(DJ-PCW 10-DB)

**DESKTOP  
DIRECT  
from  
DIGITAL**

Taking PCs into the world ahead

**1-800 PC BY DEC (1-800-722-9332)**

Please reference AHQ when you call.

# PUT YOUR PC TOGETHER ON PAPER.

**FAX**  
TOLL FREE TO  
**1-800-524-5694**

and we'll send you a special system recommendation.  
Or call 1-800-722-9332 and we'll recommend by phone.

**OPEN**  
*For Business*

**DESKTOP DIRECT**  
from  
**DIGITAL**

Taking PCs into the world ahead

**digital™**

Intel and 80486 are registered trademarks of Intel Corporation. Microsoft Windows, and DOS are trademarks and MS-DOS is a registered trademark of Microsoft Corporation. Novell is a trademark of Novell Corporation. Apple is a registered trademark of Apple Computer, Inc. Dell is a registered trademark of Dell Computer Corporation. Compaq is a registered trademark of COMPAQ Computer Corporation. AST is a trademark of AST Research, Inc. The DIGITAL logo, DECstation, DECpc and PATHWORKS are trademarks of Digital Equipment Corporation.

Your Name \_\_\_\_\_

Title \_\_\_\_\_

Company Name \_\_\_\_\_

Address \_\_\_\_\_

City \_\_\_\_\_ State \_\_\_\_\_ Zip \_\_\_\_\_

Office Telephone No. \_\_\_\_\_ Your FAX No. \_\_\_\_\_

If you have an idea of the PC specs you need, just jot them down in the blanks provided and we'll recommend a system that's right for you.

Here are my specs. Now call me with my new system recommendation.

\_\_\_\_\_  
\_\_\_\_\_  
\_\_\_\_\_

## Customization Worksheet

Your base system is a:  286  386  486  Other

How many applications will your PC(s) run in a typical workday? \_\_\_\_\_

What best describes the type of work the system will be used for?

(Check all that apply):

- |  |   |  |
|--|---|--|
| <input type="checkbox"/> Word Processing           | <input type="checkbox"/> Desktop Publishing         | <input type="checkbox"/> Scientific Research                                   |
| <input type="checkbox"/> Order-entry               | <input type="checkbox"/> Education                  | <input type="checkbox"/> Software Development                                  |
| <input type="checkbox"/> Database (filing records) | <input type="checkbox"/> Design (CAD/CAM)           | <input type="checkbox"/> E-Mail  |
| <input type="checkbox"/> Financial Calculations    | <input type="checkbox"/> Engineering                | <input type="checkbox"/> Other industry-specific applications (please specify) |
| <input type="checkbox"/> Retail Store Management   | <input type="checkbox"/> Industrial Process Control |  |

How many people work in your group, department or small business?

Less than 10  10-20  20-35  More

Is your operating system:

DOS  DOS with Windows  OS/2  MAC  UNIX™  Other

### Questions:

Which of the following graphics-oriented applications best describes your needs? (Check all that apply)

- |   |  |  |
|---|--|--|
| <input type="checkbox"/> Desktop Publishing | <input type="checkbox"/> Realtime Modeling | <input type="checkbox"/> AutoCad           |
| <input type="checkbox"/> CAD/CAM            | <input type="checkbox"/> Animation         | <input type="checkbox"/> Business Graphics |
|   | <input type="checkbox"/> Image Processing  |  |

### LAN Manager

How many PCs do you have installed? \_\_\_\_\_ From how many manufacturers? \_\_\_\_\_

What kinds of connections does your PC(s) require? (Check all that apply)

- Links with other PCs in the immediate surroundings  
 Connection to the local area network (LAN) throughout a building  
 A line to a host system in a remote location

What kind of media (cable) is used in your LANs today? \_\_\_\_\_

What is the networking software now being used in your company? \_\_\_\_\_

What kind of host system will your PC communicate with?

DEC  IBM  Other \_\_\_\_\_

### What Kind of Service Do You Really Need?

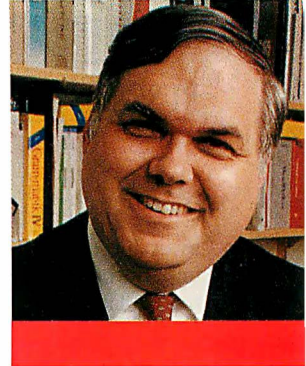
- On-site Hardware Support  Software Support  Telephone Support  
 Training  FAX Hotline

How many of your users take portables on the road? \_\_\_\_\_

Do you currently have a service contract(s) for your PCs?  How many? \_\_\_\_\_

**1-800 PC BY DEC (1-800-722-9332)**

Please reference AHQ when you call.



WAYNE  
RASH JR.

## WINDOWS MOVES OUT

**C**omputing on the road has always been a pain. The problem is that the things you do at the office are usually comfortably within the state of the art, but the same work stretches the state of the art considerably when you're away from your home base. The fact remains, though, that many business users require exactly the same capabilities when they travel as they do when they are back at their offices. If this means that they must use Microsoft Windows when they travel, then they must be prepared to stretch the state of the art. Sometimes, unfortunately, the industry isn't quite ready for all the stretching that may be required.

### On the Road Again

I had the opportunity to test the amount of stretching that both the technology and the industry will support during a series of trips last fall. These trips took me from the beaches of Waikiki to the cobbled streets of Prague, and in the process I learned a lot about what it's like to use sophisticated hardware and software while traveling.

Over the past year, I've begun using Windows-based software for a growing portion of my work. I started with Excel for Windows because of its clear superiority over Lotus 1-2-3. That led me to start using Word for Windows for some tasks and Microsoft Project for project management. Still, I did most of my writing with WordStar and WordPerfect, and that meant that much of my work didn't require Windows and therefore didn't require terrific power. Most notebook computers would work fine if all I had to do was write.

Two things changed this past fall. The first was that I found myself having to create or modify presentations while traveling. The other was that Windows-based word processing finally reached the point where I didn't mind using Windows-compatible products for serious writing. With these changes in requirements and capabilities, I found that the benefits of having a consistent graphical interface exceeded the drawbacks, even while traveling.

In Honolulu, for example, I needed access to Microsoft Project during discussions with both my client and with subcontractors during the start-up phase of a network installation. While I could have carried a floppy disk and used a computer at the client's site, this presumed that the client had Microsoft Project installed on a computer that would be available for my use. Since I couldn't make that assumption, I needed to take along the software and a computer that would support it.

Likewise, while I was in Prague, I needed to write and send my column for BYTEWEEK, and I needed the ca-

pability to create documents and presentations for the Czechoslovakian client. I can write my column using nearly anything, but producing clear, attractive, and professional-looking documents and presentations requires sophisticated tools. This was one area where having a Windows-based presentation package, such as PowerPoint, was a plus. Even better was the new WordPerfect for Windows, which allowed me to use a GUI-based word processor that would support the diacritical marks that are used in the Czech and Slovak alphabet.

While I could have done without Windows on these trips, it would have been a lot harder, and it would have meant using tools different from those I use at the office.

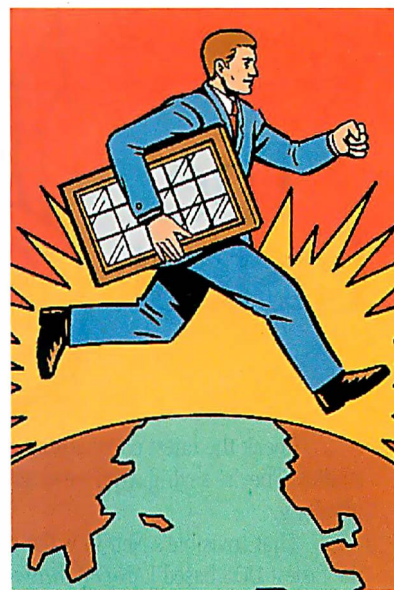
During my visit to Czechoslovakia, I enjoyed the unique sensation of starting this column in a thirteenth-century palace using WordPerfect for Windows running on a Zenith Mastersport 386SLe notebook computer—a memorable contrast between old technology and new.

### The State of the Art

It takes a very capable machine to support the requirements I had on last fall's series of trips. On one hand, I needed a computer with enough memory and disk space to support Windows and several applications. On the other hand, I needed a computer that would be small and light enough that I could carry it through airports around the world, that would have enough battery life that I could power it up for security personnel, and that would be functional on an airliner if I needed to use it there.

I used two computers that met all these requirements: the Librex 386SX/20 and the Zenith Mastersport 386SLe. The Librex is typical of moderately priced 386SX notebook computers, while the Mastersport's 25-MHz 386SL CPU, practical design, and exceptional screen make it clearly the best Windows-capable notebook computer

**Better notebook computers make traveling with Windows a workable proposition**



available today. The Mastersport is also unperturbed by the rigors of international travel. The standard power supply works equally well on 220-volt, 50-cycle power in Europe, 115-V power in the U.S., and 100-V power in Japan. Battery life on the computer is enhanced by the standard power management features in its Intel 386SL processor chip. And the Mastersport is small and light enough to be useful even in the depths of the coach section on a Lufthansa 747.

What's also important is that both the Mastersport and the Librex have backlit triple-supertwist screens with sufficient clarity and contrast to make Windows use reasonably pleasant. While neither machine has a color screen, I didn't find that to be much of a problem. In fact, the Mastersport's 9-inch screen is good enough that clients tended to gather around to admire it, and it's large enough that I could use PowerPoint's slide-show capability to produce presentations.

**Entanglements**

Of course, capability is one thing and actual use is another. While there's a lot of excellent Windows software available, and while there's finally some decent hardware available for use when you travel, trying to actually use your handy Windows software when you're away from the office could get you into serious trouble. The reason is that the licensing practices of some software companies simply haven't kept up with the technology—or with reality, for that matter.

Windows itself is usually not the problem, since it seems to be bundled with just about every computer sold these days, but the applications are a different story. In the course of preparing this column, I used several packages on the road that I also use at the office. There are also packages that I couldn't legally use, so I didn't.

WordPerfect for Windows was the easiest solution. WordPerfect Corp. (Orem, UT) has modified its licensing agreements so that you can install WordPerfect on any computer you want as long as you use only one copy at a time. This is perfect for the traveling business user, who will use the copy on the desktop machine at the office and the copy on the laptop machine when traveling.

With Microsoft, the licensing situation can best be described as somewhat weird. It lets you install applications on a laptop or home computer, provided you use the copy on a dedicated computer 80 percent of the time. You can get around this requirement if you actually carry the physical copy of the software license with you when you use the software. But how do you measure 80 percent? Over what period of time? Does this mean that users who travel a lot must have two copies of Microsoft applications while those who don't need only one? Let me know if you figure out the answer to this one.

DCA, meanwhile, has one of the better Windows communications packages around, but don't try to use the same copy on the road that you have back in the office. The license for DCA's Crosstalk for Windows follows DCA's outmoded, mainframe-based concept of allowing only a single copy of the software, plus an archival copy. You can have a copy of Crosstalk for Windows on the office machine, or a copy on the laptop, but to have both, you need to buy two copies. This concept is ludicrous and only succeeds in making software pirates of otherwise honest business users.

Sadly, far too many software vendors insist on silly license requirements such as those used by DCA. Limitations such as those and, to a lesser extent, bizarre

# Out of Sight LAN Performance.

**Hard Disk Access Load/Four Stations**  
(requests per second) BEST

Invisible Ethernet NET/30	396.0
POWERLAN	263.0
SilverNET-OS	246.0
TONET	166.0
Plus	132.0
ReadyLink	121.0
Operating System	113.0
LANtastic	110.0
LanSoft	109.0
LANtarm	81.0
MainLan Ethernet	81.0

**Peer-to-Peer Network Scores**

NET/30 Version 2.0	6.5
LANtastic Version 2.0	6.4
InfoNOC Version 2.55	6.1
LANtastic Version 4.0	6.0

Data courtesy of InfoWorld Magazine.

**The Fastest.**      **The Best.**

BUYERS ASSURANCE SEAL  
INFO WORLD

Check the latest comparison studies. They're saying what we've said all along.

That Invisible's Net/30 is flat out the fastest DOS based LAN (*PC Magazine*). And the #1 rated network for all-around, peer-to-peer performance (*InfoWorld*).

Plus Invisible brings the ease-of-use of Windows to network management. Turning a difficult task into a

virtual piece of cake. As to support: for technical savvy, availability, and friendliness, nobody outshines Invisible. Nobody.

These things are important. Because they help you get faster, easier access to the information you need. For more information call 415/570-5967 (don't be surprised if an engineer answers). Or FAX 415/570-6017. Or write 1142 Chess Dr., Foster City, CA 94404.

Invisible. Out of sight.





# MINUTEMAN TAKES CHARGE IN OVER 1000 JCPENNEY STORES.

Every time JCPenney sells a pair of jeans, a toaster or a bottle of perfume, MINUTEMAN takes charge. That's because more than one thousand JCPenney stores rely on MINUTEMAN UPS systems to back up power to their point-of-sale systems.

Every day your company relies on its voice and data communications equipment to stay productive. Unfortunately, the electricity that powers these vital systems is not reliable.

Blackouts, brownouts, spikes, surges and even lightning strikes are common in most business environments. And the high



#### MINUTEMAN PRODUCTS

- On-line and standby UPS
- Shutdown software for every available operating system
- 300VA to 10KVA
- Power boost design on the new MINUTEMAN Power Master 600
- Automatic voltage regulators
- International models

cost of losing vital information and productivity due to power outages and surges calls for preventive measures.

Power requirements can be confusing. And your company has unique needs that often require

custom solutions.

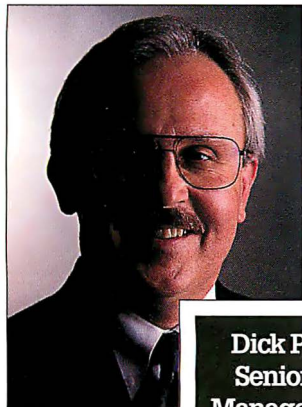
MINUTEMAN offers the most comprehensive line of UPS systems available, protecting all your business equipment from stand-alone workstations to the largest of the IBM AS/400s.

MINUTEMAN products are sold and serviced worldwide. Call on our skilled professionals to help you determine your exact power protection needs.

Call our toll-free POWER HOTLINE now for your free Power Protection Guide.

**(800) 238-7272**

**MINUTEMAN**<sup>®</sup>  
UNINTERRUPTIBLE POWER SUPPLIES



**Dick Patefield,  
Senior Project  
Manager for Store  
Systems Support,  
JCPenney**

Recently JCPenney Co., Inc. changed its operations from the old POS systems to the new PC-based technology, relying on PC platforms for point-of-sale and in-store support. And they back each

one up with help from MINUTEMAN.

*"There was a violent surge in one of our stores," says Patefield. "If we didn't have the MINUTEMAN unit, it probably would have seriously damaged all of our point-of-sale equipment.*

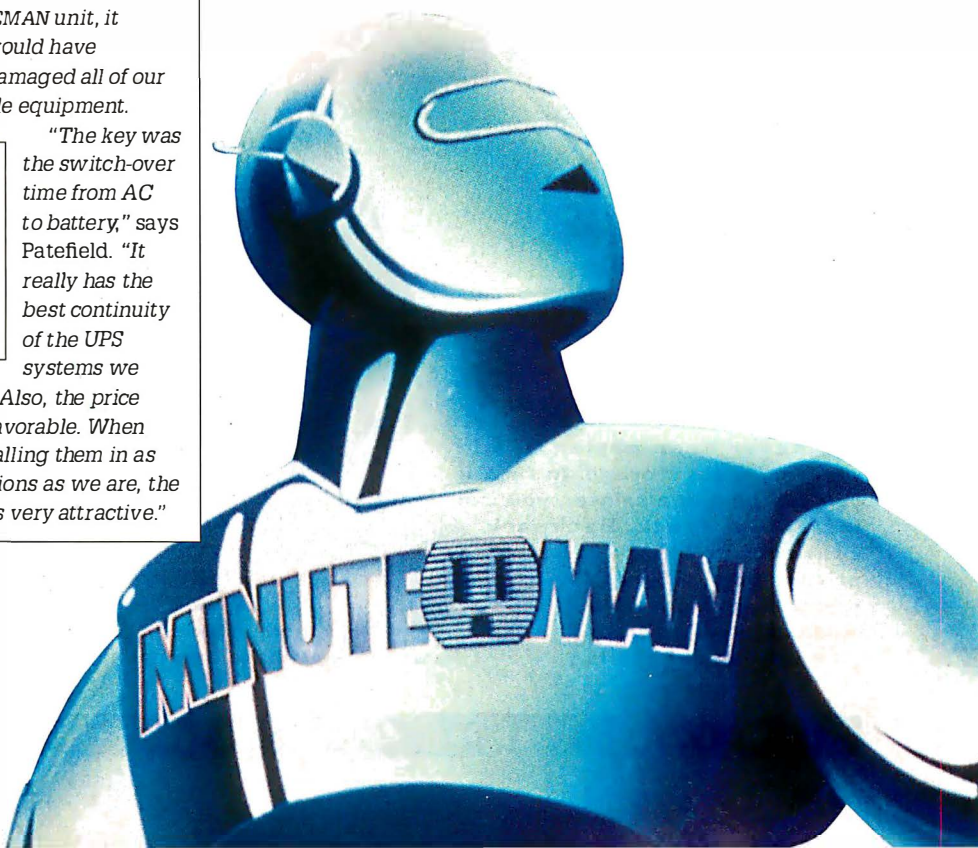
*"The key was the switch-over time from AC to battery," says Patefield. "It really has the best continuity of the UPS systems we evaluated. Also, the price was very favorable. When you're installing them in as many locations as we are, the pricing was very attractive."*

**SEE US AT  
COMDEX CHICAGO  
BOOTH #113  
CEBIT '92  
HALL 17, STAND B56**



© 1992 Para Systems, Inc., 1455 LeMay Drive, Carrollton, Texas 75007 (214) 446-7363 (214) 446-9011 fax

**Circle 91 on Inquiry Card.**



limitations such as Microsoft's, have no discernible positive effects. They can irritate users, or they can cost users more money than they should, or they can result in a user choosing a package with a sane approach to software licensing. Mostly, though, they irritate business users who don't like thinking of themselves as criminals and who don't like vendors who ignore life in the real world. In my case, I left Crosstalk for Windows installed on one of the office machines and used Procomm Plus on the road. It might not be a Windows package, but Datastorm Technologies understands how people really use computers.

**Real-World Use**

Now that Windows works on the road, what do people in the real world do with their new Windows-capable computers? My seatmate on one flight was typical. I watched him as I sipped a glass of Dom Pérignon from the comfort of my first-class seat on a United 747. First, he unloaded a pile of spreadsheet pages, a few documents, and a presentation. Next came a Compaq notebook computer and a Ballpoint mouse.

After the airplane took off and our glasses of champagne were refilled, my neighbor opened his tray table and placed the Compaq in front of him. He attached the mouse and powered on the computer. He ran Windows. Finally, my neighbor began to use Windows for its single most common use. He placed the pointer on a 10, dragged it over to a jack, and then clicked to turn another card over as he became happily engrossed in another try at solitaire. I silently toasted his luck and opened a copy of BYTE to catch up on the industry. ■

*Wayne Rash Jr. is a contributing editor for BYTE and a principal and technical director of the Network Integration Group of American Management Systems, Inc. (Arlington, VA). He is coauthor of two books for business network users: The Executive Guide to Local Area Networks and The Novell Connection. You can contact him on BIX as "waynerash" or in the to.wayne conference.*

*Your questions and comments are welcome. Write to: Editor, BYTE, One Phoenix Mill Lane, Peterborough, NH 03458.*

**ITEMS DISCUSSED**

**Excel for Windows 3.0**.....\$495  
**Microsoft Project for Windows** .....\$695  
**PowerPoint for Windows**.....\$495  
**Windows 3.0** .....\$199  
**Word for Windows 2.0** .....\$495  
 Microsoft Corp.  
 (206) 882-8080

**Circle 1223 on Inquiry Card.**

**Librex 386SX/20** .....\$2999  
 Librex Computer Systems, Inc.  
 (408) 441-8500

**Circle 1221 on Inquiry Card.**

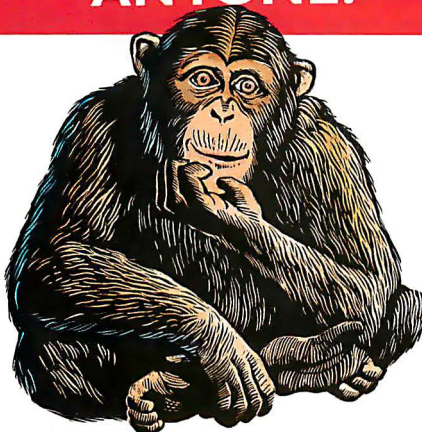
**Mastersport 386SLe** .....\$4995  
 Zenith Data Systems  
 (800) 553-0331

**Circle 1222 on Inquiry Card.**

**WordPerfect for Windows**.....\$495  
 WordPerfect Corp.  
 (801) 225-5000

**Circle 1224 on Inquiry Card.**

**ANYONE  
 CAN INSTALL  
 BACKPACK.  
 ANYONE.**



It's never been easier to add external mass storage. In fact, if you can plug in a printer, you can install Backpack. Backpack connects to the parallel printer port of any PC compatible or portable *without* interface cards or tools! Backpack is



available in 3.5" and 5.25" diskette, QIC 40 (40/120MB) and QIC 80 (80/250MB) tape, as well as hard drive models. Several computers can share one Backpack, so

you can back up your work or take it home to another computer. So don't monkey around with difficult-to-install drives. Call for full Backpack information today.



**backpack**

**MicroSolutions**

# Developers: Lock Up Your Profits

Windows 3.0  
Support Available

We have the key for protecting your software profits and your copyright.

Software piracy's a crime! What it can do to a developer's profit margin is shameful. The cost of development and marketing products demands you receive the revenue you are entitled to. We have the solution.

- Custom hardware and software for each developer
- Encrypted interrogation routines and debug disablers. Over 140 language interfaces available.
- Available active read/write memory and on-board microprocessor provide the ultimate protection
  - Keys for PC "compatibles," Macintosh, UNIX and RS-232C standard
  - Total compatibility, reliability and end user satisfaction

We have the key.  
Call us for more information  
or a demonstration package.

**1-800-843-0413**



**MICROPHAR**

In EUROPE:  
MICROPHAR, 122 Ave. Ch. De Gaulle 92200,  
Neuilly-Sur-Seine, FRANCE, Tel: 33-1-47-38 21-21 Fax: 33-1-46-24-76 91

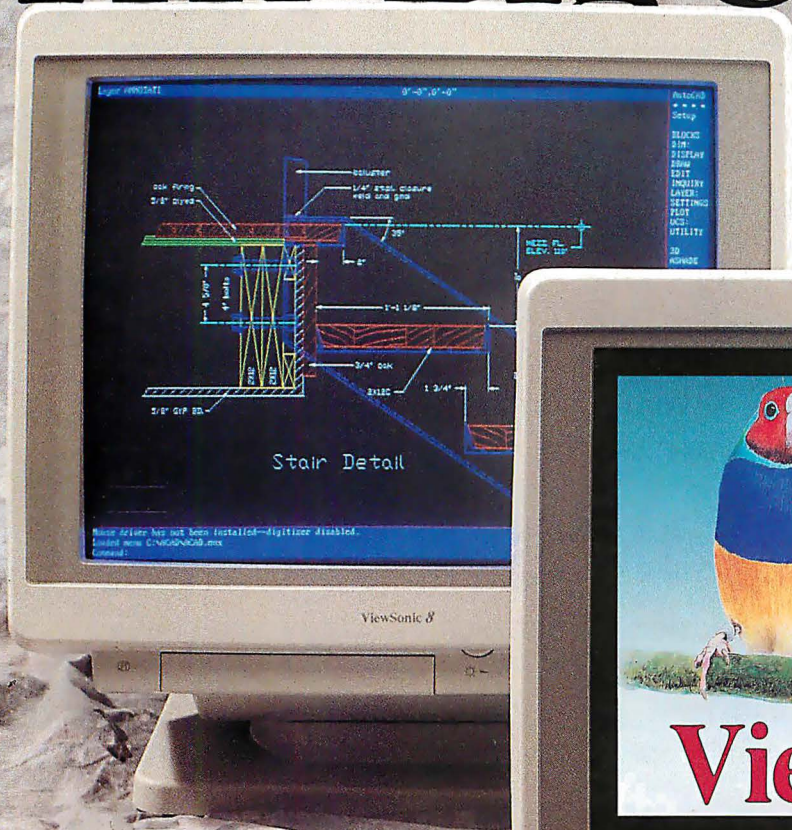
**For Distributors in:**

- \*BELGIUM, E2S (091 21 11 17)
- \*GERMANY, AUSTRIA: Microphar GmbH (06223 - 73730)
- \*HUNGARY, Polyware Kft (76-22-307)
- \*ITALY, Siosistemi (030 24 21 074)
- \*POLAND, Microphar Poland (32 586 848)
- \*PORTUGAL, HCR (1 56 18 65)
- \*SCANDINAVIA, Microphar Nordic (45 53 51 70 33)
- \*SPAIN, Microphar España (032 37 31 05)
- \*SWITZERLAND, SAFE (024 21 53 86)
- \*THE NETHERLANDS, Infotac (015 15 88 37)
- \*UNITED KINGDOM, Clearsoft (091 378 91 91)

**PROTECH**  
MARKETING, INC

9600-J Southern Pine Blvd.  
Charlotte, NC 28217  
Tel: 704-523-9500 FAX: 704-523-7651  
Hours: Mon-Thurs: 8:30-7:00, Fri: 8:30-5:30 ET  
*Open late to better serve our west coast clients.*  
Se Habla Español

# The Big Screen



20-Inch



17-Inch



These two new 1280 x 1024 ultra high resolution monitors will soon be in offices all over the world. That's because they're so *powerful!*

Consider this: Our 17" and 20" non-interlaced microprocessor-enhanced monitors will automatically adjust the image the way you want. There are 16 preset modes which can be programmed by the end-user. With built-in memory, these monitors do what you want...and they don't forget. Plus the crystal clarity and sharp focus on the non-glare, anti-static screen are simply unbeatable. NO distortion and low radiation. The ViewSonic 7 even has a flat/square screen.

The ViewSonic 7 (17") and ViewSonic 8 (20") feature a new level of high performance for desktop publishing, CAD/CAM and other graphics-intensive applications. They are designed for PCs, Mac II and Sun systems.

Visit your dealer TODAY and see for yourself why ViewSonic monitors, from the 14" to the 20", are becoming a standard in offices throughout the world.

**ViewSonic®**

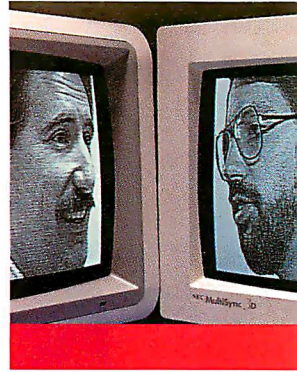
12130 Mora Drive  
Santa Fe Springs, CA 90670  
(213) 946-0711 (800) 888-8583 Fax (213) 946-1618



All products and brand names are trademarks of their respective companies.

INTERNATIONAL DISTRIBUTORS: Australia (02-476-4777, Fax: 02-477-7561); Austria (04252-2700, Fax: 0452-3177); Canada (416-479-5525, Fax: 416-479-1834 and 604-270-8561, Fax: 604-270-1953); Germany (0431-548030, Fax: 0431-5480366 and 05732-101932, Fax: 05732-101947) Hong Kong (389-8252, Fax: 343-6479); Italy (02-82442156, Fax: 02-8256993); Korea (02-784-2915, Fax: 02-784-2549); Poland (59-120314, Fax: 39-120314) Spain (93-419-2322, Fax: 93-419-1178); Taiwan (02-248-4072, Fax: 02-240-8238)

Circle 133 on Inquiry Card (RESELLERS: 134).



**BYTE** editors debate the issues with contributors, readers, and industry experts

## THE FUTURE OF PEN COMPUTING

**R**oundtable is a forum in which **BYTE** editors, contributors, readers, and industry experts debate key issues that affect how you purchase and use hardware and software. The “conversations” take place on BIX, where you can participate in the roundtable conference.

**Editor’s note:** *This month, **BYTE** invited pen-computer software and hardware developers to discuss pen-computing technology. Senior editor Rob Mitchell moderated the discussion.*

*Stylus-based input systems started with niche-market forms-based data-collection applications. New pen-specific operating systems such as Windows for Pens and PenPoint promise to widen the market for these machines. Who will buy these systems, and for what uses?*

**DAN BRICKLIN:** People will buy [pen computers] because they can do what other computers can’t—[you can use them] while standing up or in other situations where a keyboard is inappropriate. Another example is when you want handwritten text or illustrations, such as sketches of damage to a motor vehicle.

Laptops and mice don’t mix well. In many situations, people use a pencil and paper, not a laptop, because the information to be captured does not lend itself well to a keyboard or a mouse. Unfortunately, much of this information needs to be stored and retrieved, and computers would be very helpful if only they could accept handwriting without translating it. Many people will find pen computers more natural, even with slow handwriting recognition, just as some find dictation natural, and others don’t.

**NICHOLAS BARAN:** Most situations that require standing up and using a pen as an input device are *task-specific* activities. Initially, I see a very specialized market.

Pen-based vendors are missing the mark in selling the machines as general-purpose computers at this stage in the game. Perhaps a few executives with generous expense accounts might buy pen-based machines as a luxury item, but we are still far away from these machines becoming a mass commodity.

**STEVE LIFFICK:** Mass-market acceptance of the technology will have to wait until prices come down from the current range of \$3000 to \$5000.

This is why it’s important to appeal to today’s notebook buyer. [This person] is prepared to buy a machine that runs all of [his or her] current applications. If we can offer a notebook computer with enhanced portability and usability, key pen-specific applications, and a really cool platform to boot—all for incremental cost—we can win the buyer from the generic notebook-computer market.

**KEN DULANEY:** We see four types of pen computers emerging. These are clipboards, characterized by large screens, long battery life, and low prices; tablets, characterized by large screens and high-speed processors; pentops, pen-enhanced notebooks; and consumer hand-helds, characterized by small size and weight.

Two subclasses are consumer and industrial. Consumer hand-helds are “Pen Wizards.” Industrial hand-helds have a high degree of ruggedness.

Clipboards and industrial hand-helds are highly vertical. Pentops and consumer hand-helds are highly horizontal. Tablets could play in either market.

We see three software choices for pen computers: Windows for Pens, which is highly horizontal; PenPoint, which Go wrote to be horizontal but could be adapted to vertical applications; and Grid’s PenRight, developed for use in custom applications.

We see the following matchups. Clipboards: PenRight for now because they usually have less-than-386 performance and cannot run Windows for Pens

**NICHOLAS BARAN**  
Co-editor,  
*Pen-Based Computing:*  
*The Journal of Stylus Systems*

**DAN BRICKLIN**  
Vice President,  
Boston Development Center  
Slate Corp.

**JEFF DAO**  
Director of Applications  
Engineering  
Communication Intelligence  
Corp.

**KEN DULANEY**  
Director of Marketing  
for Portables  
Grid Systems Corp.

**HOWARD EGLOWSTEIN**  
Testing Editor, **BYTE** Lab

**STEVE LIFFICK**  
Program Manager,  
Windows for Pens  
Microsoft Corp.

**KEVIN MANKIN**  
Director of Product Marketing  
Momenta Corp.

**ANDY REINHARDT**  
Editor in Chief, **BYTEWEEK**



Impressive any way  
you look at it.



Our Still Video Imaging Kits let you convert objects into digitized images, ready for use on Mac, PC and Windows programs like PageMaker™, Ventura™, Photoshop™, Persuasion™, MediaMaker™ and HyperCard™.

Impressed? Call 1-800-221-3333 ext. 313 for dealer locations and a free brochure.



Brand and Product names are trademarks of their respective holders.

or PenPoint. Tablets: All three operating systems. Pentops: Windows for Pens. Consumer hand-helds: PenPoint, which is scalable and horizontal. But since not many people know what operating system is on a Sharp Wizard type of product, other OSes could play. Industrial hand-helds: PenRight for now.

Our studies show that the most successful pen computer will be the replacement for the Sharp Wizard ([which sells for] under \$1000). This is a highly horizontal product and generally a companion to a desktop machine.

**JEFF DAO:** We must shake off our perception that the U.S. is the only market in the world. Many languages make a keyboard look ridiculous (Japanese, Chinese, and Korean are good examples). Pen input allows computers to be localized much better for the world market, and this benefit applies not only to hand-helds, notepads, and pentops, but also to desktops and workstations. A good example is Communication Intelligence's MacHandwriter, which Apple markets in Japan. It offers direct entry of over 3000 kanji characters and uses the wealth of existing Macintosh applications such as PageMaker, Word, and Excel.

**ANDY REINHARDT:** Pen-based computing doesn't have to be synonymous with mobile computing, although that's the most obvious point of entry. There will be whole classes of applications developed for mobile versus mouse-substitute pen computing. Perhaps Grid and other vertically oriented solutions like hand-held terminals will define mobile pen computing, while pentops and high-end tablets like NCR's 3125 will constitute the executive class that runs 386-based GUIs.

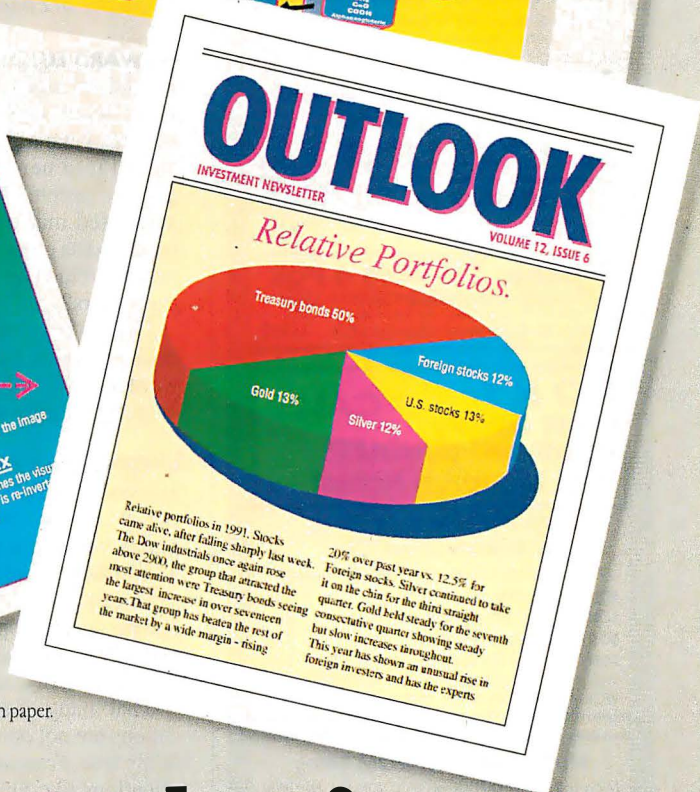
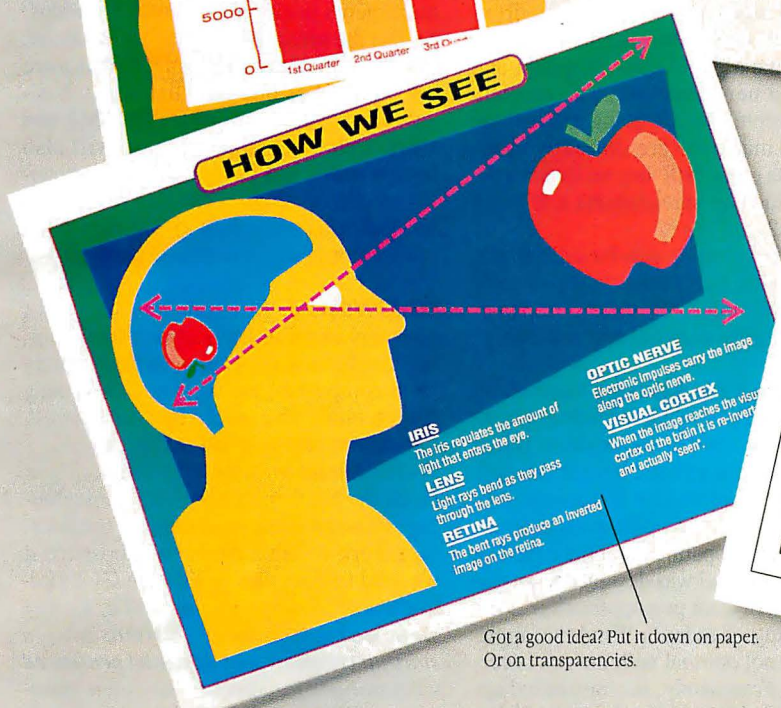
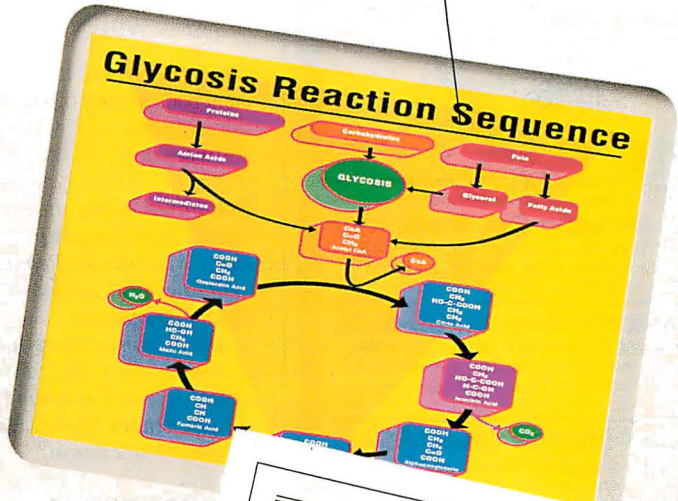
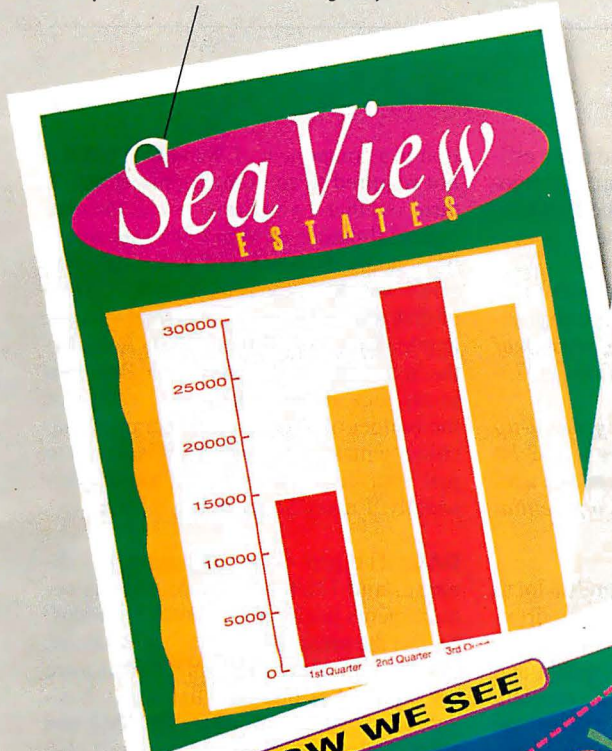
For networking, PenPoint includes the interesting In Box/Out Box feature, which queues up messages and automatically recognizes the presence of a network. This is especially ideal for radio-based communications: As soon as you come within receiver range, your messages flow in and out without your having to do anything.

**KEVIN MANKIN:** Mobile computing is essential to the advancement of pen-based software. The previous generations of portables all ran software developed for a desktop. Since a pen enables software to be accessible in meetings, software must evolve that is less demanding to a user in a meeting.

Less-demanding, more-intuitive, and more-efficient software will result from software [developed for use] in meetings, and that software also will be less

A banquet of colors—16.7 million outrageously brilliant shades.

With PostScript-Language compatibility and HP-GL with 35 fonts, they'll read you loud and clear.



Got a good idea? Put it down on paper. Or on transparencies.

# Presenting color for big eyes and small budgets.

How do you buy a color printer when your eyes say yes, but your budget's begging for mercy? Easy. Just get a Phaser™ II PX.

It gives you millions of rich, brilliant colors to play with, all at 300 dpi. So you can satisfy your eyes. And it works with Macs, PCs, UNIX workstations, Windows, you name it.

Now to soothe your budget—the Phaser II PX is the lowest-priced, full feature color printers on the market. The one with “the brightest colors and the smoothest blends”\* that “stands head and shoulders above the rest.”\*\*

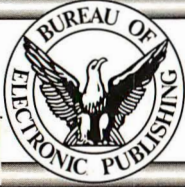
So go ahead and let your eyes choose the printer. And tell your accountant not to worry. Call 1-800-835-6100, Dept. 20J for a free output sample.



**Tektronix**  
The best and the brightest.

\*Mac User, May '91 issue. \*\*PC Computing, Sept. '91 issue. Phaser is a trademark of Tektronix, Inc. for color printers and related products. PostScript is a trademark of Adobe Systems Incorporated which is registered in the USA and other countries. Other marks are trademarks or registered trademarks of the manufacturers or marketers of the products with which the marks are associated. France: (1) 69-82-82-82; U.K.: 0800-521749; Germany: (220) 9569-0; Italy: (2) 8444; Sweden: (8) 20 21 10; Holland: (205) 13300; European Operations Center: 44-628-899-255

# CD-ROM



## Multimedia CIA World Tour

MPC Title! With info straight from the CIA -- Plus Maps from Hammond, Inc. and flags & National Anthem segments New Version! \$99

## Monarch Notes on CD-ROM

Over 200 Study Guides on One CD-ROM Disc - The Entire Collection (many out of print) The definitive multimedia source for understanding the world's greatest literature. PC & Mac Only \$99

## Great Literature Classic Edition

The Personal Library - Multimedia version Includes full text, spoken passages by famous actors and original illustrations. PC & Mac \$99

## Countries of The World Encyclopedia

Full text of over 100 Study Books, Maps, National Anthems, Flags & more! PC & Mac \$395

## U.S. History on CD-ROM

WINNER 1991 OPA BEST EDUCATIONAL PRODUCT Full Text & Images PC/Mac \$395

## Pioneer CD-ROM 6 Pak

6 PC/MAC DISCS BUNDLED FOR ONLY \$395! U.S. History • Courtiers/World • Shakespears • Holmes • Birds • Software Potpourri Six Pack & Minichanger (Save over \$1000) \$1489

## SONY Laser Library Enhanced BUNDLES! With Monarch Notes!

### High Performance SONY CD-ROM Drive Kits

Fast, MPC compatible drive kits in-stock

- SONY CDU-535 kit (internal) CALL
- SONY CDU-541 kit (internal) MPC ready CALL
- SONY CDU-7201 kit (desktop) CALL
- SONY CDU-7211 kit (desktop) MPC ready CALL

Also: Pioneer Minichanger, CDT, NEC, Hitachi, WORM & Erasable drives, in-stock - Call

### Multimedia CD-ROM Titles

- Microsoft Bookshelf best selling CD-ROM disc Best Price \$79
- Beethoven's Multimedia MPC classic disc \$79
- Grolier's Encyclopedia 21 volumes, VGA pictures Call
- Mammals - Nat. Geographic/IBM pictures & text Call
- Presidents - Nat. Geographic/IBM pictures & text Call
- Compton's Multi-Media Encyclopedia 795

### Libraries / Science / Business

- Between Heaven & Hell II even stranger \$99
- Street Atlas Windows map with every US street Call
- TIME Magazine Compact Almanac 5,000 articles Call
- Family Doctor home medical guide 98
- McGraw-Hill Ref. Set 100,000 terms: 7,300 articles 495
- Speed Dial entire U.S. Yellow Pages on one disc Sale
- Oxford Textbook of Medicine general reference 595
- PC-Sig Library new edition, newest version Call
- Oxford English Dictionary over 250,000 headwords! 889
- Phonedisc USA Telephone Directory - East or West 989
- Bureau On-Line CD-ROM Library, FREE access to 12 different CD-ROM Discs, CALL !!!
- GSA # G500K91AGS5280
- HOURS M-F 8:30am - 6:30pm EST



## Bureau of Electronic Publishing, Inc.

Dept. B, 141 New Road, Parsippany, NJ 07054

FAX # 201-808-2676

CALL: **800-828-4766** ORDERS  
201-808-2700 INFORMATION

## ROUNDTABLE

demanding, more intuitive, and more efficient back at your office desktop. The "mobile software tail" will wag the "desktop software dog" for the first time.

*Pen-based applications developers must choose between competing operating systems. Windows for Pens is an extension of Windows that works with existing Windows applications.*

*Other competitors take a ground-up approach. Go Corp.'s PenPoint is a 32-bit object-oriented operating system that uses a flat memory model. How is a potential developer to choose?*

**HOWARD EGLOWSTEIN:** There's a lot to be said for writing to a standard environment. Windows for Pens seems like a solid idea: Take a popular environment and extend it to new hardware. The problem is, if the people who are going to use these pen-based machines are primarily interested in data entry, will they really need access to Windows spreadsheets and word processors?

I'm not developing pen-based applications anymore, but if I was, I'd swing toward an environment with less emphasis on compatibility with old applications.

**LIFFICK:** Much ado has been made about Windows for Pens being inherently "hampered" by, or limited to, desktop transplants because it existed before the pen. This simply is not so. Our application programming interface was designed to leverage the special capabilities of the pen. The pen API is new and was designed to enable the creation of cool pen applications.

That many of today's Windows applications are not optimal with the pen is certainly true. Fortunately, pen-optimized applications like Slate's PenApps are being written for Windows for Pens.

Corporate developers are picking our environment because of the large number of development tools available for Windows for Pens. Visual Basic has been especially good at helping us create mock-ups of applications on the fly. Once we show MIS types that you can do pen applications and do them quickly, they can base their decisions on other factors. The OS is a known quantity, and many folks understand how to write for Windows.

*Windows is a sophisticated environment designed for desktop machines. Won't Windows for Pens be more resource-intensive than native pen OSes?*

**LIFFICK:** Windows is basically a bunch of .DLL and .EXE files—some required and some not. For example, the Write applica-

tion is a component of Windows, but it is not required to run other applications. It turns out that if you throw out all the non-essential pieces of Windows—as would be done by the vendor of a vertical solution—Windows for Pens requires 1.6 MB of disk space and can run several average applications in 2 MB of RAM. Actually, the scalability of Windows for Pens is a pretty nice feature, although it can force the builder of a resource-constrained machine to make some tough decisions as to just what files are really required. (Personally, I'd say Solitaire is a must!)

**DAO:** The pen-computing market is diverse, and [different] applications requirements justify different OS solutions. So far, the press has focused on PenPoint, Windows for Pens, and PenDOS. But there are other OSes out there that many businesses use, such as the Mac OS, OS/2, and Unix. Pen extensions to these will also have a strong market potential. The benefits of pen computing are also relevant to workstations and smaller hand-held computers, not just notepads and pentops.

**EGLOWSTEIN:** At Hindsight, we didn't have any existing applications to convert, our machine wasn't going to be remotely DOS compatible, and we wrote everything from scratch. That forced us to take a fresh look at the pen as an input device.

Our model was the lined school pad (with the big 1-inch lines). It had no concept of windowing, and making the interface work would have been impossible if we tried to start with an existing GUI. [Editor's note: *Prior to joining BYTE, Eglostein was a cofounder of Hindsight—a start-up company that designed pen-based workstations for special education classrooms. Hindsight's Letterbug was built to teach handwriting to dyslexic students.*]

**DULANEY:** Pen-enabling an existing OS is a short-term fix. Ultimately, the OS or environment has to be rewritten to take advantage of the pen. At Grid, we use a GridPad to allow people to sign into our building. Pen-enabling an existing software package would have been a complete failure. We had to use many software interface techniques that were not even considered in keyboard- or keyboard-/mouse-aware applications. The folks at Microsoft, Go, and Grid have started all over again in designing the software. Successful pen computing can require no less.

*Next month the roundtable on pen computing continues, as participants discuss the limits of handwriting recognition, display technology, and other issues. ■*



# GATEBUSTERS!



**SONY  
CD ONLY \$299!  
SOFTWARE  
LIBRARY  
AVAILABLE**

**2 YEAR  
WARRANTY!  
ALL  
SYSTEMS**

**\$2,899  
486-33 ISA\***

**\$3,499  
486-33 EISA\*\***

- 32-Bit Intel 80486/33 MHz CPU
- Zero-Wait 64KB (Exp. to 256KB) High Speed Cache\*
- Zero-Wait 128KB High Speed Cache\*\*
- 4MB Zero-Wait State 32-bit memory on the World's Best Motherboard made by AMI (Expands to 32MB\*/96MB\*\*)
- 8 Expansion Slots 16-bit\*/7-EISA and 1-32/8 bit\*\*
- **SONY 1304 HG 14" SVGA Monitor (1024 x 768 Non-interlaced)**
- Orchid ProDesigner II VGA Card with 1MB RAM
- 207MB 15ms Maxtor IDE Hard Drive
- Teac 1.2 AND 1.44 Floppy Drives
- 2 Serial/1 Parallel Ports I/O\*
- 2 Serial/2 Parallel Ports I/O\*\*
- PC Power & Cooling 300 Watt Power Supply
- Vertical Case: 6 Bays/Security Lock/LED (Also shown is our optional deluxe case 450 W PS)
- **Keytronics 101-key Enhanced Keyboard**
- **AMI BIOS/CMOS Set-up/Diagnostics/Clock/Calendar**
- 3-Ring Cloth Binder for Manual and Software
- 10-year Lithium Battery/ **TOUCHE** Tool
- 800 number for Lifetime Technical Support
- TRW On-Site Service Available to Most Locations
- Federal Express Replacement of Defective Components
- FCC B Certification



**\$1,899 386-33 MHz  
COMPLETE SYSTEM  
Upgradable to 486**

**386 20SX Starting at \$799**

COLORADO 120MB Tape Back-Up Option \$249  
BOCA 2400 Baud Internal Modem Option \$69

**TOUCHE**  
MICRO TECHNOLOGIES

A PC PROS Company  
8205 South Cass Avenue Darien, Illinois 60559  
708/810-1010 Fax 708/810-9490



## THE **TOUCHE** COMMITMENT TO QUALITY AND VALUE KEEPS GROWING!

**OUTSTANDING.** That is the word PC Magazine used to describe our system! We're very proud of our 486-33 review and we encourage you to read it.

One example: Of 30 systems reviewed, **TOUCHE** ranked #1 in the small-record DOS access file test and #2 in the large DOS access file test for speed! To achieve this feat we relied on Maxtor and Ultrastor, two fantastic product partners.

Maxtor and Ultrastor are just two companies on a long list of companies we obtain high-quality components from to custom-build high-quality systems. AMI-SONY-Intel-Teac-Orchid-Keytronics-Micropolis-CYRIX-SIEMENS-PC Power & Cooling-BOCA are all names you'll easily recognize. You'll never see us offer components from **Fui-Manchui** or other tongue-twisting companies you've never heard of before.

**WYSIWYG** is a term used in desktop publishing. What You See Is What You Get is also a standard we use in building our systems. That means you get exactly what you expect when you receive your order from us. No hidden surprises or cut corners that many of our competitors try to sneak by with cheap or low quality components.

The use of AMI motherboards **guarantees** full DOS-UNIX-OS2 compatibility. We custom-build every system and offer special prices on enhancement items to upgrade your system like CD ROM's, digitizers, laser printers, scanners, 20" monitors, and hundreds of other products.

Our parent company, PC PROS, was founded in 1982. *Before you buy any system, ask all the hard questions and compare.* Who makes the motherboard? This is one of the most important questions to ask since this is the heart and soul of any computer. We use more AMI motherboards than anyone in the world. **Don't be fooled by claims of an AMI BIOS equaling an AMI motherboard.** Insist you receive a system with the best motherboard money can buy... an AMI.

Whether you're government, FORTUNE, major institution or just need a machine or two for your home or office, we offer the absolute best quality and service anywhere!

**WHO YA GONNA CALL?  
708/810-1010**

Circle 269 on Inquiry Card.

**Register Now for Spring's**

# COME TO YOUR SOURCE COMPUTING



**Only COMDEX gives corporate decision makers a *total solutions event*.**

It's the spring's largest display of computer-related products and services, providing the computing tools your company needs to gain competitive advantages and bigger business payoffs.

- ▶ Save time and money by one-stop shopping with over 900 exhibiting companies from around the world!
- ▶ Increase your productivity and payback through new and better corporate computing applications!
- ▶ Complete your product/application evaluations!
- ▶ Upgrade your knowledge through the expanded COMDEX Conference featuring a special program on Corporate Solutions!

**It's almost showtime...  
register for COMDEX/Spring today!**

**For more information:**

**Call: (617) 449-8938    Fax: (617) 449-2674**

**Biggest Computer Event!**

# COMDEX.

## FOR CORPORATE SOLUTIONS.

### Plus 4 Exciting Showcases!

- ▶ **COMDEX Multimedia Showcase.** Evaluate cutting-edge products at the industry's largest multimedia exhibition.
- ▶ **COMDEX Network Computing Showcase.** Connect with the latest high-performance network computing products and services.
- ▶ **COMDEX Imaging Showcase.** Meet the companies and the product specialists who can help you determine your best imaging application opportunity.
- ▶ **COMDEX UNIX®/Open Systems Showcase.** See the hardware, software, equipment and services your business needs to get up and running across multiple platforms with UNIX and Open Systems.

### Free access to WINDOWS™ WORLD '92!

As a COMDEX/Spring attendee, you'll have free access to the world's leading exposition and conference on Windows computing. The only Windows event produced in cooperation with Microsoft, WINDOWS WORLD features hundreds of exhibitors, a Windows Conference, and a keynote address by Microsoft Chairman Bill Gates.



**COMDEX®/Spring '92**

The World's Leading Computer Trade Show for Resellers and End-Users

**April 6-9, 1992 • McCormick Place • Chicago, Illinois USA**

COMDEX and WINDOWS WORLD Conference and Exposition are properties of INTERFACE GROUP - NEVADA, Inc.  
Microsoft and the Microsoft Logo are registered trademarks and Windows is a trademark of Microsoft Corporation.  
UNIX is a registered trademark of UNIX System Laboratories, Inc., a subsidiary of AT&T.  
©1991 The Interface Group • 300 First Avenue, Needham, MA 02194-2722 USA

**Circle 69 on Inquiry Card.**

# Software Without Walls

Distributed object management systems can integrate diverse operating systems and applications and optimize your current systems

HERBERT M. OSHER

**T**o stay responsive and competitive, your company needs access to the most current and accurate information available. However, most of today's computing environments include a complex patchwork of incompatible mainframes, minicomputers, personal computers, and systems software.

Gaining transparent access to your information means coping with multivendor networks, "legacy" (i.e., entrenched) applications, diverse operating systems, and competing standards. The open systems intended to fill these needs are too often walled in by inflexible applications and complex environments.

Organizations today need to optimize their computing systems. They need an environment that builds and integrates diverse operating systems and applications—essentially, software without walls. One solution is a new class of object-oriented technology called *distributed object management* (DOM) and provided by companies like HyperDesk, DEC, Hewlett-Packard, and Sun Microsystems.

## Why Object-Oriented Software?

The basic components in an application change less frequently than do the functions that an application performs. For example, a spreadsheet cell can be an object. The functions this cell supports—Calculate, Move, Format, and so on—may change over the application's lifetime, but the object itself—the cell—remains constant. The objects are extensible, and, therefore, so are the applications.

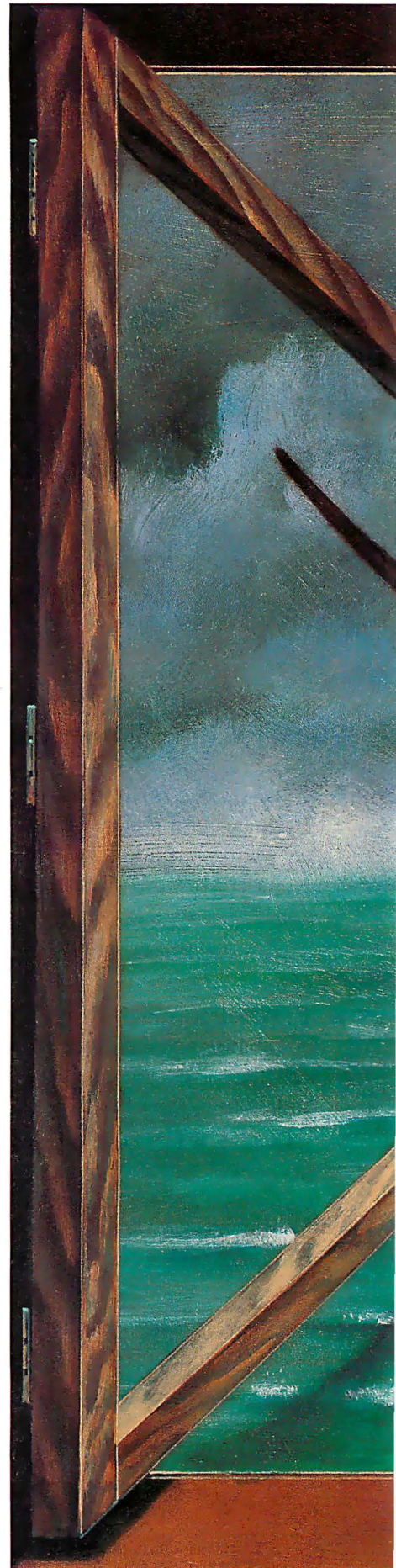
If you use predefined objects, you don't have to reinvent them each time a new service or application comes along. For example, in developing an application that uses word processing functionality, you can reuse the word processing objects.

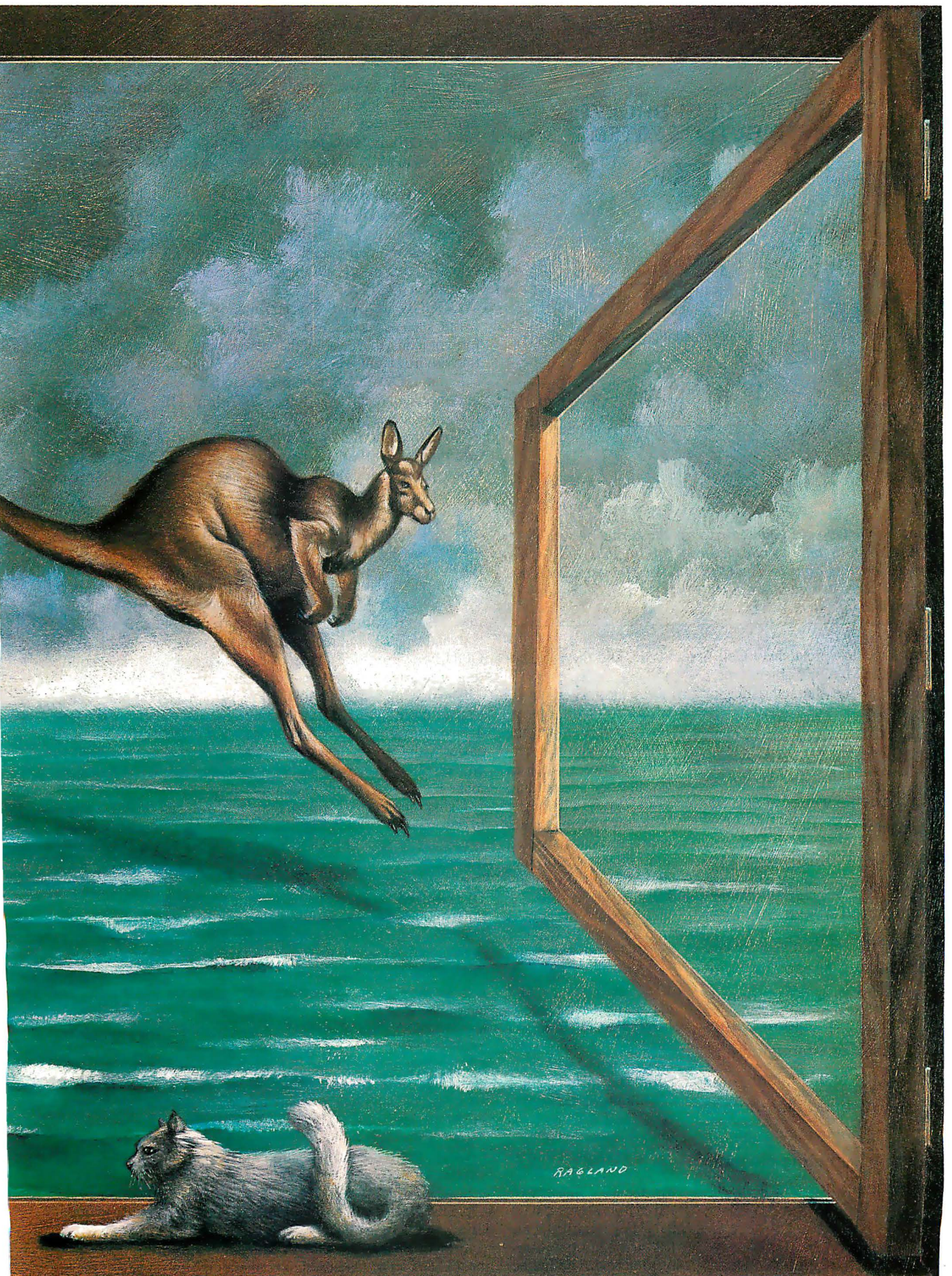
Reusability saves both design and development time and reduces the time to market for new products. In an object-oriented system, the software is modular in design, so the pieces are reusable.

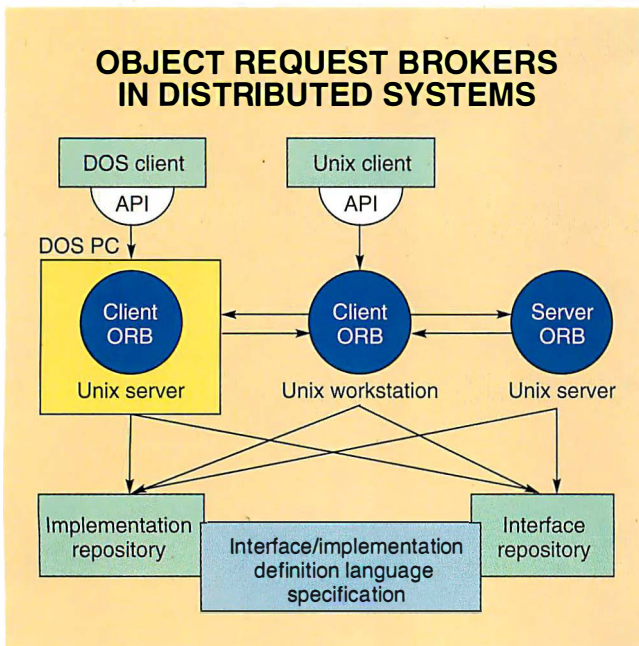
## What Is an Object?

Every component in an object-oriented system has data and operations that define it as a particular kind of object. For example, a workstation window, a spreadsheet cell, and a wolf can all be modeled as objects. Each object comprises certain information (i.e., the data) and can be used in certain ways (i.e., its operations).

Objects with the same data and operations are categorized into types. For example, the workstation window belongs to the Window object type, the spreadsheet cell







**Figure 1:** The Object Request Broker is the kernel of a standardized DOMS and provides interoperability and reuse of a system's existing objects. The ORB enables client applications to access services and other objects that exist anywhere in the distributed system.

belongs to the Spreadsheet Cell object type, and the wolf belongs to the Mammal object type.

Each type has characteristics, or attributes, associated with it along with the operations. For example, the Mammal type has certain attributes, such as circulatory system and skin type, while the Window type has other characteristics, such as menu bars, scroll bars, and up and down arrows.

Types are organized into a hierarchy that determines how operations and attributes are shared. Using the hierarchy, you can define a type broadly and then refine it into successively finer subtypes, each of which inherits the attributes and operations of its "supertype" and adds its own unique operations.

For example, Felines, Canines, and Marsupials are all subtypes of the Mammal type. These subtypes inherit the attributes and operations of Mammal. The Feline

subtype adds its own unique operations, such as Purr and Retract Claws, while the Canine subtype adds others, such as Bark and Hunt in Packs. The ability to inherit attributes and operations greatly reduces repetition within designs and programs, and it is one of the main advantages of an object-oriented system.

**Today's Classifications**

Object-oriented technology has provided three classifications of object-oriented systems that are in the marketplace today. They are object-oriented graphical user interfaces (OOGUIs), object-oriented databases (OODBs), and object-oriented programming languages (OOPLs).

OOGUIs are usually based on some metaphor from the real world, such as the desktop. The GUIs might include objects in the form of icons on a desktop that represent items contained in an office environment, such as a calendar, clock, wastebasket, and calculator. OOGUIs on the market today include the Macintosh interface, Microsoft Windows, OSF/Motif, DECwindows, Open Look, and others.

To perform actions, you select an icon with a mouse. The system then sends the icon operations, such as Move, Duplicate, Open, and Delete. These operations are separate from the actual icon itself and can operate on other icons (i.e., objects) in the system.

OODBs represent and manage objects and their attributes, relationships, and operations. OODBs also enable the creation of application-specific models of real-world constructs.

Complex systems that require actions among objects in the system's informational model may also find OODBs useful, as may systems with unstructured data requirements (e.g., voice, text, and video). Multiple applications can share these objects, and OODBs can provide many of the database facilities required (e.g., security, transactions, and recovery).

The driving force behind OOPLs is to make computers easier to use, more visual, more interactive, and easier to program. Translating applications specifications to actual code should be easier with OOPLs than it has traditionally been. Object-oriented modeling, designing, and programming provide the tools that make these goals easier to attain.

Using the object-oriented approach, you can model solutions to organization problems in a real-world way. Fewer trade-offs are necessary to accommodate systems, applications, and exceptions.

**Distributed Object Management Systems**

Pulling such diverse components together and managing their communications require some form of mechanism. Currently, each organization that produces and markets an OOGUI, OODB, or OOPL limits the number of platforms its object-oriented system operates on. In addition, these components usually don't interoperate with each other. A distributed object management system (DOMS) addresses this lack by providing the following:

- A single interface to manage the complexities of a heterogeneous environment
- A uniform framework, based on standards and extensibility, to build, integrate, and deploy open distributed-computing applications
- A method for creating location independence for client applications

A DOMS lets you build applications using a standardized interface while reusing the system's existing objects. With the advent of DOMSes, the Object Management Group (OMG; see the text box "The Object Management Group" on page 125) has

**BYTE ACTION SUMMARY**

Pulling diverse systems and applications together and managing their communications require some form of mechanism. A distributed object management system provides a single interface to manage the complexities of a heterogeneous environment; a uniform framework, based on standards and extensibility, to build, integrate, and deploy open distributed-computing applications; and a method for creating location independence for client applications.

# The Object Management Group

CHRISTOPHER M. STONE

**T**he Object Management Group (OMG) is unique. Let's face it, trying to get computer technologists and marketers to agree to a set of rules for the future of software development before economic entrenchment dictates direction is an anomaly.

Object technology was born in the basements of R&D labs and has long had their altruistic outlook stamped on it. "Objectphobia" has been a disease in the ranks of middle and upper management in vendor and user organizations for years. Object technologists were the ones invited to present their views on the last day of the conference at 4:30 p.m.

Armed with logic, mathematics, and analogies only a chemistry teacher could love, object technology suffered from a basic problem in the computer industry—too many people of above-average intelligence trying to prove its worth. The computer industry suffers from the tenet that theology and metaphysics are the 1000 points of light and that the consumers, or people that spend money, are all test sites.

## What Is the OMG?

The OMG is a technology-endorsement group, not a standards body. What we create may become de facto standards, but we are not accredited to enforce them. We don't sell software. We distribute a specification derived from commercially available technology that has been selected through an arduous, open, well-documented process in the hope that the membership and industry alike will clone it, develop to it, or buy source or binary code from an instance of it. In short, we set down rules for object technology that will make software development easier, reusable, modular, and high-quality.

Problems? Nothing evangelism won't cure. There is a fundamental problem found in any industry trying to lay down rules before money talks. The lack of applications interoperability is the problem. Period.

## The OMG Role

There is widespread agreement that the OMG is trying to move an entire industry toward the development of interoperable applications. There is not, however, agreement as to how this is to be done.

Like any democratic forum, the OMG needs the support and commitment of its membership. And as in other computer trade groups, jockeying for position is a recreational sport. The vendor and user communities have begun to put their trust and support behind Open Software Foundation, X/Open, and Unix International. Object technology needs to be raised to that level.

## Evidence: CORBA, Object Messaging

For the first time in the computer industry, the consensus on the early specification for a technology has become reality. Credit goes to Hewlett-Packard, Sun Microsystems, NCR, Object Design, DEC, and HyperDesk for reconciling what many had thought to be irreversibly warring factions—with the winners being the software development community.

Building the Common Object Request Broker Architecture (CORBA) by combining static binding with a dynamic application programming interface may appear to be like mixing OSF/I and System V together, but at OMG there is the willingness to try. OMG's mission from Day 1 was to foster cooperation and create industry consensus in advance of the market. In doing so, interface specifications could be agreed to early on without economic pressure.

The Object Request Broker (ORB) is the most significant new approach to software standardization since consortium forming came into vogue a few years ago. The process of selection that is used at OMG, although it is not entirely without flaw, has demonstrated that technical merit can overcome bureaucracy.

In essence, the work is being completed as OMG is helping to solve many of the discrepancies among other consortia, as we define applications development environments onto the consortium-driven standards. The CORBA will be a fundamental enabling technology for distributed computing for independent software vendors, end users, and standards groups alike.

## Next Step?

The next OMG test will involve the development of an object model that will describe the formalism of an object and its use in data management. There are academic and semicommercial object models everywhere that attempt to describe a specific function, such as managing devices in network management, but no single group has attempted to solve the whole problem: reaching an agreement on a data model with widespread applicability.

Just as we were confident that we could produce an ORB, we're confident that the OMG will produce an object model within the next six months. In addition, object services for languages, databases, document-content architectures, and windowing systems will also be starting shortly. Although we don't believe that this list of tasks can be completed in 12 months, it is the beginning of true sharing of libraries or objects among the development community and the eventual end user.

Detailed information concerning OMG membership, mission, and goals is available. Please contact Elizabeth Jewitt, Member Relations, OMG Headquarters, 492 Old Connecticut Path, Framingham, MA 01701, (508) 820-4300; fax (508) 820-4303.

*Christopher M. Stone is president and a founder of the Object Management Group (Framingham, MA). Prior to the founding of OMG, he was group manager and director of software products at Data General. You can reach him on BIX c/o "editors."*

sponsored the Object Request Broker. The ORB is the kernel of a standardized DOMS and provides interoperability (see figure 1).

The ORB enables client applications to seamlessly access services and other objects regardless of where they reside. To understand DOM more fully as the solution to open distributed computing, you need more technical details.

### The Technical View

In its simplest definition, an object would be the specific case (or instance) of a generalized software template. This template is just a mechanism for describing some entity. Its form is open-ended, so it's extremely flexible.

When a template layout is defined in the system, it's called a *class*. When the fields within that template are filled in with specific information, that instance or instantiation of the class template is an *object*. Therefore, a class describes the set of specific implementations or instances called objects.

For the purposes of this article, I'll assume that a class template consists of a set of attributes and a set of methods. Attributes can be simple data items like integers or character strings, or much more complex data like files (in these cases, the attributes are pointers to those items).

The methods can be anything from compiled subroutines written in a conventional programming language like C to code written in interpretive languages, or even to shell scripts. When these template fields are filled in with specific data, the template becomes an object.

### The ORB and DOM

The ORB represents the core of DOM. It can be viewed as a network operating system with one basic command, EXECUTE. The format of this command would be something like EXECUTE [object\_name, method, parameter1, parameter2, ..., parameterN].

The job of the ORB is to locate the named template (the object), start the specified operation (the method), and pass it the parameters it needs. Since objects can exist anywhere on a network, you can locate them via a name service or a unique identifier—a *handle*.

The ORB also needs to provide other capabilities associated with object-oriented systems. While these concepts have fancy names (e.g., subclassing, inheritance, and polymorphism), they are simple to understand in the context of the software class templates.

Subclassing is when you tell the system to make a copy of a template but give it another name. You can revise the behavior of any of the copied (i.e., inherited) methods and then add some new methods and attributes of your own; this is called *specialization*.

In specializing a template, you create a new version of the class—it is similar to the original class but different. It lets you take advantage of something previously developed, possibly for a different purpose, and modify it to suit the new function. This mechanism provides the reusability benefits of object orientation and promotes cost-effective software systems that are easier to develop, maintain, and enhance.

A variation on this theme is to substitute a different method but with the same name as one in the original template. Since methods are invoked by name, this allows you to leave your application unchanged yet still receive the benefits of the modification. This process is known as *overriding*.

The ability to override allows you to maintain a consistent interface while hiding the differences in implementation. This capability is called *polymorphism*.

Any object-based system needs to support these capabilities, as

well as an ORB. So how are they provided? Simply by including some primitive (root) templates (base classes) as part of the basic ORB. Built into these base classes are methods that provide the functionality of subclassing, inheritance, and polymorphism. In other words, you would use a command line like EXECUTE [base\_class\_name, subclass\_method, parameter1=new\_class\_name, ...].

Using the same EXECUTE command to invoke the subclass or substitute method now provides basic object-oriented functions. In fact, by adding more of these intrinsic operations to the base classes, you can continue to enhance the system's capabilities and make them available through the same simple interface mechanism.

These built-in objects are predefined classes, or templates, manipulated by the same basic interface. Since you can change or replace these classes, even the system's basic capabilities can be modified and extended.

This ability raises a couple of interesting questions:

1. If the base classes provide the basic object-oriented functionality and the ability to create, inherit, and override classes and objects, how do you create the base classes in the first place?

Have a bootstrap process that loads an initial set of classes. This process exists and is easy to use with something called the Interface/Implementation Definition Language compiler.

2. If you can redefine the system's basic functionality, how do you maintain compatibility?

Develop a standard for these basic functions and classes (the role the OMG is expected to play). The base classes and their object life-cycle methods are known as a *type repository*. For compatibility and true interoperability among different implementations of an ORB, a standard for these classes and methods must be created.

### Dynamic Integration

So now you have a mechanism for wrapping (or encapsulating) a template around any collection of data (attributes) and programs (methods) and treating it as a manageable entity called an object. And you have the first definition of a specific template format called a class, and all implementations of that template (with specific data and code filled in) called instances, or objects, of that class.

Data can be simple numbers or complex bit maps. Code can be compiled language modules (e.g., C) or interpreted scripts.

Objects have names and can be anywhere on a network using a name service. You can build complex client-server applications by creating servers that these templates describe, and clients can access these services by invoking their methods through the ORB.

If you build applications in this manner, you can move the pieces around easily, make changes to services without affecting the clients, prototype using files and scripts, and replace them with more efficient implementations using compiled code.

In addition, if you develop a class template, you should be able to modify or add new code without bringing the system down or affecting already-running applications. This is known as *dynamism*.

The system should be able to select which of multiple methods (with the same name) to use based on user preferences (whatever machine you're running on that day, language preferences, and other cultural or system preferences). This is referred to as *context-sensitive method binding*.

You (or the client application) should be able to ask the object to describe itself—its methods, the parameters required, and its attributes. Thus, by exploration, new capabilities and services can be discovered and used at run time. This is a capability of dy-



# News for small computer users: Blackout protection for just \$169!

## At last! A real-value Standby

BEST has made finding an SPS with real value easy. If you've made the decision that all you need is basic power protection, take a look at our new Patriot™ Standby Power System. Patriot, available in sizes from 250 to 850 VA, provides great performance at the lowest cost — just \$169!

## Blackout protection on a budget

Patriot offers reliable backup power. It's a new power protection solution from Best Power Technology, Inc., the world's leading manufacturer of single-phase UPS. Patriot features: **Exceptional lightning and surge protection.** Patriot passes ANSI/IEEE C62.41 Categories A and B tests. It also passes rigorous UL 1449 tests for surge suppression — few standbys can say this.

## Full-time EMI/RFI noise filtering.

Patriot filters electrical noise that locks up your computer and scrambles your data.

**High voltage protection.** Patriot steps in to prevent high voltage from damaging your computer. No other standby offers this feature.

**Output designed for computer loads.** Patriot's backup power is designed for switch-mode power supplies.

**Safe, assured transfer time.** Patriot transfers to inverter in four milliseconds or less. A proprietary microprocessor-controlled detection system ensures quick, reliable operation that keeps your system running during a power failure.

**Interface Port for LANs and multi-user systems.** Patriot has an interface port (450 VA model and larger) that



Users are surprised by Patriot, BEST's new real-value Standby Power System (SPS): maximum performance at a low price!

lets it trigger an unattended, orderly shutdown on many computer systems.

## Status indicator and alarms.

Patriot's two audible alarms and triple-mode status indicator light warn you of overloads and low battery runtime.

## The Double Lifetime Warranty

We're so sure Patriot stops any surge that we're offering an incredible Double Lifetime Warranty! It covers our surge suppression circuitry from failure as long as you own your Patriot. If Patriot ever fails to protect the equipment plugged into it from lightning, surges, or spikes, we'll replace it and repair the protected equipment. Certain restrictions apply. Ask for details.

## We're your Power Partner™

We've always been trendsetters in the power protection field. Now we're your total Power Partner, offering everything from advanced surge suppressors, to standby power systems, to on-line uninterruptible power systems, at prices you can afford.



Everything you need to choose the right power protection devices.

## Which Patriot fits your needs?

Patriot Model	Capacity (VA/Watts)	Runtime Full/Half Load	Dimensions (in inches) H/W/D	Weight (in lbs.)	Output		Price
					Receptacles Qty.	Type	
SPS 250B	250/170	10M/30M	7/5.5/11	18	2	5-15R	\$169
SPS 450B	450/300	5M/15M	7/5.5/11	21	4	5-15R	\$279
SPS 650B	650/430	5M/15M	7/5.5/16	25	4	5-15R	\$449
SPS 850B	850/600	5M/15M	7/5.5/16	30	4	5-15R	\$599

We can ship you a Patriot via UPS or Federal Express!

Express-order service

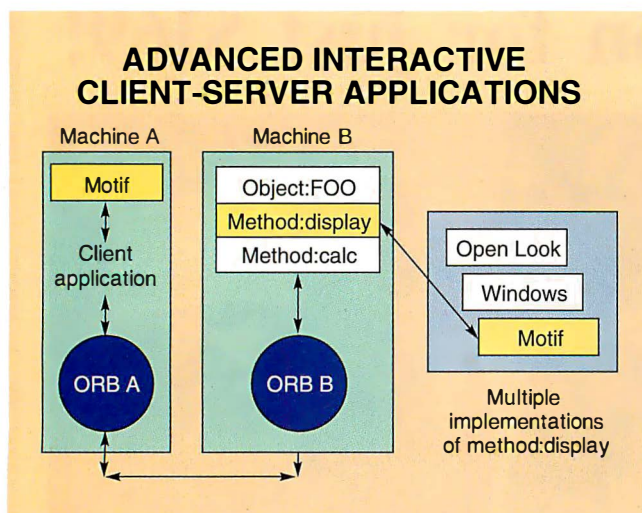
Order a Patriot now!

800-356-5794, ext. 3494

You'll receive a copy of our FREE "Guide to Power Problems." Learn to spot and solve your power quality problems.

**BEST**

Best Power Technology, Inc.  
P.O. Box 280 - Necedah, WI 54646  
Toll-Free 800-356-5794, ext. 3494  
(U.S.A. and Canada)  
Telephone (608) 565-7200, ext. 3494  
Telex No. 701934 (Best Power UD)



**Figure 2:** In this example of a client-server application, a client application is running on one CPU and operating system (machine A), with some additional object services (in this case, calculations) running on a different machine (machine B). The client application has discovered the object handle of object FOO. The implementation of FOO resides on machine B, and the calc operation is available for it. The client application issues a request to FOO for operation calc. The ORB on machine A routes the request to the ORB on machine B, which selects the correct method and returns the results to the client application. Next, the client application issues a display request for FOO, which is automatically routed to machine B, where the local ORB determines the display method required for display of FOO on machine A and returns the appropriate file to machine A for execution.

namism. And finally, all this software should be portable across different hardware, operating systems, and networks.

### DOM Examples

**Object queries:** Data-intensive applications (e.g., typical commercial on-line or database applications) require efficient query mechanisms to retrieve attribute information about a particular object or about every object in a group. Since the object types in a system must be able to change dynamically, the DOMS supports a query mechanism.

The DOMS's query mechanisms let you specify the attributes desired at run time instead of having to code their names into procedure calls. For example, if there are 50 objects of a certain type and the application needs five attributes from each object, one dynamically constructed DOMS survey call will return all the data.

**Legacy expansion:** DOMSes should at least provide mechanisms for building new applications. In addition, they should provide a mechanism for integrating previously existing applications and data. The encapsulation of existing applications and data as objects is known as *legacy expansion*.

One way to provide this functionality is through an encapsulation facility that uses interpreted scripts and languages. You need not write and compile code to encapsulate existing applications.

**"User-centric" applications:** Interactive, graphical application environments let you customize and adapt the software without programmer intervention. Such environments support incremental learning, discovery, change, and growth. This capability

will be required in future advanced desktops, office-automation systems, and workgroup applications.

The system must be able to accept modifications and the creation of "meta-applications" built of component objects without affecting either the client code or its own ability to remain operational during the changes. Yet the system must also protect all objects and prevent or restrict changes if security so dictates.

The ability to support user-centric applications is what differentiates a platform capable of dynamic operation from one that implements a CORBA (Common Object Request Broker Architecture)-compliant dynamic invocation to static functionality. The HyperDesk DOMS provides both dynamic invocation and dynamic operation.

**Advanced interactive client-server applications:** Applications need the ability to operate across a diverse mix of hardware and software platforms. For example, in figure 2, a client application is running on a particular CPU and operating system (e.g., a Sun Sparcstation with SunOS and Motif) with some object services (maybe a CAD object) running on a different machine (e.g., a Cray supercomputer). This type of applications architecture requires calculation services from objects and mechanisms to display the results of those calculations.

Using a DOMS, it's easy to separate the object's operations into those that are display-independent and those that are display-dependent. Moreover, once this separation is made, the system's knowledge of the client context makes it possible for the ORB to select the correct display method. This eliminates the need to write environment-specific code.

In this example, the ORB determines that the appropriate display method is for the Motif environment on machine A and returns a Motif user-interface-description file to machine A for execution. The class-definition object can have multiple display methods stored with it. For instance, it can have one for each display environment (e.g., Motif, Open Look, and Microsoft Windows).

### Software Without Walls

To create the type of open distributed computing described here, you need a complete DOMS with an advanced suite of tools and services that complements an OMG-compliant ORB. A complete DOMS bridges the operating-system, applications system, and communications protocol void that exists today and enables you to bring applications and systems together into a cohesive unit.

Some of the advantages of a complete DOMS are as follows:


- Your organization can retain its existing hardware and software assets while integrating new applications and solutions easily and seamlessly.
- You can take advantage of the extensibility and reusability of objects to cut down development time and deliver distributed applications more easily.
- You can integrate existing applications economically. Even large legacy applications written in COBOL or FORTRAN can be encapsulated within a single object, preserving past software investments.

With DOM, building and integrating open distributed applications is practical. You can gain simplified access to information, wherever it is—giving your company a competitive advantage. Software without walls is no longer a promise; it's a reality. ■

*Herbert M. Osher is president of HyperDesk Corp. (Westborough, MA), which develops distributed-computing software based on object management technology. You can reach him on BIX c/o "editors."*

# WE CHANGED THE SHAPE OF COMPUTING...

We put the best features of your favorite  
computer into a keyboard.



**B**efore KNS  
(Keyboard Network  
Station), when you  
purchased a computer  
system, the manufacturer  
threw-in the keyboard. Now,  
when you buy a KNS keyboard,  
we'll throw-in the computer.

And what a computer! Choose from  
286 and 386SX models in a variety of CPU  
speeds. Specify up to 4MB of RAM. Your KNS  
comes standard with Super VGA adapter, 3.5"  
floppy disk drive, 2 serial ports, 1 parallel port and a  
16-bit expansion slot—all housed in a lightweight,  
portable, AT-style keyboard.

A network interface card can be installed in the built-in 16-bit expansion slot; installation is  
quick and easy. And, KNS is compatible with most popular network operating systems.

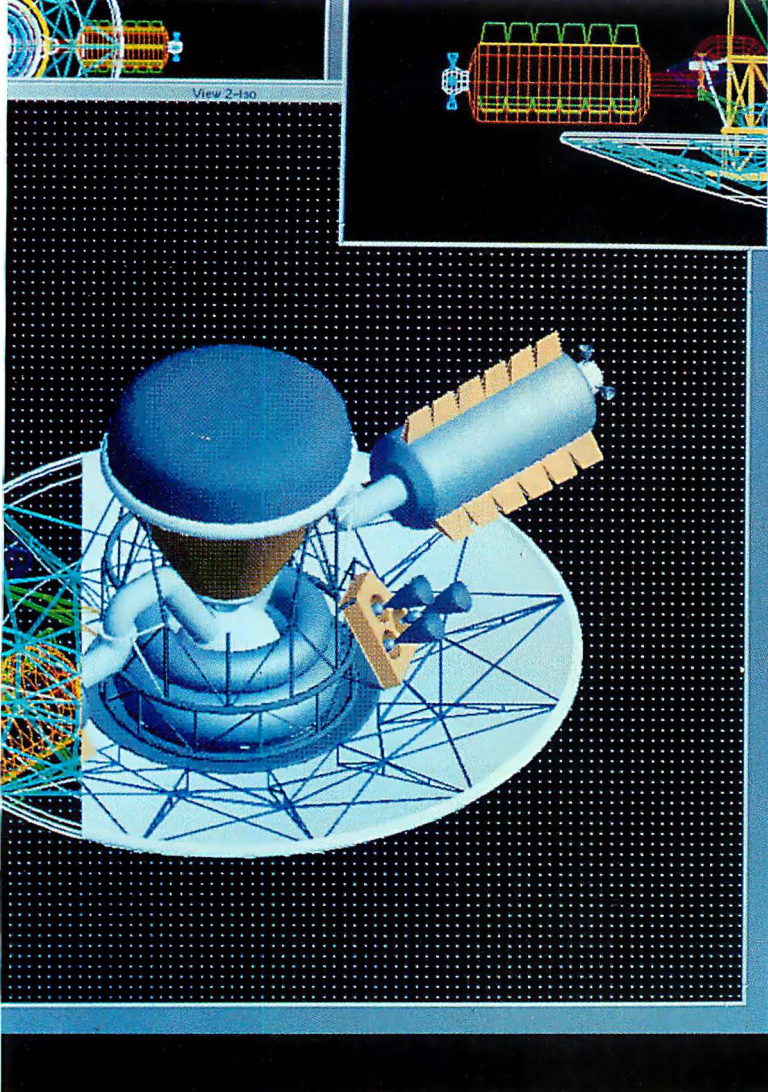
We changed the shape of computing and the KNS will change the way you add workstations  
to your network.

**"ULTRATEK—Everything for the LAN Builder"**

**ULTRATEK Products, Inc.**

Distributed by: AIC (U.S.A.) • (714) 894-1675

AIC (U.K.) 081-961-9661



# Come A Little Closer



T560i

Yes, it displays images that crisp. Yes, it does conform to the strict new Swedish MPR II and TCO guidelines, the world's toughest VLF and ELF emission standards. Yes, it does have an *intelligent* front control panel. Yes, it is a NANA O monitor. And the closer you get, the better we look.

Take a close look at the increased clarity and brightness of Trinitron technology through graphic applications such as CAD, Desktop Publishing and Windows, and see their true colors.



T660i

With flicker-free 1280 x 1024 ultra high resolution and .26mm trio pitch, the 17-inch FLEXSCAN T560i gives you more work space without sacrificing desk space. For those who prefer a larger work area, the FLEXSCAN T660i's 20-inch screen size is ideal.

With the innovation and ergonomics of NANA O's FLEXSCAN T-Series monitors, no other monitor can come close. That's why the

T560i won the **1991 BYTE AWARD OF DISTINCTION.**



Take a closer look at your nearest NANA O dealer today, or for more information call NANA O.

## NANA O

**1-800-800-5202**

1-310-325-5202 (CA)

Fax: 1-310-530-1679

Trinitron, Windows and FLEXSCAN are trademarks of their respective companies. "Satellite" graphic images created by Jerry D. Flynn, Design Engineer, Cocoa Beach, FL. "Lunar Landing" created by Design Visualization Group, McDonnell Douglas Space Systems Company

**Circle 84 on Inquiry Card (RESELLERS: 85).**

# System Bus or System Bottleneck?

Whatever happened to EISA and the Micro Channel?

TREVOR MARSHALL

**I**BM has taught us that compatibility is the single most important attribute for a mass-market bus. Without compatibility, there is no incentive to produce the innovative, third-party peripherals that have largely determined what we can expect for today's personal computers.

The second most significant characteristic is speed. The bus must be fast enough to transfer data from modern high-speed peripherals to the host CPU with no noticeable degradation in system performance.

The original IBM XT was shipped with a very limited 8-bit expansion bus. It was not long before add-in cards started to tax its capabilities, so, with the release of the IBM AT, this 8-bit bus was widened to 16 bits and increased functionality was added. This created a clumsy (but standard) protocol now dubbed Industry Standard Architecture (ISA).

Four years ago, IBM announced with great fanfare that it had created the most advanced bus a desktop computer would ever need. It was called the *Micro Channel*. Soon after, a consortium of IBM competitors announced its own "perfect" bus, dubbed EISA (for Extended ISA). Both of these buses were claimed to be extensible, to have much higher performance than ISA, and to be its obvious successor.

Yet despite the claims (and hopes) of both EISA and Micro Channel promoters, neither architecture has managed to take a significant share of the market. Less than 5 percent of PC-compatible machines sold worldwide use the EISA bus. The remainder are mostly still ISA (AT-bus) compatibles. The Micro Channel has made an impact, but primarily in applications where bus speed is not a factor, such as point-of-sale terminals and data-entry stations. Consequently, the volume of Micro Channel add-in boards sold is still small.

## Mastering the Buses

The XT bus was designed to complement a 4.77-MHz 8088 processor. It did that job well, delivering adequate transfer speeds for the add-in adapters of that day.

By the time the AT was released, it was becoming evident

that microcomputers were soon going to catch up with the performance of the minicomputers and mainframes that still dominated computing. Consequently, the designers of the AT enhanced the XT bus by adding more DMA channels, more interrupts, and, most important, a 16-bit data bus. And they did this while retaining downward compatibility with the XT bus.

The AT bus proved adequate for the types of add-in adapters needed to complement the performance of an AT-class machine. The bus structure was reverse-engineered, multisourced, and dubbed the ISA bus.

Both the Micro Channel and EISA designers sought to overcome some of the limitations remaining in the ISA design. First, they provided a 32-bit data path to match the newly emerging 32-bit processors, such as the 386 and 486. Second, they paid a lot of attention to increasing the data transfer rates by more tightly specifying the bus transfer protocols. Third, they gave both buses considerable capability to support multiple bus masters.

A bus master is another, usually peripheral, processor that plugs into the bus yet can access the host processor's memory and usually all the system peripherals as well. You need bus-master capability if your system is going to support intelligent drive controllers, such as those used in high-end

## BYTE ACTION SUMMARY

What does bus mastering have to do with EISA and the Micro Channel? A bus master supports intelligent drive controllers, image-processing functions, and a host of other leading-edge applications. It can transfer data from a peripheral card without affecting the CPU control program. EISA and Micro Channel both permit such concurrent processing;

# Signals on the Wire

A transmission line is a wire down which a signal from the CPU propagates to a peripheral. The simplest case, where only resis-

tive terminating elements exist, is shown in figure A (see reference 1).

A 5-volt source with a series damping resistance of  $Z_0/4$  ohms ( $Z_0$  is the

characteristic impedance, typical of most printed circuit board conductors) feeds the bus wiring. A typical  $Z_0$  on a printed circuit board is 50 to 150 ohms (see reference 2). The peripheral terminates the bus with an effective resistance of  $5 \times Z_0$  ohms.

Due to the loss in these resistances, only 4.7 V of the 5-V TTL high level that the CPU generates will be available to drive the peripheral. Because of signal reflection, you can't decrease the series resistance to transfer more energy along the bus.

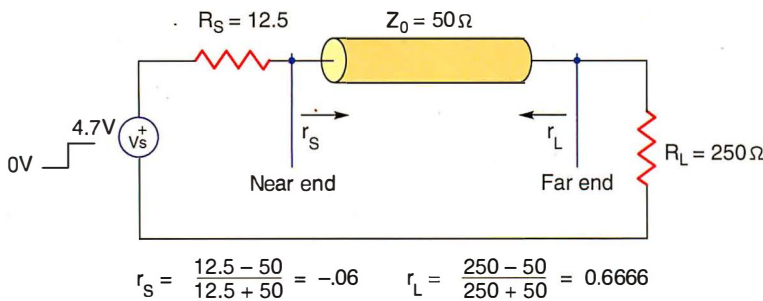
Consider an 8-inch bus. When the CPU's signal reaches its far end, some of the energy is reflected to the source, giving rise to a theoretical waveform (see figure B). The voltage on the bus oscillates around the final value. If the oscillation grows too great, it exceeds the threshold value at which a logic device (e.g., a bus receiver) is triggered to change state. The receiver may then change its output value based on a false input generated by circuit ringing. Usually, the circuitry will fail to work properly, but sometimes the system can read the false value as a valid bit. In the real world, there is capacitance, not just pure resistance, to drive.

Figure C is an early ISA clone's system clock (pin AXX) measured at the end of the bus. The signal badly overshoots the 0-V level and, in fact, reaches a negative voltage of about -3 V. Then the signal "rings" back to a level of about 0.8 V, causing most logic gates to malfunction.

On the positive transition, almost no overshoot occurs, although the peak voltage is only 3 V—much less than the theoretical 5-V maximum. The difference is due to an asymmetrical driving impedance.

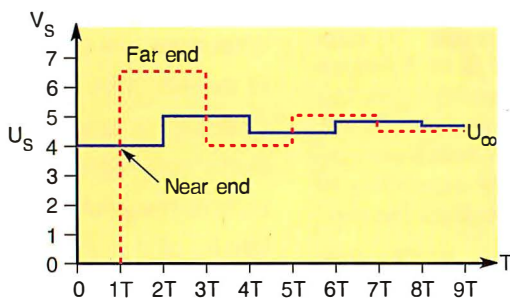
The designer of the bus in figure C mistakenly used a very fast buffer device (a 74F245) to drive the clock

## A TYPICAL TRANSMISSION-LINE BUS STRUCTURE



**Figure A:** The electrical model of what seems like a simple line of copper on a circuit board. The input signal (in this case, a typical 0- to 4.7-V logic transition) is modeled as the voltage source ( $V_s$ ) for the transmission line. It must drive not only the relatively docile loads of pure resistance ( $R_s$ , the source resistance, and  $R_L$ , the load resistance) but also the more difficult reactive components  $Z_0$  (characteristic impedance of the transmission line),  $r_L$  (normalized impedance of the load), and  $r_s$  (normalized source impedance).

## WAVEFORMS AT NEAR AND FAR END OF BUS



**Figure B:** A logic transition occurs at the near end of a bus at time 0 and arrives at the far end at  $1T$ , with significant overshoot. The overshoot propagates back to the near end and changes the voltage there. The reflections travel up and down, decreasing, until at  $8T$  the bus settles near its final logic level.

network servers. It is also useful in many industrial applications, such as image grabbing and image processing.

The ISA bus can only support bus masters if they are set up as DMA controllers. This limits the data throughput to around 1.5 MBps. In addition, the host CPU is usually halted during any bus-master transaction.

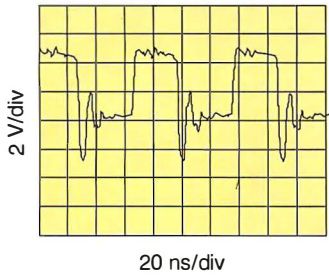
A bus master should be able to, for example, transfer data

from another peripheral card without affecting the control program running on the host CPU. EISA and Micro Channel both permit such concurrent processing; ISA does not.

### Speed Limits on Buses

The speed of light limits how fast signals can propagate down a bus structure. But today's buses operate nowhere near this

## CLOCK WAVEFORM FROM A POOR PC CLONE



**Figure C:** This oscillograph is taken from an early ISA clone. It shows the system clock (pin AXX) measured at the end of the bus and severe overshoot.

directly, without any series-damping resistor. The output impedance of this buffer (which should be greater than  $Z_0/2$  to control overshoot) is extremely low when the signal goes from high to low (the *pull down* cycle) but fairly high when the signal goes from low to high (the *pull up* cycle).

If a slower logic gate had been used, the designer would have achieved faster system operation overall, less overshoot would have occurred, and the final voltage would have been achieved more quickly. This is what happens on the positive side, which is only half as fast as the negative. On the negative side, the signal achieves the steady-state level almost instantaneously.

The oscilloscope time base was set for one horizontal division every 20 nanoseconds with the CPU speed at 50 MHz. So, here is a bus where one handshake transaction would make a mod-

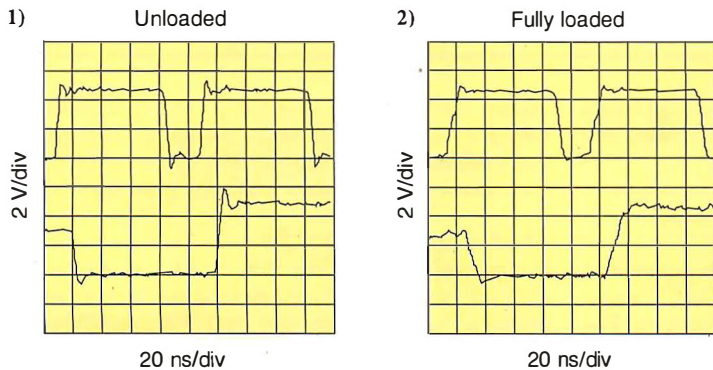
ern CPU wait almost a full cycle for it to complete. ISA, Micro Channel, and EISA buses require at least three transactions in every bus transfer cycle.

In an optimally designed system, these transactions occur much faster. Parts 1 and 2 of figure D are taken from a Mac IIfx NuBus. Part 1 was taken at the far end of the bus, with two cards (the test card and a video card) plugged in. A little overshoot exists, but not enough to cause logic to malfunction. The rise and fall times of the signals are fast, and the ultimate signal levels are close to 0 and 5 V. The two signals shown are the system clock and start.

Part 2 was taken under the same conditions, but this time with every bus slot filled. The extra loading that the four additional peripheral cards impose has reduced the rise and fall times, and the overshoot and settling are insignificant compared to transition times. This performance is typical of a bus designed using today's best technology.

So, the fastest time in which a transaction can occur seems to be 10 ns; 20 ns would be safe. So you can expect an ISA, EISA, or Micro Channel bus to manage one transaction every 30 to 60 ns using interface chips like the IIfx's. Thus, even the fastest bus transaction will take between one and two instruction cycles on a 33-MHz CPU.

## MAC IIFX NUBUS OSCILLOGRAPHS



**Figure D:** (1) An oscillograph taken at the far end of a Mac IIfx NuBus, with just two cards (the test card and the video card) plugged in. A small amount of overshoot is present, but not enough to cause logic to malfunction. The rise and fall times of the signals are quite fast, and the ultimate signal levels are very close to 0 and 5 V. (2) Another measurement from the far end of a Mac IIfx NuBus—but this time every slot on the bus has been filled. The rise and fall times have now been reduced by the extra loading of the four additional peripheral cards, and the overshoot and settling are insignificant compared to the transition times. This performance is typical of a bus designed using the best technology available today.

*Editor's note: All oscillographs reproduced here are 20 ns per division horizontally and 2 V per division vertically. Equipment used for testing bus signals was as follows: oscilloscope—500-megasample-per-second Fluke digital scope; probes—100x resistive probes, 1500-MHz bandwidth, Philips PM8912.*

### REFERENCES

1. Arabi, Tarif. National Semiconductor Application Note 707.
2. Jordan, Edward, ed. *Reference Data for Engineers: Radio, Electronics, Computer, and Communications*, 5th ed., pp. 22–25. Indianapolis: Howard Sams, 1985.

fundamental limit, do they? On the contrary.

An electrical signal travels down a *perfect* bus at about 7.86 inches per nanosecond. A 33-MHz CPU executes instructions as fast as one every 30 ns. Thus, if this CPU sent out a request on a perfect bus to a perfect peripheral, you would lose one complete computational cycle for every 20 feet the signal had to travel. Naturally, in our *imperfect* world, things are much worse. To

comprehend the fundamental performance limits for buses, you need to understand something about transmission-line theory (see the text box "Signals on the Wire" on page 132).

Since bus physics fundamentally limits bus speed, the only easy way to improve the data transfer speed is to increase the width of the data bus (i.e., the number of data bits that can be exchanged for each set of bus transactions) or decrease its length.

*continued*

# Compatible May Not Mean Easy

I recently tried to install one of the new low-cost fax-modem cards into a Hewlett-Packard 486 EISA-based computer. The EISA bus is compatible with ISA, right? So you just plug in the ISA card and it should work, right? Wrong.

I plugged in the fax card and installed the BitFax software as described in the manual. When I ran the program, it informed me that no fax card was present.

A check of the manual showed that all the DIP switches were set correctly for COM3, so there shouldn't have been any clash with the hardware already installed in the computer. Then inspiration struck me. I remembered seeing a press release about EISA doing away with the need for "complex" DIP switches and replacing them with a set-up program. Referring to the HP man-

ual confirmed that the EISA machine would not recognize the ISA add-in card until it had been "installed" and that I would need an Adapter Configuration File from the add-in's manufacturer before the EISA bus could recognize the fax card.

I borrowed a copy of the EISA Programmers Reference Manual from HP and, over the course of an hour or so, learned yet another programming language, wrote the Adapter Configuration File, and got the fax card up and running. A call to HP technical support later revealed that HP could send me a file containing a set of common adapter descriptions. If a card is sufficiently similar to a "common" adapter, then that file would have worked.

But why? Why couldn't I just plug the card in and have it work?

From day 1 of the IBM announce-

ments, I had fully understood the proprietary nature of the Micro Channel bus. It was obvious that if I chose to go the Micro Channel path to higher performance, I would have to buy specialized adapter cards, there would be fewer sources for them, and they would be more expensive. But I never anticipated that EISA would have similar barriers to the free-market economics that have made personal computer technology such a success.

Luckily, now that third-party (clone) vendors are starting to ship EISA machines, software has been written to ease the installation task. Most clones now ship with installation software that scans the bus, looking for I/O ports and memory maps that it recognizes, like the COM ports on a fax adapter. If you have a nonstandard peripheral, however, you are still out of luck.

With today's driver technology, a 32-bit bus can achieve a data rate of about 60 MBps, a 16-bit bus can reach about 30 MBps, and an 8-bit bus can attain about 15 MBps.

The PCXI Consortium has been formed to define a variant of the EISA bus that is better able to serve the needs of scientific, engineering, industrial, and other power users. It has extra undefined pins capable of carrying signals between cards on high-speed local buses. These pins can also be used to carry Data Translation's (Marlborough, MA) DT-Connect bus architecture. The DT-Connect bus can transfer data at a rate of 100 MBps using standard 74FCT bus-driver ICs.

## Bursts and Streams

To reduce the number of signal transactions needed per data transfer, you would use so-called *burst* or *streaming* data modes. The data rates that the Micro Channel and EISA promoters quote, 40 MBps and 33 MBps respectively, are possible only with data streaming.

The problem is that for data streaming, the data needs to be of a continuous nature. Data from a drive controller is often continuous. But the speed of data being sent to a video card is more likely to be determined by CPU processing speed, and the data's transfer is usually performed in the slower single-transaction modes.

For example, a typical 8-bit ISA bus achieves a data rate of only about 1 MBps in practice—10 percent of the theoretical maximum. Its primary limitations are the response time of the cards in the bus and the nature of the motherboard logic, which uses wait states to slow down the bus to synchronize with its own internal response times. These limitations apply equally to wider buses and to EISA and Micro Channel implementations.

I recently checked the relative speeds of a 16-bit Ethernet

adapter card and an 8-bit version of the same product. The 16-bit card provided only a 20 percent performance improvement. You don't need to use an advanced EISA system when the primary limitations are still processor- and network-related.

## The Compatibility Factor

Compatibility among the ISA, EISA, and Micro Channel systems implies, at least, that software designed to run on ISA machines will run the same way on EISA and Micro Channel systems. By and large, this has proved to be true.

In addition, compatibility implies that you can expect hardware designed for the Micro Channel to run in any Micro Channel machine and, similarly, EISA-designed hardware should run in any EISA machine. EISA promoters also claim that ISA adapter cards will run in an EISA machine (see the text box "Compatible May Not Mean Easy" above).

However, some problems have occurred that have delayed achieving compatibility within Micro Channel systems. The early interface chip from Chips & Technologies (the 6311) worked fine in the IBM PS/2 Model 50, but it did not work well with the later Models 70 and 80 because the IOCHRDY signal operated incorrectly (see the text box "Which Micro Channel Is It?" on page 136).

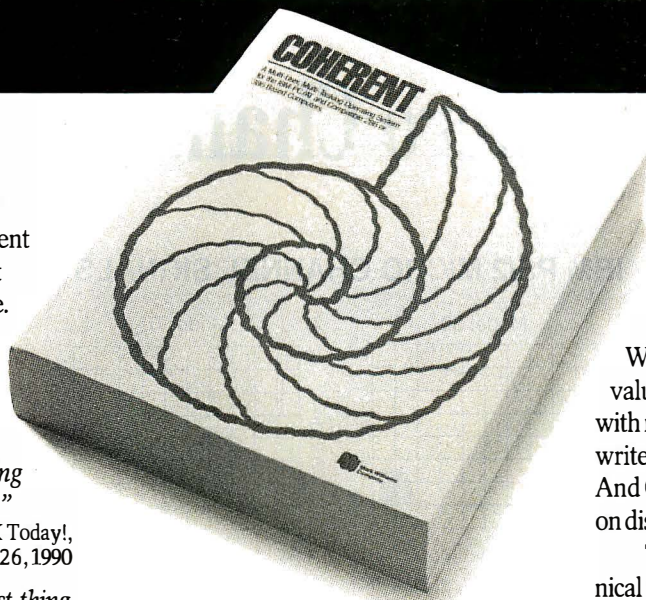
Thus, some manufacturers who embraced the Micro Channel early in its development had to redesign their Micro Channel products at an early stage in their life cycle. Not only did this reduce the number of available adapters, it also increased their cost. But these early problems have been overcome, and both Micro Channel and EISA have now achieved the levels of hardware compatibility expected of them.

However, with the RISC System/6000 series of RISC workstations, IBM introduced a Micro Channel with a larger physical



# "I can't believe it's not UNIX."

—Sean Fulton, UNIX Today!



Take it from the critics, Coherent is so close to UNIX, you won't believe your eyes. Or the price.

*"Mark Williams Co. seems to have mastered the art of illusion; Coherent comes so fully qualified as a UNIX clone, you find yourself thinking 'I can't believe it's not UNIX.'"*

—Sean Fulton, UNIX Today!,  
November 26, 1990

*"...(Coherent) may be the best thing that has happened to UNIX yet."*

—William Zachmann, PC Week,  
November 5, 1990

*"If you want to come as close as you can to real UNIX for a low price, COHERENT can't be beat."*

—Warren Keuffel, Computer Language Magazine, November 1990

*"If you want a UNIX-like development and learning system for less than \$100...I don't see how you can go wrong with Coherent."*

—David Fiedler, BYTE Magazine,  
November 1990

## OVER 30,000 USERS, AND MORE EVERY DAY!

Why is Coherent now the world's best-selling UNIX clone?

	MWC COHERENT Version 3.2	SCO XENIX 286 Version 2.3.2.
No. of Manuals	1	8
No. of Disks	5	21
Kernel Size	64K	198K
Install Time	20-30 min.	3-4 hours
Suggested Disk Space	10 meg	30 meg
Min. Memory Required	640K	1-2 meg
Performance*	38.7 sec	100.3 sec
Price	\$99.95	\$1495.00

\*Byte Exec benchmark, 1000 iterations on 20 MHz 386.  
Hardware requirements: 1.2 meg 5¼" or 1.4 meg 3½" floppy,  
and hard disk.

## NEW RELEASE 3.2

# \$99.95\*

Because like the original UNIX, Coherent is a powerful, multi-user, multi-tasking development system with a complete UNIX-compatible kernel and C compiler.

Features include Lex and Yacc, a vi editor, SCSI support and UUCP capabilities.

And Coherent comes with a full set of over 200 UNIX commands including text processing, program development, administrative and maintenance functions. All of it fully documented in our highly acclaimed 1200 page manual.

### WHAT UNIX WAS MEANT TO BE.

Unlike current versions of UNIX, Coherent is lean and efficient. Small and beautifully powerful, the way UNIX was originally designed.

Coherent runs on affordable 286 as well as 386 and 486 based IBM-PCs and compatibles with space to spare. Enough space to keep DOS co-residing on your hard disk.

And it's so fast to install, so fast to learn and just so fast, Coherent leaves UNIX in the dust.

### HARD TO BELIEVE? IT KEEPS GETTING BETTER.

Like Coherent, all Mark Williams products are incredible values. Including regular updates with new and enhanced features. Our write-your-own device driver kit. And COHware, contributed software on diskette.

There's also on-going free technical support via telephone. An active user network and a UUCP Bulletin Board System. Plus, with our new 3.2 release:

- A new Korn shell with sophisticated command-line editing.
- Postscript and PCL support for troff adding access to hundreds of new fonts.
- Improved UUCP support.
- International keyboard and character set support.

### TAKE 60 DAYS TO CONVINCE YOURSELF

Will you agree with the critics and Coherent's 25,000-plus users?

Try it. And if you don't think Coherent is everything you ever wanted in UNIX, we'll refund your money. No problem. No hassle.

You can't go wrong. So get to a phone, FAX or mailbox now and order Coherent today. At \$99.95, it's unbelievable.

## 1-800-MARK WMS

(1-800-627-5967 or 1-708-291-6700)

FAX: 1-708-291-6750

60-DAY MONEY BACK GUARANTEE!



**Mark Williams  
Company**

60 Revere Drive  
Northbrook, IL 60062

\*Plus shipping and handling. Coherent is a trademark of Mark Williams Company. UNIX is a trademark of AT&T. XENIX is a trademark of Microsoft.

**Distributors:** Australia (07) 266-2270, Czechoslovakia 632-62877, Denmark 42-88-72-49, Finland 47-871-201, France (1) 46-72-80-74, Germany (0511) 53-72-95/(030) 313-7015, Norway 211-0950, Singapore 336-0188, Sweden (0) 660-192-90.

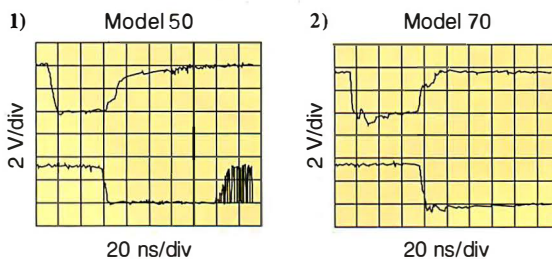
# Which Micro Channel Is It?

Not all Micro Channel implementations are the same, even when they are from IBM. Figure A shows two oscillographs; part 1 was taken from an IBM PS/2 Model 50, and part 2 from an IBM PS/2 Model 70. The two waveforms, ADL (Address Latch) and CMD (Command), are supposed to delineate two different phases of the transaction cycle.

Notice that on the Model 50 the waveforms actually overlap. While the same waveforms on the Model 70 look more like the data book says they should, the quality of the signals on this bus is still nowhere near as good as those on the Mac IIfx's NuBus (see the text box "Signals on the Wire" on page 132).

Peripheral designers have to design cards that will work

## IBM PS/2 MICRO CHANNEL SIGNALS



**Figure A:** (1) is from a bus measurement in an IBM PS/2 Model 50, and (2) is from a test of an IBM PS/2 Model 70. The two waveforms represent measurements of the address strobe (upper trace) and command strobe (lower trace) lines and are supposed to show two distinct phases of the transaction cycle. Notice that on the Model 50 the lines actually overlap, causing a period of uncertainty that add-in card manufacturers can handle by building in bus-settling delays when designing Micro Channel cards. While the same waveforms on the Model 70 look more as they should, the quality of the signals on this bus is still nowhere near as good as that of those measured on the NuBus of the Mac IIfx.

in all machines, both slow and fast. The only way to ensure this compatibility is to avoid the use of the advanced features that are available only on faster bus implementations.

Therefore, an add-in card designer has to use logic slow enough to accommodate the timing variations seen on the Model 50, instead of designing a card that will be upgradable to the 160-MBps peak Micro Channel data rate.

For the RISC System/6000 series of workstations, IBM introduced another version of the Micro Channel architecture, this one allowing for the use of larger option cards. The workstation version of the Micro Channel began as a 32-bit-wide bus, but there are plans to upgrade it to a 64-bit-wide revision supporting block transfers.

card size (it is now almost as big as an AT ISA card) and new, higher-speed, burst-transfer modes. So is the Micro Channel add-in you are buying PS/2 Micro Channel-compatible or RS/6000 Micro Channel-compatible?

### Why Buy ISA Machines Now?

EISA and Micro Channel machines are still considerably more expensive than their ISA counterparts. Part of this difference is due to how much the EISA chip set costs the computer manufacturer. The other part is due to a recognition that an EISA machine won't sell as well as an ISA system will. In addition, only Intel currently ships an EISA interface chip. It is expensive compared to the ISA chips, which are available from a number of vendors.

In return for the higher price of the EISA and Micro Channel systems, greater levels of system performance are expected. But in actual use, this expectation has often not been met. Meanwhile, many designers have found a better way of increasing system speed: close coupling.

### Close Coupling

RAM is the most speed-critical resource that a CPU needs. To improve system speed and bypass bus limitations, you can closely couple the main memory system to the CPU over its own dedicated bus.

Although the original XT had only 64K bytes of closely coupled (motherboard) memory and needed add-in memory cards to

run any significant software, most computer systems sold today have several megabytes of high-speed, closely coupled memory on the motherboard. Add-in memory cards are rarely needed. Thus, bus-speed limitations no longer affect the CPU's ability to obtain data quickly from its main memory.

### Local Intelligence

The same design methodology is now being applied to all the subsystems that make up a computer system. Vendors often claim that you need a fast bus for faster video (for applications such as multimedia). But as Nick Baran warned (see "The Bus Stops Here," February 1990 BYTE), none of these expansion buses really has enough raw bandwidth to directly transfer pixels at the rates needed for real-time video displays.

Peripherals need more local intelligence to off-load some of the host CPU's computing tasks. This is already happening in two areas: drive controllers and video display cards. The data rate of the ISA bus is slower than that of many modern hard disk systems. However, if you mount a memory cache on the drive controller, it acts as a buffer between the disk data rate and the bus data rate.

Even though the disk speed of the original AT computers was limited to around 260 KBps (the 2-to-1 interleave data rate), most controllers now operate at the 500-KBps rate of 1-to-1 interleave disks. The data from a whole track is stored in memory on the drive controller. It is then available when the host CPU is

# Who says a good idea can't be rushed?

Maybe we can't speed up your creative juices. But we can speed up your output. And free up your computer quicker than before.

All with the new ColorPoint PSX color printer.

Besides being PostScript language compatible, it comes with a faster chip, a bigger memory and a new memory management scheme.

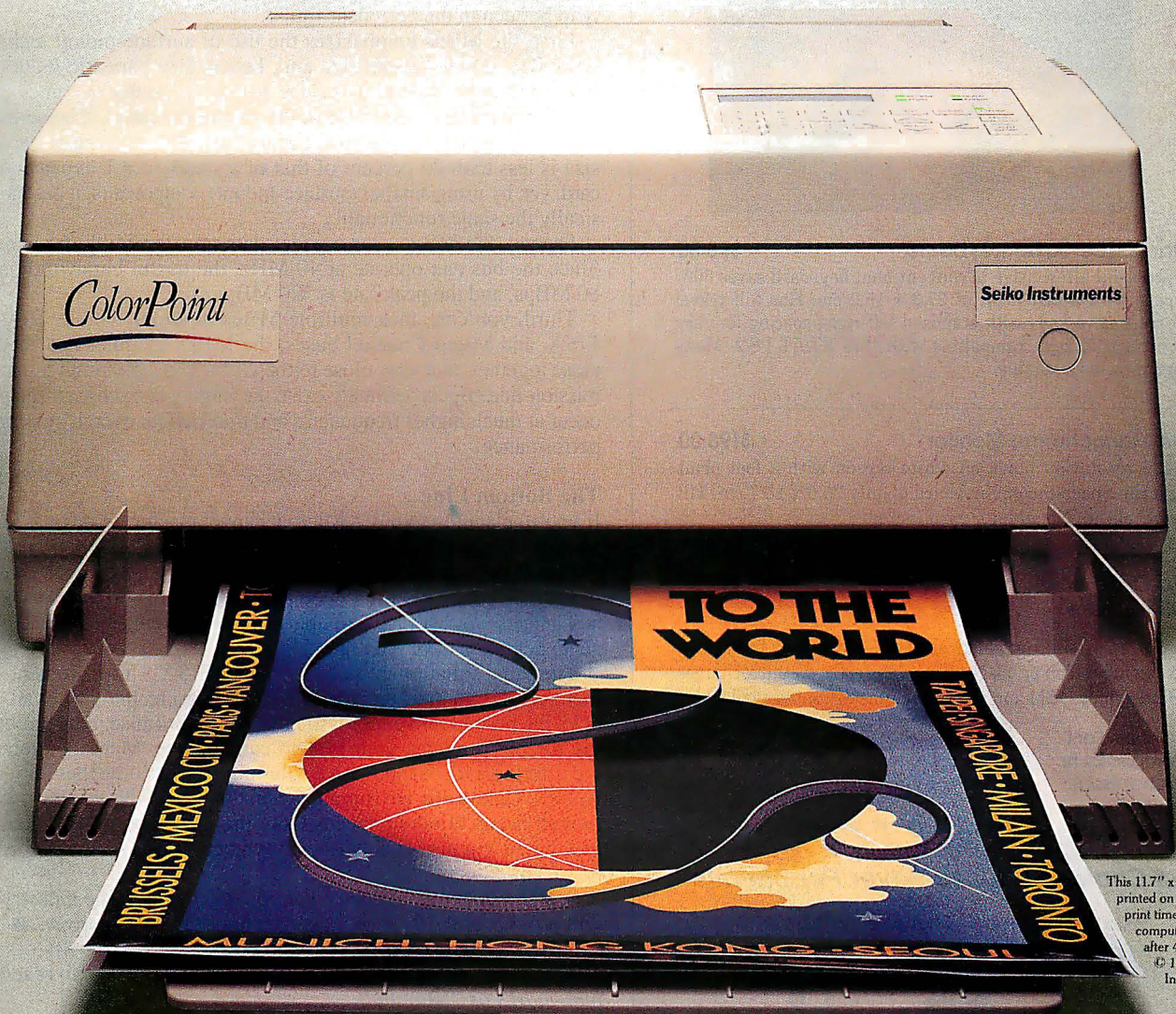
Which, in English, means it'll 'remember' your entire job — not to mention everyone else's. As well as process one image while printing another.

Call 1-800-873-4561, dept. SI-J6, to find out more.

About how your good — no, great — ideas can be rushed, after all.

Introducing the ColorPoint PSX printer. **SII**

Seiko Instruments



This 11.7" x 17.1" image was printed on the PSX. Total print time just 5 minutes, computer free to use after 49 seconds. © 1991 Seiko Instruments.

# Space - Savers

NEW



## Stand-Alone LCD Monitor **\$995.00**

This 10" black on white monitor is easy-to-read, yet compact. Resolution is 640x480 for sharp, flicker-free image. Sharp's high refresh rate, triple supertwist nematic technology with back lighting provides a super bright, low radiation screen with a wide viewing angle. The adjustable monitor base is only 29x14 cm. It lets you mount the LCD monitor on vertical surfaces or fold for transport. Comes with 1.5 m cable and VGA adaptor card. No external power required. IBM AT compatible.

NEW  
PRICE  
ONLY  
**\$98.00**



## Popular Space-Saver Keyboard **\$98.00**

First successful alternative to conventional keyboard saves 60% desk space with a foot print of 27.3 x 15.2 cm. Has full travel tactically responsive keys with standard left-right spacing for easy touch typing. 100 keys, compatible with IBM XT/AT PS/2. Many language versions available.

## 9" VGA Monochrome Monitor **\$198.00**

640 x 480 resolution black on white screen with a foot print to match the Space-Saver Keyboard of only 25.0 x 25.7 cm. Tilt and swivel stand. No adaptor card included.

To Order  
Call Toll Free **1-800-328-2589**

1 year warranty on all products shown. Order direct from stock with 15 day full return privileges. Visa, MasterCard, AmEx charges and COD accepted. OEM and reseller volume discounts available.

Spec Sheets Sent  
By Automatic 24 hr.  
FAX Transmission **1-703-662-1675**

# DATALUX

## First Choice In Space-Saver Peripherals

2836 Cessna Drive • Winchester, VA 22601

Phone 703 662-1500 • Fax 703 662-1682



## SYSTEM BUS OR SYSTEM BOTTLENECK?

ready to use it. This architecture doubles system performance without needing any changes in the bus itself.

### Enter Localbus

Intel has defined a bus for closely coupling peripherals to the CPU. Called *Localbus*, it essentially connects peripherals directly to CPU control lines. Similar connections to VGA controller chips have yielded a significant performance improvement over the same VGA chips on either EISA or Micro Channel adapter cards.

True, there is a limit to the number of peripherals you can connect through the Localbus. However, that limit is now mainly the limit of capacitive loading. Placing the Localbus chips on the motherboard very close to the CPU has reduced the inductive (transmission-line) component.

Moving beyond Localbus performance, CPU technology is migrating toward the "PC on a chip." In that vein, the CPU is incorporating more and more of the key peripherals into itself.

### High-Speed RISC Connections

RISC processors are already operating at 50-MHz and 60-MHz clock rates, requiring efficient connections between the CPU and memory and between the CPU and peripherals. The SPARC Consortium has defined a bus, called *MBus*, that is very similar to Localbus and incorporates several important innovations likely to be seen in the very near future.

First, the MBus emphasizes the use of surface-mount technology to achieve small size and, hence, low parasitic inductance and capacitance. Thus, the bus never really becomes a "transmission line" (for electrically oriented readers, it behaves more like distributed lumped capacitors). The maximum card size is less than 20 percent of that of a standard AT expansion card, yet, by using smaller (surface-mount) components, it has basically the same functionality.

Second, the MBus uses a wider data transfer width: 64 bits. Since the bus can operate at 40 MHz, the useful bandwidth is 80 MBps, and the peak rate is 320 MBps.

Third, you can stack multiple MBus modules. Unlike ISA, EISA, and Micro Channel buses, the MBus modules are very close together, and very close to the CPU. Thus, although transmission-line effects definitely exist, the ringing and other artifacts occur at much higher frequencies and don't affect overall system performance.

### The Bottom Line

If you're planning to buy a Micro Channel machine today based on its promise of extensibility to 160 MBps, forget it. The Micro Channel may support that data rate one day, but just as you had to upgrade your CPU from 8086 to 286 to 386 to 486 to get their advantages, you will have to upgrade your system and peripherals to get that sort of data rate.

The same situation pertains to ISA or EISA. Until all manufacturers design their machines using the best technology available, the peripheral vendor will have to compromise, thus limiting the performance your system can achieve. Manufacturers are offering a lot of innovative solutions to overcome these limitations. Unless you are running a Unix or NetOS-based network (which needs blinding speeds from the drive controller), then ISA-based machines using Localbus technologies will probably do the job.

Select a system that does what you want today. The industry will provide brand-new products to choose from tomorrow. ■

Trevor Marshall is a consulting editor for BYTE. You can reach him on BIX as "tmarshall."

# What a racket!

**\$** 3,000 bucks for a CAD program?  
Are you kidding?

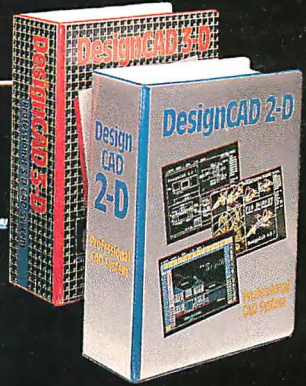
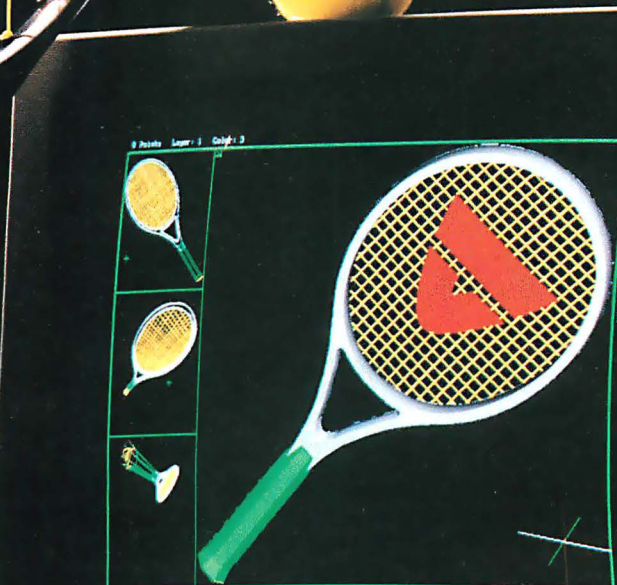
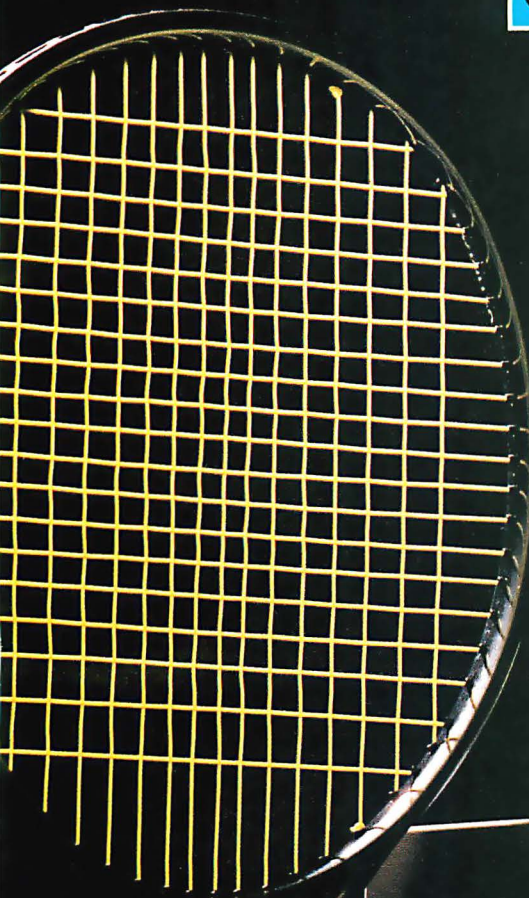
DesignCAD 2D is only \$349, and it has more and better features than the other CAD programs that cost \$3,000!

And, if you're ready for a three dimensional CAD program, there is the state-of-the-art DesignCAD 3D . . . for only \$499!

DesignCAD is the software used in the design of Andre Agassi's tennis rackets, the Patriot missile, and scores of other high tech, low tech, and no tech products.

So what's all the racket about? It's because we believe that it's silly to spend more on a CAD system than you would on a word processor. Agree? Well, the ball's in your court.

*Your product designed with DesignCAD?  
Let us know, and maybe we'll put it in one of our ads.*



For a *free* demo disk and 16 page color brochure, contact:



**American**

Small Business Computers, Inc.

One American Way • Pryor, Oklahoma 74361  
(918) 825-4844 • FAX (918) 825-6359

European Headquarters:

102 Rue La Fontaine • 75016 Paris, France  
Phone 331 4520 6540 • FAX 331 4520 6539

Other offices in:

Athens • Barcelona • Brussels • Bucharest • Istanbul • London  
Mexico City • Paris • Prague • Sao Paulo • Tokyo • Warsaw  
Circle 17 on Inquiry Card.



CAD/CAM Software



December 11, 1990  
DesignCAD 2-D, Version 3.1



December 17, 1991  
DesignCAD 2-D, Version 5.0

Also Available for Macintosh

# How Can Northgate® Offer You A Powerful, Upgradable 486SX™ System For Only \$2449?



## **Like The Great Sphinx, Some Phenomena May Never Be Explained.**

If new technology is always the most expensive, how is it possible for Northgate Computer Systems, Inc. to bring you the newest technology in upgradable systems at such a phenomenally low cost? Like the Great Sphinx, we're not

revealing our secrets. But we *can* tell you this...

Northgate's new line of Elegance™ ZXP™ 486SX and DX computers incorporates the new ZIF (Zero Insertion Force) socket that lets you upgrade to faster, more powerful processors in seconds. A new chip and a flip of the lever is all it takes to transform your system into virtually any

Elegance ZXP system you like... at a price you're sure to like.

Our new ZXP motherboards are the latest in a series of innovations that made Northgate one of the nation's premier manufacturers of 386 and 486 systems. We've also achieved a worldwide reputation for quality, as evidenced by a room full of awards from major industry publications.

# Decision-Making Is Easy With Our Free Kit.



If the decision concerning the purchase of computer systems falls on your shoulders, our Decision-Maker's Kit is one resource you'll want to have by your side. It's loaded with information that will help you make the right computing decisions. There's no obligation. No pressure. Just the facts that will make your decision-making phenomenally easy.

For your free kit, return the attached card today or call toll-free:  
**800-345-8709**



"Smart Tools  
for Business"™

## Free Decision-Maker's Kit from Northgate®

Return this postage-paid card for your phenomenal, free Decision-Maker's Kit. In a hurry? Call us and we'll mail your kit today.

Name \_\_\_\_\_  
(please print)  
Title \_\_\_\_\_  
Company \_\_\_\_\_  
Address \_\_\_\_\_  
City \_\_\_\_\_ State \_\_\_\_\_ Zip \_\_\_\_\_  
Business phone (\_\_\_\_\_) \_\_\_\_\_  
Home phone (\_\_\_\_\_) \_\_\_\_\_  
Fax # (\_\_\_\_\_) \_\_\_\_\_

1. Are you interested primarily in computers for your:  
 Home     Business     Both
2. If you indicated "business," what is your role in the purchase of computer systems?  
 Decision-maker     Decision-influencer     None
3. What computer products have you been considering?  
 386SX™ -based systems     386DX-based systems  
 486SX™ -based systems     486DX™ -based systems     Notebooks  
 Dedicated network servers     LANs
4. How many computer systems do you already have at your company? \_\_\_\_\_
5. When will you most likely make your next computer purchase decision?  
 Less than 3 months     3-6 months     Within 12 months     Don't know
6. What applications will you be running?  
 Word Processing     Accounting     Spreadsheet     Desktop publishing  
 Database     Networking     Other \_\_\_\_\_
7. Are you thinking about leasing systems?  
 Yes     No
- Check this box if you would like to have a NorthgateSystemsConsultant call you.

© Copyright Northgate Computer Systems, Inc. 1992. All rights reserved. Northgate and the Northgate 'N' logo are U.S. trademarks or registered U.S. trademarks of Northgate Computer Systems, Inc. 80386SX, 80486SX and 80486 are U.S. trademarks of Intel. We support the ethical use of software. To report software copyright violations, call the Software Publishers Association's Anti-Piracy Hotline at 1-800-380-PIR8.

CODE B3303

# Decision-Making Is Easy With Our Free Kit.



If the decision concerning the purchase of computer systems falls on your shoulders, our Decision-Maker's Kit is one resource you'll want to have by your side. It's loaded with information that will help you make the right computing decisions. There's no obligation. No pressure. Just the facts that will make your decision-making phenomenally easy.

For your free kit, return the attached card today or call toll-free.



"Smart Tools  
for Business"™



NO POSTAGE  
NECESSARY  
IF MAILED  
IN THE  
UNITED STATES

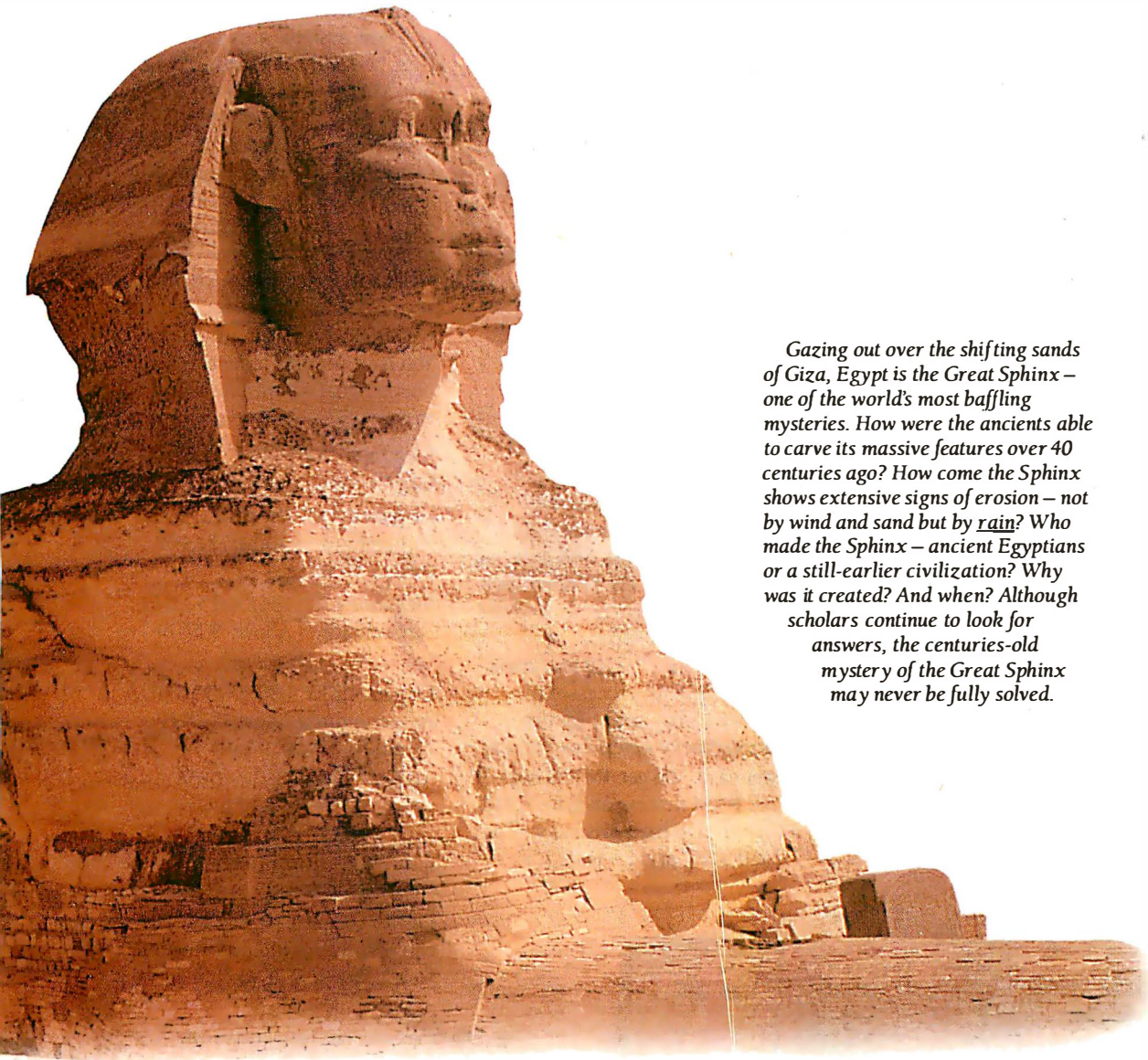
**BUSINESS REPLY MAIL**  
FIRST CLASS MAIL PERMIT NO. 23357 MINNEAPOLIS, MN

POSTAGE WILL BE PAID BY ADDRESSEE

Northgate Computer Systems, Inc.  
Attn: Dept. DM  
P.O. Box 59175  
Minneapolis, Minnesota 55459-9894







*Gazing out over the shifting sands of Giza, Egypt is the Great Sphinx – one of the world's most baffling mysteries. How were the ancients able to carve its massive features over 40 centuries ago? How come the Sphinx shows extensive signs of erosion – not by wind and sand but by rain? Who made the Sphinx – ancient Egyptians or a still-earlier civilization? Why was it created? And when? Although scholars continue to look for answers, the centuries-old mystery of the Great Sphinx may never be fully solved.*

Our service and support package, too, is nothing less than phenomenal. Services include a 30-day money back guarantee, overnight shipment of replacement parts at our expense for one year, 24-hour toll-free technical support and on-site service plans from NCR®. Northgate backs every system with a comprehensive one year parts and labor warranty. Second and third year warranty plans also available.



Turn the page for more information on this modern-day phenomenon.

**Call for complete pricing and custom configuration information.  
800-345-8709**

Major corporations, volume purchasers and government agencies call National Business Accounts: 800-545-6059



7075 Flying Cloud Drive, Eden Prairie, MN 55344

## A Towering Achievement In Quality, Performance, Innovation And Value.

Phenomenal performance. Upgradable by design. Unsurpassed value. That's what the new ZXP™ systems are all about.

They're designed to take full advantage of new upgrade processor technology – so they can accommodate the higher clock speeds of today...and tomorrow.

The ZXP motherboard features our innovative Zero Insertion Force (ZIF) socket that lets you instantly upgrade your system. Just drop in a new chip and flip the lever to lock it into place. It couldn't be faster or easier.

Another secret behind the extraordinary performance of the new systems is its 64K external cache to enhance the performance of any processor, particularly those running at faster speeds.

The Elegance™ ZXP line starts with a 486SX/16 processor in either a five-bay, space-saving desktop case or seven-bay Vertical Power case. You get 4MB of high-speed RAM that expands to 32MB, a 100MB IDE hard drive as well as 1.2MB 5.25" and 1.44MB 3.5"

floppy drives. Plus, each system comes with a Northgate 101 keyboard and 14" SVGA color monitor.

These systems are FCC Class B Certified and come with MS-DOS® 5.0, Microsoft® Windows™ 3.0, mouse, and DiagSoft™ QA Plus™ system diagnostic/performance software. Most important, you get our package of support services – all at no extra charge.

So call today to place your order. Use your system for 30 days. If you aren't satisfied, send it back within 30 days for a full refund. You have nothing to lose. And a phenomenal computing solution to gain.

Elegance ZXP 486SX/16 MHz  
\$2449 Lease as low as \$85.57/mo.\*

Elegance ZXP 486SX/20 MHz  
As Configured Above \$2499  
Lease as low as \$86.47/mo.\*

Elegance ZXP 486SX/25 MHz  
As Configured Above \$2799  
Lease as low as \$96.85/mo.\*

Elegance ZXP 486DX/33 MHz  
As Configured Above \$2899  
Lease as low as \$100.31/mo.\*

All prices above for desktop cases. Add \$150 for Vertical Power case.

Windows Users! Get up to 12 times the speed of SVGA with an accelerator card. Call for special pricing.

Call for complete pricing and  
custom configuration information.  
**800-345-8709**

Major corporations, volume purchasers and government agencies call National Business Accounts: 800-543-6059

Charge it to your VISA, MasterCard, Discover, American Express or Northgate Big 'N' Card.



7075 Flying Cloud Drive, Eden Prairie, MN 55344

© Copyright Northgate Computer Systems, Inc. 1992. All rights reserved. Northgate, Elegance, Omnicolor, and the Northgate logo are U.S. trademarks of registered U.S. trademarks of Northgate Computer Systems. 80486 is a registered U.S. trademark of Intel. Microsoft, MS-DOS and Windows are trademarks or registered U.S. trademarks of Microsoft Corporation. All other products and brand names are U.S. trademarks and registered U.S. trademarks of their respective companies. Prices shown are in U.S. dollars and do not include shipping, handling charges, and appropriate sales taxes. Offer valid in U.S. and Canada only. Prices and specifications subject to change without notice. Northgate reserves the right to substitute components of equal or greater quality or performance. All items subject to availability. We support the ethical use of software. To report software copyright violations, call the Software Publishers Association, Attn: Piracy Hotline at 1-800-388-7178. \*Monthly lease payments are based on a 36-month standard, fair market value, non-renewable lease. 12-60 month leasing options available for qualified businesses.

CODE B2603

# The Birth of the Microprocessor

An invention of major social and technological impact reaches its twentieth birthday

FEDERICO FAGGIN

**T**here are turning points in the history of technology when something new and major happens. Something unstoppable and irreversible arises (e.g., the automobile, the airplane, or the microprocessor) that becomes the catalyst for sweeping social and technological changes.

Such inventions don't come from new scientific principles but from the synthesis of existing principles. The new form expands the previous one in both predictable and unpredictable ways. Typically, the unexpected consequences are the most valuable.

Such inventions are frequently born out of a few believers' struggle with those who have something to lose from change, set in a background of indifference. Because these inventions have a certain inevitability about them, the real contribution lies in making them work.

You have to believe in the idea passionately enough to carry on the struggle, until it is firmly rooted in the world and has a life of its own. It is a work of intellect and love. On the twentieth anniversary of the introduction of the first microprocessor, the 4004, I would like to tell you the story of the early years.

## In the Beginning

In 1969, Silicon Valley was the center of the semiconductor industry, and one-year-old Intel was one of the most prestigious spin-offs from Fairchild Semiconductor. Intel and a few other companies envisioned that semiconductor memories were the wave of the future and would replace the magnetic-core memories then in use.

Later that year, some people from Busicom, a young and enterprising Japanese calculator manufacturer, came to Intel looking for a custom-chip manufacturer. They wanted a set of approximately 10 custom circuits for the heart of a new low-cost, desktop-printing calculator.

Intel was in no position to bid for this totally

custom contract. The company had no in-house expertise in random-logic design, and it would have taken too many engineers to do the work. But Ted Hoff, manager of the Application Research Department at Intel, thought there was a better way to handle this task.

In those days, there was a controversy about calculator design: standard versus custom. The proponents of custom design were in the majority. They argued that designing general-purpose calculator chips wasn't cost-effective: Standard chips would need to incorporate too many options and thus would be bigger and more expensive than custom-tailored ones.

Standard-design proponents argued that if you structured



the calculator as a small programmable computer, it could be both versatile and cost-effective. Fairchild had already done pioneering work in this area, developing a 1-bit serial CPU architecture, as had Rockwell, where Michael Ebertin and his coworkers designed a more sophisticated CPU. The idea of a "CPU on a chip" had been around since the mid-1960s.

Since the invention of the IC in 1959, the semiconductor industry had doubled the number of components integrated into a single chip every year. In the early 1960s, small-scale integration (SSI) allowed a few tens of components to form simple logic gates. By the mid-1960s, medium-scale integration (MSI) enabled a few hundred components to function as counters, adders, multiplexers, and so on. Large-scale integration (LSI), capable of integrating a few thousand components on a single chip, would soon occur.

A few SSI devices had replaced printed circuit boards containing discrete components (e.g., transistors, diodes, and resistors). A few MSI devices had replaced printed circuit boards containing many tens of SSI devices. It was obvious that a few LSI devices could soon replace printed circuit boards containing many tens of MSI devices.

Engineers wondered what kind of a general-purpose function could possibly need that many components. The answer was already evident: semiconductor memories and CPUs for small computers. Such CPUs already needed one or more printed circuit boards that were full of SSI and MSI components. In the late 1960s, LSI arrived, and it was just a matter of time until a CPU on a chip appeared. Hoff saw in the Busicom need an opportunity to define a small set of standard components designed around this CPU-on-a-chip idea.

During the fall of 1969, Hoff, aided by Stan Mazor, an applications engineer at Intel, defined an architecture consisting of a 4-bit CPU, a ROM to store the program instructions, a RAM to store data, and several I/O ports to interface with external devices such as the keyboard, printer, switches, and lights. They also defined and verified the CPU instruction set with the help of Busicom engineers—in particular, Masatoshi Shima.

### BYTE ACTION SUMMARY

While the microprocessor has made the personal computing revolution possible, the first single-chip CPUs were not greeted with enthusiasm. Engineers who designed the early microprocessors fought technical battles and management indifference. In hindsight, inventions that change the world seem to have a certain inevitability about them. But the real contribution—and risk—lie not in conceiving them but in making them work.

#### Enduring the Pains of Birth

While working at Fairchild in 1968, I developed silicon-gate technology, a new process technology for fabricating high-density, high-performance MOS ICs. Intel adopted this technology, allowing it to build high-performance memories and the microprocessor before the competition did. My desire to design complex ICs with silicon-gate technology led me to work for Intel.

So, in April 1970, my new job at Intel was to design a cal-

culator chip set. Presumably, Hoff and Mazor had already completed the architecture and logic design of the chip set, and only some circuit design and chip layouts were left to do. However, that's not what I found when I started at Intel, nor is it what Shima found when he arrived from Japan.

Shima expected to review the logic design, confirming that Busicom could indeed produce its calculator, and then return to Japan. He was furious when he found out that no work had been done since his visit approximately six months earlier. He kept on saying in his broken English, "I came here to check. There is nothing to check. This is just idea." The schedule that was agreed on for his calculator had already been irreparably compromised.

Shima and I were in the same boat. Hoff was away on business and thought his job was finished. Mazor could not resolve the remaining architectural issues that Shima promptly brought up. There I was—behind before I had even begun. I worked furiously, 12 to 16 hours a day.

First, I resolved the remaining architectural issues, and then I laid down the foundation of the design style that I would use for the chip set. Finally, I started the logic and circuit design and then the layout of the four chips. I had to develop a new methodology for random-logic design with silicon-gate technology; it had never been done before.

To make the circuits small, I had to use bootstrap loads, which no one at Intel thought was possible with silicon-gate technology. When I demonstrated them, bootstrap loads were promptly put to work in the ongoing memory designs as well.

I called the chip set "the 4000 family." It consisted of four 16-pin devices: The 4001 was a 2-Kb ROM with a 4-bit mask-programmable I/O port; the 4002 was a 320-bit RAM with a 4-bit output port; the 4003 was a 10-bit serial-in, parallel-out shift register to be used as an I/O expander; and the 4004 was a 4-bit CPU.

The 4001 was the first chip designed and laid out. The first fabrication of the 4001 (called a *run*) came out in October 1970, and the circuit worked perfectly. In November, the 4002 came out with only one minor error, and the 4003, also completed, worked perfectly. Finally, the 4004 arrived a few days before the end of 1970. It was a major disappointment because one of the masking layers had been omitted in the wafer processing. The run was unusable.

Three weeks after that disappointment, a new run came. My hands were trembling as I loaded the 2-inch wafer into the probe station. It was late at night, and I was alone in the lab. I was praying for it to work well enough that I could find all the bugs so the next run could yield shippable devices. My excitement grew as I found various areas of the circuit working. By 3:00 a.m., I went home in a strange state of exhaustion and excitement.

Verification continued for a few more days. When the testing was finished, only a few minor errors had been found. I was elated. All that work had suddenly paid off in a moment of intense satisfaction.

In February 1971, the 4004 masks were corrected, and a new run was started. At about the same time, I received the ROM codes from Busicom so that I could tool the masks and make the production 4001s for the first calculator.

By mid-March 1971, I shipped full kits of components to Busicom, where Shima verified that his calculator worked properly. Each kit consisted of a 4004, two 4002s, four 4001s, and two 4003s. It took a little less than one year to go from the idea to a fully working product.

Now that the first microprocessor was a reality, I thought that the chip could be used for many other applications. Unfortunately, Intel's management disagreed, thinking that the 4000 family was good only for calculators. Furthermore, the 4000

# Access dBASE IV and FoxPro files from C or C++

**Customer Browse**

Customer No.	Last Name	First Name
32482	Stickle	Jim
949	Stickel	Ron
34732	Stice	Vern
35007	Stevenson	Alan
8092	Steward	Baline
22824	Stewardson	
12842	Stewart	
39148	Stewin	
16785	Steyn	
27096	Sthankiya	
15523	Stiansen	
33045	Stickley	

**Customer Edit**

Customer No.

Last Name

**Find**

Search On:

Search Value:

Call for a  
**FREE**  
Browse/Edit  
utility.

*Design CodeBase  
Browse/Edit screens using  
any resource toolkit.*

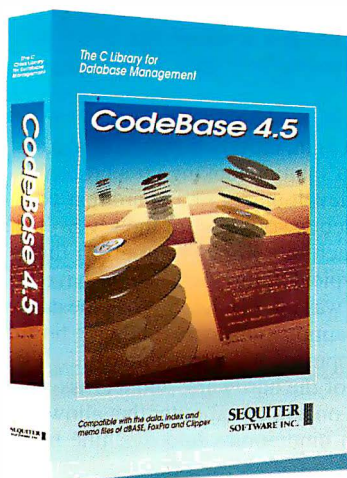
- Multi User
- Portable (DOS, Unix, ...)
- Royalty Free DLL
- C++ interface included

Use CodeBase 4.5 from **Visual Basic** or **Turbo Pascal** for Windows.

Use the super-fast, super-small **FoxPro 2.0** CDX or the Clipper NTX index files.

" Our product was too slow under FoxPro 2.0, so we rewrote it in C using CodeBase. Now it is incredibly fast."

Jeff Reed, DCS Computer Services



## CodeBase 4.5

The C Library for DataBase Management

**SEQUIER**  
SOFTWARE INC.



TEL. 403•437•2410  
FAX 403•436•2999  
Europe 33.20.24.20.14

# 209,9644-54 AVE., EDMONTON, AB, CANADA T6E-5V1

family had been designed under an exclusive contract. It could not be announced or sold to anyone but Busicom.

The opportunity to prove that the 4000 family was good for other applications came when the need for a production tester arose. The tester was clearly not a calculator application, so I decided to use the 4004 as the tester's main controller. In that project, I gained considerable insight into what could and could not be done with the 4000 family. When the tester was successfully completed, I had additional ammunition to convincingly lobby for the 4000 family's introduction.

I urged Robert Noyce, then president of Intel, to market the 4004. I suggested that perhaps Intel could trade some price concessions for nonexclusivity. (I had heard from Shima that Busicom was hurting in the marketplace and needed a lower price to effectively compete.) Noyce succeeded in obtaining nonexclusivity from Busicom for the 4004 for applications other than calculators. Shortly after that, in mid-1971, Intel decided to market the 4000 family.

In November 1971, the 4000 family, now known as MCS-4 (for Microcomputer System 4-bit), was officially introduced with an advertisement in major trade publications. The main caption read, "Announcing a new era of integrated electronics"—a very prophetic ad.

### A Younger but Brighter Sibling

In 1969, Computer Terminal Corp. (now Datapoint) visited Intel. Vic Poor, vice president of R&D at CTC, wanted to integrate the CPU (about 100 TTL components) of CTC's new intelligent terminal, the Datapoint 2200, into a few chips and reduce the cost and size of the electronics.

Hoff looked at the architecture, the instruction set, and the CTC logic design and estimated that Intel could integrate it all on a single chip, so Intel and CTC entered into a contract to develop the chip. The Datapoint CPU chip, internally called the 1201, was an 8-bit device. Intended for intelligent terminal applications, it was more complex than the 4004.

The 1201 looked like it would be the first microprocessor to come out, since its design was started first, and I had four chips to design, the CPU being the last. I was a bit disappointed, but I had enough to worry about. However, after a few months of work on the 1201, the designer, Hal Feeney, was asked to design a memory chip, and the CTC project was put on ice.

In the meantime, CTC had also commissioned Texas Instruments to do the same chip design as an alternative source. At the end of 1970, Intel resumed the 1201 project under my direction, and Feeney was reassigned to it.

Early in June 1971, TI ran an advertisement in *Electronics* describing its MOS LSI capabilities. A picture of a complex IC with the caption "CPU on a chip" accompanied a description of TI's custom circuit for the Datapoint 2200. The ad continued, "TI developed and is producing it for Computer Terminal Corp. ..." and gave the chip's vital statistics. The dimensions were 215 mils by 225 mils, a huge chip even for 1971 technology and 225 percent larger than Intel's estimate for the 1201.

The TI chip, however, never worked and was never marketed. It faded away, not to be heard from again until TI's current legal battles. Surprisingly, TI patented the architecture of the 1201, which was Datapoint's architecture with Intel's inputs, and now asserts broad rights on the microprocessor. TI might have been the first company to announce the microprocessor, but making it work was the trick.

An invention requires a reduction to practice, not just an idea. And in 1990, the U.S. Patent Office awarded a patent to Gilbert Hyatt for the invention of the microcomputer chip (about 20 years after his original filing date). News of the award took the in-

dustry by surprise because Patent Office proceedings are secret and Hyatt wasn't widely known. While Hyatt was said to have built a breadboard prototype implementation (using conventional components) of his microprocessor architecture, no single-chip implementation was ever produced. Again, this idea was not reduced to practice. For more information on this, see "Micro, Micro: Who Made the Micro?," January 1991 BYTE.

What Gilbert Hyatt, TI, and others failed to do, Intel did: It made the first microprocessor work—at a low cost and in volume production. It took vision, guts, and lots of work to bring to market a product that was different from all the others, a product that required lots of customer training, support, and groundwork. Intel did it, taking a big risk at a time when it was still small and could ill afford to fail.

Three critical tasks had to be performed before the idea of the microprocessor could take root. First, the production technology of the time had to economically implement a useful architecture. Second, someone had to design, develop, and bring the chip to production with sufficiently low manufacturing costs. And third, the microprocessor had to be made available to the general market. This last task required a true belief in the device and its ability to transform hardware design.

During the summer of 1971, as work on the 1201 was progressing nicely, Datapoint decided that it didn't want the 1201 anymore. The economic recession of 1970 had brought the price of TTL down to where the 1201 was no longer attractive. However, because Seiko of Japan had expressed an interest in it, Intel decided to continue with the project. Datapoint agreed to let Intel use its architecture in exchange for canceling the development charges. Intel was free to commercialize the 1201 as a proprietary product.

Designed after the 4004, the 1201 was not too difficult a project. Architecturally, the 1201 was very similar to the 4004—despite the 1201's being an 8-bit CPU—and many of the design solutions used in the 4004 readily applied to the 1201. There was only one bad moment.

Intel was all set to introduce the 1201 (later renamed the 8008) when I discovered some intermittent failures. It took me a feverish week to solve the problem. It was a nasty one, at the crossroads of device physics, circuit design, and layout: The charge stored in the gate of the transistors in the register file was leaking away due to substrate injection. I had to modify the circuit and the layout to fix the problem.

### Making the Sale

To use a microprocessor, you first had to visualize a problem as a computer program and then write and debug it in some kind of hardware-simulation environment before committing the program to ROM. Fortunately, Intel had just developed the 1701, the first EPROM to use a floating polysilicon gate as the storage element.

The 1701 was a 2-Kb device programmable with special hardware and erasable with ultraviolet light. Introduced six months earlier than the 1201, the 1701 was a solution looking for a problem. However, it made possible the development of a board that you could use to develop, run, and debug software for the MCS-4.

Microprocessors required much more marketing effort than conventional components. A typical component would have a 6- to 10-page data sheet, and that was all. The MCS-4 had the data sheets, a programming manual, applications notes showing how to use the components, a development board capable of implementing a functional prototype of the hardware, and a cross assembler (i.e., a program running on a minicomputer that allowed the conversion from instruction mnemonics into machine language).

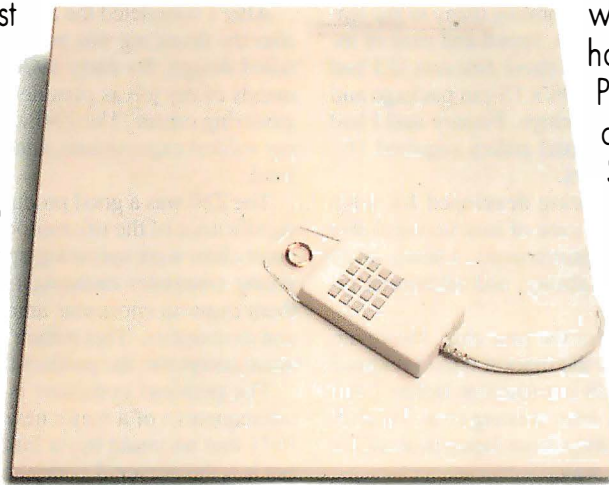
*continued*

# While Our Competitors Are Diligently Trying To Emulate The SummaSketch® II...

## We Proudly Announce SummaSketch II Plus.

The world's best selling, most emulated, most acclaimed desktop tablet just got better. We've taken SummaSketch II, the industry standard, and added several new features to create a tablet that is, unquestionably, the world's best.

Unlike some competitors, we put everything in the box—4-button cursor and 2-button stylus (or 16-button cursor), interface cables and a utilities diskette with Windows® 3.0 and ADI® drivers. Plus we've added things like 2000 lines per inch resolution and 10 mil accuracy—standard. Plus the fastest, easiest set-up and configuration procedure. Plus an offer for a free AutoCAD® or CADKEY® Master Template (a \$245 value). Plus software compatibility



with over 400 programs, and hardware compatibility with PCs and Macintosh®. Best of all, it's still 100% pure SummaSketch—the editor's choice, winner of every major editorial accolade for graphics tablets. And the people's choice, with well over one-half million sold to demanding computer graphics professionals.

**Every  
decision**

**should be this easy.** In fact, the only tough decision is which Plus to choose: 12" x 12" or 18" x 12" Professional. For literature, or the name of your local dealer, call 1-800-729-7866. For technical information call 203-881-5400.



### **Summagraphics®**

*Every decision should be this easy.™*

© 1991 Summagraphics Corporation. Seymour, CT 06483. All rights reserved.

Circle 123 on Inquiry Card.

All this paraphernalia required a lot more knowledge, complexity, and cost than the semiconductor industry was prepared to handle. In addition, the engineers had to fundamentally change their approach to hardware design. With the microprocessor, you had to visualize problems in terms of software. This was the hardest obstacle of all.

In April 1972, Intel introduced the 8008, with a group of supporting chips, as a family of products called the MCS-8. The supporting chips were standard Intel products with the names changed. MCS-8 looked impressive, and market interest was high, but sales were slow.

Customers needed more than the simple design aids that Intel offered; they needed far more hardware and software tools, training, and applications support than had been anticipated. So Intel provided them with a variety of software and hardware design aids and fostered a massive engineer training program carried out by external consultants.

Then the idea of a development system arose, and Intel's management decided to commit the company in that direction. The development system is a self-contained computer specialized for developing and debugging microprocessor software. A year after the microprocessor introduction, Intel was receiving more revenues from development systems than from microprocessor chips.

## The Real Hotshot

Late in the summer of 1971, I went to Europe to give a series of technical seminars on the MCS-4 and the 8008 and to visit customers. It was an important experience. I received a fair amount of criticism—some of it valid—about the architecture and performance of the microprocessors. The more computer-oriented the company I visited was, the nastier people's comments were.

When I returned home, I had an idea of how to make a better 8-bit microprocessor than the 8008, incorporating many of the features that people wanted: most important, speed and ease of interfacing. I could have boosted both of these features if I had used a 40-pin package instead of the 8008's 18-pin package and integrated the functions of the support chips. Feeney and I had wanted to do that with the 1201, but Intel policy required 16-, 18-, and, on exception, 24-pin packages.

Using the new *n*-channel process being developed for 4-Kb DRAM would also improve speed and ease of interfacing. I also wanted to make several functional improvements: a better interrupt structure, more memory addressability, and additional instructions.

By early 1972, I started lobbying for the new chip. However, Intel management wanted to see how the market would respond to the MCS-4 and, later, to the MCS-8 introduction before committing more resources. I thought we were wasting time. I had already asked Shima to come to California from Japan to work for me, and visa formalities were under way.

In the summer of 1972, the decision came to go ahead with the new project. I finished the architecture and design feasibility so that my coworkers and I could go full steam when Shima arrived in November.

The first run of the new microprocessor, the 8080, came in December 1973. My coworkers and I corrected a few minor errors, and Intel introduced the product in March 1974. After that, Intel was clearly the leading microprocessor supplier, although other companies had competing products.

In 1972, Rockwell announced the PPS-4 (similar to the MCS-4 but packaged in 42-pin packages). The PPS-4 used four-phase design techniques and metal-gate MOS technology and achieved about the same speed as the MCS-4, thanks to a more parallel operation. Rockwell engineers stemmed the limitations of metal-gate MOS technology for a while, but the PPS-8, in-

troduced after the 8080, was no match for it.

The only serious competition for Intel came from Motorola. Motorola's product, the 6800, used MOS silicon-gate technology and was introduced about six months after Intel's 8080. In many ways, the 6800 was a better product. However, the combination of timing, more aggressive marketing, availability of better software and hardware tools, and product manufacturability—the 8080 chip size was much smaller than the 6800's—gave Intel the lead.

The 8080 really created the microprocessor market. The 4004 and 8008 suggested it, but the 8080 made it real. For the first time, several applications that were not possible with prior microprocessors became practical. The 8080 was immediately used in hundreds of different products. The microprocessor had come of age.

## A New Challenge

By the summer of 1974, I had grown restless. From the beginning, I had led all the microprocessor development activity at Intel, and, with time, I was responsible for all the MOS chip-design activity, except that on DRAMs. Intel had grown into a large company, and I found the environment stifling. So, with Ralph Ungermann, one of my managers, I decided to start a company that, unlike Intel, would be totally dedicated to the microprocessor market.

In November 1974, Zilog was founded, and a little more than a year later, the Z80 CPU, the first member of the Z80 family, was born. I had the idea for the Z80 in December 1974. It had to be a family of components designed to work seamlessly together and able to grow. It had to be totally compatible with the 8080 at the machine-instruction level and yet incorporate many more features, registers, and instructions.

After I completed the architecture and the design feasibility and after the financing was arranged, Shima joined Zilog to do the detailed design. By early 1976, the Z80 was a reality, and the demands of my job as president of Zilog had put an end to my engineering career. The Z80 was extremely successful, surpassing my wildest expectations, and Zilog became a major competitor of Intel.

The Z80 was a good product, but its timing was also lucky. The significance of the microprocessor was becoming evident. Computer clubs were sprouting up throughout the U.S. The number of young computer enthusiasts was increasing rapidly, and with them came an enormous amount of creative energy, enthusiasm, and exuberance. That milieu was the breeding ground of the personal computer, the product that popularized the microprocessor.

The personal computer is one example of the unpredictable consequences of a major new technology. Of course, we knew in 1971 that we could buy a little computer that would fit on a desk, but it is the personal computer as a socioeconomic phenomenon rather than as a feat of engineering that was a surprise to me.

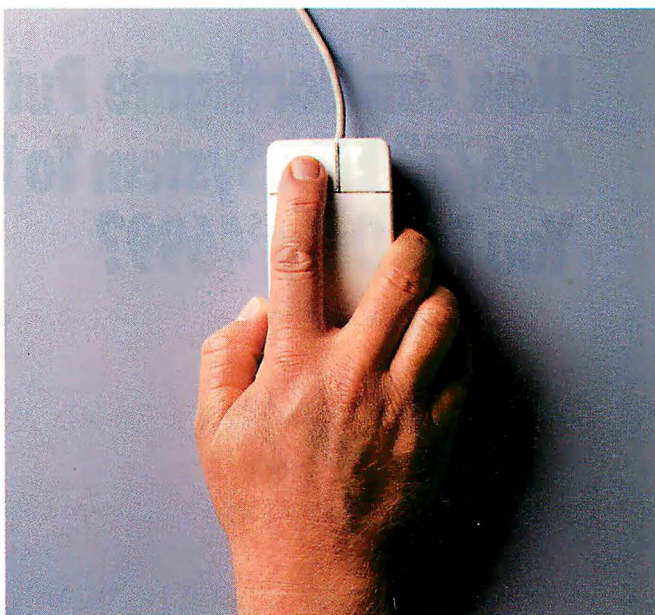
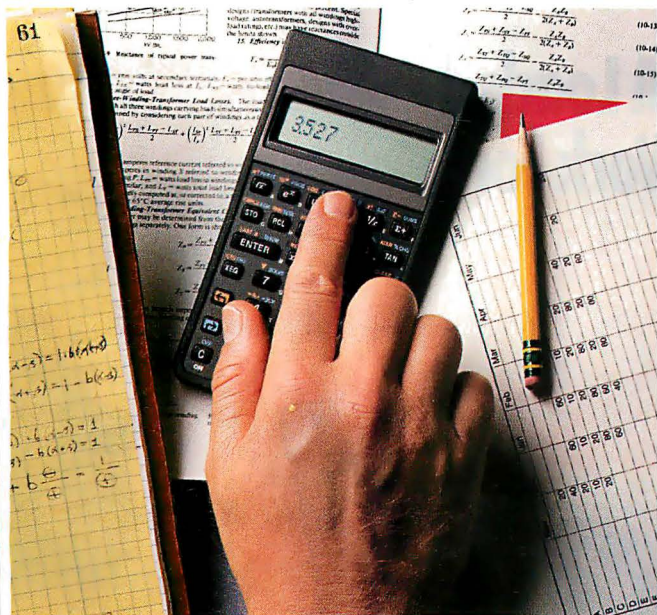
By 1977, microprocessors were firmly planted in the world and were becoming part of the fabric of everyday technology. From that point on, it became a matter of building faster, bigger, better, less expensive microprocessors. And the industry has done just that. Fueling this process is the continuing improvement in semiconductor processing technology, the source of the microelectronics revolution. ■

*Federico Faggin conceived, designed, and codesigned many of the earliest microprocessors, including the Intel 4004, 8008, 4040, and 8080, as well as the Zilog Z80. He is cofounder and president of Synaptics (San Jose, CA), a company that is dedicated to the creation of hardware for neural networks and other machine-learning applications. You can reach him on BIX clo "editors."*



# There are two ways to do your math.

## Drag. Click-n-drag.



### Solve problems fast with Mathcad 3.0.

Don't let calculations keep you from getting work done. Cruise through problems with the math package that's fast, all-purpose—and easy: Mathcad 3.0.

### The one-step system.

Mathcad 3.0 is much more than just a number-cruncher. It's an integrated math

calculation capabilities. So you can do any integral, Taylor series, or infinite sum with click-n-drag simplicity.

Done calculating? Mathcad prints out presentation-quality documents complete with equations in real math notation.

### Give your math a hand.

To help you work even faster, Mathcad 3.0 includes a Standard Electronic Handbook for instant access to hundreds of standard formulas, useful data, and commonly-used equations. Ready for interactive use, just click-n-paste them into your work. Without ever opening a reference book.

For a wider range of ready-to-use formulas and data, you can order additional Electronic Handbooks, created with the leading publishers of technical reference handbooks. Or optional

Applications Packs with modifiable templates for all major engineering and science fields.

160,000 people already rely on it.

Mathcad's the best-selling math software because it gets results. Here's how:

- Easy to learn and use Microsoft® Windows 3.0 interface

- Easy to use symbolic calculations
- Standard Electronic Handbook with hundreds of useful built-in solutions
- Other optional Electronic Handbooks available
- Differentials, FFTs, cubic splines, matrices and more
- 2-D and 3-D graphics
- Presentation-quality documentation
- Optional Applications Packs with adaptable templates for Electrical, Mechanical, Civil and Chemical Engineering, Statistics, Advanced Math, and Numerical Methods

- PC DOS, Macintosh,® and Unix® versions also available

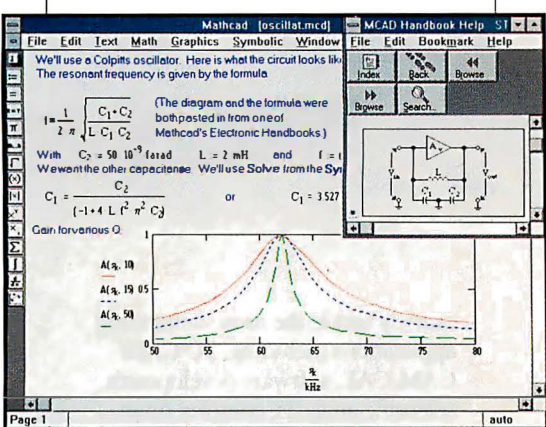
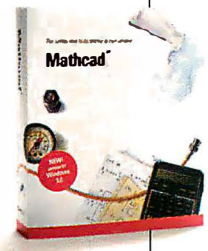
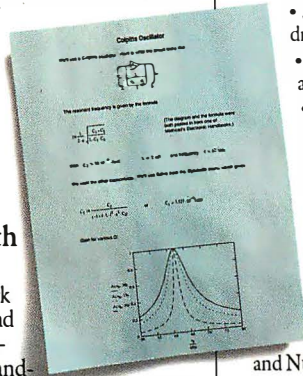
### Free demo disk.

For a FREE Mathcad demo disk, or upgrade information, call 1-800-MATHCAD (or 617-577-1017, Fax 617-577-8829). Or see your software dealer.

© 1992 MathSoft, Inc. TM and ® signify manufacturer's trademark or registered trademark respectively.

1-800-MATHCAD

# The answer is Mathcad®



system that performs everything from addition to symbolics—easily and naturally. Because it works the way you think.

Just type your calculations anywhere on the screen—just like a scratch pad—and you're done. Mathcad does the calculating. Updates answers when a variable changes. Graphs in 2-D or 3-D. Even accepts bitmapped graphics. A quick menu pick gives you full symbolic



Mathcad 2.5  
3-14-89 issue.  
Best of '88  
Best of '87

MathSoft, Inc. 201 Broadway, Cambridge, MA 02139 USA • Phone: 617-577-1017 • Fax: 617-577-8829

Australia: Hearne (03) 866 1766; Belgium: SCIA 013/55 17 75; Denmark: Engberg 42 25 17 77; Finland: Zenex 90-692-7677; France: ISE (1) 4609 24 00; Germany: Softline (078 02) 4036; Italy: Channel 02-90091773; Japan: CRC03-3665-9741; Netherlands: Klaasing01620-81600; Sweden: AkademiData (018) 240035; Switzerland: Redacom 03241 01 11; U.K.: Adept Scientific (0462) 480055. In other locations, contact MathSoft, USA.

# How Can Northgate® Put A Loaded 486™/33 EISA System To Work For You For Only \$4699?



## Like The Easter Island Statues, Some Phenomena May Never Be Explained.

Visitors to Easter Island are awestruck by the statues that greet them. That same sense of awe is experienced by people who see how much performance Elegance™ 486/33 EISA gives them for such a low price.

Equally intriguing is the Northgate 486/33 EISA system's speed, reliability and high performance.

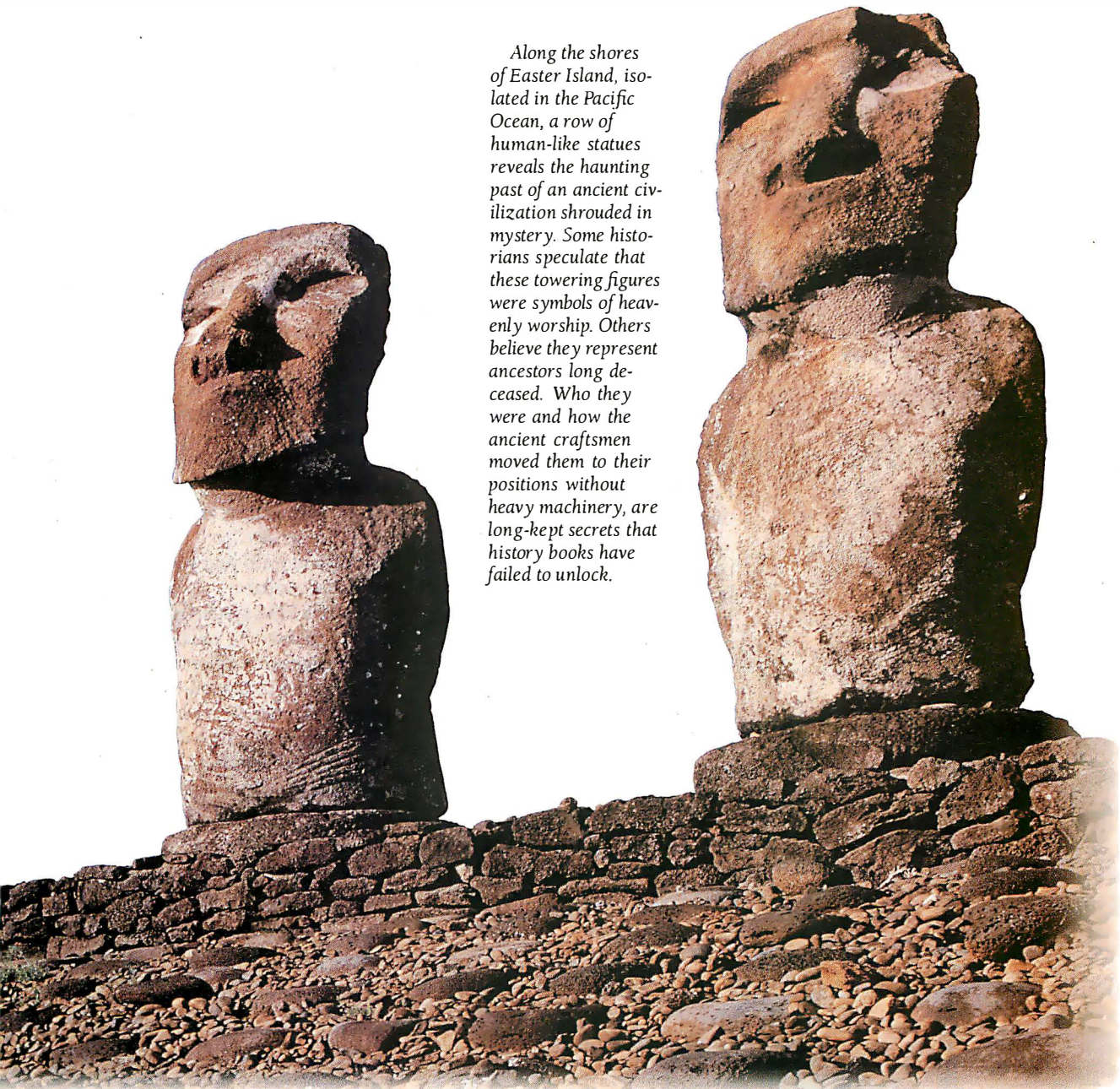
Not to be satisfied with just the speed inherent in the 486/33 chip, Northgate's engineers brought a new level of performance by adding 128K of high speed cache.

When combined with the 32-bit processing power of the EISA bus and the 200MB hard drive, you get unsurpassed power that lets you

quickly tackle the most demanding applications including: 3D CAD/CAM/CAE, software development, scientific analysis, complex financial modeling and database management.

The system comes complete with eight 32-bit EISA bus slots (six bus master and two slave) that give Elegance 486e the ability to manage large Local Area Networks at near processor speed.

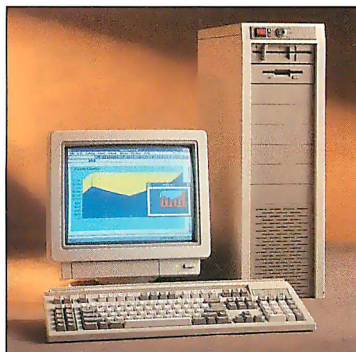
*Along the shores of Easter Island, isolated in the Pacific Ocean, a row of human-like statues reveals the haunting past of an ancient civilization shrouded in mystery. Some historians speculate that these towering figures were symbols of heavenly worship. Others believe they represent ancestors long deceased. Who they were and how the ancient craftsmen moved them to their positions without heavy machinery, are long-kept secrets that history books have failed to unlock.*



Network operations are simplified, too, thanks to self-configuring EISA adapters.

Northgate's Elegance 486 EISA boosts you to the upper echelon of business computing performance. And all for a phenomenally-low price of just \$4699. Enough to make the statues of Easter Island nod their heads in approval.

Turn the page for more information on this modern-day phenomenon.



**Call for complete pricing and custom configuration information.  
800-345-8709**

Major corporations, volume purchasers and government agencies call National Business Accounts: 800-545-6059



7075 Flying Cloud Drive, Eden Prairie, MN 55344

## We Just Filled A Very Tall Order: A High-End 486™/33 EISA For Only \$4699.

Northgate® Computer Systems, Inc. made 80386 technology more affordable for the masses. Then, we brought the power of 80486 within reach of business users. And for the most demanding applications, the tradition continues with Elegance™ 486/33 EISA. Fully loaded and priced at only \$4699, it's quite a phenomenon.

The speed will astound you. That's because this system has 8MB of rapid 32-bit DRAM and two caching memories: 8K RAM cache on the 80486 chip plus 128K of SRAM cache. Other performance gains are achieved by a 200MB IDE hard drive with integrated IDE controller and disk caching software.

Elegance 486e features 1.2MB 5.25" and 1.44MB 3.5" floppy drives. Plus, eight 32-bit EISA bus slots that easily accommodate standard 8- and 16-bit cards as well.

A high performance system like this deserves the finest in video. So, we've included a 14" SVGA color monitor with 1024 x 768

resolution and high-speed video card.

Your system arrives fully configured in a Vertical Power case with room for eight external half-height devices.

For your convenience, you get a choice of MS-DOS® 3.3, 4.01 or 5.0, Microsoft® Windows™ 3.0 and mouse, plus DiagSoft™ QA Plus™ system diagnostic/performance software. And don't forget, you get the award-winning OmniKey® keyboard, too.

After the sale, you can count on lifetime toll-free telephone technical support 24 hours a day, 7 days a week; a one-year parts and labor warranty; and on-site hardware service from NCR®. Second and third year warranty plans also available.

If a 486 EISA system is in your plans, you owe it to yourself and your business to explore Elegance 486e. Call us today, toll-free, and place your order. If you aren't completely satisfied, return it within 30 days for a full refund. You have nothing to lose. And a phenomenal computing solution to gain.

### Elegance 486e/33 MHz

**\$4699** Lease as low as \$160.71/mo.\*

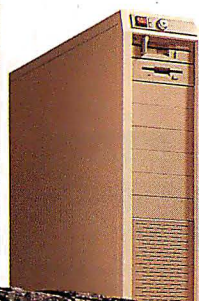
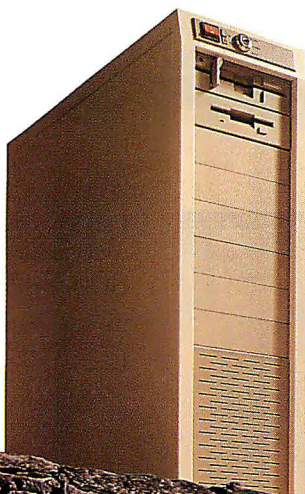
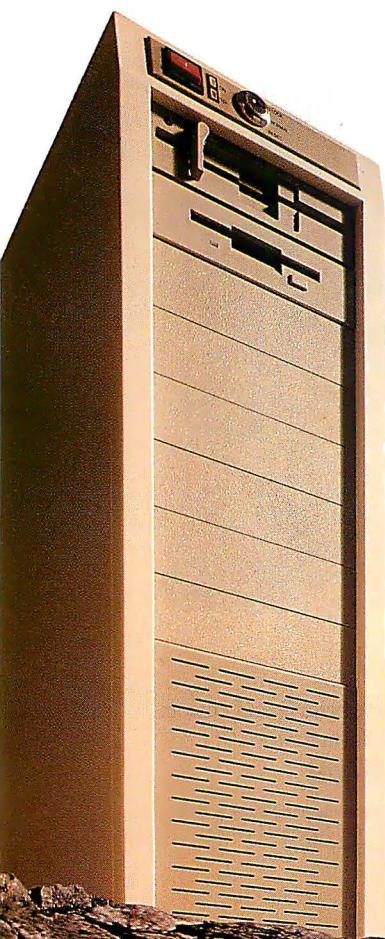
Call for complete pricing and  
custom configuration information.  
**800-345-8709**

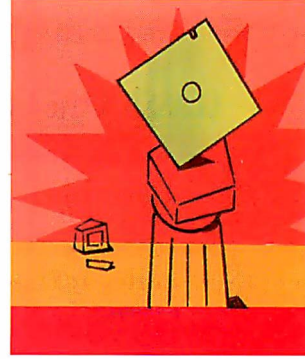
Major corporations, volume purchasers and  
government agencies call National Business  
Accounts: 800-545-6059

Charge it to your VISA, MasterCard, Discover,  
American Express or Northgate Big 'N' card.



7075 Flying Cloud Drive, Eden Prairie, MN 55344





# BASIC

Still the most popular language on microcomputers, BASIC has made considerable changes over the years

DORIS APPLEBY

**T**his six-part series, which has considered languages that have stood the test of time, would not be complete without presenting BASIC (for Beginner's All-purpose Symbolic Instruction Code). However, as *BYTE* readers have been kept up to date on changes over the years, the discussion will be brief. I want to reserve some space for taking a stab at a question posed by Russell Brown, a mathematician now retired from the U.S. Naval Research Lab, who asked, "But why so many different languages?"

## BASIC Beginnings

BASIC, which is undoubtedly the most popular computer language, is bundled with virtually every microcomputer sold. It was developed in 1964 by two Dartmouth professors, John Kemeny and Thomas Kurtz. They noticed that most decision makers in business and government are nonscientists and that their decisions dramatically affect the worlds of work and public affairs. They wondered how sensible decisions about computing and its use could be made by people essentially ignorant of the subject. They agreed that you can no more learn computing by listening only to lectures and having no computer than you can learn to drive a car by using only a manual and having no car.

Two problems needed to be overcome. First was the inaccessibility of computers, which ran in batch mode from punch cards; second was the need for a language that was easier to learn than the highly mathematical FORTRAN. BASIC, with its accompanying time-share system, solved both problems. It operated then, as now, as a desktop calculator, where you could enter

```
PRINT LOG(25)
```

and get an immediate answer, or as a programming language, with which you could write and save complete programs. Early BASIC was interpreted; now, newer versions can be compiled as well.

BASIC's detractors were powerful and vociferous, with

perhaps the most damaging charge coming in 1975 from Edsger Dijkstra: "It is practically impossible to teach good programming to students that have had a prior exposure to BASIC: As potential programmers, they are mentally mutilated beyond the hope of regeneration." It was the much-maligned GOTO as the principal control structure that led to such strong condemnation. And I must agree that such was my experience during the late 1970s. Converting a gung-ho high school BASIC hacker to structured programming when GOTOs work just fine is hard indeed.

Dartmouth BASIC was never copyrighted or standardized, so different versions that took advantage of various microcomputer features became available from almost every software developer. These included BASEX, Integer BASIC, MITS BASIC, Tiny BASIC, SWTP BASIC, RM BASIC, BAZIC, BASIC-09, Better BASIC, Professional BASIC, Macintosh BASIC, Microsoft BASIC, Applesoft BASIC, CBASIC, SBASIC, BASICA, GWBASIC, TBASIC, and a standardized ANSI Minimal BASIC in 1978 (so minimal that it was almost totally ignored by the industry).

## What's New?

Kemeny and Kurtz found this proliferation appalling and dubbed these horrible dialects of such a beautiful language "Street BASIC." They thus formed a corporation in the early 1980s and developed True BASIC, a version that meets the ANSI and ISO standard. A True BASIC program will run on any machine that supports an ANSI BASIC system. Its

## BYTE ACTION SUMMARY

Even though BASIC has humble roots and a reputation for supporting poor programming practices, it has evolved more than any other classic language. The plethora of versions have coalesced into a few real standards.

## Listing 1: True BASIC's syntax for writing program modules.

```

MODULE name
PUBLIC var 1, ..., array1(size), ... !global variables
PRIVATE routine1, ... !local variables
SHARE var1, ... !shared in
                                !procedures
                                !within
                                !the module
... !initialization
statements !code
...
procedures
...
END MODULE
    
```

## Listing 2: True BASIC code that sorts a list of student names in descending order according to their grade-point average (from True BASIC by Problem Solving by Brian D. Hahn [Weinheim, Germany: VCH, 1988, p. 109]).

```

DIM List(100) !order of merit list
DIM Mark(100) !marks
DIM Names$(100) !names in original order

LET N = 0 !counter
DO WHILE MORE DATA
    LET N = N + 1
    READ Name$(N), Mark(N)
    LET List(N) = N !initialize the list
LOOP

LET K = 0

DO !outer loop of bubble
!sort
    LET Swaps = 0 !number of exchanges
    !per pass
    LET K = K + 1 !count the passes
    FOR J = 1 TO N - K !count the tests
        IF Mark(List(J)) < Mark(List(J+1)) THEN
            LET Temp = List(J)
            LET List(J) = List(J + 1)
            LET List(J + 1) = Temp
            LET Swaps = Swaps + 1
        END IF
    NEXT J
LOOP UNTIL Swaps = 0 !must be sorted then

FOR K = 1 to N
    PRINT USING "<#####":Name$(List(K))
    PRINT USING " ##": Mark(List(K))
NEXT K

DATA Alice, 54
DATA Brian, 30
DATA Charles, 100
DATA Debby, 47
DATA Ethel, 78
END
    
```

compiler has two windows: an editing window, where you can write and edit programs, and a history (or command) window, where you can run programs and interact with them.

Programming language concepts have developed since the 1970s, along with new languages that implement the new concepts as well as take advantage of improvements in hardware. BASIC has changed also, and the two leading implementations are True BASIC and QuickBasic from Microsoft.

When BASIC was first developed, notions of structured programming were mostly in the paper-and-pencil stage. Structured code reflects in appearance a program's organization. Notions of structure include blocks, where data can be localized, and data structures, such as arrays, records, and lists, to name only a few. The new BASICs include structured features such as IF... THEN... ELSEIF... ELSE... END IF, FOR... NEXT, DO... WHILE... LOOP, DO... LOOP UNTIL, and various CASE statements. They also support graphics, matrix-handling functions, and internal and external functions and procedures. Line numbers are optional, and you can insert or delete them using the menu bar.

Another concept implemented in modern high-level languages is modularization, where data and related procedures can be bundled together, with some features kept hidden from a user. True BASIC has added this feature in the form shown in listing 1. QuickBasic's version calls global variables COMMON, local variables STATIC, and shared variables SHARED.

You can save modules and collections of BASIC code in files and include them in other programs with the INCLUDE statement, or you can store procedures and functions in a library, from which you can bring them into a program with the CALL statement. You can save and distribute compiled code in .EXE files, so developers can sell their software without source code.

But True BASIC has been kept lean in keeping with its designers' philosophy of simplicity. This is not so with Microsoft's candidates, QuickBasic and Visual Basic for Windows. Microsoft's president, Bill Gates, wants QuickBasic to replace Pascal as the language of choice for high schools. Thus it includes user-defined data types in the form of records. It makes no attempt to adhere to the ANSI/ISO standard but takes full advantage of the DOS environment. Visual Basic, an attempt to make Windows programming easy, includes icons that can be designed into the user interface as well as used while writing BASIC code.

As an example of the different capabilities of True BASIC and QuickBasic, the programs in listing 2 (True BASIC) and listing 3 (QuickBasic) sort a list of student names in descending order according to their grade-point average. There are several things to notice in these two versions for sorting an array of "pointers" to fixed array elements. First is that neither version has true pointers that contain memory addresses. An array, called List or Rank, keeps track of the array location instead. Second is the existence of record types in QuickBasic. Third is the built-in Swap function in QuickBasic, which has to be programmed in True BASIC.

You may wonder why I changed the name of the True BASIC List array to Rank in the QuickBasic version. Well, it turns out that List is a keyword in QuickBasic that lets you reassign function keys in the DOS system. Lots of things like that show up. But if you're wedded to DOS, you'll learn all these keywords quickly enough.

There are advantages to strong typing and variable declarations, as in Pascal and Ada. It is very hard for inexperienced programmers to detect errors in BASIC. Maybe BASIC is for experienced programmers like Art Ramirez (whom I will discuss in a moment) or those who want little more than a fancy calculator, and the strongly typed languages are better for beginning programmers.

*continued*



V.4.1



# Software Digest

# RATINGS REPORT

The Independent Comparative Ratings Report for Selecting IBM PC Business Software

Volume 8, Number 5

## STATISTICS PROGRAMS

Statistical programs present a high degree of complexity that limits their use. Some of the best programs have been modified to minimize that complexity, but to a large extent they remain complicated. Programs operating in mainframe environments make few concessions to the PC environment and PC users.

- Systat balances power and usability; SAS provides great power to users who master it, and Statgraphics is the easiest to learn and use. NSTL does not recommend the other programs for PC use except in businesses already running the mainframe version.
- Four of the statistics packages are sold as modules, and prices range from \$200 to over \$4,000 for a complete set. Refer to the Program Module Chart on page 10.
- Contrary to the common belief among statisticians, great differences in calculation speed separate the programs. Calculation speed can be very important to users who run frequent analysis of large data sets. (Performance Results, page 32).

Place this report in your binder behind the Miscellaneous Software tab.

Program	Version	Price	Modular	Other
*** 7.7.7.5 Systat	5	\$895-\$3,270	600KB	3D
*** 7.2.7.3 SAS Applications System	6	\$4,870	640KB	24
*** 7.2.6.8 Statgraphics	pre-5	\$995	640KB	28
*** 5.6.2.4 SPSS/PC+	4.0	\$195-\$3,040	512KB	26
	1990	\$2,195	512KB	22
			190KB	20

Ratings Key  
(On a scale of 0 to 10)  
OVERALL EVALUATION  
\*\*\*\*\* 9.0 or higher

ALL OTHER RATINGS  
★★ 6.0-6.9  
★ 5.0-5.9  
■ 7.0-9.9  
■ 5.0-6.9  
■ under 5.0

### Contents

Overview	3-12
✓ Recommendations Chart	3
Power/Usability Chart	5
Ratings Analyses	13-19
Program Reports	20-31
Performance/Quality	32-40

# If you need statistical software, this is a statistic you should know.

SYSTAT is rated #1 by Software Digest®. In fact, SYSTAT is the only statistical analysis package to receive top honors from InfoWorld, PC Magazine and PC Week. According to Software Digest: "It is the only program that successfully blends robust features, good usability and performance, and many areas of uncommon strength from analytical graphs to powerful programming."

SYSTAT. The statistics speak for themselves.

For more information call or write: SYSTAT, Inc. 1800 Sherman Avenue, Evanston, IL 60201-3793 Tel. 708.864.5670 Fax: 708.492.3567



For international representatives call: Australia 61.3.8661766, Canada 416.424.1700, Denmark 45.64.406575, Finland 358.0.6923800, France 33.1.40935000, Germany 49.61.265950 (DOS), 49.30.310423 (Mac), Italy 39.587.213640, Japan 81.33.5902311, New Zealand 64.71.562675, Norway 47.3.892240, Sweden 46.7.6076207, Switzerland 41.31.416611, The Netherlands 31.340.266336, UK London 44.81.6926636.

©1991 SYSTAT, Inc. Software Digest is a registered trademark of NSTL, Inc.

For IBM/compatible information circle 125; For Macintosh information, circle 126 on Inquiry Card.

**Listing 3:** The QuickBasic equivalent of the program in listing 2.

```

DATA 5
DATA Alice, 54
DATA Brian, 30
DATA Charles, 100
DATA Debby, 47
DATA Ethel, 78:
TYPE Student                                !user-defined
                                           !record type

    FirstName AS STRING * 9
    Mark AS INTEGER
END TYPE
READ Size%
$DYNAMIC                                    !arrays to follow
                                           !are dynamic

DIM Class(1 TO Size%) AS Student           !typed array
DIM Rank(1 TO Size%) AS INTEGER
I% = 0
DO UNTIL I% = Size%
    I% = I% + 1
    READ Class(I%).FirstName
    READ Class(I%).Mark
    Rank(I%) = I%                            !initialize Rank
LOOP
LET K% = 0
LET Swaps% = 1
DO UNTIL Swaps% = 0
    LET Swaps% = 0
    LET K% = K% + 1
    FOR J% = 1 TO Size% - K%
        IF Class(Rank(J%)).Mark < Class(Rank(J% + 1))
            Mark THEN
                SWAP Rank(J%), Rank(J% + 1)
                LET Swaps% = Swaps% + 1
        END IF
    NEXT J%
LOOP
FOR K% = 1 TO Size%
    PRINT Class(Rank(K%)).FirstName;
           Class(Rank(K%)).Mark
NEXT K%
END
    
```

**Who Uses It?**

You can customize operating-system commands with macros written in BASIC. Many laboratory instruments also have an understanding of BASIC. Art Ramirez, a low-temperature physicist at AT&T's Bell Laboratories, measures magnetic and thermal effects occurring during experiments on superconductivity. He writes controllers for various devices such as voltmeters, using either GWBASIC (QuickBasic's predecessor) or TBASIC (a version of True BASIC from a company called TransEra). His instruments "understand" BASIC, he finds it quick and easy to use, and he feels no need for anything fancier. The True BASIC company sponsors a group that distributes shareware among engineers and others who might be interested in scientific applications.

Thousands of commercial programs have been written in BASIC by people with good ideas but little programming experience. What do you do when a program needs upgrading but is written in a version of BASIC that's no longer supported by its distributor? Ah, there's the rub—in any nonstandardized language, not just BASIC. The hodgepodge of BASICs appears to have

settled down to two major contenders: the standardized, simple True BASIC and QuickBasic, which has many more features. Either one has enough structures to program some pretty serious applications.

**Why So Many Different Languages?**

In this series, I have looked at six language survivors from the 1960s. There are other, newer languages as well: C, Ada, Prolog, and ML, to name the most popular ones. To address the question of why so many languages, I suggest looking at a book by Thomas Kuhn called *The Nature of Scientific Revolutions* (University of Chicago Press, 1962).

The book was controversial because Kuhn claimed that a scientific notion was valued as much because of the group of people who found it useful as because of any intrinsic merit it might have. He traced new paradigms from the breakdown of older ones. Among programming languages, BASIC arose because of the breakdown of FORTRAN and ALGOL.

Peter Wegner of Brown University has extended Kuhn's notion of paradigms to programming languages. Part of his motivation in doing this was to provide some kind of order in the general babel of languages and dialects. He divides language paradigms into two broad categories: imperative and declarative. An *imperative* language is one that facilitates computation by means of state changes. A programmer is responsible for making assignments that change the state of a computer's memory. A *declarative* language is one in which a programmer submits a relation or function to be realized and a computer figures out how to do it.

Each of the two paradigms has three subcategories; among imperative languages are those that are block structured, object based, and supportive of concurrency. Declarative languages include those that are logic based, functional, and database specific. Of the older languages covered in this series, FORTRAN and COBOL are imperative, while Lisp, SNOBOL, and APL are declarative. None serves as a very good example of a subcategory, as newer languages have implemented these particular features better.

Each language has a devoted community that was, possibly, attracted away from an earlier language. These practitioners communicate with each other and collaborate on work using the preferred language of their group. Number-crunching scientists and engineers use FORTRAN, businesses use COBOL, novices and those looking for quick-and-easy programming use BASIC, AI researchers use Lisp, those in the humanities prefer SNOBOL, and systems analysts use APL for building experimental systems. Any of these groups may be attracted to a new language, but, as Kuhn points out, "retooling is an extravagance to be reserved for the occasion that demands it."

There are those who predict that programming will settle down into a few widely used languages—C superseding FORTRAN, Ada replacing COBOL and attracting some FORTRAN users, and Common Lisp becoming the language of choice for all functional programmers. You need only attend one or two computer conferences to find a vociferous group advocating the demise of BASIC. But members of each community appear to be pretty content with what they have, so don't look for consolidation anytime soon. ■

*Doris Appleby writes about mathematics, computer science, and pedagogy. She is also the chairperson of mathematics/computer science/information systems at Marymount College in Tarrytown, New York, and the author of Programming Languages—Paradigm and Practice (McGraw-Hill, 1991). You can reach her on BIX clo "editors."*



# WOULD YOU get on board any SYSTEM THAT only takes you 80% OF THE WAY?



THE WORST TIME to discover that you can't complete a critical application is when you're in the middle of it.

YET IT HAPPENS. Why? Because professional developers have never had a comprehensive, high-level system designed to build even the most complex applications. Never, that is, until PROGRESS.

THE PROGRESS APPLICATION Development Environment is built by developers, for developers. It provides everything you need for the fast, easy creation and execution of strategic applications—from prototype right through to delivery.

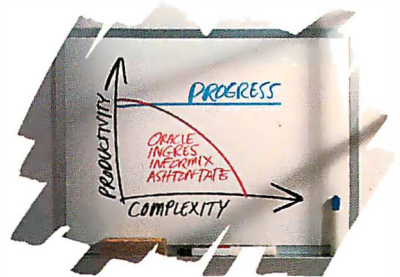
How? PROGRESS GIVES you the most flexible 4GL and relational database system available, including ANSI standard SQL. It's specifically designed to do 100%

of the job, enabling you to build industrial-strength applications with a single, high-level language. Without resorting to unproductive third-generation languages.

THE SEAMLESS PROGRESS environment gives your application the flexibility to run on almost every major platform. And to connect to most network protocols and other databases. This ensures portability and interoperability in an ever-changing heterogeneous environment.

THAT'S WHY, IN the last three Datapro Surveys and the latest VAR Business Report Card, developers rated PROGRESS #1 in virtually every category, ranging from ease of use and data management to customer support and documentation.

CALL 1-800-4-PROGRESS for survey results or how you can get a fully functional test drive. Because when you're dealing with serious applications, getting less than 100% from your system won't fly.



*The PROGRESS Application Development Environment maintains productivity during complex applications while others cannot.*

PROGRESS applications are fully portable across the broadest spectrum of hardware platforms, operating systems, networking protocols and user interfaces. So many, in fact, that we had to list them here in small type: AIX™, A/UX™, BTOS®, OS/2®, UNIX®, ULTRIX™, VMS™, XENIX®, DECNET™, LAN MANAGER™, NETBIOS™, NOVELL® NETWORKS, TCP/IP, MICROSOFT® WINDOWS™, and the X WINDOW SYSTEM™. Also, PROGRESS lets you process information in other databases, including ORACLE, Rdb and RMS.

PROGRESS is a registered trademark of PROGRESS SOFTWARE CORPORATION. All other trademarks and registered trademarks are the property of their respective manufacturers.

BYTADV03



# SCALING THE MEMORY PYRAMID

The balance of different types of memory and storage in a computer system goes a long way toward determining its performance

BOB RYAN

Consider the throughput of a hypothetical RISC-based workstation that can execute one machine instruction per clock cycle. With a 25-MHz clock, it could spit out 25 million 32-bit results every second, with a throughput of 100 MBps.

To keep the CPU of such a system operating at full speed, you need a memory system that can load one instruction and two operands and store one result every clock cycle. That's four 32-bit pieces you would have to move each cycle, which translates into a potential required bandwidth of 400 MBps.

Today, there are no desktop-class machines with memory systems capable of such bandwidths. The stumbling block is not so much technical as it is economic: High-speed memory systems are expensive, and they exhibit a price/performance curve that has more in common with an exponential function than with a linear one. The challenge in designing or purchasing a desktop system is to balance the conflicts between optimal memory design and cost.

This State of the Art section examines computer storage and how it relates to performance. This article provides an overview of today's computer storage systems and how they are likely to evolve in the near future. In "What to Stash in a Cache," Steven J. Vaughan-Nichols takes an in-depth look at the most common method used to expand the major bottleneck in most computer systems: the processor-to-main-memory interface. In "Storage Management," Mike Robinson examines the issues you'll confront in the brave new world of network-based storage and archiving. And in "Embedded Intelligence," authors Rod Kirk, Tim Christianson, and Danial Faizullahoy explore the growing intelligence found in mass-storage systems.

## The Great Pyramid

Computer storage is anything but monolithic. In a typical system, you can easily have four or five different types of storage, from the registers that feed a processor's functional units to the tape drives that back up the hard disk.

Although each type of storage has its own functions and

characteristics, each is also bound to the others in a coherent memory system. This system is designed to keep the processor as busy as possible by supplying it with required information (i.e., instructions and data) in a timely manner.

The relationships between the different types of memory can best be viewed as a pyramid. The base of each segment represents its relative size in comparison to the other storage types. Its height represents its relative speed (higher equals faster) and cost (higher equals more expensive). Figure 1 shows the memory pyramid for a typical 486-based desktop computer.

Storage technologies do not advance in lockstep. Memory speeds do not increase at the same rate as processor speeds, and processor speeds, in turn, do not directly relate to the speed of drives. As a result, the relative contribution of each type of storage in an optimal memory system changes almost daily.

## Ultimate Storage

The ultimate destination of the contents of any computer storage medium (e.g., memory, hard disk, and tape) is the processor. It executes the instructions, massages the data, and produces the results.

The processor's actions take place in its functional units, which can include an ALU, an FPU, or perhaps a vector-processing unit. However, before

## Scaling the Memory Pyramid

BY BOB RYAN

160

## What to Stash in a Cache

BY STEVEN J. VAUGHAN-NICHOLS

175

## Storage Management

BY MIKE ROBINSON

183

## Embedded Intelligence

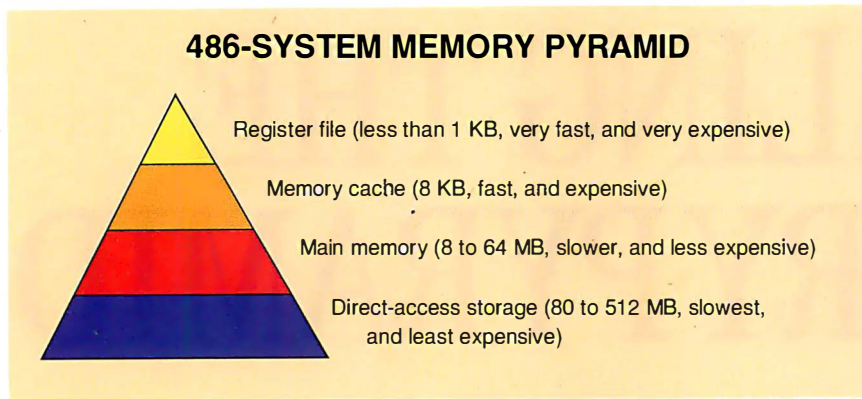
BY ROD KIRK, TIM CHRISTIANSON,  
AND DANIAL FAIZULLABHOY

195

## Resource Guide: Storage for Networks

204





**Figure 1:** The memory pyramid for a typical 486-based system consists of four layers. The processor-register file is the smallest (under 1 KB) and the fastest (10-nanosecond access) form of storage on the system. In contrast, the hard disk might store 200 MB (200,000 KB) but require 15 milliseconds (15 million ns) on average to access its contents. On the other hand, the hard disk might cost you less than half a cent per KB, and you can't get the processor registers for less than several hundred dollars per KB.

an instruction can invoke such a unit and before the unit can massage the data, the processor must retrieve the instruction or data from memory and store it in the registers. Processor registers provide the capstone of the memory pyramid.

Although instructions and data share the same memory, they often take different paths to a register. Some processors use a full Harvard architecture, which features separate paths from memory to the processor for instructions and data. Other designs use a common pathway to the processor but send the instructions and data to different internal caches.

The 486, on the other hand, stores both instructions and data in the same on-chip cache. Only when the processor moves the instructions to the instruction register and

the data to the general-purpose registers do instructions and data finally go their separate ways.

Registers are the final storage place for instructions and data before execution. A processor's register file is also the smallest (and thus most expensive) storage facility in a system.

The purpose of the memory pyramid is to get the proper instructions and data into the registers in a timely fashion. The main reason for the success of RISC-based computers over the past few years lies in their ability to keep the proper registers primed with data and instructions. RISC processors feature large register files and specialized fetch-and-store instructions that help to keep the registers filled with the proper data. The future will bring larger register files and greater use of RISC.

### Caching In on Main Memory

Below the processor registers on the memory pyramid lies the main memory system. On today's desktop computers and workstations, this system normally consists of the main memory store and one or two caches. One cache is usually located on the processor chip (the *primary cache*), and the other is off-chip (the *secondary cache*).

The processor-to-main-memory interface has always been the main performance choke point in stored-program-type computers. It's a choke point that is becoming progressively narrower.

As figure 2 shows, speed advances in the DRAM chips that make up main memory in personal computers and workstations have not kept pace with advances in processor clock speed. Thus, main memory

is more of a drag on processor performance today than it was in the earliest personal computers. As a result of this ever-widening gap, systems designers have turned to smaller, faster, and more expensive cache-memory techniques to keep the processor pipeline as full as possible.

The logic behind caches rests on the principle of locality. As explained by Hennessy and Patterson in *Computer Architecture: A Quantitative Approach* (Morgan Kaufmann Publishers, 1990), this hypothesis has two dimensions, a temporal one and a spatial one.

The principle of locality holds that a program (and thus a processor) tends to access memory items it has accessed recently—the temporal dimension. In addition, a program tends to access memory items located near the items it has accessed recently—the spatial dimension.

A cache, then, is a system that moves recently accessed items and the items near them to a storage medium (typically static RAM or processor RAM) that is faster than main memory's DRAM. Caches are classified by their speed, complexity, and size. Normally, the more complex the logic of the cache controller is, the smaller the cache you need.

Another way that you can differentiate caches is by how they update main memory. A *write-through cache* writes to main memory whenever a cached location is written to; a *write-back cache* writes to main memory only when a particular location is flushed from the cache. The former ensures constant coherency between the cache and main memory; however, its greater use of the memory bus could interfere with other cache-to-main-memory transfers.

Most high-end personal computers use a single cache: High-end 386 machines have off-chip caches, and 486 machines have caches integrated into the processor. In the future, personal computers will follow the lead of workstations and use two levels of caching: a smaller, faster primary cache and a larger, slower secondary cache. In general, caches will become larger and more complex; they must to keep pace with the increasing clock speeds of future desktop machines.

Another recent trend in personal computers is the use of virtual memory. Long a standard feature on Unix workstations, virtual memory lets you use part of your hard disk as main memory. Thus, you don't need to have enough main memory to hold all your executing applications and data at the same time.

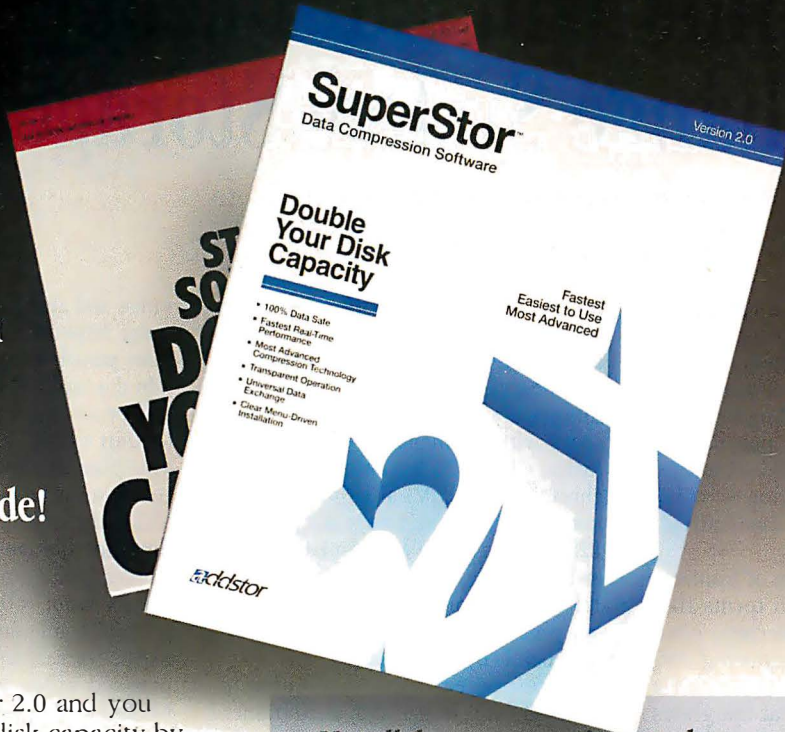
Virtual memory was developed at a time when main memory was more expensive than it is now. Today, however, virtual

## BYTE ACTION SUMMARY

Computer storage is anything but monolithic. A typical system can have four or five types of storage. The goal is to get the proper instructions and data into the registers in a timely fashion and to keep the processor busy. Some exciting ways of meeting that challenge are emerging.

# Data Compression of course, but Which One?

Why not go with the real-time data compression software being used by more PC users worldwide!



Just install SuperStor 2.0 and you instantly increase your disk capacity by 2-3 times! Then use your computer the way you normally do, no extra commands or keystrokes are required.

SuperStor 2.0 provides up to 25% greater compression than before! It's the fastest, most advanced product of its kind, with many unique features that make it more powerful, easier to use, and far more flexible than the competition. Just look at the chart to review SuperStor's numerous features—many of which are not offered by other compression products.

SuperStor 2.0 is not only the most powerful, it's the most user friendly, too! Clear, colorful graphic displays make installing and using SuperStor simple. And, SuperStor 2.0 runs with all popular operating systems and application programs.

So when choosing data compression, SuperStor is the one!

**For more information, please call  
1-800-732-3133.**

**AddStor**

3905 Bohannon Drive  
Menlo Park, CA 94025  
Tel: 800-732-3133 ■ Fax: 415-688-0466

AddStor and SuperStor are trademarks of AddStor, Inc. Copyright © AddStor, Inc., 1991. All rights reserved. Stacker is a trademark of Stac Electronics.

## Not all data compression products are created equal!

Compresses hard drives, RAM, floppy, and other removable media by an average ratio of 2:1, doubling your disk capacity!

Real-time on the fly data compression doesn't slow down your PC!

Universal Data Exchange allows compressed floppies or removable drives to be read and saved by any PC!

Fully integrated menu-driven software program offers ease of installation and operation!

Advanced Compression Utility Tool Kit scans, checks, and repairs compressed data!

Advanced Disk Optimization Utility defragments or consolidates compressed data for optimal disk performance!

Highest compression ratio of any data compression software (up to 25% greater with version 2.0!).

Automatically updates CONFIG.SYS on physical partition to further enhance transparent operation!

Dynamically adjusts drive capacity to fit more data on compressed disks with less effort!

Performance enhancing Disk Cache results in faster system performance!

Device driver easily loads high, maximizing conventional memory for RAM-intensive applications!

**SuperStor  
New Version  
2.0**

**Stacker  
2.0**

YES	YES
YES	YES
YES	NO
YES	NO
YES	NO
YES	NO
YES	NO
YES	NO
YES	YES
YES	YES

# How Will Multimedia Change System Storage?

DAVID SPRAGUE

**W**e are witnessing a revolution in the personal computer industry: the multimedia revolution. Multimedia enhances existing applications by adding rich data types (e.g., color photographs, motion video, and audio). It promises to create a new type of application aimed at group productivity rather than individual productivity.

Today, these new types of applications are described with terms like *workgroup computing*, *enterprise computing*, and *computer-supported collaboration*. Their goal is to provide a real-time environment that integrates multiuser, multisite production with information sharing. This information includes traditional forms of data as well as the video and audio data types found in multimedia.

As these new data types are incorporated into desktop computing, they will have an impact on nearly every component in the system—the CPU, memory, mass storage, expansion bus, network, and display. Of specific interest is multimedia's impact on memory and mass-storage components.

To fully integrate rich data types (particularly video and audio) into desktop computing, it is important to understand their nature and key characteristics. Unlike text and two-dimensional graphics, video and audio are time-continuous in nature: They are presented over a period of time at a specific, predefined rate. Such a constraint pre-determines two well-known characteristics of video and audio data: They are large and performance-sensitive.

## Digital Video

A typical spatial resolution for a digital motion-video window in a desktop application would be 320 by 240 pixels, or one-quarter of the screen at the standard VGA resolution of 640 by 480

pixels. The image quality of video at 320- by 240-pixel resolution is roughly equivalent to that of VHS video.

In most cases, video and photographic images are encoded in a YUV color space with luminance (Y) at full resolution (i.e., 320 by 240 pixels) and chrominance (U,V) at half resolution horizontally and vertically (i.e., 160 by 120 pixels). With 1 byte for each Y, U, and V sample, this gives an average of 1.5 bytes per pixel; that is, one Y byte per pixel, and one U byte and one V byte per 2- by 2-pixel array.

Therefore, each frame of video is 115,200 bytes in size and, at 30 frames per second, requires 3.5 MB of storage to hold 1 second of video. Because motion video contains a lot of redundancy, it can be compressed without significantly degrading image quality.

## Video Compression

You can achieve a compressed size of about 4.5 KB per frame with a compression scheme such as the Moving Pictures Experts Group (MPEG) standard (a draft standard for compressed digital video and audio that is targeted at playback from CD-ROM or other digital storage medium at an approximate data rate of 1.5 Mbps) or Intel's PLV (Presentation-Level Video).

After converting a 320- by 240-pixel image to YUV format, the compression ratio needed to condense the image to 4.5 KB is about 26 to 1. Audio data contains a lot less redundancy and cannot be compressed as much. It achieves a compression ratio of only about 4 to 1.

At these compression ratios, a CD-ROM or hard disk with a 500-MB capacity can store an hour of video and audio. The compressed data rate required for real-time playback at 30 frames per second is 135 KBps. This speed not only allows video and audio playback from disk but also makes

video and audio transmission via computer networks and T1 digital phone lines possible (see figure A).

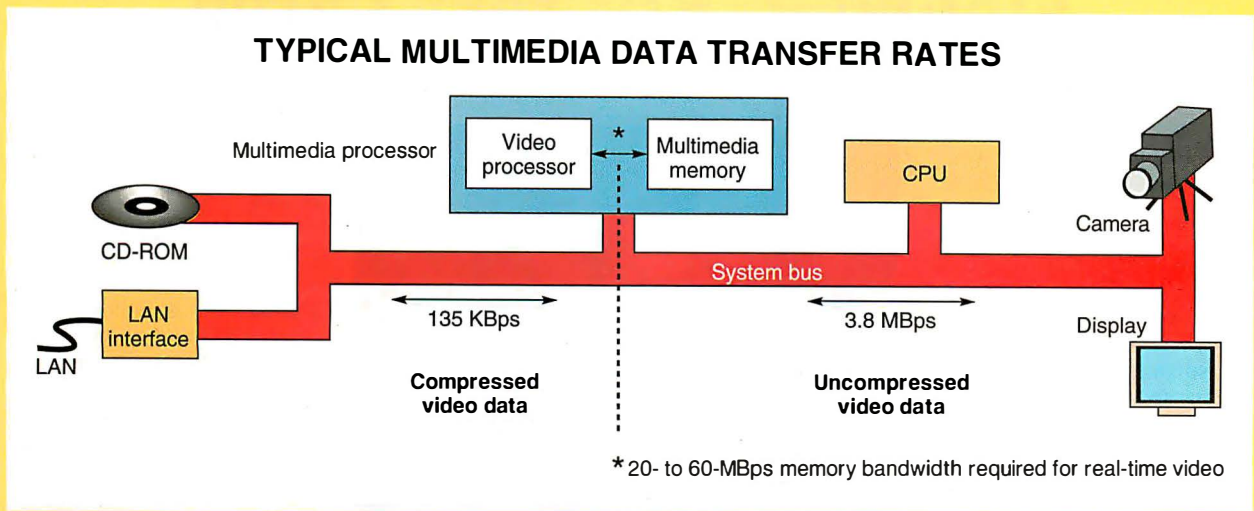
In the mid-1990s, motion-video resolution on desktop computers will start to shift to full-TV resolution (640 by 480 pixels). Because there are four times as many pixels on TV as on VGA, this resolution will require four times the storage needed for both compressed and uncompressed video. That's about 460 KB for each uncompressed frame and a data rate of 0.54 MBps for real-time playback of compressed video and audio. The ISO MPEG-2 standard, now in the early stages of development, is targeted at TV-quality video and near-CD-quality audio at a 0.5- to 1.2-Mbps compressed data rate.

The move from TV-quality to HDTV-quality video, with image sizes in the range of 1 million to 2 million pixels and compressed data rates of 2.5 to 5 MBps, will be delayed until the late 1990s because of economics as much as technical factors. With the low cost of NTSC and PAL video equipment and a profusion of source material, these formats will be slow to move to HDTV video for all but the most advanced desktop video applications.

## The Impact on Memory

The impact of multimedia on the memory subsystems of desktop machines will occur in the number and size of uncompressed video frames stored and, indirectly, in the increase in frame-buffer depth required to properly display video images. In a scheme such as MPEG, two to three frames of video are stored during the encoding or decoding processes, because the scheme uses interframe coding techniques (e.g., motion compensation).

Most early designs of video-accelerator chips will use a separate, dedicat-



**Figure A:** Multimedia processing moves data over the system bus in both compressed and uncompressed formats. The values given here are typical for one-way transfers on a single video stream. Applications such as video conferencing will require the system to simultaneously handle two streams of video information, doubling the bus traffic shown here.

ed block of memory (typically 1 to 2 MB in size) to store video frames and intermediate data created during the encoding and decoding processes. In the future, however, the trend will be to eliminate this separate memory store and use a portion of system memory for video and related data.

Although this use won't have a significant impact on memory size in 32-bit systems, it will adversely affect memory performance. The memory bandwidths required to process MPEG images are in the range of 40 to 60 MBps for compression and 20 to 30 MBps for decompression. MPEG-2 processing will almost quadruple that memory bandwidth requirement.

### Moving to More Colors

To properly present video and photographic-quality images, the frame-buffer depths must increase from the 4 to 8 bits per pixel used today to between 16 and 24 bits per pixel. Full photographic-quality displays require 24 bits per pixel—8 bits each for the red, green, and blue color components.

A 16-bit-per-pixel RGB format can display photographic-quality images with good but not perfect quality. Dithering is often used to eliminate contouring in the image. This is accomplished by masking the image with low-level noise.

Because most GUIs used today (e.g.,

Windows) store off-screen images in system memory, the storage and bandwidth requirements for GUI image data will increase by a factor of two to four as the frame-buffer depth increases.

### Massive Storage

The primary impact of multimedia on the mass-storage system will not be the size of the motion-video files. They are large but not unreasonably so, considering current trends in mass-storage density. Rather, the major impact will be in the performance sensitivity of continuous data types.

In particular, video and audio capture and playback are very sensitive to the continuous data rate and latency (as visible to the application) of the mass-storage device. If the video or audio data stream is interrupted, the resulting glitch in the playback is immediately noticeable.

You can manage interruptions in data delivery from the storage device by buffering the compressed data. This technique, however, introduces additional latency that can reduce the device's responsiveness.

### What About CD-ROM?

Although CD-ROM has a very attractive distribution cost per bit, it will only be useful in a subset of potential multimedia applications because it's a read-only device. In the enterprise comput-

ing environment of tomorrow, many of the databases containing reference material, application help, tutorial files, and multimedia clip art will be moved to a file server as a network resource.

The most common local mass storage will continue to be high-capacity and high-data-rate read/write devices. Improvements in operating systems and drivers will be required to provide high data rates, continuous streaming, and low latency at the application level.

### Pushing the Envelope

The integration of rich multimedia data types into the desktop computer will change our lives. Over the next several years, the systems architecture of the personal computer will undergo significant changes to incorporate these new data types.

The inclusion of video data, in particular will affect memory and mass-storage requirements because of video's continuous nature and large file sizes. Increases in image resolution and the requirements for multiple, simultaneous video streams will continue to push the capabilities of memory and mass-storage subsystems throughout the next decade.

*David Sprague is manager of video processors at Intel's multimedia products operation in Plainsboro, New Jersey. You can reach him on BIX c/o "editors."*

# Floppy—But Very Large

Once the only form of direct-access storage available for personal computers, floppy disks have become relatively less important in recent years than hard and optical disks. In the past, floppy disks were used for everything—program and data storage, archiving, software distribution, and data transport. Today, hard disks, tape, optical storage, and network servers have usurped most of these functions. Software distribution is the only area in which floppy disks still dominate.

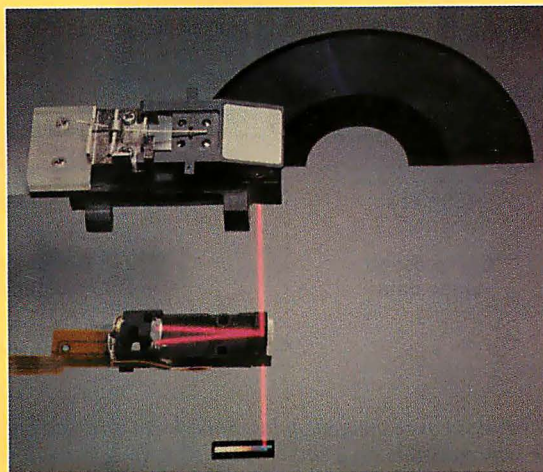
The problem isn't that floppy disks haven't increased in capacity over the years. On the contrary, they have shown a steady progression in capacity, from the 160 KB you got with the original IBM PC floppy disks to the 2.88 MB you can get today.

The problem is that floppy disk capacity has not kept pace with the massive size requirements of today's tasks (e.g., hard disk backup and program and data storage). In a world of hard disks that offer 100-MB capacity and word processors that take up 15 MB of storage space, a 1.44- or 2.88-MB floppy disk isn't terribly useful.

To enlarge the capacity of a disk, you can increase the linear density, the track density, or both. Increasing linear density means putting more bits on a track. Increasing the track density means cramming more concentric tracks into a limited area.

Increasing linear density was the tactic used to increase the capacity of 3½-inch floppy disks from 720 KB to 1.44 MB, and from 1.44 to 2.88 MB. In the latter case, Toshiba used a higher coercivity medium, barium ferrite, to double the number of bits you can store on each track. The Toshiba technology stores about 35,000 bits per inch.

The second method of enlarging disk capacity—increasing track density—has not yet been applied to floppy disks. With high track densities, you need a mechanism that will detect when the head is not aligned exactly over a spe-



*This Floptical drive system uses optical elements to split and focus the positioning light beam. One beam is directed upward to the disk while the other goes to the linear encoder, which contains the pattern needed to determine the position of the low-density read/write head over the tracks of 720-KB and 1.44-MB floppy disks. Both beams are reflected to the quad detector. If the Floptical pattern is detected, the digital servo mechanism uses the information from the first beam to position the high-density head; otherwise, it uses the information from the second beam to position the low-density head.*

cific track. This requires a feedback mechanism that enables the drive to read positioning information directly from the medium. The lack of medium-based positioning information and a feedback mechanism is the reason why today's floppy disks are stuck at 135 tracks per inch.

## Making Tracks

Several companies have been working to develop technologies to increase the track density (and thus the storage capacity) of 3½-inch floppy disks. Brier Technology and Insite Technology have succeeded in boosting the capacity of floppy disks to over 20 MB.

The Brier Flextra system uses a low-frequency magnetic signal embedded in the medium to position the read/write head precisely over the intended track. Data recording uses higher-frequency signals, permitting the head to distinguish positioning information from

data. The one drawback to the Brier drive is that it can't read and write lower-capacity floppy disks.

The Insite drive uses optical techniques to position the read/write head over the proper track. The medium is embossed with servo tracks that create areas of higher and lower contrast. A light beam reflected off these tracks can find the necessary position of the read/write head over the medium. The use of optical positioning techniques gives this technology its name: Floptical. This technology has one advantage over Flextra: It can read and write conventional 720-KB and 1.44-MB floppy disks.

The Floptical system directs the positioning light beam to the servo tracks on a Floptical disk. When the detector senses the reflected pattern of a Floptical disk, it uses the beam to obtain positioning information. When it doesn't sense the Floptical pattern, indicating the presence of a non-Floptical disk surface, it switches to an alternative positioning system for the lower-density medium (see the photo).

Floptical technology uses magnetic recording technology to actually read and write the data; optical technology is used for positioning only. In fact, the Insite technology uses two heads: one for Floptical disks and one for conventional media. Because its read/write mechanism is larger than the Flextra's, an Insite drive has a seek time about twice that of the Flextra.

## Setting Standards

To be more than niche technologies, the Flextra and Floptical drives require the support of media makers, OEMs, and customers. Quantum sells Flextra drives under the QuadFlextra name, and Verbatim makes Flextra media.

Insite has gone further in lining up industry support for its Floptical technology. Early on, the company licensed its technology to Omega to provide a second source of Floptical drives, lined



up media makers 3M and Maxell, and arranged to have MKE manufacture its drives. Last year, these companies formed the Floptical Technology Association (FTA) to promote Floptical technology and maintain compatibility across media and drives from different manufacturers.

Since last spring, the FTA has garnered support from four SCSI adapter makers, including Adaptec, and from numerous drive OEMs, including Prima Storage Solutions, Liberty Systems, Commodore Technology, Honeywell IAC, and Procom Technology. The FTA believes the ability of Floptical drives to read conventional floppy disks will attract enough OEMs and customers to create a de facto standard.

## Handicapping the Race

At more than 20 MB, the capacity of Flextra and Floptical drives is sufficient to enable floppy disks to retain their preeminence as a medium for software distribution and to once again handle applications such as hard disk backup, data transfer, and program and data storage. The final determination of viability, however, rests with the customer.

Given its wider range of support among different companies and its backward compatibility with older media, Floptical technology stands the best chance of establishing itself as the standard for high-capacity floppy disks, but Flextra technology is not standing still.

Brier has announced a 50-MB version of Flextra that will be compatible with 720-KB, 1.44-MB, and 2.88-MB floppy disks. In addition, Flextra's overall performance is better than Floptical's, and that will attract customers to whom compatibility is a secondary issue.

The biggest question concerning very high capacity floppy disks is not which will establish itself as a standard, but whether either—or some other design—can succeed in the marketplace. The answer lies with you.

memory can defeat the purpose of a high-speed memory system.

If you paid a premium for a machine with fast primary and secondary caches, you should think twice about using virtual memory to extend your system's memory capacity. An access to a hard disk location is about 200,000 times slower than an access to a main memory location.

On the other hand, virtual memory can be a lifesaver if your need for memory outpaces your ability to pay for it. With virtual memory, as with other aspects of a memory system, you have to balance the benefits against the penalties.

## Disk Revolutions

The line between main memory and direct-access storage is the most significant one in the memory pyramid. Across this divide, access speed drops by a factor of several hundred thousand.

More important, direct-access storage is the first nonvolatile type of memory on the pyramid. You don't lose the contents of direct-access storage when you turn off the power on your system. These two factors determine the future evolution of hard disk technology, the most important current form of direct-access storage.

The most significant trends in hard disk technology today are increased capacity and security. Speed is important, but given the enormous gap between disk- and memory-access times, none of the advances on the horizon are likely to have much impact on the relative speeds of drives and memory.

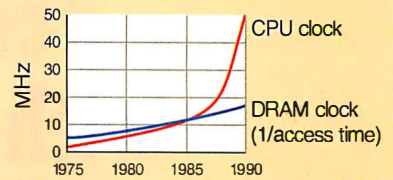
The name of the game in hard disks now is capacity. This is especially evident when you consider the storage-hungry technologies (e.g., multimedia) that are growing in importance on the desktop (see the text box "How Will Multimedia Change System Storage?" on page 164).

Capacity is a function of how tightly you can pack individual bits together on a track (i.e., linear density) and how closely you can pack tracks together on a disk surface (i.e., track density). Both these measures—and their combination, termed *areal density*—are primarily determined by the materials used to construct the disk.

Formerly, hard disks were coated with a crystalline form of ferric oxide called *gamma ferric oxide*. Particles in the coating were magnetized in the direction corresponding to the magnetic field created by the read/write head.

As the need for more tightly packed bits and tracks increased, so did the need for newer coatings. Ferric-oxide coatings reached their limits; they were too coarse to permit the bit information to be packed any more tightly.

## THE CPU/MEMORY GAP



**Figure 2:** The curves representing clock speed and memory speed have diverged markedly since the introduction of personal computers in the mid-1970s. This divergence points out the need for caches and other bandwidth-expanding techniques that let memory systems keep up with modern processors.

Today, most high-capacity hard disks use metallic thin-film coatings that let you pack the magnetic spots extremely close together. A typical high-capacity disk might have a linear density of about 60,000 bits per inch and a track density of between 1500 and 2000 tracks per inch.

Tightly packed recording spots increase both the difficulty in distinguishing one spot from another and the chance that nearby spots may alter a spot's polarity. To overcome the first difficulty, drive manufacturers have long used thin-film heads, which are more sensitive than monolithic ferrite heads.

Keeping one spot from influencing the polarity of another requires the use of materials with high *coercivity* (i.e., the measure of a material's innate resistance to changing its magnetic orientation). Using highly coercive thin films solves the polarity problem, but it introduces another. Highly coercive materials require a powerful induction field from the read/write head to change their magnetic orientation. Keeping this field from making unwanted changes in nearby spots requires a read/write head with a small inductive gap. A small gap, in turn, means that the head must travel very close to the medium, increasing the danger of a head crash.

Increasing the capacity of magnetic disks requires quite a balancing act. Each increase in track or linear density resulting from advances in the materials used requires corresponding advances in the read/write heads and in the servo mechanisms that control them.

Despite these difficulties, the growth in disk capacities will continue unabated for the foreseeable future. For example, Hitachi is already investigating the use of materials that will permit linear densities of 120,000 bpi, and IBM is researching

# Terabyte Memories with the Speed of Light

RICHARD MARLON STEIN

The mechanical speed of current mass-storage systems has not kept pace with silicon advances. The I/O bottleneck arising from this mismatch severely limits expedient access to vast data archives that need distillation for research or business purposes.

Within the next seven to 10 years, three-dimensional optical-based RAMs will emerge. With an I/O bandwidth exceeding 1 terabit per second, 3-D ORAMs will eventually replace huge disk farms and other mechanically dependent mass-storage structures.

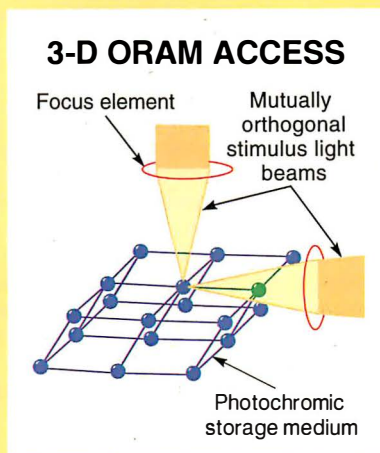
The theoretical storage-density limit for a 2-D medium (e.g., an optical disk) is  $1/\lambda^2 = 4.0 \times 10^8$  bits/cm<sup>2</sup> or 50 MB/cm<sup>2</sup>, assuming a 0.5-micrometer (10<sup>-6</sup>-meter) illumination source to address the information. For 3-D storage (e.g., a 3-D ORAM), the theoretical storage density limit is  $1/\lambda^3 = 8.0 \times 10^{12}$  bits/cm<sup>3</sup> or 1 terabyte/cm<sup>3</sup>. With 20,000 times the theoretical storage density of 2-D media, the 3-D ORAM technology clearly has a substantial advantage in capacity.

The 3-D ORAM prototypes currently under development at the University of California at San Diego and at Irvine use a small cube (1 cm<sup>3</sup>) of material composed of transparent styrene doped with a light-sensitive chemical (see references 1, 2, and 3).

When two polarized, coherent, and orthogonally oriented light beams simultaneously strike the material, a bit is recorded at their intersection in the form of an opaque dot, or pixel. The finer the light beams are, the smaller the bit becomes. The light beams can be focused to 1 micrometer, resulting in a recording density over 1000 times that of optical disk media.

## Unparalleled Bandwidth

Access speed is another important characteristic of storage systems. The typical hard drive consumes about 10 mil-



**Figure A:** 3-D ORAMs record information through the excitation of a photochromic chemical dopant. To read a bit, two photons of 1.03-micrometer wavelength provide the necessary stimulus when they strike a data bit.

liseconds during armature and head movement before reaching an arbitrary location for reading or writing.

DRAM is much faster than a hard drive, with a cycle time approaching 80 nanoseconds. Static RAM is faster still, with cycle times in the range of 20 ns, but it's also more expensive.

In contrast to these relative infinities of time, you can read or write 3-D ORAM in as short a time as 10 to 20 picoseconds (10<sup>-12</sup> seconds). This is over 1000 times faster than conventional semiconductor memories.

Furthermore, you don't access 3-D ORAMs to read or write from 1 to 32 bits at a time, as you do with standard silicon memory chips and microprocessor subsystems. You write 3-D ORAMs in a highly parallel fashion, simultaneously accessing 1 million bits of data or more in each cycle (about 1 microsecond).

To put these figures in perspective,

I'll compare them with the total memory bandwidth of a parallel-processing system containing 1000 processors, such as the newly announced CM-5 from Thinking Machines (Cambridge, MA). Assuming a 64-bit word cycle and an 80-ns memory cycle, a total memory bandwidth of 100 gigabytes per second would be possible for the 1000-processor parallel-processing system. A single 3-D ORAM can address 1 Mb every 5  $\mu$ s, for a memory bandwidth of 25 GBps.

## Storage Through Chemistry

The storage medium for 3-D ORAMs records information through the excitation of a photochromic chemical dopant called *spiobenzopyran*. When this molecule absorbs two photons of 0.538-micrometer wavelength (visible light) simultaneously, it changes color (much like light-sensitive sunglasses that darken on exposure to direct sunlight) and records a bit (see figure A).

To read a bit, two photons at the infrared wavelength of 1.03 micrometers provide the stimulus by striking the pixel. The read process is nondestructive, and the data remains intact.

The material used to store the information is susceptible to environmental conditions. The bits can randomly flip when exposed to room temperature, destroying the information content. When immersed in liquid nitrogen or dry ice, 3-D ORAMs can retain their information for weeks. Eventually, a more durable chemical dopant will be found that can withstand temperate environments without losing data.

## Address of Exotic Ingenuity

The eventual incorporation of the 3-D ORAM technology into standard computing systems hinges on the emergence of practical address-control mechanisms. DRAMs have chip-select and output-enable lines that control the dissemination of data and access to any

point in memory. A 3-D ORAM requires analogous support and control circuitry. The control lines are not fashioned from copper wire, and the signals are not electrical: They are electro-optical.

A key element of the address-control mechanism is the dynamic focusing lens, which contains filters stored as holographic images. Each filter selectively interferes with the output light field emanating from a 2-D array of pixels. This array is illuminated by a coherent light source (a laser) tuned to the storage medium's read or write wavelength. The DFL may contain several dozen holographic filters.

The filters continuously cycle, like the flickering frames seen in old moving pictures, but the holographic frames flash by at 1 MHz, not 24 Hz. The DFL cycle speed provides the limit of the speed at which information can transfer into and out of the 3-D ORAM. The filters are constructed from random-phase holograms, and the 3-D images they project do not resemble the neat creatures seen in *Star Wars* or those built by the MIT Media Lab.

As each plane of pixels (i.e., a planar slice through the storage medium) is illuminated, the current DFL filter permits a select portion of the 1 million or more visible pixels to pass through. A detector assembly registers them as bits of data. Each time a new DFL filter is active, a unique area of the pixel array is mapped onto the detector and assigned to semiconductor RAM for processing.

The detector may consist of an array of 256 by 256 photo transistors, like those used to convert fiber-optic Fiber Distributed Data Interface signals into electrical impulses for electronic digital processing.

Because a detector organized as 256 by 256 elements contains 65,536 elements, the DFL maps 1 million pixels (1 megapixel) simultaneously into the detector array. It uses a multiplexing process strobed to the holographic-filter cycle. Mapping a 1-megapixel plane into a 65,536-detector array requires the DFL to store 16 unique holographic patterns.

The detector assembly may eventually be fashioned from thousands of microlasers, each about 2 micrometers in diameter (see references 4 and 5), rather than discrete photo transistors.

## Right Write

One additional element of the electro-optical address-control mechanism is an active device called a *spatial light modulator*, which alters the polarization of the light beams used to write the pixels. When the two incident light beams intersect, the amount of energy they deposit at a particular pixel address in the storage medium is determined by the superposition of the polarized photons. At that point, the SLM alters the light-beam polarization to achieve a constant intersection amplitude, making certain that a bright pixel is written.

Constructed from liquid crystals and a combination of rare earth metals (e.g., zirconium and lanthanum), the SLM element is a vital component that contributes to the success of the 3-D ORAM.

## Ponderous Implications

The projected cost for 3-D ORAM with terabyte capacity ranges from \$10 per MB for a 1- $\mu$ s access cycle to 10 cents per MB for a 100- $\mu$ s to 1-ms access cycle. A terabyte of storage with 3-D ORAM ranges in cost from \$10 million for a 1- $\mu$ s access cycle to \$100,000 for a 100- $\mu$ s to 1-ms access cycle. Compared to DRAM, which ranges from \$100 per MB to \$30 per MB for an 80-ns access cycle, 1 terabyte of DRAM would cost \$30 million.

## REFERENCES

1. Hunter, S., F. Kiamilev, S. Esener, D. A. Parthenopoulos, and P. M. Rentzepis. "Potentials of Two-Photon Based 3-D Optical Memories for High Performance Computing." *Applied Optics*, vol. 29, no. 14.
2. "Incredibly Small Box, Incredibly Large Memory," *New York Times*, 2 Sept. 1991, sec. A, p. 37.
3. Pollack, Andrew. "The Hologram Computers of Tomorrow." *New York Times*, 9 June 1991, sec. F, p. 9.
4. Jewell, J. L., J. P. Harbison, and A. Scherer. "Microlasers." *Scientific American*, November 1991.
5. Markoff, John. "Bell Labs Laser Said To Be World's Tiniest." *New York Times*, 8 Nov. 1991, sec. C, p. 4.

*Richard Marlon Stein is a freelance writer with a particular interest in parallel processing. You can reach him on BIX c/o "editors."*

magnetoresistive heads that will let you access nearly 2 Mb per square millimeter.

The next few years will also see advances in disk subsystems, which will sport more intelligent controllers (see "Embedded Intelligence" on page 195). You will also see more fault-tolerant disk subsystems. Technologies such as redundant arrays of inexpensive disks and Compaq's Intelligent Drive Array will ensure that you will not be caught off guard if your multigigabyte disk system goes on the blink.

Another important form of direct-access storage over the next few years will be optical read/write storage that uses magneto-optical technology. MO drives feature removable media that let you move a disk from one machine to another. Although plagued by incompatible media in the 5/4-inch format, developers hope that adherence to a common 3/2-inch format will make MO technology more attractive.

MO technology is best suited to situations that require high capacity without high-speed access. Optical read/write heads are more massive (and slower) than magnetic heads. Even though you wouldn't want your database server to use MO disks, less time-critical applications can make good use of their large storage capacities.

One last direct-access technology that could have an important impact over the next few years is solid-state disks. These are actually not disks at all but simply DRAM that emulates a drive and has its own power supply. Solid-state disks are much faster than conventional disks because they are completely electronic. They sometimes come with a conventional tape or drive to back up the DRAM.

Although solid-state disks have a place in situations where speed is everything, don't expect them to cross the price/performance threshold that would make them more attractive than magnetic media. Most people who predict the imminent demise of magnetic media discount the evolving nature of the technology.

If magnetic media were not making progress, you could make a case for the widespread acceptance of solid-state media, but that isn't the case. More likely, you'll see greater use of caching controllers to improve access times for magnetic media. This is the most important contribution DRAM technology can make to disk performance.

## Gathering and Dispersing

As more workgroups, departments, and companies adopt networking technology to link individual workers, protecting data from accidental or malicious loss becomes increasingly important. Magnetic tape will

## SCALING THE MEMORY PYRAMID

**K**ingston's memory upgrade products offer a variety of solutions for enhancing **Silicon Graphics** workstations including:

### Personal IRIS

- 4D/30, 35
- 4D/RPC Indigo
- 4D/20, 25

### Professional IRIS

- 4D/40, 50, 70, 80

### Power IRIS

- 4D/100—400 series

All Kingston memory enhancements are individually tested, fully warranted, and 100% compatible.

For more information call Kingston today at:

**1-800-835-2545**

Ph. 714-435-2667

Fax 714-435-2699

Manufactured by

**Kingston**  
TECHNOLOGY CORPORATION  
17600 Newhope Street  
Fountain Valley, CA 92708

**Silicon Graphics Memory**



remain the technology of choice for the archival protection of information. The struggle among different formats (e.g., quarter-inch cartridge and 4-mm and 8-mm tape) will ensure increasing capacities and decreasing prices.

What will be different in archival storage in the future will be the intelligence of the backup systems. Archival systems will be integrated into a comprehensive storage management system that automatically makes frequently accessed files readily available and stores less frequently used files on slower media (e.g., tape or WORM drives).

Such a scheme makes the best use of faster, more expensive direct-access media while retaining access to information that is not often needed. This kind of intelligent distribution of backup is especially important in networking situations, where you can easily overburden a file server.

One of the primary causes of the growing need for more main memory and direct-access storage is the sheer size of the program and data files that today's applications require. The search is under way for a more efficient and effective way of distributing programs and data.

Given the size of current applications—with their attendant tutorials, help files, printer drivers, and so forth—it isn't unusual to find a dozen floppy disks in an application package. This increases the cost of the package and makes installation more prone to error.

Recently, some companies have tried a number of alternatives to floppy disk-based distribution. When first introduced, the Next machine came with a standard MO drive, and many companies, including Next, distributed software on compatible MO disks. The lack of an MO standard format and the absence of any significant market penetration by MO disks in general make this form of distribution of questionable value for the industry at large.

A more promising technology for program and data distribution is CD-ROM. Unlike MO, the CD-ROM has a strong foundation of data-format standards that are recognized industrywide. Thus, you can be reasonably certain that your CD-ROM drive (no matter what its make) will be able to read CD-ROM disks, given the proper interface software and driver.

Companies such as Apple and Microsoft have taken advantage of the standardization in CD-ROM players by distributing systems software to developers on CD-ROM. Unix software publishers are also turning to CD-ROM in increasing numbers in preference to the more traditional tape-based distribution.

Presently, CD-ROM is best used as an

information-distribution medium. With a capacity of over half a gigabyte, it is the preferred medium for distributing data-intensive applications. The availability of large databases is driving the broad penetration of CD-ROM drives in the marketplace, which will further spur the use of CD-ROM by traditional developers.

Other storage media commonly used for data distribution are magnetic tape, WORM, and removable hard disks, such as those made by Iomega. The problem with these media is the same lack of standards that plagues MO technology.

In the future, wide-scale distribution of programs and data will remain the province of floppy disks and CD-ROM. Recent advances in floppy disk technology will make it more attractive for this function (see the text box "Floppy—But Very Large" on page 166), and new, higher-capacity CD-ROM standards will greatly add to the utility of this technology.

Adherence to the new standards for 3½-inch MO media may avoid the polyglot of formats that crippled larger MO formats as a distribution medium and add MO technology to the list of widespread distribution media as well.

### Storage Plus

The next few years will see the introduction of 16-Mb DRAMs, 2½-inch hard disks with capacities exceeding 250 MB, standardized MO formats, and perhaps a new CD-ROM format. More important, you will see increased complexity in the bandwidth-enhancement schemes used to keep processors running at capacity. The recent announcement from DEC that it is clocking its new Alpha RISC chips (manufactured on its standard production line) at 200 MHz underscores the importance of techniques that keep pipelines full.

In the future, you may see entirely new forms of storage emerge for desktop systems. The most promising of these alternative technologies is holographic storage, which can not only store incredible quantities of data but also avoid bandwidth problems by eliminating buses entirely (see the text box "Terabyte Memories with the Speed of Light" on page 168).

Semiconductor memory and magnetic direct-access storage will continue to dominate the memory pyramid. Faster and higher-capacity generations will be produced to keep up with the bandwidth requirements of processors. In the end, however, it will be the intelligently designed and executed memory systems that will keep processors from gasping for data. ■

*Bob Ryan is a BYTE technical editor. You can reach him on BIX as "b.ryan."*

# Before You Upgrade To MPC, Listen To This.

## BYTE

USER'S COLUMN

### Sound Blaster

One of the boards we installed in the Arche 486 was Sound Blaster. With its associated software, it has quietly (no pun intended, but what the heck) become the standard sound system for advanced PCs. The Roland board has much higher sound quality for a higher price, but for anything short of professional music quality, Sound Blaster is good enough.

One use, of course...

There are lots of other accessories you can get for Sound Blaster, including musical instrument software and a voice editor. Sound Blaster has become the standard sound board, if not for the industry, at least here at Chaos Manor. Recommended.

Jerry Pournelle

## PC GAMES

### SOUND BLASTER PRO

By Barry Brenesal

The Marines may look for a few good men, but any PC game player will gladly settle for a single good sound card: one that plays both Sound Blaster and AdLib scores, one that doesn't fry your other boards, one that never draws attention to itself, one that delivers all the sophisticated sound effects and music bundled into the latest batch of game software.

Look no further: Sound Blaster Pro does it all, and more. At \$299.95 it's not cheap, but neither are its features.

Testing: One, Two . . .

Installing Sound Blaster Pro is a snap. The 16-bit card slips easily into place. It comes with a test . . .

Trying out Sound Blaster Pro is a treat. It's got great frequency response — that's the difference between listening to a film score on a tinny, muffled AM radio and hearing it on a stereo movie-theater speaker system. The orchestral soundtrack to Origin's Wing Commander is a good example, because it changes mood and melody to match the success of your current battle. Add Sound Blaster Pro to a good VGA screen and a responsive joystick (which you can plug into Sound Blaster Pro's joystick port), and the illusion of dogfighting aliens in a George Lucas-style film becomes 3-D, symphonic reality.

Another plus is the absence of the annoying background hiss that . . .

In short, Creative Labs' Sound Blaster Pro is a big winner. It's quick to install, easy to use, full-featured, and compatible with Sound Blaster and AdLib files. Signal response is excellent. And don't forget about . . .

## COMPUTE

### SNEAK PEEKS

### SOUND BLASTER PRO

In just two years, the Sound Blaster has become one of the most widely-supported PC sound cards.

It's easy to see why. The Sound Blaster contains an 11-voice FM synthesizer that makes it fully compatible with the popular Ad Lib Music Card. The day it hit store shelves, the Sound Blaster could be used with hundreds of Ad Lib compatible games and educational programs. To add even more value, the original Sound Blaster included a DAC (Digital to Analog Converter) for digitized voice and sound effects, a microphone jack for voice input, a built-in game port, a built-in 4-watt amplifier, and an optional MIDI interface.

The built-in mixer makes the Sound Blaster Pro fully compliant with Microsoft's Multimedia Level 1 Extensions to Windows. Multimedia software will be able to fade-in, fade-out, and pan the various audio sources to create elaborate sound montages.

The Sound Blaster Pro includes a CD-ROM interface for either an internal or external CD-ROM player.

There's also an internal connector for CD-Audio. The MIDI interface is compatible with the original Sound Blaster's MIDI interface, but adds the MIDI time-stamp that's part of Microsoft's new multimedia standard.

All in all, the Sound Blaster Pro is chock-full of new features, yet it's fully compatible with its younger brother.

DAVID ENGLISH

Scheduled Release: September 1991  
For IBM PC and compatibles—\$299.95

CREATIVE LABS  
2050 Duane Ave.  
Santa Clara, CA 95054  
(408) 986-1461

PC HOME JOURNAL

### SOUND BLASTER DOES IT ALL

Review by Harvey Bernstein

**T**

he Sound Blaster has so many audio applications packed into one half-sized board that it almost boggles the mind. First, it has an 11-voice stereo music

synthesizer that is fully compatible with the widely used AdLib sound format. Older software that only supports the AdLib board will automatically turn on the AdLib mode — no adjustment by the user is necessary. A separate channel is exclusively for reproducing digitized speech. A microphone jack on the back of the card allows you to digitize your own input voices. With a 4-watt stereo amplifier built in, you can run speakers or headphones directly from the card — no additional amplification is necessary. A standard joystick port also doubles as a MIDI interface, allowing you to connect a synthesizer or any other MIDI instrument. Combine this with an excellent library of software, and it is easy to see why the Sound Blaster has become so popular.

The Sound Blaster Pro is the Sound Blaster worth the investment? Yes, yes, a thousand times yes!!! When you hear how much the Sound Blaster increases the capabilities of your PC, you'll wonder how you ever got along without one.

PC

Now you can get the number one sound card as part of our new Multimedia Upgrade Kit. Which also comes with a MIDI kit, an internal CD-ROM drive and 5 CD-ROM titles, including Microsoft® Bookshelf® and Windows™ with Multimedia Extensions. In all, \$2,000 worth of goodies for just under \$850.

So before you get into multimedia, call 1-800-544-6146 or see your dealer. You'll like what you hear.

CREATIVE LABS  
**SOUND  
BLASTER PRO**



Creative Labs, Inc., 2050 Duane Ave., Santa Clara, CA 95054 Telephone: (408) 986-1461 Fax: (408) 986-1777 For international information, fax Creative Technology at (65) 773 0353. Sound Blaster is a registered trademark of Creative Labs, Inc. Windows and Bookshelf are registered trademarks of Microsoft Corporation.

Circle 146 on Inquiry Card.

# How Can A Direct Supplier Like Northgate® Give You Superior LAN Solutions And Support?



## **Like Machu Picchu, Some Phenomena May Never Be Explained.**

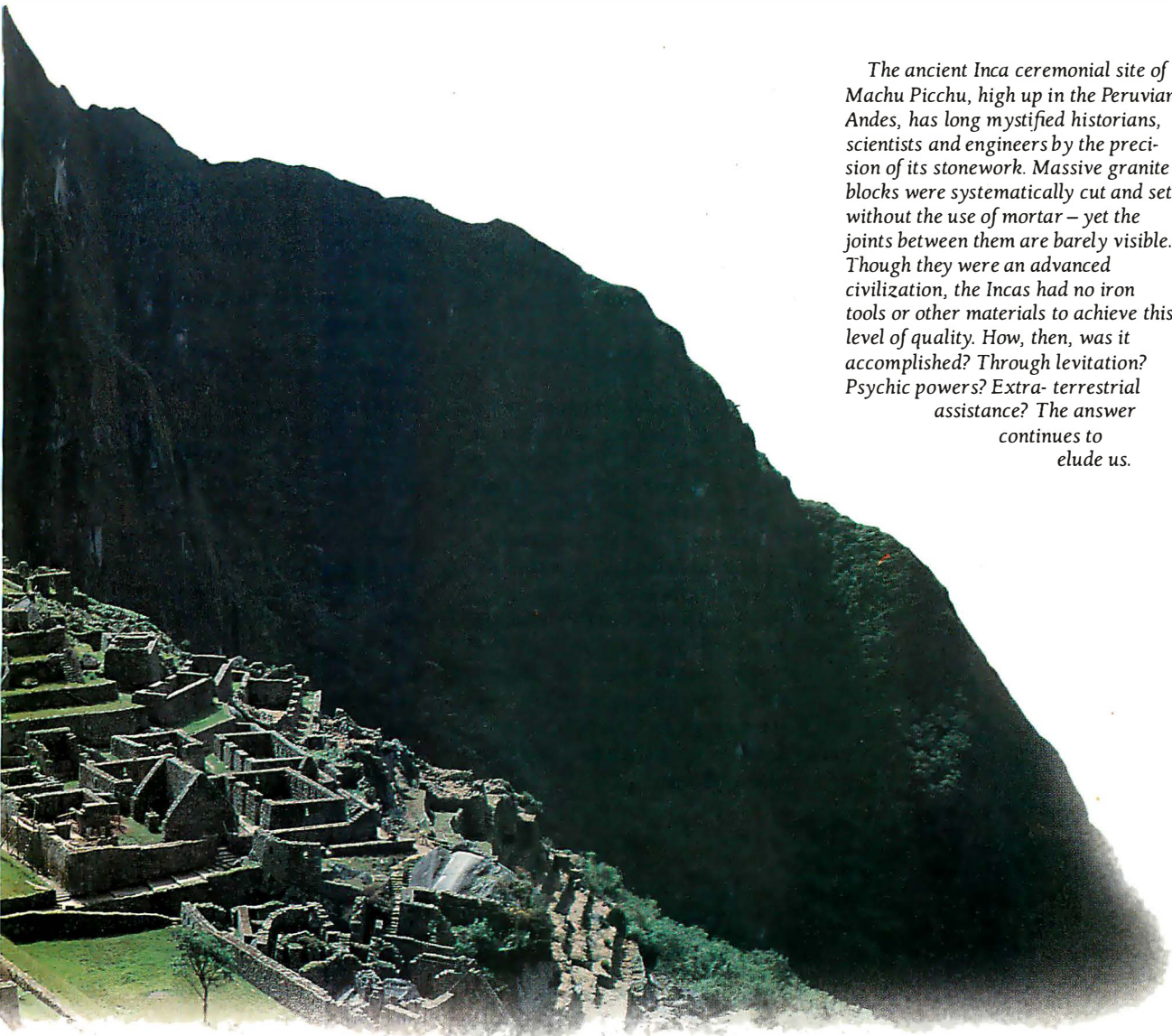
You may think that Machu Picchu and a Northgate® LAN solution have little in common. The fact is, both are the result of insightful design and skillful

engineering – the elements of a true phenomenon.

The foundation of a Northgate LAN is award-winning hardware that was specifically designed to give you unparalleled performance, and reliability. To bring even more value to your LAN, Northgate forged a strategic alliance with Novell®, allowing us to offer and support NetWare®. Then,

we aligned ourselves with IBM®, so we could design our networks with Token Ring products.

To keep your network operating at factory specifications, Northgate offers comprehensive service and support plans. We provide 24-hour toll-free telephone Technical Support 365 days a year. And our technicians are backed by Certified NetWare® Engineers. To top it off,



*The ancient Inca ceremonial site of Machu Picchu, high up in the Peruvian Andes, has long mystified historians, scientists and engineers by the precision of its stonework. Massive granite blocks were systematically cut and set without the use of mortar – yet the joints between them are barely visible. Though they were an advanced civilization, the Incas had no iron tools or other materials to achieve this level of quality. How, then, was it accomplished? Through levitation? Psychic powers? Extra-terrestrial assistance? The answer continues to elude us.*

our on-site hardware service is provided by the industry's best: NCR.®

This is your assurance that no matter what your networking needs are – from as few as four workstations to hundreds – Northgate will deliver and support a high-performance, custom-configured solution that's second to none. Turn the page for more information about this modern-day phenomenon.



Call for Complete Pricing And Custom Configuration Information.  
**800-345-8709**

Major corporations, volume purchasers and government agencies call National Business Accounts: 800-545-6059



7075 Flying Cloud Drive, Eden Prairie, MN 55344

## Northgate® "Connect And Compute" OmniLAN™ Solutions

The result of intensive research and development, OmniLAN systems are a turn-key solution that feature everything you need in a high-performance network: award-winning Northgate hardware, genuine Novell® networking software, a choice of connectivity options and comprehensive, factory-direct service and support.

And that's just the beginning. Our engineers went the extra mile by designing these systems so installation and operation can be performed by anyone.

Simply unpack, connect the color-coded cabling and turn it on. The rest, including installing network cards and operating software, has been taken care of for you.

Northgate backs your network with an ironclad one-year parts/labor warranty, 24-hour, seven-day-a-week toll-free technical support backed by Certified NetWare® Engineers and expert on-site hardware service provided by our strategic partner, NCR®. Customized service and support plans are also available.

Here's how to select the right OmniLAN system.

Pick a file server. Options include a Northgate Elegance™ SP 386/33, SP 486™/33 or 486/33 EISA file server. All include 8 or 16MB RAM, 300MB SCSI hard drive and controller, monochrome monitor and network interface card.

Choose one of four topologies: ARCNET®, ETHERNET® Thin Net, ETHERNET 10BASE-T or Northgate Local Area Wireless Network.

Now, finish by selecting your operating environment. Our strategic alliance with Novell allows us to offer NetWare 3.11 and 286 2.2 to meet your needs.

Your system also includes four Northgate 386SX™/20 Workstations configured with a 52 MB hard drive, VGA card, network interface card, 14" color monitor, and OmniKey® keyboard.

To see how Northgate meets your most demanding LAN needs, give us a call, toll free. Remember, with our 30-day money-back trial period, you have nothing to lose. And a phenomenal computing solution to gain.

Call for pricing and complete custom configuration information.

**800-345-8709**

Major corporations, volume purchasers and government agencies call National Business Accounts: 800-545-6059



7075 Flying Cloud Drive, Eden Prairie, MN 55344



© Copyright Northgate Computer Systems, Inc. 1994. All rights reserved. Northgate, Elegance, OmniKey and the Northgate "Connect And Compute" OmniLAN are trademarks of Northgate Computer Systems, Inc. NetWare and Novell are registered trademarks of Novell, Inc. ARCNET, Thin Net, and Ethernet are trademarks of Intel Corporation. IBM and PS/2 are trademarks of International Business Machines Corporation. VGA is a trademark of Intel Corporation. SCSI is a trademark of Adaptec, Inc. All other trademarks are the property of their respective owners. Components of equal or greater quality are permitted. All systems subject to availability. Software is sold separately. We warrant the hardware and software. To report software system malfunctions, call the software technical support line. Northgate Computer Systems, Inc. is not responsible for any damage to your computer system.

CODE B2803



# WHAT TO STASH IN A CACHE

Caching holds the key to system performance

STEVEN J. VAUGHAN-NICHOLS

Everyone talks about MHz and million instructions per second, but CPU speed, no matter how you measure it, isn't really a good guide to system performance. Even a rocket-fast 50-MHz 486 can be hamstrung by poor data throughput. The fastest CPU in the world can go only as fast as its data flow allows.

Today's hot chips run into two data-throughput problems. First, memory hasn't kept up with the CPU. Memory chips with 60-nanosecond access times may sound fast to you, but even a 25-MHz 486 can be left gasping for data by these chips. The second headache is that secondary storage (e.g., hard drives and floppy drives) is far slower than memory. The best raw access time you can expect from commercial products is about 9 milliseconds, an eternity for even 68000 or 286 chips.

## One Solution

Caching is the solution to both these problems. This has led to some confusion, though, because you're talking about apples and oranges when it comes to implementation.

Memory caching, like that found on the in-board caches of the 486, 68040, and IBM 386SLC, is meant to improve throughput from the chip to the memory. This kind of caching won't significantly speed up disk access.

Disk caching, represented by programs such as Multisoft's PC-Kwik and drive-caching controllers like Perspective Solutions' HyperStore 1600, is another story entirely (see the text box "Software or the Controller?" on page 178). Software uses a portion of main memory to speed disk accesses, and caching controllers make use of



dedicated on-board memory for the same purpose.

### It Looks Like a Cache

Not everything that looks like a cache deserves that title. Each of MS-DOS's buffers, for instance, is a 512-byte storage area for data shuttling back and forth from the memory to the disk. MS-DOS's buffers also hold disk file-table and directory information.

Buffers, however, use little intelligence in managing the information that flows through them. Relying on the first-in/first-out (FIFO) concept, DOS buffers are almost too simple to be caches. There's no hard-and-fast rule on the difference between buffers and caches, but a good rule of thumb is that caches manage data and buffers merely store data.

Not all disk drive controllers with static RAM have real caching. Some have a 16- to 64-KB SRAM storage area that is used only as a high-speed buffer. Other controllers add more oomph to their data-handling abilities by adding read-ahead capabilities. Many IDE drives include this performance booster in their bag of tricks.

With read-ahead capabilities, the controller reads not only the sectors containing the data called for by the CPU, but additional sectors from the same track. This method of disk I/O relies on temporal locality. When possible, most operating systems write information sequentially on a disk's tracks. This improves the chances that, by reading ahead, the controller's cache will contain the data that the processor will need next. More advanced buffering controllers (e.g., the Western Digital WD1009V-SE2 and the Adaptec ACB-2322D) buffer entire tracks of data.

### Cache Design

To make more sophisticated caches, designers must juggle a bewildering array of

considerations. There's a good reason there are so many different cache programs and hardware: There are no easy answers to the question of how to build a cache. Take, for example, that favorite cache bromide: Bigger is always better. Wrong. Bigger caches are usually better, but not always.

The data-set model demonstrates that increasing the cache's size results in a significant increase in performance at first. However, as the cache starts to become large enough to hold an entire data set, its performance-rate increase slows dramatically.

This phenomenon occurs for several reasons. Some are purely implementation matters. For instance, the cache program's processing overhead can begin to impact the cache's overall performance. Good cache management algorithms aren't small in terms of space or processor requirements.

A more fundamental problem is that a cache can become so large that more time is spent pulling information from it than would be taken digging the data out of memory. There really can be too much of a good thing, and overlarge caches are a perfect example.

### Bigger Is Not Necessarily Better

Other ingredients in cache recipes are data tags and data lines. In the most common type of cache, data is arranged using the set-associate model. In this paradigm, a cache is divided into at least two parts: data-tag space (sometimes called the cache directory) and data-line space.

Data-tag space holds the data tags, and it's like the cache's phone book. By quickly running its figurative finger down the data tags, the cache controller can quickly find the location of the desired data. These tags are connected to their matching data lines by pointers or linked lists. Each tag usually holds the base address to a set, or block, of data lines.

Data lines hold the cached data. These lines vary in length, but they are usually a multiple of the maximum word size that a processor can handle. A 386 processor's data lines, for instance, could be no smaller than 4 bytes, because the 386 is a 32-bit processor.

The longer data lines are, the more efficient the cache is. In a 32-KB cache, 32-byte data lines work far better than 4-byte lines. This works for the same reason that larger caches work better: Longer lines hold more data. In terms of the working-set model, longer data lines increase the spatial locality of a working set.

Alas, longer data lines aren't a panacea for building efficient caches. There's no rule that determines the proper blend of cache size and data-line length. For a fixed cache size and a given work load, it's dif-

ficult, but possible, to calculate the ideal data-line length. It's not an ideal world, however, and cache designers sweat blood trying to balance cache size and data-line length to make the best possible cache.

### Fetch for the Cache

When a cache starts up, it contains no data; the cache is in a cold-start state. As programs call for data, the cache begins to fill up, and its effectiveness increases. Cache controllers decide what data will be fetched into the cache by one of two schemes.

Demand fetch is the first of these approaches. It is only when the CPU demands data that the cache does not contain that the cache controller goes to main memory or secondary storage for the information it needs. The demand-fetch approach works. It offers the sterling advantage of keeping data fetching simple and stupid. It's not, however, very efficient.

Far more popular are the prefetch designs. The problem here is that there's no crystal ball predicting exactly what information the CPU will require next.

Caches generally do well with flat-memory or contiguous file systems by always fetching the next physically adjacent data element for the cache. If a program calls for data in memory location *x*, the cache will also haul in the data from location *y*. This quick-and-dirty implementation is called one block look-ahead (OBL).

As usual, though, when a solution looks fast and easy, there's a catch. In this case, bus- and memory-traffic overhead is the obstacle that keeps OBL from being an ideal solution. Prefetch schemes that are always moving data out of storage can cause memory- and bus-traffic jams on even the fastest of systems.

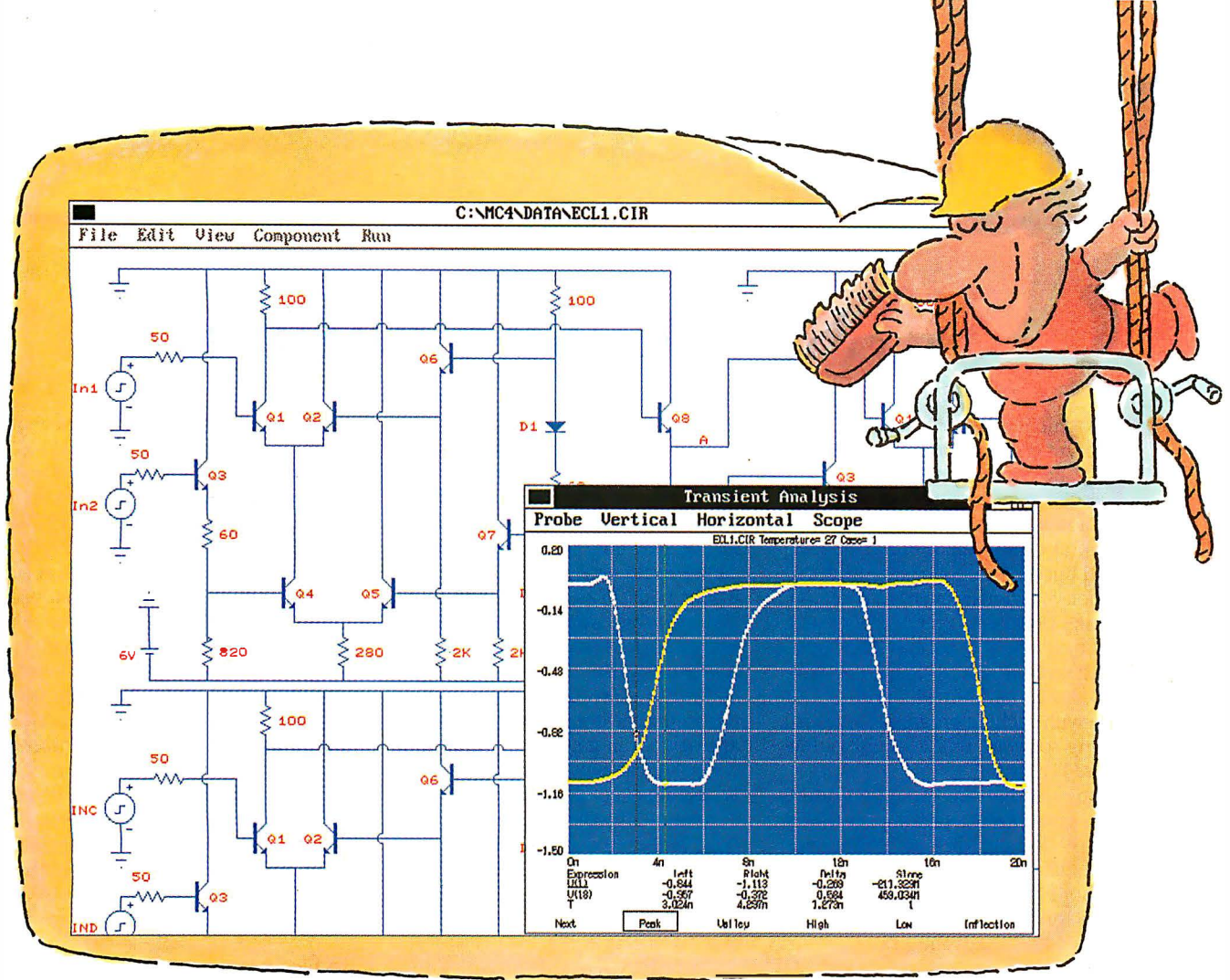
Traffic overhead is not the only problem with constantly prefetching data. By pulling in new data all the time, old data (which may still be needed) can be booted out of the cache.

These problems don't make cache designers happy. One of their responses has been to make caches prefetch data only after the controller can not find it in the cache. This approach alleviates the traffic problem, but it produces caches that perform only marginally better than caches without prefetching.

Fortunately, there's a better way. By prefetching data when there's been a hit on a prefetched data line as well as when there's been a miss, cache performance approaches that of caches that always prefetch data. This tagged prefetching works because it enables the cache to more closely model the current working set. At the same time, tagged prefetching has only a fraction of the impact on memory bandwidth as

## BYTE ACTION SUMMARY

Many believe that choosing the biggest cache option will guarantee peak performance for their new system. A cache will affect performance, but it isn't always for the better. Caches, systems, and applications must be matched.

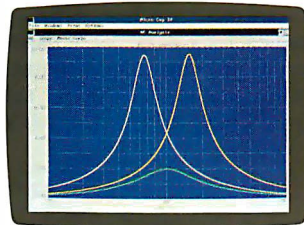


# INTRODUCING MICRO-CAP IV.™ MORE SPICE. MORE SPEED. MORE CIRCUIT.

PC-based circuit analysis just became faster. More powerful. And a lot easier. Because MICRO-CAP IV is here. And it continues a 12-year tradition of setting CAE price/performance standards.

Put our 386/486 MICRO-CAP IV to work, and you'll quickly streamline circuit creation, simulation and edit-simulate cycles — on circuits as large as 10,000 nodes. In fact, even our 286 version delivers a quantum leap upward in speed. Because, for one thing, MICRO-CAP IV ends SPICE-file-related slowdowns; it reads, writes and analyzes SPICE text files and MC4 schematic files. It also features fully integrated schematic and text editors. Plus an interactive graphical interface — windows, pull-down menus, mouse support, on-line HELP and documentation — that boosts speed even higher.

Now sample MICRO-CAP IV power. It comes, for example,



AC Analysis

from SPICE 2G.6 models plus extensions. Comprehensive analog behavioral modeling capabilities. A massive model library. Instant feedback plotting from real-time waveform displays. Direct schematic waveform probing. Support for both Super and Extended VGA.

And the best is still less. At \$2495, MICRO-CAP outperforms comparable PC-based analog simulators — even those \$5000+ packages — with power to spare. Further, it's available for Macintosh as well as for IBM PCs. Write or call for a brochure and demo disk. And experience firsthand added SPICE and higher speed — on larger circuits.

**Spectrum**

1021 S. Wolfe Road  
Sunnyvale, CA 94086  
(408) 738-4387 FAX (408) 738-4702

# Software or the Controller?

**W**hich is better, cache software or caching controllers? There's no question which one makes more of an impact on your wallet. Caching controllers may give your personal computer a much-needed boost, but they're not cheap. Prices in the thousand-dollar range are common. Caching programs, on the other hand, are sometimes free, because they're included with the operating system. MS-DOS, Unix, and Novell NetWare all come with caching programs. At most, caching software will cost only a few hundred dollars.

Choosing between spending more than a grand for the caching controller or \$200 for caching software may sound like a no-brain decision, but it's not. Both hardware and software secondary-storage caching have their advantages and disadvantages.

## Soft Cache

Software caches have more than price going for them. With a cache program, you often get control of cache size and behavior. This additional flexibility can be a great boon. If you have a RAM-hog application demanding every possible byte, you can adjust the cache size to give the rude application its fill of space. A controller's dedicated memory is untouchable.

Another point in a software cache's favor is that it's temporally closer to the CPU. No matter how fast a caching controller's memory is, its speed is straitjacketed by its need to communicate with the CPU across the bus. A software cache, even though it is lo-

cated in memory that's usually twice as slow as that in an intelligent controller, can get the data to the CPU faster. For instance, on a system with 70-nanosecond main-memory chips and an ISA bus, an efficient software cache could beat out a caching controller with 25-ns static RAM chips. The slow bus would simply prove to be too high an obstacle for the controller to hurdle.

Finally, a software cache usually improves the performance of all data-storage devices in a system. The caching controller can only effect searches that access attached devices.

It's not all wine and roses for software caches, though. Cache programs take up part of main memory. For operating systems like MS-DOS with only 640 KB of storage for programs, this is not a trifling matter.

Software caches also require their fair share of CPU time. On a lightly loaded system, this isn't a problem. Computers used for CPU-intensive tasks or multitasking may not have spare clock cycles for a cache's demands. The caching advantage of improved throughput will overshadow this problem, but a caching controller would have avoided it altogether.

## Hard Cache

The pluses and minuses of controller caches are almost a mirror image of those of software caches. Although hardware caching is far more expensive than its program-bound brethren, its performance is much better than software caching on EISA or Micro

Channel architecture bus-based systems.

A controller-bound cache doesn't burden the CPU with its own work or memory management. The CPU can stick to worrying about its programs and not worry about the cache. A side benefit of this is that caching controllers won't cause software conflicts. Software caches can occasionally clash with other programs, even in single-tasking operating systems. Caching controllers don't have this problem. In the Intel-based world, for instance, almost all caching controllers hide their complexities behind the register-level mask of the industry-standard Western Digital WD1003 controller. No matter what your operating system, your computer should never have any compatibility problems with this approach.

## What to Do

Contrary to some reports, there's really little question about when each type of caching is appropriate. Multiuser or multitasking systems, regardless of bus type, should go with hardware caching. Also, systems that demand high performance and have an EISA or Micro Channel bus to match that demand should be equipped with caching controllers. Conversely, ISA or other slow-bus computers will do better with software caching, all other factors being equal. For computers in that gray area where their technology and usage make it debatable which would be the most appropriate upgrade, vote with your pocketbook and go with additional main memory and software caching.

prefetching only on misses.

Is tagged prefetching the Holy Grail of cache design? No, it's not, because it, too, has its share of problems. Implementing tagged prefetching requires far more intelligence on the part of the cache program or hardware than its simpler counterparts. Caches that must contend with other programs for the CPU's attention can be less efficient in total system performance than their more stupid cousins.

Another problem is that any prefetching plan is highly sensitive to the data-line

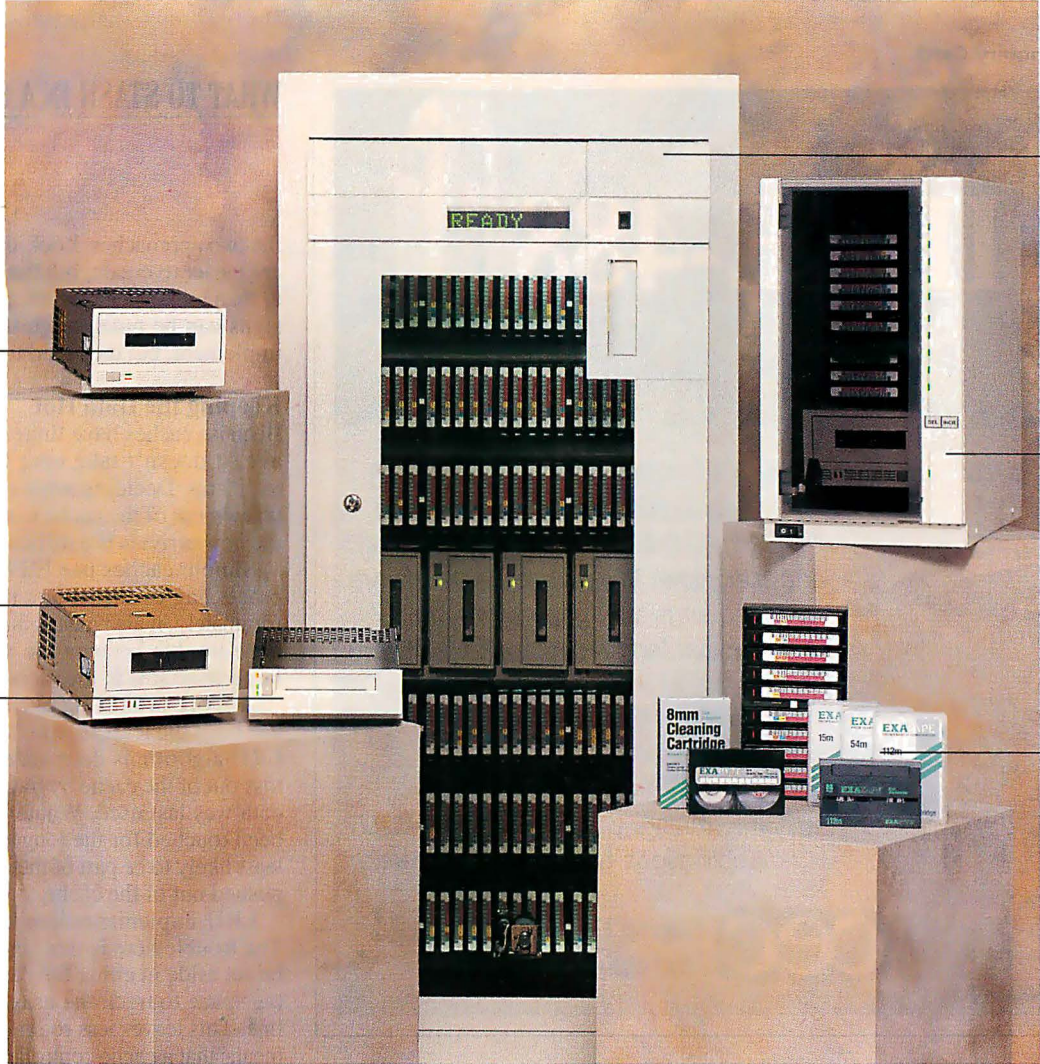
length. Usually, long data lines help any cache. With prefetching, long data lines can waste space. Whether tagged prefetching is the ideal solution for a particular cache depends on too many other variables for there to be any easy answer.

## Designing Caches

There are three basic cache designs. The first, and the easiest to design, is direct mapping. In direct mapping, the cache's data lines correspond with storage's data addresses on a one-to-one basis. Deter-

mining if a particular data element is in the cache takes only a few clock cycles. Either the data is in its cache pigeonhole, or it's not and must be fetched from storage.

This one-to-one correspondence is direct mapping's Achilles' heel. The cache is not as large as main memory, much less secondary storage. Because each cache address line must go to more than one memory location, inefficiency is built into the design. Say that cache data line one is directly mapped to locations *a* and *f*. The cache is able to hold data from only one



**EXB-8500**  
5.0 Gigabytes

**EXB-120 CHS**  
580 Gigabytes

**EXB-10 CHS**  
50 Gigabytes

**EXB-8200**  
2.5 Gigabytes

**EXB-8205**  
2.5 Gigabytes

**8mm Supplies**  
Data Cartridges  
Cleaning Cartridges  
Cartridge Holders

# WE CREATED OUR FAMILY SO YOU CAN SPEND MORE TIME WITH YOURS.

Our family of high-capacity 8mm data storage solutions means less time storing data and more time for yourself.

Whether it is simply backing up your workstation or accessing near-online network data bases, EXABYTE's 8mm cartridge tape subsystems and cartridge handling subsystems feature native data capacities from 2.5 gigabytes to 580 gigabytes.

So from high-end PCs to super computers, EXABYTE has the right 8mm data storage solution. For more information, call the regional office nearest you or **1-800-EXABYTE**.

And remember. We created our family so you can spend more time with yours.



Eastern U.S. (407) 352-5622, Ext. 82  
Central U.S. and Canada (708) 953-8665  
Western U.S. (714) 582-5211, Ext. 4  
Europe (Amsterdam) 31-3403-51347

Circle 54 on Inquiry Card  
(RESELLERS: 55).

EXABYTE Corporation 1685 38th Street Boulder, CO 80301  
©1991 EXABYTE Corporation

**IEEE-488**

You can control any IEEE-488 (HP-IB, GP-IB, 488.2) device with our cards, cables and software for the PC/AT/386, EISA, Micro Channel and Macintosh II. You get fast hardware and software support for all the popular languages, plus a software library of time saving utilities. Instrument control has never been easier.

**FREE** Informative Catalog **800-234-4CEC**  
Applications help **617-273-1818**

**cec** Capital Equipment Corp.  
Burlington, MA. 01803

Micro Channel is a trademark of IBM

## WHAT TO STASH IN A CACHE

the two approaches. Look-through designs are easier to create, but they can be slower than look-aside designs. Look-aside designs can be much more troublesome to implement, but they tend to be faster.

### Keeping the Data Hot

Because caches have finite space for storage, it doesn't take long for that space to fill up. Deciding what data should be thrown out of the cache to make room for the new arrivals is a difficult decision.

Simple caches use FIFO. This keeps processing overhead at a minimum. Unfortunately, it also means that FIFO caches have trouble keeping the working set of large programs in the cache.

A more promising avenue to explore has been the least recently used criterion. LRU algorithms determine what data to toss out of the cache by tracking when the data was last used. Whatever data hasn't been touched for the longest time (and is least likely to be part of the working set) is pushed out of the cache.

LRU implementations aren't perfect. The trouble here is that some space must be set aside in either the data space or the tag space to track the usage of each data line. This leaves less room for data. It also means that a cache controller, an MMU, or a CPU will be stuck with the job of tracking data-line usage. That leaves less time for other work.

### Reading and Writing

Most cache-design issues are hidden from users. One that isn't is the question of when a cache should write its data back to storage. The choices are write-through and several flavors of posted-write. In a way, it's rather curious that this area of caching has been highlighted for public attention. Reads outnumber writes by 9 to 1. Improving a cache's write performance just doesn't make that much difference to overall I/O.

In write-through designs, any data change is cause for the change to be written to data storage. The downside of this simple approach is that it can decrease memory and/or bus bandwidth when other processes need it more.

One variation of the write-through design that addresses the bandwidth issue is the buffered write-through. In these caches, small data writes (usually no more than a few machine words) are put into the hands of the cache controller. The CPU is free to look for its next byte of data. If the CPU finds its data in the cache, the controller writes the changed data to storage while the CPU reads from the cache. When the CPU needs to go to storage, the write is made to storage first (negating the buffered

location. When a program calls for data from both locations, the cache program will be unable to cache both *a* and *f*, even if there's a vacancy left in the cache.

The opposite of direct mapping is fully associative caching. In caches of this design, there is no fixed mapping of memory or storage. Instead, cache data lines can be set to map to any memory location.

Sounds great, doesn't it? A fully associative cache should correspond, within the limits of cache space, to the working set. The catch here is that in return for having more of the appropriate data in the cache, the cache takes longer to search.

Remember, in a direct-mapping cache, finding out if a data element is present is a lead-pipe cinch. If the information is not in the cache, the controller doesn't need to waste time looking for it. An associative-cache program must search through the cache's entire tag list before giving up.

What is the best solution? Many designers believe that a compromise, set-associative caches, offer the best general cache performance potential. Set-associative caches can be found in such designs as the Motorola 68040, the Intel 82385 cache controller chip, and the 486.

In set-associative designs, the cache space is divided into two or more separate spaces. The 68040, for instance, uses a four-way set-associative design. Both the 4-KB instruction and data caches are di-

vided into four 1-KB memory areas that contain 64 sets of 16-byte data lines. Each set virtually corresponds to a physical address. In essence, each set is directly mapped to a section of memory. Within each set, though, the data lines are given their data assignments in an associative fashion.

When the 68040 goes in search of data, the memory management unit translates the virtual addresses to physical addresses. Simultaneously, the MMU searches the appropriate cache line set for the data. This can happen because the least-significant address bits are the same for both address types. The result is that you get the benefits of direct mapping's raw speed along with the fully associative cache's ability to closely follow the working set.

### Where Has My Data Gone?

One question that frequently comes up in cache design is how a processor should search for data. Many designers support look-through (serial) caches. In this plan, the processor looks in storage for data only after it has made sure that the data isn't in the cache. In the alternative approach, look-aside (parallel) caches, the processor searches both areas at the same time.

Like almost everything else in caching, there are good things and bad things about both of these designs. The problems are symptomatic of the usual trouble between

## WHAT TO STASH IN A CACHE

write-through design's advantage), and the CPU reads from storage.

The posted-write approach gets around potential bandwidth traffic jams by not allowing any writes until the system is relatively idle. There are two ideas on when these writes should occur: always copy-back and flagged copy-back. If a cache implements an always-copy-back approach, all cached data will eventually be written back to storage, even when the data line is unchanged. Flagged-copy-back systems cut down on data traffic by posting only changed data lines to storage.

Some trouble comes with the advantages of these caching techniques. First and foremost, any kind of posted-write caching means there's a discrepancy between the data in the cache and the data in storage. Before DMA, that wasn't much of a problem. Now, though, on many architectures and systems, it's quite possible for a device to make a change to memory without going through the CPU or the cache. Processes can become completely befuddled trying to work with invalid copies of data because there's no easy way to tell which copy is the valid one.

The 68040 (which has five caching modes, including one with copy-back) uses several techniques to combat copy-back's problems. The first is bus snooping, the approach most often used by cache controllers. The 68040 can monitor data inputs on the bus. In the event of a possible data conflict, the chip can bypass memory and either read data from its internal pair of 4-KB caches or take data directly from the bus.

As a second barrier against data corruption, the 68040 employs noncacheable serialization. In this particular mode, the CPU skips over the cache for I/O operations that might be hampered by delayed writes.

The concern that weighs on people's minds about delayed writes is what happens if the system goes down. This is a real problem. Some operating systems, Unix most prominently, can cope to a degree with this kind of office disaster. Unix keeps its master file records (i.e., the superblock) in memory, and it updates the on-disk version only when the system periodically runs the sync command. Not every operating system has an fsck utility that can repair some of the damage left behind when a system failure maroons unwritten data in memory.

No one likes to clean up a system after a crash. The speed gained with delayed writes is too small to justify their use in most circumstances. Only users who need the fastest possible throughput should bother with delayed writes.

**PS/2<sup>®</sup> MEMORY**

**Introducing OS/RAM32plus<sup>™</sup> for the Micro Channel<sup>™</sup>**

- ✓ Provides from 2 to 128 Mbytes of fast memory.
- ✓ Works in 16 or 32 bit mode to meet your needs.
- ✓ Provides extended and expanded memory.
- ✓ Fast software and hardware for LIM 4.0 included.
- ✓ Automatic configuration for DOS, OS/2 and UNIX.
- ✓ Easy to install. Risk free guarantee. Two year warranty.
- ✓ Add a disk cache and RAM disk using OS/RAM32plus to get maximum performance from your computer.
- ✓ Free up low memory by moving your drivers and TSR's to OS/RAM32plus. We guarantee compatibility!

**Call today 617-273-1818 or 1-800-234-4CEC**

**cec** Capital Equipment Corp.  
Burlington, MA. 01803

PS/2 and Micro Channel are trademarks of IBM

### Making the Cache Call

Those are most of the parts of the cache puzzle, but how can you tell when a cache is working well? The main objective of any cache is to achieve the highest possible hit rate. The hit rate is determined by how many times the processor finds the requested data in the cache instead of having to go to storage. To merit high marks, a warm-state cache should have a hit rate that averages better than 90 percent.

The hit rate is not the only factor that measures success. An outstanding cache should also be able to send back the data quickly to the processor once it's been found. On the other hand, an exceptional cache should be able to report quickly when the data isn't present in the cache. This last factor is what usually trips fully associative caches.

With all these factors to consider, you might wonder how anyone ever builds a cache in the first place. One trick up cache designers' sleeves is to use cache-simulation programs. The Dinero III cache simulator, a freeware program by Mark D. Hill for SunOS and Berkeley Standard Distribution (Unix), enables developers to test their cache ideas before writing them to silicon. The Dinero III is a trace-driven simulator (i.e., made up of a set of C and awk programs) with many options that make it ideal for testing hardware and software cache assumptions.

### Practical Considerations

Dinero III may make life easier for developers, but it doesn't do anything for end users. The market is flooded with a bewildering variety of cache programs and hardware. That won't be changing anytime soon. There are simply too many variables in the caching equations for anyone to come up with a magic solution that will sweep away all other competitors from the marketplace.

For the most part, someone buying a cache won't know what mix of caching techniques have been selected. Cache designers guard their precious code creations as if they were the crown jewels. Some caches (e.g., Multisoft's Super PC-Kwik) give you command-line options so that you can turn on and off features such as full-track look-ahead buffering and posted-writes.

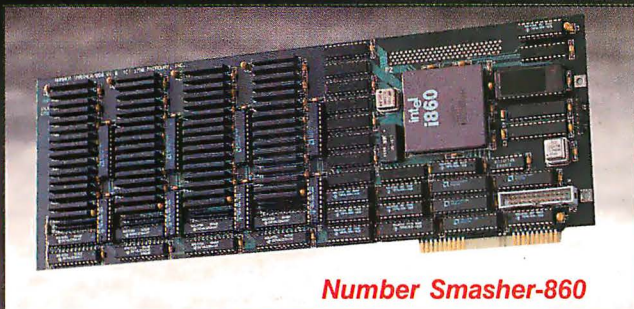
No matter what the formula is, all computers need caching. Secondary storage can never keep up with the CPU. Things aren't much better with primary-storage access speeds. In the race between memory latency and CPU speed, the CPUs continue to forge ahead. With the help of caches, our systems will try to keep up. ■

*Steven J. Vaughan-Nichols is a full-time freelance writer and former programmer/analyst from Lanham, Maryland. You can contact him on BIX as "sjvn."*

# 486-B<sup>2</sup>T

## 486/860 Speed... Microway Quality.

Microway has engineered four distinctive black tower systems. The 486-B<sup>2</sup>T is designed for high-end users. It comes standard with American 486 motherboards and power supplies, yet has a reasonable starting price of \$2,195. A broad range of options can be installed including high speed and capacity hard disks, intelligent serial controllers, tape back-up units, high end graphics adapters and our *Number Smasher-860*. These systems are ideal for configuring Novell or UNIX file servers, multiuser systems, and workstations for graphics, CAD and scientific uses. The 486-B<sup>2</sup>T comes with dual fans, *Across the Board*™ Cooling and American industrial grade power supplies. All systems are thoroughly tested, burned in and include the best technical support in the industry, which we've provided since 1982.



**Number Smasher-860**

The key to attaining workstation performance is Microway's 40MHz *Number Smasher-860*. It features a four-way interleaved 64-bit memory system that runs at 160 megabytes/sec. The *Number Smasher's* i860 has been clocked at 80 megaflops doing matrix multiplies, 67 megaflops doing FFTs and 11.8 Double Precision Linpack Megaflops on large arrays—ten times the speed of a 486 and twice the speed of a Cray 1F! One happy user recently reported that his "Baby Cray" was happily humming away saving him thousands of dollars per month in 3090 rentals. The *Number Smasher* comes with the finest i860 compilers on the market, your choice of Microway's NDP™ FORTRAN, C/C++ or Pascal.

**Call or write today for more information on Microway's new black tower systems.**



# Microway®

**Technology You Can Count On**

Corporate Headquarters, Box 79, Kingston, MA 02364 USA • TEL 508-746-7341 • FAX 508-746-4678 • U.K./Europe 081-541-5466  
France 01 43 2 69593 • Germany 069-75-2023 • Holland 40 836455 • Italy 02-74.90.749 • Japan 0474 23 1322 • Norway 6-892020



# STORAGE MANAGEMENT

Storage standards and automation are the keys to managing files and storage devices spread across a building or a continent

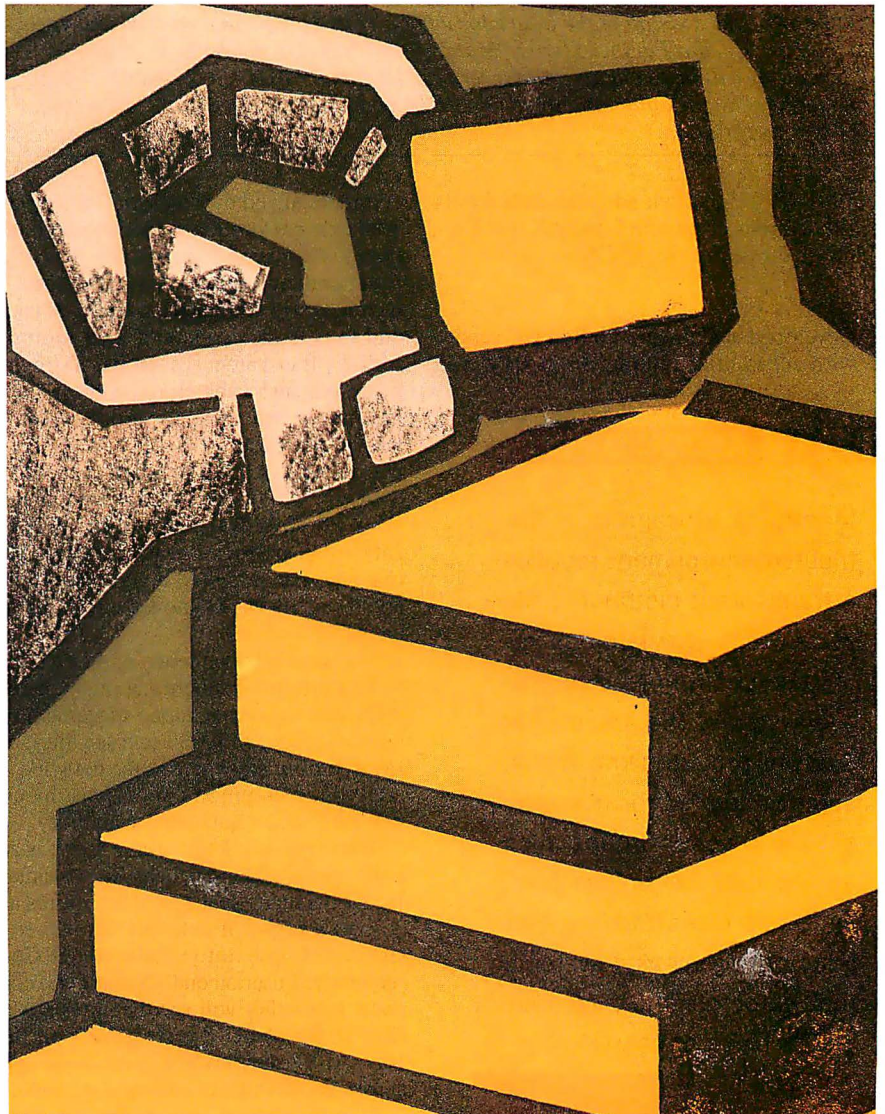
MIKE ROBINSON

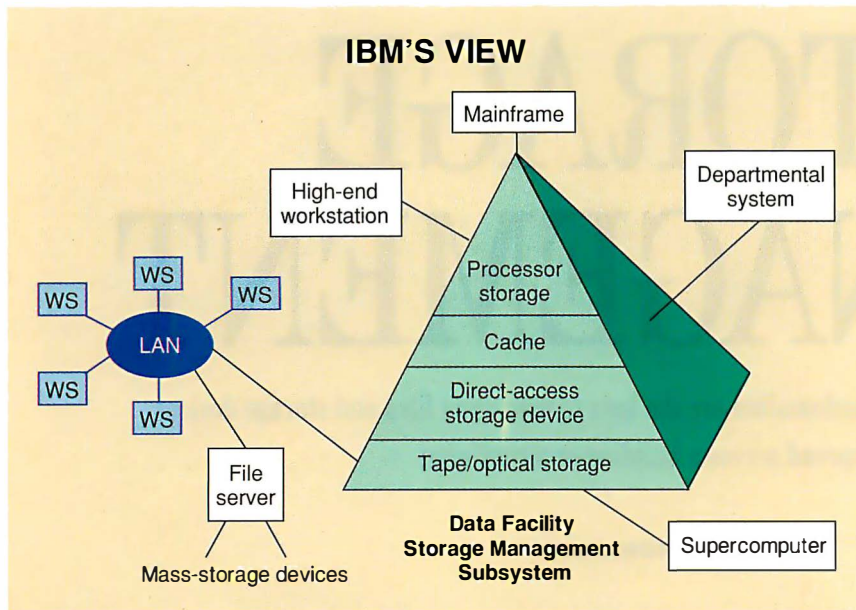
As networks grow larger and more complex, the problems you encounter trying to manage data files, applications, and general archiving become more acute. The solution to these problems is automated storage management for distributed networks. Already available for supercomputers and mainframes, automated storage management systems are beginning to appear for networks of Unix machines and even, to some extent, for PC LANs.

Ideally, automated or intelligent network storage management embraces two key capabilities: transparent access to all files on the network and management of the hierarchy (or hierarchies) of mass-storage devices. *Transparent access* means that you can call up a file without knowing where it resides and the system will find it for you. *Hierarchical storage management* includes, but is not limited to, the following key capabilities:

- automatic migration of files from disk to tape or even optical storage, depending on frequency of use, disk space, and other parameters
- automatic backup and restoration
- automatic archiving

True open distributed computing calls for a distributed file system, not just with global file access but with transparent access as well. The Unix world gained fully transparent file access with the Andrew File System, and that capability will be made available to other operating systems, thanks to the Open Software Foundation. The OSF developed the Distributed Computing Environment (DCE) (see "Distributed Open Environments," November





**Figure 1:** IBM's vision of the future for what it calls system-managed storage is based on its Data Facility Storage Management Subsystem. The near-term extensions will be to clients and servers running under IBM's AIX and OS/2 and under SunOS, for uploading to an MVS/EISA computer for backup and archiving. (WS = workstation.)

1991 BYTE), which adopted AFS for its file-system component called, the Distributed File Service (DFS).

## AFS

Developed at Carnegie Mellon University with substantial funding from IBM and

commercialized by Transarc (Pittsburgh), AFS delivers location independence, rather than just location transparency. Location independence means that a file can be moved at will without a change in its name and thus is the property that is required for fully transparent access. It is a stronger property than location transparency, which means only that an application cannot determine the location of a file from its name. In contrast to AFS, the de facto standard in the Unix world, Sun Microsystems' Network File System (NFS), offers only location transparency—that is, once a client machine has mounted a file system, the application does not know the physical location of the files.

Location independence requires a fully location-independent naming scheme. AFS uses a common name space within a network; thus, all AFS users see the same file tree from anywhere in the network. In addition, a common name space means that AFS offers unlimited scalability.

What's more, AFS's name space is actually global. (Transarc helps sites maintain the global name space, which requires access to a regional network. However, a site can choose not to participate.) Consequently, a user on one network who connects to another will see the latter's AFS files in his or her directory tree. In this way, AFS users have easy access to files across the country or around the world.

AFS consists of client/server elements

and requires an Internet Protocol network. AFS servers handle volumes (i.e., collections of files and directories) that are not limited to a fixed amount of disk space. (Typically, each user is assigned a volume.) Volumes are connected at mount points, forming a single directory tree; therefore, not only do you have transparent access to all the files, but you have that access from any AFS machine on the network. A set of databases keeps track of all the volume locations and other system management information.

When you call a remote file, it is copied into local cache memory, directed by AFS's local (client) cache manager. The original version of AFS put the entire file into cache memory; AFS 3 moves 64-KB chunks into cache memory, thus reducing network traffic. AFS uses a callback scheme to ensure cache coherency. When you write to a file, the server notifies all the clients using the file that their cache memory is no longer valid and then updates the file. When a client issues the next read request, its cache manager gets the updated version from the server.

Among other changes, the OSF's DFS replaces the callback procedure with a token-passing scheme that includes several levels of access privileges, specified by each file's creator and assigned to potential users. More important, DFS will add protocol exporters, so that it can work with Unix, NFS, PC-NFS, and eventually, other file systems.

## Standardizing Mass Storage

DCE and AFS provide part of the underlying pieces for automated network storage in a distributed environment. Other groundwork is being laid by the IEEE Technical Committee on Mass Storage Systems and Technology. The committee is well along in the development of the IEEE Mass Storage Reference Model (see "Enterprising Storage," September 1991 BYTE, page 218), which will form the basis for a set of standards for network-storage interchange. It is being developed by the committee's IEEE Storage Systems Standards Working Group. Industry members include Amdahl, Ampex, AT&T, Convex, Cray Research, Datatape, DEC, the Distributed Computing Solutions (Discos) Division of General Atomics, Epoch Systems, Hewlett-Packard, IBM, and Storage Technology.

The promise held out by projects such as the DCE—and its companion Distributed Management Environment—and by the standards that the IEEE seeks to develop are heterogeneous distributed networks, where you can call up files and data anywhere on a network without knowing the

## BYTE ACTION SUMMARY

Managing storage in a distributed environment requires a transparent distributed file system and standards for automatic control of mass-storage systems. The Andrew File System provides the transparency needed for transparent file access. Groups such as the IEEE Technical Committee on Mass Storage Systems are developing systems that automate the migration and archiving of network files.

**LOOK WHAT  
PC MAGAZINE  
HAD TO SAY ABOUT  
A VERY GRAPHIC  
AND RACY  
SUBJECT.**

# Managing National Assets

Responding to the information-storage and -retrieval needs emerging from advanced scientific research at government laboratories and universities, as well as from advances in high-performance networking, in which gigabytes and even terabytes of data are being or will be generated and shared, members of the computer industry have organized a collaborative research project to accelerate the development of technology for storage systems "that will be the future repositories for our national information assets," according to the draft paper describing the project. The industry participants are IBM's Federal Sector Division, Ampex Recording Systems, General Atomics' Distributed Computing Solutions Division, IBM's Storage Systems Products Division, Maximum Strategy, Network Systems, and Zitel. In addition, Lawrence Livermore National Laboratory will participate as the operational site and the applications supplier.

The industry members are funding their own participation. They are, however, seeking to affiliate the project, called Technology for National Asset Storage Systems, with the U.S. government's High-Performance Comput-

ing and Communications Initiative.

The project's goal is a unified storage system that is scalable to support mammoth quantities of data distributed nationally. The intention is to create a prototype and demonstration system that will represent a "significant advance in the technology for distributed storage systems capable of handling gigabyte-class files at gigabyte-per-second data rates." The system will support the widely accepted file access mechanisms (e.g., the Andrew File System [AFS]; the Network File System; the File Transfer Protocol; and the File Transfer, Access, and Management protocol).

Specifically, the participants expect the project to make major advances in hardware, software, and systems technology in the following areas:

- *network-attached high-performance storage*
- *multiple, dynamic, distributed storage hierarchies*
- *layered access to storage system services (i.e., to levels in the storage hierarchies)*
- *storage system management*

The project identifies many aspects

in which a national asset-storage system must be unified. Beyond tying together multiple-storage sites and users across the country, such a system must be unified across data types and across user needs. It must span a range of file types from small text files to huge files of sensor-based data. It must also serve the diverse needs of users, from those who need highly abstract access to transparently managed files to users whose performance needs preclude abstraction and transparent access (e.g., different requirements for caching and migration).

All the members of the project are also members of the IEEE Storage Systems Standards Working Group, and the four areas of the project are being considered by the standards group. The group has asked for prototype implementations to test and verify the advanced concepts being discussed. The intention is that the prototype to be developed by the National Asset Storage System project will serve as such a prototype for the standards group.

The starting points for new software development will be General Atomics' UniTree hierarchical file and storage management system and Transarc's AFS distributed file system.

location and the filenames, and where all mass-storage systems are managed automatically and invisibly. (The DME will address hierarchical storage management in the future.)

Making the automatic management of mass-storage systems possible requires information not only about filenames, their locations, and the access privileges but also about a file's contents. Such information is called *metadata*. Location and access information would be stored on the servers. This information already exists in AFS's databases. Metadata representing a file's contents would reside on client machines. The capability to create metadata is still a good way off.

## Automatic Management

In managing storage, network administrators must be able to free up disk space on client machines and servers when neces-

sary; place files on the least expensive storage medium that is appropriate, based on access requirements; ensure the safety of all data through adequate backup and archiving; and restore or retrieve files from backup or archival storage as needed. The automation of those and other management tasks is called *network storage management*, or sometimes *hierarchical storage management*. (As in most areas, the terminology is imprecise. Most people would argue that hierarchical storage management is a subset of network storage management, and, indeed, many people talk about managing multiple hierarchies. For these people, the storage hierarchy is not a concept but a specific storage organization with a specific type of medium or storage device at each level.)

Ideally, the network-storage management system would track all files according to a set of parameters that the network

administrator specifies, and it would track an individual's files that you specify. It then would move the files from a local or file server disk to tape or optical storage. The two most common parameters are disk utilization (i.e., maximum and minimum) and the time of last access (when disk utilization reaches the maximum, a "least-recently used" algorithm is commonly employed; conversely, a file below the top of the hierarchy could move up). Such transfer of files from one level to another is called *file migration*.

The removal of inactive files to secondary storage is also known as *disk grooming*, especially in the PC world. However, some people call only the movement of a file down the hierarchy *migration*; movement up the hierarchy is then sometimes called *retrieval*, sometimes *caching*. In addition, the retrieval of a backup copy is called *restoration*.

*continued*

“The DECpc 433  
mixes top PC performance  
with networking and blazingly fast  
video performance.”

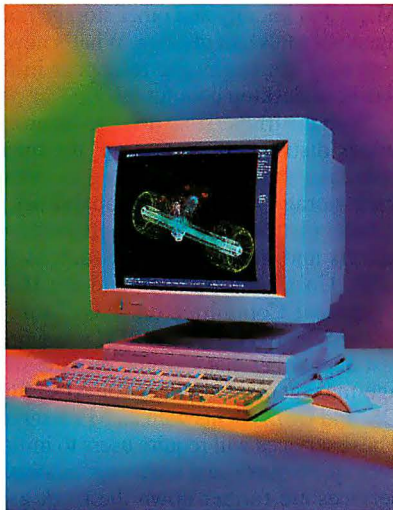
*PC Magazine*



Pretty hot stuff, huh? And that's not all *PC Magazine* felt fit to print about our DECpc™ 433

Workstation. Just get a load of this: "The DECpc 433 adds value to the existing standard without sacrificing compatibility. What's more, this machine shows strength in an area where DEC knows a thing or two: the graphics workstation market."

And how about this: "At \$5,999\*.. [this] machine is a PC designer's dream."



Of course, far be it from us to censor one of the best PC sources in the business. Especially when it comes to this quote (our favorite): "If graphics speed is important to you, give the DECpc 433 a long hard look."

Naturally, we encourage you to take them up on this suggestion.

For more information on the DECpc 433, or any PC in Digital's line, call 1-800-PC-BY-DEC. Or talk today to one of your local Digital Authorized Distributors.

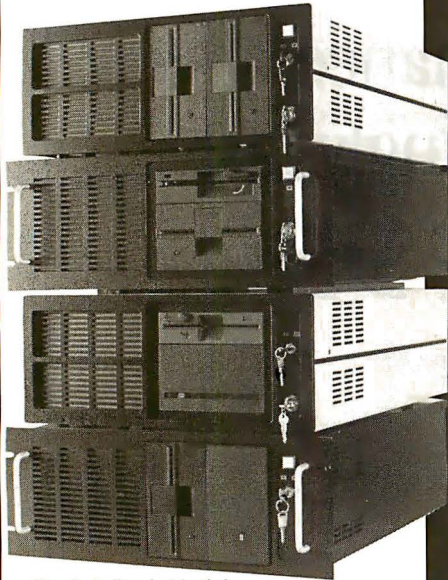
**digital**™

**D I G I T A L . T H E O P E N A D V A N T A G E .**

© Digital Equipment Corporation, 1992. The DIGITAL Logo and DECpc are trademarks of Digital Equipment Corporation. 486 and Intel Inside are trademarks of Intel Corp. \* U.S. Pricing

# Rack & Desk PC/AT Chassis

Integrand's new Chassis/System is not another IBM mechanical and electrical clone. An entirely fresh packaging design approach has been taken using modular construction. At present, over 40 optional stock modules allow you to customize our standard chassis to nearly any requirement. Integrand offers high quality, advanced design hardware along with applications and technical support *all at prices competitive with imports. Why settle for less?*



### Rack & Desk Models

Accepts PC, XT, AT Motherboards and Passive Backplanes

Doesn't Look Like IBM

Rugged, Modular Construction

Excellent Air Flow & Cooling

Optional Card Cage Fan

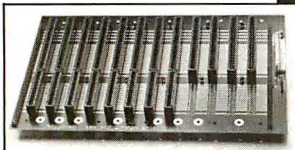
Designed to meet FCC

204 Watt Supply, UL Recognized

145W & 85W also available

Reasonably Priced

**Now Available**  
Passive Backplanes



# INTEGRAND

RESEARCH CORP.

Call or write for descriptive brochure and prices:  
8620 Roosevelt Ave. • Visalia, CA 93291

**209/651-1203**

TELEX 5106012830 (INTEGRAND UD)

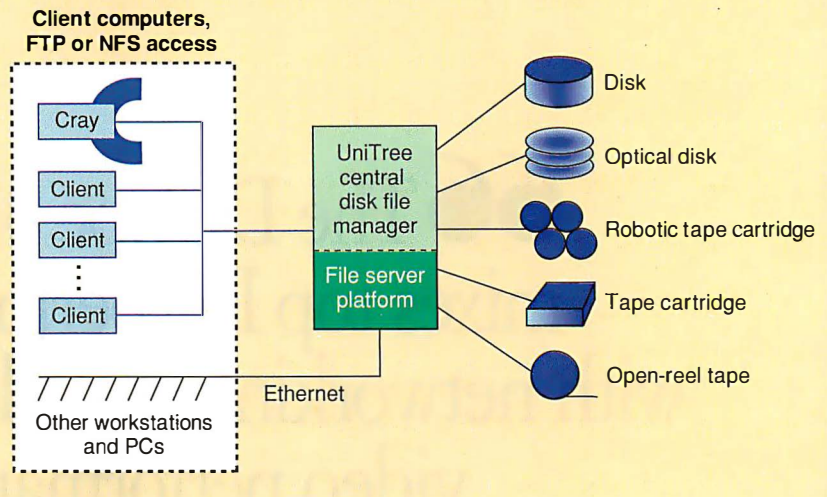
FAX 209/651-1353

We accept Bank Americard/VISA and MasterCard

IBM, PC, XT, AT trademarks of International Business Machines.  
Drives and computer boards not included.

## STORAGE MANAGEMENT

### UNITREE CLIENT/SERVER ARCHITECTURE



**Figure 2:** UniTree from the Discos Division of General Atomics provides automatic and transparent file and storage management for Unix networks that use NFS or FTP access. Shown here in its simplest form, UniTree is being enhanced with software modules that run on client computers to form what the company calls a Virtual Disk System, whereby files are invisibly migrated from a client or server disk further down the storage hierarchy.

Automatic file migration, backup and restoration, archiving, defragmentation, and tracking of files and other storage management activities are not new. They have existed for some time in the mainframe world. IBM, for instance, has the Data Facility Storage Management Subsystem for MVS (Multiple Virtual Storage) (see figure 1), and DEC has utilities supplying many of those capabilities for VMS. In addition, Cray Research offers the Data Migration Facility and other storage management tools and utilities. What's new is that they are beginning to appear in the world of desktop computers.

With the irreversible drive to heterogeneous distributed computing, the major computer makers are working to extend their storage management capabilities to smaller platforms, both through their own efforts and through groups such as the OSF, Unix International, and the IEEE Technical Committee on Mass Storage Systems and Technology. IBM announced last September that it would provide storage management services for AIX, SunOS, and OS/2 clients with an MVS server. These services will require users to initiate backup, recovery, and archiving; automatic services are further down the road, as is support for other platforms. Beyond those activities, IBM is taking part in a research project aimed at accelerating the development of technology for nationwide file systems with enormous amounts of data

and multiple storage hierarchies (see the text box "Managing National Assets" on page 186).

For its part, HP's Information Architecture Group (Colorado Springs, CO) is defining a model for distributed information access and management. Called the Distributed Information Storage Architecture, it includes a component called StoragePlus that provides automatic physical storage management. Meanwhile, DEC's Architected Information Management group is working with customers to define and develop the Distributed Heterogeneous Storage Management architecture, which will serve as the basis for new storage management products. Existing products will start migrating to DHSM this year.

### UniTree

A hierarchical file and storage management system, UniTree, is available for TCP/IP networks of Unix machines using NFS or the File Transfer Protocol (see figure 2). The core of UniTree was developed at Lawrence Livermore National Laboratory, originally as the file-serving component of a distributed operating system. The technology has been licensed by Discos (San Diego, CA), which is extending the capabilities in a joint development program with Livermore. Discos licenses UniTree to computer makers and system integrators. (It offers a similar system for

# Imagine getting twice the Bernoulli for two-thirds the price.

## The new Bernoulli 90MB.



Welcome to the next generation of

removable storage, the new Bernoulli® 90 from Iomega®.

At 90 megabytes per removable disk, we've more than doubled our capacity. Yet the new Bernoulli 90 is actually less expensive than the Bernoulli 44. A lot less. And with a new, 19-msec\* effective access time, a lot faster, too.

The best part is, it's all Bernoulli. Rugged, reliable, endless storage. Just what storage-intensive users—like Windows users—demand.

### More value.

If you need more storage, you'll welcome the Bernoulli 90, since it's now comparable in price to a hard disk upgrade. So why not buy a hard disk? Consider what you *don't* get with a hard disk.

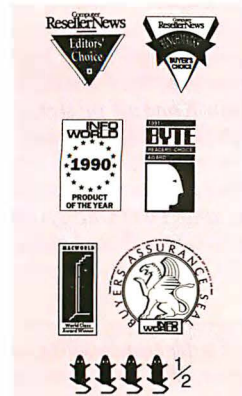
You don't get infinite storage in 90-megabyte increments—hard disks fill up. You don't get 180MB of easy backup. You don't get the physical security of

removable data disks, or head-crash-resistant technology. You don't get compatibility with all major operating systems, and workstations. And you don't get Central Point's Backup software.

In short, you don't get a Bernoulli.

### More recognition.

Leading publications have given us welcome recognition,



## Welcome to the 90s.

but with a 98 percent satisfaction

rate, our biggest supporters are Bernoulli users.

Our users enjoy worldwide support and a 24-hour\*\* drive replacement service. To further protect their investment, we've designed the Bernoulli 90 to read 44MB disks. And we're instituting an upgrade program to help get every Bernoulli user into the 90s.

**Call 1-800-777-4084†**

Questions? We don't blame you. There's a lot more you should know about—like our free, 90MB disk offer, drive configurations, Bernoulli Technology®, and specific pricing. So we've prepared a brochure that's yours with a phone call. Find out what a welcome change Bernoulli can be. Before the 90s leave you behind.



Circle 256 on Inquiry Card (RESELLERS: 257).

© 1991. Iomega, the Iomega logo, Bernoulli and Bernoulli Technology are registered trademarks, and Bernoulli Means Security For Your Data is a trademark of Iomega Corp. All other products are registered trademarks of their respective companies. \*Less than 13 msec with included caching software. \*\*U.S. only. †Phone number for U.S. and Canada. Internationally, call 322-720-99-16. For customer service questions, call 1-800-456-5522.

# BYTE

## BYTE Reprints



The BYTE Reprint Department will provide free quotations for reprints of BYTE articles. Reprints can serve as high quality, inexpensive promotional tools:

- Train and educate key personnel
- Present information at conferences/seminars
- Provide literature to users of your products

Call  
**603-924-2525**  
 for information and a free price quotation.

Minimum order: 500



## STORAGE MANAGEMENT

VMS called Data Tree.)

The current UniTree software, the UniTree Central File Manager, runs on a server as a Unix application. For optimal use of storage media or for archiving, it migrates files to off-line storage, according to parameters set by the network administrator, and keeps track of the location of those files. When an off-line file is accessed, UniTree automatically restores it for immediate use. UniTree also provides continuous automated backup and restoration, making up to 16 copies (the administrator determines the number) and automatically recalls a file from backup when you access it, and the on-line version is not available.

Furthermore, when media or device errors occur, UniTree migrates the files residing on the failing disk or other device to alternative storage. UniTree lets you bring back deleted files through a "trash can" that retains deleted files for a period of time that you or the administrator specify.

Capable of operating any peripheral device that the file server vendor supports, UniTree can manage petabytes of data and millions of files. Indeed, there is no logical limit to the UniTree file system or to the number of files managed.

Alliant, Amdahl, Control Data, Cray Research, DEC, Fujitsu, and Sun Microsystems offer machines running UniTree. Within the last year or so, powerful file servers have been introduced for large heterogeneous networks by Aptec Systems, a maker of I/O computers, and Convex Computer and FPS Computing, two minisupercomputer makers, incorporating the software. As an example of UniTree's management capabilities, Convex's file server won a contract from Sandia National Laboratories to supply a mass-storage system that provides functionally transparent access to 100 gigabytes of disk data, 1 terabyte of archival storage, and automatic file migration.

Discos is readying a family of client-software modules that extend the capabilities and performance of the UniTree system. Users will have a varying degree of file access transparency, depending on the type and number of UniTree programs installed on their client machine. The main module, the UniTree Client Disk Manager, will add the client machine's drive to the centrally managed UniTree storage hierarchy, migrating local files to the server and retrieving them automatically and transparently. Discos calls the enhanced version the Virtual Disk System, and indeed, the ability to access, automatically and transparently, any file on the system is analogous to virtual memory.

Offering similar capabilities for Unix/

NFS networks, but in a set of software and hardware products, is Epoch Systems (Westborough, MA). Epoch initially offered the Epoch-1 InfiniteStorage Servers, capable of storing 20 gigabytes to 1 terabyte in various configurations of magnetized disk and rewritable and write-once optical disks. The servers automatically migrate files among the three levels and perform automatic backup, disaster recovery, volume management, and archiving. Also, all storage remains on-line.

The Renaissance software expands those capabilities. Renaissance Migration centrally manages all network disk space on both workstations and servers. All directory and file-attribute information remains on the local disks so that the files appear to be local. Here, too, migrated files, including archival files, are automatically returned when accessed.

### Help for PC LANs

Network storage management is no exception to the general migration of features and capabilities from larger computers and Unix workstations down into the PC arena. In fact, automation of storage management tasks is already available to some extent for PC LANs, especially NetWare. Cheyenne Software, Emerald Systems, Maynard Electronics, Palindrome, and Tecmar offer NetWare products that automate storage management. In addition, Mountain Network Solutions is developing similar capabilities, and Novell is writing migration application programming interfaces for its Storage Management Services architecture to help third-party developers create automated storage products for NetWare. Still, overburdened network administrators will have to wait some time before the high-end capabilities of mainframes, of Unix servers incorporating UniTree, or of Epoch's Renaissance will be available for PC LANs. ■

### ACKNOWLEDGMENTS

*I would like to thank Sam Coleman of Lawrence Livermore National Laboratory, Bob Coyne of IBM, and Ann Kerr of the Scripps Institute of Oceanography. I would also like to thank Alan Kondoff of Hewlett-Packard, Steve Miller of SRI International, and Richard Wrenn of DEC (all active in the IEEE Technical Committee on Mass Storage Systems and Technology), Bob Barker of Munin Systems, Dale Lancaster of Convex, and Cynthia Pilkington of Legato Systems.*

*Mike Robinson is a freelance writer and editor in Lexington, Massachusetts, specializing in electronics technologies. You can reach him on BIX c/o "editors."*



# Put CompuServe at your fingertips.

Join CompuServe, and get access to more than a thousand services offering support, information, entertainment, communications, and benefits of all kinds.

**For more information about CompuServe, just mail this card, or call 800 848-8199.**

Name \_\_\_\_\_

Address \_\_\_\_\_

City, State, Zip \_\_\_\_\_

Telephone (\_\_\_\_\_) \_\_\_\_\_ **CompuServe®**

Byte/Mar.



NO POSTAGE  
NECESSARY  
IF MAILED  
IN THE  
UNITED STATES

**BUSINESS REPLY MAIL**

FIRST CLASS PERMIT NO. 407 COLUMBUS, OHIO

POSTAGE WILL BE PAID BY ADDRESSEE

**CompuServe®**

ADVERTISING DEPARTMENT

PO BOX 20212

COLUMBUS OH 43220-9988



# CompuServe puts the whole world at your fingertips.



When you connect your computer to CompuServe, you join the world's largest international network of people with personal computers. You have access to more than a thousand services that offer a source of support, information, entertainment, communications, and benefits of all kinds.

## A world of advantages.

CompuServe lets you take advantage of your personal computer in a thousand different ways.

For instance: communication. You'll get invaluable personal computer software and hardware support from other CompuServe members, as well as

product manufacturers, all over the world. Meet in special interest forums to discuss everything from science fiction to sharing software. And keep in touch through electronic mail and faxes, as well as by "talking" over 72 CB Simulator channels.

CompuServe also lets you shop coast-to-coast at hundreds of nationally known stores and take advantage of a world-class reference database. It gives you access to the latest national and international news. And our special financial files offer complete statistics on over 10,000 NYSE, AMEX, and OTC securities. You can even trade online with local discount brokers.

## Global travel and world-class fun.

CompuServe also offers airline schedules, so you can check out the bargains and book your own flights on almost any airline worldwide. You can get travel news, frequent flier information, and country and travel facts. As well as listings from over 30,000 hotels.

Plus, there are games. Sports, trivia, educational, space fantasy... you can go it alone or compete against players from all over the world. Only on CompuServe can you test your wits in the only online TV-style game show with real prizes, or leave the earth entirely in one of our interactive space adventures.

## Just give us a call.

To become a CompuServe member, you need a computer and a modem. We'll send you everything else, including a \$25.00 usage credit with your Membership Kit. In most places, you'll be able to go online with a local phone call.

To buy a CompuServe Membership Kit, see your nearest computer dealer. To receive our informative brochure or to order direct, call us today.

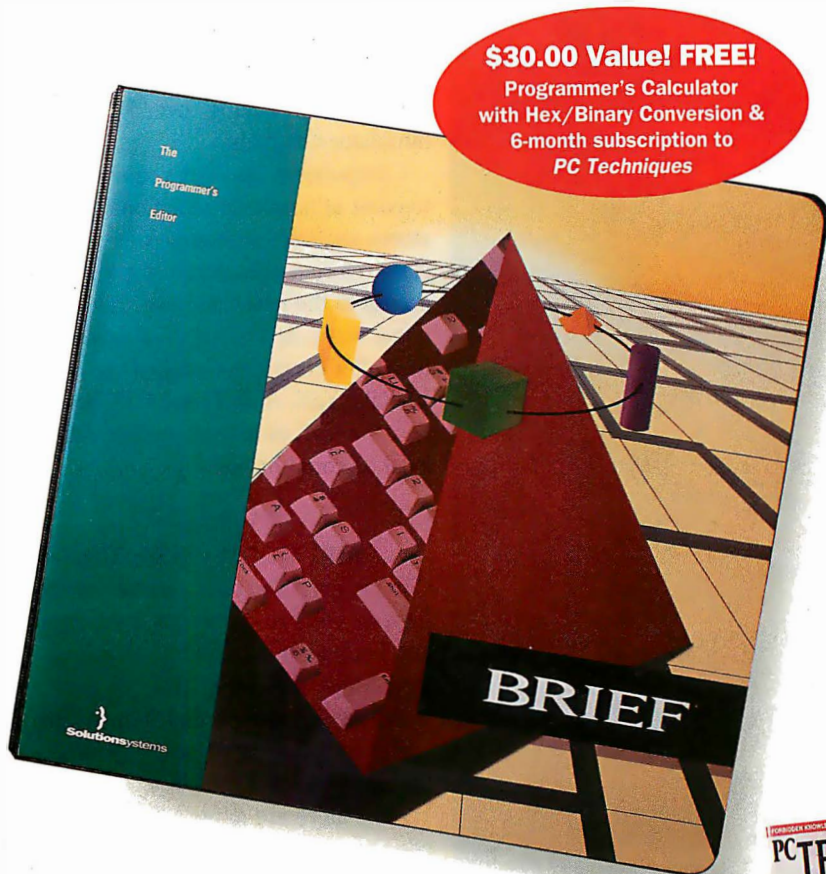
And put the whole world at *your* fingertips.

**CompuServe®**

800 848-8199

Outside U.S. and Canada: 614-457-0802

# BUY BRIEF FOR THE LOWEST PRICE IN HISTORY: \$169



BRIEF is the programmer's editor used every day by over 150,000 programmers around the world.

❶ BRIEF increases your productivity with mouse support for zippy editing. Multi-level undo and redo accommodate instant code changes. EMS memory caching speeds performance. ❷ And there's more. A completely configurable keyboard to keep you at your peak. A robust, C-like macro language for adding shortcuts. Out-of-the-box support for 42 popular compilers. Smart indenting and template editing for most popular languages spare you from time-consuming, tedious tasks. ❸ BRIEF also gives you access to Solution Systems entire lineup of productivity boosting programming tools, sold separately.



*Sourcerer's Apprentice* brings software development chaos safely under your control. *CHARGE* lets you know where you can improve code performance. *dBRIEF* for Paradox and the X-Base languages and *BRIEF* for C++ specialize BRIEF's functionality.

❹ You can take advantage of all this for **only \$169—\$80 off** BRIEF's retail list price, if you buy before March 31, 1992. ❺ And that's not all. Buy BRIEF before March 31, 1992, and receive a **free six-month subscription**, an **\$11.00 value**, to *PC Techniques*. This bi-monthly magazine gracefully blends theory and practice to improve the skills and

knowledge of all programmers—apprentice to master. ❻ If **\$80 savings** and a **free subscription** aren't enough, will a full-featured **programmer's calculator with hex/binary conversion** do it? This **\$19.00 value** is also yours



**absolutely free.** ❿ This special offer expires March 31, 1992, so act now. ⓫ Order your copy of BRIEF today.

## AND BE A BETTER PROGRAMMER IN SIX SHORT MONTHS.



Available through:

Discount  
**EGGHEAD SOFTWARE**  
America's Software Eggsperts<sup>®</sup>  
1-800-EGGHEAD

&

**THE PROGRAMMER'S SHOP**<sup>™</sup>  
1-800-421-8006

©1992, Solution Systems. All rights reserved. BRIEF requires an IBM PC, AT, or 100% compatible, 256K RAM, and two disk drives. BRIEF is a registered trademark of SDC Software Partners II, L.P. Solution Systems is a trademark of SDC Corporation. PC Techniques is a bimonthly publication; subscription offer covers three issues and is valid for new subscribers only. Subscription is cancelled if magazine ceases publication. Solution Systems, 372 Washington Street, Wellesley, MA 02181.

Circle 258 on Inquiry Card.

# EMBEDDED INTELLIGENCE

To meet the needs of increasingly sophisticated systems and applications, drives are getting smarter

ROD KIRK, TIM CHRISTIANSON, AND DANIAL FAIZULLABHOY

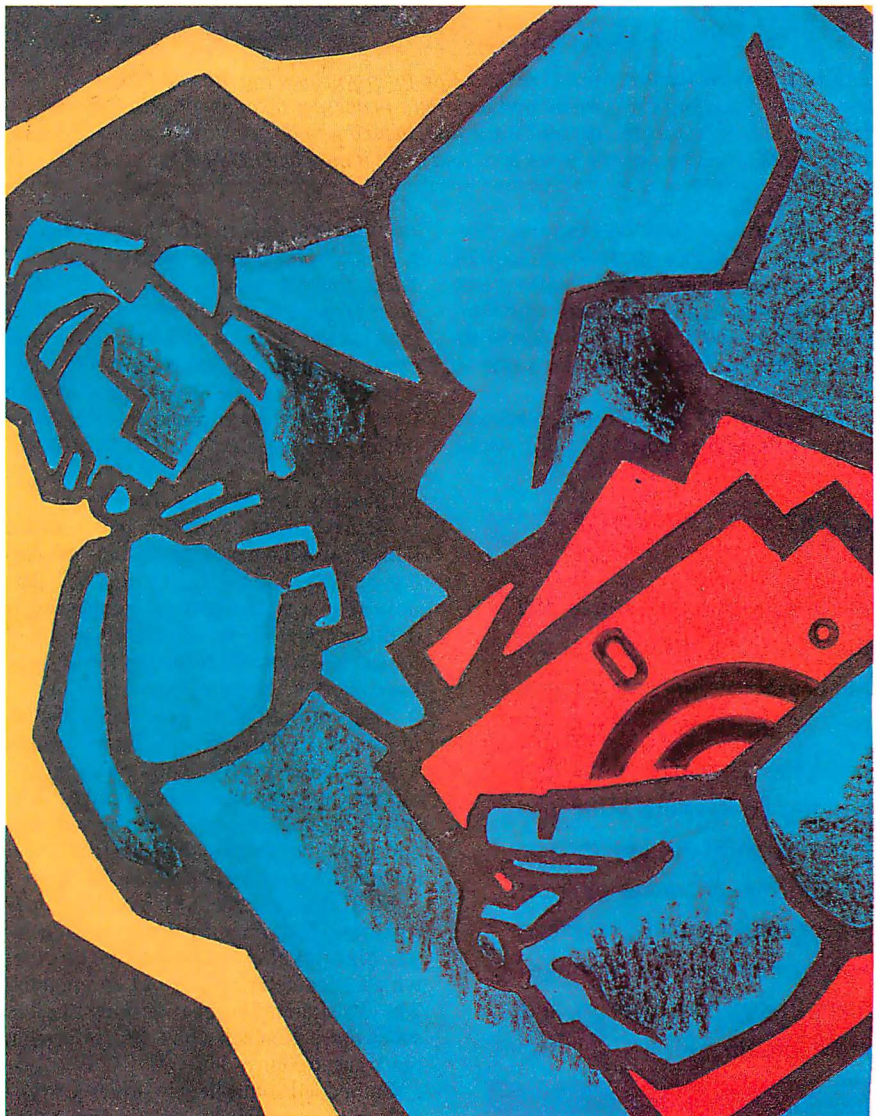
**I**ncreasing levels of intelligence and automation are now appearing in drives. Several factors are behind this trend, including demands for higher performance and more fully featured software in both operating systems and applications. For example, the size and complexity of Windows demands a lot more peripheral performance to run effectively than DOS does.

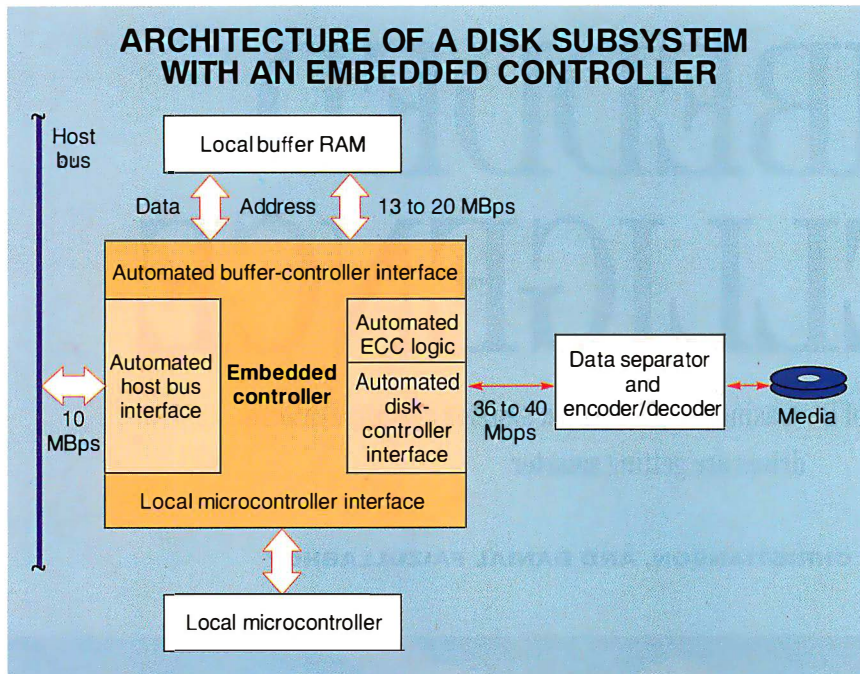
Network operating systems like Novell's NetWare and Banyan's Vines are also making new demands. Without high-speed peripherals, such systems encounter serious bottlenecks, particularly with multiple users on a file server. Older and slower peripherals cannot provide the performance needed.

Applications have moved along a similar growth path. With the 640-KB DOS boundary no longer a problem and DRAM prices moderate, applications commonly use many megabytes of disk space for programs and data. Increasingly sophisticated users expect to be able to read and write large amounts of data rapidly, not just to have a good execution speed. These expectations can't be met without high-capacity and high-bandwidth peripherals.

The need for enhanced capacity comes when drive form factors are shrinking, creating a need for vastly increased recording densities. This trend has led manufacturers of drives to use surface area more efficiently with techniques such as constant density recording (CDR) and embedding servo information on the disk.

CDR places more data on the outer tracks of a disk than on the inner ones, increasing the amount of data on a disk (see the text box "More Bits per Inch" on page 200). However, CDR also creates more





**Figure 1:** The microcontroller is responsible for programming the embedded controller, handling exceptions, and, in single-processor designs, positioning the read/write heads over the desired track and ensuring that they stay aligned. The disk buffer holds data moving between host and disk; it may be DRAM or static RAM.

work for the drive controller circuitry. Servo data keeps read/write heads aligned by feeding back alignment information from the disk to the head-positioning circuitry. These kinds of intelligent embedded controllers have added substantial value to drive control.

Increasing I/O bandwidth necessitates reducing the time required for a drive to lo-

cate the first data in the file requested as well as increasing the transfer rates between peripherals and system CPUs. To meet these requirements, you can buffer data on the peripheral, increase the media-to-buffer and buffer-to-host-CPU data transfer rates, reduce the overhead of each transfer, and support concurrent media-to-buffer and buffer-to-host-CPU transfers.

### Exploring the Architecture

Hard drives contain platters that hold the data, read/write heads and associated analog circuitry, and digital circuitry. The digital circuitry typically contains an embedded-controller IC that is closely coupled to a microcontroller, buffer RAM, and host-interface circuitry (see figure 1).

The host-bus interface is either direct, as in the case of IDE drives, or made through a host adapter or a SCSI port on the motherboard, as in the case of SCSI drives. IDE drives connect directly to the system bus and place the functionality of a traditional system drive controller inside the drive.

SCSI is an interface for intelligent peripherals. It defines *initiators*, which issue high-level commands, and *targets*, which execute the SCSI I/O commands. The SCSI standard also defines the bus states through which a bus passes during a bus transaction.

Embedded controllers in drives are typically programmable-state machines that

automate data transfer and interfacing functions under the direction of a microcontroller. Embedded-controller designs use internal registers and interrupts to communicate with the microcontroller.

Many embedded controllers execute microcode instructions that guide the embedded controller during a disk read or write. They contain disk sequencers, complete with a program counter, a stack, and branching logic to enable the use of microcode subroutines. These sequencers control track reading, writing, and formatting.

Microcode implementations typically support in-line instruction execution and branching to subroutines. The microcode program used with each drive contains a track format. Microcoded embedded controllers can typically transfer a full track of data without the microcontroller's intervention.

### Anatomy of a Disk Track

Tracks are concentric circular areas of a disk that are broken into a series of sectors, each holding an identical amount of information. An index pulse, a special pattern written on a disk, determines the starting point of each track. It can also tell you when a specific sector on a track is missing (i.e., when the index pulse passes under the head twice without a match).

Each sector on a disk contains a series of fields (see figure 2). The ID header contains the variable frequency oscillator (VFO), which is used to lock the analog circuitry to the read/write frequency; the data-sync byte; the servo positioning information fields; and the cyclic redundancy check (CRC) fields.

The data-field byte sync specifies the starting point of data (as opposed to pad, servo, or VFO fields). The CDR field is used to embed servo information in a data field. The CRC field (shown as 16 bits) is for the ID header only. The CRC can detect errors, but it cannot correct them.

The data area of a sector also starts with a VFO field and a data-sync byte. In figure 2, servo information splits the data field. (Defects in the disk itself can also split a data field.)

The error-correction code bytes are at the end of a sector's data field; they are for the data area only and can both detect errors and correct them. You can also split the ECC field or the intersector-gap regions of a sector or track.

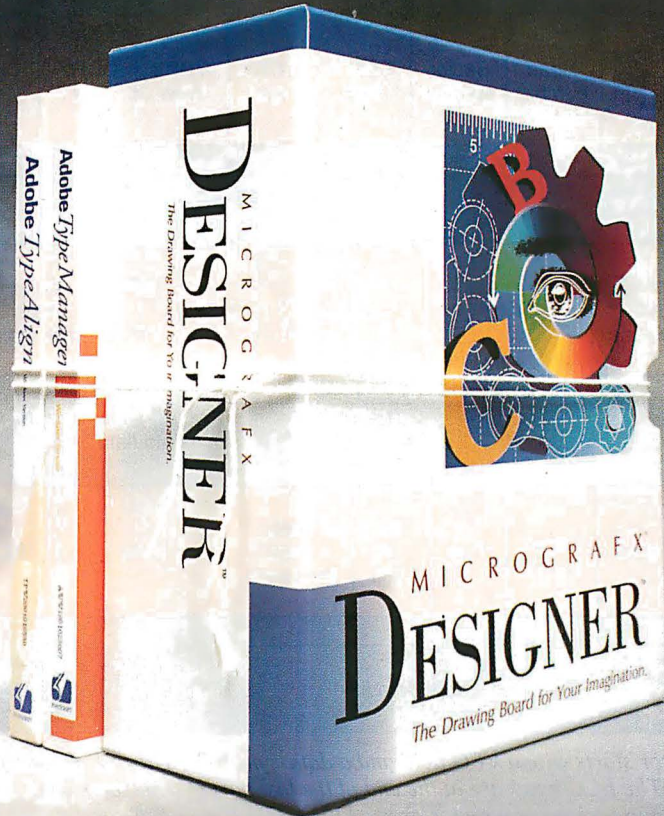
### Handling the Splits

Embedded controllers use indications on the disk surface (e.g., an index pulse or a data-sync byte) to tell them to branch within the microcode program when reading

## BYTE ACTION SUMMARY

As disk capacities increase and their physical sizes decrease, more automation and integration of functions in drives become critical requirements. Embedded controllers built into drives provide the key to continuing these trends by integrating error handling, interface automation, buffer management, energy conservation, and more into drives.

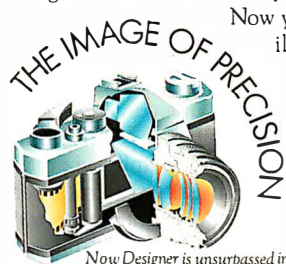
# The World's Top-Rated Illustration Software Is Getting Some Impressive Letters.



## Now Adobe type-handling software and 180 Type 1 fonts are integrated *free* into Micrografx Designer!

What do you get when you cross the world's most powerful PC illustration software with the ultimate type-handling software? You get lots of attention.

That's because there's never been anything like the new Micrografx Designer.™ We've seamlessly integrated Adobe Type Manager, plus Adobe TypeAlign, plus 180 Type 1 fonts into Designer. That's a value of over \$5,000 – free!



Now you can bring professional-looking illustration and type to everything you do. From technical drawings to transparencies, layouts to logos. As well as to PageMaker, Word for Windows, Excel and other Windows programs.

Besides choosing from a huge selection of fonts in any

size, you'll be able to add special effects like perspective, shadows and rotation. Do your own kerning and leading. Or use Designer's powerful drawing tools to alter your type at will.

Here's what people were saying about Designer even before our Adobe upgrade:

“Designer is perhaps the most sophisticated of all the illustration packages.”

PC Magazine, Editor's Choice (3 consecutive years)

“State-of-the-art features, good performance and unmatched ease of learning and use in a sophisticated package.” Software Digest, ★★★★★ (highest rating)

So why just get by when you can get noticed with Designer?

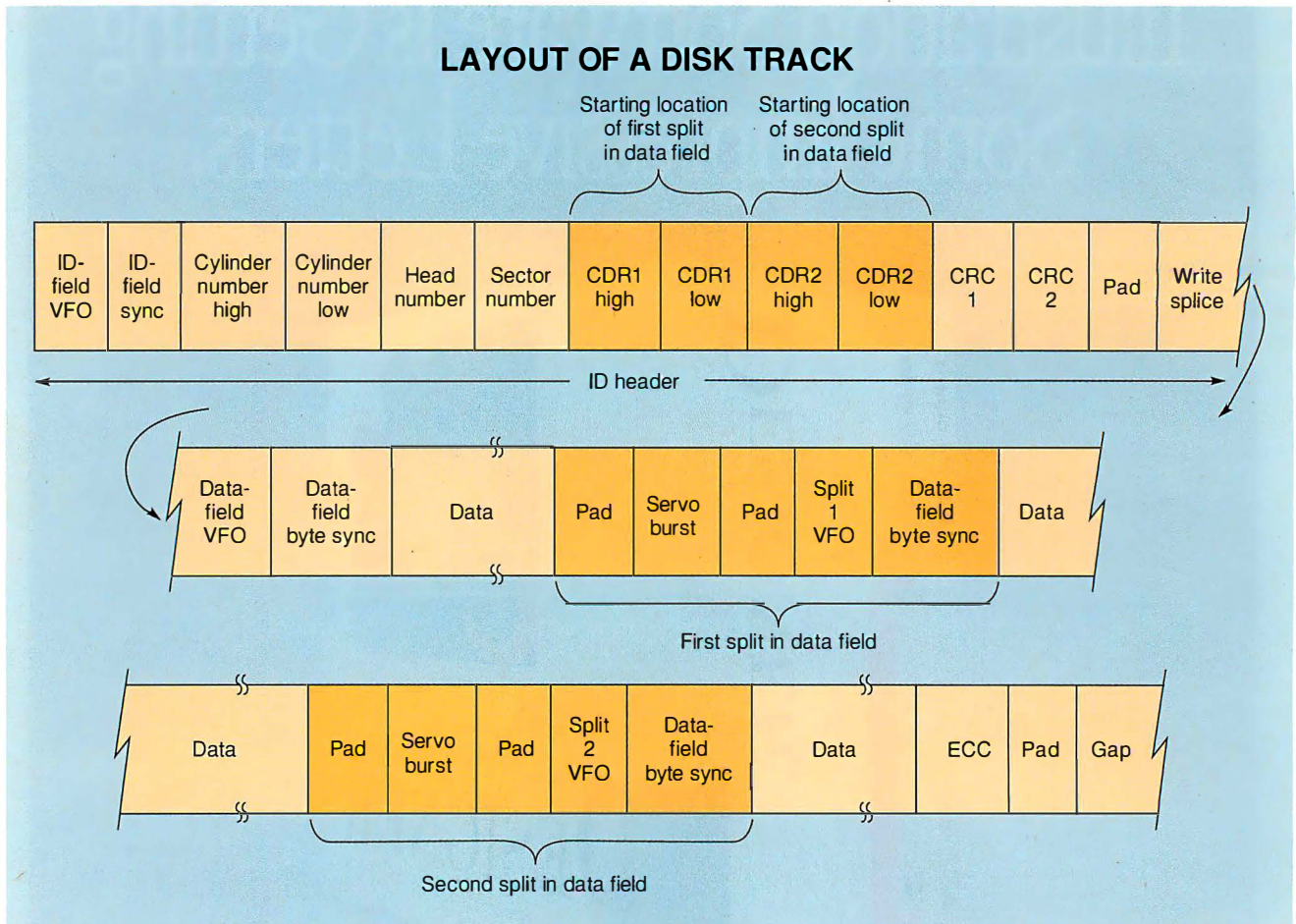
Call to order today! Registered Designer 3.X users call for your \$99.95 upgrade (\$149.95 for earlier versions).

**60-day money-back guarantee! 1-800-733-2113**

M I C R O G R A F X ®

Micrografx, Inc. 1303 Arapaho, Richardson, TX 75081 (214) 234-1769. Micrografx has offices in Los Angeles, Paris, London, Munich, Sydney and Copenhagen. Copyright © 1991, Micrografx, Inc. All rights reserved. Micrografx is a registered trademark and Micrografx Designer is a trademark of Micrografx, Inc. All other products are trademarks of their respective owners. Designer system requirements: 286 (386 recommended) IBM PC or compatible, or PS/2. 1 MB RAM (2 MB RAM recommended). 20 MB (or larger) hard disk. Windows 3.0, DOS 3.1 (or higher). Mouse or digitizing pad. Windows-compatible monitor.

Circle 80 on Inquiry Card.



**Figure 2:** The data area of a sector starts with a VFO field and a data-sync byte. The one depicted here is broken by servo information that splits the data field. The ECC bytes are at the end of the last part of a sector's data field (it's also possible to split the ECC field or the intersector gap regions of a sector or track).

or writing sector data. This process occurs after the drive controller aligns the read/write heads over a disk track.

When servo or defect areas split the data area, the microcontroller must suspend ECC computation and buffer-data transfer and restart them with precise timing to maintain correct head positioning. Otherwise, the disk has to rotate another revolution to get the head back in position over the desired data. Clearly, you don't want to add more latency to the data access.

You can use several methods to signal the embedded controller to stop or start ECC computation and buffer-data transfer. These include the header-field, microcontroller-load, and freeze-ECC methods.

The header-field method codes the locations at which to suspend ECC computation and buffer-data transfer into the CDR fields. Each CDR field specifies the point at which servo data or defects commence.

Each value is typically loaded into a first-in/first-out stack in the embedded con-

troller when the ID-header area is read. This FIFO stack feeds a *down counter* that is internal to the embedded controller and reduced by each byte transferred. An internal interrupt occurs when the counter reaches zero, and a branch to a predetermined address occurs in the microcode.

The microcode executed after the branch waits for the servo area to pass under the read/write head and looks for a VFO field and a data-sync field, which follow each split. The microcode executes a return, and ECC computation and buffer-data transfer begin where they left off. Thus, you don't need to specify the end point of the defect or servo areas.

The header-field method of implementing split fields is quite automatic. CDR values are loaded from the ID header into the FIFO stack. The microcontroller can dedicate its bandwidth to other tasks, so possibly a lower-performance, lower-cost microcontroller could provide the same data throughput. Although data splits can arbitrarily occur within a sector, the depth

of the FIFO stack limits the number of splits possible.

Another method of handling split fields, microcontroller load, relies on the microcontroller to load the embedded controller's internal FIFO stack at the appropriate times. To ensure valid data, the microcontroller must never let the FIFO stack become empty during a sector read or write. This method is quite flexible. However, the microcontroller's bandwidth limits the number of splits possible, because it must also perform other tasks (e.g., read/write head positioning and alignment).

A third method of automating split-field implementations freezes ECC computation at a certain point. Splits are placed at fixed locations (usually with respect to the last data-sync field) within every sector's data area. The embedded controller counts the transferred bytes and branches to freeze ECC computation when the count reaches zero.

This method assumes that all splits occur in the same location in every sector;



release  
3.1 shipping

# CSS: STATISTICA

**CSS/3™** Complete Statistical System with over 1,000 presentation-quality graphs fully integrated with all procedures and on-screen graph customization ■ The largest selection of statistics in a single system; in-depth, comprehensive implementations of: *Exploratory techniques; multi-way tables with banners; nonparametrics; distribution fitting; multiple regression; general nonlinear estimation; logit/probit analysis; general ANCOVA/MANCOVA; stepwise discriminant analysis; log-linear analysis; factor analysis; cluster analysis; multidimensional scaling; canonical correlation; item analysis/reliability; survival analysis; time series modeling; forecasting; lags analysis; quality control; process analysis; experimental design (with Taguchi);* and much more ■ Manuals with comprehensive introductions to each procedure and examples ■ Integrated Stats Advisor expert system ■ Extensive data management facilities (powerful spreadsheet with formulas; relational merge; data verification; flexible programming language) ■ Optimized (plain English menus/mouse) user interface: even complex analyses require just few self-explanatory selections (CSS can be run without manual; Quick Start booklet explains all basic conventions) ■ Macros, batch commands also supported ■ All output displayed in Scrollsheets™ (dynamic tables with pop-up windows and instant graphs) ■ Extremely large analysis designs (e.g., correlation matrices up to 32,000x32,000) ■ Unlimited size of files; extended precision; unmatched speed (Assembler, C) ■ Exchanges data (and graphics) with many applications (incl. Excel®, Lotus 3®, dBASE IV®, SPSS®) ■ Highest resolution output on practically all printers (incl. HP, Postscript), plotters, recorders, typesetters ■ IBM compatibles, 640k or more ■ Price: \$595.

**Quick CSS™** Subset of CSS/3: all basic statistical modules (incl. data management) and the full, presentation-quality graphics capabilities of CSS/3 ■ Price: \$295.

**CSS:GRAPHICS™** A comprehensive graphics/charting system with data management ■ All graphics capabilities of CSS/3 and, in addition, extended on-screen drawing, 19 scalable fonts, special effects, icons, maps, multi-graphics management ■ Hundreds of types of graphs ■ Interactive rotation and interactive cross-sections of 3D graphs ■ Extensive selection of tools for graphical exploration of data; fitting; smoothing; spectral planes; overlaying; layered compressions; marked subsets ■ Unique multivariate (e.g., 4D) graphs ■ Facilities to custom-design new graphs and add them permanently to menu ■ Import/export of graphs and data, 15 formats ■ Optimized (menu/mouse) user interface; even complex graphs require few keystrokes: all graphs on this page can be produced from raw data in less than 20 minutes ■ Macros, batch/commands also supported ■ Unlimited size of files ■ Highest resolution output on all hardware (see CSS/3) ■ IBM compatibles, 640k or more ■ CSS:GRAPHICS is included in CSS:STATISTICA (available separately for \$495).

**Megafile Manager™** Comprehensive analytic data base management system ■ Unlimited size of files (up to 32,000 fields or 8 MB per record) ■ Megafile Manager is included in CSS/3 and CSS:STATISTICA (separately: \$295).

**CSS:STATISTICA™** A fully integrated system that combines all the capabilities of CSS/3 and CSS:GRAPHICS into a single extremely comprehensive data analysis system ■ Price: \$795.

Domestic sl/h \$7 per product; 14-day money back guarantee.

Circle 120 for DOS. Circle 121 for MAC.  
**StatSoft™**

2325 E. 13th St. • Tulsa, OK 74104 • (918) 583-4149  
Fax: (918) 583-4376

Overseas Offices: StatSoft of Europe (Hamburg, FRG), ph: 040/4200347, fax: 040/4911310; StatSoft UK (London, UK), ph: 0462/482822, fax: 0462/482855; StatSoft Pacific (Melbourne, Australia), ph: 613-866-1766, fax: 613-866-3318; StatSoft Canada-CCO (Ontario), ph: 416-849-0737, fax: 416-849-0918. Available from: CORPORATE SOFTWARE and other Authorized Representatives Worldwide: Holland: Lemax BV 02065-98701; France: VERSION US (1) 40590913; Sweden: AkademiData 018-240035; Spain: ADDLINK, SRL; ph: 34-3-459-0722.

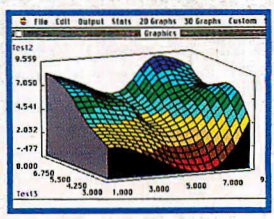
CSS, CSS 3, CSS GRAPHICS, Megafile Manager, Quick CSS, STATISTICA, StatSoft, dBase IV, Excel, Lotus, MacDraw, Macintosh, Postscript are trademarks of their respective companies. SPSS is a registered trademark of SPSS, Inc.

The grid displays a variety of statistical results:

- Top Row:** Flight Indicator of Poverty (3D surface plot), Regression Statistics (summary table), and a scatter plot.
- Second Row:** A 3D surface plot with a rainbow color scale, a regression analysis window showing coefficients, and a scatter plot.
- Third Row:** A 3D surface plot, a regression analysis window, and a scatter plot.
- Fourth Row:** Ribbon View of TEE T1/2/3 SURFACE (3D surface plot), Regression Statistics (summary table), and a scatter plot.
- Fifth Row:** A data table with columns for Name, Height, Weight, etc., a scatter plot, and a regression analysis window.
- Sixth Row:** A scatter plot, a regression analysis window, and a scatter plot.
- Seventh Row:** A scatter plot, a regression analysis window, and a scatter plot.
- Eighth Row:** A scatter plot, a regression analysis window, and a scatter plot.
- Ninth Row:** A scatter plot, a regression analysis window, and a scatter plot.
- Tenth Row:** A scatter plot, a regression analysis window, and a scatter plot.
- Eleventh Row:** A scatter plot, a regression analysis window, and a scatter plot.
- Twelfth Row:** A scatter plot, a regression analysis window, and a scatter plot.

**STATISTICA/Mac™** A CSS-compatible, comprehensive data analysis and graphics system designed for the Macintosh ■ Large selection of statistical methods fully integrated with presentation-quality graphics (incl. EDA, multiplots, a wide selection of interactively rotatable 3D graphs; MacDraw-style tools) ■ Unlimited size of files ■ Exchanges data with Excel and other applications ■ Price: \$495.

**Quick CSS/Mac™** A subset of STATISTICA/Mac: all basic statistical modules and the full, presentation-quality graphics capabilities of STATISTICA/Mac ■ Price: \$295.



# More Bits per Inch

The quest for higher-storage capacity in smaller form-factor drives has led to significant advances in magnetic-recording technology. Not long ago, most hard drives used variable-density recording, in which data is written at a constant rate and the disk rotates at a constant angular velocity (see figure A). With this technique, the data on the inner tracks is denser than the data on the outer tracks. Thus, outer track space is used less efficiently.

An alternative method now gaining wide acceptance divides each disk into concentric zones. Recording densities in each zone are optimized and are nearly equal. Because outer zones are larger in diameter, they contain more bits. They also contain more sectors. Because the read/write head traverses more bits in

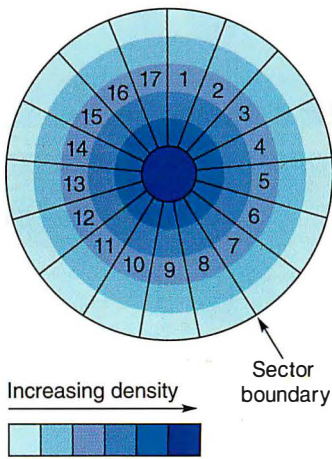
the outer zones than in the inner zones in the same amount of time (the motor speed is constant), the data rate is higher in the outer zones. This method is called *constant-density recording* (see figure B).

Another technique being used to increase densities is the embedding of servo data on a disk. In the past, fine-head-positioning information, essential to the closed-loop servo systems necessary for medium- and high-capacity drives, was stored solely on a

dedicated disk platter. Manufacturers are increasingly embedding this servo data within data fields in bursts 10 to 25 bytes in length.

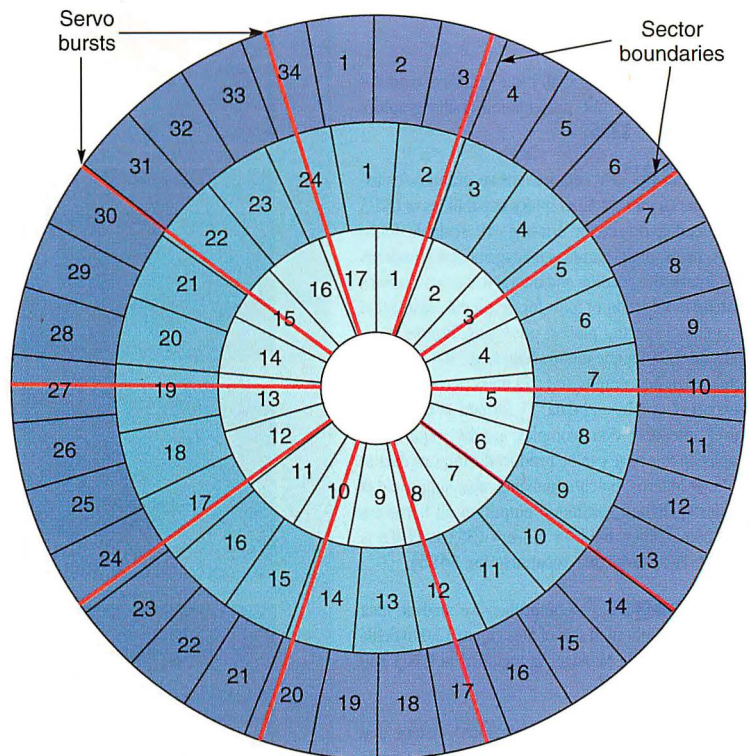
As shown in figure B, servo bursts are commonly located along a radial path from the disk center, ensuring that head-positioning data occurs at consistent intervals. These splits must be ignored during the data transfer, error-detection, and error-correction processes; the embedded controller never sees the actual data within them.

## VARIABLE-DENSITY RECORDING

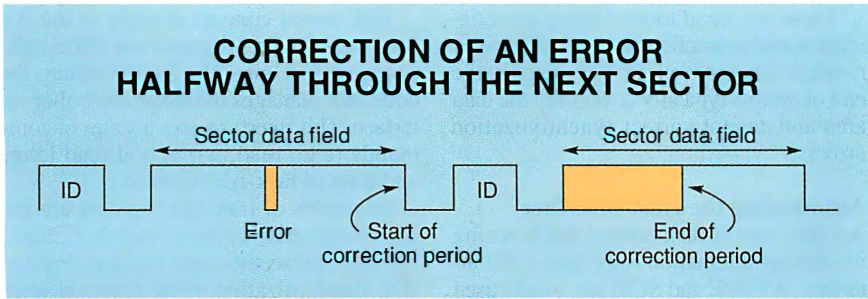


**Figure A:** Typical hard disks have used variable-density recording, which writes data at a constant rate to a disk rotating at a constant angular velocity. Variable-density recording results in a lower density (and lower storage efficiency) for recorded data on the outer tracks of a disk.

## CONSTANT-DENSITY RECORDING



**Figure B:** CDR is a more efficient storage method that is now gaining acceptance. It breaks each disk platter into concentric zones, each with a recording density optimized for it. Because the outer zones are larger in circumference, they can contain more bits. More sectors are recorded in the outer zones than in the inner zones (each sector contains the same number of data bits).



**Figure 3:** Correctable single-burst errors are typically corrected by the time the disk has rotated halfway through the data sector that follows the sector with the error.

if they don't, the microcontroller must dynamically modify the microcode program, using precious bandwidth. One potential shortcoming of this method is that the size of the counter in the embedded controller limits the number of bytes possible between servo (or defect) areas. However, this is typically not a problem, because the counter is at least 16 bits long.

Other methods for locating splits include issuing an external interrupt when encountering servo data (this requires additional external circuitry) or positioning the splits the same distance (in bytes) apart

so that the down counter always contains an identical value. Ideally, this last method should use little or no microcontroller bandwidth, leaving the microcontroller free to concentrate on head positioning.

**Embedded Error Handling**

As track and bit densities increase, the probability of errors on disk surfaces also rises; in fact, defect densities grow exponentially with increases in track densities. High data transfer rates compound the problem, so detection and correction must be rapid and accurate.

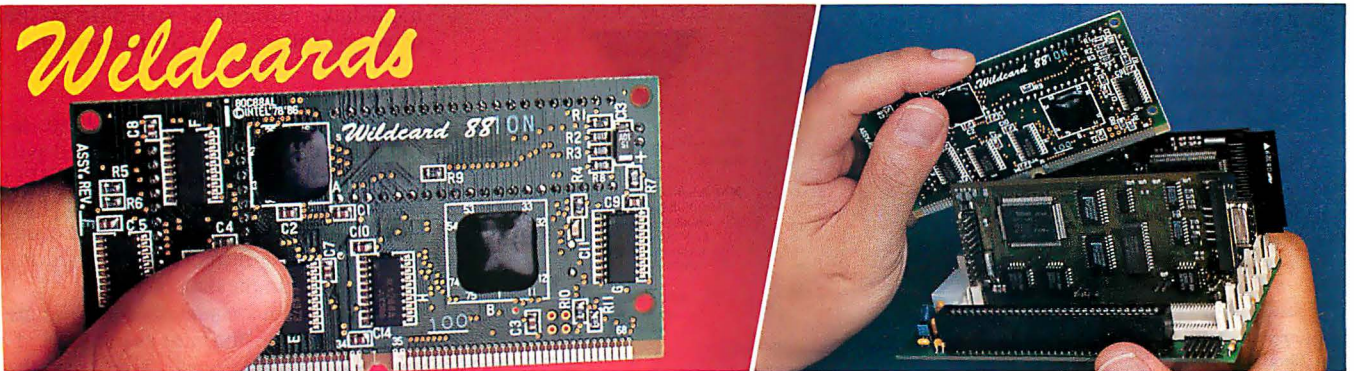
The solution is to integrate error-detection and error-correction circuitry into an embedded controller. This architecture would allow error correction without microcontroller intervention.

Error detection and correction are too complex to occur at the full-disk data transfer rate. To automate this process, you must separate the detection and correction circuitry into two blocks.

Error-detection circuitry operates on the incoming data stream to determine if it contains errors. Error-correction circuitry operates simultaneously on previously transferred data. It typically fixes correctable single-burst errors by the time the disk has rotated halfway through the next sector (see figure 3).

The microcontroller can also correct errors off-line by executing a correction algorithm. You can correct more and longer error bursts this way. You can detect double-burst errors (up to 17 bits per burst with an 88-bit Reed-Solomon ECC) and correct them (up to 11 bits per burst) on-line. You are able to detect three bursts up to 11 bits each off-line and correct even larger error bursts off-line if you can tolerate a higher probability of misdetection

# 2" x 4" EMBEDDED PC



## Microcontroller.

## Microcomputer.

"Megatel Wildcards provide PC functionality in a flexible, small format."

**Wildcard 88™**

- CPU clock to 10 MHz
- Replaces full PC motherboard
- Co-processor and BIOS socket
- DMA, Bus, DRAM, Keyboard controllers

**Multil/10**

- On-board SCSI Host Adapter (supports up to 7 devices)
- Floppy Controller (1.44M, 1.2M)
- 2 RS-232, 1 Parallel, 1 RS-485 multi-protocol serial port

**Vid/Mem:**

- 640Kb User memory
- Video/Colour LCD controls CGA, Hercules®, IBM® Mono; (runs LCD Panels)

All Wildcards are low power single +5 volt operation.

125 Wendell Ave., Weston, Ont. M9N 3K9 Fax: (416) 245-6505

Cebit'92  
Canada Stand  
Hall Six

For information on our representatives please contact our head office at the number below.

**(416) 245-3324**

Wildcard 88 and Megatel are trademarks of Megatel Computer Corp. Hercules is a trademark of Hercules Corp. IBM is a trademark of IBM Corp.



and miscorrection.

As more sophisticated circuitry is built into embedded controllers and longer ECCs are stored with each sector, larger and more frequent errors can be corrected. Certain types of disks (e.g., magneto-optical) require these more sophisticated methods of detection and correction. Higher error rates and more sophisticated error detection and correction also become necessary as bit densities increase on hard disks.

There is a trend toward using error detection and correction for track-format or nondata areas as well. ECCs located at the end of sectors typically cover only the data area and cannot correct synchronization errors.

**Automating the Host Interface**

Another area of disk control that is seeing increasing automation is the host-CPU interface. AT/IDE and SCSI are widely used interfaces.

IDE drives connect directly to the AT bus. Application programs use BIOS calls to access disk data. The BIOS contains the code that manages the drive controller interface. This interface uses a series of commands (e.g., read, write, and read long) and a set of task-file registers.

Examples of task-file registers are the sector-number, cylinder-number, head-number, and sector-count registers. Prior to IDE standardization, these registers were on a drive controller card; now they are typically internal to the embedded-controller IC in the drive.

Automating task-file-register updates during multisector reads or writes is becoming more commonplace in embedded controllers. Consider, for example, a multisector read of a series of contiguous sectors. With automatic task-file-register updates, the read process automatically updates the sector-number, head-number, and cylinder-number registers. The embedded controller contains the maximum value for each register. As each register wraps to 0, it can increment the next most significant one (e.g., the sector, head, or cylinder) in ascending order of significance.

Monitoring hardware signals on the AT bus as well as certain handshake bits (e.g., BSY or DRQ) used to interface to IDE drives is another area that more sophisticated embedded controllers are automating. These devices assert and deassert appropriate bits during data transfer and handshake sequences, speeding up the drive controller side of the transaction.

**SCSI Automation**

The SCSI-1 standard, adopted in 1986, defines the rules for asynchronous and synchronous data transfers. Both use REQ handshake signals (which the target asserts) followed by ACK handshake signals (which the initiator asserts) during transfers within the data phase.

Asynchronous transfers don't dictate how fast the initiator must assert ACK after receiving REQ; transfer rates are in the 2-Mbps range. Synchronous transfers require the exchange of messages between the target and the initiator (prior to the first transfer) to establish the maximum transfer rate they can support (the highest allowable rate is 5 MBps).

The SCSI-2 standard, formalized in 1990, defines higher-speed synchronous transfers. Maximum transfer rates are 10 MBps (100-nanosecond cycle time) on a single cable and up to 40 MBps on a double cable. Sophisticated embedded controllers already handle 10-Mbps transfers without microcontroller intervention.

The SCSI bus passes through a series

# Get a hold of the best value in LAN power protection for just \$169

suggested list price

Blackouts, brownouts, sags... Your data and hardware are vulnerable to problems that surge suppressors and power directors are just not equipped to handle.

Now there's a complete Uninterruptible Power Supply solution to suit any budget. The Back-UPS™ 250 is reliable protection for LAN nodes, 386SX machines, 286, small PS/2 systems, and internetworking hardware such as routers, bridges, gateways and hubs.

From the largest server to the smallest router, the Back-UPS Series will increase your productivity by providing a cost-effective solution to power problems. Call for your free power protection handbook.



The NEW Back-UPS 250 offers even more cost-effective protection for LAN nodes (typical runtime for a 386SX system is 10 minutes).



- Full-time surge protection and line filtering
- Models from 250 to 1200 Volt-Amps, many with LAN interface for automatic-shutdown of Novell, LAN Manager, LAN Server, LANtastic, Banyan, SCO Unix, SunOS, AIX etc.
- UL, CSA and Novell approved with a 2 year warranty
- 230V models available
- Ask about PowerChute® UPS monitoring software and Novell-compatible UPS monitoring boards



**The Back-UPS**™  
by American Power Conversion  
800-800-4APC, Dpt. A2

	Model	Application	List
NEW!	Back-UPS 250	386SX, 286, XT, AT, internet hardware, POS	\$169
NEW!	Back-UPS 400	Desktop 386, 486 systems, 286 servers	\$249
NEW!	Back-UPS 450	Tower 386, 486 systems, servers	\$329
NEW!	Back-UPS 600	Heavily configured systems, CAD/CAM workstations	\$449
	Back-UPS 800RT	Multiple systems, longer runtime applications	\$899
	Back-UPS 1200WX	Multiple systems, LAN hubs, small minis, telecom equipment	\$1199

of phases while performing a data transfer. It starts with the bus-free phase and passes through the arbitration-, selection-, command-, data-, status-, and message-bus phases. Not all phases are required with all commands.

Earlier SCSI embedded controllers handled one phase at a time, interrupting the microcontroller when a bus phase was completed. This caused a time delay while the microcontroller programmed the embedded controller to handle the next bus phase.

Because the phases of a SCSI bus are so well defined, it's possible to automate control of multiple bus phases. These features are now appearing in embedded controllers and take the form of automated sequences consisting of multiple SCSI bus phases. Microcontroller intervention is still required, but not as frequently as with earlier devices.

The following are examples of multi-phase sequences. One is the selection of a target via the selection phase, receipt of one or more message bytes, and receipt of a multibyte command in the command phase. Another is the transfer of data until the buffer is full or empty in the data phase and the transmission of the "save data pointers" and "disconnect" messages to the host. A third is the execution of the status, message, and SCSI-bus-free phases.

Note that the SCSI bus permits a target that needs time to retrieve data to disconnect from the bus, read the data, and reconnect to the bus to complete the desired transfer. Advanced embedded controllers are also automating the disconnect and reconnect operations by providing sequences of multiple SCSI bus phases that will execute without microcontroller intervention. The result is less latency between SCSI bus phases. Once again, the host adapter may well become the bottleneck.

Reconnecting the SCSI bus to a target that is ready to transfer previously requested data in a multiple initiator system has a unique set of constraints associated with it. Consider the case in which target 0 receives a command from initiator 1 for data that it must retrieve. Target 0 disconnects, retrieves the data, and tries to reconnect to initiator 1.

Prior to reconnection, the microcontroller on target 0 programs the embedded controller for reselection by initiator 1 and transfer of the requested data. If initiator 2, which has a higher priority than initiator 1, selects target 1, the programmed sequence on target 1 will not occur.

The result will be an interrupt from target 0's embedded controller to the microcontroller that is requesting assistance. La-

tency time occurs while the microcontroller determines the state of the SCSI bus. As future generations of embedded controllers contain more and more intelligence, they will be able to handle multitasking. This will negate the need for a multiple-initiator implementation to issue a microcontroller interrupt.

### Managing Buffers

Buffer RAM is typically present in drive controller designs. The microcontroller uses it for scratchpad memory and off-line error correction. It also holds host-to-disk and disk-to-host data, as well as data that the embedded controller's internal ECC circuitry is correcting. If buffer RAM contains DRAM, refresh accesses also compete for its bandwidth.

The embedded controller typically is the arbiter for RAM accesses. Thus, it must contain a multipoint access-control circuit. Many of today's embedded controllers do.

It's important not to lock out any type of access. For instance, refresh cycles must always be allowed. Host access during a disk-to-buffer-RAM transfer should also be permitted. Overlapping usage increases throughput substantially. One common way to prevent lock-out is to support *cycle stealing* (i.e., to allow the host-interface circuit to insert access cycles between adjacent disk-to-buffer-RAM cycles).

Concurrent access requires sufficient bandwidth. For instance, truly simultaneous disk-to-buffer-RAM and buffer-RAM-to-host transfers require the RAM-access bandwidth to be equal to the sum of the host and disk access rates. Embedded controllers now provide 15-Mbps buffer access rates. This compares favorably with 40-Mbps serial data rates from the disk and 10 MBps across the SCSI bus. All these values will increase in the future.

Sufficient bandwidth for concurrent access is only part of the story. Because the host and disk interfaces use different clocks, synchronization is a concern. Using internal FIFO stacks at both interfaces ensures that embedded controllers won't limit either interface's performance.

Automating disk-to-host or host-to-disk transfers (i.e., reducing microcontroller accesses to RAM and embedded-controller registers) also boosts performance. You can accomplish this in several ways. One way is to incorporate buffer management logic in the embedded controller. This logic may support any of the following:

- buffer RAM that is segmented into buffers ranging from a single kilobyte to the maximum buffer size
- interface-specific counters that track the contents of each active buffer

associated with the interface and that support circular buffers

- logic that suspends the transfer across an interface when its buffer becomes too empty or too full and that restarts the transfer when the buffer reaches a threshold level
- SCSI peripherals that are automatically disconnected when a buffer becomes too empty or too full and that are automatically reconnected when more buffer space is available

### Energy Conservation

Finally, the growing sales of portable and notebook computers have increased the importance of conserving power and prolonging battery life. Reducing power consumption means turning off power-hungry circuitry (e.g., the high-current drivers used at bus interfaces) and reducing the frequency of clock signals—or just shutting them off (because CMOS technology is widely used in embedded-controller ICs, turning off clocks eliminates the power consumption of a particular block of logic). The challenge is to provide power-down modes while supporting automatic wake-up with minimal overhead.

Power-down implementations for drives rely on partitioning logic blocks so that essential circuitry can be kept in a power-on state, and on powering down nonessential circuits (e.g., the drive motor and read/write circuits) after a predetermined time-out period. For instance, if an embedded controller connected to a SCSI bus must wake up on selection, the associated logic must remain powered up.

Typical implementations generate an interrupt when the SCSI bus is selected, so the microcontroller will power up the appropriate devices and circuits. An equivalent AT/IDE implementation would power up when it received an AT disk-access command.

Microprocessors that incorporate on-chip power-down logic are now available for laptop and notebook computers. It is only a matter of time before the same type of capability appears in microcontrollers along with the many other functions already there. When incorporated into drives, especially future generations that include the embedded controller and microcontroller in a single device, on-chip power-down logic will open the window of performance even wider. ■

---

*Rod Kirk and Tim Christianson are senior applications engineers for Adaptec's peripheral products operation in Milpitas, California. Danial Faizullahoy is a product marketing manager for Adaptec. You can reach them on BIX c/o "editors."*

# Storage for Networks

**Acer America Corp.**

401 Charcot Ave.  
San Jose, CA 95131  
(408) 922-0333  
fax: (408) 922-0176  
**Circle 1174 on Inquiry Card.**

**Advanced Digital Information Corp.**

14737 Northeast 87th St.  
P.O. Box 2996  
Redmond, WA 98073  
(206) 881-8004  
fax: (206) 881-2296  
**Circle 1175 on Inquiry Card.**

**Advanced Logic Research, Inc.**

9401 Jeronimo  
Irvine, CA 92718  
(714) 581-6770  
fax: (714) 581-9240  
**Circle 1176 on Inquiry Card.**

**Array Technology Corp.**

4775 Walnut St.  
Boulder, CO 80301  
(303) 444-9300  
fax: (303) 444-0059  
**Circle 1177 on Inquiry Card.**

**AST Research, Inc.**

16215 Alton Pkwy.  
P.O. Box 19658  
Irvine, CA 92713  
(714) 727-4141  
fax: (714) 727-9355  
**Circle 1178 on Inquiry Card.**

**Ciprico, Inc.**

2955 Xenium Lane  
Plymouth, MN 55441  
(612) 559-2034  
fax: (612) 559-8799  
**Circle 1179 on Inquiry Card.**

**Compaq Computer Corp.**

P.O. Box 692000  
Houston, TX 77269  
(713) 370-0670  
fax: (713) 374-1402  
**Circle 1180 on Inquiry Card.**

**Core International**

7171 North Federal Hwy.  
Boca Raton, FL 33487  
(407) 997-6055  
fax: (407) 997-6009  
**Circle 1181 on Inquiry Card.**

**Cubix Corp.**

2800 Lockheed Way  
Carson City, NV 89706  
(702) 883-7611  
fax: (702) 882-2407  
**Circle 1182 on Inquiry Card.**

**Data General Corp.**

4400 Computer Dr.  
Westborough, MA 01580  
(508) 366-8911  
fax: (508) 366-1299  
**Circle 1183 on Inquiry Card.**

**Dell Computer Corp.**

9505 Arboretum Blvd.  
Austin, TX 78759  
(512) 338-4400  
fax: (512) 338-8421  
**Circle 1184 on Inquiry Card.**

**Digital Equipment Corp.**

146 Main St.  
Maynard, MA 01754  
(508) 493-5111  
fax: (508) 493-8780  
**Circle 1185 on Inquiry Card.**

**Dilog**

2652 McGaw  
Irvine, CA 92714  
(714) 476-0303  
fax: (714) 476-0633  
**Circle 1186 on Inquiry Card.**

**Fujitsu America, Inc.**

Computer Products Group  
3055 Orchard Dr.  
San Jose, CA 95134  
(408) 432-1300  
fax: (408) 434-0475  
**Circle 1187 on Inquiry Card.**

**FWB, Inc.**

2040 Polk St., Suite 215  
San Francisco, CA 94109  
(415) 474-8055  
fax: (415) 775-2125  
**Circle 1188 on Inquiry Card.**

**IBM**

Old Orchard Rd.  
Armonk, NY 10504  
(914) 765-1900  
**Circle 1189 on Inquiry Card.**

**Legacy Storage Systems, Inc.**

200 Butterfield Dr., Suite B  
Ashland, MA 01721  
(508) 881-6442  
fax: (508) 881-4116  
**Circle 1190 on Inquiry Card.**

**Loviel Computer Corp.**

250 Park Ave. S  
New York, NY 10003  
(212) 979-8824  
fax: (212) 777-3261  
**Circle 1191 on Inquiry Card.**

**Maximum Storage, Inc.**

5025 Centennial Blvd.  
Colorado Springs, CO 80919  
(719) 531-6888  
fax: (719) 531-0227  
**Circle 1192 on Inquiry Card.**

**Mega Computer Systems**

10840 Thornmint Rd.  
San Diego, CA 92127  
(619) 487-8888  
fax: (619) 485-1518  
**Circle 1193 on Inquiry Card.**

**MicroNet Technology, Inc.**

20 Mason  
Irvine, CA 92718  
(714) 837-6033  
fax: (714) 837-1164  
**Circle 1194 on Inquiry Card.**

**Micropolis Corp.**

21211 Nordhoff St.  
Chatsworth, CA 91311  
(818) 709-3300  
fax: (818) 709-3497  
**Circle 1195 on Inquiry Card.**

**Morton Management, Inc.**

12079 Tech Rd.  
Silver Spring, MD 20904  
(301) 622-5600  
fax: (301) 622-5438  
**Circle 1196 on Inquiry Card.**

**NCR Corp.**

1700 South Patterson Blvd.  
Dayton, OH 45479  
(513) 445-2078  
**Circle 1197 on Inquiry Card.**

**NetFrame Systems, Inc.**

1545 Barber Lane  
Milpitas, CA 95035  
(408) 944-0600  
fax: (408) 434-4100  
**Circle 1198 on Inquiry Card.**

**The Network Connection, Inc.**

1324 Union Hill Rd.  
Alpharetta, GA 30201  
(404) 751-0889  
fax: (404) 751-1884  
**Circle 1199 on Inquiry Card.**

**Northgate Computer Systems, Inc.**

P.O. Box 59080  
Minneapolis, MN 55459  
(612) 943-8181  
fax: (612) 943-8336  
**Circle 1200 on Inquiry Card.**

**Parallan Computer, Inc.**

201 Ravendale Dr.  
Mountain View, CA 94043  
(415) 960-0288  
fax: (415) 962-8141  
**Circle 1201 on Inquiry Card.**

**Perisol Technology**

3350 Scott Blvd.,  
Building 1201  
Santa Clara, CA 95054  
(408) 988-2232  
fax: (408) 988-4431  
**Circle 1202 on Inquiry Card.**

**Sanyo/Icon**

**International, Inc.**  
764 East Timpanogos Pkwy.  
Orem, UT 84057  
(801) 225-6888  
fax: (801) 226-0651  
**Circle 1203 on Inquiry Card.**

**Storage Concepts, Inc.**

1622 Deere Ave.  
Irvine, CA 92714  
(714) 852-8511  
fax: (714) 557-5064  
**Circle 1204 on Inquiry Card.**

**Storage Dimensions, Inc.**

1656 McCarthy Blvd.  
Milpitas, CA 95035  
(408) 954-0710  
fax: (408) 954-0517  
**Circle 1205 on Inquiry Card.**

**Storage Technology Corp.**

2270 South 88th St.  
Louisville, CO 80028  
(303) 673-5151  
fax: (303) 673-5019  
**Circle 1206 on Inquiry Card.**

**Tricord Systems, Inc.**

3750 Annapolis Lane  
Plymouth, MN 55447  
(612) 557-9005  
fax: (612) 557-8403  
**Circle 1207 on Inquiry Card.**

**Zenith Data Systems**

2150 East Lake Cook Rd.  
Buffalo Grove, IL 60089  
(708) 808-5000  
**Circle 1208 on Inquiry Card.**

**Zeos International, Ltd.**

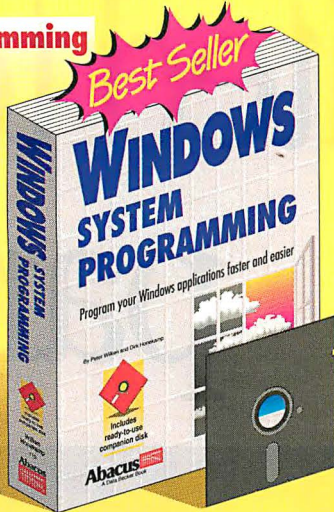
530 Fifth Ave. NW  
St. Paul, MN 55112  
(612) 633-4591  
fax: (612) 633-1325  
**Circle 1209 on Inquiry Card.**

# Computing Know How

Boost your PC Productivity—our books show you how.

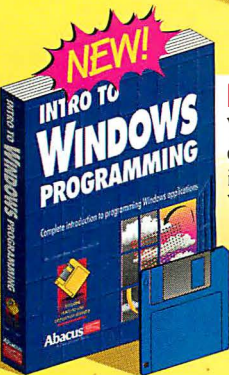
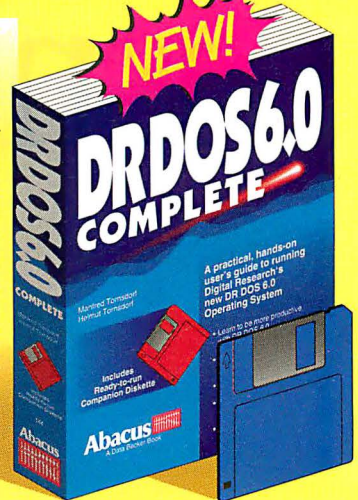
## Windows System Programming

The bible for Windows programmers. Includes the tools you need to program professional applications for operation under Windows. Contains sample applications with comprehensive documentation and background information. Also includes programming examples in C. Topics include using GDI, bitmaps and the color palette manager; using DDE (Dynamic Data Exchange) between applications; using Windows memory management; the DLL (Dynamic Link Libraries) concept and more. 740 pp with companion disk. #B116 ISBN 1-55755-116-2 \$39.95\*



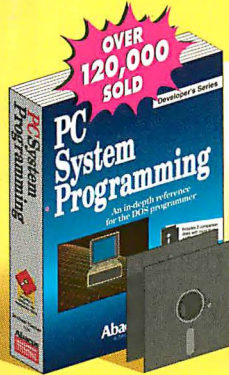
## DR DOS 6.0 COMPLETE

DR DOS 6.0 Complete is an everyday user's guide to running Digital Research's brand new DR DOS 6.0 operating system. An encyclopedia of practical info, this is the most comprehensive DR DOS 6.0 reference book available. Shows you how to use DR DOS 6.0's new features, including SuperStor disk compression, MemMAX memory saving, FileLink data transfer and much more. Find out how to become even more productive with DR DOS 6.0. Includes 3 1/2" companion diskette. #B144 ISBN 1-55755-144-8 \$34.95\*



## Intro to Windows Programming

Walks the programmer through the seemingly complex task of writing Windows applications. It introduces the reader to the overall concept of Windows programming and events using dozens of easy-to-follow examples. It's a complete introductory text for beginning or intermediate Windows programmers. Includes 3 1/2" companion diskette with example programs. #B139 ISBN 1-55755-139-1 \$34.95\*

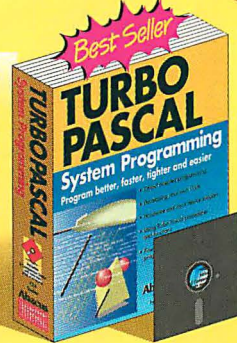


## PC System Programming

An encyclopedia of PC technical and programming information. Features parallel working examples written in Pascal, C, Assembly and BASIC. Explains how to use extended and expanded memory, hard drives, PC ports, mouse drivers, graphics and sound. Also explains memory layout, TSR programs, DOS operations and fundamentals of BIOS. Includes complete appendices. 920 pages and 2 companion disks with over 1 MB of programs. #B036 ISBN 1-55755-036-0 \$59.95\*

## Turbo Pascal System Programming

Find out how to use Turbo for performing system programming tasks, writing TSRs, performing multitasking, using SAA windowing and implementing expanded and extended memory. Learn how Turbo generates machine code, handles the mouse, scans the keyboard, uses UNITS and OOPS, performs fast screen display and more. 750 pages and companion disk with more than 800K of sourcecode. #B124 ISBN 1-55755-124-3 \$44.95\*



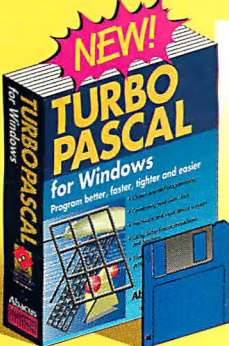
## PC Assembly Language: Step by Step

Teaches you PC assembly language from the ground up. You'll learn at your own pace using the unique simulator which shows you how each instruction works as the PC executes it. 420 pp with 2 companion diskettes. Also includes evaluation versions of A86 Assembler and D86 Debugger. #B096 ISBN 1-55755-096-4 \$34.95\*



## Turbo Pascal for Windows

Provides an in-depth look at programming using this popular development system. Includes an extensive introduction of the integrated developmental environment and a practical overview of the fundamentals and special features of Pascal programming under Windows, including Object Windows Turbo Vision. This guide also includes an introduction to the Unit concept—which is vital in understanding object-oriented programming. Includes 3 1/2" companion diskette. #B141 ISBN 1-55755-141-3 \$39.95\*



In US & Canada Order Toll Free 1-800-451-4319 EXT. 23

For fast delivery Order Toll Free 1-800-451-4319 ext. 23, or FAX (616) 698-0325

Yes, please rush the following items  Yes, please rush your free PC catalog

Apply to my:  Visa  MasterCard  Am. Express /  I have enclosed a check / M.O.

___ PC System Programming	\$59.95	___ DR DOS 6.0 COMPLETE	\$34.95
___ Intro to Windows Programming	34.95	___ Windows System Programming	39.95
___ Turbo Pascal System Prog.	44.95	___ Turbo Pascal for Windows	39.95
___ PC Assembly Language	34.95		

MI residents add 4% sales tax. In US and Canada add \$5.00 Postage and Handling.

\*Foreign orders outside North America add \$13.00 surface rate or \$20.00 air mail per book.

Card#: \_\_\_\_\_ Expires: \_\_\_\_\_

Signature: \_\_\_\_\_

Name: \_\_\_\_\_

Company: \_\_\_\_\_

Address: \_\_\_\_\_

City: \_\_\_\_\_ State: \_\_\_\_\_ Zip: \_\_\_\_\_

Phone or Fax #: \_\_\_\_\_ Dept. B3

Available at most B. Dalton Booksellers, Waldensoftware, Software Etc. and other bookstores nationwide. In the UK contact Computer Bookshops 021-706-1188 • In Australia contact Pacronics 02-748-4700

**Abacus** Dept. B3, 5370 52nd Street SE  
Grand Rapids, MI 49512

Orders: 1-800-451-4319 • Phone: (616) 698-0330 • Fax: (616) 698-0325

In US and Canada add \$5.00 postage. \*Foreign orders outside North America add \$13.00 surface rate or \$20.00 air mail per book. We accept Visa, MasterCard or American Express. Call or write for your free catalog of PC Books.

Circle 8 on Inquiry Card (RESELLERS: 9).

# Now getting free isn't limited to hoo part-time

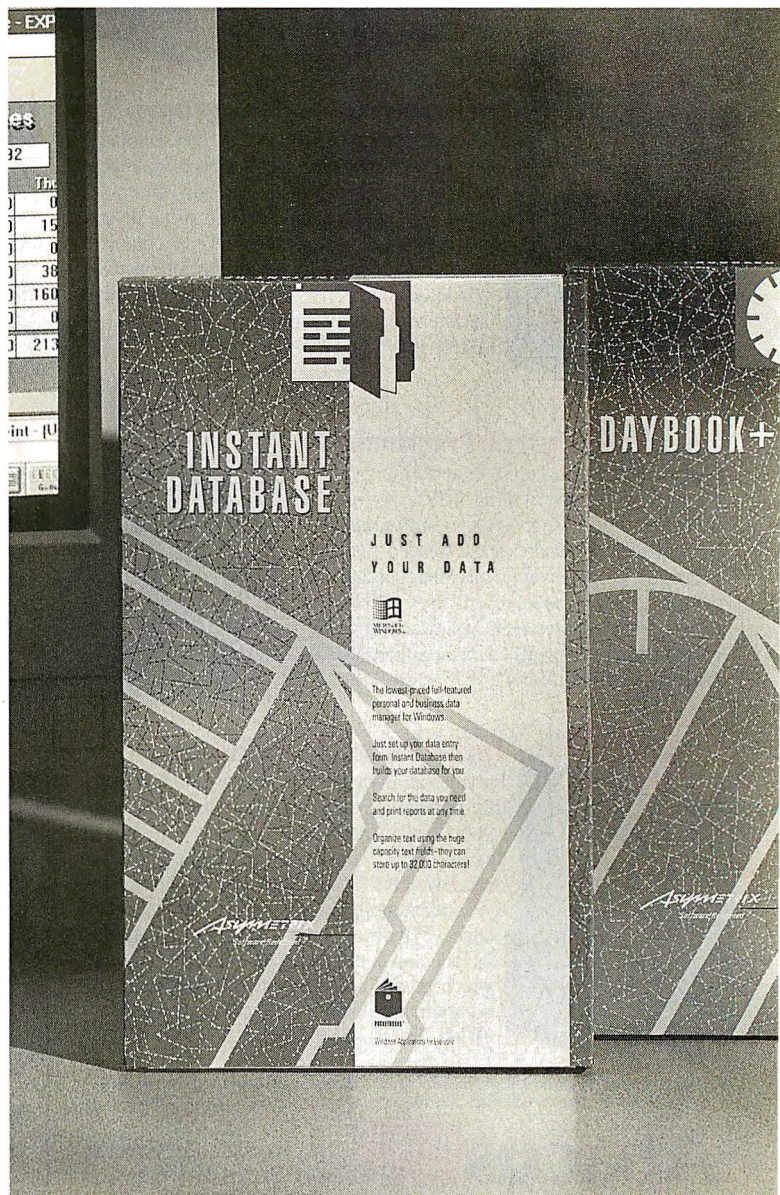
Even honest, upstanding, people can experience the joy of getting something for nothing. All you have to do is buy one of the new PocketBooks personal productivity applications and you'll get a second one, absolutely free.

Choose *DayBook+*, the everyday calendar with address book and auto-dialer. *Make Your Point*, the graphics-rich presentation builder. Or *Instant Database*, the versatile data manager.

The PocketBooks library is a dynamic line of Windows software that gives you powerful, yet simple applications designed to make running your life a little easier.

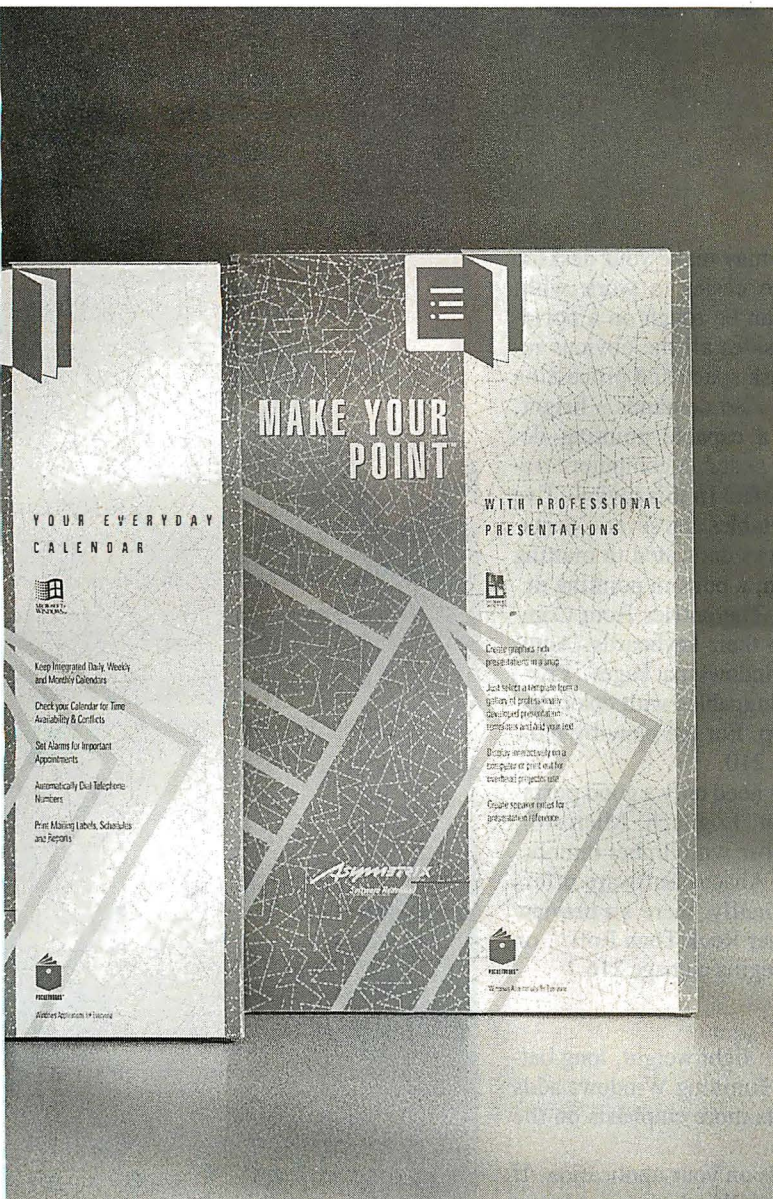
Others will be introduced over the year. And starting at \$49.95, they're a fraction of the cost of competitive software packages.

Initial purchase must be made by April 30, 1992. To order by phone, call 1-800-626-3225 and ask for Source Code PBK2F1A.





# e PocketBooks diums, bullies and e thugs.



Or visit your local dealer. Then send in your proof-of-purchase with the coupon below and receive a complimentary PocketBooks title of your choice.

And don't worry. It's perfectly legal.

**ASYMETRIX**  
*Software Redefined*

Please send me my free  
PocketBook (Circle One): DayBook+,  
Instant Database, Make Your Point.

Name \_\_\_\_\_

Title \_\_\_\_\_

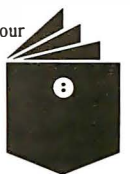
Company \_\_\_\_\_

Shipping Address \_\_\_\_\_

Phone \_\_\_\_\_

Attach this coupon with proof-of-purchase and a copy of your PocketBooks registration card and mail to: Asymetrix Corporation, PO Box 4100, Crawfordsville, IN 47933. Allow 4-6 weeks for delivery. For more information on this offer, call Asymetrix sales at (206) 637-1500.

Sales Tax Rates for applicable states: California=6.25% (plus local option tax); Massachusetts=4% (plus local option tax); New York=4% (plus local option tax); Texas=6%; Washington=8.2%



**POCKETBOOKS**

# WINDOWS ON THE ROAD

**Nine portable computers and six portable pointing devices that let you go mobile with Windows**

**HOWARD EGLOWSTEIN**

Windows more mobile. Each machine has a color screen, a built-in pointing device, or some other design enhancement for Windows. The entries from Commax, Everex, and Grid have pointing devices built into their keyboards. Aquiline, AT&T, and Texas Instruments offer portable Windows packages. From Dolch, NEC, and Toshiba, I've included AC-powered luggables with color displays so good you might consider replacing your desktop. For the blow-by-blow on each configuration, consult the features table on page 210.

If you already have a fast notebook computer, you may need only a good portable pointing device to become Windows-ready. Appoint, Logitech, Microsoft, and MicroSpeed offer several flavors of trackballs for those with limber thumbs. Suncom's ICONtroller is a miniature, clip-on joystick. Abacus Software offers NoMouse, a software-only mouse-emulation package. Finally, there's a preview of a promising new pointing device in the text box "Rather Rock Than Roll?" on page 211. [Editor's note: Coverage of pointing devices begins on page 216.]

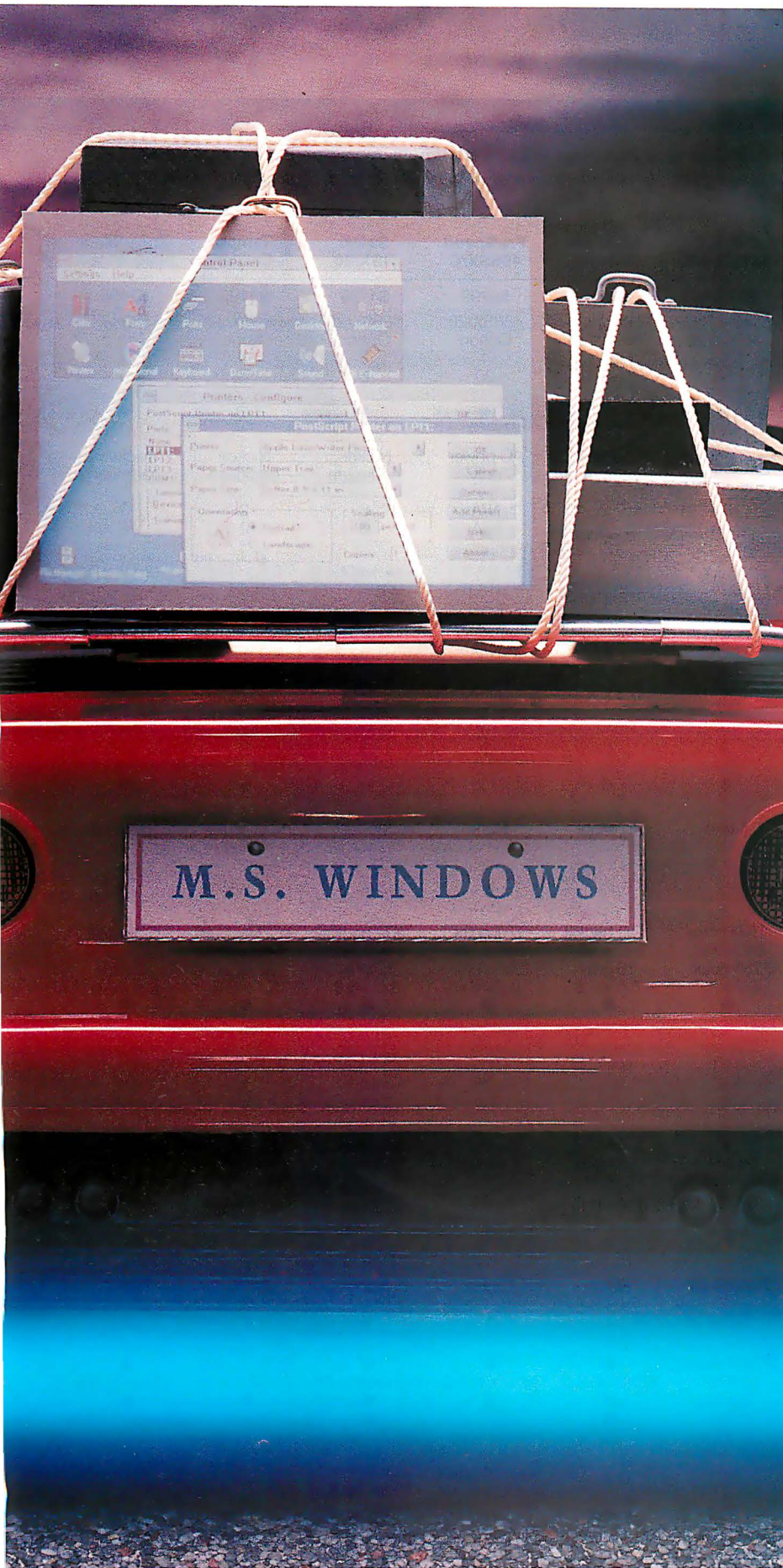
## What Makes a Portable a Windows Portable?

Windows portables require all you'd ask of any portable: light weight, long battery life, a fast processor, and a comfortable keyboard. Running Windows adds the pointer requirement, demands a hard drive, and puts more emphasis on the quality of the screen.

The weight you assign to each of these factors depends on your application. If you're looking for a general-purpose machine for part-time Windows use, almost any notebook will suffice. The coming generation of machines based on Intel's

**W**indows may make your desktop machine easier to work with, but it can be rough on a portable. Besides all the obvious requirements for disk space and processing power, Windows also demands a bright, fast screen and a capable pointing device—two things portable computers traditionally don't offer. In this review, I've gathered nine portables and several portable pointing devices dedicated to making





## BYTE ACTION SUMMARY

### ■ WHAT WINDOWS-CAPABLE PORTABLES AND POINTING DEVICES DO

These portables are ideal for running Windows; each features a pointing device and a color screen or another Windows optimization. Portable pointing devices are designed to tag along with these systems, giving you mouse capability without requiring desk space.

### ■ LIKES

New portable technologies make it possible to use Windows while traveling. Better screens and pointing devices and lighter and more capable systems mean that you can tote Windows applications almost anywhere.

### ■ DISLIKES

Many pointing devices are difficult to master; some verge on the unusable.

### ■ RECOMMENDATIONS

Although the GridCase 1550SX is well laid out and has an outstanding pointing device, the system is just too heavy for real traveling. For all-around ease of handling and good Windows operation, Everex's Tempo Carrier is the best choice.

386SL chip, represented by Zenith's Mastersport 386SL (see "Notebook Power Management at Its Zenith," December 1991 BYTE) and here by Aquiline's Arima SN386SL, will make good choices.

Full-time Windows en route makes small size and long battery life critical. It's also convenient to have the pointing device built into the keyboard so you don't have to wrestle with clamps and cables.

If you'll use Windows only when you arrive at your destination, size isn't so important, and you may not need a battery at all. Dropping the requirement for complete portability can get you a color screen or a very fast processor, in a machine like NEC's ProSpeed 486SX/C.

You might also consider an alternative to carrying Windows with you: controlling Windows applications remotely by modem. A review of some software that makes this possible appears in the text box "Windows by Phone" on page 214.

I have evaluated Windows portables

FEATURES OF PORTABLE COMPUTERS FOR WINDOWS

These are the portables that run Windows best. The most important features for Windows operation are a good screen and a comfortable pointing device, but the usual portable considerations of battery life, size, and weight will color your choice of favorite. (● = yes; ○ = no.)

	Arima SN386SL	C-P.A.C. 386SX-20C	GridCase 1550SX	ProSpeed 486SX/C	Safari NSX/20	Tempo Carrier	TravelMate 3000 WinSX
<b>Price (as tested)</b>	\$2695	\$11,040	\$3905	\$9299	\$4199	\$3195	\$3199
<b>Processor/speed (MHz)</b>	386SL/25	386SX/20	386SX/20	486SX/20	386SX/20	386SX/20	386SX/20
<b>Math coprocessor</b>	None	387SX/20	387SX/20	Option	Option	None	None
<b>Memory as tested (MB)</b>	2	4	2	4	2	2	4
<b>Memory (maximum; MB)</b>	10	16	8	20	6	8	6
<b>Memory upgrades user-installable?</b>	●	●	○	●	●	○	●
<b>Battery Technology</b>	Nickel-cadmium	AC power only	Nickel-cadmium	AC power only	Nickel-cadmium	Nickel-cadmium	Nickel-cadmium
Battery life (manufacturer's claim; hours)	5	N/A	2	N/A	6	2	3
Battery recharge time (hours)	2	N/A	2	N/A	6	2	4
<b>System unit Dimensions (W x H x L; inches)</b>	11 x 8.5 x 1.7	16 x 9.5 x 7.8	11.5 x 2.5 x 15.0	14.8 x 4.2 x 15.6	12 x 1.8 x 9.5	8.5 x 6.75 x 11 x 5.2	11 x 1.8 x 8.5
<b>Weight with battery (lb.)</b>	6.0	18.0	13.7	17.0	7.3		5.7
<b>External power supply Dimensions (W x H x L; inches)</b>	5.5 x 3 x 1.4	N/A	N/A	N/A	5 x 1.5 x 2.5	2.5 x 1.75 x 5.87 x 1.3	3.25 x 1.75 x 5.5 x 1.0
<b>Weight (lb.)</b>	0.9	N/A	N/A	N/A	0.8		
<b>Keyboard Number of keys</b>	81	86	77	91	82	80	79
<b>Detachable?</b>	○	●	○	○	○	○	○
<b>Key travel (mm)</b>	2.8	3.5	3.5	3.5	3.5	2.5	3.0
<b>External keyboard port?</b>	○	●	●	○	●	●	●
<b>Pointing device Type</b>	Trackball	None	Isopoint	None	Mouse	KeyMouse J Key	Trackball
<b>Mouse PS/2 mouse port?</b>	○	○	○	●	●	●	●
<b>Display LCD type</b>	CCFT <sup>1</sup> backlit	TFT <sup>2</sup> color	LCD backlit	TFT color	TST <sup>3</sup> backlit	LCD backlit	TST sidelit
<b>Resolution</b>	640 x 480	640 x 480	640 x 480	640 x 480	640 x 480	640 x 480	640 x 480
<b>Gray levels/colors</b>	64 gray	256 color	16 gray	256 color	32 gray	32 gray	32 gray
<b>Screen area (W x H)</b>	7.6 x 5.8	6.2 x 8.7	8.5 x 5.8	8.4 x 6.0	8.0 x 6.0	5.1 x 6.8	8.0 x 6.0
<b>External video port?</b>	●	●	●	●	●	●	●
<b>Hard drive Manufacturer</b>	Conner	Conner	Conner	Conner	Conner	IBM	Conner
<b>Size (MB)</b>	40	120	60/120	120	40	80	60
<b>Interface</b>	IDE	IDE	IDE	IDE	IDE	IDE	IDE
<b>Access time (ms)</b>	19	19	19	19	19	19	19
<b>Internal floppy drive Size/capacity</b>	3½-inch/ 1.44-MB	3½-inch/ 1.44-MB	3½-inch/ 1.44-MB	3½-inch/ 1.44-MB	3½-inch/ 1.44-MB	3½-inch/ 1.44-MB	3½-inch/ 1.44-MB
<b>Communications Internal modem</b>	2400 bps	N/A	2400 bps	Option	2400 bps	2400 bps	Option
<b>Serial ports</b>	1	2	2	1	1	2	1
<b>Parallel ports</b>	1	1	1	1	1	1	1
<b>Expansion options Standard slots</b>	None	Five 16-bit	None	1 EISA	None	None	None
<b>Proprietary slots</b>	None	None	1	1	1	1	1
<b>Bundled software Setup utilities</b>	None	ROM-based	●	●	●	ROM-based	●
<b>DOS</b>	MS-DOS 4.01	Option	MS-DOS 5.0	MS-DOS 5.0	MS-DOS 4.01	MS-DOS 4.01	MS-DOS 5.0
<b>Windows</b>	●	Option	●	○	●	●	●
<b>Cursor enhancement</b>	EZ-Cursor	None	●	○	●	None	Change Cursor
<b>Other</b>	InSync	QA Plus	○	PFS:Window-Works, Magic Cursor	AT&T Access Plus, Microsoft Prod. Pack	Diagnostics	○
<b>Warranty</b>	3 months	1 year	1 year	1 year	1 year	1 year	1 year

<sup>1</sup> Cold-cathode fluorescent transistor.

<sup>2</sup> Thin-film transistor.

<sup>3</sup> Triple supertwist.

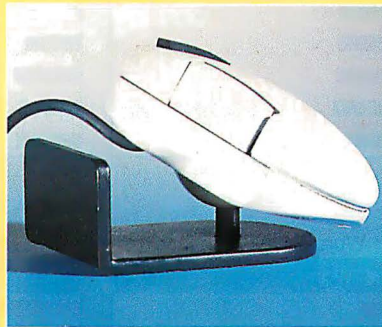
**T3200SXC**

**UltraThin Plus**

\$8476	\$3995
386SX/20	386SX/20
None	None
5	4
13	4
●	○
AC power only	Nickel-cadmium
N/A	2
N/A	4
14.6 x 4.3 x 15.6	8.5 x 1.4 x 11
17.0	4.5
N/A	3 x 1.6 x 5.8
N/A	1.0
91	79
○	○
3.5	2.5
●	●
None	Membrane/ touchpad
●	●
TFT color 640 x 480 256 color 8.3 x 6.2	TST backlit 640 x 480 32 gray 6.8 x 5.1
●	●
Conner 120 IDE 19	Conner 80 IDE 19
3½-inch/ 1.44-MB	External 1.44-MB
2400 bps 2 1	2400 bps 1 1
1 8-bit, 1 16-bit N/A	None 1
●	●
MS-DOS 4.01	DR DOS 5.0/6.0
○	○
None	○
○	○
1 year	1 year

# Rather Rock Than Roll?

If you'd rather rock than roll, take a look at Zirco's PalmPoint, a portable pointing device with a design all its own. The PalmPoint was nearing production as I assembled this review. The design



is good enough that production versions should be warmly received by those unsatisfied with current pointing-device technology.

The PalmPoint is a gadget that you control by tilting. You mount the base to the side of your keyboard and steer the cursor around by tipping the entire unit from side to side. The unit pivots on a ball attached to the stationary base. Rotating the unit moves the mouse cursor

around on the screen—it feels a lot like adjusting a car's side mirror.

I found the PalmPoint as easy to use as a real mouse, and of course it requires very little table space. If I had one complaint, it is that the ballistic

action of the PalmPoint was a little hard to get used to; I sometimes ran out of rotation space on the unit with the cursor still stranded in the middle of the screen. Still, the PalmPoint is comfortable and natural, and it should give the clip-on trackball group of portable pointers a real run for the money. For more information, contact Zirco, Inc., 10900 West 44th Ave., Wheat Ridge, CO 80033, (303) 421-2013.

quantitatively for speed and battery life. Notes on the tests appear in the text box "Measuring Speed and Endurance" on page 218, and the results are graphed in figures 1 and 2. However, my primary gauge of the quality of each machine is simply the experience of using it from day to day. I've run Windows on every one and used each in and out of the office.

### Arima SN386SL with Thumbelina

The \$2695 Arima from Aquiline has the distinction of being the only 386SL machine in this review. The 386SL-based machines have an advantage over 386SX machines in a Windows environment, thanks to the advanced power management capability of the processor. SL technology makes it easier for manufacturers to shut down vital parts of the computer during idle periods. Only 386SL designs can sleep even in enhanced-mode Windows without special hardware hacks. In BYTE's battery-life tests, the Arima was a top performer, surviving for 4 hours and 15 minutes.

The Arima comes with DOS and Windows installed and includes an Appoint Thumbelina (see page 220). Folding ac-

cess doors cover serial, parallel, and expansion ports for other options. Although the machine performed well, the construction showed a lack of attention to detail. Also, it's hard to type on the stiff, short-travel keyboard.

### C-P.A.C. 386SX-20C

The C-P.A.C. 386SX-20C portable is the cousin of the 33-MHz 486 Dolch system reviewed in "Full Color Comes to LCDs" (August 1991 BYTE). Like its high-powered kin, the 386SX-20C has a 256-color Sharp thin-film-transistor (TFT) LCD panel.

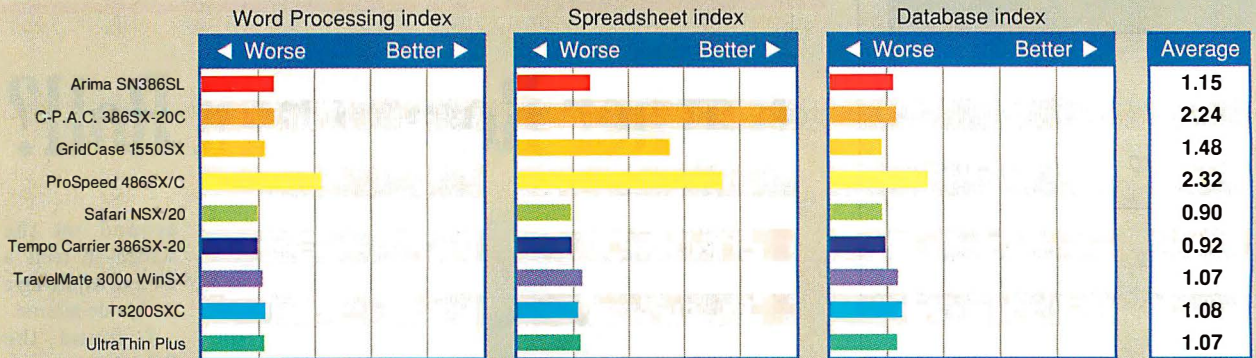
This box gives you a 3½-inch 120-MB IDE hard drive, five ISA expansion slots, and a full-size keyboard for \$11,040. Although it looks portable, it carries like a suitcase—18 pounds is a lot of computer to drag around. However, once you get where you're going, it's like having a full-featured desktop.

The color screen is excellent, and the keyboard is a joy. Benchmark performance was outstanding even considering the C-P.A.C.'s 387SX FPU advantage. This system blasted the other 386SX/20s even on our CPU benchmarks, where floating-point speed does not play a part.

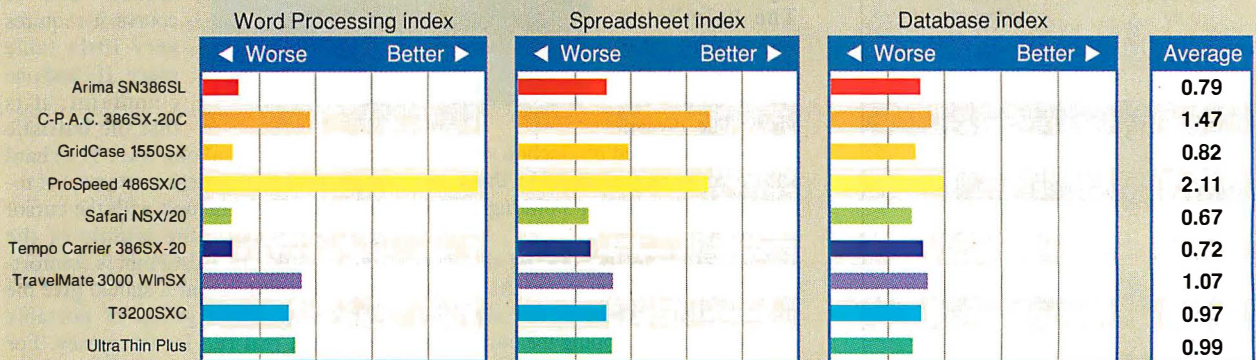
*continued*

# BYTE BENCHMARK RESULTS

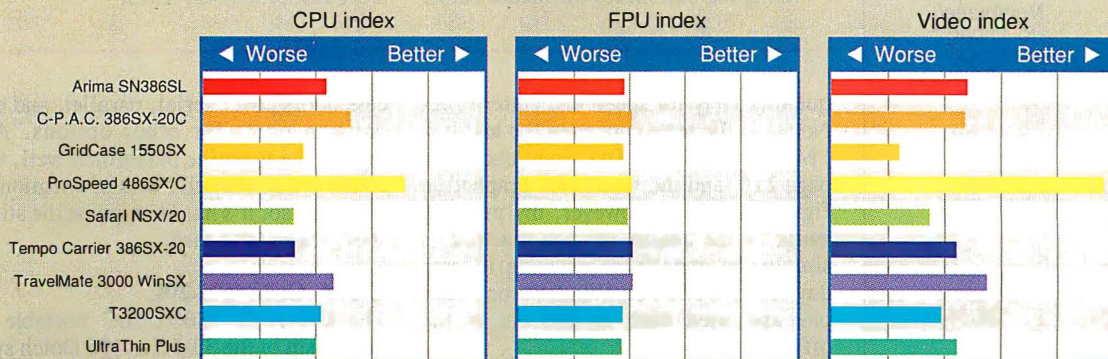
## DOS APPLICATIONS



## WINDOWS APPLICATIONS



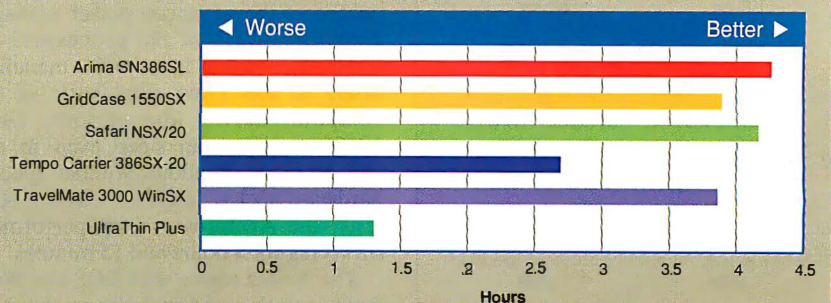
## DOS LOW-LEVEL TESTS



**Figure 1:** The high-speed NEC ProSpeed 486SX/C proved the fastest portable, as you'd expect. However, there were unexpected performance variations among the 386SX/20 designs, from the top-performing Dolch C-P.A.C. 386SX-20C (which included a math coprocessor) to the surprisingly sluggish AT&T Safari NSX/20 portable.

**Figure 2:** The dual-battery Safari NSX/20 made up for lackluster speed with outstanding battery life; it was bested only by the Aquiline Arima SN386SL notebook.

## BATTERY LIFE



**GridCase 1550SX with Isopoint**

The GridCase is one of the few remaining battery-operated portables that don't qualify as notebooks. Yes, it's very big and heavy, and compared to a notebook machine, it feels like a concrete block. However, if you worry about operating a typical notebook in a harsh environment, Grid Systems' \$3905 GridCase will put you at ease.

The GridCase turned in a very respectable 3.9 hours on the battery-life test—in good company behind the Safari NSX/20 with its dual batteries and the Arima with its 386SL.

The distinguishing feature of the GridCase is its built-in Isopoint pointing device. It's mounted in front of the space bar, right where your thumb goes. To move the mouse cursor left and right, you slide the Isopoint bar to either side. To move up and down, you roll the bar as you might roll a pencil on a desk. Pressing the bar with your thumb clicks the mouse. The Isopoint emulates a Microsoft bus mouse, and it works wonderfully well with Windows.

**ProSpeed 486SX/C**

NEC's brand-new ProSpeed 486SX/C portable smashed the competition in our performance tests, thanks to its 20-MHz 486SX processor. Like the Dolch and Toshiba portables, the ProSpeed has a 256-color TFT display. Even with the high-powered processor, the \$9299 ProSpeed still costs less than the C-P.A.C. 386SX/20C.

The ProSpeed's one EISA and one proprietary expansion slot make it less versatile than the C-P.A.C., but one standard slot will be enough for most folks. Windows is refreshingly responsive with the ProSpeed's fast processor and fast hard drive. If you need a color system for high-powered Windows applications, give the ProSpeed a long look.

**Safari NSX/20**

I liked the AT&T Safari NSX/20 as a general-purpose 386SX notebook, but it's quite expensive at \$4199. The machine has a high-quality feel, and it runs a long time (4.1 hours) on a single charge of its dual batteries. It ships with a nicely styled AT&T mouse.

The Safari NSX/20 disappointed me on performance tests. It ranked last in almost all the application tests—a showing likely related to its poor score in the low-level CPU tests.

What does the Safari bring to the Windows party? Besides the mouse and its preinstalled Windows, the machine's documentation is provided in electronic



**Photo 1:** *The Everex Tempo Carrier (right) and the Toshiba T3200SXC are both excellent machines for running Windows. The Tempo has a KeyMouse built into its keyboard for cursor control and ships with a standard mouse as well. The T3200SXC has the best color display of any portable we have seen.*

format as a Toolbook application. If you have any questions on machine operation, bring up Windows and click on the topic you need help with. I found on-line documentation a curious idea—if you're having trouble getting the machine to boot, on-disk documentation won't help.

**Tempo Carrier with KeyMouse**

Weighing in at just 5½ pounds, the Everex Tempo Carrier (see photo 1) was a pleasure to travel with. In this small package you get 2 MB of RAM, a hard drive, a floppy drive, and a built-in pointing device for \$3195.

The Everex KeyMouse piggybacks on the *J*, *F*, and *D* keys of the keyboard. All the keyboard keys auto-repeat except the *J*. When you hold down the *J* key, it turns into a mouse controller. Pushing the key gently in any direction moves the cursor. The *F* key becomes the primary mouse button.

I found KeyMouse extremely handy for Windows word processing. With your fingers in touch-typing position, you can type as usual. If you want to move the cursor, you hold your right index finger on the keyboard, move the cursor, and click with your left index finger. The movement takes some practice. Other BYTE editors tried it and never quite got

the hang of it. Everex supplies a regular mouse with the Tempo for people who can't deal with the KeyMouse or who want a mouse when they're not in an airplane seat.

Battery life was the Tempo's only real drawback. My working style doesn't often demand that I spend long hours running on battery power, so I could overlook the short 2.7-hour running time.

**TravelMate 3000 WinSX with TravelPoint**

Texas Instruments' (TI) \$3199 TravelMate 3000 WinSX is a TravelMate with modifications for running Windows. The power management hardware and software have special provisions for handling background tasks during shutdown periods and for keeping the time-of-day clock accurate.

The TravelMate 3000 WinSX also has a few touches that make presentations easier. If you're running on an external display (e.g., an LCD overhead projection panel) and you leave the machine idle, it shuts down but leaves the video output frozen with its last image. You can bring the machine alive again by pressing a button on the TravelPoint pointing device. Combining these two features

# Windows by Phone

Steve Apki

If you're committed to Windows and you need to compute while traveling, you'll learn to live with some limitations. But while you may be able to adjust to a clip-on trackball, your applications and data files may prove less adaptable. Resource-hungry applications and, especially, centralized data need to remain in your office while you're on the road. How do you keep in touch?

The four Windows remote-control packages presented here offer solutions. Each controls a Windows session running on a machine to which you're connected by modem. In effect, they bring the Windows environment to you via a phone connection. You take over the host computer, watching its screen and controlling it with your mouse and keyboard.

Because these products must operate over asynchronous lines, they have to

perform within a very restricted bandwidth. And because there is so much information present in the screens of Windows (or other GUIs) compared to text interfaces, Windows remote control over phone lines is a difficult problem.

## The New Crew

These four packages represent the next generation in Windows remote control. They fall into two categories: the classic remote-control design that ships bit maps scanned from video memory from host to remote unit (Norton-Lambert's Close-Up) and those designed to intercept Windows display calls and redirect messages across the wire (Microcom's Carbon Copy for Windows, Triton Technologies' Co/Session, and Ocean Isle's Reachout). Each design is an attempt to bring reasonable performance to Windows run by phone. The packages offer the features and utilities out-

lined in the table. All represent significant improvement over what was available only last year.

Close-Up 4.0 is the only screen-memory scanning package represented. Central Point Commute also belongs in this category, but the timing of this article meant that I could have tested only version 1.1, which Central Point plans to make obsolete by the time you read this.

Close-Up works by transmitting screen bit maps from the host to the remote unit. By heavily compressing the data, Close-Up wrings every bit of performance from the connection. In Windows, Close-Up fares best when you need to transmit bit maps or where the number of Windows graphics calls rivals the amount of data required to send bit-map updates (e.g., editing in a drawing application). Also, Close-Up's direct scan of video memory guarantees

## FEATURES OF WINDOWS REMOTE-CONTROL SOFTWARE

Remote-control packages vary in their support for DOS and Windows and the sophistication of their utilities. (● = yes; ○ = no; N/A = not applicable.)

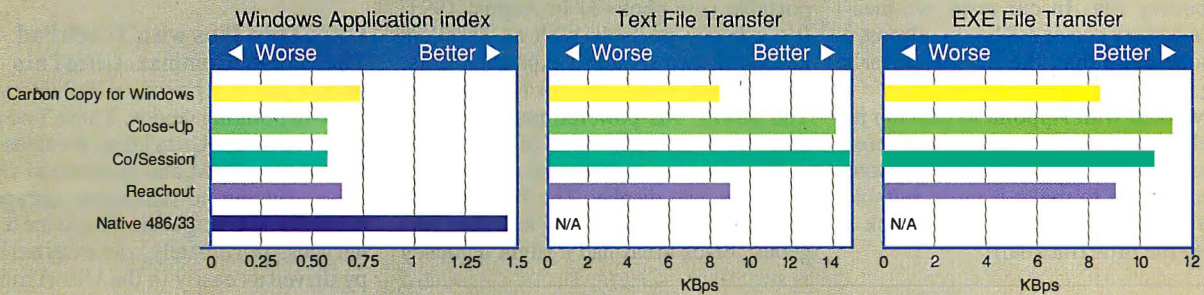
	Carbon Copy for Windows 1.0	Close-Up 4.0	Co/Session 6.0	Reachout 2.0
<b>Price</b>				
Two-PC package	\$199	\$199	\$195	\$179
<b>Windows support</b>				
Real mode	○	●	●	●
Standard mode	●	●	●	●
Enhanced mode	●	●	●	●
Full-screen DOS session	○	●	●	●
Windowed DOS session	●	●	●	●
DOS remote to Windows host	○	●	●	●
Graphics modes	Super VGA, VGA, EGA, CGA, Hercules	VGA, EGA, CGA	VGA	Super VGA, VGA, EGA
<b>DOS support</b>				
Memory required (host/remote)	N/A	34 KB (host) <sup>1</sup>	262 KB/126.2 KB <sup>2</sup>	146.7 KB (host) <sup>1</sup>
Remote mouse	N/A	●	●	○
Remote printing	N/A	●	●	○
Graphics modes	N/A	VGA, EGA, CGA	VGA, EGA, CGA, Hercules	VGA
<b>Security</b>				
Password	●	●	●	●
Call-back	●	●	●	●
Blank host	●	●	●	○
Lock host	●	●	●	●
Directory access privileges	○	○	●	●
<b>Utilities</b>				
File transfer	Windows-based	●	●	●
Chat	Windows-based	●	DOS only	Windows or DOS
Session recording	○	●	●	○
Call logging	○	●	●	○

<sup>1</sup> Remote is not a TSR program.

<sup>2</sup> Additional memory on remote required for Windows.



## REMOTE CONTROL PERFORMANCE



**Figure A:** Carbon Copy for Windows was the fastest at running Windows applications via 9600-bps modem. Close-Up and Co/Session proved to be the best at file transfers. (N/A = not applicable.)

that you'll see the same image on both displays even with ill-behaving applications.

The second class of products takes advantage of the structure of Windows to skirt some of its limitations. These packages intercept application calls to the graphics interface and send a copy of these messages to the remote system. The remote application uses these calls to build a duplicate screen.

Shipping messages consumes considerably less bandwidth than shipping bit maps. However, there is overhead in redirecting each graphics call and in decoding and acting on it on the remote system. Graphics-call interceptors are strongest where few Windows messages are required to perform an action on-screen (e.g., pulling down a menu).

There is another, less obvious advantage to this design. With either approach, screen updates are slow enough that repaints are obvious (at least at 9600 bps). But Close-Up updates the screen row by row, which is jarring. Graphics-call interceptors update object by object, which makes them more like running Windows locally. I found that the second approach made it easier to work with the delay imposed by remote control.

### Quantitatively

I ran a set of benchmarks to measure these products' performance, with a 386SX/16 calling a 486/33 host through a 9600-bps phone connection. I ran our new Windows application suite for desktops, which exercises six different Windows applications. I also timed some file transfers, since fetching files from the office will probably be a common requirement.

The application benchmarks portray a cross section of performance (see figure A). The overall winner is Carbon Copy for Windows, with Reachout a solid second. Close-Up's and Co/Session's file compression and transfer protocols placed them neck-and-neck for first on file transfers.

But are any of these programs fast enough to use? As the benchmark figures show, the quickest package ran about half as fast as a local application. While faster modems or V.42bis compression would provide improvement, the response of any of these packages at 9600 bps is tolerable, and Carbon Copy for Windows is even pleasant. If all you have is your notebook's built-in 2400-bps modem, you'll want an external 9600-bps unit.

Oddly, only Carbon Copy for Win-

dows is an all-Windows application. The others rely on a DOS-based remote application to control a Windows host. These packages let you run the control application on a relatively underpowered PC (e.g., a notebook), controlling sophisticated Windows applications in enhanced mode.

However, Carbon Copy for Windows' all-Windows orientation has its advantages. Its chat and file transfer utilities run and look like Windows applications. Reachout's chat runs under Windows, but the other packages require that you switch to a text-mode DOS application before you can transfer files or chat.

Carbon Copy for Windows is my overall favorite. It's fast, has good mouse response, and is stable in its supported modes. However, Carbon Copy for Windows does not support DOS or real-mode Windows, which may be a significant drawback in some applications. If remote control of both DOS and Windows were critical, I would choose Co/Session.

*Steve Apiki is a BYTE technical editor with a B.S.E.E. from Rensselaer Polytechnic Institute. You can contact him on BIX as "apiki."*

### COMPANY INFORMATION

**Microcom, Inc.**  
(Carbon Copy for Windows 1.0)  
500 River Ridge Dr.  
Norwood, MA 02062  
(800) 822-8224  
(617) 551-1000  
fax: (617) 551-1968  
**Circle 1317 on Inquiry Card.**

**Norton-Lambert Corp.**  
(Close-Up 4.0)  
P.O. Box 4085  
Santa Barbara, CA 93140  
(805) 964-6767  
fax: (805) 683-5679  
**Circle 1318 on Inquiry Card.**

**Ocean Isle Software**  
(Reachout 2.0)  
80 Royal Palm Blvd.,  
Suite 202  
Vero Beach, FL 32960  
(800) 882-8664  
(407) 770-4777  
fax: (407) 770-4779  
**Circle 1319 on Inquiry Card.**

**Triton Technologies, Inc.**  
(Co/Session 6.0)  
200 Middlesex Tpke.  
Iselin, NJ 08830  
(800) 322-9440  
(908) 855-9440  
fax: (908) 855-9608  
**Circle 1320 on Inquiry Card.**

lets you use the 3000 WinSX as an effective presentation aid with surprisingly long battery life. In our tests, we measured a battery run of 3.8 hours, almost a full hour more than the manufacturer's rating.

TI worked with Appoint to develop its TravelPoint device, which is almost identical to the Thumbelina. The buttons are rearranged to make it more suitable for left-handers, but I just never took a shine to the little trackball.

**T3200SXC**

BYTE reviewed the Toshiba T3200SXC portable (see photo 1) in August 1991. It's a heavy portable with an excellent keyboard, two standard expansion slots, and quality construction throughout. The \$8476, AC-powered package has a 20-MHz 386SX and 5 MB of RAM.

What makes this machine ideal for Windows is its display. The Toshiba 256-color TFT panel is nothing less than gorgeous. Black areas had a slight tendency

to show streaks, but, overall, the display looked more like a CRT than an LCD.

**UltraThin Plus with TouchPad**

The \$3995 Commax UltraThin Plus weighs just 4.5 pounds with battery and built-in pointing device. There's no floppy drive in the UltraThin; it comes with DR DOS in ROM and an external floppy drive. Having no removable storage for backup and emergencies made me a little nervous. Fortunately, the external floppy drive fits easily in the UltraThin carrying case.

While the UltraThin is a satisfactory machine vis-à-vis weight and size, its pointing technology leaves something to be desired. The upper left corner of the keyboard is a small removable module that you can replace with one of several options. By default, this unit contains just the external VGA and PS/2 mouse ports. My test unit came with a TouchPad cursor-control module (which also supports VGA and PS/2 ports). When you place your finger or a stylus on the pad, the cursor tracks in the direction you move. Four buttons next to the pad provide emulation of three mouse buttons and a "lock" button for click and drag. Using the TouchPad takes lots of practice, and I found it hard to control.

**Merrily We Roll Along**

Using a mouse requires more than your eyes for feedback. When you're heading the cursor toward a menu you've used a hundred times, your hand "knows" just how far to roll. The physical memory that you develop with a mouse is something you may not get from a more stationary device; as motions get smaller, movement becomes less automatic.

Physical memory is an important part of running Windows (or typing, for that matter). Mouse alternatives tend to require less motion than mice, so they are harder to control. For a pointing device to be as comfortable as a mouse, the controls should be large and require a good amount of movement. For the best control, large cursor movements should require more controller motion.

I checked out six portable pointing devices and how they run under Windows (see photo 2). Because personal taste is probably the most important criterion in choosing a pointing device, I also solicited opinions from other BYTE editors to keep the evaluation even.

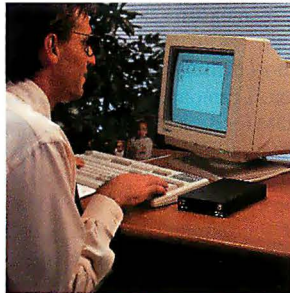
**BallPoint Mouse and TrackMan Portable**

Microsoft's \$175 BallPoint Mouse is a palm-size trackball with a nice-size ball

**take all your programs and files with you, wherever you go...**

**office...**

A *Simplicity Portable Drive* is a tiny external hard disk, the easiest and most cost effective way to add removable storage! As secure as a cartridge drive (for a lot less money).

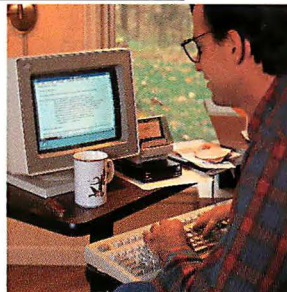


**NEW!**

**home...**

There's no place like home for getting work done, especially when you have everything with you on your *Simplicity Portable Drive*.

Never forget an important file again!



**client...**

Make presentations with confidence. Never struggle with someone else's unfamiliar software again. A *Simplicity Portable Drive* lets you take work wherever work takes you. Use any PC anywhere as easily as your own!



**simplicity portable drives**

Enjoy the confidence and convenience of taking all your programs and files with you wherever you go.

Simplicity's rugged construction and miniature size lets you grab it and run. No juggling floppies and leaving the files you need most back on your desktop.

Simplicity drives are easy to use. They attach instantly to any IBM PC

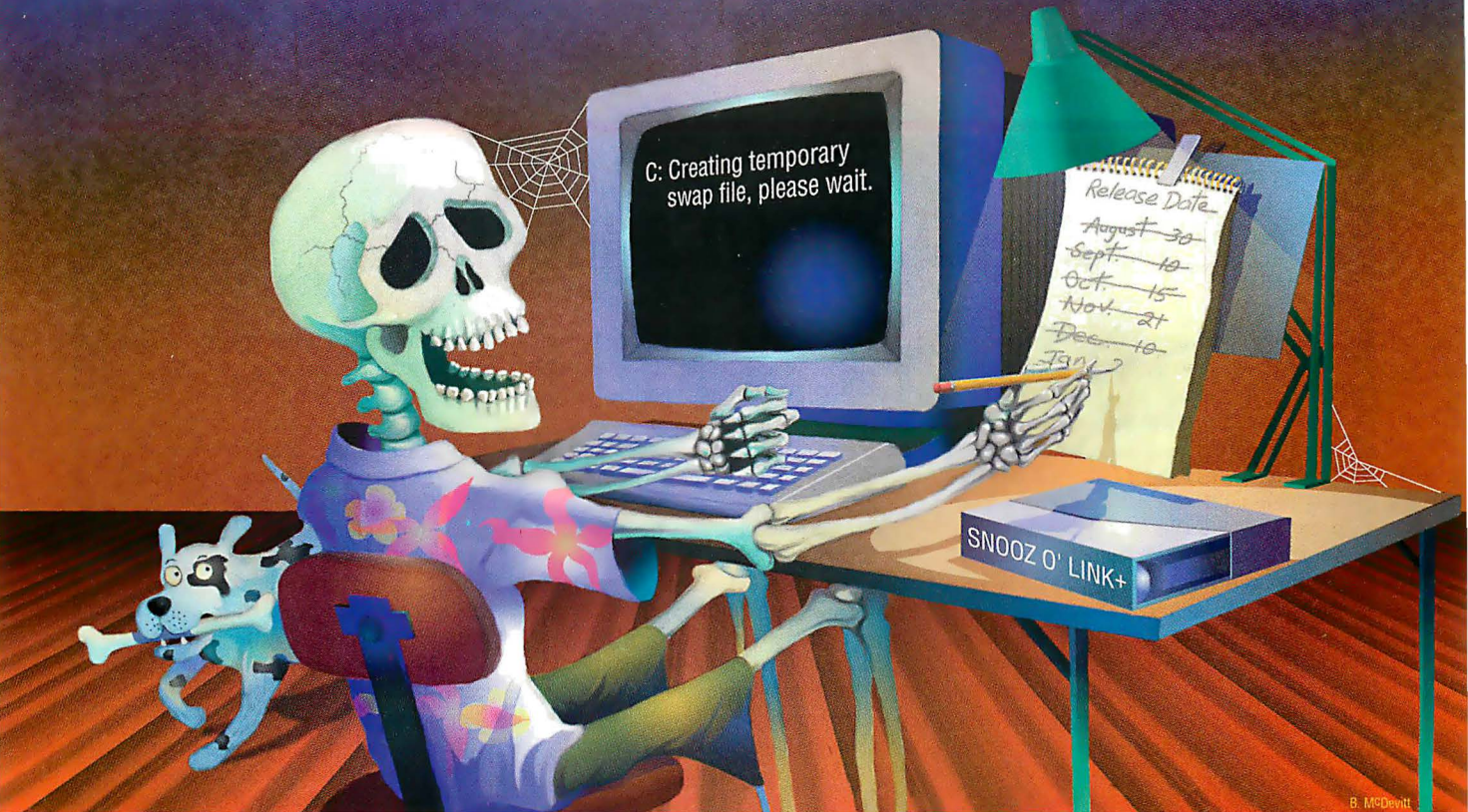
compatible, or laptop printer port. No card is needed. There's no easier way to add extra storage! 1 year warranty, 30-day money back guarantee.



**simplicity computing**

**120MB \$899, 80MB \$699, 40MB \$499  
order now! (800) 275-6525**

126 West Twenty Third Street New York, New York 10011 Phone (212) 229-1625 Fax (212) 229-2938



B. McDevitt

# How much longer can you afford to wait?

## Create Overlaid Programs-Fast.

BLINKER™, the world's first and fastest dynamic overlay linker, reduces your link time to seconds and reduces program memory requirements. Now you can use one linker for all your software projects.

## One Linker, Many Languages.

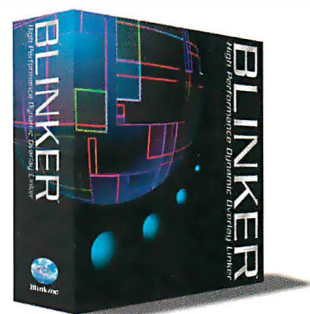
BLINKER 2.0 links and automatically overlays DOS programs written in Microsoft® C, BASIC, Assembler, QuickBASIC™, Fortran, Pascal, Watcom™ C, Zortech® C++, Clipper®, FORCE® and in Borland® C, C++, Assembler, and more.

## Save Time and Memory.

BLINKER removes the need for overlay structures, simplifies program design and reduces memory requirements to save you time, effort and memory.

## Memory Swap Function.

BLINKER is the ONLY linker to offer an integrated memory swap function, so you can run other large programs from within your program, with negligible memory overhead.



**BLINKER™**  
High Performance Dynamic Overlay Linker

## Don't Settle for Less.

Other major features include full CodeView® support, use of EMS/XMS at program run time, and enhanced execution speed of overlaid code.

## Time is Money.

BLINKER offers all this in a fraction of the time it takes to link with your current overlay linker. You know time is money, and link time is no exception.

## Free Demo

To try our free demo on your own code

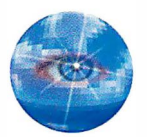


**Call: 804-355-4444** or  
**FAX: 804-355-1676**

## Order now!

If you can't wait any longer, we offer a risk free 30 day money back guarantee. Available in 5.25" or 3.5" diskette format.

**Price \$299**  
plus shipping & handling



**Blinkinc**  
P.O. Box 7154  
Richmond VA  
23221

© 1991 Blinkinc. Blinker is a trademark of ASM, Inc. Offer only applicable in US and Canada.

Circle 149 on Inquiry Card (RESELLERS: 150).

# Measuring Speed and Endurance

**T**he latest round of processor and power-conservation design improvements has prompted enhancements in the way the BYTE Lab measures system performance. This review marks the introduction of a new notebook applications benchmark suite, version 3.0, and a significant upgrade to our portable-battery-life tests. Results are shown in figures 1 and 2 on page 212.

While our low-level DOS and Unix benchmarks have remained accurate measures of system speed, our version 2.1 applications suite has begun to show its age. The unprecedented popularity of Windows and applications that take advantage of DOS 5.0's improved memory-handling capability are areas that previous versions of our test suite did not address.

We have made three major changes. First, we've broken out applications into two major categories, DOS and Win-

dows. Second, we have updated the applications we use to reflect recent upgrades. Third, and most noticeable, we have chosen a new baseline system; we retired our IBM AT standard and replaced it with a notebook baseline: the Toshiba T2200SX.

We continue to report the results of these tests as indexes based on the performance of the baseline. Therefore, our change in baseline means that you cannot compare the indexed performance results from these systems with the results of machines we've tested previously. However, you will be able to compare these results with those of portables that we'll test farther down the road.

BYTE's battery-life test relies on our laptop battery test rig (introduced in "Notebook Power Management at Its Zenith," December 1991). We place a fully charged machine in the tester and run it until it drops. Our test scenario

simulates a word processing session, where text is saved several times in an hour and typing time alternates with idle periods. The systems are allowed to shut down hard drives and backlighting and can even put the CPU to sleep during idle segments. Machines with clever power-conservation techniques or SL designs will fare better than machines without. Our tests run at approximately 55 percent duty cycle; the machine is running 55 percent of the time and allowed to shut down for the other 45 percent. Naturally, battery life will vary, depending on the way you use the machine.

Since we introduced the new test, we have added an optical sensor to monitor the display and a third actuator to handle machines with shifted-power standby switches. The host software now allows us to realistically test battery life on any machine with a serial port regardless of its operating environment.



**Photo 2:** A litter of mice and mouse-alikes: the Abacus NoMouse for Windows (screen); clockwise from right: the Logitech TrackMan Portable, Appoint Thumbelina Portable, Suncom ICONtroller, MicroSpeed MicroTrac, and Microsoft BallPoint Mouse.

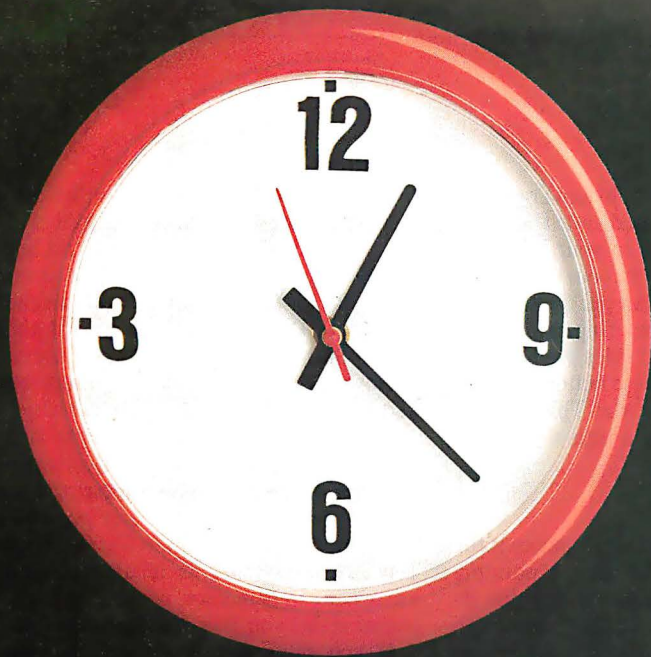
that you manipulate with your thumb. Four buttons sit around the trackball's edge so that two of them naturally fall where your index and middle fingers are, right or left handed. Before you use the BallPoint, you run a configuration program that tells the drivers which ball direction is up and which two buttons you plan to use.

Logitech's \$169 TrackMan Portable is also a Microsoft-compatible trackball that clamps to the side of your computer's keyboard. You drive the ball with your thumb and click on the mouse buttons with your index and middle fingers. The placement of the buttons makes this primarily a right-handed device, although I've spoken to some who use it left-handed.

In both look and feel the TrackMan Portable is quite similar to Microsoft's BallPoint. The TrackMan's keyboard clamp is simpler to use than the BallPoint's, but I found that the BallPoint felt better to use.

## NoMouse for Windows

Abacus's NoMouse for Windows is a \$49.95 piece of software that takes over the cursor keys on your keyboard and



# YESTERDAY WAS TOMORROW

*Are you waiting until tomorrow for a system board that was available yesterday?*

*There is a better way. MICRONICS.*

Time is ticking away... OEMs, Systems Integrators, VARs, and end users, it's the same for all.

**No Product — No Business!**

If you're waiting for your system board vendor to supply you with the latest system boards, go ahead and put your feet up on your desk... you might as well do something while your competition is taking your business away!

Yesterday, Micronics customers were shipped the latest 80486SX, and 80486 EISA system boards. In fact, we ship thousands of advanced technology system boards a month with less than a 1% failure rate.

Our reputation for high quality and superior design has made our customers the price/performance industry leaders in fully compatible system products.

Along with being EISA/ISA standard compatible, our products are designed to be compatible with Novell, UNIX and other platforms.

Micronics' leadership in advanced technology can be seen in our ability to provide new architecture breakthroughs, such as *local bus architecture*, and *80486 multiprocessors* in our product lines.

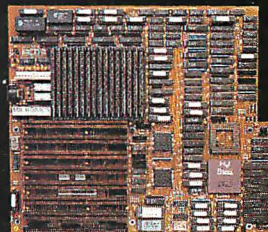
We even have a new program to certify 32-bit EISA peripheral cards to run with our EISA system boards!

You don't find this kind of support anywhere else.

Micronics customers are capturing marketshare now.

So can you.

Call us at 1-800-659-5901.



Micronics EISA Board

**MICRONICS**  
COMPUTERS INC.

232 E. Warren Avenue  
Fremont, California 94539  
(510) 651-2300  
FAX (510) 651-5612

maps them to mouse movements. Moving the cursor with keys is like steering an Etch-A-Sketch—it's hard to make curves. Still, if you tweak the settings just right, it's possible to do some word processing or spreadsheet work without a mouse.

NoMouse will also work hand-in-hand with any other pointing device. The device is very handy for making fine adjustments in desktop publishing applications and for retouching pixels in Paintbrush.

**Thumbelina Portable**

Appoint's Thumbelina Portable is a tiny trackball mounted in a small plastic block that you hold in your hand. It sells for \$99 in a package that includes a mounting bracket. You control the cursor with your thumb. To click, you move your thumb to one of two mouse buttons. A "lock" button provides for click and drag operations.

While the device certainly is portable, most of the editors never felt at home with the Thumbelina.

**MicroTrac**

MicroSpeed's \$89.95 MicroTrac is a small trackball mounted in a flat base. You can hold the unit in your hand and roll the ball around with your thumb à la Thumbelina, or you can put the thing on your desk and use your fingertips. Tiny buttons on the top and sides provide left, right, and locking mouse buttons.

Unfortunately, like the Thumbelina, the MicroTrac proved a little too tiny to control.

**ICONtroller**

The \$99 ICONtroller from Suncom is the most innovative of the add-on pointing devices. It's a tiny digital joystick that attaches to the side of your keyboard with Velcro tape and emulates a Microsoft Mouse.

Three buttons provide your mouse buttons, and a smaller button on the tip of the joystick emulates one of the three. You control the cursor speed by picking one of four accelerations with a speed button and the force you use to move the stick.

**Highlighted Selections**

Innovative pointing devices are the features that most distinguish these systems. My favorite overall was the GridCase 1550SX and its Isopoint, and the composite BYTE editor opinion was that the Microsoft BallPoint Mouse is still the best of the stand-alone pointing devices.

However, the GridCase is a little too hefty to carry around on a regular basis. TI's TravelMate 3000 WinSX might have been my favorite if it had had a better pointing device. I found the best combination of weight, screen, and pointing device in the Everex Tempo Carrier. The Tempo's KeyMouse is ideal for word processing in Windows, probably the application that you'll use most on the road.

If you must have color and battery power is not a requirement, the Toshiba T3200SXC is your best bet. It has the best TFT display, and it costs considerably less than its color competition. ■

*Howard Eglowstein is a BYTE Lab testing editor who holds an S.B. from MIT. Contact him on BIX as "heglowstein."*

COMPANY INFORMATION

**Abacus Software**  
(NoMouse for Windows)  
5370 52nd St. SE  
Grand Rapids, MI 49512  
(800) 451-4319  
(616) 698-0330  
**Circle 1321 on Inquiry Card.**

**Appoint, Inc.**  
(Thumbelina Portable)  
1332 Vendels Cir.  
Paso Robles, CA 93446  
(800) 448-1184  
(805) 239-8976  
**Circle 1322 on Inquiry Card.**

**Aquiline, Inc.**  
(Arima SN386SL)  
449 Main St.  
Bennington, VT 05201  
(800) 221-1119  
(802) 442-1526  
fax: (802) 442-8661  
**Circle 1323 on Inquiry Card.**

**AT&T Safari Systems**  
(Safari NSX/20)  
14K Worlds Fair Dr.  
Somerset, NJ 08873  
(908) 302-5800  
fax: (908) 469-4578  
**Circle 1324 on Inquiry Card.**

**Commax Technologies, Inc.**  
(UltraThin Plus)  
2031 Concourse Dr.  
San Jose, CA 95131  
(800) 526-6629  
(408) 435-5000  
**Circle 1325 on Inquiry Card.**

**Dolch Computer Systems**  
(C-P.A.C. 386SX-20C)  
372 Turquoise St.  
Milpitas, CA 95035  
(800) 538-7506  
(408) 957-6575  
**Circle 1326 on Inquiry Card.**

**Everex Systems, Inc.**  
(Tempo Carrier)  
48431 Milmont Dr.  
Fremont, CA 94538  
(800) 821-0806  
(510) 498-1111  
**Circle 1327 on Inquiry Card.**

**Grid Systems Corp.**  
(GridCase 1550SX)  
47211 Lakeview Blvd.  
Fremont, CA 94537  
(800) 222-4743  
(510) 656-1661  
fax: (510) 683-9888  
**Circle 1328 on Inquiry Card.**

**Isopoint Technologies**  
(Isopoint)  
2391 American Ave.  
Hayward, CA 94545  
(800) 683-6066  
(510) 783-6066  
**Circle 1329 on Inquiry Card.**

**Logitech, Inc.**  
(TrackMan Portable)  
6505 Kaiser Dr.  
Fremont, CA 94555  
(510) 795-8500  
**Circle 1330 on Inquiry Card.**

**Microsoft Corp.**  
(BallPoint Mouse)  
1 Microsoft Way  
Redmond, WA 98052  
(800) 426-9400  
(206) 882-8080  
fax: (206) 883-8101  
**Circle 1331 on Inquiry Card.**

**MicroSpeed, Inc.**  
(MicroTrac)  
44000 Old Warm Springs Blvd.  
Fremont, CA 94538  
(800) 232-7888  
(510) 490-1403  
fax: (510) 490-1665  
**Circle 1332 on Inquiry Card.**

**NEC Technologies, Inc.**  
(ProSpeed 486SX/C)  
1414 Massachusetts Ave.  
Boxborough, MA 01719  
(800) 632-4636  
(508) 264-8000  
**Circle 1333 on Inquiry Card.**

**Suncom Technologies**  
(ICONtroller)  
6400 West Gross Point Rd.  
Niles, IL 60648  
(708) 647-4040  
**Circle 1334 on Inquiry Card.**

**Texas Instruments**  
(TravelMate 3000 WinSX)  
P.O. Box 202230  
Austin, TX 78720  
(800) 527-3500  
(512) 250-7111  
**Circle 1335 on Inquiry Card.**

**Toshiba America Information Systems, Inc.**  
(T3200SXC)  
9740 Irvine Blvd.  
Irvine, CA 92718  
(800) 334-3445  
(714) 583-3000  
**Circle 1336 on Inquiry Card.**

REPORT CARD				INFO WORLD		
Text Retrieval Software	(InfoWorld weighting)	(Your weighting)	Ask Sam Version 4.2	Folio Views Version 2.0	Lotus Magellan Version 2.0	Zyindex Version 3.0
List price			\$295	\$495	\$139	\$295
Performance			Satisfactory	Excellent	Excellent	Very Good
Capacity	(75)	( )	Good	Very Good	Excellent	Good
Record processing	(100)	( )	Good	Excellent	Excellent	Excellent
Search capabilities	(100)	( )	Good	Satisfactory	Good	Very Good
Speed	(150)	( )	Poor	Very Good	Very Good	Very Good
Documentation	(75)	( )	Poor	Very Good	Very Good	Very Good
Ease of learning	(100)	( )	Satisfactory	Very Good	Very Good	Good
Ease of use	(75)	( )	Poor	Very Good	Satisfactory	Very Good
Error handling	(75)	( )	Good	Satisfactory	Excellent	Excellent
Support	(50)	( )	Satisfactory	Excellent	Very Good	Very Good
Support Policies	(50)	( )	Good	Good	Very Good	Very Good
Technical support	(150)	( )	Good	Good	Very Good	Very Good
Value			5.0	8.3	7.6	8.5
Final scores						

# #1 Text Retrieval Software

"Powerful and flexible search capabilities; extremely easy to learn and use."

—Patrick Marshall  
InfoWorld, August 5, 1991

Finds needed information quickly.

ZyINDEX simultaneously searches all files, thousands of pages, entire networks, with results in less than 3 seconds!

Searching is easy. To find a word, just type it. Instructions are clear and readily available.

Versatile. Powerful. ZyINDEX provides the widest range of search techniques:

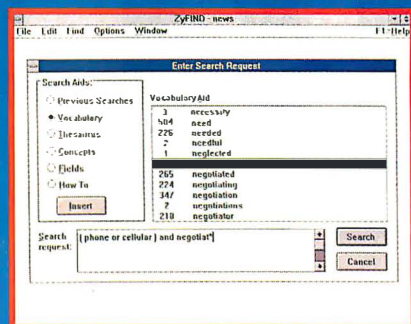
- Boolean Logic • Thesaurus
- Comments • Phrase Searches
- Numeric Range • Field Searches
- Wildcards • Conceptual Searches
- Proximity Searches... and more.

Prepare your entire drive for searching with just one keystroke. Ideally suited for networks and frequently changing text.

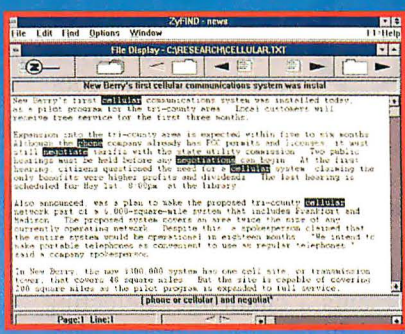
ZyINDEX finds every occurrence of your search request.

- Select any file for viewing.
- Browse or jump from hit to hit.
- Copy, paste and print.

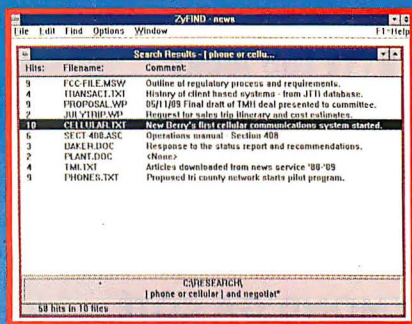
Available for DOS, Windows and UNIX. Supports WordPerfect, Word and most other word processor formats.



Type a search request.



View file with hits highlighted.



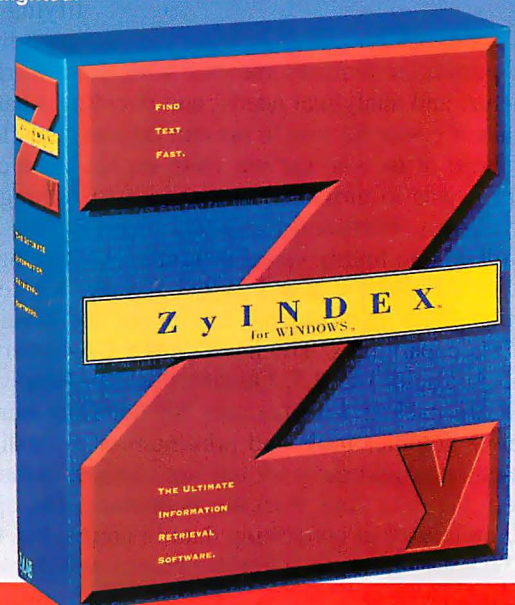
List of files found.

**ZyLAB**  
a Division of Information Dimensions, Inc.

100 Lexington Drive  
Buffalo Grove, Illinois 60089  
(708) 459-8000  
FAX (708) 459-8054

Call 1-800-544-6339  
Demo disk available

BYTE Free Demo Download  
DEMO LINK 617-861-9767



©1991

Circle 139 on Inquiry Card (RESELLERS: 140).

# CAPTAINS OF CRUNCH

**The BYTE Lab looks at the top spreadsheet programs for DOS, Windows, and the Mac**

**RAYMOND GA CÔTÉ  
AND  
DAVID L. EDWARDS**

Once dominated by mighty Lotus 1-2-3, the spreadsheet playing field is intensely competitive these days. Spreadsheets come in so many variations and are designed for so many platforms in the personal computer environment that making an informed buying decision truly presents a challenge. Selecting the right program demands identifying key features; understanding how well the implementation

of particular features meshes with your work style, financial requirements, and analytical needs; and deciding what sorts of special tools will make it easier for you to present information clearly.

Those of us who cut our teeth on Hollerith cards remember how difficult it was to turn final output into something resembling what we saw on-screen. Fortunately, things change. Just as word processors have evolved into highly visual programs, so, too, have spreadsheets.

For this BYTE Lab Product Report, we selected programs that run under DOS or Windows 3.0, or on the Macintosh; most have WYSIWYG capabilities. The list includes CA-SuperCalc 5.1, Excel 3.0, Lotus 1-2-3, Lucid 3-D 2.5, Quattro Pro 3.0, Resolve 1.0v2, and Wingz 1.1a. All are packed with features for handling numbers, but some offer superior graphics tools and presentation capabilities, as well. Certainly an essential requirement for any spreadsheet is the ability to generate graphs from the data your worksheets contain. The applications examined here do quite well at converting data to charts, but they differ in the extent to which they let you manipulate graphs and charts.

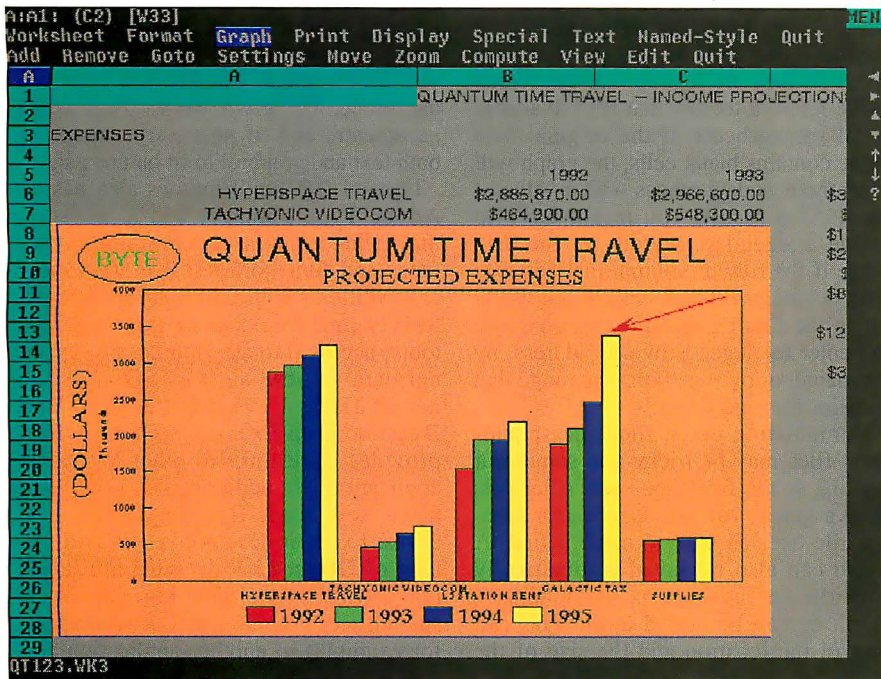
In evaluating each program, we paid careful attention to its user interface and ease of use. Options usually taken for granted—automated program installation, smooth navigation within a worksheet, and the ability to quickly generate charts and view data in different formats—were high on our list of desirable features. But we also looked at how easy the programs' other major features were to learn and use. After all, an awesome calculation function is nearly useless if you can't figure out how to make it work.

## LOTUS 1-2-3

### **FOR DOS**

Sales figures indicate that Lotus 1-2-3 still is the king of DOS spreadsheets. The latest DOS package, release 2.3, is a low-end marvel that's powerful enough to ensure loyalty to the crown among the masses. Release 3.1, slower and heavier on high-end features than release 2.3, is a top seller among corporate number crunchers. But in the realm of Windows and the Mac, Lotus 1-2-3 is an upstart challenger that must prove itself against established packages such as Excel and Wingz.





With millions of die-hard DOS users worldwide faithfully awaiting the next upgrade from Lotus, you'll be in good company if one of the three versions of 1-2-3 for DOS is your final choice. Which of the trio is right for you depends on how much processing power your system has and whether you prefer the more intuitive, polished graphical user interface of the Windows version. The newest 1-2-3 release extends the long arm of Lotus to include Macintosh users. Cross-platform mobility and ease of use are two of the new arrival's biggest selling points.

#### Lotus 1-2-3 Release 2.3

The latest DOS version of Lotus 1-2-3, release 2.3, is a big wonder in a small package. Lotus has managed to cram myriad graphics tools into a program that will run on low-end systems without sacrificing speed. The program will run on older 8088-based PCs and touts an interactive WYSIWYG display and presentation-quality output with page preview capability. It shares many of the same basic features found in 1-2-3 release 3.1 but lacks Solver and Backsolver, DataLens technology for accessing external data sources, SmartIcons, and a three-dimensional worksheet display.

Release 2.3 does, however, include provisions for using more than 100 scalable fonts in a single worksheet, a built-in word processor, a palette of 224 colors

and fill patterns for enhancing graphs, and the ability to automatically wrap text around graphs. Release 2.3 also provides an on-line tutorial, context-sensitive help, and what Lotus calls enhanced expanded memory, a memory management system that can accommodate spreadsheets as large as 12 MB.

#### Lotus 1-2-3 Release 3.1

The GUI for Lotus 1-2-3 release 3.1 for DOS is similar to that for release 2.3: the classic menu on the top line with pull-down choices from each command. And, again like release 2.3, it lacks the scroll bars, radio buttons, and sculpted window frames found in 1-2-3 for Windows.

An add-in program for 3.1 lets you customize screen colors and worksheet fonts, as well as do fancy formatting of data. As a result, 1-2-3 3.1 can print professional looking reports. The latest update, 3.1+, incorporates the spiffy graphical features of 1-2-3 2.3.

Release 3.1 goes beyond 2.3 in many other areas, offering advanced macro commands, a worksheet and cell indicator, calculation indicator, new graphing options, advanced printing functions, and the ability to search and replace information in a range of cells. A 286 microprocessor is the minimum required to run this version. In our tests of floating-point and integer calculations, the calculation engine for Lotus 3.1 proved slower than that of the speedy release 2.3.

## BYTE ACTION SUMMARY

### ■ WHAT THEY DO

These packages provide you with tools for analyzing and calculating complex sets of numerical data. To varying degrees they incorporate functions that let you turn this data into visually meaningful information.

### ■ WHAT YOU'LL LIKE

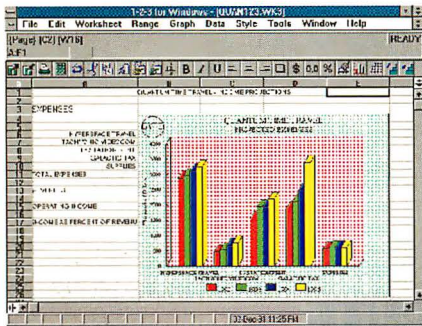
Spreadsheets not only analyze numbers; the more sophisticated programs now on the market offer slick powerful presentation tools. Those products equipped with graphical interfaces further simplify analytical procedures.

### ■ WHAT YOU'LL DISLIKE

With the increase in calculation and presentation power comes a steep learning curve. Some spreadsheet packages are just plain hard to learn.

### ■ RECOMMENDATIONS

For older machines with 512 KB of memory, nothing beats Quattro Pro. Lotus 1-2-3 release 2.3, likewise, offers speed and basic graphics functions to low-end DOS users. For sheer calculation speed, however, consider the very graphical Wingz. Under Windows and on the Mac, Excel offers elegance and ease of use; Lotus, 1-2-3 compatibility; and Wingz, throughput.



## LOTUS 1-2-3 1.0A

### FOR WINDOWS

What stands out most visually in Lotus 1-2-3 for Windows are its new Smart-Icons: a suite of over 70 worksheet and graphing buttons that you can customize to automate basic spreadsheet functions. You can, for example, assign a macro or a frequently used operation to a button; if you want help figuring out what a button does, you can simply point to it and click the right mouse button.

Lotus 1-2-3 for Windows is essentially a graphical version of high-end release 3.1 and, like release 3.1, bears some resemblance to older 1-2-3 versions. The old guard who prefer the traditional way of doing things will appreciate that the program includes a provision for accessing the classic 1-2-3 menus with the slash key (/). The command keystrokes remain the same, and old worksheet files are completely compatible with the new 1-2-3 for Windows.

The package's graphing techniques include the ability to insert and display an unlimited number of 1-2-3 graphs anywhere in the spreadsheet; the graphs are updated automatically as worksheet data changes. You can place PIC and CGM graphics files and freehand drawings in a worksheet and annotate graphs with text and simple geometric shapes, as well as paste in graphics from the clipboard.

Creating graphs is easy. You simply select a valid range of data from your worksheet, pick the Graph and New options, type a name for your graph, and press Enter. The chart first generates a line graph; you then have the option of selecting one of more than 200 combinations of styles—among them 22 3-D graph formats. To view the graph separately at a later time, you have to select it from the active list of graph names under Graph View.

To change the elements in a graph, the named graph window must be active. Pressing Control-F6 toggles the active window, alternately showing the graph

and the worksheet; clicking on the graph twice also toggles the active window. If the axis text labels in your spreadsheet are long, they will be staggered on two levels so they are legible (see the screen to the left)—a feature that isn't available in all spreadsheets. If the original data range contains blank cells, the graph will chart them as data ranges with a value of zero. As a result, you might have to define a legend separately for the data range if the row or column that has axis labels contains a blank cell. When working in the Chart Legend dialog box, you can enter the legends by cell address, by text name, or by specifying the range that contains the legend labels.

Manipulating graph files and spreadsheet files may be tricky and somewhat baffling to the first-time user. After creating a graph, you can save it as a separate file but you have to name it first. A graph can also be saved automatically with the spreadsheet as an embedded graph or can be added later. You can control the location and the size of the graph, but once it is embedded you can't annotate it, nor can you change its appearance except by altering the spreadsheet data or naming the graph and opening it as the active window. Once an embedded graph and spreadsheet are saved together, they are forever married. If you close the file and then reload it, you'll find the ever-faithful embedded graph, obscuring the data that lies beneath it (if you happened to place it on top of a portion of your spreadsheet).

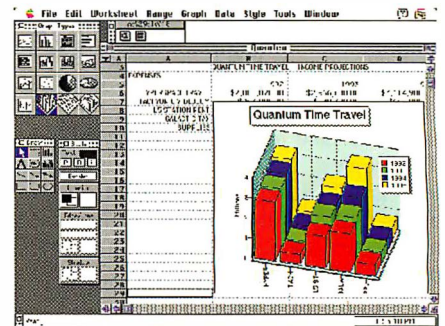
The procedure for opening a file isn't as easy as it could be. If you type the directory, filename, or file extension incorrectly, the program's File/Open window displays an error message saying the file doesn't exist. At that point, the only available options are Help or OK, but neither allows a second try. You must go back to the File menu and re-enter the directory or filename (the default Lotus 1-2-3 directory always takes precedence)—an annoying quirk to say the least.

If you are working with an imported file with a WK1 extension (the 1-2-3 release 2.3 file format) and create a graph you want to save, you will likely get an error message saying, "Incompatible worksheet information lost during saving." Don't panic. No data has been lost; the message is merely a warning, though it may not appear that way. You receive a second chance to save the worksheet under a different file extension or in the native file format for the Windows version of 1-2-3, WK3.

One of the program's most convenient features is the automatic fit-to-page

option. Often when you work with spreadsheets, page breaks are unavoidably inserted in your spreadsheet. They can be a nuisance when you want to print what you see on-screen. File Preview comes to the rescue, letting you see the Page Setup parameters and, if necessary, compress both text and graphics to fit on one page.

Lotus 1-2-3 for Windows also has an Adobe Type Manager add-in program that includes 13 scalable PostScript typefaces and font libraries; 3-D worksheet capabilities for handling large models; Solver and Backsolver goal-seeking tools; access through DataLens to external data sources such as SQL Server, dBase III and IV, and Paradox; and Dynamic Data Exchange (DDE), which provides live links to other Windows applications. In addition, 1-2-3 for Windows now reads Excel 3.0 files, but, unlike Excel, it does not yet take advantage of Object Linking and Embedding (OLE), a protocol that lets you place spreadsheet data (a graph or worksheet, for example) in another application and then launch the source program (in this case Excel) from within that application. Lotus 1-2-3 for Windows will give you everything you need to produce a winning presentation or report. Even most "classic" users will like it.



## LOTUS 1-2-3

### FOR MACINTOSH

Lotus delivered version 1.0 of 1-2-3 for the Macintosh just as we finished this product roundup, so we couldn't give it as long a look as we would have liked. Next to "1-2-3 compatibility," the phrase that best describes this newest Lotus product is "user configurable." If you see something you don't like on the screen, you probably can change it.

With Lotus 1-2-3 for Macintosh, Lotus has fallen in love with command and status boxes and tear-off menu palettes. The latter are used extensively to control such functions as graphing, drawing, and

# Mathematica 2.0: the standard for technical computing

**"The importance of the program cannot be overlooked... it so fundamentally alters the mechanics of mathematics."**

*New York Times*

**"Mathematica has the potential to change the world of science at least as much as word processing has changed the world of writing."**

*InfoWorld*

**"Mathematica is a startlingly good tool."**

*Nature*

Available across PC, Macintosh, Unix, and VMS platforms, *Mathematica* includes a full range of interactive numerical, graphical, and symbolic computation capabilities, all linked to the powerful built-in *Mathematica* language. *Mathematica* 2.0 adds still more features to the proven leader in technical computing software, including sound generation and flexible external program communication.

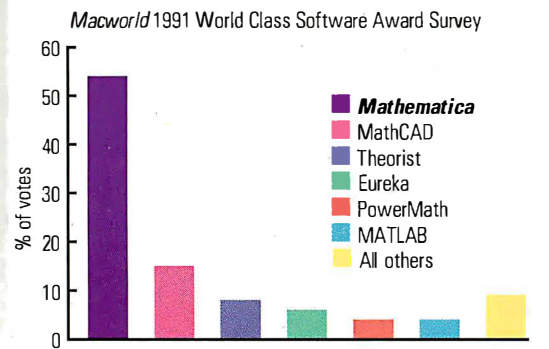
*Mathematica* has rapidly become the standard for technical computing, with more than a dozen textbooks, a quarterly journal, and several newsletters devoted to the system. *Mathematica* is in use at all of the 50 largest U.S. universities, all of the technical Fortune 50 companies, and most of the world's larger engineering firms. In fact, more than 100,000 technical professionals and students around the world are working with *Mathematica* every day.

To find out what *Mathematica* can do for you, call Wolfram Research at 1-800-441-MATH.

## Mathematica 2.0

A System for Doing Mathematics by Computer

For Macintosh information circle 135,  
For IBM/Compatible information circle 136,  
For UNIX information circle 137 on Inquiry Card.



*Mathematica* has also received best software/new product awards from:

*Macworld*, 1990-91

*MacUser*, 1989

*Discover*, 1990

*Business Week*, 1988

*BYTE*, 1989

*InfoWorld*, 1988

### Mathematica is currently available for:

MS-DOS 386, Microsoft Windows, Macintosh, CONVEX, DG AViON, DEC VAX (ULTRIX and VMS), DEC RISC, HP 9000, Apollo, IBM RISC System/6000, MIPS, NeXT, Silicon Graphics, Sony, Sun-3, and SPARC.

Prices in U.S. and Canada start at \$595. Educational discounts and student versions are available.

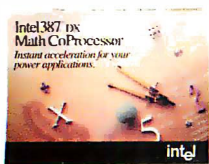
**Wolfram Research, Inc.**, 100 Trade Center Drive, Champaign, IL 61820-7237, USA  
217-398-0700; fax: 217-398-0747; email: info@wri.com

**Wolfram Research (UK) Ltd.**, P.O. Box 114, Abingdon, Oxon OX13 6TG, United Kingdom  
+44 (235) 550 440; fax: +44 (235) 550 445; email: info-uk@wri.com

© 1991 Wolfram Research, Inc. *Mathematica* is a registered trademark of Wolfram Research, Inc. *Mathematica* is not associated with Mathematica Inc., Mathematica Policy Research, Inc., or MathTech, Inc. All other product names mentioned are trademarks of their producers. Photo: George Fehrey



# Only one math coprocessor with the



When you enhance your Intel CPU with an Intel Math CoProcessor, you're destined for good karma.

It's simple. They were both invented by Intel, the microprocessor leader. And they were specifically designed to work together, ensuring 100% compatibility.

No wonder Intel's been the de facto standard in math coprocessors for the last ten years.

Intel Math CoProcessors are also compatible with more than 2,100 applications. They come with a lifetime warranty. And they now account for nine out of ten math coprocessors currently in use. All of which should effectively put your mind



# processor has achieved oneness Intel CPU.

at peace when you buy one.

It's all part of Intel's commitment to providing powerful solutions today, with industry-leading microprocessors, plus the enhancements for even greater performance. Today and down the road.

To receive a detailed information packet about the full line of Intel Math CoProcessors, call

(800) 538-3373. It has everything you need to find complete enlightenment.

**intel**®

The Computer Inside.™

Circle 67 on Inquiry Card (RESELLERS: 68)

# Spreadsheet Features

The plethora of spreadsheet programs on the market makes it difficult to make an informed buying decision. Comparing products feature for feature can help. ● = yes; ○ = no; N/A = not applicable.

	DOS SPREADSHEETS					WINDOWS
<b>Product</b>	<b>CA-SuperCalc</b>	<b>Lotus 1-2-3</b>	<b>Lotus 1-2-3</b>	<b>Lucid 3-D</b>	<b>Quattro Pro</b>	<b>Excel for Windows</b>
<b>Version</b>	<b>5.1</b>	<b>2.3</b>	<b>3.1</b>	<b>2.5</b>	<b>3.0</b>	<b>3.0</b>
<b>Company</b>	Computer Assoc. International	Lotus Development Corp.	Lotus Development Corp.	Lucid Corp.	Borland International	Microsoft Corp.
<b>Price</b>	\$149	\$495	\$595	\$99.95	\$495	\$495
<b>Upgrade Price</b>	\$149	\$150	\$150	\$49.95	\$99.95	\$129
<b>Minimum System Requirements</b>						
Processor	8088	8088	286	8088	8088	286
Memory	512 KB	384 KB	1 MB	256 KB	512 KB	1 MB
Disk space	2.2 MB	5 MB	6 MB	330 KB	5 MB	2 MB
Operating system version	DOS 3.0	DOS 2.1	DOS 3.0	DOS 3.1	DOS 3.3	Windows 3.0
<b>Recommended System Requirements</b>						
Processor	8088	8088	286	8088	8088	286
Memory	640 KB	512 KB	1.5 MB	640 KB	640 KB	2 MB
Disk space	2.2 MB	6.4 MB	8 MB	500 KB	5 MB	6 MB
Operating system version	DOS 3.3	DOS 5.0	DOS 5.0	DOS 3.1	DOS 3.3	Windows 3.0
<b>Features</b>						
Network capability	●	●	●	●	●	●
Data-import formats	dBase, DIF, text, WK1, XDIF	dBase, DIF, WK1, WKS, SYLK, text	dBase, DIF, WK1, WKS, SYLK, text	DacEasy, dBase, text, WK1	WK1, WKS, dBase, Paradox, Reflex	Clipboard, dBase, DIF, SYLK, text, WK1, WK3, WKS
Graphics-import formats	None	CGM, FMT, PIC	CGM, FMT, PIC	LCD	CGM	Clipboard
Data-export formats	dBase, DIF, text, WK1, XDIF	dBase, DIF, WK1, WKS, SYLK, text	dBase, DIF, WK1, WKS, SYLK, text	DacEasy, dBase, text, WK1	WK1, WKS, dBase, Paradox, Reflex	Clipboard, dBase, DIF, SYLK, text, WK1, WK3, WKS
Graphics-export formats	CGI, CGM, PICT, PostScript, Ventura Publisher	CGM, FMT, PIC	CGM, FMT, PIC	IMG, PCX, MAC, LCD	EPS, PCX, PIC	Clipboard
Automatic graph updating	●	●	●	●	●	●
Embedded graphs	○	●	●	○	●	●
Print preview	○	●	●	○	●	●
<b>Output options</b>						
Slide maker	●	○	○	○	○	●
Camera	●	○	○	○	○	●
Film recorder	●	○	○	○	○	●
Plotter	●	●	●	○	○	●
Maximum sheet size (rows x columns)	999 X 255	256 X 8192	256 X 8192	9999 X 254	8192 X 256	16,384 X 256

## SPREADSHEETS

## MACINTOSH SPREADSHEETS

Lotus 1-2-3 for Windows 1.0a Lotus Development Corp.	Wingz for Windows 1.1a Informix Software	Excel for the Macintosh 3.0 Microsoft Corp.	Lotus 1-2-3 for Macintosh 1.0 Lotus Development Corp.	Resolve 1.0v2 Claris Corp.	Wingz for Macintosh 1.1a Informix Software
\$595	\$499	\$495	\$495	\$399	\$399
\$150	N/A	\$129	N/A	N/A	\$37
286	286	68000	68000	68000	68000
2 MB	2 MB	1 MB	2 MB; 3 MB under System 7.0	1 MB	1 MB
5.5 MB	2 MB	3 MB	3.9 MB	2 MB	2 MB
Windows 3.0	Windows 3.0	System 6.0.3 or Finder 6.0.1	System 6.0.3 or 7.0	System 6.0.5 or AUX 2.0	6.0.2
286	286	68000	68000	68020	68020
4 MB	3 MB	2 MB	2 MB; 3 MB under System 7.0	2.5 MB	2 MB
5.5 MB	2 MB	3 MB	6.5 MB	3.2 MB	5 MB
Windows 3.0	Windows 3.0	System 7.0	System 6.0.3 or 7.0	System 7.0 or AUX 2.0	6.0.2
●	●	●	●	●	●
dBase, DIF, SYLK, text, WK1, WK3, WKS	BIFF, DIF, SYLK, text, WK1, WK3	Clipboard, dBase, DIF, SYLK, text, WK1, WK3, WKS	WK1, WK3, WKR, WR1, WKS, Excel, dBase, text	DIF, SYLK, text, Wingz, WK1, WK3	DIF, SYLK, text, WK1, WK3
CGM, PIC, Clipboard	BMP, GIF, PICT, PICT 2	Clipboard	Clipboard, Publish and Subscribe	PICT, PICT 2	BMP, GIF, PICT, PICT 2
dBase, DIF, SYLK, text, WK1, WK3, WKS	BIFF, DIF, SYLK, text, WK1, WK3	Clipboard, dBase, DIF, SYLK, text, WK1, WK3, WKS	WK1, WK3, Excel 2.2, dBase, text	DIF, Excel, SYLK, text, Wingz, WK1, WK3	DIF, SYLK, text, WK1, WK3
CGM, PIC, Clipboard	Clipboard	Clipboard	Clipboard	PICT, PICT 2	Clipboard
●	●	●	●	●	●
●	●	●	●	●	●
●	●	●	●	●	●
●	○	●	●	●	○
●	○	●	●	●	○
●	○	●	●	●	○
●	○	●	●	●	○
8192 X 256	32,768 X 32,768	16,384 X 256	256 X 8192	>1 billion cells	32,768 X 32,768

setting styles. If you aren't careful, your screen may quickly end up showing more palettes and menu options than spreadsheet information.

The program's default settings produce wonderful graphics. The colors, shading, and placement of items is excellent. All graph items—titles, legends, axis notations, and so on—are treated as objects. To move an item, you simply drag it to where you want it. To change it, you double-click on it to bring up an editing dialog box. You don't like the color combinations? You can change them one at a time. Even though the default graphs are excellent, you can make them look better by adding new fonts from the copy of Adobe Type Manager 2.0.3 included with each package.

Context-sensitive help is linked to all the program's dialog boxes. To access the on-line help pertinent to your current situation, you simply click on the question mark in the upper-right portion of the box. This is a very convenient and nonintrusive addition to the Mac's standard interface.

Lotus 1-2-3 for Macintosh has all the features we've come to expect in a high-end graphical spreadsheet: the ability to annotate a spreadsheet by adding graphics—an arrow that points out a certain cell, for example—buttons and text fields with which you can associate macro commands, support for true 3-D spreadsheets, a well-rounded macro language, and an iterative solver.

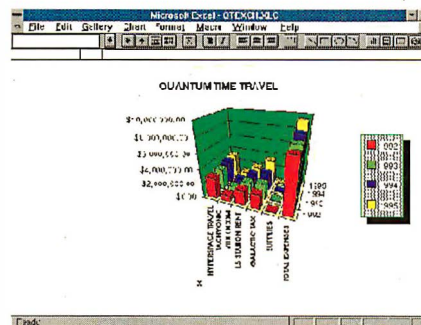
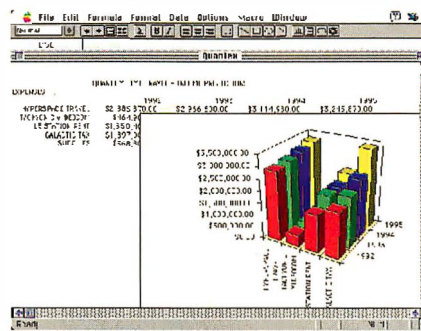
The program's performance on the BYTE Lab benchmarks indicate that Lotus 1-2-3 for Macintosh isn't a top performer when it comes to throughput. What you get instead is the ability to continue working on a spreadsheet while a recalculation goes on in the background. But although not having to wait for recalculation seems like an attractive idea, in practice we found ourselves waiting anyway because we needed to see the result of a computation before making further changes to our spreadsheet. How helpful this feature will prove depends largely on how you work. For us, the ability to abort a recalculation and quickly turn manual recalculation on and off from the keyboard seems much more useful.

The principal beneficiaries of this Lotus 1-2-3 version will be business users already running 1-2-3 on PCs. Now they can share files and macros with their coworkers who use Macs. The procedure involves shuttling files across a network or relying on Macs with floppy drives that can read PC disks, but taking 1-2-3 worksheets from PCs to Macs is about as easy as cross-platform exchanges get.

1-2-3 for Macintosh also is one of the

first packages to really tap the capabilities of System 7.0, most notably its Publish and Subscribe options. With this feature, you can "publish" data—perhaps a worksheet or graph—that other applications can "subscribe" to. Someone else—maybe the person who prepares reports for the CEO—can then subscribe to that material and place it in a document. If you make a change to the published information, the subscriber's copy changes, too. This is just one practical example of advantages offered by putting System 7.0 to good use.

Despite sluggish performance, Lotus 1-2-3 for Macintosh feels right because so many of its operations are intuitive. Let's hope that the next release pays close attention to maximizing the throughput of the computing engine. Because, after all, spreadsheets are meant to boost productivity.



## EXCEL 3.0 FOR THE MACINTOSH AND WINDOWS

Microsoft's Excel is one of the graphically oriented, feature-rich competitors that has Lotus Development looking over its shoulder. The price of this program's visual sophistication, though, appears to be speed. On the Macintosh, Excel was a poor performer in both file loading and computational speed. Under Windows, file loading speed also was poor, but computational speed was average.

Microsoft has done a good job porting Excel to the Windows 3.0 environment. Most everything we say about Excel for the Macintosh applies to the Windows version, with the notable exceptions of performance, database links, and DDE.

Like the Macintosh version, Excel for Windows gives you access to external databases; however, it relies on a separate program called Q+E to provide the link. You get interactive dialog boxes to assist you in naming the fields to extract, the ability to attach search criteria to every field, and macros. But you access a database by creating DDE links between your spreadsheet and Q+E. Although Excel provides a special Q+E macro library to simplify the interface, it would be much nicer if the database were integrated into Windows—the way it is for the Macintosh version.

While other Windows spreadsheets' dynamic linking capability starts and ends with DDE, Excel lets you take advantage of OLE by placing a worksheet or graphic in a document created with another OLE-compliant application, such as a word processor. If, while working in the word processor, you need to change the worksheet, you just double-click on it and Excel fires up; when you're done making changes, you can click out of Excel and be back in your word processor.

All in all, Excel 3.0 for Windows provides a good mix of analysis and presentation tools. It may not be the fastest spreadsheet when it comes to some operations, but it's easy to use once you learn its few idiosyncrasies. The program's Toolbar, which lets you access functions by clicking on an icon, is a great time-saver.

Navigating an Excel worksheet on either the Macintosh or Windows is quick and smooth. For procedures such as recalculation and chart updates, the program displays a percent-completed message in a status box. Excel lets you create a separate window for charts or embed them in a worksheet by simply making a palette selection. Creating a chart in a separate window is similar but requires selecting the New option from the File menu and then specifying the chart type; some users have found this to be one of the most non-intuitive processes in Excel. Charts created as separate windows are not saved with the spreadsheet, but rather in a file internally linked to the spreadsheet. Changes made to the spreadsheet appear in the chart the next time you open it. Before changing any features of an embedded chart, you must first expand it into a separate window. After making the changes, you must close the window to display the updated embedded chart.

*continued*

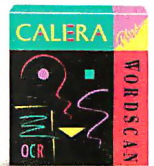




# It's Time To Think About America's Biggest Business Coverup.

Today's business is covered in paper. It's piled on desks, lost in files and burying good ideas alive. That's why we created WordScan™ and WordScan Plus for Windows. The award-winning Optical Character Recognition technology that eliminates the slow process of manually typing documents into your PC. WordScan converts any

document into text that can be read by word processing, desktop publishing and spreadsheet programs (no typist can equal 1200 words per minute or our industry leading accuracy). So you can integrate the information into your own work, ready in moments for revisions, retrieval and E-mail. Call us for details.



**CALERA**  
RECOGNITION SYSTEMS

**For A FREE Full-Working Evaluation Copy Of WordScan Plus And The Nearest Dealer Location Call (800) 544-7051**

Calera Recognition Systems 475 Potrero Ave., Sunnyvale, CA 94086 Outside USA (408) 720-0999 FAX (408) 720-1330 © 1992 Calera Recognition Systems. Calera® is a registered trademark and WordScan™ is a trademark of Calera Recognition Systems, Inc. All other products and brands are property of their respective trademark holders. Offer valid in USA only.

**Circle 33 on Inquiry Card.**

You can easily annotate charts with text and graphics once you've created them. Excel provides the standard line, circle, and box drawing tools along with tools for improving the appearance of your type. We managed to change the colors of the bars in our sample chart, something few of the other spreadsheets reviewed allowed us to do.

Another innovation is Excel's Toolbar. Like Lotus's SmartIcons, this graphical bar lets you access certain commands or procedures with a single click of the mouse. To specify type styles, make other formatting choices, or access AutoSum, for instance, you just click on the appropriate Toolbar icon.

In addition, Excel has the unique ability to change the value of a spreadsheet cell when you alter its value while creating a chart. Pressing the Control key (the program's command key) and clicking on a bar or data point, brings up a handle that you can grab and move. As you work, the updated value is displayed in the upper-left corner of the spreadsheet. This technique has limitations, however. First, not all charts may be manipulated. In particular, we couldn't directly manipulate 3-D charts. Second, if a chart element is linked to a cell containing a formula, you must be ready to tell Excel which cell in the formula to change to get the new value. Excel then uses its built-in Solver to compute a new result.

What Excel lacks in speed it makes up for in features. The program provides access to external databases through Apple's Data Access Language for the Macintosh. This arrangement gives you access to Sybase, Ingres, Rdb, Informix, Oracle, and dBase data, and you don't need to learn a complex data query language to use DAL. Excel provides interactive dialog boxes in which you can specify which fields to extract and then attach simple search criteria to each field. Advanced users may perform sophisticated database searches using SQL, and all DAL functions are available through macro commands.

Another of the program's advanced functions is Solver. This feature, which is similar to Lotus 1-2-3's Solver, lets you specify the result you want and then solve for the input to generate that result. You provide Solver with a target result, several starting inputs, and a number of constraints—cells that must remain within a particular range, for instance. When you start Solver, it repetitively recalculates the spreadsheet until all your specified conditions are met.

Working with large spreadsheets? Have too much information to fit on the screen? Try using Excel's outlining function. Outlining lets you define up to seven levels of indenting on your spreadsheet. You can collapse and expand outlined rows and columns to hide and display information. This simplifies your spreadsheet organization and allows you to quickly move around in large amounts of information.

For working within large networked groups, Excel provides integrated Microsoft Mail support, which lets you send and receive spreadsheets and charts. You also can take advantage of a customized installation program that allows you to select which additional features of Excel to install: tutorial, help, equation solver, database access, and macro library. The full installation requires roughly 3 MB of disk space.

The sheer number of features available in Excel for the Macintosh might have made it intimidating, but Microsoft has managed to fashion a program that's easy to use. If you're familiar with the basic operation of a spreadsheet, you'll have no problem learning this complex package. It doesn't have all the graphical whizbang of Wingz, but its learning curve is a gentle knoll compared to Wingz' precipitous climb.



## QUATTRO PRO 3.0

### FOR DOS

Borland International's outstanding entry in the spreadsheet domain offers bells and whistles at hurricane force. With Quattro Pro 3.0, the company apparently was determined to offer more functions, performance, and presentation effects than most other spreadsheets around. This is a product that delivers. If you need powerful visuals to get your financial message across, you'd be wise to take a close look at Quattro Pro.

Despite advanced linking and consolidation features, the ability to annotate any portion of a graph, 24 slide-show transi-

tion effects, built-in sound effects, banner printing across continuous paper—not to mention many more features that make data manipulation and windowing easier to use and documents and presentation materials easier to prepare—Quattro Pro is economical on memory. Borland's distributed memory allocation system called VROOMM (Virtual Runtime Object-Oriented Memory Manager) makes it possible to take advantage of all these features on an 8088-based system with 512 KB of memory. And the program is Windows compatible.

It's a joy to work within the Quattro Pro environment, with its slick Windows-like buttons and 3-D graphical interface. Or, if you prefer, you can work with classic 1-2-3-like pull-down menus. Either way, Quattro Pro provides a fully integrated WYSIWYG display and screen preview that shows on-screen exactly what you'll get in print—in portrait or landscape mode. Quattro Pro even has a Zoom feature that lets you increase the amount of information displayed by up to 200 percent or decrease it to 25 percent. What is more, you can toggle between a chart and a spreadsheet with a single keystroke.

Creating graphs is extremely fast. But it can seem complex because Quattro Pro offers so many options you might think you are working in a drawing package that just happens to have spreadsheet capability. Using the program's Annotator to change the appearance or color of graphs is interactive and Windows-like. With a 16-color palette and 12 tools from which to choose, Quattro Pro packs nearly all the power of a graphics package.

When it comes to graphics versatility, drawing features, and graph type, Quattro Pro outperforms all the other DOS programs we looked at. You get 10 types of two-dimensional graphs and five kinds of 3-D graphs, but unlike Wingz, the program cannot do polar and contour graphing.

You can link graphs to more than one spreadsheet or insert them directly into your worksheet. Although the initial graph is displayed in black and white, you can drop in color or fill patterns by making selections within the Graph Overall menu. The options you select do not remain checked when you return to the menu.

If you are looking for the most versatile, integrated spreadsheet and graphics package available today for DOS machines—and you want powerful linking capability, analytical tools, and data consolidation as well as plenty of presentation and publishing punch—Quattro Pro should be near the top of your list.

*continued*

# Borland ranked best Quattro Pro beats Lotus 1-2-3

Two recent industry studies objectively confirm the facts: Customers rank Borland best among software companies, and Quattro® Pro outperforms *all* Lotus® spreadsheets.

## Borland: The technology leader.

Buying software shouldn't be an act of blind faith. Before purchasing your next spreadsheet, take a hard look at the company behind it. Bigger is not better!

Because Borland is smaller than our competitor, we work smarter, we try harder, and it's paying off: Borland was just ranked "Best Application Software in Customer Satisfaction, in Small and Medium Sized Businesses," in the prestigious J.D. Power and Associates survey.

Who would you rather buy your next spreadsheet from?

Just check out the *InfoWorld* review results below. Quattro Pro wins in comparison to Lotus 1-2-3® hands down in *InfoWorld* and with more than 1,000,000 enthusiastic users.

	Quattro Pro	Lotus 1-2-3	
Number of ...	3.0 <sup>1</sup>	v. 2.3 <sup>2</sup>	v. 3.1 <sup>3</sup>
"Excellent"	7	2	3
"Very Good"	8	4	5
"Good"	0	5	4
"Satisfactory"	2	5	3
"Poor"	0	1	1
<b>Overall score</b>	<b>8.4</b>	<b>6.3</b>	<b>6.5</b>

<sup>1</sup> Source: *InfoWorld*, April 29, 1991. <sup>2</sup> Source: *InfoWorld*, June 10, 1991.  
<sup>3</sup> Source: *InfoWorld*, January 28, 1991

REPORT CARD		INFO WORLD	
SPREADSHEET SOFTWARE			
<b>Quattro Pro</b>			
VERSION 3.0			
Criterion	(Weighting)	Score	
<b>Performance</b>			
Formulas/analysis	(100)	Very Good	
Compatibility	(50)	Very Good	
Speed	(75)	Very Good	
Database	(75)	Excellent	
Graphics	(75)	Excellent	
Output	(50)	Excellent	
Macros	(50)	Very Good	
Consolidation/linking	(50)	Excellent	
Capacity	(50)	Very Good	
Network	(50)	Satisfactory	
<b>Documentation</b>			
Ease of learning	(50)	Excellent	
Ease of use	(75)	Very Good	
<b>Error handling</b>			
Support	(50)	Very Good	
<b>Support</b>			
Support policies	(25)	Very Good	
Technical support	(25)	Satisfactory	
<b>Value</b>			
Value	(100)	Excellent	
<b>Final score</b>		<b>8.4</b>	

We don't blame Lotus for trying to underplay ratings such as these, but clearly Quattro Pro is more powerful. It has better graphics, better capacity, better macros, better consolidation and linking, and much more!

## Borland and Quattro Pro: The obvious choice.

Company for company, product for product, the choice is clear. Join more than a million users and upgrade to Borland's Quattro Pro today! If you own any version of Lotus 1-2-3, for only \$129<sup>95</sup> we'll rush you your own copy of the best spreadsheet from the best company.

See your dealer or call 1-800-331-0877 now!

## J.D. POWER AND ASSOCIATES

---

APPLICATION SOFTWARE  
CUSTOMER SATISFACTION INDEX<sup>SM</sup>

---

June 6, 1991

1. **BORLAND**
2. WORD PERFECT
3. CLARIS
4. ALDUS
5. MICROSOFT
6. LOTUS

## Quattro Pro: The standard of excellence.

*InfoWorld* reviews confirm what more than one million PC users already know: Quattro Pro is the best DOS spreadsheet that money can buy. Better than *any* Lotus spreadsheet including their recently released version 2.3.



# B O R L A N D

*Software Craftsmanship*

CODE: MJ64 1991 J.D. Power and Associates Computer End User Satisfaction Study: Phase I. Office Based Small to Medium Sized Businesses<sup>SM</sup> Response from Business End Users at 1,784 business sites. Small to medium sized businesses were based on office sites with between 1 and 499 employees. J.D. Power and Associates is a service mark of J.D. Power and Associates. Borland is a registered trademark of Borland International, Inc. Copyright © 1991 Borland International, Inc. All rights reserved. Quattro is a registered trademark of Borland International, Inc. Pricing is in U.S. dollars. Offer good in U.S. and Canada only. Dealer prices may vary. BI 1429A

Circle 26 on Inquiry Card (RESELLERS: 27).

The package has achieved a level of performance that few spreadsheet applications can aspire to. Too bad Borland hasn't released a Macintosh version.

Just as we were wrapping up this BYTE Lab Product Report, Borland sent us a "pre-beta" version of its anticipated Quattro Pro for Windows. Since it's not yet a shipping program, we won't discuss its benchmark performance, but we can talk briefly about its salient features.

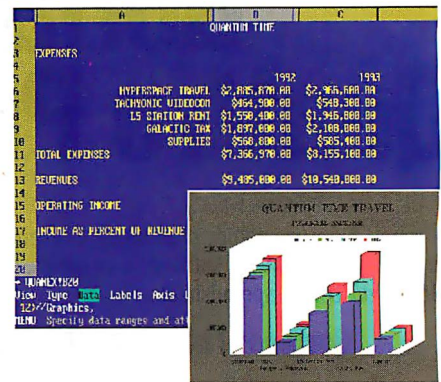
Quattro Pro for Windows has a very intuitive user interface that makes it easy to control spreadsheet functions. Context-sensitive Menus-On-Demand give you menu selections for any object on-screen (e.g., a title, page tab, cell, or graph) simply with the click of the right mouse button. The Speedbar provides customizable icons, context-sensitive buttons that automatically change with the function currently being executed; for example, the

Graph Speedbar pops up when you are working with graphics. PowerButtons, which you click on to run macros, can be placed anywhere on the screen.

Multiple spreadsheets can be linked into "notebooks." A notebook file can hold up to 256 pages, each of which can be named. Notebook windows can be tiled, stacked, or overlapped, with each page accessible by merely clicking on the notebook tabs.

Borland has maintained the stunning presentation graphics capability that is the trademark of Quattro Pro 3.0 with slideshow functions (including a light table for sorting slides), special effects (e.g., gradient washes and bit-mapped images), and drawing tools. Quattro Pro for Windows can import an incredible eight different graphics file formats, including TIF.

Borland's competitors have their eyes looking out for this project. They should.



## CA-SUPERCALC 5.1

### FOR DOS

CA-SuperCalc is an example of a perfectly competent spreadsheet program that has fallen by the wayside because it hasn't kept up with its competitors in the race to incorporate presentation features. Still, at \$149, SuperCalc delivers substantial spreadsheet power. You can load up to 255 worksheets at one time—provided you have sufficient memory—and perform block calculations across worksheets in true 3-D style. The package also boasts strong statistical features, a minimal recalc option, and an adequate macro language. Despite its strengths, SuperCalc lacks the pizzazz of today's slick WYSIWYG spreadsheets.

The package uses the familiar Lotus 1-2-3 menu structure, but the interface can get confusing at times. The command line builds a command sequence as you make menu choices; for instance, the sequence //Global,Graphics,Device shows up on the command line as you select menu options to install a plotter. The command sequence serves no useful purpose and ends up getting in your way. And if you're accustomed to navigating spreadsheets using a mouse, you may be put off by SuperCalc's lack of mouse support.

SuperCalc does, however, let you load multiple spreadsheets into memory and then link them, or you can set up a single spreadsheet file with multiple pages. With a multipage spreadsheet, you can reference cells on a different page by prefacing the cell address (referred to as the named range) with the proper page number. You also can do operations such as sums or averages across pages. These are SuperCalc's strongest features. Ample data analysis functions including matrix operations, frequency distribution, and multiple regression analysis strengthen the package.

When it comes to output capability, SuperCalc has the high-end features you expect, but it simply can't match the

# The Benchmarks

Whether or not your primary concern is high-quality graphics, spreadsheet performance always is an issue. With that in mind, we put each of the packages reviewed here through a rigorous series of tests. (See the graphs for results). We benchmarked the DOS and Windows packages on a Compaq 386/20 with 6 MB of memory, a 387 math coprocessor, and an ATI Graphics Accelerator VGA driver (1024 by 768). We ran the DOS programs under DOS 5.0 and the Windows packages in Windows 3.0's Standard mode.

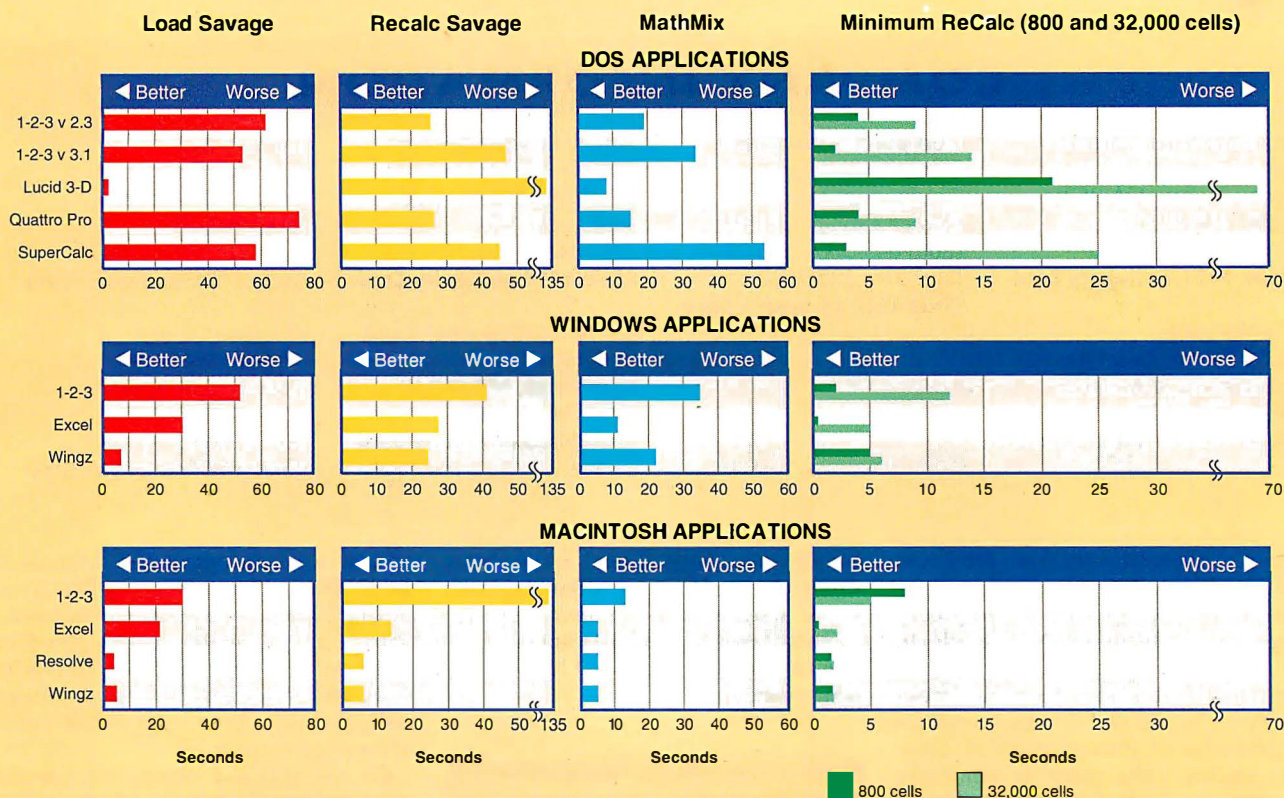
The Macintosh packages were given a workout on an 8 MB Macintosh IIfx running System 7.0. We loaded a 16 KB disk cache and initially turned off virtual memory and 32-bit addressing features. After completing the Macintosh benchmarks, we enabled Virtual Mode and 32-bit addressing. All three Mac programs were run simultaneously with Microsoft Word 4.0. We switched among all the programs randomly and noted when programs were being reloaded from disk. We found no problems with any of the programs running in this mode.

The benchmarks involve slightly modified versions of spreadsheets

used in previous BYTE Lab analyses. The Mathmix test recalculates a worksheet of 400 rows by 127 columns. Each cell is the result of a basic math operation (addition, subtraction, multiplication, or division) applied to the first two cells in its column. The result measure a package's speed at performing basic operations. Two tests based on the familiar Savage formula measure performance with floating-point operations and deeply nested formulas. The first, Load Savage, times the loading of a 320-row by 100-column spreadsheet from disk. Recalc Savage measures the time to recalculate that same worksheet.

A test to determine whether a spreadsheet program recalculates all the cells in the worksheet when a change is made, or only the cells affected by the change, rounds out our suite. This test worksheet is a 320-row by 100-column block of simple formulas. All the cells in the worksheet have calculations based on a single key. A second key is linked to only 800 of the cells. If the spreadsheet program performs minimal recalculation, the time differences between changing the two keys is noticeable.

# BENCHMARK RESULTS



For sheer loading speed, Lucid 3-D (DOS), Wingz (Windows), and Resolve (Macintosh) all take top honors. The Savage Recalc test shows the maximum floating point recalculation speeds are exhibited by 1-2-3 v 2.3 (DOS), Wingz (Windows), and a tie between Resolve and Wingz (Macintosh). The MathMix integer math recalculation test highlights Lucid 3-D (DOS), Excel (Windows), and a three-way tie among Excel, Resolve, and Wingz on the Macintosh.

All the spreadsheets, with the exception of Wingz and Resolve, demonstrate their ability to perform minimal recalculations.

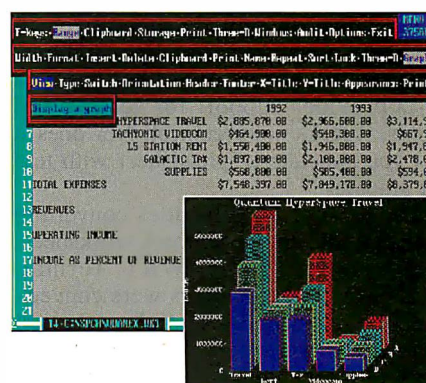
aesthetics or flexibility of the graphical spreadsheets such as Wingz and Excel. You can't edit graphics on screen nor place them in your spreadsheet. The program also lacks special annotation features. For the most part, you must build graphs manually, by cycling through various options and filling in the information required. After selecting a graph type, you invoke the Chart Data menu and fill in the ranges for each set of data in your chart. You can do this by simply typing in a range, such as B2:B6, or by pressing a function key and specifying a range using the cursor keys. Another menu option lets you select titles, axis labels, and legends. Formatting control includes color, fonts, point sizes, justification, and more. However, since you have to retreat to the View menu option to look at your results, it can get tedious if, after a few tries, the chart still doesn't look the way you think it should.

Control over publishing features is likewise hampered by the lack of a WYSIWYG interface. Report building follows the same process as graphing. You start

by selecting a destination for your report. Then, you define the range from the /Output,Printer,Range menu option, and select output options from the /Output,Printer,Options menu. You have complete control over margins, orientation, spacing, borders, as well as headers and footers. A preview option lets you check the output before you print it.

SuperCalc still is a contender, especially given its low price. However, it seems antiquated when compared against spreadsheets with desktop publishing capability. And its performance does not make up for this shortcoming. It finished dead last on the Mathmix benchmark, a test of basic mathematical calculations.

If you're looking for that special edge when producing reports from a spreadsheet, you won't get it from SuperCalc. At least not right now. Computer Associates International has a Windows version in the works, however. That edition should be more visual and intuitive than the DOS version, and if it's priced as low as SuperCalc, it will find a following as budget-conscious PC users migrate to Windows.



## LUCID 3-D 2.5 FOR DOS

Lucid 3-D 2.5 is unique among this crop of spreadsheet programs in that you can use it as a standard DOS program or as a TSR utility. The software comes in three segments: Lucid itself, a file-conversion utility, and a graphing utility. Once you load the graphing and file-conversion utilities into memory, you

## COMPANY INFORMATION

**Borland International**  
1800 Green Hills Rd.  
Scotts Valley, CA 95066  
(408) 438-8400  
fax: (408) 439-8050  
**Circle 1421 on Inquiry Card.**

**Claris Corp.**  
5201 Patrick Henry Dr.  
Santa Clara, CA 95052  
(408) 727-8227  
**Circle 1422 on Inquiry Card.**

**Computer Associates International, Inc.**  
711 Stewart Ave.  
Garden City, NY 11530  
(800) 645-3003  
fax: (516) 227-3927  
**Circle 1423 on Inquiry Card.**

**Informix Software, Inc.**  
4100 Bohannon Dr.  
Menlo Park, CA 94025  
(800) 331-1763  
fax: (415) 926-6593  
**Circle 1424 on Inquiry Card.**

**Lotus Development Corp.**  
55 Cambridge Pkwy.  
Cambridge, MA 02142  
(800) 343-5414  
**Circle 1425 on Inquiry Card.**

**Lucid Corp.**  
101 West Renner Rd.  
Dallas, TX 75082-2017  
(800) 967-5550  
fax: (214) 994-8103  
**Circle 1426 on Inquiry Card.**

**Microsoft Corp.**  
1 Microsoft Way  
Redmond, WA 98052  
(206) 882-8080  
fax: (206) 936-7329  
**Circle 1427 on Inquiry Card.**

can access them directly from the Lucid 3-D menu. Loading all three components of the package into memory consumes quite a bit of RAM, though. In one sample installation, we saw the number of bytes free plummet from 541,104 after DOS 5.0 was booted to 227,184 after all three program modules were loaded. (The order in which the programs are loaded is not important.) Lucid 3-D also provides the ability to unload the utilities, so you can free up memory when you are not using the product's advanced functions.

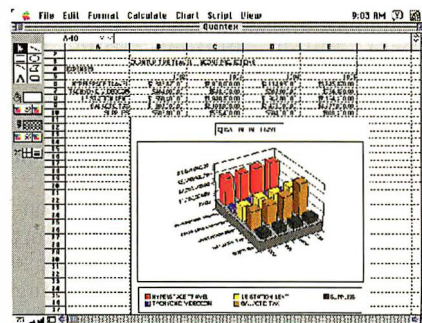
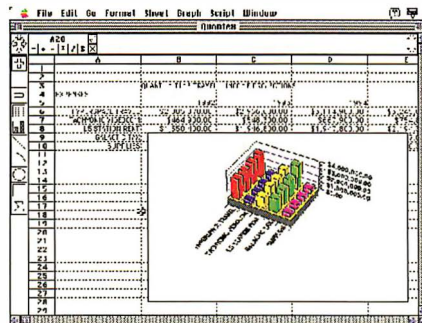
Creating our sample graph was simple: We just selected a range and then selected the Graph menu option. Lucid cannot create embedded graphs; it can only show a separate full-screen chart. It does, however, provide support for all common chart types: bar, line, 3-D, pie, area, scatter, and so on. Although Lucid 3-D provides support for scaling and fonts, it lacks color control. Nor does it let you annotate a spreadsheet with text or graphics.

Lucid 3-D had difficulties converting our example and benchmark worksheets from Lotus 1-2-3 WK1 format. Although all the numbers were converted, simple formulas and absolute cell references were not. We had to enter each of these in our worksheets manually. Lucid was the only spreadsheet we tested that had this difficulty. The single user's manual that comes with the package provided no clue to why we couldn't satisfactorily load and convert our WK1 worksheets.

Besides being a TSR, Lucid can lay claim to being one of the earliest spreadsheets to support 3-D linking. Although we are not focusing on this capability in here, it is an unusual feature to find in such an inexpensive program.

If you are looking for a presentation-

quality spreadsheet, Lucid 3-D is not a strong choice. However, if you typically work with small- to medium-size spreadsheets and need 3-D linking, then it is hard to beat Lucid 3-D for cost and performance.



ple, as well: Informix has licensed its basic Wingz product for the Macintosh to Claris Corp., which has incorporated it into a spreadsheet called Resolve. Because Resolve, Wingz for the Macintosh, and Wingz for Windows are essentially the same product, it is difficult to review them separately.

On any platform, Wingz is a consummate performer: Both the Macintosh and Windows versions were significantly faster than the competition for most operations. Unfortunately, however, Wingz does not perform minimal recalculation; it always recalculates the entire spreadsheet. Consequently, the other packages did better when only portions of spreadsheets required recalculation.

Although Wingz presents a uniform interface on all platforms, the Macintosh and Windows versions provide sufficient subtle changes to make each conform to the conventions of its environment. The one area for which this is not true is interactive help. Wingz provides a proprietary help system, and although this system is easy to use, it doesn't work as you'd initially expect a Macintosh or Windows help system to work. Of course, the up side to this is that folks who use Wingz on both platforms will have the pleasure of working with a consistent help system.

Wingz is a tried-and-true performer on the Macintosh. Although Informix hasn't updated the program since 1989, our experience indicates that this isn't a shortcoming: Nothing needs fixing. The package contains two spreadsheet versions: The first is a general 68000-based version; the other is optimized for the 68020. The 68020-specific version of Wingz ran flawlessly under System 7.0, even with full 32-bit addressing and virtual memory active. That qualifies it as System 7.0-compatible, but, as an older

## WINGZ 1.1A AND RESOLVE

### FOR THE MACINTOSH

Informix's Wingz presents a uniform user interface across several platforms: Macintosh, Microsoft Windows, OS/2 Presentation Manager, and OSF/Motif and OpenLook under Unix. It also offers a uniform scripting language that you can link to user-defined buttons and text fields. There is another interesting wrin-

program, it is not 7.0-aware. If you like Wingz but require System 7.0 features such as Publish and Subscribe, you should probably look at Resolve—Wingz' computational engine hooked to an updated interface—or Excel or the new Lotus 1-2-3 for Macintosh.

System 7.0-aware Resolve provides support for such advanced features as Publish and Subscribe and Bubble Help. Our benchmarks show that Resolve's throughput is comparable to Wingz', although Wingz always manages to win by a hair. Our decision to evaluate the 68020-specific version of Wingz may account for the slight speed difference.

One unique feature the three packages share is a pop-up window that appears when you move the scroll bars to navigate the spreadsheet. This window displays your position in the spreadsheet as you move the thumb of the scroll bar. If you frequently work with large spreadsheets, this feature alone makes any of the three programs worth the investment.

Generating the sample 3-D chart was slightly more intuitive in Resolve than in Wingz. That's because Claris has reduced the amount of information on

the screen by eliminating some icons from the icon palette and replacing them with menu commands. Differences also exist in regard to charting procedures, though these are largely superficial. Resolve displays the chart as soon as you select the Make Chart menu item. Wingz, on the other hand, requires you to select a location and size before you can display a chart. All three packages let you move and resize charts, however. Initial chart generation takes seconds, but you probably will spend 10 or 20 minutes fine-tuning the location of headings, labels, and ancillary text.

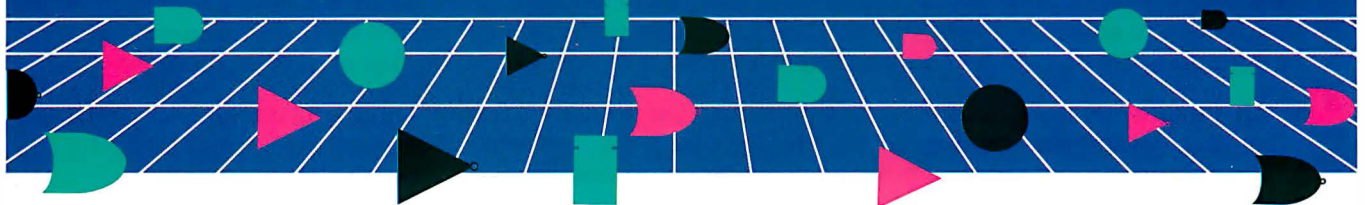
Drawing and labeling tools are available for annotating a chart with text, circles, boxes, lines, and arcs. However, you must use the Group option to associate the annotations with the chart. Otherwise, the added text and graphics will stay behind when you move the chart.

The three products support approximately two dozen chart styles, ranging from simple bar charts to sophisticated contour and polar graphs. Limited color support is provided; you can change the grid and base colors but do not have any control over the color of individual bars.

In addition to simple graphics and text annotation, Resolve and Wingz offer the ability to embed familiar control objects such as buttons, boxes containing text, and dialog boxes in a worksheet. Buttons allow you to construct an interactive interface to your spreadsheet. You may draw buttons anywhere on the spreadsheet and attach them to scripts. Dialog boxes may be used to retrieve information, which you then can incorporate into the spreadsheet. You may designate text boxes as locked or permit editing of the text, and you can do search and replace, check spelling, or add a scroll bar so that you can move around a text box more quickly. All these features taken together mean that you can create an interactive interface through which the user enters data and receives results, while the spreadsheet doing the calculations remains hidden from view.

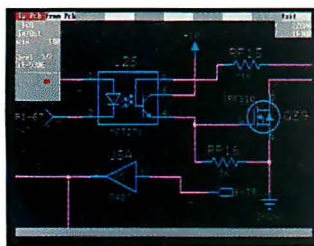
The programs' HyperCard-style scripting language, in addition to offering standard calculation and program control functions, can respond to events such as mouse clicks and movement, the opening of a new spreadsheet or the

## Totally Integrated Workstation Performance at a PC Price!

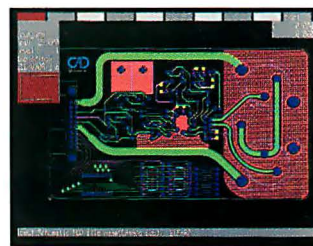
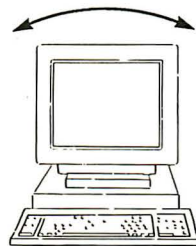


### PADS-Logic-2000 Schematic Capture System

32 Bit, virtual memory code



- Multi-sheet, design-oriented database
- Fast, graphical library browsing
- Top-Down hierarchy with back-annotation
- Automatic gate and pin Assignment
- Search and query functions across all sheets
- Context sensitive cursor for copy, move, delete
- On-line logic checking across entire database
- 1000 sheet schematic capability



### PADS-2000 Advanced PCB Design & Layout

32 bit, 1 micron database resolution

- ▲ Full SMT support both top & bottom
- ▲ Intelligent copper pour and edit
- ▲ Curved trace and polygon support
- ▲ Automatic thermal relief generator
- ▲ T-Routing and automatic track mitering
- ▲ Real-time checking with interactive routing
- ▲ Full design rules checking to +10 micron
- ▲ 32,000 IC design capability

**PADS PADS PADS PADS PADS PADS PADS**

119 Russell Street, Littleton, MA 01460 Tel: (508) 486-9521 Fax: (508) 486-8217 Toll Free: 1-800-255-7814

Software, Inc.



changing of an old one, and spreadsheet recalculation. One of the scripts included in the packages, for example, shows how to update a spreadsheet cell while the processor is idle. Other scripting features include the ability to create dialog boxes, respond to dialog boxes, and create new menu items.

Another of Wingz' helpful functions is its ability to call external functions written in languages such as C or Pascal. This allows Wingz to perform specialized, complex calculations and even interface with hardware data-acquisition systems.

Resolve requires 2 MB of disk space for a basic installation and 5 MB with examples. Wingz requires approximately 2 MB for a basic installation and another 630 KB for the program's tutorial and samples.

### Calculate Summary

In the DOS world, picking a spreadsheet has become a tough call. Quattro Pro and Lotus 1-2-3 release 2.3 are extraordinary packages; they do things on low-end machines with limited memory that most other software companies only dream of.

Both are highly graphical programs that prove you don't need a full-blown GUI to look good.

In the Windows realm, Excel, Lotus 1-2-3, and Wingz all take full advantage of the graphical environment and present you with an intuitive, attractive interface that masks complex operations. Wingz is appropriately named; when put to the test, it soars past Excel and Lotus 1-2-3. All three are strong contenders if you need a spreadsheet with one foot in the Windows environment and another in the Macintosh world.

In the Macintosh environment, Claris's Resolve is a hands-down winner for general performance and presentation capabilities. Its ease of use, price, and support for System 7.0-specific features put it ahead of the pack. Microsoft Excel simply cannot be beaten for features. If you need all the bells and whistles, access to external databases, and the ability to solve multivariable problems, then Excel is a must-have. The prize for the most graphical functions as well as the best performance goes to Wingz, an excellent product with a

steep learning curve. Wingz also merits consideration for its ability to run on Macs and Windows systems. Lotus 1-2-3 is the spreadsheet to have if you work in a shop that's committed to 1-2-3 on DOS machines but also has Macs; its cross-platform capabilities, particularly its file sharing prowess, gives it a significant edge.

While the competition in the spreadsheet market has resulted in better programs, it makes buying recommendations and decisions much more difficult. Gone are the days when you could just walk in and say, "Give me Lotus." Picking the right spreadsheet program is no longer as easy as 1-2-3. ■

*BYTE Lab editor Raymond GA Côté is continuing his 15-year love affair with computers as tools and toys. He has extensive experience as a software developer and designer of interpretive languages and user interfaces. David L. Edwards is a consulting editor for the BYTE Lab. You can reach them on BIX as "rgacote" and "dedwards," respectively.*

## DATA COMPRESSION LIBRARIES™

PKWARE's® Data Compression Libraries™ allow software developers to add data compression technology to software applications. The application program controls all the input and output of data allowing data to be compressed or extracted to or from any device or area of memory.

- All Purpose Data Compression Algorithm Compresses Ascii or Binary Data Quickly with similar compression achieved by the popular **PKZIP** software, however the format used by the compression routine is completely generic and not specific to the PKZIP file format.
- Application Controlled I/O and memory allocation for extreme flexibility.
- Adjustable Dictionary Size allows software to be fine tuned for Maximum Size or Speed.
- Approximately 35K memory needed for Compression, 12K memory needed for Extraction.
- Compatible with most popular Languages: C, C+, Pascal, Assembly, Basic, Clipper, Etc.
- Works with any 80x86 family CPU in real or protected mode. \$295.00
- No runtime royalties.

### RUNNING OUT OF EXPENSIVE DISK SPACE?

**PKZIP** can help! **PKZIP** compresses your files to free up disk space and reduce modem transfer time. You can compress a single file or entire directory structures with a single command. Compressed files can be quickly returned to their normal size with **PKUNZIP**.

Software developers can reduce the number of diskettes needed to distribute their product by using **PKZIP**. Call for Distribution License information.

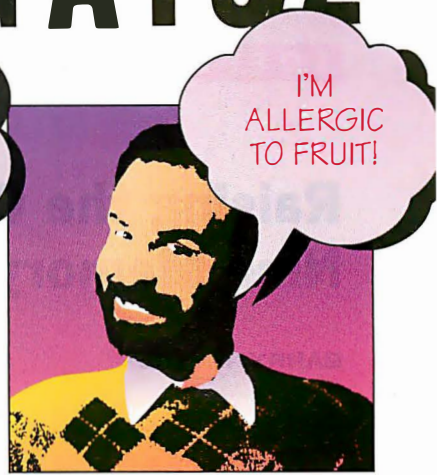
The included **PKZIP** utility lets you store compressed files as a single self-extracting .EXE files that automatically uncompresses when run. Only \$47.00



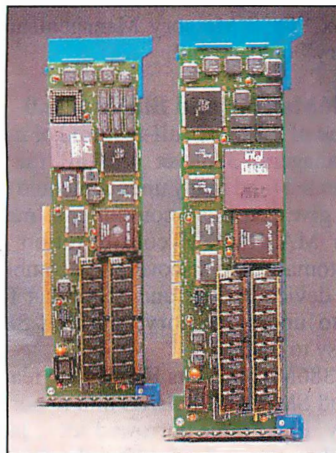
9025 N. Deerwood Dr.  
Brown Deer, WI 53223  
(414) 354-8699  
Fax (414) 354-8559



# THERE ARE LOTS OF GREAT REASONS FOR BUYING A PS/2



## ... But The Best Reason is the Aox MicroMASTER Compatible Upgrade to 386™ and 486™ Technology



If you bought your 16- or 32-bit PS/2 for its advanced bus architecture, congratulations... because now, Aox MicroMASTER cards let you upgrade all your original PS/2s to the processor and memory level you need today.

### A Fast, Reliable Way to 386 and 486 Performance and Compatibility

The MicroMASTER 386 and MicroMASTER 486 are BUS MASTER adapter cards that simply plug into any slot of a MicroChannel-based PS/2. The MicroMASTER takes control of the bus and turns your 286- or 386-based system into a 386- or 486-based powerhouse!

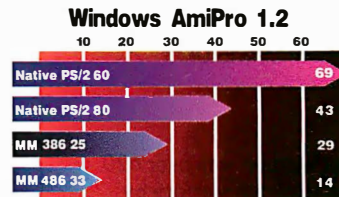
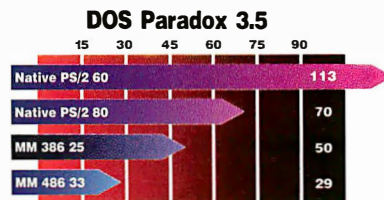
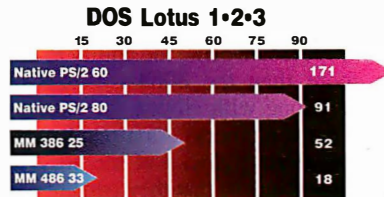
Your new 32-bit architecture opens up a new window to DOS 5.0™, OS/2™, Windows 3.0™, DESQview 386™, and UNIX™ to name a few. And the MicroMASTER has more than enough power to serve as your platform for office automation, database management, file server applications and software development.

### Features of the MicroMASTER:

- ▶ Easy one-step installation—no chips to pull or drivers to install
- ▶ Supports up to 16MB of 32-bit memory on board
- ▶ Runs new generation 80386-based operating systems and applications
- ▶ Compatible with IBM PS/2 models 50, 50z, 55SX, 60, 65, 70, 80, 90 and 95

For further information on the Aox MicroMASTER 386, 486 or our other fine upgrade products, call us toll-free at:

**1•800•232•1269**



Benchmarks shown in these charts are based on real world applications, taking into account CPU, memory, disk, and video performance. Smaller numbers indicate higher performance.

# Aox MicroMASTER

486 Totten Pond Road, Waltham, Massachusetts 02154 (617) 890-4402 FAX: (617) 890-8445

**The High-Performance BUS MASTER That Upgrades Your PS/2 to 386 or 486 Power.**

All products are registered trademarks or trademarks of their respective holders. The Intel Inside Logo is a trademark of Intel Corporation.

**SOFTWARE**

# Raising the Ceiling: Nine Memory Managers for Today's Processors

**BARRY NANCE**

The PCs of today are generally burdened with stacks of TSR utilities, drivers for nonstandard devices, and links to other systems through network software. These all take up memory, and, traditionally, they're shoe-horned into that 10-year-old bugaboo, the 640-KB DOS application area.

New processors bring the ability to address more than the 8088's 1 MB of memory, along with silicon for *managing* that extra memory. As a result, you can move around blocks of memory in the address space so that they can appear anywhere, in any order. By deftly moving memory around, it's possible to move

TSRs, drivers, and other resident software out of the 640-KB space, freeing more memory for DOS applications.

In this review, I'll examine nine utilities that tap into the memory management features of 286, 386, and 486 processors, and some specialized memory management chips, to give DOS applications more room. In addition, I found two inexpensive shareware memory managers that may be just right for you (see the text box "The Shareware Side" on page 244). If you're running DOS on a late-model PC that has some extra memory, you should probably use one of these programs.

SMARTIPX is 192 KB but whittles itself down to 9 KB of resident code—a good test for these memory managers.

If you're not familiar with the standards, acronyms, and buzzwords associated with DOS memory managers, you'll want to scan the definitions in the text box "DOS Memory Management Glossary" on page 242.

### 386Max 6.0 and BlueMax 6.0

One of the most full-featured of memory managers, 386Max uses all the documented (and many undocumented) tricks to give you more conventional memory. Its MAXIMIZE configuration utility automatically discovers the combination of device drivers and TSRs that fit best into upper memory, making 386Max easy to install.

386Max used its FlexFrame feature to load SMARTIPX.EXE into upper memory. FlexFrame borrowed some memory and temporarily disabled the EMS page frame to load the 192-KB executable file. Once SMARTIPX shrank to its 9-KB resident size, 386Max returned the unused memory to its previous state. DOS 5.0 by itself couldn't load SMARTIPX into upper memory.

Included with 386Max is ASQ, a computer configuration and memory-usage analysis program. You can use ASQ if you're curious about your computer; you don't need it for the normal operation of 386Max.

Of the utilities I evaluated, 386Max provides the most types of interfaces to expanded and extended memory. With 386Max, you get support for EMS 4.0, Extended Memory Specification (XMS), Virtual Control Program Interface (VCPI), DOS Protected Mode Interface (DPMI), and Virtual Direct Memory

## BYTE ACTION SUMMARY

### ■ WHAT DOS MEMORY MANAGERS DO

Memory managers use the advanced capabilities of late-model Intel CPUs to make more memory available to DOS applications.

### ■ LIKES

You often wind up with over 620 KB of conventional memory by using one of these products, even with bulky LAN drivers installed.

### ■ DISLIKES

Memory managers can be difficult to configure.

### ■ RECOMMENDATIONS

Use 386Max (or BlueMax, if you have a PS/2).

### The Test-Bed

The nine memory managers I put under the microscope are 386Max 6.0 and BlueMax 6.0 from Qualitas, QEMM-386 6.0 from Quarterdeck Office Systems, Dynamic Memory Control 3.0 from Adlersparre & Associates, Memory Commander 2.11 from V Communications, Maximizer 3.3 from SoftNet Communication, NetRoom 2.01 from Helix Software, and QMAPS 2.0 and UMB Pro 2.0 from Quadtel.

To test these products, I used several computers in a variety of configurations. Two notebook computers took part: a Bitwise Designs 33-MHz 386 and CompuAdd's Companion SX, a 20-MHz 386SX. Both had 4 MB of RAM and ran DOS 5.0. The desktop units in the test were a Gateway 2000 386/33 with 16 MB of RAM, an IBM PS/2 Model 70 with 6 MB of RAM, and an IBM PS/2 Model 80 with 5 MB of RAM. I put all the machines on a NetWare LAN. I used Xircom Pocket Token Ring adapters with Xircom's SMARTIPX.EXE on the Bitwise and CompuAdd notebook systems;

## DOS MEMORY MANAGER FEATURES

*Of the 11 memory managers tested, only three—386Max, BlueMax, and QEMM-386—can have TSRs larger than available memory and automatically allocate TSRs. (● = yes; ○ = no; N/A = not applicable; NS = no support.)*

	386Max 6.0	BlueMax 6.0	QEMM-386 6.0	Dynamic Memory Control 3.0	Memory Commander 2.11	Maximizer 3.3	NetRoom 2.01	QMAPS 2.0	UMB Pro 2.0	CTMAP 0.98	VRAM/386 and HRAM 1.0
<b>Price</b>	\$130	\$155	\$99.95	\$79.95	\$99.95	\$49.95	\$99	\$129.95	\$89.95	\$30	\$35
<b>Works with DOS 5.0</b>	●	●	●	●	●	●	●	●	●	●	●
<b>Works with Windows</b>	●	●	●	●	●	●	●	●	●	●	●
<b>Can instance TSRs</b>	●	●	○	○	●	●	○	○	○	○	○
<b>Minimum RAM required</b>	1 KB	1 KB	2KB	22 KB	3KB	64 KB	4 KB	2 KB	8 KB	0 KB	15 KB
<b>Maximum RAM manageable</b>											
EMS	32 MB	32 MB	>32 MB	N/A	15 MB	NS	32 MB	32 MB	NS	NS	32 MB
XMS	4 GB	4 GB	64 MB	N/A	15 MB	NS	32 MB	64 MB	NS	NS	32 MB
<b>Drivers and TSRs in upper memory</b>	●	●	●	N/A	●	●	●	●	●	●	●
<b>TSRs larger than available memory</b>	●	●	●	○	○	○	○	○	○	○	○
<b>Unloads drivers, TSRs</b>	○	○	○	●	○	○	○	○	○	○	○
<b>Automatic TSR allocation</b>	●	●	●	N/A	○	○	○	○	○	○	○
<b>Memory mapper software</b>	●	●	●	●	●	●	●	●	●	○	●
<b>CPU types</b>	1, 2	1, 2	1, 2	Any	1	1, 2	1, 2	1	1, 2	2	1

1 = 386, 486

2 = Chips & Technologies 82C212 NEAT, 82C235 SCAT, or 82C302 or 82C307 Chipset DRAM controller.

Access Services (VDS). In addition, 386Max supports the instancing of TSRs in DOS sessions under 386 enhanced-mode Windows. Instancing lets you run multiple copies of a TSR or driver in different DOS sessions.

If you have a 386-based IBM PS/2, IBM supplied you with extra ROM BIOS code that can operate in protected mode. Under DOS, you don't need it. A separate Qualitas product, BlueMax, is a special version of 386Max that remaps the ROM BIOS memory and gives you another 84 KB of upper memory.

### QEMM-386 6.0

QEMM-386 is another full-featured memory manager. Its OPTIMIZE function automatically analyzes your computer's configuration and memory and tells QEMM-386 where best to put your device drivers and TSRs. If you have 10 TSRs and device drivers of varying sizes and want to configure by hand, you'll find there are 3,628,800 combinations to try. Better let OPTIMIZE do the work.

The dynamic management scheme that 386Max calls FlexFrame has a QEMM-386 equivalent named Squeeze. Squeeze allows QEMM-386, like 386-

Max, to bring honor to itself by loading the 192-KB SMARTIPX TSR into upper memory.

QEMM's computer and memory analysis software, MANIFEST, is more complete than ASQ. As with ASQ, you probably won't need MANIFEST in the normal course of operating QEMM.

QEMM provides EMS, XMS, VCPI, and VDS support, although not DPMI. QEMM can also remap ROM BIOS memory with what it calls Stealth technology. On a PS/2 with no network card installed, QEMM typically gives you an extra 96 KB of upper memory; on a Compaq 20e, it can give you 136 KB of upper memory to use.

QEMM is compatible with Windows 3.x, but it can't instance TSRs in a DOS session. Like 386Max, QEMM specially recognizes NEAT or SCAT chip sets from Chips & Technologies and makes use of their unique memory management functions.

### Dynamic Memory Control 3.0

Dynamic Memory Control (DMC) is an add-on for products like QEMM and 386Max, not a competitor. With DMC, you can unload device drivers and TSRs

from memory and then load new ones without rebooting.

You can use DMC on device drivers and TSRs loaded in conventional memory as well as upper memory. You may already be familiar with the public-domain MARK/RELEASE utilities, which became popular when people first began using TSRs. DMC goes several steps further, letting you manage TSRs in upper memory and letting you load and unload device drivers from the DOS command line. I used DMC to unload IBM's LAN Support Program device drivers and replace them with Locus Computing's PC Interface device drivers so that I could switch from NetWare to PC Interface on a Token Ring LAN without rebooting.

### Memory Commander 2.11

Other memory managers can provide more than 640 KB of conventional DOS memory—up to over 700 KB worth—but Memory Commander goes further. Depending on your computer's configuration, Memory Commander can give you up to 952 KB of conventional memory in which to run DOS applications. But the catches are numerous: You must use a monochrome display adapter, you can't

# DOS Memory Management Glossary

**conventional memory** The memory that's directly addressable by an Intel CPU in real mode. The upper boundary is normally the infamous 640-KB limit, but some memory managers raise that.

**DOS Protected Mode Interface (DPMI)** Developed by Microsoft, DPMI offers functions similar to VCPI but enforces control over extended memory access.

**expanded memory** Invented jointly by Lotus, Intel, and Microsoft, expanded memory lets an application bank-switch RAM, in 16-KB blocks, from an Expanded Memory Specification memory card into conventional or upper memory. Version 4.0 of EMS is the most recent. On 386 and 486 machines, memory managers can trans-

form extended memory into expanded memory.

**extended memory** Memory that is above the 1-MB threshold, addressable only in protected mode.

**Extended Memory Specification (XMS)** Also developed by Lotus, Intel, and Microsoft, this standard provides a rudimentary means for DOS applications to use portions of extended memory.

**high memory area (HMA)** The first 64 KB of extended memory, minus 16 bytes, beginning at the 1-MB threshold. Through a quirk in the design of the 286, 386, and 486 CPU chips, it is possible to address these 65,520 bytes in real mode.

**upper memory** The memory between 640 KB and 1 MB. Video adapters, ROM BIOS chips, hard drive controller ROMs, and network adapters live in this region, but there are "holes"—upper memory blocks—that some memory managers can map as conventional memory.

**Virtual Control Program Interface (VCPI) memory** Quarterdeck Office Systems and Phar Lap Software developed the VCPI standard to let DOS applications cooperatively share extended memory without conflict.

**Virtual Direct Memory Access Services (VDS)** Another Microsoft standard, VDS lets a memory manager and a computer's hardware components share the use of the DMA controller.

load a lot of TSRs and device drivers into upper memory, you can't access EMS memory, you can't use Windows, and you can't have an adapter card whose memory address overlaps the 952-KB area. If you can live with these restrictions, then you can have 952 KB of conventional memory. On a VGA-equipped computer, you can get up to 920 KB if you don't use graphical applications, and up to 800 KB if you do use graphics.

Memory Commander shifts and remaps video display adapter memory, on the fly, as you use your computer. This memory is normally located just above the 640-KB boundary. Memory Commander maintains a list of applications internally, so it knows which video mode is appropriate for an application.

Besides offering more conventional memory, Memory Commander has many of the same features as the other memory managers. It supports EMS 4.0, XMS, VCPI, and VDS; it loads device drivers and TSRs into upper memory; and it can instance TSRs within a Windows 3.x DOS session. However, Memory Commander was unable to load SMARTIPX into upper memory.

## Maximizer 3.3

If all you want to do is manage upper memory, and if you don't mind a little

manual effort to help Maximizer find and use upper memory blocks, Maximizer is a less expensive alternative to the other memory manager products. During installation, you give Maximizer commands (op codes) to tell it which areas in upper memory to use.

Maximizer can load device drivers and TSRs into upper memory, and it can make more than 640 KB available to your DOS applications. It couldn't load SMARTIPX into upper memory, and it won't give you EMS 4.0, XMS, VCPI, VDS, or DPMI memory. But it works with Windows and DOS 5.0, and it lets you instance device drivers and TSRs within an enhanced-mode DOS session.

## NetRoom 2.01

Its name suggests that it works only on LANs. Actually, you can use NetRoom just like the other 386-based memory managers to load even nonnetwork drivers and TSRs into high memory. NetRoom uses the special capabilities of the 386 CPU chip to remap upper memory and to provide EMS 4.0 and XMS support. It does not, however, offer VCPI, VDS, or DPMI support. It, too, failed to load SMARTIPX into upper memory.

The installation procedure is somewhat more automatic than Maximizer's, but it is not nearly as easy to use or as

transparent as that of QEMM-386 or 386Max. NetRoom's DISCOVER program includes a text editor for making modifications to your CONFIG.SYS and AUTOEXEC.BAT files.

NetRoom's strength is the extent to which the documentation describes how to set up NetRoom for particular LAN environments, including NetWare, Banyan Vines, LAN Manager, 3Com+, PC LAN Program, and LANtastic. Like 386Max and QEMM, NetRoom specially recognizes Chips & Technologies' NEAT or SCAT chip sets and makes use of their memory management functions.

## QMAPS 2.0 and UMB Pro 2.0

QMAPS stands for Quadtel Memory Allocation and Paging System; UMB Pro refers, of course, to Upper Memory Blocks. QMAPS is an EMS 4.0 memory manager that uses EMS to load device drivers and TSRs into upper memory.

QMAPS isn't as full-featured as 386Max or QEMM, but it supports more memory specifications than NetRoom or Maximizer: EMS 4.0, XMS, VCPI, and VDS. QMAPS cannot instance device drivers or TSRs within a Windows DOS session, but it is compatible with Windows 3.x and DOS 5.0.

Installing QMAPS is not quite as "hands-on" an operation as installing

# When You Think 387, Think Faster.

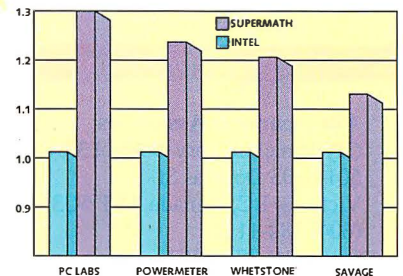
## Introducing The Price Performance Leader In Math Coprocessors.

The benefits of our new SuperMath™ coprocessors are very easy to understand:

- ▶ Faster execution of software packages such as Lotus 1-2-3, Microsoft Excel, and AutoCad 386
- ▶ Plug-in compatible and software compatible with industry standard 387DX and 387SX coprocessors
- ▶ Up to 600% better performance at the instruction level
- ▶ Perfect system companion to industry compatible 80386 CPUs – including CHIPS' own Super386™
- ▶ CMOS processing and on-chip power management circuitry dramatically reduce power consumption

### SuperMath Coprocessor

PART NO.	PKG.	PIN-OUT
38700SX	68-pin PLCC	Pin-Compatible
38700DX	68-pin CPGA	Pin-Compatible



For more information on our SuperMath coprocessors, call (800) 944-MATH.

**SuperMath Coprocessors. The fastest way to improve your system.**



**Opening The Future Of Microprocessing.**

# The Shareware Side

**C**TMAP 0.98 from Burton Systems Software is a shareware memory manager for computers using a Chips & Technologies chip set. At only \$30, it's a steal.

If you are using a 286, 386, or 386SX computer that includes a Chips & Technologies 82C212 NEAT chip set, an 82C235 SCAT chip, or an 82C302 or 82C307 Chipset DRAM controller chip, CTMAP knows how to rearrange and manage memory so you get up to 944 KB of conventional memory. If you have EGA or VGA but don't use graphics, CTMAP extends the 640-KB ceiling upward to 704 KB or 736 KB. By mapping up to 240 KB of discontinuous upper memory space, CTMAP lets DOS have even more memory. However, some software can't use discontinuous RAM.

The CTMAP memory manager doesn't put the CPU in protected mode, and it doesn't install a TSR program or device driver, which makes it highly compatible with protected-mode soft-

ware. It even works in the DOS boxes of versions 1.2 and 1.3 of OS/2.

## VRAM/386 and HRAM 1.0

Beginning with version 1.05, Biologic turned VRAM/386 and the companion HRAM into a commercial product. Still, the shareware version 1.0 is quite capable and reasonably priced at \$35.

VRAM/386 uses the same memory-mapping techniques as the other 386-based products in this review. It converts extended memory into expanded memory, following the EMS 4.0 specification, and it can raise the 640-KB ceiling by 96 KB if you're not using VGA. VRAM and HRAM can manage up to 208 KB of upper memory for relocating TSRs and device drivers. HRAM manages upper memory blocks. One drawback to VRAM is that you must use its CHKMEM utility to find out what blocks of upper memory are available and manually tell VRAM about them. VRAM is compatible with Windows and supports the VCPI standard.

Maximizer, but you will need to figure out where you want to put things in memory. A menu-driven configuration utility will help you. And QMAPS offers up to 28 standard configurations from which you can select at installation time.

UMB Pro, also from Quadtel, is much like Maximizer—it manages upper memory blocks so you can load drivers and TSRs high, but it doesn't give you EMS 4.0, XMS, VCPI, VDS, or DPMI memory. However, it does work with Windows 3.x and DOS 5.0. Neither QMAPS nor UMB Pro managed to load SMART-IPX into upper memory.

## Still a Necessity

The best of these programs is 386Max (or BlueMax for a PS/2). It's so easy to use and offers such significant benefits that it should be part of every 386 and 486 DOS system.

The trend toward protected-mode and Windows-native applications may well eliminate the need for memory managers one day. But as long as I have pet programs that *must* run in that all-important first megabyte of memory, I will continue to depend on memory managers. ■

*Barry Nance is a consulting editor for BYTE. He manages a 70-node NetWare LAN and is the editor of the IBM Exchange and moderator of the lans conference on BIX, where you can reach him as "barryn."*

## COMPANY INFORMATION

**Adlersparre & Associates**  
(Dynamic Memory Control 3.0)  
501-1803 Douglas St.  
Victoria, BC, Canada V8T 5C3  
(604) 384-1118  
fax: (604) 384-3363  
**Circle 1231 on Inquiry Card.**

**Biologic Corp.**  
(VRAM/386 and HRAM 1.0)  
P.O. Box 1267  
Manassas, VA 22110  
(703) 368-2949  
fax: (703) 361-8251  
**Circle 1232 on Inquiry Card.**

**Burton Systems Software, Inc.**  
(CTMAP 0.98)  
P.O. Box 4156  
Cary, NC 27519  
(919) 233-8128  
fax: (919) 233-0716  
**Circle 1233 on Inquiry Card.**

**Helix Software**  
(NetRoom 2.01)  
47-09 30th St.  
Long Island City, NY 11101  
(800) 451-0551  
fax: (718) 392-4212  
**Circle 1234 on Inquiry Card.**

**Quadtel Corp.**  
(QMAPS 2.0, UMB Pro 2.0)  
3190-J Airport Loop Dr.  
Costa Mesa, CA 92626  
(714) 754-4422  
fax: (714) 754-4426  
**Circle 1235 on Inquiry Card.**

**Qualitas, Inc.**  
(386Max 6.0, BlueMax 6.0)  
7101 Wisconsin Ave., Suite 1386  
Bethesda, MD 20814  
(800) 733-1377  
(301) 907-6700  
fax: (301) 907-0905  
**Circle 1236 on Inquiry Card.**

**Quarterdeck Office Systems**  
(QEMM-386 6.0)  
150 Pico Blvd.  
Santa Monica, CA 90405  
(213) 392-9851  
fax: (213) 314-4219  
**Circle 1237 on Inquiry Card.**

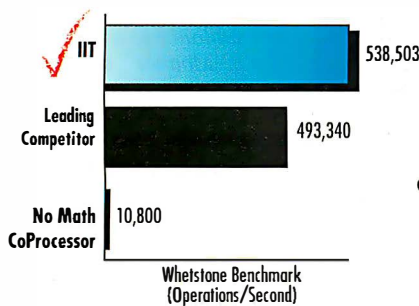
**SoftNet Communication, Inc.**  
(Maximizer 3.3)  
11 Hillcrest Dr.  
Great Neck, NY 11021  
(212) 956-2390  
**Circle 1238 on Inquiry Card.**

**V Communications**  
(Memory Commander 2.11)  
4320 Stevens Creek Blvd.,  
Suite 275  
San Jose, CA 95129  
(408) 296-4224  
fax: (408) 296-4441  
**Circle 1239 on Inquiry Card.**

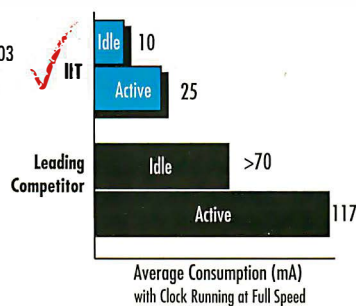
# WHEN IT COMES TO MATH COPROCESSORS THE CHOICE IS SIMPLE!



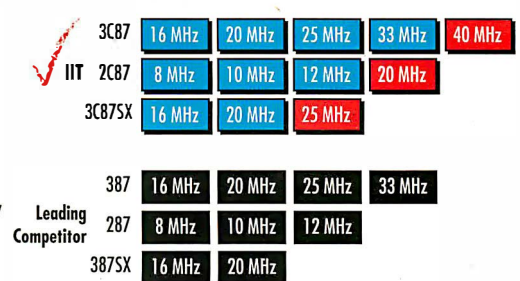
## HIGH PERFORMANCE



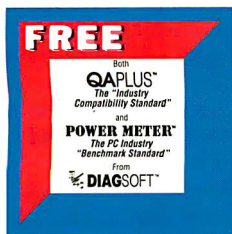
## LOW POWER CONSUMPTION



## HIGHEST SPEED GRADES



## VALUE



- ✓ Guaranteed 100% Compatibility with all 286, 386 and 386SX systems
- ✓ Warranted For the Lifetime of Your System
- ✓ Free QAPLUS and POWERMETER Software

Call now for more information  
800-832-0770  
408-727-1885

Test results obtained on a 20 MHz 386SX system.

The IIT logo is a trademark of Integrated Information Technology, Inc. (IIT). QAPLUS and POWERMETER are trademarks of DiagSoft, Inc. All other trademarks are of their respective companies. ©1991 IIT. All rights reserved.



## SOFTWARE

# NetWare Grows Lean, Not Mean

**BARRY NANCE**

While Novell's NetWare and Microsoft's LAN Manager slugged it out for dominance on the network-operating-system high ground, the peer LAN arena heated up with a competition of its own. The result was a group of tailored products that suit small workgroups for whom server-based NetWare is too expensive.

Recently, Novell introduced its own peer-to-peer LAN operating system, NetWare Lite. Like most other peer LAN products, NetWare Lite is DOS-based, so you don't need to purchase a separate computer to act as a file server. Smaller workgroups can cost-justify a NetWare Lite LAN (\$99 per node for the software) in situations where NetWare 2.2 (\$895 for five users, \$1995 for 10 users—not to mention the cost of a file server) is not in the budget.

Last November, I reviewed five peer-to-peer LANs ("Peer LANs Offer a Low-Cost Network Alternative," November 1991 BYTE). Just about the time that issue hit the newsstands, Novell began selling NetWare Lite. This month I put NetWare Lite 1.0 through the same paces as the other products, using the same criteria: reliability, ease of use, price, security, features, and performance.

### Network Trials

I ran a set of LAN-based test suites to determine NetWare Lite's reliability, application compatibility, performance, and peer-to-peer communications capability. The reliability test concurrently copies 1000 files totaling 15 MB between several machines to test for file errors under load. NetWare Lite passed this test without incident. As with the other peer LAN products, you can trust Lite with your data.

The compatibility suite checks for LAN-operating-system compliance with DOS file-sharing conventions. All DOS applications issue DOS function calls to

**Screen 1: A NetWare Lite menu option displays drive mappings. Here, drives E through I are Lite drives, while drive N is a NetWare 3.11 file server.**

NetWare Lite NEI Utility 1.0  
Logged in to the network

Main Menu  
Communicate with  
Display your use  
Map drive letter  
Print  
Set your password  
Supervise the ne

Drive Network Directory Server Your Rights

A:				
B:				
C:				
D:				
E:	CDRIVE	IBMAT		ALL
F:	CDRIVE	ATRONICS		ALL
G:	DDRIVE	ATRONICS		ALL
H:	CDRIVE	GATEWAY		ALL
I:	HARDISK	GATEWAY		ALL
J:				
K:				
L:				
M:				
N:				(NATIVE NETWORK)

Status for Server

Server up-time	0 Days	0 Hours	0 Minut
Server version	v 1.00		
Server address	000000000015	CFG	PEAK
Network auditing	Off	Connections	4 2 2
SHARE running	Yes	Client tasks	10 2 1
Server memory size	65,160	Open files	40 1 0
	COM	Num net directories	4 2
		Num net printers	1 0
Server-busy packets	2	Print buffer size	512
Server cache hits	43%	Receive buffers	3
Packets received	184	Receive buffer size	4,096
Bad packets received	30	Num read buffers	3
Watchdog terminations	0	Read buffer size	4,096

F1-help Esc-go back Enter-map drive letter Del-delete F1

**Screen 2: The Lite server status screen bears a strong resemblance to a NetWare 3.11 "Monitor" screen.**

perform LAN file I/O. Certain functions (e.g., create file, change directory, and delete file) should behave exactly the same on a LAN as they do on a local disk. Other functions (e.g., open file, read file, write file, and lock record) operate differently on a file server so that multiple users of an application can share, or not share, files as necessary.

As I mentioned in November, a LAN operating system that passes these tests implements the specifications correctly, and it should work fine with Paradox, dBase, FoxPro, WordPerfect Office, and other DOS-based applications. NetWare Lite passed the DOS file-sharing test suite but didn't achieve a perfect score. I found that two workstations that attempted to open the same file in compatibility mode (as described in the IBM *DOS Technical Reference*) were both able to open the same file under NetWare Lite. With the other peer LAN products, as with server-based NetWare 2.2 and 3.11, the second workstation's open attempt failed, as it should. The error is a small one, and it probably won't affect your applications if you buy NetWare Lite.

The performance suite determines the

LAN operating system's network file I/O performance by reading and writing files of random sizes. PowerLAN won the race last November; it proved itself a second time by outdistancing NetWare Lite (see the benchmark graph). For this test, I used a LAN whose topology is based on Thomas Conrad's 100-Mbps fiber optics-based TCNS, with 33-MHz 486 ALR PowerPro and 33-MHz 386 Gateway 2000 computers as peer servers/workstations. Certainly, with 100-Mbps fiber optics and fast workstations such as these, the hardware was not a limiting factor.

I set up a 32-KB RAM cache with DOS 5.0's SMARTDRV.SYS, and I rebooted all the computers prior to each test. I asked a Novell spokesperson why NetWare Lite was slower, and he told me that it's designed for simple operation and ease of use, not speed. Fair enough.

The final suite tests PC-to-PC communications using both NetBIOS and IPX programming techniques. Third-party LAN utilities, remote control, and some E-mail packages use these protocols to talk PC-to-PC. NetWare Lite passed the tests in this category with fly-



ing colors, and it is the only peer LAN operating system that provides *both* IPX and NetBIOS protocols.

### Easy to Install

Easy installation, ease of use, and simplicity are NetWare Lite's hallmarks. The manual gets high marks for readability. I would almost suggest that you get a copy of NetWare Lite just to read the manual—it's the best introduction to networks I've ever seen. The manual uses a series of railroad metaphors to explain LAN basics, making difficult concepts clear with its illustrations. The on-line help facility is similarly clear and comprehensive.

You share directories and printers on each designated server with simple commands or with NetWare Lite's menuing system (see screens 1 and 2). The menus are clear, direct, and virtually foolproof. NetWare Lite is compatible with Microsoft Windows, although you must specify "no network" or "MS/Network compatible" instead of the usual "NetWare network" setup option.

NetWare Lite interoperates with its bigger brothers, NetWare 2.2 and 3.11. You simply run NETX.COM in addition to the NetWare Lite software and then log into the server as usual. NetWare Lite comes with Open Data Link Interface drivers for a variety of network adapters, and it works with any adapter that supplies an ODI driver.

NetWare Lite supports up to 25 users, somewhat less than other peer LAN products. There is no technical reason it couldn't support more users, but Novell

probably prefers that you'll switch to regular NetWare when your LAN grows to 25 users. NetWare Lite will not recognize an uninterruptible power supply. It can, if you wish, let you share a CD-ROM drive across the network. NetWare Lite does not support remote boot; each workstation must have a floppy or hard drive from which to run the software.

If you press Ctrl-Alt-Del at a server, NetWare Lite asks you if you are sure you want to reboot the computer. If you go ahead and reboot the server, workstations can reconnect, but only by answering "Retry" to the DOS "Abort, Retry, Ignore?" message. When I asked Novell about this, a spokesperson said that the company would think about making the reconnection process friendlier and more automatic in a future release.

Printing to a shared printer is easy with NetWare Lite. At a workstation, you use a NET CAPTURE command much like the one you'd use with regular NetWare to redirect printouts to a remote printer. You can specify whether you want a banner page (job separator page) printed, the number of copies to print, whether a formfeed should automatically be inserted into the print stream by NetWare Lite, the amount of idle time NetWare Lite should use to detect the end of the print operation (in case the application doesn't actually close the LPTx device when it's done printing), the setup string NetWare Lite should use as a prefix to the print material, and other print parameters. You can view and change the print queue; NetWare Lite displays job number, user, job name, and job status

## BYTE ACTION SUMMARY

### WHAT NETWARE LITE DOES

NetWare Lite lets PCs share each other's hard disks and printers as equals, without your having to use a separate file server.

### LIKES

NetWare Lite is the easiest peer LAN to install, use, and manage. It operates well by itself or as part of a larger NetWare 2.2 or 3.11 LAN.

### DISLIKES

Performance will become an issue as your LAN grows. Reconnecting to a rebooted server isn't automatic.

### RECOMMENDATIONS

If you're new to networking, or want to have a peer LAN within a larger NetWare LAN, get NetWare Lite.

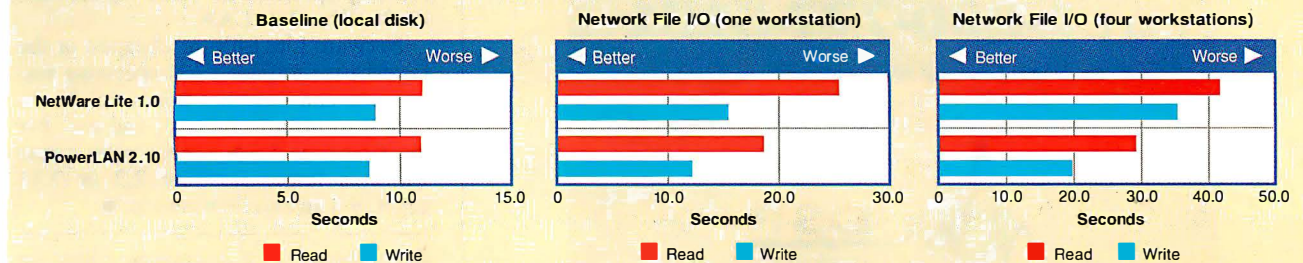
### PRICE

\$99 per node

### FOR MORE INFORMATION

Novell, Inc.  
122 East 1700 South  
Provo, UT 84606  
(800) 346-7177  
(801) 429-5900  
Circle 1225 on Inquiry Card.

## BYTE PEER-LAN BENCHMARKS

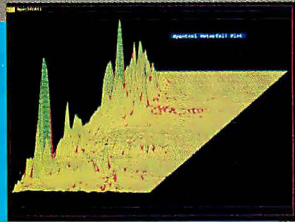


NetWare Lite is fast, but not fastest. PowerLAN, the fastest peer LAN BYTE has tested, outran NetWare Lite on our tests. NetWare Lite's score of about two-thirds the speed of PowerLAN makes it about average among peer LANs we benchmarked in November.

# DADiSP 3.0

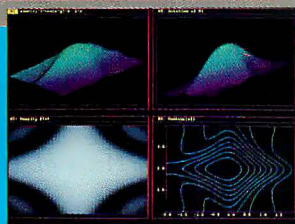
for

## Scientific Data Analysis



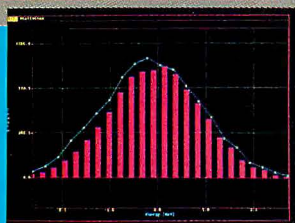
### Engineering

Signal Processing & FFTs  
Filter Design  
Speech/Communications  
Sonar & Radar  
Electronics Design  
Mechanical Test  
Vibration Analysis



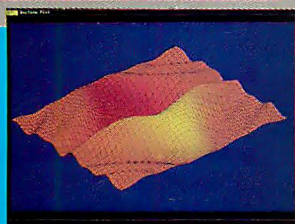
### Image Processing

Medical Imaging  
Satellite  
Seismology  
Terrain Rendering  
Communications



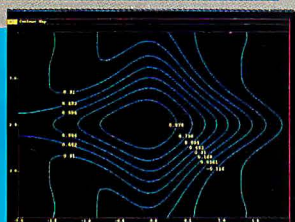
### Lab Automation

Data Acquisition  
IEEE-488  
Test & Measurement  
Process Control  
Quality Improvement  
Manufacturing Test



### Science

Statistics  
Experimental Design  
Hypothesis Testing  
Peak Analysis  
Chemistry  
Medical Research  
Quality Management

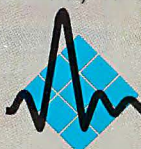


### Matrix Processing

Inverse/Transpose  
Eigen Values & Vectors  
Matrix Math  
2D FFTs and convolutions  
3D and 4D Graphic Displays  
Operations Research

**CALL 1-800-777-5151**

for your free DADiSP Trial Kit. DADiSP is available for SUN, HP, IBM, NeXT, DEC, Concurrent, and Silicon Graphics workstations, and of course, IBM PC compatibles.



**DSP**  
Development  
Corporation

One Kendall Square, Cambridge, MA 02139,  
617-577-1133, FAX: 617-577-8211

## NETWARE GROWS LEAN, NOT MEAN

so you can check on your printout.

Your data is as secure with NetWare Lite as with regular NetWare. For each user, you can enable/disable the account, grant or revoke supervisor (management) privileges, require passwords, set the minimum number of characters and expiration date of the password, and of course delete accounts. For each directory, you can specify default access rights and single out those users who should have nondefault access rights.

NetWare Lite is copy-protected, but there are no laser holes burned into the distribution disks. Instead, when you start NetWare Lite at a workstation, it communicates with the other workstations to see if that same instance of the software is already running at another workstation. If software has to be copy protected, this is the way to do it—a network-based scheme is the least intrusive and easiest to administer.

For technical support, Novell offers several options. You can fax your inquiries to Novell, use the NetWare forum on CompuServe, ask your dealer to answer your questions, or use Novell's new 900 support number.

### Less Filling...

Novell programmers tried to make NetWare Lite take up as little memory as possible. I found that the various NetWare Lite modules took a total of 96.8 KB on a server machine: 13.8 KB of adapter support software (including IPX), 13 KB of client software, 63 KB of server software, and 6 KB of SHARE .EXE. On a nonpeer, client-only workstation, NetWare Lite uses only 26.8 KB of RAM.

DOS 5.0 by itself can load all but the server module into high RAM. QEMM or 386Max can load all the modules, including the server code, into high RAM on a 386 computer. Using QEMM, and with DOS 5.0 loaded high, I had 635 KB of conventional memory available for running applications while logged into the NetWare Lite LAN.

NetWare Lite isn't the cheapest or the fastest peer-to-peer LAN operating system you can buy. But it's certainly the easiest to install, manage, and use. For the first-time LAN, or for peer access within a larger NetWare 2.2 or 3.11 LAN, it's an excellent choice. ■

*Barry Nance is a consulting editor for BYTE. He manages a 70-node NetWare LAN and is the editor of the IBM Exchange and moderator of the lans conference on BIX, where you can reach him as "barryn."*



# DOS 5.

# DOS 5 with MAX 6.

There's no doubt about it. DOS 5 is the sleekest, most convenient, most powerful DOS upgrade in history.

And it's a great place to start if you really want to get the ultimate in PC performance—without even lifting a finger.

### New MAX 6—the driving force in automatic memory management.

Top performance requires as much conventional memory as possible. So applications can run faster. And so you can load Windows, TSRs, even a network, and have memory to spare.

Of course, DOS 5 helps with its smaller program size. And it does let you load programs high—if you want to do it by hand.

But for optimal memory management that's totally automatic, you need new MAX version 6—386MAX® for PC compatibles, and BlueMAX™, the only memory manager designed to recover up to 250% more high DOS memory on IBM PS/2s.

They're the dramatically advanced versions of the fastest growing brand of memory managers in the world. Now with better memory recovery, superior optimization, and amazing ease of use.



**Intelligent, thoughtful, and totally reliable.**

Just type *maximize*, and MAX takes over with its automatic memory management tools.

Like new 386MAX ROMsearch™ that recovers massive holes of unused system BIOS memory. New 386MAX VGAswap™ that creates more contiguous memory on all VGA/EGA systems.

Like SmartMemory™ that takes care of memory allocation for you, so you'll never again have to think about what kind of memory your computer needs. And new Maximize Reordering that helps fit more programs into high DOS by automatically arranging programs for optimal loading, every time.

And using MAX 6 is a cinch thanks to the new graphical interface, complete with pull-down menus, mouse support, and context-sensitive help. There's even a new improved version of ASQ™ the intelligent system analyzer and tutorial, right on board.

**The ultimate in power and luxury is more affordable than ever.**

New 386MAX 6 for 286\*, 386, and 486 PC compatibles is now just \$99.95. And new BlueMAX 6 for 386 and 486 IBM PS/2s is only \$124.95.

Frankly, whether you use DOS 5 or not, only MAX 6 will have you on your way to maximum PC performance with an absolute minimum of effort.

See your dealer or call toll-free today.

# 1-800-676-0386

Call to upgrade for just \$29.95 plus \$5 S&H\*\*



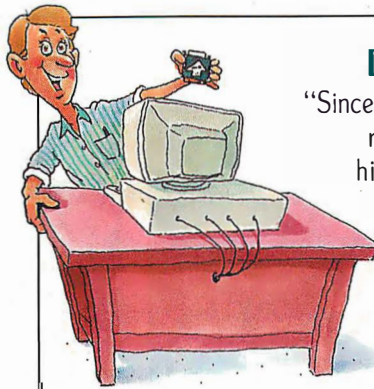
# The Intelligent Memory Managers™

© 1991, 1992 Qualitas. Qualitas, 7101 Wisconsin Avenue, Suite 1386, Bethesda, MD 20814. All company and product names are trademarks or registered trademarks of their respective owners. System Requirements: Any 386 or 486 PC or PS/2, min. 256K of extended memory, DOS 3.0 or higher, and hard disk drive. \*386MAX supports 286 systems with Shadow RAM. Feature availability and memory recovery may vary. \*\*Offer valid in North America only.

**QUALITAS®**

Circle 105 on Inquiry Card (RESELLERS: 106).

# WHY SOFTWARE COMPANIES ARE CHOOSING HARDLOCK™

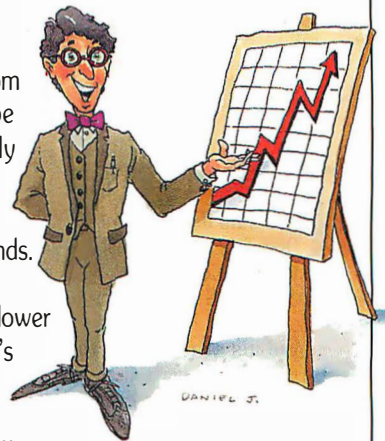


## Developers Say...

"Since the Hardlock uses an algorithmic response chip, I am assured of the highest level of protection. Also, the optional programmable memory means I can keep custom configurations in Hardlock rather than in a file. I can protect my .EXE or .COM files directly and/or incorporate Glenco's high level language interface routines into my software. And, I feel confident I'll have Glenco's support if I use other programming languages."

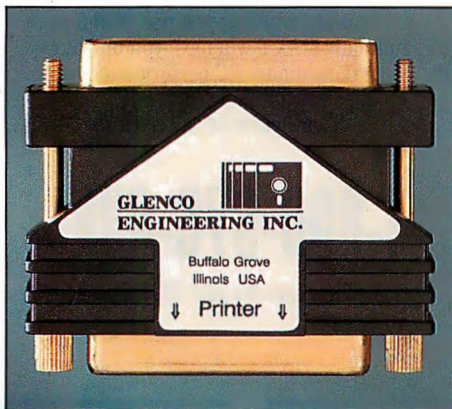
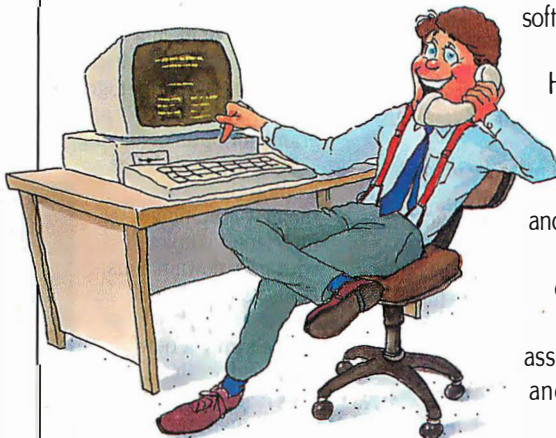
## Accountants Say...

"Hardlock provides our company with a healthier bottom line. Since our software can't be copied, our revenue has steadily increased. The unique programming board allows us to program the Hardlock in seconds. This ensures optimum delivery schedules from Glenco and a lower inventory cost for us. Hardlock's field programmable feature means a single Hardlock can protect more than one product."



## End Users Say...

"Hardlock allows me to backup my software investment. I just plugged Hardlock into the printer card, connected the printer cable, and forgot about it. Since Hardlock doesn't require a battery, I am assured of reliability and no down time."



Actual size shown.

**Hardlock** — programmable, algorithmic response and memory option — all in one

**GLENCO ENGINEERING INC.**  
SERVING THE SOFTWARE INDUSTRY SINCE 1979

270 Lexington Drive  
Buffalo Grove, Illinois 60089-6930  
(708) 808-0300 FAX 808-0313  
1-800-562-2543

**HARDLOCK™**  
**The Preferred Protection System!**

**1-800-562-2543**

**H A R D L O C K**

For a distributor in Europe contact, FAST Electronic GmbH 49-89-539800-20 FAX 49-89-539800-40

For International information circle 59, For End-User information circle 60 on Inquiry Card.

## SOFTWARE

# Swift Programming for Windows, in Windows

TOM YAGER

Windows programs may be easy to use, but as any experienced Windows programmer will tell you, they're a pain to write. That pain comes partly from the complexity of Windows itself. Even more bothersome, Windows C programming tools traditionally run under DOS, which requires cumbersome switches between environments to develop and debug your code.

Microsoft's QuickC for Windows changes all that, at least for those C developers who work on simple Windows applications, or would like to. The *Quick* in QuickC for Windows has a broad meaning: Microsoft bills the product as the fastest way to develop C programs for Windows. After working with it for a while, I think the company's right.

### Setting Up

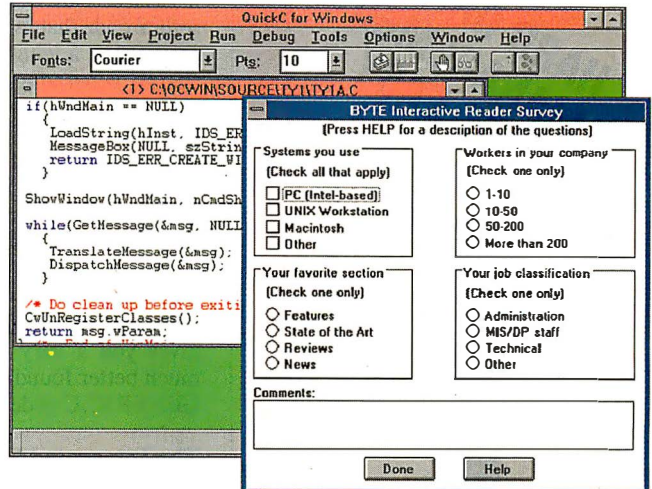
I installed QuickC for Windows on a Toshiba T200SX laptop with 5 MB of memory and a 60-MB hard drive. I ran Stacker 2.0 on the hard drive to give QuickC a little more room to breathe. As with most Windows programs, QuickC's installation is almost completely automatic. The standard installation takes up a bit over 6 MB, although you do have the option of selecting only those portions of the package you wish to install.

The product's hefty size results from its incredible completeness. QuickC for Windows includes everything necessary for developing Windows programs, so there's no need for the Windows Software Development Kit (SDK). There are also several sample applications and a set of help files that, by themselves, justify the cost of this package.

### Help Is on the Way

If you're learning Windows, or learning C, or (heaven help you) tackling both at once, I can think of no better place to start than with QuickC for Windows. The help system is more complete, and more *helpful*, than any I've seen. Wading through Microsoft's examples, or anyone's C or Windows code, for that matter, becomes much easier: When you come across a confusing function call, C keyword, Windows structure definition, or other entity, just double-click on it and

*The QuickC for Windows integrated environment places an editor, a compiler, a debugger, and other tools under the control of a central interface.*



press F1. There are copious hypertext links to other help entries, and QuickC's help system adds embedded icons representing major subject groups. There are even source code samples in some of the help file entries.

With my 5 MB of system memory, I hopped in and out of the QuickC for Windows help system with relative ease. On systems with less memory, the Windows help system can be a drain on resources, and it becomes much less effective as an aid when you have to wait several seconds for it to pop up. The problems of the standard Windows help system are magnified by QuickC for Windows; it updates the help system executable file, WINHELP.EXE, with a larger, more capable one during installation.

### Supporting Roles

While QuickC is (obviously) a compiler, that portion of it seems almost incidental compared with the rest of the package. QuickC for Windows includes a valuable set of tools: the Dialog Editor, for visual layout of dialog boxes; the Image Editor, for editing graphical objects (primarily icons and cursor shapes); QuickCase:W, a simple applications generator; and behind-the-scenes tools, which include the linker, resource compiler, and library manager. Of these, the most visible are the Dialog Editor and QuickCase:W.

The Dialog Editor should be familiar to experienced Windows programmers, but it will also give you *déjà vu* if you've used Visual Basic; the Dialog Editor's interface shares much with this other programming environment. In it, you

create dialog boxes (windows that pop up to collect information from the user) by dragging buttons, text fields, labels, list boxes, and other interface objects into a prototyping window. The editor lets you assign unique names and ID numbers to your objects either as you create them or later as you select the objects one at a time and edit their name and ID fields.

The Dialog Editor isn't as capable as some I've worked with, but it gets the job done. When you're finished, the editor saves the dialog box, or boxes, that you created during your session to a set of files: a resource (.RES) file, an include (.H) file, and a .DLG file. The .DLG and .H files get #included into your application's resource script (.RC) file, while the .RES file is the Dialog Editor's reference copy of your interface. The .RES extension is also used by the resource compiler (a required step in the Windows development process), and that complicates things; Microsoft should have chosen a unique extension for the Dialog Editor's reference files.

QuickC for Windows includes a rudimentary code generator, QuickCase:W. This program, which is licensed from Caseworks, lets you build a Windows application by drawing a prototype of its interface; it's programming, WYSIWYG-style. The QuickCase:W main window is a slight superset of the prototype window, and you construct your interface through a combination of mouse and keyboard actions. I found this a little cumbersome; there are too many things you *must* do from the keyboard. Perhaps the best thing about QuickCase:W is how

# BACK BY POPULAR DEMAND!

**HARD DRIVE  
MANAGEMENT  
MADE EASY**



**SpeedStor<sup>®</sup> for DOS**  
Hard Drive Installation, Management And Diagnostic Software

- Install and partition hard drives in minutes
- Maximize speed, capacity and efficiency with advanced utilities
- Comprehensive diagnostics not found in DOS

## NEW v6.0 FEATURES!

- DOS 5.0-compatible
- Supports 8-, 16- and 32-bit controllers
- Works with memory managers

\$99.95\* SRP \$29.95\* Upgrade

\*Plus tax, postage and handling

To order, call  
**800-967-4246 Ext. 2**

**OVER 700,000 INSTALLED**

**STORAGE  
DIMENSIONS**

The Industry Leader In Storage Solutions

**UPGRADE  
\$29.95\***

## PROGRAMMING FOR WINDOWS

easy it makes building menus. You can link menu items to certain actions, including the popping up of dialog boxes (created with the Dialog Editor).

When you've finished building your interface, QuickCase:W churns out the source code that makes it work. This process takes a *long* time, so I'd advise against generating your code before you are completely finished. What you get, however, is worth the wait: a full set of files, ready to load into QuickC for Windows and compile directly. Your application won't do much until you add your own code, but the QuickCase:W code generator places comments (how heavily it comments is up to you) in areas where you need to add functional code. This gives you a very workable skeleton—a much better foundation than Microsoft's *GENERIC.C* code example.

### The Integrated Environment

You can't buy a compiler these days without some kind of integrated environment coming along for the ride. QuickC for Windows' integrated environment, unlike some others, actually enhances your productivity by bringing together all the essentials in one customizable interface (see the screen).

The editor and debugger work through child windows of the main QuickC window; you can have as many of them open as you like. To avoid having to open them all again when you rejoin a project later, QuickC for Windows lets you save several named window configurations.

I expected QuickC for Windows to cut some corners compared to Microsoft's so-called Professional Development System, and the primary loss of functionality is in the debugger. The debugger that's part of the integrated environment doesn't match CodeView (QuickC for Windows can generate CodeView-compatible debugging data), but it will help you zero in on the problems you're likely to encounter in small applications. Single-stepping, breakpoints, and watch expressions are part of the debugger's repertoire, and that's a good start. What you won't get is support for expression evaluation, the ability to watch Windows messages fly around, and some of the other "advanced" debugging features.

### Know Thy Limitations

QuickC for Windows is not the only set of Windows development tools that any programmer could ever need. You may get involved in a project that's simply too big or too complicated for QuickC for Windows to handle. But QuickC for Windows is enough to get new programmers start-

## BYTE ACTION SUMMARY

### ■ WHAT MICROSOFT QUICKC FOR WINDOWS IS

A Windows-hosted C development system for the creation of Windows and DOS programs.

### ■ LIKES

Everything needed for Windows development is in one package. The program also includes a bundled applications generator and remarkably comprehensive on-line documentation.

### ■ DISLIKES

Lack of dual media types, a sluggish applications generator, and a limited debugger.

### ■ RECOMMENDATIONS

QuickC for Windows is a great starting system for budding Windows developers, and it's a well-designed integrated environment for experienced programmers.

### ■ PRICE

\$199

### ■ FOR MORE INFORMATION

Microsoft Corp.  
1 Microsoft Way  
Redmond, WA 98052  
(800) 426-9400  
(206) 882-8080  
fax: (206) 936-7329

Circle 1226 on Inquiry Card.

ed, cheaply and easily, and it's also just right for the kind of small, relatively simple applications that dominate most programmers' to-do lists.

Obviating the need to switch between DOS and Windows also makes QuickC for Windows a more comfortable place to work than the typical Microsoft C/Windows SDK environment (if you can call it that). So QuickC for Windows can also serve as a nice launching pad for larger projects. In general, if you write Windows C programs, or would like to start, grab a copy of QuickC for Windows. ■

*Tom Yager is a BYTE technical editor and author of the book UNIX Program Design and Development for IBM PCs (Addison-Wesley, 1991). He can be reached on BIX as "tyager."*

## SYSTEM

# Apple Reinvents the Notebook

TOM THOMPSON

For two years, Apple's Macintosh Portable was the butt of jokes. After all, its suitcase-size, 18-pound bulk didn't measure up to notebook-size DOS computers that weighed 5 to 7 pounds. But at last fall's Comdex, Apple reentered the notebook market with a vengeance when it introduced three PowerBooks—notebook-size Macs that weigh from 5 to 7 pounds (see "A Peck of New Apple Macintoshes," November 1991 BYTE). These new Macs, with their ability to read DOS floppy disks, transparently connect to an office's AppleTalk network, and print to fax, make on-the-go computing easier and more productive than ever.

### Meet the PowerBooks

All three PowerBooks (see photo 1) have 640- by 400-pixel screens and two expansion slots. One slot is for added memory; the other is for a fax/modem board. The \$2299, 5.1-pound PowerBook 100 is based on a 16-MHz 68000. It has a 9-inch supertwist LCD, 2 MB of RAM, and a 20-MB hard drive (see photo 2). It's basically the Mac Portable's hardware and ROMs in a much smaller package, one that will easily fit inside a briefcase. The most noticeable difference between the two computers is that the PowerBook 100 does not have a built-in floppy drive, although Apple offers an external SuperDrive as an option. The external floppy drive runs off the PowerBook 100's battery, and it has a cover to prevent debris from getting into the drive.

The PowerBook 140 and 170 are slightly larger and heavier (6.8 pounds), have an integral SuperDrive, and use the more powerful 68030 processor. They also have an Enhanced Apple Digital Sound Chip (EADSC) for high-quality sound output, plus sound recording circuitry and a microphone. The \$2899 PowerBook 140 uses a 16-MHz 68030 and includes 2 MB of RAM, a 20-MB hard drive, and a 10-inch supertwist LCD. The \$4599 PowerBook 170 has a 25-MHz 68030, a 68882 FPU, 4 MB of RAM, a 40-MB hard drive, a fax/modem board, and a 10-inch, high-contrast, active-matrix LCD screen (see photo 3).

*continued*

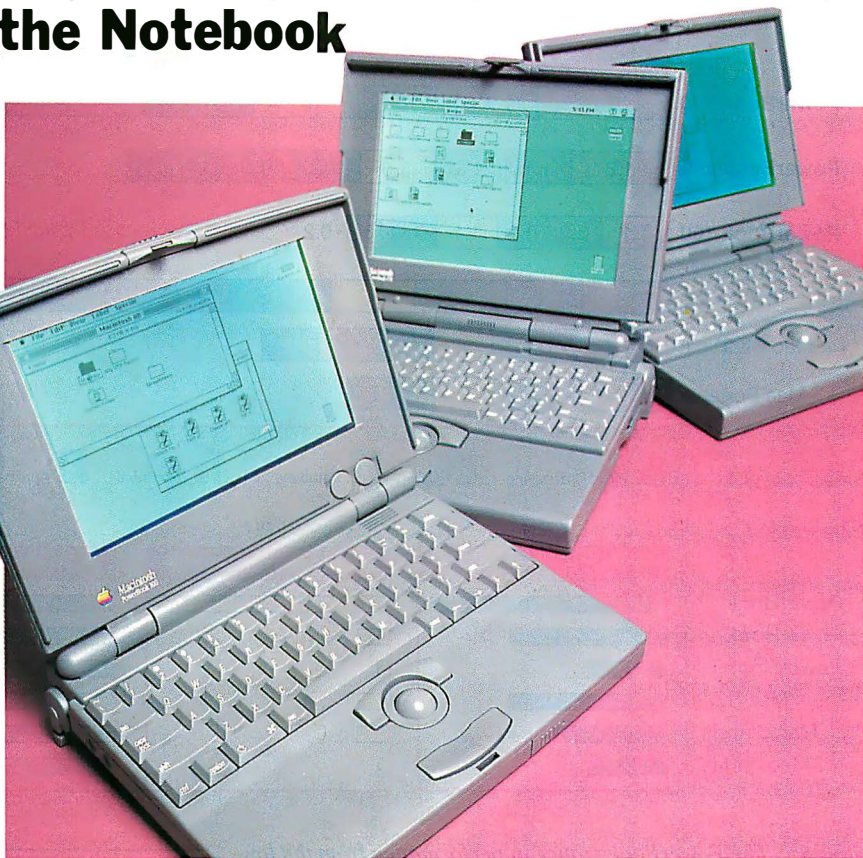


Photo 1: Apple's PowerBook 170, 140, and 100 set the standards for portability and ease of use.

## BYTE ACTION SUMMARY

- **WHAT THE POWERBOOKS ARE**  
Notebook-size Macintoshes.
- **LIKES**  
Sturdy, ergonomic design, excellent weight, and a centrally located trackball make carrying and using a PowerBook a snap. Fax capabilities are closely integrated with applications software and easy to use. Remote networking software has superb security features.
- **DISLIKES**  
Battery life is shorter than that of the Mac Portable, and remote networking software's 2400-bps transfer rate limits the size of print jobs or file copies.
- **RECOMMENDATIONS**  
For cost-conscious users doing light-duty tasks, the PowerBook 100 with external floppy drive is a good buy. For those who demand more power, the PowerBook 170's 25-MHz parts deliver top Mac performance in a notebook.
- **PRICE**  
PowerBook 100, \$2299  
PowerBook 140, \$2899  
PowerBook 170, \$4599
- **FOR MORE INFORMATION**  
Apple Computer, Inc.  
20525 Mariani Ave.  
Cupertino, CA 95014  
(408) 996-1010  
**Circle 1230 on Inquiry Card.**

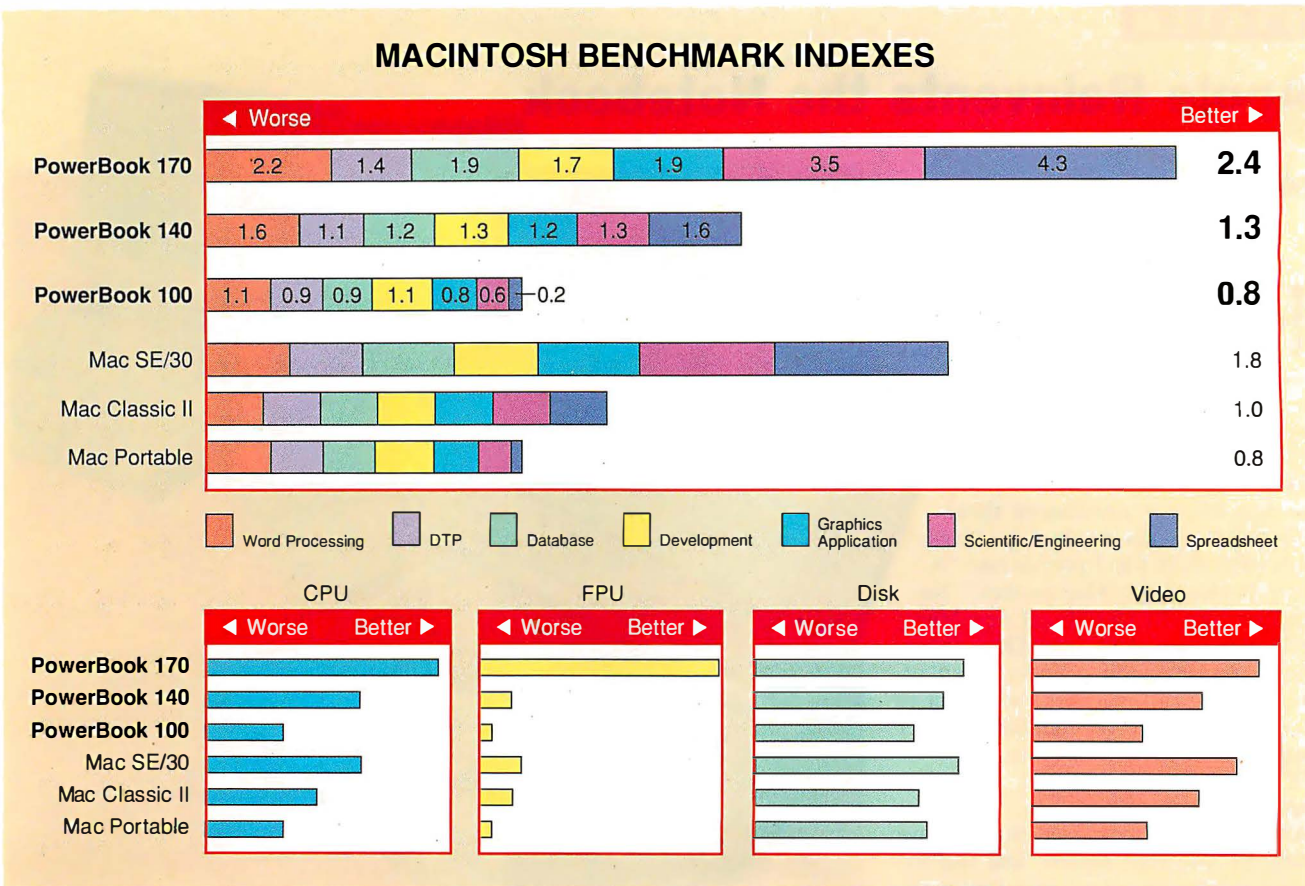


Figure 1: The PowerBooks range in performance from the low-end PowerBook 100 to the high-end PowerBook 170. Each approximates the performance of an older Mac model, from the Mac Portable-like PowerBook 100 to the Mac IIcx level of the PowerBook 170.

Dhrystones	
PowerBook 170	4166
PowerBook 140	2941
PowerBook 100	1923
Mac SE/30	3125
Mac Classic II	2000
Mac Portable	2000

All machines were tested running System 7.0.1. Except for the Dhrystone test, all results are indexed. For each test, a Mac Classic II = 1, and higher numbers indicate faster performance. The floating-point benchmarks use the SANE library. Comprehensive test results and detailed configurations are available for all machines on request.

**Test and Measurement**

I tested each of the three models for performance and battery life. Apple shipped the PowerBook 100 and PowerBook 140 to BYTE with 4 MB of RAM and an optional fax/modem board. All three systems got along well with my collection of applications, INITs, and the benchmark testing software. I had only one problem—a crash with Suitcase II 1.2.11.

Figure 1 shows the results of BYTE's performance tests. The PowerBook 100, with the heart of a Mac Portable, turned in Mac Portable performance, as expected. Interestingly, the humble Classic II musters slightly more power than a PowerBook 100, but then it does pack a 68030 CPU. The PowerBook 140 puts up more or less the same performance as an SE/30 or IIcx, although its lack of an FPU makes it slower at pure number crunching. The PowerBook 170 is basically a notebook Mac IIcx, except for the

slightly slower LCD screen. Both the 140 and 170 models are candidates for portable desktop computers.

Sound reproduction on the higher-end systems with the EADSC doesn't quite match that of the Quadras, but it does offer better quality than current Mac II systems. You'll notice an occasional pop or crackle when power-conservation software switches the sound circuitry off several seconds after the PowerBook plays a sound.

I measured battery life both qualitatively and with BYTE's new notebook battery tests. These are the same scripted tests we use to test DOS notebooks; they use the same testing rig and the same script (see "Measuring Speed and Endurance," page 218). I've ported the support software of these tests to the Mac to get battery-life estimates.

Figure 2 shows the results. None of these systems lasts as long as the Mac

Portable: It outlasted them by several hours. The times obtained are nearly double those of Apple's, but that's because our tests are based on a 55 percent duty cycle (display backlight set to half its maximum intensity, with the notebook active about half the time and idle the rest), while Apple's estimates are based on continuous, heavy-duty activity with the backlight intensity set to maximum. My experience indicates that battery life can range from about 45 minutes (performing a download with display intensity at maximum and continuous disk I/O) to a little over 2 hours if you can run the application in memory alone.

Based on these seat-of-the-pants observations and our battery tests, Apple's estimates seem reasonable. Remember that the amount of charge and abuse the battery has taken can affect running time as well. This explains the shorter intervals I got with the Powerbooks, because I



# New QEMM-386 v6.

**“It’s nothing less than a dream come true”**  
—Steve Gibson InfoWorld 8/26/91

Suddenly PC users have a lot of memory managers to choose from. Seems that everyone has figured out what users have been telling us for years: they need every last ‘K’ of available memory between 640K and 1 megabyte—especially if they’re running on a network. Or using TSRs.

Our new QEMM-386 version 6 is the best way to get the most out of memory. It ‘pools’ all your memory so that it’s available in whatever form your programs need—expanded or extended. You don’t even need to know the difference. QEMM does it all for you. Instantly. Whereas DOS 5, for example, requires you to figure out what you need, then manually allocate memory and reboot every time you need to change.

As for the all-important ‘conventional’ memory area, our new version 6 increases the amount of memory freed-up. Our exclusive ‘optimize’ feature automatically seeks out TSRs and device drivers and moves them into high memory—the area between 640K and 1 megabyte. All you have to do is type ‘optimize’.

QEMM-386 v6 finds more high memory than any other memory manager. *Byte Magazine’s* tests showed it produced net memory gains of 21K to 132K over DOS 5.0 alone, for instance.

**#1**  
QEMM is the number one selling PC utility.

## There’s no better way to manage your memory.

they need to run fast and efficiently. And you get to have your TSRs.

Not every PC can benefit from Stealth. But every PC can benefit from ‘Squeeze’—our new feature to manage those TSRs that need more memory at start up and less when they’re resident.

Memory allocation is temporarily increased, then squeezed down after it’s needed.

QEMM can use idle video memory to produce a further 96K gain on EGA and VGA systems when running character-based programs.



### A priceless \$60 bonus.

QEMM comes with Quarterdeck Manifest, the award-winning analysis program that makes it easy to see what’s going on ‘under the hood’ of your PC.



See and understand how your PC works with Manifest.

Manifest does for memory what PC Tools Deluxe does for disks.

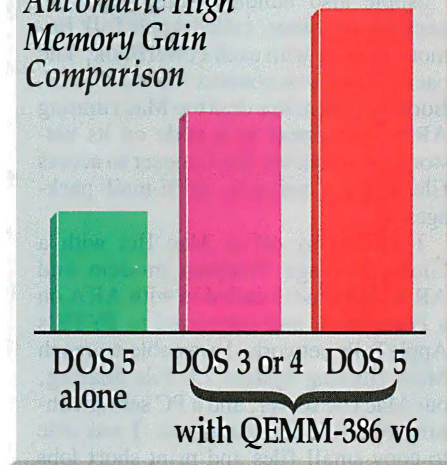
### Benefits for Windows, too.

Whether you’re running DOS 3, 4, 5, or Windows, QEMM can improve your 386/486’s performance.

That means you may not need a faster CPU. You may not need more RAM. QEMM makes your favorite programs work better by giving them more memory to run in.

QEMM helps you get the most out of the software you own today.

### What you can expect Automatic High Memory Gain Comparison



### Stealth takes you to network and TSR heaven.

Our breakthrough ‘Stealth’ technology makes available areas normally taken up by ROM. Areas that QEMM-386 can use to load memory-hogging drivers and TSRs. Big programs can get the memory

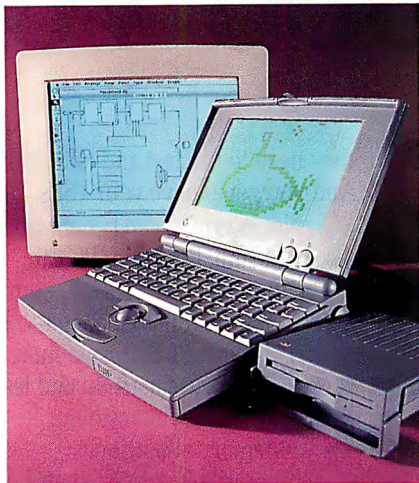


For orders only, call toll-free (800) 354-3222 7AM-5PM PST.

Quarterdeck Office Systems, 150 Pico Boulevard, Santa Monica, CA 90405 (310) 392-9851 Fax (310) 314-4219  
Quarterdeck International Ltd., B.I.M. House, Crofton Terrace, Dun Laoghaire, Co. Dublin, Ireland Tel. (353) (1) 288-1444 Fax: (353) (1) 284-4380

©1992 Quarterdeck Office Systems. Trademarks are property of their respective owners.

Circle 108 on Inquiry Card.

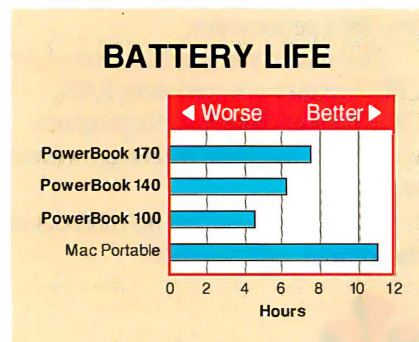


**Photo 2:** The PowerBook 100, with an Envisio memory/video expansion board. Envisio's Notebook Display Adapter is driving a second screen on the AppleColor 13-inch monitor in the background while providing an extra 2 MB of RAM.

used them constantly, never allowing the batteries to get a full charge. Also, the PowerBook 100 arrived with its battery completely discharged, which can damage the battery. This is why, despite its low-power components, the PowerBook 100 conked out sooner than the 68030-based versions.

**Keep in Touch**

The PowerBook 170's communications device is a 9600-bps send-only fax/2400-bps data modem. A PowerBook with this option becomes a powerful tool for keeping in touch with the office and clients while on the road. You can send E-mail to those offices that use on-line services.



**Figure 2:** Battery test results show that the new PowerBooks aren't as long-lived as the old Mac Portable. However, the greatly reduced weight and better screen compensate for the shorter battery life.

For those that don't, you can fax documents to their fax machine.

The Fax Sender software bundled with the Apple fax modem allows you to print a document loaded with tables, charts, artwork, and scanned images to a fax machine. It has two components: a background imaging and transmittal application, and a Chooser-selectable driver. The application is analogous to the Print Monitor, the Mac's background printing software.

To send a fax, you launch the application that created the document, pick Fax Sender in the Chooser, and issue the Print command. Fax Sender is easy to use and works with documents that have a mix of different typefaces. With TrueType or ATM, fonts are imaged at high resolution, making for great output—certainly a good way to impress a customer. I sent PageMaker 4.0 documents to the office fax while traveling, and I even faxed PostScript drawings from Adobe Illustrator 3.0.1 without problems.

Apple also bundles AppleTalk connectivity software, called AppleTalk Remote Access, with each PowerBook. The package lets you connect via the PowerBook's modem to a desktop Mac running ARA and appear as a node on its network. You then use the Chooser to access file servers, printers, or E-mail packages.

I set up my office Mac IICI with a Global Village Teleport modem and ARA. At home, I called in with ARA on a PowerBook and connected to BYTE's AppleTalk network. I was able to reach Macs running System 7.0 File Sharing, our Mac file server, and a PC server running NetWare for Macintosh. I was able to copy small files and print short jobs with no trouble. But if you think LocalTalk's 230-Kbps rate is slow, a 2400-bps network connection will really try your patience.

**A PowerBook in Your Future?**

If you use a GUI to keep your computing tasks sorted out, the Mac does it best, especially for notebook computing. The PowerBook's centrally located, built-in trackball favors neither hand and avoids the bolt-on headaches that plague most PC pointing devices. The integration of applications with the communications software has no equal. I expect PC notebooks, which have already mimicked the Mac's GUI with Windows 3.0, to imitate many PowerBook features. I'd like battery life to be longer, but for now, I'll carry plenty of spare batteries.

With a fax/modem board installed, a



**Photo 3:** The PowerBook 170 delivers Mac IICI performance. Both it and the PowerBook 140 have 32-Bit QuickDraw and support for virtual memory in their 1-MB ROMs.

PowerBook provides several ways to keep in touch with the office or with customers. I've frequently plugged a PowerBook into a phone jack and made use of fax, terminal, and ARA in one sitting. All I had to do was point and click to use another service without rebooting. With software that supports sound, you can use the PowerBook 140 and 170's microphone to voice-annotate documents. With all the capabilities the PowerBook offers, the question becomes, Where can I get one?

Don't let the PowerBook 100's middling benchmark scores fool you into thinking this is a wimpy machine; it's not. I've used it (and a Mac Portable before that) to telecommute and even to develop software with Symantec's Think C compiler. The PowerBook 100 makes a cost-effective "data bucket" for those who want to write reports or use a terminal program.

If you need desktop power for complex reports, professional graphics, and big spreadsheets, consider the PowerBook 140 and 170. I recommend the PowerBook 170, since it comes with a crisp screen, larger hard drive, more RAM, an FPU, and the fax/modem board as standard equipment. And you'll enjoy its 25-MHz computing power on the road or at your desk. ■

*Tom Thompson is a BYTE senior technical editor at large. He has a B.S.E.E. from Memphis State University. Contact him on BIX as "tom\_thompson" or on AppleLink as "T.THOMPSON."*



# YES!

Enter my one-year (12 issues) subscription to BYTE for only \$24.95. I'll **save 40% off the single copy price**. Plus, I'll also receive BYTE's Annual Special Issue FREE with my paid subscription. If at any time I'm not satisfied with BYTE, I may cancel for a full refund on all unmailed copies.

Payment enclosed     Bill me

NAME \_\_\_\_\_

COMPANY \_\_\_\_\_

ADDRESS \_\_\_\_\_

CITY \_\_\_\_\_ STATE \_\_\_\_\_ ZIP \_\_\_\_\_

Please allow 6-8 weeks for delivery. Basic subscription rate is \$29.95. (Mexico, \$29.95 payable in U.S. funds.)

**SAVE  
40%**

# BYTE



NO POSTAGE  
NECESSARY  
IF MAILED  
IN THE  
UNITED STATES

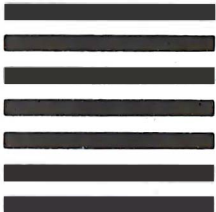
**BUSINESS REPLY MAIL**

FIRST CLASS MAIL PERMIT NO. 42 HIGHTSTOWN, NJ

POSTAGE WILL BE PAID BY ADDRESSEE:

**BYTE**

Subscription Department  
P.O. Box 558  
Hightstown, N.J. 08520-9409



## APPLICATION

# WordPerfect for Windows

NICHOLAS BARAN

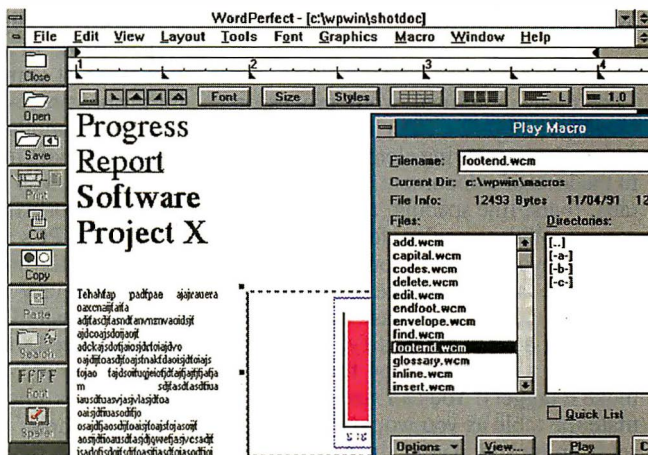
**W**ordPerfect for Windows is a monster word processor. Like its chief rival, Microsoft Word for Windows, the program is packed with every conceivable feature short of higher-end desktop publishing tools. This program is a far cry from a text editor with a GUI slapped onto it. With its columnar text, formatting tools, and manipulation of graphics, WordPerfect for Windows can be used for many of the kinds of documents that are generally done with software like PageMaker or Ventura Publisher.

Although an in-depth comparison with Microsoft Word for Windows is beyond the scope of this review, I have used both Word and WordPerfect and was struck more by their similarities than by their differences. Both are much easier to learn than their DOS counterparts. In the never-ending features battle, these programs are approaching the saturation point, and it is difficult to differentiate them—it's much like comparing a Lincoln and a Cadillac.

With more than 200 menu options, WordPerfect for Windows incorporates all the functions that are found in today's WYSIWYG word processors, including basic column-layout capabilities, multiple fonts, macros, tables, indexing, and the ability to place and size graphics. The package also has an equations editor, a spelling checker, a thesaurus, and a file manager/viewer (called the File Navigator) that makes it easy to find documents (and also runs fast text searches). Being a good Windows program, the package takes advantage of the Clipboard and Dynamic Data Exchange, allowing you to establish "hot links" between other Windows documents (e.g., an Excel or Lotus 1-2-3 spreadsheet) and WordPerfect documents. Unlike the latest Word for Windows or Ami Pro 2.0, the program does not yet take advantage of Object Linking and Embedding. WordPerfect says those protocols will be implemented in "a subsequent release," probably within a few months.

This software demands high-performance hardware—nothing less than a 386 with 4 MB of RAM (which the company recommends) will do: While Word-

*The Button Bar on the left side and the ruler at the top let you access frequently used commands and procedures easily. The window for playing macros is opened on the right.*



Perfect will run on a 286 PC with 2 MB of memory, the performance would be barely acceptable. Even on a 386, some operations—like scrolling down a half-page table—can seem sluggish. The full application occupies 9 MB of hard disk space, which, unfortunately, is becoming a common demand these days, but space-conscious users, like laptop owners, can choose to install a minimalist version (i.e., no macros, no file manager, no learning help, and no hyphenation) that takes up about 5 MB.

### CUA Menus or DOS Keys: Your Choice

With this new GUI version, the company has managed to maintain the look and feel of the traditional text-based WordPerfect while making it work like a Windows product. This challenge was complicated by the fact that the MS-DOS version of WordPerfect has traditionally relied on the IBM PC function keys, which have different functions running under Windows, as specified by the Common User Access (CUA) standard (developed by IBM and Microsoft as the standard keyboard and mouse interface for Windows and OS/2).

WordPerfect addressed this problem by providing two keyboard interfaces: the traditional DOS keyboard interface and the Windows CUA interface. You can choose the one you prefer. The program comes with a function-key template that has the CUA key codes on one side and the standard DOS codes on the other. I found the CUA interface easier and recommend using that even if you're a veteran DOS WordPerfect user. Since

many keyboard operations are now easier to perform with the mouse, the transition to the CUA standard is not that difficult.

Overall, the program's developers have succeeded in striking a balance between WordPerfect and Windows. This program feels like a Windows product and behaves much like one, using the standard windowing system for cascading multiple windows, minimizing and maximizing windows, and so forth. You can shrink a window to get it out of the way and then maximize it when you need to work in it again.

On the other hand, the interface has changed considerably from the traditional DOS and Unix versions of WordPerfect. WordPerfect for Windows takes excellent advantage of the graphical environment and the mouse, with features such as an on-screen ruler, a Button Bar, and easy cut and paste. Veteran WordPerfect users will have to make some adjustments, but for the most part, these are positive changes. The main thing is that WordPerfect has maintained complete file compatibility with other versions of the product.

### Incompatible Macros

Because of the CUA interface and the graphical environment, the company was forced to design a new macro language for its Windows version of WordPerfect. As with the keyboard interface, the DOS version of WordPerfect relies heavily on the function keys and Alt key for macro definition.

The program's new macro system includes a BASIC-like programming language that has loops and conditional

statements. Nevertheless, macros are easy to "record." There's a handy window for calling up a list of all macros and another window for viewing the contents of macros. WordPerfect provides facilities for at least partial conversion of DOS WordPerfect macros.

### The Ruler and the Button Bar

Like many graphical word processors, WordPerfect puts a ruler at the top of the screen for specifying elements that relate to the look of a document (e.g., margins, tabs, fonts, line spacing, and text justification). With the ruler, formatting commands involve just a mouse-click on an icon. The table tool is one of the sharpest parts of the ruler. It basically lets you construct a table by modifying a simple grid (e.g., dragging it by the corner to make it bigger). You can size and manipulate the table as you would a graphic or set it up by specifying, in a little dialog box, the number of horizontal and vertical rows.

The company has also added a slick icon-based menu strip, called the Button Bar, where you can place commands, menu items, and macros that you use

often and want to activate with a single click. This customizable feature is similar to the Smart Icons in Ami Pro. You can set up a different bar for different types of documents.

### Portability a Big Plus

If you work in a mixed environment, WordPerfect is probably the best choice for a word processor. It now runs in one version or another on Windows, DOS, and OS/2 machines; Macintoshes; Next computers; Sun Sparcstations; Silicon Graphics workstations; IBM RISC System/6000s; PCs running SCO Unix 386 or SCO Xenix; machines running under AT&T System V and VAX VMS; and its original target, Data General minicomputers. Indeed, one of the most compelling features of WordPerfect is the portability of files among all these platforms.

For example, I tried opening a file using WordPerfect for Next: It opened up as if it were a native Next WordPerfect document. And WordPerfect for Windows on a 386-based PC opened a Next WordPerfect file without a hitch, including bit-mapped graphical images embedded in the document. While some of

these platforms do not support the latest version of WordPerfect, at least the document structure is the same, providing a basic level of portability.

### Weirdnesses and Weaknesses

I ran into a few minor problems with the product. In particular, the File Open function does not provide a simple method of listing available directories. You have to type in C:\\*.\* to see the root-level list of directories. Another annoyance is the disappearance of minimized windows (i.e., windows that you collapse to an icon). I could always find these minimized files, but on several occasions, it took more doing than should have been necessary. The problem is that the minimized icons don't always remain on the screen. Trying to launch a minimized file sometimes resulted in an unexplained "application error." Other users have reported the usual mysterious Windows crashes but said these incidents inexplicably dwindled the longer they used the program.

Some users have found inconsistency with "WYSIWYG" between the screen and the printer. Although inconsistency was sometimes the case when in regular mode—for example, the space between type and graphics could be misleading—the print-preview mode appeared accurate. I printed to a PostScript file in my tests and found no problems with output. The product includes some 900 printer drivers and can also use the Windows printer drivers, which should be plenty for most people.

There are some bugs that creep in when you're working with a page that has an image on it. For example, the program sometimes redraws the graphic incorrectly; after you save the file, however, it looks OK.

But these are fairly minor complaints; WordPerfect says it will fix them in a maintenance release. Despite the bugs, WordPerfect for Windows is a solid product. It improves on the DOS version in so many ways that users of that edition will be tempted to move to Windows just to run the new WordPerfect. And it's so much easier to use; the Windows version won't suffer from the rap that WordPerfect is too hard to learn. It's been a long time coming, but WordPerfect for Windows was worth the wait. ■

*Nicholas Baran, a longtime WordPerfect user, is a consulting editor for BYTE and co-editor of Pen-Based Computing, an industry newsletter based in Sandpoint, Idaho. You can reach him on BIX as "nickbaran."*

## BYTE ACTION SUMMARY

### ■ WHAT WORDPERFECT FOR WINDOWS IS

WordPerfect for Windows is WordPerfect 5.1 adapted to the Microsoft Windows 3.0 environment. It's a graphical word processor with desktop publishing capabilities such as fonts and graphics, columns, and tables; a macro language; and a Button Bar.

### ■ LIKES

This is a good implementation of the Windows environment, yet it preserves file compatibility with other versions of WordPerfect. It provides virtually every feature you would want short of full-scale desktop publishing. Setting up document formats and tabular material is particularly easy. This package will nix the rap that WordPerfect is difficult to learn and use.

### ■ DISLIKES

Minor annoyances such as the File Open function and minimized window function need

improvement. Bugs when working with graphics are troublesome. The sheer size and number of features can be overwhelming. Performance is less than zippy on anything less than a 386.

### ■ RECOMMENDATIONS

WordPerfect is a solid product backed by a solid company; it's particularly attractive if you use other computer systems running WordPerfect. Highly recommended.

### ■ PRICE

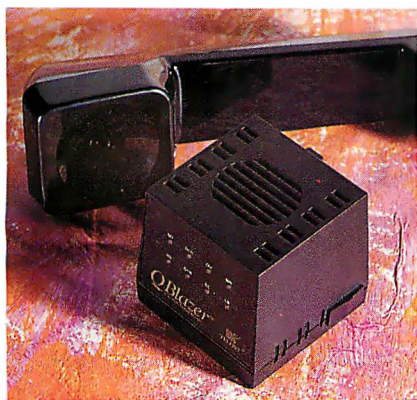
\$495; upgrade, \$99; additional site licenses, \$349 with documentation, \$295 without

### ■ FOR MORE INFORMATION

WordPerfect Corp.  
1555 North Technology Way  
Orem, UT 84057  
(800) 451-5151  
(801) 225-5000

Circle 1105 on Inquiry Card.

# REVIEWER'S NOTEBOOK



## Telebit Modem QBlazes Through On-Line Space

The Telebit QBlazer modem is small (less than 2½ inches on a side), but it holds big capabilities: portable connectivity of up to 38,400 bps. The QBlazer, which will run off a 9-volt battery for about 2 hours, is designed primarily for on-line communications between high-capacity systems and portable personal computers. The high performance for asynchronous stream communications makes it ideal for serial line Internet Protocol network connections.

You won't find the built-in file transfer protocols of the Telebit TrailBlazer Series—PEP (Packetized Ensemble Protocol), XMODEM and YMODEM, Kermit, and UUCP—but you will find V.32 and MNP levels 1, 2, 3, and 4 for error-corrected data connections. Plus, you get both MNP level 5 and V.42bis data compression for effective data transfer of up to 38,400 bps.

The QBlazer can store two entire configurations of the nearly 50 registers as well as two phone numbers in nonvolatile memory. The modem supports all standard specifications from 300 bps (Bell 103J) through 9600 bps (CCITT V.32). The modem command language is a superset of the standard "AT" commands, so you can easily use it with all the common personal computer communications programs.

For \$745, you get the modem, cables, manuals, external power supply, a travel pouch, and the communications and file transfer program MTEZ (from MagicSoft). Small, maybe even cute, the Telebit QBlazer opens up a huge world of interactive computing to users of portable computers.

## Stacker 2.0 Squeezes Out More Space

When a BYTE Lab editor needed to free up some space on his Toshiba T2000SX's hard disk, we decided to give a couple of on-the-fly compression programs a shot. We learned that not all compression programs are created equal. But we did get the results we wanted when we tried Stac Electronics' Stacker 2.0.

The 30-KB program installed gracefully and automatically, and a few minutes later, we turned the T2000SX's 20-MB hard drive into a defragmented virtual 40-MB drive that not only survived 386 enhanced-mode Windows but every nasty application we could throw at it. We installed Stacker again after upgrading the T2000SX to a 60-MB drive, with similar results. It has been stable now for a lengthy period of constant use. Stacker 2.0 is marvelous: very fast, easy to use, and completely transparent. We recommend it.

## SoftNode: A Different Kind of NetWare for Macintosh

With Insignia Solutions' PC emulators—SoftPC and SoftAT—Macintoshes can run DOS programs. Insignia's new SoftNode makes the emulated PC or AT a genuine NetWare client. Macs can then access a NetWare file system shared with DOS PCs.

Of course, you already have that capability if your environment includes PCs, Macs, and Novell's NetWare for Macintosh. But SoftNode gives Macs extra capability: They can run networked DOS applications and communicate directly with NetWare servers and clients over Novell's IPX transport. The product includes Open Data Link Interface (ODI) drivers for EtherTalk and AppleTalk, an IPX gateway/router, and a DOS 3.3 NetWare shell.

We tested SoftNode on a Mac Quadra 900 and a Mac IIfx, both connected directly to an Ethernet-based NetWare LAN. Since we had a direct Ethernet connection, we needed only to drag a few files into the Insignia folder on the Mac, launch SoftAT, and run a DOS batch file that loads NetWare.

If you already have an Ethernet/Local-

Talk router (at BYTE we're running Cayman Systems' GatorBox), the SoftNode router only needs to exchange packets at the AppleTalk/IPX level. Or SoftNode can manage both Ethernet/LocalTalk and IPX/AppleTalk routing. Either way, you'll need a gateway Mac that connects to the Ethernet and LocalTalk networks concurrently.

Insignia's NetWare implementation does everything by the book. The ODI-based IPX transport layer has performed flawlessly, so DOS programs that talk directly to IPX, such as Eicon Technology's Access/X.25, have run without a hitch. We ran the DOS version of a networked FoxPro 2.0 application, but the speedy Quadra became a slow AT in the process.

Clearly, the SoftAT/SoftNode combination isn't well suited to compute-intensive tasks. But if you've got a client/server application that's glued to DOS and IPX, and you need to have it materialize on a Mac, SoftNode looks like the right magic bullet.

—The BYTE Lab

*Reviewer's Notebook provides new information—including version updates, new test data, long-term usage reports, and reader feedback—on products and product categories.*

### ITEMS DISCUSSED

**QBlazer** .....\$745

Telebit Corp.  
1315 Chesapeake Ter.  
Sunnyvale, CA 94089  
(800) 835-3248  
(408) 734-4333  
fax: (408) 734-3333

**Circle 1227 on Inquiry Card.**

**SoftNode**.....\$175

Insignia Solutions, Inc.  
526 Clyde Ave.  
Mountain View, CA 94043  
(415) 694-7600

**Circle 1228 on Inquiry Card.**

**Stacker 2.0** .....\$149

Stac Electronics  
5993 Avenida Encinas  
Carlsbad, CA 92008  
(800) 522-7822  
(619) 431-7474  
fax: (619) 431-0880

**Circle 1229 on Inquiry Card.**

# We understand how you feel when your presentation goes badly.



If your LCD projection panel doesn't perform as well as you do, you're the one that ends up looking foolish. That's why we gave the MagnaByte® 6001 true color saturation and outstanding image clarity. And we made it so easy to set up and use, virtually anyone can give a professional, glitch-free presentation. Anywhere.

With the lightweight MagnaByte 6001, whatever appears on the computer screen is projected in thousands of crisp, rich colors

through an overhead projector. And you can still use your mouse or key commands to manipulate graphics, call up different screens or type in new text. All in brilliant 640 x 480 resolution.

Seeing is believing. Ask your AV dealer for a comparative demonstration. For the Telex dealer nearest you, call 1-800-828-6107.

Because if you can't show it as well as you know it, your presentation isn't the only thing that will suffer.

©1991 Telex Communications, Inc.

*The MagnaByte® 6001.*



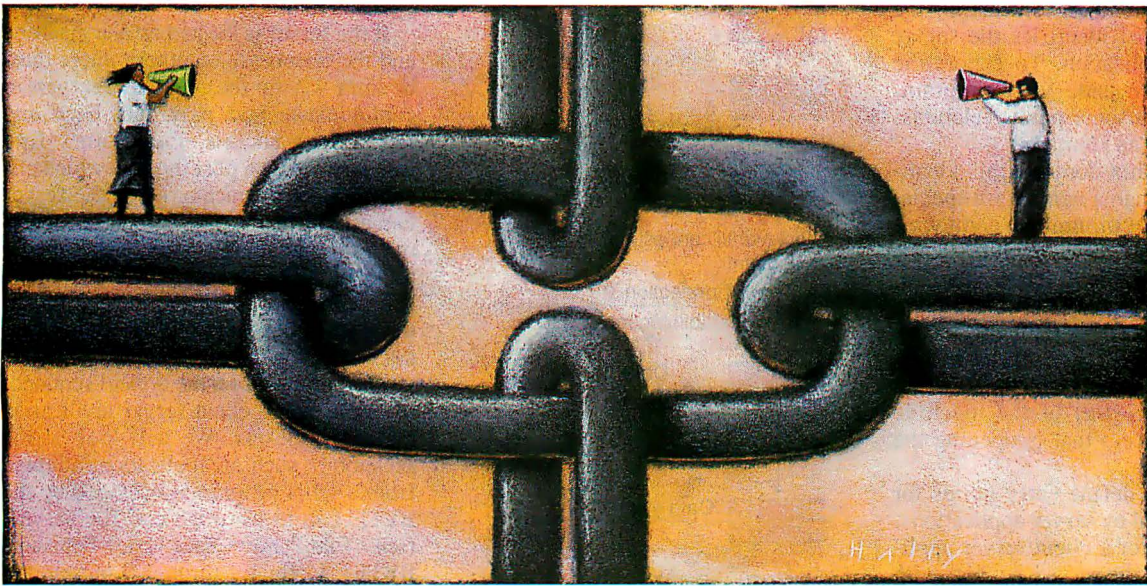
Compatibility: IBM and IBM-compatibles with VGA output Macintosh II and LC.

**TELEX**®

Circle 128 on Inquiry Card (RESELLERS: 129).



# TAPPING INTO SOCKETS



**T**he Berkeley Standard Distribution Unix model for interprocess communications is known as “sockets.” A socket is a general-purpose IPC mechanism useful for both stand-alone and networked applications. In BSD Unix, sockets are part of the kernel and are accessible by way of system calls. Non-BSD Unix systems provide sockets in the form of libraries—as do other operating systems, including MS-DOS, Mac OS, and OS/2. You can use sockets to distribute a single source code client/server application throughout a population of machines running any of these operating systems, so long as each runs the requisite IP substrate.

If you can carve up an application into processes that run on separate computers, you get the most mileage out of the special capabilities of each computer. One computer, a file server, might control an array of high-capacity drives, applying most of its computing power to the efficient management of all this storage. Another machine, the compute server, may hit its stride when performing complex calculations. Still others—workstations and personal computers—may serve best as user-interface engines running Microsoft Windows, MultiFinder, or the X Window System.

Harnessed to a network, this collection of computers works most efficiently when you can assign the right kind of work to each kind of machine: disk I/O to the file server, number crunching to the compute server, and user interfaces to the display servers. To achieve

that distribution of labor, the processes on each of these machines must be able to communicate with the appropriate processes on the other machines. That’s where sockets come in.

## Anatomy of a Socket

The sockets model generalizes the standard I/O functions that you find in common C language libraries: `open()`, `read()`, `write()`, and `close()`. It augments these functions with data structures and methods that enable these I/O functions to pass data through network connections. The characteristics of a socket are determined by the following:

- the domain in which the socket operates,
- the name structure to which the socket is (optionally) bound,
- the socket type, and
- the socket protocol.

On BSD Unix systems, the most common domain is called simply “Unix” and typically governs the IPCs conducted among processes running on a single system. In that domain, sockets are used for, among other things, the pipes that connect the flow of data from the standard output of one process to the standard input of

**Here’s how to build a portable client/server application for TCP/IP networks**

another. In this installment of *Some Assembly Required*, we focus instead on the Internet domain that governs IPCs that travel through networks.

What about that “optional name structure” mentioned above? When you program with ordinary files, the `open()` call requires as an argument the name of a file. But when you create a socket using the `socket()` call, you specify the socket domain, the socket type, and the protocol; there is no filename or path. There is only a socket number (returned by the function call) that identifies the socket within your application. To export the socket for use outside your program, you’ve got to do some public relations; the socket needs an identity.

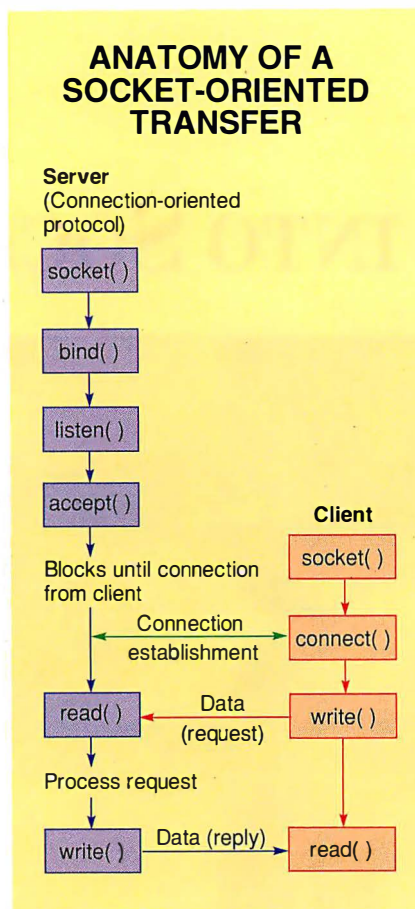
In the BSD Unix domain, this identity—little more than a name for a special file—enables your program to communicate with other processes running on the same system. In the Internet domain, however, the socket needs a more complex identity. The structure of this identity is defined in `<netinet/in.h>` and includes a port number and the Internet address (*netid/hostid*) of the machine running the process that is opening the socket.

Port numbers define entry points for services provided by server applications. The server part of a client/server application associates the service it offers with what is called a “well-known” port number. On Unix systems, port numbers of commonly used well-known services are listed in `/etc/services`. Avoid these numbers unless you want to either use or provide one of the services.

The Internet address is a 4-byte (32-bit) number. This number is usually written as four separate decimal numbers delimited by dots; for example, 192.1.1.5. The Internet address is often associated with a host ID name; the file `/etc/hosts` contains the address-to-name mapping. You can call `gethostbyname()` to inquire about a system by name, or `inet_addr()` to ask about it by address.

## Types and Protocols

In IP terminology, the basic unit of data transfer is a *datagram*—which is basically a header followed by some data. Datagrams are an “unreliable and connectionless” delivery system. But this doesn’t mean that they are a useless delivery system; it simply means that it is not the responsibility of the Internet to confirm that datagrams are delivered. Programs that use IP must do this for themselves, or at least there must be a higher-level protocol (e.g., TCP) that



The typical flow of events for a connection-oriented transfer using sockets. (Figure courtesy of *Unix Network Programming* by W. Richard Stevens, Prentice-Hall, 1990.)

provides the service of reliability.

A socket that works only at the datagram level is called a *datagram socket*. A *stream socket*, on the other hand, requires a reliable connection. Once a connection has been established with a stream socket, the data appears to flow as a constant stream from one point to another. This is called a *connection-oriented* protocol. The examples we’ll present in this article use stream sockets.

Another type of socket is the *sequenced packet socket*, which belongs to the XNS (Xerox Network Services) domain. Still another type, which has the most attractive name of all, is the Reliably Delivered Message socket. A fifth type is the *raw socket*, used by special, privileged programs to access very low-level protocols. For our purposes here, though, we’ll focus just on the stream socket and its application in the development of client/server applications. Master this, and the rest will be easy.

## The Client/Server Connection

TCP/IP stream sockets enable a client program (or *process*, if you prefer) to communicate with a server program. In the client/server model, the server offers some “service” that clients can use. A database server, for example, handles requests from database clients. With such an architecture, several users running the client application can simultaneously add, modify, and retrieve records, while a single process can reliably control access and locking.

If the server is located on one machine and the clients are on others, there must be some way for the clients and servers to communicate and pass data back and forth. With sockets, the server’s first task is to set up a port through which clients can communicate. Once the server has established a port (or ports) and is open for business, it waits for customers to serve. When a client comes to a port (i.e., connects a socket to the port), then the actual client/server business gets under way.

The figure shows the typical sequence of events for a client/server application that uses sockets. We will look at the skeleton of such an application, adapted from a set of programs developed by the BYTE Lab to test high-end file servers (see “File Servers Face Off,” February BYTE). Listings 1 through 5 present the essence of these programs, the socket foundation for any client/server application.

Naturally, we need a server program with which to communicate. Following an example in the book *UNIX Program Design and Development for IBM PCs* by Tom Yager (Addison-Wesley, 1991), we collected all the socket initialization functions in a utility function, `createService()` (see listing 1). This function takes the port number we wish to use (13760 in our case) and returns a socket number (or a negative number if it fails).

Note that all the initialization steps take place in this function, including `socket()`, which creates the socket; `bind()`, which binds the new socket to the name/address structure; and `listen()`, which specifies that the socket will be used as a server. If successful, the server program now “owns” this port, and no other programs can connect to it for the purpose of creating a server. But the port is not actually open for business until the server program calls `accept()`.

Once the socket has been initialized, the server program can then handle a client connection (see listing 2). The `accept()` function does not return until

**Listing 1:** A simple version of `createService`. First we created the address structure. Then we called the `socket()` function to create a TCP socket resource. The `bind()` function associates the socket resource with the port number and the host Internet address in the address structure. Once this is complete, the server then states its intention to `listen()` on that particular socket for communication from clients.

```
int createService( ushort port )
{
    struct sockaddr_in serverSockAddr;
    int serverSocket;

    /* clear and set name/address structure */
    bzero( &serverSockAddr, sizeof( serverSockAddr ));
    /* Convert port number to network byte order. */
    serverSockAddr.sin_port = htons( port );
    serverSockAddr.sin_family = AF_INET;
    /* Allow connections from all clients. */
    serverSockAddr.sin_addr.s_addr = htonl( INADDR_ANY );

    /* Create TCP socket. */
    serverSocket = socket( AF_INET, SOCK_STREAM, 0 );

    /* Bind socket to port and client-address range. */
    bind( serverSocket, &serverSockAddr,
        sizeof( serverSockAddr ));

    /* Set up a queue for up to five connection requests. */
    listen( serverSocket, 5 );

    return serverSocket;
} /* createService */
```

**Listing 2:** The server (parent) process.

```
/* Define a port on which to listen. */
#define Port (ushort)13760
```

a client communicates with the server. This function then returns with a new socket value, which is used for all further communications with the newly connected client task. The well-known socket only serves to establish the initial hookup between the two processes. A socket arbitrator then moves the conversation to another socket number—one that it picks.

### Parent and Child

There are now two sockets. One is bound to the well-known port and was used to establish the initial connection. It is now free to listen for further clients wanting to communicate. The second socket is connected to the client that has just begun communicating.

We don't want to have an `accept()` block the business that is going on with the established socket connection, so we should take advantage of the fact that we are running in a multitasking operating system and split the server into two separate processes. The original process will

continue looking for new clients, and the spawned process will handle requests pertaining to the recently established client/server connection.

We achieve this by executing a `fork()` function, which starts a second copy of the program. At this point, there are two programs executing the same code, but we want them to exhibit different behav-

ior. Both programs are at the same point in execution; they've just returned from a `fork()`.

A process can determine whether it is a parent or a child by examining the process identifier (called the `pid`) returned by the `fork()` function. If the `pid` is 0, then the process is the child and can go ahead with its business. First, though, it should do some cleanup by closing the original socket, which it no longer needs (see listing 3).

However, the original server process (i.e., the parent) needs to continue listening on the well-known socket for other clients that wish to communicate, and therefore it should loop back to `accept()`. This is the purpose of the `while(1)` loop in listing 2.

When the server receives a command to terminate, it should call `shutdown()` and then `close()` (see listing 3). The `shutdown()` function takes as parameters the socket to be shut down and a second, numeric, value. This value may be 0, 1, or 2 and determines how much of

```
main( void )
{
    struct sockaddr_in clientSockAddr;

    int serverSocket;
    int clientSocket;
    int addrLen;
    int pid;

    short result = 0; /* assume success */
    Boolean done;

    /* Create a new socket and init TCP service on selected
    port. */
    serverSocket = createService( Port );

    addrLen = sizeof( clientSockAddr );

    /* Loop while looking for client connection requests. */
    while( 1 )
    {
        /* The following call blocks until a client wants to
        connect. */
        clientSocket = accept( serverSocket, &clientSockAddr,
            &addrLen );

        pid = fork( );

        if( 0 == pid )
        {
            /* the code for the child server goes here. */
            .
            .
            .
        }

        close( clientSocket );
    } /* while */

    return result;
} /* main */
```

**S**tream sockets are not the only kind of sockets that you might want to use across a network.

**Listing 3:** *The child-server code, ready to provide services.*

```

if( 0 == pid )
{
close( serverSocket ); /* child doesn't need original
socket */
done = FALSE;

while( !done )
{
#define MaxBufLen 256
ushort bufLen = MaxBufLen;
ushort opcode;
char buffer[MaxBufLen];

readShort( clientSocket, &opcode );
switch( opcode )
{
/* some case statements for services */
.
.
}

shutdown( clientSocket, 2 );
close( clientSocket );
}

```

**Listing 4:** *A simple version of connectToServer, used by the client to open a connection with a server.*

```

int connectToServer( char *serverName, ushort port )
{
struct sockaddr_in serverSockAddr;
struct hostent *serverHostEnt;
int toServerSocket;
ulong hostAddr;
short result = (-1); /* assume failure */

/* Clear and set server address structure. */
bzero( &serverSockAddr, sizeof( serverSockAddr ));
hostAddr = inet_addr( serverName );
if( (long)hostAddr != (long)(-1) )
{ /* we've got an address */
bcopy( &hostAddr, &serverSockAddr.sin_addr,
sizeof( hostAddr ));
} else

```

```

{ /* Ask host database/name server for host entry. */
serverHostEnt = gethostbyname( serverName );
if( NULL == serverHostEnt )
{
fprintf( stderr, "Can't locate host \"%s\"\n", serverName );
goto egress;
}
/* Copy address from host entry to socket structure. */
bcopy( serverHostEnt->h_addr, &serverSockAddr.sin_addr,
serverHostEnt->h_length );
}
serverSockAddr.sin_family = AF_INET;
serverSockAddr.sin_port = htons( port );

/* Create a socket. */
toServerSocket = socket( AF_INET, SOCK_STREAM, 0 );
connect( toServerSocket, &serverSockAddr,
sizeof( serverSockAddr ));
result = toServerSocket;

egress:
return result;
} /* connectToServer */

```

**Listing 5:** *The client process.*

```

#define Port (ushort)13760 /* that widely known socket port
number */

void main( void )
{
int toServerSocket = -1;

/* Try to connect to a server. */
toServerSocket = connectToServer( svrName, Port );

/* Communicate with server */
.
.
.

/* When done, tell server to terminate process. */
.
.
.

if( toServerSocket >= 0 )
{
shutdown( toServerSocket, 2 );
close( toServerSocket );
}
return result;
} /* main */

```

the network communication to terminate. If the value is 0, then further receives are disallowed. If the value is 1, further transmission is disallowed. If the value is 2, both sends and receives are disallowed. In our case, since we are done with all communication, we select 2. Once all sends and receives are shut down, `close()` needs to be called to release any system resources the socket may have required.

Now that we've got a server, we need to create a client that can use its services. The client program in listings 4 and 5 is simpler than the server. As with `create-`

`Service()` for the server, we gathered the initialization routines into a single function, `connectToServer`, which takes the server's host name or address and a port number and returns a socket value that is used for further communication.

The only tricky part of `connectToServer()` is that you need to be able to locate the machine on which the server is running. As with ordinary file I/O, you then use write and read functions to exchange data with the server. When the client is ready to end the session, it calls `shutdown()` and `close()`.

## Socket to 'Em

The full programs from which we drew these examples are available in electronic format (see page 5 for details). We developed the test programs under MS-DOS 5.0 using the PC/TCP Development Kit from FTP Software and Microsoft C 6.00a. We then ported the programs to SCO Unix System V without a single code change.

The client operates under both DOS and Unix. The server program will not execute under DOS, since DOS is not a multitasking environment. However, you could build a single-task server under

# Your interface doesn't have to be a straitjacket.



C-scape is the most flexible user interface package for text or graphics-based applications.

All too often user interface management systems force you to program with your hands tied. You do things their way or not at all.

C-scape sets you free. It provides powerful features - scrolling windows, mouse support, menus, text editors, help, data entry, etc. - yet lets you tie your own functionality to these objects without touching the underlying code.

What's more, C-scape's object-oriented architecture makes it easy to integrate with any other C library. So you aren't locked into one solution.

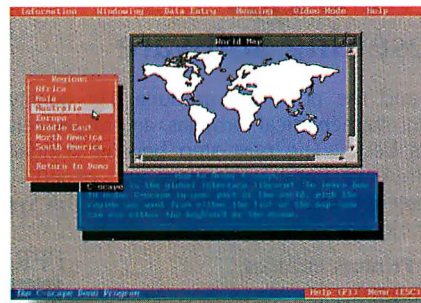
Unlike many other screen managers, C-scape is a true windowing environment. Which makes it powerful enough to tackle the most

demanding user interface requirements.

C-scape is also so easy to use you can affordably build elegant new interfaces even for simple applications and databases.

Prototyping and code generation are no problem. C-scape's Look & Feel interactive screen designer lets you create full featured

screens, test them, and then automatically generate complete C source code or binary screen files.



Applications built with C-scape can run on PC's...

C-scape applications port without modification across DOS, extended DOS, OS/2, UNIX, AIX, the X Window System, QNX and VMS.

And since C-scape supports text and graphics

simultaneously, it's a smart choice for users who want to add graphics to existing text applications.

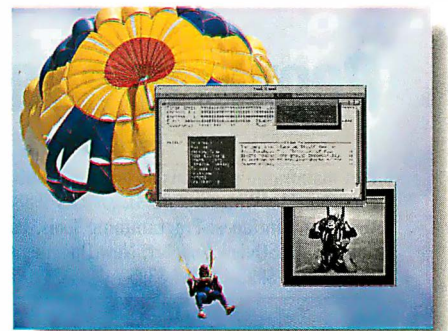
See for yourself why thousands of programmers worldwide use C-scape. Call for a copy today. And escape the interface straitjacket.

Liant is the world's leading supplier of open systems programming tools,

languages, and

libraries. Call for your free Liant product catalogue.

**30 DAY MONEY BACK GUARANTEE. CALL FOR FREE DEMO 1-800-662-9866.**



...and under the X Window System.

# LIANT

In Europe, call our Berlin office at 030-391-5045. Training and international support available.

Liant logo type, C-scape and Look & Feel are trademarks of Liant Software Corp. Other trademarks belong to their respective companies. Copyright © 1991 by Liant Software Corporation, 959 Concord St., Framingham, MA 01701. 508-872-8700, FAX: 508-626-2221.

Circle 141 on Inquiry Card (RESELLERS: 142).

## Make Your Best Work Look Its Best!

Name	Definition
Gamma	$\Gamma(z) = \int_0^{\infty} t^{z-1} e^{-t} dt$
Sine	$\sin(x) = \frac{1}{2i} (e^{ix} - e^{-ix})$
Zeta	$\zeta(s) = \sum_{k=1}^{\infty} k^{-s} \quad (\Re s > 1)$

## PC<sub>T</sub>EX Typesetting Software

For professional publishing and the power to produce high-quality technical documents, scientific notation, mathematical formulas, and tables, rely on PC<sub>T</sub>EX to make your work look its best. The next step beyond standard desktop publishing, PC<sub>T</sub>EX is the difference between average and expert. You'll get professional typesetting at amateur prices. And with our new PC<sub>T</sub>EX Systems, you get everything you need, with no extra costs.

The PC<sub>T</sub>EX System for Laser Printers includes:

- PC<sub>T</sub>EX and PC<sub>T</sub>EX/386, Version 3.1
- Our screen previewer and laser printer drivers
- $\mathcal{A}\mathcal{M}\mathcal{S}$ - $\mathcal{T}\mathcal{E}\mathcal{X}$  and  $\mathcal{L}\mathcal{A}\mathcal{T}\mathcal{E}\mathcal{X}$  Macro Packages
- Free Technical Support

For a free catalog and demo disk, call 415/388-8853. See the best for yourself! Personal  $\mathcal{T}\mathcal{E}\mathcal{X}$ , Inc. • 12 Madrona Ave. • Mill Valley, CA • Fax: 415/388-8865

PERSONAL  
**TEX**  
INC

## SOME ASSEMBLY REQUIRED

Once we have a server, we need to create a client that can use its services.

DOS and communicate to it from another system.

Stream sockets are not the only kind of sockets that you might want to use across a network. And sockets are not the only way to handle IPCs across a network. There are other IPCs for other networks, but sockets are the most widely implemented ones.

The sockets mechanism was initially introduced in BSD 4.2 Unix in 1981. That implementation provided sockets as system function calls; in other words, sockets were built into the BSD kernel. Unix System V release 4.0 employs the streams mechanism for hooking external drivers to the kernel; thus, SVR4 sockets are implemented in terms of streams.

What is impressive is that the same source code that we have provided here can be compiled with little or no modification on any of these disparate systems and implementations, and the sockets work across these different worlds. This is an illustration of reliable IPCs in a truly heterogeneous computing environment. ■

### ACKNOWLEDGMENTS

We wish to thank Tom Yager for all his help and also chapter 5 of his book UNIX Program Design and Development for IBM PCs (Addison-Wesley, 1991), which gave us a jump-start into the world of TCP/IP programming.

Raymond G A Côté, a testing editor for the BYTE Lab, is a certified Macintosh developer. You can contact him on BIX as "rgacote." Ben Smith is a BYTE technical editor and author of the book UNIX Step-by-Step (Howard W. Sams, 1990). You can contact him on the Internet as "ben@bytepb.byte.com" or on BIX as "bensmith."

Your questions and comments are welcome. Write to: Editor, BYTE, One Phoenix Mill Lane, Peterborough, NH 03458.

## People are talking about us.

### F77L-EM/32 & Lahey Ergo OS/386

Port mainframe programs as large as 96MB to 386/486's with this 32-bit DOS-Extender compiler. The Winner of PC Magazine's 1988 Technical Excellence Award just got better. New Version 4.0 includes: Programming Tools, Popular Fortran 90 features, Virtual Memory Support, DESQview Support, New Documentation and Free Unlimited Runtime Licenses. F77L-EM/32 \$995 OS/386 \$395

### F77L

The fastest real-mode compiler available. F77L can take advantage of your 386 PC by generating 32-bit instructions. New Version 5.0 includes: Fortran 90 features, Weitek support, and Video Graphics. \$595

### Lahey Personal Fortran 77

Version 3.0: Full ANSI 77, Editor, Debugger, Linker, Library Manager, Microsoft and Borland C interfaces. A great learning tool at an unbeatable price. \$99



When people talk about FORTRAN the name mentioned most often is

**Lahey**  
Computer Systems Inc.

Contact us to discuss our products and your needs. (800) 548-4778  
Lahey Computer Systems, Inc. P.O. Box 6091, Incline Village, NV 89450  
Tel: (702) 831-2500 FAX: (702) 831-8123

**FORTRAN IS OUR FORTE**

# HASP™

## The Professional Software Protection System

See us at



Aladdin is a world leader in the field of software protection. During the last six years we have helped thousands of software producers in more than 40 countries to protect their software.

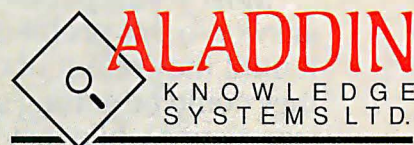
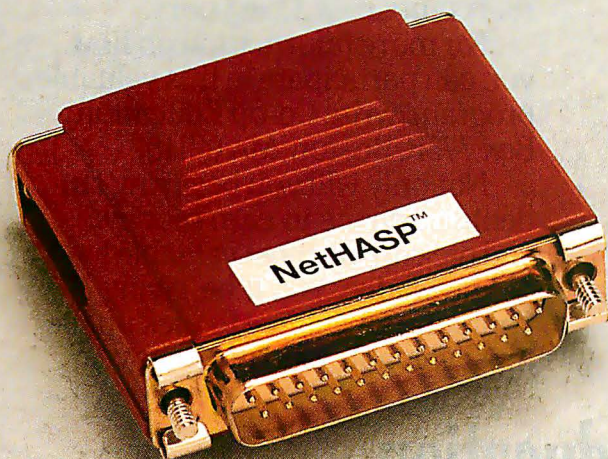
The HASP™ system is based on advanced ASIC (Application Specific Integrated Circuit) components and sophisticated encryption algorithms. State-of-the-art engineering ensures full protection of your software with no hassles for your customers.

HASP plugs are designed for the IBM PC & PS-2 families and their compatibles, as well as for Apple-Macintosh computers. Full software support is provided for dozens of languages and compilers under DOS, OS/2, WINDOWS-3, SCO XENIX, SCO UNIX 386, AIX, PHAR-LAP, and AUTOCAD.

NetHASP™, the latest addition to the HASP family of software protection systems, makes it possible to activate a protected program from several stations in a network using only **one** plug.

NetHASP works both on Novell networks and on those based on the NET-BIOS protocol, and it can therefore be used on almost any LAN.

To learn more about why so many professionals have chosen HASP, please contact:



15 Beit Oved St., Tel-Aviv, Israel  
P.O.Box: 11141 Tel-Aviv 61110,  
Tel: 972-3-5375795  
Fax: 972-3-5375796

**In North America:**

### ALADDIN SOFTWARE SECURITY

306 Weymouth St.,  
Dix Hills, NY 11746, USA  
Tel: 800-223 4277, 516-586 2845  
Fax: 516-586 1602

**Australia** Conlab Pty. Ltd., Tel: 3 8985685, Fax: 3 8995759  
**Belgium** Akkermans Intl. bvba, Tel: 3 2338826, Fax: 3 2315438  
**Czechoslovakia** ATLAS Ltd., Tel+Fax: 2 821280  
**Denmark** SC Metric a/s, Tel: 42 804200, Fax: 42 804131  
**France** Logidata Intl., Tel: 50707375, Fax: 50753144  
**Germany** CSS GmbH, Tel: 201 74970, Fax: 201 748644  
**Greece** Unibrain SA, Tel: 1 6465195, Fax: 1 6423648  
**Holland** Akkermans Automatisering BV, Tel: 45 241444, Fax: 45 245515

**Italy** Partner Data S.r.l., Tel: 2 33101709, Fax: 2 347564  
**Korea** Hanil System Inc., Tel: 2 5639161-5, Fax: 2 5538079  
**New Zealand** The Training Solutions Co., Tel: 4 666014, Fax: 4 697190  
**Poland** System Tel: 061 45065, Fax: 061 324134  
**Portugal** Futurmatica Lda., Tel: 1 4116269, Fax: 1 4116277  
**Spain** PC Hardware, Tel: 3 2493193, Fax: 3 3337497  
**Switzerland** Opag Informatik AG, Tel: 61 7112245, Fax: 61 7115355

**Circle 12 on Inquiry Card.**

# HOW DO YOU GET A JOB WITHOUT EXPERIENCE? AND HOW DO YOU GET EXPERIENCE WITHOUT A JOB?

Most young people have one answer to this problem. They avoid it until they're out of college. But they could be getting solid work experience while they're still in college. With your company's help. And ours.

We're Co-op Education. A nationwide program that helps college students get real jobs for real pay, while they're getting an education.

But we can't do it without you.

Those real jobs have to come from real companies. Like yours.

For more information on how you can participate in this valuable program, write Co-op Education, Box 775E, Boston, MA 02115.

Not only will you be giving students a chance to earn money and pick up the most valuable kind of knowledge, you'll be giving yourselves a chance to pick up the most valuable kind of employee.

## Co-op Education.

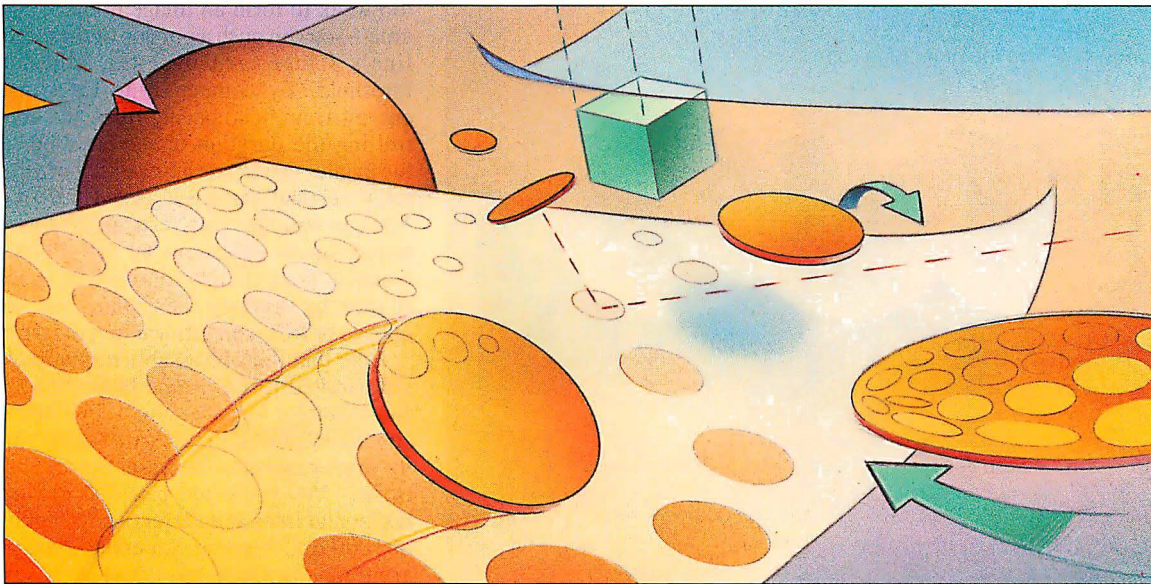
You earn a future when you earn a degree.



A Public Service of This Publication ©1987 National Commission for Cooperative Education



## ENHANCING LASER- PRINTER RESOLUTION



**T**he hottest laser battle going has nothing to do with the world of science fiction. But you could still say that it's in the realm of special effects. How can you make the eye see smoother lines and better halftones? Laser-printer manufacturers are tuning their engines so that they can produce pages with effective resolutions beyond the familiar 300-dot-per-inch limits. I'll look at some of the techniques that companies like Apple, DP-Tek, Hewlett-Packard, LaserMaster Technologies, and XLI use to achieve these effects.

There are two general approaches to resolution enhancement: edge smoothing and gray-scale enhancement. The former approach includes Apple's FinePrint, DP-Tek's Super Smoothing Technology (SST), HP's Resolution Enhancement Technology (RET), and LaserMaster's TurboRes. Gray-scale enhancements include Apple's PhotoGrade, DP-Tek's LaserPort Grayscale controller, and XLI's Super LGA.

For most people, laser printers are synonymous with quality and precision. Relative to what a dot-matrix printer can do, a laser printer produces amazingly sharp, consistent output. But, if you look closely, you can still see the jagged edges along sloped lines and curves. If you magnify the pixels, you will see that they are not perfectly round. You may also see stray specks of toner around the edges and between pixels. These imperfections are a consequence of the indirect nature of laser printing.

The direct imaging process that phototypesetters use exposes light-sensitive paper, or *film*, to a light source such as a laser. Responding to small variations in the light intensity, this process produces images that are extremely sharp. Resolution is typically from 1200 to 2400 dpi.

Laser printers, by contrast, use an indirect process. The laser exposes a light-sensitive print drum and creates an electrically charged image on the drum's surface. Toner particles receive an opposite charge, so they are attracted to the image that the laser forms. The printer engine then transfers the image to a piece of paper and fixes it in place by heat fusion.

### Basic Theory of Resolution Enhancement

How can this process be tweaked to boost resolution? Within limits, you can reliably modulate the laser at a higher clock rate than the default for a 300-dpi printer, thereby boosting the horizontal resolution beyond 300 dpi. The higher horizontal resolution improves the shape of nearly vertical edges but does little for those that are nearly horizontal. Most laser printers conveniently provide a video I/O port through which an

**Thanks to an assortment of clever techniques, standard laser printers are producing sharper vector graphics and more photo-realistic images**

external controller card can directly regulate the laser modulation.

Vertical resolution is a different kettle of fish. It's controlled by the interaction between the drum and a rotating mirror, which creates the scan lines. In a typical laser-printer engine, there are 300 scan lines for every inch of travel; therefore,

the vertical resolution is fixed at 300 lines per inch (400- and 600-lpi engines are also available). Theoretically, you could make mechanical alterations to existing printers to control vertical resolution. However, the complications and expense of such modifications make this approach impractical. Instead, strategies

for enhancing vertical resolution exploit quirks of the printing process.

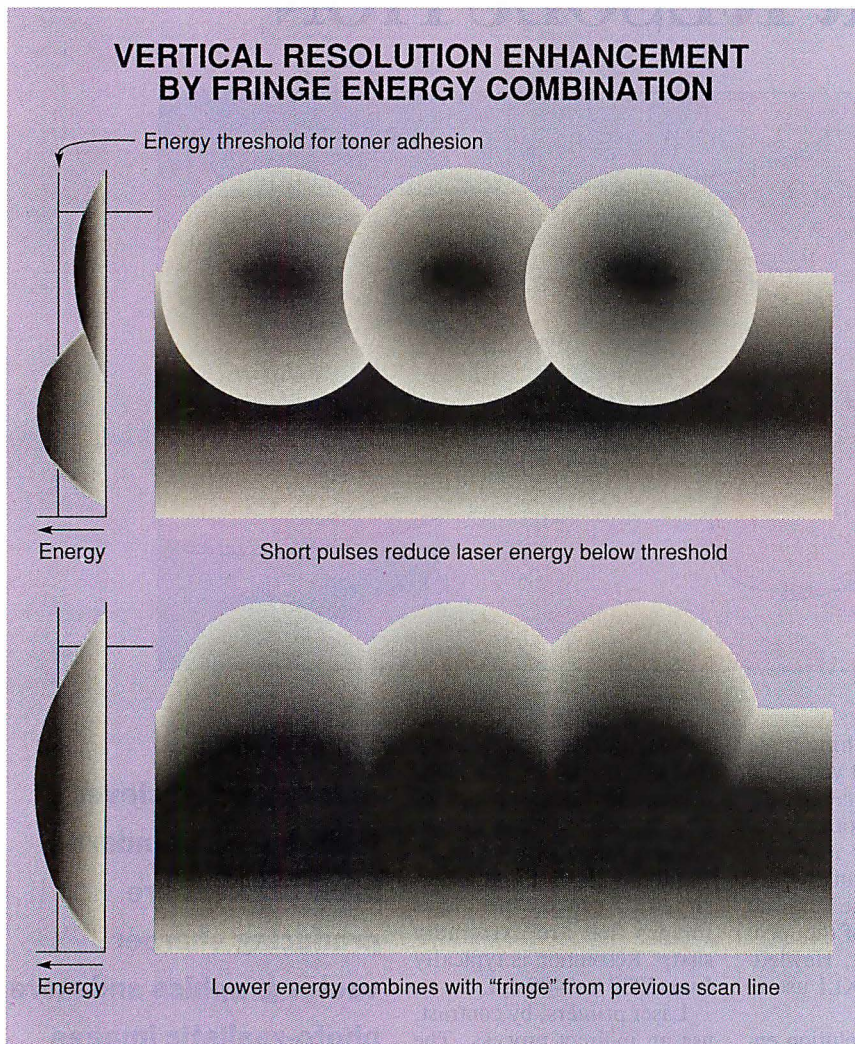
At the fringes of the laser's beam, the intensity drops off, much like a flashlight's beam, which has a bright center spot surrounded by a dimmer halo. The region of the drum under this fringe area doesn't receive enough energy to make the toner stick to the drum. However, if you augment the fringe area's charge with a brief pulse of laser light on a preceding or following scan line—a pulse too weak to form an image in the fringe area—you can push a portion of the target line's fringe area over the adhesion threshold. By compensating for fringe energy from neighboring lines and controlling the duration of the laser burst, the printer can create a line or dot of arbitrary vertical thickness (see figure 1). You can simulate this vertical resolution enhancement effect on an HP Printer Control Language-compatible laser printer by sending the printer the sequence of PCL code shown in listing 1.

Note that the addressable resolution is still limited to the frame buffer's size; for example, consider the 1000- (horizontal) by 400-dpi (vertical) frame buffer implemented in the LaserMaster controller. You could not plot 500 distinct horizontal lines at an effective resolution of 1000 dpi. But you can create lines of arbitrary thickness and therefore have a higher effective vertical resolution along the edge. By gradually tapering the line thickness while moving horizontally, you can form an edge with steps of finer granularity than that of the frame buffer. The effective resolving power can be nearly continuous, limited more by other factors (e.g., toner particle size) than by laser-modulation rates.

DP-Tek takes a different tack with its TrueRes technology. TrueRes doubles both the horizontal and vertical resolution and gives you access to each pixel through a 600- by 600-dpi frame buffer.

## Make Way for Gray

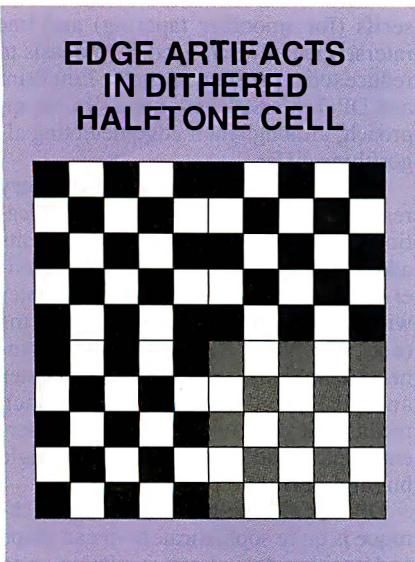
Because a laser printer can print only black or white, gray areas in images (e.g., photographs) must be approximated with patterns of black and white. Laser-printer enhancement technology uses two approaches. The first technique, exemplified by DP-Tek's Laser-Port Grayscale controller, modulates the laser to produce an even spray of toner over an area. The density of the toner determines the gray level. The resulting images resemble photographs and are particularly well suited to direct production of photo-realistic images. However, the detail is too fine for reproduction on



**Figure 1:** A weak pulse of laser light on the upper scan line combines with fringe energy delivered to the lower scan line to fatten the line. The upper part of the diagram shows an ideal situation in which the two scan lines do not interact; the lower part shows the actual, combined effect. (Courtesy of LaserMaster Technologies)

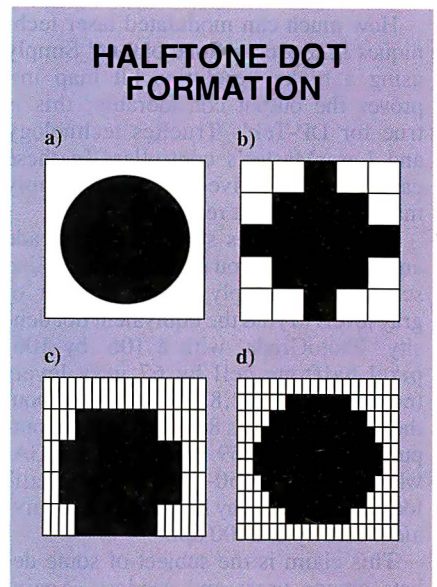
### Listing 1: Simulating vertical resolution enhancement on a PCL printer.

```
[Esc]*t300R
[Esc]&l.16C[Esc]*r0A
[Esc]*b16WUUUU[255][255][255][255][Esc]*b16W[255][255][255][255][255][255][255][255]
[Esc]*rB
[Esc]&l8C
[FF]
```



◀ **Figure 2:** Pixel doubling makes the edges of this dithered halftone cell stand out.

**Figure 3:** Both horizontal and vertical resolution enhancement benefit the precision with which a halftone dot can be formed. The figure shows (a) an ideal halftone dot, (b) a halftone dot emulated at 300 dpi, (c) a halftone dot improved with horizontal resolution enhancement, and (d) a halftone dot improved with both vertical and horizontal resolution enhancement.



an offset printing press.

The other technique is called *halftoning*. When you output a bit map to a PCL printer, the application typically creates dithered halftone cells that behave like metapixels. Within each cell, the number of pixels that are on (black) or off (white) determines the gray level of the cell (see figure 2). There will be  $n^2 + 1$  gray levels, where  $n$  is the number of pixels along one side. As you increase the gray levels, you get a more realistic selection of gray shades, but you lose resolution. This resolution, the number of halftone cells per inch, is called the *line screen*. It is measured in lines per inch.

If you are reproducing your work on a printing press, it is important to select the appropriate line screen; for example, in a newspaper, 65 to 85 lpi is fairly standard. Other presses used for magazines and corporate brochures print at screen resolutions of from 133 to 200 lpi.

PostScript printers cluster pixels in a cell to emulate a halftone dot. Figure 3a shows a cell with a 50 percent halftone dot, and figure 3b shows one possible emulation of that pattern at 300 dpi. You can alter the cell's fill pattern to change the effect, or you can rotate to change the screen angle.

**Complexities of the Halftone Process**

The task of producing good halftone output is fraught with complications. What prints well on a laser printer may not reproduce so nicely on an offset press. The number of pixels in a halftone cell—whether evenly dithered or dot-clustered—determines the gray level. Given a specific line screen (60 lpi) and the printer's resolution (300 dpi), you can

calculate the size of the halftone cell—in this case, 5 by 5 pixels. A 50 percent gray level would fill half of these cells (i.e., 12 or 13).

But which 13 cells should be filled? With straight dithering, the resulting gray level will have a fairly even tone, yet a cell may exhibit artifacts. In figure 1, for example, the edges of the cell stand out because the pixels meet. This problem could be solved by moving to an even-numbered cell size (e.g., a 4- by 4-pixel cell, or a 75-lpi screen). But this approach introduces yet another problem. When printed on an offset press, the cell behaves like a 212-lpi screen—the al-

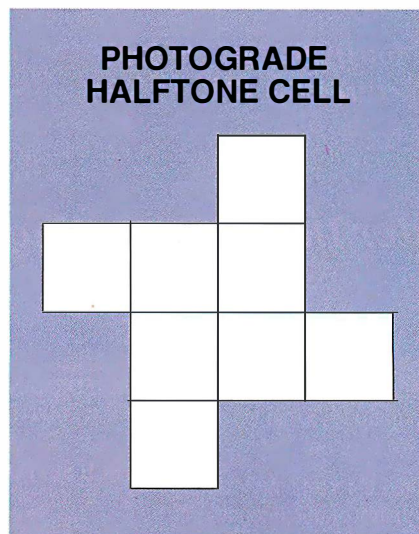
ternating pattern (at 300 dpi) creates rows of pixels at a 45-degree angle within the cell itself—too fine for accurate reproduction.

**Halftoning with Resolution Enhancement**

Resolution enhancement gives you the opportunity to emulate a halftone dot more precisely. Figure 3c shows what the LaserMaster controller can do. Because it's pixel-addressable along the x-axis, horizontal resolution enhancement improves the shape of the emulated dot. XLI's Super LGA technology goes a step further: It applies both horizontal and vertical enhancement techniques to the formation of the halftone dots (see figure 3d). As a result, even more gray levels are available than through a simple horizontal resolution boost.

In some cases, the halftone cell may not be square. Apple uses a rather unusual shape with PhotoGrade. The default cell pattern for PhotoGrade (see figure 4) results in a 45-degree, 106-lpi screen with 67 gray shades. The shape looks somewhat odd, but Apple claims that it lends itself to efficient calculations, thus improving rendering speed.

Halftone imaging can dramatically cut data-storage requirements. Consider a 16- by 16-pixel halftone cell. Such a cell supports 257 shades. If the pixels were stored individually as a bit map, they would require 256 bits, or 32 bytes of memory. When converted to a halftone cell, the same image area can be stored as a single byte, because 256 gray levels can be described by one 8-bit selector. That's a dramatic reduction in memory requirements.



**Figure 4:** The unusual shape of Apple's PhotoGrade halftone cell lends itself to efficient calculations and speedy rendering.

*continued*

How much can modulated laser techniques improve halftone output? Simply using a higher-resolution bit map improves the output considerably; this is true for DP-Tek's TrueRes technology and LaserMaster's controller. In these cases, the effective resolution simply matches the output resolution.

With techniques such as PhotoGrade and Super LGA, you must square the line screen and multiply by the number of gray levels to find the equivalent dot density. PhotoGrade, with a 106- by 106-pixel halftone cell by 67 gray levels (equivalent to 752,812 dots), has about the same density as 867-dpi dithered output ( $867^2=751,869$  dots). Super LGA, which claims a 150- by 150-pixel halftone cell by 256 gray levels, has an equivalent density of 2400 dpi.

This claim is the subject of some debate among users and vendors. Again, due to the indirect nature of the process, a region of dark grays may saturate to black. Similarly, light areas may not meet the threshold and print white. In other mixed areas, the interaction allows additional detail to appear, and the resulting images are quite impressive.

## Different Strokes for Different Vendors

Laser modulation is now quite common for vertical resolution enhancement. But the implementation can vary significantly from company to company. One difference lies in where the resolution enhancement is processed—before or after the image is rasterized (i.e., converted into a pixel-by-pixel image). For example, LaserMaster, one of the pioneers in vertical resolution enhancement along edges, stores data as idealized images. This technique reduces the memory demands on the frame buffer. As each character prints, the TurboRes algorithm applies the ideal image shape to the real-time rasterization process. Hence, a stroke of fractional width can be rasterized as a fractional width.

HP's widely recognized RET takes the other tack. RET alters the image after it has been rasterized. The printer stores six lines of data and compares the pattern formed by each pixel and its nearest neighbors to known edge patterns. If a match is found, the printer modulates the laser to smooth the edges. Stored patterns include objects such as

serifs (for smoother tapering) and line intersections (which need deemphasis to reduce toner pooling). Apple's FinePrint and DP-Tek's SST both use a similar approach, although their edge-detecting algorithms differ.

Where does the enhancement circuitry reside? Apple and HP make modifications to the printer. These enhancements add to the appeal for a particular model—and you can use the same printer with any number of hardware platforms (e.g., Macintosh, ISA, and Micro Channel architecture systems). LaserMaster and XLI supply add-in cards, which means that you can upgrade many different printer models but are tied to a single bus architecture.

DP-Tek's TrueRes modulation technique is quite sophisticated—it can shape and position dots at any resolution up to double that of the native engine. By combining this effect with pixel-by-pixel addressability, TrueRes can reproduce odd resolution images, such as a fax (203 by 98 pixels or 203 by 196 pixels) or 240 by 240 pixels (a fairly standard resolution in Japan). These features are available in chip sets that laser-printer

“... **ISYS** replaces ZyINDEX for DOS as the industry standard for unstructured DOS text retrieval programs.”† PC Sources 11/91

*Text retrieval faster than a speeding bullet...*

Usually, the time you want to find information most is when you're in the middle of something. Without exiting your work, pop up ISYS, get what you need, then copy and paste it into whatever you're working on!

Don't take our word for it. PC Week, May, 1991, rated ISYS tops in flexibility and functionality, as well as file compatibility and quality of documentation.\*

**\$99 TRADE-IN OFFER: Send us your ZyINDEX disk and receive your ISYS replacement by return mail. \$395 value.**

### SEARCH CAPABILITIES

- Full range of capabilities: Boolean logic, Proximity, Wildcard and Phrase searches.

**ISYS** 2.0    **ZyINDEX** 3.1 for DOS

**YES**    **YES**

### EASE OF USE

- Terminate-and-stay-resident (TSR) option; ability to run search without leaving your document.
- Activate word processing documents from within the search program.
- Cut and Paste to anywhere in your document.
- All functions from main menu. No need to return to DOS to execute functions.

**YES**    **NO**

**YES**    **NO**

**YES**    **NO**

**YES**    **NO**

### PERFORMANCE

- Consistently faster indexing and retrieval.\*
- Network pricing based on concurrent usage.

**YES**    **NO**

**YES**    **NO**

### TECH SUPPORT

- Unlimited toll-free technical support.

**YES**    **NO**

Free **ISYS** Demo Disk:  
**1-800-992-ISYS**  
(1-800-992-4797)\*

**od**

17th Floor, 3900 West Alameda Avenue, Burbank, CA 91505, (818) 972-1798 Fax (818) 972-1636 **ODYSSEY DEVELOPMENT**

\*PC Week comparative review (May 20, 1991) revealed search times between 25% and 53% faster than ZyINDEX. **Circle 147 on Inquiry Card (RESELLERS: 148).** and index creation time 32% faster than ZyINDEX (tests performed by PC Week Labs on identical databases).

†PC Sources, November 1991

© 1992

# Up to Date. Down to Earth.



UNIX is changing the world of computers, the world of business – quite simply, changing the world. It's revolutionizing office automation. It's required for U.S. government computer contracts. It's the backbone of information strategies worldwide.

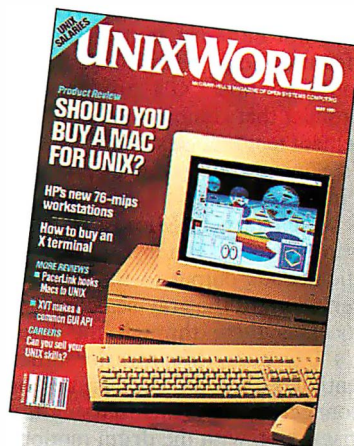
That's why you need **UNIXWORLD** – the magazine that keeps you up to date on the rapidly changing world of open systems computing. Each issue brings you the latest product trends and technical advances that can affect your business. The inside story on some of the biggest high-tech companies. Easy-to-understand programming tips and tutorials that can help your company use UNIX to its fullest. And unbiased hardware

and software reviews to help you invest wisely when you buy.

**UNIXWORLD's** in-depth features go beyond dry technical facts to show how the pieces fit together – to tell you what's important about the advances and strategies that are changing your world. And **UNIXWORLD** consistently offers the freshest, most down-to-earth writing that you'll find in any computer publication.

Subscribe today and receive the next 12 issues of **UNIXWORLD** for just \$18.00 – half the regular newsstand price. Save even more by ordering for two or three years. You can't lose – every subscription to **UNIXWORLD** comes with a no-risk guarantee\*.

**Subscribe now!**  
**Call toll-free:**  
**1-800-257-9402 ext. 29**



**If you're into UNIX, you need**

**UNIXWORLD**  
McGraw-Hill's Magazine of **OPEN SYSTEMS COMPUTING**.

\***UNIXWORLD's** no-risk guarantee: If not satisfied, cancel and receive a full refund for the balance of your subscription. UNIX is a registered trademark of UNIX System Laboratories, Inc.

DH1AUW9

vendors can purchase. The individual vendors then market a modified engine that competes with HP and Apple by adding value to the printer. TrueRes is also available in the form of a separate controller called TruePoint, so you can use it to upgrade existing laser printers.

LaserMaster emphasizes master-page production for offset printing, where clean edges and faithful reproduction of type is important. TurboRes claims a 1000- by 1000-dpi resolution, although the continuous nature of vertical enhancement allows much finer vertical control. As of this writing, LaserMaster does not store bit-mapped data in a halftone format. Instead, the company uses a dithered frame buffer that matches the vertical scan density of the engine (400 lines for its own hardware) and boosts the horizontal resolution to 1000 dpi. LaserMaster's dithering algorithms faithfully reproduce variable line screens and angles. It supports both PC and Macintosh platforms. The company also supplies adapters for 300-dpi laser printers, as well as its own printer, which uses a 400-dpi engine.

By the time you read this, LaserMaster will have announced an upgrade called TurboGray that applies TurboRes vertical-resolution enhancement techniques to halftone images. By preprocessing several formats (e.g., PostScript and PCL 4), LaserMaster controllers can apply the proper enhancement technology to the right image—edge or bit map.

Whereas LaserMaster stresses edge enhancement and applies dithering methods to halftone images, XLI enhances halftone images with shaped (i.e., vertically enhanced) dots. As of this writing, XLI does not enhance text, although such a feature should be available by the time you read this. XLI produces an OEM product that combines other edge-enhancement technologies to text.

XLI's Super LGA technology is embodied in the company's LaserPix controller, which targets Microsoft Windows applications. When a Windows application sends output to the printer, the LaserPix grabs the gray-scale images and processes them through the laser printer's I/O port. Meanwhile, other data continues through the parallel or serial connection. By synchronizing the I/O transmission with the drum motion, the LaserPix can add the enhanced images while the page prints. If the laser printer supports edge smoothing (as the LaserJet Series III does), your output can have the combined enhancements of both technologies.

The LaserPix controller provides only

two screens: 75 lines at a 63-degree angle and 150 lines at a 0-degree angle. Both screens use 256 gray levels. For most offset printing, 150 lines is too fine. XLI has targeted this resolution for use in imaging applications, where direct output is useful or economical; for example, medical imaging and electron microscopy often use expensive Polaroid cameras to capture images. With the LaserPix, you can use a laser printer as a fairly inexpensive substitute for photographic reproduction.

Print speed is also emphasized with the LaserPix. Indeed, screen selections have been limited to optimize the rasterization algorithms. The controller transfers images to the printer much faster than a parallel or serial port. As long as the print run is fairly small, the system is useful for multiple copies.

Apple includes edge and gray-scale enhancement on its printers. FinePrint provides the edge enhancement, and PhotoGrade improves gray-scale images. These technologies are available in the new LaserWriter IIF and IIG Grayscale printers.

Apple uses a mix of pre- and postprocessing to keep PhotoGrade and FinePrint from interfering with each other. The FinePrint postprocessing circuitry recognizes the PhotoGrade format and turns itself off when a bit-mapped image is processing. Earlier, I showed you that PhotoGrade uses 67 gray shades—a seemingly strange choice, since that works out to 8.375 levels per pixel. Why not an even 8 or 9 levels? Due to variations in physical properties (e.g., toner particle size), what may appear as subtly different shades of gray in one print run may appear as the same shade in the next run. Apple's experiments showed that 67 levels per halftone cell was a practical maximum for consistent results. In fact, the PhotoGrade format allows for 16 levels per pixel (or 128 levels per cell), so Apple is leaving room for expansion.

**Pushing Laser Printers to the Limit**  
Apple is taking a conservative approach in limiting its gray scale to 67 shades. It is possible to push the engine to higher effective resolutions, as companies such as XLI are doing. But even at claimed effective resolutions of 2400 dpi, it would be premature to proclaim the demise of the phototypesetter. Although the effective resolutions offered by these enhancement techniques approach or exceed the levels offered by typesetters, the laser-printer images are not as sharp. The interaction between toner and drum and even gear noise from the paperfeed

mechanism (which appears as dark bands on the printout) limit the clarity of plain paper output.

Nevertheless, many applications do not require the full clarity of phototypesetter output. Enhanced laser-printer output offers a marked improvement over standard 300-dpi printing. Certainly, there are many people who use 300-dpi pages for camera-ready output. For these users, resolution enhancement offers a cost-effective path to higher quality. You can also directly use the plain paper output of a laser printer for applications as simple as correspondence or as complex as small-volume production. With the various enhancement options available, you can select a price and features that are appropriate for your specific task. ■

*Bradley Dyck Kliewer is the principal of DK Micro, a PC and AS/400 consulting firm in Minneapolis, Minnesota. He is author of EGA/VGA: A Programmer's Reference Guide, 2d ed. (McGraw-Hill, 1990), and he can be reached on BIX as "bkliewer."*

### COMPANY INFORMATION

**Apple Computer, Inc.**  
20525 Mariani Ave.  
Cupertino, CA 95014  
(408) 996-1010

**Circle 977 on Inquiry Card.**

**DP-Tek, Inc.**  
9920 East Harry  
Wichita, KS 67207  
(800) 727-3130  
(316) 687-3000  
fax: (316) 687-0489

**Circle 978 on Inquiry Card.**

**Hewlett-Packard**  
3000 Hanover St.  
Palo Alto, CA 94304  
(800) 752-0900  
(415) 857-1501

**Circle 979 on Inquiry Card.**

**LaserMaster Technologies, Inc.**  
7156 Shady Oak Rd.  
Eden Prairie, MN 55344  
(800) 477-7717  
(612) 944-9330  
fax: (612) 943-3469

**Circle 980 on Inquiry Card.**

**XLI Corp.**  
800 West Cummings Park, Suite 6650  
Woburn, MA 01801  
(800) 338-0506  
(617) 932-9199

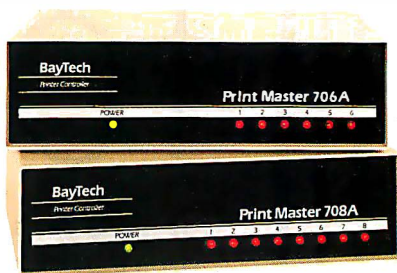
**Circle 981 on Inquiry Card.**



**33000**  
CHARACTERS PER SECOND

BayTech takes you a step into the future with...

# HIGH SPEED PRINTER SHARING



*Print Master®  
Model 706A  
and 708A*

## OUTSTANDING FEATURES:

- High speed printer sharing
- 6 or 8 parallel ports
- 33000 cps input/output
- 4MB buffer capacity with 1MB standard
- Port selection in Windows® and graphics applications
- Processes up to 660 pages of text per port, per minute
- Processes up to 2.6 pages of graphics per port, per minute
- Other 4 to 24 port printer sharing solutions also available
- Unlimited toll-free tech support

## YOUR PRINTER SHARING ADVANTAGE

Print Master® 706A and 708A are high speed parallel printer sharing solutions designed for large text and graphics applications. Both units support up to 33000 characters per second input/output and feature a 1MB buffer that is field upgradeable to 4MB.

The large buffers and high speed parallel ports allow your graphic workstations, network file servers, and standalone PCs to quickly off-load print jobs which will enable them to perform more important tasks.

With more than 1 million connections, BayTech has been serving users for over 15 years. Buy with confidence and let BayTech be your printer sharing solution. For reliable, high performance, affordable printer sharing devices—multiplexers, modems, and data acquisition/control devices, contact a BayTech representative *today!*

Because Resources Should Be Shared



Bay Technical Associates, Inc.  
Data Communication Products Division  
200 N. Second Street, P.O. Box 387  
Bay Saint Louis, MS 39520

Fax: 601-467-4551  
Phone: 601-467-8231 or toll-free

**800-523-2702**

### INTERNATIONAL DISTRIBUTORS

<b>Australia</b> Shuttle Computer Systems (03) 596 8888	<b>Finland</b> Genine Oy Impdata (921) 547200	<b>Italy</b> Torino BRM Italiana (011) 771.00.10	<b>Norway</b> A/S Kjell-Bakke 47-6-832000	<b>Switzerland</b> Sengstag Computers AG 0041.1.950.54.44
<b>Belgium</b> Multiway Data Belgium 03-666-3854	<b>France</b> Gradoo France (1) 42 94 99 69	<b>Milano</b> I.T.D. (02)749.0749	<b>Singapore</b> Mark Systems (FE) Pte., Limited 65-2261877	<b>United Kingdom</b> A-Line Datasped Devices Ltd. 0533-778899
<b>Denmark</b> Trend Communications A/S 53 65 23 45	<b>Germany</b> Munich AMS Computech GmbH (089) 126806-0	<b>Mexico</b> Intertec (52-83) 33-6622	<b>Spain</b> Vidmar Control (93)2454803	<b>Trend Communications</b> Limited (0628) 530611
	<b>Dusseldorf</b> Multiway Data Germany 0211-251875	<b>Netherlands</b> Multiway Data Netherlands 079-424 111	<b>Sweden</b> Maldata Teknik AB 46-8-705 3 6 00	

Circle 22 on Inquiry Card (RESELLERS: 23).



# Reading worth writing for.

If you're looking for some good reading, you've just found it. The free Consumer Information Catalog.

The Catalog lists about 200 federal publications, many of them free. They can help you eat right, manage your money, stay healthy, plan your child's education, learn about federal benefits and more.

So sharpen your pencil. Write for the free Consumer Information Catalog. And get reading worth writing for.



**Consumer Information Center  
Department RW  
Pueblo, Colorado 81009**



# NETWORK SLEUTH

**T**he PC program this month is QVersion, a NetWare utility that tells you configuration information for each user. QVersion will help when you install the new version of the NetWare NetX.COM shell program. NetX 3.3 fixes a bug described in my December 1991 NetWorks column ("The Black Art of Networking").

The problem was that local buffering of files within NetX sometimes lost data before it could write it to the file server. If you're using version 3.01E through 3.22 of the NetX shell, contact your NetWare dealer for the free upgrade to version 3.3.

You can ask that all users on your network install the new version of NetX in their machines, but how can you tell who followed instructions? QVersion lets you quickly survey your entire LAN to ensure that everyone is using up-to-date network software. It displays each user's log-in name, Internet Packet Exchange (IPX) and NetX versions, network address, adapter ID (i.e., node address), and last log-in date and time. If you have console operator rights, you can use the program if you install it in the "public"

## QVersion lets you quickly discover any NetWare user's network configuration

directory on your file server.

Run QVersion to see the status of all nodes. To see one user's configuration, type QVERSION followed by that user's log-in name. You need type in only the first few letters of the log-in name; QVersion will do the rest. The program doesn't scroll output, so be sure to type QVERSION | MORE to view the results one screen at a time, or type QVERSION < FILENAME to send the output to a file.

### Behind the Curtain

QVersion is freeware. I wrote it in Turbo C and included the source code.

You don't need a separate third-party function library to do network programming. QVersion is self-contained. The `int86x()` call returns an entry point that

you use to communicate with (and through) IPX and NetX. QVersion stores the entry point in a far-pointer-to-a-function data item. The utility performs IPX/NetX operations merely by invoking the function.

QVersion first looks for active (i.e., logged-in) nodes by using a `GetConnectionInformation()` function call for each connection number. This call returns the user ID and log-in time (the same information displayed by NetWare's Userlist utility). QVersion sends a diagnostic query packet to each active workstation with a `SendIPX()` call. It uses a `GetInterNetworkAddress()` call to obtain the network number and node address. The `GetLocalTarget()` call tells QVersion if the `SendIPX()` packet must cross one or more bridges on its way to the other node.

QVersion next sets up a special diagnostic sequenced-packet-exchange session with the target workstation and requests the IPX and NetX version. It stores the returned IPX and NetX version data, terminates the SPX session, displays the results, and moves on to the next workstation. ■

## UNIX/Ben Smith

### Mail Prep Made Easy

**T**he freeware programs `uuencode` and `uudecode` are quite simple utilities that prepare binary files for transfer over Unix mail systems. Although simple, they have become standard utilities found throughout the Unix community. If they aren't already on your Unix system, they should be.

Unix mail systems transfer and store messages only as text files, despite the fact that the UUCP system can transfer binary files. The `uuencode` program generates a map of the binary file using only the printable 7-bit characters. By using some clever bit-shifting, developer Mark Horton is able to use only four ASCII characters to represent 3 binary bytes. Counting the extra overhead of a header, a trailer, and the end-of-line character in every 45-character line, the net increase is only 35 percent. A hexadecimal dump would require a 100 percent increase in file size. The `uuencode` and `uudecode` programs make it possible to send binary files as mail messages.

## MAC/Tom Thompson

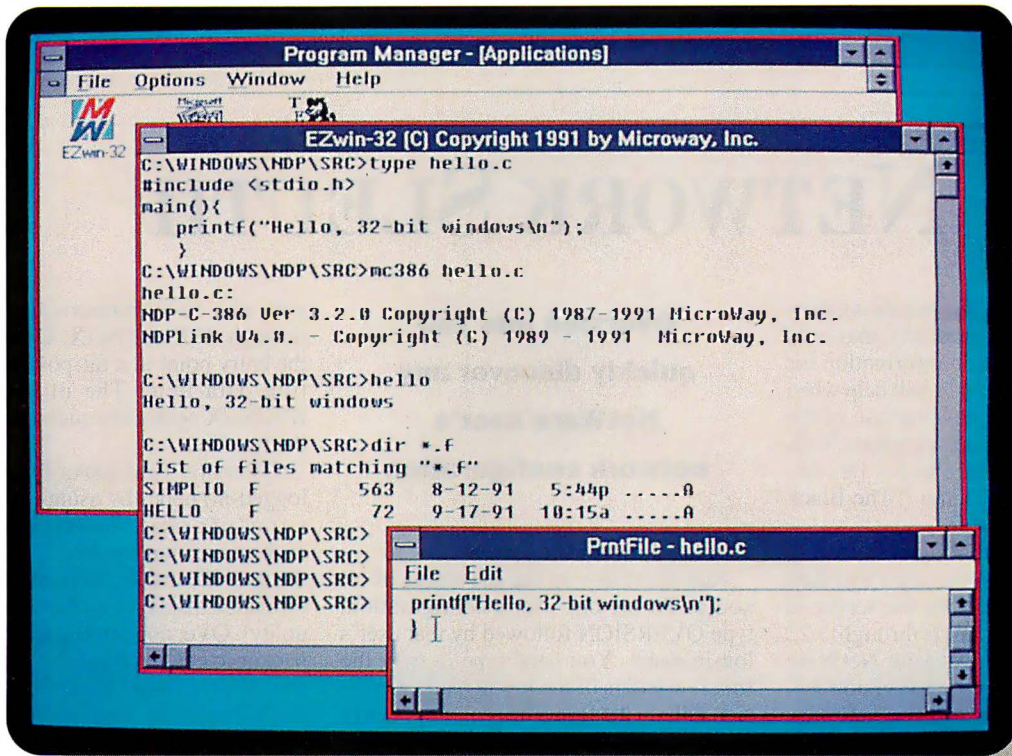
### BroadCast Gets the Message Out

**B**roadCast is a shareware program written by Joachim Lindenberg, a German Mac programmer. It is an elegantly simple Chooser-selectable RDEV that lets you transmit up to 255-character messages and replies to other networked Macs. The recipient, who must run BroadCast, hears a chime tone and sees a message window on-screen. The recipient can dismiss the window or type a response. The All button lets you send a public message to all users.

BroadCast is network savvy. I've sent messages from a Quadra and a Mac IIci in an Ethernet zone through a GatorBox to Macs in a LocalTalk zone. BroadCast works with AppleTalk Remote Access, which lets you leave messages on the screens of office Macs from a PowerBook in the field. BroadCast costs \$25 for each zone or \$100 per network. Registered users get a Unix version of BroadCast that lets Macs and Unix workstations communicate.

Editor's note: Software Corner programs are available in a variety of formats. See "Program Listings" on page 5 for details. We solicit your contributions for this column. If you've written a program or utility that you think others might find useful, let us know. We'll pay \$50 for any program we use. Write to: Software Corner, BYTE, One Phoenix Mill Lane, Peterborough, NH 03458.

# Hello 32-bit WINDOWS!



## **EZWIN32™ simplifies porting 32-bit FORTRAN, C, C++ and Pascal to WINDOWS.™**

Microway's 32-bit WINDOWS solution makes it possible to build and execute 32-bit applications that run on WINDOWS using the standard I/O techniques you are familiar with. As you can see from the screen, applications developed with EZWIN32 build and execute in a 386 enhanced WINDOW, yet have the look and feel of DOS or WINDOWS.

The EZWIN32 development environment uses special versions of Microway's NDP™ FORTRAN, C|C++ or Pascal compilers, each of which has been rebuilt to execute as an EZWIN32 application. EZWIN32 uses the WINMEM32 DLL to get direct access to 32-bit protected mode from WINDOWS, thus overcoming the limitations of DPML.

The EZWIN32 environment includes a command shell modeled after MS-DOS,

which includes batch files, a browseable work-in-progress buffer, an editor, SETable environment variables, the ability to change drives, execute 32-bit applications on top of WINDOWS and display, rename, make or delete directories. In short, it is possible to edit, compile and run 32-bit applications without leaving an EZWIN32 WINDOW.

EZWIN32 also delivers character based I/O which does not obsolete your existing sources. Our EZWIN32 C and FORTRAN libraries allow standard console I/O, which means that C and FORTRAN library routines such as printf(), READ and WRITE work normally. Optional products include a binding utility for developers that makes it possible to sell 32-bit WINDOWS applications, an interface to the WINDOWS API, Weitek support, and Cyrix EMC support.

EZWIN32 comes with your choice of one globally optimizing NDP FORTRAN, C|C++ or Pascal compiler. The basic version lets you build and execute 32-bit character based programs on WINDOWS and is reasonably priced at \$595. Write or call for a complete description of our 386, 486, and i860 languages, development tools and DOS and WINDOWS extender products.

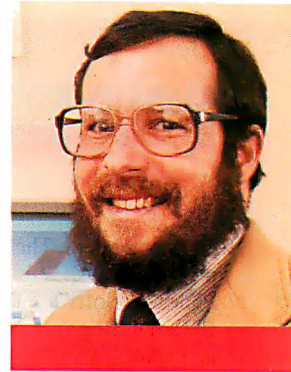


EZWIN32, and NDP are trademarks of Microway. WINDOWS is a trademark of Microsoft.

# **Microway®**

## **Technology You Can Count On**

Corporate Headquarters, Box 79, Kingston, MA 02364 USA • TEL 508-746-7341 • FAX 508-746-4678 • U.K./Europe 081-541-5466  
France 01 43 2 69593 • Germany 069-75-2023 • Holland 40 836455 • Italy 02-74.90.749 • Japan 0474 23 1322 • Norway 6-892020



MARTIN  
HELLER

## 32-BIT WINDOWS TODAY

Software developers use DOS extenders—and now, Windows extenders as well—to create 32-bit programs that speed up computations on large arrays or large images. For instance, 32-bit versions of AutoCAD are noticeably faster than the equivalent real-mode DOS versions and much faster than the OS/2 Presentation Manager versions. The architecture of the 386 chip makes 32-bit operations between two and five times faster than ordinary 16-bit operations. This more than balances out any overhead incurred when a DOS extender has to simulate real-mode interrupts to access DOS and BIOS services.

When a 16-bit protected-mode program has to use huge-pointer arithmetic, it incurs tremendous overhead. In real mode, huge pointers juggle segments and offsets. But in 16-bit protected mode, when huge pointers juggle selectors and offsets, juggling selectors means accessing the local descriptor table and all sorts of other rigmarole.

How bad can this be? Worse than you would imagine. I used profiling on one line of C that was looping on a simple assignment with huge addressing in a Windows program. I discovered that it was taking 60 percent of the execution time in a routine to read a graphics interchange format (GIF) image and convert it to a Windows device-independent bit map (DIB). When I rewrote the line to use the `_fmemcpy` function, so that it did address calculations once per scan line instead of once per pixel, it became an insignificant (i.e., less than 1 percent) component of the overall execution time. The next step—converting the program to 32-bit operation—seems like it should net a factor of 2 increase in speed.

Last December in this column, Walter Oney wrote about the technologies available to write 32-bit Windows programs; you might want to go back and read it. I'm not going to cover the technology so much as address the practical aspects of con-

verting a Windows program to 32-bit systems.

### 32-bit Systems

Both OS/2 2.0 and Windows New Technology (NT) are 32-bit systems with a migration path from Windows. For that matter, Unix with the X Window System and Motif could also be characterized as a 32-bit system with a migration path from Windows. The differences among these systems are vast, but from the point of view of a Windows programmer, the most serious question is "How much rewriting will I have to do?" From the point of view of a marketer, the most serious question is "How many people will pay for our

program on this platform?"

It looks like IBM will be providing a 32-bit version of Mirrors (developed by Micrografx) to make it easier to port from Windows to OS/2 2.0. I haven't seen it yet, so I can't comment on how much work will be involved. Microsoft has designed the Win32 application programming interface (API) to be highly compatible with 16-bit Windows, with the exception of the packing of parameters in messages. It looks like most Windows programs will port to NT with a few weeks of effort.

I've found one third-party tool for porting from Windows to Unix with OSF/Motif. It's the Wind/U API Library from Bristol Technology. I understand from the people who ported CorelDraw to Unix that other tools are available.

For all the hype, relatively few people are running any of these systems—they represent niche markets. DOS and Windows are still the bread-and-butter platforms for most PC applications developers. I have compilers and toolkits from Watcom and MetaWare that let me build 32-bit Windows programs for plain old Windows 3.x. They are available now, and they work.

### Watcom C/386 and FORTRAN 77/386

Watcom is a spin-off from the University of Waterloo's computer science department. I ran Waterloo FORTRAN and PL/I compilers on an IBM 360/67 in 1972. They were hot compilers then, and Watcom has maintained the tradition.

I currently have version 8.5 of Watcom's C and FORTRAN compilers in both 16- and 32-bit flavors. There is a lot to like about these compilers. Their optimization is rather good. You can combine FORTRAN and C in a single executable file—a real boon if, for example, you have a large library of FORTRAN routines for numerical methods. The 16-bit compilers support DOS, OS/2, Windows, and 16-bit

**These Windows extenders  
let you create  
32-bit programs**



DOS extenders. The 32-bit compilers support Windows; 32-bit DOS extenders from Phar Lap Software, Ergo Computing, and Rational Systems; Novell NetWare loadable modules; and AutoDesk AutoCAD development system (ADS) applications.

You can install all four compilers in the same directory because they share a common toolkit. The toolkits are pretty complete—linkers, debuggers, profilers, a make utility, graphics libraries, and sample source code to support all those environments. The compilers aren't inexpensive. C/386 is currently on sale for \$795, but it normally sells for \$995.

I'll concentrate here on Watcom C/386 as it applies to 32-bit Windows programming. Remember that the Windows 3.0 API is all 16-bit calls and callbacks. Watcom supplies a supervisor for the 32-bit environment that is bound with your 32-bit flat-memory-model program linked against special 32-bit Windows and C libraries. The 16-bit application resources, stack, and local heap all reside in the supervisor.

The Watcom Windows supervisor takes care of allocating 32-bit memory and loading your application. It has glue functions so that 32-bit functions can call the Win-

dows API and DOS, and "glue-back" functions so that Windows can call back to 32-bit routines.

Watcom's approach is a valiant attempt to make the transition from 16-bit Windows to 32-bit Windows easy, but a number of areas require rewriting. One problem area is data passed in messages. Windows routinely packs pointers into the long parameter of its messages; these pointers are not automatically converted by the Watcom supervisor. Whenever you have code that casts `LPARAM` to or from a pointer, you'll have to explicitly convert 16-bit near and far pointers to and from 32-bit pointers.

Some callback functions (e.g., `EnumFonts`) pass pointers that need explicit conversion. You have to do special things to make a procedure instance from a 32-bit function or to call a function for which you got the procedure address. Subclassing is tricky because you have to provide a 16-bit callback address. You can't use the pointers you get from `LocalLock` or `GlobalLock` until you've converted them.

All this memory management stuff can become confusing, especially when you need 32-bit far pointers. It's easy to mess

up your pointer conversions. There's also a lot of overhead from the supervisor and its allocation of 32-bit memory. You're talking about 2-MB applications here.

On the other hand, the speed improvement when you get everything working is dramatic. One of the sample applications that ships with the Watcom C compilers is a Windows Life simulation. The 32-bit version—which copies arrays using `memcpy` rather than fooling around with huge pointers and `_fmemcpy`—really flies.

Watcom C/386 has an option to build C programs using standard I/O into 32-bit Windows applications, just by recompiling and relinking. That's one feature that you won't find in the competition.

## MetaWare High C Windows ADK

MetaWare had the first 32-bit Pascal and C compilers available for DOS. The company grew up along with Phar Lap in the 386 DOS-extender market. High C got an early reputation as a compiler with good optimization and fussy diagnostics. I bemoaned those diagnostics, the lack of a source-level debugger, and MetaWare's somewhat Spartan C library in these pages several years ago.

*continued*

1988-89

U.S. Delivery \$3.00  
Foreign Delivery \$4.00

1990-91-92

U.S. Delivery \$6.00  
Foreign Delivery \$8.00  
Canada & Mexico \$6.50

## BYTE BACK ISSUES FOR SALE

	1988	1989	1990	1991	1992
January					
February					
March					
April					
May					
June					
July					
August					
September					
October					
November					
December					
Special Issues				Outlook '92	

The above prices include postage in the US. European customers please refer to Back Issue order form in International Advertising section of book.

Please indicate which issues you would like by checking (✓) the boxes. Send requests with payment to:

BYTE Back Issues, One Phoenix Mill Lane, Peterborough, NH 03458, (603) 924-9281

Check enclosed    Charge:  VISA     MasterCard

Card # \_\_\_\_\_

Exp. Date \_\_\_\_\_

Signature \_\_\_\_\_

Name \_\_\_\_\_

Address \_\_\_\_\_

City \_\_\_\_\_

State \_\_\_\_\_ Zip \_\_\_\_\_

All orders must be prepaid. Please allow four weeks for delivery.

Issues Available



"On sheer audacity for price-performance ratio, we loved Mix's products"

Tim Parker - Computer Language



**\$19.95**

**\$19.95**

"Power C is a heavy-weight contender - at a bantamweight price"

Stephen Davis  
- PC Magazine

"The Ctrace debugger is where Mix really shines. It is magnificent."

David Weinberger  
- Computer Shopper



**Power C**

combines a high-performance C compiler with superb documentation, at a price that brings chuckles from over 50,000 satisfied customers. That's because Power C performs favorably against compilers costing 10 times as much. And you can't buy a compiler that's more reliable or easier to use - at any price. Perhaps that's why Power C has won Computer Shopper's Best Buy award for three years running.

- compatible with ANSI C standard
- integrated Make utility
- library of over 450 functions
- IEEE software floating point
- supports 8088/286/386/486 CPU
- memory resident program support
- supports 8087/287/387 math chips
- small/medium/large memory models
- mixed model with near/far/huge
- allows arrays larger than 64K
- CGA, EGA, VGA & Hercules graphics
- 650 page manual with tutorial

**\$10.00**

**Power C Library Source**

includes our Power C assembler, plus the C and assembly language source code to over 450 functions in the Power C library. Unlike our competitors, who charge \$150.00 or more for library source code, we've made ours very affordable.

**\$10.00**

**Power C BCD Business Math**

includes binary coded decimal floating point routines and financial functions to calculate interest, depreciation, etc.. BCD routines are used for dollars and cents calculations to eliminate inaccuracies caused by rounding.

**Power C requires DOS 2.0 or later, 320K memory, 720K disk space. Master C requires DOS 3.0 or later, 384K memory, hard disk.**

**Power Ctrace**

combines state-of-the-art technology with a friendly interface, making it very easy to find and correct your programming mistakes. No time consuming edit/compile cycles are needed to track down bugs. Simply compile your program once with the trace option, and Power Ctrace does the rest. Multiple windows display your C source code, the values of all your program variables, program output, watch points, and assembly instructions. Put Power Ctrace to work for you, and we guarantee that you'll be a more productive C programmer.

Order line:

**1-800-333-0330**

Technical Support:  
1-214-783-6001  
Fax: 1-214-783-1404

Mix Software, 1132 Commerce Drive,  
Richardson, TX 75081

**Get a FREE copy of Master C (limited time offer)**

The Waite Group's  
**MASTER C**  
Four 5.25" PC  
Disks Included

Let the PC Teach You C

**\$44.95** value  
**FREE**

Mitchell Waite  
Stephen Prata  
Rex Woodard

Published by the highly acclaimed Waite Group, Master C is a revolutionary book/disk package that turns your PC into a C instructor. Master C teaches you, quizzes you, notices problems you are having, and recommends action. In a pilot study at IBM, students using Master C retained 19% more knowledge than students who learned from a lecturer. Now you can receive this \$44.95 package absolutely FREE when you purchase all four Power C products described above. Just ask for the Master Pack.

"Master C eschews flash for elegant competence, and it works!"

Jeff Dunteman - PC Techniques

**60 day money back guarantee**

Name \_\_\_\_\_  
Street \_\_\_\_\_  
City \_\_\_\_\_  
State \_\_\_\_\_ Zip \_\_\_\_\_  
Telephone \_\_\_\_\_

Please send me a free brochure

Paying by:  Check  Money Order  
 MC  Visa  Amex  Discover  
Card # \_\_\_\_\_ Exp \_\_\_\_\_

Disk Size:  5 1/4"  3 1/2"

**Product(s) (Not Copy Protected)**

Power C (\$19.95) \$ \_\_\_\_\_  
 Power Ctrace (\$19.95) \$ \_\_\_\_\_  
 Power C Library Source (\$10) \$ \_\_\_\_\_  
 Power C BCD Business Math (\$10) \$ \_\_\_\_\_  
 Master Pack (\$59.90) \$ \_\_\_\_\_  
(includes all of the above plus Master C)  
Add Shipping (\$5 USA - \$10 Canada - \$30 Foreign) \$ \_\_\_\_\_  
Texas Residents add 8.25% Sales Tax \$ \_\_\_\_\_  
Total amount of your order \$ \_\_\_\_\_

Circle 83 on Inquiry Card.

I've since changed my opinion of fussy diagnostics: It may be painful to clean your code to compile without warnings, but it's a lot more painful to find errors that slipped through the compiler. MetaWare has significantly improved its libraries and debuggers since then, too. I now have nothing to complain about.

With its latest product, the Windows Application Development Kit (ADK), MetaWare has aimed to make its 32-bit Windows environment better than Wat-

com's. There are some advantages to bringing your product out second.

In the MetaWare ADK environment, the local heap resides in the supervisor. The difference from Watcom's implementation is that LocalAlloc returns a 32-bit far pointer, so you don't have to do any further conversions to use the local heap. However, malloc is a better choice than LocalAlloc. It allots 32-bit near memory, which can be accessed much faster. MetaWare also redefines standard

Windows far data types (e.g., LPSTR) to suit the 32-bit environment.

You still need to explicitly convert some 16-bit pointers to and from 32-bit pointers with the ADK, but not as many as with Watcom C/386. You don't need to worry about converting pointers from MakeProcInstance for callback functions. It does the right thing automatically. But you'll have to change some function definitions to satisfy High C's type checking: The message argument to Windows procedures has to be changed from type unsigned to type word.

Another difference between the two products is that MetaWare's supervisor dispatches Windows API calls through a jump table, which is supposed to be faster than Watcom's call-gate implementation. I don't know how important that is. I couldn't see any big speed difference.

Overall, I find it hard to recommend one of these products over the other. MetaWare might require fewer changes in your Windows code for 32-bit operation and has better documentation. Watcom adds the capability to turn DOS C programs into 32-bit Windows programs and supports FORTRAN with C. You won't go far wrong with either choice. ■

*Martin Heller develops software and writes about computers, despite a Ph.D. in physics and despite having worked, literally, as a rocket scientist. He is the author of Advanced Windows Programming (Wiley, 1992). You can reach him on BIX as "mheller."*

*Your questions and comments are welcome. Write to: Editor, BYTE, One Phoenix Mill Lane, Peterborough, NH 03458.*

## TURN PCs INTO X TERMINALS

HCL-eXceed family  
of PC X servers  
from  
Hummingbird.

RELEASE 3.0:

The new generation  
in X server software

PC  
X servers:

**HCL-eXceed/W**,  
X server for PCs running  
MS-Windows. Integration  
between X and MS-Windows.

**HCL-eXceed Plus**, DOS-based  
X server. Supports EGA, VGA and  
Super VGA.

**HCL-eXceed HiRes**, same as "Plus"  
but also supports 8514A, XGA and TIGA 2  
graphic standards.



Hall 12,  
Stand B06/C05



**HUMMINGBIRD  
COMMUNICATIONS LTD.**

2900 John Street, Unit 4, Markham, Ontario, Canada L3R 5G3  
Telephone: (416) 470-1203, Fax: (416) 470-1207  
In Europe: 37-39 rue de Vermont, 1202 Geneva, Switzerland  
Telephone: 41 (22) 733 18 58, Fax: 41 (22) 734 14 79

### ITEMS DISCUSSED

**FORTRAN 77/386 8.5** .....\$795  
**Watcom C/386 8.5** .....\$795  
Watcom, Inc.  
(519) 886-3700

**Circle 1152 on Inquiry Card.**

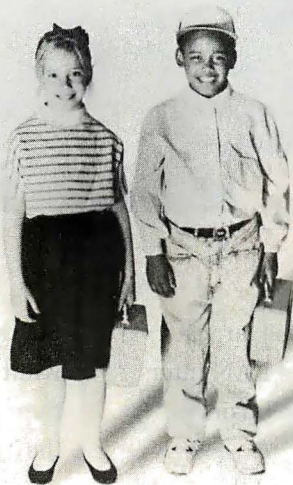
**High C Windows Application  
Development Kit** .....\$395  
with High C compiler, 32-bit  
debugger, and ADK .....\$795

MetaWare, Inc.  
(408) 429-6382

**Circle 1153 on Inquiry Card.**

**Wind/U API  
Library** .....\$20,000-\$200,000  
Bristol Technology, Inc.  
(203) 438-6969

**Circle 1154 on Inquiry Card.**



# Invest in something with growth potential.

America's economic future depends on a motivated, educated work force. At a Boys & Girls Club, kids learn the life skills and job skills they need to grow into productive members of our American economy, as well as our society.

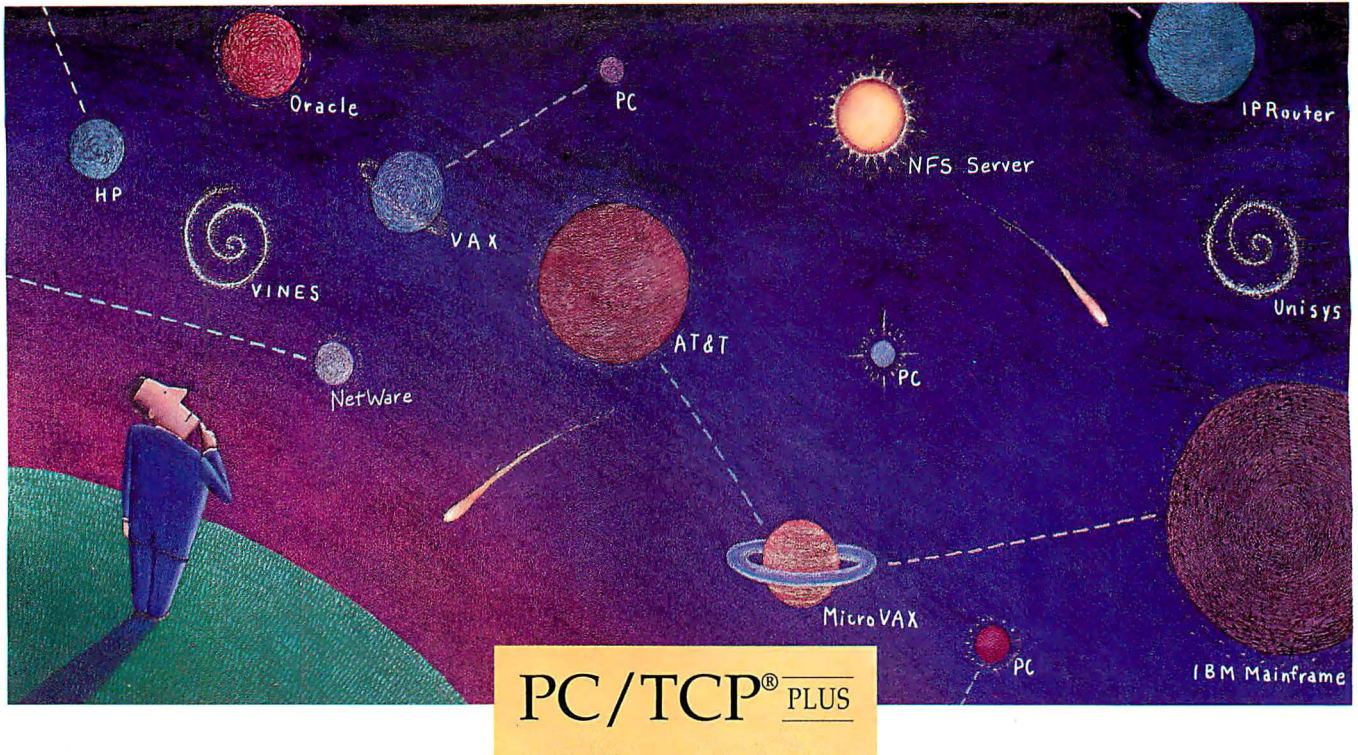
Please make a contribution to the Boys and Girls Clubs. You'll be investing in the growth of America.



**BOYS & GIRLS CLUB**

SUPPORT THE CLUB THAT BEATS THE STREETS

# There's only one way to get around out here.



**OS2 VERSION  
NOW AVAILABLE!**

The most  
comprehensive  
TCP/IP  
implementation  
in the industry.

**SUPPORTS NFS!**

No matter who or what your PC needs to communicate with, there's nothing like PC/TCP Plus. It's not only the fastest, but also the most comprehensive TCP/IP implementation in the industry. And PC/TCP Plus has NFS™ access built right in.

Providing connectivity to other PCs, minicomputers and mainframes, PC/TCP Plus communicates over Ethernet, Token Ring and StarLAN networks with operating systems ranging from UNIX and VMS to VM and MVS. And you can forget hardware incompatibility; PC/TCP Plus

supports the largest selection of LAN interfaces in the business.\*

From around the world to around your office, now your PC can transfer files, send and receive electronic mail, emulate VT100, VT220 and IBM 3278 terminals, access NFS servers, and much, much more. VINES™ and NetWare™ users will appreciate PC/TCP's full compatibility, as will customers of Oracle's distributed PC database products. And with our Development Kit, including a Berkeley Sockets library, you have all you need to produce custom applications.

So, the next time you want to get from here to there, get PC/TCP Plus, the TCP/IP implementation that gives you a whole new perspective on network communication. Call us at (617) 246-0900 for more information.

VAR Inquiries Welcome  
Reseller Inquiries Invited

PC/TCP is a registered trademark of FTP Software, Inc.  
VINES is a trademark of Banyan Systems, Inc.  
NetWare is a trademark of Novell, Inc.  
NFS is a trademark of Sun Microsystems, Inc.

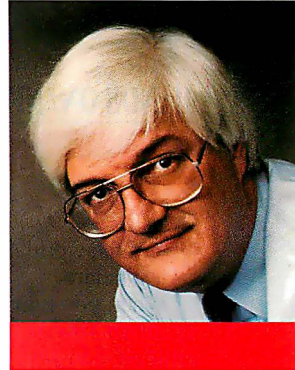
FTP Software, Inc.  
26 Princess St.  
Wakefield, MA 01880-3004  
Phone: (617) 246-0900  
Fax: (617) 246-0901



\*PC/TCP Plus supports interfaces from Acer, Allied Telesis, Apricot, AT&T, BICC, DEC, D-Link, DSC, Excelan, Gateway Communications, IBM, IMC Networks, Intel, Interlan, Longshine, MCAssociates, National Semiconductor, Novell, Proteon, Schneider & Koch, Scope, 10Net, 3Com, Tiara, Torus, TRW, Ungermann-Bass, Univation, Western Digital and YCS, in addition to the ASI, NDIS and Packet Driver specifications.

Circle 57 on Inquiry Card (RESELLERS: 58).





**BARRY  
NANCE**

## LAN ANALYZERS MOVE TO AI

If you have a utility or other tool that's indispensable yet frustrating to use, you know how I feel about LAN analyzers. Three companies—Network General, Hewlett-Packard, and Novell—are currently applying AI to their network analyzers to make them easier to use. The technology has a long way to go, but the initial efforts show promise.

You have to be a specialist to use a network analyzer when LAN problems occur. The analyzer captures thousands of packets by eavesdropping on the LAN's message traffic. Looking through this mountain of data to determine the cause of a problem is difficult. Understanding the patterns of what's normal and what's not requires a keen eye and a sharp mind.

A network manager with a protocol analyzer is like a doctor who reaches for a microscope to view cells in a blood sample. The analyzer is the microscope; as the doctor, you have to know what normal cells look like and how many of each type you should see.

Most analyzers consist of a dedicated PC with a special network card and software. They let you look inside network packets and detect specific LAN problems (e.g., a failing device, a configuration error, or a LAN bottleneck). The analyzer selects those frames that meet the filtering criteria you set up, captures them in a file, and summarizes the frames or decodes them to show their contents.

You can tell a network analyzer to show only error frames, frames traveling between two nodes, frames of a certain type or that contain a given pattern of data, or frames that exceed size and frequency thresholds you establish. Some analyzers also let you inject extra traffic on the LAN to simulate adding more nodes.

Once you know what to look for, you can use a network analyzer to find the token-ring adapter on your LAN that's causing a broadcast storm, to track routing errors to a misconfigured gateway, or to determine which file server is receiving

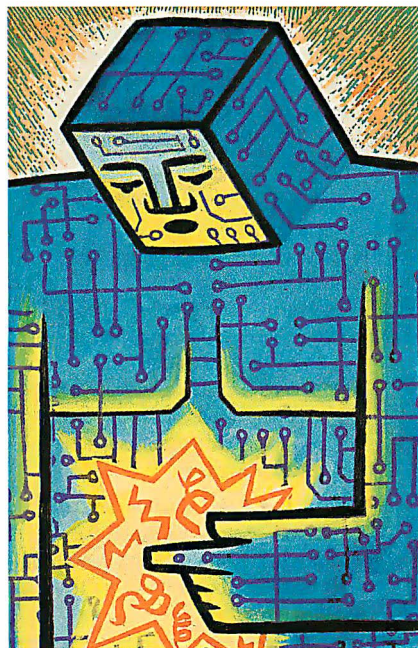
an inordinate amount of message traffic. It's up to you, however, to plan ahead, note what you're looking for, and concentrate on finding the cause of the problem. Knowing what to look for and where to look are the areas where expert systems can help.

Hewlett-Packard's Network Advisor was the first AI-assisted analyzer to ship. It has a rule-based AI front end called Fault Finder. Network General plans to release Expert Sniffer about the time you read this, and Novell is working on a version of its LANalyzer that uses AI techniques.

### First Steps to AI

The Network Advisor consists of a 386-based portable PC with a monochrome or

### Adding AI to analyzers will revolutionize network troubleshooting



color LCD and a specially designed LAN interface that performs data acquisition. The Fault Finder software, which HP wrote in Prolog, runs on top of DOS and contains more than 100 rules. Its Smalltalk-based GUI can be a bit slow and cumbersome.

At present, Fault Finder can help solve just a few physical-layer problems. On a token-ring LAN, it can monitor for station-insertion failures, hard errors, media-access-control (MAC) beacon frames, congested station receivers, and ring beaconing.

If you ask it to explain itself, Fault Finder can tell you the basis for its reasoning. An example is: "The ring is considered to be beaconing if a station has transmitted eight consecutive Beacon MAC frames."

Solving a few simple problems and providing a few explanations won't justify Network Advisor's \$20,000+ price for most users, but it's a start. HP expects to move up the protocol ladder into more complicated scenarios. The list of symptoms you can ask Fault Finder to investigate will eventually grow from "can't connect" to such problems as "sporadic slowdowns," "can't access server 3," and "corrupted server files."

The first Expert Sniffer will also solve about 100 typical physical-layer problems, will recommend the proper actions for a given symptom, and will learn about your network by monitoring network activity. It won't have a fancy GUI, but it will support the widest variety of network protocols. I haven't seen the AI version of LANalyzer, but it will probably offer the most in-depth analysis of NetWare protocols.

### Room for Improvement

Like most tools, an analyzer is something you'll use when the situation demands it. You won't spend 8 hours a day, five days a week, operating an analyzer. Therefore, vendors should make the interface compliant with Common User Access (CUA). IBM's user-interface guidelines aren't the

best in the world, but they are catching on as a standard.

When you hurriedly power up an analyzer to find out why your LAN just crashed, you don't want to have to fumble around with the user interface. A CUA interface, whether text- or GUI-based, will make the analyzer easier to use on an occasional basis.

Vendors also need to make it easier to log onto the LAN from the analyzer, and analyzers should identify network nodes by name as well as by the more esoteric physical address. Even in a problem situation, one or more servers may still be alive and accessible. You may want to print some data on the network's spooled printer. Or, after a problem is solved, you may want to store results on the server. Analyzer manufacturers should supply a variety of preinstalled workstation software.

You need to be able to trust your analyzer. When more than one problem happens simultaneously, and your heart sinks as you get multiple (perhaps conflicting) signals from the analyzer, you need a way to verify its reasoning and its conclusions. The software should let you print out the

**T**he AI software should let you print the entire rule base, using clear, simple English sentences.

entire rule base, using clear, simple English sentences. For difficult problems, you'll want to sit back and pore over the rule base as a reference while you search for potential causes. In the same vein, the analyzer must be able to show you, step by step, why it has reached a certain conclusion.

The vendors could print the rule base in the manual, but the rule base should change as the analyzer learns about your LAN. This doesn't happen yet. The ana-

lyzer should also let you modify the rule base, in the same way you add new words to a spelling-checker dictionary in your word processor.

The problems you solve will undoubtedly happen to other people. If you had a way (perhaps by modem) to send case histories back to the vendor, and if the vendor had software that digested these scenarios to produce an updated rule base, other users of that analyzer could periodically download a new factory-supplied rule base and learn from your experiences. (You will someday be the other person, by the way.) The analyzer software should keep a record of problems as you solve them, and it should feed these solutions back to a central site.

Finally, LAN traffic doesn't exist in a vacuum. Eavesdropping on the packets as they go by isn't enough. The analyzer should come with diagnostic workstation software that you run at nodes you select and that interacts with the analyzer. The analyzer could control a portion of the LAN traffic to help diagnose problems with specific workstations or particular segments of the LAN.

The diagnostic software should include

# Give Us Your Toughest Peripheral Sharing Problem

*...or your simplest! Master Switch, the intelligent data switch from Rose Electronics, can handle it. The Master Switch series is so versatile and sophisticated, peripheral sharing becomes easy.*

Anyone who appreciates ease-of-operation and technologically-advanced capabilities knows the Master Switch is the right choice...for sharing printers, plotters, modems, and any device with a serial or parallel port. Here's why:

- Any combination of serial or parallel ports
- Easy selection of peripherals
- User-expandable memory up to 4 megabytes
- Simultaneous access to all devices
- Rated 'fastest switch' by PC Magazine
- Advanced features include job queue, port contention, data collection, job control menu, initialization strings, pop-up menus, and many more
- Complete technical support; one-year warranty

**The Low-Cost LAN Alternative**

With our MasterNet software, the Master Switch provides many convenient LAN functions, such as E-mail, file transfer, and directory access.

Designed and manufactured in the USA. Field-proven in thousands of applications. The Master Switch answers any peripheral sharing challenge. Choose the intelligent data switch that handles your most complex needs, yet is easy to set up and operate... choose Master Switch.



**ROSE ELECTRONICS**

(800) 333-9343  
 FAX (713) 933-0044 • (713) 933-7673  
 P.O. Box 742571 • Houston, Texas 77274  
 Call for complete information and our catalog of Switching and Sharing Solutions. Dealer inquiries welcome.

# When you need 3780 RJE...



## ▶ Call CLEO.

Our 3780Plus<sup>•</sup> is the leading 3780/2780 BSC solution for EDI, point-of-sale, medical claims filing, electronic funds transfer, and other remote batch transfer

applications. It's been proven in over 50,000 worldwide installations.

3780Plus provides full IBM 3780/2780 RJE emulation for IBM PC/XT/AT, PS/2, and RS/6000 systems. It also works with DEC VAX and RISC-based systems, as well as Altos, DG, HP, MIPS, NCR, NeXT, Prime, Pyramid, Sequent, Sun, and Tandem systems, among others.

3780Plus is easy to install and use. It features auto-dial and auto-answer. External modem auto-dialing capabilities include UDS BSC, SADL, AT Command Set, and V.25bis.

Our powerful Scripting Command Language

and Application Program Interface make unattended operation easy.

We offer 3780Plus on high-speed modem boards, high-performance coprocessor boards, and economical synchronous interface boards. It's also available with SYNCcable+,<sup>™</sup> our easy-to-install external communications processor that allows synchronous communications through asynchronous ports.

3780Plus comes with complete documentation, ongoing technical support, a full 12-month warranty, and a 30-day money-back guarantee.

*To learn more, call us today at 1-800-233-2536.*

● *write to us at 2652 Eastrock Drive, Rockford, Illinois 61109. Fax: 815/397-6535.*

**CLEO**   
CLEO Communications  
A Division of Interface Systems, Inc.

▶ DOS

▶ UNIX

▶ XENIX

▶ AIX

▶ VMS

▶ Ultrix

▶ SunOS

▶ HP-UX

▶ DG/UX

▶ FlexOS

▶ IBM 4680 OS

▶ More!

AVAILABLE WORLDWIDE!

In Europe, call Sintec Peripherals Ltd. in Slough, England, at +44-0753-811888 (fax: +44-0753-811666).

a server module (i.e., a NetWare loadable module or value-added process, an OS/2 LAN Server program, or a Unix program). The analyzer could then communicate with both the workstation diagnostic software and the server module to diagnose LAN problems—a sort of CAT scan for your network. With this whole-network approach to finding problems, an AI-assisted analyzer could solve performance problems by locating bottlenecks on the LAN.

**The Road Ahead**

Eventually, AI-based analyzers will move beyond simple physical-layer maladies to more complex problems. To find out why a LAN is sluggish, you might use an AI-based analyzer to capture frames between specific nodes (e.g., a workstation and a server) and instruct the analyzer to display network utilization, frame counts, and the total number of bytes captured. During analysis, you'd examine when each frame appeared on the network and what that frame contained.

The AI subsystem could help by asking you to characterize the work done by the workstation operator during the test period. It might then correlate that work

with the timing of the message traffic for that workstation, taking into account the traffic for other nodes, and help you see why you have a performance problem. If you could load analyzer diagnostic modules at both the affected workstation and the server, you could perform controlled experiments. With the help of the AI subsystem, you could pinpoint a bottleneck, be it a slow server hard drive, insufficient server memory, an inefficient drive controller, a congested network adapter, or some other problem.

Network analyzers are complicated and expensive tools, but they give you a perspective on your LAN traffic that you can't otherwise get. Today's AI-based network analyzers won't help much once you've mastered the basics of using a protocol analyzer.

Tomorrow's products will be more useful in solving more complex problems, perhaps even performance bottlenecks. But don't underestimate the analytical effort you need to expend. It will always be your responsibility to do the deeper analysis to determine what the analyzer's conclusions and recommendations mean to your LAN. ■

*Barry Nance is a contributing editor for BYTE. He manages a 70-node NetWare LAN, and he is the editor of the IBM Exchange and moderator of the lans conference on BIX, where you can reach him as "barryn."*

*Your questions and comments are welcome. Write to: Editor, BYTE, One Phoenix Mill Lane, Peterborough, NH 03458.*

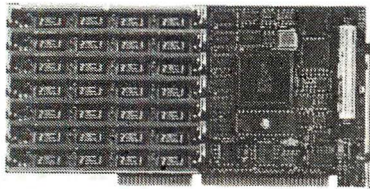
**ITEMS DISCUSSED**

**Expert Sniffer** .....N/A  
 Network General Corp.  
 (415) 688-2700  
**Circle 1149 on Inquiry Card.**

**AI LANalyzer** .....N/A  
 Novell, Inc.  
 (408) 434-2300  
**Circle 1150 on Inquiry Card.**

**Network Advisor** ... \$20,300 and up  
 Hewlett-Packard Corp.  
 (719) 531-4000  
**Circle 1151 on Inquiry Card.**

**ROMDISK™**



**High Performance  
 Multimegabyte Disk Emulators**

**NEW MODELS / LOWER PRICES**

- Floppy Drive and multimegabyte emulators for ISA bus computers
- 180K to 14 MB capacities
- EPROM, Flash or SRAM technologies
- Autobooting, Single or Dual disk emulation under PC or MS DOS
- List prices from \$195

**CURTIS, INC.**

2837 No. Fairview Ave. • St. Paul, MN 55113  
 612/631-9512 FAX 612/631-9508

PC DOS is a trademark of IBM; MS DOS is a trademark of Microsoft

**AccSys™ for Paradox.**  
 Because you shouldn't  
 be stuck  
 pulling the engine.

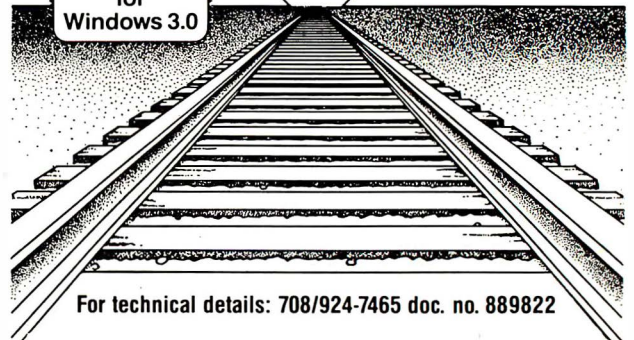
- 100% compatibility guaranteed
- Support for ALL popular C & C++ compilers
- Twice the speed and half the size (DBA, May '91)
- C Source available for all memory models
- Trade up to AccSys:

get credit for your  
 current engine

Ideal  
 for  
 Windows 3.0



**Copia  
 International  
 Ltd.**  
 VOICE: 708/682-8898  
 FAX: 708/665-9841  
 Wheaton, Illinois 60187



For technical details: 708/924-7465 doc. no. 889822

# Train for a High-Paying Career as a Computer Service Technician

**Only NRI teaches you to service today's hottest computers as you build your own powerful 386sx/20 MHz micro—featuring a mini tower case, 1 meg RAM, 40 meg IDE hard drive, and exciting new diagnostic tools!**

Jobs for computer service technicians will almost double in the next 10 years according to Department of Labor projections, making computer service one of the top 10 growth fields in the nation.

Now you can cash in on this opportunity—either as a full-time industry technician or in a computer service business of your own—once you've mastered electronics and computers the NRI way.

**Get inside the West Coast 386sx computer system... and experience all the power and speed of today's computer technology!**

Now NRI includes the powerful new West Coast 386sx computer system as the centerpiece of your course to give you hands-on training with state-of-the-art computer technology. You build this 1 meg RAM, 32-bit CPU computer from the keyboard up, plus you now go on to install a 40 meg IDE hard disk drive to complete your total computer system. But that's not all!

Now you learn to diagnose and repair XT, AT 80286/80386, and compatible computers with the remarkable diagnostic hardware and software included in your NRI training. See the other side for more details about this latest NRI training breakthrough.

**Understanding you get only through experience**

You need no previous background in electronics to succeed with NRI. You start with the basics, rapidly building on the fundamentals of electronics to master such advanced concepts as digital logic, microprocessors, and computer memories.

Best of all, you learn by doing—first by performing hands-on experiments with your NRI Discovery Lab and digital multimeter. Then you actually build and test the powerful 386sx/20 MHz computer system you train with and keep.

**Learn at home in your spare time**

With NRI, you learn at your own convenience in your own home. No classroom pressures, no night school, no need to quit your present job until you're ready to make your move. And all throughout your training you've got the full support of your personal NRI instructor and the entire NRI technical and support staff.

Get all the facts from NRI's free full-color catalog. Send today!



**NEW!  
386sx/20 MHz  
Mini Tower  
Computer!**

**Your incomparable hands-on training includes all this:**

NRI's Discovery Lab you use to design and modify circuits, diagnose and repair faults • Hand-held digital multimeter with "talk-you-through" instructions on audio cassette • Digital logic probe that lets you visually examine computer circuits • The latest West Coast 386sx/20 MHz computer, featuring a 32-bit 80386sx CPU, "intelligent" keyboard, and 1.2 megabyte, high-density 5-1/4" floppy drive • 40 meg IDE hard disk drive you install internally • 64K ROM, 1 meg RAM • MS-DOS, GW-BASIC, and Microsoft Works software • Ultra-X diagnostic package including R.A.C.E.R. plug-in card and QuickTech menu-driven software for fast, professional troubleshooting • Reference manuals, programming guidelines, and schematics.

**See other side for highlights of NRI hands-on computer training**



**SEND CARD TODAY FOR FREE NRI CATALOG**

**NRI Schools**

McGraw-Hill Continuing Education Center  
4401 Connecticut Avenue, NW  
Washington, DC 20008



**Check one FREE catalog only**

- Microcomputer Servicing
- TV/Video/Audio Servicing
- Industrial Electronics & Robotics
- Telecommunications
- Basic Electronics

For career courses approved under GI Bill, check for details.

- Computer Programming
- Security Electronics
- Electronic Music Technology
- PC Applications Specialist
- Programming in C++ with Windows

Name \_\_\_\_\_ Age \_\_\_\_\_  
(please print)

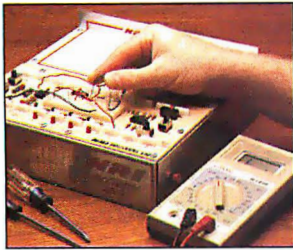
Address \_\_\_\_\_

City \_\_\_\_\_ State \_\_\_\_\_ Zip \_\_\_\_\_

Accredited Member, National Home Study Council

170-032

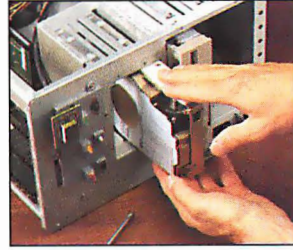
# Get In-Demand Computer Servicing Skills With NRI "Hands-On" Training



You set up and perform electronics experiments and demonstrations using your NRI Discovery Lab. You even interface the lab with your 386sx computer to "see" keyboard-generated data.



After you build this digital logic probe, you explore the operation of the West Coast 101-key, detached "Intelligent" keyboard and its dedicated microprocessor. You go on to check out the power supply installed in the main unit of the computer.



You examine the 1.2 meg, 5-1/4" floppy disk drive, learning disk drive operation and adjustment. Later, you dramatically improve your computer's data storage capacity by installing a powerful 40 meg IDE hard drive.

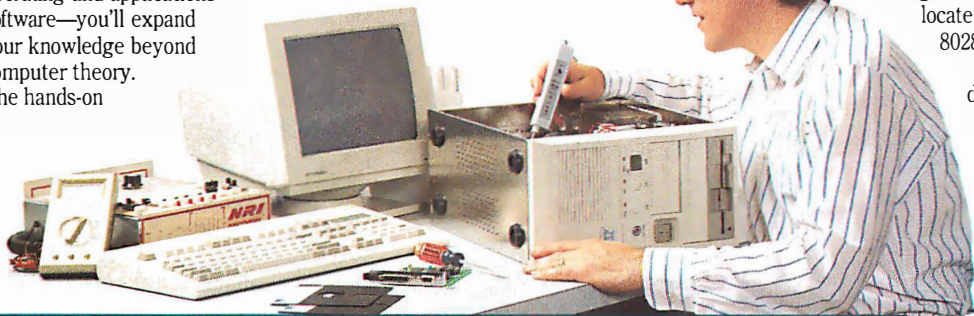


You learn to quickly diagnose and service virtually any computer problem with the extraordinary R.A.C.E.R. plug-in diagnostic card and QuickTech diagnostic software now included in your course.

**With NRI total systems training, hands-on mastery is "built-in"**

No computer stands alone...it's part of a total system. That's why NRI builds meaningful training around the kind of powerful computer system you'll be called on to service and repair in the real world.

As you assemble your West Coast 386sx/20 MHz mini tower computer system—complete with monitor, floppy drive, hard drive, operating and applications software—you'll expand your knowledge beyond computer theory. The hands-on



demonstrations and experiments you perform bring theory to life, giving you a total mastery of computer operation. But NRI doesn't stop there.

**New! Includes diagnostic hardware and software for quick, accurate troubleshooting**

Your NRI training now includes a remarkable diagnostic package that allows you to quickly locate and correct defects in IBM XT, AT 80286/80386, and compatible computers.

You'll use the Ultra-X R.A.C.E.R. diagnostic card to identify individual defective RAM chips, locate interfacing problems, and pinpoint defective support chips. With your QuickTech diagnostic software package, also from Ultra-X, you'll go on to test the system RAM and such peripheral adapters as parallel printer ports, serial communications ports, video adapters, and floppy and hard disk drives.

This ingenious diagnostic package is just one more way NRI's real-world, hands-on training gives you both the knowledge and the professional tools to succeed as today's in-demand computer service technician.

**SEND CARD TODAY FOR FREE NRI CATALOG**



**BUSINESS REPLY MAIL**

FIRST CLASS MAIL PERMIT NO. 10008 WASHINGTON, D.C.

POSTAGE WILL BE PAID BY ADDRESSEE

**NRI SCHOOLS**  
**McGraw-Hill Continuing**  
**Education Center**  
**4401 Connecticut Avenue, NW**  
**Washington, DC 20078-3543**

NO POSTAGE  
 NECESSARY  
 IF MAILED  
 IN THE  
 UNITED STATES



**Free catalog tells more...send today!**

Send the postage-paid card today for NRI's big, free catalog that gives all the facts about NRI computer training. See for yourself how NRI hands-on training can help you cash in on the growing opportunities for skilled computer service technicians.

If the card is missing, write to NRI at the address below.

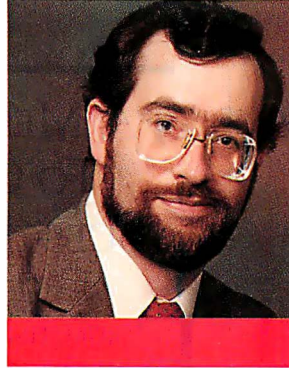
**NRI Schools**

McGraw-Hill Continuing Education Center  
 4401 Connecticut Avenue, NW  
 Washington, DC 20008



IBM is a registered trademark of International Business Machines Corp. R.A.C.E.R. and QuickTech are registered trademarks of Ultra-X, Inc.





DAVID  
FIEDLER

## X HITS THE SPOT

In the last episode, I had just managed to get my PC (running DOS) talking to a Unix workstation via Ethernet, TCP/IP, and Telnet. Flushed with this success, I immediately made plans to simultaneously expand my network and contract my bank account.

When the smoke cleared, I was left with a pile of receipts and several computers. My trusty, once-state-of-the-art 16-MHz 386DX machine, filled to its personal limit of 4 MB of RAM, was relegated to the back room, where it will perform tasks that DOS emulators running on Unix find impossible. Wanting to see if there truly was life beyond MS-DOS, I tried Digital Research's DR DOS 6.0.

### Even I Run DOS Sometimes

I am very happy with any product that doesn't require opening the manual, and DR DOS more than qualified. I tested it on four different machines, and it chose reasonable defaults, based on the CPU, RAM, and other hardware it found available during installation.

The real reason I wanted DR DOS was for its disk compression, because I didn't want to put any more money into the ancient disk technology existing on this particular machine. Under MS-DOS 3.2, I was forced to set up separate 32-MB (drive C) and 8-MB (drive D) partitions on the 40-MB drive, and drive C had 26 MB used. After installing DR DOS, I have 33 MB of free space on drive C, and I still have a drive D, although it's now twice as big as before. This capability alone makes me think that DR DOS 6.0 is a logical upgrade from MS-DOS... any version.

So the relevant question is, Why doesn't someone write a compressing disk driver for Unix, using similar technology? With compression built into the kernel, you could run your root file system in regular mode for compatibility and mount user file systems that would be compressed, on the fly, to and from the disk. There's a minor performance hit, but one that I con-

sider well worth it for a 150 percent to 300 percent compression ratio.

### Up, Up, and Away

To keep my system stable while upgrading it, I decided to keep all my old boards and disks and upgrade the motherboard to a more modern 386 running at 33 MHz with a cache. I wanted to be able to use SIMMs for easy RAM expansion. To hold down costs, I built it myself.

There's a chain of Domino Computer Stores ((510) 226-1800) here in northern California, where you can go in and select your motherboard, case, RAM, and other options from a competitively priced "à la carte" menu. Then you sit down at a static-safe bench with an electric screw-

driver and go to work.

With my now much-faster main system humming away, I went out and bought a 486-based workstation, so I would have something to network to (and run X Window System, Motif, and Open Desktop software on). I'm still waiting for some more network goodies to show up, but I did manage to hook my workstation to the Mobius workstation (mentioned last month) without blowing anything up.

### Starting X

The start-up procedures for X and Motif are complex enough to rate some mention. There are two ways for X to initialize. Using the `startx` program, you log in as a normal "text" user and can switch to X at any time. You can also set up the `xdm` program, which is a display manager that puts the selected display or multiscreen directly into graphics mode, from which you log in and enter X immediately. If you have X terminals, `xdm` is also useful, because they work only in graphics mode.

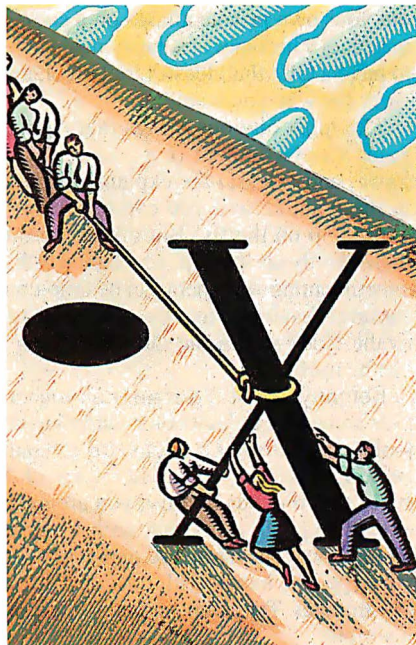
If you run `startx`, it first consults a `.startxrc` file in your home directory to find out which X clients (i.e., X-oriented application programs) you want to begin running with. My `.startxrc` file looks something like the one found in listing 1.

The `startx` program itself is just a shell, which calls `xinit`, which then runs the X server (i.e., the program that runs the display). The `xinit` program can use two home directory start-up files called `.xinitrc` and `.xserverrc` (see below). The `xdm` program has a similar start-up file called `.xsession` for launching clients.

### Your Own Private Idaho

Have you set up your log-in environment so that whenever you log in, everything is just the way you like it? Or maybe you'd like to set up your log-in this way, but you've never found the time. In either case, let me warn you: If you think developing all your favorite `ksh` or `csh` aliases took a

### Setting up your X and Motif environment, and why to bother doing it



## A MESSAGE TO OUR SUBSCRIBERS

FROM TIME TO TIME WE make the BYTE subscriber list available to other companies who wish to send our subscribers material about their products. We take great care to screen these companies, choosing only those who are reputable, and whose products, services or information we feel would be of interest to you. Direct mail is an efficient medium for presenting the latest personal computer goods and services to our subscribers.

Many BYTE subscribers appreciate this controlled use of our mailing list, and look forward to finding information of interest to them in the mail. Used are our subscribers' names and addresses only (no other information we may have is ever given).

While we believe the distribution of this information is of benefit to our subscribers, we firmly respect the wishes of any subscriber who does not want to receive such promotional literature. Should you wish to restrict the use of your name, simply send your request to the following address.

**BYTE** Magazine

Attn: Subscriber Service  
P.O. Box 555  
Highstown, NJ 08520



## HANDS ON/THE UNIX /bin

**Listing 1:** A sample .startxrc file. This is the same idea as .xinitrc.

```
/usr/bin/X11/xrdb .Xresources
mwm 2>/dev/null &
xdt -iconic -geometry 600*222-0-0 2>/dev/null &
odtterm -blink -T 'uname' -j -ut -geo 80*25+0+0
```

**Listing 2:** A sample .Xdefaults file with explanations of each line following as a comment.

```
Mwm*interactivePlacement: false
! if true, you will have to position
! each window "by hand" with the mouse

Mwm*useIconBox: false
! takes up a lot less screen space

Mwm*keyboardFocusPolicy: pointer
Mwm*focusAutoRaise: true
Mwm*autoRaiseDelay: 750

! These three lines let the mouse
! pointer automatically uncover
! and select the current window.
! If you prefer to specifically
! click on a window to select it,
! try these instead:

Mwm*keyboardFocusPolicy: explicit
Mwm*focusAutoRaise: true
Mwm*startupKeyFocus: true
```

long time, wait until you discover X and Motif!

It seems that the more visual the environment, the more personal it becomes. While it's annoying, perhaps, to do without your own private aliases on a strange machine, it becomes absolutely maddening to have a GUI that doesn't look, feel, and work the way you want it to.

The most obvious things that change your X environment (e.g., xsetroot, xset, and xterm) are explained clearly in the manual, and you can experiment with them on the fly. But others are initialized only on start-up, which means that experimenting with them can be time-consuming. I've found that the settings made by the .Xdefaults file shown in listing 2 can be useful.

Before you edit .Xdefaults, you can pick some nice default colors and fonts by looking in /usr/lib/X11/rgb.txt and running xlsfonts. David's Law of X states that on your first try, you are guaranteed to pick colors that aren't implemented on your hardware and fonts that you won't be happy with for more than a few minutes. Try again, and this time keep it simple.

### More Tricks at Your Service

If you've been wondering how to get the X server running so that it initializes with the "floating logo" screen saver, try starting it up by putting a line like the following in a file called .xserverrc in your home directory:

```
/usr/bin/X11/Xsight -p 5 -save
300 -logo -v off
```

This works, as is the case on SCO Open Desktop, where the X server is Xsight from Locus Computing. Other servers can be called "X" rather than "Xsight." You can do this on the fly by executing the command xset s 300 5 s noblank.

There are some nonobvious things you can do with xterm. Try starting it up as xterm -T 'uname' -cr green in your .startxrc file. You'll not only be able to see the cursor, but the name of the machine xterm is running on will be clear. And you can use the same .startxrc file on any machine on your network with the correct results.

A marvelously straightforward introductory book on X is *The X Window System: A User's Guide* by Niall Mansfield



# NOTICE

WE'VE BEEN ASKED TO MAKE IT VERY CLEAR THAT  
THERE'S A WHALE OF A DIFFERENCE BETWEEN QNX® AND UNIX®.

## WE'RE GLAD TO OBLIGE.

**E**VEN THOUGH THE QNX REALTIME OPERATING SYSTEM IS NOT BASED ON UNIX SOURCE CODE, WE CAN UNDERSTAND HOW SOME DEVELOPERS MIGHT CONFUSE THE TWO. AFTER ALL, QNX FOLLOWS THE LATEST IEEE POSIX 1003.1 AND 1003.2 OPEN SYSTEMS STANDARDS, SO YOU GET THE SAME API AND UTILITY SET FOUND IN MANY UNIX SYSTEMS.

BUT LOOK BENEATH THE SURFACE AND YOU'LL SEE TWO FUNDAMENTALLY DISTINCT ARCHITECTURES. A MONOLITHIC OS ON THE ONE HAND, A MICROKERNEL OS ON THE OTHER. THEY'RE DIFFERENT SPECIES ALTOGETHER, AS DIFFERENT AS A WHALE AND A SCHOOL OF DOLPHINS.

### ARCHITECTURE YOU CAN BUILD ON

QNX'S MODULAR, MICROKERNEL ARCHITECTURE GIVES YOU REMARKABLE FLEXIBILITY. OS SERVICES ARE PROVIDED BY A TEAM OF COOPERATING PROCESSES RATHER THAN BY A MASSIVE MONOLITHIC KERNEL. THE RESULT? YOU CAN STRIP QNX DOWN TO A ROM-ABLE EMBEDDED SYSTEM. OR BUILD IT UP TO A VAST NETWORK AND HARNESS THE POWER OF HUNDREDS OF CPUS.

OUR PRICING IS MODULAR TOO, SO YOU'RE NOT FORCED TO PAY FOR WHAT YOU DON'T NEED.

### REALTIME PERFORMANCE

#### YOU CAN COUNT ON

NEED THE SPEED OF A FAST, REALTIME EXECUTIVE? QNX CLOCKS IN AT 16  $\mu$ SEC PER CONTEXT SWITCH ON A 33 MHZ 80486.

BUT QNX DOESN'T STOP THERE. WITH ITS PRIORITY-DRIVEN, PREEMPTIVE SCHEDULING, YOU CAN BUILD REAL REALTIME SOLUTIONS.

### DISTRIBUTED PROCESSING

#### YOU CAN BET ON

QNX CAN TRANSFORM A BUNCH OF ISOLATED MACHINES INTO A SEAMLESS SUPERCOMPUTER,

ORCHESTRATING HUNDREDS OF CPUS WITH ITS NETWORK-WIDE IPC.

YOU'RE IN COMPLETE CONTROL OF ALL RESOURCES AT ANY POINT, FROM THE PLANT FLOOR RIGHT UP TO YOUR DESKTOP.

### SUPPORT YOU CAN DEPEND ON

DURING THE LAST TEN YEARS, WE'VE EARNED A REPUTATION FOR OUTSTANDING TECHNICAL SUPPORT. WE OFFER EVERYTHING FROM 24-HOUR ONLINE CONFERENCING TO ONSITE CONSULTING, SO YOU CAN EASILY REACH THE PEOPLE WHO MAKE UP THE QNX DEVELOPMENT TEAM. THEIR EXPERTISE CAN HELP YOU KEEP YOUR DEVELOPMENT PROJECTS RIGHT ON COURSE.

TO FIND OUT HOW YOUR APPLICATIONS CAN THRIVE IN THE QNX ENVIRONMENT, CALL 1-800-363-9001, (EXT. 101).

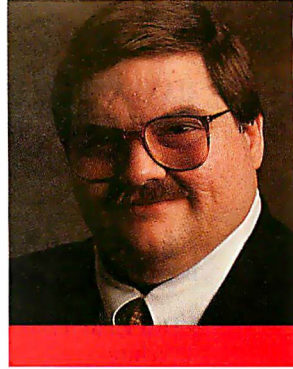


REALTIME OPERATING SYSTEM  
Circle 107 on Inquiry Card.

QUANTUM SOFTWARE SYSTEMS LTD.  
175 TERENCE MATTHEWS CRESCENT  
KANATA, ONTARIO, CANADA  
K2M 1W8  
TEL: 613-591-0931  
FAX: 613-591-3579

# ARCHITECTURE MAKES THE DIFFERENCE





DON CRABB

## MANAGING MAC UPGRADES

One reason for my being an unabashed Mac fan is the ease with which you can upgrade the machine. Adding hard drives is no tougher than plugging in another drive into the SCSI chain. And adding new video or other expansion capabilities is no tougher than plugging in an auto-configuring NuBus card and restarting the Mac.

That's the way it's gone for me since my first 128-KB Mac, back in January 1984 (except for the NuBus business, of course, which came with my first Mac II in 1987). I've plugged in disks, printers, modems, NuBus cards, and all manner of third-party doodads without so much as a whimper, much less a groan, from my Macs. Until now. Last night saw a struggle before I finally succeeded in replacing my trusty old SuperMac Technology Spectrum/8 video card (8 bits of color on a SuperMac 19-inch Trinitron RGB monitor) with a hot new SuperMac Thunder/24 card.

The Thunder/24 card (aptly named) is one of a new generation of ultrafast 32-Bit QuickDraw accelerator video cards. It provides 24-bit video (16.7 million colors), where my old Spectrum/8 card could handle only 256 shades.

The Thunder/24 can accelerate both 8- and 24-bit modes on the Mac. The Thunder/24 that I installed in my Mac IIci (a machine that I have already accelerated with a DayStar Digital 50-MHz 60830 PowerCache card and a DayStar 64-MB RAM PowerCard) included the maximum 8 MB of extra GWorld video RAM. This helps accelerate off-screen bit maps that some video and animation software packages use.

In the informal tests that I conducted, the Thunder/24 was three to 30 times faster in 8-bit acceleration mode than my old Spectrum/8, depending on the software. It made working with 24-bit mode a pleasure, instead of the jerky updating that caused me to remove my older Spec-

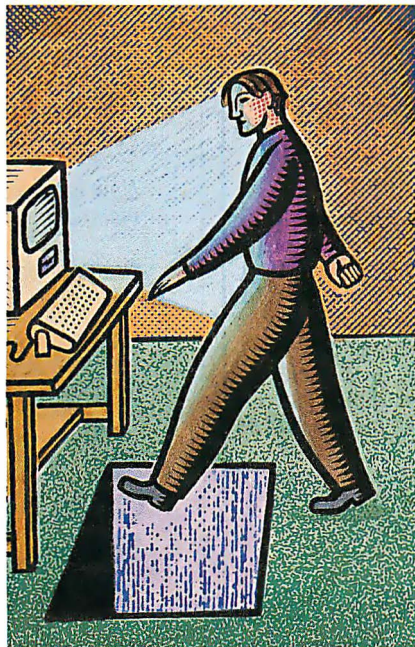
trum/24 in the first place (and go back to the Spectrum/8).

### Installation Difficulties

The Thunder/24 has explicit installation instructions. Being an experienced and somewhat arrogant MacFolk, I quickly dispensed with these in favor of the Crabb Standard Method—plug the sucker in and get going. That was a mistake.

I had forgotten an important piece of NuBus auto-configuration lore: When you remove an existing card (in this case, the Spectrum/8), you need to restart the Mac with no card in that slot to clear the old NuBus card settings from PRAM. Normally, the Mac checks the card IDs with copies of IDs stored in PRAM. If they

### A firsthand account of the trials and tribulations of upgrading Macs



don't match, it auto-configures the new card into the system. Occasionally, for reasons unknown, this mechanism fumbles. Hence the lore.

You risk doing exactly what I did—installing the new card in the old slot, restarting the machine, and watching the auto-configuration software misstep. As far as the Mac is concerned, nothing at all has changed, so it uses the old NuBus PRAM settings for that slot. In the case of the Thunder/24, those settings aren't compatible with the old Spectrum/8 settings. As a result of this bit of upgrade hubris on my part, I not only succeeded in disabling my 19-inch display (I couldn't even get the display to recognize the Thunder/24's self-test mode), I also blew away an Integrated Data Storage Systems' Wip40Q SCSI hard drive that was sitting at the end of my SCSI chain.

Fortunately, I had a second display connected to my IICI (an AppleColor 13-inch RGB monitor connected to an Apple 8-24GC accelerated NuBus card), so I wasn't flying totally blind. After removing the Thunder/24, restarting the machine to clear out that slot's PRAM, and replacing the card (all the while checking the configuration using the working Apple monitor), I finally got the thing into self-test mode.

Satisfied that I had fried neither the card nor the monitor, I put the Thunder/24 into its monitor setup mode, where it would march through different monitor synchronization rates until it found the right one for my monitor. When the card hit the correct monitor frequency, I would see an image of a keyboard, at which point I would bang the space bar to lock in the scan frequency.

Unfortunately, in all my fiddling, I had managed to loosen the Apple Desktop Bus (ADB) connection to my keyboard. Thus, the blasted thing wasn't transmitting my space-bar signal, and the board kept cycling through its test patterns. Most annoying. Finally, my brain came back online, and I reconnected the keyboard and

signaled the right pattern. Things have been fine ever since.

## I Did Learn Something

This little experience taught me a few important lessons. First, no matter how experienced you are at adding NuBus cards to your Mac, you must read and follow the directions from the card's manufacturer. Second, try to eliminate all other interactions (e.g., loose ADB cables) when upgrading your Mac. You might mistakenly assume that you're having problems with the upgrade when the real problems are those you created yourself beforehand.

Finally, *never* think that upgrading your Mac is a simple task. It might be easy, especially when you follow directions, but the stuff that is going on behind the scenes of a "simple" NuBus card insertion is anything but simple.

## Software of the Month

One of the problems I faced when I completed my Thunder/24 installation was the dead Wip40Q drive. This baby was sitting at the end of my SCSI chain, and it didn't like all the fiddling I had done. It simply refused to put in an appearance on my

**N**ever think that upgrading your Mac is a simple task.

Desktop. I tried the old public domain standbys SCSIProbe and SCSTools (two Control Panels) to get the Wip40Q back on-line, but neither could do the trick. Both Control Panels showed the drive hooked to the SCSI chain and its SCSI ID number, but neither was able to mount it.

Because I had two fresh and complete backups of this drive (courtesy of Dantz Development's outstanding Retrospect backup program), I wasn't too worried about blowing away the data on this drive. I just wanted to get the thing back on-line where it belonged. I also wasn't too sanguine about using the formatting utility that came with the Wip40Q to assist in

this function, because I had had trouble with it in the past.

As I was contemplating a backdoor solution to my problem (I thought about hooking the Wip40Q to another Mac and accessing it as a file-share drive), I went through the day's mail. One of the things I found was a utility called DiskMaker 1.10 from a company I had never heard of: Golden Triangle Computers. This utility had been sent to me so that I could format the Quadram QuadFlextra drive I had been sent to play with (this is one of those new drives that squeezes 20 MB onto a special floppy disk; I'll have more to say about it next month, but so far it's worked beautifully).

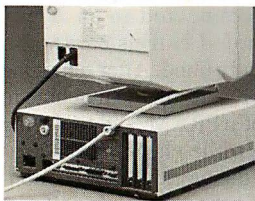
After I read the DiskMaker manual, it was pretty clear to me that it was far more than a specialty utility for the QuadFlextra. It was a full-blown SCSI drive formatter and manager. Since I've always been a fan of such utilities—LaCie's Silverlining has been at the top of my list and was waiting in the wings if DiskMaker failed—I decided to give DiskMaker a chance.

I fired up DiskMaker, and it found the Wip40Q without failure. In fact, merely clicking on its icon in the DiskMaker

## COMPUTER SECURITY PRODUCTS

COMPLETE LINE OF PROVEN AND EASY TO INSTALL  
COMPUTER SECURITY PRODUCTS FOR COMPUTERS.

### PREVENT COMPUTER THEFT!



### Kabit™ Security System

This system allows you to secure all your computer components: CPU, monitor, keyboard, printer. **Internal component security:** Kabit fasteners secure the rear panel of CPU protecting internal boards and hard drives. Fasteners available for all applications. Prices \$34.95 to \$49.95 depending on system.

### DISK DRIVE LOCK™



### IBM PS-2 DLK-270 Series

Now you can lock a diskette into your disk drive and force the computer to boot from the diskette. Disk Drive Lock models available for PS/2 - 30, 55SX, 50, 70 and 90. Protect your data from viruses or from being copied. Other drive locks to fit most non IBM PS/2 and Macintosh disk drives. List price \$24.95

Order your free catalog of these and many other security products. Purchase orders accepted. Quantity pricing available. Shipping not included. MC/VISA accepted. Dealer inquiries invited.

**Secure-It, Inc.** 1-800-451-7592

18 Maple Court East Longmeadow, MA 01028

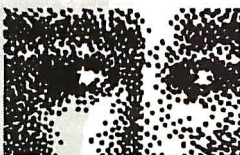
# ComputerEyes/RT

## 24-Bit Color Frame Grabber

Affordable, accurate real-time video frame capture for IBM PC computers. Supports all standard VGA, SuperVGA, and now HiColor, and True-color displays. Real-time video preview directly on VGA monitor. Outputs files in all formats: TGA, TIF, PCX, GIF, ColoRIX, and more. Comes complete with excellent user software; Windows drivers and Developers Package are also available.

Now includes free CineMaker software for capturing video animations!

See your dealer or call for information and free demo.



**COMPUTER  
EYES**

**Under \$600!**

For information,  
call (617) 329-5400.  
To order, see your dealer  
or call (800) 346-0090.

Digital Vision, Inc.  
270 Bridge Street  
Dedham, MA 02026

control window made it magically appear on the Desktop (the manual doesn't mention this capability). That gave me a chance to check the disk out with Symantec Utilities for Macintosh II, the System 7.0-compatible version of SUM. SUM II revealed that the directory was scrambled. I ran the SUM Recovery program, pulled off all the files and stuck them on another disk, wiped the disk clean, and proceeded to reformat it with DiskMaker.

DiskMaker formatted the disk in short order, and I used it to install a "polled" SCSI driver on the disk. A polled driver handles the transfer of data by requesting and acknowledging the transfer of each byte that the Mac file system sends it. This kind of driver is a bit slower than a blind driver (which compiles a series of transfer requests before reading or writing them blindly), but it is the most reliable. DiskMaker can also write a blind SCSI driver, but my experience with the Wip40Q showed it to be a bad candidate for that type of operation.

After all this fiddling, the Wip40Q is now back on-line, humming along nicely with the other drives, and working with the SuperMac Thunder/24 card without a hitch. The DiskMaker driver has proven so reliable that I'm thinking of eventually reformatting my other SCSI drives with it so I can install this driver. ■

*Don Crabb is the director of laboratories and a senior lecturer for the computer science department at the University of Chicago. Don is also a contributing editor for BYTE. His new book on System 7.0 is now in bookstores. He can be reached on BIX as "decrabb."*

*Your questions and comments are welcome. Write to: Editor, BYTE, One Phoenix Mill Lane, Peterborough, NH 03458.*

## ITEMS DISCUSSED

**DiskMaker 1.10**.....\$79  
Golden Triangle Computers, Inc.  
(619) 279-2100  
**Circle 1146 on Inquiry Card.**

**Symantec Utilities for Macintosh II**.....\$149.95  
Symantec Corp.  
(408) 253-9600  
**Circle 1147 on Inquiry Card.**

**Thunder/24**.....\$4999  
SuperMac Technology  
(408) 245-2202  
**Circle 1148 on Inquiry Card.**

## Order BYTE Program Listings on Disk!

BYTE listings are available on disk if you want to compile or read the complete source code listings of programs. Disks include any Software Corner programs available for the format you have chosen. BYTE listings are available from December 1985 to the present at the prices stated on the order form.

For direct ordering call TOLL-FREE: 800-258-5485. New Hampshire residents call: 603-924-9281 M-F, 8:30am to 4:30pm, Eastern Time for credit card orders only. Subscription Customer Service: 800-232-BYTE.

ORDER FORM: to place your order, complete the information below, and mail to: BYTE on Disk, One Phoenix Mill Lane, P.O. Box 809 Peterborough, NH 03458-0809. Please complete in full.

Name \_\_\_\_\_  
Address \_\_\_\_\_  
City \_\_\_\_\_  
State \_\_\_\_\_ Zip \_\_\_\_\_  
County or Parish \_\_\_\_\_ Country \_\_\_\_\_  
Credit Card # \_\_\_\_\_ Exp. Date \_\_\_\_\_  
Signature \_\_\_\_\_ Date \_\_\_\_\_

Please allow 6-12 weeks for delivery.

MARCH

5-1/4 Inch: <input type="checkbox"/> IBM PC	3-1/2 Inch: <input type="checkbox"/> Apple Macintosh <input type="checkbox"/> IBM PS/2
IN USA/Single Month	
<input type="checkbox"/> BYTE listings \$13	<input type="checkbox"/> BYTE Listings \$14
IN USA/Annual Subscription	
<input type="checkbox"/> BYTE Listings \$110	<input type="checkbox"/> BYTE Listings \$120
OUTSIDE USA/Single Month	
<input type="checkbox"/> BYTE Listings \$17	<input type="checkbox"/> BYTE Listings \$18
OUTSIDE USA/Annual Subscription	
<input type="checkbox"/> BYTE Listings \$140	<input type="checkbox"/> BYTE Listings \$150

\*Please indicate the issue date below. If you are beginning an annual subscription, note the starting issue.

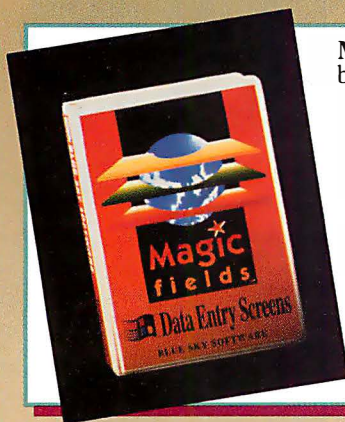
BYTE Program Listings  
Month \_\_\_\_\_  
Year \_\_\_\_\_

Check enclosed  
 MasterCard  
 VISA  
 U.S. funds enclosed. (If ordering from outside the U.S., please remit in U.S. funds drawn on U.S. bank. Thank you.)

**BYTE**

**MS  
CORN**

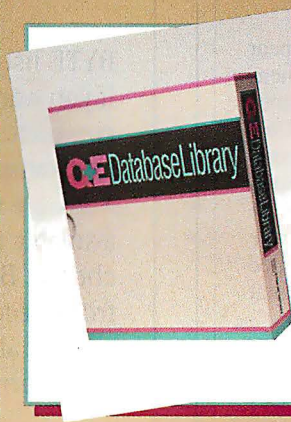
# The Programmer's Shop™



## Magic Fields™ for Windows by Blue Sky Software™

Save time by creating Windows data entry screens the smart way. Magic Fields is a large collection of objects that perform data field validation. No coding—just point and click to define intelligent input fields (numeric, text, date, currency, phone #, etc). Fully customizable including fonts, colors & chiseled steel 3-D NeXT look. Extremely powerful. Use any Windows resource editor. No royalties. Highly Recommended.

Intro Price: \$349 **PS Price: \$329**  
FastFacts 2001-007



## Q+E Database Library (QELIB) by Pioneer Software

A set of Dynamic Link Libraries (DLLs) for Windows and OS/2 that integrates relational database functionality into applications you develop. Any authoring tool that can call a DLL can take advantage of QELIB's common call-level interface. Developers can write one application that works with Oracle, Sybase, SQL Server, DB2, Paradox, dBASE, Netware SQL, Ingres, XDB, SQL Base, Btrieve, EE DBM, ASCII and/or Excel. LIST: \$399 **PS Price: \$379**  
FastFacts 2137-012

### 386 DEVELOPMENT

	LIST Price	PS Price
386 Max 6.0	\$ 100	\$ 89
386DOS Extender	495	479
Blue MAX	125	109
DESQview 386	220	189
F77-EM32 + OS/386	1390	1149
FoxBASE+/386	595	479
High C 386/486	795	749
NDP Fortran 386	895	829
QEMM 386	100	75
SVS C3/ANSI C Comp.	1195	325
WATCOM C8.5 386	995	639
C Code Builder	695	579

### ASSEMBLY

MS MASM	150	105
Spontaneous Assembly	199	159

### BASIC & ADD-ONS

BAS-C Commercial	895	819
dB/LIB Professional	189	179
GFA BASIC 386	295	200
Microsoft BASIC PDS	495	349
MS QuickBASIC V4.5	99	69
QuickPak Prof. V4.0	199	189

### C LANGUAGE COMPILERS

Instant C	495	479
Quick C	99	69
Microsoft C 6.0	495	349
Watcom C 8.5	495	439

### CASE & PROTOTYPERS

Demo II V3.0	249	239
EasyCase Plus	495	449
G-Base Professional	799	699
Instant Replay Prof.	595	575
Layout	300	239
Show Partner F/X	395	295

### COMMUNICATIONS

ADD-ONS		
Blast PC Plus	295	250
C Asynch Manager 3.0	219	189
Essential COMM	329	249
Greenleaf Comm Library	359	309
HyperACCESS/IV for DOS	100	75
Procomm Plus	119	99
QuickComm	149	129

### DBASE

Alpha 4	549	469
Clipper 5.01	795	570

dBASE IV	795	549
dBMAN V	295	219
dBXL	249	169
FoxPro 2.0	795	499
FoxBASE +	395	279
Nutshell Plus II	395	295
QuickSilver	599	399

### DBMS

CLARION Prof. Dev.V2.1	845	475
File Pro Plus	699	669
Magic PC	800	779
Paradox V3.5	795	555
R:BASE 3.1	795	645

### DBMS CODE GENERATORS

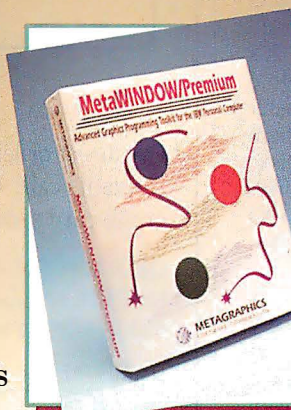
DataBoss	695	649
Genifer	395	289
Pro-C w/Workbench	795	735
UI2 Developer's Release	595	449

### DBMS TOOLS & LIBRARIES

Artful Two	295	285
Accsys for dBASE	395	349
CLEAR + for dBASE	200	179
CodeBase 4.5	395	349
Comet Multiport	169	149
Comm Tools for Clipper	299	269
C Works	698	649
dBX/dBport w/source	1000	895
dGE 4.5	295	279
dSalvage Professional	200	195
Essential B-tree w/source	199	149
Faircom c-tree Plus	595	495
FLIPPER Graphics Lib.	295	279
FUNcky.LIB	249	239
Nantucket Tools II	695	499
Net Lib	299	269
Novell BTrieve	595	479
Pro Clip	195	185
R&R for dBASE & Comp.	249	229
R&R Code Generator	199	159
Scrimage	149	139

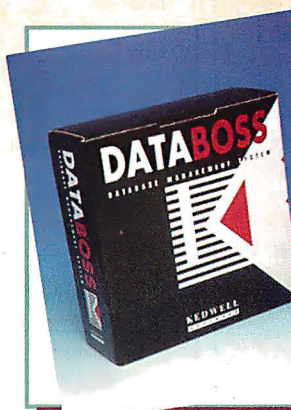
### DEBUGGERS/ DISASSEMBLERS

Dis/Doc Professional	250	229
Multiscope for DOS	179	99
Periscope/EM	295	259
Periscope I/OK	495	459
Periscope IV	Varies	
Sourcer 486 w/BIOS pre-proc.	170	149



## MetaWINDOWS/PREMIUM by Metagraphics

A professional graphics toolkit with a complete set of drawing routines, and dynamic device support in a unified graphics system. PCX support imports & exports graphic files from a variety of sources. Graphics input supports keyboard, mice, timer, touch screen, tablets, while built-in hardcopy outputs graphics to laser & dot-matrix printers. Supports Herc, CGA, EGA, VGA, 16-, 256-, 32K-color SVGA's up to 1280x1024, 8514/A and IBM XGA. Works with 286/386 DOS Extenders, C and C++ compilers. LIST: \$595 **PS Price: \$549**  
FastFacts 318-006



## DataBoss 3.5 by Kedwell Software

DataBoss 3.5 is a complete environment for developing relational database applications and generating Pascal or C/C++ source code. DataBoss has a powerful WYSIWYG report designer and true context-sensitive help throughout. "PC Week" reviewed DataBoss as the most complete database creation system around for the PC.

LIST: \$695 **PS Price: \$649**  
FastFacts 5277-001

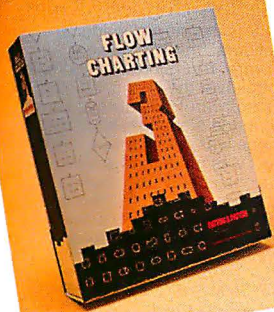


## SpeedEdit for Windows

by Bradford Business Systems  
SpeedEdit is a professional level text editor available for Windows 3.0, X-Windows Motif, & X-Windows OpenLook as a true windows application. Also available are DOS, OS/2, SunOS, SCO Unix & Xenix, Interactive Unix, ATT Unix, HP-UX, MPE & MPE-XL character versions. Includes user customization; DDE; regular expressions; language sensitivity; keyboard macros; multiple file access; compilation & testing from within. Call for Unix, MPE & multi-user pricing. LIST: \$295 **PS Price: \$265**  
FastFacts 2835-004

# We give developers what they need...

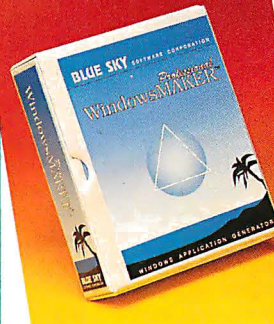
- Tools to automate every aspect of the development cycle – over 5,000 in all
- FREE pre-sales technical support



### Flow Charting 3 by Patton & Patton

Flow Charting 3 is your solution for quick and simple flowcharts. Ideal for documentation, Flow Charting 3 is a free-form drawing tool to create, modify, and edit flowcharts in up to 50-80% less time than it used to take by hand. Features include: export/import, portrait or landscape orientation, high resolution dot matrix and laser support, international character support.

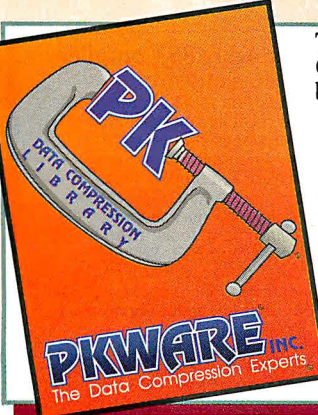
LIST: \$250 **PS Price: \$199**  
FastFacts 1923-007



### WindowsMAKER™ Professional by Blue Sky Software™

Considered the easiest and fastest way to create MS-Windows applications in C/C++. Generate the Windows .EXE w/complete source & production files (no royalties). Just Point & Click to define the Windows user interface. Lets you animate your design to instantly test look & feel and make changes on the fly without needing to compile. Custom code is preserved during code regeneration. The leading development tool for Microsoft Windows. Highly Recommended.

LIST: \$995 **PS Price: \$895**  
FastFacts 2001-006

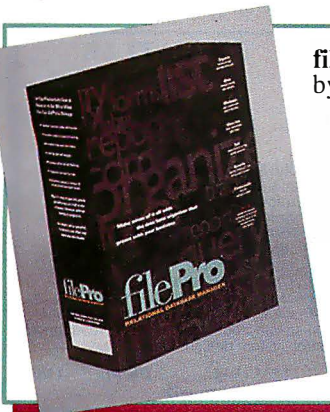


### The PKWARE Data Compression Library by PKWARE

The PKWARE Data Compression Library allows software developers to add data compression technology to applications. The application program controls all data I/O, allowing data to be compressed or extracted to any device or area of memory. Only 35K of memory is needed to compress data, and only 12K is needed to extract data.

Compatible with MSC, BC++, TC, TP 6.0, Clipper, Basic 4.5, 7.1, ASM.

LIST: \$295 **PS Price: \$275**  
FastFacts 3043-011



### filePro Plus by The Small Computer Co.

filePro Plus is a Menu Driven Application Generator, 4GL and RDBMS. Some of the tools include a CUSTOM Menu Generator, Screen and Report Painter, built-in debugger, event driven processing, browse look-up windows and the ability to create your own data types. filePro Plus applications are completely portable on over 200 hardware platforms and over 12 operating systems.

LIST: \$699 **PS Price: \$669**  
FastFacts 3969-003

Turbo Debugger & Tools 150 119

#### DEVELOPMENT TOOLS

AllClear	300	259
ASMFLOW Prof.	200	179
Blinker	249	235
dANALYST Gold		
Windows & DOS	495	100
C-DOC	189	179
Charge	75	69
CLEAR+ for C	200	179
Codan	395	349
Install	250	219
INSTALLIT w/source	249	239
MKS Make	149	129
MKS RCS	249	229
Optlib	75	74
Optasm	150	145
Optlink/Compress	350	345
Optlink/2	350	345
PC-Lint	139	115
PVCS Config. Builder	250	219
PVCS Version Manager	600	529
.RTLINK Plus	495	419
.RTPatch	495	419
Sourcerer's Appr. Prof.	499	459
The Documentor	295	229
TLIB	139	125

#### EDITORS

BRIEF	249	Call
BriefFor C++	129	119
Cheetah	145	50
dBrief	129	119
Emacs	325	279
Epsilon	250	229

KEDIT	150	139
PVCS Profes. Editor	300	249
SPF/PC	295	249
SpeedEdit	295	265
Vedit +	185	159

#### FORTRAN

F77L FORTRAN	595	549
Microsoft FORTRAN 5.1	450	309
RM/FORTRAN	595	499
Watcom FORTRAN 77	495	449

#### GRAPHICS

Essential Graphics Chart	399	349
GFX Graphics Library	150	139
GraphiC	465	419
graphics-Menu		
w/ Data Entry	249	229
GSS Graphics Dev't Tlkt.	795	699
GX Effects	199	179
w/ Source	399	369
GX Text	149	129
w/ Source	299	289
HALO Professional	395	319
MetaWINDOW/PLUS	395	349
PCX Programmer's Tlkt.	249	229
QuickPix	495	479
Victor w/source	295	279
Z-Phigs Professional	795	769

#### HARDWARE

Boca-SVGA w/1MB	245	179
Hard Card IIXL 50MB	389	369
MouseMan Cordless	199	139
Sola Net. 450 VA/UPS	349	249
Sound Blaster	239	189

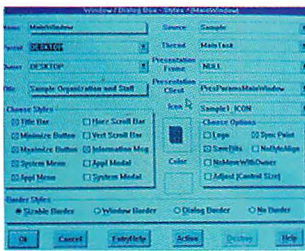
# THE PROGRAMMER'S SHOP 1-800-421-8006

All prices subject to change. Int'l. prices will vary.

Nat'l Accounts : 800-446-1185 FastFax: 617-740-0025

# And MORE!...

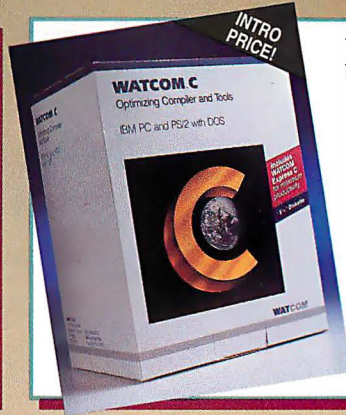
## GPF GUI Program Facility by GPF Systems



Gpf (GUI Programming Facility) is a powerful point and click visual programming environment. With Gpf you can prototype, test and generate a complete OS/2 PM GUI in a fraction of the time required to hand code. With no royalties, Gpf offers 16 and 32 bit OS/2 PM support with:

- Extended Edition SQL code generation
- Automatic Help Creation (IPF)
- user defined controls
- full control of fonts, colors, etc.

LIST: \$995 **PS Price: \$979**  
FastFacts 3227-005



## WATCOM C/386 by WATCOM

Develop and debug 32-bit applications for extended DOS and Windows. Includes royalty-free 32-bit DOS extender, true 32-bit Windows GUI Application Kit, our fast, light, and reliable 32-bit Code Optimizer, licensed Microsoft Windows SDK Components, an interactive Source-Level Debugger, an Execution Profiler and More!

LIST: \$795 **PS Price: \$639**  
FastFacts 1044-020

## OBJECT-ORIENTED/C++

Borland C++	495	379
C++ Science & Engineer	1000	895
M++	295	279
Math.h++	100	95
Poet/DOS	399	379
Smalltalk/V	125	85
Tools.h++ w/Source	200	179

## OTHER PRODUCTS

Alpha RPL	595	99
Bootcon	60	Call
Carbon Copy	199	179
Clip'nSave	80	79
Disk Dupe Pro	179	159
Fast!	99	89
FastBack Plus	189	159
Flow Charting 3	250	199
GraphBASE	100	95
HEADROOM	130	89
HiJaak	199	149
LapLink Pro	150	115
Link & Locate ++ - Ext.	479	399
Mace Utilities	149	99
Mcapture	99	98
Norton Anti-Virus	129	119
Norton Utilities 6.0	179	149
pcANYWHERE IV	179	159
PC Tools Deluxe 7.1	179	149
PC-KWIK Power Pak	130	119
QuickNet	199	195
Remote2	195	139
Speak2Me	99	98
SpinRite II	89	79
System Sleuth Pro	149	99
Turbo EMS	100	89

## PASCAL

MetaWare Prof. Pascal	495	480
Microsoft Pascal	300	199
Quick Pascal	99	69
Pascal ASYNCH Mgr.	175	159
Turbo Pascal 6.0	150	109
Turbo Professional	135	119

## TEXT SCREEN ADD-ONS

C Worthy w/Source	649	549
Greenleaf DataWindows	395	339
HI-SCREEN Pro II	395	319
MEWEL Window System	295	279
POWER SCREEN	169	149
Vitamin C	395	369
VC Screen - painter	149	139
Vermont Views w/ source	890	819

## UNIX/XENIX

db_FILE/RETRIEVE MU	595	569
ESIX/V Rel4 Dev. 2/usr.	1295	1229
ESIX/V unltd	1695	1595
Informix SQL	Varies	

## Interactive Systems:

UNIX Sys. V/386 4.0:		
Graph & Dev.	1795	1595
Starter	1295	1145
Complete	2795	2475

## LPI-FORTRAN

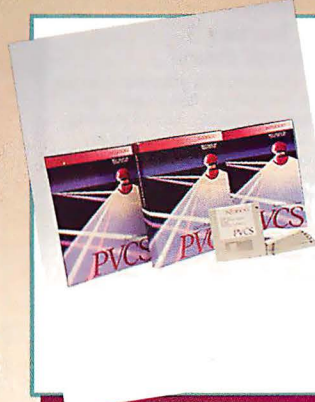
M++ for Unix	Call	
M++ for Unix w/ source	Call	
Microport V/4 Complete	3000	2879
Norton Utilities for Unix	295	269

## Santa Cruz Operations:

UNIX Operating Sys.	595	559
UNIX Dev't System	995	895
VP/ix	495	429
XENIX Oper. Sys. 386	595	559
XENIX Dev. Sys. 386	795	689
UHC UNIX Sys. V Rel.4	2395	2199
WordTech Quicksilver	1495	1295

## WINDOWS & OS/2

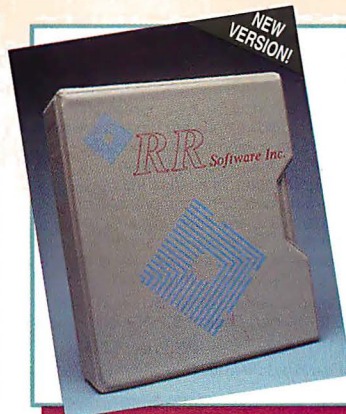
ACTOR Professional 4.0	495	449
BRIEF for OS/2	249	Call
Case: PM (for C or C++)	1995	1899
Case: W Corporate Vers.	995	969
Class Manager	399	379
dBFAST/Windows	550	529
DialogCoder	549	539
GFA BASIC for Windows	495	275
Graphics Server SDK	495	455
Guild	1995	Call
Instant Windows for Win.	495	439
KnowledgePro Windows	549	395
MS Windows V3.0	149	119
MS Windows SDK V3.0	500	365
Multiscope Windows Deb.	379	315
Objectieve/Windows	395	379
ObjectVision by Borland	150	129
OptLink/Windows	350	345
OS/2 PM Toolkit 1.2	500	369
Poet/Windows	499	469
ProtoView	695	675
Quick C for Windows	199	149
Realizer	395	349
Smalltalk/V PM	500	399
Spinnaker Plus	495	455
Time after Time	80	75
ToolBook	395	349
Visual BASIC	199	165
WindowsMaker Prof.	995	895



## PVCS Version Manager by Intersolv (formerly Sage)

PVCS is the market leader in Configuration Management software. PVCS provides complete control over the configuration of your software. You always know who made a change, what the change was, when it was made, why it was made and what revisions contain the change. You can even prevent unauthorized changes and coordinate revisions, special versions and upgrades - automatically.

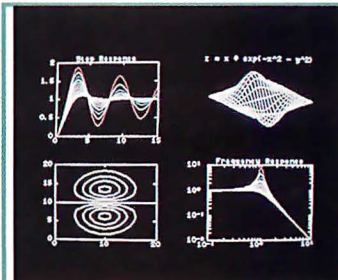
LIST: \$600 **PS Price: \$529**  
FastFacts 111-089



## Janus/Ada x86 Compiler by R. R. Software

Janus/Ada for DOS: the power and reliability of Ada, priced for everybody! You get a full implementation of the Ada standard - compiler, linker, royalty-free runtime libraries, multiple memory models, environment, tools, even an Ada tutorial. And R.R. Software supports you with 11 years of Ada experience and know-how. Now's the time for you to use Janus/Ada.

LIST: \$99 **PS Price: \$95**  
FastFacts 586-002



## 386 MATLAB™



386 MATLAB is the premier interactive and programmable software package for high-performance numeric computation in scientific and engineering applications. It combines numerical analysis, matrix computation, and 2D/3D graphics, with an easy-to-use interface where problems and solutions are expressed mathematically. 386 MATLAB Application Toolboxes add specialized functions for a broad range of applications such as signal processing, control system design, parametric modelling, splines, and optimization.

LIST: \$1595 **PS Price: \$1585**  
FastFacts 879-009

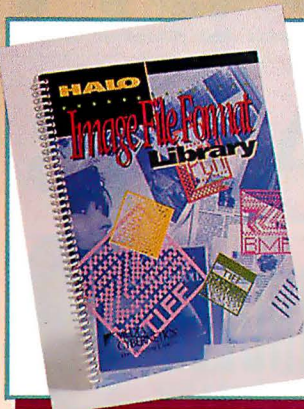


- DOS, Windows, OS/2 and UNIX tools – for every major language
- FREE, comprehensive buyers guides
- Instant, on-line product literature with *FastFaxts!*
- International Support –

**THE PROGRAMMER'S SHOP :**

DEUTSCHLAND  
 Telefon: 0231/1768-0  
 Telefax: 0231/1768-16  
*International prices will vary*

ITALIA  
 Telefono: 02-48.01.11.11  
 Telefax: 02-48.01.11.07



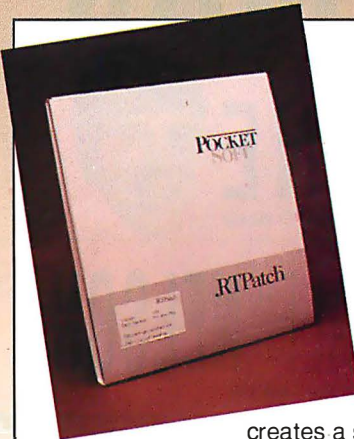
**HALO Image File Format Library** by Media Cybernetics

*Instant file support for your applications*

Add image file reading and writing to your applications with the HALO Image File Format Library. Makes your application instantly compatible with hundreds of graphics and imaging products. Offers complete support for TIFF (Tagged Image File Format), PCX (PC Paintbrush), BMP (Windows Bitmap), and CUT (Dr. HALO). Works with Borland C++, Turbo C, Turbo C++, and Microsoft C.

DOS	Windows
LIST: \$249	LIST: \$349
<b>PS Price: \$199</b>	<b>PS Price: \$279</b>

*FastFaxts 86-073*



**.RTPatch**

by Pocket Soft, Inc.

.RTPatch allows you to update files or entire systems by sending only the changes between versions. .RTPatch compares the old version of a file (or set of files) to the new version, and

creates a small patch file that

contains just the differences. This patch file is then sent to the end user. The patch file is then used to change the end user's old version into the new one.

The advantages of patching are numerous: Patches are typically very small and therefore use less disk media or BBS time. Patches are also very easy to create and apply, thus taking the hassle out of updating. Patches can also be posted on public BBS's without fear of theft since the patch is useless if you do not have an original copy of the program. Finally, patches are very safe. Extensive verification insures that a correct patch is created and applied.

.RTPatch works on any file type in DOS, OS/2, and Windows, and comes with a full 45-day, no-risk, money-back guarantee. There are NO RUN-TIME charges or Royalties of any kind.

LIST: \$495

**PS Price: \$419**

*FastFaxts 127-7013*



**Clipper 5.01**

by Nantucket Corp.

Clipper's open architecture lends unprecedented freedom to application development. Its language is fully extensible with user-defined functions and new user-defined commands. You can extend the language with routines written in Clipper itself, or integrate code from other languages like C, Assembler, dBASE® and Pascal. Develop applications larger than available memory, without defining overlays. Clipper's compiler generates stand-alone, executable files for cost-free, unrestricted distribution.

LIST: \$795	<b>PS Price: \$570</b>
-------------	------------------------

*FastFaxts 1139-003*

**What is FastFaxts?**

Access literature on any of our products via FAX machine. **FREE!**

Call 617-740-0025 from any fax phone!

Follow the voice computer's instructions and enter your product's code number. Then await your instant print out of product literature.



**THE PROGRAMMERS' SHOP**  
 National Accounts  
**800-421-8006**  
**800-446-1185**



90 Industrial Park Road, Hingham, MA 02043 • Canada 800-446-3846 • Mass. 617-740-2510 • FAX: 617-749-2018  
 Credit card orders processed *only* when product is shipped. All prices subject to change. Int'l. prices will vary.

BY392



THE ASSOCIATION FOR COMPUTING MACHINERY PROUDLY PRESENTS



# THE COMPUTER MUSEUM'S 1992 COMPUTER BOWL

FRIDAY MAY 1, 1992

## THE HASSLE IN THE CASTLE

ANOTHER TECHNICAL KNOCKOUT



CHARLIE  
"JOHANN SEBASTIAN"

EAST vs WEST



JOHN F.  
"FUTURE"

### BACHMAN vs SHOCH

Captain, Bachman Information Systems, Inc.

Captain, Asset Management Company

BILL "THE ELBOW"

### MACHRONE

Ziff-Davis Publishing Company



VS



JEFF "THE KILLER"

### KALB

MasPar Computer Corporation



DR. DAVID L.

### "HALF" NELSON

Fluent Machines Inc.

RUTHANN

### "THE MIGHTY" QUINDLEN

Alex. Brown & Sons



ANDY "M.C."

### RAPPAPORT

The Technology Research Group, Inc.



VS

THE EXAMINER  
BILL GATES  
Microsoft Corporation



PAUL "BEARER"

### SEVERINO

Wellfleet Communications, Inc.



VS



VERN "THE ACE"

### RABURN

Slate Corporation

DR. JOHN E. "KNOCK KNOCK"

### WARNOCK

Adobe Systems, Incorporated



LIVE SITE THE PARK PLAZA CASTLE  
BOSTON, MASSACHUSETTS



CLOSED CIRCUIT SITE

XEROX PALO ALTO  
RESEARCH CENTER,  
CALIFORNIA

This is the rematch fans have been waiting for all year. Ever since the last action-packed Technical Knockout, the West has been clamoring for another go at the Champions from the East. On May 1, they'll get their chance to lace 'em up.

Join us at live at ringside or at the closed circuit site for all the blow by blow excitement of *The Hassle In The Castle* - The Computer Museum's 4th Annual Computer Bowl. It's sure to be *Another Technical Knockout*.

#### Presenter

The Association for Computing Machinery

#### Underwriters

Apple Computer, Inc.  
Digital Equipment Corporation

#### Judges

Pamela McCorduck  
Author  
Heidi Roizen  
T/Maker Company

#### Founders

Pat Collins Nelson &  
Dr. David L. Nelson

#### Official Sponsors

Bank of Boston  
The Bank  
BASF Information  
Systems  
The Diskette

Intel Corporation  
The Microprocessor

MasPar Computer  
Corporation  
The Massively Parallel  
Computer Company

Merrill, Pickard,  
Anderson & Eyre  
The Venture Capital Firm

Price Waterhouse  
The Accounting Firm

Radius Inc.  
The Systems  
Enhancement Company

Robertson,  
Stephens & Co.  
The Investment Bank

Stratus Computer, Inc.  
The Transaction  
Processor

Visix Software Inc.  
The High Performance  
Workstation Software Co.

Wellfleet  
Communications, Inc.  
The Internetworking  
Company

#### Promotion

PARTNERS & Simons

The Computer Bowl is broadcast on the PBS series, Computer Chronicles, hosted by Stewart Cheifet. The Computer Bowl is a project to benefit the educational programs of The Computer Museum, 300 Congress St., Boston, MA 02210.

For tickets and sponsorship information 617-426-2800 ext. 346.

#### Engraving

HK Graphics

# ASK BYTE

## Coprocessor Crunch

I am considering buying a math coprocessor for my 20-MHz 386SX and noticed several ads in BYTE. One claimed that the Cyrix chip was faster than the Intel chip. Is there really a difference in the various math coprocessors from Intel, Cyrix, and Integrated Information Technology (IIT)?

John Graham  
Lake Mary, FL

All the FPUs, except for the Weitek Abacus 3167 and 4167 chips, are functional equivalents of their Intel counterparts. However, differences in the internal design of each chip let some FPUs perform some operations faster or use less power. BYTE Lab technical director Rick Grehan reviewed and benchmarked FPUs in "FPU Face-Off" in the November 1990 BYTE. Unfortunately, no 387SX clone chips were available at that time. Of the chips tested, he liked IIT's 2C87 for 286 machines and Cyrix's FasMath 83D87 for 386DX-class machines. Weitek's Abacus chips also performed well, but they are not 387-compatible. Thus, your application has to support them.—Stan Wszola

## Move Over, Mac

I have just moved to a new job where I'm the only PC user in a veritable sea of Macs. Everyone here is on an AppleTalk network. I'm completely shut out from accessing the laser printer, interoffice communications, and any direct link to mainframe services. I've heard that I can buy a card and some software for my PC that will let me connect to the Mac network. Could you please help me out with PC-to-Mac communications and the names of network cards?

Charles Ramcharan  
Sackville, New Brunswick, Canada

Of all the multiplatform networking schemes available for desktop machines, AppleTalk is one of the few that has its act together. Because it's so well defined, many vendors offer AppleTalk products.

First, get your PC cabled to the network. AppleTalk can run over Ethernet, token ring, LocalTalk, or twisted-pair wiring (e.g., Farallon Computing's PhoneNet). I'll assume that you're using LocalTalk or PhoneNet.

To connect to your AppleShare server, you can use one of two products. The PhoneNet Card PC\*LocalTalk is available for \$295 from Farallon Computing (2000 Powell St., Emeryville, CA 94608, (415) 596-9000). The DL series interface is available for \$299 from Dayna Communications (50 South Main St., Fifth Floor, Salt Lake City, UT 84144, (801) 531-0600). The Farallon package comes with a PhoneNet cable connector and AppleShare file/print access software. Dayna's DL card comes with DaynaShare (equivalent to Farallon's access software) and a DB-9 connector that accepts a standard LocalTalk or PhoneNet connector.

This may sound like alphabet soup, but it's straightforward. You simply drop the card into the PC, connect



the interface node to the board and the network, and install the software. If your Macs use NetWare for Macintosh, you'll want the Dayna product, which includes NetWare support. The Farallon software simply makes the PC look like another Mac on the AppleTalk network.

That takes care of printing and file sharing. For communications, two popular E-mail packages allow sending Mac mail to and from PCs. QuickMail

(CE Software, Inc., P.O. Box 65580, 1801 Industrial Cir., West Des Moines, IA 50265, (800) 523-7638) and Microsoft Mail (Microsoft Corp., 1 Microsoft Way, Redmond, WA 98052, (800) 426-9400) are both adept at talking bilingually. I'm not sure how your mainframe link works, but if you're using either NetModem or NetSerial (Shiva Corp., 1 Cambridge Center, Cambridge, MA 02142, (800) 458-3550), the DOS Connect program will let you tap in from the PC.—Howard Eglowstein

## Environment Space

Steve Apiki's response to Paul M. Smith's question about environment space and Windows 3.0 (Ask BYTE, October 1991) is appropriate in the standard DOS situation, but it does not seem to work with a .BAT file invoked under Windows.

My experience (which included increasing the environment size in the CONFIG.SYS file, as suggested) showed that when Windows spawns a DOS window, it sets the environment size to be only as big as currently required. There is no space available for other variables.

I solved the problem by creating a lengthy entry in the environment prior to calling Windows. For example, I type SET ENVIRONMENT\_FILLER=abcdefghijkl... and then run Windows. Next, I clear the environment space at the beginning of every .BAT file by typing the following:

```
@ECHO OFF
SET ENVIRONMENT_FILLER=
```

This yields many spare characters for use as variables within the .BAT file. The number depends on how many characters you insert in the original SET statement.

I have read through the descriptions of the various Windows .INI files to see if there is a way of extending the environment, but I haven't found it yet.

I trust this helps.

Rick Lugg  
Bryanston, South Africa

## Laser-Printer Engine Orphans

Some time ago, several raw Canon LBP-CX laser-printer engines came into my possession. They are old but faithful and almost unused. It would be a shame to throw them away. However, they are without a standard interface. The only outside connection is the video/control interface. If I could get more out of them

than current base models, some investment could be warranted.

In the text box "New Life from an Old Printer" (October 1991 BYTE, page 204), you mention ways to revitalize old engines. Unfortunately, the company addresses are not listed.

Torbjorn Sund  
Tromso, Norway

*We inadvertently left out the addresses. Here they are:*

Canon U.S.A., Inc.  
1 Canon Plaza  
Lake Success, NY 11042  
(516) 488-6700

Questar Technologies, Inc.  
500 Alden Rd., Suite 212A  
Markham, Ontario,  
Canada L3R 5H5  
(416) 477-1918

Skeller Associates  
1336-A Channing Way  
Berkeley, CA 94702  
(415) 649-4831

*You might want to contact Questar's German office at Botzinger Strasse 60, 7800 Freiburg, Germany, 049-761-47804-13. —Raymond G A Côté*

### Unix Communications

**I** am looking for a copy of uucp for communicating from some remote DOS machines to our Unix system. Can you help me?

Jim Handsel  
Honolulu, HI

*You can find versions of uucp (the Unix-to-Unix copy program) to suit every budget and adventurous spirit. In the public domain, look for a version of uucp for DOS and OS/2 on BIX (join the ibm.os2/listings conference and download uupc11k2.zip). Austin Code Works (11100 Leafwood Lane, Austin, TX 78750, (512) 258-0785) sells a copy of uucp for \$25. Both versions include source code; neither is a commercial package.*

*If you prefer a commercial package, try Software Concepts Design (594 Third Ave., New York, NY 10016, (212) 889-6431). Its RamNet program, which sells for \$149, provides concurrent background processing of data transfers. Vortex Technology (P.O. Box 1323, Topanga, CA 90290, (310) 455-9300) publishes UULINK, which also supports unattended data transfers.*

—Raymond G A Côté

### Video Info

**I** would like some information about the Tseng Laboratories ET 4000 VGA controller chip, especially hardware-related information. I read about the Tseng Labs data book. How can I find it?

I would also like information about the programming

of Edsun's Continuous Edge Graphics D/A converter chip. I want to write programs in C, BASIC, and assembly language using the CEG mode.

Gyorgy Komarik  
Baltimore, MD

*You can get a data book and other references for the Tseng Labs chip by writing to Tseng Laboratories, Inc., 10 Pheasant Run, Newtown Commons, Newtown, PA 18940, (215) 968-0502.*

*The Edsun chip is an exciting new development that won a BYTE Award of Distinction (see "The 1990 BYTE Awards," January 1991). Edsun claims that the chip brings photo-realistic graphics to standard VGA displays by smoothing the rough edges of graphics images. A big problem right now is the lack of driver software for PC applications, so Edsun should welcome new developers. You can contact the company at Edsun Laboratories, Inc., 564 Main St., Waltham, MA 02154, (617) 647-9300.*

—Stanford Diehl

### IDE Worries

**I** have an IDE hard drive system, but I am not sure what I can and cannot do with it. I am scared of buying software that doubles disk capacity, unfragments disks, password-protects disks, and the like. The manuals for some popular packages (e.g., PC Tools) mention only the standard interfaces, not IDE. Is there any reason for me not to purchase any of these products, like Norton Utilities, as long as I don't do low-level formatting?

Chris Murphy  
Denver, CO

*You've hit the head right on the platter. Most disk utility packages will support IDE drives and can perform every operation except low-level formatting. I recommend calling the manufacturer of the software you plan to purchase to make sure it supports IDE drives.*

*The embedded controller in an IDE drive masks the actual physical characteristics of the hard disk so that it can maintain compatibility with current DOS BIOSes. This scheme lets the drive work properly with DOS and provides other benefits (e.g., letting the hard disk have more than the DOS limit of 1024 tracks). Regardless of the drive's actual physical characteristics, the software sees a standard geography. That's why disk utilities cannot low-level format the disk: They can't know the actual physical characteristics of an IDE drive.*

*You need not worry about an accidental low-level format. The drives receive their low-level format at the factory, and an IDE drive won't accept a low-level format command. Other operations (e.g., disk caching, pattern testing, data recovery, data relocation, password protection, and data compression) will work as expected on an IDE drive. —Stanford Diehl ■*

*The BYTE Lab welcomes your questions. Address correspondence to Ask BYTE, BYTE, One Phoenix Mill Lane, Peterborough, NH 03458. You can also send BIX mail c/o "editors."*

*We read every letter, but due to the volume of mail received, we cannot guarantee a response. We edit all letters for clarity and brevity. Letters appear in BYTE about four months after we receive them.*

# THIRD INTERNATIONAL COMPUTER FORUM (ICF)



## COME TO MOSCOW!

- The ICF brings together people that influence and determine the major trends of information technologies in the USSR and world-wide
- The ICF lets western companies obtain top-quality, first-hand information about the real and potential computer and software markets in the USSR
- The ICF provides Soviet computer professionals with better access to products and technologies from the rest of the world

### Scheduled Speakers:

- Philippe Kahn (Borland)
- Jerry Kaplan (Go)
- Greg Herrick (Zeos)
- Dick Williams (Digital Research)
- Esther Dyson (EDventure Holdings)
- Stewart Alsop (InfoWorld)
- Ken Wasch (Software Publishers Association)
- Fred Langa
- and others.

### Topics:

- Status of the USSR computer market; business opportunities
- Future of PC market
- Workstations market
- Macintosh
- UNIX applications
- LAN policy
- LAN practice
- Windows and OS/2 market
- Pen-based technologies
- etc.

If you're a part of the emerging Soviet and east European computer industry, or if you want to learn more about doing business with that rapidly-growing market, *you need to attend the Third Annual International Computer Forum!*

#### SAVE MONEY BY PRE-REGISTERING

The registration fee covers access to keynotes, sessions, presentations, exhibitions, cultural programs, 3 lunches and 3 receptions. Register before March 31, 1992 and receive the special discount rate of just US\$760. After March 31, 1992 the normal fee of US\$840 applies.

#### RESERVE YOUR EXHIBITION SPACE

Price includes exhibition space itself, labor for building the booth, power supply (220 volt, 50Hz), and furniture (tables, chairs, etc.). The fee is US\$3400 for each 9 sq.m. (\$2800 for the members of ICC).

#### FOR MORE INFORMATION

Contact the ICC at:

Mall: 101813 USSR,  
Moscow, Proyezd Serova, 4.  
Fax/phone: 7-095-921-09-02.  
MCI ID: 439-1034.  
Internet: levon@staff.icc.msk.su.  
San Francisco-Moscow  
Teleport: ICC.

**JUNE 15-18, 1992  
WORLD TRADE CENTER, MOSCOW, USSR**



"not just another board game"

# COMMUNICATION

Quatech produces a full line of communication boards for the PC-XT, AT and MicroChannel systems including:

### Asynchronous:

- 2 port for PC/AT
  - DS-100:RS-232
  - DS-200:RS-422
  - DS-300:RS-485
- 2 port for PC/XT/AT
  - DS-102:RS-232
  - DS-202:RS-422
  - DS-302:RS-485

### Synchronous

- Bisync, SDLC, HDLC
  - SCB-1020
  - 1 channel RS-232
  - SCB-1040
  - 1 channel RS-422
  - SCB-1050
  - 1 channel RS-485

### Multiport

- 8 port RS-232
  - ES-100
  - Block addressing
  - MS-100
  - Selectable addressing by port
- 4 port RS-232
  - QS-100
  - Flexible addressing

# WAVEFORM SYNTHESIZER

The WSB-100 Waveform Synthesizer Board has the best set of numbers in the market. With speeds to 20MHz and 32K memory at \$1290, it's making waves in more ways than one.

### WSB-10

- PC/XT/AT, 12 bit arbitrary signal generator
- Onboard oscillator for independent operation
- Internal data rates programmable from 200 nS/point to 429 sec/point
- Output signal defined up to 2048 pts.
- 10 Megahertz maximum output

### WSB-100

- PC/AT, modular arbitrary signal generator
- DMA support for high speed waveform definition
- Output signal defined up to 32,000 points
- 20 Megahertz maximum output
- An analog or digital module is required for operation
  - WSB-A12: 12 bit analog waveform module
  - WSB-D16: 16 channel digital pulse generator module

# DATA ACQUISITION

Quatech has developed a full line of data acquisition products for the IBMPC-XT, AT, MicroChannel and compatibles. These high performance, low cost boards provide analog-to-digital, digital-to-analog, and digital input/output functions.

### PXB-160

- True 16 bit digital I/O
- Configurable as two eight-bit ports
- Handshake signals available for 16 bit I/O transfer
- List price below \$400

### SAC-12

- 16 single ended A/D input channels
- 12 bit resolution
- 3 16 bit interval counters/timers
- 3 digital I/O lines
- Switch selectable address

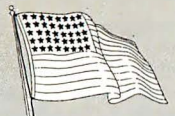
### DAQ-16

- 8 A/D inputs & 2 D/A outputs
- 16 bit/100KHz
- 4 digital I/O lines
- 2 DMA channels for continuous acquisition

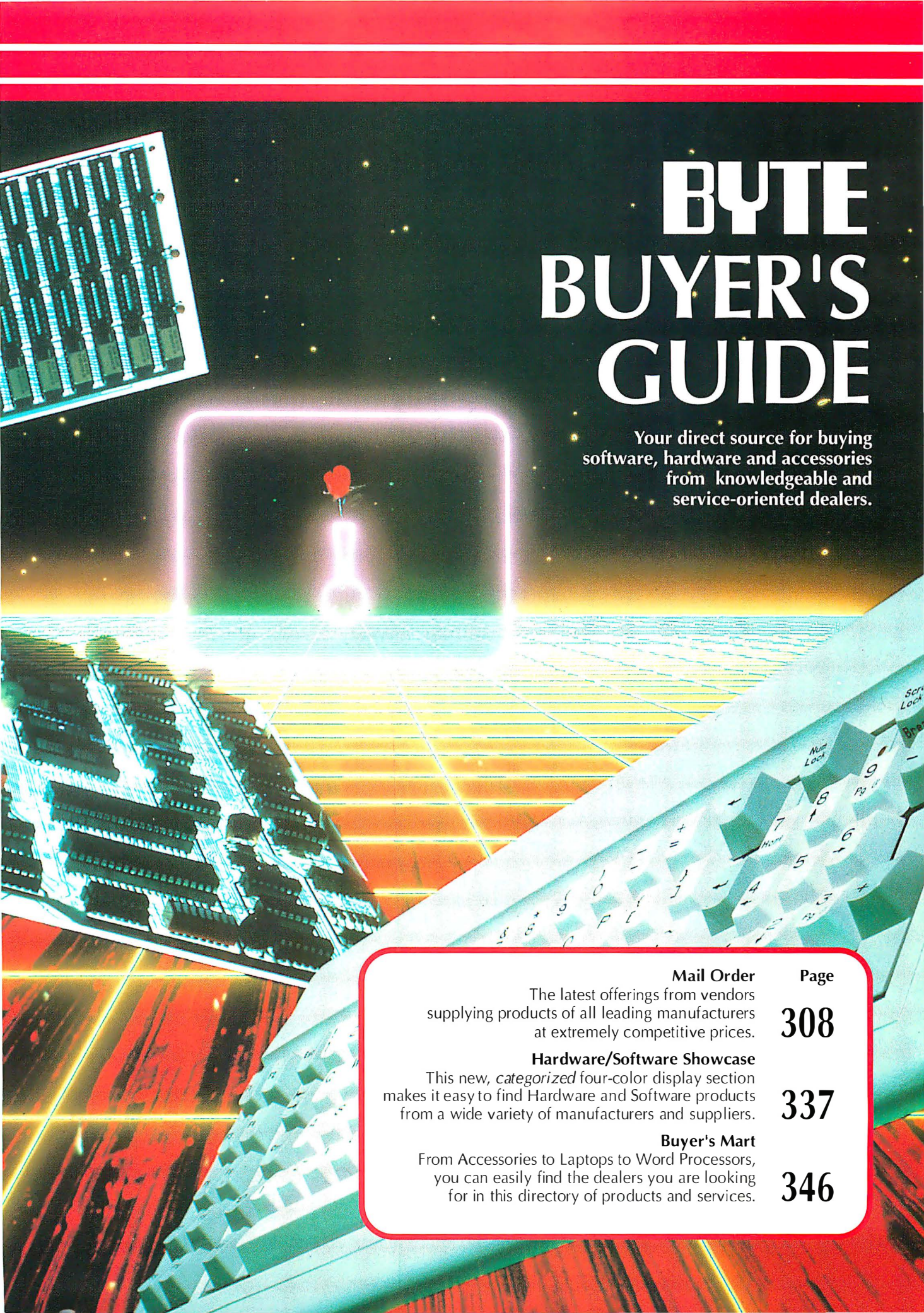
# 1-800-553-1170

## Call for a free catalog or fax (216) 434-1409

International distributors call: Australia/Interworld Electronics 03-521-2952, Canada (Western)/Interworld VCR 604-984-4171, England/Diamond Point International 634-722-390, Finland/Lab Hitech OY 0672497, France/Elexo 33-1-69302880, Germany/Jupiter Electronic Systems 06181/75041, Israel/RCM Ltd. 972-03-5447885, Italy/N.C.S. Computer Italia 03311 770-016, Netherlands/ACAL Auriema 040-816565. IBM PC-XT, AT and MicroChannel are registered trademarks of IBM Corporation.



Made in U.S.A.



# BYTE BUYER'S GUIDE

Your direct source for buying software, hardware and accessories from knowledgeable and service-oriented dealers.

	Mail Order	Page
The latest offerings from vendors supplying products of all leading manufacturers at extremely competitive prices.		308
This new, <i>categorized</i> four-color display section makes it easy to find Hardware and Software products from a wide variety of manufacturers and suppliers.	Hardware/Software Showcase	337
From Accessories to Laptops to Word Processors, you can easily find the dealers you are looking for in this directory of products and services.	Buyer's Mart	346

# CAD ONE *Custom Built Computers*

*Signature Series*

## 386/486 Mini Tower



## 386/486 Full Tower



**Computers  
Built to your  
Specifications  
at Competitive  
Prices!!  
12 Month  
Parts & Labor  
Warranty**

### **CAD ONE 386sx-25**

200 Watt Power Supply  
AMI BIOS  
VLSI Chipset  
INTEL Processor  
Seven 16 Bit Slots  
2MB 80ns SIMM Memory  
(Expandable to 16MB)  
TEAC 1.2 & 1.44 Floppy  
Two serial, One parallel and  
One game port  
80MB Hard drive  
Super VGA Card w/512k  
KFC Super VGA monitor  
(1024 x 768)  
101 Full size keyboard  
DOS 5.0

**System Price \$1495.00 \***

### **CAD ONE 386-33**

64K CACHE  
200 Watt Power Supply  
AMI BIOS  
OPTI Chipset  
INTEL Processor  
Eight 16 Bit Slots  
4MB 70ns SIMM Memory  
(Expandable to 32MB)  
TEAC 1.2 & 1.44 Floppy  
Two serial, One parallel and  
One game port  
80MB Hard drive  
Super VGA Card w/512k  
(1024 x 768)  
KFC Super VGA monitor  
(1024 x 768)  
101 Full size keyboard  
DOS 5.0

**System Price \$1895.00 \***

### **CAD ONE 486-33**

256K CACHE  
200 Watt Power Supply  
AMI BIOS  
ETEQ Chipset  
INTEL Processor  
Eight 16 Bit & One 32 Bit Slots  
4MB 60ns SIMM Memory  
(Expandable to 64MB)  
TEAC 1.2 & 1.44 MB Floppy  
Two serial, One parallel and  
One game port  
130MB Hard drive  
Super VGA Card w/1MB  
(1024 x 768)  
KFC Super VGA monitor  
(1024 x 768)  
101 Full size keyboard  
DOS 5.0

**System Price \$2395**

#### **OPTIONS FOR ABOVE SYSTEMS**

IRWIN ACCUTRAK 250MB TAPE BACKUP W/SOFTWARE	\$275.00
IDENTITY INTERNAL 2400 BAUD MODEM W/MNP-5 & SOFTWARE	129.00
CARDINAL INTERNAL TX/RX FAX MODEM W/AUTO DETECT	185.00
IDENTITY INTERNAL 9600 BAUD MODEM V.42 BIS & MNP-5	399.00
PANAMAX MAX4 4 OUTLET SURGE PROTECTOR	69.00

## **ORDERS 800-524-1006**

\* Prices and availability subject to change according to market conditions, and without notice!



## MOTHERBOARDS

486-50 MHz .....	\$CALL
486-33 MHz 256k Cache .....	CALL
486-25 MHz 128k Cache .....	CALL
386-40 MHz 64k Cache .....	CALL
368-33 MHz 64k Cache .....	CALL
386SX-25 MHz .....	249.00
386SX-16 MHz .....	215.00
286-16 MHz .....	125.00

## I/O CONTROLLERS

Multi I/O IDE HDD/FDD w/ 2S/1P/1G Port .....	\$29.00
IDE HDD FDD Controller ...	18.00
AT I/O 2S/1P/1G port .....	18.00
Adaptec 1522 KIT .....	187.00
Adaptec 1542 KIT Busmaster	290.00
MFM-AT Controller .....	77.00

## COMMUNICATIONS

### MODEMS

Identity Int. 2400 BAUD with software .....	\$ 98.00
Identity Int. 2400 BAUD modem MNP-5 w/software .....	129.00
Identity Ext. 2400 BAUD with software .....	120.00
Identity Ext. 2400 BAUD modem MNP-5 w/software .....	165.00
Identity Int. 9600 BAUD with MNP-5, V.42 BIS .....	415.00
Identity Ext. 9600 BAUD with MNP-5, V.42 BIS .....	475.00

### FAX MODEMS

Identity Int. TX/RX .....	\$135.00
Adtec Int. TX/RX .....	135.00
Adtec Int. TX/RX with auto detect voice/fax .....	189.00
Cardinal Int. TX/RX with MNP-5 .....	195.00
Identity 2400 BAUD POCKET modem MNP-5 .....	189.00

## VIDEO

Trident 8900C w/256k .....	\$ 79.00
Trident 8900C w/512k .....	99.00
Trident 8900C w/1MB .....	129.00
Oak VGA w/256k .....	69.00
Oak S-VGA w/512k .....	89.00
Paradise w/256k .....	69.00
Paradise w/512k .....	89.00
Cardinal w/256k .....	112.00
Cardinal w/512k .....	149.00
Cardinal w/1MB .....	185.00
Enhanced-VGA 1280 x 1024 (XGA) .....	215.00
32k color w/software (ROM)	59.00
CEG Chip w/software .....	69.00

## MONITORS

### KFC

14" Super VGA .28 DP 1024 x 768 .....	\$334.00
14" Super VGA .39 DP 1024 x 768 .....	285.00
14" Super VGA .28 DP Non-interlaced .....	370.00
14" Multisync .28 DP	380.00
17" Super VGA .....	CALL

### IDENTITY

14" S-VGA .28 DP .....	\$335.00
14" S-VGA .41 DP .....	280.00
14" VGA .31 DP .....	295.00
14" VGA .41 DP .....	249.00

### AOC

14" Super VGA .28 DP .....	\$348.00
14" VGA .31 DP .....	295.00
14" VGA Mono .....	135.00

### PACKARD BELL

14" S-VGA .28 DP .....	\$355.00
14" S-VGA .39 DP .....	275.00
14" VGA .39 DP .....	255.00

## DATA TRANSFER

MANUAL DATA SWITCHES  
AUTO-DATA SWITCHES  
GENDER CHANGERS  
NULL MODEM ADAPTORS  
PRINT SPOOLERS  
PRINT BUFFERS  
INTERFACE CONVERTERS  
LINE BOOSTERS

WE CARRY A COMPLETE  
LINE OF CABLES  
AND ACCESSORIES

Printer cable 6 Ft .....	\$5.50
Printer cable 10 Ft .....	7.00
Printer cable 15 Ft .....	13.00
Printer cable 25 Ft .....	25.00
Printer cable 50 Ft .....	35.00

## NETWORKING

16 Bit ARCNet card .....	\$108.00
8 Bit ARCNet card .....	65.00
ARCNet 8 port active hub ...	173.00
ARCNet 4 port passive hub ...	10.00
16 Bit ETHERNet card .....	156.00
8 Bit ETHERNet card .....	138.00
C-NET ARCNet pocket adpt	210.00
C-NET ETHERNet pocket	275.00
3Com Ether Link II 3C503	CALL
3Com Ether Link + 3C505	CALL
3Com Ether Link 16 3C507	CALL

## POWER BACKUP and SURGE PROTECTION

Leadman 550VA .....	\$299.00
w/Novell interface .....	39.00
Leadman 1100VA .....	599.00
American Power Backup ....	CALL
Panamax MAX4 Surge .....	59.00
Panamax MAX6 Surge .....	69.00
Panamax SUPERMAX .....	109.00
QVS 6 outlet surge .....	20.00

## STORAGE DEVICES

### HARD DRIVES

SEAGATE  
WESTERN DIGITAL  
MAXTOR

(Call for price & product availability)

### FLOPPY DRIVES

TAEC 1.2MB .....	\$69.00
TEAC 1.44MB .....	69.00
TEAC 2.88MB .....	125.00
Toshiba 360 .....	79.00
Toshiba 1.2MB .....	75.00
Toshiba 1.44MB .....	69.00

### TAPE BACKUP

Irwin 120MB Accutrak .....	\$210.00
Irwin 250MB Accutrak .....	275.00
Irwin 120 External Plus .....	365.00
Irwin 250 External Plus .....	445.00
Identity 120/250 Internal .....	255.00
Identity 120/250 External .....	375.00

## PRINTERS

IBM/Lexmark 9-pin narrow	\$CALL
IBM/Lexmark 9-pin wide .....	CALL
IBM/Lexmark 24-pin narrow ..	CALL
IBM/Lexmark 24-pin wide .....	CALL
IBM/Lexmark Laser 5 ppm .....	CALL
IBM/Lexmark Laser 6 ppm .....	CALL
IBM/Lexmark Laser 10 ppm .....	CALL
PANASONIC .....	CALL
STAR Micronics .....	CALL

## MISC.

Media Vision Thunderboard	\$154.00
Pro-Audio Spectrum .....	355.00
TRAX midi board .....	139.00
Navstar PC interface .....	CALL
DRAFIX Windows CAD .....	595.00
DRAFIX ULTRA 4.0 .....	350.00
ULTRA 386 Upgrade .....	175.00
DRAFIX QwkStart .....	119.00

## Additional CAD ONE products

PLOTTERS - DIGITIZING TABLETS - MICE - MEMORY PRODUCTS AND UPGRADES - BATTERIES  
KEYBOARDS - CASES - POWER SUPPLIES - CD ROM DRIVES - MULTIMEDIA BOARDS  
TOSHIBA COPIERS - FAX MACHINES - TERMINALS - MATH CO PROCESSORS

Prices and availability subject to change according to market conditions, and without notice!

Not responsible for typographical errors. All returns must be in original packaging.

Sales 800-524-1006 Fax orders 508-778-1887 Tech support 508-778-1990

**CAD ONE** COMPUTER DESIGN, Inc.

270 Communication Way #4D  
Hyannis, MA 02601

Phone (508) 778-1895

Fax (508) 778-1887

We accept MASTERCARD, VISA No service  
charge. Sorry, no AMEX or C.O.D.



CHECKS and M.O. WELCOME  
Products may be subject to a 20%  
restocking fee. No returns after 30 days

Business hours: Monday - Friday 9 A.M. to 8 P.M. Saturday 9 A.M. to 5 P.M. Eastern Standard Time

# Smooth Translation At A Scaled Down Price . . . And That's No Fish Tale!

With the LANCAST Twisted-Pair/Coax Translator, incompatibility in your network is a thing of the past.

This unique translation product bridges the gap between Coaxial based Ethernet LANS and the newer generation of IEEE 802.3 10Base-T Twisted-Pair LANS. By translating the signals between the

two LAN media types, your network can operate smoothly and efficiently with no loss of network integrity or capability. What's more, we do it at a price that fits your budget.



Smooth translation at a scaled down price of \$295.00, it's no wonder that many major computer firms are using the "twister" Translator. Call today for a free product brochure.



The "twister" Translator, Transceivers, Network Interface Cards, Repeaters, and other fine essential connectivity products are now available from LANCAST.

**LANCAST**  
STANDARD HIERARCHICAL NETWORKS

10 Northern Blvd., Unit 5  
Amherst, NH 03031  
Tel: (800) 752-2768 • (603) 880-1833  
Fax: (603) 881-9888

©1992 CASAT Technology Inc.

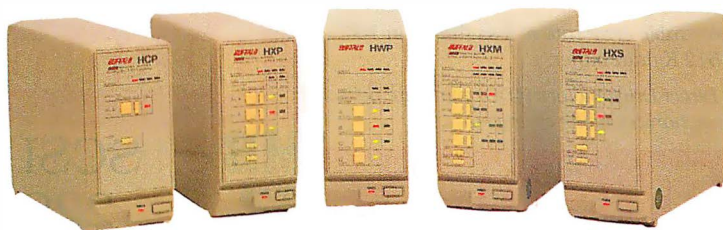
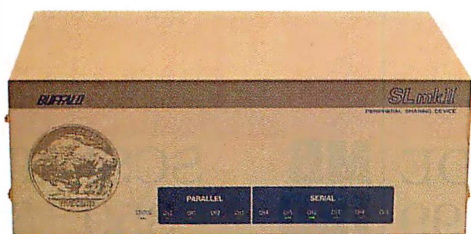


Circle 167 on Inquiry Card.

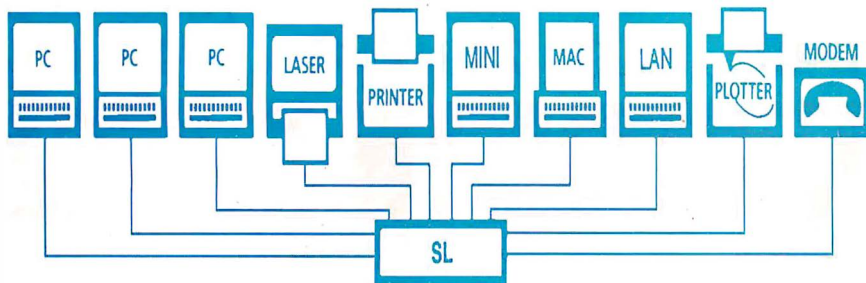
# POWER to SHARE

## with Printer Sharing Solutions from Buffalo Products

Now your work group can share expensive printing equipment. Each member of your team can have access to the maximum printing power of the whole group. Using Buffalo Products peripheral sharing devices, each PC can be connected to all of your output devices. Expensive, high-powered peripherals (like high performance laser printers and plotters) can be shared by everyone.



**Advanced Features + High Quality + Low Cost = Industry Leader**



### Buffalo Box Features:

- Pop-up Menu & Windows Option
- Easy Installation & Use
- Rapid Data Transfer
- User Upgradable Memory
- Reliable Automatic Switching
- No PC RAM Memory Required
- Toll-Free Application Consulting
- Toll-Free Technical Support
- 45-Day Money-Back Guarantee

Model	Ports	PCs/ Printers	Memory Available	Priced From
SL	6 Ser/4Par	Any Combination	256KB-4MB	<b>\$495</b>
SLP	8 Par/2 Ser	Any Combination	256KB-4MB	<b>\$495</b>
HXS	4 Serial	Any Combination	256KB-16MB	<b>\$295</b>
HXM	2 Ser/ 2 Par	Any Combination	256KB-16MB	<b>\$295</b>
HWP	5 Parallel	3/2, 4/1	256KB-16MB	<b>\$295</b>
HXP	4 Parallel	2/2, 3/1	256KB-16MB	<b>\$245</b>
HCP	2 Parallel	1/1	256KB-16MB	<b>\$225</b>
AS31	4 Parallel	3/1	None	<b>\$175</b>
AS41	5 Parallel	4/1	None	<b>\$195</b>
AS81S	9 Ser/ 1 Par	8/1	None	<b>\$189</b>

**US and Canada Toll-Free  
(800) 345-2356**

FAX (503) 585-4505  
Buffalo Products, Inc.

2805 19th St. SE, Salem, OR 97302-1520

# 2 Gb

## SCSI Portable DAT

# \$1499

APS Portable DAT provides these features:

*Compact size and a light weight - based on Archive's Python 3.5-inch DAT mechanism, the unit measures 6 x 8 x 2.5 inches and weighs under 4 pounds.*

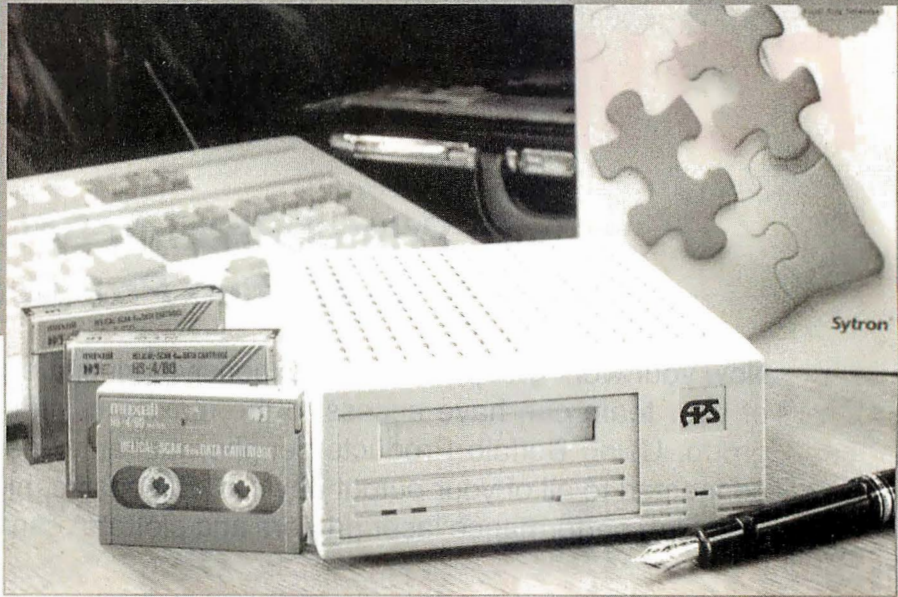
*Extremely high capacity - 2.0 Gigabytes on the 90-meter Maxell™ DAT cartridge supplied with purchase.*

*High speed random access to any file on tape.*

*Uncorrectable error rate of less than 1 in 10<sup>15</sup> bits; 512 K data buffer.*

*Four Direct-Drive motors (4DD) eliminate belts and mechanical mode changes.*

Ask about our full line of Macintosh SCSI hard drives.



## Toshiba

### CD ROM

**3301B** 579

"Bare" Drive includes Drive, Data Cable, Rails & Extenders

- 8-bit SCSI kit (AIC) add \$109
- 16-bit SCSI kit (Adaptec 1520) add \$149
- 16-bit SCSI Bus Master kit (Adaptec 1540) add \$229
- 16-bit MCA SCSI Kit (Adaptec 1640) add \$329
- 32-bit EISA SCSI kit (Adaptec 1740) add \$599
- 16-bit IDE Kit add \$1
- Many Models available with Floppy Controller

**• 30-Day Money-Back Guarantee •**

All products carry a 30-day money-back guarantee. Your risk in the transaction is the cost of shipping.

**• Disk-for-Disk Replacement Warranty •**

Quantum, Maxtor, Syquest and Archive drives carry a two-year "parts & labor" disk-for-disk replacement warranty. WREN, Teac, WangDAT, Conner, Micronics products and Syquest Cartridges carry a one-year "parts & labor" disk-for-disk (board-for-board) replacement warranty.

**• Mounting Hardware & Cables Included**

All Hard Drives include rails, extenders and data cables required for standard operation. Board products are populated but without RAM.

**• Toll-Free Technical Support •**

Toll-Free Technical Support, 9am to 7pm Monday thru Friday, Central Time. As often or for as long as you need.

• Prices & Specifications Subject to Change Without Notice •

## Quantum

MB	SCSI	IDE
52	229	199
105	339	319
120	449	Call
210	*While Quantities Last 629	599
240	699	789

## Maxtor

MB	SCSI	IDE
120	359	349
213	579	559
340	999	889
535	1549	N/A
760	1649	N/A

## Micronics

386sx	ISA 20	259
386dx	ISA 25	419
386dx	ISA/33/Cache	569
486dx	ISA/33/Cache	999
486dx	EISA/33/Cache	1549

## SyQuest

MODEL	Bare
SQ-555	399
SQ-5110(88)	609
Dual(ext. 44)	899
Dual(ext. 88)	1449

# 1-800 235-3707



2900 S. 291 Hwy  
Independence, MO  
64057  
(816) 478-8300

M-F 7am-9pm CT  
Sat 10am-4pm CT



Visa/MC, Discover No Surcharge

AMEX Accepted

International: 1-816 478-8300 FAX: 1-816 478-4596 (24 HRS)  
Toll Free UK: 0800-897-545 Toll Free Australia: 0014-800-125-875

# NEVADA COMPUTER

## SPECIALS BELOW DEALER COST:

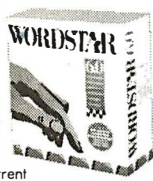
- #1.) Compaq 4MB Module 113132-00 \$199.00 #2.) IBM 2MB Module 6450604 \$89.00  
 #3.) 40MB Hard Drive IDE 28MSEC \$169.00 #4.) 4MB X 9 - 80NS Simm Module \$149.00

### WORDSTAR 6.0 SYSTEMS

OR WORDSTAR 2000 REL. 3.5



This is not a misprint! These are the exact same ones selling for over \$300.00 from our competitors. We have thousands in stock. These are current versions.



286-12MHZ.....	\$899.
286-16MHZ.....	\$949.
386-16SX.....	\$999.
386-20SX.....	\$1099.
386-25MHZ.....	\$1199.
386-33MHZ W/64K CACHE.....	\$1399.
486-33MHZ W/64K CACHE.....	\$1899.



Systems include: 14" VGA Monitor & Cord w/512K, Desktop or Mini Tower case (200 Watt power supply), 1 Year Warr., DOS 5.0, Parallel, Serial, Clock & Game Port, 1MB Memory, 1.2/5 1/4 Floppy, 101 Key Keyboard, 40MB Hard Drive.

### INTEL COPROCESSOR

<b>5 YEAR WARRANTY!</b>		80386 BASED MACHINES:
<b>Quantity</b>	80286 BASED MACHINES:	80387-1616MHz <b>169.00</b>
8088 BASED MACHINES:	80287-66MHz <b>49.00</b>	80387-2020MHz <b>179.00</b>
8087-5MHz <b>49.00</b>	80287-8 8MHz <b>59.00</b>	80387-2525MHz <b>189.00</b>
8087-2 8MHz <b>79.00</b>	80287-1010 MHz <b>89.00</b>	80387-3333MHz <b>199.00</b>
8087-1 10MHz <b>119.00</b>	80287-XL <b>99.00</b>	80387-SX16 <b>124.00</b>
		80387-SX20 <b>144.00</b>

### CONTROLLERS

IDE/H/Floppy **39.00**, 16bit WD 1:1 **49.00**, 8Bit HD only **49.00**  
 FOR FLOPPY: SuperFloppy Controls 1.2, 360K, 720K & 1.44Drives **49.00**

### FLOPPY DRIVES

360K/5 1/4" **49.00**, 720/3 1/2" **49.00**, 1.2MEG **58.00**, 1.44MEG-3 1/2" **58.00**,  
 Tandon TM100 2, the original IBM Drive **99.00**

### 10 MEG HARD DRIVE

Halfheight-80MSEC-6Month Warranty List 149.00  
 Your Cost **69.00** w/controller & cable add **50.00**

### 20 MEG HARD DRIVE

3 1/2" -40MSEC-6 MONTH WARRANTY. W/5 1/4" MOUNTS  
 YOUR COST **99.00** w/controller & cable add **50.00**

### Connor, Maxtor, Seagate Hard Drives

PART#	SIZE	ACCESS TIME	INTERFACE	YOUR COST
New-20MB	21MB	65Msec	MFM	<b>149.00</b>
New-40MB	44MB	28Msec	IDE	<b>179.00</b>
New-40MB	40MB	28Msec	MFM	<b>229.00</b>
New-80MB	80MB	18Msec	IDE	<b>299.00</b>
New-80MB	80MB	28Msec	MFM	<b>449.00</b>
New-120MB	120MB	18Msec	IDE	<b>349.00</b>
New-210MB	210MB	18Msec	IDE	<b>599.00</b>
New-330MB	330MB	18Msec	IDE	<b>1,195.00</b>

(All Hard Drives have a 1 Year Warranty)

### 60 MEG TAPE BACKUP

Mfg. by Wangtek, compatible w/MS DOS, Novell, SCO Xenix, Pick. Complete w/controller, cable and manual. **\$399.**

### 120MB Tape Backup by Everex

Software, controller & 2 year warranty. DC600 Tape. List \$895.00  
 Limited Quantity. **\$495.00**

FOR SALE BELOW DISTRIBUTOR COST! LIST \$495.00 ea.  
 (Get 100 pieces for \$79.00 ea.)

YOUR CHOICE **99.00** ea.

### PS/2 50/60 BOARD

#### AST ADVANTAGE/2

Comes with OK expandable to 8Meg using SIMMS.  
 SuperPak utility software.

OK - **49.00** 2MEG - **149.00** 4MEG - **249.00**  
 8MEG - **449.00**

### 200 WATT POWER SUPPLY

Direct AT replacement, UL Appr., 110/220V, 4 Drive Connectors.  
 200WATT **39.00** 150WATT for XT **49.00**

### EVEREX EVEREX EVEREX

EGA W/ 256K..... **29.00**  
 16 Bit 1-1 Hard/Floppy Controller..... **29.00**

Call for all Everex Products!

### FAX CARD

### W/ 2400 BAUD MODEM

Automatic group III digital FAX, background operation, send and receive text, screen images, scan pages., Hayes compatible, modem built on. FAX 9600/7200/4800/2400. Software, telephone cord.  
 YOUR COST **99.00** (Without Modem) **59.00**

### MODEMS W/MNP Level 5

Fully Hayes compatible, monitor speaker/volume control. 2400/300Baud transmission rate, addressable COM 1, 2, 3, 4, Compatible w/IBM PC, XT, AT & Compatibles. 2year Warranty. Full Duplex operation, complete w/software. Auto dial, Auto answer.

INTERNAL **49.00** EXTERNAL **79.00**

### MONITORS



**12" GREEN MONOCHROME Tilt & Swivel Base..... \$59.**

14" MONO/TILT AMBER FLAT SCREEN.....	\$99.
14" VGA..... 640X480..... [41 Doi].....	\$247.
14" VGA..... 1024X768..... [28 Doi].....	\$299.
14" VGA..... 1024X768..... [Non Interlaced].....	\$349.
VGA CARD..... 256K Exp 1MEG.....	\$79.

We also carry memory for HP, Epson, WYSE, Silicon Graphics, AT&T, Acer, ALR, Apple, AST, Everex, DEC, SUN, Dell

#### COMPAQ MEMORY

MODEL	MEMORY ADDED	COMPAQ EQUIV. PART#	YOUR COST
DESKPRO 286	512K KIT	113012-001	<b>59.00</b>
DESKPRO 286N, 386N	1MB MODULE	118688-001	<b>59.00</b>
	2MB MODULE	118689-001	<b>128.00</b>
	OK BOARD	118700-001	<b>98.00</b>
386SX/20	4MB MODULE	118690-001	<b>269.00</b>
DESKPRO 386/16	1MB BOARD	108069-001	<b>238.00</b>
	2MB BOARD	108069W71	<b>348.00</b>
	1MB KIT	108071-001	<b>119.00</b>
	4MB BOARD	108070-001	<b>498.00</b>
	4MB KIT	108072-001	<b>269.00</b>
DESKPRO 386S	1MB BOARD	113633-001	<b>139.00</b>
	4MB BOARD	113634-001	<b>299.00</b>
	1MB MODULE	113646-001	<b>79.00</b>
	4MB MODULE	112534-001	<b>229.00</b>
DESKPRO 386/20, 25, 286E	1MB MODULE	113131-001	<b>59.00</b>
	4MB MODULE	113132-001	<b>199.00</b>
DESKPRO 386/20E/25E	1MB BOARD	113644-001	<b>129.00</b>
	4MB BOARD	113645-001	<b>328.00</b>
DESKPRO 386/33, 486/25/33/33L	2MB MODULE	115144-001	<b>128.00</b>
	8MB MODULE	116561-001	<b>639.00</b>
SYSTEMPRO	32MB MODULE	116568-001	<b>3950.00</b>

#### PORTABLES

MODEL	MEMORY ADDED	COMPAQ EQUIV. PART#	YOUR COST
PORTABLE II	512K KIT	107331-001	<b>38.00</b>
	INTFC BD	107808-001	<b>149.00</b>
	EXPBD	107811-001	<b>199.00</b>
	2MB KIT	107332-001	<b>119.00</b>
SLT/286	1MB MODULE	110233-001	<b>129.00</b>
	4MB MODULE	110237-001	<b>458.00</b>
LTE/386S/20	1MB BOARD	121125-001	<b>169.00</b>
	4MB	121125-002	<b>419.00</b>
LTE/286	1MB BOARD	117081-001	<b>89.00</b>
	4MB BOARD	117081-003	<b>398.00</b>
PORTABLE 386/20	1MB KIT	1077651-001	<b>169.00</b>
	INTFC BD	107707-001	<b>88.00</b>
	4MB BOARD	107653-001	<b>479.00</b>
	4MB EXTBRD	107654-001	<b>479.00</b>
SLT/386	1MB MODULE	118303-001	<b>129.00</b>
	2MB MODULE	118304-001	<b>219.00</b>
	4MB MODULE	118305-001	<b>469.00</b>

#### TOSHIBA MEMORY

TOSHIBA MODEL	MEMORY ADDED	TOSHIBA EQUIV. PART #	YOUR COST
PORTABLE 2000SX	1MB BD	PCI 4-PA8311U	<b>129.00</b>
T1000SE & XE/LE	2MB BD	PCI 4-PA8312U	<b>179.00</b>
T2000/22000SX	1MEG	PCI 8-PA8316U	<b>119.00</b>
	2MEG	PCI 8-PA8317U	<b>179.00</b>
	4MEG	PCI 8-PA8318U	<b>399.00</b>
T2000SX/T1000LE	2MEG	PCI 4-PA8315U	<b>679.00</b>
	4MEG	PC-PA2000U	<b>189.00</b>
	4MEG	PC-PA2001U	<b>419.00</b>
	8MEG	PC-PA2002U	<b>719.00</b>
T3100E	2MEG	PC9-PA8340U	<b>119.00</b>
PORTABLE T1200XE	2MB BD	PCI 3-PA8306U	<b>119.00</b>
PORTABLE T1400	2MB BD	PC9-PA8302U	<b>119.00</b>
PORTABLE T3100E	2MB KIT	1PC9-PA8341U	<b>148.00</b>
PORTABLE T3100SX	2MB BD	PCI 5-PA8308U	<b>119.00</b>
	4MB BD	PCI 5-PA8310U	<b>229.00</b>
PORTABLE T3200	3MB BD	PC6-PA7137U	<b>219.00</b>
PORTABLE T3200SX & T3200SX/C	2MB KIT	PCI 2-PA8307U	<b>119.00</b>
	2MB	PCI 9-PA8318U	<b>129.00</b>
	4MB KIT	PCI 2-PA8309U	<b>229.00</b>
	4MB	PCI 9-PA8319U	<b>289.00</b>
PORTABLE T5100	2MB BD	PC7-PA8301U	<b>119.00</b>
DESKTOP T8500 or	2MB KIT	PCI 0-PA8304U	<b>119.00</b>
PORTABLE T5200 & T5200C	8MB KIT	PCI 0-PA8313U	<b>638.00</b>

#### BOCA MEMORY BOARDS

**8088 XT MACHINES** - BOCA RAM 8 Bit 0.2 MEG BOARD. USES 256K D-RAM. OK 99.00 1 Meg **148.00** 2MEG **189.00**  
**80286 & 386 AT MACHINES** - BOCA AT PLUS (BRAT80) OK 8MEG BD. 4.0 LUM COMPATIBLE. CONVENTIONAL, EXPANDED & EXTENDED MEMORY. SUPPORTS DOS, OS/2, LIM/EMS & EMS  
 OK **99.00** 2MEG **169.00** 4MEG **249.00** 8MEG **389.00**  
**BOCA RAM 2 PLUS**  
 FOR PS 2 50, 60, 80Z, 6570, 80, 90, 95. 0-8MB LUM/EMS 4.0, USES 1MB SIMMS  
 2MB **219.00** 4MB **309.00** 8MB **489.00**

#### RAM CHIPS (DIPS)

DESCRIPTION	150NS	120NS	100NS	80NS	70NS
64X1	<b>1.20</b>	<b>1.45</b>	<b>1.65</b>		
64X4	<b>2.25</b>	<b>2.25</b>	<b>2.25</b>	<b>2.95</b>	
256X1	<b>.95</b>	<b>1.05</b>	<b>1.10</b>	<b>1.15</b>	<b>1.95</b>
256X4		<b>3.95</b>	<b>4.45</b>	<b>4.95</b>	<b>5.45</b>
1MEG X1		<b>3.50</b>	<b>3.85</b>	<b>4.10</b>	<b>4.45</b>

#### IBM PS/2 MEMORY

FREE MEMORY WITH PURCHASE OF PS2 MEMORY*	MEMORY ADDED	IBM EQUIV. PART #	YOUR COST
IBM PS/2 MODEL PS/1	2MB	N/A	<b>139.00</b>
PS/225/286	512K KIT	30F5348	<b>38.00</b>
30-286, 502& 55-SX, 65SX	2MB KIT	30F5360	<b>107.00</b>
PS/250&2.55SX, 65SX	1MB SIMM	6450603	<b>59.00</b>
	2MB SIMM	6450604	<b>89.00</b>
55SX&65SX	4MB MODULE	34F2933/87F9977	<b>219.00</b>
50, 50Z, 55SX & 60, 65SX	2-8MB BOARD	1497259/6450609	<b>349.00</b>
PS/2	1MB SIMM	6450603	<b>52.00</b>
70-E61, 061, 1, 21, P70	2MB SIMM	6450604	<b>89.00</b>
PS/270-A21 A61, B21, B61	2MB SIMM	6450608	<b>98.00</b>
PS/280-041	1MB MODULE	6450375	<b>98.00</b>
PS/280-111, 121, 311, 321	2MB MODULE	6450379	<b>138.00</b>
80 A21, A31, A61	4MB MODULE	6451060	<b>249.00</b>
80 BMB	8MB	6450129	<b>499.00</b>
PS/235X LS& 40SX	2-8MB BOARD	6450605 CR	<b>328.00</b>
PS/2	2-14MB BOARD	34F3077 CR	<b>358.00</b>
ALL 70's & 80's	4-16MB BOARD	34F3011	<b>488.00</b>
90, 95 & P75	2MB	6450902	<b>99.00</b>
Installpairs	4MB	6450128	<b>308.00</b>
PS/2 75SX, 90, 95, P-75	8MB	6450130	<b>519.00</b>

#### HEWLETT PACKARD LASER JET MEMORY

MODEL	MEMORY ADDED	H.P. EQUIV. PART#	YOUR COST
HP I&II	2MB MODULE	33448	<b>107.00</b>
	4MB MODULE	33445B	<b>177.00</b>
HP 3A, IID	1MB MODULE	33474A/B	<b>98.00</b>
HP IIP	2MB MODULE	33475A/B	<b>117.00</b>
	4MB MODULE	N/A	<b>179.00</b>
HP IIS	1MB MODULE	N/A	<b>79.00</b>
	4MB MODULE	N/A	<b>229.00</b>

#### SIMM MODULES

DESCRIPTION	120NS	100NS	80NS	70NS	60NS
256X8	<b>5.00</b>	<b>8.00</b>			
256X9	<b>9.00</b>	<b>14.00</b>	<b>17.00</b>	<b>26.00</b>	<b>29.00</b>
1MEG X 9		<b>39.00</b>	<b>42.00</b>	<b>49.00</b>	<b>64.00</b>
4MEG X 9			<b>149.00</b>	<b>169.00</b>	<b>199.00</b>

Quantity Discounts Available...CALL!!

#### ORDERS ONLY

**800-654-7762**

TECHNICAL/CUSTOMER SERVICE/ORDER STATUS:  
**(702) 294-0204 FAX (702) 294-1168**  
 HOURS: M-F 8:00-6:00 PST, SAT 9:00-3:00 PST

Mfg. part #'s for convenience only. Some memory products 3rd party.

WE ACCEPT INTERNATIONAL ORDERS  
**WE ALSO PURCHASE EXCESS INVENTORY! FAX OR CALL.**  
 NO SUPPORTS RETURNS  
**ALL PRICES FINAL.**

Trademarks are registered with their respective Co.'s.  
 386, 387, 287, SX, are trademarks of Intel Corp.



#### TERMS:

NO SURCHARGE FOR MC/VISA  
 MC, VISA, AE, COD CASH, NET  
 Purchase orders from Universities  
 Fortune 1000 & Government Agencies  
 Personal Checks, COD add \$5.00  
 20% Restocking Fee on refunds within 30 days  
 No refunds or exchanges after 30 days - WARRANTY ONLY



PRICES SUBJECT TO CHANGE. SHIPPING: UPS (Min. \$8.25)  
**684 Wells Road, Boulder City, Nevada 89005**

# BUY COMPLETE POWER FOR LESS



## SYSTEM SPECIAL

486-20S  
486-20SX  
Motherboard  
CPU, 1MB Ram  
IDE Controller  
1.44 FDD  
2S/1P  
Monocard & Monitor  
Keyboard  
**\$799**

## MODEM FAX SPECIAL

S/R/FAX  
9600/2400 ... **\$79**  
4800 External  
Send Fax  
Modem ... **\$69**  
9600 BPS  
Modem ... **\$299**

# Sii MICROS 1-800-424-1126

## BARE BONES SYSTEMS

**288-16 @ \$299 386-SX25 @ \$444 386-33 @ \$599 486-20SX @ \$699**  
**386-16 @ \$399 386-DX25 @ \$549 386-40 @ \$699 486-33 @ \$899**

\* All the bare bones systems include: CPU Motherboard, 1 MB Ram, great looking Chasis, 200W P/S, 1.2 or 1.44 MB Drive, 1:1 FD/DH Controller

<b>386-25 SX</b> <ul style="list-style-type: none"> <li>• 1MB Ram</li> <li>• Power Supply, Chassis</li> <li>• 40 MB Hard Disk</li> <li>• 1.2 &amp; 1.44 Floppy Disk</li> <li>• Keyboard, 101 Keys</li> <li>• SVGA Card</li> <li>• 1024 x 768 Monitor, 28 dp</li> </ul> <p><b>\$ 1,099</b></p>	<b>386-25DX</b> <ul style="list-style-type: none"> <li>• 1MB Ram</li> <li>• Power Supply, Chassis</li> <li>• 40 MB Hard Disk</li> <li>• 1.2 &amp; 1.44 Floppy Disk</li> <li>• Keyboard, 101 Keys</li> <li>• SVGA Card</li> <li>• 1024 x 768 Monitor, 28 dp</li> </ul> <p><b>\$ 1,199</b></p>	<b>386-33</b> <ul style="list-style-type: none"> <li>• 1MB Ram</li> <li>• Power Supply Chassis</li> <li>• 40 MB Hard Disk</li> <li>• 1.2 &amp; 1.44 Floppy Disk</li> <li>• Keyboard, 101 Keys</li> <li>• SVGA Card</li> <li>• 1024 x 768 Monitor, 28 dp</li> </ul> <p><b>\$ 1,299</b></p>	<b>486-20SX</b> <ul style="list-style-type: none"> <li>• 4 MB Ram</li> <li>• 100MB Hard Disk</li> <li>• Case &amp; Power Supply</li> <li>• Keyboard, 101 Keys</li> <li>• SVGA Card</li> <li>• 1024 x 768 Monitor, 28 dp</li> <li>• 1.2 &amp; 1.44 Floppy Disk</li> </ul> <p><b>\$ 1,599</b></p>	<b>486-33</b> <ul style="list-style-type: none"> <li>• 4 MB Ram</li> <li>• 100 MB Hard Disk</li> <li>• Case &amp; Power Supply</li> <li>• Keyboard, 101 Keys</li> <li>• SVGA Card</li> <li>• 1024 x 768 Monitor, 28 dp</li> <li>• 1.2 &amp; 1.44 Floppy Disk</li> </ul> <p><b>\$ 1,799</b></p>
--	---	--	--	---

MOTHER BOARDS	MEMORY/SIMMS	MATH CO-PROCESSORS	OTHER AD-ONS AND PERIPHERALS	WHY BUY FROM Sii?
XT-12 .....\$49 286-12 .....\$89 286-16 .....\$99 286-20 .....\$149 386SX-16 .....\$199 386SX-20 .....\$249 386SX-25 .....\$259 386DX-20* .....\$159 386DX-25* .....\$159 386DX-33* .....\$199 386DX-40* .....\$249 486SX-20 .....\$499 486DX-33 ISA* .....\$299 486DX-50* .....\$399 486DX-33 EISA* .....\$899 *CPU not included.	4164 .....\$1.25 4464 .....\$1.75 41256 .....\$1.25 44256 .....\$4.50 1 x 1 MEG DRAMS ...\$4.50 1 x 8 SIMMS .....\$36 1 x 9 SIMMS .....\$45 4 x 8 SIMMS .....\$129 4 x 9 SIMMS .....\$139 Toshiba, IBM, ALR, AST, Compaq, Macintosh, Zenith Memory Modules Available	80287-10 .....\$89 80287-12 .....\$129 80387-16SX .....\$139 80387-20SX .....\$159 80387-25SX .....\$169 80387-20DX .....\$175 80387-25DX .....\$175 80387-33DX .....\$175 80387-40DX .....\$299 IDE, SCSI, ESDI HARD DISKS FROM 40 MB TO 1 GB AVAILABLE	Case & Power Supply ..\$99 Full Tower Case & Power Supply .....\$169 Mono Monitor .....\$99 VGA 1024 x 768 .28 dp Monitor .....\$359 101 Keyboard .....\$45 IDE Controller .....\$29 SCSI Controller .....\$169 SVGA Card 1024 x 768 .....\$99 Mono Card .....\$29 Tape Back Up 120 MB . \$259	<ul style="list-style-type: none"> <li>• One year warranty</li> <li>• 15 days money back guarantee</li> <li>• Parts flown by air for replacement</li> <li>• Quality parts used</li> <li>• 800 customer service no.</li> <li>• Last but not least, shop at ALR, AST, COMPAQ, IBM, ZENITH and then call us. We have the best quality service &amp; prices.</li> </ul>

ALL TYPES OF HARD DISKS,  
LAN CARDS, CD-ROM AVAILABLE.

14451 Newport Avenue, Tustin, CA 92680  
(714) 731-5489 FAX: (714) 731-1538

## PURCHASE ORDERS WELCOME

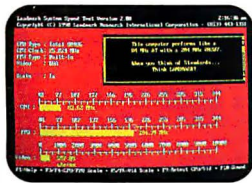
Prices subject to change without notice. Add 4% for Mastercard or Visa orders. Net terms please add 5% to the total. Shipping and handling charges extra. These are COD prices.



# PC DIAGNOSTICS MADE EASY

## SPEED TEST YOUR PC

You've seen the *Landmark Speed Rating* advertised by many major PC manufacturers, now you can have your own copy of the **Landmark System Speed Test™**. Accurately measure CPU, math, and video speeds to make an informed purchasing decision, determine the best PC for the job or maybe just win some bets in the office on whose PC is really faster! Includes the Landmark AT CMOS RAM Setup program to update your system configuration *on-the-fly*. **CALL for current pricing!**



## THE 5 MINUTE SOLUTION TO FLOPPY DRIVE FAILURE

With **AlignIt™** you can clean, diagnose, and align your floppy drives in minutes *without* a scope. Patented technology requires only a screwdriver to perform ANSI-accurate alignments (.3 mil).

AlignIt is ideal for corporate users with 2 or more PCs because it includes a "GOLD STANDARD" feature so you can align all your PCs to the same in-house standard, guaranteeing that all your floppies are perfectly interchangeable between PCs.

80% of all floppy drive failures can be fixed with AlignIt. So don't replace your drive, save time and money instead.

Includes dual size floppies, (both high and low density) and no-mess pre-lubricated cleaning diskettes (both sizes) good for 180 uses. Replacements and single drive size versions available. For all PCs and compatibles. **CALL for current pricing!**

## PROFESSIONAL LEVEL PC TROUBLESHOOTING

**Landmark Service Diagnostics™** is ideal for professionals requiring the most exhaustive diagnostic test capabilities. Each module is CPU specific, including PC, XT, AT, 386/486, and PS/2. Since 1981 major manufacturers like Wang, Xerox, Prime, Sony, DEC, NEC, and NCR have relied on Service Diagnostics to tackle their toughest operating problems.

Intended for professional service and repair technicians, Service Diagnostics is also easy to use for the novice. Clear, concise on-line help and intuitive menus make finding system problems a breeze. Tests all CPUs, math chips, all memory, floppy, fixed and non-standard disk drives, standard/non-standard printers, system board, video, com ports and all keyboards. Utilities include low-level reformat, log bad sectors, edit bad sector table; the partition editor allows you to set up multiple partitions; back-up program transfers hard disk image on unformatted floppies and allows for restore after reformat.

Ideal for UNIX and other operating systems, the self-booting version doesn't require DOS. The manual offers troubleshooting tips to the component level. Also available in a complete kit including: all CPU specific software, dual size floppy alignment software (see AlignIt), and PC/XT & AT ROM POSTs. **PC Magazine Editor's Choice 8/90.**

## PC WON'T BOOT? THEN JUST KICKSTART IT!

Don't replace your motherboard, use **KickStart 2™**. When serious hardware problems occur, nothing gets you up and running as fast. KickStart 2 measures power within 2.5% on all four voltages, shows Power-On Self-Test (POST) failure codes, and features on-board ROM-based diagnostics allowing you to determine and remedy the problem quickly, easily, and inexpensively!

Built-in serial and parallel I/O allows for testing via modem, or simply logging results to a remote terminal, printer or laptop. You can configure your own test routines and store them in KickStart 2's battery backed-up CMOS RAM saving valuable setup time. Includes serial and parallel loopback plugs and Landmark JumpStart™ AT ROM BIOS for testing PCs that don't issue POST codes. KickStart 2 tests your system regardless of O/S (even UNIX).

On-board switches, LEDs, and digital displays allow complete control over testing in systems lacking video or disk (ideal for motherboard or system burn-in).

KickStart 2 is the ultimate SECURITY CARD too! With both supervisor and user levels of password protection, you can prevent unauthorized use of your PC and accidental running of destructive tests. **CALL for current pricing!**

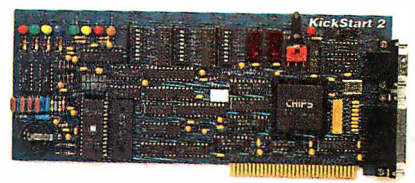
*"KickStart 2 system diagnostics board helps users check out virtually every aspect of a PC's hardware system... the board is a worthy investment for computer maintenance." David Claiborne, PC Week*

## HOW TO DEBUG A DEAD PC

Need an inexpensive solution for dead or problematic PCs and motherboards? Try **KickStart 1™** or **JumpStart ROM POST™**, two quick and easy to use debugging tools.

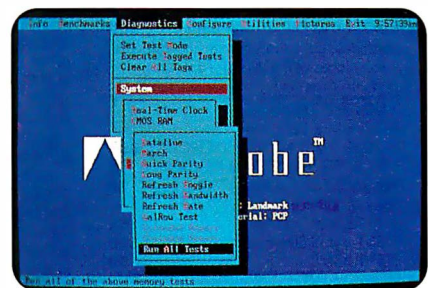
KickStart 1 test card shows power status on all four voltages and binary PORT 80 Power-On Self-Test codes. The manual translates error codes for easy failed circuit isolation. **CALL for current pricing!**

JumpStart ROM POST is a plug-in chip designed to replace your motherboard BIOS for testing purposes. Tests include CPU register and logic, 8087 math coprocessor, 8253 timer, 8237 DMA controller, 8259 interrupt controller, parity error and memory refresh logic, erroneous maskable/non-maskable interrupt detection, display adapter (MDA, CGA, EGA), keyboard, keyboard controller, floppy controller, drive A: read Base memory at normal & slow refresh rates, and POST checksum. Display of motherboard switch configuration. **CALL for current pricing!**



KickStart 2 is ideal for permanent installation. It eliminates the need for an I/O card, provides remote and on-site diagnostic capabilities for quick repair time and offers a solid hardware based solution to unauthorized access with impenetrable password protection.

## SLASH DOWNTIME AND OPERATING PROBLEMS



With **PC Probe™** you'll save time and money when your PC starts acting up. In one easy-to-use package you get *Diagnostics, Virus Protection (for over 700+ known viruses), Benchmarks, Performance Enhancement Utilities, and System Information*. Combined, this arsenal of tools will keep your system up and running at peak performance and remove the mystery about what's inside.

PC Probe diagnostic testing quickly isolates the source of hardware problems, even locating bad RAM chips. It tests system board, RAM, video, keyboard, com ports, floppy drive, hard drive, Ethernet card and more. Run PC Probe tests in batch mode or single pass, remote or on-site.

PC Probe allows you to increase your hard drive data transfer rate by determining optimum interleave and changing it, prevent catastrophic data loss by performing data revitalization, reformat the hard drive, run external programs, display and edit CMOS RAM on-the-fly, prevent accidental hard drive data destruction with passwords, diagnose problems with device drivers installed.

The 200 page on-line manual has built-in table of contents, topic/text search, and troubleshooting tips. PC Probe comes with dual size floppies and 9 & 25 pin serial/parallel port loopback plugs. For PC XT, AT, 386, 486 and compatibles using DOS 2.0 or higher. **CALL for current pricing!**

- Toll-Free Lifetime Tech Support
- 90 Day Money-Back Guarantee
- Federal Express Shipping

## CALL (800) 683-6696

Fax (813) 443-6603 • Voice (813) 443-1331  
Dealer Inquiries Welcome



**LANDMARK**  
RESEARCH INTERNATIONAL CORPORATION  
*First in PC Testing... Since 1981*

703 Grand Central Street • Clearwater, Florida 34616

Copyright © 1991. PC Probe, AlignIt, KickStart, JumpStart, ROM POST, and Service Diagnostics are trademarks of Landmark Research International Corp. All Rights Reserved. Other names are trademarks of their associated owners.



*"Overall, Service Diagnostics: The Kit was the best performer. (You can) locate and identify most of the computer problems you'll ever encounter. If you're running a service department, Service Diagnostics is not an option, it's a necessity." Bill O'Brien, PC Magazine*

- Service Diagnostics XT/AT Kit...SAVE \$\$ CALL NOW •
- Service Diagnostics PS/2 Kit...SAVE \$\$ CALL NOW •
- XT ROM POST...SAVE \$\$ CALL NOW •
- AT ROM POST...SAVE \$\$ CALL NOW •

-- Individual pricing available on all kit components, please inquire --

# Save BIG on Computer Products

NO EXTRA CHARGE for credit cards

## DRIVES AND BACKUPS

**Conner Hard Drives**  
 3000 42MB 3.5" IDE 28ms \$179  
 3104 104MB 3.5" IDE 25ms \$349  
 3204 209MB 3.5" IDE 19ms \$575

**Seagate Hard Drives**  
 ST351AX 40MB IDE 3.5" \$199  
 ST225KIT 20MB w/Cont. XT \$225  
 ST238 RLL 30MB RLL XT w/Cont. \$239  
 ST251-1 40MB 28ms 1/2 HT \$249  
 ST4096 80MB 28ms \$489

**Micropolis**  
 1355 159MB ESDI FH 23ms \$469  
 1664 345MB ESDI FH 18ms \$999

**Plus Development Hard Drive Cards**  
 Hard Card IXL 50MB \$309  
 Hard Card IXL 105MB \$459

**Mountain Internal Tape Backups**  
 40/120MB XT or AT \$249  
 80/300MB AT \$499

**Archive Tape Back-up**  
 40MB Internal XT or AT \$249  
 80MB Internal AT \$325

**Irwin Tape Back-Up**  
 Accutrak 120MB Internal Drive \$179  
 Accutrak+ 120MB External Drive \$309  
 Accutrak+ 120MB Internal Drive \$239  
 Accutrak+ 250MB Internal Drive \$299

**Sony CD-ROM**  
 Ext. 7205 AT/XT w/Laser Library \$569  
 Includes: Compton's Family Encyclopedia, Languages of the World, Toolworks, World Atlas and more...

**FLOPPY DRIVES**  
**Toshiba Disk Drive Kits**  
 ND 04D 5.25" 1/2 HT 360K (PC/XT) \$59  
 ND 08DEG 5.25" 1.2MB (PC/AT) \$75  
 ND 356T 3.5" 1.44MB AT Kit \$75

**Sony Disk Drives**  
 3.5" 720K (PC/XT/AT) \$59  
 3.5" 1.44MB Slimline Bare \$59  
 3.5" 1.44MB \$59

**MONITORS**  
 Panasonic 14" Color 1024 x 768 C1381i (.28mm) \$349  
 C1395 non-interlaced (.28mm) \$479

**Packard Bell 14" Color**  
 8551VG VGA 640 x 480 (.51mm) \$199  
 8539VG VGA 640 x 480 (.39mm) \$249  
 8528SV SVGA 1024 x 768 (.28mm) \$349

**NEC Multisync Color**  
 2A 800 x 600 14" \$399  
 3FGX 1024 x 768 15" \$639  
 4FG 1024 x 768 15" \$775  
 4DS 1024 x 768 16" \$999  
 5D 1280 x 1024 20" \$1899

**Sony 14" Color**  
 1304HG 1024 x 768 Multiscan \$599  
 1320 640 x 480 VGA \$419

**JOYSTICKS**  
 Etronics Super Shooter Joystick \$10.99  
 Etronics Watta-Shoothah Joystick \$10.99  
 Gravis Analog Joystick \$31.99

**Mice**  
 Etronics Smartee Mouse \$25.00  
 IMSI Serial/Bus Mouse \$39.99  
 IMSI Pet Mouse \$19.99  
 Logitech Mouseman Combo \$69.99  
 Logitech First Mouse Serial \$39.99  
 Logitech Trackman Serial \$69.99  
 Logitech Portable Trackman \$99.00  
 Microsoft Ballpoint for Laptops \$119.99  
 Microsoft Serial Mouse w/Wind. \$139.99  
 Microsoft Mouse Serial/Bus \$79.99  
 Mouse System Omnimouse II w/Point Bus/Ser. \$49.99/\$35.99

**DIGITIZERS**  
 Summagraphics Summasketch I \$299.99  
 Summagraphics Summasketch Professional 18 X 12 \$599.00  
 Kurto 12 x 12 XLP Digitizer \$249.99  
 Kurto IS/One 12 x 12 corded or cordless \$359.99

**SCANNERS**  
 Logitech Scanman 256 \$279.99  
 MouseSystems HandScan w/OCR \$149.99  
 Panasonic Flatbed I, II, and III \$CALL  
 Epson Desktop Color Scanner \$1099.00

## PACKARD BELL COMPUTERS

Monitor not included

THESE PACKARD BELL SYSTEMS INCLUDE:  
 • 2 Floppy Drives • Enhanced 101 Keyboard • 2-Button Mouse  
 • Tutorial • DOS 5.0 • QBasic • Free Software

**PACKARD BELL**  
 America grew up listening to us. It still does.  
 Not affiliated with any former Bell System entity

1 YEAR ON-SITE WARRANTY

	FORCE	SX16N	SX16N+	820N	486SX
Processor		80386SX-16		80386SX-20	80486SX-20
Hard Drive	40MB	100MB	100MB	100MB	105MB
Stand. RAM	1MB	2MB	2MB	2MB (16K Cache)	4MB (8K Cache)
Max RAM	5MB		16MB (32K Cache) 32MB (128K Cache)		
Expansion Slots	3 16-BIT		4 16-BIT		
Video Support	800 X 600 (256K) Memory		1024 X 768 (512K) Memory		
I/O Ports	15, 1P, 1M, 1G, 1VGA, 1KB		25, 1P, 1M, 1VGA, 1KB		
ELEK-TEK Price	\$899	\$1099	\$1399	\$1899	

2400B Internal Modem with SX16N+, 820N & 486SX. Windows 3.0 with 820N & 486SX

### Packard Bell 14" Color Monitors

8551VG	8539VG	8528SV
640x480 (.51mm)	640x480 (.39mm)	1024x768 (.28mm)
\$199	\$249	\$349

PB Monitors Warranty: 1 yr. on-site when purch w/a PB Force system (limit 1 per system) Purch. separately; carry-in or mail-in 1 yr. warranty

### 386SX-20MHz NOTEBOOK COMPUTER

• 80C386SX/20MHz • 2MB RAM exp.8MB • 2400B Int. Modem  
 • 40MB Hard Drive • 3.5" 1.44MB FDD with send/fax  
 • Free Carrying Case • 640 x 480 VGA • 1 yr. depot warranty

\$1799

### MATH COPROCESSORS

**Intel Math Coprocessors**  
 8087 (5MHz) \$85  
 80872 (6/8 MHz) \$119  
 80871 (10MHz) \$159  
 80287XL (6,8,10MHz) and 80C287 (12MHz) \$79.99  
 80287XLT Compaq LTE/286, and Tandy 2800 \$79.99  
 80387SX-25(SL-25MHz) \$145  
 80387SX (1.6MHz) \$119.99  
 80387SX (20MHz) \$129.99  
 80387 (1.6, 20, 25, 33MHz) \$199.00  
 80487SX (20/25MHz) \$459.00

**Cyrix Math Coprocessors**  
 82587 (8-20MHz 80286) \$79  
 83D87-16 (1.6MHz 80386) \$179  
 83D87-20 (20MHz 80386) \$179  
 83D87-25 (25MHz 80386) \$179  
 83D87-33 (33MHz 80386) \$189  
 83D87-40 (40MHz 80386) \$219  
 83S87-16 (1.6MHz 80386SX) \$109  
 83S87-20 (20MHz 80386SX) \$119

**CHIPS AND SIMMS**  
 256K (all speeds) \$CALL  
 1MB (all speeds) \$CALL  
 Simms Modules (all speeds) \$CALL  
 Sippis (All Speeds) \$CALL

### ACCELERATOR/UPGRADE BOARDS

**Sota**  
 286i Accelerator \$199  
 386SI Accelerator \$299  
 Express 386SX 16MHz Upgrade \$299  
 Express 386SX 20MHz Upgrade \$349  
 I/O - II Drive Controller \$89

**TRONICS**  
**MODEMS**  
 ▲ 100% Hayes Compatible  
 ▲ 2 Year Warranty

DISKETTES	ELK-TEK	maxell.	3M	Verbatim.
3 1/2" DSDD	6.50	7.99	7.99	7.50
3 1/2" DSHD	12.99	14.99	14.99	13.99
5 1/4" DSDD	3.99	5.50	5.99	5.50
5 1/4" DSHD (IBM AT)	7.50	9.99	9.99	8.99

In addition to the above, we stock preformatted & color diskettes.

### 3M DATA CARTRIDGES

**Regular**  
 DC100A (Mini) \$14.99  
 DC300XL/P \$20.00  
 DC600A \$21.00  
 DC6150 \$22.00  
 DC6250 \$26.99  
 DC6320 \$29.00  
 DC6525 \$34.00

**Pre-formatted**  
 DC600HC/latomat™ \$25.50  
 DC6150/Zetomat™ \$28.00  
 DC2000/Kappomat™ \$19.00  
 DC2000/Thetomat™ \$19.00  
 DC2000/Rhomat™ \$20.99  
 DC135G Magnus \$36.99  
 2000 Tape Drive Cleaner \$19.99

Call for Large Quantity Pricing. Call for Wholesale Pricing on 3M Computer Tape.

## SOFTWARE

AfterDark for ProCom Plus \$66.99  
 Windows \$26.99 Publisher's Power Pak  
 All Type \$45.99 for WordPerfect \$45.99  
 Easy Tax \$45.99 Quattro Pro \$289.99  
 The Farside QEMM 386 V6  
 Computer Calendar w/Manifest \$59.99  
 for Windows \$49.99 Quicken V5.0 \$43.99  
 Fastback Plus Quicken for  
 V3.0 \$119.99 Windows \$28.99  
 JK Lasser's Income Tobias Taxcut \$39.99  
 Tax \$22.99 Turbo Tax '91 \$44.99  
 Laplink Pro \$89.99 TurboTax/Quicken  
 LetterPerfect \$129.99 5.0 Bundle \$72.99  
 MS Excel V3.0 for WordPerfect  
 Windows \$314.99 V5.1 \$235.99  
 PC Tools V7.1 WordPerfect for  
 w/Antivirus \$109.00 Windows \$79.99

We Stock 2500 Other Software Titles

"Complete Line Of

**EPSON** **Panasonic**  
 Office Automation  
 & **OKIDATA**

Dot Matrix & Laser Printers  
 Call For Our Low, Low Prices!"

**GENUINE HP** **HEWLETT**  
**PACKARD**  
**LASER TONER CARTRIDGES**

HP92275 - LaserJet IIP/IIIP+/IIIP \$59.99\*  
 HP92285 - LJ/LJ+/LJ 500+ \$81.99\*  
 HP92295 - LaserJet II/IIID/IIID/IIID \$79.99\*  
 HP92291 - LaserJet IIISi \$107.99\*  
 \* Quantity Discounts Available

**Trays**  
 Lower Cassette IIP/IIIP+/IIIP \$135  
 Letter\*\* / Legal Size\*\* IIP/IIIP+/IIIP \$49 / \$59  
 Envelope Tray\*\* IIP/IIIP+/IIIP \$65  
 Letter / Legal Size II/IIID/IIID/IIID \$52 / \$60  
 Envelope Tray II/IIID/IIID/IIID \$70  
 Letter Size IIISi / Legal Size IIISi \$95 / \$95  
 Executive Size IIISi \$95  
 \*\* Requires Lower Cassette

**Memory Boards**  
 1MB Memory LJ/IIIP/IIID/IIID \$149.00  
 2MB Memory LJ/IIIP/IIID/IIID \$249.00  
 DeskJet/DeskJet Plus Ink Cartridges \$14.50

**HP LASERJET PACIFIC**  
**ENHANCEMENTS**  
 25-IN-1 Font Cartridge II/IIIP/IIID \$25.99  
 25-IN-1 Font Car. DeskJet 500/Plus \$99  
 1MB Memory Board IIP/IIIP/IIID \$99  
 2MB Memory Board IIP/IIIP/IIID \$149  
 Postscript Cartridge for IIP/IIID/IIID/IIID \$49

### MODEMS AND FAX BOARDS

**Internal**  
 Hayes  
 2400 Baud with Software \$239  
 9600 Baud V.42 w/Software \$499  
**Internal Hayes Compatibles (with software)**  
**Practical Peripherals**  
 2400 / 2400 V.42 \$75 / \$169  
 2400 IBM PS/2 \$199  
 9600 V.42 \$379

**External**  
 Hayes (no software incl.)  
 2400 Baud \$329  
 2400 Baud Pocket Edition \$119  
 9600 Baud V.42/V.42 Ultra \$499/\$649  
 Hayes Optima 9600 Baud Ext. \$359

**External Hayes Compatibles**  
**Practical Peripherals**  
 2400SA / 2400SA V.42 \$169 / \$199  
 9600SA V.42 \$459  
 2400 Pocket Modem \$99  
 2400V.42 Pocket Modem w/send fax \$159

**Other Hayes Compatibles**  
 Intel 9600 Baud with Software \$CALL  
 Intel 9600 V.32bis with Software \$CALL  
 All U.S. Robotics High Speed Modems \$CALL

**Fax Boards**  
 Freecom Fax 96 Board \$99  
 Freecom Fax / Modem \$119  
 Intel Satisfax/Fax Board \$CALL  
 Practical Peripherals External 2400  
 Send/Receive Fax w/9600 send/recv. \$109  
 Practical Peripherals Internal 2400  
 Send/Receive FAX w/9600 send/recv. \$99  
 Etronics NEW Internal 2400 Send/Receive  
 Fax Modem w/9600 send/receive \$85

Write for free catalog.  
 Prices subject to change; products subject to availability.  
 Not responsible for printing or typesetting errors.

**RETURN POLICY**-- All sales are final except defectives which will be replaced with identical merchandise only. Computers and large peripherals--3 work days after delivery; most small items, 30-calendar days, after which manufacturer's warranty applies. No returns will be accepted without an RMA number. Unauthorized returns and refused shipments subject to 15% restocking charge. ALL ELEK-TEK MERCHANDISE IS BRAND NEW, FIRST QUALITY AND COMPLETE.

### CORPORATE CUSTOMERS INVITED

We offer large bid opportunities. DUNS # 09-718-0517  
**OPEN ACCOUNTS**--Net 30 terms available to D&B accounts rated 2A1 or better, actual freight charges FOB Skokie, IL. Phone (as above) fax orders to Corporate Accounts 708-677-7168, mail P.O.'s (as above) to Dept. C1132  
**PREPAID ACCOUNTS**--Use Visa, MasterCard, check, money order (no cash or c.o.d.'s please). When ordering by mail please call in advance for shipping and handling charges. Shipments to IL add 7.75% tax. Minimum order \$15.00.

# ET VALUELINE

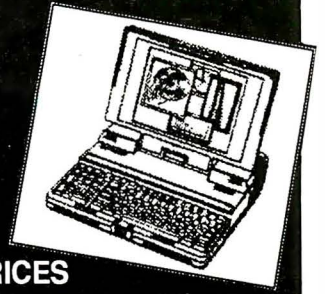
WHERE MORE THAN JUST THE PRICE IS RIGHT

7350 North Linder Avenue, Skokie, Illinois 60077  
**800-395-1000** IN IL: 708-677-6660  
 ET Valueline is the telemarketing and mail order department of Elek-Tek, Inc.



# tote-a-lap

"experts in portable intelligence"



PRICES CONTINUE TO DIVE SO PLEASE CALL FOR OUR MOST CURRENT PRICES

## TOSHIBA MEMORY

1 MB	\$98
1.5MB	\$128
2 MB	\$158
4 MB	\$298
8 MB	\$498

FOR T1000SE, T1000LE, T1000XE, T2000, T2000SX, T2000SX, T2200SX, T3300SL, T4400SX

## TOSHIBA MODEMS ON SALE

2400B INTERNAL MODEM FOR T1000, T1100+, T1200, T1600, T3100, T3100E, T3100SX, T3200SX, T3200SXC, T5100, T5200, AND T5200C

**\$78**

## LAPTOP/NOTEBOOK SUPER SALE

AST PREMIUM EXEC 386SX/25C	80MB WITH 8MB RAM	\$4,238
AST PREMIUM EXEC 386SX/25C	60MB WITH 8MB RAM	\$4,128
AST PREMIUM EXEC 386SX/25	80MB WITH 8MB RAM	\$2,698
AST PREMIUM EXEC 386SX/25	60MB WITH 8MB RAM	\$2,448
AST PREMIUM EXEC 386SX/20	60MB WITH 8MB RAM	\$2,328
AST PREMIUM EXEC 386SX/20	40MB WITH 8MB RAM	\$2,078
EVEREX TEMPO/LX 386SX/20	60MB WITH 5MB RAM	\$2,318
EVEREX TEMPO/LX 386SX/20	40MB WITH 5MB RAM	\$2,148
SHARP PC-6681	80MB WITH 6MB RAM	\$CALL
SHARP PC-6661	60MB WITH 6 MB RAM	\$2,218
SHARP PC-6781	80MB WITH 8MB RAM	\$CALL
SHARP PC-6881	80MB WITH 8MB RAM (COLOR)	\$CALL
TEXAS INSTRUMENTS TM2000	40MB WITH 3MB RAM	\$1,468
TEXAS INSTRUMENTS TM2000	20MB WITH 3MB RAM	\$1,158
TEXAS INSTRUMENTS TM3000	WinSX 80MB/6MB RAM	\$CALL
TEXAS INSTRUMENTS TM3000	WinSX 60MB/6MB RAM	\$CALL
TEXAS INSTRUMENTS TM3000	80MB WITH 6MB RAM	\$2,468
TEXAS INSTRUMENTS TM3000	60MB WITH 6MB RAM	\$2,388
TEXAS INSTRUMENTS TM3000	40MB WITH 6MB RAM	\$2,328
TEXAS INSTRUMENTS TM3000	20MB WITH 6MB RAM	\$2,038
ZENITH MASTERSPORT 386SL	60MB WITH 8MB RAM	\$3,898
ZENITH MASTERSPORT 386SL	60MB WITH 8MB RAM	\$3,228
ZENITH MASTERSPORT 386SX	60MB WITH 4MB RAM	\$2,528

## LAPTOP/NOTEBOOK HARD DRIVE UPGRADES

40MB 2.5" HARD DRIVE UPGRADE (MOST BRANDS)	\$398
60MB HARD DRIVE UPGRADE (MOST BRANDS)	\$498
80MB 2.5" HARD DRIVE UPGRADE (MOST BRANDS)	\$598
100MB 3.5" HARD DRIVE UPGRADE (MOST BRANDS)	\$498
200MB 3.5" HARD DRIVE UPGRADE (MOST BRANDS)	\$748
COMPUADD COMPANION 40MB HARD DRIVE UPGRADE	\$548
GRID 1720 60MB HARD DRIVE UPGRADE	\$648
PANASONIC CF-270 60MB HARD DRIVE UPGRADE	\$648
SHARP PC-6220 40MB HARD DRIVE UPGRADE	\$548
TANDY 2810-HD 60MB HARD DRIVE UPGRADE	\$648
TEXAS INSTRUMENTS TM2000 40MB HD UPGRADE	\$548
EXTERNAL 20MB BATTERY-POWERED HD UPGRADE	\$358
EXTERNAL 40MB BATTERY-POWERED HD UPGRADE	\$498
EXTERNAL 60MB BATTERY-POWERED HD UPGRADE	\$578
EXTERNAL 80MB BATTERY-POWERED HD UPGRADE	\$668

NOTE: All hard drive upgrades are supplied with a new BIOS whenever necessary, and come with a full one-year warranty.

**1-800-9-LAPTOP**  
**(1-800-952-7867)**

TEL: (415) 578-1901  
FAX: (415) 578-1914

## UPGRADED TOSHIBA SUPER SALE

T5200C	200MB WITH 14MB RAM	\$6,188
T5200	200MB WITH 14MB RAM	\$3,868
T5200	100MB WITH 14MB RAM	\$3,598
T5100	100MB WITH 4MB RAM	\$1,978
T5100	40MB WITH 4MB RAM	\$1,598
T4400SX	80MB LCD WITH 10MB RAM	\$4,708
T4400SX	80MB GAS PLASMA WITH 10MB RAM	\$CALL
T3300SL	80MB WITH 10MB RAM	\$CALL
T3200SX	120MB WITH 13MB RAM	\$CALL
T3200SX	120MB WITH 13MB RAM	\$CALL
T3200SX	40MB WITH 13MB RAM	\$CALL
T3100SX	80MB WITH 13MB RAM	\$2,958
T3100SX	40MB WITH 13MB RAM	\$2,298
T2200SX	80MB WITH 10MB RAM	\$3,968
T2200SX	60MB WITH 10MB RAM	\$3,748
T2200SX	40MB WITH 10MB RAM	\$3,528
T2000SX	60MB WITH 10MB RAM	\$2,998
T2000SX	40MB WITH 10MB RAM	\$2,758
T2000SX	60MB WITH 9MB RAM	\$2,778
T2000SX	40MB WITH 9MB RAM	\$2,558
T2000SX	20MB WITH 9MB RAM	\$2,448
T1600	40MB WITH 5MB RAM	\$1,738
T1600	20MB WITH 5MB RAM	\$1,338
T1200XE	60MB WITH 5MB RAM	\$CALL
T1200XE	40MB WITH 5MB RAM	\$1,968
T1200XE	20MB WITH 5MB RAM	\$1,738

## UPGRADE TODAY AND SAVE!

TOSHIBA T1200XE/T5100 2MB UPGRADE...\$98

APPLE POWERBOOK 2/4/6MB UPGRADE	\$128/\$248/\$328
APPLE QUADRA 16MB UPGRADE	\$598
AST PREMIUM EXEC 1MB/4MB UPGRADE	\$48/\$168
COMMODORE CLT286/386 2MB UPGRADE	\$98
COMPAQ LTE/386s 1MB/4MB UPGRADE	\$148/\$288
COMPUADD COMPANION/SX 2MB/4MB UPGRADE	\$88/\$178
EVEREX TEMPO/LX 2MB/4MB UPGRADE	\$98/\$188
GRID 1720/1750 2MB/4MB UPGRADE	\$98/\$188
HP 95LX PALMTOP 512K/1MB UPGRADE	\$188/\$328
IBM PS2 L40SX 2MB/4MB/8MB UPGRADE	\$98/\$198/\$378
NCR 3125 512K/1MB UPGRADE	\$188/\$328
PANASONIC CF170 1MB UPGRADE	\$68
PANASONIC CF270/370 2MB UPGRADE	\$98
PANASONIC CF270/370 4MB UPGRADE	\$188
POQUET PALMTOP 512K/1MB UPGRADE	\$188/\$328
SANYO MBC-17NB/18NB 2MB/4MB UPGRADE	\$98/\$188
SHARP PC-6641/TI TM3000 2MB/4MB UPGRADE	\$88/\$178
TANDY 2810HD/3810HD 2MB/4MB UPGRADE	\$98/\$188
TOSHIBA T3100 & T3100/20 2MB UPGRADE	\$268
TOSHIBA T3100SX 4MB UPGRADE (1 SLOT)	\$178
TOSHIBA T3200 3MB UPGRADE	\$168
TOSHIBA T5200 2MB/8MB UPGRADE	\$98/\$398
ZENITH MASTERSPORT 386SL/386SX 2MB UPGRADE	\$98
ZEOS 286/386SX NOTEBOOK 2MB UPGRADE	\$98

WE ARE OFFICIALLY LISTED IN THE TOSHIBA TECHNICAL INFORMATION GUIDE AS THE LEAST EXPENSIVE RECOGNIZED MEMORY MANUFACTURER FOR TOSHIBA LAPTOPS/NOTEBOOKS

ALL MEMORY UPGRADES COME WITH A LIFETIME WARRANTY & A 48-HOUR EXCHANGE GUARANTEE!

ABSOLUTELY NO SALES TO DOMESTIC RESELLERS

Some prices may reflect cash discounts. Not responsible for typographical errors.

# tote-a-lap

"experts in portable intelligence"

550 Pilgrim Dr. Suite F ■ Foster City, CA 94404

3.5" EXTERNAL FLOPPY DRIVE FOR COMPUADD COMPANION SHARP PC-6220 TEXAS INSTRUMENTS TM2000 **\$198** (while supplies last)

**NEW!** 60 MB HARD DRIVE UPGRADE FOR GRID 1720 PANASONIC CF-270 TANDY 2810HD **\$648**

SHARP PC-6220 TI TRAVELMATE TM2000 COMPUADD COMPANION **MEMORY UPGRADE** 1MB...\$98 2MB...\$188

**NEW!** 40 MB HARD DRIVE UPGRADE FOR SHARP PC6220 TI TRAVELMATE TM2000 COMPUADD COMPANION **\$548**

SE HABLA ESPANOL (Pregunte por Hector)

# Get A Lode Of This.

## Our Three-Way Guarantee Just Got Better.

The LodeStar Three-Way Personal Guarantee has always been one of the industry's most comprehensive. But now it just got better. Introducing The LodeStar Five-Way Personal Guarantee. Now, every LodeStar system is covered five ways to insure your complete satisfaction. And that should take a lode off your mind.

### 1. MONEY BACK GUARANTEE.

If you change your mind for any reason simply return your LodeStar system to us in original condition within 30 days of your receipt and we'll refund your money.

### 2. FREE LIFETIME TECHNICAL SUPPORT.

For as long as you own your system, we'll give you FAST, FREE unlimited technical advice and guidance from our expert staff. This includes any support needed to upgrade or modify your system.

### 3. FREE LIFETIME LABOR SUPPORT.

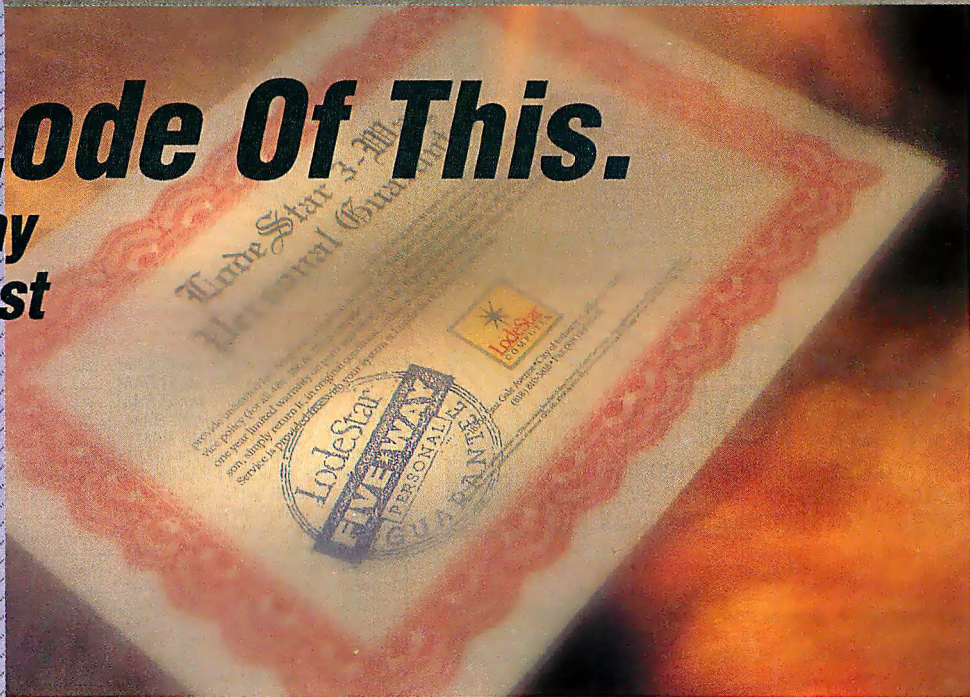
Although you will probably never need it, for as long as you own your system, it will be protected by our 100% labor warranty.

### 4. FREE 2-YEAR PARTS WARRANTY.

For a full two years after purchase, your LodeStar computer will be covered by our 100% parts warranty with fast turn around on any replacements.

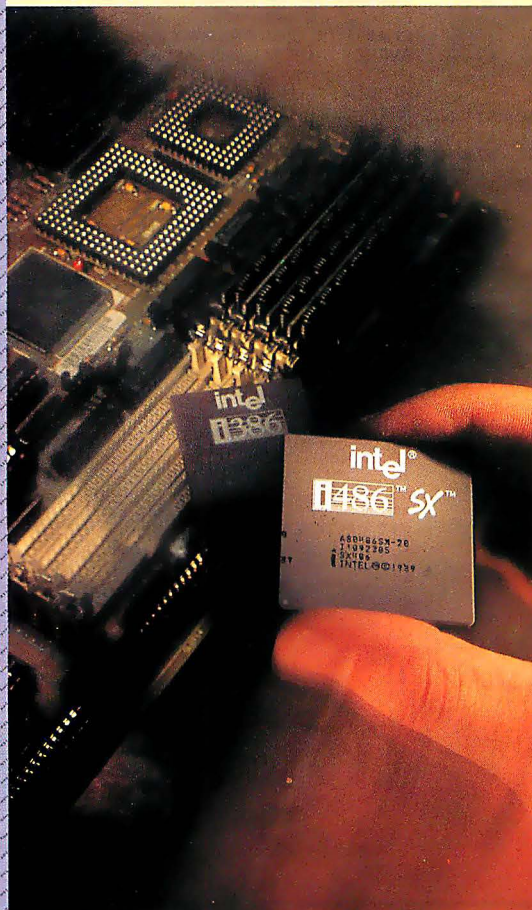
### 5. FREE 1-YEAR ON-SITE SERVICE.

For a full one year after purchase, you'll have the added security of our coast-to-coast FREE on-site service.



## Modulless Upgradeables

# Carry A Greater Lode In The Future



Easy and inexpensive upgrades are built right into your LodeStar computer. Unlike conventional modular upgradeable systems from other companies, you can upgrade your LodeStar system at a fraction of the cost—all the way from 386DX to 486SX or 486DX, at any clock speed.

Thanks to our unique non-proprietary Modulless Upgrade design, LodeStar systems can be upgraded by simply plugging in the new chip and oscillator that comes in their inexpensive upgrade kit. Another bright idea from LodeStar—it's just that simple!

Every LodeStar computer is fully loaded with value. This includes unsurpassed quality throughout. To make certain of this, every system is individually pre-tested and burned-in for 72 hours prior to shipment. And of course, we stand behind our quality with our comprehensive Five-Way Personal Guarantee. You will see this quality all the way from our StarView SVGA Non-Interlaced Monitors with flicker-free image, to our own StarKey extended keyboards. And we pack in even extra value by pre-loading MS DOS 5.0 & Windows 3.0, as well as a Hi-Res 400 DPI serial mouse on every system. And our systems can be upgraded to include optional cache, RAM, more hard disk capacity, larger monitor, and a host of other enhancements you may require. Add it all together - stellar performance, brilliant quality, and guarantee that outshines all others - and you've got LodeStar.



**Starflex 386 DX Upgradeable Systems**

**Starflex 386-33C**

**\$1899**

Intel 80386/33 Processor  
64K Cache RAM (Expandable to 256K)  
4MB RAM (Expandable to 32MB)  
125MB IDE Hard Drive with Cache  
Teac 1.2MB 5.25" & 1.44MB 3.5" Drives  
1MB SVGA Non-interlaced Color Card  
14" SVGA Non-Interlaced 1024x768  
Flicker-Free Color Monitor  
2 Serial, 1 Parallel, & 1 Game Port  
MS DOS 5.0 & MS Windows 3.0  
Starkey 102 Keyboard  
Hi-Res Serial Mouse  
Desktop CPU Case (Verticals optional)  
Upgradeable to 40 MHz &  
486sx 20, 486 33/50

**Starflex 386-25C**

**\$1779**

Intel 80386/25 Processor  
64K Cache RAM (Expandable to 256K)  
4MB RAM (Expandable to 32MB)  
85 MB IDE Hard Drive with Cache  
Teac 1.2MB 5.25" & 1.44MB 3.5" Drives  
1MB SVGA Non-interlaced Color Card  
14" SVGA Non-Interlaced 1024x768  
Flicker-Free Color Monitor  
2 Serial, 1 Parallel, & 1 Game Port  
MS DOS 5.0 & MS Windows 3.0  
Starkey 102 Keyboard  
Hi-Res Serial Mouse  
Desktop CPU Case (Verticals optional)  
Upgradeable to 33/40 MHz &  
486sx 20, 486 33/50

**386sx 16MHz**

**\$1259**

Intel 80386sx/16 Processor  
2MB RAM & 42 MB Hard Drive w/Cache  
Teac 1.2MB 5.25" & 1.44MB 3.5" Drives  
1MB SVGA Color Card  
14" SVGA 1024x768 Color Monitor  
2 Serial, 1 Parallel, & 1 Game Port  
MS DOS 5.0 & MS Windows 3.0  
Starkey 102 Keyboard  
Hi-Res Serial Mouse  
Desktop CPU Case (Verticals optional)

**386sx 25MHz**

**\$1299**

**Starflex 386-40C**

**\$1939**

**Case Options**

Every LodeStar system comes with four C.P.U. Case options: The Desktop, or the Mini, Mid or Full Vertical Cases.



**Starflex 486 Upgradeable Systems**

**Starflex 486-33C**

**\$2289**

Intel 80486/33 Processor w/ 8KB internal  
Cache & Built-in Math Coprocessor  
64K Cache RAM (Expandable to 256K)  
4 MB RAM (Expandable to 32MB)  
125MB IDE Hard Drive with Cache  
Teac 1.2MB 5.25" & 1.44MB 3.5" Drives  
1MB SVGA Non-Interlaced Color Card  
14" SVGA 1024x768 Non-Interlaced  
Flicker-Free Color Monitor  
2 Serial, 1 Parallel, & 1 Game Port  
MS DOS 5.0 & MS Windows 3.0  
Starkey 102 Keyboard  
Hi-Res Serial Mouse  
Mid-Vertical or Desktop CPU Case  
Upgradeable to 50MHz

**Starflex 486-50C**

**\$3129**

**Starflex 486SX-20C**

**\$2049**

Intel 80486sx/20 Processor  
64K Cache RAM (Expandable to 256K)  
4 MB RAM (Expandable to 32MB)  
125MB IDE Hard Drive with Cache  
Teac 1.2MB 5.25" & 1.44MB 3.5" Drives  
1MB SVGA Non-Interlaced Color Card  
14" SVGA 1024x768 Non-Interlaced  
Flicker-Free Color Monitor  
2 Serial, 1 Parallel, & 1 Game Port  
MS DOS 5.0 & MS Windows 3.0  
Starkey 102 Keyboard  
Hi-Res Serial Mouse  
Mid-Vertical or Desktop CPU Case  
Upgradeable to 33/50MHz

Circle 186 on Inquiry Card.

*\*Mid & Full Verticals may be additional on some systems.*

**1.800.875.7568**

**- Warranty -**

"One of the most conspicuous things that differentiate LodeStar from its competitors is extensive warranty support."

**- Craftsmanship -**

Layout is excellent..... Wonderfully uncramped sight that greets you when you open the case with LodeStar's tower, you don't have to fight a mass of tangled cables and jagged edges."

**- Technical Support -**

"As a further test of technical support, I deliberately destroyed..... I then gave the system and a phone to an inexperienced friend. A LodeStar technician competently took her through the process....."

**- Prompt Response -**

"When I called with a question..... I was immediately connected to a knowledgeable technician."

**- Summary -**

"The combination of high performance, low price, and one year of free on-site services makes LodeStar 486 an attractive buy."

- PC Sources 1992



18539 East Gale Ave.  
City of Industry,  
California 91784  
Tel: 1.818.810.3818  
Tech Support:  
1.800.875.7569  
Fax: 1.818.810.5928

GOVERNMENT SCHOOLS AND CORPORATE PURCHASE ORDERS WELCOME. All prices and specifications subject to change without notice. 2-Year Parts Warranty applies to LodeStar products only. Money Back Guarantee does not include shipping & handling, and all returns must be shipped pre-paid & in resalable condition. Please call to confirm all warranty details. Photography is for illustration only. No surcharge on VISA, MasterCard, & Discover. 2% cash discount on all Pre-Paid systems. Purchase orders are accepted on approved credit. California orders add 8 1/4% sales tax. All product names, trademarks and registered trademarks are the property of their respective companies. For more written information, please call for our FREE product catalog.

# The Only Thing More Reliable Than Our Products Is Our Customer Service.

**W**e may carry the widest selection of the most dependable products in the industry but it's our customer service that sets us apart. And when you want to upgrade your computer, that's important.

At Universal, we're knowledgeable about all of our products. So we'll be able to help you figure out what you need and how to install it. And we'll do it in a way

that'll be very understandable.

We'll help you in other ways, too.

Our prices are very competitive. And every product is checked for quality before it's shipped. Plus, you can have your order sent same day, overnight or whatever way you want.

And after you receive your order, you won't have anything to worry about either.

Because everything we sell comes with a 5 year warranty, a 30 day, money back guarantee and is guaranteed to be compatible with your computer. So you're covered no matter what happens.

Also, you can always phone, fax or mail us with any questions regarding our company or products. And we'll

be happy to give you the information you want.

Overall, no one else works with you as much as we do.

So if you want to upgrade your computer and you need more than a product listing, call Universal. We'll provide you with products and service that'll help you every step of the way.



## EXPANSION BOARDS

### Orchid Technology

Ramquest 16/32  
OK \$229 2MB \$329  
2-8MB for PS/2 50/55/60/70/80  
Ramquest 8/16 OK \$149 2MB \$245

### BOCA Research

Bocaram At Plus  
OK \$119 2MB \$199 2-8MB LIM 4.0 AT's  
Bocaram AT/IO Plus  
OK \$157 2MB \$257 up to 4MB  
w/ser & par ports  
Bocaram 2 for PS/2's OK \$159 2MB \$259  
Bocaram XT-PS/2 30 1MB \$159

### AST Research

6pak 286 OK \$109 2MB \$209  
Rampage Plus 286 OK \$239 2MB \$309  
up to 8MB for AT UM 4.0  
Pastram 286 1MB \$279  
Cupid 32 OK \$250

### Intel

Above Board Plus 8 w/2MB \$499

## VIDEO GRAPHICS CARDS

### ATI

8514 Ultra 512K PS/2 or ISA BUS \$439  
Graphics Ultra 512K & mouse \$545  
Graphics Vantage w/512K \$369  
NEW!!! VGA Stereo XL w/1MB \$375  
VGA Wonder XL 1MB w/mouse \$229

### Orchid Technology

Fahrenheit 1280 w/1MB & Sierra \$389  
Prodesigner IIS 512K \$199 1MB \$239  
Prodesigner IIMC for PS/2 1MB \$399

### BOCA Research

BOCA Super VGA 512K \$139 1MB \$179

## PRINTER UPGRADES

### Hewlett Packard

Laserjet IIP, III, I1D, I1IP  
1MB \$69 2MB \$119 4MB \$199  
Laserjet II, I1D  
1MB \$95 2MB \$149 4MB \$249

### Panasonic 4420 & 44501

1MB \$109 2MB \$149 4MB \$249  
4450 1MB \$179 4455 2MB \$269

### Epson EPL 6000 & EPL 7000

1MB \$129 2MB \$151 4MB \$255

### IBM 4019 & 4019E

1MB \$115 2MB \$145 3.5MB \$209

### OKI 400, 800, 820, 830, 840

1MB \$119 2MB \$169 4MB \$219

### Canon

LBP4 2MB \$229 LBP 8 2MB \$119

## MEMORY CHIPS & MODULES

### DRAM

1X1-70NS \$5.25 256X4-80NS \$5.15  
1X1-80NS \$4.95 256X4-100NS \$4.95  
256X1-80NS \$1.99 256X1-120NS \$1.75  
256X1-100NS \$1.85 256X1-150NS \$1.50  
64X4-80NS \$3.00 64X1-100NS \$1.75  
64X4-100NS \$2.75 64X1-120NS \$1.60

### SIMM/SIPP Modules

4X9-70NS \$199 4X9-80NS \$169  
1X9-70NS \$49 1X9-80 \$45  
1X9-100NS \$44

## MATH CO-PROCESSORS

### U1S1

US83C87-16, -25, -20 & -33 \$199  
US83C87-16SX \$115 -20SX \$139  
New US83C87-40 \$279

### Intel

80387-16, -20, -25 & -33 \$249  
80387-16SX \$139 -20SX \$189  
80287-10 \$89 80287XL \$125

## IBM PS/2 UPGRADES

### IBM PS/2 Memory

6450604 2MB MOD 50Z, 55SX, 70 \$99  
6450608 2MB MOD 70A21 \$119  
34F2933 & 77 4MB PS/2 SIMM \$209  
30F3360 2MB for 30-286 \$99  
6450128 4MB MOD 90 & 95 \$269  
6450902 2MB MOD 90 & 95 \$129  
6450609 2-8MB MOD 50, 50Z, 60 \$350  
6450605 2-8MB MOD 70 & 80 \$350  
34F3077 2-14MB MOD 70 & 80  
w/2MB \$355  
34F3011 4-16MB MOD 70 & 80  
w/4MB \$477

### Procom PS/2 Hard Drives

Zero Slot 124MB MDL 50 \$795  
124MB MDL 50Z, 55SX, 70 \$740  
200MB MDL 50Z, 55SX, 70 \$1065

### PS/2 Accelerators

Model 50 & 60 Intel Snap-in 386  
386SX-20MHZ \$435

### Kingston

SX-Now 386SX 20MHZ for 50, 60, 50Z  
& 30-286 \$359 25MHZ \$459

## COMPAQ UPGRADES

### Compaq Deskpro

Deskpro 386/20, 25, 20E, 25E & 386S  
4MB Module \$259 4MB expboard \$327  
Deskpro 386/33, 486/25 Systempro  
2MB Module \$149 6 socket exp. brd.  
w/2MB \$395

### 1/3 height floppy disk drives

1.44MB \$129 1.2MB \$139

### Portable LTE 286

1MB \$99 2MB \$169 4MB \$379

### Portable LTE 386S/20

1MB \$209 4MB \$399

### Portable 386/20

1MB Upgrade kit \$145 4MB exp/ext  
brd \$375

SLT 286 1MB \$119 4MB \$429

SLT 386 1MB \$129 2MB \$255

4MB \$435

## LAPTOP UPGRADES

### Toshiba

T1200XE/SE, T1600, T3100E, T3100SX,  
T3200SX, T5100, T5200, 2MB \$119  
T3200SXC, 2MB \$159 4MB \$329  
T1000SE/XE/LE & T2000SX 1MB \$119  
2MB \$229  
T1000LE & T2000SX 4MB \$359  
T3100SX, T3200SX 4MB \$229  
T3200 3MB \$219

### Megahertz Laptop Modems

2400 BD internal \$137 w/MNP5 \$189  
2400/9600 FAX/Modem w/MNP5 \$339

Same day shipping by UPS, Federal Express or DHL. Order worldwide by P.O., C.O.D., APO, FPO & credit card with no surcharge added. 20% restocking fee on all non-defective returns.

800/678-8648

UNIVERSAL

MEMORY PRODUCTS



UNIVERSAL MEMORY PRODUCTS  
15451 Redhill, Suite E, Tustin, CA 92680  
Phone: 714/258-2018 Fax: 714/258-2818

*Special Offer!*

# BYTE

**YES!** Enter my one-year (12 issues) subscription to BYTE for only \$24.95. **I'll save 40% off the single copy price.** Plus, I'll also receive BYTE's Annual Special Issue FREE with my paid subscription. If at any time I'm not satisfied with BYTE, I may cancel for a full refund on all unmailed copies.

Payment enclosed     Bill me

NAME \_\_\_\_\_

COMPANY \_\_\_\_\_

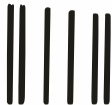
ADDRESS \_\_\_\_\_

CITY \_\_\_\_\_ STATE \_\_\_\_\_ ZIP \_\_\_\_\_



IW23133

Please allow 6-8 weeks for delivery. Basic subscription rate is \$29.95. (Mexico, \$29.95 payable in U.S. funds.)



NO POSTAGE  
NECESSARY  
IF MAILED  
IN THE  
UNITED STATES

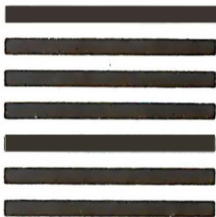
**BUSINESS REPLY MAIL**

FIRST CLASS MAIL PERMIT NO. 42 HIGHTSTOWN, NJ

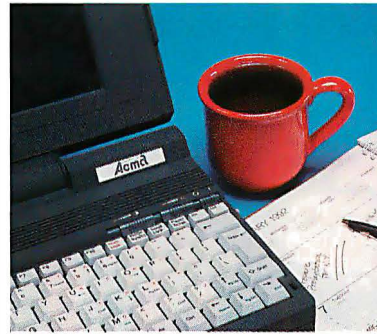
POSTAGE WILL BE PAID BY ADDRESSEE:

**BYTE**

Subscription Department  
P.O. Box 558  
Hightstown, N.J. 08520-9409



# "POWER BEYOND YOUR DREAMS."



## BEST BUY 486/33i

Intel486™ 33MHz » 8MB RAM » 256K Cache » Teac 1.2MB & 1.44MB FDD » Quantum 210MB IDE HDD w/64K DisCache® buffer (15ms) » caching controller w/4MB » 14" Seiko 1450 SVGA monitor (1024x768) » Orchid Pro-IIs SVGA card w/1MB » 120MB tape backup » 2 serial, 1 parallel, & 1 game port » 101 keyboard » Tower case » Windows 3.0 » DOS 5.0 » Hi-Res Mouse » 1yr. TRW on-site service. **\$3,698**

## SX/20 NOTEBOOK

Intel386™ SX/20MHz » 1MB RAM upgradeable to 5MB » Teac1.44MB FDD » Conner 40MB IDE HDD » VGA CCF-T backlite TSTN type LCD monitor w/16 shades of gray » 1 serial & 1 parallel port » 80 key keyboard » 3 hour battery life » 6.3 lbs. w/battery » carrying case » battery charger » supports external VGA monitor and keyboard. Optional Fax/Modem only \$160. Extra batteries \$75. **\$1,795**

## 386SX/20MHz

Intel386™ SX/20MHz » 2MB RAM expandable to 8MB » Teac 1.2MB & 1.44MB FDD » Quantum 52MB IDE HDD w/64K DisCache® buffer (17ms) » 14" Hyundai Super VGA monitor (1024x768) » 16-bit VGA card w/512K » 2 serial, 1 parallel & 1 game port » 101 key keyboard » Windows 3.0 » DOS 5.0 » Hi-Res Mouse » 1yr. TRW on-site service. **\$1,295**

## 386/25 & 33MHz

Intel386™ 25 & 33MHz » 4MB RAM expandable to 32 & 64MB » 64K Cache 33MHz » Teac 1.2MB & 1.44MB FDD » Quantum 105MB IDE HDD w/64K DisCache® buffer (17ms) » 14" Super VGA monitor (1024x768) » 16-bit SVGA card w/1MB » 2 serial, 1 parallel, & 1 game port » 101 key keyboard » Windows 3.0 » DOS 5.0 » Hi-Res Mouse » 1yr. TRW on-site service. **25MHz \$1,795**  
**33MHz \$1,895**

## 486/33MHz EISA

Intel486™ 33MHz » 8MB RAM » 256K Cache » Teac 1.2MB & 1.44MB FDD » Quantum 210MB IDE HDD w/64K DisCache® buffer (15ms) » 15" NEC 4FG Super VGA flat square screen monitor (1024x768) » Orchid Pro-IIs SVGA card w/1MB » 2 serial, 1 parallel, & 1 game port » 101 key keyboard » Windows 3.0 » DOS 5.0 » Hi-Res Mouse » 1yr. TRW on-site service. **\$3,895**

**W**hen it comes to offering the highest quality components, blazing-fast performance, friendly service, and unbeatable value, Acma ranks among the best! Just ask the experts at PC Magazine *For Your Dollar.* BYTE Magazine applauded Acma components, blazing-fast for "Speed And Reliability At performance, friendly service, and unbeatable value, Acma ranks among the best! Just ask the experts at PC Magazine *An Outstanding Price.*" Clearly, if you demand the best, you won't find a better choice than an Acma computer. And we who said Acma offers guarantee it with a "No *Power Beyond Your Questions Asked*" 45-Day *Dreams,*" and "A *Solid Value* Money-Back guarantee!



"The Perfect Windows 3.0 Workstation" "Our Favorite Is The Acma"

## FEATURES & SERVICES

- ▼ 45-Day "NO QUESTIONS ASKED" Money-Back Guarantee\*
- ▼ One-Year Parts And Labor Warranty
- ▼ FREE One Year On-Site Service In Most U.S. Locations
- ▼ FREE Lifetime Toll-Free Technical Support (Mon. - Sat.)
- ▼ FREE 24 hour, 365 days a year, tech-support bulletin board!
- ▼ Major credit cards honored (not charged until order ships)
- ▼ Net credit terms available for qualified businesses
- ▼ Windows 3.0 & DOS 5.0 preloaded FREE (except notebook)
- ▼ FREE Return Shipping Of Replacement Or Repaired Parts\*\*
- ▼ NEW PRODUCTS! Fax/modem card, \$115 » Programmable keyboard, \$125 » 1.2GB hard disk drives, Call Today!
- ▼ Personal And Business Leasing Plans
- ▼ Special GSA And Quantity Discounts
- ▼ SPECIAL! \$1.00 Upgrade Program
- ▼ 48 Hour High-Temperature Burn-in

**GSA# GS00K91AGS5107**  
**Call Toll-Free 800-456-8809**

COMPUTERS, INC.  
**Acma**

**ORDER TODAY TOLL-FREE!**  
**800-456-1818**

Open 6am-7pm Weekdays and 8am-4pm Saturdays (PST)  
International 510-623-1212, 24 Hour Fax 510-623-0818



B0392

© 1991, Acma Computers, Inc., 48501 Warm Springs Blvd., Fremont, CA 94539 All prices and specifications are subject to change without notice. \*The 45-day money-back guarantee covers Acma brand computers with Impression Plus or Hyundai monitors only (software, printers, peripherals, and shipping are not included). All brand names are registered trademarks of their respective companies. \*\*Customer pays shipping to Acma for parts replacement or repair, and Acma pays return shipping to customer. Call today to confirm complete details.

Circle 159 on Inquiry Card.

MARCH 1992 • BYTE 321

# Pick A Card

# Volante

Draw  
your  
winning  
card from  
National  
Design's  
Volante Series



of high speed graphics boards.

All Volante high speed graphics boards offer:

- Built on ISA, MicroChannel or VME bus
- Video memory upgrades to 4 MB
- Program memory upgrades to 4 MB
- Razor sharp resolutions from 1024x768 up to 1600x1280
- Blazing color selection from 8-bit to 24-bit true color
- Optional TI TMS34082 floating point processor for enhanced 3D acceleration
- Superior speed of the TI TMS34020 graphics engine paired with National Design's advanced ASIC technology
- LIFETIME WARRANTY - no gamble here!

Whether your game is CAD, Microsoft Windows, graphic arts, multi-media or medical imaging, Volante has a card for you at a fraction of the cost charged by the competition.

Call 800-253-8831 now for information  
on the breathtaking Volante series.  
Phone: 512-343-5055 Fax: 512-343-5053



NATIONAL DESIGN, INC.  
9171 CAPITAL OF TEXAS HWY. H-230  
AUSTIN, TEXAS, 78759

Circle 171 on Inquiry Card (RESELLERS: 172).





&



**(800)  
831-2888**

# Hi-Tech USA Monthly Specials

**EISA  
486-33C  
\$1,678**

**386-40C  
64k cache  
\$698**

**386-33  
\$618**

**386-25  
\$568**

**386SX  
20 MHz  
\$478**

**286-25  
\$418**

**EISA  
486-25C  
\$1,628**

**All systems Include:**  
Motherboard & CPU, 1 MB memory installed (512KB for 286 systems), 1:1 2HD/2FD controller, 1.2 MB or 1.44 MB Floppy Drive, Internal clock/calendar, Math coprocessor socket, 2 Serial/1 Parallel ports, Enhanced case w/ Power Supply, 101-key Enhanced Keyboard, MS-DOS 5.0 or 4.01 or 3.3.

Hard Drive + Video Upgrade	40MB	80MB	120MB	200MB
12" mono + MGP card	\$266	\$366	\$436	\$636
14" VGA + VGA card	\$436	\$536	\$606	\$806
14" SVGA (1024 x 768) + SVGA Card	\$526	\$626	\$696	\$896
14" SVGA (non-inter) + SVGA Card	\$606	\$706	\$776	\$976

**286-20  
\$388**

**ISA  
486-33C  
\$948**

**VIDEO OPTIONS**

14" SVGA (1024x768, 0.28) Monitor with	\$ 338
16-bit SVGA 512k card	\$ 48
NEC 3FGX/4FG/4DS/5D	\$ 678/828/998/1888
Sony 1304 HG (1024x768, 0.25)	\$ 568
Nanaco 9070U/9080i	\$ 898/1078
Oak VGA-256k (800x600, 16-bit)	\$ 48
Trident 1MB (1024x768x256)	\$ 88
Orchid Prodesigner IIS with 1MB	\$ 178
Orchid Prodesigner IIS w/ Hi-Color	\$ 218
Orchid Fahrenheit 1280	\$ 298
Diamond Speed Star with 1MB	\$ 178
Diamond Speed Star Hi-Color	\$ 218
Video 7, 1024i (512 KB)	\$ 188
Video 7, VRAM II (1MB)	\$ 348

**HARD DISK DRIVES**

40mb/28ms (IDE)	\$ 178
80mb/18ms (IDE)	\$ 278
100mb/16ms (IDE)	\$ 298
120mb/16ms (IDE)	\$ 348
130mb/15ms (IDE)	\$ 348
200mb/16ms (IDE)	\$ 548
240mb/15ms (IDE)	\$ 578
340mb/15ms (IDE or SCSI)	\$ 948
676mb/16ms (ESDI or SCSI)	\$ 1398

**MISCELLANEOUS**

Citizen 200GX (9-pin)	\$ 168
Citizen GSX-130/140+ (24-pin)	\$ 258/328
Citizen GSX-145 (24-pin)	\$ 398
Color option for Citizen printer	\$ 48/68
Panasonic Printers	\$ Call
Windows 3.0 + Super Mouse II	\$ 68
Internal Modem 2400 baud	\$ 48
Fax Modem (9600 Fax, 2400 Modem)	\$ 88
Logitech Mouseman serial/bus	\$ 64/74
Best prices on memory upgrades	\$ Call

**286-16  
\$358**

**ISA  
486-25C  
\$898**

**386-33C  
64k cache  
\$648**

**386-25C  
64k cache  
\$618**

**386SX  
25 MHz  
\$498**

**386SX  
16 MHz  
\$438**

**286-12  
\$338**

**Free 3-button mouse with a complete system purchase**

## ▲ Why Hi-Tech USA! ▲

1. Lifetime toll-free technical support.
2. One year parts, 2 years labor warranty.
3. 30 days satisfaction money-back guarantee.\*
4. We customize to your requirements.
5. Combinations of the best state-of-the-art components
6. 72 hour burn-in test.
7. World wide shipping.
8. Replacement parts shipped at no cost to you.
9. Superior reputation for service, quality & value.
10. Purchase orders are welcomed and subject to approval.



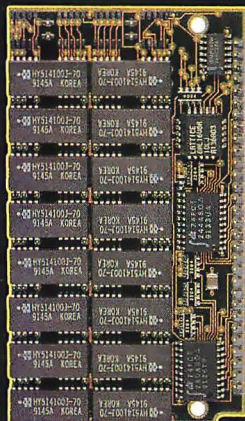
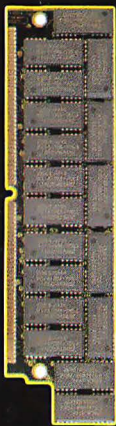
## Terms and Conditions

- ▲ Prices and specifications subject to change without notice
- ▲ \* Guarantee will be honored only for IBM incompatibility reasons, covers only Hi-Tech USA brand computers, and excludes computer peripherals, software, and shipping charges. All other returns subject to 15% restocking fee. No refunds after 30 days.
- ▲ Prices reflect cash discount.
- ▲ All logos and trademarks are registered trademarks of their respective companies.

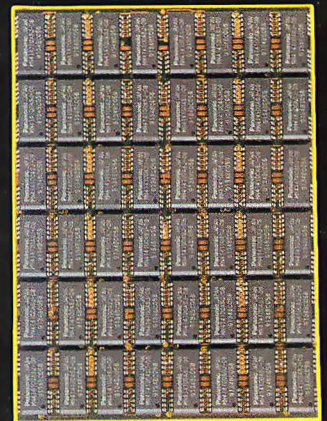
**Order Number** 1-800-831-2888  
**Technical & Service** 1-800-831-2780  
**International Orders** (408) 262-8688  
**FAX Orders** (408) 262-8772  
**1562 Centre Point Drive Milpitas, CA 95035**

# 16MB TECHNOLOGY NOW!!!

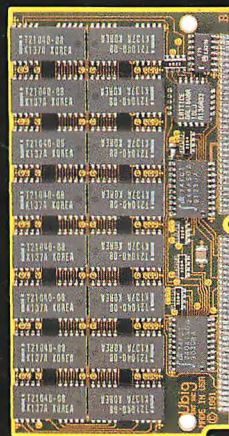
ACER 486 SX  
**16MB**



MAC II fx  
**16MB**



MAC QUADRA 900  
**16MB**



COMPAQ SYSTEMPRO  
**32MB**

ALSO AVAILABLE: **8M X 36, 32MB MODULE**

**OTHER MEMORIES AVAILABLE:**

ACER, ALTIMA, AST, CHAPLET, DELL, EPSON, HP, IBM, NEC, PANASONIC, QMS, SAMPO, SHARP, SILICON GRAPHICS, SUN MICROSYSTEMS AND ZENITH.

**CALL FOR OUR COMPLETE CATALOG**

**CitiTronics**  
Inc.

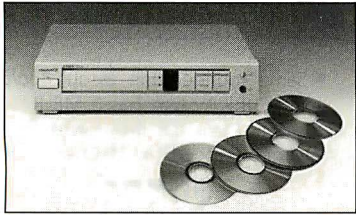
TERMS: C.O.D. CASH, VISA OR MASTERCARD.  
COMPANY AND UNIVERSITY P.O.'S ACCEPTED UPON CREDIT APPROVAL.

414 CLOVERLEAF DR., UNIT B, BALDWIN PARK, CA 91706

TEL. (818)855-5688 FAX (818)855-5687

# CD-ROM or PALMTOP

## \$169. Giveaway!\*



Magnavox



Psion



\* Purchase a WORX 486/33-256C before March 15, 1992 and for an additional \$169, receive either the new Magnavox CDD461RS external CD-ROM with approximately \$2000 worth of free software or the amazing, new PSION Series 3 Palmtop Computer!

### WORX 286/16

16Mhz 286 processor  
2MB standard RAM  
Teac 5.25" and 3.5" Floppies  
Western Digital Caviar 85MB  
<18ms w/adaptive, Segmented  
32k cache  
16-bit VGA card w/512k  
14" MicroScan 1024x768 Color  
VGA Monitor  
parallel, 2 serial, game ports  
Keytronic 101-key Keyboard  
Microsoft DOS 5.0

**\$1,395**

2/125MB/VGA-1MB/NI

**\$1,695**

### NEW! WORX 386SX/25-32C

25Mhz 386SX Processor  
**32k Cache RAM**  
2MB standard RAM  
Teac 5.25" and 3.5" Floppies  
Western Digital Caviar 85MB  
<18ms w/adaptive, Segmented  
32k cache

16-bit VGA card w/512k  
14" MicroScan 1024x768 Color  
VGA Monitor  
parallel, 2 serial, game ports  
Keytronic 101-key Keyboard  
Microsoft Mouse  
Microsoft DOS 5.0  
Microsoft Windows 3.0

**\$1,745**

2/125MB/VGA-1MB/NI

**\$1,995**

### WORX 386/33-64C

33Mhz Intel 386 processor  
**64k Cache Ram**  
4MB standard RAM  
Teac 5.25" and 3.5" Floppies  
Western Digital Caviar II  
125MB Hard Drive  
<15ms w/adaptive, Segmented  
32k Cache

16-bit VGA card w/1MB  
14" MicroScan 1024x768  
Non-interlaced Color  
VGA Monitor  
parallel, 2 serial, game ports  
Keytronic 101-key Keyboard  
Microsoft Mouse  
Microsoft DOS 5.0  
Microsoft Windows 3.0

**\$2,245**

4/85MB/VGA-512k/I

**\$1,995**

### 256k Cache RAM WORX 486/33-256C

33Mhz Intel 486 processor  
8MB standard RAM  
Teac 5.25" and 3.5" Floppies  
Western Digital Pirana  
212MB Hard Drive  
14ms w/adaptive, Multi  
Segmented 64k cache  
16-bit VGA card w/1MB  
14" MicroScan 1024x768 Non  
Interlaced Color VGA Monitor  
parallel, 2 serial, game ports  
Keytronic 101-key Keyboard  
Microsoft Mouse  
Microsoft DOS 5.0  
Microsoft Windows 3.0

**\$3,095**

4/125MB/VGA-1MB/NI

**\$2,595**

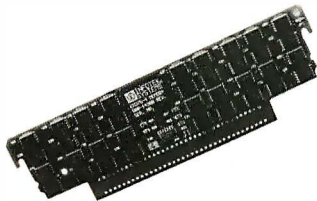
All WORX computers come with a 1-year warranty on parts and labor as well as a 30-day, money-back satisfaction guarantee.

#### Options Pricing:

**HD Upgrade**  
85 to 125 .....\$100  
125 to 212 .....\$250

**Memory Upgrade**  
2 to 4 .....\$125  
4 to 8 .....\$250

**Video Upgrade**  
512K-Interlaced  
to 1MB and  
Non-Interlaced .....\$150



#### HP WORKSTATION MEMORY HEADQUARTERS

Model	340	360	345/ 375/ 380	400 Series	700 Series	330/ 350/ 370
4MB	1595	1850	1250	1250	-	CALL
8MB	-	3000	1695	1695	-	CALL
12MB	-	4150	-	-	-	CALL
16MB	-	-	1295	2995	3495	CALL
32MB	-	-	5995	5995	6895	CALL

1982 — TEN YEARS OF SERVICE — 1992

## ComputerWORX



*With PRIDE and CARE, from a small mill town along the rocky vacation coast of Southern Maine, ComputerWORX manufactures quality computers using the highest quality components available.*

469 Elm Street  
Biddeford, ME 04005

Sales: 800-639-2185  
207-284-0291

Customer Support and  
Nationwide Service: 207-284-4892

Hours:  
Weekdays, 9 AM to 9 PM, EDT  
Saturday, 10 AM to 6 PM, EDT

Call for PS/2 CPU and Memory upgrades. Call for networking info and prices.  
Prices subject to change. Shipping and handling not included.

# More Features & Unbeatable Low Prices



## Increase Your Cache Flow Comtrade's Incredible 486 With 256K Cache.

AS YOU KNOW, IN TODAY'S COMPETITIVE MARKET THE SUCCESS OF ANY COMPUTER DEPENDS ON VALUE. ■ VALUE MEANS THE RIGHT FEATURES AT THE RIGHT PRICE. ■ BUT IT ALSO MEANS QUALITY. ■ BECAUSE YOU EXPECT IT, COMTRADE HAS MADE QUALITY THE CORNERSTONE OF IT'S PRODUCTS SINCE 1986.

PART OF WHAT SETS COMTRADE ABOVE THE REST IS AN IMPRESSIVE LIST OF STANDARD FEATURES. ■ MS-DOS 5.0, WINDOWS 3.0, NON-INTERLACED .28 SVGA MONITOR FOR ABSOLUTELY FLICKER-FREE IMAGE, HIGH SPEED HARD DISK FOR ACCESS TIMES AVERAGING 15MS, A HI-RESOLUTION 400 DPI MOUSE, AND 8 EXPANSION SLOTS FOR VAST UPGRADEABILITY. ■ COMPARE COMTRADE TO THE COMPETITION --- AND YOU'LL FIND THEIR EXPENSIVE OPTIONS DON'T MEET OUR STANDARDS.



### What Make COMTRADE A Sure Thing.

- 30 DAY MONEY BACK GUARANTEE
- ONE YEAR WARRANTY ON PARTS
- LIFETIME WARRANTY ON LABOR
- 72 HOURS BURN-IN TIME BEFORE SHIPPING
- LIFETIME TOLL-FREE SERVICE & SUPPORT
- EXPRESS REPLACEMENT PART
- 6 YEARS EXPERIENCE IS YOUR ASSURANCE

All systems are FCC approved ■ Price Subjects to Change  
Hours: Monday-Friday 7:00-7:00; Saturday 10:00-6:00



## 486/33 MHz Plus

- Same configuration as our 486/33 except this system has 8 MB RAM, 210MB 15ms IDE 64K Cache Drive Diamond SpeedStar Hi-Color Card.

**\$2575**

## 386/40 MHz SVGA

- 128K High Speed Cache
- 4 MB RAM (70ns)
- 1.2 MB & 1.44 MB Floppy Drive
- 130 MB 15ms IDE 64K Cache Drive
- 16-Bit 1024x768 SVGA Card with 1MB
- 14" Non-interlaced .28dp Color Monitor (VESA Standard for Flicker-free Display)
- 2 Serial, 1 Parallel & 1 Game Ports
- Enhanced 101-key Keyboard
- Hi-Resolution 400 DPI Serial Mouse
- Free MS-DOS 5.0 & Windows 3.0

**\$1775**

## 486/33 MHz SVGA

- 256K High Speed Cache
- 4 MB RAM (70ns)
- 1.2 MB & 1.44 MB Floppy Drive
- 130 MB 15ms IDE 64K Cache Drive
- 16-Bit 1024x768 SVGA Card with 1MB
- 14" Non-interlaced .28dp Color Monitor (VESA Standard for Flicker-free Display)
- 2 Serial, 1 Parallel & 1 Game Ports
- Enhanced 101-key Keyboard
- Hi-Resolution 400 DPI Serial Mouse
- Free MS-DOS 5.0 & Windows 3.0

**\$2095**

## 386/33 MHz SVGA

- 128K High Speed Cache
- 4 MB RAM (70ns)
- 1.2 MB & 1.44 MB Floppy Drive
- 130 MB 15ms IDE 64K Cache Drive
- 16-Bit 1024x768 SVGA Card with 1MB
- 14" Non-interlaced .28dp Color Monitor (VESA Standard for Flicker-free Display)
- 2 Serial, 1 Parallel & 1 Game Ports
- Enhanced 101-key Keyboard
- Hi-Resolution 400 DPI Serial Mouse
- Free MS-DOS 5.0 & Windows 3.0

**\$1725**

## 386/25 MHz SVGA

- 4 MB RAM (70ns)
- 1.2 MB & 1.44 MB Floppy Drive
- 85 MB 15ms IDE 32K Cache Drive
- 16-Bit 1024x768 SVGA Card with 1MB
- 14" Non-interlaced .28dp Color Monitor (VESA Standard for Flicker-free Display)
- 2 Serial, 1 Parallel & 1 Game Ports
- Enhanced 101-key Keyboard
- Hi-Resolution 400 DPI Serial Mouse
- Free Microsoft DOS 5.0
- Free Microsoft Windows 3.0

**\$1545**

## 386/25 MHz SX

- 2 MB RAM (70ns)
- 1.2 MB & 1.44 MB Floppy Drive
- 52 MB 15ms IDE 64K Cache Drive
- 16-Bit 1024x768 SVGA Card with 1MB
- 14" Non-interlaced .28dp Color Monitor (VESA Standard for Flicker-free Display)
- 2 Serial, 1 Parallel & 1 Game Ports
- Enhanced 101-key Keyboard
- Hi-Resolution 400 DPI Serial Mouse
- Free MS-DOS 5.0 & Windows 3.0

**\$1295**

**1.800.969.2123**



**COMTRADE**


"Where Quality Is Everything"

1016-B Lawson St • City of Industry • CA 91748  
Fax: 818.964.2492 • Tel: 818.964.6688

Circle 181 on Inquiry Card (RESELLERS: 182).

# We've got you covered at Data Hut.

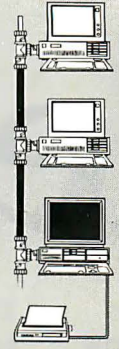
Here's six of our 5000 products.



**Ethernet Cards:** Most companies make an average Ethernet adapter. But, for superior quality, reliability, and performance, all you have to do is choose Gateway.

Our award-winning G/Ethernet and G/EtherTwist LAN adapters give you the widest selection of adapters, the most complete line of operating system drivers, and more. All at the best price.

Gateway also supplies the perfect G/EtherTwist hubs for any application—Whether it's coax, UTP or Fiber Optic, 8 Port to 22 Port, with management.



**\$CALL**

**PC MAGAZINE EDITORS' CHOICE**

We carry all of the Gateway products!

## Flashdrive Parallels

**Flashdrive Parallel AC Only Hard Drive:** The Flashdrive Parallel Hard Drives offer an easy way for you to add a hard drive through the parallel port to any laptop, notebook, PC/AT Desktop and PS/2 Computer. So compact and portable, you will take the flashdrive anywhere the laptop goes. Best of all is the low low price of this top seller! Measures: 9.5"L X 6" X 2.5"H 23 MS Access.

**Flashdrive Parallel Battery/AC Power Hard Drive:** The flashdrive battery version includes Nicad Batteries with an average of 4-6 hours of battery time, in a package that weighs only a pound and a half. Measures 5"W X 5.25L X 1.5"H. Total Package 150KB transfer rate 19MS access time. Comes in 20, 40, 60, 80, 120, 204, or 340MB. Access times vary from 15MS to 23MS.

**\$CALL**

## adaptec

**Fast Data Transfer Rates:**

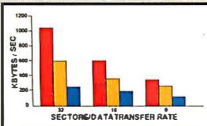
- 33 MBytes/sec on the EISA bus
- 10 MBytes/sec synch. Fast SCSI data rate
- 5 MBytes/sec synch. SCSI data rate
- 2 MBytes/sec async. SCSI data rate

**\$959**

**The EISA SCSI Master**

Complete High-Performance EISA SCSI Host Adapter Kit - Featuring the AHA-1740 32-bit EISA-to-Fast SCSI Intelligent Bus Master Host Adapter

**Also Includes:** ASW-1410 DOS Software Manager allowing support for up to seven SCSI devices • ASW-1440 Novell NetWare 286 and 386 Software Manager • ASW-1420 OS/2 Software Manager • ASW-C174 Configuration Software File with Installation Guide • Full support in SCO XENIX, SCO UNIX, and ISC UNIX • Internal SCSI ribbon cable • Software Information Card • Product Registration Card



DSK31.NLM, Novell Netware 386, Intel486/33 MHz, WREN VII AHA-1740 Utilizing operating system Cache EISA Caching Host Adapter Utilizing Onboard Cache Red-AHA-1740/Enhanced Mode Yellow-AHA-1740/Standard Mode Blue-EISA Caching Host Adapter



## SyQuest

**Ideal for applications requiring:**

- High Performance
- Data Transportability
- Data Security
- Privacy of Data Files
- Fast Backup
- Fast Retrieval of Archival Data
- Unlimited Capacity
- Unlimited Off-Line Storage

**Black or Beige**

**\$499**

**5.25-inch High Performance Removable Cartridge Disk Drive - Migration Between Systems and Platforms Made Easy**

**Key Features:** Removable 44 MByte Formatted Cartridge Media • Industry Standard Half-Height 5.25-inch Form Factor • 20 Millisecond Average Seek • Data Transfer Rate of up to 1.25 Megabytes per second • Fully Embedded SCSI Controller • 8K Buffer • 1:1 Interleave • Self-Diagnostics at Power Up • Transparent Defect Management with Track and Sector Sparring • Automatic Error Correction and Retires • Field Proven Reliability of 30,000 Hour MTBF

**Optional:** Host Bus Adaptor for IBM PC XT/AT BUS. I/O Device Driver Software Recognizes and Manages Cartridge Interchange.

## MAXOPTIX TAHITI® FAMILY

**1-gigabyte Erasable Optical Disk Drive with SCSI Controller.** Tahiti 1 is an erasable optical disc drive with performance characteristics equal to magnetic disk drive technology. It offers seek times faster than that of traditional removable disk pack drives; and in most cases, higher capacity. Using a unique split optics mechanism, the Tahiti 1 can achieve 25 to 35 msec average seek time over 325 megabytes of a single side, high capacity 1 gigabyte cartridge or ANSI/ISO standard 650 megabyte cartridge, respectively. The 1 gigabyte cartridge can provide up to 500 megabytes of capacity per side. The Tahiti 1 optical disk drive features an embedded SCSI controller within a 5.25 inch form factor, permitting installation in high performance personal computers and work stations.



External Kit -  
Everything You Need

**\$8,900**

## Maxtor®

**The Maxtor Panther® 1 SCSI Family**

.8, 1.2 and 1.7 Gigabyte - 5.25 inch Magnetic Disk Drive w/ SCSI-2 Command Set & 100,000 Hour MTBF.

Offering a low SCSI command overhead of <500 usec, synchronous data transfers of 5 Mbytes/sec, and a differential interface option. The Panther 1 SCSI family of drives sets a new level of SCSI capability, with significant systems performance advantages, including more I/O per second at lower service request times. In the systems environment, Panther 1 SCSI disk drives provide faster job processing, faster terminal response time and a wider range of new application possibilities.

1.2G **\$2,999**

1.7G **\$4,499**

- No surcharge on credit
- COD & Purchase Orders Accepted
- All Pricing & Availability subject to change without notice
- #6 North Ct. St., Owingsville, KY 40360
- Hours: M-Sat 9AM - 8PM EST
- FAX 606-674-3917
- LOCAL 606-674-3916



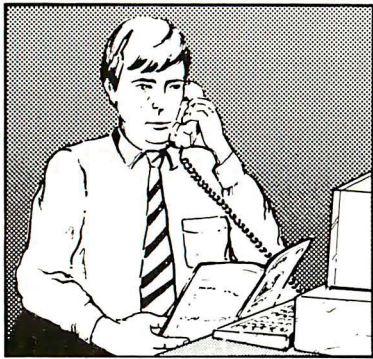
# 1-800-487-3488

**We Carry Over 5000 Products • Free Technical Support  
Risk Free 30 Day Money Back Guarantee**



Buy with

# Confidence



In an effort to make your telephone purchasing a more successful and pleasurable activity, The Microcomputer Marketing Council of the Direct Marketing Association, Inc. offers this advice, "A knowledgeable buyer will be a successful buyer." These are specific facts you should know about the prospective seller before placing an order:

## Ask These Important Questions

- How long has the company been in business?
- Does the company offer technical assistance?
- Is there a service facility?
- Are manufacturer's warranties handled through the company?
- Does the seller have formal return and refund policies?
- Is there an additional charge for use of credit cards?
- Are credit card charges held until time of shipment?
- What are shipping costs for items ordered?

Reputable computer dealers will answer all these questions to your satisfaction. Don't settle for less when buying your computer hardware, software, peripherals and supplies.

## Purchasing Guidelines

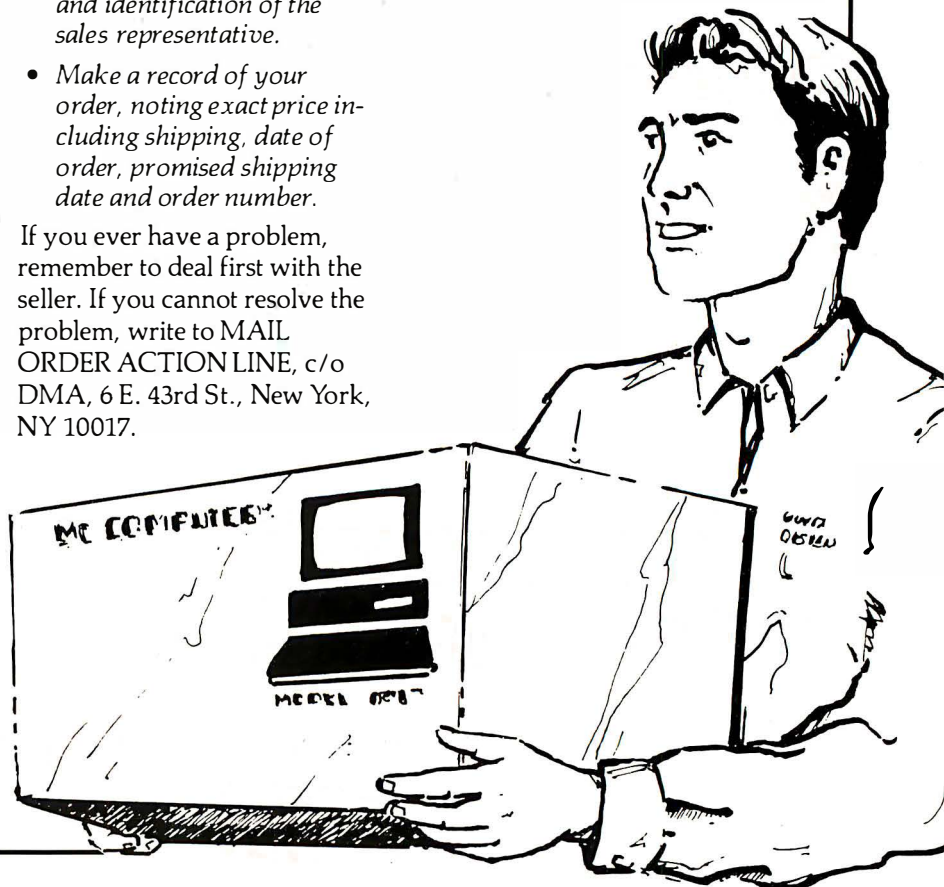
- State as completely and accurately as you can what merchandise you want including brand name, model number, catalog number.
- Establish that the item is in stock and confirm shipping date.
- Confirm that the price is as advertised.
- Obtain an order number and identification of the sales representative.
- Make a record of your order, noting exact price including shipping, date of order, promised shipping date and order number.

If you ever have a problem, remember to deal first with the seller. If you cannot resolve the problem, write to MAIL ORDER ACTION LINE, c/o DMA, 6 E. 43rd St., New York, NY 10017.

This message is brought to you by:

the MICROCOMPUTER  
MARKETING COUNCIL  
of the Direct Marketing  
Association, Inc.  
6 E. 43rd St.,  
New York, NY 10017

**MMC**  
MICROCOMPUTER  
MARKETING COUNCIL  
of the Direct Marketing Association, Inc.



# ONE OF THE BEST OEM SYSTEM MANUFACTURERS IN THE USA

## ABTECH 450 BLACK

### COMPLETE BLACK SYSTEM

- 486/50 Mhz Motherboard
- 256K Cache
- 486/50 Mhz CPU
- 8 MB RAM on board exp. to 64MB
- 1.2 (5.25") and 1.44 (3.5") MB FD
- 200 MB SCSI HD
- ADPTEC SCSI FD/HD Controller
- Medium Black Tower Case 230 W. P/S
- Enhanced Black Keyboard
- SVGA Display Card 1024 x 768 w/1 MB RAM
- Black 1024 x 768 PROTON Monitor

»\$3,699«

made in the  
USA  
made in the

Black Monitor by **PROTON™**  
WORLD LEADING MANUFACTURER  
OF HIGH QUALITY T.V. AND MONITORS



The sign of  
excellence in  
performance  
and quality



The  
assurance  
of quality  
components  
in each  
ABTECH  
system



The  
assurance  
of support  
and service



### Other Systems

#### STANDARD CONFIGURATION

- 486/33 Mhz \$1,299
  - 386/25 Mhz \$ 899
  - 386/25 Mhz \$ 799
  - 386SX/20 Mhz \$ 699
- Motherboard
  - AMI BIOS/ Intel CPU
  - 4MB RAM
  - 1.2 MB FD (5.25")
  - 1.44 MB FD (3.5")
  - IDE Ctrl. w/2serial,1 parallel,1 game
  - Desktop Case w/200W P.S.
  - 101 Enhanced Keyboard

### Hard Drives

- 40 MB IDE HD \$189
- 80 MB IDE HD \$299
- 120 MB IDE HD \$379
- 200 MB IDE HD \$579
- 345 MB ESDI \$1,499
- 760 MB ESDI \$1,799
- 1.2 GB ESDI \$2,899
- Internal CD-ROM \$399
- 120MB Tape back up \$269
- 250MB Tape back up \$329

### ◆ OPTIONS ◆

Add to above configuration

CUSTOM  
CONFIGURATION  
AVAILABLE  
ON ANY SYSTEM

### Monitors w/video card

- 12" Amber display monitor \$79
- 14" Amber display monitor \$119
- 14" B&W display monitor \$119
- 14" Mono VGA monitor \$169
- 14" SVGA color monitor (1024x768) \$389
- 14" SVGA non-interlaced monitor \$469
- Call for 20" Monitors pricing
- 14" PROTON Black SVGA color monitor \$469
- Med. Tower Case w/ Power supply add \$25
- Full Size Tower Case w/ Power supply add \$45
- Med. Black Tower Case w/Power supply add \$65

Free for all  
Corporate  
Accounts



### SERVICES:

1. Complete UNIX System turn key and consulting
2. Complete healthcare turn key and consulting
3. Worldwide delivery of computer system and hard drive by DHL.
4. OEM and distributors welcome.

Our trained  
technicians  
can provide  
solutions



### ABTECH 386SX/16 Notebook



\$1,899

Dual Battery (7 hrs.)◆2MB RAM ~ to  
8MB◆40MB HD (60MB option)◆VGA  
LCD/64 gray scales◆Interchange  
modules ~Fax/modem, voicemail,  
scanner etc.. 386/25 & 386/33 available.

### '91 Buyer's Guide



Byte Outlook 92  
Computer Buying World  
Computer Shopper

Solbourne  
Sparc  
Station  
Authorized  
Dealer



818.575.0007

24 HOURS

FAX

818.575.1500



**ABTECH**

INCORPORATED

1431 N. Potrero Ave. Unit B.  
S. El Monte, CA 91733  
USA

### International Liaisons

ABTECH Argentina  
Buenos Aires, Argentina  
Tel: 783.2266  
Fax: 782.6890

ABSTRACT Technology  
Burcrest, Romania  
Tel: 104273  
Fax: 120581

ABTECH Brazil  
São Paulo, Brazil  
Tel: 212.2559

ABTECH China  
Beijing, China

©1991 ABTECH Inc. The brands or names mentioned are trademarks of their respective companies. ABTECH and its logo is a trademark of ABTECH Inc. Shipping, handling and applicable taxes are excluded in prices. Prices are subject to change. The usage of credit cards are subject to surcharge. 30 days money back guarantee.

## Sending Your Computer to Medical School ..... Helps You Stay Healthy!

Is that indigestion ... or a heart attack? **Doctor Schueler's Home Medical Advisor** gives you an enormous amount of accurate medical information with a few keystrokes. Developed by Board Certified Emergency Physicians and currently used in doctors' offices.

The **Symptom File's** question and answer format generates over 600 illustrations and 450 diagnoses.

The **Disease File** gives info about the symptoms and treatment of over 450 diseases. Know EXACTLY which specialist treats your problem.

Learn how to treat over 130 injuries with the **Injury File**, everything from frostbite to ankle sprains.

Identify and learn the side effects of over 800 prescription and over-the-counter drugs with the **Drug File**.

Included are a **Test File** of medical tests and a **Poison File** listing household ingestions—great for mothers with toddlers. Registered users will be eligible for updates at a cost of five dollars, so YOUR medical encyclopedia NEVER goes out of date. Call now. This indispensable reference tool prints medical information for family and friends and makes learning FUN!

Manufacturer's suggested price: \$99.95

Introductory offer: **\$69.95** 512K RAM EGA/VGA

Same Day Shipping!

IBM & Compat.



See your software dealer or call **1-800-788-2099**

**PIXEL PERFECT, INC.**

10460 S. Tropical Tr., Merritt Island, FL 32952



## ALL IN ONE

# Fax, Scanner, Printer, Copier

WHAT-YOU-PRINT-WHAT-YOU-FAX

**SEND** faxes directly from any Windows application in the same format as if you would print it to LaserJet printer .

**RECEIVE** faxes as files and print them to your LaserJet printer.

**SCAN** full page documents, and save them as PCX, TIFF, MSP or DCX files .

**COPY** documents on plain paper via LaserJet or directly on fax paper.

Or turn off your PC and use ETFAX7 as a

**STAND-ALONE FAX MACHINE**



# \$595

**COMPEX INTERNATIONAL INC.**

312 Broadway Street Cambridge, MA 02139 USA

(617)354-5045, FAX (617)864-9516

AMEX, VISA, MASTER CARD, DINERS

## 1-800-626-8112

Or call **Get-a-Fax** at 617-354-1133 from your fax machine, and ask for document # 3011



# Protects While You Type!

SafeSkin® is the finest  
keyboard protector  
in today's  
marketplace.

## Compare these unequalled features:

- Remains in place while you use your computer
- Prevents and repairs and protects delicate keyboards from dust, spills, smoke, ashes, staples.
- Wrap around design gives full keyboard protection.
- Anti-glare finish reduces eyestrain.
- Soft, flexible, retains normal keyboard feel.
- Durable, washable high-tech polymer lasts for years.
- More than 800 models. Available for most PC's, laptops, workstations and clone keyboards.

**SafeSkin®**  
KEYBOARD PROTECTOR

Circle 169 on Inquiry Card (RESELLERS: 170).

**Merritt**  
COMPUTER PRODUCTS

Dealer and OEM inquiries invited.

In the USA contact: Merritt Computer Products; 5565 Red Bird Center Dr., Ste 150; Dallas, TX 75237; Tel. 214/339-0753; Fax 214/339-0753.  
In Europe contact: DEAL B.V.; Van Berckelweg 36; P. O. Box 208; 2200 AE Noordwijk ZH; Holland; Tel. 31-1719-41133; Fax 31-1719-46225.

## "ARTEC Products"

saving the money  
& time for you

★ The "SCAN KIT PPD"  
option for notebook PC  
use scanner.

See us at:  
Cebit '92  
March 11~18  
Booth No: Hall 8  
1.0G F27/2



- ARTEC PRODUCT LINE**
- Flatbed Color Scanner .....A4000C
  - Hand-Held color Scanner ....A256S
  - Hand-Held OCR B/W Scanner ....A400Z
  - Serial Mouse .....AM30, AM25, AM24S, AM22, AM28
  - Optical Serial Mouse .....A20DLX
  - Bus Mouse: ATARI, COMMODORE/AMIGA, NEC/EPSON, MICROSOFT Mouse compatible.....AM29

### ULTIMA ELECTRONICS CORP.

**MAIN OFFICE**  
9F, NO. 18, ALLEY 1, LANE 768, SEC. 4, PA TE ROAD, TAIPEI, TAIWAN, R.O.C. TEL: 886-2-7885470 (REP.) FAX: 886-2-7885657, 7885655

**USA BRANCH**  
1156 ASTER AVENUE, SUITE A, SUNNYVALE, CA 94087, U.S.A. TEL: 408-246-9208 FAX: 408-246-9207

### Circle 177 on Inquiry Card (RESELLERS: 178).

**DENMARK**  
UNIPRO SCANDINAVIA BIRKEMOSEVEJ 32, 8361 HASSELAGER, DENMARK TEL: 4586286366 FAX: 4586286870

**HOLLAND**  
SOECOMA COMPUTERS NED. BV DOMMELSTRAAT, ZUID 23-25 5503-NA VELDHOVEN THE NETHERLANDS. TEL: 31-40-533515 FAX: 31-40-544535

**HUNGARY**  
HUMAN soft Ele tronics Ltd. 11-1149 Budapest, Angolu, 24/b HUNGARY TEL: 361-183 3930 FAX: 361-18311789

**GERMANY**  
ELITO ELECTRONIC GMBH NUMBERGER STR. 41 8570 PEGNITZ/OFR. GERMANY TEL: 09241/5065 FAX: 09241/1508

**GERMANY**  
R + P SUPERWAVE ELECTRONIC GMBH M. VON RICHTHOFEN STR. 15, 1000 BERLIN 42 TEL: 030-788-040 FAX: 030-786-4147 TLX: 181419 BURYA R + P COMPUTER GMBH QUERSTUCKEN 3A, 2000 NORDERSTEDT, TEL: 040-524-50-38 FAX: 040-524-29-01

All brand names and registered trademarks are the property of their owners.

# AMT INTERNATIONAL

(408) 432-0552 • (408) 432-1790

**LOWEST PRICES**  
**SAME DAY SHIPPING**  
**Fax: (408) 944-9801**

#### COMPAQ MEMORY

**DeskPro 286-E, 386-20/20E/25**

- 1MB 113131-001 .....\$125.00
- 4MB 113132-001 .....\$330.00

**DeskPro 286N, 386N and 386SX**

- 2MB 118689-001 .....\$200.00
- 4MB 118690-001 .....\$545.00

**DeskPro 386S**

- 1MB 113646-001 .....\$125.00
- 4MB 112534-001 .....\$315.00

**DeskPro 386-33, 486-33 & SystemPro**

- 2MB 115144-001 .....\$200.00

#### AST MEMORY

**Bravo-288, Workstation**

- 512K Kit500510-010 .....\$59.00
- 2MB Kit500510-002 .....\$150.00

**Premium 386-16/20C**

- 1MB Kit500510-007 .....\$95.00
- 4MB Kit500510-008 .....\$275.00

**Premium 386-20**

- 1MB Kit500510-003 .....\$150.00
- 4MB Kit500510-004 .....\$350.00

**Bravo-386SX**

- 4MB Kit500510-008 .....\$369.00

**Premium 386-SX/25/33 & 486-25**

- 1MB 500718-002 .....\$80.00

#### HEWLETT-PACKARD MEMORY

**Vectra QS/16S**

- 1MB D1540A .....\$112.00
- 4MB D1542A .....\$325.00

**Vectra QS/20PC, RS/25PC and 20C**

- 1MB D1640A .....\$126.00
- 4MB D1642A .....\$365.00

**Vectra 486PC**

- 1MB D2150A .....\$115.00
- 4MB D2151A .....\$390.00

#### IBM PS/2 MEMORY

**Models 30-286, Exp. Board 1497259**

- 512 K Kit 30F534B .....\$54.00
- 2MB Kit 30F5360 .....\$175.00

**Models 70-E81/121, 55SX, 65SX**

- 1MB 6450603 .....\$95.00
- 2MB 6450604 .....\$179.00

**Models 55SX, 65SX, 34F3077 & 34F3011**

- 4MB 34F2933 .....\$370.00

**Models 70-A21**

- 2MB 6450608 .....\$150.00

**Models 80-141**

- 1MB 6450375 .....\$145.00

**Models 80-111/1311**

- 2MB 6450379 .....\$220.00

**All Models 70 and 80**

- 2-8MB w/2M 6450605 .....\$489.00
- 2-14MB w/2M 34F3077 .....\$500.00
- 2-16MB w/4M 34F3077 .....\$925.00

**Models 50, 50Z, 55 SX & 60**

- 2-8MB 1497259 .....\$599.00

#### LASER PRINTER MEMORY

**Hewlett-Packard Laser Jet IIP, III & IID**

- 1MB 33474B .....\$110.00

**2MB 33475B .....\$150.00**

**4MB 33477B .....\$215.00**

**Hewlett-Packard Laser Jet IIP & IID**

- 1MB 33443B .....\$110.00
- 2MB 33444B .....\$150.00
- 4MB 33445B .....\$215.00

**IBM Laser 4019 and 4019e**

- 2MB 1039137 .....\$369.00
- 3.5MB 1038675 .....\$469.00

**Canon LBP-8II, 8IIR, 8IIT**

- 2MB S63-1880 .....\$225.00
- 4MB Part #VA .....\$439.00

#### LAPTOP AND PORTABLE MEMORY

**TOSHIBA MEMORY**

- 1MB Model 1000SE/XE .....\$265.00
- 2MB Model 1000SE/XE .....\$325.00
- 2MB Model T1200XE .....\$230.00
- 2MB Model T1600 .....\$230.00
- 2MB Model T3100E .....\$175.00
- 2MB Model T3100SX .....\$175.00
- 4MB Model T3100SX .....\$395.00
- 4MB Model T3200SX .....\$175.00
- 2MB Model 5100 .....\$215.00
- 2MB Model T5200,T8500 .....\$185.00
- 8MB Model T5200,T8500 .....\$950.00

**ZENITH MEMORY**

- 1MB SuperSport 286 & 286ES199.00
- 2MB SuperSport 286 & 286E \$350.00
- 2MB SuperSport SX/Alpha .....\$350.00
- 4MB SuperSport SX/Beta .....\$350.00

#### COMPAQ MEMORY

- 1MB Portable LTE 286 .....\$175.00
- 2MB Portable LTE 286 .....\$225.00
- 1MB SLT-286 .....\$225.00
- 4MB SLT-286 .....\$775.00

#### NEC MEMORY

- 1MB Prospeed 286 .....\$270.00
- 2MB Prospeed 386 .....\$450.00

#### ZENITH MEMORY

**Zenith Z-386/20/25/33 & 33E**

- 1MB ZA36/3800ME .....\$100.00
- 4MB ZA3800MK .....\$525.00

**Zenith Z-386/20/25 & 33**

- 2MB ZA3600MG .....\$199.00

**Zenith Z-386 SX**

- 2MB Z-605-1 .....\$225.00

#### MATH COPROCESSORS

**INTEL**

- 8087-5 MHz .....\$70.00
- 8087-2 8MHz .....\$70.00
- 8087-1 10MHz .....\$135.00
- 80287-6 6MHz .....\$79.00
- 80287-8 8MHz .....\$79.00
- 80287XL 8/10MHz .....\$89.00
- 80287XTL 12MHz (Laptop) .....\$99.00
- 80287-10 10MHz .....\$89.00
- 80C287-12 12MHz .....\$109.00
- 80387SX-16 .....\$129.00
- 80387SX-20 .....\$135.00
- 80387DX-20 .....\$140.00
- 80387DX-25 .....\$185.00
- 80387DX-30 .....\$195.00

**80387DX-33 .....\$195.00**

#### WEITEK

- 3167-20 20MHz .....\$300.00
- 3167-25 25MHz .....\$450.00
- 3167-33 33MHz .....\$500.00
- 4167-25MHz .....\$600.00
- 4167-33MHz .....\$700.00

#### CYRIX

- 8C87-8 .....\$59.00
- 8C287-10 .....\$75.00
- 8C287-12 .....\$85.00
- 8C287-20 .....\$85.00
- 8C387-20 .....\$155.00
- 8C387-25 .....\$158.00
- 8C387-33 .....\$175.00

#### IIT

- 8C87-8 .....\$69.00
- 8C287-10 .....\$79.00
- 8C287-12 .....\$89.00
- 8C287-20 .....\$89.00
- 8C387-20 .....\$175.00
- 8C387-25 .....\$175.00
- 8C387-33 .....\$200.00

#### AMD

- 80C287-10 .....\$89.00
- 80C287-12 .....\$110.00

#### SIMM MODULES

**IBM TYPE**  
Add \$2.00 for SIPP

- 4Mx9-80 .....\$145.00
- 4Mx9-70 .....\$145.00
- 1Mx9-60 .....\$40.00
- 1Mx9-10 .....\$40.00
- 1Mx9-80 .....\$40.00
- 1Mx9-70 .....\$40.00
- 256x9-70 .....\$12.00
- 256x9-10 .....\$12.00
- 256x9-80 .....\$11.00
- 256x9-60 .....\$12.00

#### APPLE-MAC

- 1Mx8-70 .....\$50.00
- 1Mx8-10 .....\$40.00
- 1Mx8-80 .....\$45.00
- 4x8-80 .....\$190.00

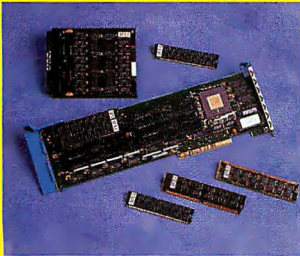
**2393 QUME DRIVE,  
SAN JOSE, CA 95131**

#### DRAM - DRAM - DRAM

DRAM 1MGX1	DRAM 64X1	DRAM 64X4	DRAM 256X4	AAA 2800-08
1 MGX1-120NS .....\$5.00	4164-150 .....\$2.00	4464-15 .....\$1.50	256X4-120NS .....\$5.00	AAA 2800-07 .....\$3.25
1 MGX1-100NX .....\$5.25	4164-120 .....2.50	4464-12 .....1.99	256X4-100NS .....2.00	AAA 2800-60 .....4.50
1 MGX1-80NX .....\$5.50	4164-100 .....2.75	4464-10 .....2.50	256X4-80NS .....2.25	1X4-80 ZIPP .....35.00
1 MGX1-70NX .....\$7.75	4164-80 .....3.00	4464-8 .....2.50	256X1-70NS .....2.35	256X1-STATIC COL 1X4-80STT ZIPP .....39.00
1 MGX1-60NX .....7.50		256X1-150NS .....\$1.79	256X1-60NS .....\$3.99	1X4-70STT ZIPP .....39.00

# It's not only the memory that makes the difference, it's "The Source!"

## IBM MEMORY

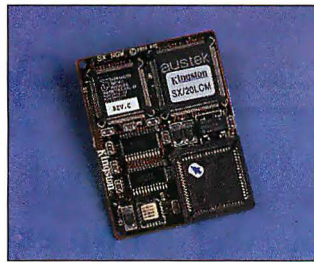


PS/1	2MB	IBM PN N/A	\$119
PS/2 30/286, 1497259	2MB Kit	30F5360	\$109
PS/2 35SX,LS,40SX,50Z,55SX,LS,65SX,LS,70	1MB	6450603	\$59
	2MB	6450604	\$119
PS/2 70-A21;A61;821;861	2MB	6450608	\$129
PS/2 35SX,LS,40SX,55SX,LS,65SX,LS,34F30XX	4MB	34F2933	\$269
PS/2 35SX; LS, 40SX	8MB	6450129	\$589
PS/2 57SX, 90, 95	8MB	6450130	\$509
PS/2 80-141	1MB	6450375	\$79
PS/280-111/311	2MB	6450379	\$139
PS/290,95 and P75 (Install in pairs)	2MB	6450902	\$119
	4MB	6450128	\$209
Expansion boards for all models 50 and 60			
	2-8MB w/2MB	1497259	\$319
	2-16MB w/2M	6450609	\$339
Expansion boards for all models 70 and 80			
	2-14MB w/2M	34F3077	\$349
	4-16MB w/4M	34F3011	\$459

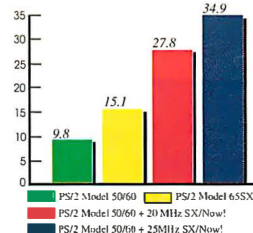
## SX/NOW! PROCESSOR UPGRADE

Kingston Technology Corp.'s SX-Now! is the undisputed performance champ.

-PC Magazine October 29, 1991



Landmark Speed Test (1.1)



Don't replace your system... Upgrade your 286 to a 386SX with Kingston's SX/Now!

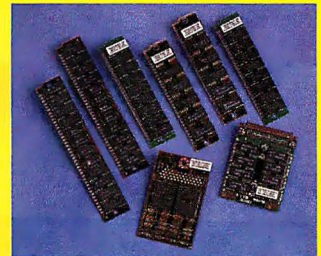
- SX/Now! 80386SX Processor features:**
- Available in 20 or 25MHz
  - 16 Kbytes of Cache Memory
  - Onboard High Speed Clock
  - Requires No Expansion Slot
  - 80387SX Co-Processor Socket
  - 5-Year Warranty
- Now available for:**
- IBM PS/2 25/286, 30/286, 50, 50Z, 60
  - Original IBM AT
  - AST Premium 286 and Bravo 286
  - Hewlett-Packard ES286/12

SX/Now! provides true multitasking and background operation for Windows 3.0, OS/2, and 386 specific software. Improves system performance up to 350%!

- SX/Now! 20MHz Accelerator** ..... \$439
- SX/Now! 25MHz Accelerator** ..... \$539



## LAPTOP MEMORY



<b>AST</b>	
Executive Notebook	1MB ..... \$79
	4MB ..... \$219
<b>COMPAQ</b>	
Portable LTE386S/20	1MB ..... \$179
	4MB ..... \$379
Portable LTE 286	1MB ..... \$89
	4MB ..... \$219
SLT-286	1MB ..... \$129
	4MB ..... \$449
SLT-386	1MB ..... \$129
	4MB ..... \$399
<b>IBM</b>	
L40SX laptop	2MB ..... \$129
	4MB ..... \$219
	8MB ..... \$449
<b>TOSHIBA</b>	
T1000SE/LE/XE, T2000SX	2MB ..... \$229
	4MB ..... \$359
T1000LE, T2000SX	8MB ..... \$789
	2MB ..... \$229
	4MB ..... \$359
	8MB ..... \$789
T1200XE, T1600, T3100E	2MB ..... \$129
	2MB ..... \$129
T3100SX, T3200SX, SXC	4MB ..... \$229
	3MB ..... \$229
	2MB ..... \$129
	2MB ..... \$129
	2MB ..... \$129
	8MB ..... \$469
<b>NEC</b>	
Powermate Port. SX	2MB ..... \$399
	8MB ..... \$1399
ProSpeed 286, 386SX16	1MB ..... \$129
	4MB ..... \$399
ProSpeed SX20	1MB ..... \$159
	4MB ..... \$449
<b>ZENITH</b>	
MastersPort SL	2MB ..... \$209
MastersPort 386SX	2MB ..... \$209
S.S. SX, 286E, SilmsPort	2MB ..... \$169
SuperSport SX	2MB ..... \$169
SuperSport 286, 286E	1MB Kit ..... \$119
SuperSport 286E, SilmsPort	4MB ..... \$449
TurboSport 386, 386E	1MB ..... \$169

## NEC MEMORY

<b>Powermate SX</b>	
2MB Brd.	APC-H855 ..... \$499
4MB Brd.	APC-H853 ..... \$729
<b>Powermate SX Plus</b>	
1-2MB Brd.	APC-H850E ..... \$239
4-8MB Brd.	APC-852E ..... \$629
<b>Powermate SX/20</b>	
2MB CPU	OP-410-8101 ..... \$199
2MB Brd.	OP-410-8102 ..... \$239
<b>Powermate 386/20</b>	
2MB	APC-H655E ..... \$359
<b>Powermate 386/25</b>	
2MB	APC-H655X ..... \$359
<b>Powermate 386/25S</b>	
2MB Kit	OP-410-5201 ..... \$199

## HP MEMORY

<b>Vectra GS/16S; 20PC, RS/20PC; 25PC, 20C</b>	
1MB Kit	D1540/1640A ..... \$69
4MB Kit	D1542/1642A ..... \$199
<b>Vectra 386/16N, 386/20N</b>	
2MB	D2406A ..... \$159
8MB	D2404A ..... \$609
<b>Vectra 486 PC (Install in Pairs)</b>	
1MB	D2150A ..... \$69
4MB	D2151A ..... \$299
<b>Vectra 386/25, 486/25T, 33T (Install in Pairs)</b>	
2MB	D2381A ..... \$129
<b>Vectra 486PC and 386/25 PC</b>	
8MB	D2152A ..... \$549

## PRINTER MEMORY

<b>Hewlett-Packard LaserJet IIP, IIIP, IIID</b>	
2MB	33475B ..... \$125
4MB	33477B ..... \$199
<b>Hewlett-Packard LaserJet II and IID</b>	
2MB	33444B ..... \$125
4MB	33445B ..... \$199
<b>Hewlett-Packard DeskJet 500 and Plus</b>	
256K	22707B ..... \$99
<b>IBM Laser 4019 and 4019e</b>	
2MB	1039137 ..... \$149
3.5MB	1038675 ..... \$219
<b>IBM Laser 4029 All Models</b>	
2MB	1183334 ..... \$179
4MB	1183335 ..... \$359
<b>Canon LBP-4</b>	
2MB	PN N/A ..... \$249
<b>Brother HL-8, BE</b>	
2MB	MB-820 ..... \$199
<b>Panasonic 4450I and 4420</b>	
2MB	KX-P441 ..... \$149
4MB	PN N/A ..... \$239
<b>Toshiba Page Laser 6</b>	
4MB	LS6-NB0100 ..... \$219
<b>Okilaser 400</b>	
1MB	70014701 ..... \$99
2MB	OKI PN N/A ..... \$129
<b>Texas Instruments MicroLaser and XL</b>	
1MB	2555739-0001 ..... \$79
<b>Epson EPL 6000</b>	
2MB	IBS401 ..... \$149

## COMPAQ MEMORY

<b>DeskPro 386-20, 20E and 25</b>	
1MB	113131-001 ..... \$89
4MB	113132-001 ..... \$219
<b>DeskPro 386S/16</b>	
1MB	113646-001 ..... \$89
4MB	112534-001 ..... \$219
<b>DeskPro 286N, 386N and 386SX/20</b>	
1MB	118688-001 ..... \$69
2MB	118689-001 ..... \$119
4MB	118690-001 ..... \$269
<b>DeskPro 386-33, 486-33 and SystemPro</b>	
OK Board	116569-001 ..... \$129
2MB	115144-001 ..... \$229
8MB	116561-001 ..... \$419
<b>DeskPro 386-20e and 25e</b>	
1MB Board	113644-001 ..... \$139
4MB Board	113645-001 ..... \$309
<b>DeskPro 386S</b>	
1MB Board	113633-001 ..... \$139
4MB Board	113634-001 ..... \$329

## AST MEMORY

<b>Premium 386C, 386-16</b>	
4MB Kit	500510-008 ..... \$189
<b>Premium 386, 386-20</b>	
4MB Kit	500510-004 ..... \$249
<b>Bravo 386-SX, WS/286, 386</b>	
2MB Kit	500510-002 ..... \$99
4MB Kit	500510-008 ..... \$189
8MB Kit	500824-001 ..... \$389
<b>Premium 386/25;33;Premium II 386SX/16;20</b>	
1MB w/WPB	500780-003 ..... \$69
<b>All Premium and Bravo 486 Models</b>	
2MB w/WPB	500718-004 ..... \$129
8MB w/WPB	500780-001 ..... \$459
<b>Premium II 386SX/20 and 386SX/16</b>	
4MB w/WPB	500780-004 ..... \$229

## SIMM / DRAM

<b>SIMMS AND SIPPS</b>		<b>DRAM CHIPS</b>	
4MX9-80	\$169	1X1-80	\$4.50
1MX9-80	\$48	256X4-80	\$5.00
256X9-80	\$15	256X1-80	\$1.80

## ZENITH MEMORY

<b>Zenith 486/33ET</b>	
4MB Kit	ZA-4200-MZ ..... \$293
16MB Kit	ZA-4200-M8 ..... \$1279
<b>Zenith Z-386/20/25/33 and 33E</b>	
1MB	ZA36/3800ME ..... \$69
4MB	ZA3800MK ..... \$299

## EXPANSION BOARDS

**BocaRam/AT Plus**  
Up to 8MB for any AT or 16 bit compatible machines running up to 33MHz. Offers all types of memory, provides a maximum of 8MB LIM/EMS 4.0.  
2MB with DRAM or SIMM ..... \$199

We also stock memory for Acer, ALR, Apple, Arche Technologies, AT&T, Austin, Bondwell, Chinon, Clizzen, Commodore, CompuAdd, DataWorld, Dell, DTK, Everest, Gateway, GRID, Hyundai, Intel, Leading Edge, Magnavox, Micro Express, Midern, Mips, Mitsubishi, NCR, Next, Northgate, Olivetti, Packard Bell, PC Brand, Paquet, Samsung, Silicon Graphics, Smith Corona, Swan, Tandy, Unisys, Wang, Wyse, Zeos and Others.

### PRICE, QUALITY, AND SUPPORT

• Same Day Shipping • Free Technical Support • Overnight and Saturday Delivery Available • All Products User Installable • No Surcharge on Visa or Mastercard • APO/FPO/International Orders Welcome • Purchase Orders Accepted from Gov't, Universities, and Qualified Firms •



"The Only Source for Computer Memory!"

### DELIVERY GUARANTEED

Follow your package every step of the way with 3 day International delivery via Federal Express, UPS, or DHL. Fast, inexpensive, dependable delivery anywhere in the world! Information in tracking shipments is available at your request.



Outside the U.S.

1-714-588-9866

Business Hours: Monday - Friday 8AM - 5PM

1-800-535-5892

Fax Line

1-714-588-9872

Fax your orders 24 hours a day, 7 days a week!

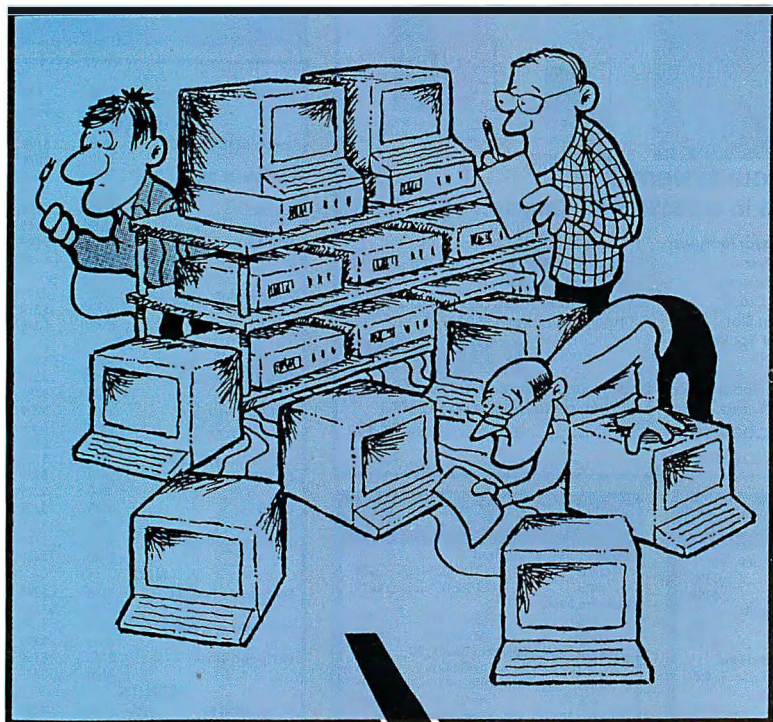
Mail Orders to: FIRST SOURCE INTERNATIONAL, INC. 36 ARGONAUT, STE. 140 ALISO VIEJO, CA 92656

Terms and Conditions: All products are third party and manufacturers' part numbers are for your convenience. All products carry a full manufacturer's warranty. All products are guaranteed 100% compatible at your money back. All freight charges are non-refundable. A 20% restocking fee will be charged on all non-defective returns, unopened, and refused or canceled orders. All items must be returned within 15 days with original documentation and packaging. Returned Merchandise Authorization number is required. Prices and availability are subject to change without notice. Minimum order of \$50. All purchase prices are at the time of order are final. First Source International cannot be responsible for errors in typography or photography. We will be happy to advertise price valid only on identical brands, offer not good for SIMMs or DRAM. All trademarks and registered trademarks are of their respective companies.

# CONTROL UP TO **96** PC FILE SERVERS WITH **1** KEYBOARD AND MONITOR USING...

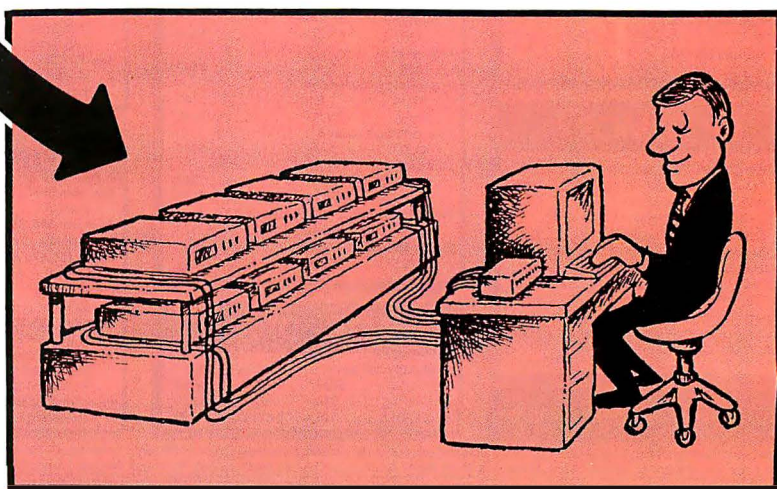
## **COMMANDER**

by cybex



- No external power
- "One-Touch" selection
- Mix PC, PC/XT, PC/AT and PS/2
- "AutoBoot" Feature boots attached computers without operator intervention after power failure
- Shows PC power status
- Mouse support available

- TTL (MDA, CGA, EGA) up to 600 feet away
- VGA up to 400 feet
- Each unit accommodates from 2 to 8 PCs
- Up to 12 units can be cascaded
- Mounting kit available for 19" rack installation



Dealer Program Available

**Cybex Corporation**  
2800 H Bob Wallace Ave.  
Huntsville, Alabama 35805  
(205) 534-0011  
Fax (205) 534-0010

PC, PC/XT, PC/AT and PS/2 are trademarks of International Business Machines Corp.

**You May Recognize Some Of Our Customers...**

- |                                    |                 |
|------------------------------------|-----------------|
| Intel Corporation                  | N.A.S.A.        |
| U.C. Berkeley                      | Washington Post |
| Procter & Gamble                   | AT & T          |
| Digital Equipment Corp.            | M.I.T.          |
| Eastman Kodak                      | DuPont          |
| U.S. Marine Corps                  | Exxon           |
| U.S. Army/Navy                     | Xerox           |
| U.S. Veterans Hospital Admin. Ctr. |                 |
| Lockheed Missile/Space Engineering |                 |
- ...and the list goes on and on...

Dealer Inquiries Welcome.  
Government, Corporate &  
University P.O.'s Welcome!

**FREE ON-SITE**  
Service to most locations.

**Hours:**  
Mon thru Fri - 7:30am to 6:00pm (PST)  
Sat - 10:00am to 4:00pm (PST)

- Prices subject to change without notice.
- Prices reflect 3% cash discount.
- Special GSA and Quantity discounts.
- Trademarks belong to their respective companies.
- Not responsible for typographical errors.
- The Intel Inside Logo is a trademark of Intel Corporation.



We offer Superior products and the best values  
in the Industry at unbeatable prices!

# Intelligent Choices

**Standard System Features:** (\*Unless specified differently in Specials)

- |                             |                                    |   |
|-----------------------------|------------------------------------|---|
| ■ Motherboard - Intel CPU   | ■ Dual IDE HDD/FDD controller      | <b>OPTIONS:</b>   |
| ■ Math co-processor socket  | ■ 2 serial/1 parallel/1 game ports | Mid-Tower ..... add - \$60                                |
| ■ 4MB 70ns RAM on-board     | ■ 101 Keytronics keyboard          | Full-Tower (10-bays, 230W Power Supply) ..... add - \$100 |
| ■ 1.2 and 1.44MB FDDs(Teac) | ■ Desktop case w/200W UL/PS        |   |

**SYSTEMS:** (Prices below do not include Hard disk drive, monitor/card)

- |  |                  |
|--|------------------|
| 486-33 EISA w/64k cache (Micronics MB).....                          | <b>\$1,995</b>   |
| 486-33 ISA w/64k cache (MCI/Symphony) upgradable to 50MHz .....      | <b>\$1,155</b>   |
| 486SX/20 w/64k cache (Symphony) upgradable to 33MHz/50MHz .....      | <b>\$945</b>     |
| 386-33 w/64k cache , (Symphony) upgradable to 40MHz .....            | <b>\$850</b>     |
| 386-25 (Symphony) upgradable to 33MHz/40MHz .....                    | <b>\$760</b>     |
| 386-SX20 w/64k cache/SX-20 non-Cache .....                           | <b>\$735/675</b> |
| Micro-LVanda 386SX-V20 Notebook 2MB RAM, 40MB HDD, 6.2lbs, VGA ..... | <b>\$1485</b>    |

**MICRO-L<sup>S</sup>**  
ISA 486-33 CACHE (Symphony) **\$2165**

- Intel 80486-33MHz Processor - Upgrades to 50MHz; Socket for removable crystal allows for CPU changes
- AMI BIOS, Symphony™ Chipset, Dallas DS1287 real-time clock (w/10-year warranty)
- 256k Cache SRAM expandable to 1MB
- 4MB RAM 70ns expandable to 32MB onboard
- 1.2MB & 1.44MB FDDs (TEAC) • IDE HD/FD Contrlr
- 130MB, 15ms, 64kCache IDE HDD
- SpeedStarPlus, 1MB, 16-bit VGAcad, Hi Sierra color (VESA Standard for Flicker-free display)
- 14" Super Multiscan, 1024x768, non-interlaced 0.28dp, (Relisys-1422)
- 1 Parallel/2 Serial Ports
- Keytronics 101 keyboard (USA)
- Mid-Tower case (heavy duty), 230W UL power supply
- MS-DOS 5.0 • MS-Windows 3.0 & MS compbl mouse
- OPTION: 210MB IDE HDD add- \$235
- OPTION: Sony CPD-1304 monitor add - \$265

FCC Class B

**MICRO-L<sup>S</sup>**  
386-33c (Symphony) **\$1725**

- Intel 80386-33MHz CPU - Upgrades to 40MHz; Sckt for removable crystal allows CPU changes
- AMI BIOS, Symphony™ Chipset, Dallas DS1287 real-time clock (w/10 year warranty)
- 128k Cache SRAM expandable to 1MB onboard
- 4MB RAM 70ns expandable to 32MB onboard
- 130MB, 15ms IDE HD/FD Contrlr
- 1.2 and 1.44MB Flop
- 1 Parallel/2 Serial/1 C
- 16-bit VGA Card w/1 (VESA Standard for F
- 14" Super Multi-scan, (Relisys RE-1422)
- Deluxe Baby Case w/200W UL P/S 6-bays
- Keytronics 101 Keybd (USA) • MS-DOS 5.0
- MS-Windows 3.0 & MS compatible mouse
- OPTION: 386-40 SVGA system - add \$45
- OPTION: Mid-Tower - add \$60



## MOTHERBOARDS

- |  |           |
|--|-----------|
| 486-33 EISA 64K Cache/Micronics.....               | \$1535    |
| 486-33 AT 64K Cache - Symphony Upg to 50MHz .....  | \$745     |
| 486-SX/20 64K Cache - Symphony Upg to 33/50MHz ... | \$475     |
| 386-33/40 w/64K Cache - Symphony .....             | \$395/435 |
| 386-25 Non-cache - Symphony Upg to 33/40MHz .....  | \$295     |
| 386-SX20 w/32k Cache Non-cache .....               | \$275/215 |

## HARD DRIVES

- |   |               |
|---|---------------|
| Max10r 81MB/130MB/213MB IDE HDD.....          | \$285/360/595 |
| Max10r 380MB ESDI/768MB SCSI HDD.....         | \$1025/1395   |
| Max10r 1.02 GB SCSI .....                     | \$1995        |
| Conner CP-30104 120MB/CP-3204 200MB IDE ..... | \$345/545     |
| Quantum Pro Dr 105MB/120MB/240MB IDE .....    | \$320/365/595 |
| .....   | \$575         |
| (SCSI/EISA) .....                             | \$260/480     |

## MONITORS

- |  |       |
|--|-------|
| Relisys S Multiscan NL1024x768 RE-1422.....          | \$305 |
| Nanao 9080-I VGA 16", 1024x768 .....                 | \$360 |
| NEC Multisync 4-FG .....                             | \$795 |
| Genoa 7800 VGA Card 1MB, Flicker-free(ET-4000) ..... | \$135 |
| SpeedStar+ VGA 1MB, w/H Sierra.....                  | \$195 |
| Orchid Pro D IIs 1MB, w/H Sierra.....                | \$195 |
| Orchid Fahrenheit 1280 w/1MB.....                    | \$295 |

## MISCELLANEOUS

- |  |           |
|--|-----------|
| FAX modem 9600/send/Recv/shw.....                | \$95      |
| U.S Robotics 9600 int.V.32 PC/V.42 bis.....      | \$445     |
| Colorado DJ-10 T-Back-up 120MB/DJ-20 250MB ..... | \$235/305 |
| American Smart UPS 600VA/APC-1250V.....          | \$445/845 |

For your protection, we check thoroughly for stolen credit cards.



**Microline Computers - Taiwan**  
Phone: 011-886-7-345-0025  
Fax: 011-886-7-345-0060

**Info/CA Orders: (510) 770-1900**  
**Fax: (510) 770-1912**

**MICROLINE COMPUTERS**  
INCORPORATED  
46757 Fremont Blvd., Fremont, CA 94538  
Orders Only Call **1-800-777-2219**

# YOU DIDN'T BUY A FAX CARD SIMPLY FOR YOUR READING PLEASURE.

Today's fax cards provide you with an untouchable static image that can only be read.



Before you can revise or edit an incoming computer fax you must retype the entire document into your PC.

That is, unless you have new FAXGrabber™, the only Windows fax utility that

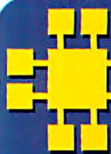
automatically converts fax images into more than 50 word processing, desktop publishing and spreadsheet programs. And because it uses Calera's award-winning OCR technology, accuracy and ease of use are assured. To save \$50, order today.



**CALERA**  
RECOGNITION SYSTEMS

Call 1-800-4-FAX-GRAB, Ext. 10 To Get FAXGrabber For Just \$99 Before May 30, 1992

Works with all leading fax cards. FAXGrabber is a trademark of Calera Recognition Systems. © 1992 Calera Recognition Systems, Inc. All other trademarks are property of their respective holders



# JDR Microdevices®

2233 Samaritan Drive, San Jose, CA 95124

Serving you since 1979

BUY WITH CONFIDENCE FROM JDR!

- 30-DAY MONEY BACK GUARANTEE
- 1 YEAR WARRANTY
- TOLL-FREE TECH SUPPORT



## CALL FOR YOUR FREE CATALOG TODAY!

FOR PC'S, MONITORS, DISK DRIVES, KEYBOARDS, MODEMS, CABLES, CONNECTORS, SOFTWARE, ICS, PROGRAMMING PRODUCTS, TEST EQUIPMENT, COMPONENTS & MORE!



## INTERFACE CARDS

### 16-BIT IDE MULTI I/O

\$69.95



- 286/386/486 COMPATIBLE
- SUPPORTS 2 IDE HARD & 2 FLOPPY DRIVES
- TWO SERIAL, ONE PARALLEL & ONE GAME PORT

MCT-IDEIO	.....	\$69.95
MCT-IDEFH	IDE HARD/FLOPPY CARD	\$29.95
MCT-IO	MULTI I/O CARD FOR 8088 SYSTEMS	\$59.95
MCT-AIO	16-BIT SERIAL/PARALLEL/GAME PORT	\$49.95
MCT-EEMS	16-BIT EEMS CARD	\$149.95
SIMPLY-RAM	8MB SIMM MEMORY CARD(OK)	\$199.95



## HARD DRIVES

89MB \$319

IDE	3-1/2"	ST-351A	44.7MB	28MS	\$199
IDE	3-1/2"	ST-3096A	89.1MB	16MS	\$319
IDE	3-1/2"	ST-3144A	131MB	16MS	\$399
IDE	5-1/4"	ST-1239A	212MB	16MS	\$619
IDE	5-1/4"	ST-2383A	338MB	16MS	\$1159
IDE	3-1/2"	ST-1480A	426MB	14MS	\$239

NOTE: HD-MHW REQUIRED TO MOUNT IN 5-1/4" SLOT. .... \$9.95

## FLOPPY DRIVES

FDD-1.44X	1.44MB 3.5" FLOPPY - BLACK	\$79.95
FDD-1.44A	1.44MB 3.5" FLOPPY - BEIGE	\$79.95
FDD-1.2	5.25" DOUBLE-SIDED HD 1.2MB	\$89.95
FD-55GFV	5.25" TEAC DOUBLE-SIDED HD 1.2MB	\$99.95
FDD-360	5.25" DOUBLE-SIDED DD 360K	\$69.95

## BREADBOARD ON-A-CARD

• 8088 CARD ACCESSES ALL 62 I/O SIGNAL CONNECTIONS; 16-BIT CARD ACCESSES 96 • ACCEPTS UP TO 24 14-PIN IC'S

PDS-600	8-BIT CARD	\$49.95
PDS-610	16-BIT CARD VERSION	\$59.95

## PROTOTYPE CARDS

W/SILK-SCREENED LEGENDS

JDR-PR2	8-BIT WITH I/O DECODE LAYOUT	\$29.95
JDR-PR10	16-BIT WITH I/O DECODE LAYOUT	\$34.95

## UNIVERSAL PROGRAMMER/TESTER

• PROGRAMS EPROMS, EEPROMS, PALS, BI-POLAR PROMS, 8748 & 8751 SERIES, 16V8 & 20V8 GALS • TESTS TTL, CMOS, DYNAMIC & STATIC RAMS

MOD-MUP REQUIRES HOST ADAPTOR BELOW .... \$499.95

## EPROM PROGRAMMING MODULES

• PROGRAMS 24-32 PIN EPROMS, CMOS EPROMS & EEPROMS, 16K TO 1024K • HEX TO OBJ CONVERTER

MOD-MEP	REQUIRES HOST ADAPTOR CARD	\$119.95
MOD-MEP-4	4-EPROM UNIT	\$169.95
MOD-MAC	HOST ADAPTOR CARD	\$29.95

## POST CODE DISPLAY CARD

\$49.95

READ DISPLAY AND CHECK MANUAL FOR POWER-ON SELF-TEST CODE

- 286/386/486 COMPATIBLE
- WORKS WHEN SOFTWARE WON'T EVEN BOOT YOUR PC

PCODE ..... \$49.95

## 1024 X 768 VGA CARD \$149.95

- 8/16-BIT 8088 & 286/386/486 COMPATIBLE
  - 1024 X 768 IN 256 COLORS (REQUIRES 1MB)
  - 800 X 600 IN 256 COLORS
  - 512K VIDEO RAM EXPANDABLE TO 1MB
  - ANALOG OR MULTISYNCH MONITOR SUPPORT
- |               |                       |          |
|---------------|-----------------------|----------|
| MCT-VGA-1024+ | 1024 X 768/256 COLORS | \$149.95 |
| MCT-VGA-16    | 8/16-BIT VGA CARD     | \$49.95  |



## 1024 x 768 \$349.95 VGA MONITOR

- 1:1 ASPECT RATIO: 0.28 DOT PITCH
  - 14" DIAGONAL SCREEN
  - COMPATIBLE WITH ALL VGA ADAPTORS
- |               |                        |          |
|---------------|------------------------|----------|
| VGA-MON-1024  | .....                  | \$349.95 |
| VGA-MON-1024N | NON-INTERLACED VERSION | \$389.95 |



## 1024 X 768 \$469.95 VGA PACKAGE

- 8088 & 286/386/486 COMPATIBLE CARD & 1024 X 768 INTER-LACED MONITOR
  - 1:1 ASPECT RATIO: 0.28 DOT PITCH
- |               |                       |          |
|---------------|-----------------------|----------|
| VGA-PKG-1024+ | .....                 | \$469.95 |
| VGA-PKG       | 640 X 480 VGA PACKAGE | \$349.95 |



101-KEY \$49.95

BTC-5339	.....	\$49.95
MAX-5339	101-KEY ENHANCED MAXI-SWITCH	\$69.95
K103-A	101-KEY ENHANCED WITH CLICK	\$84.95

## 3-BUTTON MOUSE \$14.95

- ACCURACY 290 -1450 DPI
  - MICROSOFT & MOUSE SYSTEMS COMPATIBILITY MODES
  - OPTO-MECHANICAL DESIGN
  - WINDOWS 3.0 COMPATIBLE
- JDR-MOUSE-3 ..... \$14.95



## DYNAMIC RAM

PART#	SIZE	SPEED	TYPE	PRICE
41256-100	262144x1	100ns	DIP	1.49
41256-80	262144x1	80ns	DIP	1.69
41256-60	262144x1	60ns	DIP	2.39
414256-80	262144x4	80ns	DIP	5.95
1MB-100	1048576x1	100ns	DIP	5.49
1MB-80	1048576x1	80ns	DIP	5.99
1MB-60	1048576x1	60ns	DIP	6.49
41256A9B-80	256K x 9	80ns	SIMM	16.95
41256A9B-60	256K x 9	60ns	SIMM	19.95
421000A9B-10	1MB x 9	100ns	SIMM	49.95
421000A9B-80	1MB x 9	80ns	SIMM	54.95
421000A9B-60	1MB x 9	60ns	SIMM	59.95
424000A9B-80	4MB x 9	80ns	SIMM	178.95
424000A9B-60	4MB x 9	60ns	SIMM	219.95

## MATH CO-PROCESSORS

MANUAL, SOFTWARE GUIDE & 5 YEAR WARRANTY

PART#	SPEED	PRICE	PART#	SPEED	PRICE
8087	5 MHz	89.95	80287-XLT	12 MHz	94.95
8087-2	8 MHz	129.95	80387-DXP	33 MHz	209.95
8087-1	10 MHz	169.95	80387-SX	33 MHz	129.95
80287-XL	12 MHz	94.95	80387-SX20	20 MHz	149.95
83D87-16	16 MHz	199.95	83D87-40	40 MHz	239.95
83D87-20	20 MHz	199.95	83S87-16(SX)	16 MHz	129.95
83D87-25	25 MHz	199.95	83S87-20(SX)	20 MHz	149.95
83D87-33	33 MHz	209.95	83S87-25(SX)	25 MHz	159.95
IIT (CYRIX)					
2C87-8	8 MHz	79.95	2C87-12	12 MHz	99.95
2C87-10	10 MHz	89.95	2C87-20	20 MHz	119.95

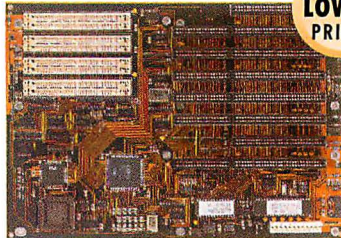
## MAXIMIZE CO-PROCESSOR SPEED

OUR "2ND STAGE" ALLOWS 10 & 20MHZ CO-PROCESSORS TO RUN AT FULL SPEED IN THE SLOWEST 286 SYSTEMS

2ND-STAGE FOR 10/20 MHZ 80287'S ..... \$29.95

## MOTHERBOARDS

NEW LOWER PRICES



## 16MHz MINI 386-SX \$249.95

- NORTON SI 11.1 • LANDMARK AT SPEED 20.0
  - EXPANDABLE TO 16MB ON-BOARD • AMI BIOS • SIX 16-BIT AND TWO 8-BIT SLOTS • CHIPS & TECHNOLOGY CHIPSET • SOCKET FOR 80387-SX CO-PROCESSOR • 8.5" X 13" SIZE FITS MINI-286 AND FULL-SIZE 286 CASES
- |               |                           |          |
|---------------|---------------------------|----------|
| MCT-M386SX    | .....                     | \$249.95 |
| MCT-M386SX-20 | 20MHZ MINI 386-SX         | \$299.95 |
| MCT-M386-25   | 25MHZ MINI 386            | \$399.95 |
| MCT-C386-33   | MINI-SIZE 33MHZ CACHE 386 | \$599.00 |
| MCT-C386-40   | MINI-SIZE 40MHZ CACHE 386 | \$899.00 |
| MCT-M486-33   | MINI 33MHZ CACHE 486      | \$995.00 |
| MCT-M286-16   | MINI 16MHZ 286            | \$149.95 |
| MCT-M286-12   | MINI 12MHZ 286            | \$129.95 |
| MCT-TURBO-10  | 10/4.77MHZ 8088           | \$69.95  |

## UPRIGHT CASE \$99.95

- FOR STD., FULL AND MINI-MOTHERBOARDS
  - MOUNTS FOR 3 FLOPPY AND 4 HARD DRIVES
  - TURBO AND RESET SWITCHES
  - SPEED DISPLAY, POWER, DISK LEDS
- |           |                   |          |
|-----------|-------------------|----------|
| CASE-100A | .....             | \$99.95  |
| PS-250TW  | 250W POWER SUPPLY | \$129.95 |
| PS-300TW  | 300W POWER SUPPLY | \$149.95 |
- POWER SUPPLIES ARE U.L. APPROVED



## MORE CASES...

- |          |                           |          |
|----------|---------------------------|----------|
| CASE-70  | FULL-SIZE 286 STYLE CASE  | \$89.95  |
| CASE-120 | MINI-UPRIGHT W/200W P.S.  | \$199.95 |
| CASE-JR  | MINI FLIP-TOP W/200W P.S. | \$149.95 |
| CASE-50  | MINI-SIZE 286 STYLE CASE  | \$59.95  |

## POWER SUPPLIES

- U.L. APPROVED • 110/220V, 50/60HZ
- |          |                                   |          |
|----------|-----------------------------------|----------|
| PS-150   | 8088 150 WATT                     | \$69.95  |
| PS-200X  | 8088 200 WATT                     | \$89.95  |
| PS-200   | 286/386/486 200 WATT              | \$89.95  |
| PS-250   | 286/386/486 250 WATT              | \$129.95 |
| PS-300   | 286/386/486 300 WATT              | \$149.95 |
| PS-250TW | 286/386/486 250W, EXTERNAL SWITCH | \$129.95 |
| PS-300TW | 286/386/486 300W, EXTERNAL SWITCH | \$149.95 |



## 2400 BAUD MODEM \$49.95

- 2400/1200/300 BPS INTERNAL DATA MODEM • FULL HAYES AT COMPATIBILITY • INCLUDES PROCOMM SOFTWARE
- MCT-241 ..... \$49.95



## 9600 BAUD V.42 BIS MODEM \$399.95

- CCIT V.42BIS/V.32/V.22BIS/BELL 212A AND HAYES AT COMMAND SET COMPATIBLE
  - 2 YEAR PROMETHEUS WARRANTY
- |            |                                    |          |
|------------|------------------------------------|----------|
| PRO-96E    | .....                              | \$399.95 |
| PCCB6201   | INTEL SATISFACTION 16-BIT FAX CARD | \$399.95 |
| PCEM7296   | INTEL 9600 BAUD EXTERNAL MODEM     | \$479.95 |
| VIVA-24E   | VIVA 2400BPS EXTERNAL MODEM        | \$119.95 |
| VIVA-24MNP | VIVA 2400 BPS W/ ERROR CORREX.     | \$149.95 |



SALES 800-538-5000

Customer Service 800-538-5001 Local/Int'l 408-559-1200  
 Technical Support 800-538-5002 Fax 408-559-0250

TERMS: For shipping & handling include \$5.00 for ground and \$7.50 for air. Orders over 1 lb. and foreign orders may require additional shipping charges—contact our Sales Dept. for the amount. CA residents must include applicable sales tax. Prices subject to change without notice. We are not responsible for typographical errors. We reserve the right to limit quantities and to substitute manufacturer. All merchandise subject to prior sales. A full copy of our terms is available upon request. Items pictured may only be representative. JDR, the JDR logo, JDR Microdevices, and the MCT logo are registered trademarks of JDR MICRODEVICES, INC. Modular Circuit Technology, is a trademark of JDR MICRODEVICES, INC. Copyright 1992 JDR MICRODEVICES.

KEY CODE 1027

**Accessories/Supplies**



8 fl. oz.

**HI  
TEC  
HYGIENE**

Clean and Protect your computer with DATA FACE™ CRT



8 fl. oz.

Cleaner & Anti-Static. SPEAK EAZZY™ Telephone Fragrance & Cleanser. Remove dirt and germs with a little zing to your business and home telephones.

**ORDER DIRECT**

Name \_\_\_\_\_

Address \_\_\_\_\_

City \_\_\_\_\_ State \_\_\_\_\_ Zip \_\_\_\_\_

**DATA FACE:** \$7.95 ea. \_\_\_\_\_ \$83.67/cs (12) \_\_\_\_\_ \$ \_\_\_\_\_

**SPEAK EAZZY:** \$6.45 ea. \_\_\_\_\_ \$67.80/cs (12) \_\_\_\_\_ \$ \_\_\_\_\_

Scent:  Peppermint  Bubble Gum  Mountain  
 Jasmine  Tangerine Shipping \$ **FREE**

**Erin-American Ltd.**  
**Ft. Harrison Industrial Park**  
**Terre Haute, IN 47804** Total \$ \_\_\_\_\_

Payment: Check \_\_\_\_\_ VIS /MC \_\_\_\_\_ Corp P.O. \_\_\_\_\_

Card No. \_\_\_\_\_ Exp. Date \_\_\_\_\_

Signature \_\_\_\_\_

Circle 250 on Inquiry Card.

**Add-In Boards**

**ROBOFAX** • SALES/MARKETING • CUSTOMER SUPPORT  
 • PUBLIC INFORMATION • 900 NUMBERS

**YOUR 24-HOUR SALES ASSISTANT**

CALL ROBOFAX FROM ANY FAX PHONE  
 RECEIVE VOICE PROMPTS  
 SELECT DOCUMENTS  
 RECEIVE DOCUMENTS AT YOUR FAX MACHINE

ROBOFAX Permits Callers to Request Information and then Faxes Requested Documents W/O Operator Intervention

**800-292-7771** ROBOFAX EZ.....\$995  
 ROBOFAX DEMO LINE: 800-925-7626 Single-line, one call PC kit  
 ROBOFAX.....\$2,995  
 Multi-line, two call PC kit

**ADD ON AMERICA**  
 A DIVISION OF ROHM CORPORATION  
 433 N. MATHILDA AVE. • SUNNYVALE, CA 94086 • (408) 746-1590 • FAX (408) 746-1593

Circle 195 on Inquiry Card.

**Rackmount Solutions**

RACKMOUNT COMPONENTS - QTY 25 PRICING

Rackmount Chassis 19"x7"x17"	\$183
Rackmount VGA Monitors	\$531
Rackmount Monitor Shelf	\$113
Rackmount Keyboard Shelf	\$88

RACKMOUNT PLATFORMS - Qty 1 Pricing

RMS286-12	\$549	RMS386-33	\$1095
RMS386SX-16	\$795	RMS486-33	\$1695

System Platforms include 7" Rackmount Chassis, 200W Power Supply, Motherboard, 1.0MB Memory, IDE, FDC, 2-Ser, Par, 1.2MB or 1.44MB Floppy Disk Drive, 1 Year Warranty

RACKMOUNT CHASSIS - 15 Models up to 20 Board Slots  
 SLOT CPU BOARDS - 486, 386, 386SX, 286  
 RACKMOUNT MONITORS - Super VGA and Monochrome  
 RACKMOUNT CABINET - Modular from 21" to 96" high

**VALLEY TECHNOLOGY INC.** 2468 Armstrong Street  
 Livermore CA 94550  
 (510) 447-2030 FAX: (510) 447-4559

Circle 244 on Inquiry Card.

**POS-EQUIPMENT**

Printers • Displays • Scanners • Drawers  
 PC Card which turns your PC into a POS Terminal

**dietrich**  
 SINCE 1928

Zaehringerstr. 326  
 D-7800 Freiburg  
 Germany

Phone 49-761-552719 • 54915  
 FAX 49-761- 5 68 81

Circle 209 on Inquiry Card.

**VOICE MASTER KEY® SYSTEM II**  
 VOICE RECOGNITION & SPEECH RESPONSE  
 FOR IBM PC/XT/AT/386, PS/2, LAPTOPS, COMPATIBLES

FOR PRODUCTIVITY, PRESENTATIONS, SOFTWARE DESIGN, ENTERTAINMENT, LANGUAGE TRAINING, EDUCATION, MORE...  
 SPEECH/SOUND RECORDING AND PLAYBACK. Desktop Audio sound editing allows you to create custom sound applications. Variable sample rate (to 20 KHz) and compression levels. A four-voice music synthesizer is included also!  
 VOICE RECOGNITION TSR utility allows you to add voice command keyboard macros to your CAD, desktop publishing, word processing, spread sheet, or entertainment programs. Up to 64 voice commands in RAM at once—more from disk.  
 HARDWARE SYSTEM contains built-in speaker with separate volume and tone controls, external speaker and headphone jacks. Enclosure made of sturdy vinyl-clad steel. Attaches to parallel printer port without affecting normal printer operation (U.S. Patent 4,812,847). Headset microphone, printer cable, 9 volt AC adapter (110 volt UL/CSA listed), and comprehensive user manual included.

**QUALITY THROUGHOUT. MADE IN USA. ONLY \$219.95**  
**ORDER HOTLINE: (503) 342-1271 MON-FRI, 8 AM TO 5 PM PST**  
 Visa/MasterCard, company checks, money orders, CODs (with prior approval) accepted. Personal checks subject to 3 week shipping delay. Specify computer type when ordering. Add \$5 shipping charge for delivery in USA and Canada. Foreign inquiries contact Covox for C&F/CI/F quotes. OEM configurations available.  
**30 DAY MONEY BACK GUARANTEE IF NOT COMPLETELY SATISFIED.**  
 CALL OR WRITE FOR FREE PRODUCT CATALOG

**COVOX INC.** TEL (503) 342-1271  
 675 Conger Street FAX (503) 342-1283  
 Eugene, Oregon 97402 BBS (503) 342-4135

Circle 207 (RESELLERS: 208) on Inquiry Card.

**Pro-tecT Computer Products**

**Pro-tecT**  
 "The Keyboard Protector"

Pro-tecT™ "The Keyboard Protector"  
 All computer keyboards are vulnerable, open to attack! Dust, food, liquid, spills, "A DISASTER WAITING TO HAPPEN."  
 Pro-tecT Computer Products, the leader in Computer Protection, has designed a transparent, flexible, durable custom keyboard cover that remains in place during keyboard use! Highest Quality Keyboard Protector available on the market today, or full refund guaranteed! Available for most popular keyboard makes and models. When ordering always specify keyboard make and model. List \$24.95.

Toll-free 1-800-669-7739  
 Fax 801-295-7786  
 CeBIT Booth A4 USA#6

Distributors wanted

Circle 242 (RESELLERS: 243) on Inquiry Card.

Communications/Networking • Computer Systems

**PC/AT Dual Port Comm. Coprocessor**

**GMM Sync2/CCP™**

- High Performance 16 bit Microprocessor.
- 80X86 code compatible
- 1 or 2 Serial Ports with Full Duplex DMA
- Uses 8530 or 85C30 SCC chip
- 256k Dual Ported RAM (512k, 1Meg - optional)
- 8k, 16k, 32k, 64k Window Size (Programmable)
- RS232/RS422/RS485/V.35
- SOURCE CODE DEBUGGER Kit Available.



Other PC/AT & PS/2 (MCA) 8530 based products available. Extremely competitive pricing. Call for additional information

(714)752-9447 FAX (714)752-7335

GMM Research Corporation  
2938 S. Daimier St., Suite 121  
Santa Ana, CA 92705

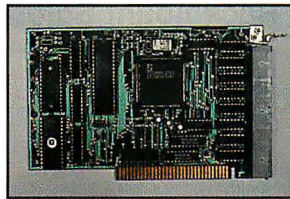


GMM Products Are All Made in USA.

Circle 212 on Inquiry Card.

**PCSS-8I  
Intelligent  
Serial Coprocessor**

- On board processor handles serial communication tasks.
- 32K-128K Dynamemory.
- Eight ports per board.
- High performance - low cost!
- DOS, SCO XENIX, SCO UNIX drivers included.



To order call toll-free 1-800-282-GTEK(4835)



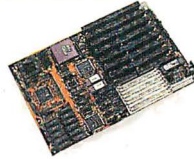
Development Hardware & Software  
P.O. Box 2310,  
Bay St. Louis, MS 39521-2310 U.S.A.

Mississippi & Technical Support (601) 467-8048 • Fax: (601) 467-0935

Circle 213 on Inquiry Card.

Computer Systems • Data Acquisition

**50 MHz 80486 ISA/EISA 23 MIPS**



**ISA SYSTEM BOARD**

MODEL	CACHE	MIPS	OK	4M
486/50	64K	24.0	CALL	CALL
486/33	64K	15.2	1195	1395
486/25	64K	11.2	1095	1295
486/20SX	64K	9.0	895	1095
386/40	64K	9.8	695	895
386/33	64K	8.3	625	825

\*256 Cache Available

**Third Generation Feather Light  
SONIC 386/20SL NOTEBOOK**



- Latest Intel 386/20SL Chip Set
- Intelligent Power Management
- Total Weight 4.8 lbs.
- 2 Mb of RAM (Max 8 Mb)
- 0/16/64 KB Smart Cache Architecture
- Crisp 640X480 VGA Display
- 1.44 Floppy Disk
- Whisper Quiet 40 MB Hard Disk
- 60/80 Mb Optional
- 1 Serial, 1 Parallel Port
- 80 Key Keyboard with Full 101 Key Emulation
- J-Key Mouse Design
- 3 Hours Battery Pack
- FCC Class B Pending

TECHNOLOGY POWER ENT., INC.

**FEATURES**

- 64/256K Write Back Cache
- Burst Mode Design
- Shadow RAM on Video & BIOS
- 64MB 32 Bit Memory Expansion Slots
- Baby-size with Eight Expansion Slots
- UNIX, OS/2 & Novell 100% Compatible
- One Year Full Warranty
- Made in the USA

Complete Desktop System with 1.2 MB Floppy HD/Floppy Controller, 101 Keyboard and 4MB Memory

MODEL	BASE	MONO	VGA
486/50	CALL	CALL	CALL
486/33	1795	1970	2245
486/25	1695	1870	2145
486/20SX	1495	1670	1945
386/40	1295	1470	1745
386/33	1225	1400	1675

\*FCC, UL & CSA Available  
\*Tower-Add \$200 Hard Drive Available

**386SX with IDE/2S/1P**

BOARD	
386SX-16	.....230
386SX-20	.....269
386SX-25	.....289

**BARE BONE SYSTEM UL/FCC B**

386SX-16	.....370
386SX-20	.....409
386SX-25	.....429

**HARD DRIVE**

QUANTUM IDE 52MB	.....215
QUANTUM IDE 105MB	.....339
QUANTUM IDE 200MB	.....699

47273 Fremont Blvd., Fremont, CA 94538  
Tel: 510-623-3818 FAX: 510-623-3840

Circle 234 on Inquiry Card.

**LOW-LOW-LOW**

Computer Systems / Notebook / Complete Network Solutions

IBM Apple COMPAQ AST  
ALR VEREX and others

**SURAH 386/486 ISA/EISA**  
Compatible Computers  
**AMI/Mylex Motherboards**  
IOMega Bernoulli Drives  
**CD ROMS Tape Backup**  
Mini-SCSI • Parallel to SCSI  
Host Adapter  
**Trantor Systems**

**LAN Cards/other products**  
3COM, Novell, Anthem, Gateway,  
Proteon & others  
**Hard Drives/Floppy Drives**  
IDE (Netware Ready)/SCSI  
Also available for IBM, Compaq, Apple  
**Memory/Upgrades**  
DRAMs, SIMM Modules  
Math coprocessors  
**Laser Printers/Scanners**  
**Plotters/Digitizers/Software**



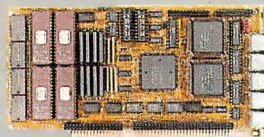
44912 Osgood Road, Fremont CA 94539 USA  
Phone: (510) 651-5101 Fax: (510) 651-5241  
1-800-543-1001 Nationwide Orders  
UK Fax: 081-855-9657

Circle 232 on Inquiry Card.

**AT Systems in ROM**

**Single Board Computers**

- Run DOS from ROM
- PC code compatible
- Large memory space
- Passive backplanes



Develop code on a PC. Use standard PC cards for expansion. Burn your code and DOS into ROM and run on our CPU cards.

**KS6 CPU:** NEC V53 uP(286eq), 5 serial, 2 Parallel, Clock, AT bus  
Max of 4M Ram, 2M Rom, 512K battery backed Sram. \$349-q1 oem  
**KS3 CPU:** V40 uP, 3 Serial, 2 Par., Clock, Flop, Keybd. \$249-q1.

303-444-7737

Fax 303-786-9983 655 Hawthorn Ave., Boulder CO 80304



Circle 219 on Inquiry Card.

**BYTE**

Breaks the 4-Color Price Barrier  
with the **Hardware/Software Showcase**

See how affordable it is to advertise to BYTE's  
500,000 computer professionals in this section!

Call for more advertising information:  
**(603) 924-2695 or (603) 924-2598**



## 20-BIT A/D For PC/XT/AT & Compatibles

Linearity .0005 percent of full scale

**\$300** software included

### LAWSON LABS, INC.

74 4TH AVE. NW 800 321-5355  
KALISPELL, MT 59901 406 257-5355



Circle 221 on Inquiry Card.

## NEW SHARE A SIGEN 250MB PORTABLE NEW TAPE BACKUP & REDUCE COST/USER

No controller card required. Connects to parallel port. Installs in less than 3 minutes. Great for Laptops. 9.5 MB/min transfer rate.

**Capacity**  
60/100 MB 1/4" cartridge  
250/500 MB 1/4" cartridge  
1200/2000 MB 4mm DAT



**Supports**  
DOS, OS/2  
Novell 286, 386  
Unix, Xenix

Industry standard SYTOS Plus software and for file server based NLM and VAP Tapeware.



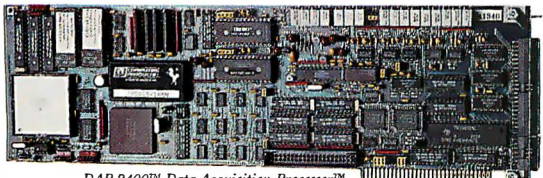
**SIGEN**

Phone (408) 737-3904 • Fax (408) 737-3910



Circle 235 on Inquiry Card.

## The Intelligent Solution For Data Acquisition



DAP 2400™ Data Acquisition Processor™

ANALOG I/O

DIGITAL I/O

- Inputs to 235K samples per second
- Outputs to 250K samples per second

FFT and FIR-filtering

Digital Signal Processing at 10 MIPS

16 MHz CPU with DRAM to 512K

20 MHz DSP with SRAM to 96K

DAPL™ Operating System

- 100+ standard commands
- Custom commands in C

**MICROSTAR**

**LABORATORIES™**

2265 116th Avenue NE  
Bellevue, WA 98004  
FAX (206) 453-3199

Send for FREE catalog.

Or call us at (206) 453-2345

Circle 225 on Inquiry Card.

## CUSTOM KEYBOARD PRODUCTS

- Custom Key Imprinting—all brands!
- Custom Colored keys for IBM®, DEC®, Wyse®, Key Tronic®, Cherry®, and more!
- Full color keyboard templates made to your exact specifications.
- Custom and stock keytop label kits for software support & languages.
- Custom membrane & full-travel keyboards.
- Express turnaround services.
- A total line of keyboard enhancements.



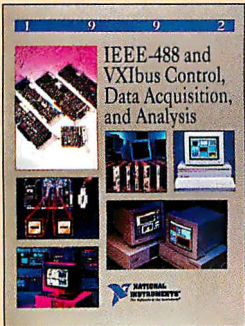
**CUSTOM HOTLINE 800 937-1337**  
from the leader in Keytop Innovations™

**Hooleon CORPORATION**

P.O. Box 230 • Dept. BYTE  
Cornville, AZ 86325  
602 634-7515  
FAX 602 634-4620

Circle 216 on Inquiry Card.

## Instrument Control and Data Acquisition



IEEE-488 and VXIbus Control, Data Acquisition, and Analysis

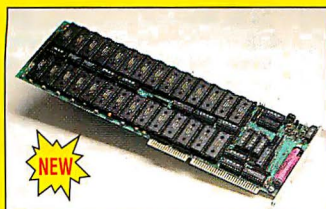
Free 1992 catalog instrumentation products for PCs, workstations, and more. Features IEEE-488.2 interfaces and software, plug-in data acquisition boards, VXIbus controllers, DSP hardware and software, and signal conditioning accessories. Application software for complete acquisition, analysis, and presentation of data, including graphical interfaces. Application tutorials and training classes also detailed.

512-794-0100 FAX: 512-794-8411  
1-800-433-3488 (U.S. & Canada)

National Instruments, 6504 Bridge Point Parkway, Austin TX 78730

Circle 226 on Inquiry Card.

## PCDC-14 Hard Disk Caching Accelerator



NEW

**Makes Your Computer Run 10 Times As Fast!**

- Works with any hard disk.
- Half sized card can cache up to 14 Megabytes.
- Non-volatile memory becomes permanent part of hard disk.
- Disk access to times of less than 200 microseconds (0.2mS).
- Satisfaction Guaranteed!

To order call toll-free  
1-800-282-GTEK (4835)



OEM & Dealer  
Inquiries Welcomed!

**GTEK**, INC.

DEVELOPMENT HARDWARE & SOFTWARE  
P.O. Box 2310 • Bay St. Louis, MS 39521-2310 U.S.A.  
Fax 601-467-0935  
Mississippi & Technical Support 601-467-8048

Circle 214 on Inquiry Card.

# STAND ALONE DISKETTE DUPLICATOR

OVER 300 DISKS PER HOUR

5.25" and 3.50" Models



SIMPLE AND FAST FROM \$1699

TEL: (416) 503-3335  
FAX: (416) 252-4084

**AXIOMATIC**

Circle 198 (RESELLERS: 199) on Inquiry Card.

**Mail Order • Memory/Chips/Upgrades**

**Industrial PC Solutions**

RELIABLE, AFFORDABLE, FLEXIBLE

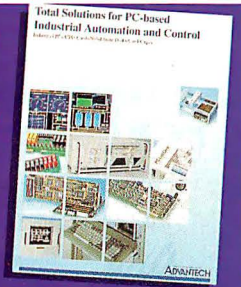
- Industrial PCs
- Industrial I/O Cards
- 286/386/486 CPU Cards
- PC-Bus Card Cages
- RAM/ROM Disks
- Rack Mount Keyboards

**1-800-800-6889**

(In California 408-293-6786)

Industrial & Lab Automation with PCs  
**ADVANTECH**

1310 Tully Road, #115, San Jose, CA  
FAX: 408-293-4697



**FREE!** New 140-page PC-based industrial automation reference guide for your system and OEM needs.

Circle 196 on Inquiry Card.

**Why Pay More For Memory?**

MEMORY UPGRADES for Laptops, Notebooks, Desktop computers, and Laser Printers at the LOWEST PRICES!

Save BIG on memory for:

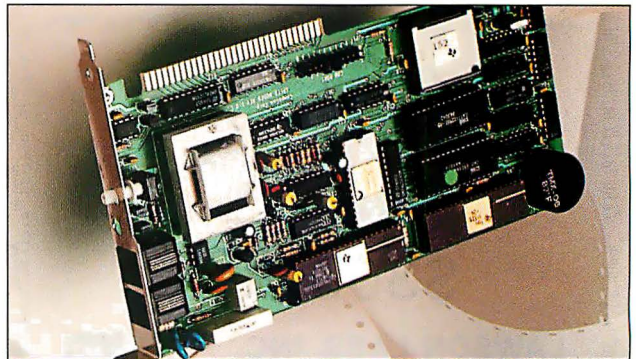
- Apple • AST • ALR • AT&T • Brother • Canon • Compaq • Epson • HP Laser & Vectra • IBM • Kyocera • NCR • NEC • OKI • Packard Bell • QMS • Samsung • Sanyo • Sun • TEC • TI • Toshiba • Zenith • Simms • SIPS & Drams

Five-year warranty. Great customer service, quality products, prompt delivery, and the best prices are just a toll-free phone call away... VOLUME DISCOUNTS FOR INSTITUTIONAL, CORPORATE AND GOVERNMENT ACCOUNTS. INTERNATIONAL INQUIRIES WELCOMED.

800-ANA-SIMM or 1-805-984-5683  
or in Canada 800-231-SIMM Call Now!  
ANACAPA MICRO PRODUCTS, INC.

Circle 249 on Inquiry Card.

**Modems/Multiplexors • Misc. Hardware • Multimedia**



**COMPUCOM**

**9600 bps MODEM \$169**

Compucom is one of the few modem manufacturers who develops its own modem technology. 95+% of all modem vendors use third party designs and/or chip sets. They're modem manufacturers...Compucom's the modem innovator. See for yourself!

- Speedmodem Champ, 9600 bps csp \$169 / 199
- Star, 14,400bps v.32/32bis,csp, v.42/42bis \$499 / 539
- Storm, 9600bps v.32,csp, v.42/42bis \$299 / 339
- Remote Pro, remote access software \$59
- Voicemail, fax, caller ID opt.-- 30 day money back trial

**CALL NOW**

(800) 748 6840, (415) 499 7600, Fax (415) 499 3366

Circle 204 on Inquiry Card.

**ICs PROMPT DELIVERY!!!** Same day shipping (usually) Quantity one prices shown for January 19, 1992

Memory for almost ALL computers

DYNAMIC RAM		EPROM	
4M Board for hp Lw's w/2MB	\$125.00	27C4001 512Kx8 150 ns	\$28.00
SIMM 4Mx9 70 ns	155.00	D28F010 128Kx8 150 ns	24.00
SIMM 1Mx9 60 ns	50.00	27C1000 128Kx8 200 ns	6.30
SIMM 1Mx9 80 ns	44.00	27C512 64Kx8 120 ns	4.75
4 Mbit 4Mx1 80 ns	25.00	27128 16Kx8 250 ns	3.40
4 Mbit 1Mx4 80 ns	28.00		
1 Mbit 1Mx1 70 ns	4.70	<b>STATIC RAM</b>	
41256 256Kx1 80 ns	1.85	1 Mbit 128Kx8 Real	\$22.00
41256 256Kx1 100 ns	1.70	62256LP 32Kx8	100 ns 5.75
44256 256Kx4 80 ns	5.25	Sat. del. on Fed-Ex orders received by: Th: S-2 1-4 lbs \$6.25 Fr: P-1 1 lb \$17.00 FED-EX COD +\$5.00	
4464 64Kx4 100 ns	1.50		

OPEN 6 1/2 DAYS, 7:30 AM-8:00PM • SHIP VIA FED-EX ON SAT.

**MICROPROCESSORS UNLIMITED, INC.**

24,000 S. Peoria Ave., Beggs, OK 74421

MasterCard/VISA or UPS CASH COD • No minimum order.

\$1 for packing materials. Shipping and insurance extra.

**(918) 267-4961**

Circle 224 on Inquiry Card.

**Measurement & Control**

Remote monitoring? Unique measurement problem? These are our specialties. Contact Elexor. We'll help you find a solution...fast!

**ELEXOR**

... The Solutions Company!



- Stand Alone
- Free Software
- Programmable
- Multi-addressing
- Battery Capability
- Off-site monitoring
- Signal Conditioning
- Integrated Systems
- Unlimited I/O points
- PC, MAC, DEC, etc

ELEXOR ASSOCIATES  
phone (201) 299-1615  
fax (201) 299-8513  
P.O. Box 246  
Morris Plains, N.J. 07950

Circle 266 on Inquiry Card.

**LAPTOP MEMORY**

UPGRADES FOR ALL POPULAR MANUFACTURERS, INCLUDING:

- Toshiba
- Compaq
- NEC
- Zenith
- Epson
- Hewlett Packard
- Packard Bell
- AST
- Panasonic
- Sanyo
- AT&T
- Everex
- IBM
- Leading Edge
- Sharp
- Bondwell
- Texas Instruments

The **MEMORY** Depot

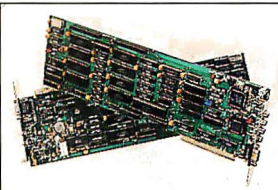
"Your stop for memory upgrades"

All Products Covered By Manufacturer's Limited Lifetime Warranty. Guaranteed 100% Compatibility. We accept VISA, Mastercard, C.O.D. and P.O.'s

**Call Now For Current Prices! 800-237-2447**

Circle 245 on Inquiry Card.

**IMAGING CARDS MODEL 1-800-292-1160**



- 512/24 512x480x24 - **New**  
Full 24 bit color board, multi. in, 24 bit RGB out .....\$795
- 512 512x480x8 - **Advanced**  
grayscale board. Multi res/multi image, 4 inputs, in/out LUTS, dual ping-pong buffers, RGB out .....\$795
- 02 256x240x8 Workhorse 8 bit grayscale. 2 inputs, 24 bit RGB out, cursor .....\$495
- 03 256x240x6 Economy 6 bit version of -02 above .....\$395

Video Framegrabbers for the XT/AT/386

- Real time grab/display
- Complete with software
- 60 & 50 Hz. Video
- Quality since 1987!
- Money back guarantee

**Control Vision**

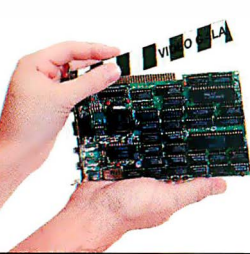
Box 596 Pittsburg, KS 66762  
316-231-6647 Fax: 231-5816

Circle 206 on Inquiry Card.

## VIDEO FRAME GRABBERS

PCX, TIF, GIF and more file formats.  
IBM PC/XT/AT Compatible, NTSC & PAL

VGA VIDEO GALA .....\$595.00 Three boards in one: VGA + VCR output + Live video in a window. Captures 640 x 480 true color.  
VIDEO GALA .....\$499.00 Captures 640 x 480 true color in real time.  
GALA GS .....\$399.00 Capture 640 x 480 with 256 shades of grey in real time.

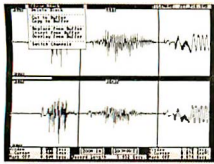


HRT 512-8 .....\$995.00  
Multifeatured high performance industrial model with an Image Processing Library. 512 x 512 in 256 shades of grey.  
HRT 512-24 .....\$1995.00  
Same as HRT 512-8 except in 24 bit color.



P.O. Box 76, Lewiston, New York 14092 U.S.A.  
Tel: 416-497-6493 Fax: 416-497-1636

Circle 215 on Inquiry Card.



## SuperSound™

Best Value!  
Easy To Use Too!  
Digital Audio Authoring  
Workstations \$239 - \$640

Having Problems With Big Name Products or  
Their Tech Support - Try Us And Be Pleased.

Developers of Windows 3, Toolbook, Visual Basic use  
our DLLs, Create SuperSound, SoundBlaster, Covox,  
Disney Sounds; Import sound files from Mac, Amiga

IBM-PC DOS DIGITAL AUDIO from \$20  
USA Made High Quality, 30 Day Money-Back Guarantee

- LIKE HAVING A CASSETTE TAPE RECORDER IN A PC.
- Fastest, easiest Editors with the most features for the price.
- Simple hardware / software installation- NO DMA jumpers.
- No Extra Charge for Technical Support on our products.
- DOS Extender Version - Up To 16 MB Working Space.
- Programmer's Libraries for Popular Languages.

Products by Silicon Shack, 4760 Castlewood Drive, San Jose, CA 95129  
Ph: 408 - 446 - 4521 FAX: 408 - 446 - 5196

Tech. Info./Orders: 800 - 969-4411 Ask for FREE PRODUCT CATALOG.

In Far East: Bayware Japan, Inc. Tel: (03)972-5391 FAX: (03)959-1214 SuperSound, SoundFX, SoundCard are trademarks of Silicon Shack, Ltd.

Circle 231 on Inquiry Card.

## PROTEUS - MULTIFACETED INSTRUMENT (From \$1295)

Universal Programmer  
DIP40 and PLCC20-84

Data Logger and  
Controller

PCB Tester &  
PC-XT/AT Bus  
Emulator

### UNIVERSAL PROGRAMMER

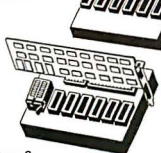
- Memory (up to 8MB), FLASH, SERIAL EPROMs; All Intel MICROS, 87C751; Over 1000 PLDs (AMD MACH, PALCE, GALS, BiCMOS 22V10, Lattice 7ns B series, MAPL, QUIET Series)
- PLCC to 84 pin, GANG Memory, Micro, PCMCIA memory cards
- Up to 104 fully protected pins
- Standard parallel printer port
- Optional PC for stand-alone operation
- Fully integrated Algorithm Development Language allows users to add/change parts
- True State Machine Testing capability (rise/skew < 10ns)
- True full Selfcalibration & Diagnostics

### CONTROLLER & DATA LOGGER

- Software includes libraries, application program and driver for Labtech Notebook
- Output current at multiplexed channels:  
V<sub>cc</sub> 2A max.  
HV1/HV2 700/350mA max.  
V<sub>pull</sub> 150mA max.



PROTEUS-PC  
(optional palm-top  
side-in PC)



Standard IBM-PC  
parallel printer port



PROTEUS Main Unit  
(PRO-MU40 ... MU104)

5-13 Pin Driver Boards  
(PRO-DM0D8)

- Output current at main channels: 4A max.
- Programmable current source:  
On HV1 output 100mA; 200mA/V
- Short circuit protection:  
All channels have independent thermal and current protection
- Update rates:  
50µs (D/A/D for independent channels)  
2µs (multiplexed channels)

### PCB TESTER & PC-XT/AT BUS EMULATOR

- Supports in-circuit and out-of-circuit functional IC Testing, Resistance Testing, Signature Analysis
- Emulates PC-XT/AT bus for plug-in board development and debugging
- Built-in ADEL (Algorithm Development Language) allows for writing of customized PCB test programs
- Library of functions offered, which can be linked with the source application program for debugging under VIEWCODE or Borland DEBUGGER



750 North Pastoria Avenue, Sunnyvale, CA 94086 USA  
Tel: (408) 730 - 5511 Fax: (408) 730 - 5521

Circle 200 on Inquiry Card.

## EP-1140 E/EPROM & µcontroller Programmer

- ◆ Supports the NEC 8 Mbit EPROM and all EEPROMs from 2716 to 16-bit, 4 megabit
- ◆ Connects to the standard parallel printer port on IBM and compatible
- ◆ Qualified and recommended by Intel, National Semiconductor, Signetics and others



\$895.00

- ◆ Single EXE file for easy updates
- ◆ Lifetime FREE software updates available via BBS (713) 461-4958 or US Mail
- ◆ Call 1-800-225-2102 for a complete literature packet and demo disk
- ◆ Made in the USA

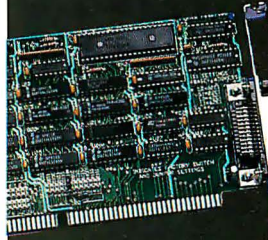
## BP MICROSYSTEMS

Houston, TX 77043 • PH: (713) 461-9430 • FAX: (713) 461-7413

© 1991 BP Microsystems, Inc.

Circle 201 on Inquiry Card.

## IEEE 488.2



Hardware for IBM PC/AT, Micro Channel, Sun, Macintosh, DEC, and NeXT.

Software for DOS, Windows, UNIX, VMS, menu- and icon-driven environments.

IEEE 488 extenders, analyzers, converters, analog I/O, and digital I/O.

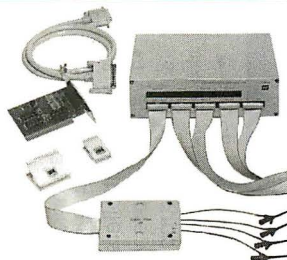
Call for your free IEEE catalog



IOtech, Inc. • 216.439.4091 • Fax 216.439.4093

Circle 218 on Inquiry Card.

## 200 MHz Logic Analyzer



- 400 MHz max sampling rate
- up to 128 channels
- 16K samples/channel
- 16 level triggering
- Variable threshold voltage
- Sophisticated triggering
- FREE software updates

\$799 - LA12100 (100 MHz)

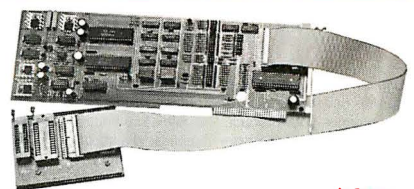
\$1299 - LA32200 (200 MHz-32-ch.)

\$1899 - LA32400 (400 MHz-32-ch.)

Price is complete.  
Pods and software included.

## Universal Programmer

PAL  
GAL  
EPROM  
FLASH  
EEPROM  
PROM  
87xxx...



\$475

- 16V8, 20V8, 22V10, GALS
- 26V12, 20RA10, 18V10 GALS
- 2716-27040 EPROMs
- 87xxx MICROS
- EEPROMs (incl. 8 pin serial)
- 16 bit EPROMs
- Byte Split/Merge (16 & 32 bit)
- JEDEC, INTEL HEX, Motorola 'S' files
- Dallas NVS RAM programming
- FREE software updates on BBS



Call - (201) 808-8990  
Link Computer Graphics, Inc.

369 Passaic Ave., Suite 100, Fairfield, NJ 07004 FAX: 808-8786

Circle 222 on Inquiry Card.

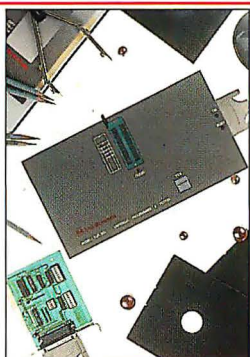
**Programmable Hardware**

UNIVERSAL PROGRAMMER, EMULATOR, & TESTER

**TUP-400 \$745.00 NEW**  
**TUP-300 \$645.00**

- New Improved hardware and software.
- The most complete PC-based Universal Programmer, Programs PLD (PAL, GAL, EPL, EPLD, PEEL, MAX, MACH...), E(E)PROM, (up to 16Mbit), Flash EPROM, BPROM, Special PROM, MPU (87XX, 68XX, Z8, PSD301, PIC16XX, TMS320EXX, UPD75PXXX, HD637XXX...).
- Covers DIP, PLCC, QFP, SOP, and PGA with 8 to 84 pins. Gang Programming adapters available also.
- EPROM EMULATION capability.
- Tests digital ICs and DRAMs (SIMM/SIP adapter available).
- Free software updates and new device added upon request.
- IC Manufacturers' approval.
- 1-year warranty, 30-day money-back guarantee.

CALL TODAY FOR MORE INFORMATION.  
 Distributors are welcome!



**Tribal Microsystems Inc. Tel (510) 623-8859**  
 44388 S. GRIMMER BLVD., FREMONT, CA 94538 • FAX (510)623-9925

Circle 236 on Inquiry Card (RESELLERS: 237).

**SuperSite™**

**Programs it All!  
 for only \$695**

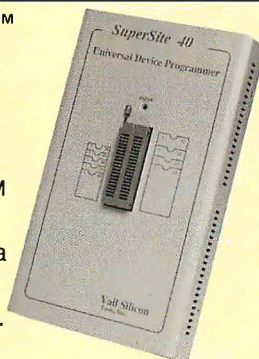
PLD, GAL, Micro, PROM, EE/PROM

Get the best 40 pin-device programmer today and receive a free CUPL Starter Kit.

14 Day Money Return Policy.

For more information call:

**Vail Silicon (305) 491-7443**



Circle 223 on Inquiry Card.



**SUPERPRO™  
 UNIVERSAL PROGRAMMER**

- Super easy-to-use menu driven software
- Free & continual updates on BBS
- Universal programming for PAL, GAL, EPLD, EPROM, & Microcontrollers, etc.
- 1 year hardware warranty & telephone support
- also low cost UNIPRO at \$399 EPROM programmer at \$149

Special offer of this month at \$699 (U.S. only) includes at no charge one of • 4 socket adapter or • PAL compiler or • EPROM eraser (9 chips)

**XELTEK**

SUNNYVALE, CA (408) 745-7974  
 FAX(408) 745-1401 BBS(408) 745-7256

Circle 240 on Inquiry Card.

**Instant Microcontroller + Instant C =  
 Instant New Product**

Use our Little Giant™ and Tiny Giant™ miniature microprocessor-based computers to instantly computerize your product. Our miniature controllers feature built-in power supplies, digital I/O, serial I/O (RS232 / RS485), A/D converters (to 20 bits), solenoid drivers, time of day clock, battery backed memory, watchdog, field wiring connectors, and more! Designed to be easily integrated with your hardware and software. Priced from \$159. Core modules as low as \$59. Low cost, interactive Dynamic C™ makes serious software development easy.



**Z-World Engineering**

1724 Picasso Ave., Davis, CA 95616 USA (916) 757-3737  
 Fax: (916) 753-5141 Automatic Fax: (916) 753-0618  
 (For automatic fax call from your fax, request catalog #18)

Circle 241 on Inquiry Card.

**Tape Drives**

**9 Track Tape Subsystem  
 for PC/XT/AT/386/PS2**

- Best Quality
  - Lowest Prices
- 800/1600/3200/6250 BPI

CALL 1-800-886-4827



**Laguna Data Systems**

26941 Cabot Road, Laguna Hills, CA 92653  
 Tel: 714-367-0497, Fax: 714-367-0508



Circle 220 on Inquiry Card.

**Desktop 9-Track Tape Subsystem  
 #1-selling 9-track system on desktop.**



Qualstar's low cost 1/2-inch 9-track Streaming tape systems bring full ANSI data interchange to IBM AT, PS/2 or Macintosh, giving your micro the freedom to exchange data files with nearly any mainframe or minicomputer in the world.

Systems include DOS or Xenix compatible software, coupler card and cables. High reliability 1600 or 6250 BPI capability may be used for disk backup as well as data interchange.

**QUALSTAR®**

Call us today! For details and to order: Fax (818) 882-4081  
 Phone (818) 882-5822

9621 Irondale Ave., Chatsworth CA 91311

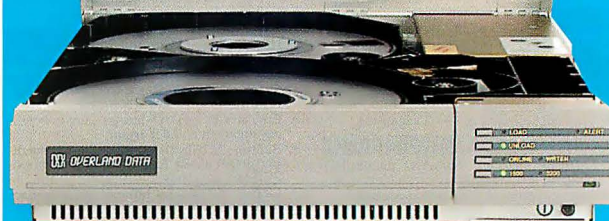
©1989 Qualstar Corp. All product and company names and trademarks are the exclusive property of their respective owners.

Circle 229 on Inquiry Card.

**PC 9-Track  
 & 3480**

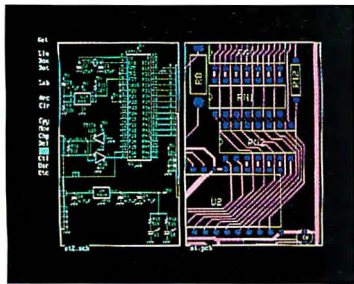
- ✓ Widest choice of solutions
- ✓ Modern desktop subsystems
- ✓ Plug-and-play, easy to use
- ✓ Comprehensive software
- ✓ Excellent service and support

Call now for more information  
 and a free catalog.



**800-729-8725**  
**OVERLAND DATA®**  
 San Diego, CA

Circle 227 on Inquiry Card.



**HiWIRE II Schematic and PCB Software**

With support for expanded and extended memory, HiWIRE II can handle your most demanding schematic and PCB designs. The unique HiWIRE II editor allows you to display and edit schematics and PCBs simultaneously, using the same commands for each. HiWIRE II is \$995, and is guaranteed.



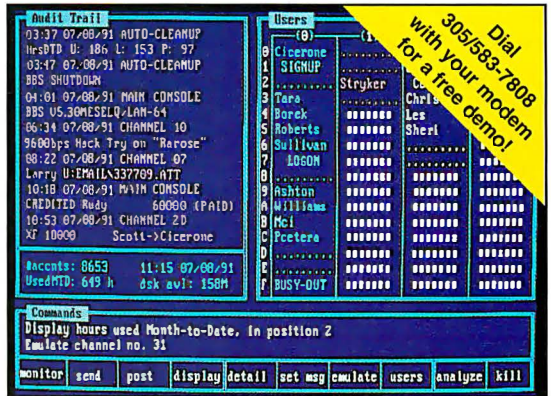
Wintek Corporation  
1801 South Street  
Lafayette, IN 47904

**(800) 742-6809**

Call (800) 742-6809  
or (317) 448-1903

Circle 239 on Inquiry Card.

**"Bulletin boards become a major means of communication"** -Wall Street Journal



Dial 305/583-7808 with your modem for a free demo!

Lots of users (up to 256 at the same time), from all over the world or all around your office, can call into The Major BBS® using modems, your Novell LAN, or X.25 networks such as CompuServe. With a single PC AT, PS/2, 386, 486 or compatible, using DOS 3.1 or later, you can provide:

- E-mail & file transfers
- Public message areas
- Modem server features
- Teleconferencing
- Online order entry
- Multi-user databases
- Polls & questionnaires
- ...24 hrs/day, 7 days/week!

**Call 305/583-5990 or fax 305/583-7846**



**EM320**  
**WINDOWS**

DEC VT320 Emulation for Microsoft Windows 3.0

- 132 column display
- Cut and paste
- Kermit file transfer
- Windows style help
- Local or ANSI color
- Automatic window sizing
- Double high/wide characters
- LAT or TCP/IP support
- Modem dialer/Phone book
- Command language

Diversified Computer Systems, Inc. (303) 447-9251  
FAX (303) 447-1406 Tektronix 4105/107 Emulation also available

Circle 210 on Inquiry Card.

Let your "true colors shine through" when you advertise your computer products in **BYTE's** **HARDWARE/SOFTWARE SHOWCASE**

our newest, affordable, 4-color advertising section!

Call for more details:  
**(603) 924-2695**  
or **(603) 924-2598**

**dBASE Data Entry**

The TransTerm 5 is a work station data entry/display terminal for on-line shop floor data collection into PC/AT/PS-2 systems. The unit is one of a family of such terminals which feature LC displays for operator prompting and data entry via sealed touch keys or an optional barcode scanner or badge reader (Code39,UPC+). A multi-terminal network controller (up to 250 stations) and a dBASE IV compatible software package are also available. System costs start below \$300 per station. Options include display backlighting, barcode scanning, counter inputs, control output.

**COMPUTERWISE®**  
302 N. Winchester • Olathe, KS 66062  
913-829-0600 • 800-255-3739 • FAX 913-829-0810

Circle 205 on Inquiry Card.

## Education • Engineering/Scientific • Graphics

EARN YOUR COLLEGE DEGREE AT HOME

**B.S. & M.S.**  
In Computer Science

Get the opportunity and earning power a college degree confers—without leaving home and without spending thousands of dollars.

- Approved for tuition reimbursement by leading corporations
- ALL COURSES BY CORRESPONDENCE
- Most courses interactive
- Approved Ada course available
- Qualified instructors available on telephone help lines

**AMERICAN  
INSTITUTE  
OF  
COMPUTER  
SCIENCES**

The leading edge of learning

Phone: 1-205-323-6191 • FAX: 1-205-328-2229  
2101 BYX Magnolia Ave. • Suite 200 • B'ham, AL 35205**TURN YOUR PRINTER INTO A  
PEN PLOTTER**

FPLOT™ lets you use your printer as a pen plotter. You get fast, high resolution plots with FPLOT. If you use a CAD or graphics program, you can use FPLOT to produce your plots with the full capabilities of your printer.

- Supports most dot matrix, laser, and ink jet printers
- High resolution output, no jagged lines
- Faster than pen plotters or most laser built-in and cartridge emulations
- Screen preview with zoom and pan
- Supports background plotting
- Device driver mode plots from inside your graphics program
- Stand-alone mode for fastest plotting
- Plot multiple plots with a single command
- Lets you control line thickness
- Full color plotting support
- Plot large plots on wide carriage printers, or as a mosaic
- Compatible with most CAD and graphics programs
- 100% emulation of the HP 7475A pen plotter

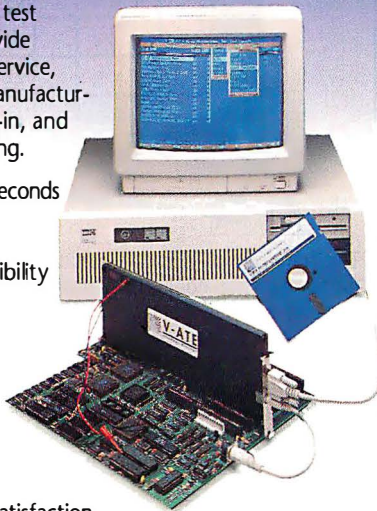
List Price  
**\$119.00**  
+ S&H 3.00**FPLOTT CORP.**24-16 STEINWAY STREET, SUITE 605  
ASTORIA, NEW YORK 11103  
(718) 545-3505

Circle 211 on Inquiry Card.

**FINALLY, SERIOUS  
PC HARDWARE  
DIAGNOSTICS!**Now Supports  
XT/AT/and EISA  
**PS30,35&40  
CERTIFIED!**

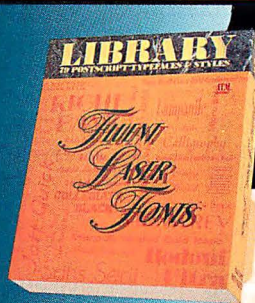
The V-ATE family of test products provide solutions for PC field service, repair depot, R&amp;D, manufacturing inspection &amp; burn-in, and quality assurance testing.

- Test a PC system in seconds
- Insure ZERO hardware defects
- Test for PC Compatibility
- Quality Assurance Certification
- Replace costly test equipment
- Find failures in a 100% dead system
- Eliminate defective PC returns
- Increase customer satisfaction & lower costs thru product quality


**VISTA MICROSYSTEMS, Inc.**  
6 Whipple St., No. Attleboro, MA 02760  
Tel. 508-695-8459 • FAX 508-695-8688

Circle 238 on Inquiry Card.

## Graphics

*"If I could buy only one PostScript font package, this would be it."*

WordPerfect Magazine September 1991

**Fluent  
Laser  
Fonts™  
Library**  
A Large  
Font  
Inventory  
at a Very  
Low Price!
**79 typefaces of superior quality**

- Quick, easy installation & use
- 50% discount offer on additional font volumes

**PC/DOS Version**

- PostScript Type 1 fonts
- **FREE!** - Adobe's ATM®
- Use with most printers w/Windows
- Exceptional WordPerfect® Installer
- **\$189.95**

**Macintosh Version**

- PostScript Type 1 and TrueType fonts
- **\$179.95**

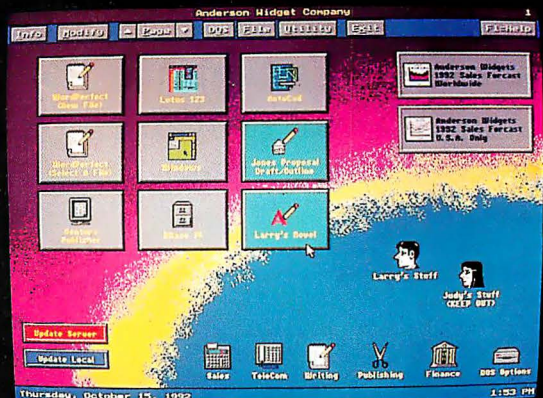
Casady &amp; Greene, Inc.

22734 Portola Dr., Salinas, CA 93908-1119

(408) 484-9228 (800) 359-4920

Fax (408) 484-9218

Circle 202 on Inquiry Card (RESELLERS: 203).

**The New Industry Standard in  
Graphical Menuing Systems!**
 Free Form Screen Layout  
Choice of Fonts & Colors  
Automatic Installation  
File Manager  
Icon Editor  
Calculator  
Calendar  
Phone Dialer  
Usage Tracking  
Password Protection  
User Prompting  
NOT Memory Resident  
PCX Background (req. EMS)  
Network Compatible  
Supports CGA/EGA/VGA/Herz  
Does NOT require Windows™
**QuikMenu™ III****\$89.95\***

30 day money back guarantee

**1-800-545-1392**

Fax: (503) 388-8221

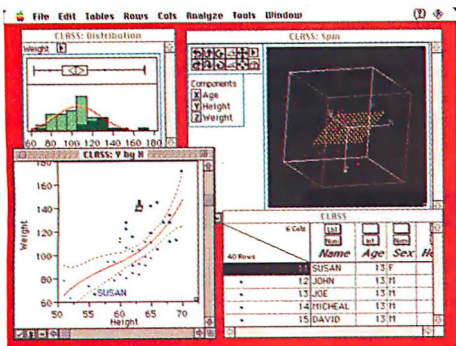
Demo disk available  
OEM & Dealer inquiries welcome  
\*Please add \$5.00 shipping & handlingOSCS  
Software  
Development  
Inc.

354 NE Greenwood Ave., Suite 108 ▲ Bend, OR 97701

Circle 246 on Inquiry Card.

**JMP® Statistical Discovery Software**

*"This application can do the jobs of as many as six separate programs and do them all well. Yet it is not*



*overly complicated or bulky... We believe that JMP is an excellent value and will make short work of all but the most demanding mainframe-oriented data-analysis chores."*

**MacWEEK**



Call today for a free demo disk and Points of Interest from the leading name in data analysis software...SAS Institute Inc. 919-677-8000. Fax 919-677 8166. JMP is a registered trademark of SAS Institute Inc. Copyright © 1992

Circle 230 on Inquiry Card.

**Cross Assemblers, Simulators, Disassemblers**



Processor Families:

8051	8096	8048
Z80	64180	6301
6805	6800	1802
6811	6502	68k
8085	6801	Z8

Join Thousands of Satisfied Customers Worldwide.

Call:

**PseudoCorp**

716 Thimble Shoals Blvd., Newport News, VA 23606  
Tel: (804) 873-1947 • Fax: (804) 873-2154

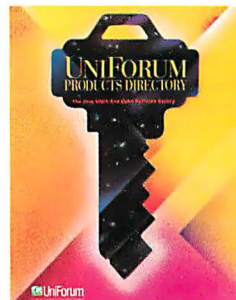
Circle 228 on Inquiry Card.

**Don't Move without telling BYTE**

Clip out form at right mail to: ➤

BYTE Magazine  
Subscriber Service  
P.O. Box 555  
Hightstown, NJ 08520

**THE ONLY UNIX AND OPEN SYSTEMS SOURCE**



**Why look anywhere else?**  
If it's not in the 1992 UniForum Products Directory, chances are you won't find it elsewhere. The 1992 Directory features 7,600 products and services from 2,100 vendors. We've got it all. More software. More hardware and peripherals. More developers, consultants, books and headhunters than available anywhere else. Only \$95.

To order, call 800-255-5620

UniForum 2901 Tasman Dr., #201, Santa Clara, CA 95054  
(800) 255-5620 (408) 986-8840 Fax (408) 986-1645

Circle 247 on Inquiry Card (RESELLERS: 248).

**How to Make Great Color Images!**



Image-In-Color software for Windows 3.0 is the most advanced true-color, CGA, VGA or 24-bit image processing system available for the PC! Spectacular functions provide a darkroom on your desk, with precise control of pressure, density and size of retouching tools such as pencil, paint brush, air brush and others. Clone items in an image instantly! Use photographic filters for powerful dimensions in design. CMYK color separations are super fine-tuned and calibrated by Agfa Compugraphic. Supports HSV and RGB color, with intuitive color or picking. Supports all popular 16- or 24-bit video boards and scanners including:



IMAGE-IN INCORPORATED

**1-800-345-3540**

406 E. 79th St. • Minneapolis, MN 55420 • FAX 612-888-3665  
Outside N. America call CPI, Geneva + +41-22-436-800

IBM 3119  
Microtek HP  
Ricoh Howtek  
Sharp

Circle 217 on Inquiry Card.

At least 8 weeks before you move, please give us your new address and/or name change. (Please Print)

New address, name \_\_\_\_\_  
Name \_\_\_\_\_  
Address \_\_\_\_\_ Apt. \_\_\_\_\_  
City \_\_\_\_\_  
State \_\_\_\_\_ Zip \_\_\_\_\_

Print current name and address  
(or affix the mailing label from your current issue of BYTE here)

Current address, name \_\_\_\_\_  
Name \_\_\_\_\_  
Address \_\_\_\_\_ Apt. \_\_\_\_\_  
City \_\_\_\_\_  
State \_\_\_\_\_ Zip \_\_\_\_\_

# THE BUYER'S MART

## A DIRECTORY OF PRODUCTS AND SERVICES

THE BUYER'S MART is a monthly advertising section which enables readers to easily locate suppliers by product category. As a unique feature, each BUYER'S MART ad includes a Reader Service number to assist interested readers in requesting information from participating advertisers.

Effective January 1, 1992.

RATES: 3 issues—\$625 6 issues—\$600 12 issues—\$525 13 issues—\$500  
Prepayment must accompany each insertion. VISA/MC Accepted.

AD FORMAT: Each ad will be designed and typeset by BYTE. Advertisers must

furnish typewritten copy. Ads can include headline (23 characters maximum), descriptive text (250 characters is recommended, but up to 350 characters can be accommodated), plus company name, address and telephone number. Do not send logos or camera-ready artwork.

DEADLINE: Ad copy is due approximately 2 months prior to issue date. For example: November issue closes on September 8. Send your copy and payment to THE BUYER'S MART, BYTE Magazine, 1 Phoenix Mill Lane, Peterborough, NH 03458. For more information call Joseph Mabe at 603-924-2656. FAX: 603-924-2683.

### ACADEMIC COMPUTING

#### Transputer Education Kit Get started with Parallel Processing \$396

Kit includes ready-to-use PC add-in board with T400 transputer, 1MB of RAM, and PC interface. Complete with Occam2 and C compilers, assembler, source-level debuggers, example programs, and 1500 pages of documentation (incl. schematics). Expandable!

#### Computer System Architects

950 N. University Avenue, Provo UT 84604  
(800) 753-4CSA (801) 374-2300 FAX (801) 374-2306

Inquiry 701.

### ACCESSORIES

#### RADIOACTIVE?

Plot it on your PC with The RM-60 RADIATION MONITOR. Serial or printer port. Detects: ALPHA • BETA • GAMMA • X-RAY. MicroR, 1000 times the resolution of standard geiger counters. Excellent for tracking RADON GAS. Find sources. New: Version 2.7 + WINDOWS. Plot: • Background • Cosmic Rays • Clouds • Foods. Call/Write for PC MAGAZINE review. • TSR • GM Tube. VISA/MC/EURO Phone orders. Not satisfied? Full refund.

800-729-5397 or Tel/Fax: (302) 655-3800  
Aware Electronics Corp.  
P.O. Box 4299, Wilmington, DE 19807 \$149.50

#### CUT RIBBON COSTS!

Re-ink your printer ribbons quickly and easily. Do all cartridge ribbons with just one inker! For crisp, black professional print since 1982. You can choose from 3 models: Manual E-Zee Inker — \$39.50  
Electric E-Zee Inker — \$94.50  
Ink Master (Electric) — \$189.00  
1000s of satisfied users. Money-back guarantee.

#### BORG INDUSTRIES

525 MAIN ST., JANESVILLE, IA 50647  
1-800-553-2404 In IA: 319-987-2976

Inquiry 702.

#### KEYBOARD, VIDEO, MOUSE

Extension with **EXTENDER**  
Splitting with **COMPANION**  
Switching with **COMMANDER**

Boosts signals up to 600 feet. Control up to 96 PCs with one keyboard and monitor.

#### CYBEX CORPORATION

2800H Bob Wallace Ave., Huntsville, AL 35805  
Phone 205-534-0011 Fax 205-534-0010

Inquiry 703.

#### HEWLETT PACKARD

Buy — Sell — Trade

Laser Jet II/III Color Pro (7440)  
Laser 2000 2 Meg/4 Meg upgrades HP 7550A  
Desk Jet Draft Pro DXL/EXL  
Rugged Writer Draftmaster II/II  
Electrostatic Plotters C1600 (D Size)/C 1601 (E Size)  
Science Accessories Corporation Sonic Digitizers  
36" x 48" (2750) 60" x 72" (3175)

#### T. E. Dasher & Associates

4117 Second Ave. S., Birmingham, AL 35222  
Phone: (205) 591-4747 Fax: (205) 591-1108  
(800) 638-4833

Inquiry 704.

346 B Y T E • MARCH 1992

### BAR CODE

#### LABELING SOFTWARE

On EPSON, IBM, OKI dot matrix or LaserJet. Flexible design on one easy screen. Any format/size. Up to 120 fields/label. 18 text sizes to 3"-readable at 100'. AIAG, MIL-STD, 2 of 5, 128, UPC/EAN, Code 39. File Input & Scanned logos/symbols (PCX)—\$279. Other programs from \$49. 30-day \$\$ back.

#### Worthington Data Solutions

417-A Ingalls St., Santa Cruz, CA 95060  
(408) 458-9938 (800) 345-4220

#### BAR CODE READERS

For PC, XT, AT, & PS/2, Macintosh, and any RS-232 terminal. Acts like 2nd keyboard, bar codes read as keyed data. With steel wand—\$399. Top rated in independent reviews. Works with DOS, Xenix, Novell, Alloy, -ALL software. Lasers, magstripe, & slot badge readers. 30-day \$\$ back.

#### Worthington Data Solutions

417-A Ingalls St., Santa Cruz, CA 95060  
(408) 458-9938 (800) 345-4220

#### PORTABLE READER

Battery-operated, handheld reader with 64K static RAM, 2x16 LCD display, 32-key keyboard, Real-Time-Clock. Wand or laser scanner. Program prompts and data checking through its own keyboard. Easy data transfer by RS-232 port or PC, PS/2 keyboard. Doubles as On-Line Reader. 30-day \$\$ back.

#### Worthington Data Solutions

417-A Ingalls St., Santa Cruz, CA 95060  
(408) 458-9938 (800) 345-4220

#### PRINT BAR CODES/BIG TEXT FROM YOUR PROGRAM

Add bar codes and big graphics characters to your program. Print from ANY MS-DOS language. Bar codes: UPC, EAN, 2 of 5, MSI, Code 39, Epson, Oki, IBM dot matrix text up to 1/2". LaserJet up to 2". Font characters not required. \$179-\$239. 30-day \$\$ back.

#### Worthington Data Solutions

417-A Ingalls St., Santa Cruz, CA 95060  
(408) 458-9938 (800) 345-4220

#### BAR CODE READERS

Keyboard emulation for PC/XT/AT & PS/2's, all clones and any RS-232 Terminal. Transparent to your operating system. Available with Steel wands, Lasers, Slot & Magstripe Readers. Same day shipping. 30-day money-back guarantee. One-year warranty. Reseller discounts available.

#### AMERICAN MICROSYSTEMS

2190 A Regal Parkway, Euless, TX 76040  
(800) 648-4452 (817) 571-9015 FAX (817) 685-6232

### BAR CODE

#### BAR CODE PRINTING SOFTWARE

- MS/PC DOS SYSTEMS
- 9 & 24 PIN DOT MATRIX
- H-P LASER JET/PLUS/SERIES II
- MENU-DRIVEN or MEMORY RESIDENT
- CODE 39, 1/25, UPC A/E, EAN 8/13
- BIG TEXT & BAR CODE SOFTONTS

#### AMERICAN MICROSYSTEMS

2190 A Regal Parkway, Euless, TX 76040  
(800) 648-4452 (817) 571-9015 FAX (817) 685-6232

#### PORTABLE BAR CODE READER

Battery operated, handheld reader with 64K RAM, 54 key keyboard, real-time clock, 2X16 LCD display, and built-in calculator. Supports WAND, CCD, and LASER. Built-in program generator supports multiple programs and data files. Interfaces to PC & PS/2 keyboards, RS-232 terminals, and HAYES compatible modems. 30-DAY MONEY-BACK GUARANTEE.

#### AMERICAN MICROSYSTEMS

2190 A Regal Parkway, Euless, TX 76040  
(800) 648-4452 (817) 571-9015 FAX (817) 685-6232

#### BAR CODE READING

\$149.00

Complete with Wand

#### COMPUTER RESOURCES GROUP

629 Silverdale Drive, Claremont, CA 91711

CALL (714) 624-8734

Inquiry 705.

#### BAR CODE WEDGE & WAND: \$179

AGGRESSIVE PRICING! . . . Reseller discounts. User software-transparent keyboard emulation wedges for PC's, clones, PS/2, and Macintosh. RS-232 bar code readers. LASER, CCD scanners, bar code slot readers, magnetic stripe. Scans all popular bar codes. Label and Bar code printing software. 30-day money back.

#### DATA HUNTER

6181 Medford, Huntington Beach, CA 92647  
(714) 892-5461 Fax 714-892-9768

Inquiry 706.

#### I. T. S. Bar Code Solutions

Bar codes are easy using our FULL line of readers & printers. They plug & play with your existing CPU/printer/terminals/software systems in your office, store, truck, factory or warehouse. ITS' bar code DOS programs print on matrix or laser printers. 30 day refund, 1 year warranty. OEM/VAR/ Dealer discounts.

#### International Technologies & Systems Corp.

655-K North Berry St., Brea, CA 92621-Western USA  
13 Welwyn Court, Richmond, VA 23229-Eastern USA  
(800)228-9487 (714)990-1880 (804)741-6725 (FAX)990-2503

Inquiry 707.



## BAR CODE

### PC BAR CODE SPECIALISTS

Bar code readers designed for fast, reliable, cost-effective data entry. They emulate your keyboard, so scanned data looks just like it was typed in! Choose from stainless steel wand, laser gun, card slot reader, and magnetic stripe scanner. Also, powerful Bar Code and Text printing software. Great warranty. Generous dealer discounts.

**Seagull Scientific Systems**  
15127 N.E. 24th, Suite 333, Redmond, WA 98052  
206-451-8966

### DATA INPUT DEVICES

Bar Code, Magnetic Stripe Readers & SmartCard Encoder/Reader for microcomputers & terminals, including IBM PS/2 & others, DEC, Macintosh, AT&T, CT, Wyse, Wang. All readers connect on the keyboard cable & are transparent to all software. UPC & 39 print programs, magnetic encoders, & portable readers are also available.

#### TPS Electronics

4047 Transport, Palo Alto, CA 94303  
415-856-6833 Telex 371-9097 TPS PLA  
1-800-526-5920 FAX: 415-856-3843

Inquiry 708.

### TIMEWAND II

#### RUGGEDIZED PORTABLE BAR CODE READER

The TimeWand II is made with a durable cast metal case to give your data full protection. Three memory sizes of 32K, 64K or 128K are available. Standard features include a 19-button keypad and a 32-character display which shows the bar code that has been scanned along with the date and time. TimeWand II starting at \$698.00.

Call today for a free information kit.

#### VIDEX, INC.

1105 NE Circle Blvd., Corvallis, OR 97330 (503) 758-0521

Inquiry 709.

## BBS

### BBS SYSTEMS

\*\* BBS Package now available with "Programmer Fresh" shareware on CD ROM. Have a going BBS within days. Complete start-up package available @ best prices.

GREAT HOBBY -- GREAT AVOCATION \*\*

#### Islo Tech Inc.

PO Box 431, Excelsior, MN 55331  
800/722-9724, 612/934-2024 (Voice)  
612/934-2824 (Fax)

Inquiry 710.

## CAD

### PCB & SCHEMATIC CAD—\$195

"EASY-PC" for single-sided and multilayer boards to 17" x 17" with up to 1500 ICs including surface mount. Phenomenally fast and easy to use. Over 11,000 copies sold. Needs PC/X/17286/386 HERC/CGA/EGA/VGA. Output to laserjet/injet/dot matrix printer, pen-plotter, photo-plotter and NC Drill. Not copy protected. VISA/MC/AMEX welcome. For full info circle inquiry # or contact us direct.

#### NUMBER ONE SYSTEMS LTD.

Harding Way, St. Ives, Huntingdon, Cambs, England, PE17 4WR  
Tel 011-44-480-61778 Fax 011-44-48-494042

Inquiry 711.

### VIEW CAD DRAWINGS

SirlinVIEW Allows non-CAD users to view AutoCAD DWG, DXF & HPGL files on PCs. Print, Plot, attach notes and hyper-link between files. Change views and layers. Accurate! Query databases to locate & highlight objects on the screen.

Also, linkable SirlinVIEW/LIB allows developers to add viewing capabilities to their own applications.

#### Sirlin Computer Corporation

25 Orchard View Dr., Ste. 14, Londonderry, NH 03053  
(603) 437-0727 Fax (603) 437-0737

Inquiry 712.

## CAD/CAM

### STEPPER MOTOR CONTROL

FROM A MOTOR PORT!

NEW

Indexer LPT™ software  
VERSION 2.1

\$249

VISA/MC

- Controls up to six motors simultaneously
- Linear and Circular Interpolation.
- New features to accommodate machine control.
- Easy-to-use DOS device driver. Super Manual.
- CAD-CAM interface available.

#### Ability Systems

Corporation, 1422 Arnold Ave.  
Roslyn, PA 19001 (215) 657-4338  
FAX (215) 657-7815

Inquiry 713.

### FREE TECHNICAL REPORT!

Just request info about the:

#### "CAD/CAM Developer's Kit" Series

C Libraries for CAD/CAM, Engineering and GIS Applications  
650+ routines for DXF input/output, graphical display, line/arc/ellipse/NURB spline construction/editing, and much more than can be described here.

Phone or FAX (617) 899-4350 for more information.

#### Building Block Software, Inc.

371 Moody Street, Waltham, MA 02154

Inquiry 714.

### GREAT NEWS AutoCAD USERS

KIS Scaling "The Problem Solver" makes R11 Vport scaling easy. Create R11 Dimstyles "On The Fly" with KIS DIM Module Icons. KIS Scaling, REAL control of text, arrows & LTSscale for R10 or R11. AutoDwgLoad lets you load drawings with popdown menu. New EXTEND-TRIM.LSP—Tutorial + AutoSizing + Autosave. Multi-scale dwgs are easy, so is ordering 800-833-4547. ONLY \$249.

#### KIS SOFTWARE, INC.

Box 663, Pearisburg, VA 24134

Inquiry 715.

## CD-ROM

"Programmer Fresh" Shareware available now. Newest programs and latest updates. Quarterly update 1/1/92. Also, Islo/Tech Select Shareware CD ROM with over 400 MB of IBM, Amiga, and Mac shareware and graphics. IBM files updated to 1/1/92. BBS Kit available.

#### Islo Tech Inc.

PO Box 431, Excelsior, MN 55331  
1-800/722-9724, 612/934-2024 (Voice)  
612/934-2824 (Fax)

Inquiry 716.

### FACE THE FACTS!

Discover the Advantages of the New and Improved  
Wayzala World Factbook 1991

To date, this is Wayzala's highest quality release of the world factbook on CD-ROM. It projects our highest standards for maps and the most current information in both text and database or spreadsheet formats. This CD-ROM also contains our TextWare retrieval software and is useable for comparisons between countries on all major data and compatible with all spreadsheet and database programs. Available immediately for the Macintosh and IBM PC or compatibles and comes with our standard 60 day money-back guarantee. Suggested retail price is \$12000 - Order now for our very special introductory offer price of only \$49.00!

#### WAYZALA TECHNOLOGY INC.

Post Office Box 807, Grand Rapids, Minnesota 55744  
Tel: 800-735-7321 (218) 326-0597 Fax: (218) 326-0598

Inquiry 717.

## COMMUNICATIONS

### SDLC, HDLC AND X.25 SUPPORT

Use Sangoma hardware and software to provide cost effective, robust and easy-to-use SDLC, HDLC and X.25 links from MS-DOS, UNIX, PC-MOS, etc. All real time communication functions performed by intelligent co-processor card.

Full function SNA emulation packages also available.

#### Sangoma Technologies Inc.

(416) 474-1990 1-800-388-2475

Inquiry 718.

## COMPUTER INSURANCE

### INSURES YOUR COMPUTER

SAFWARE Computerowners coverage provides replacement of hardware, media and purchased software. As little as \$49 a year covers accidents, theft, power surges and more. One call does it all. Call 8 am-10 pm ET. (Sat. 9 to 5)

TOLL FREE 1-800-848-3469

(Local 614-262-0559)

SAFWARE, The Insurance Agency Inc.

Inquiry 719.

## CROSS ASSEMBLERS

### CROSS ASSEMBLERS

Universal Linker, Librarian  
Targets for 42 Microprocessors  
Hosts: MS-DOS, UNIX, VAX VMS

#### ENERTEC, INC.

BOX 1312, 811 W. Fifth St.  
Lansdale, PA 19446

Tel: 215-362-0966 Fax: 215-362-2404

Inquiry 720.

### CROSS ASSEMBLERS/SIMULATORS

New unique full-function simulators for the 8096 and 80C196 controllers, featuring ALL MODES of interrupts, plus the HSI, HSO, and A/D functions.

We also support the 8048/49, 8080/85, 8051/52, and Z80 controllers with excellent, reasonably priced Cross Assemblers and Simulators.

#### Lear Com Company

2440 Kipling St., Ste. 206, Lakewood, CO 80215  
(303) 232-2226 FAX: (303) 232-8721

Inquiry 721.

## CROSS DISASSEMBLERS

### PROFESSIONAL DEVELOPMENT SOFTWARE ASSEMBLERS/DISASSEMBLERS

8051, 8048, 8096, 8080/85, Z80/180, Z8000, SPARC, 6800, 6809, 68HC11, 680X0, 6502/C02, 6301, 9900

COMPLETE, OPTIMIZED DEVELOPMENT TOOL SETS FOR THE ENGINEERING PROFESSIONAL

CALL (408) 773-8465

LOGISOFT PO BOX 61929, SUNNYVALE CA 94086  
FAX: (408) 773-8466

Inquiry 722.

## DATA ANALYSIS

### FORECASTING SALES • INVENTORIES • BUYING

- DynaMind™ Neural Network Software
- Developed with Intel • PC Based
- Finds patterns in large amounts of data
- Menus, manual, full-color graphic interface
- Processes data from spreadsheets

ONLY \$145!

FREE Brochure: 303/442-3539

NeuroDynamX, Inc.  
PO Box 323  
Boulder, CO 80306  
FAX 303/442-3539

Inquiry 723.

## DATA RECOVERY

### Lst yr dta?

We can find it.

- 95% success rate • Fast turn around
- Priority service available • Clean room
- Servicing Novell, DOS, Macintosh, SyQuest and removable media, Unix, Xenix, OS/2, Banyan Vines, Bernoulli, Sun and more!

#### ONTRACK DATA RECOVERY, INC.

6321 Bury Drive, Eden Prairie, MN 55346  
1-800-872-2599 • 612-937-5161

Inquiry 724.

# THE BUYER'S MART

## DATA RECOVERY

**Now we're  
ONTRACK in  
London Too.**

### ONTRACK DATA RECOVERY EUROPE, LTD.

Surrey House, 34 Eden St., Kingston upon Thames, Surrey KT1 1ER U.K.  
0800-24-39-96 • 44-81-549-3444

Inquiry 725.

## DATA/DISK CONVERSION

### INCOMPATIBLE COMPUTERS?

We transfer files between incompatible computers, dedicated word processors and 9-track tape. Thousands of formats are supported, including cartridge tapes. We're committed to customer satisfaction and quality conversions at affordable prices. Call for a free quote today!

• 24-hour turnaround available •

**Disk Interchange Service Company**  
2 Park Drive • Westford, MA 01886 • (508) 692-0050

Inquiry 726.

### Quality Conversions

Tape — Cartridge  
Disk — Scan  
Lowest Price

Call... 1ST Run Computer Services Inc.

**(800) 833-2207** (outside NY)  
**(212) 779-0800** (in NY)

Inquiry 727.

### THE #1 CHOICE

#### In disk & tape conversion

for many leading corporations, government agencies, law firms, and companies in every industry...world-wide.

Free test • Satisfaction guaranteed

### Graphics Unlimited Inc.

3000 Second St. North, Minneapolis, MN 55411  
(612) 588-7571 FAX: (612) 588-8783  
1-800-745-7571

Inquiry 728.

### QUALITY CONVERSIONS

to or from virtually

#### ANY TAPE OR DISK FORMAT!

Horan Data Services converts and translates data to/from 9-TRACK TAPE, 3480, 8MM & 1/4" CARTRIDGES AND ALL SIZES & DENSITIES OF DISKETTES.

Thousands of formats supported including EBCDIC, ASCII, databases, dedicated and PC word processors and typesetters.

Call 1-800-677-8885

Hours 8:00AM to 5:30PM Eastern Time  
817 Main Street, Third Floor, Cincinnati OH 45202

Inquiry 729.

### IBM PC TO HP FILE COPY

FASTER EASIER TO USE

Update version uses windows: Call for free demo! IBM PC <to> HP File Copy allows IBM PCs, PS/2, compatibles to interchange files with Hewlett-Packard Series 70, 80, 200, 300, 1000, 9000s.

#### Oswego Software

Box 310 708/554-3567  
Oswego, IL 60543 FAX 708/554-3573

Inquiry 730.

348 BYTE • MARCH 1992

## DATA/DISK CONVERSION

### CONVERSION SERVICES

Convert any 9-track magnetic tape to or from over 3000 formats including 3 1/2", 5 1/4", 8" disk formats & word processors. Disk-to-disk conversions also available. Call for more info. Introducing OCR Scanning Services.

#### Pivar Computing Services, Inc.

165 Arlington Hgts. Rd., Dept. #B  
Buffalo Grove, IL 60089 (800) Convert

Inquiry 731.

## DISK DRIVES

### IBM PS/2 HARD DRIVES

30MB	MOD 30, 30-286	\$350
30MB	MOD 50Z, 55SX	450
60MB	MOD 50Z, 55SX, 70	695
120MB	MOD 50Z, 55SX, 70	795

New, genuine Big Blue Product with 1 yr. Warranty. Call for Model 60/80 drives. Terms: COD/MC/Visa

### COMPUTER TECHNIQUES

Merritt Island, FL 32953-3484  
Phone/Fax (407) 453-8783

Inquiry 731.

## DSP DEVELOPMENT

### Digital Signal Processing

- TMS320C30 and TMS320C25 processor boards with up to 8Mbyte fast SRAM.
- Analog interface modules, dual channel, 16-bit resolution, up to 400KHz sample rate.
- C compilers, Assembler/Linkers, Simulators.
- Data acquisition and analysis software.
- Filter design software.

#### Bridgenorth Signal Processing Inc.

P.O. Box 469 Tel: (604) 538-0003  
Custer, WA 98240 FAX: (604) 535-9073

Inquiry 732.

## EDUCATION

### B.S. & M.S. In COMPUTER SCIENCE

The American Institute for Computer Sciences offers an in-depth correspondence program to earn your Bachelor of Science and Master of Science degrees in Computer Science at home. B.S. subjects covered are: MS/DOS, BASIC, PASCAL, C, Data File Processing, Data Structures & Operating systems. M.S. program includes subjects in Software Engineering and Artificial Intelligence.

#### AMERICAN INST. for COMPUTER SCIENCES

2101-BY Magnolia Ave. South, Ste. 200, Birmingham, AL 35205  
800-767-2427 205-323-6191

Inquiry 733.

## ENTERTAINMENT

### Go, NEMESIS, Go

Go - a Zen game. So appealing, it has endured 4,000 years. So useful, governments study it.

NEMESIS Go Junior entices novices of any age. NEMESIS Go Master Deluxe satiates the addicted. Windows, Macintosh and DOS versions available.

Chaos Manor User's Choice Award (BYTE/1990)

#### Toyogo, Inc. (800) 869-6469

PO Box 25460-Y, Honolulu, HI 96825-0460  
(808) 396-5526 fax: (808) 396-4126

Inquiry 733.

## FAULT TOLERANCE

### No\*stop Network

No\*stop Network, the only Level 3 Fault Tolerant software product that allows MIRRORRED SERVERS and CONTINUOUS PROCESSING in any PC/LAN. Supports Novell, Microsoft, IBM, Banyan, etc. Any server environment—DOS, OS/2, Unix, Wang, DEC, etc.

#### Nonstop Networks Limited

20 Waterside, New York, NY 10010  
212-481-8488

Inquiry 734.

## FINANCIAL SOFTWARE

### BrainMaker:

"The most fascinating computer software I've ever seen...learn about this stuff." *John Dvorak, PC Mag.* Predicts stocks, bonds, sales, inventories. Comprehensive manual. Menus. 12,000 sold. PC or Mac.

Still only \$195!

Free Flyer: 800/284-8112, 916/477-7481

**California Scientific Software**

Inquiry 735.

## FLOW CHARTS

### New Windows 3.0 Diagramming Tool

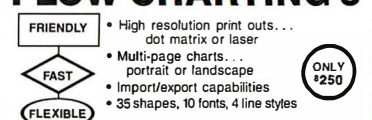
ADS Diagrammer is a general purpose diagramming tool which can be used to create flow charts, block diagrams, structure charts, DFDs, and more. Customize for your type of diagram by adding your own symbols and line terminators to the existing libraries. Draw symbols within symbols. Link Objects. Manipulate curves directly. Call for free trial disk.

#### \$250 Atlantic Design Systems

Phone: (800) 745-6095 or (603) 524-2943  
Fax: (603) 524-3657

Inquiry 736.

## FLOW CHARTING 3



Call for free demo disk!  
**PATTON & PATTON** 800-525-0082 ext. 1315  
Software Corporation 485 Cochran Cr., Morgan Hill, CA 95037  
See our ad on page 102

Inquiry 737.

## WINDOWS FLOWCHARTER \$129

RFFlow 2.0 is a professional drawing tool for flowcharts & org charts. Requires Microsoft Windows 3.0. 100 shapes auto adjust in size. Diagonal lines and curves. Auto line routing and re-routing. Click on a shape to bring up a sub-chart. Move charts to other apps. via the Clipboard. Call for free trial disk.

#### RFF ELECTRONICS

1053 Banyan Court, Loveland, CO 80538  
Phone: (303) 663-5767 FAX: (303) 669-4889

Inquiry 737.

## FONT

### Meet our NEW "FASE" in the crowd

• Fonts on-the-fly for WordPerfect 5.0/5.1 • Scalable • Infinite font effects • WYSIWYG previewer • supports most printers/fax board • 150 fonts library • network version available • basic package includes 35 Type 1 fonts • NewFase V3.0 introductory offer \$79 expires 12/31/91 (Reg. \$99)

"NewFase" does what the best software utilities are supposed to do: save you time and money, and make your work look good." Karl Signell, Capital PC Monitor, 11/90

#### MicroPress

41 Witherspoon St., Princeton, NJ 08542  
TEL 908-821-0255 FAX 908-821-5339

Inquiry 738.

## HARD DRIVE REPAIR

### HARD DRIVE REPAIR

ALSO

#### DATA RECOVERY

FAST TURN!! CALL FOR DETAILS

### H&W micro labs, inc.

528-C Forest Parkway, Forest Park, GA 30050  
404-366-1600 Fax: 404-366-0040

Inquiry 739.

## HARD DRIVE REPAIR

CAPACITY	MFM/RL/ESDI/SCSI/IDE	LOWEST DISC DRIVE REPAIR PRICES
Test & Evaluation	\$15	
10-29Mb	75	
30-39	85	
40-49	105	
50-85	140	
86-120	175	
121-160	205	
161-350	259	
351-700	395	

**jb TECHNOLOGIES, INC.**  
5105 Maureen Lane  
Moorpark, CA 93021  
Phone: (800) 688-0908  
FAX: (805) 529-7712

Inquiry 740.

## HARD DRIVES

### MONSTER DRIVE SALE™

PLI External SCSI Hard Drives for PC, Mac, NeXT  
These top rated drives are manufactured by Peripherals Land, Inc. (PLI)

Fixed	Removable	
104 mg Connor (Mini)	498.33	44 mg SyQuest 599.53
200 mg Connor (Mini)	819.28	88 mg SyQuest 798.57
320 mg WrenRunner II	179.708	21 mg Sony Floptical 551.83
635 mg WrenRunner II	2524.08	CD-ROM 649.53
PC SCSI Cards & Adapters	Media & Sony Opticals	Call
ISA QuickSCSI (DOS)	168.63	OS2, Novell, Unix QuickSCSI 193.63
Parallel to SCSI Adaptor	176.75	PS2 MCA SCSI 220.83

**CONCORD PSF & MAGIC**  
Voice & Fax: (503) 645-0324 PO Box 190, Beaverton, OR 97075 0190  
Shipped Fed Ex Economy \$7 in USA. Visa/MasterCard/Discover billed as Trade Mark.

Inquiry 741.

## HARDWARE

### AMI/MYLEX MOTHERBOARDS

386	33MHz, 64k, IDE, 2SP&PP	\$ 695
386sx	20MHz, IDE, 2SP&PP	349
486	33MHz, 64k Cache (baby) ISA	1259
486	33MHz, 128k, EISA	1695
GXE 020 B	EISA/TIGA Graphics Adapter	1379
DCE 376	EISA/SCSI Adapter	695
LNE 390	Network Interface for EISA 32-bit	325

2 Year Warranty Factory Service

### EXALINX, Inc.

Beautiful Buffalo, New York USA  
(800) 992-5469 FAX (716) 882-9650

Inquiry 742.

## DOS & WINDOWS PROBLEMS

can be resolved with an Award BIOS ROM Upgrade. Windows 3.0 and DOS 5.0 support. Add IDE drives, 3 1/2" 1.44Mb floppies, more. Call for our FREE Catalog.

### KOMPUTERWERK, INC.

851 Parkview Blvd., Pittsburgh, PA 15215  
ORDERS 800 423-3400 Tech (412) 782-0384 Fax (412) 782-5077

Inquiry 743.

## MAINFRAME POWER

### Microcomputer Price!

- MultiTask
  - REAL DOS
  - Unlimited Users\*
  - Ethernet Compatible
- ONLY...\$995<sup>00</sup>** Which includes
- New fast 40 MEG HD (17msec) replaces your C drive
  - Complete setup with utilities. DOS & DOS files, menu & system manual.
  - Can boot regular single user DOS also

### OCTOPUS SYSTEMS Inc.

"Many DOS arms to serve you"  
404-448-4980 FAX: 404-448-5032

Inquiry 744.

## PRE-OWNED ELECTRONICS, INC.

THE Independent Provider, serving the Dealer, Professional, Corporate, Government, and Educational Buyer since 1985.

APPLE® II & MACINTOSH® SYSTEMS • PARTS • EXCHANGE REPAIRS

Call for a Catalog... 800-274-5343  
Int'l: 617-275-4600 • Fax: 617-275-4848  
205 BURLINGTON ROAD • BEDFORD, MA 01730

Inquiry 745.

## HARDWARE

### 386SX, 20MHZ, 1MB, 2FL, 80MB - \$990

MACINTOSH, IBM, AST, EPSON, ALTIMA, NEC, SHARP, HP, HOUSTON INSTRUMENTS, ROLAND, 3M

### Call UCC

213-921-8900 Fax 213-802-0831

13738 Artesia Blvd. 150, Cerritos, CA 90701  
INTERNATIONAL ORDERS WELCOME

Inquiry 746.

## HARDWARE/COMPUTERS

### NEW! 20MHz 16-bit FORTH Single Board Controller with 8ch 10-bit A/D, 3ch 8-bit D/A

TDS2020 FORTH CONTROLLER AND DATA-LOGGER - 4"x3" board uses Hitachi 16-bit H8532 CMOS µP. Screams along at 3MIPS, but runs on only 30mA. On-board high-level easy FORTH language and assembler—no need for in-circuit emulator! Up to 512K NVRAM, 45K PROM. Attach keyboard, lcd, 12C peripherals. Interrupts, multi-tasking, watchdog timer, editor, 33 I/O, 2 x RS-232, 6-16v 300mA data-logging! Free ready-made software solutions. Program with PC. Use for machine control, data-logging, inspection, robotics, remote monitoring, etc. \$299 (25s) STARTER PACK \$499.

CALL NOW FOR DETAILS!

Saelig Company

European Technology

Sale-or-return

tel: (716) 425-3753

fax: (716) 425-3835

Inquiry 747.

### SC/FOX™ EMBEDDED COMPUTERS

PC Parallel Coprocessor Plug-in Boards: 15MIPS avg 50 MIPS burst using the SC32 32-bit CPU or the 16-bit Harris RTX 2000\*. VME Master/Slave System Controller SBC: 18 MIPS avg 70 MIPS burst, uses RTX 2000 cpu, SCSI, 2 ser, 1 prt ports, 10 640K bytes. Stand-Alone Single Board Computers: 18 MIPS avg 80 MIPS burst, 3U or 100x100mm Eurocard-size using either SC32 or RTX 2000. Ideal for embedded real-time control, data acquisition, robotics, and signal processing. OEM software development system included.

**SILICON COMPOSERS INC** (415) 322-8763  
208 California Avenue, Palo Alto, CA 94306

Inquiry 748.

## SDK-386™ \*

\*386 is a trademark of Intel Corporation. Used by permission. BRAND NEW AND AVAILABLE ONLY FROM URDA, INC. along with the URDA SDK-85 and SDK-86 educational trainers and microprocessor development systems. The URDA SDK-51 will be available next year. Other 8, 16, and 32 bit systems are available.

### Phone URDA, Inc.

1-800-338-0517 or 412-683-8732

Inquiry 749.

## LAN ALTERNATIVE

### BYTEPRINT • BYTEWAY • BYTELINK

Protec Microsystems' affordable, reliable, and powerful LAN alternatives let you share peripherals and data across multiple platforms or between PCs.

### SIMPLY • EFFORTLESSLY • QUICKLY

### Protec Microsystems Inc.

1-800-363-8156

Fax: (514) 694-6973

Inquiry 750.

## LANS

## FREELAN

### Complete LAN solution at LAN CARD price

- 2 user Ethernet Starter kit for \$229, including: • Two 8-bit Ethernet cards (w/drivers) • Two terminators and one 15' cable
- Network Operating System for two users. File sharing, Printer sharing. ► 2 user Arcnet Starter Kit for \$159.
- Additional user: Ethernet \$119, Arcnet \$84. • LAN cards and NOS separately available.

### Crystal Computing Corporation

3140 De La Cruz Blvd. Suite 200, Santa Clara, CA 95054  
Tel (408) 748-0125 (800) 726-6209 Fax (408) 748-0879

Inquiry 751.

## LANS

## The \$25 Network

Try the 1st truly low-cost LAN

- Connect 2 or 3 PCs, XT's, AT's
- Uses serial ports and 5-wire cable
- Runs at 115K baud
- Runs in background, totally transparent
- Share any device, any file, any time
- Needs only 14K of RAM

Skeptical? We make believers!

### Information Modes

P.O. Drawer F, Denton, TX 76202

817-387-3339 Orders 800-628-7992

Inquiry 752.

## LANS/SOFTWARE

### NetRunner

Remote Control Program for just \$19.95

- Control remote computer across WAN or LAN • Running on NetBIOS, Novell, RS-232 and Modem • Keyboard locking • Remote execution • File transfer. \$19.95 per user, \$24.95 starter kit, \$99.95 unlimited.
- Network Operating System available for \$39.95, with File/Record locking, Printer Spooling, Peer-to-peer.

### Crystal Computing Corporation

3140 De La Cruz Blvd. Suite 200, Santa Clara, CA 95054  
Tel (408) 748-0125 (800) 726-6209 Fax (408) 748-0879

Inquiry 753.

## LAPTOP COMPUTERS

### SAVE! LAPTOPS\*NOTEBOOKS SAVE!

TOSHIBA • EVEREX • ZENITH • AT • T • TANDON  
AST • SHARP • BONDWELL • ALR • LIBREX  
PANASONIC • ALTIMA • LEADING EDGE  
PACKARD BELL • SAMSUNG • NEC • TI • COMPAQ

### • We ALSO carry accessories and software • Computer Options Unlimited

12 Maiden Lane, Bound Brook, NJ 08805

CALL: (800) 424-7678 Need Help?: 908-469-7959  
9-9 M-F 9-5 Sat. 6 days Worldwide Sales

Inquiry 754.

## IBM CONVERTIBLE

MEMORY-128K \$79 256K \$225 384K \$295

MODEMS-Standard \$75 Enhanced \$175

CRT ADAPTER-for monitors \$99

SERIAL/PARALLEL ADAPTER-\$120

MONITORS-Monochrome \$115 Color \$249

COMPACT Carrying Case \$39

ENHANCED LCD-\$79 BATTERY-\$89

HARD DRIVES-20 Meg-\$495 40 Meg-\$695

MORE ACCESSORIES AVAILABLE

### COMPUTER RESET

P.O. Box 461782, Garland, TX 75046

Phone (214) 276-8072 BBS & FAX (214) 272-7920

Inquiry 755.

## LAPTOP PERIPHERALS

### LAPTOP POWER ADAPTERS

AC and DC input

### TOSHIBA INTERNAL CARDS

Fax/modems: 9600/2400bps, software, acoustic port Modems, exp: 2400 bps, acoustic or serial port Modem, dedicated: 2400 bps (notebooks, T31&3200SX) Serial I/O cards: RS232, RS422, SCSI, HPIL, barcode

Contact us for more information:

PRODUCT R&D Corporation (Calif.)

805/546-9713 Fax 805/546-9716

Inquiry 756.

## PRINTER UTILITY

### NO MORE PAPER SWAPPING

Merge text and PCX files for output on a HP LaserJet or compatible with FormPrinter 10. Run from DOS or integrate into your app. Preload images in printer memory for increased throughput. Include Code 39 bar codes using escape sequences in the text file. Create the PCX files with the editor of your choice. Fully configurable. EXE \$79.00. With source code (MS-C & MASM) \$109.00

### TLC TECHNOLOGY

1831 Wells Branch Pkwy, suite 222, Austin, TX 78728  
(512) 795-3403

Inquiry 757.

# THE BUYER'S MART

## PRODUCT MANAGEMENT

### Keep Track of Bug Reports

New tool gives instant access to information about pending bug reports/suggestions on the products you maintain or support. Eases planning of new releases. No more paperwork, lost reports or hunting for customers' example files. Multiple users (development, marketing, QA) can independently categorize, prioritize, and arrange records. KeyTrack \$495

#### C Street Software

(805) 486-7807 • (800) 350-8649 • Fax (805) 483-7809  
3L Ltd (UK) +44 506 41 59 59 Fax +44 506 41 59 44

Inquiry 758.

## PROGRAMMERS TOOLS

### YOUR SALES MESSAGE

about the special computer product or service that you provide belongs in print.

### THE BUYER'S MART

can help you reach computer professionals and produce valuable inquiries for your company!  
Call Joseph Mabe for more information

**603-924-2656**

or

**Fax: 603-924-2683**

Inquiry 759.

### C and C++ DOCUMENTATION TOOLS

- C-CALL (\$59) Graphic-trees of caller/called hierarchy.
- C-CMT (\$59) Create, insert, update comment-blocks for each function, listing functions and identifiers used.
- C-METRIC (\$49) Path complexity, lines/stmts/comments.
- C-LIST (\$49) List, action-diagram, reformat programs.
- C-REF (\$49) Local/global/parameter cross-reference.
- SPECIAL (\$189) All 5 as DOS/OS2 "C-DOC" program.

### SOFTWARE BLACKSMITHS INC.

6064 St. Ives Way, Mississauga, ONT Canada L5N-4M1  
(416) 858-4466

Inquiry 760.

### DON'T DEVELOP NETWORK APPLICATIONS

without NPPC, a powerful library sub-routine package that handles all the details of NetBIOS or IPX programming! NPPC supports high-level program communications at the message level for all server/client and peer-to-peer models. If you are using C or Assembler, NPPC allows you to write a single application that runs on BOTH IPX AND NetBIOS without any modifications. NPPC is compatible with any true NetBIOS emulator, therefore applications written with NPPC will work with most LANs in the marketplace. We offer a 30 day money back guarantee.

NPPC for IPX or NetBIOS: \$195.00, with source: \$395.00

### SOFTWAREHOUSE CORPORATION

326 State Street, Los Altos, CA 94022

(415) 949-0203 FAX: (415) 949-0208

Inquiry 761.

## PUBLIC DOMAIN

### \$1.00 PER DISK NO MINIMUM ORDER!

Free Catalog of 700+ Programs  
Many Unique, Hard to Find Titles.

(Watch For Our On-Line BBS -Coming Soon!)

### Northern Micro Systems

16 Main St. Absarokee, MT 59001  
(406) 328-4343

Inquiry 762.

### FREE CATALOG FOR IBM PD AND SHAREWARE

SELECTED PROGRAMS  
LATEST VERSIONS  
Low as \$1.50

### SOFTSHOPPE, INC.

TEL: 800-829-2378 • 313-761-7638  
FAX: 313-761-7639

P.O. Box 3678, ANN ARBOR, MI 48106

Inquiry 763.

350 B Y T E • MARCH 1992

## ROM BIOS UPGRADES

### AMI, PHOENIX & MR BIOS

Upgrade your IBM PC, XT, AT or compatible. Also 386SX & 386 versions. Supports 2 user-defined hard drives, 10/1/02 KB, 360, 720, 1.2 & 1.44 floppies, setup in ROM, All Video, Windows 3.0 Diagnostic in ROM AMI 286 & 386 versions only. CALL. New version just came in.

### Advanced Software

4 1/2 Marlboro Road Suite 2R, Derry NH 03038  
800-835-2467 603-432-1532  
Fax: 603-890-1185

Inquiry 764.

## SECURITY

### FIGHT PIRACY!

Since 1986, companies worldwide have been choosing Az-Tech security products. If you demand the strongest protection available, why not choose one of these "proven leaders":

- EVERLOCK Copy Protection
- EVERTRAK Software Security
- EVERKEY II "The Lock"

For IBM and Compatibles. 30 day money back guarantee. Free info and demo disk available.

### Az-Tech Software, Inc.

201 East Franklin, Richmond, MO 64085

(800) 227-0644 Fax: (816) 776-2700  
(816) 776-8398

Inquiry 765.

### THE ULTIMATE COPY PROTECTION

- Completely Menu Driven *Quite Simply*
- Defeats all Hardware/Software Copiers *The Best*
- No Source Code Changes *Ways To*
- Multiple Layering *Protect Your Valuable*
- No Damaged Media *Software Investment*
- Full Hard Disk & LAN Support
- Unlimited Metering, FREE Demo Disk

STOPVIEW™ STOPCOPY PLUS™ (800) 879-2224

BBI COMPUTER SYSTEMS, INC. (301) 871-1094  
14105 Heritage Lane, Silver Spring, MD 20906

FAX: (301) 460-7545

Inquiry 766.

### Cop's CopyLock II

The professional software protection with TRUE Machine Install. Option Board safe. Supports OS/2, Windows and Trace.

### LINK Computer

Int'l: +45 31232350 Fax +45 31238448

US/CAN: 800-344-2545 Fax 408-923-7061

Inquiry 767.

### BIT-LOCK® SECURITY

Piracy SURVIVAL 8 YEARS proves effectiveness of powerful multilayered security. Rapid decryption algorithms. PARALLEL or SERIAL port-transparent security device. Complemented by economical KEY-LOCK™ and multifeatured COMPU-LOCK™ including countdown, timeout, data encryption, and multiprotocol protection. (Dos/Unix/Mac). Also, access control.

### MICROCOMPUTER APPLICATIONS

3167 E. Otero Circle, Littleton, CO 80122  
(303) 770-1917

Inquiry 767.

### HANDS OFF THE BOARD® 1/2 SIZE SECURITY BOARD

Stop floppy boot — Require password to boot PC  
Real-time disk encrypt — prevent boot sector virus  
Prevent DOS FORMAT/FDISK and low-level formats  
Set hard disk READ ONLY or turn ON/OFF  
Turn floppies, printers and COM ports ON/OFF  
IBM XT, AT Bus — DOS V3.0+ — \$149.95 + \$5.00 S/H

### SYSTEMS CONSULTING INC.

PO BOX 11209, Pittsburgh, PA 15238  
(412) 781-5280

Inquiry 768.

## SERVER MIRRORING

### No\*stop Network

No\*stop Network, the only Level 3 Fault Tolerant and Backup software that allows MIRRORED SERVERS and CONTINUOUS PROCESSING in any PC/LAN. Supports Novell, Microsoft, IBM, Banyan, etc. Any server environment—DOS, OS/2, Unix, Wang, DEC, etc.

### NONSTOP NETWORKS LIMITED

20 Waterside, New York, NY 10010  
212-481-8488

Inquiry 769.

## SHAREWARE

Latest Software Versions! Feature of Month:  
"Sure Pick Lotto" program.

Catalog available.

Special premium offer with all purchases.  
Only Quality Products.

PO Box 431, Excelsior, MN 55331  
Islo Tech Inc. 1-800-722-9724, 612/934-2024 (Voice)  
612/934-2824 (Fax)

Inquiry 770.

### FREE SOFTWARE for IBM® •11 asstd. PKGS.

TRY US! 15/5.25" or 8/3.5" Disks full of our best selling software - FREE. Choose from games, fonts utilities, business, educational, desktop publishing, jokes/tricks, Windows, clipart, religion. Pay only \$5.00 shipping per package. Credit cards only.

### SMC SOFTWARE PUBLISHERS

619 931-8111

Inquiry 771.

## SOFTWARE/ACCOUNTING

### dBASE BUSINESS TOOLS

- GENERAL LEDGER
- ORDER ENTRY
- JOB COSTING
- BILL OF MATLS
- PAYROLL
- PURCH ORD/INVENTORY
- ACCOUNTS RECVABLE
- JOB ESTIMATING
- SALES ANALYSIS
- ACCOUNTS PAYABLE

\$99/\$198 ea. + S&H

### DATAMAR SYSTEMS Cred. Card-Check-COD

8586 Miramar Place, San Diego, CA 92121

(619) 452-0044 (800) 223-9963

Inquiry 772.

### MULTI-CURRENCY ACCOUNTING

- Keep accounts in any currency
- Evaluate balances with 3 exchange rates
- Compute gain/loss on exchange
- Full-featured LAN G/L \$199.95+s&h
- Fully functional Demo \$5
- VISA/MC. 30 days money back. Dealers welcome.

### vertech Inc.

17 Ch. Chavanne, CH-1196 Gland, Switzerland  
Tel 011-4122-364-54-90 Fax 011-4122-364-53-93  
BBS 011-4122-364-53-43

Inquiry 773.

## SOFTWARE/BUSINESS

### DATA ENTRY SOFTWARE

Full featured, heads-down data entry with two-pass verification, edit language, operator stats, much more! Designed for the PS/2®, PC, XT, AT or compatibles. PCs from \$395 LAN version available

FREE 30 day trial

Computer Keys Tel: 206/776/6443  
21929 Makah Rd., Fax: 206/776-7210  
Woodway, WA 98020 USA: 800/356-0203

Inquiry 763.

## SOFTWARE/ENGINEERING

### Filter Design Software

• Design Passive LC Filters New-FILTERMASTER-Passive filter design program synthesizes LC reactance filters from user specifications. All conventional types and approximations are supported along with graphical analysis of the filter characteristics. Aleviates tedious and time consuming cookbook methods.

**intisoft**  
The leader in low cost full featured CAE tools

P. O. Box 710, San Pedro, CA 90733-0710  
(310) 833-0710 FAX (310) 833-9658

Inquiry 774.

### MICROSTRESS CORPORATION

Announcing MICROSAFE 2D/3D Rel. 3.10  
Structural Analysis Program for IBM PCs & compatibles. Number of nodes, elements & loading conditions limited by disk space & modal bandwidth (11000 d.o.f.) Color graphics support on various display cards (EGA, VGA, VEGA, HERCULES etc.). \$350. SAFEACAD (bi-directional AUTOCADD interface ver. 9+) \$110. SAFELIBs (Beam Element Libraries for steel, wood & concrete incl. complete AISC Database) \$85. Does not incl. shipping.

P.O. BOX 3194, BELLEVUE, WA 98009  
TEL/FAX (206) 450-0316

Inquiry 775.

### MIXED-MODE SIMULATION TopSPICE/plus \$159

Upgrade to the power of true Analog/Digital Behavioral mixed-mode circuit simulation for PC. SPICE2g6/3 compatible. Built-in event-driven logic simulator. Behavioral modeling. Graphics postprocessor. FREE demo.

### PENZAR DEVELOPMENT

P.O. Box 10358, Canoga Park, CA 91309  
(818) 594-0363 (800) 272-0674 Fax (818) 340-6316

Inquiry 776.

### Worstcase Gets Even Better! ECA-2 Analog Circuit Simulator

Offers the best Monte Carlo and Worst-Case Analyses TWICE the speed at HALF the cost!

- Interactive/batch modes • Full Nonlinear Simulator
- On line, Real Time Graphics • Multiple Plots
- AC, DC, Transient, Fourier, Temperature

### Tatum Labs, Inc.

P.O. Box 1263, Ann Arbor, MI 48106-1263  
(313) 663-8810

Inquiry 777.

## SOFTWARE/GEOLOGICAL

### FREE SOFTWARE CATALOG

Over 160 earth science programs for the PC & Macintosh!

- CIVIL ENGINEERING
- BASE MAPPING
- EXPLORATION
- SURVEYING
- SURFACE MODELING
- MINING
- OIL & GAS
- HYDROLOGY
- GIS
- GEOPHYSICS

**RockWare** 4251 Kipling St., Ste. 595  
Wheat Ridge, CO 80033

(303) 423-5645 • Fax (303) 423-6171 • RockFAX\* (303) 423-7112  
\*24-hr. automated product information line

## SOFTWARE/GRAPHICS

### NEW VERSION! TGL Professional v. 4.0

### "The Ultimate CAD/CAM/CAE Graphics Engine"

TGL, the most complete toolbox of 2D & 3D geometric routines available today! Now over 600 routines including NURBS, DXF, Graphics, Surfacing, Hidden Line, Volumes, Areas, Transforms, Perspectives, Polygon (Int/Union/ Diff), Clipping, Tangents and more. With full source. 30 day guarantee. \$500.00 S&H incl. Foreign \$535.00US. S&H via Int'l Air Post incl. Use VISA or MasterCard. A technical paper on TGL is available upon request.

### Disk Software Inc.

2116 E. Arapaho Rd., Suite 487, Richardson, TX USA 75081  
Phone: 214-423-7288 — 800-635-7760 — FAX: 214-423-7288

Inquiry 778.

## SOFTWARE/GRAPHICS

### RAINDROP™

FAST, compact PrtScr Utility for end users AND developers. Hardcopy as fast as 10 secs. Average binary size - 6 kbyte. 14 video graphic standards. Scale, rotate, colorize and more. 'CALL' from user-written programs. Complete 9- & 24-pin dot-matrix, inkjet, and laserjet library \$44.95+\$3 s/h.

### ECCLECTIC SYSTEMS

8106 St. David Ct., Springfield, VA 22153  
(703) 440-0064 Fax (703) 455-8965

Inquiry 779.

### Z-PHIGS Windows

The Standard 3D-Graphics Development System  
Use the power of the most sophisticated 3D-graphics system available today. A powerful library with 2D/3D functions saves you years of development time in the fields of CAD, Multimedia etc. Spectacular rendering features like Phong shading, light effects, material definitions, texture-mapping and much more makes it simple and quick to create impressive realistic images.

### WISE Software

Seelandstr. 3, D-2400 Lübeck 14, Germany  
Tel: (+49)-451-3909-413 Fax: (+49)-451-3909-499

Inquiry 780.

## SOFTWARE/LANGUAGES

### IntegrAda

Standard Air Force PC Ada Compilers & environments for MS-DOS and UNIX. Integrated programming systems include validated Ada compilers, language sensitive editors, complete libraries and other Ada programming tools. FREE demo.

**AETECH, Inc.** From \$395  
380 Stevens Ave., Ste. 212 Solana Beach, CA 92075  
(619) 755-1277 Fax: (619) 755-7540

Inquiry 781.

## SOFTWARE/MATHEMATICS

### Mathematical Modeling On Your PC Science Engineering Business

- Faster, Easier, more Powerful than other methods
- Nonlinear Algebraic and Differential Systems
- Solve For Any Parameter Values • No Programming
- Complex • Vectors • Natural Mathematics Editor
- Simulation • Optimization • Graphics

New Chico Solver 2.3 (916) 342-3279 Only \$399  
Full refund for 30 days if not satisfied. VISAMC/PO#  
Chico Software Company PO Box 5174, Chico, CA 95927

Inquiry 782.

### OPERATIONS RESEARCH @ \$149 for your IBM or Compatible

LP88—Linear programs up to 3000 rows by 15000 columns.  
BLP88—Bounded LPs up to 2500 rows by 12500 columns.  
MLP88—Mixed-integer linear programs up to 800 by 4000.  
TSAB8—Transportation problems up to 1200 sources/sinks.  
NLP88—Nonlinear programs up to 800 by 4000.  
TPRO88—Shortest path and traveling salesman problems.  
Student/Demo Package—Reduced capacity versions for students. Manual on diskette. No site license required.  
Turbo Pascal Units—Compiled CRIMS procedures for developers.

**Eastern Software Products, Inc.**  
P.O. Box 15328, Alexandria, VA 22309, (703) 360-7600, Fax (703) 360-7654

Inquiry 783.

### MATHEMATICIANS—ENGINEERS

Have you ever seen functions of a complex variable? Would you like to really understand differential operators like div, grad and curl? How about a peek into the fourth dimension? Call or write for information on our latest PC and Macintosh software.

### Lascaux Graphics

7601 N. Calle Sin Envidia, Tucson, AZ 85718  
(602) 544-4229 — 1-800-338-0993

## SOFTWARE/PACKAGING

### FREE SOFTWARE PACKAGING CATALOG

Everything you will need to Package, Distribute, and Ship Your Software! From manuals and binders to mailers and shippers

### LABELS \* LABELS \* LABELS

For your diskettes, plain or custom printed, dot matrix or laser printers... free samples

### ... FREE CATALOG ...

### Hico & Associates

8586 Monticello Dr., West Chester, OH 45069  
Phone/Fax 513-777-8586

Inquiry 784.

## SOFTWARE/SCIENTIFIC

### MATFOR

### BEST VALUE FOR NUMERICAL COMPUTING

An interpreter with a comprehensive set of functions for Applied Mathematics, Engineering Analysis, Statistics, and Graphics. IEEE Software says that "there is clearly significant scientific work embodied in the interpreter—the program is no lightweight." Use it risk-free under 30-day unconditional guarantee. Lowest priced mathematical toolbox. From \$150. Protected Mode versions also available.

### Computational Engineering Associates

3525 Del Mar Heights Road, Suite 163, San Diego CA 92130  
(619) 259-8863

Inquiry 785.

## FREE CATALOG

A great selection of scientific software products for plotting, non-linear curve fitting, chemical equilibrium, simulation, statistics, symbolic algebra, and more. Prices from \$150. Call:

### 1-801-943-0290

MicroMath, Salt Lake City, UT 84121-0550

Inquiry 786.

### VT<sub>E</sub>X: Scientific Desktop Publishing

- Equations • Tables • Graphics • Scalable Fonts • Supports most printers • WYSIWYG previewer • Foreign Languages • Special Symbols • Font Effects • Indices • Only \$299
- "TEX of Tomorrow"—Notices of AMS, March 1991.

### MicroPress, Inc.

68-30 Harrow Street, Forest Hills, NY  
Tel (718) 575-1816 Fax (718) 575-8038

Inquiry 787.

### GEOMETRY/TRIGONOMETRY CALCULATOR

**Apollonius** — Sketch-based geometry/trigonometry solver. State-of-the-art variational geometry system lets you sketch your geometry or trig problem and automatically solves for distances, angles and areas. Integrated equation calculator, graphs and tables plus DDE and clipboard support. Ideal for surveyors, engineers, machine shops, students, architects, or anyone who uses trig. Runs under MS Windows 3.0 \$98

**Saltire Software 1-800-659-1874**

Inquiry 788.

## SOFTWARE/SORT

### OPT-TECH SORT/MERGE

Extremely fast Sort/Merge/Select utility. Run as a MS-DOS command or CALL as a subroutine. Supports most languages and file types including Btrieve and dBASE. Unlimited file sizes, multiple keys and much more! MS-DOS \$149. OS/2, XENIX, UNIX \$249.

(702) 588-3737

### Opt-Tech Data Processing

P.O. Box 678 — Zephyr Cove, NV 89448

Inquiry 789.

# THE BUYER'S MART

## SOFTWARE/VOICE/FAX

### MULTI-VOICE® TOOLS

Multi-Voice Tools is a complete development Toolkit for Pascal or "C" to access all the features for most speech processing boards available today. It helps you write MULTI-LINE VOICE APPLICATION systems in minutes. A number of programming examples are provided. All programs and libraries are delivered with source code. Dialogic, Rhetorex, Pika, VBX: \$599. Watson (Single Line): \$99. ALSO AVAILABLE: FAX Programmer's Toolkit (\$199). Based on CAS specifications. Visa/MC accepted.

### ITI Logiciel

4263 Cristophe-Colomb, Montreal, Quebec, Can. H2J 3G2  
TEL (514) 597-1692 FAX (514) 526-2362

## STATISTICS

### VISUALIZE YOUR DATA

MCA+ transforms most marketing and social science data to easily understood perceptual maps. Communicate complex relations with ease using presentation quality charts. Most printers supported. Demos available

### Bretton-Clark

89 Headquarters Plaza, Morristown, NJ 07960  
(201) 993-3135 FAX: (201) 993-1757

Inquiry 790.

### NCSS 5.x Series — \$125

Easy-to-use menus & spread sheet. Multiple regression. T-tests. ANOVA (up to 10 factors, rep. measures, covariance). Forecasting. Factor, cluster, & discriminant analysis. Nonparametrics. Cross Tabulation. Graphics: histograms, box, scatter, etc. Reads ASCII/Lotus. Many new add-on modules.

### NCSS

329 North 1000 East, Kaysville, UT 84037  
Phone: 801-546-0445 Fax: 801-546-3907

Inquiry 791.

## TRANSLATION

Tradoc translates and localizes your technical documentation into the following languages:

+ French + Russian  
+ Spanish + Arabic  
+ German + Italian...

Turnkey service: Desktop Publishing, typesetting and printing of your brochures and manuals.

205 Gibson Rd., Annapolis, MD 21401  
(301) 267-8655 FAX (301) 267-8180

Inquiry 792.

## UNINTERRUPTIBLE POWER

### ELIMINATE LAN DOWNTIME AND DATA LOSS

APC protects more LANs than any other brand of UPS. Call for your FREE power protection handbook detailing:

- SmartUPS high-performance protection, PC Magazine's Editors' Choice
- BackUPS cost-effective protection starting at \$169
- PowerChute automatic shutdown software for all major OS
- SurgeArrest network grade surge protection

"Our highest marks go to the SmartUPS 900" BYTE 5/91

**American Power Conversion APC Europe**  
132 Fairgrounds Road, 4 Rue St. Claire Deville Lognes,  
West Kingston, RI 02892 77447 Marne la Vallée Cedex 2,  
800-541-8896 FRANCE (+33) 160178400  
Fax: (+33) 160178029

Inquiry 793.

## UPS

### TRUST YOUR PC TO SOLA UNINTERRUPTIBLE POWER SYSTEMS

Quality manufacturing. Affordable prices.  
UL listed/CSA certified. Risk-free Guarantee.  
Call today for your FREE 1992 Power Selection Guide.

1-800-TRY SOLA — Ext. 1033

### SOLA

1717 Busse Rd., Elk Grove Village, IL 60007

Inquiry 794.

## UTILITIES

### WANTED!!

Corporation would like to purchase install routines or batch files for automatic installation of popular DOS and/or Windows Business Applications.

Contact: **John Stevens**  
214-231-2254

Inquiry 795.

### \$29 MATH COPROCESSOR

- 287, 387, X87 emulator
- See BYTE 3/1991 p. 90, PC Magazine 2/1991 p. 302

### \$5 SUPER PASSWORD SOFTWARE

- No one can break it • Double lock protection
- Invisible password • Movable password

### \$39 VIRUS PROTECTION CARD

- Immune to virus after installation
- Support networks • No RAM needed

Buy Math Coprocessor & Virus Card, Get Super Password FREE  
**MULTIX, INC.**, 4203 Beltway Dr., Suite 7, Dallas TX 75244  
Tel: (214) 239-4989 Fax: (214) 239-6826 We accept MasterCard and VISA

Inquiry 796.

### Why You Want BATCOM!

BATCOM is a batch file compiler that transforms your .bat files to .exe files to make them faster. BATCOM extends DOS with many new commands so you can read keyboard input, use subroutines, and much more. In addition, BATCOM protects your source code. No royalties! Only \$59.95. Order today!

**Wenham Software Company**  
5 Burley St., Wenham, MA 01984  
(508) 774-7036

Inquiry 797.

## Attention U.S. BYTE Subscribers

Watch for the next **BYTE DECK** mailing that will be arriving in your mailbox soon!

Use this as a fast, convenient tool to purchase computer products and services. It's loaded with essential hardware and software products that you should be aware of when making your buying decisions...and it's absolutely FREE!

If you have a computer product or service, and would like to reach 275,000 influential **BYTE** magazine subscribers, please give Ed Ware a call today at (603) 924-2596.

# BYTE DECK

Here's what a **BYTE Deck** advertiser has to say:

"Ten years ago we advertised in the very first **BYTE Deck**—the number of sales leads we received was enormous! The **BYTE Deck** was so successful for us, that we have continued to use it over the past ten years!"

Lisa Tarpoff, Marketing Manager, Heath Company, Benton Harbor, MI





PS/2 model 55SX-60 meg .....	1985
PS/2 model 70-120 meg .....	3195
IBM model 35-40 meg .....	1795
PS/2 model 70-A21 .....	4195
PS/2 model 95-320 meg .....	14950
*** Monitor Extra ***	



DeskPro Models

286E-40/120 meg .....	1595/1695
386S-20 MHz 120 meg .....	2375
386/20E-120 meg .....	2795
386/25E-120 meg .....	4085
386/33M-120 meg .....	4995
* Call for other models - Monitor Extra *	

### NOVELL SPECIALS

<b>Netware Version 2.2</b>	
5 users .....	595
10 users .....	1395
50 users .....	CALL
100 users .....	CALL
<b>Netware 386 V.3.11</b>	
20 users .....	2195
100 users .....	CALL
250 users .....	CALL

# BRAND NAMES LOW PRICES

LEADER  
SINCE 1983

We export to Europe, Asia  
& the Far East

We Honor Manufacturer's  
Warranties

Call for details

### AST LAPTOPS

EX386SX20 MDL 60 .....	2375
EX386SX20 MDL 80 .....	CALL
EX386SX25 MLD 60 .....	2575
EX386SX25 MDL 80 .....	CALL
EX386SX25C MDL 60 .....	4395
EX386SX25C MDL 80 .....	CALL

### LAPTOPS

Compaq LTE/286 40 meg .....	1895
Compaq LTE/386 60 meg .....	3295
Toshiba 2000SX 40 meg .....	2650
Toshiba 2200SX 60 meg .....	3395
Toshiba 3200SXC 120 meg .....	5650

Call for pricing on other brand name models



### MEGACUBE ISA BUS

486-33 System	
8 meg 128K Cache ESDI	
16 meg 128K Cache ESDI .....	CALL

### Step 386-20 MHz System

1 meg RAM, 64K Cache, 1.2 & 40 meg Drive, 640x480 VGA Combo .....	CALL
--	------

### Step 386-25 MHz System

1 meg RAM, 64K Cache, 1.2 & 40 meg Drive, 640x480 VGA Combo .....	CALL
--	------

### Step 386-33 MHz System

2 meg RAM, 64K Cache, 1.2 & 150 meg Drive 1024x768 VGA Combo .....	CALL
---	------



AST Bravo 386SX20 MDL 1 .....	1070
AST Bravo 386/25 MDL 1 .....	2295
AST Premium 386SX20 MDL 1 .....	1295
AST Premium 386/33 MDL 1 .....	2225

### INTEL COPROCESSORS

80287 XL .....	\$99.00
80387 SX-16 .....	\$135.00
80387 SX-20 .....	\$149.00
80387 DX25/33 .....	\$205.00

WE STOCK  
TOSHIBA

CITIZEN  
OKIDATA  
EPSON

HITACHI  
TALLGRASS  
ARCHIVE

NEC  
ALR  
WYSE

HOUSTON INSTRUMENTS  
MICROSOFT  
SUMMAGRAPHIC

INTEL  
PC MOUSE  
CALCOMP

## ACS Computers

All systems include

Made  
in  
USA

- Intel CPU
- 4 meg RAM memory expandable to 64 meg  
- Desktop or tower case
- 2 serial, 1 parallel
- 101 keyboard
- 1.2 & 1.44 Teac drive
- SVGA card w/1 meg & SVGA monitor
- MS DOS 5.0
- MS Windows & mouse

486/33 with 200 meg HD .....	2250
386/33 with 120 meg HD .....	1995
386SX/20 with 40 meg HD .....	1420

One year limited warranty



NOVELL  
Authorized  
Dealer

### LAN BOARDS

8 bit Arcnet .....	110
16 bit Arcnet .....	220
8 bit Ethernet .....	190
16 bit Ethernet .....	275
8 port Active Hub .....	325
Token Ring Card .....	399
Tokenhub 4-port .....	355

Call for other  
LAN Accessories

### LASER PRINTERS

HP Laser IIISI .....	3595
Hp Laser IIID .....	CALL
HP Laser III .....	1525
HP Laser IIIP .....	CALL
OKI OL 400 .....	665
OKI OL 800 .....	CALL
OKI OL 840 P.S. ....	1720
Panasonic 4420 .....	835
Panasonic 4450 .....	1295
NEC Silentwriter 2 .....	CALL

### PRINTERS

Epson LQ 200 .....	245
Epson LQ 570 .....	295
Epson LQ 870 .....	480
Epson LQ 1170 .....	625
OKIDATA 320 .....	330
OKIDATA 390 .....	465
Citizen HSP-500 .....	335

### HARD DISKS

<b>CONNOR</b>	
CP30104 120 meg .....	CALL
CP3204F 220 meg .....	CALL

QUANTUM, MAXTOR,  
SEAGATE

CALL FOR ALL MODELS

Corporate Accounts  
Welcome

Call for Discounts  
on Volume  
And  
Consultant Orders  
Exports  
Available

# Computerlane inc.

Outside California: 1-800-526-3482

Inside California: 818-884-8644 • FAX: 818-884-8253

7500 Topanga Canyon Boulevard, Canoga Park, CA 91303

Hours: Monday - Friday 9 - 6, Saturday 10 - 6

Compaq is a Registered Trademark of Compaq, IBM is a Registered Trademark of International Business Machines.

ALL QUOTED  
PRICES ARE CASH  
PRICES ONLY

Visa, MasterCard  
and  
American Express  
are higher

Prices subject to change  
without notice.

\*Quantities are limited

# ASTRIX 486

## It Simply Costs Less

### 486-33 PLATFORM—\$1,091

- 33 MHz Intel 486
- 256K Cache
- 1 MB RAM
- 1.2 MB 5.25" Drive or 1.44 MB 3.5" Drive
- IDE Hard Disk Controller
- 1 Parallel & 2 Serial Ports
- 101 Key Keyboard
- Desktop Case (small footprint)
- 200W Power Supply

Benchmarks: 14.8 MIPS, 151.9 Landmark



Guaranteed 100% IBM AT and Novell compatible. Lifetime technical support. 1 year parts & labor warranty. 30-day money-back guarantee. Custom configurations available.

### 486-33 COMPLETE—\$2,491

- PLATFORM system (left column) with:
- 200 MB, 15ms IDE Hard Drive
  - 4 MB RAM
  - Second Floppy Drive
  - 14" Color SVGA Monitor, 1024 x 768, non-interlaced
  - 16-bit, 1MB Super-VGA Card
  - MS-DOS 5.00
  - Tower Case with 10 Drive Bays
  - 300W Power Supply

To get your 486 for \$1,091, call **ASTRIX**, toll free:

**(800) 445-5486**

 In CA: (408) 946-2883   
Fax: (408) 946-1610

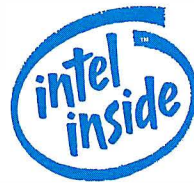
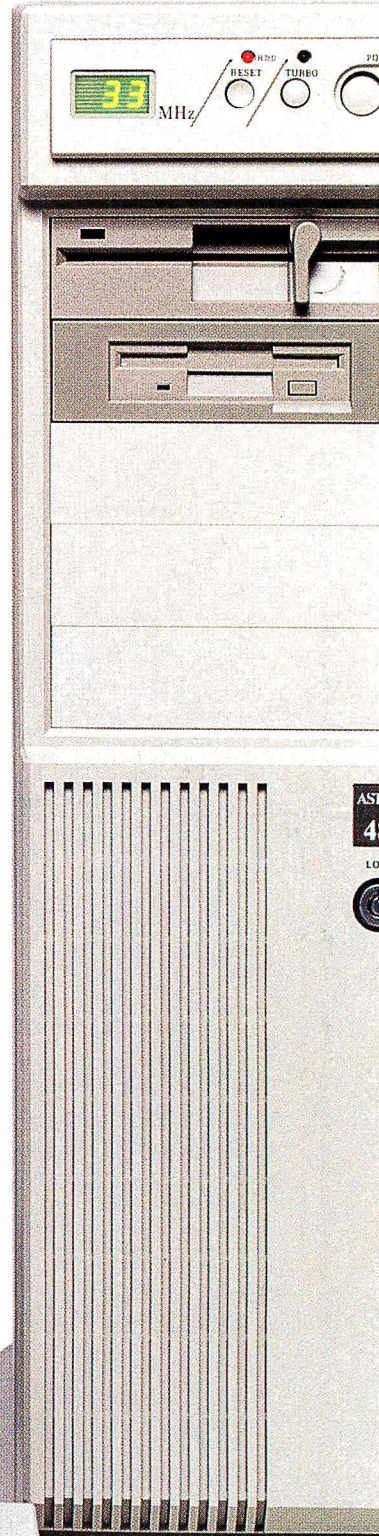
### 486-33 SERVER—\$6,991

- PLATFORM system (left column) with:
- **Fault-tolerant operation**
  - Dual 380 MB, 0.5ms Drives with Hard Disk Mirroring<sup>1</sup>
  - 16 MB RAM
  - ESDI Caching Disk Controller<sup>2</sup>
  - 500W UPS<sup>3</sup>
  - Super-VGA Display, 1024x768
  - MS-DOS 5.00
  - Tower Case with 10 Drive Bays

<sup>1</sup>Hard disk mirroring protects data. In the event of hard disk failure, the system automatically switches to a second hard drive containing a mirror image of the first drive. Mirroring eliminates the need to maintain backups.

<sup>2</sup>A caching disk controller reduces drive access time to 0.5ms (from 16ms). It also increases throughput by 400%, eliminating disk bottlenecks.

<sup>3</sup>A UPS (Uninterruptible Power Supply) keeps the server running in the event of a power failure.



The Intel Inside logo is a trademark of Intel Corporation.



**ASTRIX™**  
HIGH-SPEED PC WORKSTATIONS™

Circle 180 on Inquiry Card.

ASTRIX Computer Corporation, 1546 Centre Pointe Drive, Milpitas, CA 95035. ASTRIX is a trademark of Four D Corporation. IBM-AT is a trademark of IBM Corporation. 486 is a trademark of Intel Corporation. Other indicated trademarks belong to their respective owners. Prices and specifications are subject to change without notice. © 1991 by ASTRIX Corp. All rights reserved.



# FREE PRODUCT INFORMATION

Mail Your Completed Card Today. For Quicker Response, Fax to 1-413-637-4343!

Circle the numbers on Inquiry Card which correspond to inquiry numbers assigned to items of interest to you.

Check all the appropriate answers to questions "A" through "E".

Print Your name and address and mail, or fax to 1-413-637-4343

Fill out this coupon carefully. PLEASE PRINT.

NAME \_\_\_\_\_  
 TITLE \_\_\_\_\_  
 COMPANY \_\_\_\_\_  
 ADDRESS \_\_\_\_\_  
 CITY ( ) STATE ZIP  
 PHONE ( ) FAX

**A. What is your primary job function/principal area of responsibility? (Check one.)**

- MIS/DP  Sales/Marketing  
 Programmer/Systems Analyst  Engineer/Scientist  
 Administration/Management  Other

**B. What is your level of management responsibility?**

- Senior level  Professional  
 Middle level

**C. Are you a reseller (VAR, VAD, Dealer, Consultant)?**

- Yes  No

**D. What operating systems are you currently using? (Check all that apply.)**

- PC/MS-DOS  UNIX  
 DOS + Windows  MacOS  
 OS/2  VAX/VMS

**E. For how many people do you influence the purchase of hardware or software?**

- 1-25  51-99  
 26-50  100 or more

Please send me one year of *BYTE Magazine* for \$24.95 and bill me. Offer valid in U.S. and possessions only.

MARCI  
 IRSD03A

**Inquiry Numbers 1-493**

1 2 3 4 5 6 7 8 9 10 11 12 13 14 15 16 17  
 18 19 20 21 22 23 24 25 26 27 28 29 30 31 32 33 34  
 35 36 37 38 39 40 41 42 43 44 45 46 47 48 49 50 51  
 52 53 54 55 56 57 58 59 60 61 62 63 64 65 66 67 68  
 69 70 71 72 73 74 75 76 77 78 79 80 81 82 83 84 85  
 86 87 88 89 90 91 92 93 94 95 96 97 98 99 100 101 102  
 103 104 105 106 107 108 109 110 111 112 113 114 115 116 117 118 119  
 120 121 122 123 124 125 126 127 128 129 130 131 132 133 134 135 136  
 137 138 139 140 141 142 143 144 145 146 147 148 149 150 151 152 153  
 154 155 156 157 158 159 160 161 162 163 164 165 166 167 168 169 170  
 171 172 173 174 175 176 177 178 179 180 181 182 183 184 185 186 187  
 188 189 190 191 192 193 194 195 196 197 198 199 200 201 202 203 204  
 205 206 207 208 209 210 211 212 213 214 215 216 217 218 219 220 221  
 222 223 224 225 226 227 228 229 230 231 232 233 234 235 236 237 238  
 239 240 241 242 243 244 245 246 247 248 249 250 251 252 253 254 255  
 256 257 258 259 260 261 262 263 264 265 266 267 268 269 270 271 272  
 273 274 275 276 277 278 279 280 281 282 283 284 285 286 287 288 289  
 290 291 292 293 294 295 296 297 298 299 300 301 302 303 304 305 306  
 307 308 309 310 311 312 313 314 315 316 317 318 319 320 321 322 323  
 324 325 326 327 328 329 330 331 332 333 334 335 336 337 338 339 340  
 341 342 343 344 345 346 347 348 349 350 351 352 353 354 355 356 357  
 358 359 360 361 362 363 364 365 366 367 368 369 370 371 372 373 374  
 375 376 377 378 379 380 381 382 383 384 385 386 387 388 389 390 391  
 392 393 394 395 396 397 398 399 400 401 402 403 404 405 406 407 408  
 409 410 411 412 413 414 415 416 417 418 419 420 421 422 423 424 425  
 426 427 428 429 430 431 432 433 434 435 436 437 438 439 440 441 442  
 443 444 445 446 447 448 449 450 451 452 453 454 455 456 457 458 459  
 460 461 462 463 464 465 466 467 468 469 470 471 472 473 474 475 476  
 477 478 479 480 481 482 483 484 485 486 487 488 489 490 491 492 493

**Inquiry Numbers 494-986**

494 495 496 497 498 499 500 501 502 503 504 505 506 507 508 509 510  
 511 512 513 514 515 516 517 518 519 520 521 522 523 524 525 526 527  
 528 529 530 531 532 533 534 535 536 537 538 539 540 541 542 543 544  
 545 546 547 548 549 550 551 552 553 554 555 556 557 558 559 560 561  
 562 563 564 565 566 567 568 569 570 571 572 573 574 575 576 577 578  
 579 580 581 582 583 584 585 586 587 588 589 590 591 592 593 594 595  
 596 597 598 599 600 601 602 603 604 605 606 607 608 609 610 611 612  
 613 614 615 616 617 618 619 620 621 622 623 624 625 626 627 628 629  
 630 631 632 633 634 635 636 637 638 639 640 641 642 643 644 645 646  
 647 648 649 650 651 652 653 654 655 656 657 658 659 660 661 662 663  
 664 665 666 667 668 669 670 671 672 673 674 675 676 677 678 679 680  
 681 682 683 684 685 686 687 688 689 690 691 692 693 694 695 696 697  
 698 699 700 701 702 703 704 705 706 707 708 709 710 711 712 713 714  
 715 716 717 718 719 720 721 722 723 724 725 726 727 728 729 730 731  
 732 733 734 735 736 737 738 739 740 741 742 743 744 745 746 747 748  
 749 750 751 752 753 754 755 756 757 758 759 760 761 762 763 764 765  
 766 767 768 769 770 771 772 773 774 775 776 777 778 779 780 781 782  
 783 784 785 786 787 788 789 790 791 792 793 794 795 796 797 798 799  
 800 801 802 803 804 805 806 807 808 809 810 811 812 813 814 815 816  
 817 818 819 820 821 822 823 824 825 826 827 828 829 830 831 832 833  
 834 835 836 837 838 839 840 841 842 843 844 845 846 847 848 849 850  
 851 852 853 854 855 856 857 858 859 860 861 862 863 864 865 866 867  
 868 869 870 871 872 873 874 875 876 877 878 879 880 881 882 883 884  
 885 886 887 888 889 890 891 892 893 894 895 896 897 898 899 900 901  
 902 903 904 905 906 907 908 909 910 911 912 913 914 915 916 917 918  
 919 920 921 922 923 924 925 926 927 928 929 930 931 932 933 934 935  
 936 937 938 939 940 941 942 943 944 945 946 947 948 949 950 951 952  
 953 954 955 956 957 958 959 960 961 962 963 964 965 966 967 968 969  
 970 971 972 973 974 975 976 977 978 979 980 981 982 983 984 985 986

**Inquiry Numbers 987-1479**

987 988 989 990 991 992 993 994 995 996 997 998 999 1000 1001 1002 1003  
 1004 1005 1006 1007 1008 1009 1010 1011 1012 1013 1014 1015 1016 1017 1018 1019 1020  
 1021 1022 1023 1024 1025 1026 1027 1028 1029 1030 1031 1032 1033 1034 1035 1036 1037  
 1038 1039 1040 1041 1042 1043 1044 1045 1046 1047 1048 1049 1050 1051 1052 1053 1054  
 1055 1056 1057 1058 1059 1060 1061 1062 1063 1064 1065 1066 1067 1068 1069 1070 1071  
 1072 1073 1074 1075 1076 1077 1078 1079 1080 1081 1082 1083 1084 1085 1086 1087 1088  
 1089 1090 1091 1092 1093 1094 1095 1096 1097 1098 1099 1100 1101 1102 1103 1104 1105  
 1106 1107 1108 1109 1110 1111 1112 1113 1114 1115 1116 1117 1118 1119 1120 1121 1122  
 1123 1124 1125 1126 1127 1128 1129 1130 1131 1132 1133 1134 1135 1136 1137 1138 1139  
 1140 1141 1142 1143 1144 1145 1146 1147 1148 1149 1150 1151 1152 1153 1154 1155 1156  
 1157 1158 1159 1160 1161 1162 1163 1164 1165 1166 1167 1168 1169 1170 1171 1172 1173  
 1174 1175 1176 1177 1178 1179 1180 1181 1182 1183 1184 1185 1186 1187 1188 1189 1190  
 1191 1192 1193 1194 1195 1196 1197 1198 1199 1200 1201 1202 1203 1204 1205 1206 1207  
 1208 1209 1210 1211 1212 1213 1214 1215 1216 1217 1218 1219 1220 1221 1222 1223 1224  
 1225 1226 1227 1228 1229 1230 1231 1232 1233 1234 1235 1236 1237 1238 1239 1240 1241  
 1242 1243 1244 1245 1246 1247 1248 1249 1250 1251 1252 1253 1254 1255 1256 1257 1258  
 1259 1260 1261 1262 1263 1264 1265 1266 1267 1268 1269 1270 1271 1272 1273 1274 1275  
 1276 1277 1278 1279 1280 1281 1282 1283 1284 1285 1286 1287 1288 1289 1290 1291 1292  
 1293 1294 1295 1296 1297 1298 1299 1300 1301 1302 1303 1304 1305 1306 1307 1308 1309  
 1310 1311 1312 1313 1314 1315 1316 1317 1318 1319 1320 1321 1322 1323 1324 1325 1326  
 1327 1328 1329 1330 1331 1332 1333 1334 1335 1336 1337 1338 1339 1340 1341 1342 1343  
 1344 1345 1346 1347 1348 1349 1350 1351 1352 1353 1354 1355 1356 1357 1358 1359 1360  
 1361 1362 1363 1364 1365 1366 1367 1368 1369 1370 1371 1372 1373 1374 1375 1376 1377  
 1378 1379 1380 1381 1382 1383 1384 1385 1386 1387 1388 1389 1390 1391 1392 1393 1394  
 1395 1396 1397 1398 1399 1400 1401 1402 1403 1404 1405 1406 1407 1408 1409 1410 1411  
 1412 1413 1414 1415 1416 1417 1418 1419 1420 1421 1422 1423 1424 1425 1426 1427 1428  
 1429 1430 1431 1432 1433 1434 1435 1436 1437 1438 1439 1440 1441 1442 1443 1444 1445  
 1446 1447 1448 1449 1450 1451 1452 1453 1454 1455 1456 1457 1458 1459 1460 1461 1462  
 1463 1464 1465 1466 1467 1468 1469 1470 1471 1472 1473 1474 1475 1476 1477 1478 1479



NO POSTAGE  
 NECESSARY  
 IF MAILED  
 IN THE  
 UNITED STATES

**BUSINESS REPLY MAIL**  
 FIRST CLASS MAIL PERMIT NO. 176 PITTSFIELD, MA

POSTAGE WILL BE PAID BY ADDRESSEE

**BYTE**

**READER SERVICE**  
 PO Box 5110  
 Pittsfield, MA 01203-9926  
 USA



# FREE PRODUCT INFORMATION

Mail Your Completed Card Today. For Quicker Response, Fax to 1-413-637-4343!

Circle the numbers on Inquiry Card which correspond to inquiry numbers assigned to items of interest to you.

Check all the appropriate answers to questions "A" through "E".

Print Your name and address and mail, or fax to 1-413-637-4343



NO POSTAGE  
NECESSARY  
IF MAILED  
IN THE  
UNITED STATES

**BUSINESS REPLY MAIL**  
FIRST CLASS MAIL PERMIT NO. 176 PITTSFIELD, MA

POSTAGE WILL BE PAID BY ADDRESSEE

# BYTE

READER SERVICE  
PO Box 5110  
Pittsfield, MA 01203-9926  
USA



Fill out this coupon carefully. PLEASE PRINT.

NAME \_\_\_\_\_  
TITLE \_\_\_\_\_  
COMPANY \_\_\_\_\_  
ADDRESS \_\_\_\_\_  
CITY \_\_\_\_\_ STATE \_\_\_\_\_ ZIP \_\_\_\_\_  
PHONE \_\_\_\_\_ FAX \_\_\_\_\_

A. What is your primary job function/principal area of responsibility? (Check one.)

- MIS/DP  Sales/Marketing  
 Programmer/Systems Analyst  Engineer/Scientist  
 Administration/Management  Other

B. What is your level of management responsibility?

- Senior-level  Professional  
 Middle-level

C. Are you a reseller (VAR, VAD, Dealer, Consultant)?

- Yes  No

D. What operating systems are you currently using? (Check all that apply.)

- PCIMS-DOS  UNIX  
 DOS + Windows  MacOS  
 OS/2  VAX/VMS

E. For how many people do you influence the purchase of hardware or software?

- 1-25  51-99  
 26-50  100 or more

Please send me one year of BYTE Magazine for \$24.95 and bill me. Offer valid in U.S. and possessions only.

MARCH  
IRSD03A

**Inquiry Numbers 1-493**

1 2 3 4 5 6 7 8 9 10 11 12 13 14 15 16 17  
18 19 20 21 22 23 24 25 26 27 28 29 30 31 32 33 34  
35 36 37 38 39 40 41 42 43 44 45 46 47 48 49 50 51  
52 53 54 55 56 57 58 59 60 61 62 63 64 65 66 67 68  
69 70 71 72 73 74 75 76 77 78 79 80 81 82 83 84 85  
86 87 88 89 90 91 92 93 94 95 96 97 98 99 100 101 102  
103 104 105 106 107 108 109 110 111 112 113 114 115 116 117 118 119  
120 121 122 123 124 125 126 127 128 129 130 131 132 133 134 135 136  
137 138 139 140 141 142 143 144 145 146 147 148 149 150 151 152 153  
154 155 156 157 158 159 160 161 162 163 164 165 166 167 168 169 170  
171 172 173 174 175 176 177 178 179 180 181 182 183 184 185 186 187  
188 189 190 191 192 193 194 195 196 197 198 199 200 201 202 203 204  
205 206 207 208 209 210 211 212 213 214 215 216 217 218 219 220 221  
222 223 224 225 226 227 228 229 230 231 232 233 234 235 236 237 238  
239 240 241 242 243 244 245 246 247 248 249 250 251 252 253 254 255  
256 257 258 259 260 261 262 263 264 265 266 267 268 269 270 271 272  
273 274 275 276 277 278 279 280 281 282 283 284 285 286 287 288 289  
290 291 292 293 294 295 296 297 298 299 300 301 302 303 304 305 306  
307 308 309 310 311 312 313 314 315 316 317 318 319 320 321 322 323  
324 325 326 327 328 329 330 331 332 333 334 335 336 337 338 339 340  
341 342 343 344 345 346 347 348 349 350 351 352 353 354 355 356 357  
358 359 360 361 362 363 364 365 366 367 368 369 370 371 372 373 374  
375 376 377 378 379 380 381 382 383 384 385 386 387 388 389 390 391  
392 393 394 395 396 397 398 399 400 401 402 403 404 405 406 407 408  
409 410 411 412 413 414 415 416 417 418 419 420 421 422 423 424 425  
426 427 428 429 430 431 432 433 434 435 436 437 438 439 440 441 442  
443 444 445 446 447 448 449 450 451 452 453 454 455 456 457 458 459  
460 461 462 463 464 465 466 467 468 469 470 471 472 473 474 475 476  
477 478 479 480 481 482 483 484 485 486 487 488 489 490 491 492 493

**Inquiry Numbers 494-986**

494 495 496 497 498 499 500 501 502 503 504 505 506 507 508 509 510  
511 512 513 514 515 516 517 518 519 520 521 522 523 524 525 526 527  
528 529 530 531 532 533 534 535 536 537 538 539 540 541 542 543 544  
545 546 547 548 549 550 551 552 553 554 555 556 557 558 559 560 561  
562 563 564 565 566 567 568 569 570 571 572 573 574 575 576 577 578  
579 580 581 582 583 584 585 586 587 588 589 590 591 592 593 594 595  
596 597 598 599 600 601 602 603 604 605 606 607 608 609 610 611 612  
613 614 615 616 617 618 619 620 621 622 623 624 625 626 627 628 629  
630 631 632 633 634 635 636 637 638 639 640 641 642 643 644 645 646  
647 648 649 650 651 652 653 654 655 656 657 658 659 660 661 662 663  
664 665 666 667 668 669 670 671 672 673 674 675 676 677 678 679 680  
681 682 683 684 685 686 687 688 689 690 691 692 693 694 695 696 697  
698 699 700 701 702 703 704 705 706 707 708 709 710 711 712 713 714  
715 716 717 718 719 720 721 722 723 724 725 726 727 728 729 730 731  
732 733 734 735 736 737 738 739 740 741 742 743 744 745 746 747 748  
749 750 751 752 753 754 755 756 757 758 759 760 761 762 763 764 765  
766 767 768 769 770 771 772 773 774 775 776 777 778 779 780 781 782  
783 784 785 786 787 788 789 790 791 792 793 794 795 796 797 798 799  
800 801 802 803 804 805 806 807 808 809 810 811 812 813 814 815 816  
817 818 819 820 821 822 823 824 825 826 827 828 829 830 831 832 833  
834 835 836 837 838 839 840 841 842 843 844 845 846 847 848 849 850  
851 852 853 854 855 856 857 858 859 860 861 862 863 864 865 866 867  
868 869 870 871 872 873 874 875 876 877 878 879 880 881 882 883 884  
885 886 887 888 889 890 891 892 893 894 895 896 897 898 899 900 901  
902 903 904 905 906 907 908 909 910 911 912 913 914 915 916 917 918  
919 920 921 922 923 924 925 926 927 928 929 930 931 932 933 934 935  
936 937 938 939 940 941 942 943 944 945 946 947 948 949 950 951 952  
953 954 955 956 957 958 959 960 961 962 963 964 965 966 967 968 969  
970 971 972 973 974 975 976 977 978 979 980 981 982 983 984 985 986

987 988 989 990 991 992 993 994 995 996 997 998 999 1000 1001 1002 1003  
1004 1005 1006 1007 1008 1009 1010 1011 1012 1013 1014 1015 1016 1017 1018 1019 1020  
1021 1022 1023 1024 1025 1026 1027 1028 1029 1030 1031 1032 1033 1034 1035 1036 1037  
1038 1039 1040 1041 1042 1043 1044 1045 1046 1047 1048 1049 1050 1051 1052 1053 1054  
1055 1056 1057 1058 1059 1060 1061 1062 1063 1064 1065 1066 1067 1068 1069 1070 1071  
1072 1073 1074 1075 1076 1077 1078 1079 1080 1081 1082 1083 1084 1085 1086 1087 1088  
1089 1090 1091 1092 1093 1094 1095 1096 1097 1098 1099 1100 1101 1102 1103 1104 1105  
1106 1107 1108 1109 1110 1111 1112 1113 1114 1115 1116 1117 1118 1119 1120 1121 1122  
1123 1124 1125 1126 1127 1128 1129 1130 1131 1132 1133 1134 1135 1136 1137 1138 1139  
1140 1141 1142 1143 1144 1145 1146 1147 1148 1149 1150 1151 1152 1153 1154 1155 1156  
1157 1158 1159 1160 1161 1162 1163 1164 1165 1166 1167 1168 1169 1170 1171 1172 1173  
1174 1175 1176 1177 1178 1179 1180 1181 1182 1183 1184 1185 1186 1187 1188 1189 1190  
1191 1192 1193 1194 1195 1196 1197 1198 1199 1200 1201 1202 1203 1204 1205 1206 1207  
1208 1209 1210 1211 1212 1213 1214 1215 1216 1217 1218 1219 1220 1221 1222 1223 1224  
1225 1226 1227 1228 1229 1230 1231 1232 1233 1234 1235 1236 1237 1238 1239 1240 1241  
1242 1243 1244 1245 1246 1247 1248 1249 1250 1251 1252 1253 1254 1255 1256 1257 1258  
1259 1260 1261 1262 1263 1264 1265 1266 1267 1268 1269 1270 1271 1272 1273 1274 1275  
1276 1277 1278 1279 1280 1281 1282 1283 1284 1285 1286 1287 1288 1289 1290 1291 1292  
1293 1294 1295 1296 1297 1298 1299 1300 1301 1302 1303 1304 1305 1306 1307 1308 1309  
1310 1311 1312 1313 1314 1315 1316 1317 1318 1319 1320 1321 1322 1323 1324 1325 1326  
1327 1328 1329 1330 1331 1332 1333 1334 1335 1336 1337 1338 1339 1340 1341 1342 1343  
1344 1345 1346 1347 1348 1349 1350 1351 1352 1353 1354 1355 1356 1357 1358 1359 1360  
1361 1362 1363 1364 1365 1366 1367 1368 1369 1370 1371 1372 1373 1374 1375 1376 1377  
1378 1379 1380 1381 1382 1383 1384 1385 1386 1387 1388 1389 1390 1391 1392 1393 1394  
1395 1396 1397 1398 1399 1400 1401 1402 1403 1404 1405 1406 1407 1408 1409 1410 1411  
1412 1413 1414 1415 1416 1417 1418 1419 1420 1421 1422 1423 1424 1425 1426 1427 1428  
1429 1430 1431 1432 1433 1434 1435 1436 1437 1438 1439 1440 1441 1442 1443 1444 1445  
1446 1447 1448 1449 1450 1451 1452 1453 1454 1455 1456 1457 1458 1459 1460 1461 1462  
1463 1464 1465 1466 1467 1468 1469 1470 1471 1472 1473 1474 1475 1476 1477 1478 1479

# READER SERVICE

## ALPHABETICAL INDEX TO ADVERTISERS

Inquiry No.	Page No.	Inquiry No.	Page No.	Inquiry No.	Page No.	Inquiry No.	Page No.
8-9	ABACUS SOFTWARE . . . . . 205	207-208	COVOX INC . . . . . 337	167	LANCAST . . . . . 310	228	PSEUDOCORP . . . . . 345
157-158	ABTECH . . . . . 329	146	CREATIVE LABS INC . . . . . 171	174-175	LANDMARK RESINT'L CORP . 315	173	QUA TECH INC . . . . . 306
491-492	ACE CAD . . . . . 92IS-71	448-449	CTX INTERNATIONAL INC 92IS-29	416-417	LANTECH . . . . . 92IS-80	105-106	QUALITAS (N.A.) . . . . . 249
10-11	ACER INCORPORATED . . . . . 41	44	CURTIS INC . . . . . 290	221	LAWSON LABS INC . . . . . 339	229	QUALSTAR CORP . . . . . 342
159	ACMA COMPUTERS INC . . . . . 321	164	CYBEX CORPORATION . . . . . 334	259	LEGACY STORAGE SYS (INT'L) 249	107	QUANTUM SOFTWARE . . . . . 293
195	ADD ON AMERICA . . . . . 337	45	CYBEX CORPORATION (INT'L) CIII	141-142	LIANT SOFTWARE CORP (N.A.) 265	108	QUARTERDECK OFFICE SYS . 255
153	ADDSTOR INC . . . . . 163	488	DAN TECHNOLOGY PLC . . . . . 92IS-5	143-144	LIANT SOFTWARE CORP (INT'L) 265	109	RAIMA CORP . . . . . 65
13	ADVANCED MICRO DEVICES 20,21	187-186	DATA HUT . . . . . 327	462	LIGATURE LTD . . . . . 92IS-24	110-111	RAINBOW TECHNOLOGIES . 55
430-431	AGC ELECTRONICS CORP 92IS-44	46-47	DATALUX CORPORATION . . . . . 138	222	LINK COMPUTER GRAPHICS . . . 341	*	REASONABLE SOLUTIONS 92IS-84A-B
567	AIMS INFORMATION SYS . 92PC-8	*	DELL COMPUTER . . . . . 92UK-9	186	LODE STAR COMPUTER . . . . . 318,319	*	ROSE ELECTRONICS . . . . . 288
12	ALADDIN KNOWLEDGE SYS . . 267	509	DELL COMPUTER . . . . . 92UK-11	463	LOGIC PROGRAMMING ASSOC . 92IS-71	428-429	ROYAL INFO ELEC. LTD . . . 92IS-83
507	ALTEC . . . . . 92IS-47	48	DELL COMPUTER CORP (N.A.) CIII	551-552	LUCKY COMPUTER CO . . . . . 92MW-3	478	S'NW ELECTRONICS . . . . . 92IS-40
432	AMDS EUROPE LTD . . . . . 92IS-19	49	DELL COMPUTER CORP (N.A.) CIV	556-557	LUCKY COMPUTER CO . . . . . 92NE-3	117	S'NW ELECTRONICS . . . . . 294
*	AME INSTIT FOR COMP SCI . . . 344	574	DEXPO SPRING . . . . . 92SO-3	562-563	LUCKY COMPUTER CO . . . . . 92PC-5	230	SAS INSTITUTE INC . . . . . 345
196	AMERICAN ADVANTECH . . . . . 340	209	DIETRICH POS EQUIPMENT . . . 337	572-573	LUCKY COMPUTER CO . . . . . 92SO-5	112-113	SECURE IT INC . . . . . 296
14-15	AMERICAN MEGATRENDS . . . . 99	405	DIGI DATA LTD . . . . . 92UK-10	500	M.L.L. SW & COMPUTERS IND. LTD. . 92IS-52	*	SEIKO INSTRUMENTS USA . . . 137
16	AMERICAN POWER CONV . . . . . 202	451	DIGIMETRIE . . . . . 92IS-38	260-261	MAG INNOVISION . . . . . 8,9	114	SEQUITER SOFTWARE INC . . . 147
433	AMERICAN POWER CONV 92IS-62	*	DIGITAL EQUIPMENT CORP (N.A.) 108A-F	558	MANCHESTER EQUIP CO 92NE-8	235	SIGEN . . . . . 339
17	AMERICAN SMALL BUSICOMP 139	*	DIGITAL EQUIPMENT CORP . . . 185	*	MANCHESTER EQUIP CO 92NE-8A-B	183-184	SII MICROS . . . . . 314
160	AMT INTERNATIONAL . . . . . 332	*	DIGITAL EQUIPMENT CORP . . . 187	*	MARK WILLIAMS CO . . . . . 135	*	SILICON GRAPHICS . . . . . 24,25
249	ANACAPA MICRO PRODUCTS . 340	51	DIGITAL VISION . . . . . 296	498	MARKUS SOFTWARE DIST 92IS-32	*	SILICON GRAPHICS . . . . . 56,57
434-435	AOC INTERNATIONAL . . . . . 92IS-57	210	DIVERSIFIED COMPUTER . . . . . 343	262-263	MATHEMATICA INC . . . . . 34-35	231	SILICON SHACK . . . . . 341
18-19	AOX . . . . . 239	438	DOWTY COMMUNICATIONS 92IS-9	78	MATHSOFT INC . . . . . 151	145	SIMPLICITY COMPUTING . . . 216
575	APPRO INT'L INC . . . . . 92SO-2	452	DRHUGGLE & PARTNER GMBH . 92IS-34	576-577	MCCORMICK DATA DIST . . . . . 92NE-5	*	SOFTLINE CORP . . . . . 92IS-43
*	APS TECHNOLOGIES . . . . . 312	52	DSP DEVELOPMENT CORP . . . . 248	*	MCGRW HILL NRI . . . . . 290A-B	*	SOFTWARE PUBLISHING . . . 100,101
494	ARABIC PUBLISHER . . . . . 92IS-70	53	DTK COMPUTER INC . . . . . 97	467-468	MDBS INC . . . . . 92IS-11	118	SOFTWARE SECURITY INC . . . 98
436	ASP COMPUTER PROD . . . . . 92IS-10	165	ELEK TEK . . . . . 316	462	MECKLER LTD . . . . . 92IS-68	402	SOLIDISK TECHNOLOGY LTD 92UK-2
20-21	ASTRESEARCH INC . . . . . 107	266	ELEXOR INC . . . . . 340	465-466	MEGADATA . . . . . 92IS-28	513-514	SPARCOM CORPORATION 92IS-72
180	ASTRYX COMPUTER CORP . . . . . 354	453-454	ELIASHIM MICROCOMP . . . . . 92IS-64	79	MERITEL COMP TECH . . . . . 201	119	SPECTRUM SOFTWARE . . . . . 177
152	ASYMETRIX . . . . . 206,207	*	ELONEX . . . . . 92IS-2	169-170	MERRITT COMPUTER PROD . . . 331	120-121	STATSOFT . . . . . 199
408	ATOMSTYLE LTD . . . . . 92UK-7	501	EMULTEK . . . . . 92IS-42	82	MICROSOLUTIONS COMP PROD . 112	510-511	STB SYSTEMS . . . . . 92IS-49
198-199	AXIOMATIC . . . . . 339	250	ERUL-AMERICAN LTD . . . . . 337	80	MICROGRAFX . . . . . 197	479-480	STONY BROOK SOFTWARE 92IS-13
200	B&C MICROSYSTEMS . . . . . 341	455	EUTRON . . . . . 92IS-50	185	MICROLINE COMPUTERS . . . . . 335	122	STORAGE DIMENSIONS . . . . 252
22-23	BAY TECHNICAL ASSOC . . . . . 277	420-421	EVERSOURCE INT'L CORP 92IS-75	61	MICRONICS COMPUTER INC . . . 219	123	SUMMAGRAPHICS CORP . . . . 149
*	BEST POWER TECH . . . . . 92IS-84A-B	54-55	EXABYTE CORPORATION . . . . . 179	224	MICROPROCESSORS UNLTD . . . 340	553	SUMMIT MICRO DESIGN . . . 92MW-5
24-25	BEST POWER TECHNOLOGY . . . 127	456	FAST ELECTRONIC GMBH 92IS-55	*	MICROSOFT CORPORATION . . . . 19	154	SUPRA CORPORATION . . . . . 103
450	BIX . . . . . 363	424-425	FBU-FAMOUS BUSI UNITED INTL INC 92IS-76	*	MICROSOFT CORPORATION . . . . 71	232	SURAH INC . . . . . 338
437	BLAISE COMPUTING INC . . . . . 92IS-67	489-490	FIRST INTERNATIONAL COM 92IS-51	225	MICROSTAR LABORATORIES . . . 339	124	SYMANTEC . . . . . 22
149-150	BLINK INC . . . . . 217	166	FIRST SOURCE INT'L . . . . . 333	469-470	MICROSYSTEMS SOFTWARE 92IS-69	407	SYMCORP INC . . . . . 92UK-8
26-27	BORLAND INTERNATIONAL . . . . 233	412-413	FORMOSA MICROSYS, INC 92IS-77	252-253	MICROTEST (INT'L) . . . . . CIV	125-126	SYSTAT LTD . . . . . 157
28-29	BORLAND INTERNATIONAL . . . . 11	56	FOX SOFTWARE INC . . . . . 76,77	*	MICROWAY . . . . . 182	409	SYSTEMC . . . . . 92UK-4
201	B P MICROSYSTEMS INC . . . . . 341	211	FLOT CORP . . . . . 344	*	MICROWAY . . . . . 280	477	SZKI COGNITA CORP . . . . . 92IS-12
406	BRAIN BOXES . . . . . 92UK-10	57-58	FTP SOFTWARE . . . . . 286	471	MINOLTA GMBH . . . . . 92IS-17	422-423	TAKEN CORP . . . . . 92IS-82
399	BUFFALO PRODUCTS . . . . . 311	*	GALACTICOMM INC . . . . . 343	83	MIX SOFTWARE . . . . . 283	233	TALKING TECHNOLOGY INC . . 338
30-31	BUREAU OF ELECT PUBL . . . . . 118	*	GATEWAY 2000 . . . . . 43-50	472	MORTICE KERN (MKS) . . . . . 92IS-39	414-415	TATUNG CO . . . . . 92IS-79
251	BYTE REPRINTS . . . . . 190	*	GATEWAY 2000 . . . . . CII,1	495	MOUNTAIN NETWORK SOLU 92IS-41	234	TECHNOLOGY POWER ENTER 336
*	BYTE SUB MESSAGE . . . . . 292	59-60	GLENCO ENGINEERING . . . . . 250	264-265	MYLEX CORPORATION . . . . . 85-92	481-482	TECHPOWER COMPANY LTD 92IS-54
50	BYTE/DEMOLINK . . . . . 361	457	GLOCKENSPIEL . . . . . 92IS-37	84-85	NANAO USA CORP . . . . . 130	127	TEKTRONIX . . . . . 117
*	C++ REPORT . . . . . 92IS-84C-D	212	GMM RESEARCH CORP . . . . . 338	171-172	NATIONAL DESIGN . . . . . 322	128-129	TELEX COMMUNICATIONS . . . 260
*	C USERS JOURNAL . . . . . 92IS-84A-B	566	GPF SYSTEMS, INC . . . . . 92PC-6	86	NATIONAL INSTRUMENTS . . . . . 7	130	TEXAS INSTRUMENTS . . . . . 105
189	CAD ONE COMPUTER DES 308-309	559	GPF SYSTEMS, INC . . . . . 92NE-7	*	NATIONAL INSTRUMENTS . . . . . 92IS-84C-D	*	TEXAS MICROSYSTEMS . . . . 66-69
33	CALERA RECOGNITION SYS . . . . 231	39	GREENVIEW DATA . . . . . 79	226	NATIONAL INSTRUMENTS . . . . . 339	42	THE COMPUTER MUSEUM . . . . 302
161	CALERA RECOGNITION SYS . . . . 335	458	GREY MATTER LTD . . . . . 92IS-15	87	NEC . . . . . 29-31	245	THE MEMORY DEPOT . . . . . 340
34	CANON USA INC . . . . . 116	213	GTEK INC . . . . . 338	168	NEVADA COMPUTER . . . . . 313	426-427	TNC GROUP . . . . . 92IS-81
35	CAPITAL EQUIPMENT CO . . . . . 180	214	GTEK INC . . . . . 339	474-475	NEWGEN SYSTEMS CORP 92IS-33	131	TOSHIBA AMERICA INC . . . . 81-83
36	CAPITAL EQUIPMENT CO . . . . . 181	565	GUIDEWARE CORP . . . . . 92PC-4	*	NORTHGATE COMP SYS . . . . . 140-144	176	TOTE-A-LAP . . . . . 317
202-203	CASADY & GREENE, INC. . . . . 344	61	HAUPPAUGE COMP WORKS . . . . 73	*	NORTHGATE COMP SYS . . . . . 152-154	244	TRI VALLEY TECHNOLOGY INC 337
410-411	CATHAY COMP & TECH INC 92IS-74	62	HERCULES COMPUTER TECH . . . 38	*	NORTHGATE COMPSYS . . . . . 172-174	236-237	TRIBAL MICROSYSTEMS . . . . 342
568-569	CBIS INC . . . . . 92SO-7	*	HEWLETT PACKARD . . . . . 2-3	147-148	ODYSSEY DEVELOPMENT . . . . . 272	483	TRULIN CORPORATION . . . . . 92IS-69
439	CHERRY MIKROSKHALTERGMBH 92IS-58-59	192	HI-TECH USA . . . . . 323	564	OKIDATA . . . . . 92PC-3	499	U/C/M LTD . . . . . 92IS-30
403	CHEWELLS SCIENTIFIC PUBL LTD 92UK-20	215	HIGH-RES TECHNOLOGIES . . . . 341	493	ON TIME MKT/MARSTEN PETERSEN . 92IS-66	177-178	ULTIMA ELECTRONICS CORP . . 332
496-497	CHIMEX DEVELOPMT CORP 92IS-61	216	HOOLEON . . . . . 339	246	OSCS . . . . . 344	151	ULTRATEX PRODUCTS . . . . . 129
37	CHIPS & TECHNOLOGIES (N.A.) 243	63	HUMMINGBIRD COMM . . . . . 284	227	OVERLAND DATA INC . . . . . 342	485-486	UNI AIR . . . . . 92IS-65
193	CITITRONICS . . . . . 324	459	I-COM . . . . . 92IS-66	476	OXFORD ELECTRONIC PUBL 92IS-56	484	UNIBIT SPA . . . . . 92IS-48
440-441	CLARION SOFTWARE . . . . . 92IS-31	217	IMAGE IN INC . . . . . 345	*	PACIFIC DATA PRODUCTS . . . . 95	247-248	UNIFORMOR ASSOCIATION . . 345
*	CLEO COMMUNICATIONS . . . . . 289	515	INEX TECHNOLOGY INT'L 92IS-72	32	PADS SOFTWARE INC . . . . . 237	445	UNITRON . . . . . 92IS-22
442-443	COMPEX . . . . . 92IS-27	66	INTEGRAND RESEARCH . . . . . 188	91	PARA SYSTEMS . . . . . 111	179	UNIVERSAL MEMORY PROD . . 320
162	COMPEX INTERNATIONAL . . . . . 330	64-65	INTEGRATED INFO TECH . . . . . 245	92	PATTON & PATTON . . . . . 102	*	UNIXWORLD . . . . . 273-275
444	COMPUCLASSICS . . . . . 92IS-6	67-68	INTEL CORPORATION . . . . . 226,227	93-94	PC POWER & COOLING . . . . . 75	223	VAIL SILICON . . . . . 342
204	COMPUCOM CORP . . . . . 340	69	INTERFACE GRPSFTBU (N.A.) . 120,121	269	PC PROS . . . . . 119	132	VERMONT CREATIVE SW . . . . 15
401	COMPUMART . . . . . 92UK-13	70	INVISIBLE SOFTWARE . . . . . 110	578-579	PC-EASE INC . . . . . 92SO-8	133-134	VIEWSONIC . . . . . 114
446	COMPUSAVE INT'L . . . . . 92IS-23	218	IO TECH . . . . . 341	95-96	PERSCOPE COMPANY, THE . . . . . 104	512	VIKING . . . . . 92IS-70
38	COMPUSERVE . . . . . 191-193	258-257	IOMEGA . . . . . 189	97	PERSONAL TEX . . . . . 266	502-503	VISIONETICS INT'L . . . . . 92IS-68
40	COMPUTER ASSOCIATES . . . . . 33	460-461	ISLAND SYSTEMS . . . . . 92IS-8	98-99	PINNACLE MICRO . . . . . 12,13	238	VISTA MICROSYSTEMS . . . . . 344
41	COMPUTER FRIENDS . . . . . 294	506	ITALIAN SOFTWARE AGENCY 92IS-35	190-191	PIXEL PERFECT/MEDICAL ADV 330	487	WALKER, RICHER & QUINN 92IS-21
447	COMPUTER QUICK . . . . . 92IS-46	71	JAMECO ELECTRONICS . . . . . 16,17	100	PKWARE INC . . . . . 238	*	WATCOM PRODUCTS INC . . . . 27
*	COMPUTERSOLUTIONSNW 92IS-84C-D	267-268	JDR MICRODEVICES (INT'L) . . 243	418-419	PORA CORPORATION . . . . . 92IS-78	239	WINTEK CORP . . . . . 343
163	COMPUTERLANE UNLIMITED 353	6-7	JDR MICRODEVICES . . . . . 336	473	PROGRAMMER'S ODYSSEY . . . . . 92IS-36	135-137	WOLFRAM RESEARCH . . . . . 225
205	COMPUTERWISE . . . . . 343	72	KEA SYSTEMS LTD . . . . . 94	76	PROGRAMMER'S PARADISE 61-63	404	WORKSTATION SOURCE 92UK-15
194	COMPUTERWORX . . . . . 325	219	KILA . . . . . 338	*	PROGRAMMER'S SHOP . . . . . 298-301	240	XELTEK . . . . . 342
181-182	COMTRADE . . . . . 326	73-74	KINGSTON TECHNOLOGY . . . . . 170	258	PROGRAMMER'S SHOP . . . . . 194	241	Z-WORLD ENGINEERING . . . . . 342
206	CONTROL VISION . . . . . 340	504-505	KYE SYSTEMS CORP . . . . . 92IS-84	101-102	PROGRESS SOFTWARE . . . . . 159	138	ZEOS INTERNATIONAL . . . . . 6,6A-D
*	COPIA INTERNATIONAL . . . . . 290	220	LAGUNA DATA SYSTEMS . . . . . 342	103-104	PROTECH MARKETING INC . . . . 113	139-140	ZYLBAK/DIVISION OF IDI . . . . 221
43	COREL SOFTWARE . . . . . 53	75	LAHEY COMPUTER SYSTEMS . . . . 266	242-243	PROTECT COMPUTER PROD . . . . 337		

\* Correspond directly with company.

To get further information on the products advertised in BYTE, fill out the reader service card by circling the numbers on the card that correspond to the inquiry number listed with the advertiser. This index is provided as an additional service by the publisher, who assumes no liability for errors or omissions.

\*Correspond directly with company.

## INDEX TO ADVERTISERS BY PRODUCT CATEGORY

Inquiry No.	Page No.	Inquiry No.	Page No.	Inquiry No.	Page No.	Inquiry No.	Page No.
<b>HARDWARE</b>							
<b>926 ACCESSORIES/SUPPLIES</b>				<b>939 MEMORY/CHIPS/UPGRADES</b>			
200	B&C MICROSYSTEMS	341		13	ADVANCED MICRO DEVICES	20,21	
209	DIETRICH POS EQUIPMENT	337		432	AMDS EUROPE LTD	92IS-19	
250	ERIN-AMERICAN LTD	337		249	ANACAPA MICRO PRODUCTS	340	
242-243	PROTECT COMPUTER PROD	337		18-19	AOX	239	
112-113	SECURE IT INC	296		35	CAPITAL EQUIPMENT CO	180	
<b>927 ADD-IN BOARDS</b>				38	CAPITAL EQUIPMENT CO	181	
195	ADD ON AMERICA	337		166	FIRSTSOURCE INT'L	333	
14-15	AMERICAN MEGATRENDS	99		61	HAUPPAUGE COMP WORKS	734	
406	BRAIN BOXES	92UK-10		67-68	INTEL CORPORATION	226,227	
442-443	COMPEX	92IS-27		73-74	KINGSTON TECHNOLOGY	170	
207-208	COVOX INC	337		224	MICROPROCESSORS UNLTD	340	
148	CREATIVE LABS INC	171		245	THE MEMORY DEPOT	340	
451	DIGIMETRIE	92IS-38		179	UNIVERSAL MEMORY PROD	320	
420-421	EVERSOURCE INTL CORP	92IS-75		<b>940 MISCELLANEOUS HARDWARE</b>			
489-490	FIRST INT'L COMPUTER	92IS-51		200	B&C MICROSYSTEMS	341	
412-413	FORMOSA MICROSYS, INC	92IS-77		37	CHIPS & TECHNOLOGIES (N.A.)	243	
62	HERCULES COMPUTER TECH	38		146	CREATIVE LABS INC	171	
215	HIGH-RES TECHNOLOGIES	341		66	INTEGRAND RESEARCH	188	
67-68	INTEL CORPORATION	226,227		464	MECKLER LTD	92IS-68	
79	MEGATEL COMP TECH	201		513-514	SPARCOM CORPORATION	92IS-72	
81	MICRONICS COMPUTER INC	219		<b>941 MODEMS/MULTIPLEXORS</b>			
	* MICROWAY	182		507	ALTEC	92IS-47	
264-285	MYLEX CORPORATION	85-92		22-23	BAY TECHNICAL ASSOC	277	
171-172	NATIONAL DESIGN	322		34	CANON USA INC	116	
95-98	PERISCOPE COMPANY, THE	104		204	COMPUCOM CORP	340	
173	QJA TECH INC	306		41	COMPUTER FRIENDS	294	
510-511	STB SYSTEMS	92IS-49		412-413	FORMOSA MICROSYS, INC	92IS-77	
422-423	TAKEN CORP	92IS-82		418-419	PORA CORPORATION	92IS-78	
233	TALKING TECHNOLOGY INC	338		154	SUPRA CORPORATION	103	
426-427	TNC GROUP	92IS-81		<b>942 MONITORS &amp; TERMINALS</b>			
244	TRI VALLEY TECHNOLOGY INC	337		434-435	AOC INTERNATIONAL	92IS-57	
483	TULIN CORPORATION	92IS-69		448-449	CTX INTERNATIONAL INC	92IS-29	
502-503	VISIONETICS INT'L	92IS-68		63	HUMMINGBIRD COMM	284	
<b>928 COMMUNICATIONS/NETWORKING</b>				260-261	MAG INNOVATION	8,9	
10-11	ACER INCORPORATED	41		84-85	NANO USA CORP	130	
195	ADD ON AMERICA	337		87	NEC	29-31	
408	ATOMSTYLE, LTD	92UK-7		428-429	ROYAL INFO ELECTRICS, LTD	92IS-83	
	* CLEO COMMUNICATIONS	289		414-415	TATUNG CO	92IS-79	
442-443	COMPEX	92IS-27		133-134	VIEWSONIC	114	
44	CURTIS INC	290		<b>943 MULTIMEDIA</b>			
212	GMM RESEARCH CORP	338		206	CONTROL VISION	340	
213	GTEK INC	338		146	CREATIVE LABS INC	171	
504-505	KYE SYSTEMS CORP	92IS-84		448-449	CTX INTERNATIONAL INC	92IS-29	
252-253	MICROTEST (INT'L)	CIV		51	DIGITAL VISION	296	
264-265	MYLEX CORPORATION	85-92		215	HIGH-RES TECHNOLOGIES	341	
407	SYMICRON LTD	92UK-8		474-475	NEWGEN SYSTEMS CORP	92IS-33	
233	TALKING TECHNOLOGY INC	338		231	SILICON SHACK	341	
151	ULTRATEX PRODUCTS	129		127	TEKTRONIX	117	
<b>929 COMPUTER SYSTEMS</b>				128-129	TELEX COMMUNICATIONS	260	
157-158	ABTECH	329		499	UIC/IM LTD	92IS-30	
10-11	ACER INCORPORATED	41		133-134	VIEWSONIC	114	
159	ACM COMPUTERS INC	321		<b>944 PRINTERS/PLOTTERS</b>			
430-431	AGC ELECTRONICS CORP	92IS-44		436	ASP COMPUTER PRODUCTS	92IS-10	
567	AIMS INFORMATION SYS	92PC-8		399	BUFFALO PRODUCTS	311	
575	APPRO INTERNATIONAL INC	92SO-2			HEWLETT PACKARD	2,3	
20-21	AST RESEARCH INC	107		471	MINOLTA GMBH	92IS-17	
180	ASTRIX COMPUTER CORP	354		474-475	NEWGEN SYSTEMS CORP	92IS-33	
189	CAD ONE COMPUTER DESIGN	308,309		584	OKIDATA	92PC-3	
410-411	CATHAY COMP & TECH INC	92IS-74			* PACIFIC DATA PRODUCTS	95	
496-497	CHIMEX DEVELOPMENT CORP	92IS-61			* ROSE ELECTRONICS	288	
193	CITITRONICS	324			* SEIKO INSTRUMENTS USA	137	
162	COMPEX INTERNATIONAL	330			* SOFTWARE PUBLISHING	100,101	
194	COMPUTERWORX	325		127	TEKTRONIX	117	
181-182	CONTRADE	326		130	TEXAS INSTRUMENTS	105	
488	DAN TECHNOLOGY PLC	92IS-5		<b>945 PROGRAMMABLE HARDWARE</b>			
46-47	DATALUX CORPORATION	138		200	B&C MICROSYSTEMS	341	
48	DELL COMPUTER CORP (N.A.)	CIV		201	BP MICROSYSTEMS INC	341	
49	DELL COMPUTER CORP (N.A.)	CIV		218	IO TECH	341	
	* DELL COMPUTER	92UK-9		222	LINK COMPUTER GRAPHICS	341	
509	DELL COMPUTER	92UK-11		236-237	TRIBAL MICROSYSTEMS	342	
	* DIGITAL EQUIPMENT CORP (N.A.) 108A-F			223	VAIL SILICON	342	
	* DIGITAL EQUIPMENT CORP	185		240	XELTEK	342	
	* DIGITAL EQUIPMENT CORP	187		241	Z-WORLD ENGINEERING	342	
53	DTK COMPUTER INC	97		<b>946 SCANNERS/OCR/DIGITIZERS</b>			
165	ELEK TEK	316		504-505	KYE SYSTEMS CORP	92IS-84	
	* ELONEX	92IS-2		462	LIGATURE LTD	92IS-24	
424-425	FBI/FAMOUSBUS/UNITED INTL	92S-76		<b>947 TAPE DRIVES</b>			
489-490	FIRST INTERNATIONAL COMP	92IS-51		14-15	AMERICAN MEGATRENDS	99	
412-413	FORMOSA MICROSYS, INC	92IS-77		405	DIGIDATA LTD	92UK-10	
	* GATEWAY 2000	CII,1		256-257	IOMEGA	189	
	* GATEWAY 2000	43-50		227	LAGUNA DATA SYSTEMS	342	
192	HI-TECH USA	323		495	MOUNTAIN NETWORK SOLU	92IS-41	
67-68	INTEL CORPORATION	228,227		227	OVERLAND DATA INC	342	
256-257	IOMEGA	189		229	QUADSTAR CORP	342	
71	JAMECO ELECTRONICS	16,17		<b>948 UPS</b>			
219	KILA	338		16	AMERICAN POWER CONV	202	
551-552	LUCKY COMPUTER CO	92MW-3		433	AMERICAN POWER CONV	92IS-62	
556-557	LUCKY COMPUTER CO	92NE-3		22-23	BAY TECHNICAL ASSOC	277	
582-583	LUCKY COMPUTER CO	92PC-5			* BEST POWER TECHNOLOGY 92IS-84A-B		
572-573	LUCKY COMPUTER CO	92SO-5		24-25	BEST POWER TECHNOLOGY	127	
558	MANCHESTER EQUIP CO	92NE-8		<b>949 BUSINESS</b>			
	* MANCHESTER EQUIP CO	92NE-6A-B		91	PARASYSTEMS	111	
576-577	MCCORMICK DATA DIST	92NE-5		93-94	PC POWER & COOLING	75	
465-466	MEGADATA	92IS-28		<b>SOFTWARE</b>			
185	MICROLINE COMPUTERS	335		<b>949 BUSINESS</b>			
	* NORTHGATE COMPUTER SYS 140-144			33	CALERA RECOGNITION SYS	231	
				161	CALERA RECOGNITION SYS	335	
				40	COMPUTER ASSOCIATES	33	
				506	ITALIAN SOFTWARE AGENCY	92IS-35	
					* MICROSOFT CORPORATION	71	
				469-470	MICROSYSTEMS SOFTWARE	92IS-89	
				32	PADS SOFTWARE INC	237	
				92	PATTON & PATTON	102	
				97	PERSONAL TEX	266	
				110-111	RAINBOW TECHNOLOGIES	55	
				124	SYMANTEC	22	
				<b>950 CAD/CAM</b>			
				17	AMERICAN SMALL BUSICOMP	139	
				32	PADS SOFTWARE INC	237	
				239	WINTEK CORP	343	
				<b>951 COMMUNICATIONS/NETWORKING</b>			
				408	ATOMSTYLE, LTD	92UK-7	
				568-569	CBIS INC	92SO-7	
				442-443	COMPEX	92IS-27	
				210	DIVERSIFIED COMPUTER	343	
				438	DOWTY COMMUNICATIONS	92IS-9	
					* GALACTICOMM INC	343	
				515	INEX TECHNOLOGY INT'L	92IS-72	
				70	INVISIBLE SOFTWARE	110	
				167	LANCAST	310	
				246	OSCS	344	
				110-111	RAINBOW TECHNOLOGIES	55	
				407	SYMICRON LTD	92UK-8	
				487	WALKER, RICHER & QUINN	92IS-21	
				<b>952 DATA ACQUISITION</b>			
				451	DIGIMETRIE	92IS-38	
				86	NATIONAL INSTRUMENTS	7	
				<b>953 DATABASE</b>			
				149-150	BLINK INC	217	
				28-29	BORLAND INTERNATIONAL	11	
				205	COMPUTERWISE	343	
					* COPIA INTERNATIONAL	290	
				187-188	DATA HUT	327	
				58	FOX SOFTWARE INC	76,77	
				508	ITALIAN SOFTWARE AGENCY	92IS-35	
				147-148	ODYSSEY DEVELOPMENT	272	
				109	RAIMA CORP	85	
				114	SEQUIETER SOFTWARE INC	147	
				409	SYSTEM C	92UK-4	
				139-140	ZYLAB/DIVISION OF IDI	221	
				<b>954 EDUCATIONAL</b>			
				8-9	ABACUS SOFTWARE	205	
					* AME INSTITUTE FOR COMP SCIENCES	344	
					INTERFACE GRPSFTBU (N.A.) 120,121		
					MCGRAW HILL NRI	290A-B	
				190-191	PIXEL PERFECT/MEDICAL ADV	330	
				<b>955 ENGINEERING/SCIENTIFIC</b>			
				403	CHEWELLS/SCIENTIFIC/PUBL LTD	92UK-20	
				451	DIGIMETRIE	92IS-38	
				52	DSP DEVELOPMENT CORP	248	
				501	EMULTEK	92IS-42	
				174-175	LANDMARK RES INT'L CORP	315	
				78	MATHSOFT INC	151	
					* NATIONAL INSTRUMENTS 92IS-84C-D		
				119	SPECTRUM SOFTWARE	177	
				238	VISTA MICROSYSTEMS	344	
				135-137	WOLFRAM RESEARCH	225	
				<b>956 GRAPHICS</b>			
				484	ARABIC PUBLISHER	92IS-70	
				202-203	CASADY & GREENE, INC	344	
				43	COREL SOFTWARE	53	
				448-449	CTX INTERNATIONAL INC	92IS-29	
				211	PILOT CORP	344	
				260-281	MAG INNOVATION	8,9	
				262-283	MATHEMATICA INC	34,35	
				80	MICROGRAFX	197	
				84-85	NANO USA CORP	130	
				474-475	NEWGEN SYSTEMS CORP	92IS-33	
				246	OSCS	344	
</							

To get further information on the products advertised in BYTE, fill out the reader service card by circling the numbers on the card that correspond to the inquiry number listed with the advertiser. This index is provided as an additional service by the publisher, who assumes no liability for errors or omissions.

\*Correspond directly with company.

## INDEX TO ADVERTISERS BY PRODUCT CATEGORY

Inquiry No.	Page No.	Inquiry No.	Page No.	Inquiry No.	Page No.	Inquiry No.	Page No.
448 COMPUSAVE INTERNATIONAL	92IS-23	963 PROGRAMMING LANGUAGES/TOOLS		103-104 PROTECH MARKETING INC	113	132 VERMONT CREATIVE SOFTWARE	15
458 GREY MATTER LTD	92IS-15	437 BLAISE COMPUTING INC	92IS-67	110-111 RAINBOW TECHNOLOGIES	55	<b>970 WINDOWS</b>	
76 PROGRAMMER'S PARADISE	81-83	* COMPUTER SOLUTIONS NW	92IS-84C-D	118 SOFTWARE SECURITY INC	98	152 ASYMETRIX	208,207
* PROGRAMMER'S SHOP	298-301	57-58 FTP SOFTWARE	286	<b>965 SHAREWARE</b>			
478 S'N'W ELECTRONICS	92IS-40	457 GLOCKENSPIEL	92IS-37	* COMPUTER SOLUTIONS NW	92IS-84C-D	33 CALERA RECOGNITION SYS	231
117 S'N'W ELECTRONICS	294	559 GPF SYSTEMS, INC	92NE-7	* REASONABLE SOLUTIONS	92IS-84A-B	181 CALERA RECOGNITION SYS	335
* SOFTLINE CORP	92IS-43	588 GPF SYSTEMS, INC	92PC-6	<b>966 SOFTWARE DUPLICATION</b>			
445 UNITRON	92IS-22	39 GREENVIEW DATA	79	198-199 AXIOMATIC	339	565 GUIDEWARE CORPORATION	92PC-4
<b>959 MATHEMATICAL/STATISTICAL</b>		458 GREY MATTER LTD	92IS-15	<b>967 SPREADSHEETS</b>			
230 SAS INSTITUTE INC	345	480-461 ISLAND SYSTEMS	92IS-8	26-27 BORLAND INTERNATIONAL	233	217 IMAGE IN INC	345
120-121 STATSOFT	199	506 ITALIAN SOFTWARE AGENCY	92IS-35	<b>968 UNIX</b>			
<b>960 MISCELLANEOUS SOFTWARE</b>		75 LAHEY COMPUTER SYSTEMS	268	* CLEO COMMUNICATIONS	289	280-281 MAG INNOVISION	8,9
33 CALERA RECOGNITION SYS	231	141-142 LIANT SOFTWARE CORP (N.A.)	265	39 GREENVIEW DATA	79	* MICROSOFT CORPORATION	19
161 CALERA RECOGNITION SYS	335	143-144 LIANT SOFTWARE CORP (INT'L)	265	141-142 LIANT SOFTWARE CORP	265	* MICROSOFT CORPORATION	71
452 DR HUGGLE & PARTNER GMBH	92IS-34	463 LOGIC PROGRAMMING ASSOC	92IS-71	143-144 LIANT SOFTWARE CORP	265	84-85 NANAO USA CORP	130
456 GREY MATTER LTD	92IS-15	500 M.L.L. SAW & COMPUTERS IND LTD	92IS-52	* MARK WILLIAMS CO	135	135-137 WOLFRAM RESEARCH	225
464 MECKLER LTD	92IS-66	498 MARKUS SOFTWARE DIST	92IS-32	472 MORTICE KERIN (MKS)	92IS-39	139-140 ZYLAB/DIVISION OF IDI	221
493 ON TIME MKT/KARSTEN PETERSEN	92IS-66	487-468 MDBSINC	92IS-11	473 PROGRAMMER'S ODYSSEY	92IS-38	<b>971 WORD PROCESSING/DTP</b>	
190-191 PIXEL PERFECT/MEDICAL ADV	330	* MICROWAY	280	247-248 UNIFORM ASSOCIATION	345	432 AMDS EUROPE LTD	92IS-19
477 SZKI RECOGNITACORP	92IS-12	* MICROSOFT CORPORATION	19	135-137 WOLFRAM RESEARCH	225	* MICROSOFT CORPORATION	19
512 VIKING	92IS-70	83 MIX SOFTWARE	283	<b>972 BOOKS/PUBLICATIONS</b>			
<b>961 ON-LINE SERVICES</b>		258 PROGRAMMER'S SHOP	194	* C++ REPORT	92IS-84C-D	147-148 ODYSSEY DEVELOPMENT	272
450 BIX	363	101-102 PROGRESS SOFTWARE	159	476 OXFORD ELECTRONIC PUBL	92IS-56	* PACIFIC DATA PRODUCTS	95
50 BYTE/DEMOLINK	361	228 PSEUDOCORP	345	139-140 ZYLAB/DIVISION OF IDI	221	* C USERS JOURNAL	92IS-84A-B
38 COMPUSERVE	191-193	479-480 STONY BROOK SOFTWARE	92IS-13	<b>973 MISCELLANEOUS</b>			
459 I-COM	92IS-66	124 SYMANTEC	22	251 BYTE REPRINTS	190	* BYTE SUB MESSAGE	292
<b>962 OPERATING SYSTEMS</b>		* WATCOM PRODUCTS INC	27	574 DEXPO SPRING	92S-3	* UNIXWORLD	273-275
* MARK WILLIAMS CO	135	404 WORKSTATIONSOURCE	92UK-15	42 THE COMPUTER MUSEUM	302		
107 QUANTUM SOFTWARE	293	<b>964 SECURITY</b>					
108 QUARTERDECK OFFICE SYSTEMS	255	12 ALADDIN KNOWLEDGE SYSTEMS	287	153 ADDSTOR INC	163		
		453-454 ELIASHIM MICROCOMPUTERS	92IS-64	440-441 CLARION SOFTWARE	92IS-31		
		455 ELUTRON	92IS-50	174-175 LANDMARK RES INT'L CORP	315		
		456 FAST ELECTRONIC GMBH	92IS-55	246 OSCS	344		
		59-60 GLENCO ENGINEERING	250	100 PKWARE INC	238		
		416-417 LANTECH	92IS-80	105-108 QUALITAS (N.A.)	249		

### BYTE ADVERTISING SALES STAFF:

Jennifer L. Bartel, National Sales Manager, 14850 Quorum Drive, Suite 380, Dallas, TX 75240, tel. (214) 701-8496  
Liz Coyman, Inside Advertising Sales Director, One Phoenix Mill Lane, Peterborough, NH 03458, tel. (603) 924-2518

#### NEW ENGLAND

ME, NH, VT, MA, RI, CT, ONTARIO  
CANADA & EASTERN CANADA  
Dan Savage (617) 860-6344  
Patricia Payne (603) 924-2654  
McGraw-Hill Publications  
24 Hartwell Avenue  
Lexington, MA 02173  
FAX: (617) 860-6899

#### EAST COAST

NY, NJ, PA, DE, VA  
Kim Norris (212) 512-2645  
Ariane Casey (212) 512-2368  
Patricia Payne (603) 924-2654  
McGraw-Hill Publications  
1221 Avenue of the Americas—  
28th Floor  
New York, NY 10020  
FAX: (212) 512-2075

#### SOUTHEAST

NC, SC, GA, FL, AL, TN, VA,  
MS, AR, LA, DC, MD, WV, KY  
John Y. Schilin (404) 843-4782  
Patricia Payne (603) 924-2654  
McGraw-Hill Publications  
4170 Ashford-Dunwoody Rd., Suite 520  
Atlanta, GA 30319  
FAX: (404) 252-4056

#### MIDWEST

IL, MO, KS, IA, ND, SD, MN,  
WI, NE, IN, MI, OH  
Kurt Kelley (312) 816-3328  
MaryAnn Goulding (603) 924-2684  
McGraw-Hill Publications  
Two Prudential Plaza  
180 North Stetson Ave.  
Chicago, IL 60601  
FAX: (312) 816-3370

#### NORTHWEST

ROCKY MOUNTAIN  
CO, OK, TX,  
(214) 701-8498  
Barry Echavarría (603) 924-2574  
McGraw-Hill Publications  
14850 Quorum Dr., Suite 380  
Dallas, TX 75240  
FAX: (214) 991-8208

#### NORTH PACIFIC: San Francisco, CA

NORTHERN CA, OR, ID, MT,  
WY, NORTHERN NV  
Roy J. Kops (415) 954-9728  
McGraw-Hill Publications  
425 Battery Street  
San Francisco, CA 94111  
FAX: (415) 954-9788

#### NORTH PACIFIC: Campbell, CA

SILICON VALLEY, HI, WA, AK,  
W. CANADA  
Bill McAfee (408) 879-0381  
Leslie Hupp (408) 879-0381  
McGraw-Hill Publications  
1999 South Bascom Ave., Suite 210  
Campbell, CA 95008  
FAX: (408) 879-9067

#### SOUTH PACIFIC: Los Angeles, CA

LOS ANGELES COUNTY, AZ,  
NM, SOUTHERN NEVADA  
Alan El Faye (213) 480-5243  
Jonathan Sawyer (603) 924-2685  
McGraw-Hill Publications  
3333 Wilshire Boulevard #407  
Los Angeles, CA 90010  
FAX: (213) 480-5249

#### SOUTH PACIFIC: Costa Mesa, CA

ORANGE COUNTY,  
SAN DIEGO COUNTY, UT  
Ron Cordick (714) 753-8140  
Jonathan Sawyer (603) 924-2685  
McGraw-Hill Publications  
15635 Alton Pkwy., Suite 290  
Irvine, CA 92718  
FAX: (714) 753-8147

Peterborough, NH Office: Inside Sales FAX: 603-924-2683 Advertising FAX: 603-924-7507

#### Hardware/Software Showcase

Mark Stone (603) 924-2895  
Ellen Perham (603) 924-2598  
BYTE Publications  
One Phoenix Mill Lane  
Peterborough, NH 03458

#### The Buyer's Mart (1x2)

Joseph Mabe (603) 924-2656  
BYTE Publications  
One Phoenix Mill Lane  
Peterborough, NH 03458

#### BYTE Deck

Ed Ware (603) 924-2598  
BYTE Publications  
One Phoenix Mill Lane  
Peterborough, NH 03458

#### EURO-DECK

James Bail (603) 924-2533  
BYTE Publications  
One Phoenix Mill Lane  
Peterborough, NH 03458

#### BYTE International Direct

Response Postcards  
Ellen Perham (603) 924-2598  
BYTE Publications  
One Phoenix Mill Lane  
Peterborough, NH 03458

### International Advertising Sales Staff:

McGraw-Hill Publishing Co., Wimbledon Bridge House, One Hartfield Road, Wimbledon, London, SW19 3RU, England, Tel: 44 81 543 1234, Fax: 44 81 540 3833

#### GERMANY, SWITZERLAND,

AUSTRIA, UNITED KINGDOM  
Roz Weyman (44 81 545 6269)  
Christina Barton (44 81 545 6270)  
McGraw-Hill Publishing Co.  
Wimbledon Bridge House  
One Hartfield Road  
Wimbledon, London SW19 3RU  
England  
Tel: 44 81 543 1234  
FAX: 44 81 540 3833  
TELEX: 892191

#### BENELUX

Ellen Pardede  
Balenburg 105  
3437 AB Nieuwegein  
The Netherlands  
Tel: 31 34 92 49498  
FAX: 31 34 92 37944

#### FRANCE, ITALY

Zena Coupé, Amanda Blakett  
A-Z International Sales Ltd.  
70 Chalk Farm Road  
London NW11 8AN  
England  
Tel: 44 71 284 3171  
FAX: 44 71 284 3174

#### ISRAEL

Dan Ehrlich  
Ehrlich Communication  
International  
P.O. Box 11297  
Tel Aviv 6 1112, Israel  
Tel: 972-52-588 245  
Tel: 972-52-588 246  
FAX: 972-52-585 685

#### HONG KONG

William Chu  
Seavex Ltd.  
503 Wilson House  
19-27 Wyndham St  
Central, Hong Kong  
Tel: (852) 868-2010  
FAX: (852) 810-1283  
TELEX: 60904 SEVEX HX

#### TAIWAN

Summer Chien  
Candice Lo  
Acer TWP Corp.  
19-2, Lane 231,  
Fu Hsing North Road  
Taipei 10445, Taiwan  
R.O.C.  
Tel: (886) 2 713 6959  
FAX: (886) 2 715 9501

#### AUSTRALIA

Ian McDonald  
Hugh Anderson Pty. Ltd.  
119 Market Street  
South Melbourne, Australia  
Tel: (61) 3-696-5411  
FAX: (61) 3-696-5892

#### INDIA

David Strike  
Sandell Strike Skinner  
Whipp Pty Ltd.  
64 Victoria Street  
Box 109, North Sydney  
NSW 2060, Australia  
Tel: (61) 2-922-2977  
FAX: (61) 2-922-1100

#### KOREA

Jeon-Gwon Seo  
DooBee International Limited  
Center Building (Byulgwang)  
1-11 Jeong-dong, Choong-ku  
C.P.O. Box 4557  
Seoul, Korea  
Tel: (82) 2 776-2096  
FAX: (82) 2 755-9860  
TELEX: 787-27117

#### PHILIPPINES

Luis Nunez  
Far East Media Consultants  
806-B Filipinas Life Bldg.  
6786 Ayala Ave.  
1200 Makati  
Metro Manila, Philippines  
Tel: (83) 2-810-1330  
FAX: (83) 2-816-1974

#### SINGAPORE

Jocelyn Domingo  
Seavex Ltd.  
400 Orchard Road, #10-01  
Singapore 0923  
Republic of Singapore  
Tel: 65 734 9790  
FAX: 85 732 5129  
TELEX: RS35539 SEAVEX

#### INDONESIA

Paula Kalangie  
Pacific Intermedia  
14/F., ArthaLoka Bldg.  
Jalan Jend. Sudirman No. 2  
Jakarta Pusat, Indonesia  
Tel: (82) 21-586-811  
FAX: (82) 21-720-2609

#### JAPAN

Maseki Mori  
McGraw-Hill Publishing Co.  
Overseas Corp.  
Room 1528  
Kasumigaseki Bldg.  
3-2-5 Kasumigaseki,  
Chiyoda-Ku  
Tokyo 100, Japan  
Tel: 81 33 581 9811  
FAX: 81 33 581 4018

# EDITORIAL INDEX BY COMPANY

Index of companies covered in articles, columns, or news stories in this issue.  
Each reference is to the first page of the article or section in which the company name appears.

## Company, Page # Inquiry #

<b>A</b>		
Abacus Software, 208	1321	
AceCAD, 64	1289	
Acer America, 204	1174	
Action Laser Products, 64	1285	
Adaptec, 160, 175		
Addison-Wesley, 261, 291		
Adlersparre & Associates, 240	1231	
Advanced Digital Information, 204	1175	
Advanced Logic Research, 204	1176	
AGE Logic, 72	1299	
Alliant, 183		
Amdahl, 183		
Ampex Recording Systems, 183		
Apple Computer, 23, 93, 115, 160, 253, 269, 295	977 1170 1230 1310 1305 1322	
Application Techniques, 80		
Applix, 78	1305	
Appoint, 208	1322	
Aptec Systems, 183		
Aquiline, 208	1323	
Array Technology, 204	1177	
AST Research, 204	1178	
AT&T, 183, 208, 257	1324	
AT&T Bell Laboratories, 155		
ATI Technologies, 93	1162	
<b>B</b>		
Banyan Systems, 195		
Biologic, 240	1232	
Bitstream, 80	1311	
Borland International, 39, 74	1211	
Bose, 59	1275	
Brier Technology, 160		
Bristol Technology, 281	1154	
Bureau of Electronic Publishing, 93	1167	
Burton Systems Software, 240	1233	
Busicom, 145		
Business Forecast Systems, 78	1307	
<b>C</b>		
Canon U.S.A., 303		
Carnegie Mellon University, 183		
CE Software, 303		
Ceram, 60	1282	
Cheetah International, 93	1159	
Cheyenne Software, 183		
Chico Software, 84	1314	
Chips & Technologies, 131		
Cimmetry Systems, 80	1309	
Ciprico, 204	1179	
Clarion Software, 23		
Commax Technologies, 208	1325	
Commodore Technology, 160		
Communication Intelligence, 115		
Compaq Computer, 23, 160, 204	1180	
Computer Peripherals, 64	1286	
Control Data, 183		
Convex Computer, 183		
Core International, 204	1181	
Cray Research, 183		
Crescent Software, 93	1171	
Cubix, 204	1182	
Cyrix, 303		
<b>D</b>		
Da Vinci Systems, 70	1295	
Dantz Development, 295		
Dariana, 51	1215	
Data General, 204, 257	1183	
Datamedia, 58	1274	
Datapoint, 145		
Datatape, 183		
Dayna Communications, 303		
DEC, 23, 122, 183, 204	1185	
Dell Computer, 42, 204	1184	
Desmond International, 80	1312	
Digital Research, 291		
Digital Tools, 78	1306	
Dilog, 204	1186	
Dimensional Insight, 84	1316	
Distributed Computing Solutions, 183		
Dolch Computer Systems, 208	1326	
Domino Computer Stores, 291		
Dove Computer, 70	1294	
DP-Tek, 269	978	
DSP Development, 84	1313	
Dycam, 93	1161	
<b>E</b>		
Edmark, 23		
Edsun Laboratories, 303		
Emerald Systems, 183		
Epoch Systems, 183		
Ergo Computing, 281		
Everex Systems, 58, 59, 208	1272 1278 1327	
Extended Systems, 72	1296	
<b>F</b>		
Fairchild Semiconductor, 145		
Farallon Computing, 303		
FPS Computing, 183		
Fujitsu America, 183, 204	1187	
FWB, 204	1188	
<b>G</b>		
General Atomics, 183		
Go, 115		
Golden Triangle Computers, 295	1146	
Grid Systems, 115, 208	1328	
<b>H</b>		
Handykey, 51	1214	
Helix Software, 240	1234	
Hewlett-Packard, 23, 122, 131, 183, 269, 287	979 1151 1219	
Hewlett-Packard/Apollo, 36	1219	
Honeywell IAC, 160		
HyperDesk, 122		
<b>I</b>		
IBM, 23, 36, 131, 160, 183, 204, 246, 257, 281, 287	1189	
Icarus, 74	1301	
Imaging Automation, 60	1280	
Inference, 74	1303	
Insignia Solutions, 259	1228	
Insite Technology, 160		
Integrated Data Storage Systems, 295		
Integrated Information Technology, 303		
Intel, 23, 131, 145, 175, 208, 303		
Intex Solutions, 80	1308	
Iomega, 160		
Isopoint Technologies, 208	1329	
<b>J</b>		
Jensen & Partners International, 23		
<b>K</b>		
Kilowatt Software, 93	1168	
Knowledge Adventure, 93	1164	
Kodiak Technology, 72	1297	
<b>L</b>		
L-com, 64	1287	
Language Systems, 74	1302	
LaserMaster Technologies, 269	980	
Laura Technologies, 60	1281	
Lawrence Livermore National Laboratory, 183		
Legacy Storage Systems, 204	1190	
Liberty Systems, 160		
Librex Computer Systems, 109	1221	
Locus Computing, 291		
Lotus Development, 23, 364		
Loval Computer, 204	1191	
<b>M</b>		
Maxell, 160		
Maximum Storage, 204	1192	
Maximum Strategy, 183		
Maynard Electronics, 183		
Mega Computer Systems, 204	1193	
Meida Vision, 93	1169	
MetaWare, 281	1153	
Microcom, 208	1317	
MicroMath Scientific Software, 84	1315	
MicroNet Technology, 204	1194	
Micropolis, 204	1195	
Microsoft, 10, 23, 39, 109, 115, 155, 160, 208, 246, 251, 257, 281, 303	1212 1223 1226 1331 1332	
MicroSpeed, 208		
MIT, 160		
Mobius Computer, 58	1271	
Modular Software Systems, 93	1157	
Morgan Kaufmann Publishers, 160		
Morton Management, 204	1196	
Motorola, 23, 36, 145, 175		
Mountain Network Solutions, 183		
Multisoft, 175		
<b>N</b>		
National Instruments, 60	1283	
NCR, 122, 204	1197	
NEC Technologies, 208	1333	
Nestor, 23		
NetFrame Systems, 204	1198	
The Network Connection, 204	1199	
Network General, 287	1149	
Network Interface, 70	1293	
Network Systems, 183		
Next, 257		
Northgate Computer Systems, 204	1200	
Norton-Lambert, 208	1318	
Novell, 23, 183, 195, 246, 281, 287	1150 1225	
<b>O</b>		
Object Design, 122		
Ocean Isle Software, 208	1319	
Open Software Foundation, 122, 183		
<b>P</b>		
Pace Scientific, 64	1288	
Palindrome, 72, 183	1300	
Parallan Computer, 204	1201	
PC Power & Cooling, 93	1173	
Perceptive Solutions, 93, 175	1163	
Perisol Technology, 204	1202	
Phar Lap Software, 281		
Philips, 23		
Poqet Computer, 23		
Positive, 58	1273	
Practical Peripherals, 70	1292	
Prima Storage Solutions, 160		
Procom Technology, 160		
<b>Q</b>		
Quadtel, 240	1235	
Qualitas, 240	1236	
Quanta Press, 93	1155	
Quantum, 59, 160	1279	
Quarterdeck Office Systems, 93, 240	1160 1237	
Questar Technologies, 303		
<b>R</b>		
Rational Systems, 281		
Reference Software International, 51	1218	
<b>S</b>		
Sandia National Laboratories, 183		
Sanyo/Icon International, 204	1203	
SAS Institute, 23		
Seiko, 145		
Shiva, 303		
Siemens-Nixdorf, 23		
Skeller Associates, 303		
Slate, 115		
SoftNet Communication, 240	1238	
Software Concepts Design, 303		
Sony, 23, 36		
Sota Technology, 93	1166	
Stac Electronics, 259	1229	
Storage Concepts, 204	1204	
Storage Dimensions, 204	1205	
Storage Technology, 183, 204	1206	
Sun Microsystems, 23, 36, 122, 183, 257		
Suncom Technologies, 208	1334	
SuperMac Technology, 295	1148	
Symantec, 253, 295	1147	
SynOptics Communications, 72	1298	
<b>T</b>		
Tandy, 23		
Tecmar, 183		
Telebit, 259	1227	
Texas Instruments, 145, 208	1335	
3M, 160		
Toshiba America Information Systems, 160, 208	1336	
TouchStone Software, 93	1158	
Transarc, 183		
Traveling Software, 93	1165	
Tricord Systems, 204	1207	
Triton Technologies, 208	1320	
Truevision, 51	1216	
Tseng Laboratories, 303		
<b>U</b>		
Unison World Software, 93	1156	
University of California at San Diego, 160		
Unix International, 122		
Unix Systems Laboratories, 23		
<b>V</b>		
V Communications, 240	1239	
Verbatim, 160		
Vortex Technology, 303		
<b>W</b>		
Walker Scientific, 64	1290	
Watcom, 281	1152	
Wavefront Technologies, 36		
Weitek, 303		
Western Digital, 175		
WordPerfect, 109, 257	1105 1224	
<b>X</b>		
X/Open, 122		
Xerox Network Services, 261		
Xircom, 70	1291	
XLI, 269	981	
<b>Y</b>		
Yale University, 362		
<b>Z</b>		
Zenith Data Systems, 109, 204, 208	1208 1222	
Zeos International, 204	1209	
Zilog, 145		

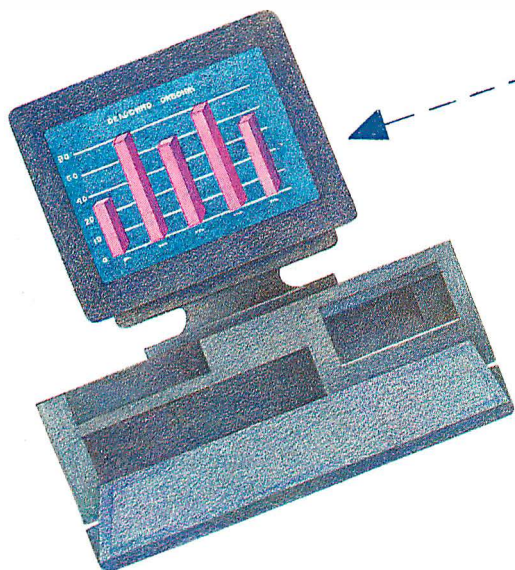
# FREE Software Instantly On-Line With BYTE DEMOLINK



Download free demo software from top publishers directly to your computer. . . for just the cost of a phone call!

BYTE DEMOLINK lets you preview software instantly by calling the telephone number in the city nearest you. All you need to access BYTE DEMOLINK is a PC, a modem and a telecommunications program. The latest demo software is at your fingertips for your evaluation.

Call **BYTE DEMOLINK** today to connect with these free software demos—It's only a phone call away!



## Here are the newest software packages available on DEMOLINK:

### AutoPACK Tutor

A powerful interactive computer-based AutoCAD training program for novice or experienced users. Tutor starts with an introductory module on the basics of AutoCAD, includes an exercise module that takes the user through step-by-step instructions of object snap, dimensioning, blocks, etc., and has a complete on-line reference system that replaces AutoCAD "Help" with animated examples and clear explanations. AutoPACK Tutor by Gräbert Systems, Inc.

Select the file `aptdemo.exe`

### TropicSoft C++ Classes

A set of the most efficient and complete C++ classes for building MS-DOS Windows application interfaces. Designed to dramatically reduce memory and exe size, increase execution speed and reduce lines of code by as much as 80%. Also features the flex "C" programming to compile in any memory model and run in any Windows mode. (Source code available.)

Select the file `tsdemo.exe`

### WINFAX PRO 2.0

Send and receive laser quality faxes from any Windows 3 application directly to any fax device or your PC. WINFAX PRO is recognized by Windows as a print device so a single fax can be composed from within pages of different Windows applications. Specify at what date and time the fax will be sent, and WINFAX PRO will send the fax to either one recipient or a group of recipients. Faxes can be printed or viewed upon receipt. WINFAX PRO manages fax numbers, recipients and groups with its built-in phonebooks. Cover pages can be fully customized to include log files, ASCII text files and fax merge capabilities. Call 1-800-268-6082 for more information.

Select the file `winfax.exe`

### ZyINDEX

ZyINDEX, by ZyLAB Corp., is the premiere text retrieval system for DOS and Windows. Search thousands of documents in seconds, regardless of where documents are located or with what word processor they were created.

Select the file `zyindex.exe`

### DEMOLINK Windows

Use our new Windows front-end software to automate your DEMOLINK sessions.

Select the file `dlwin.exe`

### Other Software Packages Available:

ASQ, by Qualitas

C++/Views, CNS, Inc.

C-Scape with Look & Feel, Liant Software Corp.

**BYTE  
DEMOLINK**

Free Demo Download  
**617-861-9767\***

\*Call the nearest DEMOLINK office anytime. Telecom settings: 2400 or 1200 baud, 8 data bits, 1 stop bit, and no parity. Enter DEMOLINK at the prompt.

Chicago 312-616-1071    Denver 303-220-0328    Los Angeles 213-383-9856    New York 212-797-5620    San Francisco 415-434-4510    Toronto 416-960-3187    Washington, DC 202-463-4920

Circle 50 on Inquiry Card.

## Mirror Worlds

The ultimate database might mirror reality

Every medium, thought Marshall McLuhan, is entangled with an earlier one. Most computers work at emulating typewriters, which in their time emulated printing presses. Spreadsheet packages maintain the typewriter model, though with a calculator grafted on. Change a percentage, recalculate, recopy: Nothing new except automation's speed.

But if David Gelernter is right, get set for More! Much More! His *Mirror Worlds* is subtitled "The Day Software Puts the Universe in a Shoebox... How It Will Happen, and What It Will Mean." Gelernter, whose fields of expertise at Yale are computer science and AI, reminds us that the millions of bits on a CD might be lamely described as "a list of instructions that tell the CD player what to do," although "encoded music" would be a better term. Likewise, think of any software package not as a list of instructions but as an encoded machine. So what kind of machine would you like? Forget typewriters. How about a Grand Central Station of information? A mirror world?

"These Mirror Worlds are like regular old-fashioned databases to some extent," but much more powerful. The version chiefly discussed is a mirror of your city, and it's a "high-tech voodoo doll," since "by interacting with the images you interact with reality." So, "you can parachute in your own software agents. They look out for your interests, or gather data that you need, or let you know when something significant seems to be going on."

How's the traffic just now? Let's see a picture. Zoom in on the Five Points area. Ugh. Better try a different route to the office. And Aunt Em's surgery? A few keyclicks: Good, she's out of intensive care. That saved a quarter-hour of fretting on hold. Her doctor, by the way, had a message yesterday nudging him to try Test W; that was thanks to an all-points alert from an expert: "If a patient ever shows up who is suspected to be suffering from X, and a W test isn't scheduled within 24 hours, let someone know." Yes, "constant vigilance to every possible source of screw-up." If, even once in a decade, a warning like that comes awake to prevent one serious medical glitch, we're delighted.

Aunt Em raises a principle. "The public at large is entitled to enter the City Hospital Mirror World, and to learn a good deal about what's going on. Furthermore, anyone is entitled to see his own medical records. But very few people have access to anyone else's, although they are all stored down here. Access to private information is closely controlled."

Not snoopware, then. "The goal is merely to convert the *theoretically* public into the *actually* public. What was always available in principle merely becomes available *in fact*." As to why this is important, Gelernter is a quick hand with analogies: The modern fighter aircraft, "so fantastically advanced you can't fly it," needs computer adjustment every few milliseconds lest it pop off out of control. And "modern organizations are close to the same level of attainment, except that, when they're out of control, they don't crash in flames; they shamble on blindly forever."

Thus, local governments "hover close to the jagged edge of clique-ridden sham, engaging the interests of a negligible fraction of the voters." Suppose we could all learn what's really been going on? Especially the night before an election?

Yes, there's a fairly strong political subtext. But most of *Mirror Worlds* is devoted to persuading us that the Mirror World software is just about at hand. Briefly, it depends on recursion (do the same thing on progressively larger scales) and resembles the "objects" BYTE readers hear so much about: neat capsules that contain instructions and await specifics. Being aimed at that mythical being, the General Reader, the exposition is deft with metaphor. I'll skip past many very interesting pages to alight on the book's epilogue, where Ed and John are having a chat.

Ed uses a Mac but hates manuals and "boring complexity that imposes on my time." John says, "Lighten up, these things are fun." Two temperaments. And soon Ed is complaining about technology—"a centrifuge... designed to stratify society on a person's fondness for playing games with machines." John proposes that Wordsworth's sentiment—*To me, the meanest flower that blows can give / Thoughts that do often lie too deep for tears*—has degenerated to Greenpeace, with "a nasty, desperate edge today, because it's dying." As it may be, says Ed, but the future then seems to be, "Know everything, feel nothing." So, *Mirror Worlds*: "A perfectly clean, neat, analytical silence," a paving of the riverbed, a huge exclusion. No more smells, chirps, oinks, rustlings. Just Overview. Yes, Ed has a point. Imagine yourself hooked on Overview. Would you (now) like yourself (then)?

What's finally disarming about the book is Gelernter's acceptance of Ed and John as alter egos. Yes, he thinks *Mirror Worlds* is imminent. Yes, he's enthusiastic. Yes, he's ambivalent. He ends up "smiling wryly."

But a smile still more wry is conceivable: Science? Or science fiction? Is software of such complexity thinkable? Maintainable? Do we really want who-knows-who (Mafia, IRS) watching everything? Utopia, then, or galloping paranoia? Finally, the record of futurists hasn't been good. What they've tended to foresee, not being wanted, never came to pass. In the 1930s, TV was to supplement the telephone. See Aunt Em while you talk with her! But nobody cared. TV eclipsed radio instead. ■

*Mirror Worlds*, David Gelernter, Oxford University Press, 1991, \$24.95 in softcover, 237 pp., ISBN 0-19-506812-2.

Hugh Kenner is Franklin and Callaway Professor of English at the University of Georgia. He writes for publications ranging from the *New York Times* to *Art & Antiques*. His recent books include *Mazes and Historical Fictions*. You can contact him on BIX as "hkenner."

Your questions and comments are welcome. Write to: Editor, BYTE, One Phoenix Mill Lane, Peterborough, NH 03458.



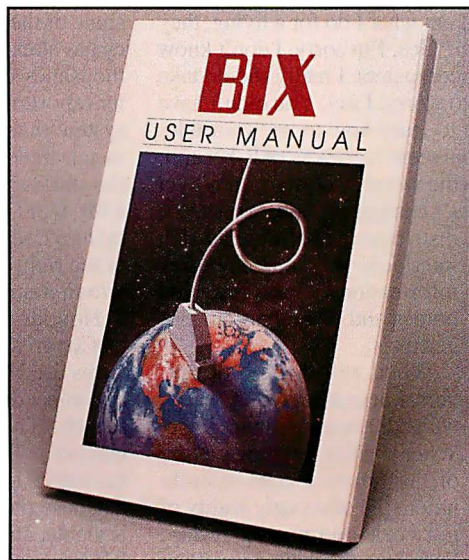
# Where Do You Go for Help When You're the Expert?

## BIX – the On-Line Service for People Who Know Computers!

**G**et answers, advice and code from top programmers, designers, and consultants. BIX is home to hardware and software engineers, systems designers, independent consultants, technology buffs and computer industry celebrities. *All sharing information on their favorite subject ... computing!* And the resources on BIX are substantial.

### More High-Quality Tools and Information on BIX.

Our software libraries are packed with the latest high-quality tools, programs and code to help you do a better job. So, whether you're looking for a special utility, TSR, highly qualified advice or just stimulating conversation, you'll find it on BIX.



### Get Answers in These Conferences and Many Others:

<b>borland</b>	Borland International official technical support
<b>c.plus.plus</b>	Discuss the C++ programming language
<b>ibm.windows</b>	IBM/Microsoft Windows
<b>ibm.os2</b>	OS/2 Operating System
<b>ibm.utils</b>	Utility software for IBM Computers
<b>microsoft</b>	Products from Microsoft

### Subscribe to BIX On-line for Only \$39 a Quarter Now!

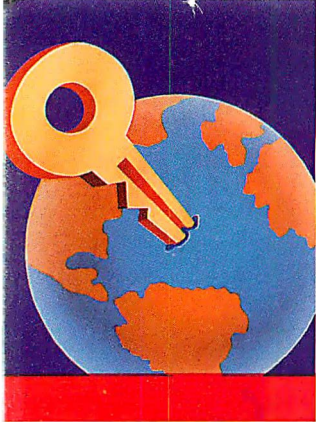
Just set your telecommunications program for full duplex, 2400 or 1200 baud, 7 bits, even parity, 1 stop bit. Get your Visa, MasterCard, or American Express card ready. Have your modem call 617-861-9767\*, enter "bix" at the prompt. When you are prompted for "Name?" enter "bix.deal" and complete on-line registration.

### Money-Back Guarantee!

Try BIX for 30 days and if you're not completely satisfied, call Customer Service and we'll refund your subscription fees. **But if you decide BIX is for you, we'll give you an additional 30 days on your annual subscription.**



\*Connect to BIX locally via BT Tymnet – call 800-336-0149 for your local access number, fees are outlined on-line. BIX handles billing for BT Tymnet connect fees. Other access available. Call BIX at 800-227-2983 or 603-924-7681 for more information.



JON UDELL

## STOP BIT

# INFOGLUT AT YOUR FINGERTIPS

**Even as more and better information search-and-retrieval systems become available, the major problem worsens: There is no common way to use them all.**

**W**hen people find out what I do for a living, they often apologize: "Gee, I'm sorry, I don't know anything about computers. I really should take a course." Not to worry, I say. You didn't have to go to school to learn how to use your telephone, did you? Computers seem hard now only because they can't quite melt into the woodwork; they aren't yet simply appliances. But that's changing. Global networks, distributed software, and rich interfaces will someday carry information to our offices and homes and place it at our fingertips.

When will this era of universal access arrive? Clearly, we've got some distance to go. When I paint my rosy picture of the future, I conveniently ignore the often ugly reality of network computing today. Spend too much time wrestling with memory managers, configuration files, routers, or interrupt request conflicts, and it's easy to lose sight of the big picture. Still, I take for granted that the nuts and bolts will eventually fall into place. I fully expect that we'll see gigabit-per-second data highways and distributed applications that exploit them by the turn of the century. What worries me is whether I'll be able to find what I'm looking for.

A friend who works at Lotus Development told me that he sold a used car in just 2 hours by posting an ad in a Notes database. The scary twist is that he spent the first 90 minutes just trying to figure out which Notes database to use. Here, I think, lies the ultimate challenge of "information at your fingertips." Who's going to put it there, and how?

Information scientists have thought long and hard about this problem. In general, there are just two approaches: Throw everything into the pot and index it all, or carve things up into chunks and index those. Even with storage, networks, and processors gaining size, speed, and intelligence at a breathtaking rate, it's hard for me to imagine that a planetary database will ever be effectively indexed in its entirety. Most theorists agree that there can be no substitute for the venerable 2000-year-old Aristotelian method: classification. How can we, entering the third millennium, apply that technique to a knowledge base undergoing explosive growth?

Eventually, of course, we'll have to get machines to do

some of the classification for us. The Reuters news agency has already taken a step in this direction. Every day, the thousands of news stories transmitted to Reuters from its reporters around the world pass through an expert system that assigns category codes. If you're a precious metals trader, you'll want your Reuters feed to include all the stories about gold and to exclude those that mention a Mr. Gold or the American Express gold card. Reuters's system does in fact attain both high recall (it finds most of the right items) and high precision (it finds few of the wrong items). That's a laudable achievement.

How do the Reuters categories relate to the Library of Congress Subject Headings, or to the sets of index terms used by Nexis, ABI/Inform, and the countless other compendia you might consult during a no-holds-barred search? They don't. A bird's-eye view of the world's electronic databases reveals an archipelago, each island having its own passport and dialect. You can't fault the database publishers. No standard controlled vocabulary is viable, and none seems likely to emerge anytime soon. It's not even clear whether such a thing is possible. Certainly the task is so daunting we'd all prefer that legions of Connection Machines or Knowledge Navigators will render it moot. But while we're waiting around for the world's information systems to spontaneously organize themselves, can't we do anything to improve matters?

Think about what happens when a company forms and brings a product to market. It's up to the company to ensure that its own name and the name of its product don't infringe on established names. Why bother? Pure self-interest: It's expensive to retool your packaging and advertising when someone challenges a name you've neglected to trademark. Now imagine the same self-interest at work helping to categorize goods, services, and information products so they'll be found when searched for. Nobody would force you to classify your widget, your store, your book, or your TV program, nor would anyone care whether you'd used the correct terminology. But just think of the advertising dollars you'd save if you hit on the right combination. ■

*Jon Udell is a BYTE senior technical editor at large. You can reach him on BIX as "judell."*

*Stop Bit is a forum for informed opinion on personal computing topics. The opinions expressed are those of the author and not necessarily those of BYTE. Your contributions and comments are welcome. Write to: Editor, BYTE, One Phoenix Mill Lane, Peterborough, NH 03458.*

# WE COULD CHALLENGE THE COMPETITION TO MATCH OUR NEW 4 HOUR ON-SITE SERVICE, BUT THEY WOULDN'T SHOW UP UNTIL TOMORROW.

Call for emergency computer service from the other guys and what do you get? Often, an agonizing wait, watching your business slowly grind to a halt.

Which is why Dell is introducing Critical Care™ service in 17 major metropolitan areas. Beginning March 30, if you have a mission-critical problem, you'll be able to get a technician on-site in no more than 4 hours.\*

And not just some guy with a set

of screwdrivers. We're talking about a full-fledged Novell-certified field engineer trained on every Dell system.

When he arrives, he will have been briefed on your problem. Given a history of your system. And equipped from a multi-million dollar parts inventory.

In short, a computer commando.

But the best part about Critical Care is that you'll probably never have to use it.

Our award-winning technical hotlines solve 90% of problems reported over the phone, usually in 10 minutes or less.

So call us and ask for more details about Critical Care. Or call the other guys and ask about their emergency service. They'll get back to you.

Eventually.

## 800-553-6039

TO ORDER, CALL PLEASE REFERENCE 11E61.  
HOURS: 7AM-9PM CT MON-FRI, 9AM-4PM CT SAT, 10AM-3P MCTSUN  
IN CANADA, CALL 800-668-3021. IN MEXICO, 95-800-010-0664.



# SOME MORE LOW BLOWS TO THE COMPETITION.

Here's news that's going to make a lot of computer manufacturers wince. We've dramatically reduced the prices of our entire range of Dell systems. So now you can buy one of

the best computers on the market without knocking out your budget.

And while other companies' standards often go down along with their prices, we'll still give you the

**LOWERED BY  
\$220**



Dell 316SX 16 MHz i386SX System\*  
System includes  
50 MB Hard Drive, VGA Color Monitor,  
2 MB RAM

- 1024 x 768 integrated video support
- Novell certified
- Expandable to 8 MB RAM
- 3 16-bit expansion slots
- Keyboard Password Protection
- 1 floppy drive

**LOWERED BY  
\$300**



NX20 from Dell 20 MHz i386™SX System\*  
System includes  
40 MB Hard Drive, VGALCD, 2 MB RAM

- 60 MB Hard Drive also available
- 8.3 x 11" footprint
- 6.8 lbs.
- 2-3 hour battery life
- CCFT edgelit triple supertwist display
- 32 Gray levels
- Full size keys with 3mm travel
- Modem, memory and coprocessor options
- One year return to factory warranty.

**LOWERED BY  
\$300**



Dell 486P/20 20 MHz i486™SX System\*  
System includes  
80 MB Hard Drive, UltraScon™ 14C  
Color Monitor, 4 MB RAM

- Upgradeable processor design
- 40% faster performance than 386DX systems
- Keyboard Password Protection
- RAM expansion to 64 MB
- 1024 x 768 integrated video support
- 1 floppy drive

service and support package described by *PC Week's* editors as "overkill."

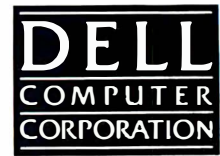
Our toll-free technical hotlines solve 90% of reported problems over the phone, usually in 10 minutes or less. Our TechFax<sup>SM</sup> line offers system information 24 hours a day. And if needed, a trained technician can be at your desk-side with a solution in hand, usually by the next business day.<sup>Δ</sup>

Perhaps this is why Dell comes so highly recommended. After all, we've won *PC Week's* Corporate

Satisfaction Poll for PCs, portables and servers an unprecedented eight times.

So call us and find out why over two-thirds of the FORTUNE 500<sup>®</sup> now use Dell computers. But don't bother talking to our competitors; they're a little short of breath.

We just took the wind out of their sales.



800-553-6046

TO ORDER, CALL. PLEASE REFERENCE 11E63.  
HOURS: 7AM-9PM CT MON-FRI, 9AM-4PM CT SAT, 10AM-3PM CT SUN  
IN CANADA, CALL 800-668-3021. IN MEXICO, 95-800-010-0664.

## LOWERED BY \$800



Dell 486P/33 33 MHz i486 System\*  
System includes  
100 MB Hard Drive, UltraScan 14C  
Color Monitor, 4 MB RAM

- Upgradeable processor design
- Programmable Flash EPROM for easy BIOS upgradeability
- Expands to 64 MB RAM using 32-bit SIMMs with gold-plated connectors
- 1024 x 768 non-interlaced monitor with 70 Hz refresh rate for flicker free operation
- 1 floppy drive

## LOWERED BY \$1,000



Dell 486D/33 33 MHz i486 System\*  
System includes  
200 MB Hard Drive, UltraScan 14C  
Color Monitor, 4 MB RAM

- 5 storage bays, 6 16-bit slots
- 8 KB internal cache
- RAM expands to 64 MB using 32-bit SIMMs with gold-plated connectors
- 1024 x 768 non-interlaced monitor with 70 Hz refresh rate for flicker free operation
- 1 floppy drive

## AND INTRODUCING



Dell 486D/16 16 MHz i486SX System\*  
System includes  
50 MB Hard Drive, VGA Color Monitor,  
2 MB RAM

- Upgradeable processor design
- Programmable Flash EPROM for easy BIOS upgradeability
- RAM expands to 64 MB using 32-bit SIMMs with gold-plated connectors
- SmartVu™ Diagnostic Display
- Supports up to 5 storage devices
- 6 16-bit expansion slots
- 1 floppy drive



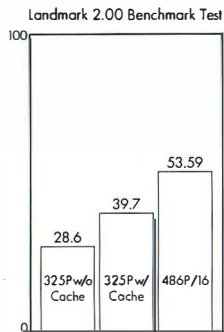
# AFTER YOU PUT YOUR JAW BACK IN ITS PLACE, CALL US.

You'll find the Dell® 486P/16 as surprising as our competitors find it shocking.

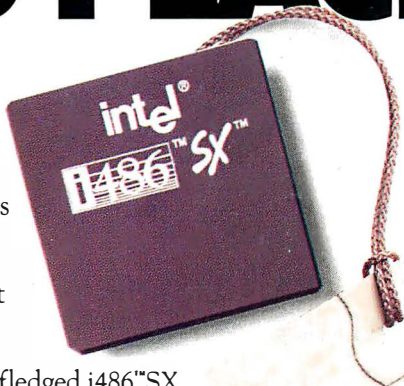
It delivers full-fledged i486™SX performance at the price of an i386™DX machine; up to 40% more processing power at virtually no additional cost.

And that's just for starters. Because the 16 MHz i486SX processor easily upgrades all the way up to a high-end 33 MHz i486DX system, and even beyond.

In other words, this is a computer that comes with the future built in. Along with some Dell technical innovations you'll be amazed to get at a price like this.



Features like programmable Flash EPROMs, for example, that make BIOS upgrading a matter of slipping in a diskette. 32-bit SIMMs with gold-plated connectors for greater



reliability. And built-in 1024 x 768 video support for high resolution graphics.

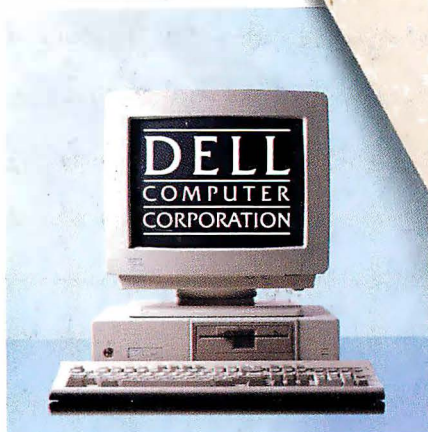
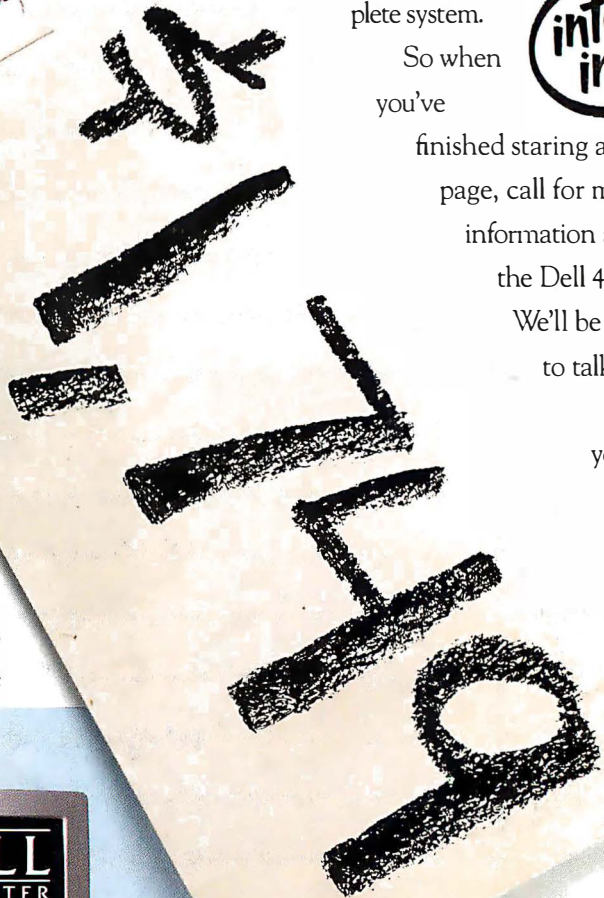
All this, starting at an unbelievable \$1,749 for a complete system.

So when you've



finished staring at this page, call for more information about the Dell 486P/16. We'll be happy to talk to you.

Even if you're speechless.



\$1,749 Lease\*: \$66/Month\*\*  
 Dell 486P/16 16 MHz i486SX System  
 System includes 50 MB Hard Drive, VGA  
 Color Monitor, 2 MB RAM and 1 Floppy Drive

800-545-7133

TO ORDER, CALL PLEASE REFERENCE 11EC2.  
 HOURS: 7AM-9PM CT MON-FRI, 9AM-4PM CT SAT, 10AM-3PM CT SUN  
 IN CANADA, CALL 800-668-3021. IN MEXICO, 95-800-010-0664.

Circle 49 on Inquiry Card.