

# BYTE

FEBRUARY 1991

A MCGRAW-HILL PUBLICATION

## 15 NOTEBOOK COMPUTERS

RATED FOR:

- Size and Weight
- Battery Life
- Display Quality
- Data Storage
- Keyboards
- Durability
- Expandability

PAGE 148



# TOMORROW'S Laptops

- PEN, VOICE, TOUCH INPUT
- NEW DISPLAYS • NEW CHIPS
- NEW STORAGE DEVICES
- NEW VISIONS

Xerox PARC's Newest GUI:  
The Information Visualizer

IBM's XGA Graphics

The New ARCnet Plus

Queuing Analysis

**PLUS:**

- Excel 3.0
- OS/2 "Lite"
- Adobe Illustrator 3.0
- Stacker
- OOP Libraries
- Sparcstation IPC
- RasterOps 1024MC Colorboard
- Storyboard Live!

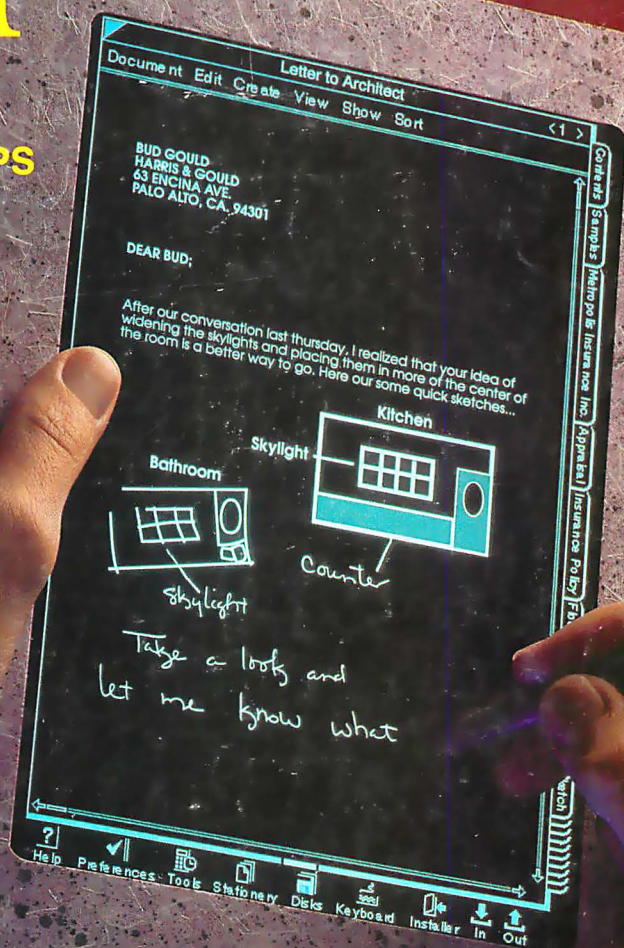



**THE NEW DELL SYSTEM 433TE**  
33 MHz EISA i486™

• i486 microprocessor running at 33 MHz with 128 KB external cache.

**Commercial Lease Plan. Lease for as low as \$377/month.**

330 MB Super VGA Color System (800 x 600) \$10,499

Price listed includes 4 MB of RAM.\* 80, 100, 190 and 650 MB hard drive configurations also available.



**THE NEW DELL SYSTEM 425TE**  
25 MHz EISA i486.

• i486 microprocessor running at 25 MHz.

**Commercial Lease Plan. Lease for as low as \$278/month.**

190 MB Super VGA Color System (800 x 600) \$7,499

Price listed includes 4 MB of RAM.\* 80, 100, 330 and 650 MB hard drive configurations also available.



**THE DELL SYSTEM 433E**  
33 MHz EISA i486.

• i486 microprocessor running at 33 MHz.

**Commercial Lease Plan. Lease for as low as \$307/month.**

100 MB Super VGA Color System (800 x 600) \$8,499

Price listed includes 4 MB of RAM.\* 80, 190, 330 and 650 MB hard drive configurations also available.

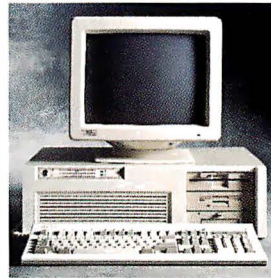

**THE DELL SYSTEM 425E™**  
25 MHz EISA i486.

• i486 microprocessor running at 25 MHz.

**Commercial Lease Plan. Lease for as low as \$235/month.**

100 MB Super VGA Color System (800 x 600) \$6,499

Price listed includes 4 MB of RAM.\* 80, 190, 330 and 650 MB hard drive configurations also available.



**THE NEW DELL SYSTEM 325D**  
25 MHz 386™

• Intel 80386 microprocessor running at 25 MHz with 32 KB external cache.

**Commercial Lease Plan. Lease for as low as \$112/month.**

40 MB VGA Color Plus System \$2,999

Price listed includes 1 MB of RAM.\* 80, 100, 190, 330 and 650 MB hard drive configurations also available.



**THE DELL SYSTEM 316SX**  
16 MHz: 386SX.

• Intel 80386SX microprocessor running at 16 MHz.

**Commercial Lease Plan. Lease for as low as \$79/month.**

40 MB VGA Color Plus System \$2,099

Price listed includes 1 MB of RAM.\* 20, 80, 100 and 190 MB hard drive configurations also available.



**THE DELL SYSTEM 320LX**  
20 MHz: 386SX.

• Intel 80386SX microprocessor running at 20 MHz.

**Commercial Lease Plan. Lease for as low as \$104/month.**

40 MB VGA Color Plus System \$2,799

Price listed includes 1 MB of RAM.\* 80, 100, 190, 330 and 650 MB hard drive configurations also available.

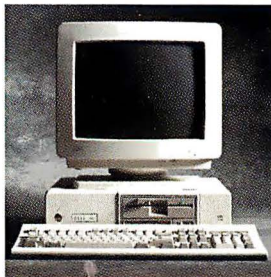

**THE DELL SYSTEM 210**  
12.5 MHz: 286.

• 80286 microprocessor running at 12.5 MHz.

**Commercial Lease Plan. Lease for as low as \$59/month.**

20 MB VGA Monochrome System \$1,549

Price listed includes 1 MB of RAM.\* 20, 80 and 100 MB hard drive configurations also available.



**THE NEW DELL SYSTEM 320LT**  
20 MHz: 386SX.

• Intel 80386SX microprocessor running at 20 MHz.

**Commercial Lease Plan. Lease for as low as \$131/month.**

20 MB, 1 MB RAM.\* \$3,599

40 MB hard drive configurations also available.

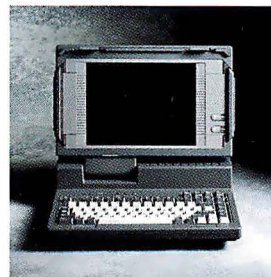

**THE DELL SYSTEM 316LT**  
16 MHz: 386SX.

• Intel 80386SX microprocessor running at 16 MHz.

**Commercial Lease Plan. Lease for as low as \$112/month.**

20 MB, 1 MB RAM.\* \$2,999

40 MB hard drive configurations also available.

The Dell System 433TE and 425TE are class A devices sold for use in commercial environments only. \*Performance Enhancements: Within the first megabyte of memory, 128 KB (316SX, 320LT, 316LT and 210) 96 KB (333D and 325D) or 384 KB (320LX, 425E, 433E, 425TE and 433TE) of memory is reserved for use by the system to enhance performance. Can be optionally disabled on 333D, 325D, 316SX and 210. All systems are photographed with optional extra. All prices and specifications are subject to change without notice. Dell cannot be responsible for errors in typography or photography. †Source: From Compaq October 15, 1990 press release. ‡Source: From Compaq July 23, 1990 press release. \*Payment based on a 36-month, open-end lease. †Leasing arranged by Leasing Group, Inc. In Canada, configurations and prices may vary. Dell and DELL SYSTEM are registered trademarks. 425E and SmartVu are trademarks of Dell Computer Corporation. Intel is a registered trademark and 386, 486, and i486 are trademarks of Intel Corporation. Other trademarks and trade names are used to identify the entities claiming the marks and names of their products. Dell Computer Corporation disclaims any proprietary interest in trademarks and trade names other than its own. †On-site service may not be available in certain remote locations. Shipping, handling and applicable sales tax not included in the price. For information on and a copy of Dell's 30-day Total Satisfaction Guarantee, limited warranty, and Xerox's Service Contract, please write to Dell USA Corporation, 9505 Arboretum Boulevard, Austin, Texas 78759-7299. ATTN: Warranty. © 1990 Dell Computer Corporation. All rights reserved.

# TOP OF THE MARK.

So what do you get by paying the extra mark-up for a Compaq?

Not a better computer. Dell's new 386™ systems are as fast, expandable and compatible as Compaq's.

Not better service. In 8 straight *PC Week* polls of corporate customers, Dell's service rated much higher than everyone else's.

Not better personal attention. From the

moment you first call us, and for as long as you own your computer, we'll work

with you custom configuring your computer and answering any questions—no matter how small—whether it be technical, sales or service related.

In fact, the only thing extra you get from Compaq is, well, mark-up.

**Our new 386's pull a fast one on pricier computers.** Both the 33 MHz Dell System® 333D and 25 MHz Dell System 325D are faster and more expandable than most higher priced systems.

The new Dell® 325D is a fast, reliable machine with up to 16 MB of RAM on the

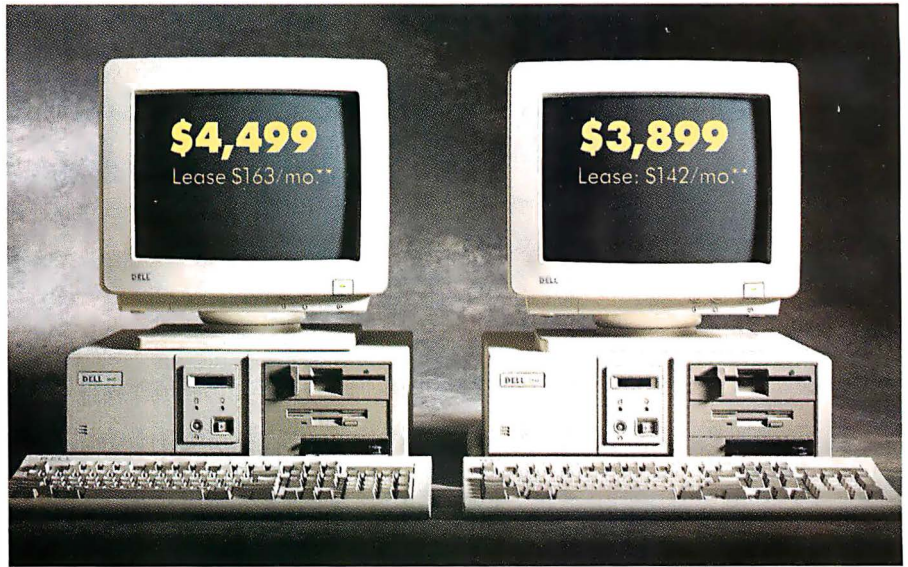

The new Dell 33 MHz and 25 MHz 386 computers. System includes: VGA Color Plus Monitor, 100 MB hard drive, 4 MB RAM.

system board and a 32 KB cache designed into a compact footprint.

The new Dell 333D is as good as a 386 PC can get. Not only is it 33% faster than the Dell 325D, it has a 64 KB cache for an extra kick in performance.

**We design every machine to our specs, then build it to yours.** We design our computers; we know them inside out. So when you call us, we can talk to you about what you need a computer

## THE NEW DELL SYSTEM 333D 33 MHz 386 AND THE NEW DELL SYSTEM 325D 25 MHz 386.

### STANDARD FEATURES:

- Intel® 80386 microprocessor running at 33 MHz (333D) or 25 MHz (325D).
- Page mode interleaved memory architecture.
- Standard 1 MB of RAM,\* optional 2 MB or 4 MB of RAM expandable to 16 MB on system board.
- Integrated VGA controller with 1024 x 768 support.
- Integrated hard drive and diskette drive interface.
- 64 KB (333D) or 32 KB (325D) SRAM cache.
- SmartVu™ Advanced System Diagnostic Display.
- Socket for Intel 80387 or WEITEK 3167 math coprocessor.
- 5.25" 1.2 MB or 3.5" 1.44 MB diskette drive.

- 6 industry standard expansion slots (five 16-bit, one 8-bit).
- High-performance IDE (40 MB, 80 MB, 100 MB, 190 MB) and ESDI (330 MB, 650 MB) hard disk drives.
- 1 parallel port, 2 serial ports, PS/2 compatible mouse port, all integrated.
- 177 watt power supply.
- 12-month Xerox® On-Site Service Contract.

333D 325D

40 MB VGA Color Plus System \$3,599 \$2,999

Prices listed include 1 MB of RAM,\* 80, 100, 190, 330 and 650 MB hard drive configurations also available.

AD CODE 11EB1

TO ORDER, CALL

800-365-1460

HOURS: 7 AM-9 PM CT M-F 8 AM-4 PM CT SAT

In Canada 800-387-5752. In the U.K. 0800 414535. In France (1) 30.60.68.00. In Germany 06103/701-0. In Sweden 0760-71350.

# TOP OF THE MARK-UPS.



Compaq's 33 MHz and 25 MHz 386 computers.  
System includes: VGA Color Monitor, 120 MB hard drive, 4 MB RAM.

for, and then put together the most efficient, economical package for you. We take you through all the choices you have in memory sizes, monitors, storage devices, high performance controllers and accessories. Once you agree about exactly what you need, we immediately begin custom configuring your computer, perform a completed system test, then send it off.

Then you get 30 days to use it. If you aren't satisfied, send it back. We'll return your money, no questions asked.

**Even if something goes wrong, it won't wreck your day.** Actually, one of the nice things about our service is that you'll rarely need it. Another *PC Week* poll category we dominate is the one called "reliability"—due in no small measure to our extensive burn-in testing on each computer before it goes out the door.

But, for the sake of argument, let's suppose something does go wrong with your Dell computer. Both the Dell 333D and 325D come with our SmartVu,<sup>™</sup> the built-in diagnostic display that ingeniously identifies problems even if the monitor goes down.

If you still need help,

our Dell toll-free technical support hotline solves 90% of all problems over the phone, often within 4 or 5 minutes. Or, if you use our new Dell TechFax line at 1-800-950-1329, we'll fax back technical information immediately.

If we still haven't solved the problem, we'll send trained technicians from the Xerox Corporation<sup>^</sup> to your desk the next business day with the solution in hand.

**For sale, for lease,<sup>^</sup> for less.** Call us. Talk to a computer expert whose only job is to give you exactly what you want in computers, service, software, printers and financing.

You'll get solid information that could save you time and money on computers with high marks, not high mark-ups.

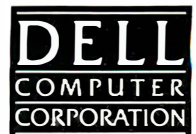

# HERE'S OUR NEW STORE, SO YOU'LL NEVER HAVE TO GO TO THEIR STORE AGAIN.

When you buy a computer from a typical computer store, here's what you get:

A beefy retail mark-up.

Pressure to buy things you don't want.

That crummy feeling of not knowing what you're getting, because the salesman isn't sure what he's selling.

And, when there's a problem, some guy with a screwdriver taking your computer apart.

When you call Dell, on the other hand, here's what you get:

A frank talk with computer experts about what you need, and a recommendation about the best overall package for you.

Custom configuration, with options including monitors, memory sizes,

software,  
accessories and  
peripherals.

Service —

consistently voted the best in the industry—  
by computer experts who know our computers  
inside and out.

A variety of financing and leasing<sup>o</sup> options.

A firm promise to perform a fully configured



## THE NEW DELL SYSTEM® 333D 33 MHz 386.

### STANDARD FEATURES:

- Intel® 80386 microprocessor running at 33 MHz.
- Page mode interleaved memory architecture.
- Standard 1 MB of RAM\*, optional 2 MB or 4 MB of RAM expandable to 16 MB on system board.
- Integrated VGA controller with 1024 x 768 support.
- 64 KB high-speed SRAM.
- Socket for Intel 80387 or WEITEK 3167 math coprocessor.
- 5.25" 1.2 MB or 3.5" 1.44 MB diskette drive.
- 6 industry standard expansion slots (five 16-bit, one 8-bit).
- High-performance IDE (40 MB, 80 MB, 100 MB, 190 MB) and ESDI (330 MB, 650 MB) hard disk drives.
- 1 parallel port, 2 serial ports, PS/2 compatible mouse port, all integrated.
- SmartViu™ - Advanced System Diagnostic Display.
- 12-month On-Site Service Contract provided by Xerox.

40 MB VGA Color Plus System \$3,599

Price listed includes 1 MB of RAM, 80, 100, 190, 330, and 650 hard drive configurations also available.

AD CODE 11EB1

systems test, and ship by two-day air standard.

A 30-day, no questions asked, money back  
guarantee.

A one-year limited warranty.

And a great price.

Call us now. Why waste a trip when everything  
you need is right in front of you?

TO ORDER, CALL

**800-365-1460**

HOURS: 7 AM-9 PM CT M-F 8 AM-4 PM CT SAT.

In Canada 800-387-5752. In the U.K. 0800 414535. In France (1) 30.60.68.00. In Germany 06103/701-0. In Sweden 0760-713 50.



# There's An Double Your

## Introducing The ALR POWERPRO

*With the POWERPRO's advanced modular system architecture, the choices you make today won't limit your options tomorrow.*

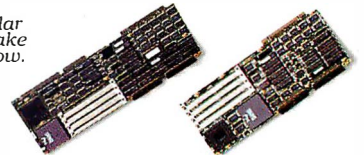

**Just Upgrade the CPU!™**



Additionally, all models will be able to accommodate future, faster, processors. With 49-MBs of possible RAM, twelve expansion slots, and accommodations for up to 2.5-GB of internal stor-

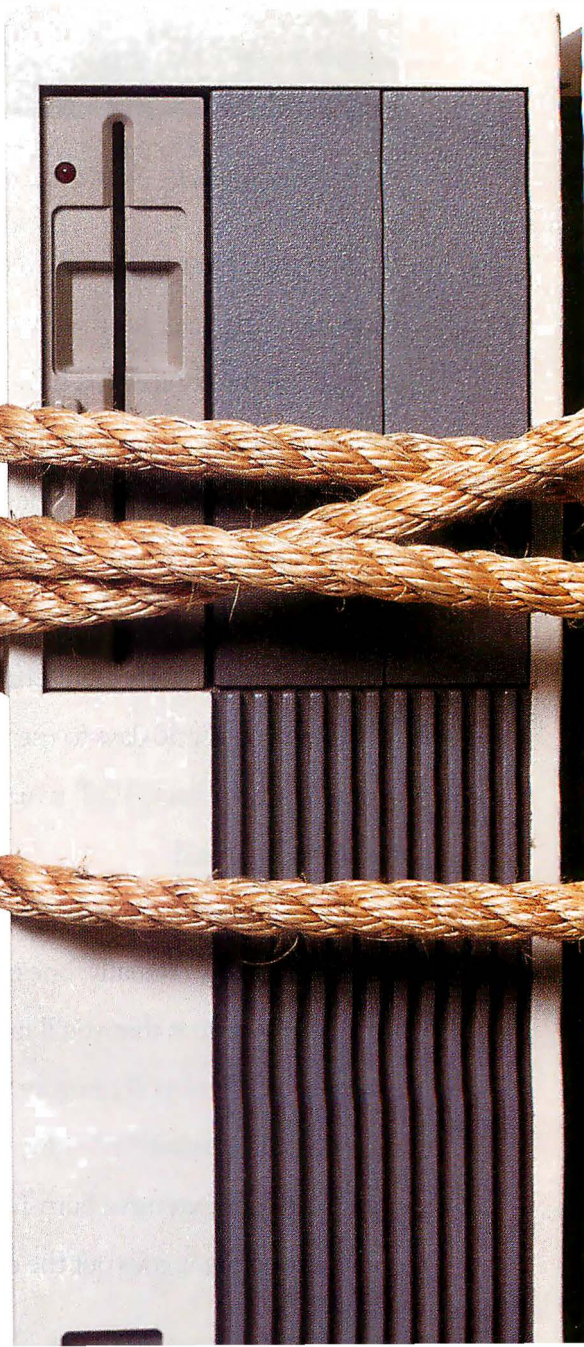

Strapping two traditional PCs together won't give you the dual processing power you need to keep pace with today's growing networks and multi-user environments, but the new ALR®POWERPRO will. It's the affordable, high-performance alternative to the COMPAQ® SYSTEMPRO™.

Whether you need a system for single or multiple users, CAD/CAM, office automation, manufacturing management systems, shared databases or a host of other applications, there's a POWERPRO that delivers. Choose between one or two 33-MHZ i486 processors and up to 1-MB of cache for performance ranging from 14.7 to 40 VAX™ MIPS. Single CPU models can be quickly and easily upgraded to dual processing.

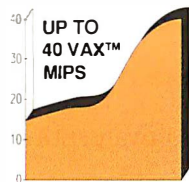

age (up to 10-GB of total storage utilizing an external ALR expansion chassis), the POWERPRO has the expandability needed to keep pace with your future needs. The POWERPRO also incorporates a 32-bit EISA bus, so you'll have maximum com-

patibility with cutting-edge enhancement products while enjoying the affordability of today's low-cost "AT" compatible hardware.

**SUPERIOR CACHE**  
The POWERPRO uses ALR's proprietary

# Easier Way To Processing Power.

## Single or Dual Processing Performance with Prices Starting at \$7495

PROCACHE scalable cache memory architecture. This mainframe-like read-and-write-back design is more efficient than the standard write-through architecture found on the SYSTEMPRO.

ing, spanning and mirroring — with greater flexibility and higher performance. ALR's SDA protects your data while helping to eliminate hard disk bottlenecks.

### OFF THE SHELF COMPATIBILITY

The SYSTEMPRO-compatible ALR POWERPRO runs off the shelf dual-processing versions of SCO® UNIX™ with SCO MPX as well as Banyan® Vines™ SMP. And it's positioned for use with future dual processing versions of Novell® NetWare™, OS/ 2™ and LAN Manager 2.0™.

Manufacturer	ALR	ALR	Compaq
Model Name	POWERPRO 486/33 VM 64	POWERPRO 486/33 SMP 512	SYSTEMPRO 486/33
CPU	Single 33-MHz i486	Single 33-MHz i486	Single 33-MHz i486
# of Processors	1	1	1
Max. # of Processors	2	2	2
Bus Architecture	32-bit EISA	32-bit EISA	32-bit EISA
Memory Cache	64-KB	512-KB	512-KB
RAM Std.	5-MB	17-MB	8-MB
Hard Drive	none	330-MB <18ms	240-MB <19ms
Expansion Slots	12	12	11
Price	\$7,495	\$14,495	\$20,995

More importantly, this scalable architecture allows you to equip the POWERPRO with up to 1-MB of cache.

### ADVANCED DISK PERFORMANCE AND SECURITY

Yet the POWERPRO's performance edge doesn't stop there. Selected models use ALR's SCSI SDA (Software Disk Array) to provide the capabilities of hardware disk arrays — including disk strip-

Only ALR can deliver a dual-processing system that's more powerful than the COMPAQ SYSTEMPRO for a price that's up to 30% less.

For more information call ALR now;

**1-800-444-4ALR**

**ALR®**

Advanced Logic Research, Inc.

9401 Jeronimo Irvine, CA 92718  
(714) 581-6770 FAX: (714) 581-9240

**Available at these selected**

**resellers:** ALR Power Partner Resellers

Connecting Point  
COMPUTER CENTERS

ENTRE

TCBC

Prices based on U.S. Dollars.  
Prices and configurations subject to change without notice - please verify competitive prices with manufacturer. System shown with optional monitor. ALR is a registered trademark of Advanced Logic Research, Inc. All other brand and product names are trademarks or registered trademarks of their respective owners. © 1990 by Advanced Logic Research, Inc.

Circle 12 on Reader Service Card (RESELLERS: 13)

# CONTENTS

February 1991  
Volume 16, Number 2

## COVER STORY ▷

### The Point of the Pen

PAGE 211

GO's new PenPoint operating system brings handwriting recognition to the laptop.



Laptop Technologies/200

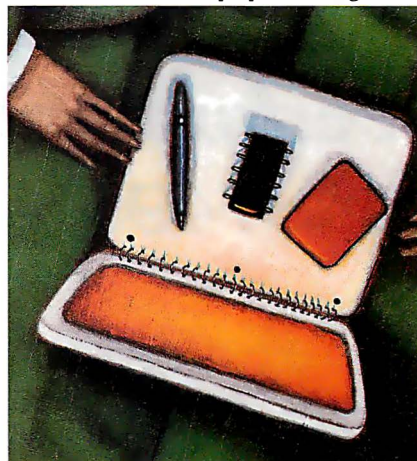

## NEWS

- 19 **MICROBYTES**  
The new MS-DOS 5.0 is almost ready, and fractal compression technology comes to market.
- 44 **WHAT'S NEW**  
Kodak prints computer color, a look at the most miniature modem, Smalltalk does Windows, and more.

## FIRST IMPRESSIONS

- 127 **SHORT TAKES**  
*Fax-O-Matic and FaxConnection, fax machines that use a laser printer for output from Tall Tree Systems and Extended Systems*
- Mathematica for Windows 3.0, Wolfram Research's great addition*
- Storyboard Live!, IBM's multimedia software*
- FileMaker Pro, Claris gives a face-lift to its database*
- Stacker, Stac Electronics lets you double your hard disk space instantly*
- 136 **New Extras for Excel**  
Microsoft's new version can do spreadsheet outlining.
- 143 **OS/2 Goes on a Diet**  
OS/2 1.3: leaner, meaner, faster.

## REVIEWS

- 148 **PRODUCT FOCUS**  
**Perfectly Portable**  
These 15 notebook-size computers mix PC power with state-of-the-art portability.
- 164 **Libraries with Class**  
A handful of C++ libraries.
- 169 **The Littlest SPARC**  
Sun's Sparcstation IPC squeezes RISC power onto even the smallest desk.
- 176 **PS/2 Blues Disappear with First 16.7-Million-Color MCA Adapter**  
RasterOps releases the first true-color, 24-bit display adapter for PS/2s.
- 178 **An Artist's Old Tool Learns New Tricks**  
Adobe's Illustrator 3.0 offers improved text handling and a new graphing capability.
- 183 **Statistical Analysis for the Executive**  
KnowledgeSeeker provides an analytical statistical tool for executive decision making that nearly works like magic.
- 186 **Concern for the Editing Environment**  
The Iliad Group's PIEdit creates an integrated development environment for cross-platform programmers.
- 190 **Reviewer's Notebook**  
Arche and Club 386s performed admirably during a six-month stint in the BYTE lab.

## STATE OF THE ART

- 200 **LAPTOP TECHNOLOGIES**  
**Introduction**
- 203 **Dynabook Revisited with Alan Kay**  
From Xerox PARC to Apple, Alan Kay's most enduring contribution may be a machine that has not yet been built.
- 223 **Touch-and-Feel Interfaces**  
Laptops of the near future will have to include built-in pointing devices to support GUIs.
- 229 **LCDs and Beyond**  
Nick Baran reviews the state of the art of display technologies and describes some fascinating alternatives.
- 239 **Destination Laptop**  
Squeezing the components of an AT-class machine onto a single chip will have a great impact on the portable computers of the future.
- 251 **Memories in My Pocket**  
Solid-state memory cards provide the size, weight, and capacity necessary to be practical in a notebook computer.
- 260 **Resource Guide: Portable Sources**  
A who's who in portable computers.



Network Operating Systems/268

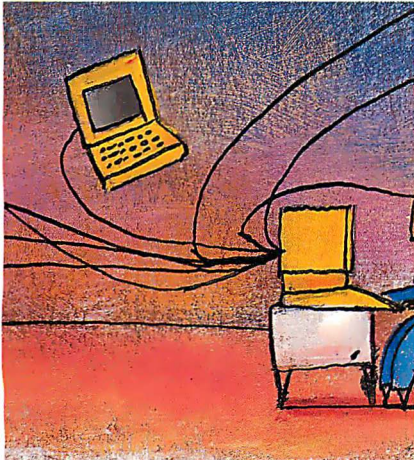

Macinations/101



**EXPERT ADVICE**

73

**COMPUTING  
AT CHAOS MANOR**

**A Pack of Laptops**  
by Jerry Pournelle  
Jerry picks the ideal portable computer.

89

**DOWN TO BUSINESS  
Corporate Style**

Wayne Rash Jr.  
How consistent is the language of your business documents?

95

**BEYOND DOS:  
WINDOWS AND OS/2  
Whither Windows?**

by Jon Udell  
Putting Windows 3.0 and OS/2 2.0 on the scales.

101

**MACINATIONS  
Macintosh: The Next Generation**

by Don Crabb  
Don converses with MacFolk to determine new directions for Mac evolution.

107

**THE UNIX /bin  
Heed the Standards**

by David Fiedler  
A look at some current standards battles and how they could affect Unix users.

119

**NETWORKS  
The Return of ARCnet**

by Brett Glass  
ARCnet Plus is a fast alternative to Ethernet and Token Ring hardware, and it's downward-compatible with ARCnet.

**FEATURES**

- 268 **The Future of Network Operating Systems**  
What lies ahead for network operating systems? Major players in the field make their predictions.
- 277 **An Easier Interface**  
An innovative new user interface from Xerox's Palo Alto Research Center makes use of color and 3-D graphics.
- 285 **XGA: A New Graphics Standard**  
The Extended Graphics Array offers full graphics functionality as well as bus mastering.

**HANDS ON**

- 293 **Making Windows Work**  
Here's help if you're experiencing pains with Windows 3.0.
- 301 **UNDER THE HOOD**  
**Fax Facts**  
The little-known digital secrets tucked inside every fax device.
- 309 **SOME ASSEMBLY REQUIRED**  
**A Practical Guide to Queuing Analysis**  
William Stallings, an authority on data communications, presents some simple tools for analyzing many kinds of problems.

**DEPARTMENTS**

- 6 **Spotlight**  
Your answers and comments help shape our test procedures.
- 10 **Editorial**  
Facing Hard Times?
- 33 **Letters, Ask BYTE, and Fixes**  
Readers debate DTP.

**PERSPECTIVES**

- 356 **CHAOS MANOR MAIL**
- 358 **PRINT QUEUE**  
**Never-Never Land**  
Science and lunacy collide in a fascinating book about experiments over the edge.
- 360 **STOP BIT**  
**Great Expectations**  
Advice on how not to get burned the next time you buy a system for your business.

**READER SERVICE**

- 346 Editorial Index by Company
- 348 Alphabetical Index to Advertisers
- 350 Index to Advertisers by Product Category
- Inquiry Reply Cards: after 352

**PROGRAM LISTINGS**

- From BIX: Call (800) 227-2985
- From BYTEnet: Call (617) 861-9764
- On disk: See card after 280

BYTE (ISSN 0360-5280/91) is published monthly with an additional issue in October by McGraw-Hill, Inc. U.S. subscriber rate \$29.95 per year. In Canada and Mexico, \$34.95 per year. Single copies \$3.50 in the U.S., \$4.50 in Canada. Executive, Editorial, Circulation, and Advertising Offices: One Phoenix Mill Lane, Peterborough, NH 03458. Second-class postage paid at Peterborough, NH, and additional mailing offices. Postage paid at Winnipeg, Manitoba. Registration number 9321. Registered as McGraw-Hill, Inc. for GST #R123075673. Printed in the United States of America. **Postmaster:** Send address changes, USPS Form 3579, and fulfillment questions to BYTE Subscriptions, P.O. Box 551, Hightstown, NJ 08520.

# UNLEASH TURBO SPEED

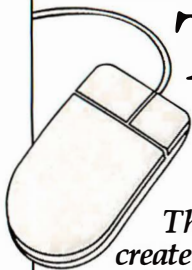

*The fastest way to create powerful programs with Turbo Pascal 5.5, Turbo C 2.0 and Turbo C++!*

## POWER TOOLS PLUS™/5.1 - \$149

*- lightning-fast routines to help you:*

- ◆ Add easy-to-use integrated mouse support for windows and menus
- ◆ Generate context sensitive help screens
- ◆ Resize and move windows and use drop shadows for that professional look
- ◆ Let users choose from window-oriented pick lists
- ◆ Create and access "huge" data structures
- ◆ Use multiple-line edit fields with fully configurable edit keys
- ◆ Add EMS support
- ◆ Write TSRs and ISRs easily
- ◆ Create powerful programs in Turbo Pascal 4.0, 5.0 & 5.5!

## Turbo C TOOLS™/2.0 - \$149

*- fast, high quality functions to help you:*

- ◆ Add easy-to-use integrated mouse support for windows and menus
- ◆ Quickly include virtual windows and menus
- ◆ Integrate your windows and menus with Turbo C's text windows
- ◆ Create context-sensitive help screens
- ◆ Provide multiple-line edit fields with fully configurable edit keys
- ◆ Write TSRs and ISRs easily
- ◆ Create powerful programs in Turbo C 1.0, 1.5, 2.0 and Turbo C++!

### FREE with these products!

All source code, complete sample programs, and a comprehensive manual are included. We offer free technical support and a bulletin board dedicated to technical issues.

### Unleash your potential!

We offer programming tools that are fast, flexible and affordable. Call now to order, or to ask for a free brochure on our full line of products for C and Pascal.

### Put Blaise tools to the test!

If during the first 30 days you are not satisfied, we'll refund your money.

**Call (800) 333-8087 today!**

**BLAISE COMPUTING INC.**  
2560 Ninth Street, Suite 316 Berkeley, CA 94710  
(415) 540-5441 FAX (415) 540-1938

Trademarks are property of their respective holders.

# S P O T L I G H T

## WE PICK YOUR BRAIN TO MAKE OUR PICKS

*Monthly surveys help the BYTE Lab fine-tune the Product Focus to suit your needs*

The next piece of mail you get from BYTE might be a questionnaire seeking your thoughts on a product category. Starting this month, the BYTE Lab is surveying a random sampling of BYTE subscribers in an effort to better hone our Product Focus section to suit your needs.

BYTE has always consulted its readers and other industry experts in preparation for product comparisons. The BIX (BYTE Information Exchange) conferencing system, in particular, has been invaluable to us in this regard. The survey allows us to get a timely, statistically accurate snapshot of both your interest and requirements for a given product type.

The survey for this month's Product Focus on notebook PCs, for instance, told us which brands of notebook PCs you use (see above right), which features are important to you (see below), and what applications you intend to use (see below right). The results were mostly in sync with our expectations, but there were surprises. For example, over half of you want both a hard disk drive and

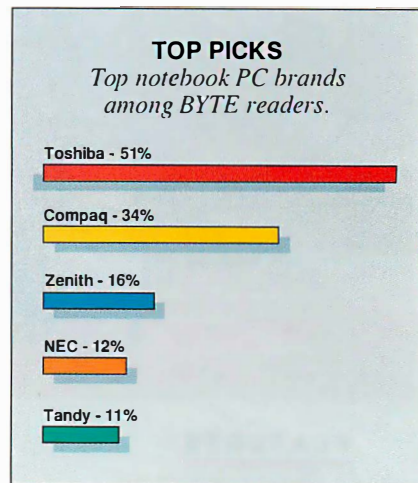

a floppy disk drive, rating this feature higher than either performance or price.

Your answers and comments helped shape our test procedures. Our new application benchmark suite for notebook and laptop PCs, premiering in this issue, owes much to your responses. When it came time to make recommendations to you about which notebook PC to buy, we knew what you were looking for.

These days, you need much more than benchmark scores to make intelligent purchasing decisions. You also need the perspective that comes from knowing both the market and its customers—the perspective that the BYTE Lab is committed to provide to you. ■

—Michael Nadeau

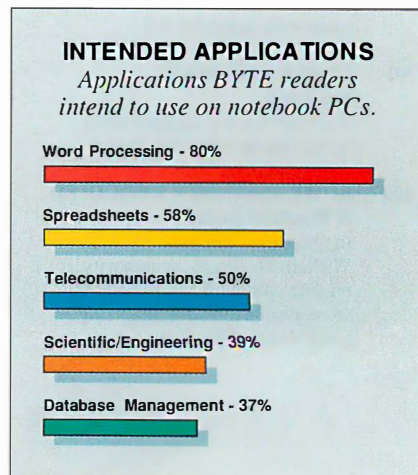
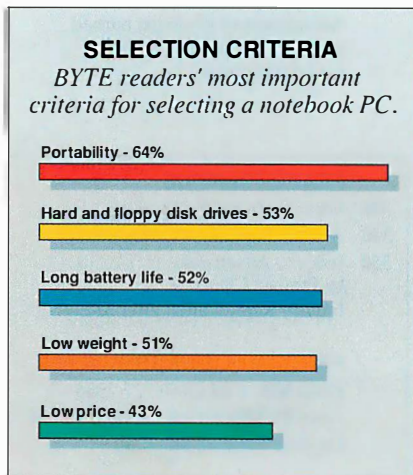

# And Truth Comes Out.

**Software Digest** **RATINGS REPORT**  
 The Independent Comparative Ratings Report for Selecting IBM PC Business Software

Volume 7, Number 13

## MULTIUSER DATABASE PROGRAMS

Ratings Key: ■ 7.0-10.0 ■ 5.0-6.9 ■ under 5.0

Software Digest Rating	Overall Evaluation	Overall Power	Program Name	Version Tested	Performance Versatility	Error Handling	Ease of Learning	Ease of Use	Memory Requirement	Price	Volume Purchase Agreement	Page
***	7.0	6.7	dBase IV	1.1	■	■	■	■	450KB	\$795	✓	28
**	6.8	5.1	Paradox	3.5	■	■	■	■	640KB	\$995	✓	32
**	6.8	7.1	FoxPro/LAN	1.02	■	■	■	■	512KB	\$1,095	✓	30
**	6.4	5.1	DataEase	4.2	■	■	■	■	640KB	\$750	✓	26
*	5.8	3.6	R:Base	3.0	■	■	■	■	520KB	\$995	✓	34
*	5.7	6.0	Clarion Professional Developer	2.1	■	■	■	■	512KB	\$845	✓	24
*	5.7	6.6	Advanced Revelation	2.01	■	■	■	■	640KB	\$995	✓	22

REPRODUCTION OR QUOTATION IN WHOLE OR IN PART IS PROHIBITED WITHOUT PRIOR WRITTEN PERMISSION. All rights reserved. © 1990 by NSTL, Inc., Plymouth Corporate Center, Plymouth Meeting, PA 19462, 800-223-7093

The new dBASE IV® version 1.1 has been rated the #1 Multiuser Database by Software Digest Ratings Report (Volume 7 Number 3, October, 1990).

Because Software Digest accepts no advertising whatsoever, subscribers pay hundreds of dollars a year to receive their reviews—which are considered highly unbiased and objective.

In summation, their 75-page report says: "Among the top ranking programs, dBASE IV (version 1.1) is the most well rounded, with solid performance, versatility, and usability." Commenting on speed, Software Digest points out that "dBASE IV produces all three test reports as fast as or faster than FoxPro/LAN." As for Ease of Use/Ease of Learning, dBASE IV scored as many times in the Excellent range as any other database product tested.

Of course, Software Digest is definitely not alone in its conclusions.

Because consumers have already made dBASE IV version 1.1 the #1 best-selling PC database in the world.

Call 1-800-437-4329 ext. 1407 for more information.

Better yet, call 1-800-2ASHTON now to upgrade.

The truth is, no other database can do so much to improve productivity.

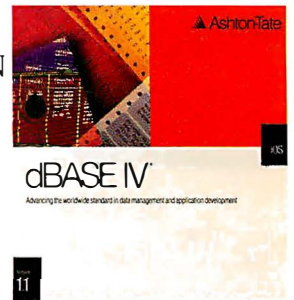

**Ashton-Tate**

# The only point on Windows

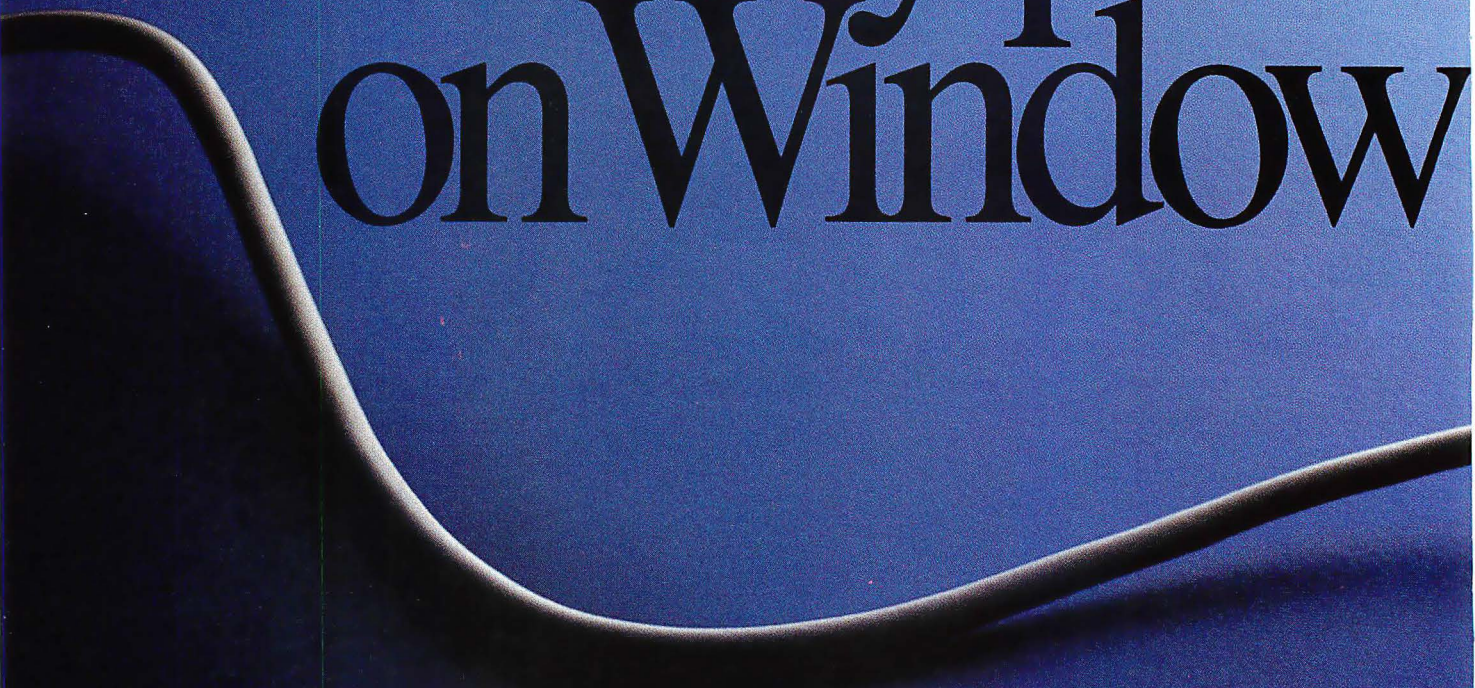

As the people responsible for the Microsoft® Windows™ graphical environment, we believe we're in a good position to offer some very sound advice on Windows computing. And

that, as you've probably guessed by now, is the Microsoft Mouse.

You see, the Mouse allows you to navigate the Windows environment and applications with untold ease, as

# ter you'll need s Computing.



well as unparalleled precision.

Furthermore, we've made the decision to buy a Mouse even easier. Now it's available either with software, or on its own for the purist.

Visit a dealer and check it out for yourself. We think you'll see our point.

**Microsoft**  
Making it all make sense<sup>®</sup>

the Microsoft logo are registered trademarks and Making it all make sense, the Microsoft Mouse design and Windows are trademarks of Microsoft Corporation. The Microsoft Mouse design is protected by U.S. Design Patent #302,426.

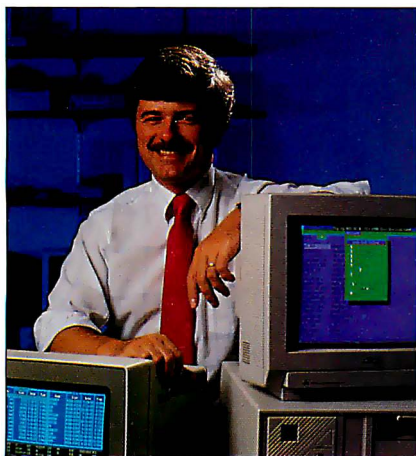

# FACING HARD TIMES?

Don't overlook some powerful tools to help you stretch your computing dollars

**A**s I write this, the Bush administration keeps dancing around the "R" word—recession. It's not official yet because the politicians prefer silly euphemisms like "a meaningful downturn in the economy."

On top of the economic doubts, there's the whole mess in the Middle East. Perhaps the situation there will have resolved itself by the time you read these words, but it doesn't seem likely.

No one can predict what the overall effects will be, but at least in BYTE's topic areas, the reaction to these uncertainties is clear, consistent, and conservative: Through our reader mail, focus groups, and other means, you're telling us that this year you'll have to be more careful than ever in spending your (or your company's) computing dollars.

Word of mouth is one of the best ways to supplement product reviews. But there are obvious limitations to word of mouth.

The on-line variant—would you call it word of modem?—gets around the limitations. With one question, you can tap into the collective wisdom of people from around the world. The odds are good that you can find someone who has personal experience in solving almost exactly the same problem you're trying to solve, or who has very recently dealt with the company you're considering doing business with. It's an unmatched resource when you're making every dollar count.

Almost any of the large on-line systems can serve, although some of the largest systems can cost a fortune to access and suffer from content dilution—large numbers of subscribers who cannot

meaningfully answer your questions. Paying premium rates to get uninformed answers is hardly the way to stretch your computing dollars.

But if you pick your system carefully, there's a wealth of information to be had at low cost. Naturally, I'm BIX-biased, and you should decide which on-line system to use for yourself.

But, just by way of example, here's a small part of a thread of messages taken from the "compatibility" topic of the *ibm.pc* conference on BIX. See how one BIXer—concerned about spending money with a mail-order vendor—got a flood of excellent, firsthand advice:

*ibm.pc/compatibility #227, from rmstutz, Title: CompuAdd clones*

Who has had experience with CompuAdd clones? General opinions? Any likes or dislikes? Quality? Support? I'm in the market for a clone, and they are close by. Any good-quality mail-order clone manufacturers to recommend? Thanks all, Rich

*ibm.pc/compatibility #228, from barryn*

CompuAdd sells pretty good computers, I understand. I've bought a number of peripherals from them over the years (monitors, modems) and have been happy with the equipment. However, the computer I use most right now is from Gateway 2000.

*ibm.pc/compatibility #229, from bkep*

We buy all our computers from CompuAdd. I don't particularly like the monitors (GoldStar), the keyboards are pretty good, we haven't had any hardware problems that weren't our fault, and the technical support is first-rate. They even have on-site service. They were at our place the next day when we asked for help with a disk problem.

*ibm.pc/compatibility #230, from jndunlap*

I've read good things about CompuAdd's

machines and support. I've had good luck with my Gateway 386—seems it was one of the last with a motherboard they discontinued, so they did a lot of phone diagnosis, real knowledgeable people, patient. I'd also look closely at Austin Computer Systems—I read a review of one of their machines that fairly glowed about its craftsmanship and fit.—arky

*ibm.pc/compatibility #231, from bstrauss*

CompuAdd's advantage is that they also run retail stores, so you can see the box. Most of the big mail-order names are also good, provided you use your head. This means: Ask questions about exactly what you are getting. Put it in writing when you place the order (fax it to them if you are in a hurry). Use a credit card—it gives you some protection.

*ibm.pc/compatibility #234, from vic.sobranie*

I can vouch for the quality of the Austin computers. I have a 286/16 that I bought from them going on two years ago. It's a great machine. I used to know several of the people there, since our offices were all but next door to each other in Austin, and they're all very nice. Hopefully, their technical staff has improved since I dealt with them last, but the machines are so good you should never need to talk to them. . . . Vic

And so on. Almost every conference has similar threads: No matter what your question, there's an army of helpful souls out there, on-line, who are willing to share their personal experiences with you—and who'd appreciate hearing your experiences, too.

No matter what the economic future holds, you can find the help you need to stretch your computing dollars to the utmost: It's as near as your telephone.

—Fred Langa  
Editor in Chief  
(BIX name "flanga")

**Don't miss the Borland Languages Conference.**  
April 28 through May 1, 1991, San Francisco, CA. For information, call 1-800-942-TURBO



# Borland's Turbo Pascal 6.0 is the Fastest Way from Inspiration to Application

## Jump-Start Your Application

When you're inspired to write a program, you want to spend your time developing code that solves your problems. Not hours and hours writing common routines for event handling, data management or user interface.

Now, you can jump-start your applications development by programming with the latest release of the World's #1 Pascal Compiler, Turbo Pascal® 6.0 with Turbo Vision™.

## Now with Turbo Vision

With Turbo Vision, the first object-oriented application framework for DOS, you get a giant head start on creating better applications in far less time. Use a Turbo Vision object and your program automatically inherits a hot program architecture that includes overlapping windows, pull-down menus and mouse support. Turbo Vision makes it fast and easy—setting you free to develop the parts of your applications that solve your problem.

And Turbo Pascal 6.0 comes loaded with Turbo Vision applications including a calendar, a calculator, an editor, a clock, a directory browser and forms.

## New Turbo-Charged Environment

The new Turbo Integrated Development Environment (IDE) features a multi-file editor, overlapping windows and mouse support.

And Turbo Help lets you copy, compile and run an example program for every standard Pascal library routine so you can use it in your code.

## Pro Version with Turbo Drive™

Turbo Pascal® Professional 6.0 also includes: a professional version of the compiler with Turbo Drive,† for compiling big applications in extended memory; Turbo Debugger® 2.0, for killing the toughest bugs; Turbo Profiler™ 1.0, for eliminating bottlenecks; and Turbo Assembler® 2.0, the world's fastest, 100% MASM-compatible assembler.

## An Inspiring Offer

REGISTERED TURBO PASCAL OWNERS: You can upgrade to Turbo Pascal 6.0 for only \$69<sup>95</sup>\* or to Turbo Pascal® Professional 6.0 for only \$99<sup>95</sup>\* direct from Borland. The suggested retail price for Turbo Pascal 6.0 is \$149<sup>95</sup>, and \$299<sup>95</sup> for Turbo Pascal Professional 6.0.



**To order, see your dealer**  
**To upgrade, call now: 1-800-331-0877**

Circle 37 on Reader Service Card  
(RESELLERS: 38)

**B O R L A N D**  
*The Leader in Object-Oriented Programming*

CODE: MA98

\*Add \$10.00 for shipping and handling. Offer expires August 31, 1991. Offer good in U.S. and Canada only. Mail orders to Borland International, Inc., P.O. Box 660001, Scotts Valley, CA 95067-0001. Residents in CA, CT, GA, IL, MA, MI, NY, OH, PA, TX, VA and WA, please add appropriate sales tax. For orders outside the U.S., call (408) 438-5300. Turbo Drive compiler requires 1Mb extended memory. Hard disk recommended. Copyright ©1990 Borland. All Borland products are trademarks of Borland International, Inc. Corporate Headquarters: 1800 Green Hills Road, P.O. Box 660001, Scotts Valley, CA 95067-0001. (408) 438-5300. Offices in Australia, Denmark, France, Germany, Italy, Japan, Singapore, Sweden and the United Kingdom. Porsche is a registered trademark of Porsche. BI 1391B

# Compaq introduces an 8½"×11" awesome display of power.

One look at our powerful new notebook PC, and you'll see why more FORTUNE 500 and FORTUNE Service 500 companies choose COMPAQ portables and laptops over all others.\* Now see it in person at your Authorized COMPAQ Computer Dealer.

Call 1-800-231-0900, Operator 138 for the location nearest you.  
In Canada, 1-800-263-5868, Operator 138.

**COMPAQ**

---

It simply works better.

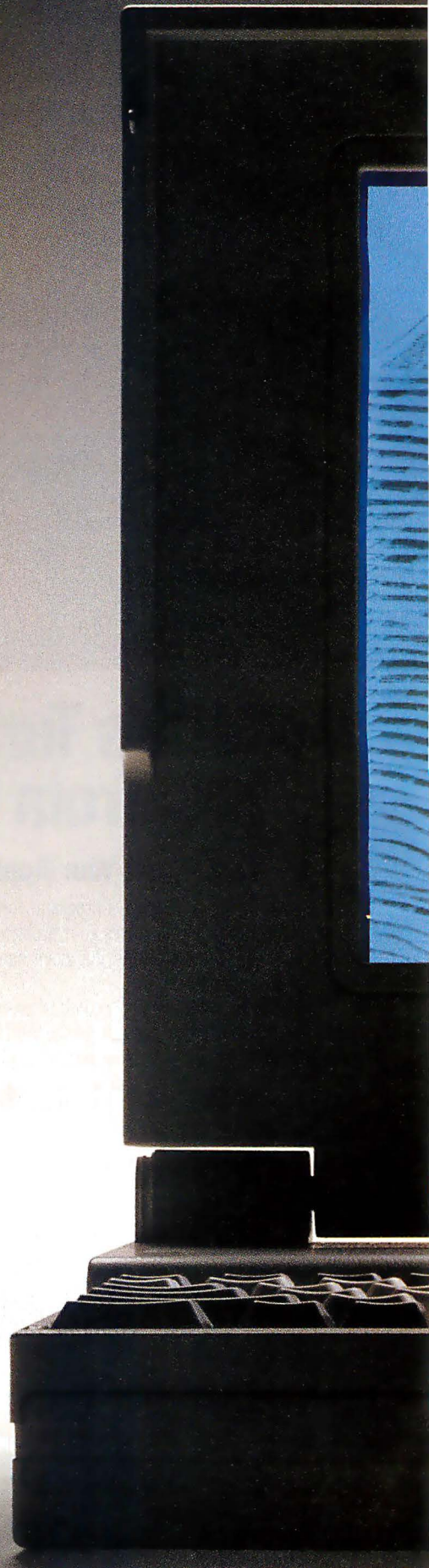



# YOU'RE LOOKING AT THE NEW COMPAQ LTE 386s/20 PERSONAL COMPUTER, THE MOST POWERFUL NOTEBOOK PC ON THE PLANET.

■ YES, IT'S SMALL, BUT  
LOOK HOW BIG IT IS  
ON THE INSIDE.



■ STORES UP TO  
30,000 PAGES.  
THE ONLY NOTEBOOK  
PC THAT OFFERS  
A 60-MB FIXED DISK  
DRIVE.

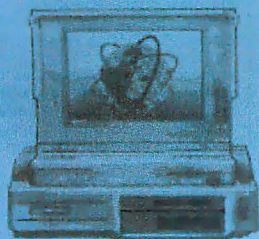

■ VGA DISPLAYS  
RAZOR-SHARP  
GRAPHICS IN 16  
GRAY SHADES.



■ MORE THAN 3  
HOURS' BATTERY  
LIFE PLUS INTERNAL  
FAST CHARGE.

■ ADD A DESKTOP  
EXPANSION BASE  
FOR MORE OFFICE  
CAPABILITY.

■ TRAVEL MUCH? OUR WORLDWIDE  
WARRANTY ASSURES SERVICE IN  
OVER 60 COUNTRIES.



■ YOU CAN EVEN PLUG IN A MOUSE.

■ THE 20-MHz  
INTEL 386SX  
PROCESSOR WITH  
CACHE SETS YOUR  
PRODUCTIVITY  
ON FIRE.

■ AT A MERE  
7.5 LB. WITH  
BATTERY, IT  
TRAVELS  
LIGHT.

■ THE 2-MB  
HIGH-SPEED  
RAM IS  
EXPANDABLE  
TO 10 MB.

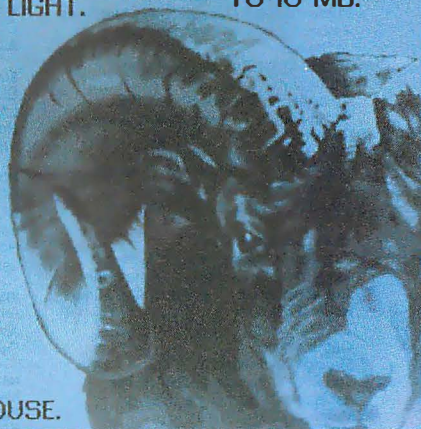

COMPAQ

# BYTE

**EDITOR IN CHIEF**  
Frederic S. Lunga

**MANAGING EDITOR**  
Anne Fischer Lent

**NEWS**  
*New York: Managing Editor: Rich Malloy*  
*Associate News Editor: Andrew Reinhardt*  
*Peterborough: Senior Editor, Microbytes:*  
D. Barker, *Senior Editor, New Products:*  
Stan Miestkowski  
*Associate News Editors, What's New: David*  
*Andrews, Martha Hicks, Carol Swartz*  
*Editorial Assistant: Amanda Waterfield*  
*San Francisco: News Editor: Owen*  
*Linderholm*  
*Associate News Editor: Jeffrey Bertolucci*  
*London: Senior Editor: Colin Barker*

**BYTELAB**  
*Managing Editor: Michael Nadeau*  
*Technical Director: Rick Grehan*  
*Senior Editor: Dennis Allen*  
*Technical Editors: Alan Joch, Robert*  
*Mitchell, Tom Yager*  
*Testing Editors/Engineers: Stephen Apiki,*  
*Stanford Diehl, Howard Eglowstein,*  
*Stanley Wszola*

**STATE OF THE ART**  
*Senior Editor: Jane Morrill Tazelaar*  
*Technical Editor: Robert M. Ryan*

**FEATURES**  
*Senior Editor: Kenneth M. Sheldon*  
*Technical Editors: Janet J. Barron,*  
*Ben Smith*

**SENIOR EDITORS, AT LARGE**  
Tom Thompson, Jon Udell

**SPECIAL PROJECTS**  
*Senior Editor: Gene Smarte*

**SENIOR CONTRIBUTING EDITOR**  
Jerry Pournelle

**CONTRIBUTING EDITORS**  
Don Crabb, David Fiedler, Hugh Kenner,  
Mark J. Minasi, Wayne Rash Jr.

**CONSULTING EDITORS**  
Jonathan Amsterdam, Nick Baran,  
Laurence H. Loeb, Trevor Marshall,  
Dick Pountain, Phillip Robinson,  
Peter Wayner

**COPYEDITING**  
*Chief Copy Editor: Lauren A. Stickler*  
*Copy Administrator: Cathy Kingery*  
*Copy Editors: Susan Colwell, Jeff*  
*Edmonds, Margaret A. Richard,*  
*Warren Williamson*

**EDITORIAL ASSISTANTS**  
*Office Manager: Peggy Dunham*  
*Assistants: Linda C. Ryan, June Sheldon*

**ART**  
*Director: Nancy Rice*  
*Assistant Director: Joseph A. Gallagher*  
*Art Assistant: Jan Muller*  
*Technical Artist: Alan Easton*

**BIX** BYTE INFORMATION EXCHANGE

**DIRECTOR**  
Stephen M. Laliberte

**MANAGING EDITOR**  
Tony Lockwood

**MICROBYTES DAILY**  
*Coordinator: D. Barker Peterborough,*  
*Rich Malloy New York, Nicholas Baran*  
*Sandpoint, ID, Jeffrey Bertolucci*  
*San Francisco, Laurence H. Loeb*  
*Wallingford, CT, Stan Miestkowski*  
*Peterborough, Wayne Rash Jr.*  
*Washington, DC, David Reed Lexington,*  
*KY, Andrew Reinhardt New York,*  
*Jan Ziff Washington, DC*

**PRODUCTION**  
*Director: David R. Anderson*  
*Senior Editorial Production Coordinator:*  
Virginia Reardon  
*Editorial Production Coordinators:*  
Barbara Busenbark, Denise Chartrand

**TYPOGRAPHY**  
*Systems Manager: Sherry Fiske*  
*Applications Manager: Donna Sweeney*  
*Typesetter: Christa Patterson*

**ADVERTISING SERVICES (603) 924-6448**  
*Assistant: Christine W. Tourgee*  
*Customer Service Supervisor: Linda Fluhr*  
*Senior Account Coordinator: Lyda Clark*  
*Account Coordinator: Dale J. Christensen*  
*Materials Coordinator: Karen Cilley*  
*Advertising Assistant: Roxanne Hollenbeck*  
*Creative Services Manager:*  
Susan Kingsbury  
*Production Artist: Lillian J. Wise*  
*Quality Control Manager: Wai Chiu Li*  
*Production Coordinator: Rod Holden*

**ADMINISTRATION**  
*Publisher's Assistant: Donna Nordlund*

**MARKETING AND PLANNING**  
*Director: L. Bradley Browne*  
*Marketing Communications Manager:*  
Pamela Petrakos-Wilson  
*Public Relations Manager: Dawn Matthews*  
*Assistant Promotion Manager: Lisa*  
Jo Steiner  
*Marketing Art Director: Stephanie*  
Warnesky  
*Associate Art Director: Sharon Price*  
*Senior Market Research Analyst: Julie*  
Perron  
*Copyrights Coordinator: Faith Kluntz*  
*Reader Service Coordinator: Cynthia*  
Damato Sands  
*Marketing Assistant: Carol Pitman*

**FINANCIAL SERVICES**  
*Business Manager: Kenneth A. King*  
*Assistants: Marilyn Parker, Diane Henry,*  
JoAnn Walter, Jeanne Gatcombe, Jaime  
Huber, Agnes Perry

**CIRCULATION**  
*Director: Glyn Standen*  
*Subscriptions Manager: Paul Ruess*  
*Assistant Manager, Subscriptions:*  
Margaret Liszka  
*Subscriptions Assistant: Holly Zilling*  
*Newsstand Manager: Vicki Weston*  
*Distribution Coordinator: Karen Desroches*  
*Back Issues: Louise Menegus*  
*Direct Accounts Coordinator: Ellen Dunbar*  
*Direct Accounts Telephone Sales*  
*Representative: Karen Carpenter*

**BUILDING SERVICES**  
George Clarke, Cliff Monkton,  
Gary Graham, Ed Codman

**PERSONNEL**  
*Human Resources Administrator: Patricia*  
Burke, *Human Resources Assistant: Fran*  
Wozniak, *Receptionist: Beverly Goss*

**EXCHANGE EDITORS**  
*Macintosh Exchange: Laurence H. Loeb,*  
*IBM Exchange: Barry Nance, User Group*  
*Exchange: David Reed, Interactive Game*  
*Exchange: Richard Taylor, Amiga*  
*Exchange: Joanne Dow, Writers Exchange:*  
Wayne Rash Jr., *Tojerry Exchange: Jerry*  
Pournelle, *Telecommunications Exchange:*  
Stephen Satchell

**PUBLISHER**  
Ronald W. Evans

**ADVERTISING SALES**  
*Associate Publisher, Vice President*  
*of Marketing: Steven M. Vito*

*Administrative Assistant: Carol Cochran*

*Eastern Advertising Director:*  
Arthur H. Kossack (312) 616-3341  
*Sales Assistant: Julie Watson*  
*Western Advertising Director:*  
Jennifer L. Bartel (214) 701-8496  
*Sales Assistant: Mary Lynn Heinritz*

**NEW ENGLAND**  
ME, NH, VT, MA, RI, CT, ONTARIO,  
CANADA, & EASTERN CANADA  
Daniel D. Savage (617) 860-6344

**EAST COAST**  
NY, NJ, NY, DE, PA  
Kim Norris (212) 512-2645  
Ariane Casey (212) 512-2368

**SOUTHEAST**  
NC, SC, GA, FL, AL, TN, VA, MS, AR, LA,  
DC, MD, WV, KY  
John Schilin (404) 843-4782

**MIDWEST**  
IL, MO, KS, IA, ND, SD, MN, WI, NE,  
IN, MI, OH  
Kurt Kelley (312) 616-3328

**SOUTHWEST, ROCKY MOUNTAIN**  
CO, OK, TX  
Alison Keenan (214) 701-8496

**SOUTH PACIFIC**  
SOUTHERN CA, AZ, NM,  
LAS VEGAS, UT  
Ron Cordek (714) 753-8140  
Alan El Faye (213) 480-5243

**NORTH PACIFIC**  
HI, WA, OR, ID, MT, NORTHERN CA, WY,  
NORTHERN NV, WESTERN CANADA  
Bill McAfee (408) 879-0381  
Roy J. Kops (415) 954-9728  
Leslie Hupp (408) 879-0381

**INSIDE ADVERTISING SALES**  
*Director: Liz Coyman*  
*Administrative Assistant: Susan Boyd*  
*Sales Secretary: Vivian Bernier*

**NATIONAL ADVERTISING SALES**  
Mary Ann Goulding (603) 924-2664  
Patricia Payne (603) 924-2654  
Jon Sawyer (603) 924-2665  
Scott Gagnon (603) 924-2651

**BYTE BITS (2x3)**  
Mark Stone (603) 924-6830

**THE BUYER'S MART (1x2)**  
Brian Higgins (603) 924-3754

**CATALOG SHOWCASE/INT'L CARDS**  
Ellen Perham (603) 924-2598

**REGIONAL ADVERTISING SECTIONS**  
James Bail (603) 924-2533  
Barry Echavarria (603) 924-2574  
Larry Levine (603) 924-2637

**BYTEDECK**  
Ed Ware (603) 924-6166

**INTERNATIONAL ADVERTISING SALES STAFF**  
See listing on page 349.

**EDITORIAL AND BUSINESS OFFICE:**  
One Phoenix Mill Lane, Peterborough, NH  
03458, (603) 924-9281.

**West Coast Branch Offices:** 425 Battery St.,  
San Francisco, CA 94111, (415) 954-9718;  
15635 Alton Pkwy., Suite 290, Irvine, CA  
92718, (714) 753-8140.

**New York Branch Editorial Office:** 1221 Avenue  
of the Americas, New York, NY 10020, (212)  
512-3175.

**BYTEnet:** (617) 861-9764 (set modem at 8-1-  
N or 7-1-E; 300 or 1200 baud).

**Editorial Fax:** (603) 924-2550. **Advertising Fax:**  
(603) 924-7507.



**SUBSCRIPTION CUSTOMER SERVICE:** Outside  
U.S. (609) 426-7676; inside U.S. (800) 232-  
BYTE. For a new subscription—(800) 257-  
9402 U.S. only, or write to BYTE Subscrip-  
tion Dept., P.O. Box 555, Hightstown, NJ  
08520. Subscriptions are \$29.95 for one  
year, \$54.95 for two years, and \$74.95 for  
three years in the U.S. and its possessions.  
In Canada and Mexico, \$34.95 for one year,  
\$64.95 for two years, \$87.95 for three years.  
In Europe, £29 (U.S. \$50) for fast surface  
delivery, £41 (U.S. \$70) for air delivery. All  
other countries, U.S. \$150 for fast surface  
delivery. Air delivery to selected areas at  
additional rates upon request. Single copy  
price is \$3.50 in the U.S. and its posses-  
sions, \$4.50 in Canada. Foreign subscrip-  
tions and sales should be remitted in U.S.  
funds drawn on a U.S. bank. Please allow  
six to eight weeks for delivery of first issue.

**EDITORIAL CORRESPONDENCE:**  
Address editorial correspondence to:  
Editor, BYTE, One Phoenix Mill Lane,  
Peterborough, NH 03458. Unacceptable  
manuscripts will be returned if accom-  
panied by sufficient postage. Not res-  
ponsible for lost manuscripts or photos.  
Opinions expressed by the authors are not  
necessarily those of BYTE.

**PHOTOCOPY PERMISSION:**  
Where necessary, permission is granted by  
the copyright owner for those registered with  
the Copyright Clearance Center (CCC),  
27 Congress St., Salem, MA 01970, to  
photocopy any article herein for personal or  
internal reference use only for the flat fee of  
\$1.50 per copy of the article or any part  
thereof. Correspondence and payment  
should be sent directly to the CCC, 27  
Congress St., Salem, MA 01970. Specify  
ISSN 0360-5280/91, \$1.50. Copying done  
for other than personal or internal reference  
use without the permission of McGraw-Hill,  
Inc., is prohibited. Requests for special  
permission or bulk orders should be  
addressed to the publisher. BYTE is avail-  
able in microform from University Microfilms  
International, 300 North Zeeb Rd., Dept.  
PR, Ann Arbor, MI 48106 or 18 Bedford  
Row, Dept. PR, London WC1R 4EJ,  
England.

**OFFICERS OF MCGRAW-HILL, INC:**  
Joseph L. Dionne, Chairman, President and  
Chief Executive Officer; Robert N. Landes,  
Executive Vice President, General Counsel  
and Secretary; Walter D. Serwatka,  
Executive Vice President; Frank D.  
Penglase, Senior Vice President, Treasury  
Operations; Robert J. Bahash, Executive  
Vice President and Chief Financial Officer;  
Thomas J. Sullivan, Executive Vice  
President, Administration; Mary A. Cooper,  
Senior Vice President, Corporate Affairs,  
and Executive Assistant to the Chairman;  
Ralph R. Schulz, Senior Vice President,  
Editorial.

Founder: James H. McGraw (1860-1948).

 Copyright © 1991 by McGraw-Hill.  
 Inc. All rights reserved. BYTE and  
BIX are registered trademarks of  
McGraw-Hill, Inc. Trademark registered in  
the United States Patent and Trademark  
Office.

 Member  
Audit Bureau of Circulation

# Perfection on display.

## THE IBM 8515 DISPLAY.

When you're looking for the perfect display to complement your IBM Personal System/2,<sup>®</sup> the 8515 is clearly the one you should choose.

## VGA NOW. XGA ON DEMAND.

Right now you may only need VGA, but as your needs change so

can the 8515. In fact, this display can easily handle picture-perfect high-resolution (1,024 x 768) graphics, either through XGA or an 8514/A Adapter card, depending on what suits your needs best.

## QUALITY BY DESIGN.

The 8515 is an affordable 14" display that was designed to be more

reliable. It has fewer parts and that leads to fewer problems—it's that simple.

Add to that a striking contrast-enhancing background and you'll experience clarity and color richness like you've never seen.

Plus, you'll also be looking at almost 50% more viewing area in about the same footprint as our popular 12" display.

The IBM 8515 Display: now all the reasons to choose it are perfectly clear.

Find out more. Contact your IBM Authorized Remarketer or marketing representative. For a remarketer near you, call 1 800 IBM-2468, ext. 913.



(Actual unretouched screen.)

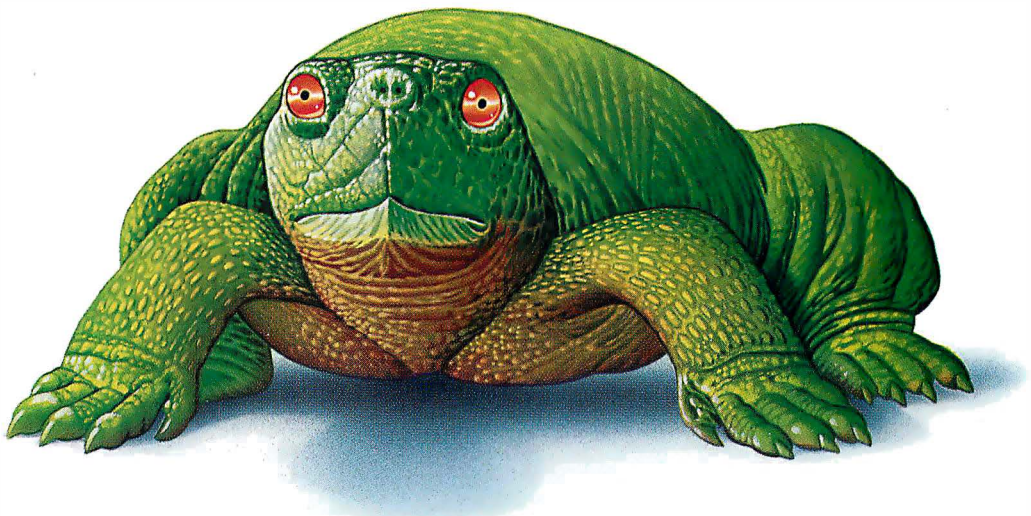

## **How Your Data Feels Without Our Teflon Coating.**

Let's face it.

If you're a bit of data, it can be a pretty terrifying world out there.

Especially when an object as tiny as a particle of stray dust can zap you out of existence.

Or when a mere pencil shaving has the power to

send you spinning into oblivion.

When something is that delicate, it needs all the protection it can get.

Which is why so many people are switching to Verbatim's DataLifePlus® disks.

Our disks are the only disks in the world protected

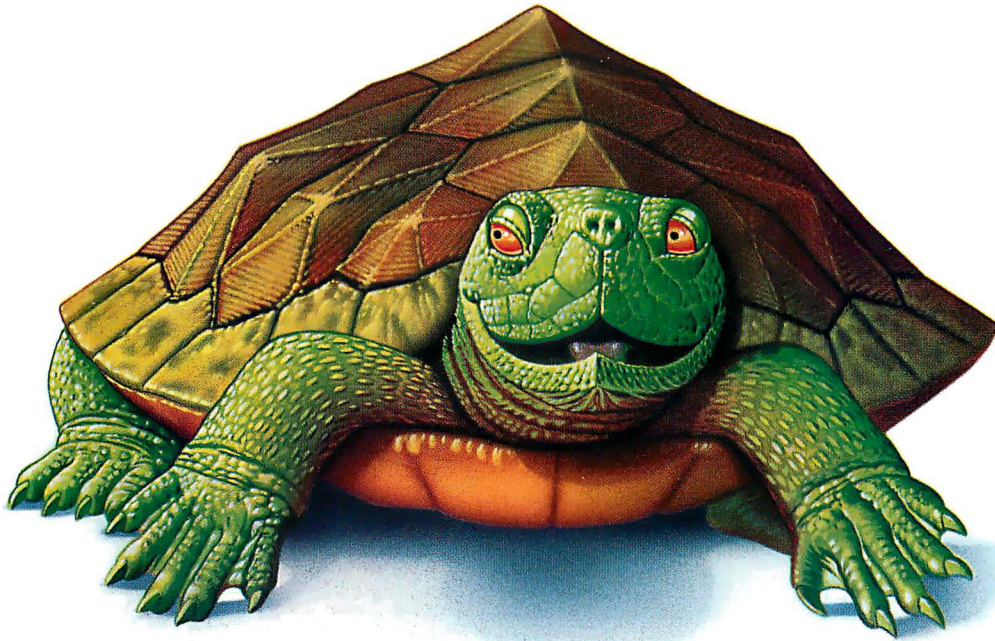

## How Your Data Feels With Our Teflon Coating.

by an exclusive Teflon® coating. That means you can actually wipe fingerprints, dust, even pencil shavings off the recording surface. Without wiping out your data.

And like all of our disks, every DataLifePlus floppy is certified 100 percent error-free and

backed by a complete lifetime warranty.

So next time, insist on Verbatim® disks.

After all, you wouldn't want someone to expose you to the cold, cruel world without proper protection.

Why do that to your valuable data?

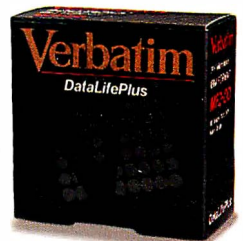

# One of the Most Important Components Built Into our Computers.



**Y**ou're looking at the strongest customer assurance program in the industry – Tri-Star's Customer

Assurance Program. A customer assurance program that's second to none. No one else stands behind their product with as much confidence as Tri-Star. No one. A lot of companies talk about service – but with Tri-Star you get it in writing.

Tri-Star's confidence in the quality, workmanship and reliability of the Flash Cache is reflected by these five comprehensive guarantees: 2 Years Parts & Labor Warranty 60 Day Money Back Guarantee 1 Year On-Site Service Overnight Parts Replacement Life-time Toll Free Tech Support

Another Tri-Star exclusive ensures your new Flash Cache computer is fully prepared, extensively tested, and thoroughly inspected before delivery. In addition you will receive MS-DOS, Microsoft Windows, and a 400 DPI mouse completely installed and custom configured. Tri-Star Service, it is without peer.

Circle 254 on Reader Service Card

## FLASH CACHE

FEATURES INCLUDE:

- ◆ Intel 386/486 25MHz or 33 MHz Processor
  - ◆ 4MB of High Speed 32-bit DRAM
  - ◆ 64K of Read/Write-Back SRAM Cache
- ◆ 104MB (386) or 200MB (486) Hard Drive
  - ◆ 1.2MB 5.25-inch Floppy Drive
  - ◆ 1.44MB 3.5-inch Floppy Drive
- ◆ 16-bit SVGA Graphics Card w/1MB DRAM
- ◆ 14" Non-interlaced 1024 x 768 Color Monitor
  - ◆ Microsoft DOS 4.01 & Windows 3.0
  - ◆ High Res 400 DPI Three Button Mouse
- ◆ Quality 101 Enhanced Tactile Keyboard
  - ◆ Two Serial Ports & One Parallel Port
  - ◆ Fully DOS, Unix & OS/2 Compatible

386/25	486/25
\$2695	\$3995

386/33	486/33
\$2995	\$4695

...THE BEST MIX OF SUPPORT, SERVICE, AND CUSTOMER SATISFACTION POLICIES OF ALL THE COMPUTERS IN THIS REVIEW.

PC MAGAZINE  
JULY 1990



**TRI-STAR**  
COMPUTER CORPORATION  
**1.800.678-2799**

707 West Geneva  
Tempe, Arizona  
85282

Tech Support  
1.800.688-TECH  
Telephone 602.829-0584

Fax 602.345.0110

Monday - Friday  
7:00am-7:00pm MST

Saturday  
9:00am-4:00pm MST

All prices and specifications subject to change without notice. Money Back guarantee does not include shipping charges. On-Site service available in most U.S. locations. 2 Year Warranty includes system and keyboard. All systems have been verified or certified to comply with part 15 of the FCC rules.

# MICROBYTES

Research news and industry developments shaping the world of desktop computing

Edited by D. Barker

## Users Will Have More Room for Applications Under New DOS; 5.0 Due Soon

The next version of MS-DOS will soon be in the hands of users, say sources involved in the beta-testing program. According to people who've gotten a look at preliminary versions of the new operating system, Microsoft has developed a DOS that's stouter in terms of capabilities but is leaner in size.

Some of the biggest changes to DOS will involve memory management, changes perhaps inspired by the innovative memory manager in Digital Research's DR DOS 5.0. MS-DOS 5.0 will come with a new utility that loads most of the operating system into the high-memory area of extended memory, yielding more room for running application programs. Current versions run in the low-memory zone, taking up RAM that could otherwise go to applications. But most of DOS 5.0 (which is about 60K bytes, beta testers say) can reside above that, in the first 64K-byte block above 1 MB. As a result, users of DOS 5.0 will have about 45K bytes of RAM that they don't have now. This improved efficiency will be possible with 286, 386, and 486 systems equipped with extended memory; due to processor design, it won't work with older PCs.

On 386 and 486 machines, DOS 5.0

can save even more memory by loading TSR programs, device drivers, and other programs into the upper-memory block (between 640K bytes and 1 MB), sources say. This is similar to what Quarterdeck's LOADHI utility does in QRAM and QEMM products.

Like DOS 4.0, the new edition has a graphical shell for file and directory operations, but it looks more like Windows 3.0 than DOS 4.0, said sources who've seen preliminary versions. Files and directories are presented as icons in a tree structure. As with a real graphical interface, you can navigate this shell, issue commands, and launch applications by pointing and clicking, sources say. The shell includes one of the most significant enhancements to MS-DOS: a task switcher for bouncing between programs without having to shut one down and start another up. Microsoft has confirmed that DOS 5.0 will support the Virtual Control Program Interface.

The new operating system will come with a sophisticated help system, which calls to the screen a brief summary of any DOS command (done by typing `/?` after a command) or explanation of certain features, such as task switching. DOS 5.0 will also come with several

BYTE's Comdex poll continues to reflect an expectation that Extended DOS — DOS enhanced with Windows or Desqview, for example — will be the dominant desktop operating system by 1995. Results at fall Comdex were essentially the same as in previous polls, except that Extended DOS picked up about 10 points, a significant shift in opinion. A record 41 percent said they believe Extended DOS will dominate the desktop by 1995. That increase in votes might have come from OS/2, which continues to slide in the poll. In 1988, more than one-third of those surveyed said OS/2 would be the dominant operating system by 1995; now,

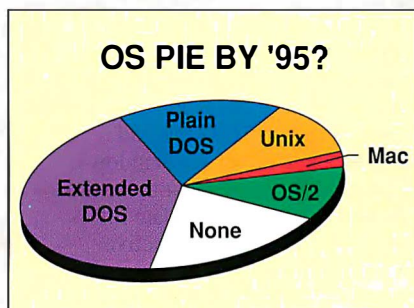

about 12 percent say that. Eighteen percent said plain DOS will continue its current reign. Unix fell to its lowest vote since the poll's debut in 1988, coming in at 17 percent. The Mac OS continued to hold at about 3 percent, while 10 percent envision a democratic world in which no one system dominates.

## NANOBYTES

At a Comdex breakfast for 1500 of its closest friends and dealers, IBM offered a glimpse of a 3½-inch magneto-optical floppy disk capable of holding about 120 MB. Or, as Personal Systems Division vice president James Cannavino calculated it, up to 85 disks' worth of data, 12,000 graphics displays, or a 5-minute multimedia presentation. Company officials pointed out that this was not a product announcement but one of those "technology demonstrations" — which IBM watchers know generally precede a product announcement by six months to a year.

Buying one of the new Mac Classics has been like trying to buy a Mazda Miata when they first arrived: good luck finding a dealer who has one. According to dealers and other sources speaking to Microbytes Daily, there were about 100,000 of the machines on back order as the end of 1990 approached. Corporate customers as well as individuals are buying the new "Cheap Mac." Stores in the New York City area — where the basic Classic (\$999 list) is selling for as low as \$699 — said that they couldn't fill the orders. Most dealers would not even hazard a guess as to when a machine that was paid for today would be delivered, but one store representative said that it could be between three and five weeks. Apple officials wouldn't comment on shipment numbers, but one spokesperson did confirm that sales have been higher than expected. The Classics "went out of warehouses like they had wheels on them," he said.

Advanced Logic Research (Irvine, CA) plans to come out with a competitor to Compaq Computer's 7½-pound LTE 386s/20 computer soon. It'll be comparable to Compaq's 20-MHz SX system but will cost less, said ALR vice president Dave Kirkey. The little Compaq lists for around \$6000.

## NANOBYTES

**DVI coming to the Mac: New Video Corp.** (Venice, CA) plans to bring Digital Video Interactive technology to the Macintosh, using Intel's upcoming i750 "multimedia" chips. New Video's DVI products will let users capture video and create productions on the Mac and also play them back on the PC under DOS and Windows, New Video officials say. The company is currently prototyping delivery boards for software developers and plans commercial products for this quarter. Among these products will be a NuBus board for the Mac II (probably around \$2500) that will come with 2 MB of video RAM, built-in special effects, and other features yet to be determined; the board will offer real-time, full-motion video and audio capture and playback, New Video says. In a recent demonstration for BYTE, the DVI board was in fact two separate boards; company officials admit that they've got a lot of engineering work left to do when it comes to whittling the components down to fit on a single board.

**Motorola's 68040** microprocessor, which will be the brain of several new computers expected this year, is **finally available** in a production version. Plagued by technical difficulties, particularly with the multi-processor functions of the chip, the million-transistor 68040 has been delayed almost a year. (Motorola had initially expected to ship the 68040, which was announced right before Intel's i486, last January.) While the 68040's arrival is good news for Next and other vendors, such as Hewlett-Packard, who plan to release 68040-based machines, supplies will be limited for the first half of the year. According to a Motorola representative, the company will initially deliver the 68040 in "lots of several hundred per week" but has a backlog of "250,000 to 500,000" orders, which won't be filled until summer.

**Matsushita Electric** (of Japan) plans to build Unix systems around Sun's **SPARC** architecture. These RISC systems, expected in desktop and laptop models, will conform to SPARC Compliance Definition 1.0 and run Sun's version of Unix and the Open Look graphical interface.

utilities for restoring files accidentally deleted and for rebuilding disks. According to sources, Microsoft has licensed Central Point Software's Mirror program and incorporated it in DOS 5.0; Mirror captures an image of the file allocation table, which you can then use to restore a disk that's been damaged or mistakenly formatted.

Microsoft has replaced DOS's GWBASIC with an interpreter and debugger extracted from the company's QuickBASIC. However, GWBASIC programs will work with the new interpreter, one source said.

The minimalist EDLIN program has bowed out to a full-screen ASCII editor that is complete with pull-down menus, a change applauded by several beta testers. Some sources pointed out one

addition that won't be appreciated until hardware designers implement the necessary device: support for 2.8-MB floppy disks. And as Digital Research does with DR DOS, Microsoft plans to offer OEMs a ROM version of DOS 5.0, according to a source inside the company.

When the new DOS will be ready was still up in the air at press time. A Microsoft staff member said that the company was putting DOS 5.0 through a rigorous testing program and would release it when "it's stable." March or April are likely, according to some reports. As for the cost, some sources said that the retail price could be as low as \$99; one analyst said that it probably won't be more than \$199, the price of DR DOS 5.0.

— D. Barker

## New Blues Will Mean Better Color Displays

**W**hile color LCDs continue to appear in more and more portable PCs, full-color electroluminescent displays remain confined to the laboratory. The reason? The lack of a good blue phosphor to match the brightness of the green and red phosphors, according to Jonathan Gilbert, marketing manager at Planar Systems (Beaverton, OR), the largest U.S. maker of EL displays.

But Planar, a leading researcher in color EL technology, has high hopes for a new blue phosphor that the company has been working with for the past year. "We've succeeded in increasing its brightness by a factor of about 15 in the last nine months,"

Gilbert says. "And we only have a factor of about 2 to go. Once we get to that stage, it'll be bright enough to match the existing green and red phosphors. Then we can begin putting together a full-color display."

EL displays account for less than 2 percent of the flat-panel displays sold today, according to Stanford Resources figures quoted by Planar Systems. Although EL displays offer better contrast and a broader viewing angle than LCD or plasma screens, their high-power consumption and lack of color have limited their use in portable PCs.

— Jeffrey Bertolucci

## Object Links Coming to Windows Applications

**A**s part of its plan to provide dynamic connections between different kinds of applications, Microsoft has released to developers a beta version of its Object Linking and Embedding technology for Windows. Applications that implement these links will be able to swap and update information easily, through a collective effort that will yield sort of a universal Clipboard on steroids. OLE objects are "opaque," Microsoft says, meaning the target application doesn't have to understand the format of the data in the object. OLE will initially show up in Windows programs, but it's designed to work across platforms. Microsoft says the developer tools for OS/2 and Macintosh will be ready soon.

Linking allows many applications to reference a single block of data, and it

puts the mechanism in place to update all the referents when the original data changes. The downside: the fragility of the link. Embedding allows one application to store data from another application within a single document; the embedded data automatically moves if the document moves. The downside: Each copy of the data is private, and there is no mechanism for updating it automatically if the source data changes.

According to Microsoft's Viktor Grabner, the first OLE applications should ship in the first quarter of this year. "The current OLE libraries are stable enough for developing code, but we wouldn't want applications shipped with the current code—there will undoubtedly be bugs we'll want to fix in the libraries. However, the application





# Still writing code with the same old tools?

You're only as good as the tools you use. An excellent reason to acquire the new Microsoft® Windows™ Software Development Kit. Tools tailor-made to build applications for the huge new Windows market.



Including a specially made CodeView® debugger for Windows that easily debugs even the largest applications.

And all the "how to" help you'll ever need—from the extensive hard copy and online documentation to the sample source code to the comprehensive IBM® CUA style guide.

Plus some sophisticated analysis tools and improved resource editors.

All of which suggests that if you're not

using our SDK, then you're trying to write tomorrow's programs with yesterday's tools.

But that's a situation you can easily fix with the following official code numbers:

(800) 323-3577, Dept. M24.

Call now to update your old kit with the Windows version 3.0 SDK at \$150 per kit. Or call us just to answer your questions.

The sooner you dial, the sooner you can really go to work on Windows apps.

Instead of just toying around with them.

**(800) 323-3577**

**Microsoft**  
Making it all make sense®

Offer good only in the 50 United States. Payment in U.S. funds (plus a \$7.50 shipping and handling fee and applicable sales tax). Please allow two to four weeks for delivery. © 1990 Microsoft Corporation. All rights reserved. Microsoft, CodeView and the Microsoft logo are registered trademarks and Making it all make sense and Windows are trademarks of Microsoft Corporation. IBM is a registered trademark of International Business Machines Corporation. CAPTAIN MIDNIGHT is the registered trademark of Sandiz Nutrition Corporation which does not endorse the Windows SDK and is not affiliated with Microsoft.

# Any rese to a desktop purely in

VGA Display

386SX Power

3.5" Floppy Drive

Removable  
Hard Drive

Comfortably-Sized  
Keyboard

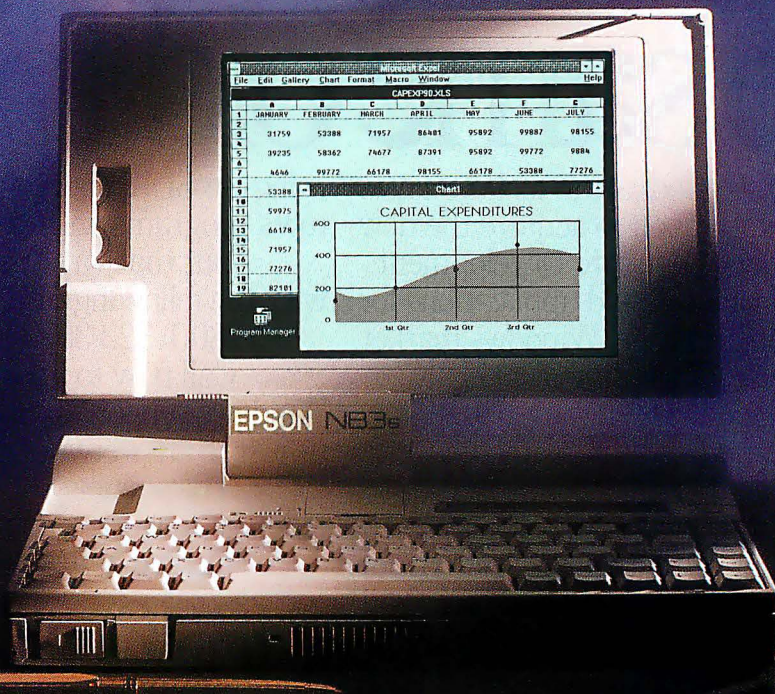

# resemblance computer is intentional.

---

## Introducing the Epson 386SX Notebook Computer.

---

Until now, opting for a portable computer has typically meant settling for less computer.

The new 5.8 pound Epson® NB3s notebook changes all that. In a big way.

Inside this stunningly compact package lies the computing power equal to that of a 386™ SX desktop. With more than enough memory—up to 5MB of RAM—to run all the leading business applications, such as Windows™ 3.0.

The backlit LCD screen produces crystal-clear VGA graphics. And the NB3s comes with a standard 3.5 inch floppy drive, plus the innovative choice of

removable 40MB or 20MB Conner® hard drives.

This 5.8 pound package even includes a rechargeable battery, plus room for such options as an internal modem and math coprocessor. And with its optional portable expansion unit, you gain two standard card slots and the ability to add a 120MB hard drive for true desktop expandability.



*Here is where the resemblance ends:*

*the NB3s weighs just 5.8 pounds*

*and measures 8.4 x 11.8 x 1.7 inches.*

By any measure of performance, the Epson NB3s is a giant among notebooks. In fact, you could say it is the perfect computer for the portable user who wants everything. Except compromise.

Engineered For The Way You Work.™



## NANOBYTES

**Europe** has become a **major market for American software**, according to a new report from the **Software Publisher's Association**. The trade group said that European sales of American software grew by nearly two-thirds in the third quarter of 1990 to \$228 million. Combined software sales for DOS and Windows were up over half, the SPA reported, with Macintosh program sales in Europe up by a staggering 83 percent. The SPA report is based on figures provided by 32 software houses, including Lotus, WordPerfect, Microsoft, and Ashton-Tate. An SPA research assistant said the international market now accounts for nearly a third of total sales of the companies in the survey.

**Apple Computer** is now willing to license its **Apple Terminal Services** protocols to developers and corporate MIS departments. ATS protocols pass between a mainframe computer and a personal computer. Programs can thus retrieve information from a mainframe or minicomputer and display it on a graphical terminal—a Mac, an IBM PC running Windows, or a Unix workstation running X Window System. Before, ATS protocols could be used only to display the retrieved data on a Mac. Apple says that ATS differs from terminal screen protocols because it lets a mainframe programmer control the microcomputer's user interface and desktop.

If the **U.S. government** doesn't do something soon, its **computer records** will be inaccessible and unusable, a Congressional committee has warned. A new study by the House Committee on Government Operations warns of increased difficulty in preserving and accessing old computer records housed in the various federal archiving systems. Problems will be caused by changes in hardware and software, lack of documentation, nonstandard data-file formats, and deterioration of storage media, the report said. The committee advocates an overhaul of the way the government stores data files and information, recommending that standard record-keeping rules and procedures be built into federal electronic information systems.

programming interfaces have been frozen, so developers will not have to change their own code when the final libraries are released." Grabner estimates that a developer will need 8 to 10 weeks to add embedding and linking to an application.

OLE, which builds on Microsoft's Extensible Compound Document Architecture specification, provides developers with libraries and examples to help them implement Bill Gates's vision of "document-centric," as opposed to "application-centric," computing. The idea is to make it easy for users to construct seamless documents containing data and other elements (e.g., graphics and charts) from multiple and disparate sources.

Beta libraries for OS/2 and the Macintosh should be available early this year, he said. "The push is coming from the applications side: Microsoft is committed to adding OLE capabilities to all its Windows applications, and if you look at those programs, they're all supported on multiple platforms. We want the same capabilities to be available no matter what platform the program is running on."

Some of what Microsoft hopes to accomplish with OLE is similar to what Hewlett-Packard is doing with

NewWave. "Microsoft is moving in the same direction we are, telling developers they should write applications that work with each other," said HP's Bill Crow, chief architect of NewWave.

OLE, however, "is a less ambitious approach than NewWave," he said. "By working within the limitations of the existing file system, it sacrifices some capabilities. In OLE, as in today's hot links, linking depends on one application remembering the location of a file. That link can be broken easily if the file moves: There is no mechanism for tracking the file location and updating the name. NewWave, by contrast, has an intelligent object manager that takes care of mapping objects to files."

Crow and Grabner agree that NewWave and OLE can coexist. "OLE and NewWave are philosophically similar," Crow said. "Once a developer has structured his application to support OLE, it shouldn't be that difficult to modify it to support NewWave. We'd like to see applications work in both environments, and we're thinking about ways to make that easy, or even automatic." According to Grabner, "There should be some way for NewWave to provide a wrapper to interface with OLE to make everything work together transparently."

— Martin Heller

## Hitachi Neural Prototype Thinks, Learns Quickly

**H**itachi Ltd. has developed a prototype neurocomputer that demonstrates the promise of this emerging technology. The device is built on a single semiconductor wafer and contains more than 1100 neural circuits. It can perform 2.3 billion learning operations per second, more than 10 times the speed of a Hitachi supercomputer running a neural-network simulation, company officials said during a recent demonstration of the machine.

Neurocomputers mimic the learning ability of the human brain, thus making them better suited than traditional computer architectures to tasks such as recognition, pattern matching, and optimization, proponents say.

Hitachi doesn't currently plan to distribute its general-purpose neurocomputer as a product, but the technology in it will surface in commercial systems. "It will be commercialized in about two years, first in Japan," a company official said. Because of the computation speeds and learning capabilities, this technology will probably find its first applications in

financial and security systems.

The Hitachi neurocomputer is based on large-scale integration neural components originally made public in 1989. The components, built in 0.8-micron CMOS technology, each contain 576 interconnected neural circuits. Eight of these chips are connected on a single semiconductor, using wafer-scale integration, to form the neurocomputer.

The device shown was housed in a beige box (12 by 9 by 8½ inches) attached to a Hitachi Unix workstation. The workstation served as a windowing front end, while the neurocomputer ran sample software applications. One demonstration involved handwriting verification: The system "learned" the pattern of a signature based on the pressure and direction the user applied to the stylus and was later able to recognize the signature with near 90 percent certainty. In another example, the system made stock price predictions.

Hitachi says that it is "generally accepted" that a neurocomputer will need at least 1000 interconnections to be practical. The system that the

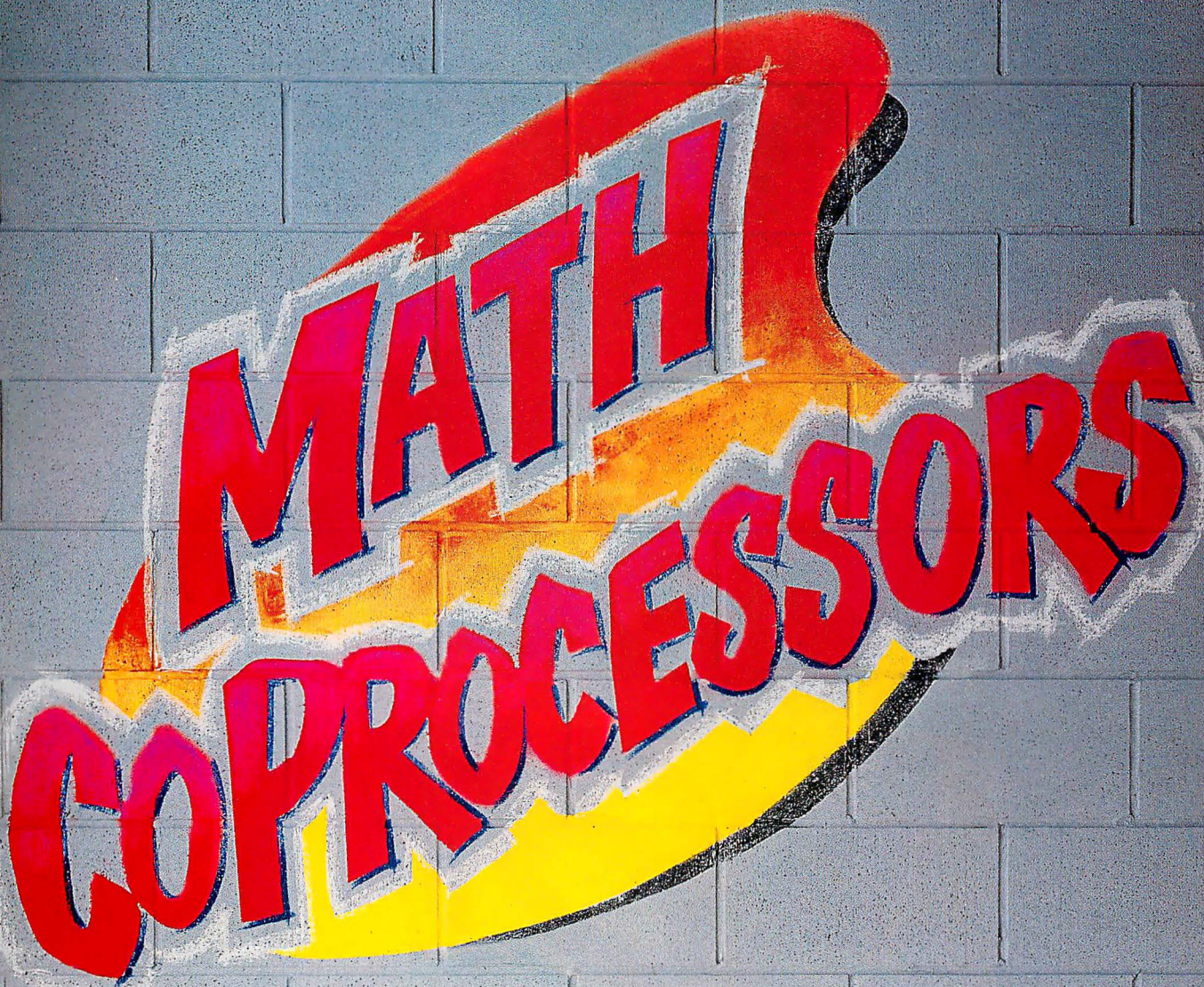

# MATH COPROCESSORS

You know what you need  
to speed up your  
power applications.  
There's just one more thing  
you should know.



Only one math coprocessor is a  
chip off the old block.

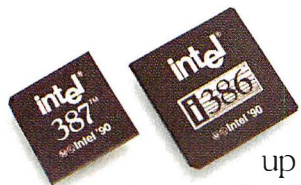

That's Intel's. And our new family of Math CoProcessors is faster—up to 50% for the 287XL.

In fact, working side by side with the Intel microprocessor already inside your computer, an Intel Math CoProcessor can increase the speed of your spreadsheet, graphics, CAD and

database programs by as much as 500%. That's good to know.

And the fact that it's made by Intel is also good to know.

Because Intel developed the first Math CoProcessor in 1982, and we've shipped millions since then. Each one is manufactured by Intel in the world's most advanced logic



facility, and then tested and retested against an exacting set of criteria.

And we can guarantee that every Intel Math CoProcessor lives up to the industry hardware standards we helped develop, delivering the same results regardless of what type of computer you're doing calculations on.

So call Intel at (800) 538-3373. Ask for

Literature Packet #F6 on Intel's new and improved Math CoProcessors. And put an Intel Math CoProcessor inside your computer. It's the only one with the Intel name to live up to.

**intel**<sup>®</sup>

The Computer Inside.<sup>™</sup>

©1990 Intel Corporation. 386 and 387 are trademarks of Intel Corporation.

Circle 106 on Reader Service Card (RESELLERS: 107)

## NANOBYTES

**Next** is now focusing on the considerable networking and communications capabilities of its computers, judging by new things on the horizon and recent comments made by company chairman Steve Jobs. By next summer, **Next computers will support Novell NetWare clients and links to AppleTalk** via EtherTalk. The NetWare client support will let Next users access Novell files easily, and the AppleTalk connection will eliminate having to use a \$4000 Cayman Gatorbox to hook Next machines to Macs, Jobs said. At a meeting of the Boston Computer Society, Jobs demonstrated a sample Next E-mail document that could contain elements such as sound, graphics, text, and data in one message just by cutting and pasting. By summer, the company hopes to add the capability of storing live, full-motion video in that E-mail message.

The **Association of PC Users Groups** will expand its Globalnet telecommunications network for users group officers this year. The organization plans to operate new BBSes in Australia, England, France, and Japan. The BBS in France will operate in English, French, German, and Spanish. The language the user operates in will be determined by the telephone number called. The individual user must provide translation services. Messages on the four overseas BBSes and the main APCUG BBS (in Scotts Valley, CA) will be exchanged every four days. Paul Curtis, system operator of Globalnet, said that the system serves the 155 member users groups of APCUG and other interested persons who call into the system.

The first company to market a word processor for OS/2 now plans to develop one for Windows 3.0. **DeScribe** (Sacramento, CA) hopes to ship its new program sometime during the second quarter, said marketing vice president Clif Whalen. "We'll port the entire technology set of our OS/2 program to Windows," Whalen said, but "we're still arguing about what part of the market we're going to enter." The company hopes to develop a Unix word processor "sometime down the road," he said.

company showed had 1152 connections, and more will likely be possible as the technology matures. Engineers were able to construct a network this large because they crammed the neural components onto a single wafer and used a bus-type interconnection scheme, which Hitachi calls time-sharing, to link the neurons. Multiplexing neural circuits by way of an address bus

permits a high level of logical complexity while greatly reducing the number of physical circuits needed to connect the neurons.

While dismissed by some critics as far-out technology, major chip makers like Intel are now involved in neural processors.

— *Andy Reinhardt*

## What Will Apple Do with New RISC Chip?

**A**pple Computer is investing about \$3 million in a joint \$10 million effort with VLSI Technology and Acorn Computer to develop a new RISC processor. The chip will be designed by a new Acorn spin-off called ARM Ltd. (Cambridge, England). It's not clear yet what Apple will do with ARM's RISC processor, but some observers speculate the chip could be the basis of a future Apple computer—most likely a notebook or hand-held. An Apple U.K. official would say only that it's part of the company's program of "strategic external investments in strongly differentiated technologies."

Apple is working on a RISC-based system, but the assumption around the industry has been that the machine would use Motorola's 88000 chip. It's possible that Apple will use ARM's low-power processor in either a workstation or, more likely, a portable system. Apple vice president Larry Tesler said that the company doesn't intend to replace any of the processors in existing products with the ARM chip.

"It's a strong technology for the coming years, and we think it will make a lot of money for us," Tesler said. "This is primarily an investment announcement at this point. We won't

be replacing any Mac components with ARM technology."

Barbara Kalkis of VLSI, which will fabricate the chips, said that her company was attracted by certain aspects of ARM's processor design. "It's a very small-die chip that indicates a product trend for the nineties," she said. "We're looking toward battery operation and hand-held operation as being some of the factors that we like about ARM." The chip could show up in graphics boards (Radius has plans for one, she said), modems, and LAN adapters, as well as in digital signal processors, scanners, laser printers, and tape drives, according to Kalkis.

"The key thing for us is that the RISC die that we have can be used as an application specific integrated circuit or as a standard product," Kalkis said. "It will be perfect for a notebook computer or laptop where the size of the chip becomes important, as well as battery operation." Indeed, Active Book Co. of the U.K. has already announced that it will develop a notebook computer based on the ARM RISC chip.

Apple CEO John Sculley has often noted that Apple is interested in "miniaturization and mobility."

— *Larry Loeb*

## System Uses Fractals to Compress Images

**R**esearch into fractals, mathematical descriptions of pictures, has yielded a new compression system that drastically reduces the amount of space that image files consume. Iterated Systems (Norcross, GA), founded by two Georgia Institute of Technology professors, has developed a hardware/software combo for compressing and playing full-motion images on a standard AT computer with a VGA screen. What's most unique about Iterated's system is that its compression scheme is based on fractal transforms. This process, put very simply, turns an

image into a mathematical formula. These fractal formulas are much smaller, and thus occupy less space, than the images they represent. A straight line on a VGA screen, for example, requires about 38K bytes of data, said Iterated copresident Alan Sloan; but fractal code to depict that line requires only 4 bytes, he said. Iterated's approach focuses not on compression ratio but file size.

Sloan and partner Michael Barnsley have been working on fractal-based compression for several years (they wrote about it in the January 1988



# Now you can use the incredible power of Windows 3.0 to goof off.

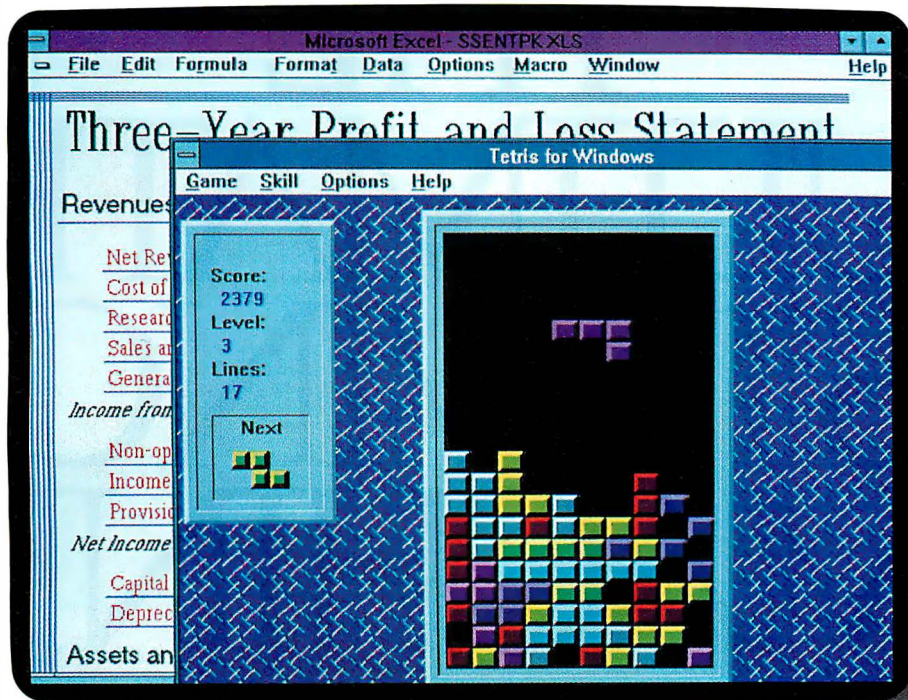

The New Microsoft® Entertainment Pack for Windows™ gives you seven spiffy games. Each one designed for pure, unproductive fun. And all accessible in seconds from any other Windows product.

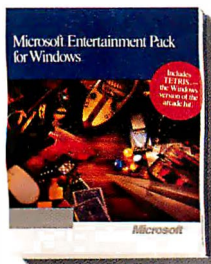

Which means you can go right from juggling numbers, to juggling those funny little blocks in TETRIS™. Another click of the mouse, and you can go from typing a letter to testing your nerves on Minesweeper. Or honing your skills on TicTactics.

Or becoming seriously addicted to one of two new kinds of solitaire.

Equally entertaining is IdleWild, the screensaver with seven radical selections. From a race through space, to a pattern that slices, dices, and scrambles your screen.

Now get to work. Call us at (800) 541-1261, Dept. P11, and ask us all about the Entertainment Pack. We'll do our best to give you a completely frivolous answer.

**Microsoft®**  
Making it all make sense®

# SUN PROUDLY ANNOUNCES THE ULTIMATE STRIVING MACHINE.

SPARCstation™ 2. If you think limits were made to be exceeded, this is your kind of machine.

After all, it exceeds all our own limits. Last year, SPARCstation 1 broke every record for price and performance. And became the best-selling workstation in history. By far. But we went right back to the drawing board. And created the entire SPARCstation 2 line.

---

POWER YOU CAN ACTUALLY USE.

To begin with, you get twice

the performance. For about the same price. 28.5 MIPS. 21 SPECmarks. And 4.2 MFLOPS. You can even have up to 96MB of RAM. And as much as 7.6GB of mass storage.

But more than just a hot engine, you get everything else you need to do your job. Unbelievably real graphics. Easy networking. A huge selection of software. And complete expandability.

Put all that together, and you get the kind of power you can actually use.

---

THE WHOLE LINE IS AWESOME.  
THE PRICES AREN'T.

---

Just look at SPARCstation 2GX. It gives you ultra-high speed at no extra cost. And brings a whole new level of performance to X-window applications. So it's ideal for electronic publishing. Financial analysis. And for anyone who has to work with 2-D and 3-D wireframe applications.

And that's just the most basic color model. We've also built SPARCstation 2GS. It lets

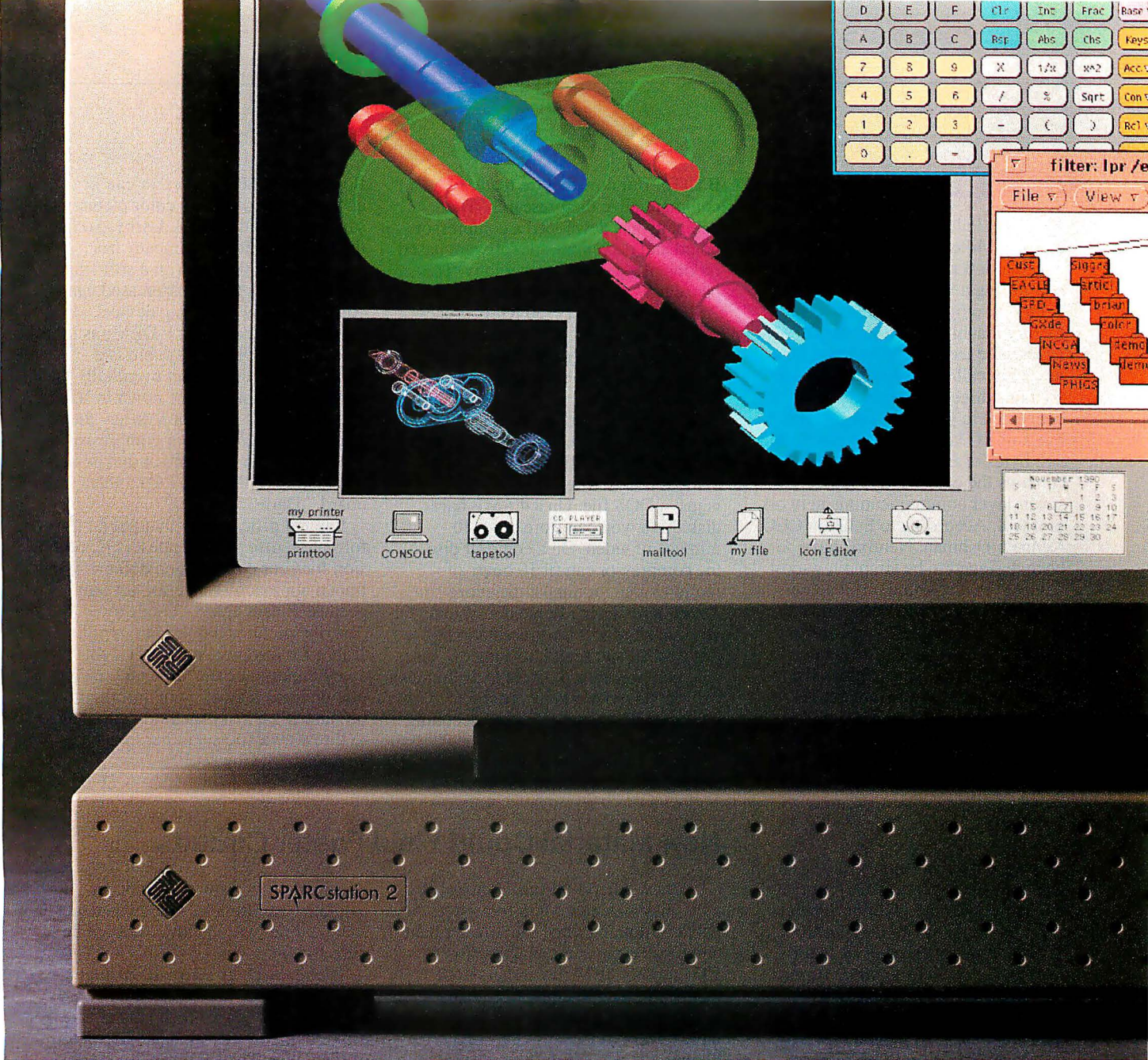

you create 3-D solid images in 24-bit true color. It's the kind of machine you hate to share. And from now on, you won't have to.

At the high end, there's SPARCstation 2GT. It does all the above, but it's been tuned especially for PHIGS, which is the highest standard for 3-D graphics on the planet. So it runs five times faster than the GS. With all this, it gives you a level of image quality you've never seen at anywhere close to its price.

---

THE WHOLE THING MAKES  
PERFECT STRATEGIC SENSE.

---

At Sun, we make a full line of SPARC-based systems. From the lowest-cost RISC/UNIX® workstation in the world to servers that support hundreds of users. They're all binary compatible. And they're built to run the most widely accepted standards for workstations.

On the subject of software, there are more than 2100 SPARCware™ applications. Including all the most popular

solids modeling programs. And the most popular PC software. And with our OPEN LOOK® interface, you'll spend less time learning the system. And more time on your real job. If you'd like to know more, call us at 1-800-821-4643. (From California, 1-800-821-4642.)

And we'll give you a better machine to strive with.



*Computers that network people.™*

are trademarks of SPARC International, Inc., licensed exclusively to Sun Microsystems, Inc. SPARC products are based on an architecture developed by Sun Microsystems, Inc. OPEN LOOK and UNIX are registered trademarks of UNIX System Laboratories, Inc.

## NANOBYTES

**Echelon** (Palo Alto, CA), started by Apple's Mike Markkula, has introduced a **new chip and protocols** for controlling a wide array of devices, from office lighting systems to factory machines to home appliances. The technology is based on a new chip called the **Neuron**, which contains three 8-bit processors connected in pipeline fashion, 10K bytes of ROM, 1K byte of RAM, and 512 bytes of EEPROM. The ROM contains the code for a complete seven-layer communications network protocol. According to Echelon CEO Kenneth Oshman, Neurons have been designed to be simple low-cost devices "that can find out if something is on, off, or in-between, and turn something on, off, or in-between." For example, a network of Neurons in your office connected to a motion detector and an ambient light sensor can ensure that the lights in your office are on only when you are there and it is dark outside. Neurons will be connected in what Echelon calls a Local Operating Network.

**Poqet Computer** (Sunnyvale, CA), maker of the 1-pound DOS-compatible Poqet PC, and **Infonet Services** (El Segundo, CA) plan to jointly develop products and services for a **worldwide messaging and communications network**. Their first product is called The Personal Communicator (\$1995), which basically is a Poqet PC, WorldPort 2400 modem, and Infonet's Notice Notebook software for using the Infonet communications system. Infonet's services include E-mail, fax/telex features, and on-line news wires.

PC users **curious about the upcoming MS-DOS 5.0** can get a sneak preview from a new book published by **Bantam**. The new edition of *The PC Configuration Handbook*, by John Woram, has an appendix discussing some of the features of the upcoming DOS. The 729-page text, subtitled *A Complete Guide to Troubleshooting, Enhancing, and Maintaining Your PC*, spends 19 pages on DOS 5.0. "It's not meant as an extensive look at DOS 5.0 but covers what you need to know from a system-configuration standpoint," a Bantam editor said.

BYTE). But now they're ready to commercialize their research. The company has developed a compressor board and decompressor software based on fractal-transform technology. The board uses eight fractal-transform ASICs and an Intel i960 RISC processor. Decoding and playback, however, can be done on any 286-based system running Iterated's decompression software module.

The compression hardware can squeeze 1.5 minutes of moving images on a regular 1.4-MB floppy disk, the company says. The compressed material is just a DOS file. On a 40-MB hard disk drive, you can store up to 40 minutes of video. On a compact disc, the compressor can fit 10 hours of motion video, or almost the entire *Rocky* epic. Using Iterated's system, you can store a video presentation on a floppy disk and send it to someone else, who can play it back, at 24 to 30 frames per second, without any special hardware; all they need is the decoding software.

Iterated's system can also be used for storing still images. On a 1.4-MB

floppy disk, the compressor can fit about 70 photo-quality color pictures, said vice president Rick Darby. So far, the highest ratio the company has achieved is 500-to-1, with a still-frame image. Images to be compressed can come from any digitizing device.

Right now Iterated's P.OEM (as in "pictures for OEMs") system is a \$25,000 investment. But eventually the technology should come down in size and price. "It's reasonable to say that future generations of our compressor could exist in a chip, and at that point, you could see this on a PC motherboard," Darby said.

Iterated officials say that fractal transformation offers the greatest compression for your computation dollars. The fractal approach is superior not only because it uses compact code to describe pictures but because, unlike JPEG, for instance, it doesn't throw away important data. "Fractal transformation throws away some information, because it's a lossy method, but it tends to throw away noise, rather than data you need," Darby said.

— D. Barker

## New Material Could Yield Faster Circuits

**A** new silicon-on-insulator material has yielded CMOS transistors capable of running three times faster than comparable pure silicon transistors, IBM reports. IBM researchers hope their SOI material could eventually lead to computer circuits that run faster and have fewer errors, says Ghavam Shahidi, a research staff member at IBM's T. J. Watson Research Center (Yorktown Heights, NY).

Silicon grown on top of an insulator offers several advantages for computer circuit designers. The insulator can help cut down on current leakage from the semiconductor and make the chip run faster. And SOI can protect computer circuits from "soft errors" caused by external radiation sources.

The different properties of semiconductors and insulators have made it difficult to produce SOI. But IBM researchers say they have developed a

new method to grow silicon on an insulator, resulting in an almost defect-free material with qualities not unlike pure silicon.

The researchers start with a silicon wafer as a base, heated to 1800°F, which produces a layer of silicon dioxide (the insulating material) on top of the wafer. They cut thin lines in the oxide, which exposes the silicon base and then pump a gas over the wafer that causes silicon to grow in blobs on top of the lines.

IBM researchers have used their SOI material to build experimental, high-speed transistors, Shahidi says. In tests, these CMOS transistors can conduct current through a 1/2-micron-thick channel. They have a switching speed of 33 picoseconds, making them three times faster than similar 1/2-micron CMOS transistors built of pure silicon.

— Jeffrey Bertolucci

**MAKE THE NEWS IN '91.** *If you, your company, or your research group is working on a new technology or developing products that will significantly affect the world of microcomputing, we'd like to write about it. Phone the BYTE news department at (603) 924-9281. Or send a fax to (603) 924-2552. Or write to us at One Phoenix Mill Lane, Peterborough, NH 03458. Or send E-mail to "microbytes" on BIX or to "BYTE" on MCI Mail. An electronic version of Microbytes, offering a wider variety of computer-related news on a daily basis, is available on BIX.*

IN GOTHENBURG, SWEDEN...

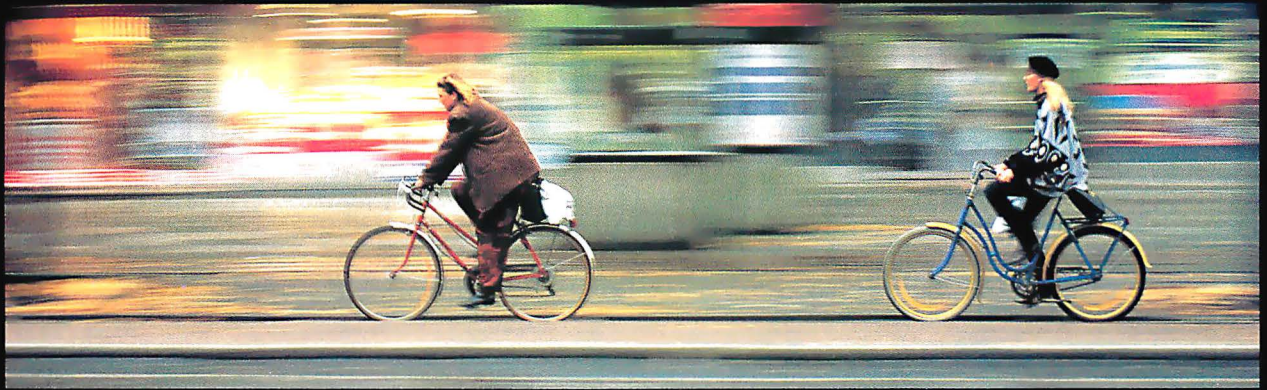

IN WORLAND, WYOMING...



AND IN SOCORRO, NEW MEXICO...



# People the World Over

Everywhere you look these days you'll find Gateway 2000 computers. That's because people everywhere know a good value when they see one. In all 50 states and in over 70 foreign countries, thousands of people are comparing price, quality and service – and choosing Gateway 2000.



## In Gothenburg, Sweden

Anders Bjernefors, a computer dealer and programmer, bought a Gateway 2000 25 MHz 486 system last April. "After many faxes and a lot of study, I selected Gateway 2000," said Anders. "I'm pleased with the machine. I received a very powerful, well-built computer for an astonishingly low price."



*Anders Bjernefors, Computer Link AB, and his Gateway 2000 25 MHz 486™ system.*

Anders was so impressed by his system and by the people at Gateway that he contacted the company about becoming a Gateway 2000 reseller. "I telephoned my salesman," Anders remembered, "and he told me I'd have to visit the factory to make the arrangements. I was on the next plane out of Goteborg on my way to North Sioux City, South Dakota."

386 and 486 are trademarks of Intel Corporation.

## In Worland, Wyoming

Bob Borst, owner and operator of Cloud Peak Pest Control in Worland, spent two and a half months researching his computer purchase. He chose a Gateway 2000 386SX. "My final decision was based on people, not hardware," said Bob. "The Gateway people make you feel like you're the most important person in the world. I didn't buy a computer – I bought Gateway."



*Bob Borst, owner and operator of Cloud Peak Pest Control, and his Gateway 2000 386SX.*

Bob was equally impressed by Gateway's service people. "One time I got into a file and couldn't get out of it," Bob related. "Even though it was a software problem, I called Gateway and they talked me through it."

## In Socorro, New Mexico

Gordon Kane, Laboratory Associate at New Mexico Tech, runs a computer lab with 15 Gateway 2000 286 systems. "At first we bought Gateway's because of the good prices," said Gordon. "But now I buy them because of the technical support, which is very superior, and because the company is committed to improving its product line."



*Gordon Kane, New Mexico Tech, with his Gateway 2000 286 lab computers.*

NMT also uses Gateway computers in its research programs. "A Gateway 386 cache system will be used

# Choose Gateway 2000!

at Kennedy Space Center next summer," said Gordon, "as part of a large program of thunderstorm studies being conducted there by NASA and the Air Force."

PC Magazine's survey about service and reliability confirms what these customers are saying:

*"Gateway shared top billing with such heavy-weights as Compaq, IBM, and HP for those who would buy their products again...Overall, Gateway's high marks bode well for the company's future, as does its commitment to customer service."*

PC Magazine  
September 25, 1990

## From the Heartland

The combination of price, quality and service makes Gateway 2000 the best value in the industry. But value alone doesn't explain how a little company in the Midwest, just celebrating its fifth anniversary, managed to outdistance hundreds of other companies, selling more systems through the direct market channel than any other PC manufacturer in the

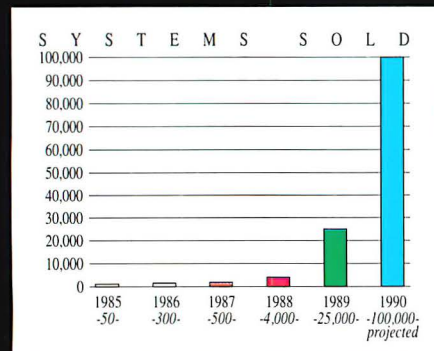

Gateway 2000 sells more computers through the direct market channel than any other PC manufacturer in the country.

Computer magazine readers will remember the company's early ads featured a picture of the Waitt cattle farm with the headline, "Computers from Iowa?"

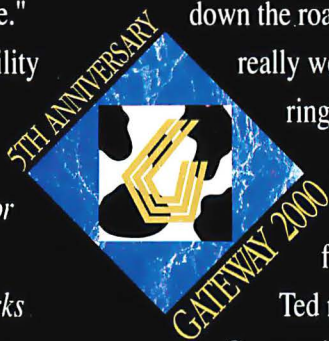

**"In the computer industry, longevity should be measured in dog years."**

country.

"It was the cows," laughed Ted Waitt, Gateway 2000 President and CEO. "Of course."

"We can't run that ad anymore," continued Ted, grinning, "because we built a new plant 14 miles down the road in South Dakota. But the cows really worked for us. They made the phones ring. From then on, though, we built our business on value – good prices on quality systems with old-fashioned, personal service."

Ted mentioned another reason for Gateway's success. "We take a long-term approach to customer service," he said.

"When you buy a computer from Gateway 2000, you become part of our family and we're going to be there for you as long as you own that machine."

As Ted talked about the company's fifth anniversary, he laughed again. "In the computer industry, longevity should be measured in dog years," he chuckled, "because everything's moving so fast. That makes Gateway 35 years old! But seriously, we've come a long way in five years. And I owe it all to the great people at Gateway and to our customers."

When you add it all up, you'll understand why you've got a friend in the business at Gateway 2000.



*Gateway 2000 will be there for you 'til the cows come home.*



8 0 0 - 5 2 3 - 2 0 0 0  
610 Gateway Drive • N. Sioux City, SD 57049 • 605-232-2000 • Fax 605-232-2023

# GATEWAY 2000 SYSTEMS

## 12MHZ 286VGA

- 80286-12 Processor
  - 1 MB RAM
  - 1.2 MB 5.25" Drive
  - 1.44 MB 3.5" Drive
  - 40 MB 17ms IDE Drive with 32K Cache
  - 16 Bit VGA with 512K
  - 14" 1024 x 768 Color Monitor
  - 1 Parallel/2 Serial Ports
  - 101 Key Keyboard
  - MS DOS 3.3 or 4.01
- \$1495.00**



## GATEWAY 386SX

- 4 MB RAM
  - 1.2 MB 5.25" Drive
  - 1.44 MB 3.5" Drive
  - 40 MB 17ms IDE Drive with 32K Cache
  - 16 Bit VGA with 512K
  - 14" 1024 x 768 Color Monitor
  - 1 Parallel/2 Serial Ports
  - 101 Key Keyboard
  - MS DOS 3.3 or 4.01
  - MS WINDOWS 3.0
- \$1895.00**



## 25MHZ 386VGA

- 4 MB RAM
  - 1.2 MB 5.25" Drive
  - 1.44 MB 3.5" Drive
  - 80 MB 17ms IDE Drive with 32K Cache
  - 16 Bit VGA with 1 MB
  - 14" 1024 x 768 Color Monitor
  - 1 Parallel/2 Serial Ports
  - 101 Key Keyboard
  - MS DOS 3.3 or 4.01
  - MS WINDOWS 3.0
- \$2395.00**

## 25MHZ 386CACHE

- 64K Cache RAM
  - 4 MB RAM
  - 1.2 MB 5.25" Drive
  - 1.44 MB 3.5" Drive
  - 80 MB 17ms IDE Drive with 32K Cache
  - 16 Bit VGA with 1 MB
  - 14" 1024 x 768 Color Monitor
  - 1 Parallel/2 Serial Ports
  - 101 Key Keyboard
  - MS DOS 3.3 or 4.01
  - MS WINDOWS 3.0
- \$2695.00**



## 33MHZ 386VGA

- 64K Cache RAM
  - 4 MB RAM
  - 1.2 MB 5.25" Drive
  - 1.44 MB 3.5" Drive
  - 200 MB 15ms IDE Drive with 64K Multi-Segmented Cache
  - 16 Bit VGA with 1 MB
  - 14" 1024 x 768 Color Monitor
  - 1 Parallel/2 Serial Ports
  - 101 Key Keyboard
  - MS DOS 3.3 or 4.01
  - MS WINDOWS 3.0
- \$3195.00**



## 25MHZ 486VGA

- 64K Cache RAM
  - 8 MB RAM
  - 1.2 MB 5.25" Drive
  - 1.44 MB 3.5" Drive
  - 200 MB 15ms IDE Drive with 64K Multi-Segmented Cache
  - 16 Bit VGA with 1 MB
  - 14" 1024 x 768 Color Monitor
  - 1 Parallel/2 Serial Ports
  - 101 Key Keyboard
  - MS DOS 3.3 or 4.01
  - MS WINDOWS 3.0
- \$3995.00**

## BEST BUY

- Same features as our 33 MHz 386 VGA system except this machine has an 80 MB 17ms IDE Drive instead of the 200 MB 15ms IDE Drive.
- \$2795.00**

## STANDARD FEATURES AND SERVICES

- Microsoft® WINDOWS™ and Mouse with all 386 and 486 systems
- 30-day money-back guarantee
- One-year warranty on parts and labor
- New leasing options now available
- Toll-free technical support for the life of the machine
- Free on-site service to most locations in the nation
- Free overnight shipment of replacement parts
- Free bulletin board technical support

## NEW SALES HOURS 7AM - 10PM CST

*Due to the volatility of the DRAM market, all prices are subject to change.*



8 0 0 - 5 2 3 - 2 0 0 0  
610 Gateway Drive • N. Sioux City, SD 57049 • 605-232-2000 • Fax 605-232-2023



# LETTERS

and Ask BYTE

## DTP Debate

As a professional desktop publisher, I read with great interest "Is the Typesetter Obsolete?" (October 1990), which compares DTP packages. While for the most part the review was informative, I must make a few comments, some relating specifically to Ventura Publisher.

First, the primary goal of desktop publishing is to communicate a message effectively, not just to "make your pages look pretty."

The authors wonder why anyone would use Ventura's headers/footers feature, since the repeating frames are so easy to use. That's true, but the headers/footers provide valuable text functions with many preset values that can be easily customized. For example, headers/footers have an option to insert the first and last match of a given tag, allowing automatic placement of page references such as those found in dictionaries and telephone books.

Ventura addresses tracking as either tighter or looser, but this does not limit it to "only two levels of tracking." You can numerically specify the amount of tightness or looseness in 100ths of ems. Moreover, tracking is not a feature designed for those "trying to do fancy things with type." It is a typographic element allowing precise control over letter and line spacing to improve readability.

Kerning is not "an adjustment made to specific characters to account for their shape." The adjustment is made to the amount of space between specific pairs of characters, not to the characters themselves.

Given that Ventura, like most DTP software, is complex and requires time to learn adequately, I understand the reviewers' misconceptions and omissions.

I was particularly interested in their comments on FrameMaker, since I am looking to upgrade my system to the Unix platform. I was disappointed that they covered only the Macintosh version, especially since the cover announced "DTP Packages for Macs, PCs, and Unix." In that light, it seems a considerable oversight and somewhat unfair not to address all available platforms, as you do with PageMaker.

Ginny Ruths  
Imagigraphics  
Colorado Springs, CO

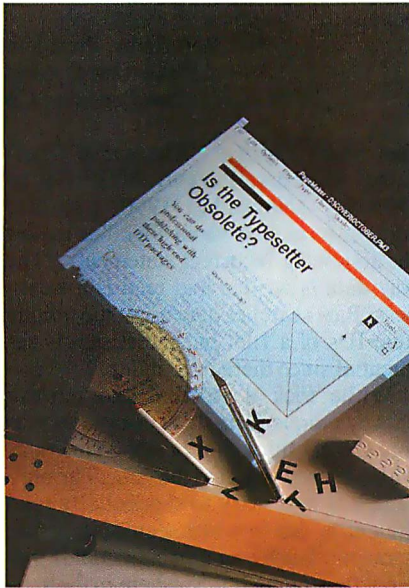

*If nothing else, we agree on one thing—desktop publishing software is complex and definitely takes some time to master. For that reason, we cut down our list of review candidates and spent our time learning each package, looking for tips and shortcuts. Except for a few specific goofs, we believe the article reads correctly as is.*

*For the review, we needed to reproduce pages from BYTE, laid out exactly as they appear in print. We chose to implement the page numbers as footers, and Ventura's inflexible placement of footers on the page made that difficult. Instead, we found that placing the page numbers as repeating frames made it much easier to get them exactly where we wanted them. Fortunately, Ventura offered us a way to get around one of its shortcomings.*

*Also, we found Ventura's tracking to be a bit lacking. Yes, you can individual-*

**WE WANT TO HEAR FROM YOU.** Please double-space your letter on one side of the page and include your name and address. Letters two pages in length or under have a better chance of being published in their entirety. Address correspondence to Letters Editor, BYTE, One Phoenix Mill Lane, Peterborough, NH 03458. You can also send letters via BIXmail c/o "editors."

*Your letter will be read, but because of the large volume of mail we receive, we cannot guarantee publication. We also reserve the right to edit letters. It takes about four months from the time we receive a letter until we publish it.*

*ly set the tracking amount by tag or selection, but you get only one setting per selection. Having to change the setting throughout the document gets to be a bit tiresome. We greatly preferred Quark's full control or PageMaker's five preset levels (in version 4.0). PageMaker's controls should give most users all the control they need. Yes, Ventura can do it, but it's clunky at best.*

*Your point about kerning is well taken. Indeed, kerning involves adjusting the space between pairs of characters. We refer to that idea throughout the text, but somehow the phrase you quote slipped through. Thanks for pointing it out.*

*As for the Unix coverage, our covers are designed as articles are being edited. Two products in the review (Interleaf and FrameMaker) are members of families of products that include Unix versions. We had hoped to get the latest incarnations of both products. For FrameMaker, that was the Mac version we tested; for Interleaf, the latest version runs only under Unix. The Unix version didn't arrive in time, so at the last minute we reverted to the PC version. The Mac FrameMaker we reviewed is a later version than the current Unix product. When the Unix version of Interleaf dropped out, the cover lines should have been changed. We're sorry for any confusion this may have caused.*

*Finally, I've been installing and working with DTP software ever since the beta versions of both Ventura and PageMaker. In the wrong hands, DTP software simply makes it easier to design horrible-looking pages. I disagree that DTP was designed for professionals. While it is a powerful tool in the hands of professionals, it's equally at home in the hands of occasional users with a flair for good design. For these users, DTP software's ability to "make pretty pages" is the primary reason they buy it.—Howard Eglowstein*

Your October 1990 story "Is the Typesetter Obsolete?" seems to have completely missed one of the premier DTP systems: the Commodore Amiga. I believe the Amiga supported color DTP first and has certainly been the price/performance leader since DTP was first available.

BYTE is a fine magazine, but its blindness to the Amiga is a blemish on its reputation. It makes the informed reader

wonder: What else is getting short shrift?

Stan Sieler  
Redwood City, CA

*I can understand your frustration. The Amiga is a very nice platform that pioneered several key areas the rest of the microcomputing world is only now starting to address. That's why BYTE covers the Amiga more than any other non-Amiga-specific magazine. For example, a quick search of the BYTE archives through October showed that we covered the Amiga 57 times in 1990, in ways ranging from splashy cover stories to references inside other articles (e.g., our recent coverage of SCSI, in which we acknowledge the Amiga's lead). The Amiga is regularly a part of "What's New," it's been in our columns, and we reviewed the 3000 when it came out. It's been in the State of the Art section and Features. And it figured in the 15th Anniversary Summit (we even interviewed Jay Miner). This is not an Amiga-hostile magazine!*

*I'm proud that we already cover the Amiga as much as we do. The rest is up to Commodore and third-party developers. If these companies give the Amiga the push it probably deserves, then we'll increase our coverage even more. But that kind of push can ethically come only from Commodore—it's not the job of editors to promote a product. We report; the companies promote.*

*In any case, we'll do our best to give the Amiga its due whenever and wherever appropriate.*—Fred Langa

### Alternatives Explored

Your article "Alternative Operating Systems, Part 3, Theos: Serious Business" (October 1990) and its technical editor Tom Yager really did their duty by bringing good ideas from quiet companies like Theos Software to the public's attention. The Theos multiuser operating system, with its BASIC and C components and operating-system-supported data files, has built a following from professional doubters—programmers and developers who have taken the time, as your editor obviously did, to investigate the platform.

My company no longer has any doubts. Working in the Theos environment has allowed us to create software without having to concern ourselves with alien data structures. Theos helps us make products that are easier to use and that are developed from the ground up for multiuser environments.

I've read and reread the article. Each

time, I felt a charge, a positive stroke that has been missing for the last five years—mainstream acknowledgment! It's the bane of the artist and a bone for the businessperson. Thanks for both bane and bone.

Ron Gibbs, President  
Phase One Systems  
San Leandro, CA

Ben Smith's article "Alternative Operating Systems, Part 4, Pick: OS or DBMS?" (November 1990) provides some information about Pick but makes the following incorrect statement: "The way data is written and read is a weakness. Pick searches data using the unique item-IDs of a file, but the search is sequential since there is no index."

While Pick does store and retrieve data by unique item-ID, it does so by putting the ID through a hashing function, which is used to locate the data. The only time it is necessary to sequentially read the entire file is when searching for an item (record) by an attribute (field) that is not the unique ID. Nowhere in the article is the word *hash* used. Hashing is fundamental to the Pick filing system. To omit hashing from a description of Pick is to reduce its elegant filing system to nothing more than a delimited flat file. You simply cannot describe Pick without discussing hashing.

Kevin M. Sproule  
Shrewsbury, MA

*You are quite right! Hashing is fundamental to Pick's organization of records based on their unique item-IDs. However, if you are searching on any field other than the item-ID, you must resort to a sequential search.*—Ben Smith

### From Inside the Beltway

It is my great pleasure to congratulate the management and employees of BYTE as you celebrate your 15th anniversary. This is a milestone in the life of any business enterprise. It is a measure of your commitment and your success. As a businessman myself for more than 40 years, I know how much work and effort have gone into making this event possible.

Take pride in your accomplishment and in the fact that, as you continue to work for the success of your organization, you are contributing to the prosperity and well-being of our entire country.

I wish you continued success.

Robert A. Mosbacher  
Secretary of Commerce  
U.S. Department of Commerce  
Washington, DC

### OS/2 Bashing?

In your 1990 *IBM Special Edition*, the article "Through a Window, Darkly" erroneously states that OS/2 doesn't recognize any printer other than an IBM Proprinter. Version 1.2 of OS/2 (surely available to the author, since it has been around for nearly a year) supports not only the IBM printer family, but many Epson and Hewlett-Packard models, for a start. In practice, this means a great number of printers, because most manufacturers choose to provide emulation for one of the above. A simple generic printer driver and a PostScript driver are also included. I accept that this is still a small selection, but it's a good deal more than just a Proprinter.

Another paragraph states that "a DOS application operating in the background with PM seems to run very slowly." This statement shows a worrying lack of research and familiarity with the system. For good technical reasons, the DOS emulator in OS/2 1.x actually suspends operation when a switch is made from DOS to a PM window.

In the same paragraph, it is stated that "you can't download from an on-line database in one session while doing word processing in another." Why on earth not? Run Kermit (or something similar) in one window and Microsoft Word in another—I do it frequently.

R. D. Eager  
Kent, U.K.

*Regarding multitasking under Presentation Manager, I wrote a little program that simply ran a loop that incremented a number and reported it. Well, I know that Microsoft says that the DOS box is in suspended animation, I rarely if ever believe claims that I don't test. In this case, I noticed that the program had incremented a few ticks of the counter between the time I switched out and when I came back to it. It may be that these were simply caused by delays in screen reporting or that the processing continues briefly after the application leaves the screen but before it's really packed away by PM. I don't know, and neither (at the time) did Microsoft. That is why I said that it "seems" to run slowly. I didn't know for sure, and I still don't.*

*The printer support for PM is a different issue, because when you install the software, it does clearly offer such printers as the HP LaserJet as options. Unfortunately, they don't all work as they should, and the LaserJet driver is one of those that seems to have problems. The one you can really count on is the Proprinter driver.*

*continued*

# We slash interface development time. (and we can prove it!)

## C-PROGRAMMERS: See for yourself how Vermont Views™ can help you create user interfaces the easy way.

If you want to start saving a tremendous amount of time and effort, call for your free Vermont Views demo kit and put us to the test. Vermont Views is a powerful, menu-driven screen designer that comes with a C library of over 550 functions. Which means you can create user interfaces in just a fraction of the time it takes to write the code yourself!

Why try to reinvent the wheel when Vermont Views lets you interactively create pull-down menus, window-based data-entry forms (with tickertape and memo fields), scrollable form regions, choice lists, context sensitive help, and a host of other interface objects.

Vermont Views combines the convenience of a fourth generation language with the power, flexibility, and blinding execution speed of native C code.

### Turn your prototype into the application.

Let's face it. With most systems, you have to throw away your prototype when coding begins. Which means you waste precious time

and effort. With Vermont Views, things are a lot different. In fact, the prototype actually *becomes the application*. So menus and data-entry forms are usable in the final application without change. Names of functions for retrieving, processing, and storing data can all be specified as the prototype is created. And that's just for starters.

### Here's a truly universal solution.

When you create an interface with Vermont Views, you can port it among PC-DOS, OS/2, UNIX, XENIX, and VMS.

Vermont Views can be used with any database that has a C-language interface (most do), and will create interfaces for any roman-based language. Our form-locking version lets you develop quickly and safely on networks and multi-user operating systems, too.

If you need DOS graphics in your applications, we also have the answer. Vermont Views™ GraphEx allows all Vermont Views' windows, menus, and forms to work in CGA, EGA, VGA, and Hercules graphics modes. So you can use your favorite graphics package to create charts, graphs, and other images to enhance text displays.



Vermont  
Creative  
Software

Pinnacle Meadows,  
Richford, VT 05476  
Phone: (802) 848-7731  
FAX: (802) 848-3502

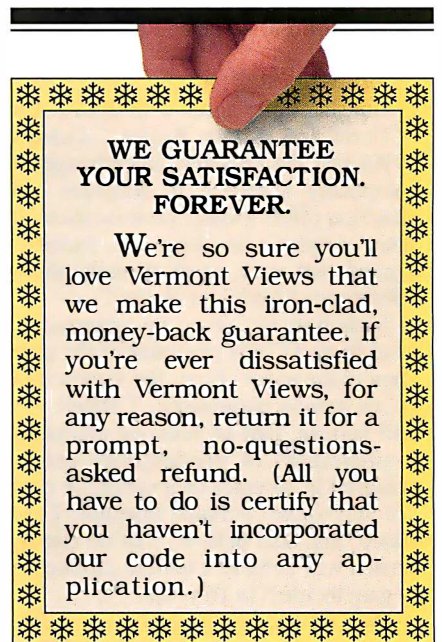

## Call for your FREE demo kit!

# 800-848-1248

(Please mention "Offer 093")

Don't take our word for it. Put Vermont Views to the test by calling for your personal, free demonstration kit. Or fax us at (802) 848-3502.

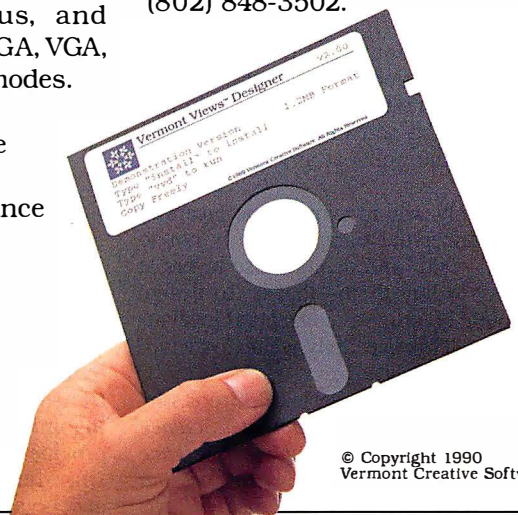

© Copyright 1990  
Vermont Creative Software

*Regarding your statement about running Kermit and Microsoft Word, what you say may be true if both applications are OS/2 versions (as I said at the beginning of the paragraph you're questioning), but if they are both DOS applications, then you cannot. OS/2 will support only one DOS program at a time, and while you can switch in and out of it, you can't multitask.*—Wayne Rash Jr.

### OOP Redux

I enthusiastically agree with Brad J. Cox ("There Is a Silver Bullet," October 1990) that the reusable, interchangeable component approach to software construction offers greater promise than any other of today's developments. Indeed, I argued that very point strongly in my 1986 paper "No Silver Bullet."

Although we agree on approach, I must protest Cox's treatment of the argument of my paper. First, the viewpoint is by no means pessimistic. I stated, and still believe, that an order-of-magnitude improvement in productivity can be achieved in 10 years by a variety of modern approaches pursued together. I also stated, and still believe, that no one approach will achieve a tenfold productivity gain by itself in 10 years.

Most of the many response papers I have seen take the form, "Oh yes, there is a silver bullet, and it is mine." I shall be most impressed by testimonials from users who are not technology developers and who say, "I have used this product/technique that somebody else supplied, and it gave me a tenfold improvement between 1986 and 1996." Observe that four of the 10 years have gone by since my November 1986 paper. I still see no single development that will by itself prove me wrong by 1996.

Second, I most emphatically did not argue, as Cox asserts, that software difficulties arise "from some deficiency in how programmers build software today." My argument was that the difficulties are inherent in the conceptual complexity of the software functions to be designed and built, at any time, by any method.

The only way to avoid some layers of these conceptual complexities is not to design, build, and debug those layers at all, but to buy them—that is, to design and build at a higher conceptual level altogether. This is exactly what Cox advocates so eloquently.

Frederick P. Brooks Jr.  
Kenan Professor of Computer Science  
Department of Computer Science  
University of North Carolina  
Chapel Hill, NC

### Computer Comrade

When I wrote my letter to you two months ago, I did not suppose that you would answer me. Then our postman gave me four thick parcels from you. I jumped like a child.

My wife could not believe that BYTE would send me four magazines. "They are capitalists," she said. "They count each pound in a pocket." But later she looked at all the BYTEs, and she said that you were not capitalists, but people with good souls.

Most interesting for me in BYTE are the articles about the history of fonts and scripts, information from the BYTE Lab, news about peripherals, reports about new software for IBM-compatible computers, and, of course, prices of software and hardware.

Thank you very much for your present, and remember that BYTE has a reader and friend in the Soviet Union.

Ignatenko I. Artem  
Moscow, U.S.S.R.

### Mac Magic

I was heartened to see two articles that appeared back-to-back in the October 1990 issue: "Interface/Shplinterface" and "Spare Me the Details." They are complementary in their appeal for hardware/software systems that keep out of the way so that users can devote their attention and energy to doing the job at hand. Both writers recognize the Mac's progress in this direction and the potential for progress in Windows 3.0. Perhaps they deplore, as I do, the fact that PC users need to waste much intellectual (and emotional) energy learning and using many arcane commands and routines to address the job at hand.

The industry seems to be moving in the right direction, and these articles support that movement. I laud your printing them. I even think they deserve to be printed again, but next time in the front of the magazine, not on the last two pages.

E. H. Gautier  
Pittsburgh, PA

## ASK BYTE



### Unix Student

I will begin my computer studies in Australia next year, and I am very interested in joining the Unix community. Can you provide me with more information on Unix-related magazines, newsletters, and organizations? Also, I would very

much like to know how to obtain free Unix software.

Chow Keng Choon  
Singapore

*Although BYTE has a regular column devoted to the Unix user and regularly runs features and reviews that are specific to Unix, you may find additional information in our sister publication, UNIX World (444 Castro St., Mountain View, CA 94041, (415) 940-1500).*

*The two most valuable organizations for the Unix community are USENIX (22672 Lambert St., Suite 613, El Toro, CA 92630) and UniForum (2901 Tasman Dr., #201, Santa Clara, CA 95054, (408) 986-8840). Every nation seems to have its own Unix users group. Australia's is AUUG; contact Jim Roper, Labtam Melbourne, 10 Whitley Way, Seaford, Victoria 3198, Australia.—B. S.*

### Affordable COBOL

I need your help in finding a COBOL compiler. The only one I'm aware of is the very expensive Microsoft COBOL compiler that is out of my price range.

Charles Igie  
Tallahassee, FL

*Try BOS National, Inc. (2607 Walnut Hill Lane, Suite 200, Dallas, TX 75229, (214) 956-7722); it provides BOS Micro-COBOL. VisiCOBOL from Innovative Computers, Inc. (26400 Southfield, Suite F, Lathrup Village, MI 48076, (313) 569-7422) is an inexpensive (\$100, last time we checked) COBOL interpreter that supports a subset of ANSI level 1 COBOL but might have what you need. Micro Focus, Inc. (2465 East Bayshore Rd., Suite 400, Palo Alto, CA 94303, (415) 856-4161) sells various COBOL compilers; call them for prices.—R. G.*

### They're Coming

As a biochemical research scientist, one of my traditional duties is to keep a notebook or daily log of my lab activities—a record of meetings, correspondence, measurements, experimental results, observations, and so on. Your article "The Spoken Word" (July 1990) about voice interfaces and dictation devices gave me the idea that speech-to-text devices could greatly reduce the burden and improve the quality of laboratory record-keeping. What I envision as being useful (and feasible) is the following scenario:

The scientist records on a small, voice-activated pocket cassette recorder (e.g., those commonly available at Radio Shack stores) the events of the day as they happen. At the close of the working day,

# CORELDRAW!

## The Overwhelming Choice Of PC Users!

1990 Publish  
Readers' Choice Awards  
December, 1990

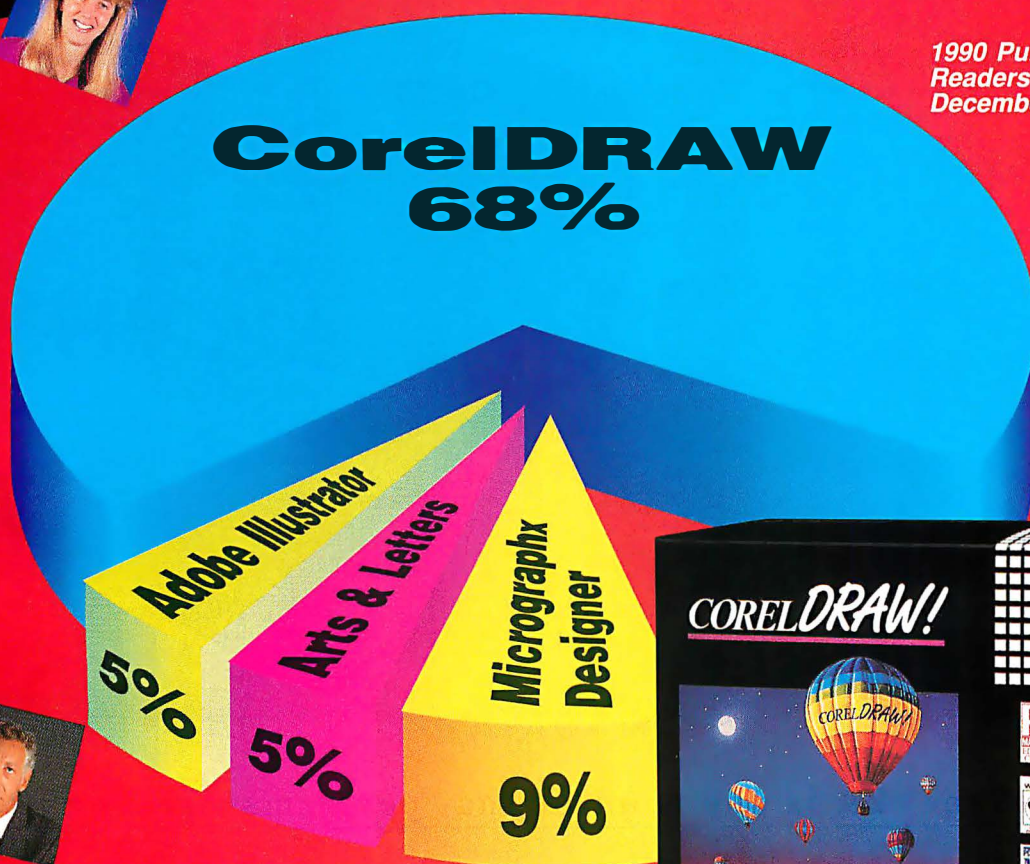

From a cast of thousands of products, the 1990 Readers' Choice Awards acknowledged CorelDRAW as *the* most popular PC program in any category. And, for the second year in a row, CorelDRAW won first place as the favorite product in the Draw category with a landslide victory – adding yet another award to this highly acclaimed program.

Call Corel now  
for more information on our  
CorelDRAW International Design Contest!

*CorelDRAW! – The World's Finest PC  
Graphics Software For EVERYONE!*

Circle 58 on Reader Service Card (RESELLERS: 59)

 **COREL**  
Tel: (613) 728-8200  
Fax: (613) 728-9790

On the left, the best-selling VGA monitor. On

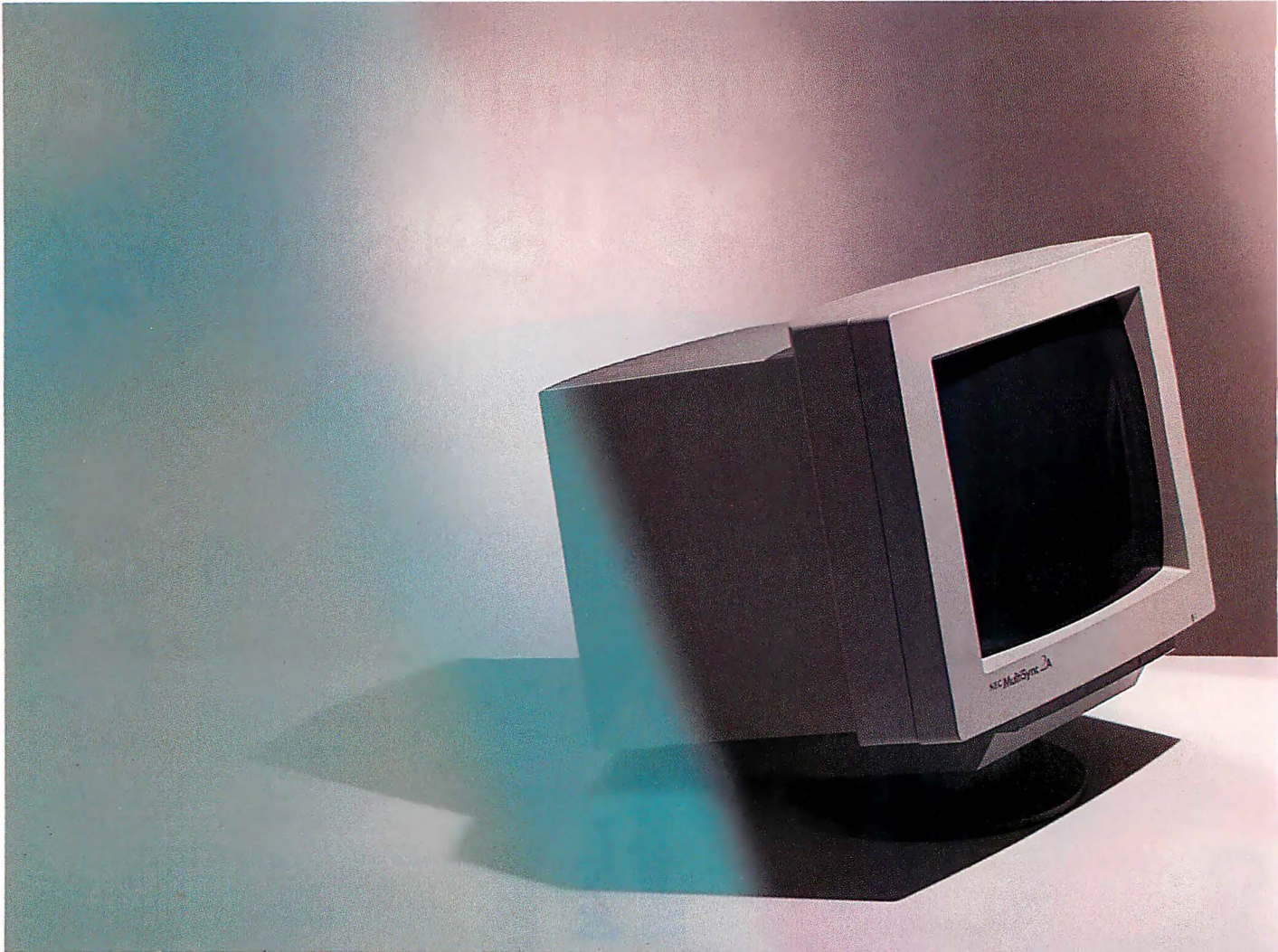

The MultiSync® 2A is one monitor that performs like two. On one hand, it's an uncompromised VGA monitor that works so well, VGA users have made it the best-selling 14" VGA color monitor in America.

On the other hand, the MultiSync 2A is also an equally uncompromised SuperVGA monitor, providing the perfect upgrade path to a standard that, at 800 x 600, gives you 56% more resolution than VGA.

the right, the best-selling SuperVGA monitor.

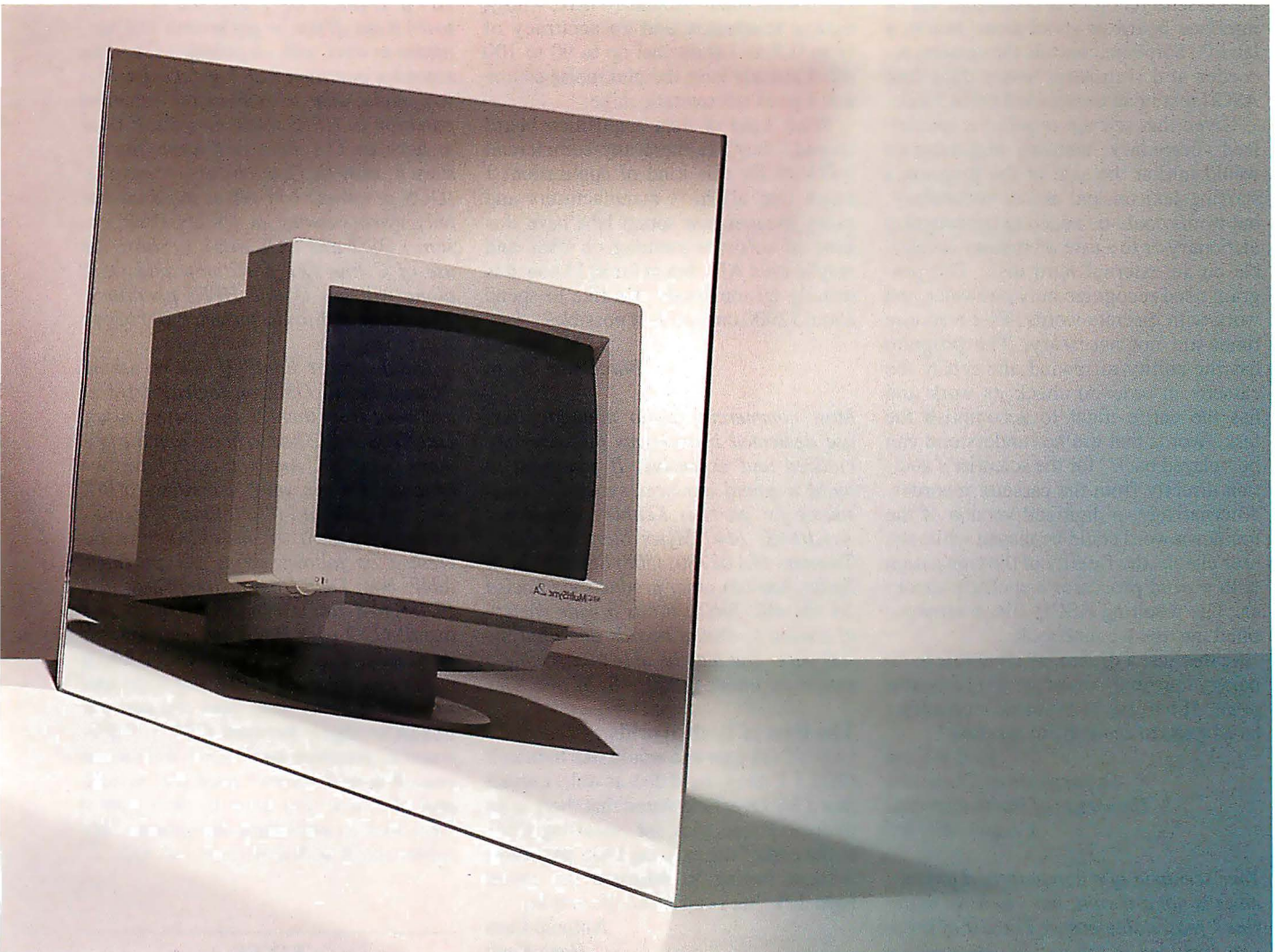

It's even available in a gray-scale version—the MultiSync GS2A—  
which delivers everything the 2A does, in glorious shades of gray.

The MultiSync 2A. It's two of the best monitors you've ever seen.

For technical information or for the location of the dealer nearest  
you, call 1-800-FONE-NEC. For product literature, call 1-800-826-2255.

In Canada, call 1-800-268-3997.

MultiSync is a registered trademark of NEC Technologies, Inc. © 1990 NEC Technologies, Inc.

*Circle 149 on Reader Service Card*

**NEC**

the cassette recorder is connected via an interface board or stand-alone box to a lab PC. Software controls the cassette recorder and translates voice data into ASCII text in an unattended batch mode.

Given that science requires a specialized vocabulary, memory requirements would inhibit the size of the program's starting lexicon and active vocabulary, but words could be added to the program dictionary or to a user dictionary accessible on an external hard disk. The program need recognize only one voice and work with discrete words. Fast response times are not necessary. The program has the ability to rewind and replay the cassette in order to check its work and has the entire night to accomplish the task. Words that are not understood can be "played back" for the scientist's audition directly from the cassette recorder. Alternatively, a digitized version of the unknown word could be played while the user checks the fidelity of the translation with a word processor's spelling checker. The resulting ASCII file is incorporated into the lab notebook.

Is this just a dream, or does this technology currently exist at a reasonable price? If not, could available technology be adapted to accomplish this task?

Paul Wilson  
Department of Chemistry  
University of North Carolina  
Chapel Hill, NC

*Your scenario of a computerized amanuensis is not a dream, but you have to define "reasonable cost." The list of products included in the article you mention shows that systems that have a large vocabulary are very expensive, while more reasonable systems just can't cope with extensive vocabularies, let alone everyday speech. Currently available systems for translating real-time speech to text are prohibitively expensive and won't soon be found on the average desktop. But be patient, they're coming.—S. W.*

### Computerized Graphic Equalizer

I have a 386SX with 4 megabytes of RAM, a 70-MB hard disk drive, and a VGA multisync monitor with a 512K-byte video card. I use the system mainly for technical applications and am very satisfied with it. I am also involved in hi-fi and am very disappointed with ordinary graphic equalizers because of the inadequate displays they incorporate.

I think that I could convert my computer into an efficient real-time analyzer if only I knew the right interface and software. What I'd like is a pink-noise analyzer to handle the range of from 25

Hz to somewhere around 16 kHz, with 1/3 octave resolution and an accuracy of from 0.5 to 1.0 decibel up to 90 to 100 dB. I already have the pink-noise source and a good electrostatic mike.

What kind of data acquisition board should I buy? Is there any commercial software for this kind of application? I know that all hi-fi manufacturers and many independent sound labs have this kind of software running on 386s and maybe even ATs, but as far as I know it is usually custom-made. I'd like to spend about \$2000 on this. Is it possible?

J. M. Saliotti  
Barcelona, Spain

*Most commercial audio manufacturers use dedicated instruments that are specialized and expensive. If you want to build a sound analyzer system, a good source for parts is Keihley Metrabyte/Asyst/DAC (440 Myles Standish Blvd., Taunton, MA 02780, (508) 880-3000). In Spain, you can order products via Pacisa SA (01-402-7060); it has a wide variety of analog-to-digital boards and analysis software. You may be able to assemble a system for under \$2000.—S. W.*

### The Best of Both Worlds

I am a DOS user and would like to install OS/2 1.2 on my hard disk as well. I recall that a BYTE article stated that there is an undocumented trick for installing OS/2 at the end of the existing DOS partitions without having to reformat the entire hard disk, but I can't find the article.

Antonio Lam  
Hong Kong

*You're probably referring to Mark J. Minasi's column, "A First Look at HPFS" (January 1990). The question was, "Will I have to reformat my hard disk to use HPFS (the High Performance File System)?" The answer was "Yes, if you've only got a single file allocation table (FAT) partition, otherwise no."*

*But you're really asking a more basic question: "Can DOS and OS/2 coexist?" Yes, they can. All versions of OS/2 1.2 I've seen recently offer a dual-boot facility. You install OS/2 (using FAT, not HPFS) on top of DOS. Then, when you boot, you can pick the operating system you want to use. This works because OS/2 can read and write FAT partitions just like DOS—specifically, the C partition, from which both systems boot. So, if you've got enough space on C for OS/2 and DOS, you're all set. If not, OS/2's installation program will tell you so, and you can trim accordingly.*

*Of course, OS/2's new file system,*

*HPFS, is pretty nifty, and you may want to try it out. If you've got several FAT partitions to work with—a primary C and an extended partition with logical drive D—you might want to convert the extended partition to HPFS. Note that you'll have to back up D's data, and when you restore it, only OS/2 will be able to read it. (DOS programs can get at the data but only when running in OS/2's DOS session.) OS/2 and DOS will now share the use of C (the FAT partition), and OS/2 alone will use D (the HPFS partition). The command to do the trick is format D: /fs:hpfs.*

*On the other hand, if you're asking "Can I install OS/2 on logical drive D and boot from there?" the answer is no. Like DOS, OS/2 has to boot from the primary partition. And you can't have two of those. Or can you? According to BIX user Jim Gilliland ("jgilliland"), a dual-primary-partition machine can be created as follows: Wipe the partition table, boot DOS from a floppy disk, use FDISK to define a primary partition, and install OS/2 with HPFS (which uses that partition), and then install DOS, which won't recognize the HPFS partition and so will create its own. Now you can use FDISK to toggle between OS/2's HPFS-based C partition and DOS's FAT-based one. Whew! I haven't tried this myself, and of course you have to start with a fresh disk to implement the scheme. My advice: Stick with dual-boot.—J. U.*

---

### FIXES

---

- The correct price for Carpenter's Dream 3.0 from Workhorses, Inc. (January, page 88) is \$74.50.
- The correct phone number for Advanced Matrix Technology (December, 1990 Product Focus, page 168B) is (800) 992-2264.
- The current address and phone number for Future Domain (November 1990 Product Focus, page 188) are 2801 McGaw Ave., Irvine, CA 92714, (714) 253-0400.
- The correct processor for the IBM XT included in the chart on page 76 of the 1990 IBM Special Edition is the 8088.
- In "FPU Face-Off" (November 1990), we inadvertently referred to an 80387-class chip manufactured by Cyrix as the FastMath 83D87. The correct name of this chip is FasMath. Winkel Engineering manufactures software that performs arithmetic calculations under the registered trademark FastMath. ■



# C++/Views™

for Microsoft Windows

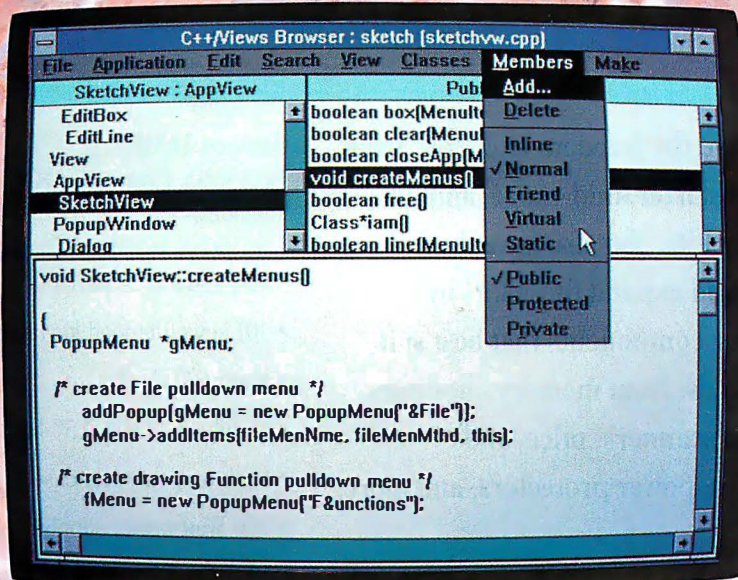

## THE MICROSOFT WINDOWS 3.0 DEVELOPMENT TOOL THAT DELIVERS FROM START TO FINISH.

**C++/Views** is a development tool for C++ programmers that not only reduces the complexity of Microsoft Windows 3.0 but also slashes development time by up to 75%.

### ***Delivers on the promise of Object-Oriented Programming (OOP).***

Encapsulates more MS Windows 3.0 functionality than any other tool on the market today. Get MS Windows applications off to a fast start with a framework of over 65 tested and ready-to-go C++ classes.

### ***Has the most complete C++ class library for MS Windows Development.***

Get started with graphical user interface classes such as windows, views, bitmaps, dialog boxes, menus, popup menus, graphics, regions, pens, brushes, controls, buttons, listboxes, valuator, editors, printers and much more. Organize your data with foundation classes such as containers, collections, sets, dictionaries, files, strings, streams and so-on. Use other classes to manage the persistence of objects across files, to perform serial communications, and to activate timed events.

### ***Provides support for the entire project.***

Comes with a complete OOP development environment including the first fully functional C++ class hierarchy *Browser*. Also includes an *Interface Generator* for building C++ dialog classes and a *Documentor* for automatically producing high quality documentation of your classes.

### ***Works with Zortech C++.***

Combine C++/Views with the **Zortech C++** compiler for a cost-effective and highly productive development environment for building your next generation software systems.

### ***Pays for itself on even the smallest project.***

Only **\$495.00** with no royalties  
Comes complete with source code.

## **C++/Views** from CNS, Inc.

CNS, Inc., Software Products Dept.  
7090 Shady Oak Road, Minneapolis, MN 55344  
(612)-944-0170 • FAX (612)-944-0923

© Copyright 1990 CNS, Inc. All rights reserved. Microsoft is a registered trademark of Microsoft Corporation.



# Freedom of Choice.

At Jameco, you have the freedom to choose from a complete line of starter, mid-range, and full powered computer kits. You also have the freedom to build and expand these kits by choosing the major components that best suit your individual needs: from memory, monitors, and disk drives; to scanners, mice, and trackballs; to cables, power protectors, and more.

*Take a look at two of our 80386 and 80386SX expandable computer kits:*

## **Jameco 25MHz 80386 Computer Kit**

Includes:

- 80386 25MHz Motherboard, 4MB RAM (expandable to 8MB)
- 101-key enhanced keyboard
- Multi I/O Card
- Toshiba 1.44MB, 3.5" DSHD floppy disk drive
- Desktop computer case
- 200 Watt power supply
- DR DOS 5.0 by Digital Research and Diagsoft's QAPlus diagnostic software

**\$1899.95** monitor extra  
**JE3825**

## **Jameco 16MHz 80386SX Computer Kit**

Includes:

- 80386SX 16MHz Motherboard, 2MB RAM (expandable to 8MB)
- 101-key enhanced keyboard
- Multi I/O Card
- Toshiba 1.44MB, 3.5" DSHD floppy disk drive
- Desktop computer case
- 200 Watt power supply
- DR DOS 5.0 by Digital Research and Diagsoft's QAPlus diagnostic software

**\$1199.95** monitor extra  
**JE3816**

Call us for our new 1991 catalog. In it you'll find an extensive offering of quality computer products and electronic components. You have the freedom to order 24 hours a day and if you need assistance, expert technicians are available from 7 am to 4 pm (PST) to help you with all your computing needs. Enjoy the freedom of choice. Call Jameco today at (415) 592-8097.

To place an order, call our  
24-hour order hotline  
**(415) 592-8097.**  
Or FAX us at (415) 592-2503,  
or (415) 595-2664.

**JAMECO**  
COMPUTER PRODUCTS

1355 Shoreway Rd., Belmont, CA 94002  
(415) 592-8097 FAX: (415) 592-2503

Terms: Prices are subject to change without notice. Items subject to availability and prior sale. Complete list of terms/warranties is available upon request.

All trade names are registered trademarks of their respective companies.

© 2/91 Jameco Computer Products



Please  
refer to  
Mail Key 1  
when  
ordering



Circle 114 on Reader Service Card

# 24 Hours a Day.



**JAMECO**

**JAMECO**

**JA**

# WHAT'S NEW

HARDWARE • SYSTEMS

## A Forward-Looking 486-25 Machine

**T**he Dasher/486-25 is an AT compatible with Novell and Unix flexibility in its expansion slots. Running at 25 MHz, the Dasher/486-25 accommodates up to five half-height 5 1/4-inch drives for fault-redundant Novell networking.

The system's 32-bit memory expansion lets you work in such environments as SCO/Xenix, Interactive 386/ix, and DOS. It comes with 4 MB of memory on a 32-bit 25-MHz controller. For more than 16 MB of memory, you add a second memory controller for a total of 32 MB of system RAM. The unit incorporates 8K bytes of cache and a floating-point processor.

In addition to eight expansion slots, the Dasher/486-25 includes a 16-bit VGA con-



*The Dasher/486-25's expandability lets you configure it to meet your computing needs.*

troller card, two RS-232C serial ports, and mouse and printer ports. It supports Windows 3.0.

**Price:** \$7995 and up.  
**Contact:** Data General Corp., 3400 Computer Dr., Westborough, MA 01580, (508) 898-4051.  
**Inquiry 1289.**

## A Laptop of Options

**D**auphin Technology has introduced the 1000 series modular laptop. Weighing from 4 to 7 1/2 pounds, depending on your combination of modules, the 1000 is easily customized.

The laptop's modularity lies in its detachable screen, network-ready architecture, diskless design, and upgradeable CPU. You can configure it at 12 MHz with a 286 chip, at 20 MHz with a 386SX chip, or at 25 MHz with a 386 chip and built-in RAM cache.

**Price:** \$3295 to \$5795.  
**Contact:** Dauphin Technology, Inc., 1125 East St. Charles Rd., Lombard, IL 60148, (708) 627-4004; fax (708) 627-7618.  
**Inquiry 1290.**

## Expansion Is the Game

**T**he Super-386SE from Hyundai is expandable from its clock speed to its

functionality. An 8-MHz unit (switchable to 16 MHz), the system comes with 2 MB of RAM (expandable to 16 MB).

You can mix 256K-byte and 1-MB single in-line memory module chips, which lets you add memory without removing any installed 256K-byte chips. Built-in ROM is 64K bytes (expandable to 128K bytes).

The Super-386SE supports EMS 4.0 and has one 8-bit and four 16-bit expansion slots. It includes one parallel and two serial ports, a system diagnostic floppy disk, a 135-W power supply, and a socket for an 80387SX math coprocessor. Options include 40-MB, 100-MB, and 200-MB hard disk drives.

**Price:** \$1595 to \$3295.  
**Contact:** Hyundai Electronics America, 166 Baypointe Pkwy., San Jose, CA 95134, (408) 473-9200.  
**Inquiry 1291.**

## A Workstation 386SX

**N**ew in the PC market, Cumulus has introduced its GLC/SBS 386SX all-in-one workstation. Running at 16 or 20 MHz, the GLC/SBS is geared toward small and medium-size businesses.

Each model of the GLC/SBS includes a fax/modem, telephone answering system, a 3 1/2-inch floppy disk drive, 1 MB of RAM, a 16-bit VGA graphics adapter and VGA monitor, and a mouse. The top-of-the-line model also has a color monitor and a 3 1/2-inch hard disk drive.

**Price:** \$1395 to \$2095.  
**Contact:** Cumulus Corp., 23500 Mercantile Rd., Cleveland, OH 44122, (216) 464-2211; fax (216) 464-2483.  
**Inquiry 1292.**

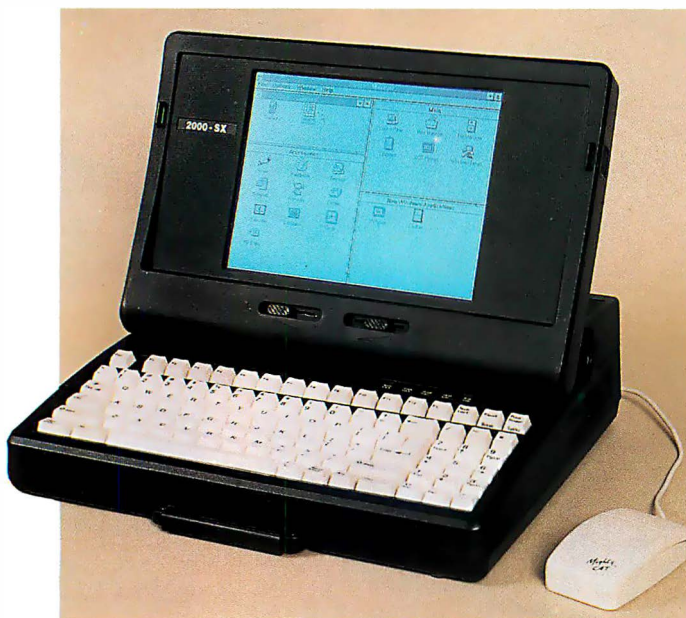

*Modular in design, the Dauphin 1000 offers a customized approach to portable computing.*

## Puma Plus

**A** digitizer with a 16-button cursor option, 100 percent compatibility with AutoCAD, a Windows 3.0 driver, and a mouse emulator is available from Hitachi America. The Puma Plus runs on PCs, the Sparcstation, and the DECstation.

Puma Plus features a 12-by 12-inch tablet with a resolution of 1016 lines per inch that works with a stylus or a 4-, 12-, or 16-button cursor. According to Hitachi, Puma Plus supports more than 250 CAD/CAM/CAE and graphics packages.

You install and operate Puma Plus by placing the color-coded menu on the tablet, pointing to the operating mode you need, and clicking a cursor button. After you configure it, Puma Plus stores all setup parameters in nonvolatile memory.

Puma Plus is available in three models. Each includes a template from Promontory Systems that is compatible with AutoCAD, VersaCAD, CAD-Key, and Windows 3.0. The tablet carries a 10-year warranty; the cursors and stylus have five-year warranties.

**Price:** \$549.

**Contact:** Hitachi America, Ltd., 950 Benicia Ave., Sunnyvale, CA 94086, (408) 773-8833; fax (408) 773-9806.

**Inquiry 1293.**

## Monitors for Different Tastes

Three monitors that address different spheres of compatibility are the MultiVision 795, the M24LMAX, and the Viking 31/72 C24.



*The Puma Plus digitizer gives you a choice of four pointing devices and a wide range of applications.*

**T**axan's MultiVision 795 Trinitron color monitor is the latest in its Trinitron series. The 14-inch auto-scanning monitor is PC or Macintosh compatible. Its 70-Hz refresh rate has a resolution of 1024 by 768 pixels in noninterlaced mode and a 0.26-mm pitch-black Trinitron tube.

Ergonomically designed with all controls up front, the Multi Vision 795 uses an aperture grille screen and a one-gun, three-beam system. It has a tilt-and-swivel base.

**Price:** \$1095.

**Contact:** Taxan Corp., 161 Nortech Pkwy., San Jose, CA 95134, (408) 946-3400.

**Inquiry 1294.**

**T**he M24LMAX 24-inch monochrome/gray-scale monitor from Image Systems works with the Apollo 2500 workstation and other terminals with 1024-by 768-pixel and higher resolutions. You can view two complete facing pages, a full B-size drawing, or multiple applications.

The monitor automatically adjusts to horizontal scanning frequencies of from 48 to 96 kHz and frame rates of from 60 to 80 Hz. It is ergonomically designed, with paper-white phosphor, a tilt-and-swivel base, and front-panel brightness and contrast controls.

**Price:** \$1995.

**Contact:** Image Systems Corp., 11543 K-Tel Dr., Hopkins, MN 55343, (612) 935-1171; fax (612) 935-1386.

**Inquiry 1295.**

**T**he Viking 31/72 C24 is a 20-inch Trinitron color monitor. It has a resolution of 1024 by 768 pixels at 72 dpi, 16.8 million colors, a 75-Hz refresh rate, an antiglare OCLI filter, and a controller for Mac II computers. In addition, it has pan and zoom capabilities and rests on a tilt-and-swivel base.

**Price:** \$7890.

**Contact:** Monitorm Corp., 5740 Green Circle Dr., Minnetonka, MN 55343, (800) 933-5740 or (612) 935-4151; fax (612) 933-5701.

**Inquiry 1296.**

## A Color Printer with Pizzazz

**T**he Kodak Diconix color 4 printer runs at speeds as high as 150 cps in draft mode in DOS and Macintosh versions. It prints color text and graphics at resolutions of up to 192 by 192 dpi.

Able to print on plain paper or ink-jet transparency material, the color printer automatically feeds as many as 60 cut-sheet pages from a built-in tray. It also handles continuous-form tractor-feed paper.

The four print heads use nonsmearing non-water-based inks. Each cartridge holds an ink supply for printing up to 500 pages.

Featuring draft, near-letter-quality, and letter-quality printing modes, the Kodak Diconix color 4 printer has three built-in fonts—Prestige 10 and 12 and Gothic 18. The printer measures 4 by 13 $\frac{1}{10}$  by 20 inches and weighs 13 pounds.

**Price:** \$1495.

**Contact:** Eastman Kodak Co., 901 Elmgrove Rd., Rochester, NY 14653, (800) 344-0006.

**Inquiry 1297.**

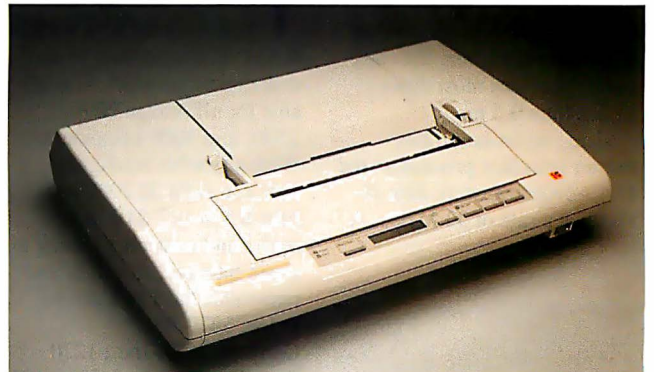

*Kodak's Diconix color 4 printer uses plain paper or ink-jet transparency material.*

## Multimedia at Home

**S**uper VideoWindows, a digital video/audio board for PC and Micro Channel systems, may be the answer to your wish for multimedia capability at home. Enabling you to play full-motion video and stereo audio from a TV camera, VCR, videodisk player, or cable TV in any size window, Super VideoWindows stores individual frames on disk or ports them to other applications.

Super VideoWindows runs under Windows 3.0 or New-Wave 3.0. An optional software developer's toolkit provides a library of C function calls.

**Price:** \$695; developer's toolkit, \$295.

**Contact:** New Media Graphics Corp., 780 Boston Rd., Billerica, MA 01821, (508) 663-0666; fax (508) 663-6678. **Inquiry 1298.**

## A One-Slot Deal

**T**he DTC6290E EISA bus-master disk drive controller from Data Technology fits into a single PC slot. It uses a custom 32-bit RISC microprocessor that supports as many as four 15-Mbps ESDI drives and up to three floppy disk drives. According to the manufacturer, the controller accesses most disks in less than 0.5 ms.

Using its on-board bus-master interface processor, the DTC6290E transfers data directly at a rate of 33 MBps. A

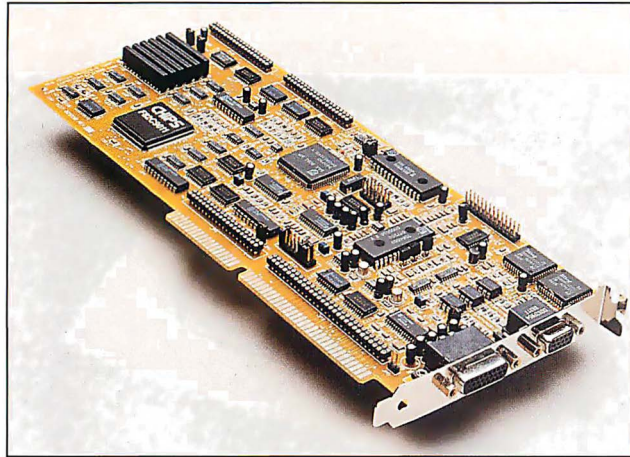

*Super VideoWindows lets you store individual video frames or port them to other applications, such as DTP or CAD/CAM.*

special feature of the board is a proprietary cache memory controller that can handle up to 4 MB of cache memory. The custom circuitry on the board anticipates the most likely area of the disk drive you would access; it then preloads the files in that area into cache memory.

**Price:** ½ MB, \$845; 1 MB, \$895; 2 MB, \$995; 4 MB, \$1195; OEM prices on request.

**Contact:** Data Technology, a division of Qume Corp., 500 Yosemite Dr., Milpitas, CA 95035, (408) 262-7700; fax (408) 942-4052.

**Inquiry 1299.**

## Double-Duty Amiga Card

**T**he AdSCSI 2080, an expansion card with 8 MB of RAM combined with a hard disk drive controller, is available for all Amiga 2000, 2500, and 3000 computers. With a flexible configuration, the AdSCSI 2080 adds Fast RAM in 2-MB increments and controls as many as seven internal, external, and removable hard disk drives.

**Price:** \$279.95. **Contact:** ICD, Inc., 1220 Rock St., Rockford, IL 61101, (815) 968-2228; fax (815) 968-6888.

**Inquiry 1300.**

## VGA Boards by Boca

**A**n entry-level 16-bit VGA board that supports a resolution of 640 by 480 pixels with 16 simultaneous colors has been introduced by Boca Research. The Basic VGA by Boca board also supports EGA, CGA, MDA, and Hercules standards and comes configured with 256K bytes of video RAM.

The Basic VGA by Boca board's 15-pin analog connector attaches to VGA or multiple-frequency monitors. The board includes automatic recognition of monitor type and a diagnostic test program.

The 16-bit Super VGA by Boca board supports a resolution of 1024 by 768 pixels with a display of 256 colors. It uses the Tseng Laboratories single graphics chip and is available with 512K bytes or 1 MB of video RAM.

**Price:** Basic VGA by Boca, \$98; Super VGA by Boca: 512K, \$195; 1 MB, \$245. **Contact:** Boca Research, Inc., 6401 Congress Ave., Boca Raton, FL 33487, (407) 997-6227; fax (407) 997-0918. **Inquiry 1301.**

## Book a Date with a ThinCard

**T**he Databook ThinCard Drive Model TMB-200-03 lets you transfer IC memory cards from your palmtop computer to a desktop DOS system. The drive emulates a floppy disk drive and includes a half-length PC board, a 3½-inch disk-drive-size unit for the memory card, and an interconnect cable. The software supports the Poquet file format and Microsoft Flash file system.

**Price:** \$489.

**Contact:** Databook, 10 Alder Bush, Rochester, NY 14624, (716) 889-4204; fax (716) 889-2593.

**Inquiry 1302.**

## A Bus on a Different Route

**B**usTek's EISA 32-bit Bus Master SCSI host adapter works with Unix, Xenix, NetWare, and OS/2 systems. Called the BT-742A and based on a proprietary Bus Master application-specific IC, the product works at transfer rates of 33 MBps with direct access to more than 4 gigabytes of host-system main memory.

The BT-742A can handle asynchronous and synchronous SCSI data transfers at rates of up to 5 MBps. Its on-board ROM BIOS lets you work as a single user in DOS and Windows and provides more than 1 gigabyte of storage capacity per drive. It incorporates an independent floppy disk drive controller chip for on-board control of one or two 3½- or 5¼-inch floppy disk drives.

**Price:** \$499. **Contact:** BusTek Corp., 2255G Martin Ave., Santa Clara, CA 95050, (408) 492-9090; fax (408) 492-1542. **Inquiry 1303.**



# The DBMS That Opens Windows™

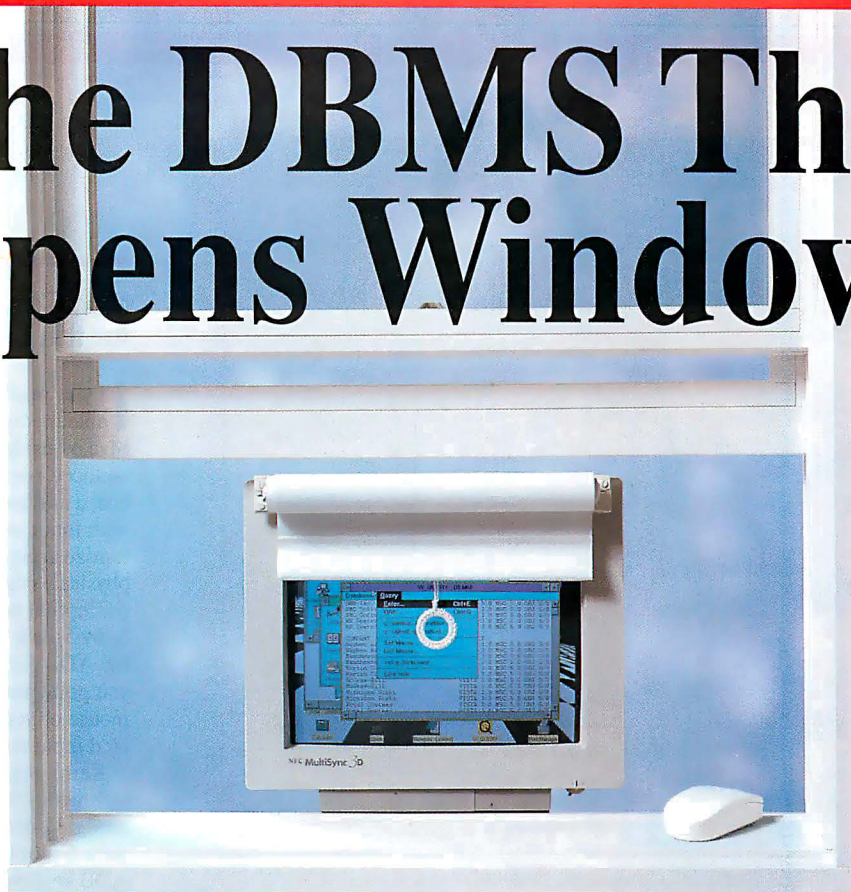

**Get High Performance Under Microsoft Windows 3.0™ With db\_VISTA III DBMS.** Develop Windows applications that are better, faster, and more profitable. db\_VISTA III combines speed, flexibility, and productivity into one DBMS tool for C and Windows programmers. Add db\_VISTA III's high-speed SQL retrieval to your application and watch your users enjoy power they've never experienced before.

**Built For Windows.** db\_VISTA III for Windows 3.0 follows all of the Microsoft

**db\_VISTA III™**  
Database Management System

guidelines for memory use. Dynamic linked libraries (DLL), multi-tasking, and multi-user environments are all supported. For even faster development, use db\_VISTA III with products like ToolBook®, Windowcraft®, or Actor®.

**No Other DBMS Opens Windows Like db\_VISTA III!**

- **Speed.** Benchmarks show db\_VISTA III significantly outperforms any DBMS under Windows.
- **No Royalties.** Increase your profits; decrease your overhead.
- **C Source Code Available.** For total programming flexibility.
- **Portability.** db\_VISTA III supports most environments.

**Special \$195 Developer's Edition**  
For a limited time only, you can get our db\_VISTA database engine for Windows for only \$195. Call today and ask about our Developer's Edition and experience how db\_VISTA III can open Windows for you.  
Developer license only; not for distribution.

**Call 1-800-db-RAIMA (1-800-327-2462)**  
In Washington State call: (206) 747-5570  
Ask for extension 109.

**Full Raima Support Services - Including Training.** Develop your applications even faster with Raima Training Classes:

- Feb. 4-8, 1991 - Switzerland
- Feb. 6-7, 1991 - United Kingdom
- Feb. 25-Mar. 1, 1991 - Boston, MA
- Mar. 6-7, 1991 - United Kingdom
- Mar. 18-22, 1991 - Bellevue, WA

**Specifications:** Single & multi-user. Automatic recovery. Automatic referential integrity. Relational and network data models supported. Relational SQL query and report writer. Complete revision capability. C source code is available. No royalties. **Supports:** MS Windows, MS-DOS, OS/2, VMS, UNIX, BSD, QNX, SunOS, Macintosh.



Raima Corporation 3245 146th Place S.E., Bellevue, WA 98007 USA (206)747-5570 Fax: (206)747-1991 Telex: 6503018237 MCI UW  
International Distributors: Australia: 61 2 419 7177 Austria: 43 022 43 81861 Belgium: 32 02 734 9818 Brazil: 55 11 829 1687 Central America: 506 28 07 64 Denmark: 45 42 887249 Finland: 358 042 051  
France: 33 1 46092784 Italy: 39 045 584711 Japan: 81 03 865 2140 Mexico: 52 83 49 53 00 The Netherlands: 31 2503 26312 Norway: 47 244 8855 Sweden: 46 013 11 1588 Switzerland: 41 064 517475  
Taiwan: 886 02 552 3277 Turkey: 90 1 152 0516 United Kingdom: 44 0992 500919 Uruguay: 598 292 0959 USSR: 01 22 35 99 07; 812 292 7210; 0142 437952 West Germany: 49 07022 34077

Copyright ©1991 Raima Corporation. All rights reserved. db\_ is registered in the U.S. Patent and Trademark Office. Windows 3.0, ToolBook, Windowcraft, and Actor are trademarks of their respective companies.

## Power-Line Tester

By using Tasco's Computer Power Monitor to test the power line supplying your computer, you can avoid damage to your system. The unit monitors line voltage and indicates power-line fluctuations.

The monitor measures true RMS voltage going into your computer. On detecting a power variation, it recommends typical solutions for the indicated problem and checks wiring polarity.

If a power failure occurs, the unit stores prior alarms that were not manually reset for up to 48 hours without power. The solid-state monitor doesn't require batteries or maintenance.

**Price:** \$538.

**Contact:** Tasco, Ltd., 2875 West Oxford Ave., Suite 5, Englewood, CO 80110, (800) 999-9952 or (303) 762-9952; fax (303) 762-1205.

**Inquiry 1304.**

## Three Cubs in the Den

Square D Company has expanded its line of Topaz uninterruptible power supply products. Available in three configurations, the Cub provides as much as 10 minutes of backup power for your PC, Macintosh, file server, or workstation.

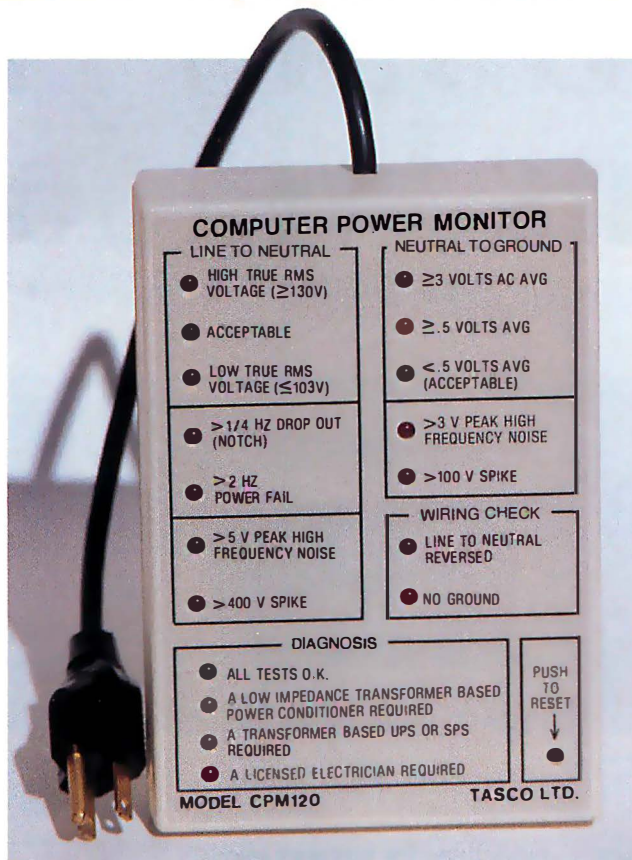
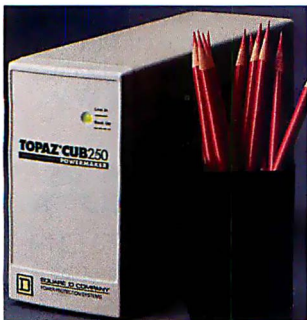

*Tasco's Computer Power Monitor measures power, warns of problems, tests the power line, and offers solutions.*

The Cub 250 is designed to protect 286, 386, and Macintosh systems; the Cub 350 works with high-end workstations and low-end file servers; and the Cub 550 is compatible with LANs, high-end file servers, and multiuser workstations. Each model uses a sealed, maintenance-free internal lead-acid battery, is fully automatic, has an audible and visual alarm, and recharges in 2 to 3 hours.

Other features include surge suppression, noise filtering, and overload protection. The Cubs work with Novell, Banyan, Santa Cruz Operation, Apple, and Xenix networks.

**Price:** Cub 250, \$249; Cub 350, \$349; Cub 550, \$589.

**Contact:** Square D Company, Power Protection Systems, 9192 Topaz Way, San Diego, CA 92123, (800) 344-0570 or (619) 279-0111; fax (619) 549-8427.

**Inquiry 1305.**

## Keep One Eye on the Camera

Proxima Cyclops, an interactive presentation pointer system that acts as a remote-control mouse, consists of a camera and a pointer with an LED. It is used in conjunction with any Proxima Data Display that has the Cyclops connector. An optional laser pointer works at up to 20 feet from the screen.

Cyclops is PC and Macintosh compatible. It attaches to the serial port of your PC; with an optional Mouse Trap, it can share the port with a mouse. Used with a Mac, it operates as a second mouse.

**Price:** \$1195 to \$4795.  
**Contact:** Computer Accessories Corp., 6610 Nancy Ridge Dr., San Diego, CA 92121, (800) 582-2580 or (800) 582-0852 in California; fax (619) 457-9647.

**Inquiry 1306.**

## Mac Connections for the Disabled

If you're physically disabled, you can now access a Mac by using Ke:nx (pronounced *connects*). A keyboard and mouse emulator with input setups that you customize according to your physical, cognitive, or visual-perceptual needs, Ke:nx is a 3- by 5-inch box that plugs into the ADB port. To use Ke:nx, you point and click with a mouse or your own specialized input device.

Ke:nx requires a Macintosh with 1 MB of RAM, a hard disk drive, System software 6.0 or higher, and an ADB keyboard.

**Price:** \$780.

**Contact:** Don Johnston Developmental Equipment, Inc., P.O. Box 639, 1000 North Rand Rd., Building 115, Wauconda, IL 60084, (800) 999-4660 or (708) 526-2682; fax (708) 526-4177.

**Inquiry 1307.**

## Parallel Printing at a Distance

Connect your printer to your parallel port and still position it 200 feet from your computer. With HyperCable, such a setup is not just wishful thinking.

Designed to work with PCs, minis, mainframes, print buffers, printer switch boxes, and LANs, HyperCable installs like an ordinary parallel cable. Using its own patented circuitry, it does not require an external power source, yet runs as fast as 200,000 bps.

**Price:** \$74 to \$249.  
**Contact:** Autotime Corp., 8950 Southwest Burnham, Tigard, OR 97223, (503) 639-2584.

**Inquiry 1308.**





1-2-3 works with either DOS or Windows 3.0. You don't have to change the way you work to work with Release 3.1

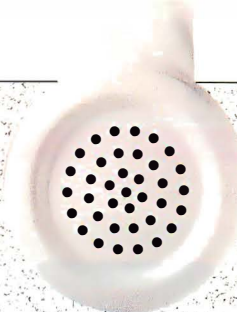

Enter data with a keyboard; manipulate it with a mouse. Release 3.1 lets you work with either, or both.

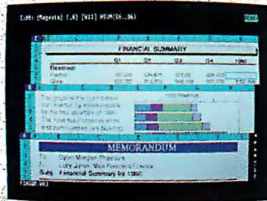

Our unique 3D design is ideal for organizing data and creating multi-page reports.

Lotus is the only software company you can call for support 24 hours a day, 7 days a week.

MATERIAL COLLECTION



Last Year's Performance	
Q4	1989
2,415,407	6,886,910
1,987,897	5,573,029
1,331,601	3,789,665
<b>5,734,905</b>	<b>16,249,604</b>
3,610,029	12,880,958

You can add words, freehand drawing and symbols to make your graphs more persuasive.

Eight combinations of typefaces let you create anything from 2 1/2" tall headlines to tiny footnotes.

Align titles or text—left, right or center—with one simple command.

Only Release 3.1 lets you automatically wrap text around a graph.

WeCycle Waste Corporation  
1990 Recycling Summary

Last year was a good year for the company. WeCycle was profitable and came very close to achieving our goals in a very uncertain economic and recycling climate.

Revenue by Product

Material collections increased over the year. Plastic's continued to bring in the most revenue and profit for the company. Prices for aluminum are still very soft and while we're continuing to collect more glass, markets for the raw material are still in their infancy.

Revenue	Q1	Q2	Q3	Q4	1990
Plastics	1,899,785	1,932,024	2,378,307	2,836,983	9,047,100
Glass	1,700,524	1,652,125	1,869,430	2,800,504	8,032,753
Aluminum	1,146,804	1,182,022	1,448,421	1,811,793	5,420,000
<b>Total</b>	<b>\$4,796,113</b>	<b>\$5,026,180</b>	<b>\$6,737,248</b>	<b>\$7,039,400</b>	<b>\$22,541,028</b>

The graph at the right details our revenue by waste material for the four quarters of 1990. The revenue managers show that communities are building their recycling programs beyond just collecting plastics. Revenue on aluminum and glass have increased as their programs have gained volume. But, we're still seeing price pressure as the supply of recyclable materials continues to exceed the demand. We need to look for ways to expand our markets and increase the use of recycled materials.

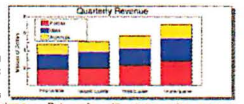

Collections by District

	1990
<b>Plastics</b>	<b>6,403,659</b>
City Center	6,403,659
South Shore	5,175,450
Western Towns	3,523,344
<b>Total</b>	<b>15,102,623</b>
<b>Glass</b>	<b>5,538,612</b>
City Center	5,538,612
South Shore	5,247,930
Western Towns	2,899,356
<b>Total</b>	<b>13,686,097</b>
<b>Aluminum</b>	<b>4,555,539</b>
City Center	4,555,539
South Shore	3,341,280
Western Towns	2,277,341
<b>Total</b>	<b>10,174,159</b>

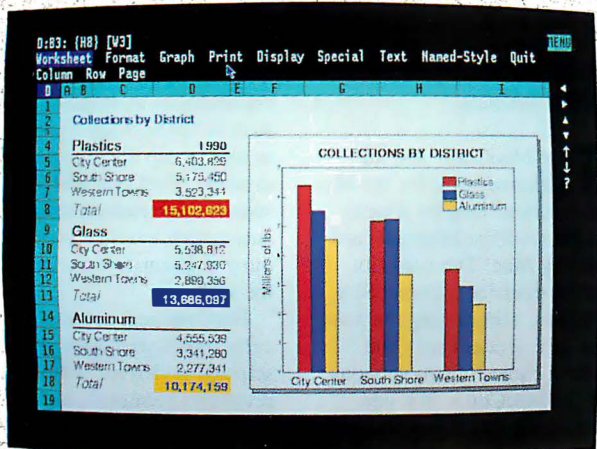
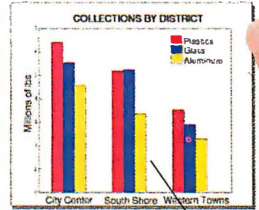

A graphical WYSIWYG (what-you-see-is-what-you-get) environment shows you exactly what your output will look like. It's easier to work with, and there's no guesswork.

Mix bold, italics, underlines, colors and typefaces to create over 100 text-style combinations—even display more than one more than any other spreadsheet.

You can choose from over 200 graph style combinations—graph per page.

# Since 1983, 7 out of 10 spreadsheet buyers have chosen 1-2-3.\* Now we're going after the other 3.

Over 10 million business people are more productive and more insightful because of Lotus 1-2-3. Now Lotus introduces 1-2-3 Release 3.1. And if you're currently using 1-2-3, you'll find it offers the features you've been wishing for. Like the ability to see, on screen, exactly what your printed output will look like. Our unique 3D approach to organizing and consolidating spreadsheet data. And the most profes-

sional and persuasive printed reports you've ever created on your computer. Or if you're one of the holdouts not using 1-2-3, you'll find it offers an interactive, graphical environment. Plus it works with Windows 3.0. And supports both a keyboard and a mouse.

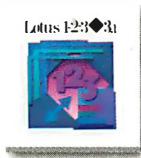

We've prepared a free demo disk to show you what 1-2-3 can do for you. **First time buyers should visit their local Lotus Reseller. Or to request a Release 3.1 Auto Demo, call 1-800-TRADEUP, ext. 673.** And see why 7 out of 10 spreadsheet buyers chose 1-2-3. And the other 3 may not be far behind.

## Introducing Lotus 1-2-3 3.1

\* Copyright 1990 Lotus Development Corporation. Lotus and 1-2-3 are registered trademarks of Lotus Development Corporation. Windows is a trademark of Microsoft Corporation. \*As reported by Audits & Surveys, Inc., measuring IBM-Compatible spreadsheet sales among computer and software dealers nationwide.

## Drive Across Your System . . .

**C**orelDriver, an interface based on a RAM-resident device driver, comes as a kit designed to provide compatibility between optical disk drives and DOS, OS/2, Macintosh, or NetWare systems. Said by its manufacturer to be compatible with most WORM (write once, read many times) and erasable optical disk drives on the market, CorelDriver supports the ISO erasable optical cartridge format. This lets users of ISO-compatible drives exchange cartridges across their operating systems.

Running with EMS memory installed, CorelDriver can use as little as 3K bytes of RAM. Without EMS memory, the driver will use up to 50K bytes of RAM.

All kits include the software device driver; utilities, including diagnostics and formatting; and cabling. DOS, OS/2, and NetWare kits also include a SCSI connection.

**Price:** \$495 to \$1795.  
**Contact:** Corel Systems Corp., 1600 Carling Ave., Ottawa, Ontario, Canada K1Z 8R7, (613) 728-8200; fax (613) 728-9790.  
**Inquiry 1309.**

## . . . or Talk Across It

**C**rosstalk Communicator, asynchronous communications software for the PC, is a terminal emulator designed for easy installation and use. Accessing dial-up information services is as easy as dialing the telephone, according to the company. Its interface is based on Crosstalk Mk.4 and Remote2.

During installation of Crosstalk Communicator, the program queries your PC to



*The CorelDriver interface kit is fully compatible with most optical drives.*

determine the number of serial ports available. It then asks which port your modem is connected to, after which it gives you a list of modem types from which you select the kind you are using.

To access a system or service, you supply information such as your telephone number, account number, and password. Crosstalk Communicator retains this information, letting you subsequently access the system with one keystroke.

You use the program's point-and-shoot dialing directory to access information systems and BBSes. File transfer protocols include XMODEM, YMODEM, ZMODEM, Kermit, and CompuServe B+.

**Price:** \$99.  
**Contact:** Digital Communications Associates, Inc., 1000 Alderman Dr., Alpharetta, GA 30202, (404) 442-3210.  
**Inquiry 1310.**

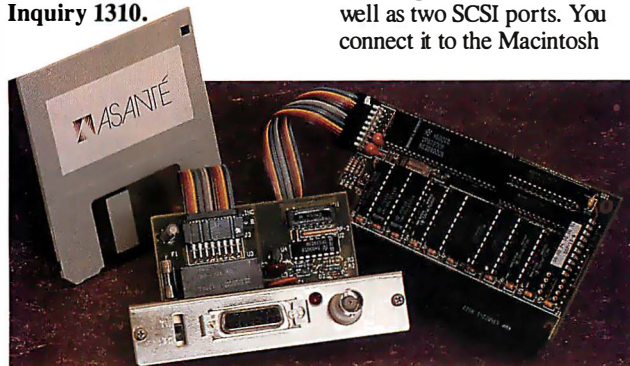

*Asanté's MacCon + 30i Ethernet card is small but reliable and easy to install.*

## Asanté Supports New Macs

**T**he MacCon + 30i, an Ethernet card for the Mac II series, is described by Asanté as the smallest Ethernet card for any Mac. The card fits in the machine's Direct Slot 030 bus, eliminating the need for an extender card. You have a choice of two versions of the MacCon + 30i: one with thick and thin ports, the other with thick and twisted-pair ports. The MacCon + 30i is register-level compatible with Apple's EtherTalk card and uses a 32-bit data bus. An optional 64K-byte buffer is available.

The EN/SC external SCSI box provides Ethernet support for the Macintosh Classic. Its standard configuration includes thick, thin, and twisted-pair connections, as well as two SCSI ports. You connect it to the Macintosh

Classic's SCSI port.  
**Price:** MacCon + 30i, \$495; 64K-byte buffer, \$50; EN/SC, \$595.  
**Contact:** Asanté Technologies, Inc., 405 Tasman Dr., Sunnyvale, CA 94089, (408) 734-4844; fax (408) 734-4864.  
**Inquiry 1311.**

## Automated Group Editing

**Y**ou can now use ForComment Document Review Groupware on VAX/VMS computers and on PCs connected to a Novell LAN. Access Technology's solution to workgroup documentation disarray, ForComment speeds up document review by automating inherent procedures previously managed by the author.

ForComment automatically routes your document to selected reviewers. After the reviewers comment on-line, ForComment collates the comments and enters them into the document, letting everyone with access immediately see what other reviewers have said. The program maintains a record of the development of the document for an audit trail of the decisions that led to the finished product.

In addition to working with such applications as WordPerfect, Microsoft Word, and WPS-Plus, ForComment is compatible with leading E-mail systems, according to the manufacturer.  
**Price:** VAX/VMS and All-in-1 versions, \$375 to \$9900; basic PC LAN version for 10 users, \$1295 (\$100 for each user above that).  
**Contact:** Access Technology, Inc., 2 Natick Executive Park, Natick, MA 01760, (508) 655-9191; fax (508) 651-3788.  
**Inquiry 1312.**

# "My Dolch 486™ is awesome. . ."

"Hey, I now own the *perfect portable* that lets me get my work done anywhere. Not just a few files . . . everything I had on my desktop!"

"Powerful? You bet! After I downloaded all my desktop stuff, on it's *200 MB HD*, I still had plenty of room left and it screamed through everything at *11 MIPS!*"

"My Dolch P.A.C. is setting new 'rules'. It's portable, fast and I still can add *4 full-size internal expansion cards*. Wow!"

"You have to see the brilliant display — I mean really see it. *TFT* is the *latest color technology*, that's fully VGA compatible."

"Hey! Don't take my word for it. Experts like PC Magazine judged my Dolch P.A.C. to: . . . *outclass all other portables*' and picked Dolch three years in a row as Editors' Choice!"



"Get a Dolch today, choose a 286™, 386SX™, 386DX™ or a 486™ like mine. . . *clearly the best PC you can buy today, and it happens to have a handle*. Get a lot more work done — where and when you want."

**Why Wait? . . . Call today.**  
(800)538-7506 US; (800) 233-2077 CA  
In Canada call Laptech 1-800-561-4527

## Dolch.

ROAD-POWER FOR THE BEST OF US

Dolch Computer Systems 372 Turquoise Street • Milpitas, CA 95035 • Tel: 408-957-6575 • Fax: 408-263-6305

™ 286, 386SX, 386DX, and 486 are registered trademarks of Intel Corporation

Circle 76 on Reader Service Card

# The Joneses.



Check out the benchmarks. When it comes to speed, pure and simple, mainframes are no longer the main attraction.

Introducing the Everex STEP 486/33 and STEP 486/25. Along with the STEP 486is, they give you desktop performance that was previously unheard of.

There are two reasons. The first, of course, is the 486™ chip. The other is AMMA™, Everex's proprietary Advanced Memory Management Architecture.

STEP486/33	34,000 Dhrystones (19.4 MIPS)
CRAY-X-MP/48	17,857 Dhrystones
IBM 3083	16,666 Dhrystones

AMMA uses "write-back" cache technology instead of the "write-through" technologies used in most PC's. The write-back cache was developed for mainframes. Everex was the pioneer in developing it for the PC. And in doing so, opened a whole new dimension in desktop performance.

With AMMA, you can write directly to the STEP 486's cache in nearly all cases. With write-through techniques, on the other hand, you lose most of the performance benefit of the cache.

# And how to keep up with them.

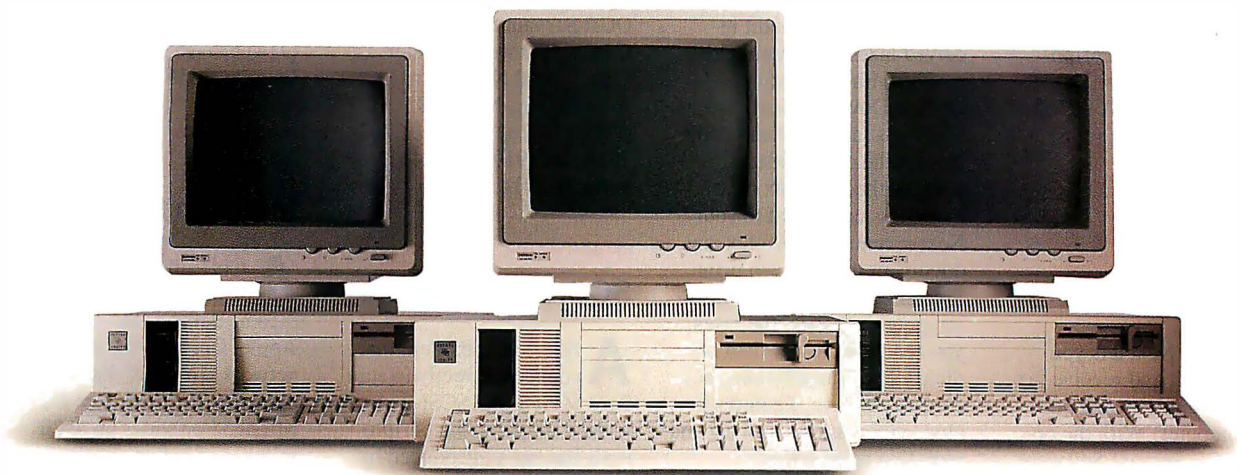

That's because write-through forces you to write to main memory much more often. And main memory is slower than the cache.

This is especially important in 486 computing, where the CPU performs as many as four times the write operations as in 386. Which makes AMMA's write-back architecture, combined with the 486's embedded cache, a powerful combination indeed.

But the STEP 486 machines give you more than just speed. They come with Programmable Drive Select. If your drive isn't listed on the set-

up table, PDS™ lets you custom-configure the BIOS. It's good for virtually any hard drive.

What's more, all STEP systems come with a one-year extendable warranty and a one year renewable on-site service contract that also covers all Everex peripherals in the system.

To find out more, call 1-800-368-STEP\* for the name of your nearest Authorized Everex Reseller—every one a high performance expert

Then you can let the Joneses try keeping up for a change.



## A Miniature Modem

Available for PC or Macintosh use, the Practical Peripherals Pocket Modem operates at 2400 bps in a credit-card-size box. It is compatible with the Hayes 2400 Smartmodem and includes an automatic answer mode and pulse or Touch-Tone dialing.

The PC version, which doesn't require batteries or a power supply, plugs into your PC's serial port. It weighs 4 ounces and measures 2¼ by 3 by ¾ inches.

The Macintosh version requires a 9-V battery adapter. It includes cables and a communications software package.

**Price:** PC version, \$159; Mac version, \$199.

**Contact:** Practical Peripherals, 31245 La Baya Dr., Westlake Village, CA 91362, (818) 706-0333; fax (818) 706-2474.

**Inquiry 1313.**

## Next, DoveFax

DoveFax Next lets you transmit and receive fax text and graphics using your Next computer. With the optional OCR Servant Software



*The credit-card-size, 2400-bps Practical Peripherals Pocket Modem accepts pulse or Touch-Tone dialing.*

from HSD Microcomputer U.S., you can also edit received faxes on-screen. Compatible with all Next machines, DoveFax Next runs at 9600-bps fax speed and 2400 bps for the data modem.

Once the DoveFax Next modem is connected to your Next system, you can fax any document that you can print. Since PostScript is used in imaging the pages, the faxes you send are clearer than ordinary fax transmissions, according to Dove. Features include automatic answering and redialing capabilities.

**Price:** Basic unit, \$499; with OCR Servant Software, \$899.

**Contact:** Dove Computer Corp., 1200 North 23rd St., Wilmington, NC 28405, (800) 622-7627 or (919) 763-7918; fax (919) 251-9441.

**Inquiry 1314.**

## SCSI Bus Extender

A fiber-optic modem that connects directly to standard SCSI-1 and SCSI-2 interface adapters and peripherals has been introduced by Applied Concepts. The Lazer Link II SCSI Bus Extender lets you increase the working distance of your SCSI bus interface from the present maximum of 19 feet to 3000 feet. It supports 5-Mbps data transfer rates in asynchronous and synchronous modes.

**Price:** \$950.

**Contact:** Applied Concepts, Inc., 5350-H Eastgate Mall, San Diego, CA 92121, (619) 453-0090; fax (619) 453-6715.

**Inquiry 1315.**



*The Lazer Link II lets you place your SCSI-linked peripherals up to 3000 feet from your controller.*

## A Plug-in Line Sharer

The Easy-Connect Line Sharer from VSI lets you connect a fax, a phone, and answering machine to an ordinary phone line without any rewiring. An electronic circuit detects when other phones on the same line go off-hook and responds to their remote Touch-Tone or dial commands. A microprocessor controller provides such features as voice alert, hold, line request, and international ring count.

**Price:** \$159.95.

**Contact:** VSI Telecommunications, Inc., 9329 Douglas Dr., Riverside, CA 92503, (800) 999-8232 or (714) 687-2492; fax (800) 444-8232 or (714) 687-2513.

**Inquiry 1316.**

## A Small but Mighty UPS

An off-line power system compatible with Novell, 3Com, Banyan, SCO Xenix, Apple, Convergent, and Prime networks has been introduced by Upsonic. The PC Might 35 provides up to 20 minutes of battery backup power during a power surge, spike, line noise, or blackout.

With a rating of 350 V, the PC Might 35 has a maintenance-free battery, overcurrent protector, overload and short-circuit protector, and line filtering. It weighs 13¾ pounds and measures 5¼ by 3¾ by 12 inches.

**Price:** \$275.

**Contact:** Upsonic, 1 Park Plaza, Suite 600, Irvine, CA 92714, (800) 877-6642 or (714) 833-7161; fax (714) 833-7164.

**Inquiry 1317.**

# IDEK

## IDEK — THE FIRST COMPLETE FAMILY OF FST COLOR MONITORS

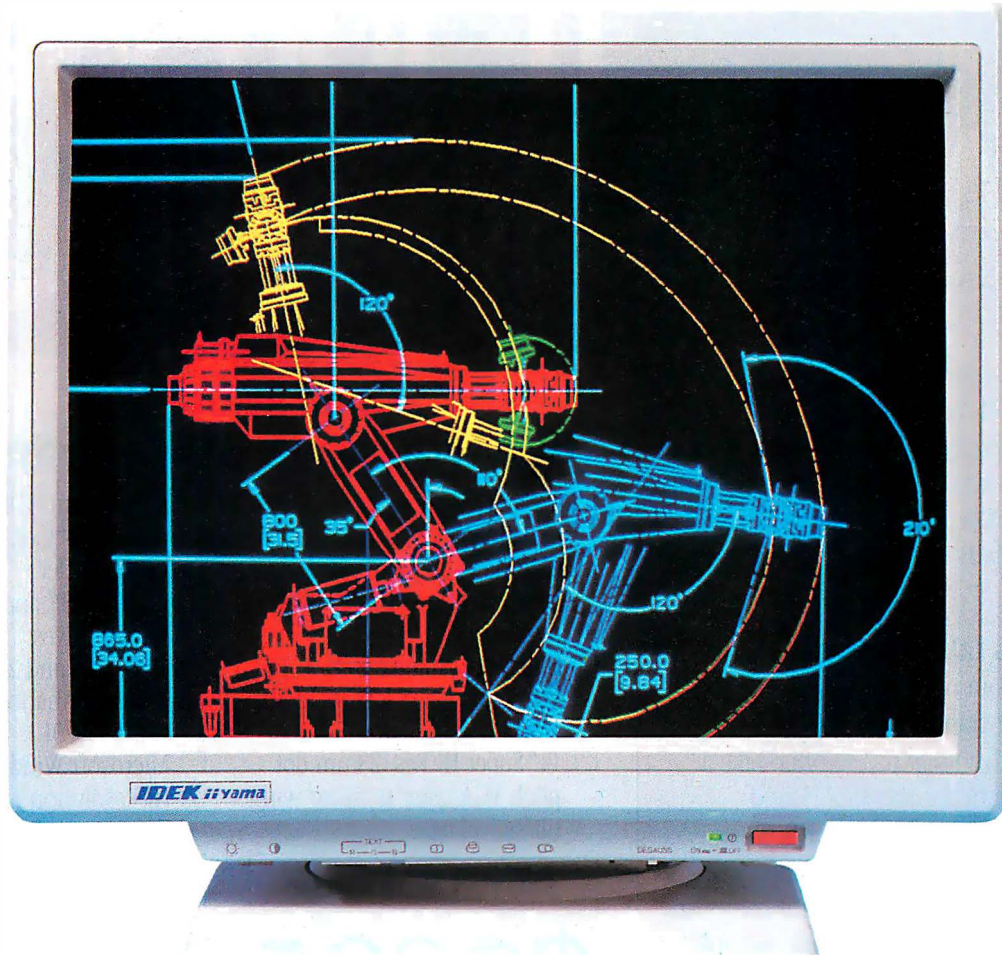

### IDEK's MULTIFLAT Series of 21-Inch Color Monitors

IDEK's MULTIFLAT Series of 21-inch Color Monitors take full advantage of the remarkable properties of their Flat Square Tubes (FST) to deliver superior resolution and a sharper image that is easier on your eyes. A glimpse at our 21" Color Monitors reveals their matchless over-scanning capability that delivers a crisp, distortion-free display across the entire screen.

In addition, Automatic Frequency Scanning realizes outstanding performance for business graphics, CAD/CAM applications as well as desk top publishing on your Mac or IBM compatible system.

As you can see below, whether your requirements are simple or complex, IDEK has the Flat Screen Color Monitor that's just right for you. And priced right, too! See for yourself what a difference a Flat Screen Monitor from IDEK can make.

#### MULTIFLAT Series (21" Flat CRT Monitors)

Model	H. Frequency	Dot	Resolution
MF-5021	15 to 38kHz	0.31	1024 × 768
MF-5121	21 to 50kHz	0.31	1024 × 768
MF-5221	30 to 80kHz	0.31	1280 × 1280
MF-5321 (A.R.Panel)	30 to 80kHz	0.31	1280 × 1280
MF-5421 (A.R.Panel)	30 to 80kHz	0.26	1600 × 1280

IDEK also offers its new Model MF-5117 17" Flat Screen Color Monitor that delivers the same superior resolution and performance as the other members of the IDEK lineup.



# IDEK iiyama

#### IIYAMA ELECTRIC CO., LTD.

##### Overseas Division

7th Fl., US Hanzomon Bldg., 2-13, Hayabusa-cho, Chiyoda-ku  
Tokyo 102, Japan

Phone: (81) 03-3265-6081 Fax: (81) 03-3265-6083

##### IDEK Europe (Germany)

Neumannstrasse 38, 6000 Frankfurt a.M. 50, West Germany  
Phone: (49) 69-521 922 Fax: (49) 69-521 927

##### IDEK North America Inc

650 Louis Drive, Suite 120, Warminster, PA 18974 U.S.A.  
Phone: (1) 215-957-6543 Fax: (1) 215-957-6551

# If You Want In A 386 System, Do

Selecting a new computer system can be a real challenge. That's where we come in. We have the knowledge, experience and the best value packed computer systems available. So, pick up the phone and check us out. Ask us about our quality. Our service. And especially our prices. You'll like what you hear.

## Let's Talk Features.

Then ask us about our new 386/25 and 386/33 systems. The list of standard features includes the latest that high technology has to offer. Like a 128 KB memory cache for the 386/25 and the 386/33, both expandable to 256 KB. Then there's the integrated VGA controller supporting 1024 x 768 resolution, with 256 vibrant colors and a 50% performance increase all made possible by 1 MB of 32-bit video memory. Plus support for interlaced and non-interlaced monitors. When it comes to features, we set the standard.

## How About Flexibility?

No one can beat our flexibility either. An integrated floppy controller and hard disk interface that support up to three floppy drives and two hard drives. Up to 16 MB of RAM on board using the new industry standard 32-bit memory modules leave all six expansion slots available.

All of these fully-loaded systems include:

- 2MB of 32-bit high speed memory (Expandable to 8MB on-board)
- High performance 1024 x 768 VGA with 256 colors including 1MB of 32-bit video memory
- 14" Super Hi-Res .28mm dot pitch VGA color monitor with tilt/swivel base

- 40MB IDE Hard Disk Drive
- 1.2MB 5.25" & 1.44MB 3.5" floppy drives
- 1 parallel and 2 serial ports
- 101-key enhanced keyboard
- MS DOS 4.01
- Microsoft Windows 3.0 & Hi-Res mouse
- Free one year on-site service

**386▼SX-16 Only \$1795.00 386▼SX-20 Only \$1895.00**

Shown with optional tape drive. 386 is a trademark of Intel Corporation.

## Compare Our New High Performance 386 Cache Systems.

- |   |   |
|---|---|
| <input type="checkbox"/> 128K cache memory expandable to 256K   | <input type="checkbox"/> 100MB 17ms IDE hard drive with 64K "look-ahead" cache buffer |
| <input type="checkbox"/> 4MB of 32-bit high speed memory (Expandable to 16MB on-board)                        | <input type="checkbox"/> 1.2MB 5.25" and 1.44MB 3.5" floppy drives                    |
| <input type="checkbox"/> High performance 1024 x 768 VGA with 256 colors including 1MB of 32-bit video memory | <input type="checkbox"/> 1 parallel and 2 serial ports                                |
| <input type="checkbox"/> 14" Super Hi-Res .28mm dot pitch VGA color monitor with tilt/swivel base             | <input type="checkbox"/> 101-key enhanced keyboard                                    |
|   | <input type="checkbox"/> MS DOS 4.01  |
|   | <input type="checkbox"/> Microsoft Windows 3.0  |
|   | <input type="checkbox"/> Hi-Resolution mouse  |
|   | Free one year on-site service   |

**386▼33 With Cache**

**\$2895**

**386▼25 With Cache**

**\$2595**

Our small footprint chassis includes both 5.25" and 3.5" floppy drives and 1 parallel and 2 serial ports. And consider this feature, our new 386/25 and 386/33 systems come standard with 5 drive bays to hold up to one additional floppy drive or tape backup and 2 hard drives.

So, we can help you add on and update to your heart's content.

## We're Made In The U.S.A.

Since 1984 our R&D center has been designing our products, and all system boards are manufactured right here in the U.S. The latest surface mount and VLSI technology is utilized for the ultimate in product reliability and space saving design. If it's performance and quality you seek, we're the standard to beat.



# The Best Value The Standard Thing



We provide you with a complete system. Ready to use the minute you open the carton. Everything is loaded,

## 800/662-6111



tested, burned in, and ready to go. And, to help you easily handle the new multi-tasking, multi-screen programs, we preload MS DOS 4.01 and Microsoft Windows 3.0, and then throw in a high resolution mouse to boot. How's that for commitment!

### We Stand Behind Our Systems And Our Customers.

At Standard Computer, we manufacture everything from high performance 486™ and 386™ systems to low cost 386/SX and 286 systems. And our total customer satisfaction program begins with a 30 day money-back guarantee. If you're dissatisfied, simply return your system within 30 days for a full refund. No questions asked.

You're also covered by our complete one-year parts and labor warranty. And when you have a question, just call our customer service hotline. It's available to you toll-free for as long as you own your system. If you need help, we'll see that you get it. If you need a part, we'll express ship it.

We'll even include one year of on-site service at no extra charge.

### Value That's Easy To Afford.

We make it easy to own and use our products. Our Standard purchasing programs are designed to fit your needs. Qualified company purchase orders, personal checks and most major credit cards are accepted.

So, go ahead. Call us. Right now. Find out why we take so much pride in our exceptional products and services.

Why our repeat customer rate is one of the highest in our industry. And why our product reliability is so good. For us, it's just the Standard thing.

# STANDARD

C O M P U T E R

12803 Schabarum Avenue, Irwindale, CA 91706,  
phone: 818/337-7711, FAX 818/337-2626.

## C++ and C on Unix

Saber's dual C++ and C language development system is designed for programmers looking to make an incremental transition to object programming. Saber-C++ supports both languages in one integrated environment. It includes a C++ interpreter for prototyping and run-time error checking, plus class, cross-reference, and data browsers.

An interactive workspace lets you enter C++ and C code, evaluating and testing functions as you code them. Saber-C++ works with standard Unix programming tools such as make, vi, and emacs, letting you develop C++ programs without leaving the Saber-C++ environment.

Saber-C++ runs on Sun, DEC, and Hewlett-Packard Unix workstations.

**Price:** \$3995.

**Contact:** Saber Software, Inc., 185 Alewife Brook Pkwy., Cambridge, MA 02138, (617) 876-7636; fax (617) 547-9011.

**Inquiry 1271.**

## Four Tools from WallSoft

WallSoft Systems, known for its line of automated development tools, has new products for C, dBASE, Clipper, and BASIC programmers.

The company has updated its UI2 Developer's Release and UI2 Touch & Go template-driven application generator. The program can now generate code that's optimized for Clipper 5.0, including

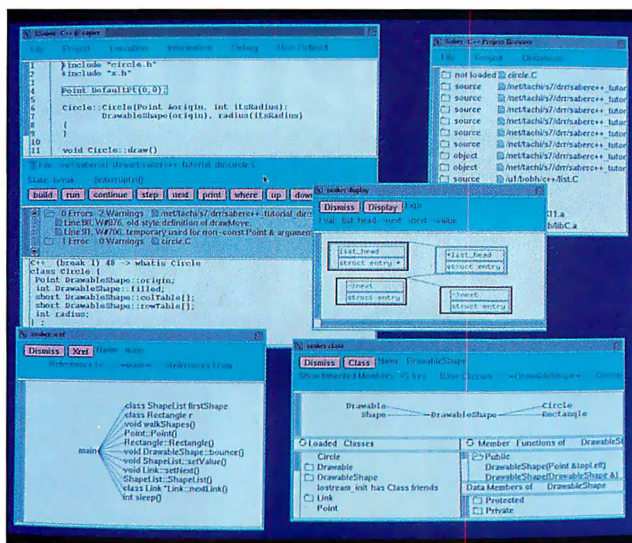

*Saber's C++ environment lets you use standard Unix tools for development in one integrated environment. The Source Panel at top right provides interactive debugging of C++ and C code.*

arrays, code blocks, nested GETs, and static and local variables. UI2 supports dBASE IV 1.1 and the windowing and mouse capabilities of FoxPro.

UI2 for C lets you build scrolling browse boxes, reports, memo fields, relational data handling, scrolling lookup windows, and other features into your C application without writing any code, the company says. UI2 for C is bundled with AIIIC, Village Software's C template system. By turning on UI2's multiuser switch, AIIIC generates multiuser code automatically. UI2 for C runs on DOS-based platforms. It also includes Sequiter's CodeBase

4.2, a multiuser C library, for handling dBASE data and index files.

With BasicAge (developed by Omicron for WallSoft), you can generate Microsoft BASIC 7.0 and 7.1 code for pull-down menus, stackable windows, reports, and other functions.

Version 1.5 of the Documentor, which makes sense of dBASE code, produces output detailing system structure and logic flow. It supports all the commands and functions found in dBASE IV and FoxPro.

**Price:** UI2 for C, \$695; BasicAge, \$595; UI2 Developer's Edition, \$595; Documentor, \$295. If you already

have UI2, two C templates are \$299.

**Contact:** WallSoft Systems, 233 Broadway, Suite 869, New York, NY 10279, (800) 233-3569 or (212) 406-7026; fax (212) 693-0979.

**Inquiry 1272.**

## C++ for Unix/386

Computer Innovations' C++ for Unix System V-based 386/486 systems contains both Super-C and object features of the C++ language. Super-C extensions include default function arguments, in-line methods and functions, type-safe linkage, and call by reference or value, the company reports.

Object features of C++ include class/method organization, overloaded operators, inheritance, polymorphism, constructors and destructors, and virtual functions. It also has standard C++ class libraries for streams and complex arithmetic. The program works with the company's Debug-2000 full-screen, multiwindow, source-level debugger.

**Price:** \$495.

**Contact:** Computer Innovations, Inc., 980 Shrewsbury Ave., Tinton Falls, NJ 07724, (201) 542-5920.

**Inquiry 1273.**

## Smalltalk for Windows

Digital's new Windows version of its Smalltalk/V programming language combines a prototype-to-delivery development style while integrating with the host Windows 3.0 environment. The environment simplifies the complex maze of subsystems in graphical environments such as the Macintosh, OS/2 Presentation Manager, and Win-

dows, Digital says. You can use browsers, inspectors, and push-button debuggers to navigate Smalltalk/V code and the Windows environment. The interface to Dynamic Data Exchange lets you share information between Smalltalk/V and other programs, while dynamic link libraries provide a way to call applications outside Smalltalk/V. The

Smalltalk/V Windows source code is compatible with the Smalltalk/V PM environment, allowing you to choose either system as a development platform and deliver applications for both.

**Price:** \$499.95.

**Contact:** Digital, Inc., 9841 Airport Blvd., Los Angeles, CA 90045, (213) 645-1082; fax (213) 645-1306.

**Inquiry 1274.**



UNIX WORLD  
TOP • 10  
PRODUCT  
OF THE YEAR  
1 • 9 • 8 • 9



# INSTANT WORKSTATION. JUST ADD OPEN DESKTOP.

Take a look at the vast majority of graphical workstations developed over the past decade and you'll see something they all have in common:

An integrated UNIX® System environment.

Now take a look at the vast majority of businesses that have put computing power directly onto their office desktops over the past decade, and you'll see something they all have in common: Industry-standard personal computers.

It doesn't take a computer to forecast the platform that's going to put graphical workstations on the vast majority of business and engineering desktops in the next decade:

An integrated UNIX System environment for industry-standard personal computers.

And that's what Open Desktop™ is all about.

Open Desktop is the complete graphical operating system that's built on the most popular UNIX System platform of all time—SCO™. And it lets you create your own networked, icon-driven workstation environment using the industry-standard 386 or 486 computers and peripherals of your choice.

In a single, easy-to-use, fully supported—and completely integrated—package, Open Desktop delivers:

- the full 32-bit, multitasking computing power of SCO UNIX System V/386
- compliance with POSIX™ and X/Open® standards
- an OSF/Motif™-based, Presentation Manager-compatible, graphical user interface
- distributed SQL database management services
- compatibility with existing DOS, XENIX®, and UNIX System applications and data files
- NFS™, TCP/IP, and LAN Manager networking facilities

And all at an unbelievably affordable price.

Discover the complete graphical operating system that leading companies worldwide are choosing as their development platform for the '90s—and using to turn their 386 and 486 PCs into instant workstations today.

Open Desktop from SCO.



SEE US AT  
UNIFORM,  
BOOTH # 1005!



For more information, call SCO today and ask for ext. 8400

(800) SCO-UNIX (726-8649) (408) 425-7222 FAX: (408) 458-4227 E-MAIL: . . !unet!scolinfo info@sco.COM

SCO, the SCO logo, Open Desktop, and the Open Desktop logo are trademarks of The Santa Cruz Operation, Inc. UNIX is a registered trademark of AT&T in the USA and other countries. POSIX is a trademark of The Institute of Electrical and Electronics Engineers (IEEE). X/Open is a registered trademark of Open Company Ltd. OSF/Motif is a trademark of The Open Software Foundation, Inc. XEMX is a registered trademark of Microsoft Corporation. NFS is a trademark of Sun Microsystems, Inc. ©1989 The Santa Cruz Operation, Inc. All Rights Reserved. The Santa Cruz Operation, Inc., 400 Encinal Street, P.O. Box 9900, Santa Cruz, California 95061 USA The Santa Cruz Operation, Ltd., Crowley Centre, Hatfield Lane, Watford WD1 8YN, Great Britain, +44 (0)924 86444, FAX: +44 (0)924 81781, TELEEX: 91732.SCOH.0N.G

Circle 203 on Reader Service Card

# Now you can afford to



# show your true colors.



No longer does your world have to be black and white.

With millions of different color shades produced by high-quality inkjet technology, the HP PaintJet printer family makes it easy for you to look brilliant.

Better yet, it doesn't take much green to get this kind of color. Only \$1,395\* for the PaintJet. Or for even faster printing, larger formats, and more font capabilities, only \$2,495\* for the PaintJet XL.

Of course, HP PaintJets are DOS and Macintosh compatible. Work with all your favorite graphics software. And print on transparencies as well as paper.



So call **1-800-752-0900, Ext. 1632** for your nearest authorized HP dealer. And get a firsthand demonstration of what the PaintJet family can do for your business communications.

You'll be surprised how high you can fly with color.

 **HEWLETT  
PACKARD**

## Drive Your Business by the Dashboard

In the business world, you need up-to-the-minute reports. However, with so many incompatible systems and programs, getting this instant information can be difficult. Channel Computing's Windows and NewWave versions of its executive information system *Forest & Trees* lets you monitor the vital signs of your business or departments. *Forest & Trees*, also available in a DOS version, resides on an IBM PC and collects data from spreadsheets, local and LAN databases, minicomputers, and mainframes, combining data into useful information, the company says. The program presents information and monitors vital signs as frequently as you wish—minute by minute, hourly, quarterly, or longer—and provides an electronic dashboard that visually alerts you when a defined condition is met.

*Forest & Trees* presents 12 main views, each of which can have more information underneath. You can build database queries in Structured Query Language commands and display information in graphs, reports, or a history of past query results.

The standard version includes interfaces to dBASE, R:base, Lotus 1-2-3, Excel, Paradox, and DataEase. Optional interfaces for SQL Server and SQLBase, Oracle, DB2, and ASCII flat files are also available. It runs over Novell, 3Com, Banyan Vines, and other LANs.

**Price:** Windows versions, \$495; NewWave version, \$595; SQL Server and SQLBase interfaces, \$1250 each; Oracle and IBM AS/400 interfaces, \$2995.

**Contact:** Channel Comput-

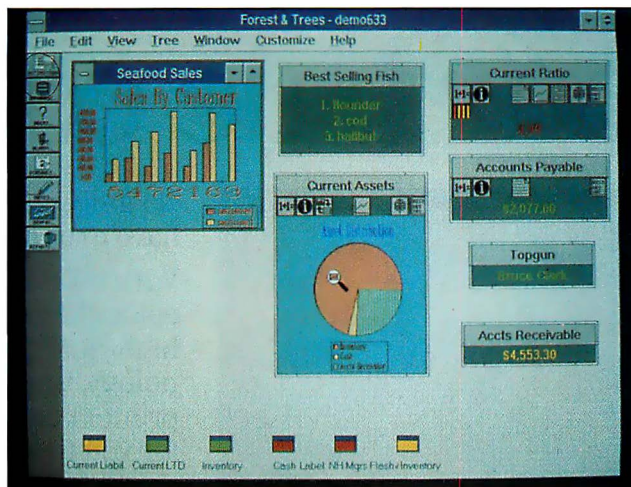

*With Forest & Trees, you can monitor the vital signs of your business without relying on MIS involvement.*

ing, Inc., 53 Main St., Newmarket, NH 03857, (800) 289-0053 or (603) 659-2832; fax (603) 659-7590.

**Inquiry 1275.**

## Spreadsheet Optimizer Evolves to Excel

Evolver, the program that does what-if analysis to the max, is now available for Microsoft Excel on the Macintosh and Windows, in addition to the original version for Informix's WingZ. Instead of you doing all the work in trying different what-if scenarios, Evolver does it for you, working in the background on your spreadsheets to optimize a value in a given cell.

You enter the cells Evolver is allowed to adjust, as well as the cell Evolver should minimize or maximize, and identify constraints. Evolver does the rest. You can add any number of constraints and give them different priorities. Evolver can optimize spreadsheets with linear, nonlinear, and stochastic (random) functions, Axcélis says.

**Price:** \$145.  
**Contact:** Axcélis, Inc., 1406 Western Ave., Seattle, WA 98101, (800) 292-3547 or (206) 624-2446.

**Inquiry 1276.**

## Three Business Analysis Programs

Business Resource Software designed its expert system to help you assess the potential risks and rewards of your business ideas. The knowledge base and rules in *Business Insight*, which runs on the IBM PC, are based on the years of experience of the company's founders, as well as research on launching new businesses and product lines, the company says.

*Business Insight* starts by asking a series of questions about the proposed business. Using the responses to these questions, the program begins to build a financial model of the business and reports on how likely the business is to succeed or fail. A spreadsheet lets you build business projections. The program will also let you do what-if analysis, comparing results of different pricing and marketing schemes. Hundreds of questions deal with such issues as the current state of the proposed market, pricing and marketing strategies, market life cycle, and competitors.

The program offers direct criticism, which can be an advantage because you expose

plans to the program in private and needn't fear brutal public comment about any failings they might have.

**Price:** \$495.

**Contact:** Business Resource Software, 2013 Wells Branch Pkwy., Suite 305, Austin, TX 78728, (800) 423-1228 or (512) 251-7541.

**Inquiry 1277.**

**B**usiness Profiles 1.4, a program for financial and insurance professionals who need to analyze business strategies and financial goals for their business-owning clients, can now export data from any of its 10 modules to Harvard Graphics. Each module is designed to maximize business performance in a particular area such as key financial ratios, valuation, continuation, owner's retirement income, key employee valuation, or business priorities and concerns.

**Price:** \$1495.

**Contact:** Financial Profiles, Inc., 5964 La Place Court, Suite 100, Carlsbad, CA 92008, (800) 237-6335, (800) 822-8302 in CA, or (619) 431-9400; fax (619) 431-9497.  
**Inquiry 1278.**

**A**utomate Your Business Plan, for the IBM PC, takes the approach developed in the book *Anatomy of a Business Plan* and combines it with a text editor and spreadsheet program with predefined planning outlines, spreadsheets, templates, and instructions. Its developer says the program automates many of the steps necessary for developing a business plan. With the spreadsheet, you can perform budgeting and financial analysis.

**Price:** \$79; book and software, \$95.

**Contact:** Out of Your Mind . . . and Into the Marketplace, 13381 White Sand Dr., Tustin, CA 92680, (714) 544-0248.

**Inquiry 1279.**

Buy BORLAND's  
Best at

# Programmer's Paradise



## TURBO PASCAL

*Turbo Pascal® takes you easily from inspiration to application.*



Turbo Pascal 6.0 with Turbo Vision represents a breakthrough in Pascal programming, in object-oriented programming, and in programming for DOS. Turbo Vision is the first object-oriented application framework for DOS, bringing home the power of OOP, and allowing programmers to easily develop sophisticated applications with advanced user interfaces.

Turbo Pascal 6.0 is just as significant today as Turbo Pascal 1.0 was in 1983. And just as version 1.0 helped spearhead the popularity of structured programming, Turbo Pascal 6.0 with Turbo Vision will lead the way in OOP.

**Turbo Pascal 6.0** \$ 99  
**Turbo Pascal Pro 6.0** \$199

## PARADOX

*Paradox® 3.5 brings new levels of power, performance and connectivity to Paradox—the #1 rated PC relational database.*

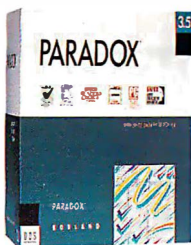

Paradox,® provides immediate database power. VROOMM™ with Turbo Drive™ makes Paradox faster, more powerful and easier to use than any other PC database. And Paradox is the ideal front end in SQL client/server applications. It allows you to ask complex,

ad hoc questions about your data without the need for programming. Contains PAL, a full-featured development language. Excellent network capabilities.

**Paradox 3.5** \$549

### TRY IT!

**GET A FREE 3-disk trial program** that you can use to run queries; create forms, reports, and graphs; and solve real business problems with the data provided. Call today! While supplies last.

## TURBO C++

Borland's new Turbo C++ supports the de facto industry standard for object-oriented programming (OOP) in C; AT&T's C++ 2.0 specification. Turbo C++ is the first



Turbo-charged native code compiler and also compiles your existing ANSI C code. The new Programmer's Platform allows you to integrate the tools of your choice. Its user interface has multiple overlapping windows and mouse support. You can also take advantage of VROOMM, Virtual Runtime Object-Oriented

Memory Manager, to write programs that break the 640K barrier.

**Turbo C++** \$139  
**Turbo C++ Professional** \$205

**P** Programmer's Paradise

**800-445-7899**  
FAX: (908) 389-9227

**BORLAND'S Best Sellers  
in Stock at Great Prices!**

	LIST OURS
Paradox 3.5	795 549
Paradox Engine (C Version)	495 349
Quattro Professional 2.0	495 329
Turbo C	99 69
Turbo C++	200 139
Turbo C++ Professional	300 205
Turbo Debugger & Tools 2.0	150 105
Turbo Pascal 6.0	150 99
Turbo Pascal Professional 6.0	300 199

### COMPETITIVE UPGRADES

	SPECIAL
Paradox 3.5	162
Quattro Pro 2.0	95
Turbo C++ Professional	139

\* Prices are subject to change without notice.

- ◆ All brand/product names are trademarks or registered trademarks of their respective holders.
- ◆ UPGRADES: Proof-of-ownership required: original disk or manual page; while supplies last.







## 3-D Wire-Frame, NURBS, Solids Under DOS

**M**icro Cadam 3D provides 3-D wire-frame, NURBS (nonuniform relational B-spline) surfaces, solids, and parametric design in a single module on a 386- or i486-based machine running DOS. Multiple viewports let you see an object in top, front, isometric, or true view.

By using the integrated 3-D display technology of Ithaca Software's HOOPS, Micro Cadam 3D can display shaded, high-definition images of surfaces and solids without requiring a separate rendering application, Cadam says. The program can organize individual design components into an assembly so that you can separate the items. You can also create, use, and save 3-D details of a drawing. You can associate copies of the details and text with a master file. With these associations, changes to the master are reflected in the detail drawings. **Price:** Micro Cadam Plus (required), \$3900; Micro Cadam 3D, \$1200. **Contact:** Cadam, 1935 North Buena Vista St., Burbank, CA 91504, (818) 841-9470; fax (818) 840-8428. **Inquiry 1280.**

## Integrated Site Planning for AutoCAD 11

**T**he latest version of Landcadd's modules for Site Planning & Landscape Design, Irrigation Design, Quadrangle, and Plant Specifier run on AutoCAD release 11, providing a way to integrate all your third-party applications on a network, the company says. New features to the modules include network

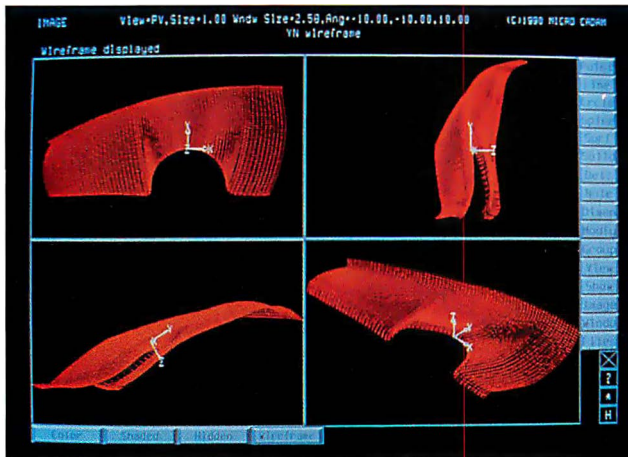

*Micro Cadam 3D lets you view this automobile fender comprising several 3-D splines in four different views, each of which is a shaded rendering of the object.*

compatibility, over 800 symbols, new Lisp routines, unlimited control points for creating a grid terrain model, and automatic elevation adjustments of blocks onto the terrain. The modules offer complete compatibility with any other AutoCAD applications from companies such as ASG and DCA.

Landcadd can act as a link between products from other vendors. Features of release 11 include automatic layering without forcing a layering convention on you, open ACAD.LSP files, the ability to run the program from any drive or directory regardless of what the ACAD variable

is set to, and the ability to use any type of unit.

**Price:** Modules range from \$295 to \$995; complete set, \$3695.

**Contact:** Landcadd, Inc., 7519 East Highway 86, Franktown, CO 80116, (303) 688-8160; fax (303) 688-8178. **Inquiry 1281.**

## 3-D Conceptual Modeling on the Mac

**A**lias developed Upfront for architects, interior designers, and facility planners who need a natural way to create 3-D drawings during

the concept phase of design. The program can export drawings to the Clipboard or in DXF, PICT II, bit-map, EPS, or Excel format.

The program supports interactive 3-D perspective sketching and drawing. It includes automatic shading in full color with hidden-surface removal. You can also use Upfront to view shadows as they would fall on a building. You can program the sun to appear as it would in real life.

Upfront runs on any Macintosh with 1 MB of RAM. **Price:** \$895.

**Contact:** Alias Research, Inc., 110 Richmond St. E, Toronto, Canada M5C 1P1, (416) 362-9181; fax (416) 362-0630. **Inquiry 1282.**

## Take a Walk in Your Computer

**B**echtel has ported its Walkthru design animation program to Silicon Graphics' IrisVision board, bringing real-time animation technology from high-end Unix workstations to the IBM PC.

With Walkthru, you can view 3-D computer models as if you were inside them, viewing shaded images and moving through the model. The program can simulate head and body movement and the operation of objects in the model, and, when used with equipment from StereoGraphics, can produce images with full-depth perception.

The program requires an Iris Vision 24-bit graphics board on the IBM PC. Walkthru is also available for the IBM RISC System/6000 and Silicon Graphics' Iris 4D.

**Price:** \$3995. **Contact:** Bechtel Software, Inc., 289 Great Rd., Acton, MA 01720, (508) 635-0580. **Inquiry 1283.**

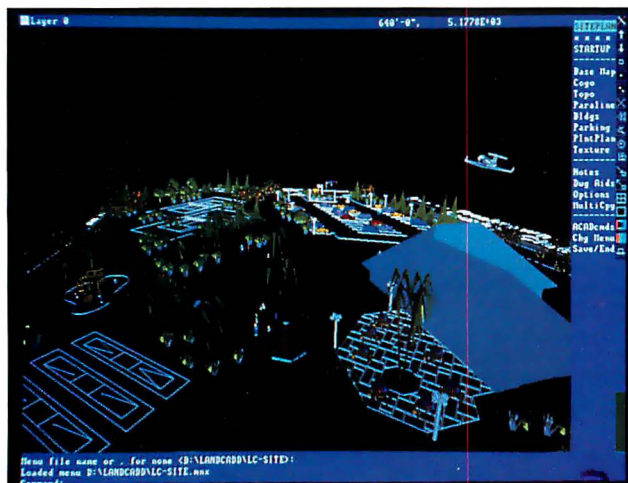

*A perspective view created in Landcadd's Site Planning & Landscape Design module.*

# WHAT MAKES A BEST SELLER A BEST SELLER?

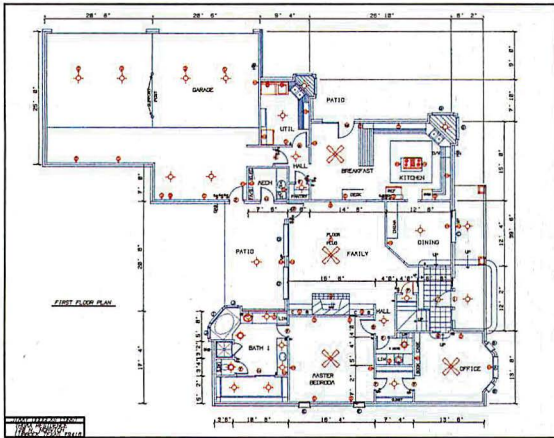

A great plot begins with a great idea, easily translated through every phase of design with Generic CADD 5.0.

## OPERATING GUIDE F300 FEEDER

### OPERATOR ADJUSTMENTS

#### INSULATOR POSITION

The air plunger position is critical in maintaining the bottomography of the stack, and must be set in unison with the FLEXION ANGLE described below. If it is too far away from the vacuum drum, too or more sheets will be fed from the feeder. If it is too close to the drum, the sheets will get under the separator before it reaches the stacked rollers. See the drawings and other below.

#### FLEXION ANGLE

The plenum is the air inside the vacuum drum that the holes of the drum pass over. The position of the air determines which part of the paper is pulled by the suction of the vacuum drum tubes. If it is too close to the separator, the vacuum tubes will cut the air in just above the end of the bottom stack. If it is too far away, the vacuum holes will pull too close of them and give the bottom sheet up against the separator, which prevents the sheet from being fed (sheet off-plugging).

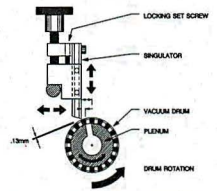

## TECHNICAL REFERENCE F3 FEEDER

Figure 1  
Feeder Cross-Section with  
Suction Cups at Home Position

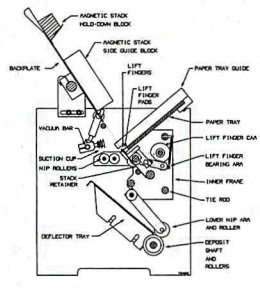

Exchange your DXF files with other CAD systems or insert designs into desktop publishing programs to create technical illustrations.

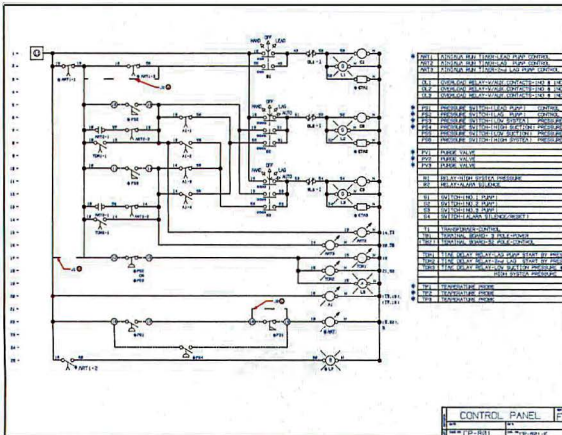

No matter the complexity, symbols keep your work flowing uninterrupted. Tap our professional libraries or create your own symbols.

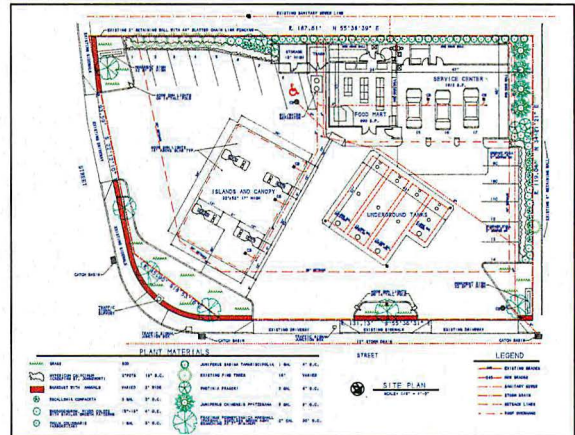

Need to fit a conventional design in a nonconventional space? Revise and improvise in less time with Generic CADD's one-stop convenience.

# A GREAT PLOT.

Ask any of over 250,000 users of Generic CADD™ They've discovered CADD that's powerful without being complicated. And professional without being pricey.

Our latest version, Generic CADD 5.0, is just \$395. It's a complete design and drafting program backed by a support team that's drawing rave reviews.

Call us at 1-800-228-3601 for our free full-color CADDalog® and portfolio of CADD drawings.

You'll see every plot has a great ending.

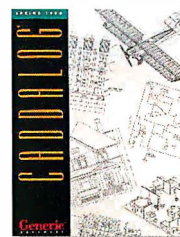

**Generic**  
SOFTWARE  
An Autodesk Company

**IT DOESN'T GET ANY EASIER.**

# CompuAdd 333T

*"Power User's Dream Machine"*  
— PC Magazine, December 25, 1990

**\$2775** (66656)

## CompuAdd's Hot Slots Boost 333T Performance

PC Magazine picked the CompuAdd 333T as Editors' Choice in a December 25, 1990 review of 45 leading 33MHz 386 computers!

*"CompuAdd wins Editors' Choice for its superb combination of performance, expandability, and service. ... For the best value in an intelligently designed PC, CompuAdd is worth the investment."*

—PC Magazine, December 25, 1990

CompuAdd's innovative engineering design team produced the *fastest 33MHz 386 computer you can buy* — as measured by top scores on *seven of nine* PC Labs benchmarks, including the 386 Instruction Mix test. PC Magazine calls the CompuAdd 333T "a speed demon" and "a power user's dream machine."

Our engineers designed two of the system's 16-bit expansion slots to maximize performance of the CompuAdd HardCache/ESDI controller card and CompuAdd Hi-Rez VGA card. We call them "hot slots." Each slot still works perfectly with a standard 16-bit expansion card, should you choose that op-

### 333 Monitor and Hard Drive Options

		MGA	CVGA*
333T	80MB	66658 - \$3575	66659 - \$4175
333T	200MB	66661 - \$3975	66662 - \$4575
333FP	80MB	66667 - \$3395	66668 - \$3995
333FP	200MB	66670 - \$3795	66671 - \$4395

\* Super VGA 1024x768 monitor with CompuAdd Hi-Rez VGA controller.

**PC**  
**MAGAZINE**  
**EDITORS'**  
**CHOICE**

December 25, 1990  
CompuAdd 333T



tion. Plus CompuAdd designed the motherboard to take maximum advantage of the optional SRAM board.

With the CompuAdd 333T or desktop 333 at the heart of your network, you'll have all the power, speed and expandability you need. Speed to keep your work flowing.

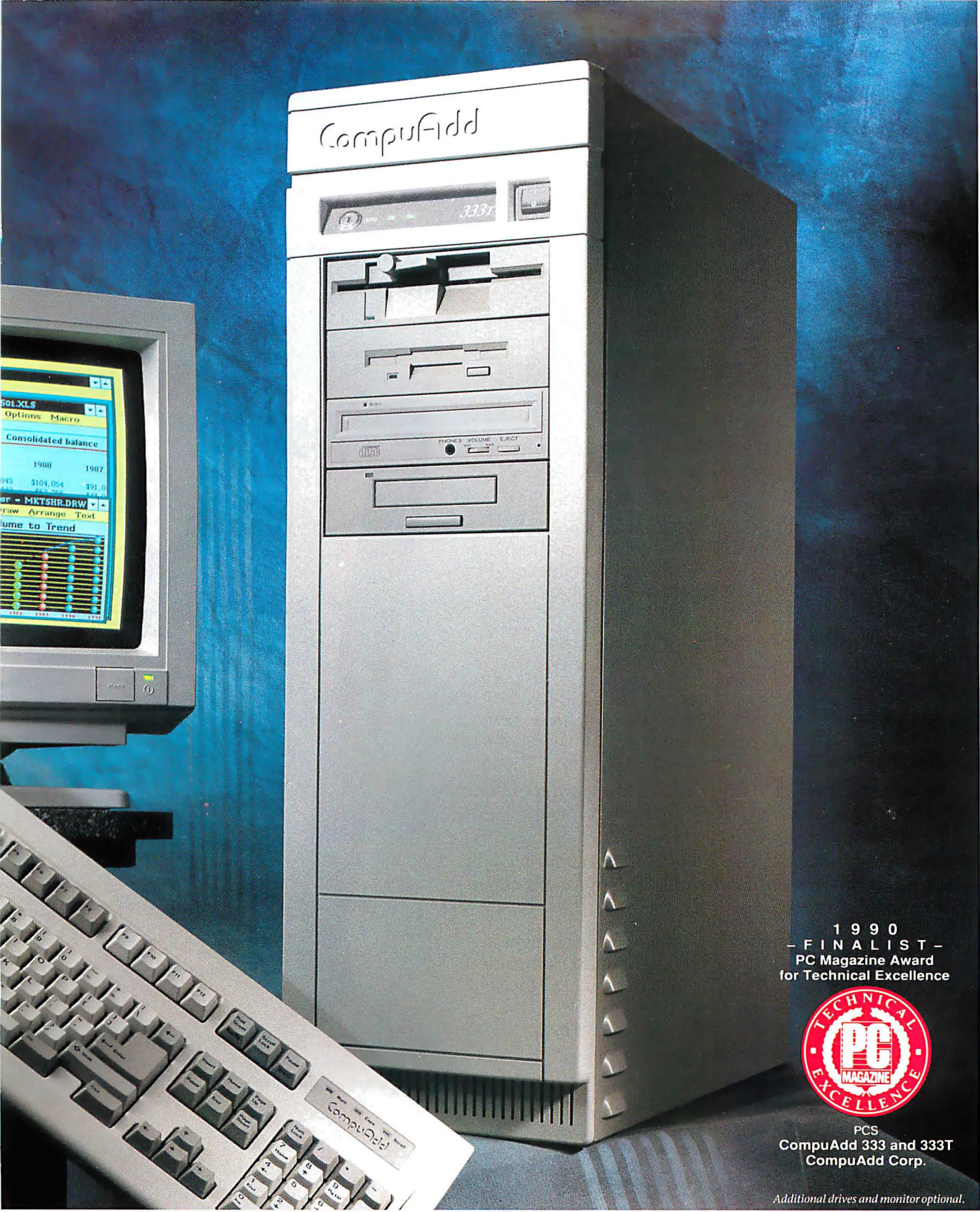

CompuAdd

333T

SOL.XLS  
Options Macro

Consolidated balance

	1988	1987
1988	\$104,054	\$91,0
1987		

er - MKTSHR.DRW  
raw Arrange Text  
ume to Trend

1990  
- FINALIST -  
PC Magazine Award  
for Technical Excellence



PCS  
CompuAdd 333 and 333T  
CompuAdd Corp.

*Additional drives and monitor optional.*

Power to run today's — and tomorrow's —  
32-bit software. Expandability to grow  
with your business. And the CompuAdd  
commitment to quality and service.

*Get Ahead with 386 Power.  
Stay Ahead with CompuAdd Value!*

**Call 800-999-7103** Key Code 815

We accept MasterCard, VISA, money orders, certified checks and personal checks (please allow ten days for processing). CODs (\$50 minimum order), company and institutional purchase orders (minimum initial purchase \$500, thereafter \$50), and wire transfers. Please add 2% to all purchases for shipping and handling (minimum \$3, shipping outside the continental United States will increase cost). Add 8% for shipping and handling to APO/FPO addresses (minimum \$10). Please add appropriate local sales tax. Thirty-day money-back guarantee does not include return freight or shipping and handling. Opened software, videotapes, other consumables and shipping costs are nonrefundable. All return items must be accompanied by a return merchandise authorization (RMA) number. Prices and product descriptions are subject to change without notice. CompuAdd is not liable for damage due to omissions or typographical errors. Call 800-666-1872 for a copy of CompuAdd's complete warranty.

**CompuAdd®**

Customer driven, by design.™

Circle 52 on Reader Service Card



# Award-Winning Notebook! CompuAdd Companion™ \$2895

Byte Award of Excellence, January 1991

## CompuAdd Companion™ Exceeds Expectations

*"The critical test for any notebook computer is in the balance between size and processing power."*

— PC Computing, December 1989

CompuAdd has what the editor expects in a portable computer. At 4.4 pounds and 1.4" thin, the new CompuAdd Companion notebook computer is what portables ought to be—light, slim and fully featured.

*"Storage media may be the biggest challenge for notebook computers."*

The CompuAdd Companion sports a fast, built-in 20MB (23ms) hard disk drive. You'll never have to buy volatile, expensive, hard to find RAM disk memory cards. You'll have all the reliable storage you need for applications and data files.

And using the pre-loaded LapLink II software, you can quickly and easily exchange files with your desktop system.

*"...today's notebook screens all offer CGA resolution or better and enough contrast to allow you to work on them for hours..."*

Why settle for less than a VGA display with the highest resolution and best contrast? The CompuAdd Companion has a bright, 640 by 480 pixel, 10-inch, sidelit LCD screen.

*"The PC must be large and powerful enough to do useful work but small enough to fit into a briefcase."*

The CompuAdd Companion uses the Intel™ 80C286 microprocessor running at 12MHz, and can handle sophisticated software applications, like Windows 3.0, Lotus 1-2-3™ and WordPerfect™ 5.1. It's compatible with MS-DOS and OS/2. The standard 1MB DRAM is expandable to 3MB.

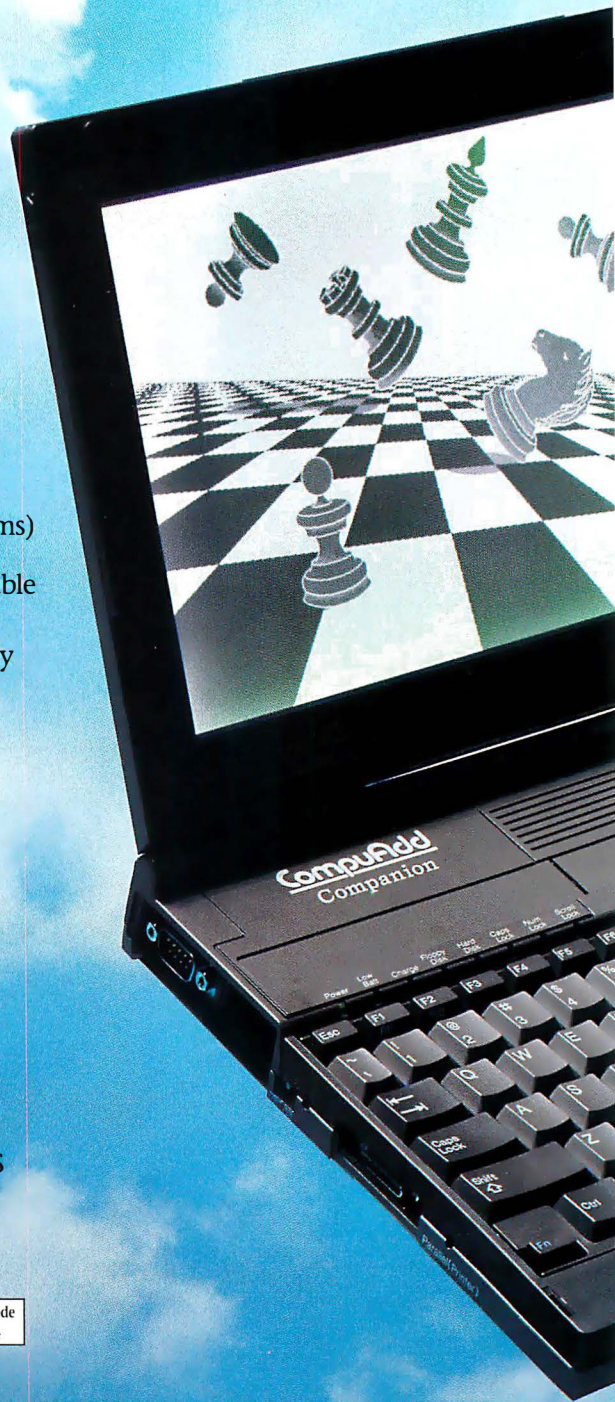

Call TODAY or visit your CompuAdd Superstore for these savings!

Key Code  
814

# 800-456-6008

Hours: Monday - Friday 7:00am to 9:00pm CST; Saturday 9:00am to 5:00pm CST

# Customer-Driven Company! CompuAdd Gives You More.

## Value And Service Direct To You!

- 89 CompuAdd retail Superstores, each a complete sales and service facility
- 30-day, money-back guarantee
- Toll-free telephone support direct from the manufacturer
- On-site service through Memorex/Telex
- Local corporate sales representatives
- Major Accounts Program
- Government/Educational sales

CompuAdd gives you more, with our superior, exclusive method of product delivery and after-sale support that sets us apart from other manufacturers.

Only CompuAdd — and no other major competitor in the industry — owns the entire product delivery system. Our corporate structure eliminates the multiple layers of franchise management and the middleman overhead you encounter at other large computer manufacturers. When you deal with CompuAdd, you deal with the boss and bypass the middleman.

CompuAdd's unique corporate structure and delivery system means we maintain *low overhead and delivery channel efficiency to bring you the best price/performance ratio in the industry.*

The bottom line is CompuAdd's direct-supplier relationship and local, face-to-face contact. No other computer manufacturer has made a service commitment equal to CompuAdd.

## CompuAdd Companion Features:

- 80C286 microprocessor running at 6,7.16, or 12MHz
- Standard 1MB high speed dynamic RAM expandable to 3MB
- 1 wait-state page-mode memory
- Dedicated 80C287 math coprocessor socket
- Built-in serial, parallel printer, numeric keypad, and modular expansion ports can be used for external CVGA monitor or modem/fax interface modules
- High-resolution 640x480 VGA display
- 20MB hard disk drive with 23ms access time
- 79-key keyboard with 101-key emulation
- MS-DOS 4.01 and LapLink II in ROM
- Rechargeable/removeable internal battery pack
- Modular AC adapter
- Dimensions: 8.5"x11"x1.4"
- System Price: \$2895 (62280)

# CompuAdd®

Customer driven, by design.™

12303 Technology Boulevard, Austin, TX 78727

We accept MasterCard, VISA, money orders, certified checks and personal checks (please allow 10 days for processing), CODs (\$50 minimum order), company and institutional purchase orders (minimum initial purchase \$500, thereafter \$50), and wire transfers.

Please add 2% to all purchases for shipping and handling (minimum \$3, shipping outside the continental United States will increase cost). Add 8% for shipping and handling to APO/FPO addresses (minimum \$10). AZ, CO, CT, DC, FL, GA, IL, IN, KS, LA, MA, MD, MI, MN, MO, NC, NE, NJ, NM, NY, OH, OK, PA, RI, SC, TN, TX, UT, VA, and WI residents, please add appropriate local sales tax. Thirty-day money-back guarantee does not include return freight or shipping and handling. Opened software, videotapes and other consumables are nonrefundable. All return items must be accompanied by a return merchandise authorization (RMA) number. Prices and product descriptions are subject to change without notice. CompuAdd is not liable for damage due to omissions or typographical errors. Call 800-666-1872 for a copy of CompuAdd's complete warranty.

Circle 53 on Reader Service Card

## Three Science Word Processors

**D**esign Science's MathType is an intelligent mathematical equation editor for Windows or the Mac that lets you construct equations by clicking on symbols and templates from menus and typing in details. The program is designed to work with another word processor.

MathType automatically sizes, spaces, and positions symbols and uses the correct typeface for standard function abbreviations such as log and sin. Once you create an equation in the Windows version, you can save it in EPS, TIFF, WMF, or Aldus Placeable Metafile format and place it in the document. MathType for Windows also supports Dynamic Data Exchange for Microsoft Word for Windows and Ami Professional. **Price:** MathType for Windows, \$249; Macintosh version, \$149.

**Contact:** Design Science, Inc., 6475-B East Pacific Coast Hwy., Suite 392, Long Beach, CA 90803, (213) 433-0685; fax (213) 433-6969. **Inquiry 1284.**

**M**athWriter 2.0, the Scientific Word Processing Program for the Macintosh, includes features standard to a general word processing program such as a spelling checker, thesaurus, and automatic hyphenation, Brooks/Cole reports. With MathWriter, you can create documents in WYSIWYG mode, editing text and mathematical expressions in the same document without leaving the program.

The program automatically sizes and centers math symbols, italicizes variables, formats tables and matrices, and shows on-screen renumbering of both equations and references to equations. A revision feature lets you track in-

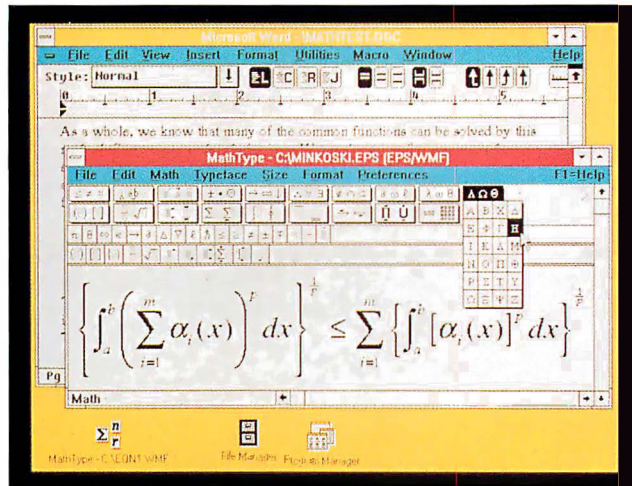

*Programs such as MathType let you do mathematical and scientific word processing without resorting to special key combinations and codes.*

sertions and deletions while you retain the original version. You accept or reject changes individually or globally. **Price:** \$395; student version, \$99.

**Contact:** Brooks/Cole Publishing Co., 511 Forest Lodge Rd., Pacific Grove, CA 93950, (408) 373-0728; fax (408) 375-6414. **Inquiry 1285.**

**C**hiWriter combines a word processor and WYSIWYG equation editor running on the IBM PC under DOS. Version 4.0 lets you select symbols from a menu and place them in your document without requiring special modes or encoding. The program lets you undo and redo up to 100 keystrokes.

With ChiWriter you can edit up to 10 documents at once and cut and paste among them. Documents can be as long as you like; if the document exceeds available memory, the excess is swapped to disk. ChiWriter supports split footnotes, variable head-

ers and footers, and automatic paragraph formatting. **Price:** \$349.95.

**Contact:** Horstmann Software Design Corp., Four North Second St., Suite 500, P.O. Box 1807, San Jose, CA 95109, (800) 736-8886 or (408) 298-0828; fax (408) 298-6157.

**Inquiry 1286.**

## Unit Conversion Program

**U**nits on Hand, available as a TSR or Windows application, lets you convert units between the English and metric systems. The program also performs unit consistency checks to prevent you from converting a volume to an area or other unit.

**Price:** \$49.95.

**Contact:** NovaComp Engineering, Inc., P.O. Box 95137, Seattle, WA 98145, (206) 634-9016; fax (206) 634-9017.

**Inquiry 1287.**

## SPREAD THE WORD

*Your new product is important to us. Please address information to New Products Editors, BYTE, One Phoenix Mill Lane, Peterborough, NH 03458. Better yet, use your modem and mail new product information to the microbytes.hw or microbytes.sw conferences on BIX. Please send the product description, price, ship date, and an address and telephone number where readers can get more information.*

## Numerical Methods, Engineering Packs for MathCAD

**M**athSoft's Numerical Methods and Civil Engineering Applications Packs for the IBM PC, Macintosh, and Unix platforms contain a number of applications for frequently performed tasks in each area, the company reports. The packs work with MathCAD, the company's program for equation editing, calculating, and plotting.

The 26 applications in the Numerical Methods Pack cover such topics as partial differential equations, polynomials, applications of contour integration, ordinary differential equations, integral equations, iterated mappings, and testing for primes.

The Civil Engineering Packs are divided into two separate packs, one for structures and materials and the other for soil mechanics and hydraulics. Key topics in the first pack include area of tension steel required for symmetrical T-beams, determination of settlement of foundations, structural design for footings (working stress design), and the design of retaining walls. The second pack includes applications for flow classification and critical depth for open rectangular channel flow, design of flocculators, determination of soil permeability from pumping test results, and soil consolidation ratio.

The application packs use MathCAD's complex arithmetic, matrix operators, equation-solving power, and plotting capabilities.

**Price:** \$99 each.

**Contact:** MathSoft, Inc., 201 Broadway, Cambridge, MA 02139, (617) 577-1017; fax (617) 577-8829.

**Inquiry 1288.**



INTEGRATING  
WINDOWS &  
OS/2 INTO  
THE CORPORATE  
ENVIRONMENT



PC WEEK & CM VENTURES PROUDLY PRESENT A MAJOR INDUSTRY EVENT

# Windows & OS/2

C O N F E R E N C E

MARCH 5-7, 1991 • SAN JOSE CONVENTION CENTER • SAN JOSE, CA

- Ask the questions, discuss the issues and learn the answers at the only independent conference and exposition focusing on Windows and OS/2 issues and applications... created especially for the corporate information manager... featuring more than 40 sessions and 250 exhibitors.

TRACKS	CORPORATE END-USER ISSUES	PRODUCT PROMISES & REALITY	CONNECTIVITY	INDUSTRY ISSUES	WINDOWS & OS/2 DEVELOPMENT	NEW TECHNOLOGY & MEDIA
<b>TUESDAY, MARCH 5</b>						
9-10 am	<b>KEYNOTE</b>					
10:30 - Noon	Downsizing from Mainframes & Minicomputers	Beyond Politics—DOS/Windows vs OS/2 PM—The User's Perspective	A Day in the Life of a LAN Manager	Window Dressing		Directions in Multimedia
2-3 pm	Cost-Justifying the Graphical User Interface	Facts & Figures: Graphical Spreadsheets	The Future of GUI Workstation Connectivity		Thinking GUI	Digitized Video
4-5:30 pm				State of the Channel	Development of Portable Software	Corporate Education & Multimedia
<b>WEDNESDAY, MARCH 6</b>						
9-10:30 am	<b>PLENARY SESSION</b>					
11-12:30 pm	Word Processing Solutions		Global Connectivity Under OS/2: Is the Package Deal a Better Deal?	Can Windows Win the GUI War?	Windows or OS/2 - Which is for You?	Authoring Tools
2-3:30 pm	Everything You Always Wanted to Know About Windows But Were Afraid to Ask!					
4-5:30 pm	Security Concerns	Presenting... PM & Windows Presentation Programs		What's Hot & What's Not in Windows	Development Using Windows Macro Languages	Distributing Multimedia Applications
<b>THURSDAY, MARCH 7</b>						
9-10 am	<b>DEVELOPER'S KEYNOTE</b>					
10:30 - Noon	End User Development	Programming for the Rest of Us	Network Management Under Windows & OS/2	Managing the Migration	Development Using High Productivity Programming Languages	
2-3:30 pm	Database Server Inquisition	Visual Representation of Data		Marketing Windows in the USA & Europe	Windows/PM Development Using the SDK	Sound & MIDI

**PC WEEK**

ZIFF-DAVIS PUBLISHING CO.  
800 BOYLSTON STREET  
BOSTON, MA 02199

Dear Computer Professional,

We're proud to be sponsoring the Windows & OS/2 Conference with CM Ventures. We see it as a visionary event with a strong future. Today, computing under Windows or OS/2 is the quintessence of corporate computing.

All of us at PC Week look forward to a long, mutually beneficial association with CM Ventures, and with you, the Windows & OS/2 Conference attendee.

There are many trade shows out there, but none more important to increasing corporate productivity through the use of innovative technologies than this one. See you there.

Sincerely,

Sam Whitmore  
Editor-in-Chief  
PC Week



**PC WEEK**

## KEYNOTE



### Directions for the Decade

Cheryl Currid,  
Director,  
Applied Information Technology,  
Coca Cola Foods

## PLENARY

### Session: Windows 3.0—the Second Year

Chair:  
Stewart Alsop  
Editor/Publisher,  
P.C. Letter

Panelists:  
Don Casey,  
VP, Spreadsheets

Division, Lotus  
Development Corp.

Paul Grayson,  
President, Micro-  
graphs, Inc.

Brad A. Silverberg,  
VP, Systems  
Division, Microsoft  
Corp.

## DEVELOPER'S KEYNOTE

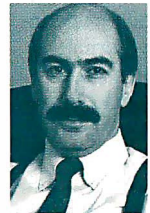

### Megatrends in Software Development

Said Mohammadioun  
President,  
Sanna Corp.

**FAST TRACKS!** 8 sessions on installing and configuring Windows • Word for Windows templating • Desktop Publishing with Windows • Automating document searches with SmartText • Network installation

**PLUS, Meet the Money: a VC Summit!**

## CORPORATE SOLUTIONS ROOM

(for Conference registrants only) Windows applications suites developed by or for major corporations, focusing on: Document Management • Heterogeneous Database Integration • IBM Host Connectivity • We will identify the resources needed by corporate MIS directors to effectively establish and maintain Windows or OS/2-based LANs.

## GET ACQUAINTED RECEPTION

(for conference attendees and exhibitors) Monday evening, March 4, 7-9pm, sponsored by PC Week and CM Ventures.

## SPECIAL EXHIBIT FLOOR ATTRACTIONS

- **PC Week Labs Shoot-Out** Watch the heated competition live, on-stage as vendors compete at creating specific solutions to typical business tasks.
- **Windows Connection** (Hasted by Computer Currents) Connect with developers, distributors, resellers, or find your new Windows or OS/2 career opportunity.
- **Hands-on Training** Sign up for free hands-on training workshops presented by a leading corporate training company.
- **GUI Test Drive Center** Take the latest Windows and OS/2 applications for a test drive in an informal, no-pressure environment.
- **Seminars for Programmers** A series of special seminars for programmers developing Windows and OS/2 applications will be held throughout the 3-day event.
- **The Great Software Giveaway** Over \$25,000 in software and other prizes will be given away in special drawings.

Registration  
Conference sessions and exhibits: \$495, if registration and payment is received on or before February 18, 1991. On-site registration, if available, is \$545.

Complete conference and registration information  
Phone: 415-601-5000 Fax: 415-601-5075  
Write: CM Ventures, Inc.  
5720 Hollis Street, Emeryville, CA 94608

Sponsored by:

**PC WEEK**

Co-sponsored by:

OS/2 & Windows magazine • Windows & Presentation Manager Assoc.  
© OS/2 is a registered trademark of IBM Corporation

Presented by:

**COMPUTER CURRENTS**

## Softview's Tax Family

Softview's Taxview Professional Series, previously available for the Mac, is now available for Windows 3.0. Also new from the company are Client Organizer, Client Write-Up, new federal forms, and six new state supplements.

The Client Organizer module, included with Taxview 1040, helps clients gather and summarize tax data. New forms included with Taxview 1040 are 2210F Farmers Underpayment of Estimated Tax, 3903F Foreign Moving Expenses, 8822 Change of Address, and TD F90-22.1 Report of Foreign Bank Accounts.

Taxview 1120, 1120-S, and 1065 include more depreciable assets and support for short year and fiscal year returns. Taxview 1065 and 1120-S automatically calculate sharing percentages and include many new forms. Forms, schedules, statements, and worksheets are available for 14 states.

Client Write-Up, also for the Mac or Windows, an accounting package for automated bookkeeping that provides unlimited customized reports through access to Microsoft Excel, is integrated with Taxview and available for \$495 for Taxview users.

The if:X Personal Tax Analyst, included free with Taxview 1065, 1120, and 1120-S, lets you compare the five-year cumulative results of as many as five different tax scenarios within a single study. It also calculates W-4 and 1040ES forms.

MacInTax for Windows and the Mac include a Forms Guide, a question-and-answer interview that helps

*MacInTax for Windows displays and prints exact replicas of IRS forms, complete with data, without requiring additional fonts.*

you determine which forms to complete. The program includes many forms, including 1040EZ, 1040X, 1040ES, and 4868, and built-in electronic filing. **Price:** Taxview 1040, \$495; Taxview 1065, 1120, and 1120-S, \$395 each; state supplements, \$69 each; Taxview/Speed>S module, \$199; if:X Personal Tax Analyst, \$79; MacInTax, \$99.

**Contact:** Softview, Inc., 1721 Pacific Ave., Suite 100, Oxnard, CA 93033, (800) 622-6829 or (805) 385-5000, fax (805) 385-5001. **Inquiry 1172.**

## TaxCut for the IBM PC

Meca Software says that its TaxCut program includes 55 forms and schedules, 10 worksheets, and its Expert Advisor for walking you through the tax-preparation process step by step. TaxCut calculates and prints any IRS-acceptable 1040 on any type of printer, the company says.

The program is also available in versions for 10 states.

Meca says the personal version of TaxCut is certified by a Big Six accounting firm with guaranteed accurate cal-

culations, or Meca pays the penalty. **Price:** \$89.95; state versions, \$39.95 each.

**Contact:** Meca Software, Inc., 327 Riverside Ave., Westport, CT 06880, (203) 222-9150 or (203) 226-2400, fax (203) 226-2480. **Inquiry 1174.**

## RapidTax for the IBM PC

Sylvia Porter's RapidTax includes built-in electronic filing software and an IRS Audit Detector that alerts you any time a deduction exceeds IRS limits (based on historical data from the IRS), which could prompt an audit. If you're married, RapidTax can determine if filing separately is your best option. The program includes a tutor, Form Help, and an interview/input mode for collecting your financial information. A professional version, which has client write-up, billing, and other modules, is available for 1040 preparation.

DacEasy, publisher of the program, is offering 38 state versions in five regional packages. When you buy a Regional State Tax Filer, which interfaces with RapidTax, you

get up to nine individual states. RapidTax also includes Light Checkbook Accounting, a checkbook and financial management program.

**Price:** \$79.95; Regional State Tax Filer, \$49.95 each; professional version, \$399. **Contact:** DacEasy, Inc., 17950 Preston Rd., Suite 800, Dallas, TX 75252, (800) 877-8088 or (214) 248-0205, fax (214) 250-3752. **Inquiry 1175.**

## TurboTax for the PC and Mac

The Logical Next Step feature of TurboTax walks you through each step as you prepare your tax return, ChipSoft says. In addition to an interview for getting a handle on what to do, the program includes a "file cabinet" for entering data by subject, and a forms finder.

TurboTax offers more than 60 forms, schedules, and worksheets, and it can print all forms in a graphical format on dot-matrix and laser printers without requiring special font cartridges. TurboTax for the IBM PC has 44 state versions; the Mac version supports 11 state returns. Both versions support tax planning, for tracking your 1991 finances after you file the return.

ChipSoft also offers a ProSeries of programs for 1040, 1041, 1065, and 1120-1120S returns. **Price:** Personal 1040 for the IBM PC, \$75; Personal States, \$40 each. Personal 1040 for the Mac, \$89; Personal States, \$49 each. ProSeries: 1040, \$395; 1041, \$395; 1065, \$295; 1120-1120S, \$395; state versions, \$250 each. **Contact:** ChipSoft, Inc., P.O. Box 85709, San Diego, CA 92186, (619) 453-4446, fax (800) 755-1040 or (800) 366-5538. **Inquiry 1173.**

# A Winner.

We didn't say it.  
PC Magazine did.



FACT FILE

EDITORS' CHOICE

Tangent  
386SX/20

Tangent  
Computer, Inc.,  
303 Beach Rd.,  
Burlingame, CA 94010;  
(800)223-6677,  
(415) 342-9388.

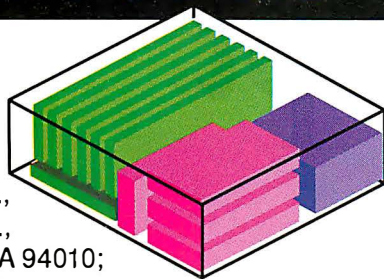

**List Price:** With 1MB RAM, 1.2MB 5.25-inch or 1.44MB 3.5-inch floppy disk drive, one parallel and two serial ports, VGA monitor, \$1,644; with 2MB RAM, 60MB hard disk, DOS 4.01, \$2,278; with 105MB hard disk, \$2,384.

**In Short:** An excellent contender with above-average electronics and hard-working peripherals, the Tangent 386SX/20 adds an FCC Class B certification to the pile to make it an extremely attractive computer for either home or office.

*"The 20 MHz 80386SX is the new entry-level business system of choice, starting right now."*

PC Magazine

### Best choice of the best choices.

Here's how PC Magazine summed up the Tangent 386<sup>TM</sup>SX/20 (Tangent's Model 320s):

*"The Tangent 386SX packs outstanding video, expandability to 8 MB, and plenty of free slots into a nicely reduced-size case. The price is right too. This PC offers a 105 MB hard disk and Orchid's ProDesigner II Super VGA card for a mere \$2295. Add in clear documentation and on-site service (with Tangent's one-year warranty) and you have a solid winner."*

*"The Tangent 386SX/20 is the best of the show; it garnered top scores in all of our video tests."*

**A system with a future.** The Tangent 386SX/20 runs all of yesterday's programs. All of today's. And most important, tomorrow's. Because it implements the full Intel 80386 feature set.

Circle 623 on Reader Service Card

\*All pricing subject to change without notice. ©1990 Tangent Computer. Tangent is a registered trademark of Tangent Computer, Inc. 386 is a registered trademark of Intel Corporation. Other product names may be the trademarks or registered trademarks of their respective companies.



November 27, 1990  
Tangent 320S

### Standard Configuration:

- Intel 20 MHz 80386SX CPU **\$2295**
- 2 MB of Memory (to 8 MB)
- 105MB 17ms Quantum Hard Disk
- Orchid ProDesigner IIe SuperVGA Card
- 14" SuperVGA Color Monitor
- Small Footprint Case w/200W Power Supply
- 5.25" or 3.5" High Density Floppy Drive
- Coprocessor Socket
- One Parallel, Two Serial, One Game Port
- 101-key Enhanced Keytronics Keyboard
- One-year Warranty with On-site Service

### Why buy their computer, when we'll build yours?

High performance. Low price, Tangent offers you a complete line of high performance systems: 20 MHz 80386, 25 and 33 MHz 80386SD, and award winning 25 and 33 MHz 80486. All, at what some people think is the best price-to-performance ratio in the business.

**Built your way.** Dealing with Tangent is like owning your own computer factory. Tell us exactly how you want your system configured, we'll build it, test it, and ship it. Your way. And even though it's your configuration, it carries our one-year warranty.

**PC Magazine's windup:** "Add an FCC Class B rating and a one-year warranty on parts and labor that includes on-site service into the bargain, and you begin to suspect that the Tangent 386SX/20 is a winner. Consider the price/performance ratio of the computer and that suspicion starts to look like a certainty."

Bill O'Brien, PC Magazine, 11/27/90

Thanks Bill. We couldn't have said it better.

Order now, Toll Free:

**1-800-223-6677**



**TANGENT**  
COMPUTER

197 Airport Blvd. Burlingame, CA 94010  
Phone: 415/342-9388 FAX: 415/342-9380

# PostScript for peanuts.



At last, low-cost, high performance PostScript® printing! This complete solution for PC publishers is yours for peanuts — from The Printer Works.

For as little as \$995.\*

That's all it takes to command this powerful system consisting of a Canon CX™ printer for superb print quality. Plus a QMS JetScript™ controller which adds true Adobe PostScript, in 35 different fonts, for trouble-free compatibility with all your favorite applications.

Now, for only \$995, you can easily produce stunning type and graphics that will make you look like a desktop wizard. And you can do it faster than with PostScript cartridges because JetScript has its own high speed processor and 3 megabytes of RAM.

JetScript was developed jointly by Adobe Systems, QMS and Hewlett-Packard to bring the power of PostScript to the HP LaserJet™ Series II. If you already have an HP LaserJet II, or an original

LaserJet, you can get the JetScript controller separately for as low as \$495. That's a whopping 80% below the list price!

Don't delay, call The Printer Works. 1-800-225-6116. And get PostScript for peanuts!



- \* JetScript with refurbished Canon CX printer, \$995
- JetScript with NEW Canon CX printer, \$1295
- JetScript for original HP LaserJet or LaserJet Plus, \$695
- JetScript for OEM CX (Cordata Etc.), \$595
- JetScript for HP LaserJet II, \$495

Prices subject to change, quantities limited. Dealer Inquiries Welcome

**THE PRINTER WORKS**

3481 Arden Road, Hayward, CA 94545

PostScript is a trademark of Adobe Systems, Inc. JetScript is a trademark of QMS, Inc. Canon CX is a trademark of Canon, Inc. LaserJet is a trademark of the Hewlett-Packard Company.  
©1990 The Printer Works

Circle 624 on Reader Service Card (RESELLERS: 625)

## Making Movies on the Mac

**A**nimation Works is a 1- to 8-bit color program for combining graphics, text, and sound into animations without making a giant commitment to training or hardware, Gold Disk says. You can use the program to create animated storyboards, simulations, sales presentations, and low-end video productions.

With the program's cel editor, you create and edit animated characters (i.e., cels). The movie editor lets you combine the animation with static or scrolling backgrounds that you've made with the background editor.

The cel editor includes tools for creating the different cels that make up the animation. An onion skin feature enables you to see the previous or next cel while creating the current cel.

The movie editor lets you define the motion or movement of the animated objects by creating paths. On-screen tools like line and elliptical paths with horizontal or vertical accelerations help you create smooth, realistic motion, the company says. You can define the path one frame at a time or register the motion



*Gold Disk's Animation Works lets you put color, sound, text, and graphics in motion on the Mac.*

selectively, as on a hand or foot. Within the movie editor, you can add sound, add coloring effects, and use a variety of wipes.

Animation Works imports standard audio files (e.g., MacRecorder, PICS, and PICT). Also included is a runtime player and external commands and functions for use from within HyperCard. Length of the movie is limited only by available memory. You can play a movie from the program or through HyperCard.

**Price:** \$199.95.  
**Contact:** Gold Disk, 5155 Spectrum Way, Unit 5, Mississauga, Ontario, Canada L4W 5A1, (416) 602-4000, fax (416) 602-4001.

**Inquiry 1177.**



*In addition to its perspective, extrude, and blend features, CorelDraw 2.0 lets you design your own typefaces.*

## Corel Steps Out with CorelDraw 2.0

**C**orelDraw 2.0 adds a suite of special effects and the ability to convert its 153 typefaces to Adobe's Type 1 format. By using CorelDraw as a font editor and the WFNBOSS conversion utility, you can create new display fonts and print them on any PostScript laser printer.

Special effects include an envelope feature for distorting any graphics object by manipulating the bounding box of that image. The perspective feature gives objects a sense of depth by moving some of the edges farther away than the others. Other new effects create three-dimensional appearances and blend objects to create an effect similar to tweening.

CorelDraw 2.0's new visual file manager, Mosaic, supports batch printing and exporting.

The CorelTrace auto-tracing utility can now trace color and gray-scale bit maps.

**Price:** \$695.  
**Contact:** Corel Systems Corp., Corel Building, 1600 Carling Ave., Ottawa, Ontario, Canada K1Z 8R7, (613) 728-8200, fax (613) 728-9790.  
**Inquiry 1179.**

## ZSoft Puts Pixel Editing on the PC

**P**ublisher's Paintbrush 2.0 includes new paint tools, editing and enhancement features, and multiple open windows. With the multiple windows, you can zoom in for precise pixel editing and see how the changes look in normal view in another window. You can also zoom out to edit larger-than-screen-size images.

New paint tools include an adjustable airbrush, gradient fills, and tiling for creating three-dimensional effects and other textures. An eyedropper feature lets you lift color from a single pixel and place it in the program's color palette. New editing features let you sharpen, blend, tint, smudge, or adjust brightness and contrast of any image portion.

**Price:** \$495.  
**Contact:** ZSoft Corp., 450 Franklin Rd., Suite 100, Marietta, GA 30067, (404) 428-0008.  
**Inquiry 1178.**

## Portfolio for the Bubble-Jet

**P**ortfolio, the integrated software package for creating presentation graphics, video, and electronic prepress, is now available for the Canon Bubble-Jet printer. Portfolio offers raster- and vector-based capabilities in the same package, along with graphing, fonts, drafting, and image editing on a 386-based machine.

**Price:** \$3000.  
**Contact:** Wasatch Computer Technology, 123 East 200 South, Salt Lake City, UT 84111, (801) 575-8043, fax (801) 575-8075.  
**Inquiry 1180.**

# MetaWare Delivers The Essential Tool For C

Way back in 1986, MetaWare delivered the first 32-bit protected-mode DOS compiler for the 386. Our High C compiler set the standard for professional software developers. High C DOS 386/486, **Version 2.3**, brings important features to extended DOS that our UNIX C customers have come to rely on for creating lightning-fast executable code:

## True Globally Optimizing Technology

Global Optimizations that increase speed of code execution include: constant and copy propagation, constant expression folding, local *and* global common subexpression elimination, removal of invariant expressions from loops, live/dead analysis, dead code elimination, global register allocation, and tail merging. We've also included faster libraries with ANSI conformance and greater Microsoft compatibility. These optimizations make Version 2.3 generate 46% better Whetstone code and 15% better Dhrystone code than our previous version. But one piece was still missing:

## True 32-Bit Source-Level Debugging

Our customers really needed a MetaWare-quality 32-bit, source-level debugger. It had to offer a friendly user interface with color or monochrome windows, featuring pull-down and pop-up menus. They needed to watch or edit data, registers, and breakpoints through windows that displayed: flags, memory in any format, variables, stack data, 387 registers, locals, globals, structs, pointers, modules, and more! **We've delivered!** MetaWare's 386 protected-mode debugger features source-level symbolic debug capabilities. High C users can tackle even the largest DOS C programs and debug code on the host or a remote DOS machine, via a standard serial port.

In an ever-changing, puzzling, multi-platform world, it's reassuring to know that:

## Your Code is Portable to Other Platforms

Many professional programmers are delighted to discover that their existing High C programs may be easily ported to many other popular platforms, including MS-DOS, FlexOS, OS/2, UNIX System V 386/486, Sun 386i, Sun-3, Sun-4, SPARC, and IBM AIX on PS/2, RT, i860, and 370, IBM AOS 4.3 on RT and 370, Am29K, Motorola 680x0, and Intel i860. And we're already talking with several of our OEMs about porting the debugger to these and other new platforms.

Our customers who are already using the combination of High C and the new debugger all agree that the new, 32-bit source-level debugger is *the essential tool* for the only compiler you need.

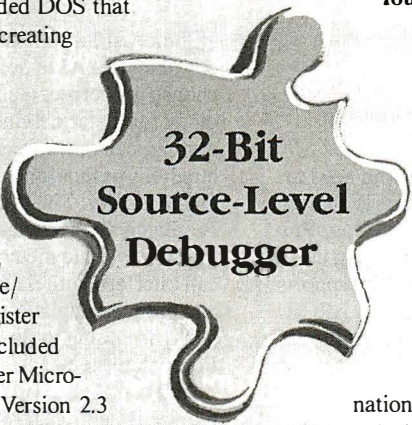

32-Bit  
Source-Level  
Debugger

**MetaWare**<sup>®</sup>  
INCORPORATED

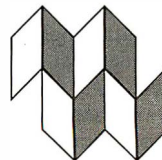

Compiler Products for  
Professional Software Developers  
High C<sup>®</sup> • Professional Pascal<sup>®</sup>

2161 Delaware Ave. • Santa Cruz, CA • 95060-5706 • 408/429-6382 • Fax 408/429-9273

MetaWare, High C, and Professional Pascal are registered trademarks of MetaWare Incorporated. Other names are trademarks of their respective companies.  
© Copyright 1990 MetaWare Incorporated

Circle 619 on Reader Service Card

## New Systat Integrates Graphics and Analysis

**S**ystat 5.0 integrates graphics and analysis procedures. New graphing capabilities include spherical mapping, dot plots for displaying densities, arrow or vector plots for fluid flow and other problems, and weather-vane plots. A new spinning procedure lets you view data in three dimensions.

Enhancements to model estimation and the Multivariate General Linear Hypothesis testing capabilities include support for the means model for designs that have missing cells or cells with unequal  $n$  values that reflect population differences. Additional hypothesis tests include new post hoc methods (e.g., Scheffe, Dunnett one- and two-sided, and Bonferroni). The program also has a variety of other statistical procedures. **Price:** \$895.

**Contact:** Systat, Inc., 1800 Sherman Ave., Suite 801, Evanston, IL 60201, (708) 864-5670.

**Inquiry 1182.**

## Exact Testing Goes Small

**W**ith StatXact, you can compute exact  $p$ -values and exact confidence intervals for small sample sizes, discrete categorical data, and imbalanced data. Cytel Software says that the program eliminates the uncertainty associated with using the asymptotic approach for these kinds of data sets.

The program runs on the IBM PC with 640K bytes of RAM and a math coprocessor. **Price:** \$495.

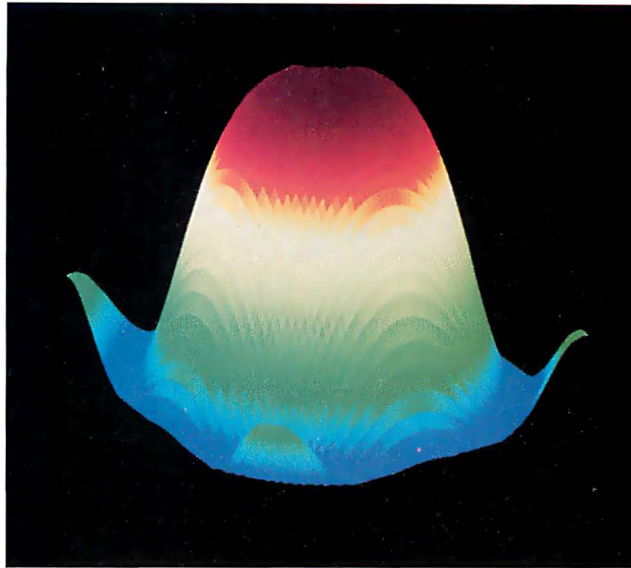

*Systat 5.0 for DOS lets you analyze data and graph it in color.*

**Contact:** Cytel Software Corp., 137 Erie St., Cambridge, MA 02139, (617) 661-2011, fax (617) 661-4405. **Inquiry 1184.**

## Economic Analysis on OS/2, Mac

**E**conomists who need to do econometric analysis on Mac, DOS, OS/2, or Presentation Manager can use Shazam 6.2, which supports Heteroskedastic and ARCH (Autoregressive Conditional Heteroskedastic) models. In addition to those functions normally found in statistical packages, Shazam 6.2 calculates auto-correlation consistent covariance matrices and hypergeometric distributions, and it solves nonlinear simultaneous equations.

**Price:** OS/2 version, \$395; other versions, \$295.

**Contact:** Shazam, University of British Columbia, Department of Economics, #997-1873 East Mall, Vancouver, BC, Canada V6T 1W5, (604) 228-2876, fax (604) 228-5915. **Inquiry 1185.**

## AI Stats Program Forecasts Thousands of Items

**F**orecast Pro, the program that uses AI to help you choose the correct methodology for historical-data forecasting, can now forecast hundreds or thousands of items automatically. The Forecast Pro Batch Version uses a variety of univariate methods and can interface with databases and production planning systems, according to Business Forecast Systems.

You can choose from techniques like simple moving average, exponential smoothing, and Box-Jenkins, or let the program choose them for you. For tracking forecast accuracy, the program provides exception reports, monitoring for forecast bias, and a built-in forecast evaluation system. Both DOS and OS/2 versions are available. **Price:** \$3995.

**Contact:** Business Forecast Systems, 68 Leonard St., Belmont, MA 02178, (617) 484-5050. **Inquiry 1183.**

## Two Stat Packages from SPSS

**S**PSS restructured its pricing policy and added features to version 4.0 of its statistical analysis package for DOS systems. Another package, SPSS for OS/2 4.1, takes advantage of the High Performance File System and Dynamic Data Exchange and has direct links to Microsoft Excel and Structured Query Language databases.

The base module of the IBM PC version contains data and file management facilities, several basic statistical procedures, a report writer, and network support. Graph-in-the-Box, New England Software's TSR graphing program, is included. From the base SPSS/PC+ 4.0 module, you can add other modules for your purposes, including a new mapping option from MapInfo for creating thematic maps. Other modules are available for additional statistical procedures, forecasting, and graphics.

The OS/2 version is a full port of SPSS 4.0 for mainframes and runs under Presentation Manager. It includes a logistic regression command and support for matrix commands. The OS/2 base system lets you extract data directly from Oracle, SQL Server, and IBM Database Manager and read it directly into SPSS for OS/2.

**Price:** SPSS/PC+ 4.0, \$195; add-on modules start at \$295 when purchased with the base, \$395 if purchased later. SPSS for OS/2 4.1, \$995. **Contact:** SPSS, Inc., 444 North Michigan Ave., Chicago, IL 60611, (312) 329-2400.

**Inquiry 1181.**



# CACHE SAVINGS

## LT 5200 Series Laptops

TWO FULL 16 BIT EXPANSION SLOTS  
"Flexibility of a Laptop, Power of a Desktop"

- Three affordable models to choose from:
  - LT 5200CD (386-25 CPU, 32K Cache) ..... \$3,599
  - LT 5200SX (386SX-16 CPU) ..... \$2,999
  - LT 5200NV (286-16 CPU) ..... \$2,399
- Expandable memory to 8MB on board
- Gas Plasma VGA Screen
- 40MB Connor IDE hard drive
- Detachable 102 key keyboard
- 2S, 1P, 1FD, XCRT Ports
- Free carrying case



## Myoda LT 3500

### \$1,499 LAPTOP BARGAIN



- Intel 802286 CPU w/O Wait State
- 6/12 MHZ Clock Speed
- EGA Gas Plasma display
- 1 MB installed 4 MB MAX
- 3.5/1.44 MB internal floppy drive
- 40 MB (28ms) hard drive
- Two serial/1 Parallel CRT port
- Free carrying case

## Myoda MD 7280

"Affordable Desktop compatability w/Intel 80286-33 microprocessor"

### \$2,295



- 64K cache SRAM memory
- 2MB RAM
- 1.2/5.25 drive & 1.44/3.5 drive
- 100MB fast HD
- 16 bit VGA card and monitor 1024 x 768
- 2 serial ports/1 parallel/1 game port
- 101 key keyboard

FREE: 2400 BPS Modem w/software, 3 button mouse, software, and surge protector

## Myoda NOTEBOOK

### Call for price



Weights under 7 lbs!

- Intel 80386-SX 16MHZ
- Standard 2MB, 4MB max
- B&W FTN LCD screen w/CCFT backlight
- 640 x 480 VGA display
- 1.44MB 3.5" Drive
- 20MB HD, 40MB optional
- Mouse, scanner, XCRT, 2S, 1P, FD, external ports
- 80 key keyboard

286 available (call for price)

## Myoda MD 5030

"High quality and low cost with full compatability"

### \$1,695



- Intel 80386SX-16 microprocessor
- 2MB RAM
- 1.2 MB 5.25" Drive
- 1.44MB 3.5" Drive
- 40MB IDE hard drive
- 16 Bit VGA card and monitor 1024 x 768
- 2 Serial/1 parallel/2 Game port
- 101 key keyboard

FREE: 3 button mouse, software, surge protector

# MYODA

1053 Shore Road, Naperville, IL 60563  
**1-800-562-1071**

Tech Support: (708) 369-5331  
No surcharge on MasterCard or Visa

- One year warranty on parts and labor
- Positive technical support
- Custom configuration
- All systems tested and approved
- 100% Compatability: DOS, OS/2, Novell, UNIX, XENIX, & LIM 4.0
- 15 Day money back guarantee
- FIMA required
- Price and availability subject to change without notice

Call for free color brochure  
OEM Inquire: 1-800-235-7360  
Dealers/Vars Inquiries: 1-800-235-7360  
or FAX: (708) 369-5068

## Design Tool for Motif Interfaces

Integrated Computer Solutions developed Builder Xcessory to help reduce the development time needed for creating OSF/Motif-based user interfaces for the X Window System. You can use Builder Xcessory, a paint-like tool for building, prototyping, and testing interfaces, by clicking icons and moving them within the interface. Builder Xcessory lets you test and modify the interface without compiling, according to the company.

Because you're manipulating Motif objects, output code exactly matches what you see, the company says. Builder Xcessory outputs C, Motif/User Interface Language, make files, and X Resource files. Because the Builder can read in UIL files, you can use it to modify existing programs.

**Price:** \$2500.

**Contact:** Integrated Computer Solutions, Inc., 201 Broadway, Cambridge, MA 02139, (617) 547-0510, fax (617) 547-0758.

**Inquiry 1189.**

## Programmer's Editor for Windows

CView 1.0 lets you write your Windows application in the Microsoft Windows 3.0 environment and includes the entire C source code.

Eastern Language Systems says that CView features automatic reformatting of files to standard C style, search and replace, and access to Windows SDK help.

**Price:** \$99.

**Contact:** Eastern Language Systems, 39 West 300 North, Provo, UT 84601, (801) 377-4558, fax (801) 377-2200.

**Inquiry 1188.**

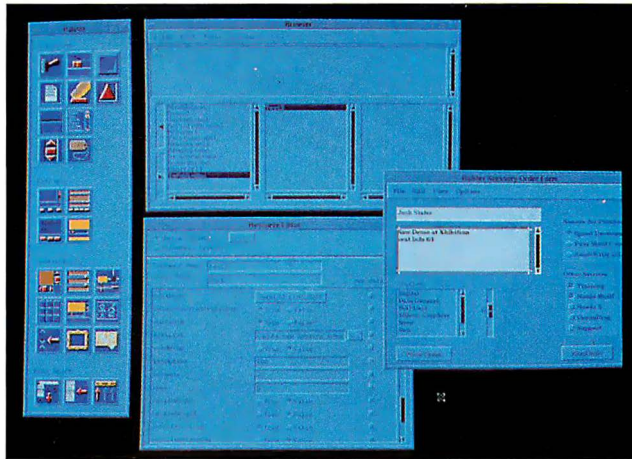

*The Builder Xcessory resource editor lets you view and modify the resources of any Motif widget. The browser lets you navigate the interface hierarchy.*

## Build GUIs for Windows, Mac, Sun

With the Tigre Programming Environment, you can develop color graphical user interfaces that run without modification on Windows 3.0, the Mac II family, and a host of Unix workstations. Written in and based on Objectworks' Smalltalk, the object system comprises the Tigre Interface Designer and the Tigris multiuser object database system.

With the environment, you can develop applications with full-motion video and sound running over a mixed network. Supported workstations include the Sun-3, Sparcstation, IBM RISC System/6000, Digital DECstation, Hewlett-Packard 9000 series, and Apollo Series 2500, 3500, and 4500.

Once you select an interface object that you need and place it on the screen, you can visually control characteristics like position, border weight, and shape. You can graphically set and change the connections between the interface and logic, the company reports. The interface designer includes a library of user interface object classes.

**Price:** \$3495.

**Contact:** Tigre Object Systems, Inc., 3641C Soquel Dr., Soquel, CA 95073, (408) 476-1854, fax (408) 479-4196.

**Inquiry 1187.**

## One-Step Mixed Make in Brief

Turbo Brief enhances Solution Systems' Brief programming editor by letting you choose from two key maps: Turbo Brief's key assignments that are consistent with Borland's Turbo Debugger and Power Brief, a key set that enhances the original Brief key assignments. Turbo Brief's integrated make utility for mixed languages combines warnings from several assemble/compiles into one error window, OurSoft says.

Turbo Brief can jump from one error to the next in different source files and languages like Pascal, C, and assembly without exiting the environment. By a single step with a hot key, you can go right to the offending line.

The program lets you edit, make, debug, compile, and run from within Brief using your favorite debugger.

**Price:** \$199.50.

**Contact:** OurSoft, P.O. Box 6396, Bellevue, WA 98008, (206) 643-0204.

**Inquiry 1190.**

## Object Programming in C

For those wanting to add object functionality to a C program without taking the deep plunge into C++, Bogie Hardware says that its OOC Libraries add message passing, methods, and classes to C programs without special pre-processors. The OOC Libraries do this in several ways.

According to Bogie Hardware, you describe data structures in a program as objects and the functionality of the program in terms of routines, or methods, that operate on those objects. Messages to methods replace subroutine calls. In this case, the libraries replace the use of a compiled object language like C++. You can also use the libraries to create a stand-alone TR prototyping development environment.

TR is an interpreted object language that is accessible through OOC Library function calls. It supports a full compiler and byte-code interpreter and interoperability between C and TR.

You can use the libraries to create a hybrid application program consisting of object C and TR components, creating an application that's partially compiled and partially interpreted, the company says.

The OOC Libraries are the first step in the development of a portable, persistent object storage system, the company says. Programs that use the libraries are portable to the Mac, IBM PC, DEC VAX, and Sun Unix.

**Price:** Single-user license, \$150; network platform starts at \$450.

**Contact:** Bogie Hardware, Inc., 502 Berlin Rd., Pittsburgh, PA 15221, (412) 371-9449, fax (412) 371-0737.

**Inquiry 1186.**



# “WE’VE RESHAPED THE POWER!”

## LANMASTER WORKSTATION . . .

is merely one-fifth the size of an IBM AT™ desk-top system but with all the power and features of a full fledged system!

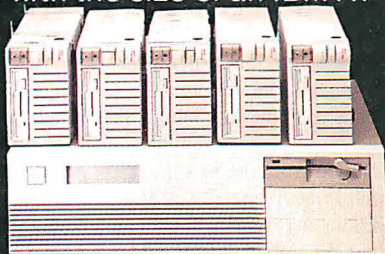

□ This incredible space saving design makes it easy to mount under a desk or counter.



□ Its chassis design ensures superior ventilation to reduce

the operating temperature, thereby giving you a computer that is durable and reliable.

□ The Lanmaster Workstation includes 16 bit expansion slot, 1 MB Ram, 1.44 MB floppy, monochrome monitor and keyboard all for **only \$595**. Also VGA model available. It's the ideal solution for today's office, school and home use.

Also in **TPS's** fine line of computer products is **TPS Notebook**, the uncompromising solution for traveling executives.

Weighing only 7 lbs., the ultra-crisp, paperwhite VGA LCD display with fluorescent back-lighting, 20 MB hard drive and 1.44 MB floppy make **TPS Notebook** the perfect *office-on-the move*.



**TPS**  
TRANS PC SYSTEM

11849 E. Firestone Blvd. • Norwalk, CA 90650  
(213) 868-6930 • (800) 876-9161 • Fax (213) 864-2249

Circle 626 on Reader Service Card (RESELLERS: 627)

## Windows Word Processing for the World

**W**orld View 1.0 is the latest in a series of multilingual word processing programs from Eastern Language Systems. It runs under Windows 3.0 and comes with a customization utility that lets you place any character in any font at any location on the keyboard. The program comes standard with support for the Latin alphabet. You can add layouts for Greek, Russian, Hebrew, and other languages.

**Price:** \$249; each additional language, \$100 each.  
**Contact:** Eastern Language Systems, 39 West 300 North, Provo, UT 84601, (801) 377-4558, fax (801) 377-2200.  
**Inquiry 1195.**

## Up and Down the Volkswriter Line

**V**olkswriter's new word processors share a common user interface and identical keystroke commands. Each version is targeted for a different level of use, letting you jump up and down the line without having to learn a new command set.

Volkswriter 2 is designed for entry-level users. Volkswriter 4 version 2.0, for executives, includes page preview, macros, a 310,000-word thesaurus, and integrated Grammatik IV, Reference Software's grammar checker. Volkswriter 6 has all the features of Volkswriter 4 version 2.0, plus Inset Graphics' technology, for importing, processing, and printing desktop publishing graphics; integrated HP AutoFont support and AGFA; and Compu-graphics' Intellifont scaling technology.

Volkswriter 4 version 2.0 is available now. Volkswriter 2

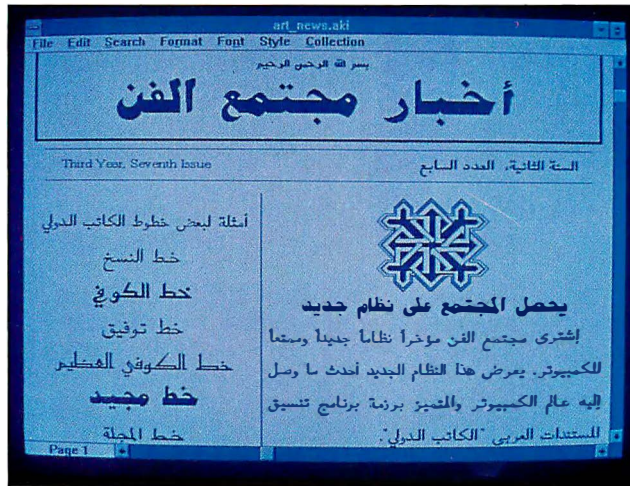

*World View 1.0 displays Greek, Hebrew, Russian, and Latin fonts in WYSIWYG mode.*

should ship by the end of March, and Volkswriter 6 should ship in the second quarter of this year.  
**Price:** Volkswriter 2, \$149; Volkswriter 4 version 2.0, \$249; Volkswriter 6, \$499.  
**Contact:** Volkswriter, Inc., One Lower Ragsdale Dr., Building 2, Suite 100, Monterey, CA 93940, (408) 648-3000, fax (408) 648-3016.  
**Inquiry 1193.**

## Dictionary/Thesaurus for Windows

**T**he Windows version of Language Master, an electronic dictionary/thesaurus/speller, is now available for site licensing. Franklin's Language Master provides complete dictionary definitions for 80,000 words and 40,000 entries from *Merriam-Webster's Collegiate Thesaurus*. The program is also available for DOS and the Macintosh.  
**Price:** \$79.95.  
**Contact:** Franklin Electronic Publishers, Inc., 122 Burrs Rd., Mt. Holly, NJ 08060, (609) 261-4800, fax (609) 261-1631.  
**Inquiry 1191.**

## Shared Word Processing in OS/2

**T**he new version of DeScribe Word Publisher for OS/2 is available in a floating-license network version. It can act as a server or client in Dynamic Data Exchange (DDE) conversations, the company says.

You can assign any text or graphics a tag name for DDE conversations. Through the DDE tags, you can link numbers in DeScribe text to a spreadsheet template with a defined formula that calculates a solution from the numbers, which DeScribe retrieves and positions in text. If you change a tagged number, it will automatically be updated to the correct value.

Version 2.0 lets an administrator define system dictionaries, layouts, and macros for shared use by all users on the network. Twenty-three dictionary options (e.g., medical, legal, and scientific) are available.  
**Price:** Server, \$595; client, \$250; dictionaries, \$149.95 each.

**Contact:** DeScribe, Inc., 4047 North Freeway Blvd., Sacramento, CA 95834, (916) 646-1111, fax (916) 923-3447.  
**Inquiry 1194.**

## Word Processor for Laptops

**L**aptop display technology has come a long way since the days of the barely readable screen, but when you're working in murky light on the road, you may still find yourself straining to see your screen. SkiSoft, publisher of Eye Relief: The Large Type Word Processor for the visually impaired, has developed a program for laptops that lets you work with normal-size text or magnify that text by two, three, or four times on the screen.

Eye Relief for Laptops offers automatic word wrap, margins, headers, footers, and page numbers. Although text appears larger on-screen, it will print normally. Eye Relief for Laptops occupies just 80K bytes of RAM and runs on a single floppy disk drive.

And for those exasperating moments when the only way you can find an invisible cursor is by hitting the Home key, SkiSoft has No-Squint II, which gives your cursor a big and bold appearance on the screen. You can use it to adjust the blink rate of the cursor from very fast to no blink at all, important for epileptics who've found that a blinking cursor can spark a seizure.

No-Squint II supports any laptop PC or desktop PC and any character-based program except for Microsoft Word, SkiSoft says. Supported word processors include XyWrite, WordPerfect, and Microsoft Works.  
**Price:** Eye Relief for Laptops, \$129.95; No-Squint II, \$49.95.

**Contact:** SkiSoft Publishing Corp., 1644 Massachusetts Ave., Suite 79, Lexington, MA 02173, (800) 622-3622 or (617) 863-1876, fax (617) 861-0086.  
**Inquiry 1192.**

# 486 Performance... 386 Price!

Adtech's wide variety of IBM compatible computers will maximize the power of your system while minimizing the cost.

Adtech can customize a computer for any application, including 486 systems.

All Adtech products undergo rigorous testing and diagnostics prior to shipping and are burned-in for at least 24 hours.

Adtech's customer support staff is available to answer any questions.

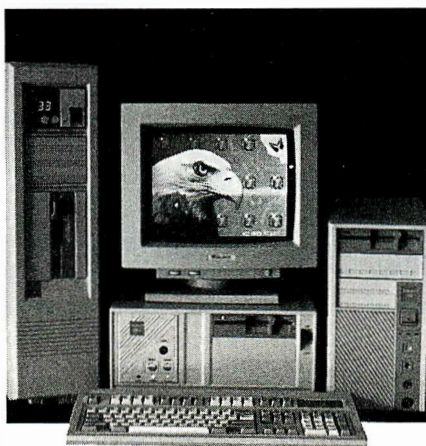

Adtech systems utilize components that are designed and produced by the industries most respected manufacturers. Adtech systems include:

- ◆ Space saving AT style minicase
- ◆ 200 watt power supply
- ◆ 1.2 MB floppy drive
- ◆ 1 Parallel, 2 serial,
- ◆ 1:1 Dual floppy/hard disk controller
- ◆ Keytronics 101 keyboard

## 115 MHz\* 486 \$1599

- ◆ 80486-25 CPU with 8K Cache
- ◆ Cache expandable to 512K
- ◆ 1MB expandable to 16 MB
- ◆ Built-in numeric coprocessor
- ◆ **486-33 Available!**

## 25 MHz\* 386SX \$699

- ◆ 80386 SX CPU running at 20 MHz
- ◆ 1MB expandable to 8 MB on board
- ◆ 80387 SX coprocessor socket
- ◆ Shadow RAM Enable
- ◆ **True 20 MHz SX w/cache available!**

## 33 MHz\* 386 \$899

- ◆ 80386-25 ΣΣ C.P.U.
- ◆ 1MB expandable to 8 MB on board
- ◆ 80387 coprocessor socket
- ◆ Shadow RAM Enable

## 25 MHz\* 286 \$549

- ◆ 80286-20 C.P.U.
- ◆ 1MB expandable to 5 MB on board
- ◆ 80287 coprocessor socket
- ◆ Shadow RAM Enable
- ◆ **True 286-25 CPU available!**

**One year parts and labor warranty  
on all Adtech systems!**

### SYSTEM UPGRADES

1:1 RLL .....	75
1:1 MFM .....	50
Full Size Case .....	25
Full Size Vertical Case .....	100
Mini-Vertical Case .....	35

### MONITORS

#### Includes Monitor & Adapter Card

Monographics 14" (Hi-Res) .....	129
VGA (Mono) 16 bit .....	229
Super VGA (1024 x 768) .....	499

### MOTHER BOARDS

25 MHz* 386 SX .....	399
25 MHz* 286 (w/ 1meg., 1:1, I/O) .....	399
33 MHz* 386 .....	699
<b>115MHz* 486 .....</b>	<b>1399</b>

### HARD DRIVES

40 Meg - Seagate ST-157A (28ms) .....	259
40 Meg - Seagate ST-251-1 (28ms) .....	259
66 Meg - Toshiba (23ms) .....	379
106 Meg - Toshiba (23ms) .....	499

### MISCELLANEOUS

5.25" 1.2 MB Floppy .....	79
3.5" 1.44 MB Floppy .....	79
Logitech Hi-res Mouse (New) .....	89
2400 Baud Modem (4800 Send FAX) .....	99
16 bit VGA (1024 x 768) (512K) .....	129
16 bit VGA (800) x 600 (256K) .....	99

# Adtech

(408) 954-8038 (800) 326-6548

2007 O'Toole Ave., San Jose, California 95131

Terms and conditions. Returns subject to 20% restocking fee. Prices and availability subject to change without notice. RMA # is required for all returns. CA residents add 6.25% sales tax. No surcharge MasterCard and VISA. \*Landmark speed test. 386, 387 and SX are trademarks of Intel Corporation.

## Security, New Budgets in Timeslips

Version 4.0 of the Timeslips III time tracking, billing, and productivity reporting program includes system security. A systems administrator can define up to eight user groups, each with its own password and rights to 27 secured operations, the company says.

The program has four new reports: User-Defined Client reports, Client Budget Worksheet, Client Hold report, and User History report. User-Defined Client reports can contain any of the data on the Client Information or History screens. Through a mail-merge file, you can export data to a spreadsheet for further analysis.

The Client Budget Worksheet lets you compare historical amount billed and amount of work in progress versus budgeted amount. The Client Hold report lets you delay client billing or bill only a portion of an account. The User History report automatically accumulates billable and unbillable hours and fees.

The program runs on DOS systems. The network version requires DOS 3.1 or higher.



*Timeslips' TSTimer feature lets you search user, client, and activity name lists, detailing activities such as phone calls.*

**Price:** \$299.95; network version, \$699.95.

**Contact:** Timeslips Corp., 239 Western Ave., Essex, MA 01929, (508) 768-6100, fax (508) 768-7660.

**Inquiry 1197.**

## LAN Contact Management at Low Cost

Diamond Data Management's Prospector program for lead tracking and prospect qualification offers full network compatibility for under \$200.

Prospector is designed to manage sales prospects or any other kind of list. It supports up to eight prospect lists, with up to 20 form letters per list. You can use the program for mass mailings as a reminder of follow-up calls and mailings. You can define up to five user categories and 10 items per prospect.

Prospector is NetBIOS-compatible and requires DOS 3.1 or higher.

**Price:** \$195.

**Contact:** Diamond Data Management, Inc., 740 Pilgrim Pkwy., Elm Grove, WI 53122, (414) 786-9000.

**Inquiry 1199.**

## Unix Contact Management

The Prospect Management System is a sales, telemarketing, prospect tracking, and analysis program that integrates with other Unix applications.

The program features sales forecasting, on-line prospect history, automatic form-letter generation, and support for multiple sales campaigns and contacts and addresses. You can use the program to track a prospect's interests, demographics, and advertising,

the company says.

The program uses Structured Query Language for its information access, but these commands are transparent to the end user.

**Price:** Starts at \$3800.

**Contact:** Data Code, Inc., 7208 Sand Lake Rd., Suite 202, Orlando, FL 32819, (407) 351-3441, fax (407) 351-5019.

**Inquiry 1200.**

## Stay in Touch with Ease

The new version of Contact Ease, a direct mail and telemarketing program for the Mac, has been optimized to run twice as fast as the previous version and supports multiline searching, WestWare says.

As you set up a marketing plan in Contact Ease 1.2, you can add any number of clients, prospects, or associates to the plan, and the program automatically generates mailing pieces and schedules phone calls according to the time frames you specify. You can test several marketing plans for a target group of contacts and compare the results for each campaign.

The program includes a word processor, Postnet printing capabilities, a telephone dialer, and a call timer. With multiline searching, you can narrow a search for prospects by area code, ZIP code, state, or any other criteria.

The program runs on TOPS, Novell, and AppleShare networks.

**Price:** \$395 for a five-user license.

**Contact:** WestWare, Inc., 10148 Diamond Head Court, Spring Valley, CA 92077, (800) 869-0871 or (619) 660-0356.

**Inquiry 1198.**



*Data Code's Prospect Management System for sales, prospect tracking, and telemarketing is written in Informix-4GL.*

台北

# TAIPEI



## COMPUTEX'91

June 4-10, 1991

Instant access to the world of computers.



### Featuring

Computers

Peripherals

Software

Office automation systems

Data communications

Applications

Mass storage

Components

### Organizers:



CHINA EXTERNAL TRADE DEVELOPMENT COUNCIL



TAIPEI COMPUTER ASSOCIATION

### Sponsor:



TAIPEI WORLD TRADE CENTER

**Venues:** TWTC EXHIBITION HALL  
CETRA EXHIBITION HALL

**Contact:** TWTC EXHIBITION HALL  
5 Hsinyi Road, Section 5, Taipei, Taiwan  
Republic of China  
Tel: (02)725-1111 Fax: 886-2-725-1314  
Telex: 28094 TPEWTC

TAIPEI COMPUTER ASSOCIATION  
3Fl., No. 2 Pa Teh Rd., Sec. 3, Taipei, Taiwan  
Tel: (02)7764249 Fax: (02)7764410

### Branch Offices:

• New York-CETDC, Inc.  
Tel: (212)532-7055 Fax: (212)213-4189  
• San Francisco-Far East Trade Service, Inc.  
Tel: (415)788-4304 Fax: (415)788-0468  
• Chicago-Far East Trade Service, Inc.  
Tel: (312)819-7373 Fax: (312)819-7377

Taipei  
Trade  
Shows  
1991

Circle 609 on Reader Service Card

## Paradox 3.5: SQL Without the Syntax

At the September general meeting of the Triangle Computer Society (NC), a representative of Borland International (Scotts Valley, CA) discussed the latest version of Paradox (3.5) and the company's aim for a database that insulates you from the complexities of Structured Query Language (SQL).

Speaking to a crowd of about 50, David Luvinson demonstrated how the program lets you use the Paradox interface to work with data on a SQL server and the program's Query by Example (QBE) method of forming relations between data. Paradox 3.5's SQL Link automatically

translates Paradox commands into SQL and sends them to the server, doing all the syntax work so you don't have to.

During the presentation, Luvinson stressed Paradox's ability to manipulate tabular views of data, multi-table forms, and table bands in tabular reports. He also provided examples of QBE methods of obtaining and summarizing data from various tables. For the finale, he showed the graphing capabilities of Paradox.

Future meeting topics of the Triangle Computer Society (contact Robert Bean at (919) 932-9635) include printers in February, Unix in March, faxes in April, networking in May, and the Amiga and Arexx in June.

—Robert Bean

## GeoWorks Unveils Less-Filling GUI

Microsoft has been riding the crest of the Windows 3.0 wave for the past few months, but with the public unveiling of GeoWorks Ensemble, GeoWorks brings a new surfboard to the graphical-user-interface party.

At the October meeting of the Boston Computer Society's IBM PC Users Group, four GeoWorks representatives (Berkeley, CA) traveled to Wellesley, Massachusetts, for the first public showing of the environment that offers most of OS/2's benefits and all the windowing management of Windows and Presentation Manager, while still running on an 8088-based PC.

To prove this point, the company set up a table that showed the program running a Hercules-equipped 640K-byte IBM XT on the low end, and a 386 on the high end. For the actual demonstration of the product, the company used a 286. Lee Llevano, vice president of marketing, said, "Most people were pretty amazed that you could get that kind of performance on an XT."

The demonstration focused on GeoWorks Ensemble's ability to run on all levels of hardware, GeoManager (the graphical file manager), its preemptive multitasking capability, and the WYSIWYG word processor.

GeoWorks Ensemble is small, requiring only 100K bytes of RAM.

—Dave Andrews



# VIMAGER

## MAKES YOUR CREATIVITY FLY HIGH!

A Complete Video Imaging Solution for Your VGA Publishing & Presentation Environment

**VIDEO INPUT**

- Video Camera
- Camcorder
- Broadcast Television
- Video Cassette Recorder
- Electronic Still Photography Camera

**ENDLESS APPLICATIONS**

- Animation
- Desktop Publishing
- Education
- Graphics Presentation
- Industrial Inspection
- Insurance
- Merchandising
- Newsletters
- Portraits
- Real Estate
- Security
- Sports

**REAL TIME IMAGE CAPTURE**

- 1/60 Second Per Field
- 1/30 Second Per Frame
- Software Programmable Image Brightness and Contrast

**IMAGE EDITING SOFTWARE**

- Grab The Image
- Crop The Image
- Store Images in Various File Formats For Desktop Publishing & Graphics Presentation Programs
- Extensive Image Enhancement Programs



**Vimagery**  
Model-10

**AI Tech**

1574 Centre Pointe Drive  
Milpitas, California 95035

408/946-3291

800/882-8184

408/946-6901 (FAX)

**DEALER AND DISTRIBUTOR INQUIRIES WELCOME**





## Nutrition Analysis for Windows

**D**ine Windows II, a nutritional-analysis and diet-improvement program that runs under Microsoft Windows, includes a database of more than 5600 foods and 24 food components, as well as a database of almost 200 activities and exercises. The new version lets you expand the database.

An optional statistics/graphics program analyzes data using line and bar charts, scatter plots, and statistical analyses. As you enter your meals, the program can provide a rating on a scale of from 1 to 10 that compares the actual diet with dietary guidelines.

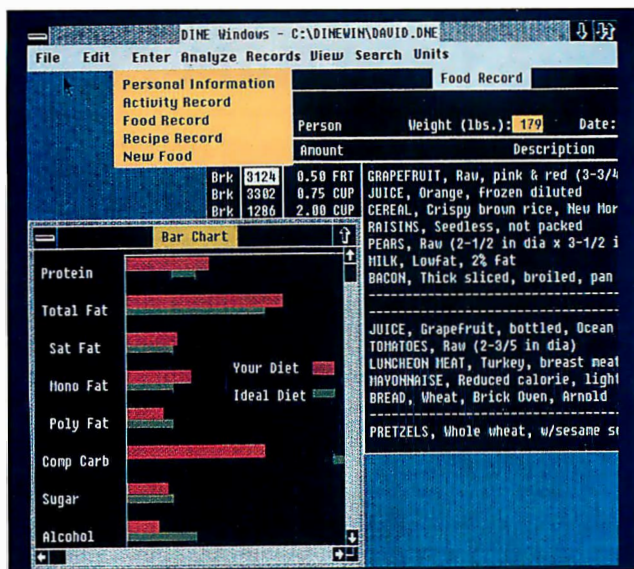

The statistics module for Dine Windows II lets you analyze data using a variety of charts.

**Price:** \$295; statistics module, \$50.  
**Contact:** Dine Systems, Inc., 586 North French Rd.,

Suite 2, Amherst, NY 14228, (716) 688-2492, fax (716) 688-2505. **Inquiry 1201.**

## Make Your Windows Display Big

**A**ristocad's new Windows 3.0 utility, More Windows, increases the application area of VGA and EGA screens, providing a virtual screen that lets you pan past the normal borders of your application. The company says that the program is an alternative to buying larger and more expensive display systems when you need to view several applications.

**Price:** \$99.  
**Contact:** Aristocad, Inc., 6920 Koll Center Pkwy., Suite 211, Pleasanton, CA 94566, (800) 338-2629, (800) 426-8288, or (415) 426-5355, fax (415) 426-6703. **Inquiry 1202.**

Leasing  
Now Available

### Digitizers

**Calcomp**  
**All Models,**  
**CALL for Savings**

#### Summagraphics

Sketch II 12 x 12, 4-But .....	340
Sketch II 12 x 12, 16-But .....	427
Sketch Pro II 12 x 18, 16-But .....	585
Large Formats .....	Call

<b>Kurta</b>	
12 x 12, 4 Puck Stylus .....	345
12 x 12, 12-But Corded .....	435
12 x 17, Corded Puck .....	585
30 x 36, 16-But .....	2015
36 x 48, 16-But .....	2394

<b>GTCO</b>	
Sketch Master 12 x 12 .....	319
SL 24 x 36 .....	Super Pricing
SL 36 x 48 .....	Super Pricing
<b>Hitachi</b>	
Puma 12x12, 4 or 12-But ...	375
Tiger 12x12, 12-But .....	648

### Complete CAD Workstations

Each system fully configured including 2 Serial Ports, 1 Parallel Port, corresponding Math CoProcessor, Enhanced "AT" 101 Keyboard, 1.2MB Floppy, DOS 3.3, GW-Basic, **SUMMAGRAPHICS SUMMASKETCH PLUS, EVEREX VGA GRAPHICS CARD and EVEREX MODEL 300-01 (15-35KHz) MULTISCAN COLOR MONITOR.** Each system thoroughly tested prior to shipment and supplied with a Full One Year On-Site Warranty!!!

System Configuration	Cache Memory	44MB MFM	80MB MFM	92MB ESDI	150MB ESDI
Everex Step 486/33 w/8MB	128Kb	-----	-----	\$7595	\$7795
Everex Step 486/25 w/8MB	128Kb	-----	-----	6595	6795
Everex Step 386/33 w/4MB	64Kb	5495	5595	6095	6295
Everex Step 386/25 w/4MB	64Kb	4695	4895	5295	5495
Everex Step 386/20 w/4MB	64Kb	4295	4495	4895	5095

### Monitor & Card Combos

Graphics Card	Only	w/ Mitsuo 19" HL6905	Hitachi 21" 4320-21AP	Hitachi 20" CM2085M	Nanao 16" 9070S	Nanao 9070U
Metheus 1228	\$1690	3689	4300	3585	-----	-----
Metheus 1224	1260	3259	3870	3155	-----	-----
#9 GX Level 2	785	2784	3395	2680	1760	1862
#9 GX Level 4	1295	3294	3905	3190	-----	-----
Rendition II/16VGA	1130	3129	3740	3025	2105	2207
Rendition II/256VGA	1505	3504	4115	3400	2480	2582
VMI Cobra 16HS	1350	3349	3960	3080	2325	2427
Video 7 VRAM 512	380	2379	3039	2275	1374	1457
Monitor Only		1999	2610	1895	975	1077

The above is a partial listing of our product line. Please inquire if you're interested in a product not listed. All names are trademarks and registered trademarks of their respective companies.

• Quoted prices reflect a 2% cash discount.  
• Prices subject to change without notice.  
• All manufacturers' warranties apply.

**We Carry a Complete Line of Modems, Network Boards & Accessories, Math & Memory Chips, Surge Protection**

#### INVENTORY REDUCTION

**5% Discount on All Purchases thru 12/31/90**

**Plotters-All Models**

Calcomp  
HP  
Houston Instruments  
Ioline  
Roland

• Rated companies call for terms.  
• C.O.D., Lease, VISA, Mastercard & Amex.  
• Member Better Business Bureau.

#### CAD Buster \$12,500.00

**EVEREXSTEP 386/33 w/8MB\* SIMM, 150MB ESDI Hard Drive**

Includes Renaissance Rendition II 16" Color with VGA Module, Hitachi CM-2085M or Mitsubishi HL-6905 19" Color Monitor, A thru D 8-Pen Plotter, 12 x 12 Digitizer your choice of three. \*5MB minimum requirement for AutoCAD/386. Delivery limited to continental U.S.A.

**1-800-289-1650**  
6760 Miller Road • Brecksville, Ohio 44141

**CAD WAREHOUSE**

© This ad copyright November 1990. ESI Automated Office Systems



# Microcom Computers

A HRW Technologies Company



<b>Standard System Features:</b> * Teac 5.25" 1.2 MB or 3.5" 1.44 MB Diskette Drive * 1:1 Interleaved Hard/Floppy Drive Controller * Enhanced 101-key Keyboard * 2 Serial & 1 Parallel Port & Real Time Clock/Calendar w/Battery * High Capacity 200 Watt System Power Supply * Small Footprint Case(14.875" W x 16.25" D x 6.75" H) * Tower Case w/230 Watt Power Supply (386/25C, 386/33C & 486/25C)						<b>Our Commitment to Service and Quality</b> * 1 Year Warranty on Parts & Labor * Toll-free Technical Service & Support * No Surcharge on Credit Card Purchases (VISA/MasterCard) * Comprehensive 72 Hour Burn-in Testing on All Systems * All Systems Made with pride in the USA <b>Microcom Mouse (Great for Windows) \$29.99</b> Hi-Resolution 3-Button Microsoft-compatible Mouse (up to 432 dpi)																																			
<b>Microcom 286/12 Systems (1 MB RAM)</b> Standard System, Hard Drive, Monitor & Video Card						<b>286/12 Hires Package (w/1 MB RAM) \$1,199</b> * 286/12 System w/42 MB 25 ms IDE Hard Disk * 5.25" 1.2 MB Drive & 3.5" 1.44 MB Drive * 14" Color Hires Monitor (1024 x 768) * 16-bit Hires 1024 x 768 VGA Graphics Card * Microsoft Windows 3.0 & DOS 3.30 or 4.01																																			
<table border="1"> <thead> <tr> <th>Hard Drives:</th> <th>IDE</th> <th>IDE</th> <th>IDE</th> <th>IDE</th> <th>ESDI</th> </tr> <tr> <th>MB/Ms</th> <th>42/25</th> <th>80/16</th> <th>105/16</th> <th>205/16</th> <th>340/16</th> </tr> </thead> <tbody> <tr> <td>Mono</td> <td>\$749</td> <td>\$949</td> <td>\$999</td> <td>\$1,349</td> <td>\$2,149</td> </tr> <tr> <td>VGA-Mono</td> <td>\$899</td> <td>\$1,099</td> <td>\$1,149</td> <td>\$1,499</td> <td>\$2,299</td> </tr> <tr> <td>VGA Hires</td> <td>\$1,149</td> <td>\$1,349</td> <td>\$1,399</td> <td>\$1,749</td> <td>\$2,549</td> </tr> </tbody> </table>						Hard Drives:	IDE	IDE	IDE	IDE	ESDI	MB/Ms	42/25	80/16	105/16	205/16	340/16	Mono	\$749	\$949	\$999	\$1,349	\$2,149	VGA-Mono	\$899	\$1,099	\$1,149	\$1,499	\$2,299	VGA Hires	\$1,149	\$1,349	\$1,399	\$1,749	\$2,549	<b>386SX/16 Hires Package (w/4 MB RAM) \$1,799</b> * 386SX/16 System w/42 MB 25 ms IDE Hard Disk * 5.25" 1.2 MB Drive & 3.5" 1.44 MB Drive * 14" Color Hires Monitor (1024 x 768) * 16-bit Hires 1024 x 768 VGA Graphics Card * Microsoft Windows 3.0 & DOS 3.30 or 4.01					
Hard Drives:	IDE	IDE	IDE	IDE	ESDI																																				
MB/Ms	42/25	80/16	105/16	205/16	340/16																																				
Mono	\$749	\$949	\$999	\$1,349	\$2,149																																				
VGA-Mono	\$899	\$1,099	\$1,149	\$1,499	\$2,299																																				
VGA Hires	\$1,149	\$1,349	\$1,399	\$1,749	\$2,549																																				
<b>Microcom 386SX/16 Systems (1 MB RAM)</b> Standard System, Hard Drive, Monitor & Video Card						<b>386/25 Hires Package (w/4 MB RAM) \$2,299</b> <b>386/25C Hires Package (w/4 MB RAM) \$2,499</b> * 386/25 or 386/25C System w/105 MB 16 ms IDE Hard Disk * 5.25" 1.2 MB Drive & 3.5" 1.44 MB Drive * 14" Color Hires Monitor (1024 x 768) * 16-bit Hires 1024 x 768 VGA Graphics Card * Microsoft Windows 3.0 & DOS 3.30 or 4.01																																			
<table border="1"> <thead> <tr> <th>Hard Drives:</th> <th>IDE</th> <th>IDE</th> <th>IDE</th> <th>IDE</th> <th>ESDI</th> </tr> <tr> <th>MB/Ms</th> <th>42/25</th> <th>80/16</th> <th>105/16</th> <th>205/16</th> <th>340/16</th> </tr> </thead> <tbody> <tr> <td>Mono</td> <td>\$1,049</td> <td>\$1,249</td> <td>\$1,299</td> <td>\$1,649</td> <td>\$2,449</td> </tr> <tr> <td>VGA-Mono</td> <td>\$1,199</td> <td>\$1,399</td> <td>\$1,449</td> <td>\$1,799</td> <td>\$2,599</td> </tr> <tr> <td>VGA Hires</td> <td>\$1,449</td> <td>\$1,649</td> <td>\$1,699</td> <td>\$2,049</td> <td>\$2,849</td> </tr> </tbody> </table>						Hard Drives:	IDE	IDE	IDE	IDE	ESDI	MB/Ms	42/25	80/16	105/16	205/16	340/16	Mono	\$1,049	\$1,249	\$1,299	\$1,649	\$2,449	VGA-Mono	\$1,199	\$1,399	\$1,449	\$1,799	\$2,599	VGA Hires	\$1,449	\$1,649	\$1,699	\$2,049	\$2,849	<b>386/33C Hires Tower Package (w/4 MB RAM) \$2,999</b> * 386/33C System w/205 MB 16 ms IDE Hard Disk * 5.25" 1.2 MB Drive & 3.5" 1.44 MB Drive * 14" Color Hires Monitor (1024 x 768) * 16-bit Hires 1024 x 768 VGA Graphics Card * Microsoft Windows 3.0 & DOS 3.30 or 4.01					
Hard Drives:	IDE	IDE	IDE	IDE	ESDI																																				
MB/Ms	42/25	80/16	105/16	205/16	340/16																																				
Mono	\$1,049	\$1,249	\$1,299	\$1,649	\$2,449																																				
VGA-Mono	\$1,199	\$1,399	\$1,449	\$1,799	\$2,599																																				
VGA Hires	\$1,449	\$1,649	\$1,699	\$2,049	\$2,849																																				
<b>Microcom 386/25 Systems (1 MB RAM)</b> for 64 KB Cache (in Tower Case), add \$200 Standard System, Hard Drive, Monitor & Video Card						<b>486/25C Hires Tower Package (w/8 MB RAM) \$3,999</b> * 486/25C System w/205 MB 16 ms IDE Hard Disk * 5.25" 1.2 MB Drive & 3.5" 1.44 MB Drive * 14" Color Hires Monitor (1024 x 768) * 16-bit Hires 1024 x 768 VGA Graphics Card * Microsoft Windows 3.0 & DOS 3.30 or 4.01																																			
<table border="1"> <thead> <tr> <th>Hard Drives:</th> <th>IDE</th> <th>IDE</th> <th>IDE</th> <th>IDE</th> <th>ESDI</th> </tr> <tr> <th>MB/Ms</th> <th>42/25</th> <th>80/16</th> <th>105/16</th> <th>205/16</th> <th>340/16</th> </tr> </thead> <tbody> <tr> <td>Mono</td> <td>\$1,299</td> <td>\$1,499</td> <td>\$1,549</td> <td>\$1,899</td> <td>\$2,699</td> </tr> <tr> <td>VGA-Mono</td> <td>\$1,449</td> <td>\$1,649</td> <td>\$1,699</td> <td>\$2,049</td> <td>\$2,849</td> </tr> <tr> <td>VGA Hires</td> <td>\$1,699</td> <td>\$1,899</td> <td>\$1,949</td> <td>\$2,299</td> <td>\$3,099</td> </tr> </tbody> </table>						Hard Drives:	IDE	IDE	IDE	IDE	ESDI	MB/Ms	42/25	80/16	105/16	205/16	340/16	Mono	\$1,299	\$1,499	\$1,549	\$1,899	\$2,699	VGA-Mono	\$1,449	\$1,649	\$1,699	\$2,049	\$2,849	VGA Hires	\$1,699	\$1,899	\$1,949	\$2,299	\$3,099	<b>Microcom 386/33C Tower Systems (1 MB RAM/64 KB Cache)</b> Standard System, Tower Case, Hard Drive, Monitor & Video Card					
Hard Drives:	IDE	IDE	IDE	IDE	ESDI																																				
MB/Ms	42/25	80/16	105/16	205/16	340/16																																				
Mono	\$1,299	\$1,499	\$1,549	\$1,899	\$2,699																																				
VGA-Mono	\$1,449	\$1,649	\$1,699	\$2,049	\$2,849																																				
VGA Hires	\$1,699	\$1,899	\$1,949	\$2,299	\$3,099																																				
<table border="1"> <thead> <tr> <th>Hard Drives:</th> <th>IDE</th> <th>ESDI</th> <th>IDE</th> <th>ESDI</th> <th>ESDI</th> </tr> <tr> <th>MB/Ms</th> <th>105/16</th> <th>150/16</th> <th>205/16</th> <th>340/16</th> <th>650/16</th> </tr> </thead> <tbody> <tr> <td>VGA-Mono</td> <td>\$2,949</td> <td>\$3,299</td> <td>\$3,299</td> <td>\$4,099</td> <td>\$5,049</td> </tr> <tr> <td>VGA Hires</td> <td>\$3,199</td> <td>\$3,549</td> <td>\$3,549</td> <td>\$4,349</td> <td>\$5,299</td> </tr> </tbody> </table>						Hard Drives:	IDE	ESDI	IDE	ESDI	ESDI	MB/Ms	105/16	150/16	205/16	340/16	650/16	VGA-Mono	\$2,949	\$3,299	\$3,299	\$4,099	\$5,049	VGA Hires	\$3,199	\$3,549	\$3,549	\$4,349	\$5,299	<b>Introducing the Revolutionary New Microcom Palm-size Desktop 286/16 Computer. (Just 9.4" x 7.3" x 1.8") \$1,999</b> Its so small that it fits in the palm of your hands! * Powerful 16 MHz 80286 Microprocessor * 3.5" 1.44 MB Diskette Drive * 42 MB 25 ms IDE Hard Disk (80, 100 & 200 MB Hard Disks Optional)											
Hard Drives:	IDE	ESDI	IDE	ESDI	ESDI																																				
MB/Ms	105/16	150/16	205/16	340/16	650/16																																				
VGA-Mono	\$2,949	\$3,299	\$3,299	\$4,099	\$5,049																																				
VGA Hires	\$3,199	\$3,549	\$3,549	\$4,349	\$5,299																																				
<b>Wait, we're not finished yet! Also Introducing the Powerful New Microcom 486/33C Tower System \$5,699</b> 20 MIPS (million instructions per second) at your fingertips! * Based on Intel's Powerful i80486-33 CPU * 4 MB RAM Standard with Advanced 128 KB Cache * 205 MB 16 ms IDE Hard Disk (340 & 650 MB ESDI Hard Disks Optional)						* 9" Color Monitor w/Hires VGA Graphics Card (up to 1024 x 768) * One expansion slot, One parallel and Two Serial Ports * Ethernet LAN Network Adapter Built-in * 82-key Mini Keyboard, Carrying Bag and Mini Tower Stands																																			
<b>And coming soon... Microcom Palm-size Desktop 386/33 Computer and Microcom Lightweight Notebook Portables</b>						* 5.25" 1.2 MB Drive & 3.5" 1.44 MB Drive * 14" Hires Monitor w/16-bit Hires VGA Graphics Card (1024 x 768) * Tower Case w/230 Watt Power Supply * Microsoft Windows 3.0 & DOS 3.30 or 4.01																																			
<b>Microcom Computers' Customers Include:</b> Xerox, GTE, Motorola, Raychem, General Electric, Hewlett-Packard, Eastman Kodak, SEGA of America, Toshiba, Genetech, Bechtel, Siemens, Holiday Inn, Pacific Gas & Electric, Pacific Bell, Wells Fargo Bank, NASA, U.S. Court of Appeals, U.S. Food & Drug Administration, U.S. Dept. of Energy, U.S. Dept. of Agriculture, U.C. Berkeley, U.C. San Francisco, Stanford University, Princeton University, University of Pittsburg, University of Vermont, Lawrence Livermore National Laboratories, John Muir Medical Center and many, many more.																																									

## To Order - Call Toll Free 1-800-248-3398

Open from 9:00 A.M. to 6:00 P.M. PST, Monday-Friday

48890 Milmont Drive, Suite 103D, Fremont, CA 94537 - 3650-18th Street, San Francisco, CA 94110 - Fax: (415)623-3628

Prices are subject to change without notice. Not responsible for typographical errors. CA residents please add 7.25% sales tax. No surcharge on credit card purchases. Personal and company use acknowledged. Tower is a registered trademark of NSR Corporation. Microcom Computers reserves the right to substitute any and all items with equivalent or better parts. All benchmarks and so vary from system to system. Prices do not include shipping and handling.

Circle 620 on Reader Service Card

## Automatic Document Indexing for the PC

**M**any word processors let you create an index as you prepare a document, but this often involves marking each word and phrase that you want included. Help Software's PC-Index creates an index automatically from any WordPerfect, Microsoft Word, WordStar, or ASCII document.

Although the program creates the index automatically, you control which words are included. You can create a list of words or phrases to include or a list of words to discard. The standard discard list that comes with the program contains

1000 of the most commonly used words in the English language. The standard discard list is customizable.

If you like to work in chapters, PC-Index can create an index from a group of related files. The program requires an IBM PC with 640K bytes of RAM.

**Price:** \$79.

**Contact:** Help Software, 16706 Bradley Court, Belton, MO 64012, (816) 331-5809. **Inquiry 1203.**

## Speak English Like a Native

**N**onnative English speakers who wish to improve their pronunciation and acquire an American accent can now use Speak Easy. Using a

microphone, speaker or earphones, and a digital sound card, you speak into the IBM PC, which digitally captures what you say. You can then replay what you said and compare it to a digitally recorded American voice. You can re-record and compare to this voice as often as necessary.

The program comes in two versions: Professional, with 22 MB of speech, or Personal, with 12 MB. Both versions include a sound card, microphone, speaker, headset, and software.

**Price:** Professional, \$995; Personal, \$595.

**Contact:** Speak Easy Language Learning Software, 1914 Corinth Ave., Suite 211, Los Angeles, CA 90025, (213) 479-3274, fax (213) 478-6875.

**Inquiry 1204.**

## Best Price Hardware Database

**F**or bargain hunters and businesses alike, the Computer Buyer's Best Price Database provides information on hardware vendors and the prices of their wares. The program provides multiple telephone numbers for each vendor and technical information.

The program requires 512K bytes of RAM on a DOS system.

**Price:** Before June 1, \$150 for a 12-month subscription (12 monthly updates); after June 1, \$300.

**Contact:** Business Computer Systems, 4990 Poplar, Suite 324, Memphis, TN 38117, (901) 753-1196.

**Inquiry 1205.**

# Attention U.S. BYTE Subscribers

**Watch for the next BYTE DECK mailing that will be arriving in your mailbox soon!**

Use this as a fast, convenient tool to purchase computer products and services. It's loaded with essential hardware and software products that you should be aware of when making your buying decisions...and it's absolutely FREE!

If you have a computer product or service, and would like to reach 275,000 influential BYTE magazine subscribers, please give Ed Ware a call today at (603) 924-2596.

**BYTE  
DECK**

Here's what a BYTE Deck advertiser has to say:

*"Ten years ago we advertised in the very first BYTE Deck—the number of sales leads we received was enormous! The BYTE Deck was so successful for us, that we have continued to use it over the past ten years!"*

Lisa Tarpoff, Marketing Manager, Heath Company, Benton Harbor, MI

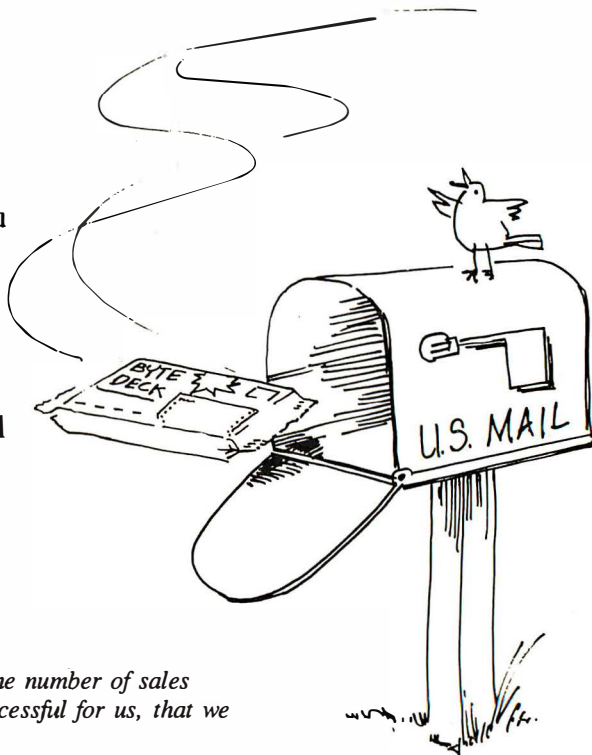

# DATAWARE and NEC

## WORKING FOR YOUR FUTURE

**NEC Desktop Systems:**  
Powermate Systems  
Businessmate Systems  
Powermate Portables

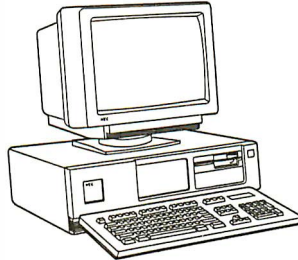

286 386SX  
386 486

286V 286  
SX/20 CSX



**NEC Laptop Systems:**  
Ultralite Notebook  
Prospeed

**NEC Monitors:**  
MCGA  
VGA  
Super VGA  
Multiscan  
Macintosh II Video  
IBM 8514/A

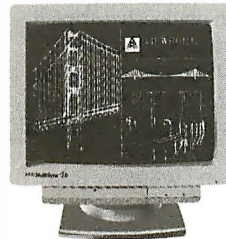

GS2A 2A  
3D 4D  
5D

*Pinwriter*  
*Silentwriter*  
*Colormate*

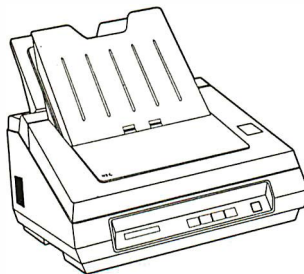

**NEC Printers:**  
Dot Matrix  
Laser  
Thermal Transfer  
Color  
Postscript

### Service and Supplies:

**NEC's Premier Northeast Service Center**  
Full support and service on all  
**NEC Technologies products**  
Complete stock of all NEC Printer Supplies



**NEC Graphics and Optical**  
Media  
Cables  
Graphics Boards  
CD-ROM Drives

# NEC

DATAWARE PRODUCTS, INC.  
295 University Ave  
Westwood, MA. 02090



(617) 461-1160 / 800-242-4DPI; Fax: (617) 461-0083

Circle 612 on Reader Service Card

## Borland Reveals Turbo Pascal for Windows

The listing in the Boston Computer Society's *Update* newsmagazine said that Borland International would introduce a "new programming language," but company representatives ended up disclosing much more.

At a special event held at the Copley Westin Hotel, a company official revealed Borland is at work on a version of Turbo Pascal that will run under Microsoft Windows and produce true Windows applications.

Borland official Gene Wang came to the Boston Computer Society meeting to introduce Turbo Pascal 6.0,

but in the course of answering questions about the new program, he confirmed work on the Windows version.

"I'm glad you asked that question," Wang said to the BCS member who asked about Turbo Pascal's compatibility with Windows and Quarterdeck's Desqview. "We were going to wait until Comdex, next week, to show some of our early work on this," Wang said, "but we decided to give the Boston Computer Society members the first glimpse at Turbo Pascal for Windows."

Wang's colleagues then started an obviously scripted demonstration of the new product. "As you can see on the screen, Turbo Pascal for Windows is a hosted graphical interface for Windows [in other words, Windows pro-

vides the user interface]; it uses the MDI, or Multiple Document Interface, for handling multiple files," Wang said.

"Notice that the dialog box for compiler options has the usual check boxes, radio buttons, and input fields. . . but it also has these awesome-looking three-dimensional push buttons."

Wang demonstrated compiling and running a simple demonstration program; while the first program was still running, Wang compiled and ran a Pascal adaptation of Charles Petzold's Hex Calculator application.

"Turbo Pascal for Windows is the beginning of a whole new product line for Windows applications development. What you saw here was a look at some research-and-

development efforts at Borland."

The company will deliver Turbo Pascal for Windows sometime in the first half of this year, Wang said. [Editor's note: *For more information on Turbo Pascal 6.0 for Windows, see the January BYTE, page 126.*]

Wang stressed that Borland's DOS program line will continue, and that Turbo Pascal's Turbo Vision application is a good introduction to object-oriented, message-passing architectures like Windows and Presentation Manager. Wang declined to answer further questions on Borland's Windows product line; however, developers attending the meeting said they are working with alpha-test versions of Turbo C++ for Windows.

—Martin Heller



PUT YOUR  
CUSTOMER SERVICE CENTER  
ON BIX

■ BIX is more than just a great on-line information service. It's a community made up of thousands of the most serious computer users in the world; people like your customers, who are always on the look-out for the latest innovations and information regarding both hardware and software. Now you can set up shop in this electronic neighborhood with your own BIX *Technical Support Conference*. That way, you can give your customers all the product information and technical support they need. Use it to post updates or fixes for your customers to download at any time. If your company doesn't operate an 800 number, a BIX conference is an inexpensive alternative. Or it can back up an existing 800 line. And when you establish a BIX conference you'll enhance your product's value because you'll be able to offer your customers special rates on BIX subscriptions. For all the details, call Customer Service at: 1-800-227-2983 (in NH, call 603-924-7681).

# BIX

# New EasyCAD 2.60 Tops the #1 Rated CAD Software

## ▶ Number 1 in user satisfaction—PC Week poll.

In competition against other top CAD software for performance, hardware compatibility, ease of use and value, EasyCAD 2.05 handily won the award that counts most—User Satisfaction. Now the best is even better.

## ▶ You Pay Only \$169.95 for the Program CAD Users Rate Number 1.

PC WORLD said it best, "This easy-to-learn program is blindingly fast, and its flexibility, wealth of features and

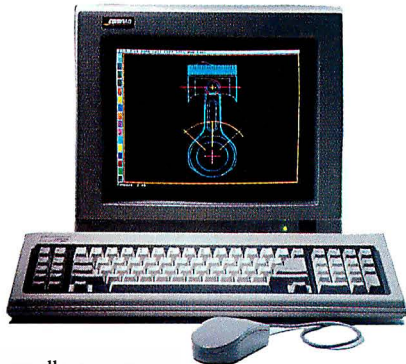

excellent user interface match those of professional programs costing thousands of dollars more."

In fact, because it is written entirely in assembly language experts say new EasyCAD 2.60's speed rivals CAD packages costing up to twenty times more. So why spend well over \$2000 to get



what EasyCAD 2.60 can deliver for just \$169.95?

## ▶ Expanded, productivity-boosting associative dimensioning.

EasyCAD 2.60's associative dimensioning feature allows you to rotate, stretch or change the scale factor of a drawing and all dimensions are instantly updated to reflect the change. This includes ordinate, angle, radius and diameter as well as other dimension formats. You never have to erase or re-enter dimensions.

## ▶ Whisk through even the largest drawings.

An enhanced memory manager lets you work through the largest drawings faster than ever.



Plot to file means you can store drawings on disk now and send it to the printer later. And version 2.60 supports PostScript printer fonts and line weight controls.

## ▶ More features, less money—guaranteed.

No other CAD software gives you so many features for so little money (and a 30-day money back guarantee):

Customizeable pull-down menus, script and macro capabilities that automate complex or repetitive tasks, DXF for exchanging drawings and files with other CAD programs and spread sheets. The list goes on.

Call (602) 967-8633 now for more information, plus the name of your nearest dealer. If you already own EasyCAD, ask about our special 2.60 upgrade offer.



EVOLUTION  
**EasyCAD 2**  
COMPUTING

437 S. 48th St., Ste. 106  
Tempe, AZ 85281-9936  
1(800)874-4028

Circle 628 on Reader Service Card

© 1991 Evolution Computing  
EasyCAD2 is a registered trademark of Evolution Computing

# BET ON A DERBY WINNER...



## 486/25C-200 PRO

- Intel 80486-25, 32-bit
- 8MB RAM, 64K Cache
- 200MB Hard Drive 15ms
- 1.2MB 5 1/4" Drive
- 1.44MB 3 1/2" Drive
- 1024X768 16-bit VGA, 1 MB
- Color Super VGA Monitor
- 2 Serial, Parallel, Game Ports
- DOS 4.01 & MS Windows 3.0
- Microsoft Mouse, 400 dpi
- Mid-size Tower Case

**\$4,295.00**

## 386/33C-200 PRO

- Intel 80386-33, 32-bit
- 4MB RAM, 64K Cache
- 200MB Hard Drive 15ms
- 1.2MB 5 1/4" Drive
- 1.44MB 3 1/2" Drive
- 1024X768 16-bit VGA, 1 MB
- Color Super VGA Monitor
- 2 Serial, Parallel, Game Ports
- DOS 4.01 & MS Windows 3.0
- Microsoft Mouse, 400 dpi
- Mid-size Tower Case

**\$3,295.00**

## 386/33C-100 PRO

- Intel 80386-33, 32-bit
- 4MB RAM, 64K Cache
- 100MB Hard Drive
- 1.2MB 5 1/4" Drive
- 1.44MB 3 1/2" Drive
- 1024X768 16-bit VGA, 1 MB
- Color Super VGA Monitor
- 2 Serial, Parallel, Game Ports
- DOS 4.01 & MS Windows 3.0
- Microsoft Mouse, 400 dpi
- Mid-size Tower Case

**\$2,895.00**

## 386/25-100 PRO

- Intel 80386-25, 32-bit
- 4MB RAM
- 100MB Hard Drive
- 1.2MB 5 1/4" Drive
- 1.44MB 3 1/2" Drive
- 1024X768 16-bit VGA, 1 MB
- Color Super VGA Monitor
- 2 Serial, Parallel, Game Ports
- DOS 4.01 & MS Windows 3.0
- Microsoft Mouse, 400 dpi
- Mid-size Tower Case

**\$2,595.00**

### DERBY DELIVERS

**One Year Warranty**

**72 Hour Burn-in Testing**

**All Systems built in the USA**

**Toll Free Technical Support**

**Life Time Technical Support**

**30 Day Money Back Guarantee  
(Less any shipping charges)**

**Hours: 9:00 to 6:00 Mon-Sat**

**Shipping & Handling: \$45.00**



**No Surcharge**



## 386/25-65 PRO

- Intel 80386-25, 32-bit
- 4MB RAM
- 65 MB Hard Drive
- 1.2MB 5 1/4" Drive
- 1.44MB 3 1/2" Drive
- 1024X768 16-bit VGA, 1 MB
- Color Super VGA Monitor
- 2 Serial, Parallel, Game Ports
- DOS 4.01 & MS Windows 3.0
- Microsoft Mouse, 400 dpi
- Mid-size Tower Case

**\$2,495.00**

## 386/SX-100 PRO

- Intel 80386 SX
- 2MB RAM
- 100 MB Hard Drive
- 1.2MB 5 1/4" Drive
- 1.44MB 3 1/2" Drive
- 1024X768 16-bit VGA, 1 MB
- Color Super VGA Monitor
- 2 Serial, Parallel, Game Ports
- DOS 4.01 & MS Windows 3.0
- Microsoft Mouse, 400 dpi
- Mid-size Tower Case

**\$1,995.00**

## 386/SX-65 PRO

- Intel 80386 SX
- 2MB RAM
- 65MB Hard Drive
- 1.2MB 5 1/4" Drive
- 1.44MB 3 1/2" Drive
- 1024X768 16-bit VGA, 1 MB
- Color Super VGA Monitor
- 2 Serial, Parallel, Game Ports
- DOS 4.01 & MS Windows 3.0
- Microsoft Mouse, 400 dpi
- Mid-size Tower Case

**\$1,895.00**

## 286/12-40 PRO

- Intel 80286-12 16-bit
- 2MB RAM
- 40MB Hard Drive
- 1.2MB 5 1/4" Drive
- 1.44MB 3 1/2" Drive
- 1024X768 16-bit VGA, 1 MB
- Color Super VGA Monitor
- 2 Serial, Parallel, Game Ports
- DOS 4.01 & MS Windows 3.0
- Microsoft Mouse, 400 dpi
- Mid-size Tower Case

**\$1,495.00**

**DerbyTech  
Computers  
Inc.**

# 1-800-24-DERBY

718 - 15th Avenue / East Moline / Illinois / 61244 / (309) 755-2662

Circle 613 on Reader Service Card (RESELLERS: 614)

**DerbyTech  
Computers  
Inc.**





# A PACK OF LAPTOPS

Getting away from it all to write takes more computers than you might think

**O**ne amusing way to spend an afternoon: try setting up a Desqview system without manuals. Of course, a story goes with it.

We have recently acquired use of a beach house. Even I don't know the phone number here. The idea of having a place to write is working, too; I've done two chapters of the sequel to *The Mote in God's Eye* and caught up on a bunch of other stuff. I can even work on this column down here.

This is possible because computers are now small enough that I can travel and still keep my computing environment. The basic idea is sound: carry not only your work, but your favorite environment: Desqview, Windows, Tornado, Norton Commander, your word processor, MathCAD—whatever you like, as well as what you can't do without.

In my case, I brought the Zenith SupersPort SX, a smaller Zenith MinisPort HD with a hard disk drive (for taking around to the beach and in my bicycle backpack), the TravelMate 2000 notebook computer from Texas Instruments, and the Ergo Brick, which is a 386SX that's smaller and lighter than the MinisPort HD. (The Brick doesn't have batteries, the power supply is external, and there's no screen.)

I also brought down a Northgate Computer Systems OmniKey Plus keyboard in the "Pournelle" layout (the oversize Backspace key is to the right of the *P*, where God intended it to be) and an Ultra-14 monitor from Princeton Graphic Systems, which, in the words of a colleague, is "some kind of monitor." Both work with either the Brick or the Super-

sPort SX; that is, the SupersPort SX has both keyboard and VGA ports as well as the built-in keyboard and supertwist screen. The keyboard and the monitor work just fine with the SupersPort SX. You do have to remove the computer's battery before you can plug in the external monitor, which means that you're not able to use the battery as an uninterruptible power supply, but that's only annoying, not fatal.

The neat part about this setup is that when I'm done, I simply unplug the external keyboard and monitor and leave them behind; all my work has been saved onto the SupersPort SX (and on a floppy disk for backup), so I am carrying it with me wherever I go next.

The SupersPort SX is plenty powerful enough for anything I'm likely to do here. It runs Desqview just fine, and even though it doesn't have as much extended/expanded memory as the Brick, it has enough to keep my word processor, Norton Commander, and a communications program going simultaneously. It runs Microsoft QuickBASIC, so I can work on Mrs. Pournelle's Reading Program if I'm inclined to. It will run Windows 3.0 if you attach a mouse. Anticipating that, I brought a Logitech TrackMan trackball, but any serial mouse would do. All told, the SupersPort SX is a lot more machine than I had at Chaos Manor three years ago.

The only problem with the SupersPort SX/Ultra-14/OmniKey Plus combination is that many programs have to be told whether they're being used by a color or monochrome setup, generally through command-line switches; thus, switching from monochrome to color can be a bit tedious if you're using Desqview. You can use batch files for programs that use a command-line switch. An example is Q&A Write, which uses various documented switches to change over to monochrome—and an *undocumented* switch, `QW -a`, to restore it to full VGA color.

I can, therefore, recommend the Su-

persPort SX not only as a portable, but as one's only machine. My fellow science fiction writer Norman Spinrad has for several years used a previous Zenith portable as his only machine. He's worked in locations from Hollywood to Moscow and done several books with it, and he has no complaints. The SupersPort SX is blooming heavy to lug around—but I like it enough that I do lug it. It is, in a word, good enough.

## Again the Brick

My other alternative is the Ergo Brick, which I wrote about last month; this is a machine with a footprint the size of a sheet of paper. It stands 4 inches high and is as powerful as any 386SX. Mine has a 220-megabyte hard disk drive, two serial ports, and a bunch of features, including a built-in 2400-bps modem.

You can't have everything: if the modem is active, you can have only one serial port; if you use the modem and a mouse, you don't have any. I discovered all this while using LapLink to transfer files from the SupersPort SX to the Brick: I could disable the modem and use the COM2 port, disconnect the mouse and use the COM1 port, or use the printer ports. I finally did the latter.

I found one serious problem with the Brick: the cursor control keys were almost useless because the key repeat rate was set preposterously fast. If I used the Backspace key, I could either tap it one space at a time or risk losing half a page of text when the auto-repeat took over. Similarly, auto-repeat on the cursor keys would take you down a whole page before you could let go.

Now if Ergo Computing had used DOS 4.01, that wouldn't be a problem, because in DOS 4.0 and above the MODE command will let you set the key repeat rate. That feature will also be in DOS 5.0. However, Ergo has—wisely in my judgment, because I do not recommend DOS 4.x—used DOS 3.3+ for the Brick, and the too-rapid key repeat was not

merely an annoyance, but a major difficulty.

A call to Ergo technical support got me the information that they'd work on the problem. Next day I got another message: they had a fix. I could dial into their BBS, or they'd mail me a disk to do the job.

I opted for the disk. What came was a bootable disk with files and control software in the AUTOEXEC.BAT; when I booted up, it offered the opportunity to revise my BIOS, also warning me to be sure that the process went to completion once it started, since any interruption would render my machine useless.

There weren't any lightning storms going on, so I told it to go ahead: with the result that my BIOS electrically erasable programmable ROMs were rewritten. Ergo has thoughtfully put EEPROMs in the Brick for just this purpose. The process took about 10 minutes; when it was done, the key repeat rate wasn't too fast any longer. In fact, it's a tad slow, and I am going to suggest they do it again, this time making it about twice as fast as it is now. This ability to change the BIOS on the fly is a neat feature of the Brick.

### Setting Up Desqview

The Brick comes bundled with quite a bit of Desqview software, and Ergo has set things up so that many programs load on start-up. Ergo furnishes all the documentation with any programs bundled in with their machine, but I didn't bring all that stuff to the beach house.

I've always known that there is some way to make Desqview open windows on start-up, but I never knew how it was done. I'm sure it's somewhere in the Desqview manual, but a reasonably diligent search of the index and table of contents didn't find it the last time I looked. It didn't seem important. My normal practice is to open Norton Commander in window one, Q&A Write in a batch file that also loads Word Finder in window two, and leave everything else to be done as I need it. It doesn't take me 20 seconds to load those two programs, so I never really cared much.

To start up the Brick, though, I had to wait for six programs to load, close each one's window, and go to the Desqview Rearrange command and set the screen back to 25 rows and 80 columns, since the Brick has Desqview shift it to 50

rows, and I don't want tiny letters when I'm writing. It took an hour to figure out what was going on, but by diligent use of Norton Commander's View File feature, I found it.

The secret is in the script name. When you first start up Desqview, you begin building a macro—they call it a script—by doing whatever you want the system to do on start-up. When you're asked for the script name, begin it with an exclamation point: !STARTUP will do, but in fact it could be !foo for all the system cares. The result will be a script named desqview.dvs, and it will run when you first invoke Desqview.

You want to be careful about doing that, though: the usual way to change that script is to start over again. If you get at all confused redoing that macro (script), you can build a script that locks the machine; at least I did. The simple remedy is to delete desqview.dvs and open your windows manually until you are completely sure what you want Desqview to do on start-up.

However, there's a better way: Notepad, the mini editor utility that comes with Desqview, knows how to edit the

# WorldPort compatibility, Toshiba™ portability.

Touchbase Systems

now gives Toshiba's complete line of low-power,

super-lightweight portables

with 2400 bps data or 2400 bps with MNP® 5

with 2400 bps data or 2400 bps with MNP® 5

super-lightweight portables

Touchbase Systems, Inc.  
160 Laurel Avenue  
Northport, NY 11768  
(516) 261-0423  
Fax (516) 754-3491

Call Now For Details: 800-541-0345

# Everything You Ever Wanted In UNIX. And Less. \$99.95\*

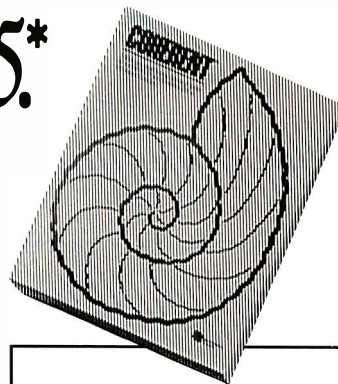

OK. We know it's hard to believe. So just consider this. Coherent™ is a virtual clone of UNIX. But it was developed independently by Mark Williams Company. Which means we don't pay hundreds of dollars per copy in licensing fees.

What's more, Coherent embodies the original tenet of UNIX: small is beautiful. This simple fact leads to a whole host of both cost and performance advantages for Coherent. So read on, because there's a lot more to Coherent than its price.

## SMALLER, FASTER... BETTER.

Everybody appreciates a good deal. But what is it that makes small so great?

For one thing, Coherent gives you UNIX capabilities on a machine you can actually afford. Requiring only 10 megabytes of disk space, Coherent can reside with DOS. So you can keep all your DOS applications and move up to Coherent. You can also have it running faster, learn it faster and get faster overall performance. All because Coherent is small. Sounds beautiful, doesn't it?

But small wouldn't be so great if it didn't do the job it was meant to do.

LESS IS MORE!	Coherent For the IBM-PC/AT and compatible 286 or 386 based machines.	Santa Cruz Operation's XENIX 286, Version 2.3.2
No. of Manuals	1	8
No. of Disks	4	21
Kernel Size	64K	198K
Install Time	20-30min.	3-4 hours
Suggested Disk Space	10 meg	30 meg
Min. Memory Required	640K	1-2 meg
Performance*	38.7 sec	100.3 sec
Price	\$99.95	\$1495.00

\*ByteExec benchmark, 1000 iterations on 20 MHz 386. Hardware requirements: 1.2 meg 5 1/4" or 1.4 meg 3 1/2" floppy, and hard disk. Does not run on Microchannel machines.

## EVERYTHING UNIX WAS MEANT TO DO.

Like the original UNIX, Coherent is a powerful multi-user, multi-tasking development system. With a complete UNIX-compatible kernel which makes a vast world of UNIX software available including over a gigabyte of public domain software.

Coherent also comes with Lex and Yacc, a complete C compiler and a full set of nearly 200 UNIX commands including text processing, program development, administrative and maintenance commands plus UUCP.

## CRITICS AGREE: IT'S AN INCREDIBLE VALUE!

*"Mark Williams Co. seems to have mastered the art of illusion; Coherent comes so fully qualified as a UNIX clone, you find yourself thinking 'I can't believe it's not UNIX.'"*

—Sean Fulton, UNIX Today!, November 26, 1990

*"...(Coherent) may be the best thing that has happened to UNIX yet."*

—William Zachmann, PC Week, November 5, 1990

*"If you want to come as close as you can to real UNIX for a low price, COHERENT can't be beat."*

—Warren Keuffel, Computer Language Magazine, November 1990

*"If you want a UNIX-like development and learning system for less than \$100...I don't see how you can go wrong with Coherent."*

—David Fiedler, BYTE Magazine, November 1990

## EXPERIENCE, SUPPORT AND A 60-DAY MONEY BACK GUARANTEE.

Wondering how something as good as Coherent could come from

## NEW COHERENT RELEASE 3.1 NOW WITH...

- elvis: vi editor clone
- SCSI (Adaptec AHA 154x series and more on the way) and ESDI support
- UUCP Bulletin Board System
- RAM disk support
- And much, much more!

**OVER 10,000 SATISFIED USERS!**

nowhere? Well it didn't. It came from Mark Williams Company, people who've developed C compilers for DEC, Intel, Wang and thousands of professional programmers.

We make all this experience available to users through complete technical support via telephone. And from the original system developers, too!

Yes, we know \$99.95 may still be hard to believe. But we've made it fool-proof to find out for yourself. With a 60-day money-back no-hassles guarantee.

You have to be more than just a little curious about Coherent by now. So why not just do it? Pick up that phone and order today.

You'll be on your way to having everything you ever wanted in UNIX. And for a lot less than you ever expected.

**1-800-MARK WMS**  
(1-800-627-5967 or 1-708-291-6700)  
FAX: 1-708-291-6750  
**60-DAY MONEY BACK GUARANTEE!**



**Mark Williams Company**  
60 Revere Drive  
Northbrook, IL 60062

\*Plus shipping and handling. Coherent is a trademark of Mark Williams Company. UNIX is a trademark of AT&T. XENIX is a trademark of Microsoft.

# POWER DEBUGGING

## BOUNDS-CHECKER

*Finds out-of-bounds memory accesses —  
AUTOMATICALLY.*

Flush out those Nasty pointer problems and other out-of-bounds memory accesses — AUTOMATICALLY.

Each time you make a change to a program, run BOUNDS-CHECKER while testing the new code. If you accidentally access out-of-bounds memory, BOUNDS-CHECKER will pop up displaying the offending SOURCE LINE. And your program runs at full speed.

### Ship Bug-Free Products

You can run BOUNDS-CHECKER while testing your program. There are no additional steps to your testing cycle, but you can feel secure when the program has passed through BOUNDS-CHECKER with no reported problems.

Many over-write problems and other out-of-bounds memory accesses do NOT show up during normal testing. An out-of-bounds memory location may be modified, but that particular location doesn't happen to be important at the time. Once the program is in the field and a certain network is loaded or a certain T&SR or device driver is loaded, that memory location suddenly becomes very important... AND THE SYSTEM CRASHES.

You can prevent these problems by making BOUNDS-CHECKER a standard part of your testing procedure.

*Gives you the protection of a protected operating system under MS-DOS.*

BOUNDS-CHECKER uses the 386 virtual machine technology to provide real-time memory protection. In addition BOUNDS-CHECKER uses the symbolic information output by your compiler to differentiate CODE and DATA. When your program is running, BOUNDS-CHECKER protects the program's CODE and all memory outside your program.

Requires 386 PC.  
MS-DOS is a trademark of Microsoft Corporation.  
386 is a registered trademark of Intel Corp.



*"BOUNDS-CHECKER and Soft-ICE make sophisticated use of the most powerful versions of Intel's processor family to track down some of DOS programming's most insidious bugs. If you're developing programs for DOS, these are essential tools."*

PC Magazine  
July, 1990 pg. 48

### Soft-ICE 2.5 New Version, New Features

The only debugger specifically designed to solve those problems unique to MS-DOS that we call the DOS Nasties.

- Memory over-writes
- Hung programs
- Program too big to debug
- Debugging T&SRs and Loadable Drivers
- Multiple Symbol Tables
- Supports Microsoft C 6.0 & Turbo C++

### Windows Developers Run CODEVIEW for Windows on a Single Monitor

*Nu-Mega has done it again!*

**CV/1™ \$129**

*Call Today, Have it Tomorrow*

BOUNDS-CHECKER .....	\$249
Soft-ICE 2.5 .....	\$386
MagicCV 3.0 .....	\$199
CV/1™ .....	\$129

#### Special Offer...

Buy BC & S-ICE .....	Save \$100
Buy S-ICE & MCV .....	Save \$86
Buy all three .....	Save \$186

*30 Day Money-Back Guarantee*



CALL TODAY (603) 888-2386 or FAX (603) 888-2465

P.O. BOX 7780 ■ NASHUA, NH ■ 03060-7780 ■ U.S.A.

Desqview script files. Nothing else will do it, because the script files contain control characters and such; but Notepad translates those characters into something you can read and lets you edit them as you like. The result is very powerful: you can make a highly complex Desqview script.

Anyway, it took me a while, but I got the Brick reconfigured to what I want; and it will now travel with me to the beach house and back.

### Notebooks and Laptops

I brought several laptops with me in addition to the SupersPort SX, which is in theory usable as a laptop—I've often used it in business class on airplanes—but is pretty heavy for that work.

Actually, I brought four: that beach house had more computing power than the U.S. government did when I was an undergraduate. There was Toshiba-San, the faithful Toshiba T1000 that Roberta relies on; the Texas Instruments Travel-Mate (TM) 2000; the MinisPort HD; and the Poquet PC. The notion was to test which machines were up to being stuffed into my backpack and taken out for

**T**he Ergo Brick will now travel with me to the beach house and back.

walks, or bicycle rides, along the boardwalk, with stops for note taking and general writing as the mood seized me—clearly not a task for the SupersPort SX, much as I like it.

Each of the four has strengths and weaknesses.

The Poquet is a DOS machine, with lots of extra features. My problem is that I can't write with it: the keyboard is just too small for me. It is *not* too small for someone who does two-finger typing; indeed, the Poquet's keyboard is somewhat better than the Atari Portfolio's, with large square keys that have a good feel.

Alas, they're just too close together for me to get my fingers on the home keys. I have noticed, though, that touch-typists with very small hands are able to use it.

The Poquet is a full computer, and you can get peripheral equipment like floppy disk drives. I'm not fond of it: I find the screen small and hard to read, the keyboard small and hard to use, and the computer a bit underpowered for what I want to do. On the other hand, it really will fit in your pocket; it weighs about as much as the Z88 but is smaller. Some people like the Poquet a lot.

The TM 2000 is about the size of the Z88, but it's a clamshell: it opens to reveal a screen that is much larger than the Z88's. Indeed, it's nearly as large as the SupersPort SX's screen and much larger than the MinisPort HD's screen. Unlike with the Poquet, screen brightness and contrast are adjusted manually, rather than by tapping keys. I find manual contrast adjustment much easier, and so has everyone else I have discussed it with.

The MinisPort HD, like the TM 2000, has a small (20 or 40 MB) hard disk drive and no internal floppy disk drive. Each has an optional external 3½-inch floppy

**SAVE 30 MINUTES  
EVERY TIME YOU  
HAVE A PC PROBLEM!**

**NEW VERSION 3.0  
Now Available!**

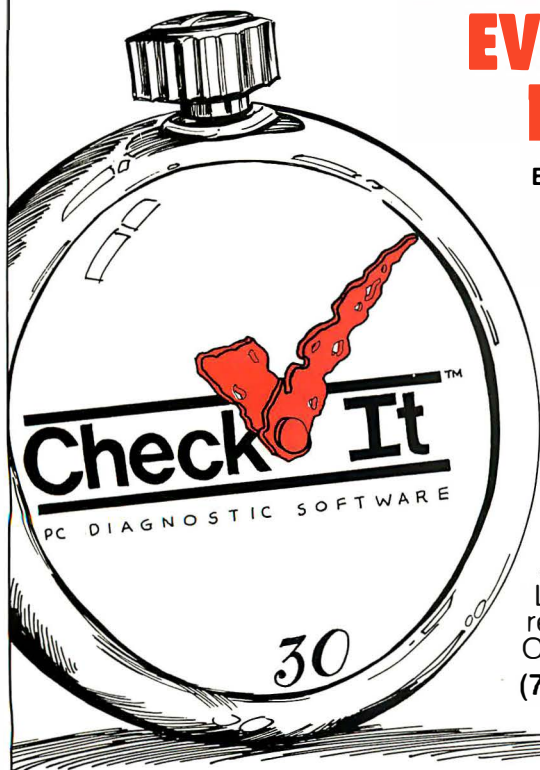

By using Check✓It® to find out if the problem is Hardware or Software

The second you suspect a problem with your PC, you should reach for Check✓It, the world's most popular PC diagnostic software. Running Check✓It should be the first thing you do -- because confirming or eliminating your PC's hardware as the source of the problem can save you time, money, and unnecessary repair calls.

Check✓It will test your PC's main system board, memory, hard disk drive and floppy disk drives, video subsystem, communication ports, printer, keyboard, mouse, or joystick. Check✓It will also display key software and setup data, including your PC's exact equipment configuration, current IRQ assignments, memory allocation, device drivers, and CMOS table.

Take a minute to run Check✓It the next time you have a PC problem. Then you'll know the answer to these key questions: Should you back it up, pack it up, and send it out for repair? Should you fix a hardware problem yourself? Or, should you concentrate on the software and configuration problems that you can correct?

The moment you suspect a PC problem, run Check✓It.  
It's about time!

Look for Check✓It at leading retail stores everywhere,  
Or call TouchStone TODAY!

(714) 969-7746 or (800) 531-0450

**TouchStone**  
Software Corporation

2130 Main Street, Suite 250, Huntington Beach, CA 92648

Check✓It is a registered trademark of TouchStone Software Corporation. Copyright ©1990 TouchStone Software Corporation. ALL RIGHTS RESERVED.



**NEW  
"Basic  
PC Maintenance"  
Hands-On Video  
Ask for it  
TODAY!**

## Finally, a fast, powerful text editor that integrates your favorite programming tools and uses no memory!

# VEDIT PLUS

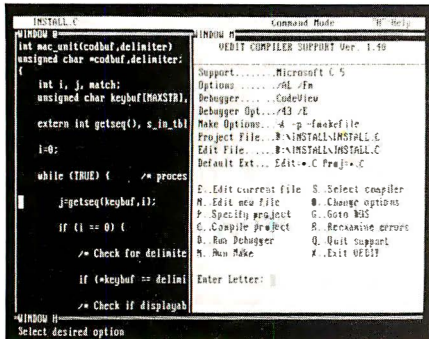

- Mouse support
- Pull-down menus
- Columnar blocks
- 1000 Level Undo
- Regular Expressions
- Small 70K, super fast
- DOS, UNIX/XENIX, FlexOS
- Also VEDIT \$69, VEDIT Jr. \$29



## FREE Evaluation Copy Call 1-800-45-VEDIT

The new VEDIT PLUS is the productivity breakthrough programmers have been looking for. Run not only popular compilers, but all of your favorite tools from within the editor. When shelling to DOS, VEDIT swaps itself and any desired TSRs out of memory to give you more memory than when you entered VEDIT.

Only VEDIT gives you the advantages of a powerful and flexible editor without giving up the convenience of an integrated environment.

VEDIT offers stunning performance, versatility and ease of use. Completely written in assembly language, it's small and lightning fast. Edit text and binary files of any size, even 100+ megabytes. Installation is trivial; VEDIT.EXE and an optional help file are all you need - no overlays, no configuration files.

Other features include multiple file editing, windows, unlimited keystroke macros, "hot keys", context sensitive help, word processing, automatic indenting and total configurability. VEDIT has been the choice of 100,000 programmers, writers and engineers since 1980.

VEDIT PLUS adds a powerful "off the cuff" macro programming language, complete with source level debugging.

VEDIT PLUS - \$185 for DOS, \$285 for UNIX/XENIX. Call for a free demo today.

## Greenview

P.O. Box 1586, Ann Arbor, MI 48106  
(313) 996-1299 \* Fax (313) 996-1308

78 BYTE • FEBRUARY 1991

disk drive. The TM 2000's floppy disk drive attaches directly to the machine, while the MinisPort HD's drive uses a cable.

The TM 2000's screen is larger, and better, than that on the MinisPort HD. After working with the TM 2000, the other screen looks small and dull; indeed, compared to the TM 2000's monochromatic VGA screen, the MinisPort HD's screen is small and dull.

The TM 2000 has one exceedingly annoying "feature": all its external connectors are equipped with small plastic covers. These are unattached to the machine, so it's dreadfully easy to lose them; indeed, I got sick of keeping track of them and used duct tape to cover the openings. This isn't pretty, but it does keep the dust out. The MinisPort HD's port covers are hinged to the case, so the problem doesn't arise.

The MinisPort HD has a handle; the TM 2000 does not. The TM 2000's screen is nicer, but the MinisPort HD's screen folds back more conveniently. And so forth.

The acid test for these two machines was to take them out to the beach on a bright sunny day and try to write notes with them; and that produced a definitive result. Under those conditions, it was almost impossible to see the TM 2000's screen. The MinisPort HD's screen, although smaller, was visible enough that I could write several pages of GrandView notes; I wasn't able to do anything very useful with the TM 2000.

Mind you, as soon as we got inside, I preferred the TM 2000's screen to that of the MinisPort HD; but so long as we were out in the bright sunlight, the MinisPort HD was clearly better. Incidentally, both of these screens are visible in light that is dim enough to make the Z88 completely useless, and both are preferable to the Z88's screen no matter what the light conditions.

### My One and Only

I certainly won't be bringing a half dozen computers with me every trip, so I'm going to have to make a decision. That will probably be the Brick for inside work and the MinisPort HD as my carry-around notebook. Note, however, that Roberta will hang onto the TM 2000, preferring that to the T1000.

If I were setting up an office and had to settle for one and only one computer, and that computer had to be portable, I'm pretty sure I'd still choose the Brick. The reason is simple: while the SupersPort SX will do everything the Brick will and can be a laptop to boot, it does not have

slots; and in these days of universal fax, that may make all the difference. The Brick has three half-card slots, meaning that I can, if I like, stuff one of the small fax boards in there.

On the gripping hand, you can send both fax and teletypes through MCI Mail. Spinrad has used a Zenith laptop as his only machine for years, and he's plenty happy; and I have very good reason to know that Zenith makes these machines rugged.

### Info Select

Last time, I mentioned Tornado, the free-form notepad and database that some people can't live without. Info Select is Micro Logic's update to Tornado.

Real improvements include the ability to insert blank spaces at the beginnings of lines, a whole bunch of housekeeping improvements and minor bug fixes, and the capability to use EMS memory. There is a decided improvement to the manual: it's larger, and everything is explained in more detail. Alas, sometimes the details can get tedious, but stick with it; an hour spent browsing through the manual may save you a hundred hours a year. Tornado certainly had the capability for saving a lot of time, and this is an improved Tornado.

It takes two dense pages to explain how to convert from Tornado to Info Select format, and when you've finished reading that, you don't know a lot more than when you started. However, the conversion itself isn't hard. One warning: if you're one of those who can't live without any notes you've made, be sure that you copy your old piles (now called *stacks*) before trying the conversion.

One improvement is the ability to dial your phone (assuming you have a modem): this means that Info Select can take your Tornado phone file and use that to call numbers. I confess I don't myself use this; I find it's about as easy to punch in the numbers myself. Some people swear by it, though.

Dubious improvements over Tornado include a hard-to-use HyperCard generator, and something I don't think is an improvement at all: the notes now tile rather than stack, so that notes never overlap. This has the effect of making things marginally neater while giving less information per screen. I liked the old system a lot better.

I also liked the older name. "Info Select" sounds like a bad TV quiz show. "Tornado" had class.

Like Tornado, Info Select is capable of changing your life; it really is easy to use, it works fine with Desqview and

# MINUTEMAN<sup>®</sup>

## UNINTERRUPTIBLE POWER SUPPLIES

### TOTAL POWER PROTECTION

- ★ BLACKOUTS
- ★ BROWNOUTS
- ★ OVERVOLTAGE
- ★ UNDERVOLTAGE
- ★ SURGES
- ★ SPIKES
- ★ EMI/RFI

### STANDBY UPS MODELS

- 250 VA To 2300 VA
- Sinewave output - 1 millisecond transfer time
- Communications interface and external battery packs available for extended run times

### ON-LINE UPS MODELS

- 500 VA To 5,000 VA
- Static By-pass Standard
- True On-Line - Sinewave outputs
- Communications Interface and external battery packs available for extended run time

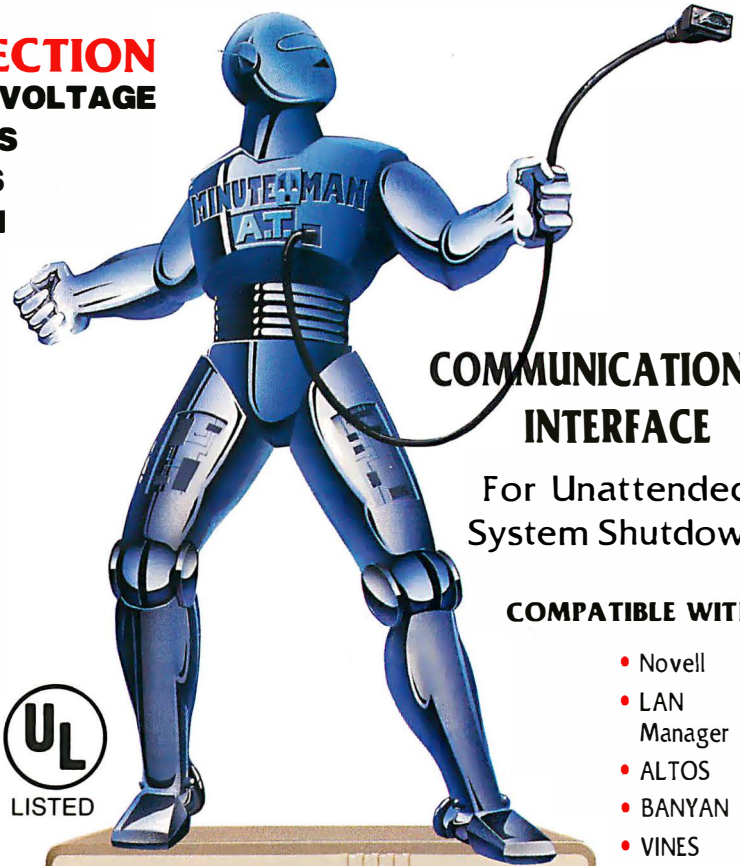

### COMMUNICATIONS INTERFACE

For Unattended System Shutdown

### COMPATIBLE WITH:

- Novell
- LAN Manager
- ALTOS
- BANYAN
- VINES
- System V
- UNIX
- Custom Configuration Any System



### NETWORK MANAGER

- Shutdown software for unattended operation
- Only software to communicate with LANs and WANs
- Novell 286 VAP and 386 NLM
- SCO Xenix

### SLIMLINE & UPRIGHT MODELS

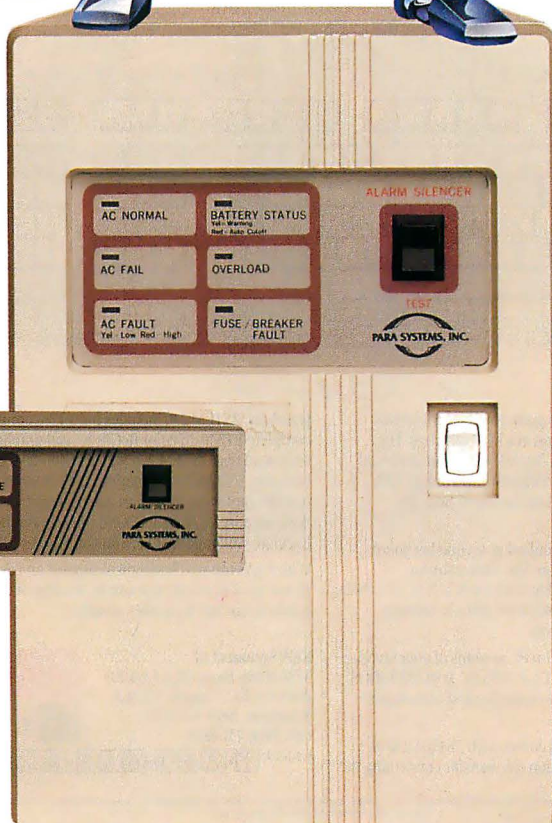

**NOVELL**  
Monitor Boards Available

FOR L.A.N.  
NOVELL LABS  
TESTED AND  
APPROVED  
NetWare Compatible



1455 LeMay Drive  
Carrollton, TX 75007

Telephone:  
(214) 446-7363

FAX: (214) 446-9011 TELEX: 140275 OMEGA

**1-800-238-7272**

"Distributed in over eighty countries"

Windows (or as a TSR program under your word processor), and it will, once you're in the habit of using it, take care of much of the stuff that's now kept on Post-it Notes and the backs of old envelopes. Recommended, even with the wimpy new name.

**Trilogy**

I don't know if a new language can make a place for itself in the microcomputer world, but if one can, it might be Trilogy.

There are now two implementations. One is from the original group headed by Dr. Voda; the other is from another of the language's designers and published by Vertical Software (VS), a division of AI Software—which, in fact, turns out to be a set of pretentious names for a company whose only product is Trilogy. They have, however, done a pretty good job of packaging, and the Trilogy environment they have developed is neat.

Trilogy is interesting: it combines fea-

tures of Prolog, a logic interpreter language in which you make statements and ask questions and let the language solve the problem for you, and Pascal, a procedural language in which you have to tell the computer what to do in tedious detail. Prolog has no variable typing. Trilogy isn't as strongly typed as Pascal, but it does have type declarations and type checking during compilation.

Trilogy has graphics capabilities; I haven't yet decided whether they're good enough to use for games, but I think they are: and if so, Trilogy would be an excellent language for game designers.

VS Trilogy produces stand-alone compiled code, although that's not obvious from the manual. The marketing manager tells me there's no attempt at obtaining licensing fees or royalties on programs written in VS Trilogy, although the "licensing agreement" on the disk envelope implies the opposite; they say they will change that immediately and are notifying everyone that they never intended to require anyone to get their permission to sell compiled products.

I've written just enough code in Trilogy to become intrigued by it. I do not know the language's future; Vertical Software is putting considerable effort into marketing it, but it's very hard for new languages to break in. I certainly would not recommend that major companies use Trilogy for writing a new spreadsheet or database, although it might produce a better one than the more customary languages do.

On the other hand, I can recommend Trilogy to those who like to experiment with computer languages and programmers who are looking for an edge in writing programs with complex logic, such as strategy games. It would also be my language of choice for experimenting with programs to build expert systems.

**The XyWrite Experience**

It all started when my collaborator Steve Stirling sent me eight or nine chapters of our new Falkenberg novel, *Tell the Spartans*: he'd saved them into one big WordPerfect file. Jim Baen, our publisher, is anxious to get this book, so he undertook to convert from WordPerfect to ASCII so that I could read and comment on what Steve had done. Alas, he merely ran the file through Word for Word, and the result was a 330K-byte file. Q&A Write, my word processor, couldn't handle that large a file on its best day; so I was stuck with finding a word processor/text editor that I could live with.

For several years, Baen has been telling me that I ought to try XyWrite III

For the **Ctrl** you've been waiting to **Find** in DEC terminal emulation, **Select** the PowerStation keyboard.



The *PowerStation* keyboard gives you the control you need for key-by-key emulation of a DEC terminal. The *PowerStation* is an exact VT200/VT300 layout keyboard that plugs into your PC. The *PowerStation* brings VAX applications to your PC without having to hunt for re-mapped keys.

Here's the opportunity to standardize on one keyboard throughout your organization. The *PowerStation* keyboard has been designed to work on PCs, XT's, AT's, PS/2's, and the AT&TPC. You can switch effortlessly between real VT's and the *PowerStation*.

The *PowerStation* lets you run PC versions of your favorite VAX applications, including EDT+, WPS-PC, WPS-PLUS/DOS, and nu/TPU. And the keyboard can be used with regular DOS applications.

The *PowerStation* keyboard comes with ZSTEM 240 or ZSTEM 220 terminal emulation software for connecting to

your VAX. ZSTEM 240 includes full VT24i emulation and complete V1340 16 color ReGIS & sixel graphics. If you only need text, ZSTEM 220 will give you fast, accurate and complete VT220/320 emulation. ZSTEM includes file transfer protocols, as well as extensive network capability, with support for Novell, 3COM, Ungermann-Bass, Excelan, Wollongong, FTP, Sun and DEC's CTERM and LAT. With KEA's top-notch technical support and documentation, plus a solid warranty, you can be assured of quality products backed by quality people.

**KEA Systems Ltd.**  
3738 North Fraser Way, Unit 101  
Burnaby, B.C. Canada V5J 5G1  
Telephone: [604] 431-0727  
Fax: [604] 431-0818  
Orders: **1-800-663-8702**



**Do it! Call Today!**

ZSTEM and the KEA and ZSTEM logos are trademarks of KEA Systems Ltd. All other brand and product names are trademarks or registered trademarks of their respective holders. Copyright © KEA Systems Ltd., 1990. All rights reserved.



To become  
the hottest name  
in dot matrix printers  
you simply build  
one terrific  
printer

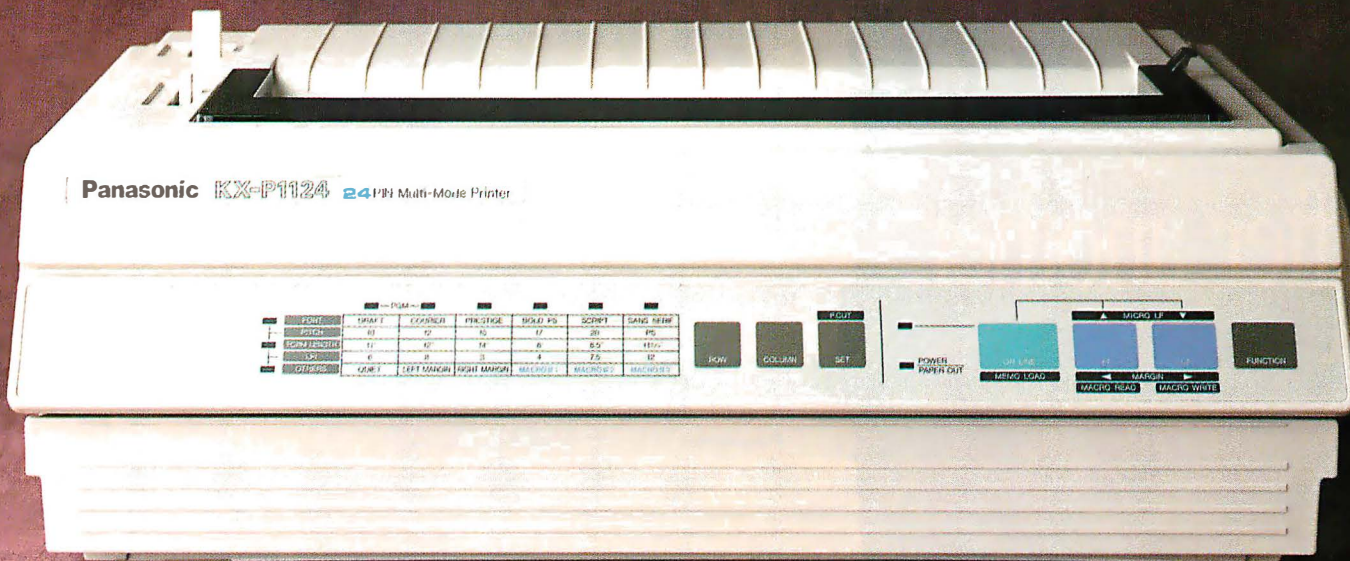

*The award-winning KX-P1124.*

after another,

after another,

after another,

after another,

after another.

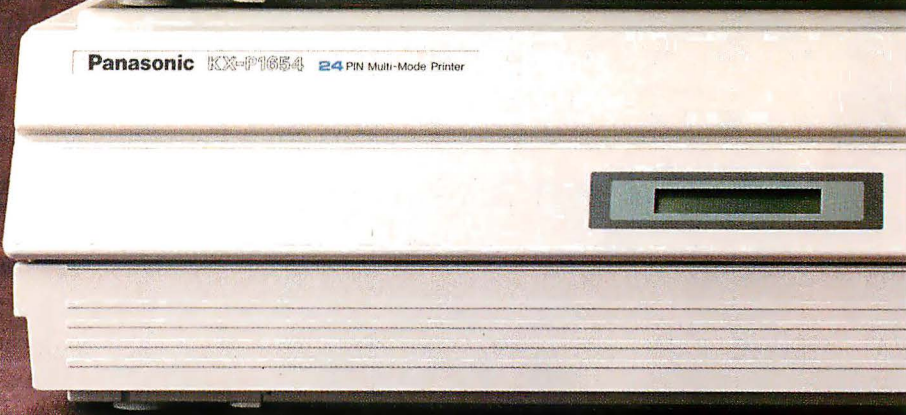
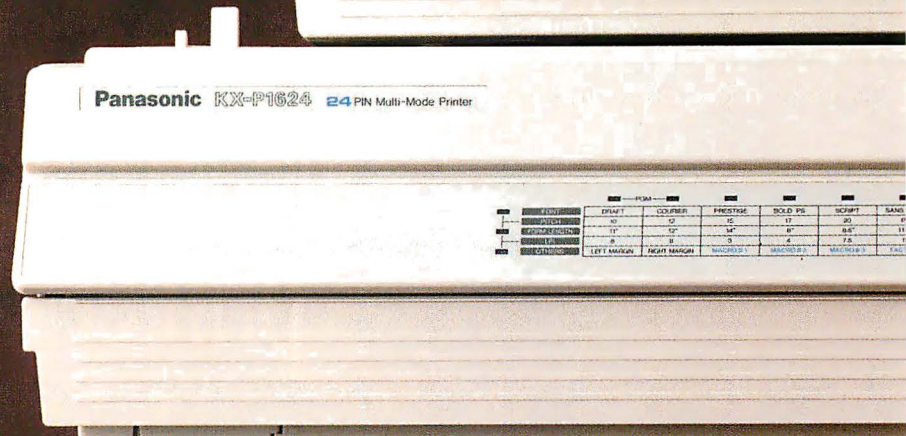



*If you want the perfect printer for the home.*



*If you want a little more speed for your home office printing.*

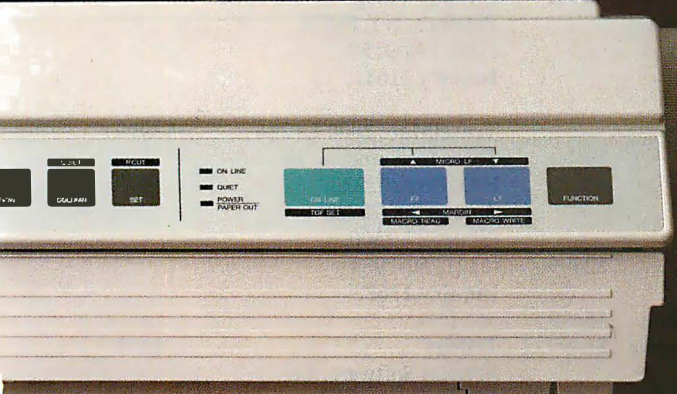

*If you want the same features as the 1124, but with a wide carriage.*

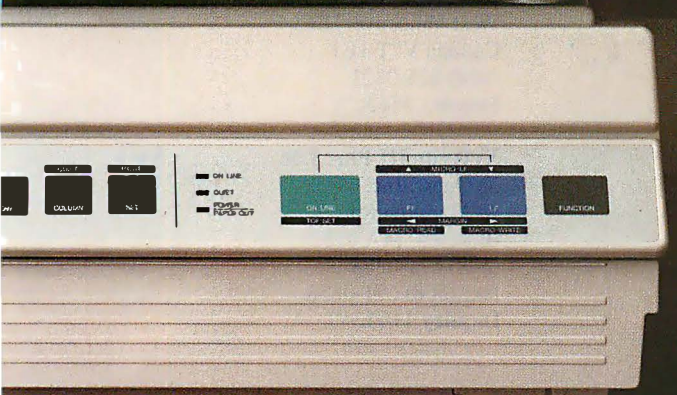

*If you want high speed, high volume for spreadsheets and financials.*



*If you want near laser quality at dot matrix prices.*

A few years ago, we redefined what people expect from a dot matrix printer. By creating a 24-pin as sophisticated as it is simple. And as affordable to buy as it is economical to own.

The KX-P1124 has won its share of awards. But it's not the only Panasonic® Dot Matrix to receive rave reviews. Now there's



a whole family to choose from. All with EZ Set™ operator panel, multiple paper paths, a variety of fonts, 2-year limited parts and labor warranty (see your dealer for details), and other features that typify our approach to price/performance for today's office environment.

There are feature-rich 9-pin models for every-day drafts. And superb 24-pins for important correspondence. In both regular and wide-carriage versions.

And we've just introduced what may well be the quintessential office printer for the 90's, the KX-P1654. A wide-carriage 24-pin that rockets along at up to 375 characters per second. With print quality approaching that of lasers.

Chances are, your first Panasonic printer will lead to another, and another, and another.

For further information on Panasonic Dot Matrix Printers, see your Panasonic dealer, or telephone toll-free **1-800-742-8086**.

*Printers, Computers, Peripherals,  
Copiers, Typewriters and Facsimiles*

**Panasonic**  
Office Automation

*Engineered for the office. Designed for people.*

## ITEMS DISCUSSED

- American Heritage Dictionary** ..... \$89.95  
Houghton Mifflin Software  
One Memorial Dr.  
Cambridge, MA 02142  
(800) 633-4514  
**Inquiry 1150.**
- Desqview 2.3** ..... \$129.95  
**Desqview/386 2.3** ..... \$219.95  
Quarterdeck Office Systems  
150 Pico Blvd.  
Santa Monica, CA 90405  
(213) 392-9851  
fax: (213) 399-3802  
**Inquiry 1151.**
- Dr. Solomon's Anti-Virus Toolkit** ..... £99  
S&S International  
Berkley Court  
Mill St.  
Berkhamsted  
Hertfordshire HP4 2HB,  
U.K.  
44-442-877877  
fax: 44-442-877882  
**Inquiry 1152.**
- Ergo Brick** ..... \$2495  
Ergo Computing, Inc.  
One Intercontinental Way  
Peabody, MA 01960  
(800) 633-1925  
(508) 535-7510  
**Inquiry 1153.**
- Info Select** ..... \$99.95  
**Tornado** ..... \$79.95  
Micro Logic Corp.  
P.O. Box 70  
Hackensack, NJ 07602  
(800) 342-5930  
(201) 342-6518  
**Inquiry 1154.**
- Keynotes for the PC**... \$79.95-\$99.95  
Digital Learning Systems, Inc.  
102 Headquarters Plaza N  
Morristown, NJ 07960  
(201) 538-6640  
**Inquiry 1155.**
- Knowledge Acquisition Series** ..... \$49.95-\$79.95  
Inductel  
18661 McCoy Ave.  
Saratoga, CA 95070  
(800) 367-4497  
(408) 866-8016  
fax: (408) 243-1762  
**Inquiry 1156.**
- MicroMath Data Analysis and Graphics Software** ..... \$149-\$349  
MicroMath Scientific Software  
2469 East Fort Union Blvd.,  
Suite 200  
Salt Lake City, UT 84121  
(800) 942-6284  
(801) 943-0290  
fax: (801) 943-0299  
**Inquiry 1157.**
- MinisPort HD** ..... \$2399  
**SupersPort SX**  
with 40-MB hard disk drive ... \$5499  
with 120-MB hard disk drive.. \$6499  
Zenith Data Systems  
1501 Feehanville Dr.  
Mt. Prospect, IL 60056  
(800) 553-0331  
(708) 699-4800  
**Inquiry 1158.**
- Poqet PC** ..... \$1995  
Poqet Computer Corp.  
650 North Mary Ave.  
Sunnyvale, CA 94086  
(800) 624-8999  
(408) 737-8100  
fax: (408) 720-8221  
**Inquiry 1159.**
- Quotemaster** ..... \$89  
Penncomp  
4660 Beechnut St., Suite 214  
Houston, TX 77096  
(713) 669-0965  
**Inquiry 1160.**
- Random House Encyclopedia** .... \$119  
Microlytics, Inc.  
2 Tobey Village Office Park  
Pittsford, NY 14534  
(716) 248-9150  
**Inquiry 1161.**
- TravelMate 2000 LT286** ..... \$3999  
Texas Instruments, Inc.  
P.O. Box 2022230  
Austin, TX 78720  
(800) 527-3500  
(512) 250-7984  
**Inquiry 1162.**
- Trilogy** ..... \$395  
Vertical Software, Ltd.  
636 Clyde Ave. W, Suite 14  
West Vancouver, BC,  
Canada V7T 1E1  
(604) 925-0321  
**Inquiry 1163.**
- XyWrite III Plus 3.56** ..... \$445  
XyQuest, Inc.  
44 Manning Rd.  
Billerica, MA 01821  
(508) 671-0888  
fax: (508) 671-0858  
**Inquiry 1164.**

Plus; indeed, he has become something of a religious fanatic on the subject. "It's the One True Word Processor," he says. Others have told me the same thing: it's tough to learn, but once learned you will, they say, never change to anything else.

So, I figured, I'm reasonably experienced with computers. I've got to use *something* to break up this file. I could get out Brief, but I haven't used that in a couple of years, because while Brief is a good candidate for the world's best programming editor, it's far too complex and touchy for creative writers; and, I thought, it would take me about as long to

relearn Brief as it would to learn XyWrite. I mean, thought I, how hard can it be to learn a word processor? So I tried it.

I very nearly went out of my mind.

Clearly it is possible to learn XyWrite, for many have done it; but I guarantee you that while you are learning it, you will get very little else done. In particular, don't even think of learning XyWrite while trying to work under a deadline. XyWrite just out of the box has a completely arcane command scheme, an actively user-hostile interface, and help files that are part of the problem.

Item: although Electric Pencil, which

I used for many years, had no on-screen margins, Q&A Write does, and I have become accustomed to 60-column (on average) lines with a left margin. XyWrite out of the box fills the screen; it even automatically hyphenates words, so if you work on a paragraph inserting and deleting text, the lines jump around as XyWrite inserts and deletes hyphens. I have always been taught that you *never* put a hyphen into a manuscript unless you want that hyphen set in type; thus, the first thing to do was to turn off the hyphenation.

XyWrite has on-line help, of course,

# Programming Books...

...ready-to-use Computing Know How— with diskettes

## BASIC Programming Inside & Out

In-depth coverage for all BASIC, QuickBASIC, GW-BASIC, and Turbo BASIC programmers. Explains sound and graphics, creating help screens, pulldown menus, managing windows in BASIC, using ML with BASIC, business presentation graphics, printing multiple columns and sideways for professional results, programming serial and parallel interfaces. Dozens of demo programs and routines you can easily adapt to your own programs. 600 pages with companion disk.

#B084 ISBN 1-55755-084-0 \$34.95

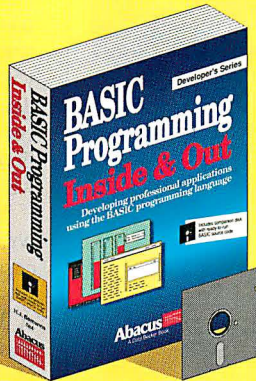

## Batch File Powertools

Boost your computing productivity with this package for making truly powerful batch files. Includes dozens of new batch commands for writing time-saving, easy-to-use "power" batch files. Book with companion disk containing powerful "Batch BASIC" commands for writing even more useful batch programs. Includes companion disk. Available January.

#B102 ISBN 1-55755-102-2 \$34.95

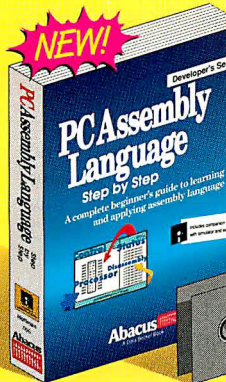
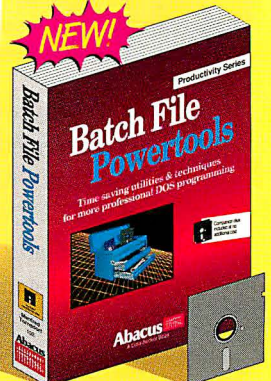

## PC Assembly Language Step by Step

Teaches you PC assembly and machine language from the ground up. You'll learn at your own pace using the unique simulator which shows you how each instruction works as the PC executes it. 420 pages with 2 companion disks. Also includes evaluation versions of A86 Assembler and D86 Debugger.

#B096 ISBN 1-55755-096-4 \$34.95

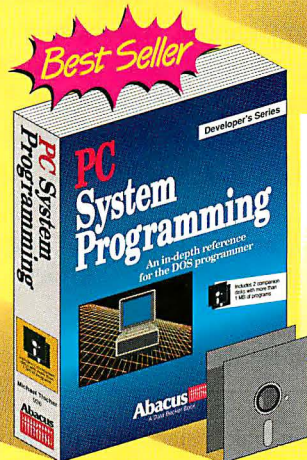

## PC System Programming

An encyclopedia of PC technical and programming knowledge. Features parallel working examples written in Pascal, C, assembly and BASIC. Explains memory layout, DOS operations, using extended and expanded memory, writing device drivers, hard disks, PCports, mouse drivers, fundamentals of BIOS, graphics and sound, TSR programs and complete appendices. 920 pages and 2 companion disks with over 1 meg. of programs.

#B036 ISBN 1-55755-036-0 \$59.95

## Programming VGA Graphics

VGA is becoming the standard display mode for PC applications. Learn techniques for writing using the flexible and powerful VGA hardware and software. Includes new, unique DOS commands to perform dozens of VGA functions. TurboPascal and BASIC extensions for VGA display modes. 670 pages with 2 companion disks.

#B099 ISBN 1-55755-099-9 \$39.95

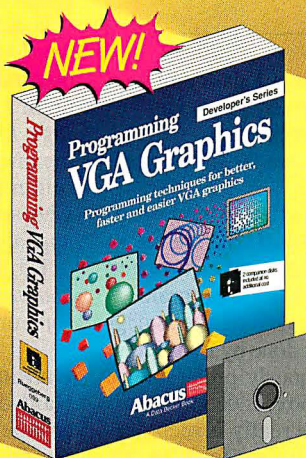

## Turbo Pascal Internals

Gives you "know how" to program faster, easier, tighter and better. Find out how to use Turbo for system programming tasks— writing TSRs, performing multi-tasking, using SAA windowing, implementing expanded and extended memory. Learn how Turbo generates machine code, handles the mouse, scans the keyboard, uses UNITS and OOPS, performs fast screen display and more. 750 pages with 2 disks of more than 800K of source code

#B080 ISBN 1-55755-080-8 \$49.95

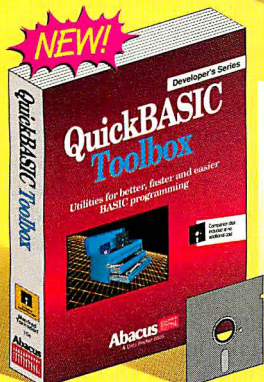

## QuickBASIC Toolbox

Packed with powerful, ready-to-use programs and routines to write your own programs faster and better. Topics include: complete routines for SAA interfacing; pull-down menus; windows; dialog boxes and file requestors; descriptions of QuickBASIC routines and a BASIC Scanner program for printing completed project listings. Includes companion disk.

Available January.  
#B104 ISBN 1-55755-104-9 \$34.95

**In US & Canada Order Toll Free 1-800-451-4319 EXT. 22**

For fast delivery Order Toll Free 1-800-451-4319 EXT. 22 or FAX (616) 698-0325

Yes, please rush the following items  Yes, please rush your free PC catalog

Apply to my:  Visa  Master Card  Am. Express /  I have enclosed a check / M.O.

\_\_\_ Assembly Language Step by Step \$34.95 \_\_\_ Programming VGA Graphics \$39.95

\_\_\_ BASIC Programming Inside & Out \$34.95 \_\_\_ Turbo Pascal Internals \$49.95

\_\_\_ Batch File Powertools \$34.95 \_\_\_ Quick BASIC Toolbox \$34.95

\_\_\_ PC System Programming \$59.95

In US and Canada add \$4.00 Postage and Handling. Foreign orders add \$12.00 postage per book.

Card# \_\_\_\_\_ Expires \_\_\_\_\_

Signature \_\_\_\_\_

Name \_\_\_\_\_

Address \_\_\_\_\_

City \_\_\_\_\_ State \_\_\_\_\_ Zip \_\_\_\_\_

Phone# \_\_\_\_\_

Available at B Dalton Booksellers, Waldensoftware, and Software Etc. and at other bookstores nationwide. In the UK contact Computer Bookshops 021-706-1188. In Canada contact Addison Wesley 416-447-5101.

# Abacus

Dept. B2, 5370 52nd Street SE, Grand Rapids, MI 49512

Orders: 1-800-451-4319 • Phone: (616) 698-0330 • Fax: (616) 698-0325

In US and Canada add \$4.00 Postage and Handling. Foreign orders add \$12.00 postage per book. We accept Visa, Master Card or American Express. Call or Write for your free catalog of PC Books.

Circle 8 on Reader Service Card (RESELLERS: 9)

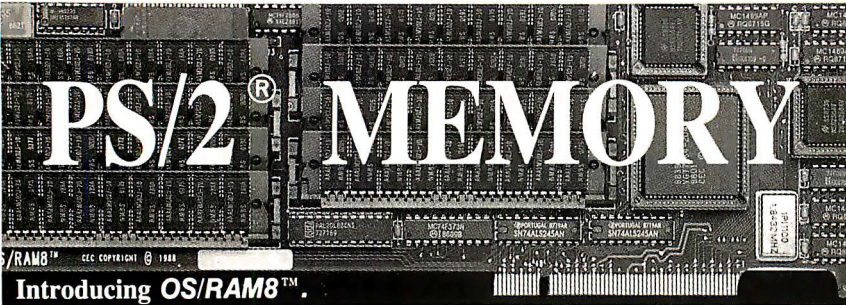

**PS/2<sup>®</sup> MEMORY**

Introducing **OS/RAM8<sup>™</sup>**

- ✓ 8 Mbytes of memory + 2 serial ports.
- ✓ Extended and expanded memory. LIM 4.0.
- ✓ Works with all of your programs.
- ✓ Run DOS or OS/2 effortlessly.
- ✓ Fast and simple switchless installation.
- ✓ Auto-configuration for all operating systems.
- ✓ Works in all Micro Channel<sup>™</sup> computers.
- ✓ Expanded memory 10 times faster than Intel.
- ✓ Risk free guarantee. Two year warranty.
- ✓ IBM approved ID. Best price. Fast delivery.

Call today 617-273-1818 or 1-800-234-4CEC

**cec** Capital Equipment Corp.  
Burlington, MA. 01803

PS/2 and Micro Channel are trademarks of IBM

and one help feature is that you can look up topics and words. Wonderful. Look up "hyphenation." "This key word is not in the help vocabulary. Is there some other way to phrase what you need to know?" "Hyphen." "This key word is not in the help vocabulary. . . ."

All right, what about setting the margins? Ask about "margin." "This key word. . . ." Indeed, I have yet to find a key word that does me any good. However, the help file will also give you a list of commands. Well, not really: it's a list of about 100 abbreviations of commands. One of them was LM, which, I thought, just might stand for left margin, and indeed did so. To set the left margin, go to the top of the text, go to the command line, and do "CMLM 8" to set the margin to 8. This seemed simple enough. Of course, you *don't* type "CMLM 8," although that's what help tells you to do. You type in "LM 8"; the "CM" is there largely to confuse you.

And on. It's also inconsistent. Sometimes the Escape key will undo what you last did; but when in the command mode, it takes you successively back until XyWrite is ready to accept a command—and then it starts putting escape characters into the command string. Since XyWrite can't execute any command that begins with an escape character, this has the result of confusing the hell out of you,

since even if you type a legal command after the escape character, you get an "illegal command" error message.

XyWrite's error messages are arrogant and unhelpful.

The result was that after an hour or so, I was so upset I had lost all interest in editing *Tell the Spartans* and just wanted to get away from this hateful program.

The next day there arrived a reconfiguration of XyWrite as done by Baen. It is, I have to say, enormously preferable to XyWrite out of the box; indeed, it's almost usable. XyWrite really is reconfigurable, with a flexibility not found in any other editor except Borland's Sprint. On the other hand, while it's easy to reconfigure XyWrite, unless you have one whack of a better memory than I have, you must either write down what you have done or edit the XyWrite help file to reflect your changes.

The bottom line is this: XyWrite doesn't so much have a steep learning curve as an initial high cliff you must climb almost unaided. Once over that cliff, you have a very powerful editor, one that will do, albeit often with difficulties, things that no other text editor will do at all. XyWrite will handle enormous files and do global searches on them with amazing speed. Unlike with WordStar, the output from XyWrite is straight ASCII, so you can send XyWrite

files through BIX or MCI Mail and still preserve all the formatting and typographical information.

It has weird idiosyncrasies—the way to change the screen colors is to put statements in the *printer* file!—and often insists on doing things its own way despite your wishes. But for people who must deal with lots of text and are more concerned with copyediting and typesetting than with creative writing, XyWrite may well be the best thing around.

Whether it's all that hot for creative writers is something else again. In my case, no.

### A Minor Retraction

Last December, I said that AHED was an electronic version of the *American Heritage Dictionary* in all its glory. That wasn't quite true. AHED is the desktop version, which is considerably abridged. I found this out in an embarrassing way: someone in a BIX conversation used the word *burke* as a verb, and someone else asked what it meant. In an effort to show off, I used Desqview to load the AHED program into a window and told it to look up *burke*.

It didn't find it, and I reported that the word (which is British) hadn't made it over here; whereupon someone looked it up in a paper copy of the *American Heritage Dictionary* and found it. (*Burke* means to suppress something quietly; the origin is the name of a Scottish murderer who suffocated his victims so that they appeared to have died of natural causes.)

I'd sure like the *complete American Heritage Dictionary* on-line. Maybe someone will make a CD-ROM of it.

### Random House Encyclopedia

Hard disk drives are getting larger and cheaper. Most of mine are now multiple hundred megabytes, and even small ones are 40 MB and more. Controllers are getting faster: the big race, in my judgment, is between a new company, Perceptive Solutions, and the older and larger Distributed Processing Technology, but there are plenty of other contenders, and several make hard disk drives about as fast as *memory access* was in the early PC days.

As a result, there's a lot of software being written to take advantage of the new disk capacity and access speed. I've written about much of it.

Some of the early efforts were plain useless. Others, like Inductel's Knowledge Acquisition Series, have wonderful databases—theirs has all the McGraw-Hill science dictionaries, as well as ways to translate words into 31 languages—but

## CHAOS MANOR

an awkward user interface. (I sure wish they'd fix that, since the programs are nearly indispensable.) Some, like Mike Wiener's Microlytics Word Finder, were both easy to use and had great databases.

Thus, when I got the new Random House Encyclopedia using a Microlytics engine, I was prepared to love it. Alas, it didn't quite work out that way.

First, installation: the program comes on 16 floppy disks. Apparently, Microlytics has never heard of data-compression programs: many programs, including the Norton Utilities and Norton Commander, come packed with ARC, PKZIP, or some such, and the installation program unpacks and explodes them. I'd have thought that system ideal for this encyclopedia, and it would save money as well. Anyway, there's nothing like swapping disks 16 times to sour you on a program.

Second, program transfer: I put the Random House Encyclopedia up on the Arche Legacy 386/33, which has an experimental copy of DOS 5.0 and one logical drive of 300+ MB. (DOS 5.0 so far runs fine; you'll love it.) I decided that I'd like to have it over on another machine, the Cheetah 486, which is still using Compaq clone DOS and thus has its hard disk partitioned into 20 33-MB logical drives. I keep word-related stuff in the D drive, so I used LapLink to transfer the INFODESK subdirectory from the Arche's C:\INFODESK drive to the Cheetah's D:\INFODESK drive. Even with LapLink in parallel mode it took a while, but it got done.

I couldn't access the file. It claimed there was something wrong with the configuration. Well, OK, so I tried to run the Setup program. It won't let you change the configuration file. OK, I got out the original floppy disks and tried to run Setup. That won't do it either. Eventually I said, what the hell, and started the installation procedure; but since I sure didn't want to swap 16 disks, I stopped it after the first disk in the hopes that this would let me run Setup.

Not only didn't it run Setup after that, but the machine began making "fire engine" noises, and a big red message appeared on the screen demanding that I reboot my computer, which indeed I had to do with the hardware switch since it was all locked up. At that point, I concluded that any company that paranoid about copies was capable of *anything* and got out Dr. Solomon's Anti-Virus Toolkit (which I highly recommend; if you have any suspicions about viruses, this kit tells you a great deal about them and can detect and eliminate most).

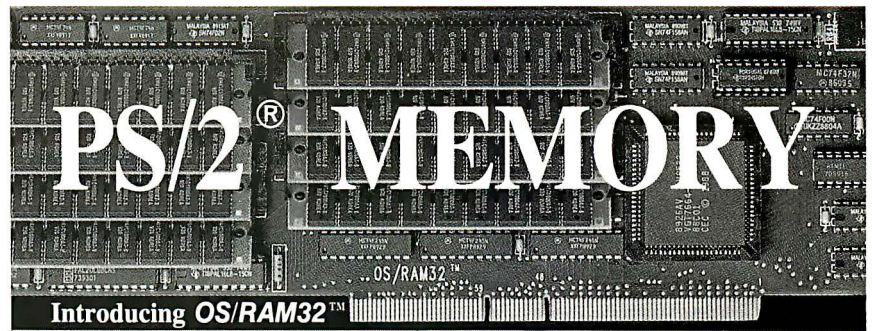

- ✓ 8 Mbytes of fast 32 bit memory.
- ✓ Works in all Micro Channel™ computers.
- ✓ Fast LIM 4.0 driver included.
- ✓ Provides extended and expanded memory.
- ✓ Easy switchless installation.
- ✓ Automatic configuration for DOS, OS/2 or UNIX.
- ✓ Risk free guarantee. Two year warranty.
- ✓ Accepted under IBM service contracts.
- ✓ From \$299 to \$998 with 8 Megabytes.
- ✓ "Best price performance", says PC Week .

Call today 617-273-1818 or 1-800-234-4CEC



Capital Equipment Corp.  
Burlington, MA. 01803

PS/2 and Micro Channel are trademarks of IBM

Now, I suppose at one level I knew that Mike Wiener, whom I have known for years, isn't going to do something awful to my machine; but at the same time, I am *not* accustomed to software that not only locks up my system to hardware reset level, but makes noises guaranteed to scare you into cardiac arrest.

This got me angry enough that I began looking at the installation on the Arche (which works). I found that the installation had, without saying anything about it, put a file called INFODESK.CFG into the root directory. I copied that over to the root directory on the Cheetah, but of course it told INFODESK that its files are on the C drive, so that didn't work.

Attempts to edit the INFODESK.CFG file with an ASCII editor were not successful, because the file contains an end-of-file mark at the beginning. However, the editor in Norton Commander 3.0 will edit it. It's tedious, because the file is one long file with no linefeeds, but it can be done, so I went through and changed every instance of C:\ to D:\; and lo!, it works. And no, I don't feel at all bad about having copies on two different machines: nobody is going to use them both at the same time.

The retrieval software, as with everything Microlytics does, works wonderfully: it's fast and reasonably intuitive, although you do have to poke about a bit

since there are features you won't suspect without playing with it. The engine they use would work for *any* book a couple of inches thick, and the compression/retrieval/sort software is really marvelous. Wiener's index and search algorithms, which he developed from work done at the Xerox Palo Alto Research Center, are the best in the business.

The Random House Encyclopedia itself is better described as an expanded dictionary than an encyclopedia: despite the 16 disks, there's far less information here than on the Grolier Encyclopedia Americana CD-ROM—but of course that shouldn't surprise you. I find it woefully inadequate. For instance, the short mythology section on Achilles tells you he was the son of Peleus and Thetis, but neither of his parents is mentioned anywhere else; while the section on Frederick Barbarossa tells almost nothing of real interest about him.

#### Quotemaster and Keynotes

These are two more programs making use of big databases on fast hard disk drives. I haven't space to do justice to either: they're both very useful. Quotemaster has about 3000 quotations; the retrieval software is good, although the default mode is not. You have to poke about to see how to use it right, but then, you can find quotes on fools, courage, or any

subject you like; these can be displayed on-screen, printed, or squirted directly into your word processor. If you write much, this isn't *Bartlett's Familiar Quotations* on-line—you need a CD-ROM drive and Microsoft Bookshelf for that—but it can sparkle up your letters. Recommended.

Keynotes for the PC is just that: a system of notes that can be accessed quickly and easily, either as a stand-alone program or as a TSR pop-up. If you use Desqview or Windows, it will work fine in its own window. I have the following Keynotes: *Writer's Handbook*, which I don't use, but beginners and editors will like it; the *Complete Secretary's Handbook*, which I do use; the *Financial Mathematics Handbook*; and the *Associated Press Stylebook*. The latter two are very good. The retrieval software is fast and efficient, and everything works as it should. Recommended.

**MicroMath**

This one makes me feel guilty: I have had some of this company's plotting and numerical calculation programs around here for a year, and I haven't written

about them. They're quite good: the cost is reasonable, they do about what you think they will, and they're simple enough to use provided you know what you're doing in the first place; that is, I wouldn't try to learn LaPlace transforms from the MicroMath LaPlace program.

I used to be reluctant to write about MicroMath, despite the quality and usefulness of the software, because they wouldn't guarantee the software once the package was opened. They have now changed that to "Try it, you'll like it, or your money back." I doubt they've had to refund anyone's money. If you do much mathematical work, you should be aware of MicroMath. Recommended.

**Winding Down**

I'm off on another trip tomorrow. The game of the month is Origin's *Wing Commander*: I liked this so much that I went out and bought—bought—a Thunderstick joystick to play it with. I never believed I'd get hooked on an arcade shoot-'em-up, but this one did it to me. The best thing I can say is that it almost weaned me from *Railroad Tycoon*.

The computer books of the month are

the *Que Quick Reference Series*: they have them on the Norton Utilities, PC Tools, Q&A, and a lot of other subjects, and I've found them uniformly good.

The book of the month is *Convictions* (Prometheus Books, 1989), the posthumous collection of essays by Sidney Hook. He was one of the important people of our century. I am proud to have debated him several times; debating Hook, like debating Norman Thomas, was an experience one did not soon forget.

Now to pay the bills, then I'm off to the Hackers' Conference, which I'll tell you about next month. ■

*Jerry Pournelle holds a doctorate in psychology and is a science fiction writer who also earns a comfortable living writing about computers present and future. Jerry welcomes readers' comments and opinions. Send a self-addressed, stamped envelope to Jerry Pournelle, c/o BYTE, One Phoenix Mill Lane, Peterborough, NH 03458. Please put your address on the letter as well as on the envelope. Due to the high volume of letters, Jerry cannot guarantee a personal reply. You can also contact him on BIX as "jerryp."*

# ABC Flowcharter for Windows

*"Simply the easiest way to document procedures."*



ABC Flowcharter™ makes drawing and editing flowcharts easier than ever. It's loaded with features that help you make and edit charts in a fraction of the time needed with other flowcharting or drawing programs.

ABC Flowcharter's advanced link feature lets you break complicated procedures into smaller, more manageable steps. Just click on a shape to display a sub-chart or procedure. It's that easy.

Ask your dealer for a demonstration or call 1-800-227-0847 for more information. See for yourself why ABC Flowcharter is quickly becoming the standard flowcharting tool for the Fortune 1000. Retail price \$295.

**Roykore™**

2215 Filbert St.  
San Francisco, CA 94123  
415-563-9175



IT HAS BEEN  
BROUGHT TO  
OUR ATTENTION  
THAT NOT EVERYONE  
BELIEVES  
PORTABLE PCs  
CAN BE AS  
FUNCTIONAL AS  
DESKTOP PCs.



# THIS SHOULD

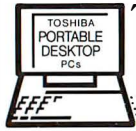

This may be hard to believe, but there really is such a thing as a portable PC that can do everything a conventional desktop can.



Some people can't imagine squeezing a 40,100 or even a 200MB hard disk into a portable PC. But when they take advantage of all that storage capacity, they find it hard to imagine life without it.

In fact, there's not just one, but an entire line of them. They're called Toshiba Portable Desktops™, and they'll forever change the way your company looks at power and productivity.

To get more information or a free Portable Desktop productivity survey, call 1-800-477-1616.

True, some business people may have trouble grasping the notion of desktop power in a portable, but when you give it some thought, it's the next logical step in computers.

There once was a day when microprocessors this powerful were unheard of in a portable. Luckily for people who crave raw power and computing speed, that day is over.

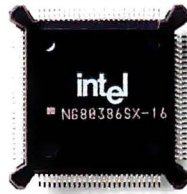

With 386™ and 386™SX microprocessors, our Portable Desk-

For those who think a PC just isn't fully functional without a color display, we developed our second-generation LCD color screen. For those who think basic is better, our VGA gas plasma systems have the perfect displays.

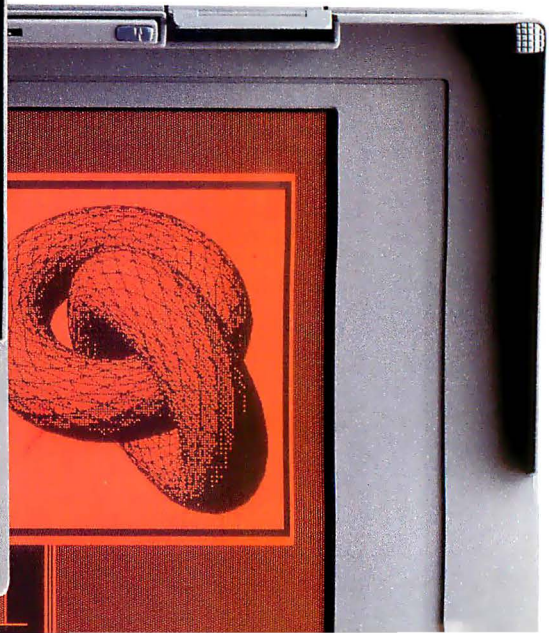
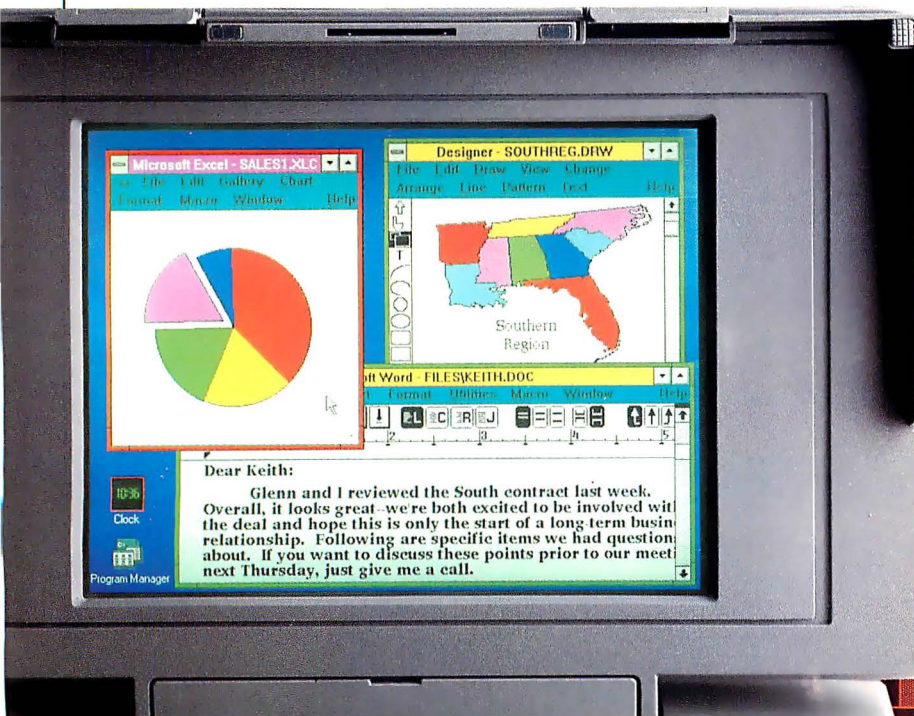

# REMOVE ALL DOUBT.



To anybody who doesn't expect a portable PC to have IBM-compatible expansion slots, we have just one thing to say. Raise your expectations.

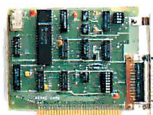

tops run all of the same applications as your company's conventional PCs.

With hard disk

drives from 40 to 200MB, you have all the flexibility to configure a system the way you want it.

With the connectivity of our multiple expansion slots and ports, our Portable Desktops fit right in with your existing system and grow as your company grows.

And to remove the last possible barrier between your

needs and our portables, we've even designed one with a high-resolution VGA color screen.

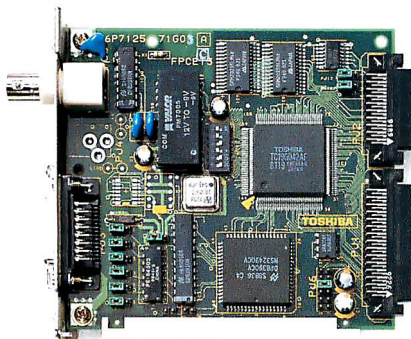

With an expansion slot for a LAN card, you get complete networking freedom without giving up all your other expansion slots.



Anyone who insists portable PC users are doomed to cramped, undersized keyboards hasn't gotten their hands on a Toshiba. We use standard-size keys and standardized key spacing so your hands will feel right at home.

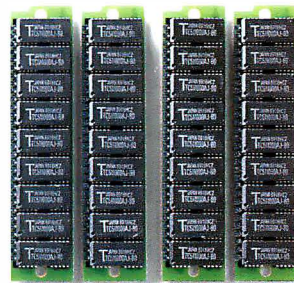

They say you can't squeeze much memory into a portable PC. But considering that our dedicated memory expansion slots let you add up to 12MB of RAM as your need for power grows, it looks like "they" were wrong again.

In other words, it really is possible to have all the capabilities of a conventional desktop in a portable.

All you have to do is try one. And believe.

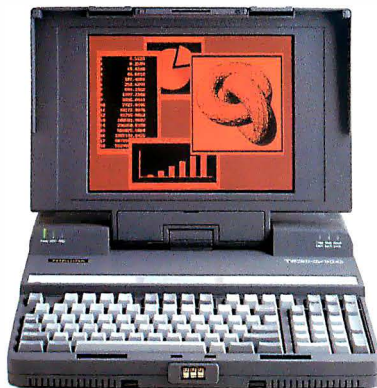

T5200. 386 microprocessor, 40, 100 or 200MB HDD, 2 to 14MB RAM, 2 IBM-compatible expansion slots (in addition to dedicated memory slots), VGA plasma display.



T5200C. 386 microprocessor, 200MB HDD, 2 to 14MB RAM, 2 IBM-compatible expansion slots (in addition to dedicated memory slots), VGA passive matrix color LCD display.

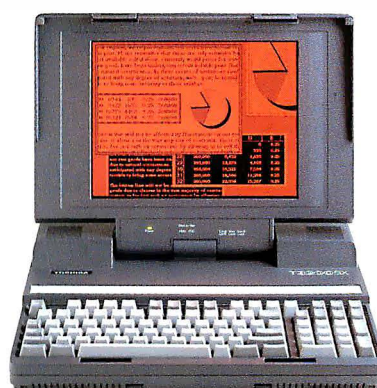

T3200SX. 386SX microprocessor, 40 or 120MB HDD, 1 to 13MB RAM, 2 IBM-compatible expansion slots (in addition to dedicated modem and memory slots), VGA plasma display.

# NOW THAT YOU'RE CONVINCED,



Okay, let's suppose you suddenly discover your company filled with powerful Toshiba Portable Desktops.

Now what?

First of all, your people can do everything around the office they've been doing with their desktop computers.

Then your key employees can turn after-hours time into productive time, since their dining room tables and breakfast nooks can serve as off-site workstations.

Your top people can add impact to their presentations with a

wealth of information and computing power at their fingertips. And the story can repeat itself—with equally impressive results—everywhere from an office 3,000 miles away to a conference room that's a mere 30 feet down the hall.



Giving your people instant access to vital information can keep them doing what they do best. Working smart.

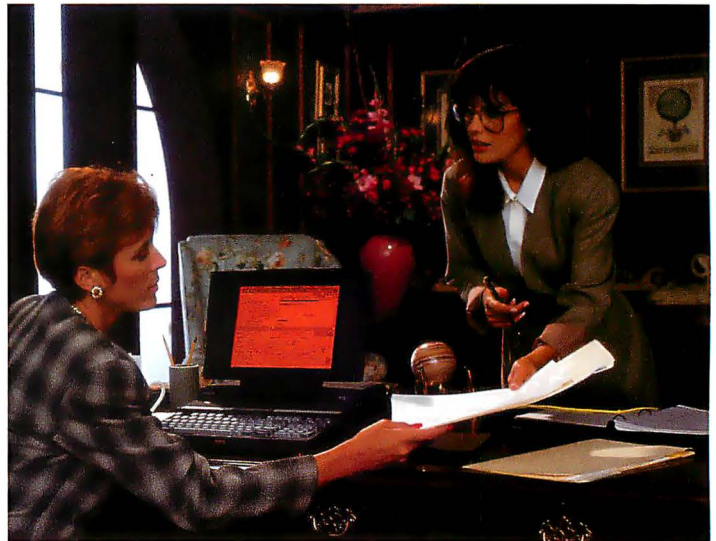

Employees can even improve their productivity in the familiar surroundings of their own office. Only now they'll have more desk space to work with.

To get more information or a free Portable Desktop productivity survey, call 1-800-477-1616.

# WHERE DO YOU GO FROM HERE?



Giving your key employees a Portable Desktop means they'll have the flexibility to work when they need to, where they want to.



When people have access to computing power outside their office, presentations are more powerful and groups are more productive.

your best people can be doing a better job than they ever could when they were chained to conventional desktop PCs.

Better yet, they can do it without sacrificing power, functionality or expandability. Or anything else, for that matter.



And yes, all that productivity can even take place within the confines of your own office desk (while using up considerably less of your desk space, we might add).

All of which leads us to one very powerful observation.

Now all of

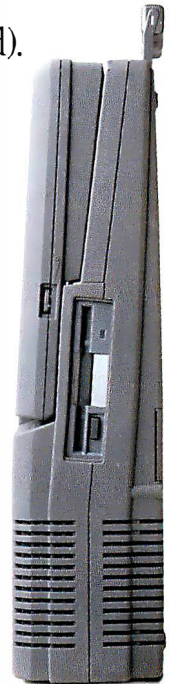

# THREE POWERFUL ARGUMENTS WHY YOUR NEXT



People said it was just a matter of time before someone built a line of portable PCs this powerful. They just didn't know it would happen so soon.

With our Portable Desktops, we've successfully combined the power and

## T5200

18.7 pounds, 20MHz 80386 with 80387-20 coprocessor socket, 2 internal IBM-compatible expansion slots, 40MB hard disk with 25msec access or 100MB hard disk with 25msec access or 200MB hard disk with 16msec access, 2MB RAM expandable to 14MB, gas plasma VGA display with 16 gray scales, 1.44MB 3½" diskette drive.

functionality of desktop PCs into slim, portable packages that give you everything you need to get ahead in business.

## T5200C

18.9 pounds, 20MHz, 80386 with 80387-20 coprocessor socket, 2 internal IBM-compatible expansion slots, 200MB hard disk with 16msec access, 2MB RAM expandable to 14MB, passive matrix VGA full-colorscreen, 1.44MB 3½" diskette drive.



# DESKTOP PC SHOULDN'T BE A DESKTOP PC.

So you get the same power. The same functionality. And the same expandability it takes to keep pace with your company's needs. The big difference is that with a Toshiba Portable Desktop, you can easily

To get more information or a free Portable Desktop productivity survey, call 1-800-477-1616.

turn all that power into increased productivity. All thanks to something

no desktop PC could ever hope to offer.

The freedom to take it with you.

## T3200SX

17.0 pounds, 16MHz 80386SX with 80387SX-16 coprocessor socket, 2 internal IBM-compatible expansion slots, 1 dedicated modem slot, 5 built-in ports, 40MB hard disk with 25msec access or 120MB hard disk with 19msec access, 1MB RAM expandable to 13MB, gas plasma VGA display with 16 gray scales, 1.44MB 3½" diskette drive.



# DON'T TAKE OUR WORD FOR IT. GET A SECOND OPINION.



What do other companies know about our Portable Desktop PCs that you don't? If you had a copy of our free productivity survey, you'd know. For example, you'd know that 93 percent of portable users said that they'd never go back to using a conventional desktop. You'd know they've reported substantial increases in productivity.

And you'd know why they place so much value on the flexibility and freedom their portables have to offer. Toshiba Portable Desktops. They're no longer a matter of convenience, they're a matter of survival.

To get more information or a free Portable Desktop productivity survey, call 1-800-477-1616.



In Touch with Tomorrow  
**TOSHIBA**

Toshiba America Information Systems Inc., Computer Systems Division.





# CORPORATE STYLE

In business communication, it's important for everyone to speak the same language

**A**s I write this, I'm also preparing for a few days in a federal courtroom as an expert witness, explaining how the small computer industry actually works. I can't discuss any details of the case, but at least part of the problem stems from differences in the way companies interpreted a statement in a federal contracting document. Part of the reason for the trouble is that people can read the same words and ascribe different meanings to them.

This trouble that can come from varying understandings of written material can be confusing enough when the only problem is the differing usage that can exist among companies. When a company has no standard way of expressing itself, the result can be chaos. To prevent this, most companies end up developing their own corporate style. They do this by having managers edit the documents of the more junior people until those people learn to write in the company style.

While managers will probably always check the documents of those who work for them, spending more time than is necessary on this task is a significant waste of management time and talent. This is especially the case when automated tools exist to check documents that companies and organizations create to ensure that they meet standards. That way, while managers will still have to check to make sure that people don't say anything that is wrong, at least they won't have to spend hours correcting word usage, grammar, and style.

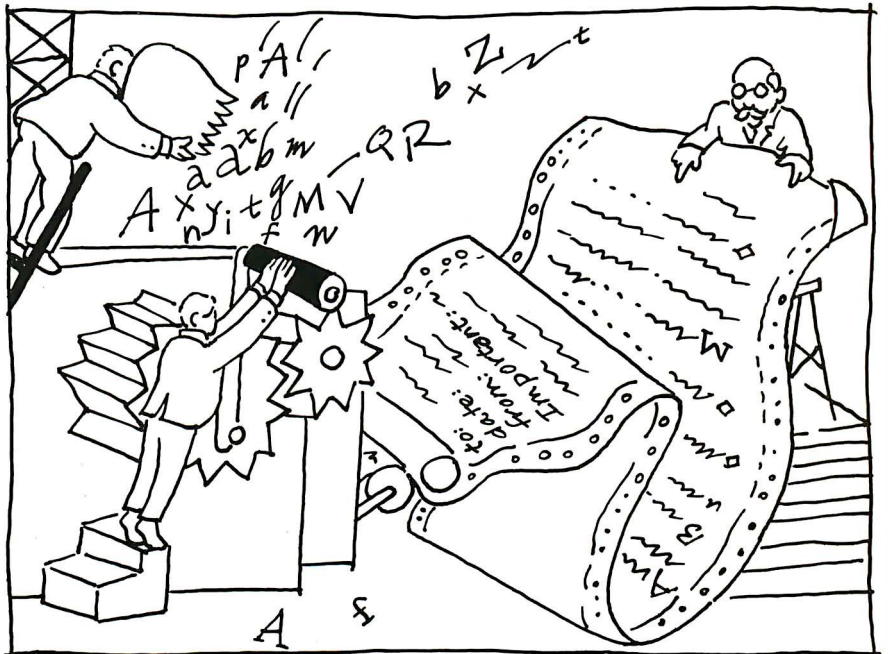

## Targeted Approach

As you probably know, grammar- and style-checking programs have been with us for some time. Two of them, Grammatik IV and RightWriter, have been hot sellers since they were introduced. The problem with these packages is that while they do an excellent job of checking generic English, they don't really help you when it comes to developing a corporate writing style or usage guide. Most companies use either their own style or the style of a particular customer, especially if that customer is the government.

Governments in general, and the U.S. government in particular, have unique characteristics in their writing. In government writing, for example, you will often see the word *inclosure* where the rest of us would write *enclosure*. There are also special usage requirements, such as the proper use of the words *shall* and *will*, in writing proposals to the government. In some cases, even a small

misuse can be very costly, so companies expend great effort making sure that the documents they send out are correct.

One way that companies can expend less effort, while retaining or even improving their accuracy in checking documents, is to use a specialized grammar or style checker. Two of these, Grammatik IV Government Edition from Reference Software and Corporate Voice from Scandinavian PC Systems, are designed specifically for use in specialized environments. Corporate Voice allows you to match your company's standard writing style to a specified ideal. Grammatik IV Government Edition, on the other hand, is designed to be used by the government and companies that deal with the government.

These products take fundamentally different approaches to the problems of providing consistency in writing. Corporate Voice compares your writing with a specific document or group of

**ITEMS DISCUSSED**

**Corporate Voice**.....\$119  
 Scandinavian PC Systems, Inc.  
 51 Monroe St., Suite 1101  
 Rockville, MD 20850  
 (800) 288-7226  
 (301) 294-7450  
 fax: (301) 251-1053  
**Inquiry 1223.**

**Grammatik IV  
 Government Edition** ..... \$99  
 (GSA pricing is available  
 from qualified vendors)  
 Reference Software International  
 330 Townsend St., Suite 123  
 San Francisco, CA 94107  
 (800) 872-9933  
 (415) 541-0222  
 fax: (415) 541-0509  
**Inquiry 1222.**

documents and shows you how you fit the style. Grammatik IV Government Edition, meanwhile, incorporates style and usage guidelines that the government already uses, and compares your document

against them, suggesting changes where appropriate. Neither package requires you to abandon your creativity in writing, although they both encourage you to modify the style of a specific document to meet the standard.

**A Voice for Change**

Corporate Voice looks at documents as a whole and analyzes them in their entirety. This makes it easy to see how your document compares with whatever is considered the standard. Because it lets you select the standard, you don't have to worry about being forced to fit a standard that really doesn't meet your needs. In addition, it includes some standards, such as generic technical, news, and magazine writing, as well as fiction from Ian Fleming, John Gardner, and Tom Clancy. If you want to create your own standard, you can tell Corporate Voice to read documents that you consider representative of the style you want to use for a particular purpose.

Once Corporate Voice has read the material you select, you can then call that a new style, and from then on, you can have Corporate Voice compare other

documents to that style. It makes heavy use of graphics in the comparison, creating a teardrop shape on the screen that represents the standard text. The text being checked appears as colored areas superimposed on the same screen. If the text being checked falls within the standard text's teardrop shape, and if other parameters such as sentence length and word usage check out as being close to the same, the document is consistent in style.

This does not mean, of course, that it's factually correct or that it's necessarily well written. For a more detailed analysis, the document being analyzed still needs to be read or checked by a program that handles proofreading. Finally, there is still no substitute for reading to confirm that the document reflects the company's position and that it's factual.

**Government Certified**

While it's nice to be able to run your company's documents through a style checker such as Corporate Voice, it isn't always possible. Sometimes the amount of written material is far too great, and sometimes the rules are far too diverse to

**The DGIS™ SDK and a TI 34010-based High-Performance Graphics Board for one amazing price.**

High performance, high resolution graphics are the wave of the future. With the DGIS Software Developer's Kit™ (SDK), qualified software developers can write for the future today.

The DGIS Developer's Kit provides everything needed to develop applications and drivers for DGIS-compatible 34010 graphics boards—boards from companies such as Compaq, Dell, Hewlett-Packard, NCR, NEC, TI and more than 30 others worldwide. Software developed with this kit can access the full power of the 34010, supporting the greatest number of high resolution graphics boards at the highest levels of performance, resolution and color.

DGIS, the premier and most widely-shipped interface for the TI 340X0 family of graphics coproces-

**THE POWER OF HIGH RESOLUTION GRAPHICS PROGRAMMING CAN BE REACHED WITH ONE EASY NUMBER:**



sors, provides an outstanding feature-rich programming model with 100+ graphics functions. The DGIS SDK includes documentation and language bindings for the DGIS interface, device drivers for Windows 3.0, utilities, and the GSS AT1050™ 1024X768 34010 graphics board (which normally sells for \$1295 alone).

The DGIS SDK is compatible with most C compilers and supports the XMS standard as well as DOS Extenders from Rational and PharLap.

Stepping up to the big screen has never been easier or more attractive. Call today.



**Call (503) 641-2455.  
 Ask for Dept. DGIS-1.**

All prices subject to change without notice.  
 GSS, DGIS, The DGIS Software Developer's Kit, GSS AT1050 are trademarks of Graphic Software Systems Inc. All other trademarks belong to their respective owners.

**SketchMate: The Intelligent Graphics Machine means incredible new creative power for you!**

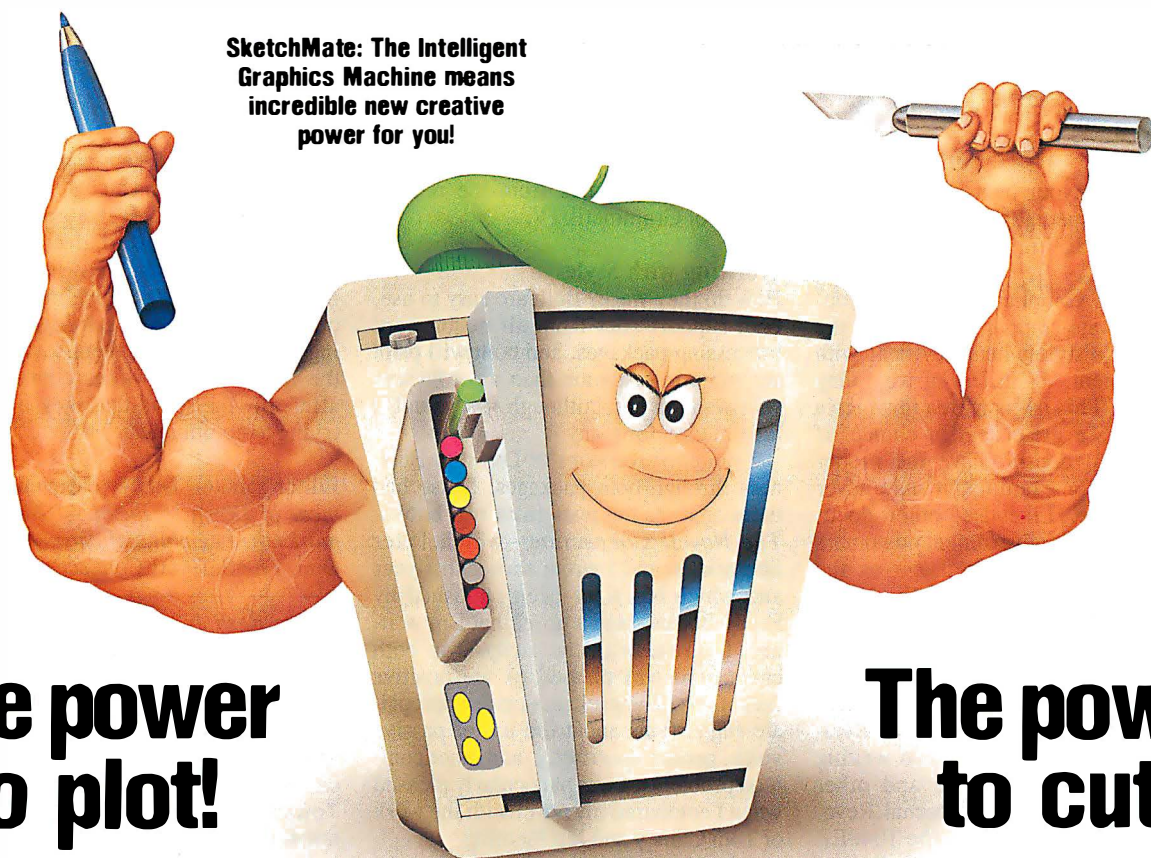

**The power to plot!**

**The power to cut!**

**Plotting Power...Signmaking Power...Professional-quality desktop plotting and signmaking for your home, office or school using your personal computer. Combined in one Intelligent Graphics Machine for \$695.**

Now you can increase your store, office, home, business, educational or personal creative expression by expanding your PC capabilities to include letter size, multi-color pen plotting for business presentations, CAD drawings, and graphics design, as well as signmaking for in-store display, clothing design, and vehicle detailing, with the incredible new SketchMate!

**The Plotting Edge...**With SketchMate you can use 32 multi-colored pens in your choice of 0.3mm and 0.6mm widths for thinner or thicker graphic output. In addition to regular paper media, SketchMate can use bond, multi-purpose bond, presentation paper, tracing paper, OHP sheets, and even matte film to accommodate most all of your plotting needs. Even poster making is supported with a choice of broad-tip pens, in most colors, to choose from.

**IT'S ONLY \$695!**

SketchMate and Intelligent Graphics Machines are trademarks of Roland Digital Group. \*Cutting capabilities offered as an option — Model #RPC-K1.

**The Cutting Edge\***...SketchMate also allows you to create your own signs, labels, and logos using a unique cutting pen that cuts vinyl or flock material. Design T-shirts, caps, clothing, and crafts. Create in-store promos, displays, and attention-getters. Customize your car, truck, boat, and RV. SketchMate combines the features of a plotter with the capabilities of a signmaking machine, giving you both!

**The Power of Flexibility...**SketchMate supports IBM PC's and compatibles and operates with a wide range of commercially available CAD and graphics software. However, you don't have to buy software to get started since SketchMate includes "ArtMate," a dedicated software program featuring 100 graphics patterns and sample designs.



# SketchMate™

## Intelligent Graphics Machine

For more information, call us at (714) 975-0560 today, or write for a catalog of the complete Roland line — the broadest collection of computer output peripherals in the world.

1961 McGaw Avenue/Irvine, CA 92714  
Telephone (714) 975-0560/Fax (714) 975-0569

Circle 193 on Reader Service Card (RESELLERS: 194)

**Roland**  
DIGITAL GROUP

make creating your own rules practicable. This is especially the case with an organization as immense as the U.S. government.

To further complicate matters, thousands of private companies must use the government's style when they deal with the government, regardless of what they might want. This isn't an area in which a company has a great deal of choice. If your proposal doesn't have the proper word usage, for example, it may never have a chance. Likewise, other documents written for government customers must reflect government usage or the government may require that they be rewritten.

To cover all bases, Grammatik IV Government Edition incorporates rules from the Government Printing Office's style manual, the National Labor Relations Board's style manual, and writing guides from the Air Force and other agencies. It also uses the Internal Revenue Service instructions for the 1040EZ form as a comparison document. So that the Government Edition can be used by companies that work outside the government, it keeps all the comparison infor-

mation and the rules from the regular edition of Grammatik IV.

**Working with Style**

How do they work? Both are easy to use, both support files from all major word processing packages, and both will print out more information than most writers will want to see, although it's valuable information for many.

I ran early versions of Down to Business through both packages. I also had them analyze the texts from two books: *The Novell Connection*—which Peter Stephenson and I wrote earlier this year and which has since been published by Brady Books—and a novel that I'm writing. I agreed with the analysis in both cases, and was pleased to see positive comments. The packages made appropriate suggestions about the use of passive voice, gender specificity, and other common problems. I was particularly pleased when I compared my novel with the work of Tom Clancy and Ian Fleming.

Of course, neither package will turn a bad writer into a Pulitzer winner, but they can help inexperienced writers get better, and they can help develop a con-

sistent style, which can be extremely important in businesses that generate written material for external consumption. What's important is that when used correctly, both packages give managers another tool to escape the drudgery of editing words, allowing them to work with the ideas that the words contain. It is, after all, the ideas that they are really trying to communicate. ■

Editor's note: *This is the final installment of Down to Business. Next month marks the beginning of Wayne's new column, The Business Connection.*

*Wayne Rash Jr. is a contributing editor for BYTE and technical director of the Network Integration Group of American Management Systems, Inc. (Arlington, VA). He consults with the federal government on microcomputers and communications. You can contact him on BIX as "waynerash," or in the to.wayne conference.*

*Your questions and comments are welcome. Write to: Editor, BYTE, One Phoenix Mill Lane, Peterborough, NH 03458.*

**Quark PC+®**

**PC XT® Compatibility  
On a 4" x 6" Board**

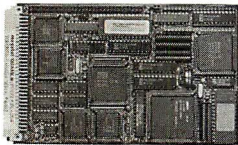

- 3 Serial Ports
- 3 watts (typical)
- XT® Bus Expansion
- Real Time Clock
- NEC V-40® Processor
- SCSI Hard Disk Control

- Up to 768k Main Memory
- Complete RS-232C Drivers
- Will boot PC, MS and DR DOS™
- Up to 10 Mhz CPU Clock Frequency
- Floppy Disk Control (1.44 M support)
- Hercules, Monochrome, CGA Video/Color LCD Controller

**Megatel Computer Corporation**

(416) 245-2953 FAX (416) 245-6505  
125 Wendell Ave., Weston, Ontario M9N 3K9  
**Densitron Corp**

2540 West 237th St., Torrance, CA 90505  
(213) 530-3530 FAX (G2/G3) (213) 534-8419  
Telex II: 910- 349-6200  
Europe/UK 0959 76600

- |                            |                         |
|----------------------------|-------------------------|
| REPS: Italy 39 331 256 524 | Austria 43 222 587 6475 |
| W. Germany 49 6074 98031   | Finland 358 0757 1711   |
| U.K. 44 959 71011          | Sweden 46 4097 1090     |
| Netherlands 31 838 541 301 | Norway 47 986 9970      |
| Australia 61 03 568 0988   | Denmark 45 244 0488     |
| France 1 47 46 94 52       |                         |

Trademarks: IBM XT® - IBM Corp. V-40 - NEC Corp. Hercules - Hercules Corp. MS+DR DOS - Digital Research Ltd. Quark - F + K Manufacturing Co.



**BACKPACK.  
IT'S A DRIVE OF A  
DIFFERENT COLOR.**



Add a disk drive without horsing around inside your computer - just plug Backpack into your parallel port! Connect your printer to the Backpack drive. No tools. No hassles. No interface cards. Backpack works with IBM and compatibles including PCs, XTs, ATs, PS/2s, PS/1s, and



laptops. It's available in 5.25" and 3.5" and comes complete with everything you need. So see your dealer or get it straight from the horse's mouth and call us about Backpack today!

**MicroSolutions**

Computer Products  
132 W. Lincoln Hwy., DeKalb, IL 60115  
815-756-3411 Fax: 756-2928

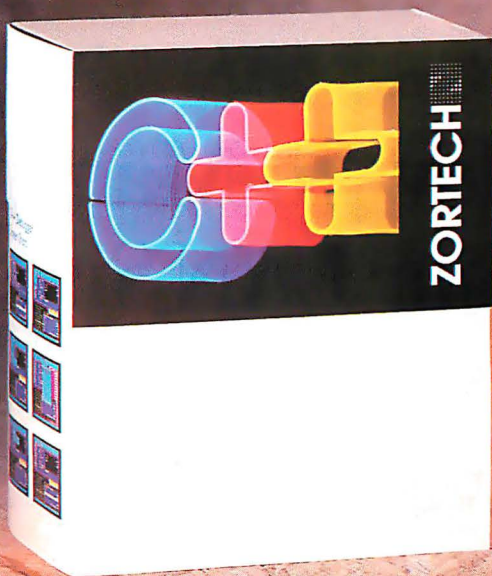

# For total portability right now, your choices are a bit limited.

ONLY ZORTECH GIVES YOU TOTAL PORTABILITY TO MS-DOS, WINDOWS, OS/2, DOS 386, UNIX 386. AND MACINTOSH. RIGHT NOW.

WHAT PLATFORM WILL YOUR APPLICATIONS BE RUNNING ON THIS TIME NEXT YEAR?

Now that C++ has made significant inroads into mainstream application development, you must choose the C++ compiler that is going to be the performance and portability leader now...and years to come.

Since 1986, we've been testing, refining and perfecting our family of C++ products tirelessly. The results are what you are reading about, a fully portable family of C and C++ products available right now.

WE INTEND TO KEEP UP THIS PACE.

In the past few years, Zortech has quietly become an industry standard earning acclaim from Byte, Computer Language, Dr. Dobbs, and many industry experts for our solid implementation, market-leading performance, and strong, relentless innovation.

WHATEVER PLATFORM YOU CHOOSE, CHOOSE ZORTECH PERFORMANCE.

With Zortech, no matter what platform you choose to develop on, a substantial performance increase will be realized due to the quality of the original Zortech C++ implementation. For instance, on MS-DOS, your program will compile up to 35% faster with the resultant code running up to 45% faster and 25% smaller than Turbo C++. But we don't stop there. On each platform, Zortech C++ is designed to improve your productivity where it really



MICROSOFT  
WINDOWS

matters... in the development cycle. For example, using the DOS/MS Windows package, you can edit, compile, link and debug the largest MS windows applications...and never once leave the Windows environment. All this plus complete plug-and-go to CNS C++/View and Commonview II! And, of course, these advantages are also available on the OS/2, DOS 386, UNIX, and Macintosh platforms.

**60**  
DAY  
MONEY-BACK  
GUARANTEE

CHOICES. CHOICES. CHOICES...

If there is one constant in C++ development, it's change. The Zortech family of products keeps your options exactly how they should be. Open.

To find out more, call today.

ORDER HOTLINE:

**(800) 848-8408**

# Zortech

Industry Standard. Industrial Strength.

ZORTECH, INC., 4-C GILL STREET, WOBURN, MA 01801 TEL: (617) 937-0596 FAX: (617) 937-0793  
ZORTECH, LTD., 58-60 BEREDFORD STREET, LONDON SE18 6BG TEL: +44-81-316-7777 FAX: +44-81-316-4138  
SUPPORTED SYSTEMS INCLUDE COMPAQ, ISA/EISA, IBM PS/2 AND 100% COMPATIBLES

\* Source: MS-DOS, C++ Compilers, A comparison by the Ladd Group, (c) 1990

Circle 278 on Reader Service Card

Chinese characters translate as "Great Wall."

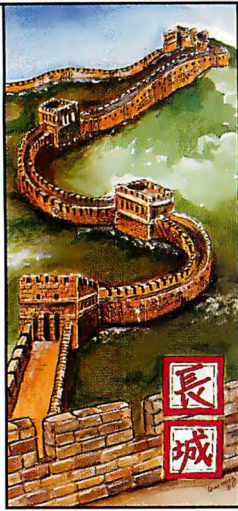

Times Change.  
The Need To Protect Doesn't.

S O F T W A R E   D E V E L O P E R S

# How To Manage Your LAN Site Licenses. Every Day. Every Time.

**L**icensing software for use on a LAN used to mean "give-away." No matter what site license limits were set, there was really no way to manage actual usage of the software once it was installed on the network.

Now, with the NetSentinel™ security/license management system from Rainbow Technologies, developers can specify how many concurrent users will be permitted—with confidence that the limits will be observed.

Simply. Effectively. Economically.

Based on proven technology from the worldwide leader in PC software protection, the NetSentinel from Rainbow Technologies can be used on most popular PC LANs.

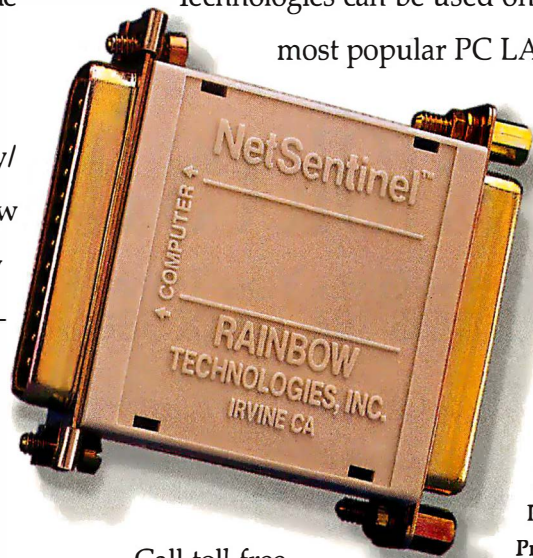

Site  
License  
Revenue  
Protection  
For LAN  
Applications.

Call toll-free  
today for more details.

With Rainbow's NetSentinel, your software need never again be a part of the "free distribution network."



**RAINBOW TECHNOLOGIES**

9292 Jeronimo Road, Irvine, CA 92718  
TEL: (714) 454-2100 • (800) 852-8569  
FAX: (714) 454-8557 • Apple Link: D3058  
Rainbow Technologies, Ltd., Shirley Lodge, 470 London Rd.  
Slough, Berkshire SL3 8QY, U.K. TEL: 0753-41512 • FAX: 0753-43610

NetSentinel is a trademark of Rainbow Technologies, Inc.  
Copyright ©1990 Rainbow Technologies, Inc.

# WHITHER WINDOWS?

1990's glamorous graphical user interface still needs a solid foundation

If you think Windows 3.0 is just another pretty face, think again. No other software product so radically expands the horizons of DOS-based computing. One day recently while editing an article, I stopped and marveled at the amount of work Windows lets me do with my 4-megabyte 386 PC. I don't usually do article layouts, but sometimes I find it helpful to drop rough text and artwork into a desktop publishing package for a quick thumbnail sketch of the final result. If you've done some DTP, you know that its software works best when surrounded by many supporting tools. Windows can make that synergy happen.

In this case, Ventura Publisher was the layout tool. I kept Corel Draw running in another window and used it to sketch a few figures. With Windows Paintbrush, which ran in yet another window, I resized, cleaned up, and added captions to other figures that the article's author had shipped to me as .PCX files.

Word for Windows occupied a fourth window. I don't write and edit much with Word, but the article required a complicated table, and I'm a big fan of Word's table editor. Meanwhile, Terminal, Windows' modest but useful telecommunications utility, was running as an icon, receiving revised text from the author. Clock, Calendar, Print Manager, and a few Notepads rounded out the collection of Windows applications helping me get through the day.

Of course, you can't get by without some good old DOS programs, too—at least I can't, not yet. So I had a few virtual DOS sessions going at the same time: Epsilon, the DOS text editor I use

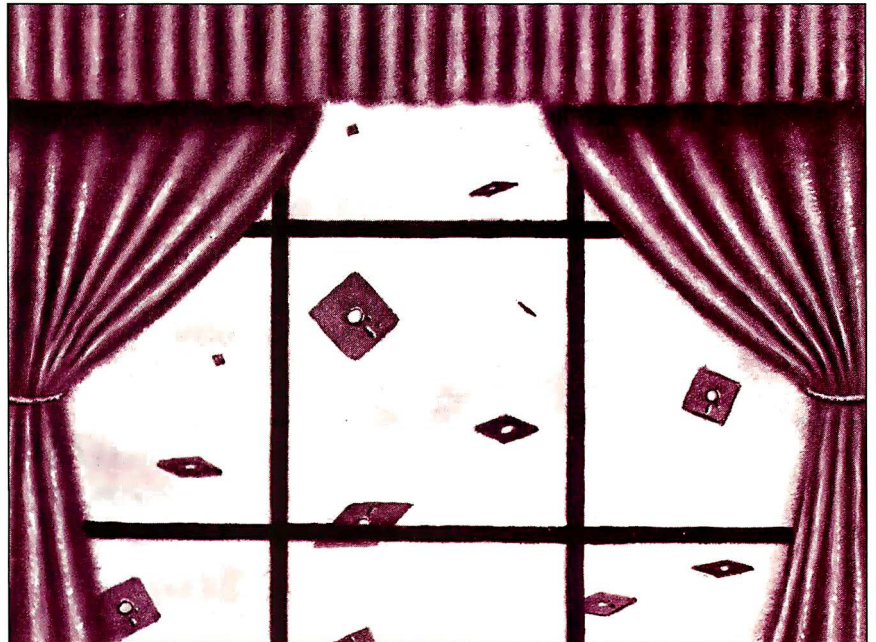

for all my writing and programming, and FoxPro, my data management ally.

My thumbnail layout took shape quickly. Interruptions weren't the annoyance they used to be. When a copy editor wandered in with a question about a previous month's article, I located the file, brought it up, and found the answer—without breaking stride or losing context.

With four major Windows applications, as many minor ones, and a pair of DOS programs all running at once, my machine showed only moderate signs of strain. That's Windows computing at its best: a pretty face, to be sure, but also a multitasking engine that pulls more useful work out of a 4-MB PC than you ever thought possible.

## A Walk on the Wild Side

A few days later I had my worst Windows catastrophe. I received a beta copy of a networking utility for which I thought

(erroneously, it turned out) that I'd need to load Novell's NetBIOS emulator. Normally, I boot DOS, run the NetWare IPX/NET4 substrate without the optional NetBIOS, and start Windows. That makes network services available to Windows itself, and to any virtual DOS sessions I launch from Windows.

Now, you don't have to load TSR programs from the original DOS session, and in the case of an optional utility like Novell's NetBIOS, you don't want to. I figured I'd just load it into the virtual DOS session in which I'd be running the program that required the NetBIOS interface. Wrong move.

When the dust settled, I surveyed the damage: My machine was still bootable, but CHKDSK reported hundreds of cross-linked clusters. Recovery was painless, since I had a fresh backup tape at hand. And I have never reproduced that particular crash; it may have been the fault of the beta NetWare shell I was

running at the time. Nevertheless, it was a rude reminder that Windows rests on a shaky foundation.

Windows 3.0 has two different modes of failure: There are Windows crashes, and then there are DOS crashes. Windows announces a failure of the first type with the message "Unrecoverable Application Error." Despite the ominous tone, UAEs are frequently benign. When a Windows program runs in protected mode (i.e., when Windows itself runs in either standard or 386-enhanced mode) and tries to write outside its authorized area in memory, Windows simply shuts the program down. It's just like a general protection fault under OS/2: The rogue task gets clobbered, but the rest of the system stays healthy.

UAE messages were common months ago when I ran lots of beta Windows 3.0 software. Now I rarely see such errors—unless I'm writing Windows programs myself, in which case they're a boon. Programmers like OS/2 because it takes the sting out of wild pointers; Windows 3.0 does much the same.

It's not the UAE that I dread, but rather the second sort of failure: errors

# Windows

## 3.0 has two modes of failure: Windows and DOS crashes.

that crash DOS and require the "three-fingered salute" (Ctrl-Alt-Del) or a hard reset. These are even more rare than UAEs, fortunately, but they can be very destructive. Windows usually gets the blame, but it's not really Windows' fault. DOS is the weak link in the chain.

Windows, like other DOS multitaskers, merely raises your expectations and encourages you to try to squeeze more work out of DOS. Because the 386/486 architecture enshrines a virtual 8086 processor in silicon, Windows' DOS multitasking usually works well. But V86 DOS sessions under Windows 3.0's 386-enhanced mode aren't isolated 1-MB partitions, as they are under, say,

IGC's VM/386. Instead, the original real-mode DOS session supports all V86 sessions spawned under Windows.

The shared-DOS approach saves a lot of memory. It's the reason I can comfortably run two or three DOS sessions along with four or five beefy Windows applications, all in 4 MB.

But it's also a source of fragility. You don't have to crash and burn to see what I mean. Go to the Settings dialog box in a windowed DOS session and choose Terminate. (While I'm happy to have the option to end a hung DOS session, it's a far cry from Unix's kill command.) Before you pull the trigger, Windows warns you to "close all applications, exit Windows, and reboot." And you had better take its advice, because Terminate will almost certainly hose the original DOS session on which the whole show depends.

### The Once and Future DOS

How can you patch up the DOS/Windows relationship? One way might be to offer an optional "VM/386" mode. If you're willing to trade memory (cheap) for stability (precious), you might, in some future version of Windows, allocate a full



**This is what it will cost you to write your own Windows™ applications.**

- A complete LISP programming environment including a LISP-aware program editor.
- Supports Dynamic Data Exchange (DDE) at a higher level than the SDK. Create both client and server applications.
- Supports GDI, the clipboard, dialog boxes and menus.
- Sample programs supplied include DDE sessions with Microsoft® Excel and Micrografix® Charisma™.
- Requires 386-based or fast 286-based machine and Windows™ 3.0.

**\$249.<sup>95</sup>**

To order Software Engineer, or for more information, just call **(214)234-2611** or Fax **(214)234-2674**

**RAINDROP SOFTWARE**

845 Arapaho Road • Suite 105 • Richardson • Texas • 75081

Some names mentioned above may be trademarks or registered trademarks of their respective holders.

## GRAPHIC TOOLS LIBRARY

**PC\_VDI:** Virtual Device Interface. Graphics library with examples. Display and Printed graphics. High Speed, high quality draw and print at 60 to 600 dpi. Outline font factory. Text at any angle. Scale text on demand. Draw on page. All GKS draw. POLYARC engine. Plots & charts. All drawing & mouse functions support Super VGA modes. **\$395.**

**PCXIO:** Source Library avail. in "C" or Assembler for fast read/write & display of PCX files at any point on screen or memory. Examine headers, palettes, compress data and clip images. Greyscale & Color Mapping. Readable, easily modifiable. Developers Utilities-pak. **\$295.**

**SCANLIB:** Image tools library. Scale image up or down (integer and fraction sfactor) or auto scale to fit in a window. Animation. Image rotate, stretch, skew, mirror, tile fill and window scroll. Virtual bitmaps and graphic pop-ups. Includes Text & mouse functions. Drag image. Support for multiple GIF, PCX, KPS, TIFF (CCITT, LZW, PACKBITS) file formats. Image database. ASCII to Fax. Clipper version. ANSI compatible. Faster. Hercules to 1024X768X256. **\$295.**

**MEGAVDI:** Mega Virtual device interface. Draw and manipulate large CAD drawings, scanned images and forms. Bitmap up to 15 MB is size with selectable pixel depth. SCANNER INTERFACE. Image pan, smooth scroll, rotate, hspeed-scale, zoom. Import GIF, PCX or TIFF (CCITT, GROUP 3, RGB 24 bit per pixel) images in a large bitmap for processing. Color print/plots with Pre-View. HP-GL and PaintJet. Clipper version. Super VGA. **\$395.**

**All products: NO ROYALTIES.** Most "C" and C++, Pascal, Fortran, MS QuickBasic 4.0 to 7.1

**NOVA INC. 708-882-4111**

2500 W. Higgins Road, #1144 DOWN LOAD  
Hoffman Estates, IL 60195 DEMO'S & INFO

**FAX: 708-882-4173 BBS: 708-882-4175**



# THE OPTICAL ZONE



**Y**ou're traveling through another dimension — a dimension of increasing storage demands and rewritable optical technology.

**S**ubmitted for your approval, storage solutions from the #1 source of optical storage systems in the world. Systems designed for Macintosh, SUN, DEC, HP, IBM and compatibles. Support for advanced applications running Unix, Xenix, A/UX, Novell, and more.

**P**innacle Micro, the leader in this new storage revolution, provides expanded storage for multimedia, digital video, pre-press, desktop publishing, CAD/CAM, and other data-intensive applications.



**I**n the Optical Zone, these storage requirements are met with the latest optical technology available. From the world's first 3.5 inch optical drive to the largest selling 5.25 inch optical drives and disk changers. On line, network, backup and archiving storage solutions from 128 Megabytes to 36 Gigabytes.

**W**ith optical storage, your data's life is prolonged and protected. Expansion is as easy as inserting another optical disc. With Pinnacle's

ASCENT™ program, systems can be upgraded from 650 Megabytes to 1 Terabyte.

*See the future ... Store the future ... Recall the future ... The future is Optical.  
For further reference, check under "S" for storage, from Pinnacle in ... The Optical Zone.*

☎ (800) 553-7070

Trademark Owners: Pinnacle Micro of Pinnacle Micro, Inc. Sun of Sun Microsystems. DEC of Digital Equipment Corp. IBM of International Business Machines Corporation. Macintosh of Apple Computer, Inc.

**PINNACLE MICRO**

THE OPTICAL STORAGE COMPANY™

15265 Alton Parkway • Irvine, CA 92718 • In CA (714) 727-3300 • FAX (714) 727-1913

Circle 176 on Reader Service Card (RESELLERS: 177)

megabyte for each DOS task and keep them all separate from one another.

Or, you can simply avoid DOS applications. That's not as farfetched as it sounds. To the extent that Windows applications meet your needs, Windows works like a charm. You can bet that every vendor of big-name DOS applications is contemplating, if not developing, Windows 3.0 versions of its products. Never mind the graphical user interface: Windows is a potent DOS extender that

makes the 640K-byte barrier seem like a bad dream.

If 1991 brings me Windows 3.0 versions of all my bread-and-butter applications, will I be satisfied? Nope. I have said that Windows expands the horizons of DOS-based computing. But strapping multiple copies of DOS into a preemptive-multitasking harness, and then yoking that ungainly contraption to the cooperative-multitasking Windows environment, can't be more than a stopgap

solution. Windows deserves better than the archaic real-mode single-tasking disk operating system that now supports it.

Will Microsoft improve DOS or supersede it? Both, apparently. A new DOS, version 5.0, should be available soon—a kinder, gentler DOS that will manage memory more intelligently than current versions. That will be a big help to DOS users, and to users of Windows, Desqview, and other DOS multitaskers. (But it won't bear much resemblance to the first DOS 5.0—an operating system now known as OS/2.)

There's plenty of speculation about DOS 5.0's successor, too. Perhaps it will be a SuperDOS featuring the High Performance File System, dynamic link libraries, improved video and communication application programming interfaces, and the DOS protected-mode interface. I'm sure all these things can, and probably should, be added to DOS.

But wait, there's already a system that does all this and more: OS/2 2.0. It has great DOS support, it will run Windows applications by way of a mapping layer (or, depending on who you talk to, directly), and, most of all, it's an industrial-strength multitasker with a future.

Unfortunately, it's a political football right now. IBM and Microsoft are making lateral passes but not advancing toward the goal line. That's a shame. With version 2.0, the two companies finally have a product that offers useful backward compatibility with the all-important DOS (and increasingly important Windows) software base, puts a solid foundation under those programs, and rolls out the red carpet for a new generation of software.

OS/2 2.0 isn't for everyone. Many, and perhaps most, of today's DOS/Windows users don't need more in the way of multitasking than the ability to do a background 2400-bps download. Windows handles that just fine (but don't count on 9600 bps). On the other hand, there's a reason why the phrase "mission-critical applications" always crops up in discussions of OS/2. It's rock solid. Why should network operating systems and server-based applications be the sole beneficiaries of that stability? I could use a healthy dose of it myself. My mission is critical, too. ■

*Jon Udell is a senior editor at large for BYTE. He can be reached on BIX as "judell."*

*Your questions and comments are welcome. Write to: Editor, BYTE, One Phoenix Mill Lane, Peterborough, NH 03458.*

	Qtr 1	Qtr 2	Qtr 3	Qtr 4
9880	389,688	384,700	433,388	
720	288,688	456,888	377,888	
90	486,288	479,184	398,487	
Hi-Hi Limit	98	78	399,388	488,488
High Limit	75			
Low Limit	55			
Lo-Lo Limit	45			
Field Limit	5			
Alarm Output	88			
Numeric Forec	CP			
	288,988	85,388	471,288	485,588
	298,688	58,488	458,388	488,585

THE POWER PRODUCT WITH THE POWERFUL RISK-FREE OFFER

## SOLA SIDEKICK. IT'LL KICK YOUR POWER PROBLEMS ASIDE.

Sola Sidekick<sup>™</sup> is the economical UPS that'll make light of even the most serious blackout. State-of-the-art design keeps your sensitive electronic equipment fully functional through every type of power line disturbance.

That means no more loss of valuable data, or damage to your system's components.

UL Listed and CSA Certified, Sidekick is only one of a full line of network compatible Sola UPS products.

NOVELL<sup>®</sup> 3Com<sup>®</sup> **BANYAN**<sup>®</sup> Microsoft<sup>®</sup>

1717 Busse Rd., Elk Grove Village, IL 60007  
708/439-2800 800/BUY-SOLA

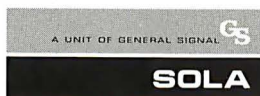
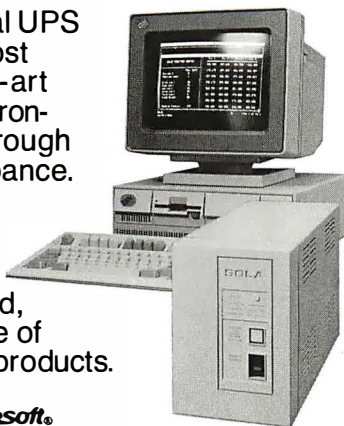

# Introducing an inexpensive solution to America's savings crisis.

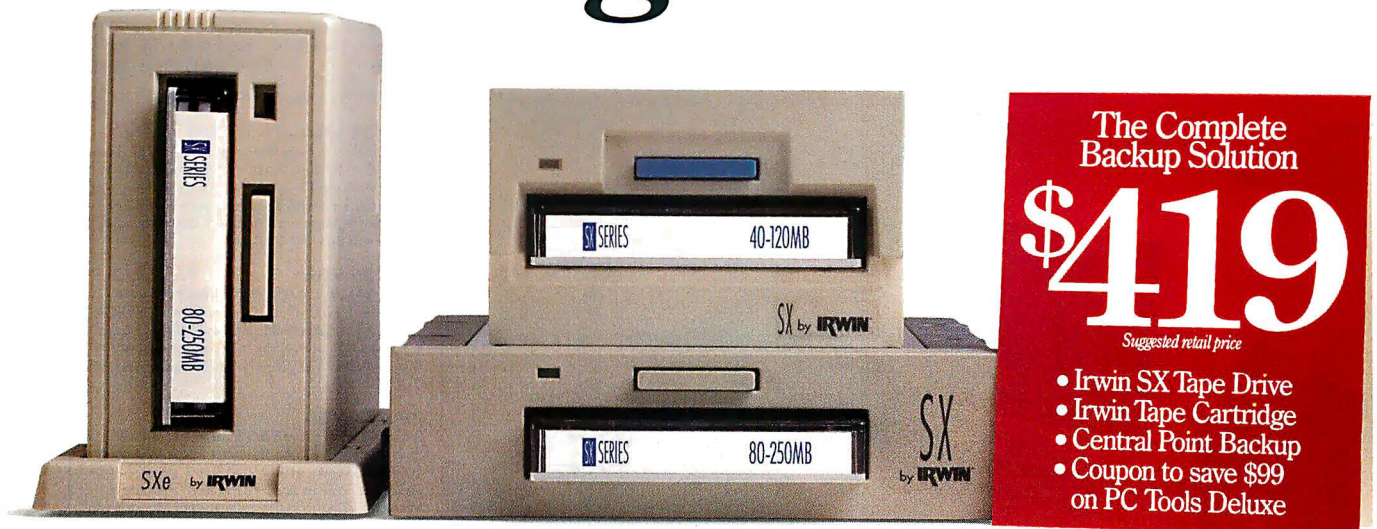

You've always wanted to own a tape drive. Unfortunately, one small thing has always stood in your way. Your savings account.

Well, now you can buy a complete tape system that can back up from 40-120 megabytes for as little as \$419.

Our Irwin SX Series™ Tape Backup Systems are ready to go right out of the box. Unlike others, they're complete systems—with all the hardware and software you need—as well as a tape cartridge.

The Irwin SX Series also includes a model that can back up 80 to a whopping 250 megabytes.

But that's not all. Every Irwin SX drive comes bundled with Central Point Backup™ software. This award-winning program works with a wide array of IBM AT, PS/2 and compatibles. Whether you choose an internal or an external system, you can back up a 40 megabyte



hard drive in less than 12 minutes.

Visual file selection, unattended backup and mouse support are just a few of the features that makes this the favorite backup utility of over one million PC users.

To save you even more money, we also include a coupon to let you buy Central Point PC Tools Deluxe™ for just \$50. A \$99 savings from its usual \$149 price tag.

So if you want to back up on tape without emptying your bank account, pick up an SX Series system at your nearest Irwin dealer.

If you don't know an Irwin dealer, call 800-BACKUP1 and we'll put you in touch with one who can end your savings crisis.

In more ways than one.

**IRWIN**  
An Archive® Company

# When You Buy ALTEC, You buy POWER, PERFORMANCE, QUALITY and SERVICE!

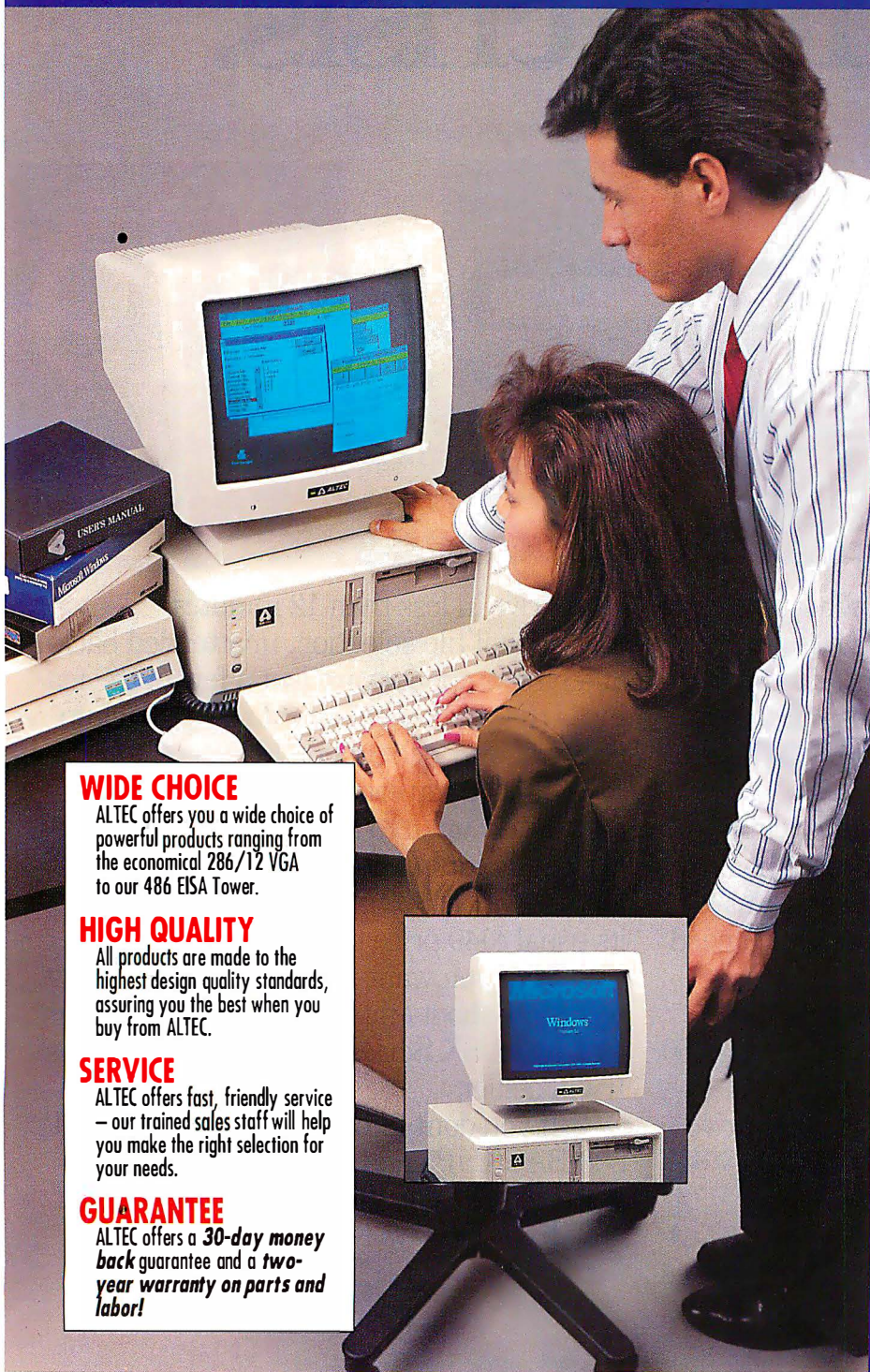

## WIDE CHOICE

ALTEC offers you a wide choice of powerful products ranging from the economical 286/12 VGA to our 486 EISA Tower.

## HIGH QUALITY

All products are made to the highest design quality standards, assuring you the best when you buy from ALTEC.

## SERVICE

ALTEC offers fast, friendly service — our trained sales staff will help you make the right selection for your needs.

## GUARANTEE

ALTEC offers a **30-day money back** guarantee and a **two-year warranty on parts and labor!**

## High quality design and Hi-Res VGA monitor — all at a low price!

### 486/33 ISA VGA **\$5,595**

64K Cache, exp 10256K • 4 Meg RAM • 1.2 MG 5.25" drive • 1.44 MB 3.5" drive • 150 MB 18ms ESDI hard drive • ESDI controller w/32K cache • 16 bit VGA card • 14" VGA monitor (1024 x 768) • 2 serial, 1 parallel & 1 game ports • 101-key Keyboard • Microsoft Window 3.0 • Hi-Res serial Mouse • MS-DOS 3.3 or 4.01  
CALL FOR EISA 486 CONFIGURATION

### 386/33 VGA **\$2,795**

64K Cache • 4 Meg RAM • 1.2 MG 5.25" drive • 1.44 MB 3.5" drive • 104 MB IDE hard drive • 16 bit VGA card • 14" VGA monitor (1024 x 768) • 2 serial, 1 parallel & 1 game ports • 101-key Keyboard • Microsoft Window 3.0 • Hi-Res serial Mouse • MS-DOS 3.3 or 4.01

### 386/25 VGA **\$2,595**

4 Meg RAM • 1.2 MB 5.25" drive • 1.44 MB 3.5" drive • 104 MB IDE hard drive • 16-bit VGA card • 14" VGA monitor (1024 x 768) • 2 serial, 1 parallel & 1 game ports • 101-key Keyboard • Microsoft Window 3.0 • Hi-Res serial Mouse • MS-DOS 3.3 or 4.01

### 386/5X VGA **\$1,895**

2 Meg RAM • 1.2 MB 5.25" drive • 1.44 MB 3.5" drive • 40 MB IDE hard drive • 16-bit VGA card • 14" VGA monitor (1024 x 768) • 2 serial, 1 parallel & 1 game ports • 101-key Keyboard • Microsoft Window 3.0 • Hi-Res serial Mouse • MS-DOS 3.3 or 4.01 • [20 Mhz version add \$150]

### 286/12 VGA COMBO **\$1,595**

1 Meg RAM • 1.2 MB 5.25" drive • 1.44 MB 3.5" drive • 40 MB IDE hard drive • 16-bit VGA card • 14" VGA monitor (640 x 480) • 2 serial, 1 parallel & 1 game ports • 101-key Keyboard • Serial Mouse • MS-DOS 3.3 or 4.01 • Panasonic 1180 printer w/cable • Surge Protector

## ALTEC'S GUARANTEE:

- 30-day money-back guarantee
- 2-year warranty for parts and labor
- **FREE** 4 month on-site service
- Lifetime toll-free technical support

**Policy:** Same day shipping with standard configuration for orders before 3 p.m. E.S.T. Shipping and handling are extra. P.O.s are welcome. Personal and company checks require 10 days to clear. Prices and specs are subject to change. Software, shipping and printer are not refundable. No surcharge for VISA & Mastercard. 2% American Express.



To Order:

**1-800-255-9971**

Technical Support: 1-800-255-9968

18555 East Gale Avenue • Industry, CA 91748  
(818) 912-8688 • FAX: (818) 912-8048



# MACINTOSH: THE NEXT GENERATION

Newer Macs need revolutionary designs to jump ahead of the PC pack

**C**ongratulations, Apple. You've got your new Macs out the door and they're winners. Amazingly enough, they're winners we can afford. The Mac LC and IIsi pack more punch (if a little less expandability) than the SE and IIfx they replace, and the monetary hit you take when buying them is also way down. Let's not forget the Mac Classic. I know I won't. Especially since I begged you to build this machine (and even named it the Macintosh Classic) way back in the August 1989 BYTE. A real Mac for less than \$1100 (discounted, of course), with 2 megabytes of RAM and a 40-MB hard disk drive. Nice job. With the new machines, Apple stands to regain market share. But is the job done? No way.

While the situation might be true regarding market share, Apple couldn't be further from the truth in thinking the job is done. The most important thing about the Classic, LC, and IIsi isn't what they cost or what they do. It's the philosophy they represent. These machines prove to us that Apple can respond positively to its customers once it makes a decision. And they prove that the engineering realization of a new Mac doesn't have to take forever.

Unfortunately, they also prove that Apple still takes too bloody long to make those realizations. The Classic, LC, and IIsi should have been agreed on long before they were finally being designed in 1990. Apple has to fix its marketing soon, or it won't make any difference how many versions of the future its engineers can invent. These fixes have got to start at the top. Apple needs a new, stable



management that cuts the bull and hammers home its strengths. In short, Apple needs Bill Campbell, the president of Claris, to run its show.

That's not just my view. It's the view of the MacFolk I've been polling informally over the last two months. They see Campbell as the only Apple executive with the intelligence and moxie to make Apple invent the future we need. Here's what the MacFolk and I see as Apple's short-term agenda, should Campbell get the job:

- Apple should introduce a 40- to 50-MHz 68040 machine this year, priced to compete against the newest Sun Sparcstations. While the Mac IIfx is plenty powerful, Apple must regain the price/performance high ground from Sun.
- Apple must get System 7.0 out the door before this summer, with all its announced parts intact. We've all waited too long for this.

- Apple must put together a realistic vision of System 8.0 that includes preemptive multitasking and a dynamic memory map. System 8.0 must debut no later than the fourth quarter of 1992. Windows 3.0 isn't sitting still.

- Apple should make whatever alliances are necessary with Sony or Toshiba or Sharp to get a line of sub-7-pound Mac laptops on the market before the end of this year. The 16-pound Mac Portable is something of a joke.

In the long term, the MacFolk want Apple to invent, by 1994, a new Macintosh that's still software-compatible with the current generation, yet oriented around the three-dimensional universe, not just a two-dimensional screen. This new Mac should have built-in high-resolution sound input and output (no less than the reproduction capabilities of the new 16-bit A/D converters found in the top-of-the-line compact disc players). It must

# Space-Saver Keyboard



**S**ave an amazing 60% of the desk or counter space now taken by a standard keyboard and enjoy improved functionality at the same time. Actual size is 273 x 152mm (10.75" x 6.0"). The new MICROTYPE Keyboard is rapidly gaining acceptance as a truly advanced alternative to the original IBM layout for many applications. Reliability of the MICROTYPE has been amply proven through extensive use in trading areas of several major stock exchanges as well as in many banks, brokerages, stores and at factory work stations.

Space is saved by compressing rows (not columns) and eliminating wide borders. Re-arranging and elevating the auxiliary key clusters also saves space while improving accessibility with reduced eyescan and head movement. Keys have full travel with a light tactilly responsive touch. All standard features such as auto-repeat, caps, num and scroll lock are included on the MICROTYPE.

PC XT/AT, PS/2 IBM and clone compatibility. Available in US and most European language versions. Made in USA with 1 year warranty.

Order direct from stock with 15 day full return privileges. VISA, MasterCard, Eurocard charges and COD accepted.

USA	1-800-DATALUX	Fax 703-662-1682	\$124.50 + 6.00 s/h
EUROPE	44+306-76718	Fax 44+306-76742	£99.00 + VAT + P&P
CANADA	514-694-0870	Fax 514-694-0871	\$189.00 Cdn + s/h

OEM and reseller volume discounts available. Keytop legend and color customization offered.



A new Space-saver product from DATALUX — Microtype keyboard and LCD monitor combination. VGA resolution, backlit, supplied with adaptor card. Call for price and availability.

"... beautifully sensitive and handles both typists with light touch and those who really bang away..."

COMPUTER BUYER'S GUIDE

"... This could be the perfect layout for an enhanced keyboard that must fit into a small area..."

COMPUMAG

## DATALUX

**DATALUX Corporation**  
2836 Cessna Drive  
Winchester, Virginia 22601

**DATALUX INTERNATIONAL LTD.**  
Euro House  
Curtis Road, 11 Old Water Road  
Dorking, Surrey, UK

### ITEMS DISCUSSED

**Lotus Marketplace: Business**  
\$695 for initial 5000-name usage license; \$150 for one year's worth of quarterly updates; \$400 for each additional 5000-name usage license; discounts available at the 25,000-name level.

Lotus Development Corp.  
55 Cambridge Pkwy.  
Cambridge, MA 02142  
(800) 343-5414  
(617) 577-8500  
fax: (617) 693-3981  
**Inquiry 1224.**

have a very high resolution 19-inch color screen with 16.8 million colors standard and the ability to show multiple levels of color depth.

In other words, the screen should offer resolution no less than what the new high-definition TV standards specify, a first step toward a 3-D Mac. This new Mac must have prodigious real memory (at least 32 MB), with growth into the hundreds of megabytes easily possible. It must include a standard thin-film hard disk drive of at least 1 gigabyte. It also needs a built-in optical read/write archival disk drive that can back up the hard disk drive several times over (3 to 5 gigabytes).

This new Mac must have an operating system and Finder that fully incorporates sound input and output and the use of detailed visuals to communicate. Given the proper voice-recognition algorithms, a mouse might not even be necessary, or it might be replaced by a more accurate cursor positioner, like an x,y digitizing wand or infrared drawing stylus.

What 1994 should hold, say the Mac-Folk, is not just more of the same with the Mac. They all agree that the tenth anniversary of the Mac must again show that Apple can invent the future. Finder twiddling, new font architectures, and improved virtual memory are fine, but they just don't go far enough. I hope Apple can take on the future Mac with the same dedication that it took on the 1984 version, which we're still using today.

### Software of the Month

I get a lot of software sent to me each month. To many people, that would be nirvana, and it used to be for me, too. But having just celebrated my twelfth anniversary as a published computer writer, my attitude has changed a bit. I just can't take an in-depth look at all the

# Lease a Macintosh System for as little as \$43.<sup>43</sup>/month.

## Why You Should Buy Your Mac from CDA.

Over the last ten years CDA has worked hard to create something unique in the field of computer mail order—a company that could provide customers with the support they would expect from a local computer dealer, along with the convenience and economy of direct-order, by mail, fax or phone. Thus CDA has grown with the computer industry and, in the process, has earned a rock-solid reputation for providing superior-quality service and support. To insure you're 100% satisfied with your purchase, CDA offers a 30 Day Money-Back Guarantee as well as a full One Year Performance Guarantee on all orders.



### IBM/Macintosh Hardware

Orange 386 .....	\$1699
DaynaFile Dual 5.25/1.2Mb .....	\$699
Dayna Translation Software .....	\$89
AccessPC by Dayna .....	\$85
Soft PC by Insignia .....	\$129

### Printers (cables included)

Apple LaserWriter IINT .....	\$3395
Personal LaserWriter NT .....	\$2475
QMS PS 410 .....	\$2199

### Scanners

Microtek MSF 300GS w/SCSI ..	\$1559
------------------------------	--------

### Modems

DoveFax Desktop .....	\$279
DataLink Mac Internal (Mac II) \$	199

### Monitors

Mega Graphics 19" Rival .....	\$1199
Magnavox 14" Color RGB .....	\$459
E-Machines T-16 w/card .....	\$2149
Ikegami 20" Trinitron w/card	\$2799
RasterOps 19" Trin w/card .....	\$4569

Please call for our complete list of Macintosh hardware & software. Purchase Orders Welcome.

Fax: (908) 832-9740 Ad#50-01  
In NJ/Outside US (908) 832-9004

US/Canada 800-526-5313

### Macintosh Classic System

- Macintosh Classic w/40 Mb Apple Hard Drive, Apple SuperDrive, Keyboard, Mouse, & 2 Megabytes of RAM
- HyperCard and MultiFinder
- Virex (anti-virus) Software
- Adobe Type Manager
- 6 Outlet Surge Protector
- 10 Diskettes
- Diskette Storage Box
- Mouse Pad

Ask for Package #9101

**CDA Price \$1,539**  
**Only \$43.<sup>43</sup>/month\***

\*Based on 48 month FMV lease

### Macintosh IIsi System

- Macintosh IIsi CPU w/40 Mb Apple HD, Apple SuperDrive, and 2 Megabytes of RAM
- Microphone
- DataDesk Switchboard
- Magnavox 14" RGB Monitor
- HyperCard and MultiFinder
- Virex (anti-virus) Software
- Adobe Type Manager
- 6 Outlet Surge Protector
- Mouse Pad
- 10 Diskettes
- Disk Storage Box

Ask for Package #9110

**CDA Price \$3,769**  
**Only \$90.<sup>23</sup>/month\***

\*Based on 60 month FMV lease

### Macintosh IICI System

- Macintosh IICI CPU w/built in Video Card, Microtech Nova 105 Mb HD Apple SuperDrive, & 4 Megabytes of RAM
- Magnavox 14" Color Monitor
- DataDesk SwitchBoard
- HyperCard & MultiFinder
- Virex (anti-virus) Software
- Adobe Type Manager Software
- Norton Utilities Software
- Total Recall Software
- Demo of Microsoft Excel
- 10 Diskettes
- Disk Storage Box
- Mouse Pad
- 6 Outlet Surge Protector

Ask for Package #9107

**CDA Price \$5,969**  
**Only \$142.<sup>41</sup>/month\***

\*Based on 60 month FMV lease

# CDA Computer Sales

1 CDA Plaza, P.O. Box 533 Califon, NJ 07830  
Apple Macintosh & LaserWriter are registered trademarks of Apple Computer Inc.

# CD-ROM

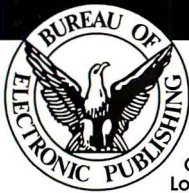

**NEW!**

Guaranteed  
Lowest Prices!

## U.S. HISTORY ON CD-ROM

Full text of 107 U.S. history books  
with 1,000 images, tables & maps!  
U.S. History on CD-ROM disc \$395

## CD-ROM BUNDLE! Get The New Philips CM-50 CD-ROM Drive Kit And 6 Discs - Only \$689

\*\*\*\*\*SAVE OVER \$1200\*\*\*\*\*

Microsoft Bookshelf best seller  
U.S. History on CD-ROM 107 books  
Sherlock Holmes on Disc 221 Baker St. fans  
Shakespeare on Disc "complete"  
Birds of America pictures and sounds  
Software Potpourri • King James Bible  
Movie Database

### CD-ROM Drives (ready to run)

Hilachi Drives- all models, PC and Mac From \$599  
NEC CDR-73 or 83 or 36 CD-ROM Drive From \$499  
Sun Moon Star CD-ROM Drive Bundle with 7 discs Col  
Pioneer Minichanger CD-ROM Drive complete kit Col  
800 MEGABYTE WORM less than \$0.18 per MB! 3,495  
Also: Denon, Chinon, & Sony drives, Best Price - Call!

### Business

C Library or Ada or Shareware Grab Bag 589  
CIA World Fact Book perfect for international "business" 99  
World Atlas color maps and statistics throughout world Col  
Microsoft Bookshelf all time best selling CD-ROM disc 199  
PC-Sig Library new edition, version 8 465  
Countries of the World over 100 reference books 495  
Telephone Directory East or West 995

### Libraries and Science

Birds of America includes pictures and sound 599  
Grolier's Encyclopedia 21 volumes, VGA pictures Col  
Medical Year Book on Disc fulltext of 1989 Year Books 195  
McGraw-Hill Ref. Set 100,000 terms; 7,300 articles 245  
Wordcruncher Disc entire works of 8 authors 249  
Pediatrics on Disc 5 years of Journal Pediatrics, 1983-89 395  
Mammals includes pictures & text Col  
Library of the Future Over 50 Authors, 450 titles Col  
Oxford Textbook of Medicine general medical reference 595  
Oxford English Dictionary over 250,000 headwords! 889  
Compton's Multi-Media Encyclopedia rave reviews 895

### Miscellaneous

Movie Directory Database/Software Potpourri 549  
Between Heaven & Hell II even stranger 99  
Sherlock Holmes or Shakespeare on Disc "complete" 99  
Sporting News Baseball CD a sports fans dream 149  
Guinness Book of World Records Multi-media PC & Mac Col

**\*\* MORE! Over 300 different titles available \*\***  
Free CD-ROM Product Guide with every order  
Money back guarantee Free tech support  
CALL - Bureau On-Line CD-ROM Library,  
FREE access to 12 different CD-ROM Discs



**Bureau of  
Electronic Publishing, Inc.**

Dept. P, 141 New Road, Parsippany, NJ 07054  
Fax # 201-808-2676

Call: 1-800-828-4766 orders only  
(201) 808-2700 information

dozens of packages sent to me each week, even though I really want to. Therefore, with the help of some of my colleagues and grad students, I've worked up a triage system to make sure every piece of software I receive each week gets looked at by a knowledgeable person who will report impressions back to me. Having this first cut will let me pick more carefully the stuff I want to emphasize in these pages.

With this new system in mind, I'm fashioning a new section in Macinations, which I'll call the Software of the Month. Each month, I'll look at one outstanding new Mac program.

This month, I give kudos to Lotus Marketplace: Business. Marketplace is a CD-ROM filled with information on over 7 million U.S. businesses. It includes the basic stuff, like names and addresses (for direct mail campaigns), and a slew of criteria that let you pick and choose the businesses you want to retrieve from the disk. You can search by business Standard Industry Code (SIC), by number of employees, and even by annual sales. With this information retrieved, you can create mailing lists, market research reports, or telemarketing call reports.

Marketplace combines huge prospect lists with target marketing software, all on the same CD-ROM. With this combination, you can find new customers without having to subscribe to more expensive on-line services that cater to this kind of direct marketing information niche. Marketplace is not cheap, of course, but the data you receive (it's updated with a new CD-ROM each quarter at a yearly subscription price of \$150) is accurate and detailed. The basic package, which lets you retrieve the information of every company on the disk (all 7 million), costs \$695. But the license limits your use to 5000 businesses. Each additional 5000 costs another \$400. Volume discounts start to kick in after you buy over 25,000 names.

Marketplace includes all the software needed to do all this fancy market research and analysis (mostly HyperCard stacks and copies of HyperCard to work with any System from 6.0.2 to the current release). You'll also need a Mac with at least 4 MB of RAM (8 MB is better), a hard disk drive, and an AppleCD SC CD-ROM drive (or 100 percent compatible) to make it happen.

The only real problem with Marketplace is speed. Accessing a mountain of data from a CD-ROM disk is slow, slow, slow, even with the fastest IIfx as your search engine. However, compared to

pulling similar data from a 2400-bps modem data link, Marketplace seems like a speed demon. And it's so much easier to use.

### Tip of the Month: BIX

It's easy to forget the most obvious stuff. I guess I do it all the time. But it's time for me to redress a glaring omission in this column: my failure to discuss the BIX Macintosh Exchange. Whether you are a Mac fan or not, you should be on BIX. I suppose that sounds self-serving, coming as it does here in BYTE. But the point is, of all the on-line services out there in on-line-services land, BIX consistently offers the most high-quality information, especially for MacFolk.

The real strength of BIX is its membership. The people who contribute their expertise and souls to the on-line conferences are among the luminaries of the computing business. If you had to pay the consulting tabs these folks charge for their services while *not* on BIX, you'd be broke in a New York second.

If you're a Mac person, you are simply missing out if you aren't on BIX hanging out regularly in all the Macintosh Exchange conferences. In addition to getting tough technical questions answered (often by many experts), you can get to Apple's press releases and follow various threads that cover technology trends and specific implementation issues. And if you like to flame on every once in a while (hey, it's good for you!), the Macintosh Exchange on BIX offers just the forum for you.

BIX isn't as flashy as America Online or AppleLink, and, at least for the time being, it lacks CompuServe's automated front-end graphical-user-interface software (Navigator). Fortunately, though, its signal-to-noise ratio is much higher than that of any of these competitors. Of course, if you can afford it, you should live on as many services as possible. But if you're looking for a lot of Mac-specific information from *real* Mac experts, you should check out the BIX Macintosh Exchange. ■

*Don Crabb is the director of laboratories and a senior lecturer for the computer science department at the University of Chicago. He is the author of a new book, Using Filemaker Pro (Simon & Schuster/Brady Books). He is also a contributing editor for BYTE. He can be reached on BIX as "decrabb."*

*Your questions and comments are welcome. Write to: Editor, BYTE, One Phoenix Mill Lane, Peterborough, NH 03458.*





## LANTastic's™ tiny RAM now has more cards to play with.

If the presence of Micro Channel machines has ever stood between you and the joy of running the award-winning LANTastic PC Network, this is your lucky day. Artisoft has just added three new Micro Channel adapters to its compliment of AE-2 Ethernet, 2Mbps and Voice adapters.

LANTastic AE-2 MC Ethernet for Micro Channel, a 16-bit adapter that can be used in either a 16-bit or a 32-bit slot, is in 100% compliance with IEEE 802.3 and Ethernet standards, and comes with on-board 16K RAM that is user expandable to 64K. Since AE-2 MC Ethernet is software compatible with Novell's NE/2000 hardware, you can run Novell "out of the box."

LANTastic 2Mbps MC adapters



are the perfect way to economically network small or midsize businesses with Micro Channel computers. Each card includes a 10Mhz coprocessor and 32K of on-board dual-ported RAM, along with software-selectable IRQ and RAMBASE address settings. Artisoft's version of the NetBIOS standard can be loaded into and executed within the adapter. This plunges the NetBIOS draw on a PC's base RAM down to just 2K and off loads the network processing onto the adapter. The cards are easy to install and use inexpensive dual-twisted pair cable.

LANTastic Voice MC adapters let you save sound and speech onto disk for playback later on Micro Channel machines. Use them with LANTastic NOS 3.0 or above, and



you can send voice messages across your LANTastic network. Just pick up the telephone handset provided with each Voice Adapter, bring up a handy on-screen menu, and talk. Use Voice Chat to carry on a real time conversation, or save the message for playback later in your own voice — either through the handset or through the Micro Channel machine's internal speaker.

Now it's easier than ever to run LANTastic's award-winning Network Operating System on Micro Channel machines. Call 602-293-6363 or fax 602-293-8065.



**ARTISOFT**  
Revolutionizing Connectivity

# Write Once, Port Many.



## With new c-tree Plus™ when you've written for one platform you've written for them all.

### SPECIAL OFFER FOR CURRENT C-TREE® USERS!

Take advantage of the exciting features offered by c-tree Plus, at a special introductory price reserved just for you — call for details!

## c-tree Plus™

Circle 81 on Reader Service Card



FAIRCOM  
corporation

4006 WEST BROADWAY  
COLUMBIA, MO 65203  
PHONE 314.445.6833

### ■ Develop on over 100 platforms — without reprogramming!

Forget the tedious, time consuming and expensive reprogramming required to move from one environment to another. With c-tree Plus™ you don't change source code at all — just recompile, link and you're running on platforms ranging from Cray supercomputers to Zenith laptops! Over 100 environments are supported, including: ■ Windows 3 ■ DOS ■ UNIX ■ OS/2 ■ VAX/VMS ■ Mac ■ SUN ■ RS-6000

Forget byte order, memory model, integer size or data alignment hassles — c-tree Plus manages it all automatically, regardless of processor architecture. And c-tree Plus even provides a utility to port your pre-existing data files *in place*.

### ■ Whether you need single, multi-user, client/server or LAN configurations, c-tree Plus supports them all!

Now you don't have to make a choice between configurations — c-tree Plus supports them all. The same application can use c-tree Plus as a powerful data management engine or as a client front-end to the FairCom Servers.

### ■ Put the latest data management technology to work in your applications!

Outstanding new features make c-tree Plus the developer's "product of choice." Features include: ■ True transaction processing\* ■ Superfiles ■ Resources ■ Full ANSI-standard SQL functionality\* ■ Batched operations ■ Ultra-high speed data & index cache ■ Row & key level locking ■ FREE FairCom® Server (Developer's Version) ■ No run-time royalties ■ Full source code ■ Extensive tech support.

### ■ Order your copy of c-tree plus today!

Start putting the power of new c-tree Plus to work in your applications right now — call FairCom today!

## (800) 234-8180, Ext. 1

\* — when used in conjunction with the FairCom Servers



# HEED THE STANDARDS

Love them or hate them, standards are something you have to deal with

**S**erving on a standards committee can be excruciatingly dull, yet it can turn into high drama when a controversial detail is debated. But the standards most people have to deal with are the ones that govern the software or hardware they're intending to buy. At such a point of decision, standards become very interesting, because failure to heed them may affect your job in a negative way. Less dramatically, there's always the problem of a standard that's not quite standard yet, which makes you scratch your head for days before finally making that big decision.

Unlike a stand-alone PC in an isolated office, Unix installations generally are designed with regard to company policies, history, and network connections. That's why it's a good idea to be aware of standards that may affect you. Perhaps more important, every new system installed that complies to a de facto standard means less work in the future to get that standard accepted.

## Going Worldwide

The most important thing about the next few years will be the realization that computers exist as part of a worldwide market. I'm not talking about whether Asian companies control the U.S. computer market, but about computer users who are much the same everywhere. That is, it's not just Americans who like to see good software and hardware design and who insist on prompts and currency representation that correspond to their local language and customs.

In some ways, the computer industry is more fortunate than other industries.

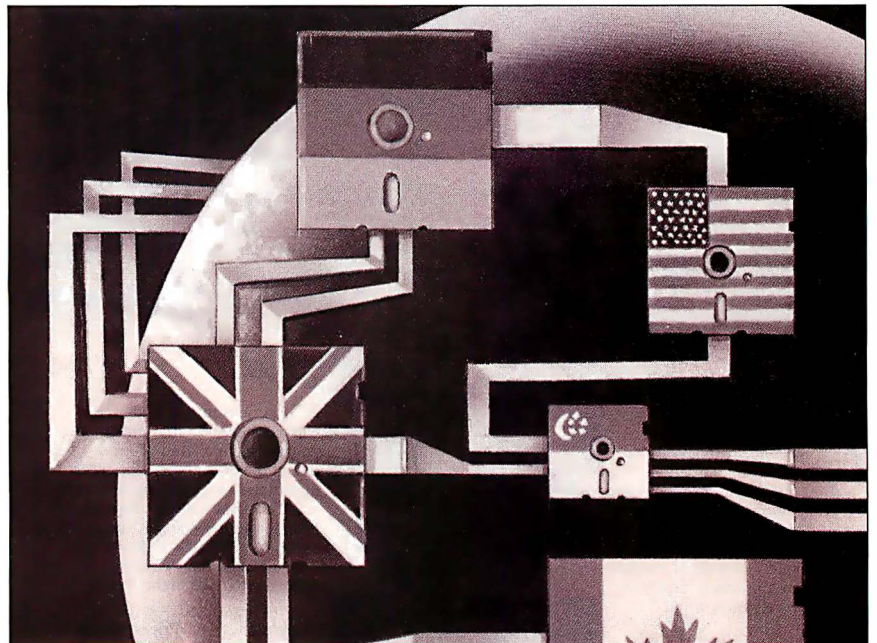

Power supplies that work on any world-wide voltage are commonplace, and many standards that started in one country (e.g., RS-232, Ethernet, and the myriad sizes of floppy disks) have been accepted in other lands as well.

## Some Real Characters

Some languages (such as kanji and Arabic) need more than ASCII to represent them, and any new international standards must address this problem (see "Around the World in Text Displays," May 1990 BYTE). That's why newer releases of Unix (starting with System V release 3.2) support so-called 8-bit ASCII, which allows extensions to larger character sets as well as to distinctly non-ASCII representations. Only 7 bits are needed for all the characters in the U.S. The eighth bit is used in two ways internationally: to expand the 128-character ASCII set to a full 255 different characters (useful for European and other lan-

guages, such as Greek and Cyrillic) or to signal that another byte of character data will follow. Future releases of Unix will support character widths of up to 32 bits, which presumably will be enough until the Alpha Centaurians land.

The problem has been that Unix was not originally designed to be the international commercial operating system it has now become. The standard Unix shell, before Unix System V.3, used the eighth bit to mark literal strings internally. The basic Unix text editor, ed, wouldn't even accept a file that contained 8-bit characters, while vi would simply strip off the eighth bit silently.

Numerous internal changes, invisible to the average user or programmer, have been made in Unix to allow the full internationalization that is complete in Unix System V.4. The result will be an environment that can be easily customized for local variations in date, time, currency, and numeric formats, as well

as language and collating sequence. All this has been made possible by the set-locale function defined in the standard C language by ANSI X3J11.

Interestingly enough, much of the movement to internationalize and standardize Unix has come from the U.S. Apart from the X3J11 standard for C (which was defined by ANSI), we have the NIST's FIPS standard and AT&T's SVID standard. The POSIX standard has been issued by IEEE, an international

organization based in New York, and the X/Open standard comes from San Francisco. Americans are not as insular as some people like to believe.

Of course, the most important move toward standardization is that of AT&T's Unix System V.4, which brings together previous versions of AT&T Unix, SCO/Microsoft Xenix, BSD Unix, and SunOS. This gives users one admittedly large Unix that can deal with programs from any of these once-separate environ-

ments. Open Software Foundation's release of its OSF/1 operating system will provide a second alternative for manufacturers and users alike. If both these competing systems prevail, at least there will be two main Unix standards to deal with, rather than four or five.

**Hoisting Those Standards**

People should look toward standards as rules that transcend traditional views of "where things belong." For instance, the traditional view is that IBM PCs and clones use LaserJet-compatible printers, and Macintosh computers use LaserWriters and other PostScript printers. My view is that PostScript is too important a standard to be relegated merely to Apple computers, because using PostScript also lets you access other devices such as typesetting machines and even windowing systems (e.g., the Next computers and the News system) that rely on Display PostScript. So I applaud makers of IBM PC software that support PostScript, and I doubly applaud recent developments, such as The Santa Cruz Operation's direct support of PostScript printers in its SCO Unix. The more PostScript is used as a mainstream Unix standard, the more you will see new hardware and software that support it.

Even saying things like "IBM PCs and clones" is now nonstandard. There's a new, Politically Correct way of saying the same thing: Industry Standard Architecture. That brings to mind the Extended ISA bus, which many manufacturers are attempting to make a de facto standard while flying in the face of IBM's own Micro Channel architecture bus. This is a perfect example of how unsettling standards wars can become. At this writing, there is no clear winner, so investors in either bus must lay down their money and take their chances.

In workstations, as I've discussed in previous columns, SPARC technology is becoming more popular. Now that Sun has relinquished licensing control of SPARC, it may become an industry-standard architecture of its own. Unlike PC-based computers, many workstations are becoming single-board computers, with expansion capabilities limited to the 64 or so megabytes of RAM that you can add to the system board or to what peripherals you can hook up to the SCSI port. In practice, that's not too limiting, since the server will have its own litany of expansion board capabilities.

What about Unix windows? The X Window System is about the closest thing to a standard you can find in this area. Once you've decided on that, you can

# Bugs are expensive. Can you afford them?

**Richard Fink, President of RainTree Computer Systems, writes, "...What it [Periscope] offers is probably the most comprehensive debugging capability on the market today. And for you and me, that means getting to market sooner. Getting to market with a cleaner product. That's an objective we all know about."**

**Periscope handles the level of debugging you need.** Whether you're developing applications written in a high-level language, doing low-level system development, or something in between, Periscope can help you find the bugs. Randy Brukardt, a developer of the Janus Ada compiler, writes, "I couldn't imagine using anything else...It is just as useful debugging my Ada code at the source level as it is for finding bugs in assembler code, even TSRs and device drivers."

**There's just not much you can't debug with Periscope.** For example, you can debug device drivers and TSRs, child processes, and software interrupts. You can trace DOS and debug foreground and background programs in the same session. Large programs are no problem. Periscope supports Plink and .RTLink overlays, and Windows

3.0 programs in real mode. You can monitor software running on another system. And you can debug the boot process, hardware interrupts, and real-time code. The Periscope software runs on 8088 through 80486 machines, supports 80386/80486 debug registers, and runs with 386 control programs in the system.

**There's a Periscope model for every budget.** Prices start at \$195 for software-only Model II-X. Model II with its handy break-out switch is \$225. Model I with 512K of write-protected RAM is \$595 for PCs and \$695 for PS/2s. Model IV with its real-time hardware trace buffer and breakpoints is \$1895 to \$2395, depending on your processor and its speed. We'll be happy to help you decide which model you need.



*Periscope Model II includes a break-out switch and the new Version 5 software. The new software, included with all models, features a menu system that makes Periscope easier than ever to learn and use.*

**Start saving money today. Call Toll-Free: 800-722-7006**

Overseas, call: UK - Roundhill Computer Systems, 0672 84 535; Germany - H+B EDV, 07542 6353; ComFood, 02534 7093; Sweden - LinSoft, 013 124780; Denmark - Rovenholm Computing, 02 88 72 49; Australia - BJE Enterprises, 02 858 561 1.



1197 Peachtree St., Atlanta, GA 30361, USA • 404/875-8080 FAX 404/872-1973



choose graphical user interfaces such as Open Look and OSF/Motif, with the decided nod to Motif right now.

Of course, the standard for LAN connections is still Ethernet and TCP/IP protocols, whether you're dealing with workstations, PCs, or Macs. In the future, you can look forward to even more connectivity as Open Systems Interconnection, fiber-optic and wide-area cable networks, and X.400 mail systems become more popular. People *like* talking to other people, and the easier it is, the better. Right now, I can send ASCII-based E-mail messages from my Unix machine on UUCP-Net to people on the Internet, MCI Mail, and CompuServe, but faxes, binaries, or image files wouldn't work. I expect that these kinds of problems will be solved in the next few years when machine brand and operating system are too petty to stand in the way of simple interpersonal communications.

#### Getting the Message Across

Here's an example of how standards have helped information exchange. Floppy disks, as mentioned above, have undergone many changes since the early days,

but there are still enough standards that Apples, IBMs, Unix systems, and even Ataris can generally exchange disks using suitable software. Manufacturers learned from this, so hard disks and tapes now generally use one of a few standard interfaces and formats (e.g., SCSI, MFM, RLL, IDE, and QIC-24). This lets you buy a disk now for one system and use it later on a different architecture, or bring data from a Sun to a 386-based Unix system via cartridge tape. SCSI deserves special mention; it transcends a device type and allows great flexibility, although there are some potential security concerns with certain SCSI devices on Unix systems.

The most important standards you'll see will be developing now for the next decade. As with communications, the growth of true universal multimedia data and applications will only come when standards that cross operating systems and machine architectures arrive. This will allow all participating machines to exchange image, text, sound, and video data, using whatever hardware exists on the target machine to speed things up. This is especially important for video

data compression and decompression, which itself will be standardized in the next few months.

At this writing, a standard called Macromedia has been proposed, and there will be others, perhaps based on the work already done by Next, in the same vein. I can only hope that a consensus is reached soon, so we can all benefit from this. Imagine getting E-mail with a verbal annotation that you can listen to and a 15-second video message that automatically pops up in a window on your screen. That's available now on several Unix platforms. But when you won't know or care what kind of machine the original message was created on, then standards will have finally done their job. ■

*David Fiedler is executive producer of Unix Video Quarterly and coauthor of the book Unix System Administration. He has helped start several Unix-related publications. You can reach him on BIX as "fiedler."*

*Your questions and comments are welcome. Write to: Editor, BYTE, One Phoenix Mill Lane, Peterborough, NH 03458.*



*Unix / Novell*

## POWERMON™

### POWER MONITORING PACKAGE

Available Now!!

Complete Power Support  
For Unix and Novell!

PowerMon software and UPS  
to support most Unix and Novell systems.  
ex: AT&T, DEC, HP, IBM, SCO, SUN, and Others

For software package and UPS contact:

CIC Distributors

314-537-0305

FAX: 314-536-2535

CIC Distributors is an Authorized Reseller of PowerMon.  
Reseller pricing available.

IT'S 11:35 p.m.

SOMEONE TWO THOUSAND  
MILES AWAY JUST SAW  
YOUR AD...AND WANTS  
MORE INFORMATION, NOW.

HOW DO YOU  
SATISFY THIS POTENTIAL  
CUSTOMER?

TRY THIS DEMO

1. Pick up the phone connected to your FAX machine and dial:  
**USA: 708-924-7465 UK: (+44) 672 84242**
2. Follow the simple voice instructions, using the phone keypad to respond.
3. You will be asked to press in the code number for FaxFacts.  
**USA—Press: 889812# UK—Press: 201#**
4. Continue to follow instructions being given over the phone.
5. Once all steps are completed, you will be asked to press the "START" or "RECEIVE" button on your FAX.
6. Within seconds, after pressing this button, you will be given information on this instantaneous literature delivery system.

FaxFacts is a product of USA: (708) 682-8898  
Copia International, Inc. UK: (+44) 672 84535  
USA FAX: (708) 665-9841

# 3270 Coax for UNIX

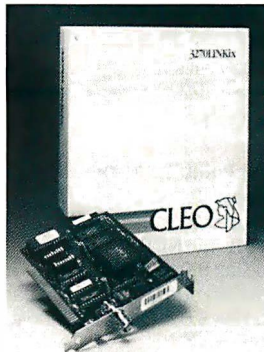

CLEO's 3270LINKix™ provides complete, cost-effective mainframe connectivity for your UNIX systems.

You just plug in a coax board (our own or any IBM advanced coax adapter or compatible), load the software, and

### *Application Program Interface*

link to your mainframe through a remote or channel-attached IBM 3174/3274 controller.

With 3270-LINKix, you get full emulation of IBM 3278 monochrome display terminals (models 2-5) and 3279 color terminals (models 2A, 2B, 3A, and 3B), in CUT or DFT mode.

You also get full IBM 3287 printer emulation (LU Types 1 and 3) for your UNIX-attached ASCII printers.

UNIX systems supported include SCO's UNIX System V 3.2, AT&T's UNIX System V/386, Interactive Systems' 386/ix, and

others. Features include:

- Application Program Interface (HLLAPI 3.0, plus

CLEO's own API)

- IND\$FILE file transfer for CMS, TSO, and CICS

- Up to five sessions, with support for SNA or channel-attached non-SNA communications, in DFT

- User-configurable keyboard mapping

- Easy menu-driven interface

*5 sessions, for SNA or channel-attached non-SNA, in DFT*

To learn more, call us today at 1-800-233-2536. Or write to us at 3796 Plaza Drive, Ann Arbor, Michigan 48108. FAX: 313/662-1965.

**CLEO**   
**CLEO Communications**®  
 A Division of Interface Systems, Inc.

See us at UniForum '91, Dallas Infomart, January 22-24, Booth #1213.

AVAILABLE WORLDWIDE!

In Europe call Sintec Peripherals Ltd. in Slough, England, at 0753-811888 (FAX: 0753-811666).

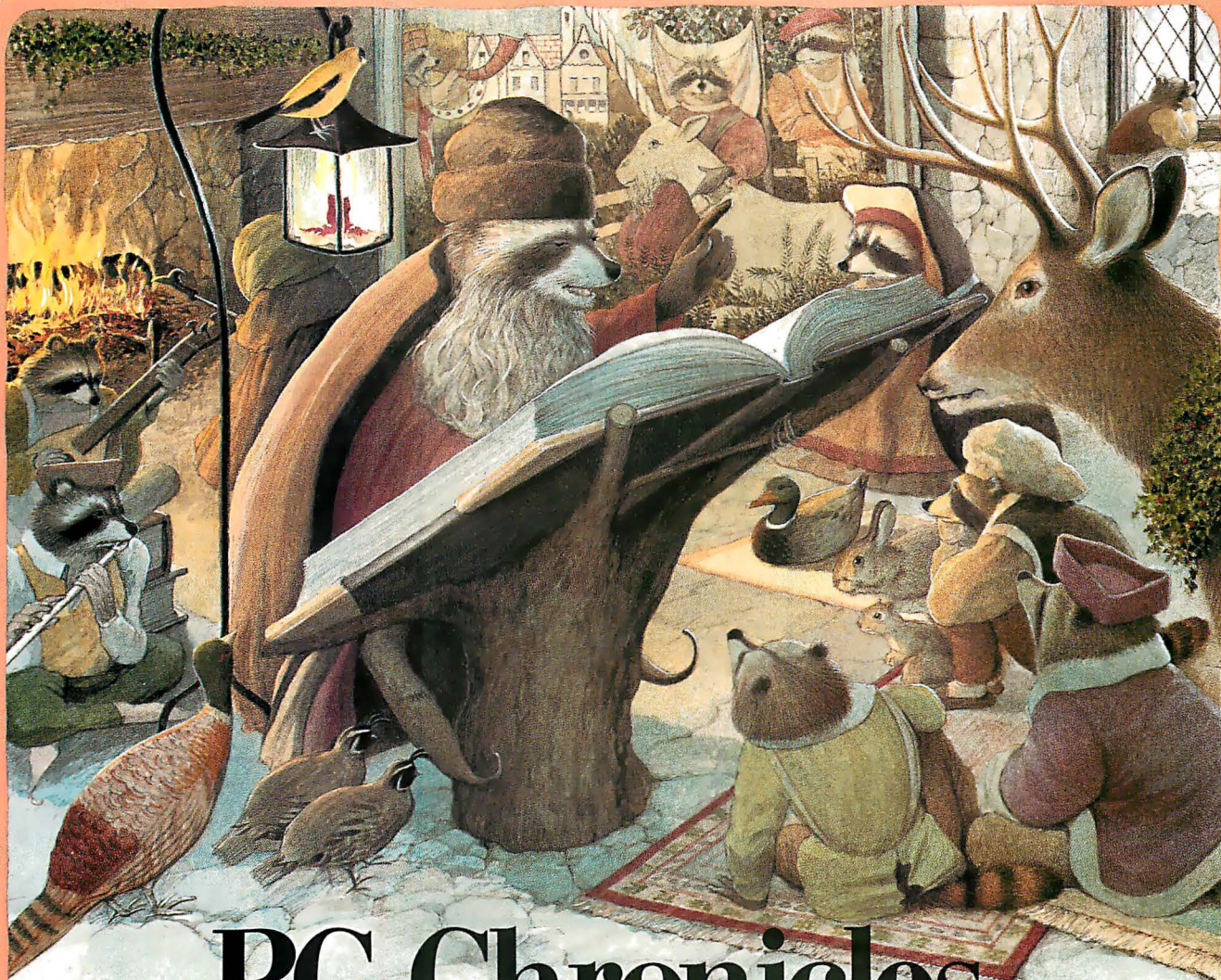

# PC Chronicles.

**Call me a lyre.  
(Or, how we wrote the book on PC mail order.)**

Truth tends to be stranger than fiction in the telltale town of Marlow, NH (pop. 564). That's why you'll often find the local color gathered 'round the ancient sage as he recounts in vivid detail how our forest glade was transformed into a PC paradise.

For, in days of yore, buying software and peripherals by mail was a perilous task, fraught with danger and uncertainty. Only those well versed in the black arts dared risk such unpredictable delivery and uncertain compatibility.

Then one day the enlightened Order of the Connection appeared majestically on the scene, bringing

the classic virtues of toll-free tech support, prompt shipping, and way-under-retail prices to the brave new world of the IBM PC. Since that glorious day our humble home has served as a beacon of light to noble users in cottages, condos, and corporations throughout America. **That'll be the day.**

It's not every day of the week you get offered your very own 1991 PC Connection Calendar. This very timely offer includes 13 classic illustrations of our legendary mascots, all your favorite holidays, and fascinating historical facts about the fiefdom of Marlow, NH. This wondrous wall calendar is free to everyone who places an order of \$750 or more between now and February 28.



Mark time with the PC Connection Calendar featuring our very own day-tripping mascots. Offer not available to accounts on net terms. One per customer.

# PC CONNECTION®



# Greetings from the

1990 World Class Award for Best Mail-Order Company



- 3 1/2" format available from us. Specify when ordering.
  - package includes both 5 1/4" and 3 1/2" disks.
  - 3 1/2" format available from manufacturer by request. Call us for details.
- CP—copy-protected; NCP—not copy-protected.

The four-digit number next to each product is the product's ITEM NUMBER. Please refer to this number when ordering. Thank you.

## SOFTWARE

We only carry the latest versions of products. Version numbers in our ads are current at press time.

Products listed here in red are Microsoft Windows Applications.

- Adobe Systems ... NCP**
- 7547  Adobe Type Manager for Windows \$59.
  - 8367  ATM & Plus Pack Bundle . . . . . 169.
  - 7392  Adobe PostScript Cartridge . . . . . 289.
- (Entire Adobe Type Library, from 1 to 133 is available. Call for more information.)
- Aldus ... NCP**
- 1332  PageMaker 3.01 . . . . . 499.
- Alpha Software ... NCP**
- 5104  Alpha Four 1.1 . . . . . 319.
- Application Techniques ... NCP**
- 1214  Pizazz Plus 2.0 . . . . . 69.



**Chipsoft ... NCP**

6221  TurboTax 8.0 & Quicken Bundle—A complete financial solution. With these two industry leading programs, you can quickly and easily transfer information for planning and preparing your taxes . . . . . \$79.

- Ashton-Tate ... NCP**
- 4450  dBASE IV 1.1 . . . . . \$499.
- Asymetrix ... NCP**
- 7384  Toolbook 1.0 for Windows . . . . . 309.
- Avery ... NCP**
- 6006  Label Pro 1.0 (Laser) . . . . . 49.
  - 7336  Label Pro 1.0 for Dot Matrix . . . . . 49.
- Bitstream ... NCP**
- 7568  FaceLift 1.0 for Windows 2.x/3.0 . . . . . 59.
  - 8040  FaceLift for WordPerfect 5.0/5.1 . . . . . 59.
  - Typeface Packages . . . . . each 89.
- Bloc Publishing ... NCP**
- 1447  Form Tool Gold 3.0 . . . . . 55.
  - 6245  Pop Drop Plus 1.0 . . . . . 59.
- Borland International ... NCP**
- 7357  Turbo C++ 1.0 Professional . . . . . 209.
  - 7356  Turbo Pascal Professional 2nd Ed. 179.
  - 6242  Quattro Pro 2.0 . . . . . 339.
  - 1514  Paradox 3.5 . . . . . 529.
- Broderbund ... NCP**
- 1434  New Print Shop . . . . . 39.
- ButtonWare ... NCP**
- 6419  PC-File 5.0 . . . . . 89.

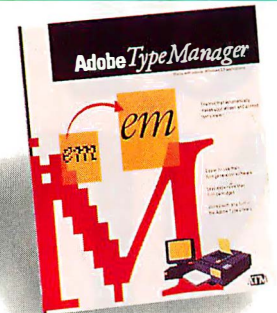

**Adobe Systems ... NCP**

7547  Adobe Type Manager for Windows—Automatically cleans up the jagged or stick figure type displayed on your screen, as well as text printed from dot matrix printers. Includes 13 scalable fonts . . . . . \$59.

- Caere ... NCP**
- 6004  Omnipage 386 2.1 . . . . . 599.
- Central Point ... NCP**
- 5039  PC Tools Deluxe 6.0 . . . . . 95.
  - 8114  Backup 6.0 . . . . . 65.
- Chipsoft ... NCP**
- 1663  TurboTax 8.0 for 1990 Taxes . . . . . 45.
  - State Packages . . . . . each 34.
  - 6221  TurboTax 8.0 & Quicken Bundle . . . . . 79.
- CompuServe**
- 7546 DOS Membership Kit . . . . . 23.
- Concentric Data Systems ... NCP**
- 6575  R & R Relational Report Writer 4.0 159.
- Corel Systems ... NCP**
- 5506  CorelDRAW! 2.0 . . . . . 389.
- Data Storm ... NCP**
- 4798  PROCOMM PLUS 1.1 . . . . . 65.
- DCA ... NCP**
- 7936  Crosstalk Communicator 1.0 . . . . . 59.
  - 2908  Crosstalk XVI 3.71 . . . . . 119.
  - 5611  Crosstalk for Windows 1.1 . . . . . 129.



**Delrina Technology ... NCP**

4325  PerFORM 2.1—Get the same award winning form generating software for GEM at a fantastically different, and low, price. Limited time offer . . . . . \$95.

- Delrina Technology ... NCP**
- 4325  PerFORM 2.1 for GEM . . . . . 95.
  - 7351  PerFORMPRO 1.0 for Windows . . . . . 299.
- Fifth Generation Systems ... NCP**
- 7725  Direct Access 5.0 . . . . . 65.
  - 7795  Disklock 1.0 . . . . . 109.
  - 3950  Fastback Plus 2.1 . . . . . 119.
- FormWorx ... NCP**
- 5810  FormWorx with Fill & File 2.5 . . . . . 85.
  - 7311  Form Publisher for Windows 1.2 . . . . . 139.
- Fox Software ... NCP**
- 6188  FoxPro 1.02 . . . . . 459.
- Franklin Software ... NCP**
- 7071  Language Master 3.0 . . . . . 49.
  - 7416  Language Master 3.0 for Windows 59.
- Funk Software ... NCP**
- 7380  P.D. Queue 1.0 (print spooler) . . . . . 52.
  - 2228  Sideways 3.3 . . . . . 59.
- Great American Software ... NCP**
- 4880  One Write Plus Acct. Sys. 2.06 . . . . . 189.
  - 5825  Money Matters 2.0 . . . . . 42.



**Corel Systems ... NCP**

5506  CorelDRAW! 2.0—The PC graphics software that's fast, fun and powerful. CorelDRAW! 2.0 now comes with more drawing power, more type control, and more value...and it's still easy to use . . . \$389.

# Icebox of Cheshire Co.



**Reality Technologies ... NCP**  
7891  **WealthStarter 1.0**—Tired of living paycheck to paycheck? Use WealthStarter to create a budgeting, savings and investing system that really makes the most of the money you make. . . . \$49.

- Hayes ... NCP**  
7983  Smartcom Exec 2.0 . . . . . 79.  
**hDC Computer Corp. ... NCP**  
7389  **Windows Express 3.0** . . . . . 52.  
7383  **First Apps 1.0** . . . . . 52.  
**Hilgraeve ... NCP**  
2323  **HyperACCESS/5 2.0 (DOS & OS/2)** 115.  
**IBM ... NCP**  
6599  **Current 1.1** . . . . . 239.  
**Individual Software ... NCP**  
6222  **Resume Maker 1.3** . . . . . 29.  
**Inset Systems ... NCP**  
7298  **Hijaak 2.0** . . . . . 99.  
7300  **Inset Plus Hijaak** . . . . . 125.  
**Insight Development ... NCP**  
8320  **Prin Tools 1.0** . . . . . 85.  
8687  **Print-a-Plot 2.0** . . . . . 189.  
**Intuit ... NCP**  
2426  **Quicken 4.0** . . . . . 39.  
**Isogon ... NCP**  
7478  **FontSpace 2.0** . . . . . 59.

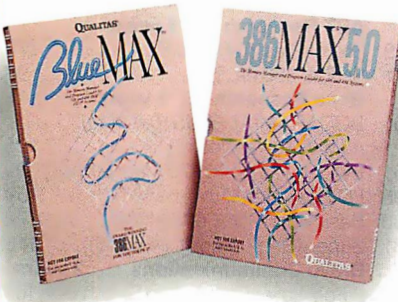

**Qualitas ... NCP**  
386MAX & BlueMAX let you run your 386 & Windows to the MAX! New! BlueMAX is the ultimate memory manager for 386 PS/2s!  
7539  **386MAX 5.1** . . . . . \$75.  
7967 **BlueMAX 5.1 (3 1/2" only)** . . . . . 85.

- Laser Go ... NCP**  
7635  **Go Script Plus 3.0** . . . . . \$189.  
**LaserTools ... NCP**  
6882  **PrintCache 2.3** . . . . . 99.  
**Lord Publishing ... NCP**  
5191  **Ronstadt's Financials 1.02** . . . . . 75.  
**Lotus ... NCP**  
5417  1-2-3 3.1 . . . . . 429.  
5653  1-2-3 2.2 . . . . . 349.  
5134  **Magellan 2.0** . . . . . 109.  
**MECA ... NCP**  
4603  **Andrew Tobias' Tax Cut-1990 Taxes** 49.  
2798  **Managing Your Money 7.0** . . . . . 135.  
**Microcom ... NCP**  
7649  **Virex 1.1** . . . . . 79.  
6234  **CarbonCopy Plus 5.2** . . . . . 119.  
**Micro Logic ... NCP**  
6787  **Info Select 1.1** . . . . . 55.

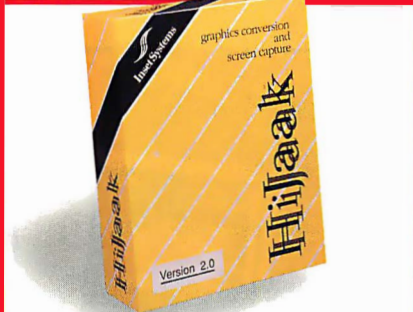

**Inset Systems ... NCP**  
7298  **Hijaak 2.0**—Capture screens and convert graphics files with Hijaak release 2.0. New features include 5K pop-up, many new raster and vector formats and support for 16 fax devices . . . . . \$99.

- Microsoft ... NCP**  
7010  **Windows 3.0** . . . . . 99.  
7388  **Project for Windows 1.0** . . . . . 459.  
7387  **PowerPoint for Windows 1.0** . . . . . 329.  
2904  **Works 2.0** . . . . . 99.  
2901  **Word 5.0** . . . . . 209.  
6195  **Word for Windows 1.1** . . . . . 329.  
2856  **Excel 2.1** . . . . . 329.  
2853  **C Compiler 6.0** . . . . . 329.  
8137  **Office for Windows (includes Excel, Word for Windows, and PowerPoint)** 659.  
**Multisoft ... NCP**  
4925  **PC-Kwik Power Pak 1.5** . . . . . 75.  
**Nolo Press ... NCP**  
2982  **WillMaker 4.0** . . . . . 39.  
**PC Globe ... NCP**  
5902  **PC Globe 4.0** . . . . . 39.  
5900  **PC USA 2.0** . . . . . 39.

**1-800/776-7777**  
**MMC** **PC Connection** 810B  
6 Mill Street  
Marlow, NH 03456  
SALES 603/446-7721 FAX 603/446-7791



**Bitstream ... NCP**  
Fast and easy-to-use, FaceLift scales printer fonts to any size. Includes 13 typefaces to give you professional documents instantly.  
7568  **FaceLift 1.0 for Windows 2.x/3.0** . \$59.  
8040  **FaceLift 1.0 for WordPerfect 5.0/5.1** . 59.

- Personics ... NCP**  
4384  **Ultravision 2.0** . . . . . 79.  
7048  **Monarch 1.0 (Data Mgmt. Tool)** . 319.  
**PowerUp ... NCP**  
7860  **Calendar Creator Plus 3.0** . . . . . 45.  
7858  **Express Publisher 2.0** . . . . . 89.  
**Precision Software ... NCP**  
6600  **Superbase 4 for Windows 1.2** . . . . . 429.  
**Qualitas ... NCP**  
7539  **386MAX 5.1** . . . . . 75.  
7967 **BlueMAX 5.1 (3 1/2" only)** . . . . . 85.  
**Quarterdeck ... NCP**  
6422  **QRAM 1.0** . . . . . 49.  
3221  **Expanded Memory Mgr. 386 5.1** . 59.  
3220  **DESQView 2.3** . . . . . 75.  
4586  **DESQView 386 2.3** . . . . . 125.  
**Reality Technologies ... NCP**  
7891  **WealthStarter 1.0** . . . . . 49.  
6572  **WealthBuilder 1.1** . . . . . 145.  
**Reference Software ... NCP**  
4396  **Grammatik IV 1.0** . . . . . 52.  
7483  **Grammatik for Windows 1.0** . . . . . 52.  
**Revolution Software ... NCP**  
4480  **VGA Dimmer 2.01 (screen saver)** . 29.  
**RightSoft ... NCP**  
4155  **RightWriter 4.0** . . . . . 54.  
**Roy Kore ... NCP**  
8162  **ABC Flowcharter 1.1** . . . . . 189.  
**Samna ... NCP**  
5799  **Ami Pro 1.2** . . . . . 309.  
**Sitka/TOPS ... NCP**  
6675  **TOPS Network Bundle 3.0** . . . . . 159.  
3720 **Flashcard 2.1 (AppleTalk ntwrk. card)** 155.  
**Softlogic Solutions ... NCP**  
3542  **Software Carousel 4.01** . . . . . 55.  
**Software Publishing ... NCP**  
3499  **PFS:First Publisher 3.0** . . . . . 99.  
3478  **PFS:First Choice 3.1** . . . . . 105.  
3496  **Professional Write 2.2** . . . . . 169.  
3482  **Harvard Graphics 2.3** . . . . . 329.  
**Solution Systems ... NCP**  
7977  **Brief 3.0 (Programmer's Editor)** . 189.  
**Spinnaker ... NCP**  
7604  **PLUS for Windows 1.0** . . . . . 289.

# The colder it gets

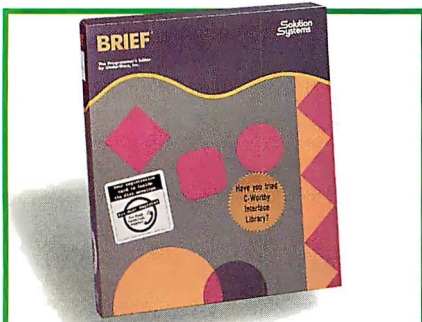

## Solution Systems ... NCP

7977  **Brief 3.0**—The programmer's editor. Gives you unmatched editing power and flexibility. Completely reconfigurable keyboard, multi-level Undo, C-like macro language, source level debugger and more ..... \$189.

## Symantec ... NCP

- 3152  The Norton Commander 3.0 . . . . . 105.
- 6397  The Norton Backup 1.1 . . . . . 105.
- 3146  The Norton Utilities 5.0 . . . . . 119.
- 3425  Q&A 3.0 . . . . . 229.
- 7999  Norton Anti-Virus 1.0 . . . . . 89.

## Systems Compatibility ... NCP

- 8215  OutsideIn 1.0 . . . . . 65.
- 6564  Software Bridge 4.1 . . . . . 79.

## TIMESLIPS ... NCP

- 2987  Timeslips III 4.0 . . . . . 195.
- 6994  PercentEdge 1.0 . . . . . 69.

## Timeworks ... NCP

- 6253  Publish-It! 1.1 . . . . . 115.

## Touchstone Software ... NCP

- 8516  PC Test 1.01 (with free VHS tape) . . . . . 45.
- 7420  Check It 3.0 . . . . . 89.

## Traveling Software ... NCP

- 5179  LapLink III 3.0 . . . . . 95.

## Ventura Software (Xerox) ... NCP

- 7796  Ventura Publisher for Windows 3.0 569.

## West Lake Data Corp. ... NCP

- 7577  PC-FullBak+ 1.12 . . . . . \$52.
- 7574  PathMinder+ 1.0 . . . . . 79.

## Wolfram Research ... NCP

- 8281  Mathematica 386 . . . . . 599.

## WordPerfect Corp. ... NCP

- 7781  LetterPerfect 1.0 . . . . . 129.
- 3804  WordPerfect 5.1 . . . . . 265.
- 6685  DrawPerfect 1.1 . . . . . 279.

## WordStar International ... NCP

- 6791  WordStar Prof. 6.0 . . . . . 279.

## XTREE ... NCP

- 6161  XTreePro Gold 1.4 . . . . . 85.

## RECREATIONAL/EDUCATIONAL

### Broderbund ... CP

- 8068  Where in the World is Carmen Sandiego Deluxe Edition . . . . . 52.
- 5851  SimCity . . . . . 33.

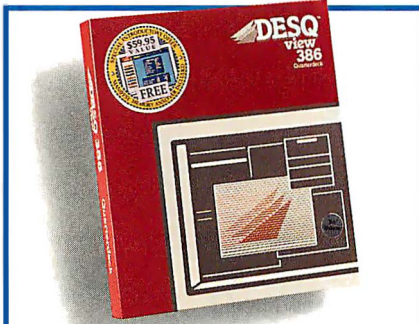

## Quarterdeck ... NCP

4586  **DESQView 386 2.3**—Put DESQView and Expanded Memory Manager 386 together and you've got DESQView 386. It can now work in conjunction with Windows 3.0 . . . . . \$125.

## Electronic Arts ... NCP

- 6436  Hunt for Red October . . . . . 20.
- 7865  PGA Golf . . . . . 39.

## Harvard Associates ... NCP

- 2324  PC Logo 3.0 . . . . . 59.

## Microsoft ... NCP

- 7881  Entertainment Pk for Windows 1.0 29.
- 8270  Aircraft and Scenery Designer 1.0 (req. FS 4.0) . . . . . 29.
- 2858  Flight Simulator 4.0 . . . . . 39.

## Microsoft Press (Books)

- 8126  Running with DOS 4th Edition . . . . . 20.
- 8129  Running Windows (2nd Edition) . . . . . 22.
- 8136  Running Microsoft Excel . . . . . 22.

## Penton Overseas ... NCP

- VocabuLearn/ce Levels I & II (French, Italian, German, Spanish, Russian, Hebrew and Japanese) . . . . . each 39.

## Sierra On-Line ... CP

- 5106  Space Quest III . . . . . 39.
- 7972  King's Quest V . . . . . 45.

## Spectrum Holobyte ... NCP

- 5993  Welltris . . . . . 22.
- 7602  Faces . . . . . 27.

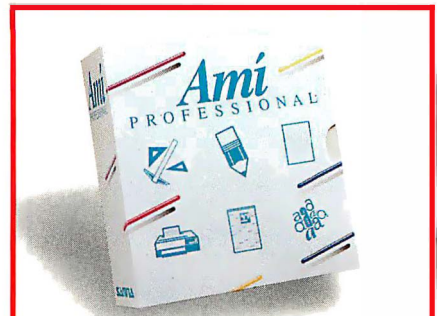

## Samna ... NCP

5799  **Ami Pro 1.2**—Windows-based word processor for high-powered office automation tasks. Includes mail merge, macros, thesaurus, style sheets, and integrated drawing and charting capabilities . . . . . \$309.

## Software Toolworks ... NCP

- 4659  Chessmaster 2100 (CP) . . . . . 35.
- 7372  World Atlas . . . . . 42.

## Stone & Assoc. ... NCP

- 5231  Phonics Plus . . . . . 22.
- 3433  Algebra Plus Vol 1 (ages 13+) . . . . . 27.

## Toyogo ... NCP

- 7676  Nemesis Go Master Deluxe . . . . . 88.

## True BASIC, Inc. ... NCP

- Kemeny/Kurtz Math Series. each 45.

## HARDWARE

**Manufacturer's standard limited warranty period for items shown is listed after each company name. Some products in their line may have different warranty periods.**

### American Power ... 2 years

- 7108 Smart UPS 400 . . . . . 339.
- 6811 360SX (stand-by power source) . . . . . 219.
- 7106 520ES (stand-by power source) . . . . . 329.

### AST Research ... 5 years

- 1299 SixPakPlus 384k C/S/P . . . . . 179.
- 8041 SixPak286 0k . . . . . 99.

### Boca Research ... 5 years

- 7001 BOCARAM/IAT PLUS (0-8 Meg) (LIM 4.0 extended) . . . . . 125.
- 7061 BOCARAM/XT 0K (0-2 Meg, LIM 4.0) 99.
- 6998 I/O Board for AT . . . . . 59.
- 8380 BasicVGA (256K 640 x 480) . . . . . 79.
- 8381 SuperVGA (1 Meg 1024 x 768) . . . . . 145.

### Bravo Communications ... 2 years

- 7400 2 Pos. Laser Compatible Switch Box 109.

### Brown-Wagh ... 1 year

- 8578 Creative Labs Sound Blaster . . . . . 179.

### Canon ... 1 year

- 7894 BJ-10e BubbleJet Printer (4.6 lb.) . . . . . 349.
- 7897 BubbleJet Ink Cartridge . . . . . 23.
- 7896 Sheet feeder for BJ-10e . . . . . 75.

### CH Products ... 1 year

- 8119 FlightStick w/Falcon & GameCard III . . . . . 79.
- 7345 RollerMouse (Trackball) serial 85. bus 99.



## TIMESLIPS ... NCP

2987  **Timeslips III 4.0**—Perfect for service professionals (ie. accountants, lawyers, etc.) who need to track & bill their time . . . \$195.  
6994  **PercentEdge 1.0**—Calculates mortgages, loans, annuities, present values, & more 69.

# the faster we ship.



**Intel ... 5 years**

7880 9600EX Modem—Provides ultra-fast data communications without sacrificing compatibility. Supports V.32 & V.42bis 9600 bps operation, as well as MNP Level/5 and Hayes compatible 2400/1200/300 bps modes . \$549.

**Curtis ... lifetime**

- 1704 Universal Printer Stand PS-1 . . . . . 18.
- 1708 Ruby-Plus SPF-2 Plus . . . . . 65.
- 7358 Command Center . . . . . 89.

**Datadesk ... 3 years**

- Glass Filter Plus (specify size) . . ea. 65.

**Epson ... 2 years**

We are an authorized Epson Service Center.

- 1906 FX-850 (80 col., 264 cps, 9 pin) . . . call
- 1904 FX-1050 (136 col., 264 cps, 9 pin) . . call
- 5183 LQ-510 (80 col., 180 cps, 24 pin) . . 289.
- 1930 LQ-850 (80 col., 264 cps, 24 pin) . . call
- 1917 LQ-1050 (136 col., 264 cps, 24 pin) call
- 5184 LX-810 (80 col., 180 cps, 9 pin) . . . 185.
- 7775 Equity LT-286e Laptop (1 yr wrnty) . 1995.
- 7774 Equity LT-386SX Laptop (1 yr wrnty) 3069.

**Hayes ... 2 years**

- 2307 Smartmodem 2400 . . . . . 349.
- 8049 JTFax 9600B . . . . . 499.
- 7391 Ultra 9600 Modem . . . . . 799.

**Hewlett-Packard ... 1 year**

- 6754 LaserJet III (w/toner) . . . . . 1699.
- 6582 LaserJet IIP (w/toner) . . . . . 1069.

**Intel ... 5 years**

- 6421 2400B MNP Internal Modem . . . . 199.
- 4696 2400B Internal Modem . . . . . 159.
- 2352 2400B Internal Modem 2 (for PS/2) 249.
- 5119 2400 Baud External Modem . . . . 179.
- 6420 2400EX MNP Modem . . . . . 229.
- 7880 9600EX Modem . . . . . 549.
- 2346 Inboard 386/PC w/1 Meg . . . . . 495.
- 5336 Above Board Plus 8 2 Meg . . . . . 599.
- 5342 Above Board Plus 8 I/O 2 Meg . . . 629.
- 7782 SatisFAXtion (fax board) . . . . . 399.

**MATH COPROCESSORS**

- 7385 80287XL (16 MHz 80286 CPU's) . . 199.
- 4750 80387SX (16 MHz 80386SX CPU's) 309.
- 2371 80387 (16 MHz 80386 CPU's) . . . 349.
- 2372 80387-20 (20 MHz 80386 CPU's) . . 399.
- 4121 80387-25 (25 MHz 80386 CPU's) . 499.

**Kensington Microware ... 1 year**

- 2582 Master Piece Plus . . . . . 109.
- 7899 Expert Mouse serial . . . 119. bus . . 129.

**Key tronic ... 3 years**

- 4518 101 Plus Keyboard . . . . . \$99.

**Kraft ... 5 years**

- 5800 3 button Thunder Joystick . . . . . 29.
- 5813 Game Card/Thunderstick Bundle . . 55.
- 7862 TopTrack (Laptop Trackball) . . . . 79.

**Logitech ... limited lifetime**

- 7768 C9 Mouse with Windows . . . . . 149.
- 6029 Trackman (Trackball) serial 85. bus 89.
- 4297 ScanMan Plus (hand scanner) . . . 179.
- 7975 ScanMan 256 . . . . . 319.
- 8694 MouseMan . . . . . 69.

**Micron Technology ... 2 years**

- 7595 2 Meg Expansion for HP LaserJet IIP or III . . . . . 119.
- 7012 Beyond Memory Board for PS/2 Model 70 (2 Meg) . . . . . 149.

**Microsoft ... lifetime**

- 7597 Microsoft Mouse . . . . . 89.
- 2897 Mouse with Paintbrush . . . . . 105.
- 2898 Mouse with Windows 3.0 . . . . . 149.

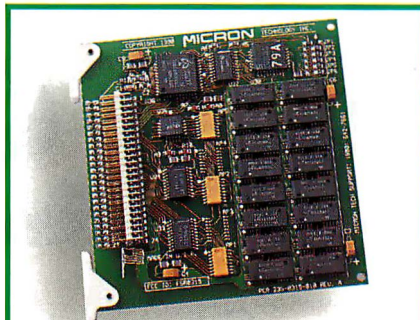

**Micron Technology ... 2 years**

7595 HP LaserJet IIP/III 2 Meg Memory Upgrade—A simple and inexpensive way for you to get the most of your laser printer. A must for desktop publishing or for printing full-page graphics . . . . . \$119.

**MicroSpeed ... 1 year**

- PC-TRAC Trackball
- 6007 serial . . . . . 75. 6008 bus . . . . . 89.
- 7271 Inport . . . . . 79. 6330 PS/2 . . . . . 79.

**Mouse Systems ... lifetime**

- 5997 Trackball (1 yr. wrnty) serial 65. bus 69.
- 7878 PC Mouse III . . . . . 89.

**NEC ... 2 years**

- 4799 Multisync 2A (VGA Monitor) . . . . 499.
- 5085 Multisync 3D Monitor . . . . . 689.

**Orchid Technologies ... 4 years**

- 7512 ProDesigner VGA II (1024 x 768) . . 299.

**PC Power & Cooling ... 1 year**

- REPLACEMENT POWER SUPPLIES
- 3203 Turbo Cool 200 . . . . . 159.

**1-800/776-7777**



**PC Connection**

810B

6 Mill Street  
Marlow, NH 03456

SALES 603/446-7721 FAX 603/446-7791

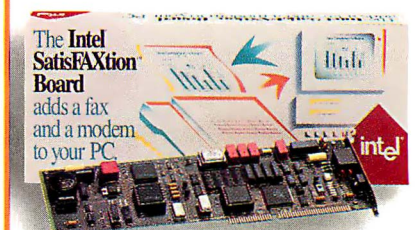

**Intel ... 5 years**

7782 SatisFAXtion—Send and receive faxes from within most applications using the print command. Built-in 2400 bps MNP modem standard. Includes coupons for free PC Tools and Fax-It software. . . . . \$399.

- 7915 Turbo Cool 300 . . . . . 165.
- 3200 Silencer 150 (84% noise reduction) 115.
- 7053 InnerSource 2210 . . . . . 399.

**Pacific Data Products ... 1 year**

- 6779 25 Cartridges in One! (for LJ II, IIP, III) Memory upgrade for LaserJet IIP/III . . 275.
- 7054 1 Meg . . . . . 149. 7055 2 Meg . . . . 199.
- 7758 3 Meg . . . . . 269. 7759 4 Meg . . . . 329.
- 7158 Pacific Page 4.0 (for LaserJet IIP/III) 379.
- 6834 Pacific Page with free 2 Meg Memory Board (for LaserJet II) . . . 379.

**Practical Peripherals ... 5 years**

- 3103 2400 Baud Internal Modem . . . . . 129.
- 3102 2400 Baud External Modem . . . . . 179.
- 5286 2400 Baud Int. MNP Modem (Lev. 5) 169.
- 5285 2400 Baud Ext. MNP Modem (Lev. 5) 209.
- 4542 2400 Baud Internal Modem for PS/2 . 229.
- 8132 PM2400 Pocket Modem . . . . . 109.
- 7934 PM9600SA Modem . . . . . 489.

**PSION .. 1 year**

- 7086 MC600 Mobile Computer . . . . . 2149.

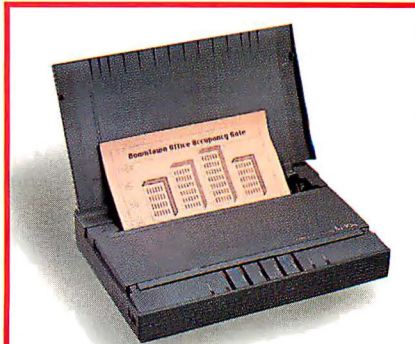

**Canon ... 1 year**

7894 BJ-10e BubbleJet Printer—Light weight, excellent print quality and a great price make this 4.6 lb. printer a winner. Choice of black or white. Optional sheet feeder . . . . \$349.

# Call 1-800/776-7777.

- Reflection Technology ... 1 year**  
 7127 Private Eye (virtual display) . . . . . \$499.
- SAFE Power Systems ... 2 years**  
 7913 Safe 650W . . . . . 459.
- Targus ... lifetime**  
 6037 Premier Leather Carrying Case. . . 199.
- TheComplete PC ... 2 years**  
 8082 TheComplete Half Page Scanner/400  
 w/ReadRight Personal OCR Software 289.
- 6797 TheComplete Fax Portable . . . . . 319.  
 5828 TheComplete Communicator . . . . 449.
- Tripp Lite ... 2 years**  
 6199 Isobar 4-6 (4 outlets, 6 ft. cord) . . . . 49.  
 6200 Isobar 6-6 (6 outlets, 6 ft. cord) . . . . 59.  
 6624 BC450 (450W Battery Backup) . . . 269.
- Video 7 ... 7 years**  
 5883 1024i VGA (includes 512k) . . . . . 199.  
 4931 VRAM VGA 512k . . . . . 369.

- TEAC ... 1 year**  
 4670 1.44 Meg Drive for PC/XT (3 1/2") . . \$89.  
 4326 1.44 Meg Drive for AT . . . . . 109.

## DISKS

- Maxell ... lifetime**  
 2789 5 1/4" MD2-D 360k Disks (Qty. 10) . . . . 12.  
 2792 3 1/2" DS/DD 720k Diskettes (Qty. 10) . . 14.  
 2793 3 1/2" DS/HD 1.44Mb Diskettes (Qty. 10) 27.

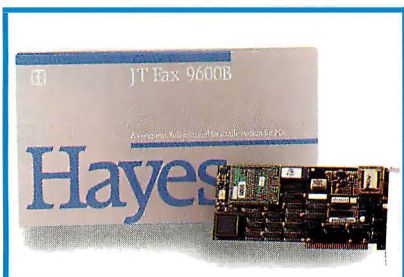

**Hayes ... 2 years**  
 8049 JTFax 9600B—Good, solid fax board from the company who wrote the book on communications. TSR fax software, print capture and one-step convert and send are just a few of the features . . . . . \$499.

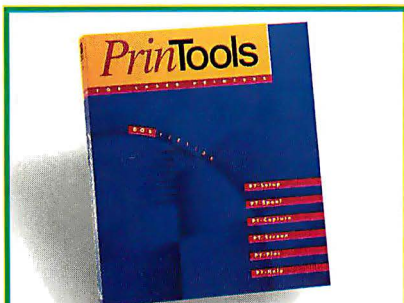

**Insight Development ... NCP**  
 8320 PrinTools 1.0—Utilities for the HP LaserJet, DeskJet & compatibles. Includes Spooler, Screen Dump, Screen Capture, SetUp, Plot with HPGL/2 support, and Help utilities . . . . . \$85.

- Sony ... lifetime**  
 3291 5 1/4" DS/DD 360k Disks (Qty. 10) . . . . 10.  
 3297 3 1/2" DS/DD 720k Diskettes (Qty. 10) . . 13.  
 3298 3 1/2" DS/HD 1.44Mb Diskettes (Qty. 10) 22.  
 8185 QD 2040 Tape Cartridge . . . . . 19.

## MEMORY

- 6556 256k DRAMs (100 ns, set of 9) . . . . call  
 5510 1 Meg x 9 SIMMs (80 nanosecond) call  
 5746 1 Meg Chips (80 ns, set of 9) . . . . . call

## OUR POLICY

- We accept VISA and MASTERCARD only.
- No surcharge added for credit card orders.
- Your card is not charged until we ship.
- If we must ship a partial order, we never charge freight on the shipment(s) that complete the order (in the U.S.).
- No sales tax, except Ohio residents (please add applicable tax).
- All U.S. shipments insured; no additional charge.
- APO/FPO orders shipped 1st Class Mail.
- International orders U.S. \$250 minimum.
- Upon receipt and approval, personal and company checks clear the same day for immediate shipment of your order.
- COD max. \$1000. Cash, cashier's check, or money order.
- 120 day limited warranty on all products. Defective software replaced immediately. Defective hardware repaired or replaced at our discretion. All items subject to availability. Prices and promotions subject to change without notice.
- To order, call us Monday through Friday 8:00 AM to 1:00 AM, or Saturday 9:00 AM to 5:30 PM. You can call our business offices at 603/446-3383 Monday through Friday 9:00 AM to 5:30 PM.



**Logitech ... limited lifetime**  
 New! ScanMan 256 offers 256 real shades of gray. MouseMan has the ultimate shape for comfort and fit.  
 7975 ScanMan 256 . . . . . \$319.  
 8694 MouseMan . . . . . 69.

## DRIVES

- IOMEGA ... 1 year**  
 5116 Bernoulli II 44 Meg Internal . . . . . 995.  
 7551 Bernoulli II Transportable 44 Meg . . 997.  
 5113 44 Meg Cartridge Tripak (5 1/4") . . . 249.  
 2500 PC2B Controller . . . . . 229.
- Mountain Computer ... 2 years**  
 2917 40-60 Meg Internal Tape Drive . . . 259.  
 5500 80-152M Int. Tape Drive . . . . . 629.  
 5190 DC2000 Pre-formatted Cartridges ea. 35.  
 6153 DC2120 Tape Cartridge (5 pack) . . 149.
- Pacific Rim ... 1 year**  
 5010 1.2 Meg External (for PS/2's) . . . . 215.  
 6602 1.44 Meg External (for PC/XT/AT) . . 239.
- Plus Development ... 2 years**  
 6424 Hardcard II 80 Meg (19 ms) . . . . . 599.  
 8304 Hardcard II XL 50 Meg (9 ms) . . . . 399.  
 8287 Hardcard II XL 105 Meg (9 ms) . . . . 689.
- Seagate ... 1 year**  
 2285 20 Meg Int. Hard Drive ST225  
 (w/controller and cables, 65 ms) . . . 255.  
 2286 30 Meg Int. Hard Drive ST238R  
 (w/controller and cables, 65 ms) . . . 269.  
 4554 40 Meg Int. HD ST251-1 (28 ms) . . . 329.



**Practical Peripherals ... 5 years**  
 7934 PM9600SA Modem—Practical Peripherals does it again by making communications affordable with their newest modem featuring the data compression & error correction of 9600bps V.32 & V.42bis operation . . . \$489.

## SHIPPING

- Note:** Accounts on net terms pay actual shipping.
- Continental US:**
- For heavy hardware items such as printers, monitors, Bernoulli Boxes, etc. pay actual charges. Call for UPS 2nd-Day & Next-Day-Air.
  - For all other items, add \$3 per order to cover UPS Shipping. For such items, we automatically use Airborne Express at no extra charge if you are more than 2 days from us by UPS ground.
- Hawaii:**
- For monitors, printers, Bernoulli Boxes, computers, hard drives, and power backups, actual UPS Blue charge will be added. For all other items, add \$3 per order.
- Alaska and outside Continental US:**
- Call 603/446-7721 for information.



# One Word About Your Hard Disk Controller

# SLOW

# One Word About the PSI hyperSTORE Controllers

# FAST

## *Intelligent Mass Storage Controllers*

Virtually all applications are disk bound. Today's PCs have over 60 times the power of their ancestors of just ten years ago, while hard disk performance has only just tripled. This makes mass storage the PC's worst bottleneck. PSI has eliminated this bottleneck with the hyperSTORE Caching Disk Controller, a sort of mass storage co-processor. The hyperSTORE

does for disk-intensive programs what a math co-processor does for number-crunching software. Databases, file servers, multiuser systems, and other disk-hungry applications start screaming . . . frustrated users stop screaming! Call (800)486-FAST now to find out more about PSI's line of intelligent controllers. All you have to gain is time.

### **hyperSTORE FEATURE HIGHLIGHTS**

- Data access in 0.28ms or less at 3-4MB/sec
- Works in any 286, 386, or i486 system
- Simultaneously control any drive interface: *MFM, RLL, ESDI, SCSI, or AT/IDE*
- Controls up to 28 physical disk drives
- 0KB to 20MB of SIMM-based cache memory
- Supports all PC-based operating systems: *DOS, Windows, UNIX/Xenix, Netware, etc.*
- Data mirroring option for fault tolerance
- **NO DEVICE DRIVERS REQUIRED**

# PSI

**Perceptive Solutions, Inc.**

2700 Flora Street · Dallas, Texas 75201  
800-486-FAST · 214-954-1774 · Fax: 953-1774

European Inquiries: 415-284-9505

"Normally, it's a bit hard to pick the most impressive item at Comdex [Spring 1990], . . . This time it was easy, . . . the hyperSTORE/1600."

*-Jerry Pournelle, Byte Magazine, September 1990*

"PSI has created the power user's ultimate Lego set for disk controllers: the hyperSTORE/1600"

*-Alfred Poor, PC Magazine, June 12, 1990*

"The real-world result will be blazing record handling from within a data file as well as unstopably fast program loads."

*-Bill O'Brien, PC Magazine, February 13, 1990*

©1990 by PSI. All rights reserved. hyperSTORE and the PSI logo are trademarks of Perceptive Solutions, Inc. Other brand and product names are trademarks or registered trademarks of their respective companies. Specifications are subject to change. · Ad Code: BY1090

**RapidFACTS™ 1-900-776-3344 • Doc#8104**

Detailed specifications faxed directly to you 24 hours/day · \$4.95 billed to your phone

Circle 171 on Reader Service Card (RESELLERS: 172)



# THE RETURN OF ARCNET

The new 20-Mbps ARCnet specification is fast and downward-compatible

**A**RCnet, one of the oldest and most robust LAN architectures, is about to be turbocharged. While ARCnet transfers data at 2.5 megabits per second—significantly slower than Ethernet or Token Ring—the soon-to-be-released ARCnet Plus will leapfrog both, turning in transfer rates of 20 Mbps. What's more, unlike any other LAN standard that's undergone a speedup, ARCnet Plus will be downward-compatible with older ARCnet equipment.

Most people think of Ethernet as the first commercial LAN standard, but that's not the case. Introduced by Datapoint in 1977, ARCnet (which stands for Attached Resource Computing Network) was doing an excellent job integrating clusters of business workstations and intelligent terminals when Ethernet was still an experiment at Xerox's Palo Alto Research Center.

## ARCnet's Slow Start

Although it was first to market, ARCnet fell behind Ethernet for several reasons. First, Datapoint kept the technology proprietary for several years, implementing it only on its own business computing systems. The first publicly available ARCnet chips were not sold until 1982, by which time Ethernet had already become popular. In addition, Datapoint—unlike Xerox, DEC, and Intel—didn't participate in the IEEE 802 committee meetings, which made Ethernet and Token Ring international standards. Finally, the fact that Datapoint was not an industry giant with the clout of these other companies may have kept the word

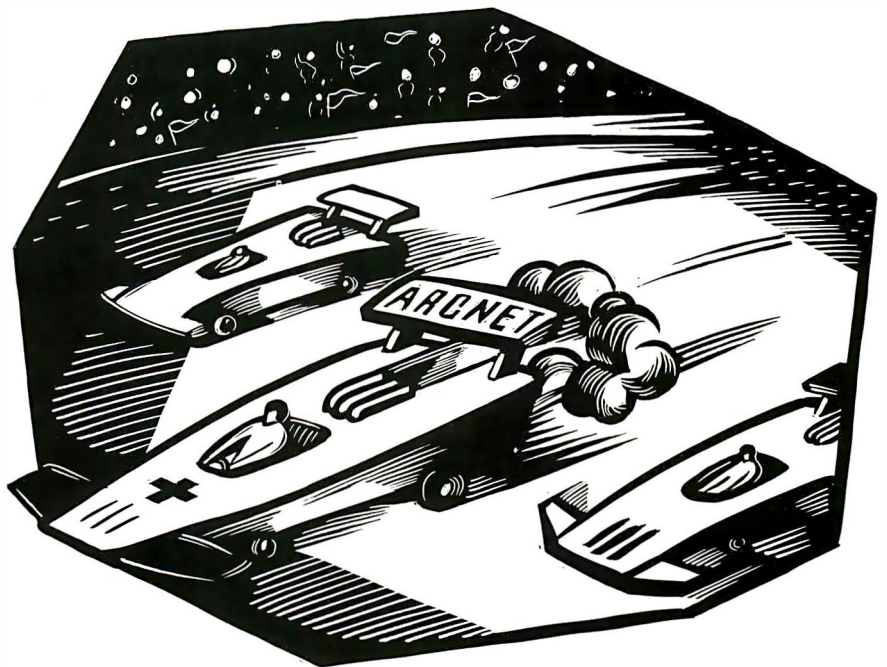

from getting out.

Nonetheless, ARCnet is still an attractive standard, and many LAN managers have embraced it. One of ARCnet's main draws is that it uses 92-ohm coaxial cable, which is the same kind used with IBM 3270 terminals and which typically costs half as much per foot as the 50-ohm coaxial cable used with Ethernet. This means that many existing structures, such as airports and older office buildings, may not need to be rewired for ARCnet, since it can run over the web of existing cable that was installed (often at great expense) for mainframe terminals. Other implementations run over twisted-pair and fiber-optic cable, and you can use ARCnet on the IBM Cabling System with 92-ohm baluns.

Another ARCnet advantage is its robustness. ARCnet was so heavily over-designed that it works amazingly well even when connectors are loose, cable runs are too long or out of spec, or

grounds are faulty or absent. An ARCnet that's built around "active" hubs—which is the recommended configuration—won't go down if you disconnect a node or forget to terminate a cable. And ARCnet's "modified token-passing" protocol, which requires that the hardware acknowledge every transaction, including passage of the token, provides a high degree of confidence that a message has been delivered.

Token passing in an ARCnet makes the network *deterministic*. That is, there is a fixed upper bound on the amount of time a station must wait before transmitting, so no one station can hog all the bandwidth.

ARCnet has a small minimum packet size, which makes it especially good at dealing with applications, such as data entry and terminal emulation, that involve the exchange of many small packets. Finally, there's price. ARCnet remains the low-cost leader. PC adapters

ITEMS DISCUSSED

**ARCnet**  
**ARCnet Plus**  
 Datapoint Corp.  
 9725 Datapoint Dr.  
 San Antonio, TX 78229  
 (800) 334-9968  
 (512) 699-7000  
 fax: (512) 699-7920  
**Inquiry 1227.**

can be had for as little as \$75; typical low-end Ethernet cards cost twice as much.

**Revvng Up the Standard**

Despite ARCnet's many advantages, published benchmarks show it lagging far behind other standards in overall throughput. ARCnet proponents realized

that they faced the spectre of dwindling market share unless bit rates also kept up with the competition. They also realized that not allowing the new, faster equipment to interoperate with existing units—as was the case when Ethernet and Token Ring moved to higher speeds—might cause users to switch to another standard. Finally, they sought to overcome some other ARCnet limitations, including the 255-node maximum per network and the low 508-byte ceiling on the amount of data per packet.

Datapoint's engineers set a challenging technical task for themselves when they decided to increase ARCnet's speed by a factor of eight *and* retain downward compatibility with 2.5-Mbps ARCnet. How they achieved this goal is extremely clever.

The figure shows how ARCnet Plus works. Nodes on a standard ARCnet sig-

nal a "1" bit by sending a 200-nanosecond pulse (consisting of a single cycle of a 5-MHz sine wave) followed by a silence of equal length. Two intervals of silence represent a "0" bit. (To make sure the receiver keeps pace with the transmitter, ARCnet precedes each byte with a 3-bit calibration pattern that consists of two 1s and a 0. This makes the actual data rate  $\frac{1}{11}$  of 2.5 Mbps, or 1.82 Mbps.) As you can see, a lot of slack time can be eliminated from this scheme: The periods of silence are wasteful, and the calibration pulses take up 27 percent of the available bandwidth.

ARCnet Plus, like ARCnet, assumes that the base bandwidth of the cable is 5 MHz, but it uses that bandwidth more efficiently. It cuts out the silent period between bits, packing them back-to-back instead. It sends a calibration pattern only once for every 8 bytes, reducing the

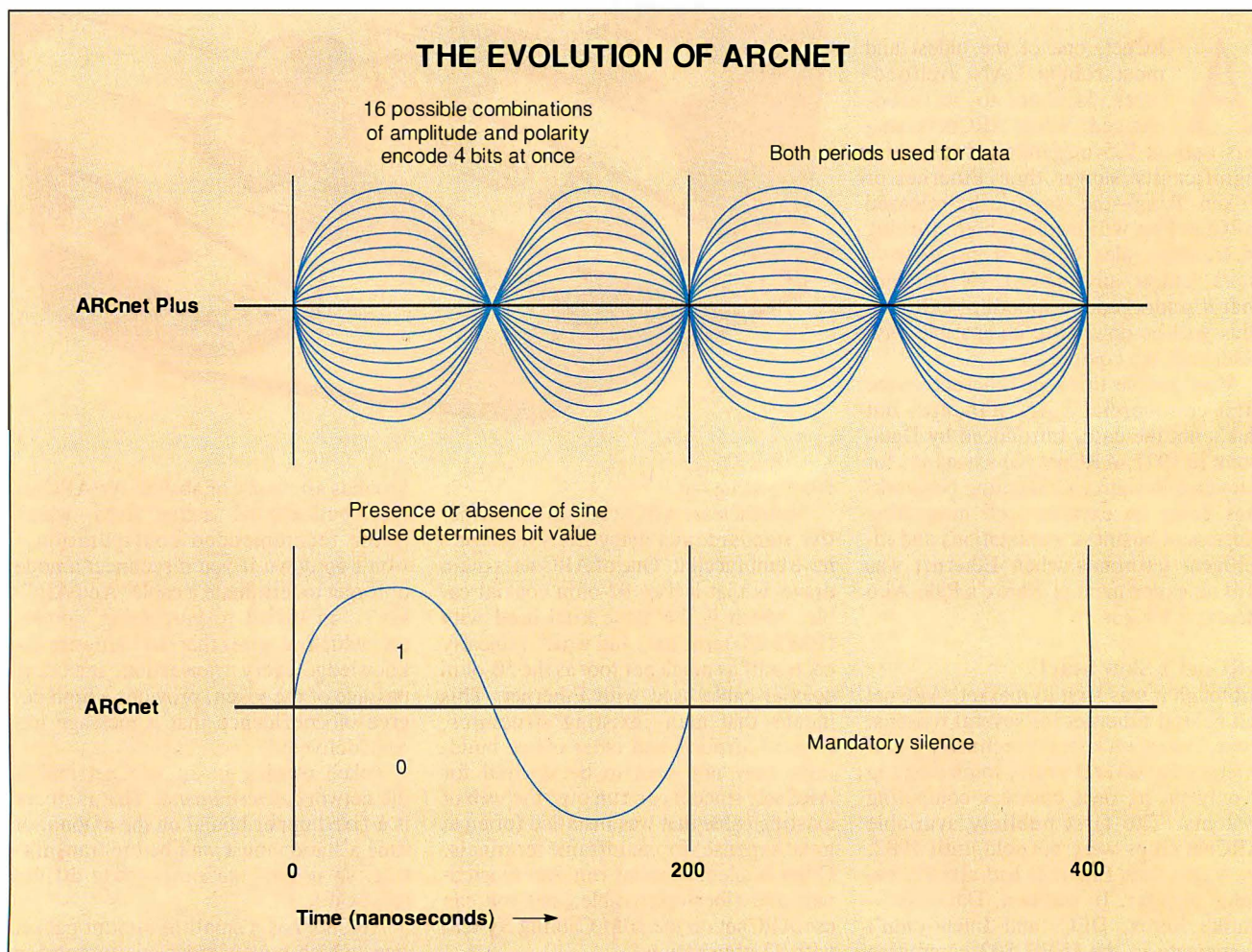

The original 2.5-Mbps ARCnet signals bit values by determining the presense or absence of a sine pulse. Here, ARCnet signals a "1" bit by sending a 200-ns pulse, followed by a silence of equal length. The 20-Mbps ARCnet Plus specification makes more efficient use of the bandwidth by using both periods for data and by using amplitude modulation to encode 4 bits into every pulse. ARCnet Plus also sends a calibration pattern once for every 8 bytes, further reducing overhead.



# 1 YEAR FOR ~~\$42.00!~~

*Special Offer! \$24.95!*

Save over 40% off the single copy price by subscribing now to BYTE! Your paid subscription will include BYTE'S annual IBM PC Special Issue.

Payment Enclosed

Bill Me Later

Name \_\_\_\_\_

Company \_\_\_\_\_

Address \_\_\_\_\_

City \_\_\_\_\_ State \_\_\_\_\_ Zip \_\_\_\_\_

No-Risk Guarantee: If dissatisfied, cancel anytime for a full 100% refund.  
Your subscription will start in 6-8 weeks.

# BYTE

IW12011



NO POSTAGE  
NECESSARY  
IF MAILED  
IN THE  
UNITED STATES

**BUSINESS REPLY MAIL**

FIRST CLASS MAIL PERMIT NO. 42 HIGHTSTOWN, NJ

POSTAGE WILL BE PAID BY ADDRESSEE:

**BYTE**

Subscription Department  
P.O. Box 558  
Hightstown, N.J. 08520-9409





# Our Printer Sharing Unit Does Networking!

## **An Integrated Solution**

Take our **Master Switch™**, a sophisticated sharing device, combine it with **MasterNet™** networking software for PCs, and you've got an integrated solution for printer and plotter sharing, file transfer, electronic mail, and a lot more. Of course you can also share modems, minis, and mainframes or access the network remotely. Installation and operation is very simple.

## **Versatile**

Or you can use the Master Switch to link any computer or peripheral with a serial or parallel interface. The switch accepts over 20 commands for controlling the flow of data. It may be operated automatically, by command, or with interactive menus. Its buffer is expandable to one megabyte and holds up to 64 simultaneous jobs. The

**MasterLink™** utility diskette for PCs comes with every unit and unleashes the power of the switch with its memory-resident access to the commands and menus.

## **Other Products**

We have a full line of connectivity solutions. If you just want printer sharing, we've got

it. We also have automatic switches, code-activated switches, buffers, converters, cables, protocol converters, multiplexers, line drivers, and other products.

## **Commitment to Excellence**

At Rose Electronics, we're not satisfied until you're satisfied. That's why we have thousands of customers around the world including large, medium, and small businesses, factories, stores, educational institutions, and Federal, state, and local governments. We back our products with full technical support, a one-year warranty, and a thirty-day money-back guarantee.



**Call now for literature or more information.**  
**(800) 333-9343**

*Give a Rose to your computer*

# RECOGNITA PLUS

SPEED, ACCURACY AND FLEXIBILITY!

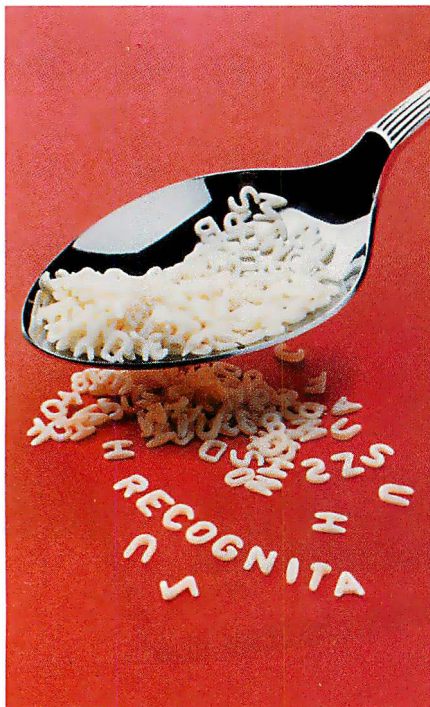

The fastest omnifont OCR Software operating in MS-DOS and Microsoft Windows environment

Dealers are welcome

Call for your demo diskette today:  
(1-800-255-4-OCR), P.O. Box 0218 Los Angeles, CA 90048 Tel: (408) 749-9935 Fax: (408) 730-1180

**Distributors:**

- AUSTRALIA**
- Dataserv  
Tel: 61-2/957-2066
- AUSTRIA**
- Artaker  
Tel: 43-222/588-05-0
- BELGIUM**
- Maxcom  
Tel: 45-43/526 9411
- Trittech  
Tel: 32-2/466-7535
- CZECHOSLOVAKIA**
- IV-Agency  
Tel: 42-2/840970
- DENMARK**
- Torsana-dtp data  
Tel: 45-43/43-35-99
- FINLAND**
- CommNec  
Tel: 358-0/493100
- FRANCE**
- Apsylog  
Tel: 33-1/40 26 22 32
- GERMANY**
- Computer 2000  
Tel: 49-89/780-40-0
- Frank Audiodata  
Tel: 49-7254/4091
- Macrotron  
Tel: 49-89/42-08-0
- Recognita  
Büroautomatisierung  
Tel: 37-41/7957-256
- GREECE**
- Electel  
Tel: 30-1/3607-521
- ICELAND**
- Höfudlausn  
Tel: 354-1/687033
- IRELAND**
- Saunders Acquisition Systems  
Tel: 353-1/366-522
- ITALY**
- Vecomp  
Tel: 39-45/577500
- JAPAN**
- Suehiro Koeki Kaisha, Ltd.  
Tel: 81-52/251-3721
- LUXEMBOURG**
- Burovision  
Tel: 352-470951
- MEXICO**
- Misermi  
Tel: 52-5/207-05-02
- NORWAY**
- ICT Databolin  
Tel: 47-2/79-58-80
- POLAND**
- FX Przeds. Inf.  
Tel: 48-12/56-57-76
- SPAIN**
- Computer 2000 Espana  
Tel: 34-3-473-16-60
- CSEI SA  
Tel: 34-3/336-33-62
- STI  
Tel: 34-1/45-869-45
- SWEDEN**
- Isogon AB  
Tel: 46-8/732-87-37
- SWITZERLAND**
- ScanSet  
Tel: 41-56/96-49-83
- TURKEY**
- EKSPA  
Tel: 90-4-139-66-11
- UNITED KINGDOM**
- Intiac Data Systems  
Tel: 44-709/547-177
- MSL Dynamics (for Africa)  
Tel: 44-293/547-788
- YUGOSLAVIA**
- LTS  
Tel: 38-11/190-572
- OEM Partners:**
- Accret
- SWEDEN**  
Tel: 46-766/355-30
- Deutsche Nichimen
- GERMANY**  
Tel: 49-211/3551-202
- EHG
- GERMANY**  
Tel: 49-7451/7051-2
- Future Technology
- AUSTRIA**  
Tel: 43-222/866350
- Getronics
- HOLLAND**  
Tel: 31-20-5861509
- Hewlett-Packard
- AUSTRIA**  
Tel: 43-222/25-00-0
- Microtek Electronics Europe
- GERMANY**  
Tel: 49-211/52607-0
- Microtek International
- TAIWAN**  
Tel: 886-35/772155
- Mitsubishi Electric Europe
- GERMANY**  
Tel: 49-2102/486359
- Pentax Europe
- BELGIUM**  
Tel: 32-2725 0570
- Ricoh Europe
- GERMANY**  
Tel: 49-211/5285-0

## NETWORKS

**U**sers with an investment in ARCnet can upgrade their networks on an as-needed basis, without having to throw out valuable equipment or run new cable.

overhead to about 16 percent. Finally—and most novel—it uses amplitude modulation to squeeze 4 bits of data into every pulse. A pulse can be either a positive- or negative-going sine wave and can have one of eight possible amplitudes from 0 to 12 volts. This yields a total of 16 combinations, enough to represent a nibble of information. That adds up to 4 bits per pulse × 5 million pulses per second, to yield a 20-Mbps data rate, excluding overhead.

When you subtract the time spent sending calibration pulses, the result is an effective data rate of 16.84 Mbps—significantly faster than Ethernet and a shade faster than 16-Mbps Token Ring. However, since an ARCnet Plus adapter is much simpler than a Token Ring board, and the per-packet overhead is much lower than for either Ethernet or Token Ring, ARCnet Plus should have a big edge in benchmark tests.

### Downward Compatibility

Every ARCnet Plus adapter will be capable of communicating with regular ARCnet nodes. This, plus the token-passing scheme, is the key to downward compatibility. When the network starts up, each node “sounds off” in turn and lets the others know if it’s capable of handling high-speed transmissions. Thereafter, whenever an ARCnet Plus node passes the token, it signals its capabilities again. Therefore, communications between two ARCnet Plus nodes can occur at 20 Mbps, but the network steps down gracefully to 2.5 Mbps whenever a slower node is involved.

In many cases, no old equipment need be removed from an ARCnet network to run ARCnet Plus. But even in the worst case, you must replace only the hubs if

you’re looking to mix old and new nodes. ARCnet’s star topology uses active hubs that amplify and distribute the signals to all nodes—in much the same way that a cable TV system uses amplified signal splitters. However, since the old hubs don’t expect the new, high-speed signals, they will filter them out instead of amplifying them.

There are two solutions to this problem. You can simply buy new hubs, or you can make sure that you don’t put two high-speed nodes on opposite sides of an old hub. There’s one other restriction: ARCnet Plus interfaces can’t attach directly to a “high-impedance” (i.e., bus-based) ARCnet. However, they can communicate with such a network through a hub.

### Bigger Packets

ARCnet Plus offers other advantages to users with large networks or with high throughput needs. The new standard allows packet lengths of up to 4096 bytes instead of the current 508 bytes. This means that certain file-server and database transactions will get a boost under the new standard. There’s also a provision for more nodes: up to 2047, compared to ARCnet’s 255. And 802.2 or IP addressing can be added to make it easy to connect ARCnet Plus networks to Ethernet, Token Ring, or TCP/IP networks using a bridge, router, or gateway.

All in all, ARCnet Plus offers an opportunity for users with an investment in ARCnet to upgrade their networks on an as-needed basis, without having to throw out valuable equipment or run new cable. It may also attract a lot of first-time buyers looking for a fast, reliable, efficient LAN standard.

When will ARCnet Plus be ready for prime time? Datapoint and other manufacturers will not say for sure, but industry observers estimate that commercial products will begin shipping in the second quarter of this year. In any case, users should cheer Datapoint’s ARCnet Plus as a first in the world of LANs: a new standard that doesn’t require that users throw away perfectly good equipment to achieve a higher level of performance. ■

*Brett Glass, a frequent contributor to BYTE, is a programmer, hardware designer, author, and consultant in Palo Alto, California. You can reach him on BIX as “glass.”*

*Your questions and comments are welcome. Write to: Editor, BYTE, One Phoenix Mill Lane, Peterborough, NH 03458.*

# Toshiba's New Disk Medium Is No Small Accomplishment.



# There's 13 Years Of Extra-High Density D

In this age of information, the voracious appetite for magnetic data storage capacity is never satisfied. Each new generation of computers brings higher performance and demand for more and more memory.

In personal computers and workstations, new applications like desktop publishing, computer-aided design and medical imaging are stretching the limits of conventional floppy disk and disk drive technology. And new technologies like digital audio tape and high definition television are placing unprecedented demands on recording techniques and media.

Toshiba Corporation anticipated this developing logjam in storage capacity as long ago as 1978, when it began research and development activity into a promising alternative to conventional longitudinal magnetic recording technology. That alternative—perpendicular recording—if perfected and made producible, promised to increase the recording density of magnetic media by at least an order

of magnitude.

Today, in 1990, Toshiba's intensive research and development, led by Dr. T. Fujiwara, has resulted in the perfection of media that are optimized for perpendicular recording, and the production of commercially available 3.5 inch floppy disks with the remarkable capacity of 4 MB unformatted.

## New Perpendicular Recording Technology

Today's conventional, longitudinal recording is reaching its limits for high density data storage. Using longitudinal recording, data is written into the



Every 4 MB Extra-High Density disk you buy will carry the symbol ED—ED tells you you're buying Toshiba technology.

magnetic medium by magnetizing adjacent cells *parallel* to the plane of the medium's surface. In perpendicular recording, magnetization of the individual cells occurs in a direction *perpendicular* to the plane of the recording medium.

To take advantage of perpendicular recording, Toshiba perfected the use of a new magnetic medium. This new medium is Barium Ferrite.

## Disk And Drive Technology

Toshiba has ushered in the era of high density recording with the development of the new 3.5 inch extra-high density floppy disk utilizing the barium ferrite medium, and new associated floppy disk drive.

The double-sided disk has an extraordinarily high recording density of 35 kilobits per inch—more than four times higher than conventional floppy disks. Yet the disks have a track density of 135 tracks per inch, the same as in conventional 3.5 inch floppies. The barium ferrite disks feature extremely high reliability—dependable performance for more than 10 million revolutions.

For high density recording and playback using this new barium ferrite 3.5 inch disk, Toshiba made certain modifications to disk drive head and drive mechanical designs. This new Toshiba disk drive technology, licensed to companies around the world, preserves downward read-write compatibility with conventional 3.5 inch 1 MB and 2 MB disks.

Under license from Toshiba, many firms in the U.S. and Japan are proceeding to exploit barium ferrite technology and several have introduced commercial



Toshiba's development of the barium ferrite medium began in 1978, led by Dr. T. Fujiwara. Today, Toshiba holds the patents for barium ferrite as a recording medium.



### A Chronology Of Important Milestones In The Development Of Barium Ferrite Media For Perpendicular Recording.

1978	12/82	7/85	1/86	4/87	9/87	4/88	9/88
Researchers at Toshiba R&D Center establish concept of barium ferrite as a medium for perpendicular recording.	Barium ferrite tape demonstrated for the first time in the world at Toshiba Private Show.	Toshiba displays and demonstrates first 3.5" floppy disk and drive at National Computer Conference.	Toshiba Ba-Ferrite floppy disk selected as one of the top new products of 1985 by Nikkan Kogyo Shinbun.	Toshiba announces development of a Ba-Ferrite 3.5" 16 MB technology.	Toshiba announces a commercial version of Ba-Ferrite 3.5" 4 MB FDD and available licensing of FD/FDD technology.	At Comdex, Data Technology announces a 5.25" 20 MB FD/FDD product utilizing Ba-Ferrite media.	Toshiba and TEAC announce a Ba-Ferrite 3.5" 4 MB FDD that is 1" high and downward read/write compatible with 1 & 2 MB disks.

# Extra Effort In Every Disk We Make.

products. Currently, standardization of the 4 MB technology has been progressing worldwide led by Toshiba and other manufacturers.

In addition to Toshiba, other companies are also extending the recording density of barium ferrite above the 20 MB range on 3.5 inch disks, by utilizing the superior characteristics of barium ferrite and new schemes for recording and tracking.



*When you see this symbol on an Extra-High Density disk, that's your assurance that you're buying not only Toshiba technology—but Toshiba quality as well.*

## Other Applications Of Barium Ferrite Technology

Toshiba's barium ferrite technology shows equal promise for other high density applications such as computer data tapes, 8mm VCR tapes, DAT tapes and future high definition television VCR tapes.

The use of barium ferrite also allows high speed contact duplication of pre-recorded tape. The speed of duplication can be several hundred times higher than can be accomplished in machine-to-machine real time duplication.

All told, the enhancement of recording media embodied in Toshiba's barium ferrite technology applied to perpendicular recording promises to extend the density of today's magnetic storage products well beyond that available today. And the technology will certainly give rise to new media applications where high density, high performance and extremely high reliability are required.

For additional information about barium ferrite Extra-High Density disks, ask the company that developed the technology—Toshiba. Telephone 1-800-843-2108.

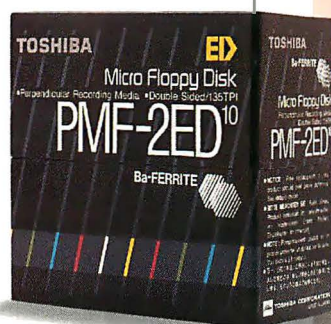

## What's Barium Ferrite?

*The particles used in conventional recording media are shaped like needles, and therefore difficulties arise in maintaining perpendicular orientation throughout the manufacturing process. Barium ferrite particles, on the other hand, are tiny flat platelets, hexagonal in shape, that can be readily arranged to have their easy axis of magnetization perpendicular to the platelet plane.*

*Barium ferrite has long been used as a permanent magnet material, but the particles for permanent magnets have grain sizes too large to be suitable for high-density magnetic recording. However, Dr. Fujiwara and Toshiba's researchers have developed ultra-fine barium ferrite particles with optimum shape, size and magnetic properties.*

*The Toshiba researchers also perfected a glass crystallization method for the manufacture of the ultra-fine barium ferrite particles.*

*The process begins by mixing glass, barium ferrite components and the ion substitution components and melting them at high temperature. The mixture is poured between rotating nip rollers for rapid quenching and forms glass flakes. These are heated again to crystallize them. The crystallized barium ferrite particles are extracted by dissolving the remaining compounds with acid, then rinsed and dried. This process produces very fine, separate particles of uniform size with excellent magnetization properties.*

*In the next step, a magnetic paint is made by mixing the barium ferrite particles in a mixture of binder resin and solvents and other ingredients. The magnetic paint then can be coated onto base polyester films and dried, and the surface smoothness enhanced by rolling. After curing, the films can be cut to form tapes, or punched out in the form of flexible disks.*

11/88

12/88

2/89

3/89

2/90

*Ba-Ferrite products at Comdex: Omega 5.25" 44 MB, Brier 3.5" 21 & 43 MB, Insite 3.5" 21 MB & Qumel Kodak 5.25" 20 MB FD/FDDs*

*Toshiba introduces the JW-530, a Japanese word processor employing a Ba-Ferrite 3.5" 4 MB FD/FDD.*

*Logitech announces the LFD-302, an add-on subsystem for the PC98 series using a Ba-Ferrite 3.5" 4 MB FD/FDD.*

*Sharp introduces the DP-3000, a desktop publishing system using a Ba-Ferrite 3.5" 4 MB FD/FDD.*

*Canon introduces a desktop publishing system using a Ba-Ferrite 3.5" 4 MB FD/FDD.*

In Touch with Tomorrow  
**TOSHIBA**

TOSHIBA AMERICA ELECTRONIC COMPONENTS, INC.

Circle 237 on Reader Service Card

© 1990 Toshiba America Electronic Components, Inc. MM0D-90-010

# Where can you get every font you'll ever need for your LaserJet III?

## Try the Library.

Our Complete Font Library Cartridge™ for the LaserJet III has 51 different typestyles, each scalable to virtually any size, so that you can make your point like never before.

Just as a library has books on every topic, our Complete Font Library Cartridge has a typeface for every kind of document you create. Choose from classic typefaces for proposals, letters, and presentations. Or from designer styles for flyers, invitations and advertising materials.

You see, each of your documents has a different message. And, the way that message is perceived depends greatly on the typeface and point size you choose. A CG Century Schoolbook means business. A CG Bodoni says style. While Cooper Black expresses creativity. Messages like this are difficult to portray on printed pages when you only have access to the one or two typefaces resident in your laser printer.

Our cartridge is unique. In fact, it's unlike any other cartridge for your LaserJet III. That's because our breakthrough windowing technology has allowed us to put what was previously in two separate cartridges, into a single cartridge. The result? Inexpensive and convenient access to every font you'll ever need for your LaserJet III.

For directions to the Library, call your nearest dealer or contact: Pacific Data Products, 9125 Rehco Road, San Diego, CA 92121, (619) 597-4643, Fax (619) 552-0889.

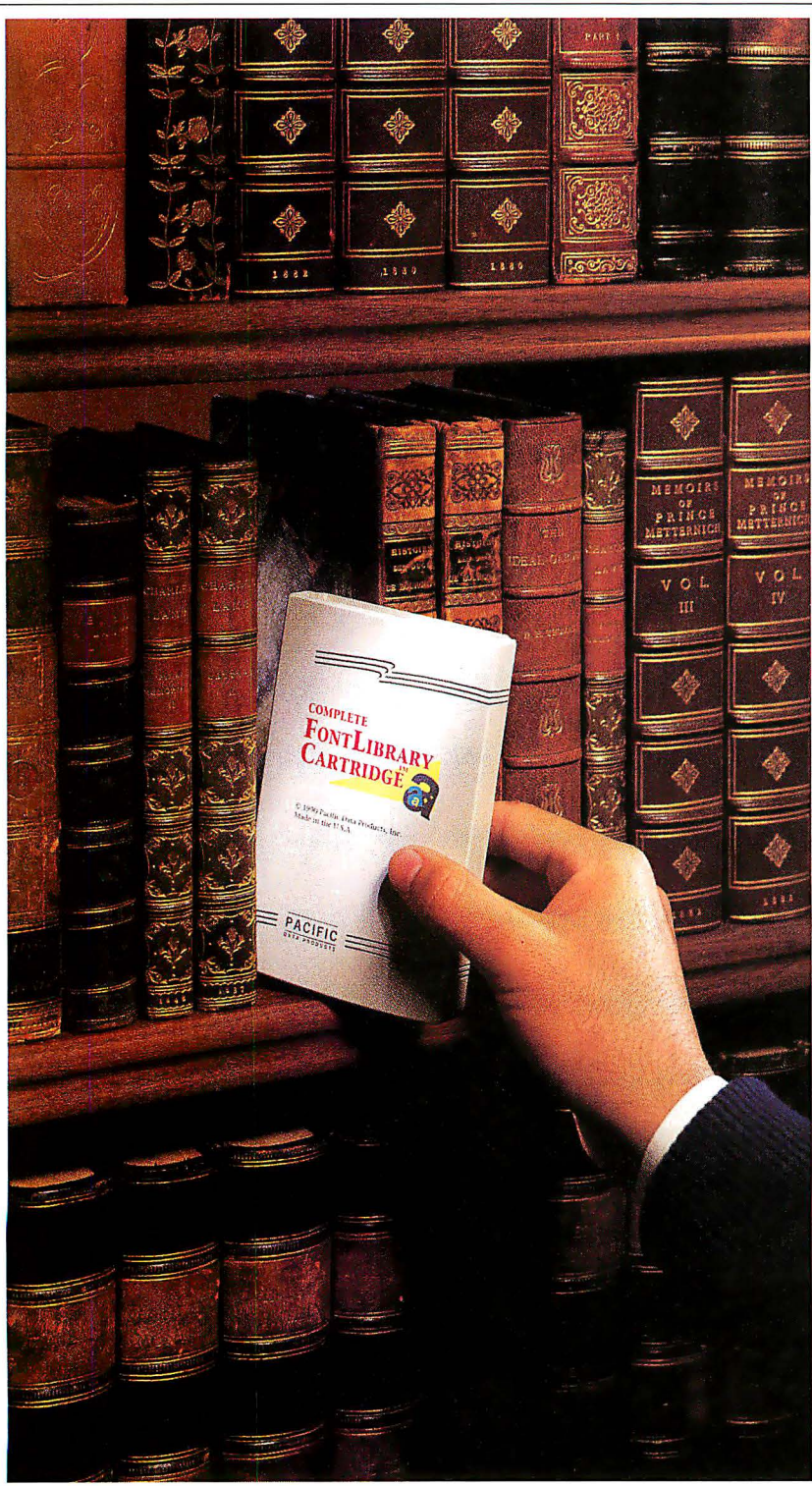

Complete Font Library Cartridge is a trademark of Pacific Data Products, Inc. LaserJet is a registered trademark of Hewlett-Packard Company. Scalable type outlines are licensed from Agfa Corporation. CG Century Schoolbook and CG Bodoni are products of Agfa Corporation. © Copyright 1990 Pacific Data Products, Inc.

**AGFA** 

**PACIFIC**  
DATA PRODUCTS



# SHORT TAKES

BYTE editors' hands-on views of new and developing products

Fax-O-Matic  
and FaxConnection

Mathematica  
for Windows 3.0

Storyboard Live!

FileMaker Pro

Stacker



## Fax Boxes Keep Your Laser Printer Busy

Unless your laser printer is hooked up to a print server in a large LAN, it probably spends most of its time twiddling its electronic thumbs, patiently waiting for the next print job while happily running up your electric bill.

Two new products are designed to keep your laser printer much busier by using it to print faxes as they're received. **Fax-O-Matic** from Tall Tree Systems and **Fax-Connection** from Extended Systems are both essentially receive-only fax machines that use a laser printer for output. Just having faxes on plain paper instead of that curly thermal paper that standard fax machines use is reason enough to go right out and buy one of these units.

OK, the name "Fax-O-Matic" does indeed conjure up images of, "It dices, it slices, it prints faxes." And it's ugly, too: a true black box. But Fax-O-Matic works perfectly. And at \$399, it's by far the most inexpensive fax box available.

Setup is simple: I plugged the printer cable from my computer into Fax-O-Matic, plugged an included cable from the unit to my laser

printer, and hooked up AC power and my fax line. Off I went. (There's also a jack for hooking up a standard fax machine for sending faxes.)

Fax-O-Matic works with any laser printer that's compatible with the Hewlett-Packard LaserJet. And you don't need gobs of RAM, either. If your laser printer has more than 256K bytes and less than a megabyte of memory, Fax-O-Matic prints faxes at 150- by 150-dot-per-inch resolution. On the other hand, if your printer has a megabyte or more, you can run a utility that

tells Fax-O-Matic to print at 300 by 300 dpi. Of course, the high-resolution mode is truly useful only if the sending fax is using the "fine" mode.

This product is full of thoughtful touches. It automatically scales legal-size faxes to fit on an 8½- by 11-inch page. And if your printer is busy doing other things when a fax comes in, Fax-O-Matic stores up to 30 pages in its internal 512K-byte buffer. As soon as the printer is free, it prints the fax.

FaxConnection is a slightly different beast. It comes in an

external version like Fax-O-Matic, but the unit I tested is an internal add-in board designed specifically for the LaserJet IID or III. It plugs into the printer's "optional I/O slot." This precludes using it with LaserJet compatibles, but it makes for a much more elegant installation. FaxConnection has a parallel port, a jack for your fax line, and another jack for hooking up a standard fax machine for sending.

Although it may look elegant, FaxConnection is considerably more of a pain to use than Fax-O-Matic. It has only a 256K-byte buffer for storing faxes (about 12 pages) if your printer is busy. In addition, it doesn't do automatic scaling of legal- to letter-size faxes. Receiving legal-size faxes requires legal-size paper, and you have to send a command to FaxConnection to tell it to receive a legal-size fax. The same holds true for telling the unit to print in fine mode. I had to use the DOS COPY command to send commands to FaxConnection.

FaxConnection has two other major disadvantages. First, it requires a laser printer with at least a megabyte of RAM. Second, it's considerably more expensive than Fax-O-Matic.

Both units, of course, don't require that your computer be turned on in order to receive and print faxes.

The idea of using your laser printer for receiving faxes isn't new, but Fax-O-Matic and FaxConnection are the first units to break the \$1000 price barrier. Of the two, I've become quite fond of Fax-O-Matic. It beats FaxConnection on features and ease of use hands down. Fax-O-Matic does its job—and does it flawlessly. And at \$399, it's a real steal.

—Stan Miastkowski

### THE FACTS

**Fax-O-Matic**  
\$399

**Requirements:**  
Hewlett-Packard LaserJet  
or compatible printer.

Tall Tree Systems  
2585 East Bayshore Rd.  
Palo Alto, CA 94303  
(415) 493-1980  
fax: (415) 493-7639

**Inquiry 1165.**

**FaxConnection**  
\$595; external version, \$695

**Requirements:**  
Hewlett-Packard LaserJet  
IID or III; external version,  
LaserJet or compatible  
printer.

Extended Systems  
6123 North Meeker Ave.  
Boise, ID 83704  
(208) 322-7575  
fax: (208) 377-1906

**Inquiry 1166.**

## Mathematica Does Windows

Many people originally thought of computers as wonderful tools for mathematicians, and they have turned out that way. But desktop PCs were useless for mathematics until the advent of programs that could perform symbolic mathematics rather than just crunch numbers. The best known is Mathematica, because it is visually more exciting and available on a wide range of hardware platforms.

Mathematica has one big disadvantage, however. It is an enormous and powerful program that requires considerable computing horsepower. It first showed up on Unix systems and has rapidly spread to many of these. It then appeared on the Mac and also on 386-based PCs. But not all versions of Mathematica are created equal.

Two in particular, the Next version and the Mac version, include "notebooks" as part of the interface. Notebooks are part of a sophisticated interface onto Mathematica documents that combines features of outlining packages with features of word processors and hooks these up to the basic Mathematica tools. Thus, Mathematica notebooks become a powerful way to create, view, edit, and work with mathematically oriented documents of any kind. Notebooks are particularly useful as a way to distribute mathematical ideas or for teaching.

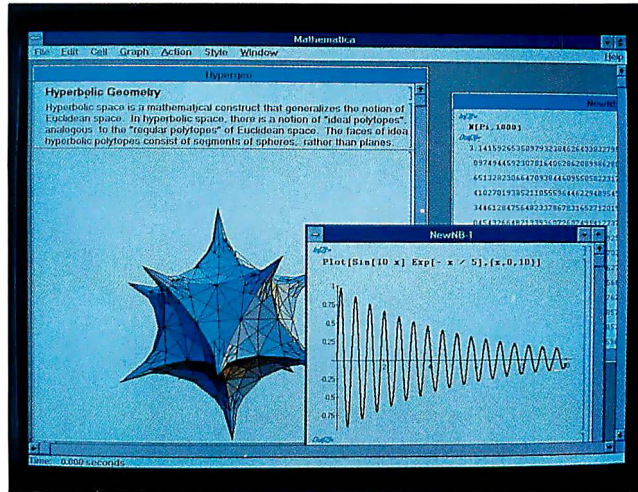

### THE FACTS

**Mathematica for Windows 3.0**  
\$995

**Requirements:**  
A 386-based PC with at least 2 MB of RAM (preferably 4 MB) and a hard disk drive.

Wolfram Research, Inc.  
100 Trade Center Dr.  
Champaign, IL 61820  
(217) 398-0700  
fax: (217) 398-0747  
**Inquiry 1167.**

Wolfram Research has now added notebooks to a new version, **Mathematica for Windows 3.0**. This is a clean conversion of other versions of Mathematica to the Windows environment, but the program's processing demands do limit the kind of systems on which it will run under Windows. To run Mathematica for Windows, you need a 386-based system with at least 2 megabytes of RAM. Doing any significant amount of work will require a system with at least 4 MB. I found

Mathematica for Windows much more friendly than the version for 386-based DOS systems. However, there is no change in what you can do.

One useful feature of this version is the ability to run only the interface portion of Mathematica on the local Windows system and use network features built into Mathematica to connect to a remote system that is running the Mathematica kernel.

Mathematica for Windows 3.0 is one of the first Windows 3.0 programs to require the use

of a 386-based system, and it runs 386-specific code in its kernel. It also makes more intelligent use of the task-switching capabilities of Windows than other programs, since the interface and kernel run independently. This means that you can open a notebook, edit some equations, ask the kernel to evaluate them, and go on to other work while the kernel calculates the results, rather than being forced to wait for the answer.

Mathematica for Windows includes all the powerful capabilities of the other versions, including the ability to rapidly perform numerical calculations of all kinds to any desired precision, to manipulate a wide range of symbolic mathematical expressions and to plot and graph sophisticated two- and three-dimensional graphs of all kinds. Mathematica also includes a powerful structured programming language geared for use with mathematics.

There is some overhead to working with Windows for Mathematica, and as a result, Mathematica can be a little slower in the Windows environment than it is running under DOS.

Overall, Mathematica for Windows is a great addition to both the Windows application lineup and to Wolfram Research's lineup of versions of Mathematica. It should be of particular interest to the educational market, especially in areas where institutions rely on PC systems rather than Unix workstations.

—Owen Linderholm

## Live, from IBM—It's Storyboard!

According to the "experts," desktop multimedia is a reality, and everybody needs it. But not many have been able to afford it—until now. **Storyboard Live!** is IBM's multimedia software, and it runs on everything from a 640K-byte XT to fully loaded 386 and 486 systems. It does a lot—still and animated com-

puter-generated graphics and text, still and moving digitized video, and high-quality audio—but with some severe drawbacks.

Each function—such as storyboard editing, playback, and animation (sprite) editing—is housed in a separate executable file. A menu program puts up a graphic of huge

buttons, and it lets you use the mouse to select the module of your choice. This is a waste; I thought it much easier to type the two-character program name from the command line.

The menu program is significant, however, because it is the first evidence of Storyboard Live!'s most serious flaw: its cheesy graphical

interface. IBM, the famed long-winded proponent of cross-platform sameness in interfaces, has failed to enforce its own law in one program that cries out for it.

Interface aside, Storyboard Live! is capable of some nifty things. Even with the limited video and audio capabilities in my system, the software let me

# They Left out Features.... We Left out the **COMMA!!**

## The only thing missing...

is the comma in the price. If you look at the chart on the right you will see prices charged by our competition. All but one contain a comma. **DesignCAD 3D** sells for \$399.00. Period. No Comma!

In order to draw the complex pictures shown below it is desirable to have the following 3D features:

- Interactive design with 3D cursor
- Blending of surfaces
- Boolean operations such as add, subtract, and intersection
- Complex extrusions
- Cross sectioning
- Block scaling
- On screen shading
- Shaded output to printers and plotters

All of these competitors left out one or more of these desirable features in their standard package. They didn't forget the most horrible feature - the comma.

**DesignCAD 3D** offers **ALL** the listed features plus many more!

If **DesignCAD 3D** has the power to create the 3D objects shown below, imagine how it could help with your design project!

**DesignCAD 3D** sells for \$399. We left out the comma. We didn't think you would mind!

### PC MAGAZINE SAYS...

*DesignCAD 3D, the latest feature-packed, low-cost CADD package from American Small Business Computers, delivers more bang per buck than any of its low-cost competitors and threatens programs costing ten times as much. For a low-cost, self-contained 3D package... DesignCAD's range of features steals the show."*

# \$399

AutoCAD rel. 10	\$3,000.00	AutoCAD AEC \$1,000.00 AutoShade \$500.00
CADKEY 3.12	\$ 3,195.00	Solids \$995.00 IGES translator \$1,995.00
DataCAD with DC Modeler	\$ 3,990.00	DataCAD Velocity \$2,000.00
<b>DesignCAD 3D ver. 2.0</b>	<b>\$ 399.00</b>	<b>NO expensive options! IGES Free, Shading Free</b>
MaxxiCAD 1.02	\$ 1,895.00	N/A
Mega Model	\$ 995.00	MegaDraw \$195, List \$295, MegaShade \$395
MicroStation PC 3.0	\$ 3,300.00	Customer Support Libraries \$1,000.00
ModelMate Plus 2.8	\$ 1,495.00	N/A
VersaCAD Design 5.4	\$ 2,995.00	N/A

Source: Byte Magazine

### BYTE MAGAZINE SAYS...

*"At \$399, DesignCAD 3D was the least expensive package we saw, yet it was one of the more powerful. ...Don't be fooled by the remarkably low price, this program can really perform."*

May 1989, page 178

Complete 3-Dimensional design features make it easy for you to construct realistic 3-D models. With full solid-object modeling capabilities you can analyze your drawing to determine the volume, surface area or even center of gravity! **DesignCAD 3-D** even permits you to check for interference between objects! Aeronautical Engineers can now find the center of gravity for a new airplane design with a couple of keystrokes. The Architect can determine the surface area of a roof for decking in a matter of minutes. The Civil Engineer can calculate the volume of a lake or dam in seconds. The Mechanical Engineer will know for sure if certain parts fit together without interference. The uses for **DesignCAD 3-D** are only limited by YOUR imagination!

### HOW DO I GET ONE?

**DesignCAD 3-D** and **DesignCAD 2D** are available from most retail computer stores, or you may order directly from us. If you have questions about which program to purchase please give us a call. All you need to run **DesignCAD 3-D** is an IBM PC or compatible computer with 640 K RAM memory and a hard disk. Both products support most graphics cards, printers, plotters and digitizers. Free Information and a demo disk are available by faxing (918) 825-6359 or telephoning:

## 1-(918) 825-4844

American Small Business Computers • 327 South Mill Street • Pryor, OK 74361 U.S.A.

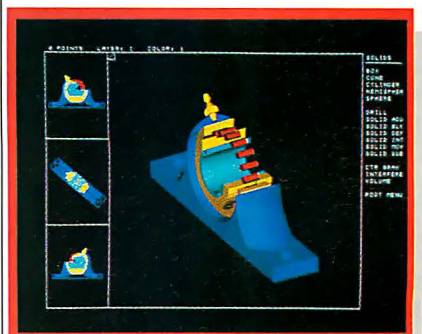
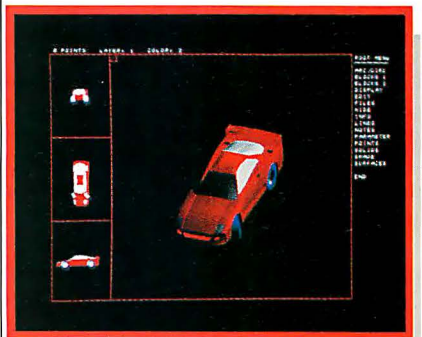
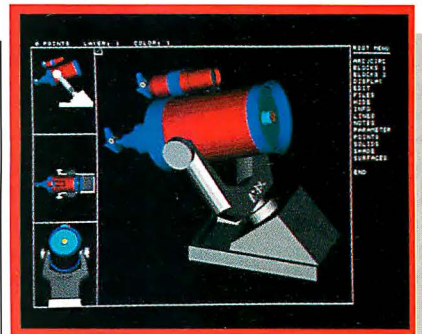

create presentations with precisely timed transitions and smooth motion of small graphical elements. It also was able to produce sound and music of surprising quality (but insufficient volume) from the system's internal speaker. This isn't new; a number of PC packages let you combine computer-generated graphics and sound.

The motion video, which I've seen demonstrated, plays back a slightly jerky series of captured video images. The colors are muted to squeeze into the limited palette of VGA or 8514/A, but the effect is impressive at first viewing.

Computer-generated animation is created in the sprite editor, which lets you create flip-book animations that can be played back in a rectangular area during a presentation. Still images can be generated with the Picture Maker or imported in a variety of popular formats. IBM supplies a library of 800 images and 11



#### THE FACTS

**Storyboard Live!**  
\$495

**Requirements:**  
IBM AT, PS/2, or compatible with DOS 3.3 or higher, an EGA or better color display, and a hard disk drive.

IBM Corp.  
Product Information Center  
P.O. Box 2150  
Atlanta, GA 30301  
(800) 426-7699  
**Inquiry 1168.**

fonts that you can use in your presentation screens.

Sound, graphics, sprites, and live video are knitted together in the Story Editor, which builds scripts in a multimedia programming language. The concept and approach of the editor are sound, and the capacity for the creation of powerful presentations, even interactive ones, is evident.

But, despite all this power and potential, IBM has saddled its flagship multimedia software package with an interface that is worse than lame. That's not to say you can't get used to it and get some real work done, but why should you have to battle with a cumbersome interface when other presentation programs don't require such sacrifices? If multimedia is to become standard on every desk, it won't be done with something like Storyboard Live! If this is the best IBM can do with desktop multimedia, my money's on Apple.

—Tom Yager

## FileMaker Pro Gives the Old a New Look

**F**ileMaker from Claris has long held a reputation in the Macintosh market for being a reliable nonrelational database. It's also a favorite among novices because of its clean interface and forgiving performance. In fact, it's extremely hard to corrupt data within a file, even if you inadvertently power down during operations. FileMaker always tries to recover when you start it up again.

There are a number of significant changes in **FileMaker Pro** from the preceding FileMaker II. Most notable of these are the addition of a pop-up menu that changes between the layout views available for a database, improved import/export of information (i.e., it now handles comma-delimited text, Lotus 1-2-3, and DIF files), interactive buttons that are able to perform actions, enhanced layout tools, better data-entry checking functions,

and multiuser support.

All these improvements are worthy and welcome, but the FileMaker database engine underneath remains basically unchanged. The face-lift that Claris has given the program removes some of the annoying quirks present in previous versions (e.g., the inability to change how you tab to fields

once a layout is done) and retains others (e.g., date fields *must* include a day, even if you only want a month and year to be in there).

Although the promotional literature trumpets the scripting available in FileMaker Pro, I found it to be seriously lacking in scope. You must first perform the actions for a

script—limited to switching layouts, finding records, sorting records, restoring page setup options and printing, or previewing a report—before you can set it up.

Editing the script is crudely possible only through the

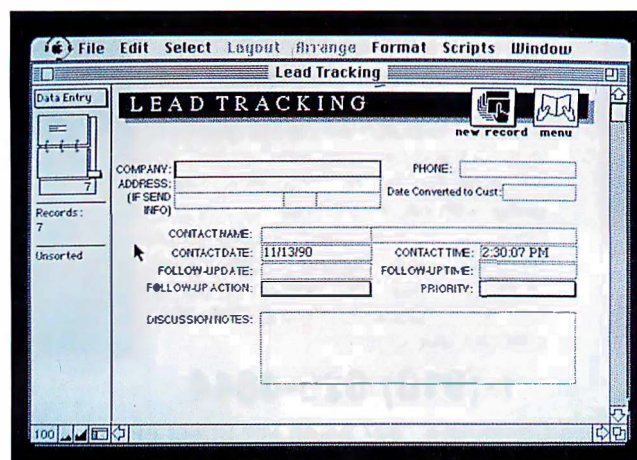

#### THE FACTS

**FileMaker Pro**  
\$299; \$99 upgrade  
for FileMaker II users

**Requirements:**  
A Mac Plus or better with two 800K-byte floppy disk drives (a hard disk drive is recommended) and System 6.0 or higher.

Claris Corp.  
P.O. Box 58168  
Santa Clara, CA 95052  
(408) 987-7000  
fax: (408) 987-7440  
**Inquiry 1169.**

# Developers: Lock Up Your Profits

The ProTech key for protecting your software profits and your copyright.

Software piracy's a crime! What it can do to a developers profit margin is shameful.

The cost of development and marketing products demand you receive the revenue you are entitled to.

The solution, ProTech.

- Custom hardware and software for each developer
- Encrypted interrogation routines and debug disablers
- Available active read/write memory and on board microprocessor provide the ultimate protection
- Key for PC "compatibles," Macintosh, UNIX and RS232C port
- Total compatibility, reliability and end user satisfaction

ProTech's the key.  
Call us for more information  
or a demonstration package.

**1-800-843-0413**

**PROTECH**  
MARKETING, INC

9600-J Southern Pine Blvd.  
Charlotte, NC 28217

Tel: 704-523-9500 FAX: 704-523-7651

Hours: Mon-Thrus: 8:30-7:00, Fri: 8:30-5:30 ET

Se Habla Espanol



choices available in a presented dialog box. Editing individual steps (e.g., in an Excel macro) is impossible. I found this quite limiting, and, thus, the scripting is of only marginal usefulness.

The multiuser support in

FileMaker Pro is of the access variety, not true AppleShare with a central server. That is, you can grant other AppleTalk users access to some files or parts of files with a command, or restrict the file to your own use exclusively. Again, this is

an improvement over FileMaker II's nonhandling of multiple users.

FileMaker Pro continues to deliver on the concept of the original FileMaker product: a reliable database that can be used for most noncritical ap-

plications. The additions made by Claris in FileMaker Pro enhance the utility of the program without introducing complications, and I continue to recommend the product to all users.

—Laurence H. Loeb

## Instant Hard Disk Expansion

With today's emphasis on graphical-user-interface-based environments, lean-and-mean applications are a thing of the past. Not only do many of today's programs hog RAM, they often require many megabytes of hard disk storage space. Add some data files, and that 20- or 40-MB hard disk drive that once looked so large begins to quickly become cramped for space.

Hard disk drives are expensive, so, rather than buying a new high-capacity model, you can just add **Stacker** and nearly double your hard disk space instantly.

Stacker performs this minor magic through the process of compressing your data on the fly and decompressing it when you call up a file.

The product comes both in a software-only version and as an 8-bit add-in card. The card uses Stac Electronics' proprietary real-time compression chip, a well-accepted chip that's widely used in tape backup systems.

I tested both the software and hardware versions on a 33-MHz 386 clone equipped with an already-large 170-MB Quantum SCSI drive. Both of these versions use a small (30K-byte) device driver and create virtual disk volumes for storing all the compressed data.

Both also have one of the easiest-to-use installation programs I've ever seen. Installing the coprocessor card is a snap; there are no cables to hook up. The installation program individually checks a variety of memory locations until it finds a free one that it can use.

Even my clone, which has every slot filled, didn't confuse it, although the manual clearly told me that I had to temporarily disable my 386Max memory manager before installation.

The same holds true with Quarterdeck Office Systems' QEMM.

The coprocessor-card installation also has an incremental installation option that

creates compressed volumes even if you don't have much space left on your disk.

This is all automatic and apparently foolproof. There's a SWAPDISK utility that renames the new volume to match the drive where the original files were. This eliminates having to change application setups and your CONFIG.SYS or AUTOEXEC.BAT files.



### THE FACTS

**Stacker**  
software version, \$129;  
coprocessor version, \$229

**Requirements:**  
IBM PC or compatible  
running DOS 3.0 or  
higher with a single free

8-bit expansion slot (for the coprocessor version).

Stac Electronics  
5993 Avenida Encinas  
Carlsbad, CA 92008  
(619) 431-7474  
fax: (619) 431-0880  
**Inquiry 1170.**

Since the software version of Stacker "steals" processor cycles, I expected large delays when I accessed files. With my 33-MHz processor and 15-millisecond hard disk drive, the delay was barely perceptible.

It would probably be much slower with a slower processor and hard disk drive. With the Stacker card, I had no noticeable delay.

In most cases, Stacker doesn't quite double storage space. The actual compression ratio varies from about 1.3-to-1 for dense .EXE files all the way to 2-to-1 (or even much more) for text files.

On a typical hard disk drive of mixed program and data files, the average comes to about 1.7-to-1. Stacker doesn't try to hide the fact at all; it comes with a utility that tells you this.

The bigger your hard disk drive, the more of a value Stacker is. And if you're like most users, you probably won't want to compress your entire hard disk. Stacker is handiest when you're squeezing big data files and for archival storage.

It's only natural to get a bit uneasy about using a product that stores your data in an otherwise-unreadable format. In particular, what happens if the Stacker card fails?

Stac Electronics has added a feature that I found very reassuring: If the coprocessor card fails, Stacker's device driver detects the failure and automatically switches to the software-only compression/decompression. To me, that's more than enough to prevent lost-data worries.

—Stan Miastkowski

# The fastest way to break into Windows.

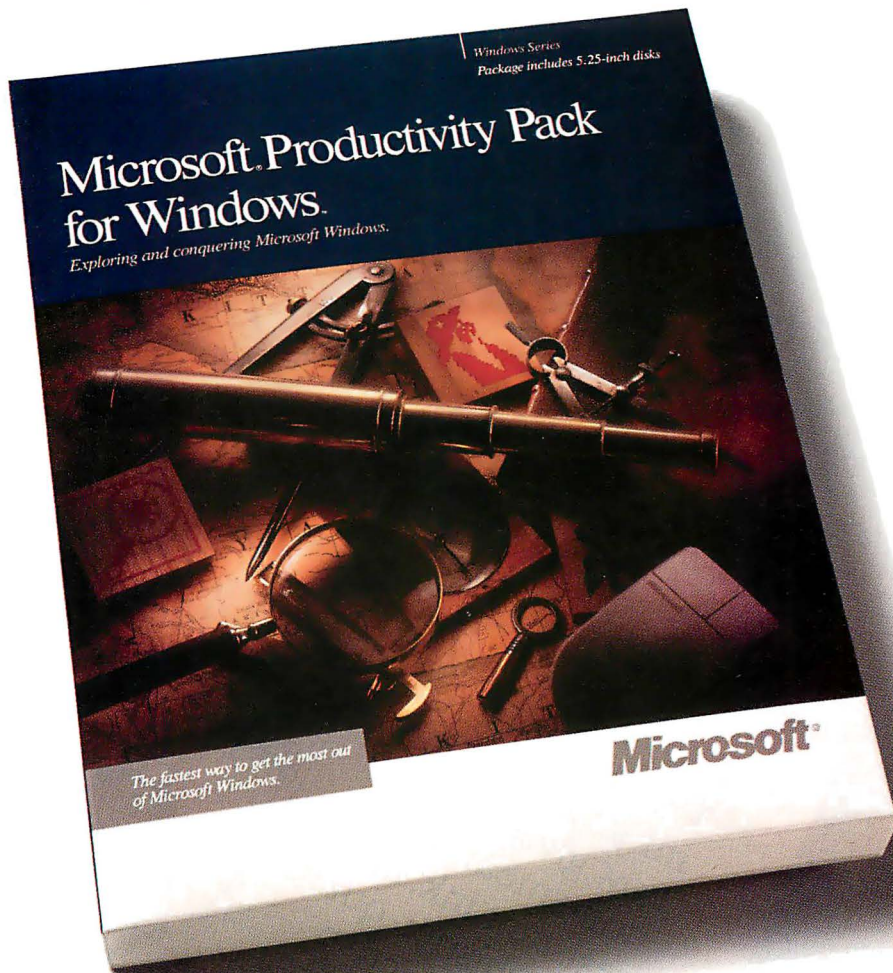

To get comfortable with the Microsoft® Windows™ environment, there's only one thing you have to do. Use it.

But now you can get even more out of Windows 3.0. Even faster. With the brand new Microsoft Productivity Pack for Windows.

It's really three tools in one:

Learning Windows, a colorful tutorial that lets you explore everything from the basics to the fine points.

Working Smarter, a section crammed with time-saving tips and strategies. (How *do* you create a RAM disk? The answer's here.)

And Quick Troubleshooter. Kind of a

built-in product support department that never closes. So you can get quick fixes any time, for many of your most common problems.

Best of all, every one of these tools is online. Which means you'll be able to learn while you work. Without quitting your applications. Or even cracking a manual.

For more information, call us at (800) 541-1261, Dept. P07. If you can't wait to get into Windows 3.0, the Microsoft Productivity Pack could be the break you need.

**Microsoft®**  
Making it all make sense®

# Born not to run.

Hewlett-Packard inkjet technology now gives you non-smear, water-resistant ink, easy and whisper-quiet operation, crisp and black 300 dpi resolution, portrait and landscape printing, multiple fonts through Windows support, 2+ pages per minute, full industry compatibility, and a three-year, rain-or-shine warranty.

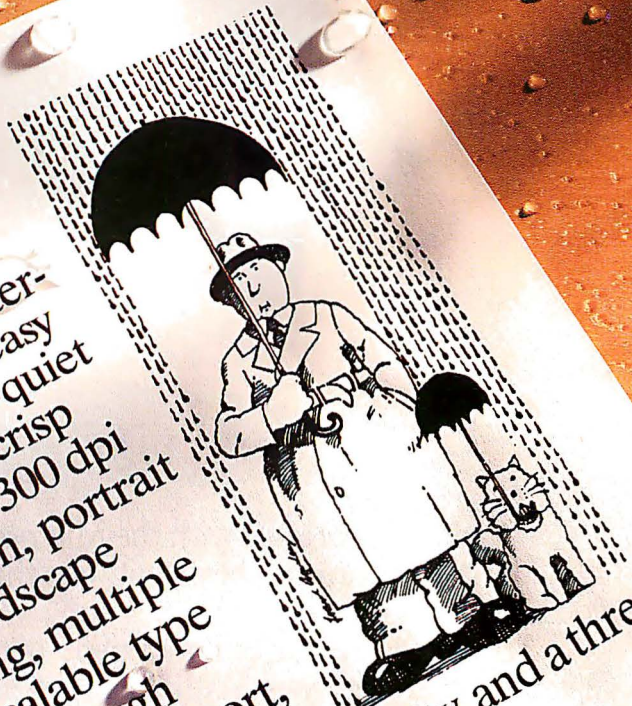

The new DeskJet 500  
\$729





**With water-resistant ink, the new HP DeskJet 500 printer produces very dry documents.**

For just \$729\*, our 300 dpi ink-jet technology makes sure your output looks beautiful. And our new water-resistant ink makes sure it stays beautiful.

Our printer is made to last, too. It has a 10-year MTBF. With reliability like that, no wonder we can offer a 3-year warranty.

Despite its low cost, the HP DeskJet 500 gives you a lot of high-end features. Such as multiple fonts, scalable to 127 points through Windows support. Two print modes – portrait for letters or landscape for spreadsheets. And industry-standard compatibility that lets you plug in and start printing.

All these features come in a conveniently compact printer that works as quietly and easily as printers twice the price.

So call **1-800-752-0900, Ext. 1911** for your nearest authorized HP dealer. You'll see that it doesn't cost much to make even dry documents look exciting.



# New Extras for Excel

Andrew Reinhardt

**M**icrosoft has given the latest release of its Excel spreadsheet the simple but evocative name "version 3.0." With such a name, you might wonder if the new Excel 3.0 will bask in the golden glow of Windows 3.0.

That vision, however, may be a bit grandiose: Excel 3.0 isn't as radical a change from its predecessor as Windows 3.0 was. But it does offer substantial new features that will strengthen Microsoft's position in the emerging battleground of Windows spreadsheets. With Informix Software's WingZ now available for Windows, and Lotus poised to deliver a Windows version of 1-2-3, Microsoft couldn't afford to rest on its lead in the graphical user interface (GUI) spreadsheet arena.

With some of the new capabilities in

Excel 3.0, Microsoft is merely playing catch-up, especially to WingZ, a competitor on the OS/2, Windows, and Macintosh platforms. For instance, like WingZ, Excel 3.0 now lets you place charts directly on the worksheet, rather than confining them to separate windows. It also supports three-dimensional graphics with user-definable rotation and perspective. And like Lotus 1-2-3/G, Excel now includes a Solver utility for multivariate goal seeking.

Some of Excel 3.0's capabilities set it apart from all its competitors. These include a new outlining feature, borrowed from the word processing world, that works surprisingly well. Excel also incorporates Microsoft's Object Linking and Embedding (OLE) technology and supports the direct manipulation of objects.

## Ease of Use

Despite the addition of several new features to Excel 3.0, Microsoft says that its primary design goal was to make the spreadsheet easier to use. A "ribbon" tool bar across the top of the screen, like the one in Word for Windows, offers shortcuts to common procedures such as cell formatting, outlining, and charting. Many actions have been made more intuitive by Microsoft's applying the rule that the mouse double-click is a gateway to more detail. And features like "best-guess" summing and user-definable styles and templates make building a model faster and easier.

Perhaps the most interesting of these features is Autosum, represented on the ribbon by an icon labeled with a Greek sigma. If you create a series of cells, highlight the next empty cell in the row or column, and then select Autosum, Excel will propose a formula that adds the

cells in the series. If Excel guesses correctly, you can accept the formula with a mouse-click; if not, you can quickly edit it. This is a much-needed shortcut for the most commonly used function in a spreadsheet.

Other icons let you call up drawing tools for adding lines, rectangles, and circles directly onto a worksheet or for creating a quick chart (by choosing a range of cells and letting Excel make a smart guess at the graph).

To lure dyed-in-the-wool Lotus 1-2-3 users to Excel, Microsoft includes a remarkable help system just for Lotus loyalists. By using the familiar slash key, 1-2-3 users can access the Help menu, which is available in two modes. In the demonstration mode, you enter 1-2-3 keystrokes (the Lotus menu tree appears in the Help dialog box), and Excel translates them into its own commands and carries them out for you while you watch. In instruction mode, the Excel equivalents of 1-2-3 sequences are listed in a brief summary note, which you can tear off and stick on your worksheet, just like a yellow Post-it note.

## Collapsing Complexity

Whether your worksheet contains a bill of materials or a balance sheet, chances are you have regions of cells that are subordinate to others; for example, months totaling into quarters or territories adding up to regions. Excel 3.0 lets you structure this information in an outline form so that you can choose the level of detail in which you wish to view your data (see the photo).

Up to eight layers of nested outlines are supported on both the horizontal and vertical axes. You can move from one level to another by clicking plus or minus icons (which can also be hidden) on the

## THE FACTS

**Excel 3.0**  
\$495

### Requirements:

For Windows 3.0: 286 or higher with 1 MB of RAM, a hard disk drive, and an EGA or better display; for OS/2 1.2: 286 or higher with 2.5 to 4 MB of RAM, a hard disk drive, and an EGA or better display; for the Mac: Mac Plus or higher with a hard disk drive and System 6.02 or higher

### Microsoft Corp.

1 Microsoft Way  
Redmond, WA 98052  
(206) 882-8080  
fax: (206) 883-8101  
Inquiry 976.

Version 3.0

for Windows 3.0, the Mac, and OS/2

features 3-D graphics, outlining,  
and a graphically impressive Solver

edge of the sheet. Or you can jump instantly from a fully exploded view that would, for example, display every row in your income statement to a completely collapsed view that would show only your company's bottom line.

Amazingly enough, you don't have to develop an outline from scratch: Excel can construct an outline automatically by analyzing the worksheet and looking for regions of cells that are added together. Even a Lotus 1-2-3 worksheet can be imported and restructured into outline form.

**Making the Link**

The most important innovation of Lotus 1-2-3 release 3.0 was its introduction of multipage 3-D spreadsheets, which are especially useful for consolidating similarly structured sheets into a master sheet. Microsoft has declined to add the same capability to Excel; instead, worksheets are maintained as separate files, and you can link cells by including a source filename and cell address in a formula.

To simplify the process of consolidating data, Excel 3.0 supports "name-based linking," in which connections are made not by cell address but by the name of a range. Therefore, you can link to a master sheet all references to "research expenses" in subsidiary sheets. Microsoft says that the direct-mapped linking of 1-2-3 can lead to mistakes if, for example, a cell used in a formula is deleted but the formula is not rewritten. Name-based linking can be more time-consuming to set up, but it is insensitive to the physical structure of source worksheets.

Excel 3.0 also supports a variety of external links. Through the clipboard, you can import text and graphics from other applications on a one-time basis. Using

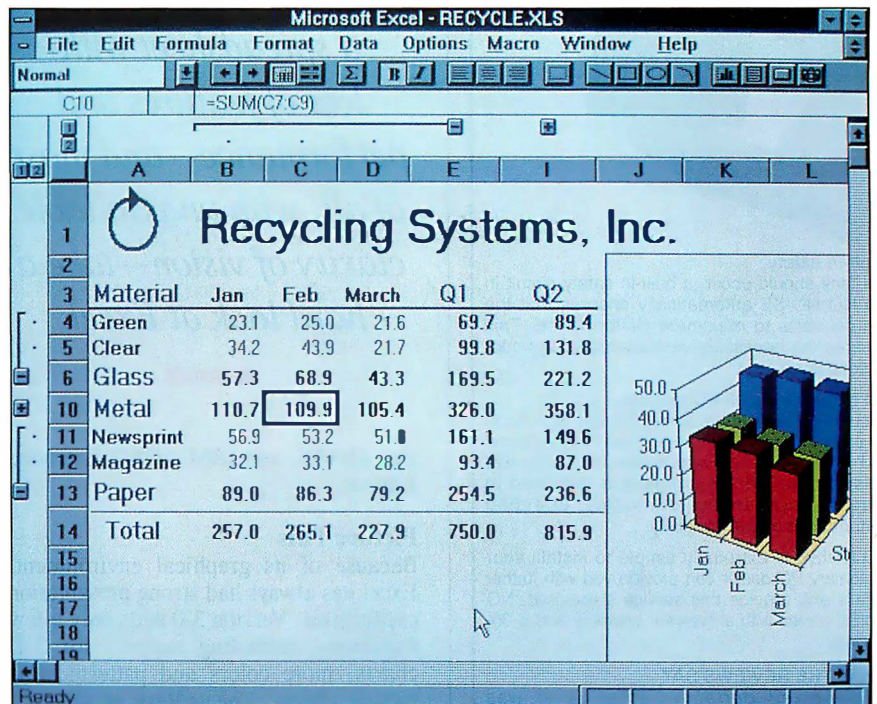

*Excel 3.0 has several new features. It lets you place charts directly on the worksheet (right); its "ribbon" tool bar (top) offers shortcuts to common procedures; and it has outlining symbols (shown at the left of the screen and below the ribbon). The plus icons indicate collapsed ranges (Q2 and Metal), while the minus icons show expanded ranges.*

## NO NOISE improves PC working environments.

**NO NOISE** removes the constant humming noise which is a daily irritation to PC operators.

It's not that the noise is high — it's more a matter of its constantly being there, from the moment you start up in the morning and until the office closes.

Constantly — for hours on end — day in and day out.

**This noise comes from the PC's cooling fan.**

The cooling fan is designed and constructed to function in air temperatures all the way up to 110°–120° F. It always runs at maximum speed. This is where the constant noise arises.

In our part of the world, we no longer need to put up with this irritating noise — thanks to NO NOISE.

**How to stop the noise.**

NO NOISE gradually reduces the speed of the fan until it corresponds with the surrounding temperature and your PC's cooling requirement. The fan is practically soundless at temperatures from 70°–90° F.

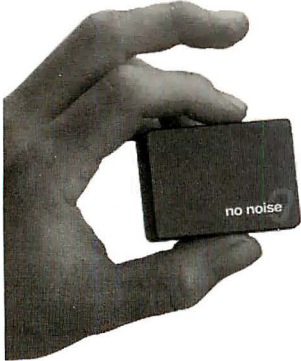

**Built-in safety**

If a fault should occur, a built-in safety circuit in the NO NOISE automatically ensures that the fan converts to maximum performance. This ensures the necessary ventilation/cooling under all conditions.

**NO NOISE suits all PC models.**

Thousands of units are already in use worldwide by computer manufacturers, major corporations and individual users, who realise that excessive noise in the work environment can lead to fatigue and stress, ultimately affecting performance and productivity.

NO NOISE is extremely simple to install; your customary PC dealer can provide you with further details and provide this service if required. NO NOISE comes with a five-year warranty and a 30-day trial.

**WHAT THE REVIEWS SAY**

"...it worked perfectly...noise level was dramatically reduced."

PERSONAL COMPUTER WORLD, U.K.

"...NO NOISE worked exactly as advertised, reducing fan noise to nil."

BYTE, International Section, February 1990

NO NOISE USA—NO NOISE UK—NO NOISE SWEDEN—NO NOISE AUSTRIA—NO NOISE NETHERLANDS—NO NOISE GREECE—NO NOISE AUSTRALIA



**ORDER NO NOISE NOW at \$99.95 by calling 1-800-SILENCE (1-800-745-3623)**

or contact your local dealer. We accept MC/VISA, P.O.s, Cashier and Personal Cheques. Please add \$4.95 for shipping and handling. All FL deliveries add 6% sales tax. VARS Dealers and OEMs call (407) 220-0100.

NO NOISE Inc., 3601 SE Ocean Blvd., Sewall's Point, Stuart, Florida 34996, Tel: (407) 220-0100 Fax: (407) 220-0101

©NO NOISE 1990

the Paste Link function, you can set up a dynamic or "hot" link to an external object, and any changes made to it in the source application will be reflected in Excel. And double-clicking on an object imported from a program that supports Microsoft's new OLE technology will bring up the program that created it.

To help connect spreadsheets to the world of servers and databases, Microsoft will bundle with Excel 3.0 a copy of Q+E, a query and edit utility developed by Pioneer Software. Q+E lets you use Excel as a front end to several databases, including Microsoft's SQL Server, Ora-

able goal-seeking. For example, you can maximize the value of one cell by changing the value of another, or you can jiggle a complex production plan with many variables and constraints to arrive at optimum profitability.

If you're a real power user, Microsoft's Solver offers a lot of flexibility and options. You can limit the amount of time or number of iterations used to achieve a solution, specify a level of precision, or constrain the Solver to a linear model. You can also customize the methods that the Solver uses, choosing tangential or quadratic extrapolation, forward or central differencing, and quasi-Newton or conjugate gradient searching.

By combining the Solver with graphics and Dynamic Data Exchange, Excel 3.0 lets you use a chart as a scratchpad for modeling. This feature is called Dragging Data Points: You create a chart, and then, by simply dragging graph points with the mouse, you can automatically change the numbers in the original spreadsheet that created it. If the point that you want to change is dependent on a formula, the Solver pops up automatically and asks you which variable you want to adjust.

### Many Products, One Vision

For the last several years, Microsoft has been steadily working to unify all its graphical software applications (whether intended for use on the Mac, Windows, or OS/2 Presentation Manager) so that they all look and behave the same way. The most recent versions of Word, for example, sport almost identical features across all platforms, and even the character-based version 5.5 has a new pull-down menu interface that uses the same commands as its GUI siblings. Besides trying to achieve consistency across many platforms for each application, Microsoft has also made different applications look the same; thus, Excel looks like Word, which looks like PowerPoint.

Excel 3.0 is the ultimate realization of this plan. As astonishing as it may seem, most volumes of the documentation are the same, whether for the Mac or an Intel-based platform. Microsoft has succeeded in making the hardware platform irrelevant, which is good news for users in mixed network environments. If you need a spreadsheet with lots of features and performance—and most of all, with unassailable clarity of vision—take a long, hard look at Excel. ■

*Andrew Reinhardt is BYTE's associate news editor in New York. He can be reached on BIX as "areinhardt."*

**I** f you need a spreadsheet with lots of features and performance—and most of all, with unassailable clarity of vision—take a hard look at Excel.

cle, dBASE, and IBM's OS/2 Extended Edition.

### Picture This

Because of its graphical environment, Excel has always had strong presentation capabilities. Version 3.0 adds only a few functions, including support for 3-D charts, more colors and patterns, and picture charts. The gallery of graphics options includes 3-D column, area, pie, and line graphs, all of which you can adjust for rotation, vertical viewing angle, and perspective.

Picture charts are graphs in which traditional bars or lines are replaced with images that you supply. Thus, for example, you could illustrate a chart of bakery sales with stacks of doughnuts.

### Solve Me a Riddle

The Solver and Backsolver in 1-2-3/G generated much excitement and were quickly copied by Lotus's competitors. Excel 3.0 is the first Windows spreadsheet to include these capabilities. You can use Excel's Solver, which is actually a separate application supplied with the spreadsheet, for single- or multiple-vari-

# Here's what they're saying about Ami Pro from Lotus.

Independent User Survey For Windows.<sup>TM\*</sup>

Word Processing Features	Ami Pro <i>for Windows</i>	Word for Windows	WordPerfect for DOS
Best Overall	50%	22%	16%
Ease of Learning	47%	28%	8%
Ease of Use	52%	23%	8%

\*Independently commissioned Windows word processor Usage and Attitude Study conducted November 1990

# Here's why th

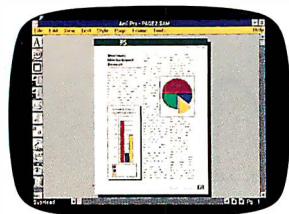

## WYSIWYG

No wonder Ami Pro™ for Windows™ is getting rave reviews from users.\* They're naturally impressed by its 360 powerful features. And even more impressed with how easy it is to use them. Ami Pro has everything you expect in a power word processor, plus important features you can't find anywhere else—like truly interactive WYSIWYG that lets you edit in any of four page views, including full-page view.

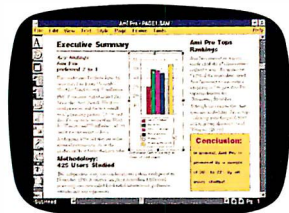

## FRAMES

Our exclusive "frames" feature lets you quickly place text and graphic elements where you want. Just position your frame anywhere on the page, then fill it with words, drawings or imported graphics. With a click of the mouse, your text automatically wraps around it.

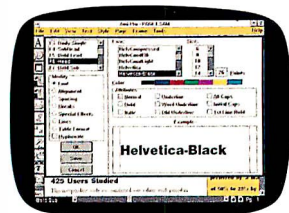

## DIALOG BOXES

Why settle for difficult programs that produce boring documents? Our friendly, interactive Dialog Boxes display all your layout options—and show you the results of commands before you execute them. So you can change your mind without wasting time.

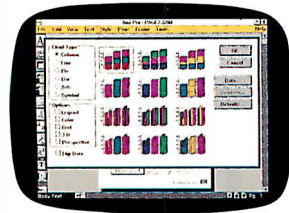

## CHARTS AND GRAPHS

In addition to a built-in drawing feature, Ami Pro instantly generates 168 varieties of presentation-quality charts and graphs, including 2-D, 3-D and perspective. Just type in the data, or import your chart information from programs like Lotus® 1-2-3.\*

**BRS**

MEMORANDUM

To: Lotus Development Word Processing Division

From: BRS Research Services, Inc.

November 5, 1990

**BRS**

### User Study Matches Expert Reviews

User preference research findings have an uncanny resemblance to what word processing and technology experts have been saying all along: Ami Pro is the new standard for word processing in the Windows environment.

The Software Digest rating, for example, places Ami Pro well above Microsoft's Word for Windows and WordPerfect in terms of overall performance.

The user research shows similar results. Ami Pro consistently outranked Word for Windows and WordPerfect in terms of

**BRS**

### USER PREFERENCE FOR WORD PROCESSORS

#### Executive Summary

**Key findings:**  
**Ami Pro preferred 2 to 1**

Users prefer Ami Pro from Lotus more than 2 to 1 over Microsoft Word for Windows and WordPerfect.

Half of the users studied ranked Ami Pro as the "Best Overall Windows word processor and overall word processing product." 51.9% said Ami Pro was easier to learn than Word for Windows and WordPerfect; 47.3% said it was easiest to learn.

A whopping 63% said they were extremely enthusiastic about the product or like it better than other word processors.

**Methodology:** 400 users. This independent study was conducted in November, 1990. A random sample of word processing users were called and their attitudes and user experience were measured.

Product	Overall Evaluation Score
Ami Pro	79.5
Word for Windows	72.5
WordPerfect	76.5

**Easiest to learn**

\*Study results and complete questionnaire available by writing Booth Research Services, Inc., 1120 Hope Road, Suite 200, Atlanta, GA 30350. Enclose \$100 plus \$3.00 shipping and handling.

# They're saying it.

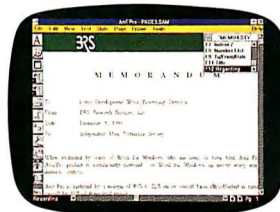
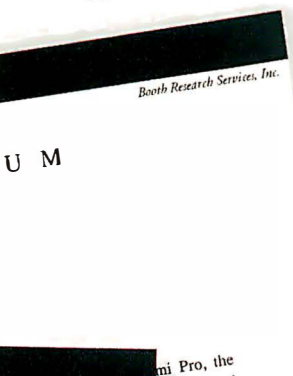

## STYLE SHEETS

Ami Pro comes with more than two dozen style sheets that have the page layout already set up and ready to go. So you can produce professionally designed business letters, memos, reports, presentations, newsletters and more—in just the time it takes to type in text.

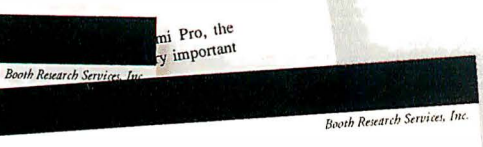

## REFERENCE STUDY: CHOSSING FOR WINDOWS

### Ami Pro Tops Rankings

Ami Pro came out on top on nearly all of the 17 characteristics ranked by users. An impressive 51.9% of the respondents rated Ami Pro easiest to use, while a whopping 56.5% gave Ami Pro top consideration for "Formatting Flexibility".

Although not cited in this chart, users also ranked Ami Pro as tops in desktop publishing (60.3%), and in getting the most out of Windows (41.2%).

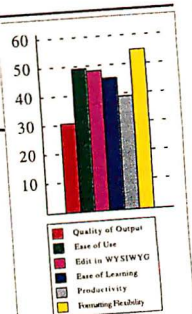

### Conclusion:

In general, Ami Pro is preferred by a margin of 50% to 22% by all users studied.

Users Studied: over a three week period of more than 1,000 word ed interviews on preference.

### FEATURES COMPARISON

Features	Ami Pro	Word for Windows	WordPerfect 6.1
Interactive WYSIWYG	Yes	Yes	No
On-Screen Font and Attributes	Yes	Yes	No
Auto Text Wrap Around Graphics	Yes	No	Yes
Editable View Levels	Yes	No	No
Global Style Sheets	Yes	No	No
Thesaurus Offers Word Meanings	Yes	Yes	No
Visual Dialog Boxes	Yes	No	No
Internal Chart Generation (10 Types)	Yes	No	No



## EXPERTS AGREE

It's easy to see why users prefer Ami Pro from Lotus two to one over Microsoft® Word for Windows™ for overall features and ease of use. And why it's received top ratings from virtually all the industry experts, racking up such coveted awards as PC World's Best Buy. The Buyers Assurance Seal from InfoWorld. And PC Magazine's Editor's Choice.

"Ami Pro received a score in Ease of Use of the User Interface that was fully 10 points higher than the next highest score, and came in 14 points ahead of the score WordPerfect™ 5.1 drew from its buyers," according to PC Week's Corporate Satisfaction Poll.

PC Magazine says, "Ami Pro has the friendliest interface and the widest range of functions... [It] is easier to use than almost any program with comparable powers."\*\*

Ami Pro is the word processing program that takes full advantage of the Windows environment, combining power word processing with the power to create professional documents fast. And with its icons and interactive features, Ami Pro is incredibly easy to learn and use. So what do you say? You've just learned about five major Ami Pro features.

Now to find out about the other 355—and how to get a free working model—turn the page.

\*\*Reprinted from PC Week July 2, 1990. PC Magazine Dec. 11, 1990. Copyright ©1990 Ziff Communications Company.

# This says it all.

## Automatic Backup Automatic Timed Save Block Manipulation Bookmarks

- Named By User • Go To
- 3D Charting • Edit Chart with Draw Tools
- Legends • Multiple Styles Per Type • 7 Chart Types

## Copy Text and Graphics Cursor Movement

- Begin/End of File • Character • Line • Page
- Paragraph • Sentence • Top/Bottom of Screen • Word

## Customizable Icon Bar

- Choose From Over 45 Functions • Quick Access to Features

## Customizable View Level

- 10-400% • Fully Editable

## Cut and Paste Date Insertion

- Today's Date • Date Printed • Date Last Edited • Definable Style

## DDE (Dynamic Data Exchange)

- Two-way • Paste Link • Text and Graphics
- Via Macro Language

## Defaults

- Backup Options • Date Styles • Dictionary Paths • Display Options • Document Path
- Draft Mode Colors • Footnote Options
- Hyphenation Hot Zone • Pair Kerning • Printer
- Icon Bar Icons • Undo Levels • View Level

## Delete Dialog Boxes

- Notes • Show/Hide • Go To Notes • Date/Time Stamp • Stacked Notes

## Document Descriptions

- Author Name • Operator Name • Revision Number • Creation Date • Revision Date
- Renameable Fields • User Defined Fields
- Display with Directory • Print with Document

## Drawing

- Cut/Paste Objects • Circles • Arcs • Squares
- Rectangles • Rounded Boxes • Diagonals
- Polygons • Polylines • Group Objects
- Snap To Grid • Fill Patterns • Line Widths
- Text Rotation • Type Text

## File Import/Export

- Advance/Write • ASCII • DBase • DCA Final Form • DCA Reversible Form • DIF • E-Mail
- Enable • Lotus WKS, WK1, WK3 • Microsoft

- Word • Microsoft Word for Windows • Multi-mate • Navy DIF • Peachtext • Rich Text Format • Sama Word • Windows Write
- WordPerfect • WordStar • Wordstar 2000

## File Management Functions

- Copy • Rename • Delete • Move • Sorted File Listing

## Font Control

- Unlimited Number of Fonts • WYSIWYG
- Limited Only by Printer

## Footnotes

- Auto Numbering • Bottom of Page • Endnotes • Number Style Option • Reset Number Option • Separator Line

## Forms Capability

- Format Complicated Forms • Fill-In-On-Screen
- Print on Preprinted Form • Protect Areas

## Frames

- Anchor to Text • Auto Text Wrap Around
- Background Shade • Contain Text or Graphics • Fixed Position On Page • Lines Around • No Text Wrap Around • No Text Wrap Beside • Overlay Frames • Repeat on Multiple Pages • Resize Frames

## Glossary

- Large Record Size • Speed Key Access

## Go To

- Any Page Number • Fast Next Item Access
- Go To Frame, Footnote, Note, Various Marks in Document

## Graphics Control

- Edit PIC Files • Drop Anywhere on Page
- Float Graphic w/Text • Place in Box • Proportional Scaling • Fit in Frame • Rotate in Single Degree Steps • X-Y Scaling • Gutter/Binding Margins

## Graphics Import

- CGM • EPS • HPGL • Lotus PIC • PCX
- TIFF • WMF

## Hard Space Headers/Footers

- Alternating • Floating

## Help

- CBT Tutorial Available • Context-Sensitive
- Indexed • Point & Shoot • Hypertext Linked
- Full Macro Documentation On-Line

## Hyphenation

- As-You-Type • Soft Hyphen • Consecutive Hyphen Control • On Paragraph Basis • Hot Zone

## Image Processing

- Control Brightness, Contrast of Scanned, Gray Scale TIFF Pictures • Sharpen Edges

## • Smoothing • Invert Image Index Generation

- Generate from List • Mark in Text • Multiple Level Indexing • Hyper Links from Index Back into Document

## Insert/Typeover Kerning

## Line Numbering Line Spacing Control

- Macros/Programming Language
- On-Line Macro Documentation • Record/Play • Assign to Function Key • Assign to Menus • Create Menus • Variables • If • Go To Statements • Case Statements • For/Next
- Prompt for Input • Subroutines

## Math Calculations Measurements

- Centimeters • Inches • Picas • Points

## Merge

- From ASCII Files • From Comma Delimited Files • From DIF Files • From WK\* Files • From dBase Files • From Ami Pro File • Label Print Function • Preview Before Print • Three-Level Boolean Conditional Record Inclusion

## Open Multiple Documents Page Breaks

- Manually Inserted • With Paragraph Style

## Page Formatting Control

- Margins • Page Size • Snaking Columns
- Line Around Page • Line Between Columns
- Portrait/Landscape

## Page Numbers

- Any Location on Page • Reset Page Number
- Five Formats for Number

## Paragraph Styles

- Quick Access with Styles Box • With Function Key • Controls: Font, Alignment, Spacing, Page Breaks, Ruling Lines, Bullets, Numeric Format in Table, Hyphenation

## Printing Color Print Options

- Over 130 Printers Supported • Number of Copies • Page Range • Reverse Order
- Collate • Print Document Description • Crop Marks • On Preprinted Form • Printer Bin Control for First/Rest Pages • Portrait or Landscape

## Real-Time Pagination Revert to Saved Version Search and Replace

- Case Insensitive • Forward or Backward
- Header/Footer/Footnote • Skip • Replace

- Replace All • Search for Style • Search by Attribute • Wildcards

## Section Outline Numbering

- 6 Levels • Number Paragraphs • Numbered Lists • User-Defined Reset

## Snaking Columns

- Up to 8 Columns • Column Balancing • On Screen • Variable Width • Variable Spaced

## Sort

- Alphabetic • Numeric • Ascending • Descending • By Paragraph • By Word • By Number of Lines • 3 Levels—3 Words Within each Level

## Spelling Check

- 130,000 Word Dictionary • Add to Dictionary
- Correct Multiple Occurrences • Entire Document • Selected Text • International Dictionaries • Rest of Document • Skip All Occurrences • Statistics Report • Unlimited User Dictionary Size

## Status Line

- Column Number • Document Name • Insert/Typeover • Line Number • Page Number

## Style Sheets

- 27 Professionally Designed • Control All Formatting in Document • Document-Only Styles • Global Styles

## Tables

- Up to 256 Columns • Column Width Control
- Row Height Control • Auto Row Height
- Lines around Cells • Shaded Cells • Connected Cells • Formulas: Four-Function Math, Sum Function, Absolute/Relative Cell Address
- Insert Rows and Columns • Numeric Alignment and Formatting

## Table of Contents

- 3 Levels • Separator Choice

## Tabs

- Center • Leader Dot • Left • Numeric • Right

## Text Enhancements

- Bold • Double Underline • Initial Caps • Italic
- Lowercase • Overstrike • Small Caps • Subscript • Superscript • Underline • Uppercase
- Word Underline

## Thesaurus

- 1.4 Million Alternatives • Definitions • Gives Inflections • Synonyms

## Undo

- Four-Level • Customizable

## Unlimited Document Size Vertical Centering Widow/Orphan Control Word Count

Call 1-800-831-9679 for your free working model of Ami Pro.

With all these advanced features, you couldn't ask for a more powerful or easier to use word processor than Ami Pro. But you could ask for a free fully functional working model\*—just by dialing our toll-free number.

Slip it into your PC, and experience the power of a serious word processor, plus built-in graphics you won't find anywhere else. Even if you don't have Windows yet, our working model with its own Windows driver will show you what you're missing. So call 1-800-831-9679 now.

Ami Pro™ for Windows™  
from  
Lotus®

Lotus Word Processing Division, 5600 Glenridge Drive  
Atlanta, GA 30342, 800-831-9679, 404-851-0007

\*Lacks some features including thesaurus, spell checker and ability to save files. InfoWorld's Buyers Assurance Seal awarded August 13, 1990 to Ami Pro 1.2.  
© 1991 Lotus Development Corporation. All rights reserved. Lotus and 1-2-3 are registered trademarks of Lotus Development Corporation. Ami Pro is a trademark of Samna Corporation, wholly owned subsidiary of Lotus Development Corporation. Microsoft is a registered trademark and Windows is a trademark of Microsoft Corporation. WordPerfect is a registered trademark of the WordPerfect Corporation.



# OS/2 Goes on a Diet

**W**hen IBM announced OS/2 1.3 last October, many people immediately dubbed it OS/2 "Lite" because of its claimed ability to do more, faster, with lower RAM and hard disk drive requirements. IBM, of course, isn't into cute product names. The product that appeared on my desk in December is officially named OS/2 SE (for Standard Edition) 1.3. In many ways, it is OS/2 Lite. But as far as features and abilities are concerned, OS/2 1.3 is no lightweight.

In its latest incarnation, OS/2 has been trimmed down to go one-on-one with Windows 3.0. It is an ironic situation indeed. After all, Microsoft developed OS/2. But the Redmond software mavens have all but abandoned OS/2 as the orders and bucks roll in for Windows 3.0. IBM isn't hitching a ride on the Windows bandwagon. The changes made to OS/2 for version 1.3 come from the coding wizards at IBM. And it's obvious that Big Blue isn't going to give up on OS/2 despite its lack of market acceptance (at least, so far).

## Red Herrings and Other Fish

Ever since its introduction, OS/2 has been the operating system that users love to hate. Admittedly, it was pushed on a market that was largely quite happy with DOS. OS/2's early versions were slow and buggy and used huge amounts of RAM and hard disk space. More important, that nifty-looking Presentation Manager (PM) interface lacked the all-important applications that made it viable. Fortunately, all that has changed, but the perceptions haven't—yet.

The realities of operating environments for the 1990s often seem to depend on marketing pressures and user prejudices rather than technical details. OS/2 was widely criticized for requiring a minimum of 4 megabytes of RAM. True enough. But at the same time, Windows 3.0 users have been finding that while the graphical user interface runs in a 286-based system with a single megabyte, you really need at least 2 MB and, ideally, more. With retail prices for a megabyte of RAM hovering in the \$50 range, the whole thing is a red herring. The bottom line is that both Microsoft and (especially) IBM want you to buy hardware. And getting the most from

## Big Blue targets

Windows 3.0 with a leaner, meaner, and faster version of OS/2



Stan Miastkowski

Windows and OS/2 often requires updated hardware.

## A Little Horse-Trading

OS/2 indeed drops your basic system RAM requirements from 4 MB to 2 MB. That opens up a large potential market of lower-capacity systems for OS/2. Of course, there's a performance price to pay. Like Windows 3.0, OS/2 1.3's multitasking makes extensive use of *swap-*

*ping*. In the \OS2\SYSTEM\ directory sits a deceptively small (1572-byte) program named SWAPPER.EXE. The swapper, along with numerous (although not-so-obvious) changes to the core operating-system code, is the key to OS/2 1.3's smaller memory needs and faster performance.

OS/2 1.3's swapper is faster and more intelligent than its predecessors. It is essentially a system resource controller that makes sure that the maximum amount of RAM is available for applications. OS/2 1.3 requires less RAM because the swapper moves unneeded operating code into a hard disk file. Swapper also keeps the DOS Box code sitting on the hard disk until you double-click on the icon.

During setup, OS/2 1.3 (as did earlier versions) creates space for a SWAPPER.DAT file on your hard disk that has a maximum size of 512K bytes. If you have a large hard disk, you can specify a swap file as large as you want. But there's a trade-off: Making the file larger can improve system performance, but making it too large can also degrade performance; it takes longer to write data into or read data from a huge file.

It was easy to see that OS/2 1.3 kept

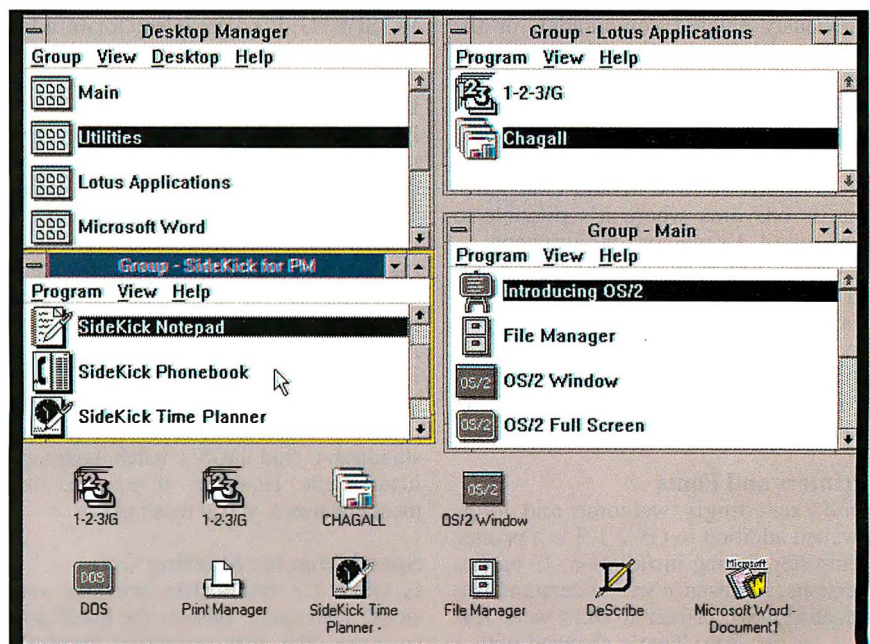

OS/2 1.3's lower memory requirements let you run many applications concurrently.

my hard disk drive from sitting idly by. In fact, the amount of hard disk file swapping is truly amazing. But since OS/2 is a true multitasking operating system, the dancing red light on my hard disk drive didn't adversely affect overall system performance.

What is the bottom line of RAM requirements? If your system has 2 MB of RAM, you can easily run OS/2 1.3 and at least two major applications.

### Getting Up and Running

Setting up OS/2 1.3 takes time and patience. Some of the more irksome parts of the process have been eliminated, and a few new features have been added. The biggest decision that I had to make was whether to use OS/2's High Performance File System. If you're installing OS/2 on a hard disk that already has DOS on it and you want to run the *dual boot* feature (i.e., starting either DOS or OS/2 at boot time), you'll have to forgo the HPFS. But if you can forgo booting DOS, the HPFS is the only way to go. Although it's not new in version 1.3, it remains one of OS/2's hidden gems. The HPFS is fast, using on-the-fly location optimization and integrated disk caching to dramatically improve overall performance. It's like having one of those expensive hardware-caching disk drive controllers hooked up to your system.

Also new in OS/2 1.3 is *selectable setup*. Unlike the previous OS/2 setup utilities, 1.3 didn't ask me whether it should add serial-device support, retrieve-command support (a quick way of recalling previously entered commands), or the command reference help. Instead, it assumed that I wanted all these features. I was given the choice of disabling them later on when the setup utility asked me if I wanted to use the default configuration or customize it. The default configuration is one area where it's possible to fine-tune 1.3's memory requirements.

OS/2 is a hard disk space hog. It needs 11 MB of storage for a full-fledged installation. If your hard disk space is tight, you can forgo a few features (like the command reference). But you still need 8 MB of hard disk space for a minimum configuration.

### Printers and Fonts

One exceedingly welcome and long-awaited addition to OS/2 1.3 is a printer setup step during installation. In earlier versions, its absence was understandable because OS/2 printer drivers were few and far between. That's changed with a vengeance; OS/2 1.3 supports nearly 100 printers, along with a couple dozen

## THE FACTS

### OS/2 SE 1.3

\$340; upgrade from prior versions, \$100; upgrade from DOS 3.0 or higher, \$285

#### Requirements:

IBM AT, PS/2, or compatible with at least 2 MB of RAM and between 8 and 11 MB of free hard disk storage.

### IBM Corp.

U.S. Marketing and Services  
1133 Westchester Ave.  
White Plains, NY 10604  
(800) 426-2468  
(914) 642-3000

#### Inquiry 977.

plotters. And it's not just IBM printers that are supported. The list is quite long and complete.

Most important for serious users, OS/2 1.3 now comes with full-featured drivers for the Hewlett-Packard LaserJet (all flavors) and PostScript printers. It's in the PostScript realm that OS/2 1.3 really shines. In the spring of 1990, IBM decided to implement Adobe font technology across its entire product line, and OS/2 1.3 is the first to see the fruits of this decision. OS/2 1.3 includes Adobe Type Manager, which has twelve "core" scalable outline fonts that come in matching screen and printer flavors. If you're using a PostScript printer, you get true WYSIWYG. It's a great leap forward for OS/2.

### REXX the King?

For advanced users, another feature new to OS/2 1.3 is REXX. REXX isn't new but has been confined to IBM's mainframe and minicomputer markets. It's a general-purpose procedural language that Big Blue has designated as the standard language for developing interpreted procedures for all Systems Application Architecture systems, which means all IBM products. Essentially, REXX is a sophisticated batch language that offers a myriad of features for those who (understandably) find DOS's batch language insufficient. However, if you are like most end users, you'll never use it.

### Speed from the Starting Gate

Is OS/2 1.3 faster than previous versions? Definitely. Besides the intelligent swapper, the core operating system's crucial loader has been completely rewritten. It can now load data in larger

blocks than its predecessors, resulting in fewer I/O cycles. Also new is IBM's implementation of the previously unused data-compaction abilities of OS/2. Taken together, it means faster performance.

How much faster? IBM says that in a "memory-constrained environment" (meaning 2 MB), file accesses are "significantly faster" than in previous versions of OS/2. Using a relatively wimpy 20-MHz 386-based AT clone with a fast (15-millisecond) hard disk drive, I found an overall performance increase over OS/2 1.2 of from 25 percent to 40 percent using standard OS/2 applications, such as Lotus 1-2-3/G and the DeScribe Word Publisher; your mileage may vary.

According to IBM, OS/2 1.3 is even faster in network access. I wasn't able to test the claims, but an IBM spokesperson told me that it now loads programs off a network server "two to three times faster" than version 1.2.

### Tying It All Together

After several false starts and disappointing incremental upgrades (punctuated by a few public spats between IBM and Microsoft), OS/2 is finally an integrated and complete product. It took IBM to do the job. Version 1.3 is remarkably stable and bug-free. I used it with a wide range of the increasingly available OS/2 applications and threw it curves by opening multiple copies of the same application. Even with a dozen programs open and running concurrently, OS/2 never even flinched; I encountered no incomprehensible error messages or system hang-ups. The same can't be said for Windows 3.0. OS/2 remains the only *true* multitasking environment.

There are realities that can't be overlooked. Sure, you can run OS/2 1.3 in a system with 2 MB. But if you want to get some real work done with several different applications, you're better off with 4 MB or more. The same can be said about Windows 3.0.

The battle isn't over yet. By now, it's clear that OS/2 isn't going to take the operating-system market by storm. But the argument that it does not work, lacks printer drivers, or uses too many system resources is now moot. It still has a long way to go to overcome the Windows 3.0 juggernaut, but unlike Windows (which is cobbled onto a now-ancient operating system), OS/2 SE 1.3 along with PM is a next-generation integrated operating environment. ■

*Stan Miastkowski is the BYTE senior editor for new products. You can reach him on BIX as "stanm."*

# WHAT IS THIS SMALL BOX ?

## A UNIX HOST!

## A LAN SERVER!

## A WORKSTATION .....

9.4 inch



The Carry-I 9300 80386SX, 4M-byte RAM, 80M-byte Harddisk,  
One Expansion Slot, VGA...

Carry-I -the World's First & Original Book-Size Desktop Computer

The Carry-I 9000 series comes complete with 80386SX/80286-16/80286-12 microprocessor (Co-Processor optional), 1024x768 VGA/MGA & CGA display interface, 1/2/4 MB RAM, one 3.5" 1.44 MB FDD or one FDD plus one 40/80 MB HDD, one 8 bit expansion SLOT, one parallel and two serial I/O ports, and one 30W auto range switching power adapter, all in the traditional 240mm x 185mm x 45mm (9.4" x 7.3" x 1.8") casing of Carry-I. Each package includes two mini-tower stands and a carry bag. The 82 key mini keyboard and 9 inch color or monochrome VGA monitor are optional.

Other Carry-I products include the 8000 series XT & AT book-size personal computers and the 6000 series XT and AT book-size LANstations, ETHERnet pocket LAN adapter and Carry Mouse.

#### DISTRIBUTOR:

• CANADA: BUDGETRON INC. TEL# 416-564-7800 FAX# 416-564-2679 • FRANCE: M3C L'INFORMATIQUE DU SUCCES TEL# 1-48271976 FAX# 1-42355916 • HONG KONG: PARKLY TECHNOLOGY LTD. TEL# 852-3051268 FAX# 852-7968427 • ISRAEL: MLL COMPUTERS SYSTEMS LTD. TEL# 3-7515511 FAX# 3-7516615 • ITALY: PRIMA COMPUTER TRADING ITALIA TEL# 522-518599 FAX# 522-518599 • MALAYSIA: COMMUNICATION TECHNOLOGY SDN. BHD TEL# 03-2748888 FAX# 03-2749988 • NETHERLAND: KOPIEERSYSTEMEN NEDERLAND B.V. TEL# 2968-84141 FAX# 2968-97436 • NORWAY: SECUS DATA A/S TEL# 2-722510 FAX# 2-722515 • SINGAPORE: TRANSHIKO PTE LTD. TEL# 4758408 FAX# 4713803 • SOUTH AFRICA: PC MART COMPUTER GROUP TEL# 11-8043355 FAX# 11-8024153 • SPAIN: AT ELECTRONIC S.A. TEL# 1-5645434 FAX# 1-4110869 • SWITZERLAND: ESS SOFTWARE TRADING SA TEL# 022-622020 FAX# 022-615650 • UNITED KINGDOM: CENTERPRISE INTERNATIONAL LTD. TEL# 256-463754 FAX# 256-843174 • WEST GERMANY: MACROTRON AG TEL# 89-4208233 FAX# 89-423745 • BELGIUM: CELEM S.A. TEL# 41-676434 FAX# 41-676515

## CARRY-I

A Refreshing Idea....  
A New Standard....  
Computing Goes Better With CARRY-I



FLYTECH TECHNOLOGY CO., LTD.  
HEAD OFFICE:  
2FL. NO. 8. LANE 50. SEC. 3. NAN-KANG  
RD. TAIPEI TAIWAN R.O.C.  
TEL# 886-2-7852556 FAX# 886-2-7852371.7837970  
W.G.:  
TEL# 49-69-746081 FAX# 49-69-749375

Bundled  
with  
**DR DOS**

U.S.A.:  
TEL# 1-408-7277373/4  
FAX# 1-408-7277375  
H.K.:  
TEL# 852-3051268  
FAX# 852-7968427

Circle 86 on Reader Service Card

Could it be that the fastest way to



© 1990 LIBREX COMPUTER SYSTEMS, INC.

**286/386sx notebook computers**

**[800] 248-4880**

corner office is no office at all?



**Librex**<sup>™</sup>

THE FREEDOM OF ONE.

Circle 299 on Reader Service Card (RESELLERS: 300)

# Perfectly Portable

## 15 notebook computers push the state of the art

Stanford Diehl, Stan Wszola, and Michael Nadeau

**P**ortable computing has come a long way since the debuts of the Osborne 1 and the Compaq Portable 10 years ago. As advancing technology has increased power and decreased form factors, portables have given way to laptops and now to notebooks—computers that weigh less than 8 pounds and are no bigger than their namesakes.

The original portables are to the notebooks what Ford's Model T is to the modern automobile. The newest notebook computers weigh less than one-fifth as much as the first portables and hold up to 10 times as much RAM—all for a price not much more than that of the original Compaq Portable.

These are exciting times for purchasers of notebook computers. The latest models are lighter, smaller, and more powerful and have better displays than ever before. We've sorted through the many notebook computers, and our report on the 15 we reviewed should help you pick the machine that best meets your needs. The features table on page 150 describes each notebook in detail. We've also created a new set of benchmarks for testing the notebook computers, including BYTE's new battery-life test (see the text box "From the Testing Notebook" on page 152). The benchmark results appear in the figure. Finally, because choosing a notebook computer is also a matter of personal preference, we have included subjective comments on our experiences using the

machines in the office and on the road.

The 15 notebook models BYTE reviewed are the Compaq LTE/286 and LTE 386s/20; the Texas Instruments (TI) TravelMate 2000 and its sister machines, the CompuAdd Companion and the Sharp PC-6220; the Grid 1810; the NEC UltraLite 286V; the Sanyo MBC-17NB and two identical machines, the Ogivar Internote 286 and the Zeos Notebook 286; the Tandy 1500 HD; the Toshiba T1000LE and T1200XE; the Zenith MinisPort HD; and the Psion MC-600.

All these machines measure no more than 12.4 by 11 by 2.2 inches, weigh less than 8 pounds, and have 20-megabyte or larger hard disk drives. They accept at least 1 MB of memory, support EMS memory, run on batteries, and operate under PC-DOS or MS-DOS. The Psion MC-600 notebook computer didn't meet all of our criteria but has some unique features that may make it worth considering (see the text box "Psion's Notebook with Flash" on page 154).

### Since You Asked . . .

To better understand what BYTE readers consider most important in selecting a portable computer, we sent out over 1000 survey forms asking subscribers for input. Notebooks have a strong allure: Almost 60 percent of those replying said they're thinking of buying a notebook computer this year.

We also asked what features they consider most important in a notebook computer. Not surprisingly, minimal size and weight topped the list. Most of those responding wanted *both* hard and floppy disk drives, and they ranked battery life as the next most important factor. Then came low price, good performance, VGA graphics capability, and durability. Much to our surprise, only 20 percent of the respondents thought that keyboard quality was a major issue. We disagree. Even if you are not a touch-typist, you'll find it tiring to use a cramped keyboard with undersized keys, short key travel,

and many function-key overlays.

Our recommendations reflect our experiences with the 15 notebook computers in this review, weighted against the criteria that readers defined as most important. (For a quick synopsis of what to look for when you decide to buy, see the text box "Choosing a Notebook Computer" on page 159.)

### Rating the Features

Desktop machines have become commodity items, but notebook computer designs and the features offered vary considerably. Here are some key factors that differentiate these machines.

*Size and weight.* All the notebook computers in this review fit in a standard-size briefcase, but some took up more room than others. In any case, when you throw in an AC power supply, an external floppy disk drive, floppy disks, and a manual or two, there isn't room in your briefcase for much more.

The same goes for the notebooks' weight, which ranges from 7.9 pounds for the Toshiba T1200XE down to 4.4 pounds for the TI TravelMate 2000. The relatively heavy T1200XE is easy to carry by itself, but when you add a power supply, a spare battery, and any other peripherals that you need, the total weight averages out to several pounds more.

*Power.* Battery life is the great limiting factor for all portables. For notebook computers, it's even more of a problem, because the battery must be proportional in size to the other components. A large battery gives you more computing time but adds extra weight and bulk.

All the computers we tested run on nickel-cadmium batteries, which provide a steady voltage and can be recharged quickly. Their only major disadvantage is that you must fully discharge them before recharging. If you don't, such batteries develop a "charge memory" that cuts battery life. Recent advances have minimized this problem, but a number of notebook computer manufacturers still



NOTEBOOK FEATURES

Notebook computers differentiate themselves more on features than on performance. Size, weight, and pricing are important, but don't forget to check expandability, display and keyboard quality, and battery life. Zeos's Notebook 286 received high marks in all these areas.

Computer	Compaq LTE/286	Compaq LTE 386s/20	CompuAdd Companion	Grid 1810	NEC UltraLite 286V	Ogivar Internote 286	Psion MC-600
<b>Processor/speed (MHz)</b>	80C286/12	386SX/20	80C286/12	V20/10	80C286/12	80C286/12.5	80C86/7.68
<b>Math coprocessor</b>	80C287	80387SX	80C287	None	None	None	None
<b>Memory (min./max.; MB)</b>	640 KB/2.6	2/10	1/3	1/2	1/5	1/5	768 KB
<b>Memory upgrades user-installable?</b>	Yes	Yes	Yes	No	Yes	No	Yes
<b>System unit</b>							
Dimensions (inches; L,D,H)	11 x 8.5 x 1.9	11 x 8.5 x 2.2	11 x 8.5 x 1.4	12 x 10.4 x 1.8	12.2 x 9.6 x 1.7	12.3 x 10 x 2	12.4 x 8.9 x 1.9
Weight (pounds)	6.9	7.5	4.4	6.7	6.5	6.6	4.9
<b>External power supply</b>							
Dimensions (inches; L,D,H)	5.2 x 2 x 3.2	5 x 2 x 3	6.5 x 1.4 x 3.5	6.2 x 2.1 x 3.1	6.7 x 1.6 x 4.3	8.1 x 2.2 x 3.3	None
Weight (pounds)	0.9	0.9	0.9	1.5	1.6	1.38	—
<b>Keyboard</b>							
Number of keys	80	80	79	81	78	82	84
Detachable keyboard?	No	No	No	No	No	No	No
Key travel (mm)	2	2	2	3.5	2	3.5	3.5
<b>Display</b>							
LCD type	Backlit	Sidelit	Backlit	Backlit	Backlit	Sidelit active matrix	Nonbacklit
Graphics resolution (maximum) in pixels	640 x 200CGA	640 x 480 VGA	640 x 480 VGA	640 x 400 EGA	640 x 480 VGA	640 x 480 VGA	640 x 200 CGA
Gray scales	4	16	16	12	16	32	8
Viewable screen area (inches; W x H)	8 x 4	7.2 x 5.4	8 x 6	8.5 x 5.3	8 x 6	7.5 x 5.75	8.5 x 5.5
<b>External video port?</b>	Yes	Yes	Optional	No	Yes	Yes	Optional
<b>Internal hard disk drive</b>	20-MB Conner	30-MB Conner	20-MB PrairieTek	20-MB Conner	20-MB PrairieTek	20-MB Conner	1- to 8-MB flash EPROM
<b>Floppy disk drive (size/capacity)</b>	3½/1.44 MB	3½/1.44 MB	3½/1.44 MB (external option)	3½/1.44 MB (external option)	3½/1.44 MB (external option)	3½/1.44 MB	3½/1.44 MB (external option)
<b>Battery type</b>	Nickel-cadmium	Nickel-cadmium	Nickel-cadmium	Nickel-cadmium	Nickel-cadmium	Nickel-cadmium	Nickel-cadmium or alkaline
Claimed battery life (hours)	3½	3	2	2	2½ (2 batteries)	2	12 (nickel-cadmium); 20 (alkaline)
Battery recharge time (hours)	8	1½	2	12	4 (2 batteries)	1	14 (nickel-cadmium)
<b>Device ports</b>							
Serial	1	1	1	1	1	1	1
Parallel	1	1	1	1	1	1	1
<b>Expansion options</b>							
Internal modem	2400 bps	2400 bps	2400/4800 bps data/fax	2400 bps	2400 bps	2400 bps	2400 bps
RAM disk?	No	No	No	No	No	No	Yes
Expansion chassis?	No	Yes	Yes	No	No	No	No
<b>Bundled software (DOS, utilities in ROM):</b>	Utilities	Utilities	DOS 4.01	DOS 3.3 and Lap-Link in ROM	DOS 4.01	DOS 4.01	DOS 3.2 and Lap-Link III in ROM
<b>Warranty (years)</b>	1	1	1	1	1	1	1
<b>FCC Class B certification?</b>	Yes	Yes	Yes	Yes	Yes	Yes	Yes
<b>Price<sup>2</sup></b>	\$3499	\$6499	\$2895	\$2895	\$3699	\$2999	\$2995

<sup>1</sup> Optional second battery extends operating time to 5 hours.

<sup>2</sup> Prices reflect basememory and storage configuration.

recommend that you discharge the battery fully before recharging.

Most notebooks will run on batteries for 2 to 3 hours, depending on how you use them. Heavy use of the hard disk drive, keeping the backlighting on maximum brightness, or using an internal modem quickly reduces battery life.

All the notebooks feature power-conservation options that let you set inactivity time-outs for one or more subsystems. If there is no activity on the keyboard after a set period, the computer shuts off power to different components, such as the hard disk drive, LCD, backlight, modem, floppy disk drive, and I/O ports. Some vendors, including Compaq, NEC, and TI, provide a standby feature that

switches the CPU to low power after you press a key or a period of inactivity has elapsed. Toshiba's auto-resume feature lets you turn off the machine while an application is running. When you power it on again, the application resumes where it left off. Power-conservation functions can greatly extend battery life, but time-outs don't help during a continuous, uninterrupted session.

All these computers have removable batteries that let you swap in a fresh spare on long trips. The NEC UltraLite 286V has two batteries; the Toshiba T1000LE holds an optional second battery in the modem slot. Both let you replace a battery without having to stop what you're doing on the computer.

**Display technology.** Notebook computers use backlit or sidelit LCDs that consume relatively little power and are lightweight. LCDs work by twisting light waves. Older LCDs put light through a 90-degree twist (called single-twist nematic), which produces a relatively low-contrast display. Newer LCDs put light through a 180-degree twist (supertwist) or 260-degree twist (triple supertwist) to improve contrast. Supertwisting is also what gives newer displays, such as that of the TravelMate 2000, their blue color.

Some new displays make use of faster active-matrix (also known as thin-film-transistor) technology. In an active-matrix display, each pixel has its own transistor, which allows precise control of



## NOTEBOOK FEATURES

Sanyo MBC-17NB	Sharp PC-6220	Tandy 1500 HD	TI TravelMate 2000	Toshiba T1000LE	Toshiba T1200XE	Zenith MiniPort HD	Zeos Notebook 286
80C286/12.5	80C286/12	V20/10	80C286/12	80C86/9.54	80C286/12	80C88/10	80C286/12.5
None	80C287	None	80C287	None	None	None	None
1/5	1/3	640 KB/1.64	1/3	1/9	1/5	1/2	1/5
Yes	Yes	Yes	Yes	Yes	Yes	No	No
12.3 x 10 x 2 7	11 x 8.5 x 1.4 4.4	12.2 x 10 x 1.6 6	11 x 8.5 x 1.4 4.4	12.2 x 10 x 1.7 6.5	12.2 x 11 x 2 7.9	12.4 x 9.8 x 1.3 6	12.3 x 10 x 2 7
8 x 2.2 x 3.4 1.4	6.5 x 1.4 x 3.5 0.9	3.6 x 1.3 x 2.2 0.5	6.5 x 1.4 x 3.5 0.9	5.75 x 1.75 x 3 1.4	5.75 x 1.75 x 3 1.4	7.25 x 3 x 1.4 1.4	8 x 2.1 x 3.3 1.4
82 No 3.5	79 No 2	84 No 3.5	79 No 2	82 No 3.5	82 No 3.5	80 No 2	82 No 3.5
Sidelit active matrix	Backlit	Backlit	Sidelit	Sidelit	Sidelit	Backlit	Sidelit active matrix
640 x 480 VGA 32 7.75 x 5.8	640 x 480 VGA 16 8 x 6	640 x 200CGA 16 7.6 x 4.6	640 x 480 VGA 16 8 x 6	640 x 400 CGA 2 7.6 x 4.9	640 x 400 CGA 2 7.75 x 4.87	640 x 200CGA 4 8.4 x 3.1	640 x 480VGA 32 7.75 x 5.8
Yes	Optional	No	Optional	No	Yes	Yes	Yes
20-MB Conner	20-MB PrairieTek	20-MB Conner	20-MB PrairieTek	20-MB Conner or JVC	20-MB Conner or JVC	20-MB Conner or PrairieTek	20-MB Conner
3½/1.44 MB	3½/1.44 MB (external option)	3½/1.44 MB	3½/1.44 MB (external option)	3½/1.44 MB	3½/1.44 MB	3½/1.44 MB	3½/1.44 MB
Nickel-cadium	Nickel-cadium	Nickel-cadium	Nickel-cadium	Nickel-cadium	Nickel-cadium	Nickel-cadium	Nickel-cadium
2	2	3½	2	3½	2½	3	2
1	2	4	2	4	3	3	1
1	1	1	1	1	1	1	1
1	1	1	1	1 (or floppy port)	1 (or floppy port)	1	1
2400 bps	2400/4800 bps data/fax	2400 bps	2400/4800 bps data/fax	2400 bps	2400 bps	2400 bps	2400 bps
No	No	Yes	No	Yes	Yes	Yes	No
No	Yes	No	Yes	Yes	No	No	No
DOS 4.01	DOS 4.01; LapLink	DOS 3.3; DeskMate	DOS 4.01, LapLink, and Battery Watch in ROM	DOS 3.3; utilities	DOS 4.01	Dos 3.3 and FastLynx in ROM	Utilities; DOS 4.01
1	1	1	1	1	1	1	1
Yes	Yes	Yes	Yes	Yes	Yes	Yes	Yes
\$2999	\$3995	\$1999	\$3999	\$2499	\$3199	\$2399	\$1995

voltage for each pixel. Pixels can have a range between off and on that permits halftones and an improved gray-scale range. The machines from Sanyo, Ogi-var, and Zeos feature active-matrix VGA displays at a full resolution of 640 by 480 pixels with 32 gray scales. These machines run graphical applications such as Windows 3.0 quickly and with amazing clarity.

Backlighting overcomes inadequate ambient lighting and increases the contrast between the image and the display background. Most notebooks have a fluorescent backlight; the NEC and Grid machines have electroluminescent backlighting, which isn't quite as bright.

**Data storage.** It's a quiet testimony to

the quality and technical innovation of Conner Peripherals and PrairieTek that practically every notebook computer uses their hard disk drives.

Most notebook machines come with 20-MB hard disk drives. These drives have a single 3½-inch platter with a typical average access time of about 25 milliseconds. Using multiple platters can increase storage limits to 40 or 60 MB. Compaq's LTE 386s/20 is the leader in data storage with its 60-MB 19-ms Conner hard disk drive. Grid has added a interesting twist by making its hard disk drive removable. You can swap in different drives, and the company plans to introduce a desktop version so you will be able to move the hard disk drive from

your notebook to your desktop computer.

When vendors added hard disk drives to their notebooks, some eliminated the internal floppy disk drive (although you can still buy external floppy disk drives for these machines). These companies say that you can do without the floppy disk drive and transfer files to a desktop computer using a file transfer program such as Traveling Software's LapLink III. Some vendors bundle LapLink or a similar utility with their machines. LapLink is fast, but it's not always convenient to run the necessary cables into the back of your desktop machine. A floppy disk drive has the added benefit of letting you make quick backups of important data when you're on the road.

## From the Testing Notebook

Most people use notebook computers differently from their desktop counterparts, so a few changes to the BYTE benchmark suite were in order this month. We ran the standard low-level CPU, disk, and video tests, but we modified the application benchmark suite to emphasize typical notebook computer applications (for a complete rundown on the application benchmarks, see "BYTE's New Benchmarks: New Looks, New Numbers," August 1990).

Specifically, we have added a second

suite of word processor benchmarks to the WordPerfect suite, eliminated the desktop publishing and CAD categories, and scaled down the database benchmarks. We substituted Lotus 1-2-3 release 2.2 for release 3.0 and added Borland's Quattro Pro, a spreadsheet designed to accommodate 808x-based systems. We have kept the compiler and engineering applications in modified form.

Our new battery-life test gauges battery life under simulated working conditions. It consists of a TSR program

that opens a text document, pumps characters into a file at a consistent rate, and automatically saves the file at 1- and 5-minute intervals until the battery has completely discharged.

We didn't enable any power-conservation features during our tests, so it's not surprising that our results generally fell short of the vendors' battery-life claims. You may get slightly better results, depending on how you work and what applications you run, but the test gives you a good idea of how the machines compare.

### NOTEBOOK COMPUTER BENCHMARKS

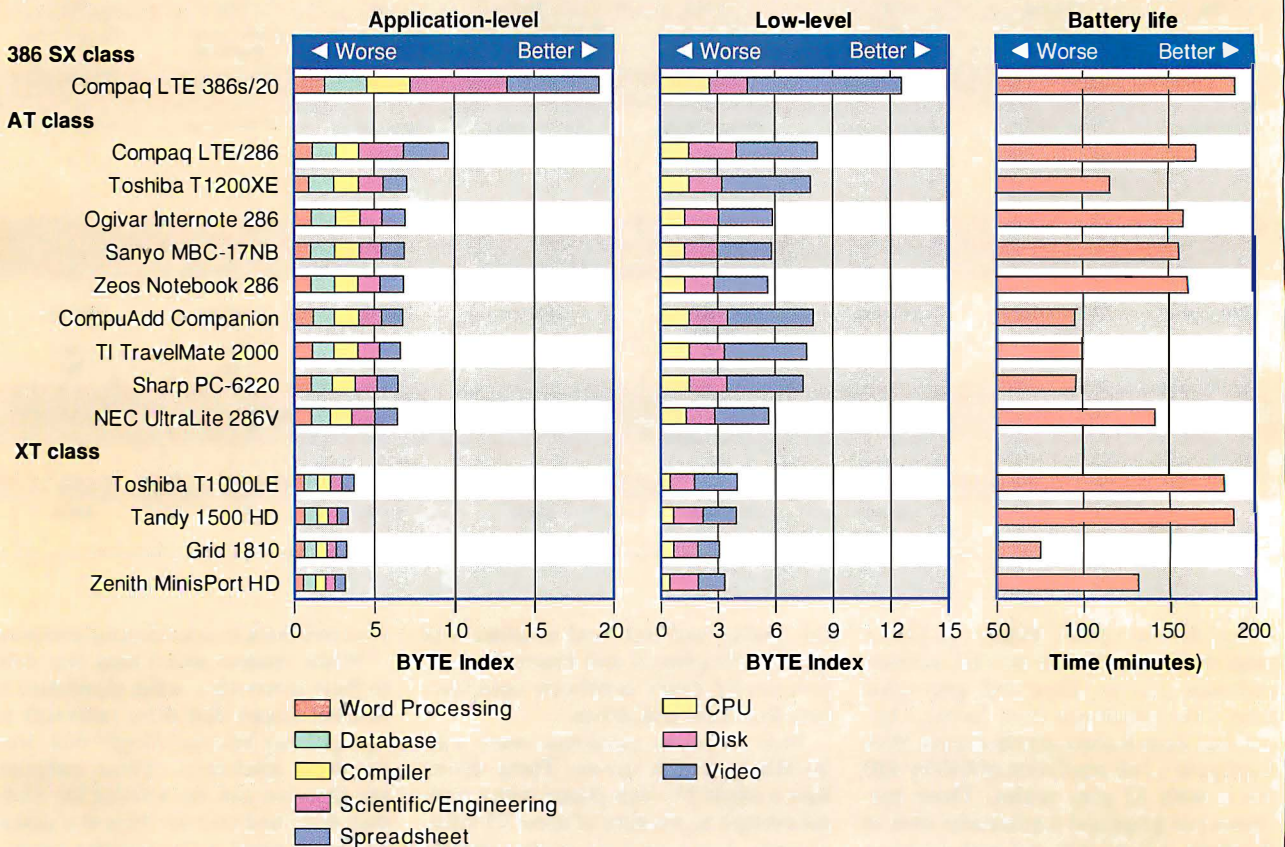

We tested performance using the standard low-level benchmarks and a modified application benchmark suite. We used Lotus 1-2-3 release 2.2 instead of release 3.0, scaled down the database tests, and added XyWrite and Quattro Pro. Performance varied little within each CPU class. The Compaq machines both included FPU's, which skewed the results to their advantage. The battery-life benchmark, which simulates a steady word processing session, clearly differentiates the machines we tested. Because our tests don't take advantage of power-conservation options, the results are a relative yardstick against which to make comparisons. Your mileage may be better or worse, depending on how you use your computer. The most robust batteries reside in the Compaq, Tandy, and Toshiba machines.

Some machines, such as the two Toshiba models, feature battery-backed RAM disks. A RAM disk is more expensive per megabyte than magnetic media, but it's fast and requires less power than a hard disk drive. Zenith's MinisPort HD maintains separate lithium batteries that power the RAM disk, so you don't lose data when the main battery runs down. Psion's MC-600 has the most intriguing data storage system. It uses Intel's flash-memory chips to create a solid-state disk drive that doesn't need battery backup.

**Keyboards.** None of the notebook keyboards had the size or feel of a good desktop keyboard. Squashing a standard 19-inch, 101-key keyboard into an 11- or 12-inch form factor does require compromises. Some vendors do away with separate function, cursor, numeric, and page-control keys, overlaying these functions on other keys. Some manufacturers lower the height of the key caps and shorten the key travel from the standard 3.5 millimeters to 2 mm to help keep the case height low.

How well these keyboards work is a subjective consideration that depends on the applications you use and how well you type. As touch-typists, we held these machines to a high standard, but don't take our word for it. We strongly recommend trying out any keyboard before you decide to buy.

**Durability.** We didn't go so far as to drop the notebook computers to see if any would break, but we did try each machine in a variety of environments. Some computers are more fragile than others and require more care—particularly the displays. One of the units with a flimsy screen, the Compaq LTE/286, went on a business trip and returned with a cracked screen. We're not sure how it happened, but the message is clear: Notebook computers require special care.

We also found some I/O port covers annoying. The Sanyo, Ovigar, and Zeos machines all have fold-down plastic covers held in place by small plastic pins that can easily break off. The TI, Sharp, and CompuAdd machines have sliding plastic covers that are difficult to remove and fall off easily if not properly inserted.

**Expandability.** All the notebook computers have a slot for an internal modem; the TI, CompuAdd, and Sharp machines offer a data/fax modem option. Some notebooks, such as the LTE 386s/20 and the TravelMate 2000, have an optional expansion chassis that allows you to install add-in boards. The TravelMate expansion chassis occupies the modem slot.

## COMPAQ LTE/286 and LTE386s/20



**B**oth of the Compaq notebook machines bear a striking family resemblance, but beneath the exterior, the LTE 386s/20 has a completely new design that incorporates Intel's 20-MHz 386SX. The LTE/286 uses a 12-MHz 80C286 processor. Both accept a math coprocessor and include floppy and hard disk drives. The 386s/20's 2.2-inch-high case—which is slightly thicker than the LTE/286's case—makes that notebook the tallest machine in the group. Both Compaqs are relatively light and easy to carry.

The LTE/286 includes a 20-MB hard disk drive and 640K bytes of RAM for \$3499. The LTE 386s/20 comes with 2 MB of RAM and a 30-MB hard disk drive for \$6499. Memory upgrades are user installable, but Compaq's \$549 list price for its proprietary 1-MB single inline memory modules is a bit steep.

The LTE/286 uses a backlit LCD that supports CGA graphics at 640 by 200 pixels with four gray scales. The LTE 386s/20 has a more desirable sidelit LCD that offers VGA at 640 by 480 pixels with 16 gray scales. Of the systems that support VGA, the LTE 386s/20's display was one of the best.

The LTEs share the same keyboard layout, using overlays for the numeric keypad, arrow, PageUp, PageDown, Home, and End keys. Compaq shortened the key travel to 2 mm to save space for the floppy and hard disk drives mounted

beneath the keyboard. The keyboard has a good feel, however, despite the short stroke.

The batteries slide into both LTE models through a side door, but the batteries are not the same in both machines. Compaq rates battery life at 3½ hours on the LTE/286 after an 8-hour recharge; the LTE 386s/20 can go for 3 hours between 1½-hour recharges. Our 286 ran for about 2¾ hours; the 386s/20 held up for slightly more than 3 hours during testing.

You can conserve battery power by setting system inactivity time-outs for the hard disk drive, display, and CPU. The Standby switch on the front panel is handy for pausing operations and then resuming later where you left off. It turns off the display and hard disk drive and puts the CPU into low-power mode.

The LTEs performed better than the other machines in this review, but both had math coprocessors installed. Since no other machine included a math chip, this skewed the results.

Both Compaqs feature standard-size serial and parallel ports, a mouse connector, a numeric keypad connector, and a video port. The LTE/286 also includes a connector for an external floppy disk drive. All I/O ports sit underneath a delicate-looking plastic flip-down cover on the LTE/286. The LTE 386s/20 has a more macho sliding cover and a connector for an optional expansion chassis.

## Psion's Notebook with Flash

**P**sion's MC-600 uses Intel's flash-memory chips as its storage medium and has a long battery life, which makes it ideal for use during long trips. The machine's 80C86 CPU runs at 7.68 MHz—a bit slower than the other notebook machines we tested. The non-backlit retardation-film LCD supports CGA graphics at a resolution of 640 by 200 pixels. The LCD has better contrast and a wider viewing angle than older LCDs, but it can't beat a backlit screen in poorly lit areas.

In place of floppy and hard disk drives, the Psion MC-600 uses "solid-state disks," Intel's nonvolatile flash-memory chips that can emulate a hard disk drive. The machine comes standard with a 1-megabyte internal RAM disk as drive C. You can expand the SSD capacity to 8 MB by installing 1- and 2-MB memory "packs" in the machine's four slots, but storage isn't contiguous: Each pack becomes its own logical drive. The MC-600 doesn't include an internal floppy disk drive but offers an external device as an option. The basic system (which costs \$2995) includes

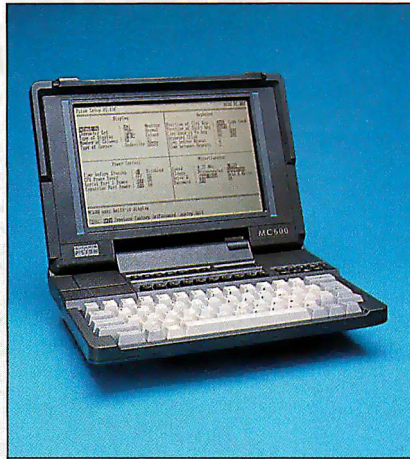

768K bytes of RAM (only 640K bytes is accessible), the 1-MB internal RAM disk, LapLink III, and DOS 3.2.

The CMOS flash-memory chips offer faster performance than EEPROMs, requiring 1 second for electrical erasure, 2 seconds for reprogramming, and 135 nanoseconds for high-performance reads. According to Intel, it is possible to erase and reprogram the flash-mem-

ory chips at least 10,000 times.

Without backlighting or disk drives to consume power, the MC-600 goes longer than most notebook computers between recharges. It can squeeze 20 hours out of eight AA alkaline batteries or 12 hours from a set of nickel-cadmium batteries. Setup screens let you configure time-outs for the display and keyboard, and a CPU power-saver mode switches the processor to low power when waiting for keyboard input.

The unit is very quiet. There are no whirs, clicks, or other bits of distracting noise associated with hard and floppy disk drives. The MC-600 has a full-travel keyboard with an XT-style layout and small, separate buttons for PageUp, PageDown, Home, End, Insert, and Delete.

The computer and its flash-memory upgrades aren't cheap. A Zeos Notebook 286 with a 20-MB hard disk drive, floppy disk drive, sidelit VGA display, and 1 MB of RAM costs \$1000 less. But the MC-600 is sturdy and should work well in situations where quiet operation and long battery life are important.

Our LTE/286 developed cracks in the plastic case just above the floppy and hard disk drives. Compaq says that it has redesigned the case and is fixing machines with this problem at no charge.

The 386s/20 has a slightly different case design and did not exhibit any flaws.

The LTE 386s/20 is the fastest, most expandable, and most expensive notebook computer we tested. Both Compaq

machines include excellent documentation. The LTE/286 set the standard in the 286 notebook arena. Other machines, however, now give you more for your money.

## SHARP PC-6220, TI TRAVELMATE 2000, and COMPUADD COMPANION

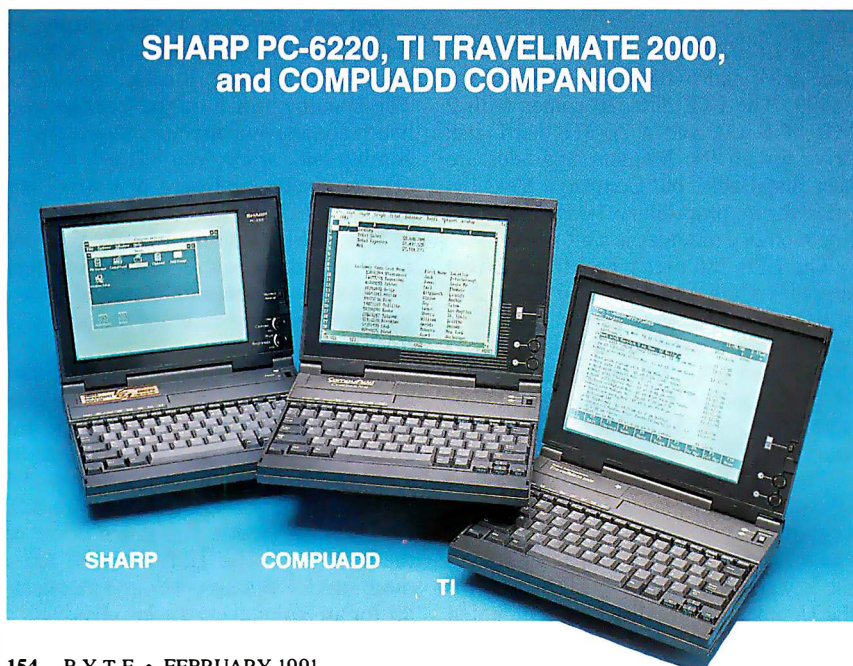

**T**hese three 80C286-based notebook PCs, designed by Sharp and TI, are all manufactured in the same TI plant in Austin, Texas. (Sharp manufactures its own model for sale overseas.) There are subtle differences among them. TI adds its own power management utility and includes DOS and LapLink in ROM. But the most obvious difference is price. The TI and Sharp systems come in at just under \$4000 in our test configuration; the CompuAdd Companion sells for \$2895. But typical dealer discounts on the TI and Sharp machines put their street prices about on a par with the mail-order CompuAdd.

These 4.4-pound machines are the smallest and lightest PCs we reviewed and have the most "curb appeal"; that is, when we put all the notebooks on a table in the BYTE Lab, editors passing by tended to gravitate toward the TravelMate, the PC-6220, or the Companion.

**WATCOM C8.0/386**  
Optimizing C Compiler and Tools  
for 386 Extended DOS

# Unleash 386 Power on Your Microsoft C Code.

- Interactive source-level debugger
- Generates high-performance code for 32-bit protected mode
- Microsoft source and library compatible
- Fast, tight code
- Profiler
- Protected-mode version of compiler
- Graphics library
- 100% ANSI C and SAA compatible
- Run-time compatible with WATCOM FORTRAN 77/386

## Experts Agree on WATCOM C:

"When Novell went looking for a 32-bit compiler for use with the NetWare 386 developer's kit, the company selected WATCOM's...It's clear that Novell chose wisely; this product is a winner."  
*Fred Hommel, BYTE, December 1989*

"WATCOM C/386 is a fantastic new ANSI C compatible compiler for 386-based PC's...If you have written your application in Microsoft C, you will love this compiler."  
*J. Richard Hines, Electronic Test, December 1989*

"Microsoft library- and source- compatibility makes WATCOM C7.0/386 ideal for porting DOS applications to 32-bit native mode. This compiler enables full 386 performance without 640K limitations."  
*Richard M. Smith, President, Phar Lap Software, Inc.*

"WATCOM is definitely the leader in object-level optimizations...For flat-out executable speed,...WATCOM C showed shining performance."  
*Computer Language, February 1989*

## WATCOM C8.0/386 Professional

• 100% ANSI C optimizing compiler • Protected-mode version of compiler • 386 run-time library object code • Windowed source level debugger • Profiler • Editor • 386 graphics library • MAKE • Linker • Object-code librarian • Object-code disassembler • Supports Phar Lap and ERGO DOS extenders

## WATCOM F77/386

• 32-bit optimizing FORTRAN compiler based on WATCOM C technology • Full ANSI FORTRAN 77 plus extensions • Includes WATCOM C development tools: Windowed source-level debugger, Profiler, Editor, MAKE, Linker, Object-code librarian and Object-code disassembler • Protected-mode version of compiler • Run-time compatible with WATCOM C8.0/386 • Supports Phar Lap and ERGO DOS extenders



**WATCOM**

**1-800-265-4555**

415 Phillip Street, Waterloo, Ontario, Canada N2L 3X2 Tel. (519) 886-3700 Fax (519) 747-4971

WATCOM C is a trademark of WATCOM Systems Inc. Trademarked names are the properties of their respective owners.  
© Copyright 1990 WATCOM Products Inc.

Although their size and innovation draw a crowd, these machines aren't necessarily your best choices.

The designers had to make sacrifices to achieve that wonderful form factor. The battery, rated at 2 hours, lasted only about 1 hour and 40 minutes during our tests. An optional battery "slice" connects to the rear of the machine, adding about 2.3 inches of length and 1.9 pounds of weight to the unit. The battery slice should provide about 3 more hours of battery life. The keyboard offers no typing angle (a fault nearly all the other notebooks shared), and its placement (it's set back about an inch from the front of the unit) and limited key travel might prove uncomfortable in heavy-duty typing sessions. Some keys (PageUp, PageDown, Home, and End are the most important ones) are embedded. That is, you must also press the Fn key to activate them. This will be awkward for some applications.

A floppy disk drive is available only as an external option. For the most part, these trade-offs are reasonable; we don't see how anyone could build a better commercially viable notebook PC in this form factor and with this processing power, given the limits of current technology.

What gives us pause, though, is the design of the case. The tension from the screen's hinge flexes the plastic above the keyboard to an uncomfortable degree on all three units. The thin display feels flimsy and offers little protection for the LCD. And the doors covering the various ports and slots aren't hinged; they snap off and can get lost easily.

Performance-wise, the TravelMate, PC-6220, and Companion were leaders among the 80C286-class notebooks, providing the most punch per pound—or per square inch. The machines also accept a math coprocessor—a feature that will come in handy if you're working with complex spreadsheets on the road.

The VGA display was crisp, with good contrast—not the best we've seen, but close. A pop-up utility lets you adjust the gray-scaling for greater contrast when necessary.

We don't recommend any of these small PCs for environments where they might get rough use, and touch-typists might opt for a notebook with a better keyboard. But the size and capabilities of these units are simply irresistible. If portability is your main concern, and you and your applications can live with the trade-offs, then any version of this very luggable notebook would be an excellent choice.



The 1810 doesn't have the black magnesium case that's become a Grid trademark, but it has the same rugged feel and some interesting features. Powered by an NEC V20 microprocessor, the Grid 1810 posted performance numbers in the same range as the XT-class notebooks. Unfortunately, the 1810's battery life doesn't measure up to that of the other machines in its class.

The 1810's keyboard is excellent. The keys have a firm tactile response, snappy recoil, and full 3.5-mm travel. Grid put the cursor keys in an inverted T shape at the bottom right corner of the keyboard. The right Shift key is reduced in size, but the unit has dedicated keys for PageUp, PageDown, Home, and End. The Insert and Delete keys sit to the right of the F1 through F10 function keys on the top row of the keyboard. When combined with a special blue function key, the Insert and

Delete keys double as the F11 and F12 keys. Function key combinations can also change the processor speed, disable the speaker, power down the disk drive, turn off the backlighting, or place the unit in full standby mode. You can also set power-conservation time-outs by invoking the setup program.

The electroluminescent backlit LCD supports 640- by 400-pixel EGA graphics with 12 gray scales. Visibility was good under all lighting conditions. Slider knobs below the screen control the contrast and backlighting levels. The screen looked good in all lighting conditions, although the backlit display was not as bright as the sidelit models we tested.

The 1810 supports a maximum of 2 MB of memory, and you cannot install memory upgrades yourself. Only the Tandy 1500 HD (1.64 MB) and the Psion MC-600 (1.768 MB) have lower memory ceilings.

The 1810's most unique feature is its removable 20-MB hard disk drive, which slides easily from the side of the unit. There are no switches to set or plugs to pull. You can buy a couple of spares and keep different applications on separate removable disk drives. Grid's announced desktop module, which lets you plug the removable hard disk drive into your desktop system, wasn't available at press time. The 1810 offers an external floppy disk drive only.

In the Grid tradition, the 1810 is technologically advanced, rugged, elegant—and overpriced. The \$2895 list price (for a unit with 1 MB of RAM, a 20-MB hard disk drive, and DOS and LapLink in ROM) makes it the most expensive notebook computer in its class. Other notebooks offer more for your money.

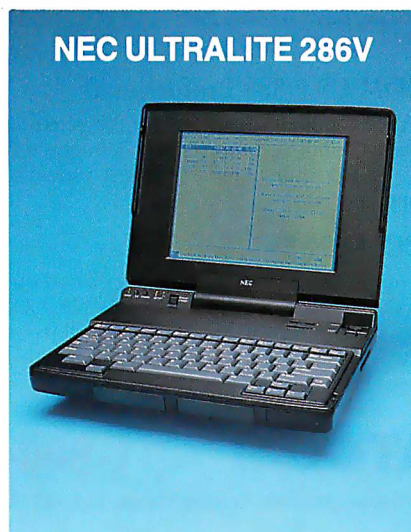

The UltraLite 286V keyboard has one of the best layouts of the machines we tested; it has large Enter, Shift, Control, and Alt keys and separate cursor-control keys. But the short, 2-mm key travel may annoy some touch-typists. The keyboard also doesn't offer much tactile feedback.

The basic 286V includes a 12-MHz 80C286, 1 MB of RAM, a 20-MB hard disk drive, DOS 4.01, and two batteries for \$3699. NEC offers an external floppy disk drive as an option.

The case design for the 286V is sleek and matte black with rounded corners. A fragile-looking fold-down plastic panel covers the I/O ports. The screen display did flex slightly when handled, but the case should hold up fine if you give it reasonable care.

The 286V's electroluminescent back-

lit LCD supports VGA modes at up to 640 by 480 pixels with 16 gray scales. Still, its image quality wasn't on a par with that of the Sharp/TI/CompuAdd trio, and the contrast and brightness controls did little to improve screen clarity.

The machine includes dual battery packs that fit under the case, and you can recharge one battery while you use the other. LEDs on the front panel blink and change color to indicate battery status.

Power conservation revolves around the Standby/Resume switch on the front panel, which operates like the Compaq LTE's switch. The standby mode saves

power during intermittent use; the resume mode turns off power for extended periods. Both modes let you return to the exact state the machine was in when you last used it. Standby mode turns off power to the hard disk drive, screen, and any peripherals connected to the computer but preserves RAM and CPU register information. You press any key to resume operation. Resume mode cuts power to all subsystems while preserving RAM and CPU register information. You press the on/off switch to resume operation. You can set up the 286V to trigger either mode after the inactivity time-

out period you specify has elapsed.

You add memory by installing a 1- or 4-MB RAM card on the motherboard. The 286V also has a slot for one battery-backed 256K- or 512K-byte RAM or ROM card. NEC offers ROM versions of Lotus 1-2-3, Metro, Agenda, XyWrite III Plus, WordPerfect, WordStar, and Microsoft Works. ROM-based application programs execute in ROM and use less power than applications run from the hard disk, but we suspect that most people will forgo using these expensive cards and just load their applications onto the hard disk.

**T**hese three 80C286-based machines share the same basic Sanyo design; the only differences are cosmetic. Prices for a 1-MB machine with a 20-MB hard disk drive, a floppy disk drive, and DOS 4.01 range from \$1995 (Zeos) to \$2999 (Sanyo and Ogivar).

These compact units appear to be more sturdy than some other units we tested, and the active-matrix displays—developed by Ogivar—are outstanding. The sidelit LCD seems brighter than that of other backlit models. It supports full 640- by 480-pixel VGA graphics with 32 shades of gray. If that's not good enough, you can plug your own VGA display into the external video port. Sanyo conveniently tucked the brightness and contrast controls below the right edge of the keyboard on the side of the unit.

The keyboard has a squishy feel, despite the full 3.5-mm travel. A complete complement of function keys lines the top of the keyboard, and Sanyo placed the cursor keys in an inverted T at the bottom right corner. You use the Fn key to access the PageUp, PageDown, Home, and End functions. If your software uses these keys liberally, you may find this layout unacceptable.

Built around a 12.5-MHz 80C286, this group of machines posted average benchmark times. The Sharp/TI/CompuAdd machines, Compaq LTEs, and Toshiba T1200XE all performed slightly better. This advantage was more noticeable while running the low-level tests than when running the application suite, however.

The Ogivar, Sanyo, and Zeos notebooks all did particularly well on the battery-life tests, consistently lasting over 2½ hours. When the battery runs down, you can pop in a spare or recharge the battery in only 1 hour. The external power supply measures 8 by 2 by 3½ inches; only the MinisPort's power-supply brick is larger.



The units fold into a compact 7-pound shell. All three appear to be solidly constructed, durable machines. A row of indicator lights lies on the main unit, just below the screen, remaining visible when the screen is folded down. A handle pops out from the front of the unit for easy carrying.

For the most part, only small nuances differentiate these three models; that is, until you come to price. The Notebook 286, a mail-order machine, costs \$1000 less than the Internote 286 or the MCB-17NB at list price. Even with dealer discounts on the Ogivar and Sanyo machines, the Zeos system will maintain an edge. The company has made a breakthrough by pricing the Notebook 286 under \$2000—a price that makes it competitive with the XT-class notebook machines.

These three models strike the best balance between power and portability. You get an acceptably small shell, but you don't have to give up a floppy disk drive or a gaudy housing.

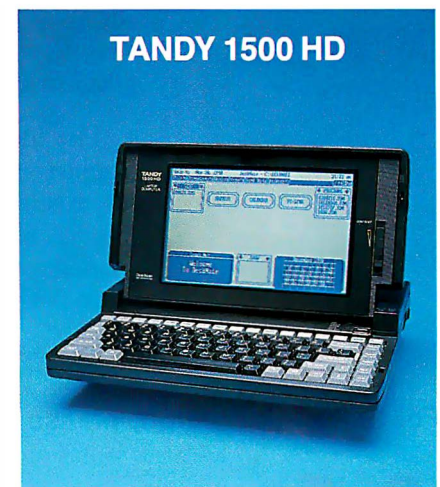

**T**andy's 1500 HD isn't the fastest XT-class machine, but it has several notable features, and Tandy's many retail outlets make servicing easier. Tandy powers the machine with a 10-MHz V20 processor. The basic system, at \$1999, includes 640K bytes of RAM, a 20-MB

# WEITEK<sup>®</sup> makes the difference!



**The 4167's 10 MFLOPS performance delivers 3X the speed of the 486!**

The new Weitek 4167 coprocessor outperforms the 486 by 3 to 1 in numeric processing. Capable of 10 MFLOPS, the 4167 has sockets in some of the most sophisticated 486 systems on the market, including Compaq, Intel, Hewlett-Packard, and Microway. The 4167 is object-code compatible with the WEITEK 3167 FPU and Microway's mW3167-PS add-in card for the MicroChannel—offering easy access to a broad base of existing CAD/CAM, scientific and engineering applications like Mathematica, CADKEY, HOOPS and Microway's NDP compilers. And look for 4167 support on upcoming products from Autodesk!

**Number Smasher<sup>®</sup>-486** converts your old AT or 386 into a powerful 486 workstation. In a review of 25 MHz 486 motherboards, Mike George of *Personal Workstation* magazine wrote, "Microway's Number Smasher-486 gives you top 486 numeric performance for the best price...Number Smasher's numeric performance exceeds that of all 25 MHz 486 systems we've tested to date." Running the Microway Benchmark Suite, the 4167-equipped Number Smasher-486 achieves 11.9 MegaWhetstones. The board features a Burst Bus<sup>™</sup> memory interface that makes it stand out in numeric problems that involve large arrays. Burst cycle response in a 486 system is much more important than second level caches, which are usually too small to be of any use on the megabyte arrays found in real world problems.

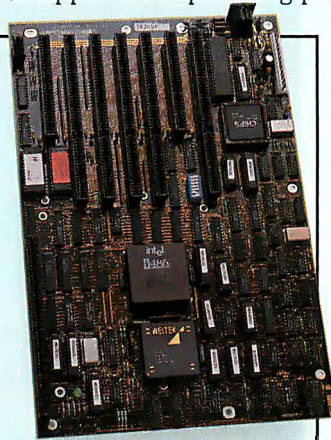

The ideal solution for numerically or I/O intensive applications is Microway's new Number Smasher-486/33T workstation. Two configurations are available, each incorporating state-of-the-art power and cooling with 300 to 600 megabyte drives.



**NDP Fortran-486, NDP C-486 and NDP C++** are your keys to unlocking the power of the 4167. Each compiler generates globally optimized, main-frame quality code and has special features that take advantage of the 4167, such as register caching, loop unrolling and automatic inlining of small procedures. These optimizations are handed off to a code generator that is tuned for the 4167, and takes advantage of its advanced instructions like multiply accumulate. In addition, the 486 versions of NDP Fortran, C++ and C properly sequence 486 and 4167 instructions so that the 486's prefetch queue has time to "breathe." NDP compilers are also available for the 386SX, 386 and i860 under DOS, UNIX, XENIX and SunOS. Thousands of Microway's satisfied customers have discovered that you can't buy a better scientific Fortran or C compiler. And our technical support is the best in the industry.

For more information, please call 508-746-7341.

# Microway<sup>®</sup>

The World Leader in PC Numerics

Corporate Headquarters, Research Park, Box 79, Kingston, MA 02364  
TEL. 508-746-7341 • FAX 508-746-4678  
U.K. - 32 High St., Kingston-Upon-Thames, 081-541-5466 • Italy 02-74.90.749  
Holland 40 836455 • Norway 9 876656 • Japan 81 3 222 0544





## Choosing a Notebook Computer

When you're selecting a notebook computer, portability has top priority. But portability involves not just the system unit's dimensions and weight, but the size and weight of the external power supply and any optional equipment you plan to carry as well.

You should also consider battery life carefully. A system should be able to run for at least 2 hours between charges. Most units have standard power-conservation features that dim the backlighting and power down the hard disk drive when the unit isn't in use. Several machines also offer a handy standby function that shuts down virtually the entire system and then, at the touch of a key, resumes operation where you left off.

No matter how careful you are, your notebook computer will face some rough treatment when you travel. All these machines need looking after, but some don't seem quite as sturdy as others. In particular, you should check how well the case protects the display.

If your main notebook applications include word processing and entering data into simple spreadsheets, performance isn't your overriding concern. Here an XT-class notebook will do a perfectly adequate job.

Don't sell yourself short on an upgrade path; someday you may want more RAM for EMS memory or a RAM disk. Check the maximum memory size and availability of other options you

may want, such as an expansion chassis.

These computers have personalities, so you should try before you buy. Although we aim to be objective, keyboards and displays are often matters of personal taste—particularly when you are running applications that require VGA mode. Make sure that you like typing on the unit and can read the display clearly in a wide range of lighting situations.

With notebook computers, you don't always get more for your money. If you decide to pay a little extra for a notebook, make sure that you are getting the extra features that you need: more disk space, a faster processor, or longer battery life.

hard disk drive, a 3½-inch 1.44-MB floppy disk drive, and Tandy's DeskMate desktop manager. You can configure memory above 640K bytes as EMS memory or as a RAM disk, but the machine accepts only 1.64 MB of RAM.

The unit's backlit LCD is easy to read in all lighting conditions, but it only supports 640- by 200-pixel CGA-mode graphics with 16 gray scales. Screen controls include a contrast slider but no intensity knob. You can toggle the backlighting on or off with a key combination.

The 1500 HD's full-travel keyboard sports a good layout with more keys (84) than any other machine we tested, except for the Psion MC-600. Tandy includes a complete set of function keys, and separate PageUp, PageDown, Home, End, and arrow keys. Unfortunately, the function keys are undersized. The Fn key controls can turn off backlighting and disk activity. There's also a hot key for placing the 1500 HD in standby mode by powering down the display and the disk. You control power conservation through the DeskMate user interface or from the DOS command prompt.

The 1500 HD folds into a 6-pound shell and has a sturdy plastic housing. Tandy rates battery life at 3½ hours; in the Lab, the 1500 HD lasted over 3 hours—better than any other machine except the Compaq LTE 386s/20. Your average should be better if you have the power-conservation features enabled. Recharge time is a relatively short 4 hours.

The 1500 HD's \$1999 price makes it an excellent buy in its class.



The Toshiba name has become synonymous with laptop computers. Toshiba's notebook entries, the T1000LE and T1200XE, have similar construction and features but differ in performance.

The T1000LE packs in a 9.54-MHz 80C86 processor, 1 MB of RAM, a 20-MB hard disk drive, a floppy disk drive, a battery, and DOS 3.3 for \$2499. The T1200XE substitutes a 12-MHz 80C286 processor for \$3199. The LE boasts more expandability than any other note-

book in its class. It supports up to 9 MB of RAM and offers an optional expansion chassis for future expandability. The chassis, which plugs into a proprietary port in the rear of the unit, wasn't available at press time. The T1200XE accepts up to 5 MB of RAM.

Both Toshiba models include bright sidelit LCDs with CGA modes of up to 640 by 400 pixels and two gray levels. Sharpness and clarity are excellent, on a par with the Ogivar/Sanyo/Zeos trio.

## Is this how your communications software deals with line noise?

**WARNING:  
File Transfer  
Aborted.**

## We have a better way.

Take one last look at this screen shot. With BLAST,<sup>®</sup> you'll never see it again. BLAST is the communications software designed to shrug off line noise. It was born twelve years ago into the world of high-stakes mainframe file transfers — where one lost bit can be a million dollar mistake.

We developed a unique full-duplex, sliding window protocol that was naturally resistant to noise. Then we added data compression, and the incredible ability to restart transfers from the point of interruption. When we put it on the test bench we found that, in addition to the safest mode of transferring files, we had produced the fastest protocol available.

We set out to build a tank and ended up with a sports car — a sports car with armor.

We added natural terminal emulation, named it BLAST and, today, it's available, through distribution, to virtually anyone with a business computer — any business computer. Call your distributor for the whole story.

**BLAST<sup>®</sup>**  
Communications Research Group  
A U.S. Robotics Company

For more information call:

**1-800-24 BLAST**

## PRODUCT FOCUS

## NOTEBOOK COMPUTERS

The T1200XE has flat control knobs for brightness and contrast, but getting the screen just right can be tricky. The T1000LE's side-mounted screen controls are easier to use. The T1200XE offers an external video port; the T1000LE does not.

Both keyboards lack a good tactile response, but the layout is adequate. They offer separate PageUp, PageDown, Home, End, and cursor-movement keys. The complete set of function keys on the top row and the Control key aren't full-size, however. Special function keys change the CPU speed, and on the T1200XE a function key diverts the video signal to the external port. This same function key also accesses a special pop-up window that reports system settings, such as current battery capacity. This is one of Toshiba's unique touches.

Another is the resume mode. When

the Toshiba machines ran out of juice during the battery-life tests, we recharged them and turned the units back on, and the tests resumed right where they left off—with the TSR program still loaded and active. This impressive feature might just prevent accidental data loss.

The T1000LE's batteries lasted just over 3 hours, rivaling the Tandy and Compaq batteries. The T1000LE has an option for a second battery, which extends the operating time to 5 hours but occupies the modem slot. The T1200XE doesn't accept two batteries, but the battery life is acceptable, if not impressive.

Both Toshiba machines are rugged, with the exception of the flimsy port covers. The Toshiba name carries a steep list price, but street prices are competitive. The T1000LE is especially enticing as a low-end model.

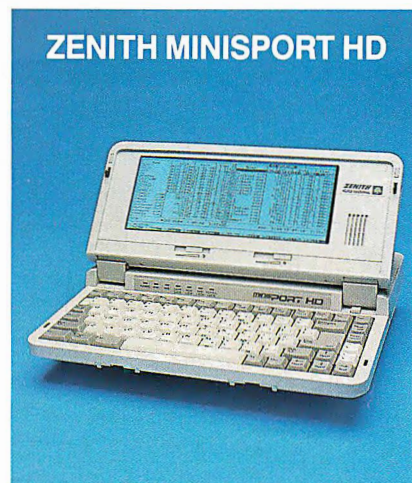

**T**he original MinisPort was a technological marvel. The new MinisPort HD still maintains an edge as one of the most portable units that we've seen. The strong case is more durable than that of most other notebook computers, yet the unit weighs only 6 pounds and fits comfortably under your arm. It also has a handy carrying handle that folds into the case when not in use. The base machine includes 1 MB of RAM, a 20-MB hard disk drive, a floppy disk drive, DOS 3.3, and a few utility programs for \$2399.

The machine has undergone some changes. The MinisPort HD uses the same 10-MHz 80C88 processor, but Zenith has dropped its experiment with proprietary 2-inch floppy disk drives in favor of a standard 3½-inch 1.44-MB model.

The keyboard has relatively flat keys that travel only 2 mm. When touch-typ-

ing, we couldn't always tell from the keyboard response whether the machine was getting all the characters. The cursor keys double as the PageUp, PageDown, Home, and End keys.

The MinisPort's fluorescent backlit LCD is dimmer and more faded-looking than the LCDs on the other systems we tested. Nevertheless, readability is good under all lighting conditions. The MinisPort has the smallest viewable screen area in the group, and its graphics capabilities aren't earthshaking: CGA mode at 640 by 200 pixels with four shades of gray. The screen tilts back 180 degrees—a unique feature that we found useful.

The MinisPort HD performed about on a par with the other low-end notebooks. Battery life, rated at 3 hours, was slightly over 2 hours when running the battery-life test. Both the Tandy 1500 HD and the Toshiba T1000LE performed better here.

The MinisPort includes DOS 3.3 and FastLynx, a self-cloning serial-port file transfer program, in ROM. Like the Toshiba and Tandy machines, the MinisPort lets you configure extra memory as a RAM disk, but the machine accepts a maximum of only 2 MB of RAM. If you need a machine for word processing or other simple tasks and that will take some abuse, we wouldn't hesitate to recommend the MinisPort.

### Top of the Class

When evaluating notebook computers, you look for minimal size and weight. The problem, though, lies in deciding how small is small enough, because the smaller you go, the more trade-offs you

# Speed. Guaranteed.

**AND  
COMPATIBILITY.  
GUARANTEED.**

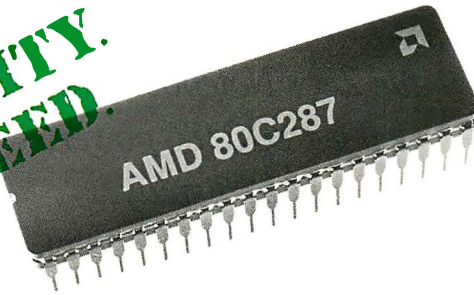

## Here's a chance to buy our \$99 Math Coprocessor at no risk whatsoever!

### High Speed, Low Price.

The performance benefits of a coprocessor are enormous. Now they're affordable too. Before the AMD 80C287 you had no choice but to pay over \$200 for a fast math coprocessor. Now you can get a coprocessor compatible with the Intel® NMOS 80287 for a terrific price - direct from AMD.

### Speed up hundreds of software applications.

The AMD 80C287 increases the performance of general business software applications like 1-2-3®, dBASE™, Excel, and hundreds of others. You can expect calculations on your favorite software to run two to ten times faster with an AMD 80C287 installed. Your graphs will draw faster, your spreadsheets will recalculate faster - your work will get done faster.

### Compatible.

The AMD 80C287 is compatible with your 80286 based PC and the hundreds of commercially available software packages written for your 80286 PC. You'll also be glad to hear that it's compatible with the Intel NMOS 80287.

### Easy to Install.

The AMD 80C287 drops easily into a socket already inside your 80286 based PC. In five minutes you can be up and running. Just pop it in and go - FAST! The AMD 80C287 comes with free floating point and fractal software to show you the immediate performance boost you'll get.

### Here's Our Risk Free Triple Guarantee.

#### Guarantee #1

If the AMD 80C287 Math Coprocessor doesn't do everything we promise, if it doesn't double or triple the speed of mathematical calculations of your favorite software applications, or if you are unsatisfied for any reason, AMD will refund 100% of your purchase price within 30 days of your purchase.

#### Guarantee #2

If your AMD 80C287 Math Coprocessor ever fails to perform for any reason, AMD will replace it free of charge - no questions asked.\*\*

#### Guarantee #3

AMD guarantees that the AMD 80C287 Math Coprocessor is compatible with your 80286 based hardware and software. If you have any compatibility problems with the AMD 80C287 during the first year, we will gladly refund the purchase price.

To Order Call Now: **1-800-888-5590**

EXT. 2600



Outside of USA (512) 345-1728

I want to double or triple the calculation speed of software running on my 286 based PC. Send me an AMD 80C287 Math Coprocessor risk free for only \$99\*. I understand that I can return the AMD 80C287 for a full refund within the first 30-days if I am not completely satisfied.

Call for a free demo disk and literature

Name \_\_\_\_\_

Visa/MC # \_\_\_\_\_

Type of PC \_\_\_\_\_

C.O.D. orders accepted

**Advanced Micro Devices** 

© 1990 Advanced Micro Devices, Inc.

1-2-3 is a registered trademark of Lotus Development Corporation. dBASE is a trademark of Ashton-Tate Corporation. Intel is a registered trademark of Intel Corporation

\*Plus tax, shipping and handling. Volume or Dealer inquires welcome.

\*\*Limited to two lifetime replacements per person.

Circle 15 on Reader Service Card

must make. If you absolutely must have the most totable notebook available, you can't do better than the 80C286-based CompuAdd, Sharp, and TI machines. However, you'll pay for the privilege. These units are the most expensive in the group, with the exception of the Compaq LTE 386s/20. You'll also forgo an internal floppy disk drive. We didn't care for the keyboards on these models, nor did we give them high marks for durability. If you're going to carry one around, we suggest keeping it tucked safely in a briefcase during trips.

When broken down by CPU class, the machines differ little in terms of performance. The 386SX-based Compaq LTE 386s/20 takes the top spot for performance—and price. But if you want a notebook computer with SX power, we think you should wait for the market to develop. A slew of 386SX notebook machines should be hitting the stores as you read this. We'll take a detailed look at these new machines in a later issue.

The 80C286-based performance heat was too close to call. The Compaq LTE/286 held a slight advantage, but it included a math coprocessor. Had the

**W**ith  
the Zeos Notebook 286,  
you get 80C286 power,  
a VGA display,  
and an internal floppy  
disk drive.

other machines had coprocessors installed, the results might have been closer. Likewise, none of the XT-class notebooks distinguished itself on the performance tests, but if you're considering one of these machines, speed probably isn't your primary criterion.

For most notebook users, an XT-class machine will do the job. You'll sacrifice some speed, and you won't get a VGA display, but you will get longer battery life and an attractive price. All four of

the low-end notebooks—the Grid 1810, Tandy 1500 HD, Toshiba T1000LE, and Zenith MinisPort HD—are rugged. Of the four, we liked the T1000LE best because of its superior display and extra features, such as resume mode. There's only one problem with going that route: the Zeos Notebook 286. For roughly the same price, you get 80C286 power and a VGA display. Why settle for less?

The Zeos Notebook 286 looks like a clear winner. But check out the identical Ogivar Internote 286 and the Sanyo MBC-17NB. Your local computer store may cut you a deal, although the Zeos price of \$1995 will be hard to beat. The CompuAdd Companion is lighter and smaller than the Zeos machine, but it costs \$2895. The Zeos machine also includes an internal floppy disk drive, a bright sidelit LCD, and a better keyboard. ■

*Stanford Diehl and Stan Wszola are testing editors/engineers for the BYTE Lab. Michael Nadeau is managing editor of the BYTE Lab. You can reach them on BIX as "sdiehl," "stan," and "miken," respectively.*

## COMPANY INFORMATION

**Compaq Computer Corp.**

(LTE/286,  
LTE 386s/20)  
P.O. Box 692000  
20555 SH 249  
Houston, TX 77269  
(800) 231-0900  
(713) 370-0670  
**Inquiry 1105.**

**CompuAdd (Companion)**

12303 Technology Blvd.  
Austin, TX 78727  
(800) 477-4797  
(512) 250-2000  
**Inquiry 1106.**

**Grid Systems Corp.**

(1810)  
47211 Lakeview Blvd.  
P.O. Box 5003  
Fremont, CA 94537  
(800) 222-4743  
(415) 656-4700  
**Inquiry 1107.**

**NEC Technologies, Inc.**

(UltraLite 286V)  
1255 Michael Dr.  
Wood Dale, IL 60191  
(708) 860-9500  
**Inquiry 1108.**

**Ogivar Technologies, Inc.**

(Internote 286)  
7200 Trans Canada Hwy.  
Ville Saint-Laurent,  
Quebec, Canada H4T 1A3  
(514) 737-3340  
fax: (514) 737-4729  
**Inquiry 1109.**

**Psion, Inc.**

(MC-600)  
57 River St.,  
Suite 306  
Wellesley, MA 02181  
(617) 237-8538  
fax: (617) 431-2155  
**Inquiry 1110.**

**Sanyo Business Systems Corp.**

(MBC-17NB)  
51 Joseph St.  
Moonachie, NJ 07074  
(800) 524-0047  
(201) 440-9300  
fax: (201) 440-1755  
**Inquiry 1111.**

**Sharp Electronics Corp.**

(PC-6220)  
Sharp Plaza  
Mahwah, NJ 07430  
(201) 529-9500  
**Inquiry 1112.**

**Tandy Corp.**

(1500 HD)  
1800 One Tandy Center  
Fort Worth, TX 76102  
(817) 390-3011  
**Inquiry 1113.**

**Texas Instruments, Inc.**

(TravelMate 2000)  
P.O. Box 202230  
Austin, TX 78720  
(800) 527-3500  
**Inquiry 1114.**

**Toshiba America Information Systems, Inc.**

(T1000LE, T1200XE)  
Computer Systems  
Division  
9740 Irvine Blvd.  
Irvine, CA 92718  
(800) 334-3445  
**Inquiry 1115.**

**Zenith Data Systems**

(MinisPort HD)  
1501 Feehanville Dr.  
Mt. Prospect, IL 60056  
(708) 699-4800  
**Inquiry 1116.**

**Zeos International, Ltd.**

(Notebook 286)  
530 Fifth Ave. NW  
St. Paul, MN 55112  
(612) 633-4591  
**Inquiry 1117.**

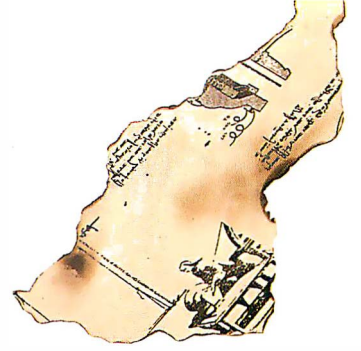

# See the Future.

The ideal 16-inch ergonomic monitor for professional graphics and business applications.

Maximum performance for CAD/CAM, spreadsheets, databases, WYSIWYG word processors and desktop publishing. Designed for PCs and Macintosh II.

1024 × 768 resolutions. Supporting the new, higher refresh rate of 70Hz and above for a flicker-free display. No distortion. Sharply focused. Bright images across the entire screen.

An anti-static, non-glare screen. Low magnetic radiation. No interference between two monitors separated by a mere six inches, for dual-display applications.

Microprocessor-controlled configuration for your applications, memorizing size and position of the screen settings you prefer.

Other monitors compete against the standards.  
**FLEXSCAN® sets them.**

## NANO®

**NANO USA CORP.**

23510 Telo Ave., Suite 5  
Torrance, CA 90505 USA  
Phone (213)325-5202  
Fax (213)530-1679

Circle 144 on Reader Service Card (RESELLERS: 145)

### FLEXSCAN 9080i

16" (15V), 0.28mm-dot pitch CRT  
1024 × 768 Super high resolution with 70Hz  
high refresh rate  
Scan Frequency: Automatic Adjustment  
H: 30-64kHz V: 50-90Hz  
VGA, 8514/A and Mac II Compatible

John M. Dlugosz

## Libraries with Class

While many software developers greeted the introduction of C++ for the PC with great excitement, others stood fast and waited. Early compilers had a very limited set of standard classes, forcing programmers to waste time building object frameworks around ordinary C library functions.

Today, a number of C++ class libraries are available that can handle everything from complex math to graphical user interfaces (GUIs). Each of the five C++ libraries that I reviewed works with either Zortech's C++, Borland's Turbo C++, or both, and produces DOS executables. System requirements will vary, depending on your specific programming project and the compiler you choose.

### C++/Views

CNS's C++/Views (\$495) has three parts: a general-purpose Smalltalk class tree, classes for writing Microsoft Windows applications, and a class browser.

The class browser is modeled after the Smalltalk browser, but it shows a few rough edges in its implementation. You have to keep a one-to-one correspondence between classes and source files, and each source file can only contain members of the proper class and nothing else. There doesn't seem to be a way to handle nonmembers or global variables at all, except by using the `main()` function, which is in a separate file by itself.

To get the browser to find your headers and the source code for the library, you have to set an environment variable. The only way to do this is to quit Windows and set the environment variable in the boot shell; there is no way to change the variable while Windows is running.

The browser has a simple configuration file; CNS should have added a search path setting to that.

After familiarizing myself with the C++/Views browser, I tried to rebuild one of the sample applications. The browser generates the make file, linker file, and other files that you need to recompile the project. It does not have an option to launch the compiler, so I opened a DOS-shell window and ran it from that.

The make file did not work, because the DOS MAKE command could not find the include files. The only way to get it to work is to delete the references to .H files from the make file manually, or to copy all include files into the current directory. The company says that this problem will be fixed in a future release, which will include full path names of files in the dependency list.

Most of the problems I had with C++/Views were due to its poor installation program, which was unable to compile as installed and had an incorrect linker response file. You must first alter the script that generates the linker response file, depending on which linker you have. The procedure is described in the READ.ME file, though.

The class library is modeled on Smalltalk's library. It's a hierarchy rooted with an object class and will be quite familiar to Smalltalk programmers. It also has a well-designed underlying architecture for dealing with event-driven programs. There is a notifier that takes care of dispatching Microsoft Windows messages throughout your program. A View class takes care of interactions with Windows for the most part, and the application itself should be separate from the

Windows messages and interactions.

The Windows classes provide a much cleaner object-oriented interface than the typical Windows Software Development Kit library does. You call virtual functions for various messages. For instance, instead of writing a Windows function with a big `switch` statement in it for handling each message type, you simply derive a class and redefine the functions of interest. You use member functions of this Windows class instead of Microsoft Windows primitive calls, which makes programming much easier and less error-prone.

C++/Views is a mostly successful attempt to make C++ look like Smalltalk. The class hierarchy, the browser, and the model/view/controller structure are all borrowed from Smalltalk. Even the examples in the manual are taken from Smalltalk texts. However, the terminology used in the manual is also that of Smalltalk, not C++.

If you wish you were using Smalltalk (or perhaps porting from it), this is a very good product for you. But if you are comfortable with C++, you might feel alienated by C++/Views.

### Financial MathLib++

Greenleaf Software's Financial MathLib++ (\$199) is a library for business applications. It features a fixed-point numeric type that can handle large decimal numbers with exact precision, several date classes, and functions commonly required by financial applications.

The installation program is fairly robust. It can copy the libraries from the release disks or rebuild them if you have the source option (source code is free to registered users). I planned to install large and small models, and since the manual said that only the large model with VROOMM was on the disk, I told the program to rebuild. It seemed to take forever to compile. In fact, I read part of the manual and had a snack, and it was *still* compiling.

Interestingly, each file contains only a few lines. In general, each file is a single function, which is what you want in a fine-grained library, so you don't link in code you don't need. The main problem is the include files. The full set of include files is brought into the program, even though you are only compiling a single member from a single class and often don't need anything other than that class definition.

The foundation of the library is the Decimal number class. Floating-point is unsuitable for many applications, because the binary representations of numbers do not behave in the same way as decimal numbers. For example, 0.1 cannot be represented exactly in binary. The Decimal class is a numeric type that behaves exactly like decimal numbers. It offers a 64-bit mantissa, which gives 18 or 19 significant digits. The exponent is in base 10. Any decimal number you write with less than 19 digits is represented exactly.

The Decimal class stores its data in a format that matches the C representation of the decimal number. This format lets you use the code in assembly language functions easily and share it between C and C++ implementations. Greenleaf Software explains that the code is protected so that friends and members can access it but other classes and functions cannot. Yet the company includes a public declaration that completely removes all protection from it. All the arithmetic operators are defined for Decimal, as are conversion operators to other arithmetic types and strings, and constructors taking various arithmetic types and a string (so you can specify values that would be inexact as a compile-time literal).

The company also provides iostream support for this class. Financial MathLib++ recognizes the formatting flags, such as width and precision, but it does not recognize other important flags (e.g., fill character, justification, and showpoint flags). It only applies the precision setting if the width is nonzero and crashes if the width is 32 characters or greater. The input function also has problems: It will break at a white space instead of the first nondecimal digit and crash if there are over 80 characters before a space, and it does not set the ios error flag if the input does not look like a decimal.

The program also has input and output functions that are enhanced versions of printf() and scanf() and know about the new types. However, they know about the C versions, not the C++ versions, of these types. For example, you

have to use the (DEC\*) cast on a decimal before passing it (note that C++ cannot implicitly convert, because this argument is in the ellipses part of the parameter list).

In addition to the Decimal class, Financial MathLib++ has DecimalArray, which is a typical vector class using Decimal as the element type. There are also several date classes, which you can use for different effects and purposes in financial calculations. These classes include Date360 (used in bond functions), Date365, and Date365NoLeapYear.

Besides supplying a number class suitable for use in financial functions, Financial MathLib++ has many functions for using them. There are functions for interest, amortization, cash-flow analysis, annuities, depreciation, and bond functions. Statistical functions are also included.

All in all, the Decimal class is quite useful, and it could prove essential in programs that need BCD-like math (especially since the BCD classes that come with Turbo C++ don't work correctly). The overloaded operators and other aspects of the class are all very good.

However, the rest of the library looks like it was too hastily converted from C. The C++ I/O is flawed, and most I/O has to be done with C-like functions. It would be nice if the various Date classes had a common base class, virtual functions for days between dates, and so on. Besides the I/O, the only real problem I found was the lack of const on some parameters. Most functions are OK, but you can't pass a const for the interest rate when calling Amortize(), for example.

#### M++

Dyad Software's M++ 2.0 (\$295) is a library for dealing with matrices and linear algebra concepts. It has array classes for various element types, including all the built-in arithmetic types and complex numbers. Arrays of up to four dimensions are provided, and you can add more dimensions if you get the source code. Ragged and rectangular arrays are also possible.

The manual's instructions are quite clear, and a quick-reference card is also provided. The program is quite intuitive, and its intended audience should be able to use the library with little or no further instruction.

There are functions for creating, re-dimensioning, and filling matrices. For example, you can fill all elements with the same value, stepped values, or random numbers with the fill(), seq-

# SEE YOUR DATA!



*New MapInfo for Windows™ and MapInfo for Macintosh™ can find, display, and analyze your data geographically. Overlay data directly from spreadsheets, databases and ASCII files onto maps—from worldwide to street level. We can even supply maps and data for the entire U.S. Street maps, ZIP codes, counties, demographics, and more.*

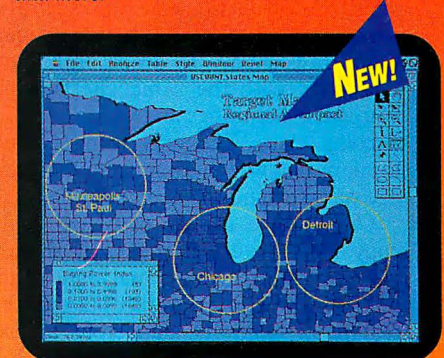

*Work with your data in three ways: on maps, graphs, and in traditional rows and columns. Use the built-in SQL querying tools to perform powerful analyses. And now, you can share data across platforms. MapInfo looks and acts the same on Windows and Macintosh.*

Now, there are more ways than ever to see your data with MapInfo. Whatever your platform—DOS, Windows™ or Macintosh®—MapInfo can help you see patterns, trends, and opportunities you may have otherwise missed.

## MapInfo® Corp.

Changing The Way The World Looks At Information®

200 Broadway Troy, NY 12180  
Call 1-518-274-8673 or 1-800-FAST-MAP  
for a reseller near you.

MapInfo and Changing The Way The World Looks At Information are registered trademarks of MapInfo Corp. Others are trademarks of their respective owners.

Add(), randUniform(), and randNormal() methods. There are also functions for printing matrices to C++ iostreams, ASCII files, and binary files. The program can read back matrices in any of these formats.

M++ includes just about every mathematical function you're likely to have heard of. But if that's not enough, there are generalized inner and outer functions, row iterators, and other functions that can apply user-supplied functions to elements in various ways.

Naturally, elements can be accessed. You have a choice of bounds-checking or no bounds-checking on a global level. Besides accessing a single element (with operator()), you can access subarrays. You can, for example, take just the first and last columns and treat that as a two-column array.

For using M++ in analyses, there are handy little functions such as solve(), which solves simultaneous linear equations. If you have to do several linear equations with the same coefficients, you can speed things up by using an LU-decomp class. The only thing I could think of that was missing from the package was the handling of eigenvalues.

One strange feature of M++ is the copy constructor. It makes a shallow copy by aliasing the actual data of the matrix. The manual points out that this feature is somewhat dangerous to use. On the other hand, the Assignment feature simply makes a copy of the data. I wonder why the software was implemented this way.

The instructions explained how to set the INCLUDE and LIB environment variables (for use with Zortech C++) or the CFG file (for use with Turbo C++). There is a simple test program that creates and prints a matrix; it did not compile on the first try. Zortech's linker was smart enough to explain that I had compiled the sample in small model, and the library was in large model. Dyad Software should have supplied a one-line batch file to compile the example (or serve as a typical example of the command line to use).

M++ 2.0 is a highly specialized library. It works very well for those who need special arithmetic. In addition, those who do numerical analysis or statistics may find C++ a better choice than other languages because of this library.

#### Tools.h++

Rogue Wave's Tools.h++ (\$200) contains not one but two sets of collection classes. One is similar to Smalltalk, but with some noticeable differences. The

#### COMPANY INFORMATION

**CNS, Inc.**  
(C++/Views)  
Software Products Dept.  
7090 Shady Oak Rd.  
Eden Prairie, MN 55344  
(612) 944-0170  
fax: (612) 944-0923  
**Inquiry 1060.**

**Dyad Software Corp.**  
(M++ 2.0)  
19650 151st Ave. SE  
Renton, WA 98058  
(800) 366-1573  
fax: (206) 228-3178  
**Inquiry 1061.**

**Greenleaf Software, Inc.**  
(Financial MathLib++)  
16479 Dallas Pkwy.,  
Suite 570  
Dallas, TX 75248  
(800) 523-9830  
fax: (214) 248-7830  
**Inquiry 1062.**

**Rogue Wave**  
(Tools.h++)  
P.O. Box 2328  
Corvallis, OR 97339  
(503) 745-5908  
fax: (503) 745-5908  
**Inquiry 1063.**

**Zinc Software, Inc.**  
(Zinc Interface Library)  
405 South 100 East,  
Suite 201  
Pleasant Grove, UT 84062  
(801) 785-8900  
fax: (801) 785-8996  
**Inquiry 1064.**

classes lack a single root, and there is no object class. Anything that is derived from the Collectible class can be stored in one of the collection classes. The idea is to take a class that already exists and add Collectible to it to create a new class when needed. For example, there are a String class and a CollectibleString class; they are derived from both the String and Collectible classes. A small section in the manual adequately discusses the design issues and why the design is done this way.

There is also a set of typedefs that give some of the classes Smalltalk-type names. For example, a binary tree class becomes known as SortedCollection. You can change the typedef associations to suit your preference.

A second set of collection classes is based on the generic macros. They create new classes as needed to hold different data. It is a fairly complete set of classes that includes vectors, linked lists, and queues.

The documentation does not provide a summary of the library's contents, but browsing through the reference guide turned up a few interesting items. Class BTreeOnDisk is a B-tree index manager. It can be used with other classes in the library as an efficient indexed file system. The RWDate class provides Julian date manipulation.

The manual gives details on how to use the library for each supported compiler, showing which compiler switches are used. The only thing you need to do is point the compiler at the include files and choose the correct library during linking. A number of sample programs are given; among them are make files for both the Borland and Zortech compilers. Everything worked on the first try.

The Tools.h++ library is clean and easy to use. The collection classes fit well into existing code and don't take over a program.

#### Zinc Interface Library

Zinc Software's Zinc Interface Library (\$199.95) is a library for developing the user interface of a program. It supports windows that can be moved and resized, and it sports pull-down menus and dialog boxes. What is interesting is that the library can be used to make text-mode as well as graphics-mode programs. In fact, it makes programs that can run in both modes.

I found the supplied sample programs sluggish when running in graphics mode with a Hercules card. With a VGA card, performance was downright slow. One particularly annoying aspect is that when you move or resize a window, mouse operations are much slower than normal. In text mode, however, the performance is very good.

My first impression while using Zinc Interface Library was that it should operate the same way Windows or other GUI systems (e.g., GEM, the Amiga, and the Mac) do, so I found it difficult to use at first. My presuppositions got in the way. The program will actually be very easy to understand for users who don't know anything about GUIs.

You can create a window, but there are no rendering functions. Instead of drawing something on a window (e.g., in response to a redraw message of some kind), the window is filled with window objects. Thus, you don't draw a string on



'CommonView makes Windows and PM applications easier to use. The compiled applications are very fast...'

Dr. Dobbs

'Logical, well structured and easy to use. CommonView and C++ is about 3 to 5 times more productive.'

British Airways  
Development Technologies Department

'Developers aiming at multiple platforms will find CommonView worth it. It is a mature tool that merits serious attention.'

PC Week

# A CommonView Shared By Many

As you can see, reviewers and customers love CommonView. They know it provides the best solution to GUI application development.

That's because CommonView is inter-operable: from the development environment to the destination, *CommonView can be shared by many.*

CommonView's support for portable GUI applications is well established - with an OSF/Motif version on the way.

Now CommonView gives you more C++ compiler support because it now works with Zortech C++.

So Zortech users can enjoy the CommonView benefits previously enjoyed by Glockenspiel C++ developers.

Like productivity, reduction in code volume and faster development.

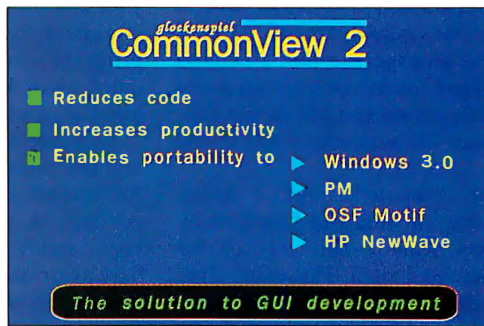

CommonView's new support for Zortech C++ marks the beginning in extending CommonView to other C++ compiler users.

It means C++ developers have full control over their development environment to extract optimum performance from the final application.

Existing CommonView developers use Glockenspiel C++ and develop from within Microsoft's Programmer's WorkBench; Zortech C++ users do so from within ZWB.

But CommonView is inter-operable.

For example, developers have the opportunity to use Zortech for rapid development, using Glockenspiel C++ for final integration.

CommonView is a high performance engine for GUI development: *you choose how to drive it.*

**Available now for Zortech C++**

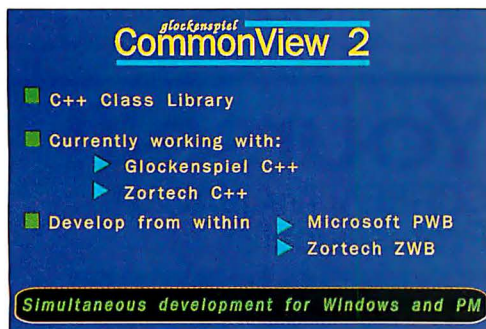

#### Specifications:

CommonView 2 for Glockenspiel C++ requires Glockenspiel C++ 2.0 and Microsoft C 6.0.

CommonView for Zortech C++ requires Zortech C++ 2.1\*

Windows SDK and/or PM SDK also required. Debug with CodeView for Windows.

CommonView tutorial and class library reference manual included. CommonView consists of over 70 classes.

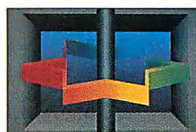

*glockenspiel*  
class constructors

#### To order:

■ **North America: Imagesoft, (516) 767-2233. Fax (516) 767-9067.** ■

Europe: UK: QA Training Ltd. (0285) 655888. Fax (0285) 650537. Italy: Inferentia, (02) 26680568. Fax (02) 2364258. Germany: PSI, (06021) 492-0. Fax (06021) 492-112. Benelux: Rijnhaave, +31 (71) 218121. Fax +31 (71) 216118

■ **Glockenspiel, 39 Lower Dominick Street, Dublin 1, Ireland. +353 (1) 733166. Fax +353 (1) 733034** ■

Glockenspiel CommonView and Glockenspiel C++ are registered trademarks of Glockenspiel Ltd. The trademarks of their respective corporations are acknowledged.

a window, but create a string object and stick it on the window. Then you can forget about it.

Interestingly, there are no graphics functions. The only graphics are icons, which you stick on windows. I called Zinc Software technical support and described an application I was trying to write that contained a window with a graph on it. I was quickly routed to someone who was an expert in that area, and he straightened out my conceptual problems and referred me to a file on the Zinc BBS that demonstrated what I was trying to do.

From the company's BBS, I downloaded a program that did graphics by creating new window-object types for lines, circles, and such. However, Zinc Interface Library had to create a new device type (derived from the normal one) to handle it. There was no redraw function in the window-object class; rather, the device class had a giant case statement in it to draw each window object.

Zinc is not a general-purpose graphics library; it is meant for forms, menus, and dialog boxes only. It is fairly easy to use and can be customized (although creating a table with palette or event codes in it is easy in principle but tedious in practice). But it doesn't do anything else, and it is rather difficult to extend. It is possible to add your own editing fields and other types to the window-object classes, but there are no instructions for these operations in the manual.

After creating a window, you stick all the fields and buttons and such on it. There are objects that enhance the win-

dow (adding the border, title, and maximize, minimize, and system buttons) and the menu. Other window objects let you place text, icons, and editing fields on the window. Once the window is all set up, there is nothing more for your program to do; the Zinc event manager takes care of everything. You can have the results of your editing stay in the field objects until you check their new values, or have your program's variables automatically updated when the user modifies the objects associated with them.

In addition to the windowing support and the event manager, there is support for context-sensitive help and error reporting. A utility lets you build help files, and various window objects can have associated help messages. The error system lets you activate your own code and actions when run-time errors occur within the library. This feature lets you have a uniform approach to all errors and integrate Zinc Interface Library's errors into the methods you use to handle errors in the rest of your program.

The documentation is fairly helpful. The theory and architecture is explained first, followed by a series of sample programs. For more information, a technical reference and more sample programs are included. However, only the public interface is documented. How to extend the library (the protected interface) is not covered. You can download other examples covering more advanced items from the company's BBS, but there is no documentation to go with them.

Zinc Interface Library is comparatively easy to use. However, you should

make sure you know just what it is before buying it, or you could be disappointed. My only other criticism is that the library uses too much text in ALL CAPS and could benefit greatly from default parameters.

### A New Frontier

Proponents have long insisted that object-oriented technology is naturally suited for certain tasks, and the libraries reviewed here offer a glimpse of the success achieved thus far. Things look good for object-oriented programming, but there is still a long way to go. Programming interfaces for operating systems and standard GUIs would benefit greatly from OOP wrappers, but very little of that has been done yet (at least in DOS). Until a programmer can write an entire application in C++—I/O and all—there will continue to be resistance. But promising solutions are just around the corner.

By far, the greatest competition that OOP languages and libraries face is not one another, but conventional languages such as C. Wooing programmers away from their familiar environments and into the turbulent world of C++ is a difficult task, but these stoic vendors deserve credit for being among the first to risk their capital on a foray into the fledgling C++-class library market. Users, programmers, and these vendors' present and future competitors will all be watching their progress carefully. ■

*John M. Dlugosz is a programmer, writer, and consultant based in Plano, Texas. He can be reached on BIX as "jdlugosz."*

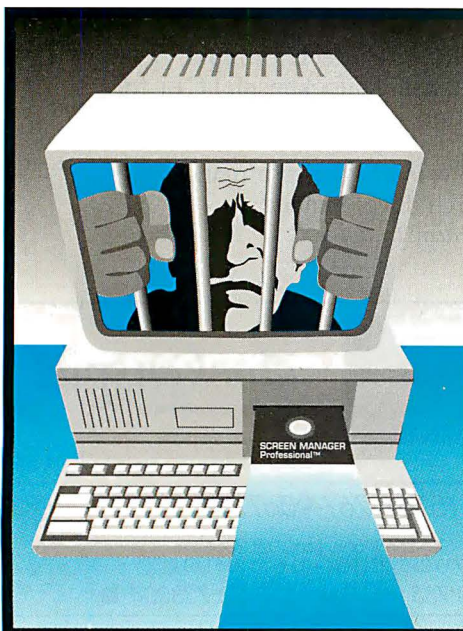

## Free Yourself! With SCREEN MANAGER Professional™

Concentrate on the substance of your programs with the advanced interface design library for C programmers. SMP gives your applications:

- Windowing
- Menus
- Mouse Support
- Field oriented data entry
- Interactive field building utility
- Keyboard Support Functions
- Contact Sensitive Help with Hypertext
- Low RAM Overhead / High Speed
- User attachable validation functions

Linkable with: Microsoft C - Zortech C, C++ - Quick C  
Turbo C, C++ - Watcom C

Only \$349.95

Source code available

**MAGEE™**

Call today for a free demonstration diskette

1-800-662-4330

P.O. Box 1587, Norcross, GA 30091 USA 404-446-6611 / BBS 404-446-6650



ZEOS<sup>®</sup>  
Simply the best  
notebook you  
can buy.

Take it from the experts:



ZEOS NOTEBOOK 286

POWER LOW CHARGE FDD HDD Caps Num Scroll  
BATT LOCK LOCK LOCK



# 10 Good Reasons To Buy From ZEOS®

## Reason #1 "Overall Excellence"

As *PC Magazine* said "Price is always a consideration. So are benchmark test results. But both factors can be deceiving, which is why we consider them in the context of other aspects that will make the difference months and years down the road"

These are the attributes which *PC Magazine* used in awarding ZEOS the coveted Editor's Choice, not once but four times. And "Overall Excellence" are the very words *PC Magazine* used in describing ZEOS systems comparing them to all others.

## Reason #2 Dazzling Performance.

In one recent '386 review, *PC Magazine* awarded ZEOS Editor's Choice. "The ZEOS '386 blows away every other computer... a smart choice" is what they said. And in another recent review, *Government Computer News* said the ZEOS 33MHz '386 is "arguably the fastest MS-DOS and OS/2 micro in the world"

Dazzling Performance is built into every ZEOS system. It's a key component of ZEOS Overall Excellence.

## Reason #3 Exceptional Quality.

*PC Resource Magazine* put it this way, "ZEOS... provides quality comparable with IBM or Compaq and does so for about 70% of the price." ZEOS uses only the very best components. And every system is fully tested and burned-in right in our own labs.

## Reason #4 Value.

*InfoWorld* says, "We find the ZEOS '386 an excellent value. Speed: Excellent. Compatibility: Excellent.

**24 HOURS!**  
ZEOS is Open  
24 Hours a Day,  
365 Days a Year!  
Toll Free!

Value: Excellent"  
*Personal Computing* said, "ZEOS... is the best value we've come across... its performance is right up there with the slickest, most expensive PCs you can buy."

## Reason #5

### Warranties and Guarantees.

ZEOS believes in its products. That's why we offer each and every customer our 30 Day Absolute Satisfaction Money Back Guarantee, no questions asked. Plus, our One Full Year Limited Warranty and Express Parts Replacement Policy. Optional On Site Service is available too. Call for details.

## Reason #6

### 24 Hour Toll Free Technical and Sales Support.

At ZEOS, the customer is #1. That's why we invented 24 Hour a Day Tech Support. For *your* convenience. If you buy a product from us we feel we should be there to help, any time of the day or night. Give us a call Toll Free! 800-423-5891. Anytime!

## Reason #7

### Experience.

Almost unique in the mail order computer industry, ZEOS maintains its own chip level Research and Development staff. In addition to Systems Manufacturing, we also operate our own Board Level Manufacturing facility.

ZEOS has been involved in Research and Development since our incorporation back in 1981. Our strong and experienced Research, Manufacturing and Technical Staff translates into superior factory direct computer systems for you.

## Reason #8 A Sterling Reputation.

In magazine after magazine and review after review ZEOS systems are cited for Overall Excellence, for Excellent Value, as the Right Choice and so on. All of this is flattering but the most important thing is this: What do our customers think? Frankly, they love us. The systems and the support. That means more to us than anything.

## Reason #9

### Easy to Buy.

ZEOS systems are easy to buy. You can pick up the phone any time of the day or night and order your new ZEOS computer. And we accept MasterCard, Visa, American Express, and Corporate Purchase Orders from Fortune 1000 Companies, Colleges, Universities and Governments. Complete Leasing Programs are available as well.

And now the Z-CARD! It's your very own ZEOS Credit Card and you can apply today. With the Z-CARD you can charge your ZEOS purchases and pay in easy monthly installments. It's just like a Bank Card. Why not apply for your Z-CARD now!

## Reason #10

### You're Going to be Very Satisfied.

When it comes right down to it, you're going to be very satisfied with your new ZEOS system. Our goal is your complete satisfaction. And that's our commitment to you. To quality. To performance. To reliability and support. To *Value*. We don't just say it, *we Guarantee it!*

FAX Orders Dial: 612-633-1325  
In Minnesota Call: 612-633-4591  
MasterCard, VISA,  
AmEx, Z-Card  
and COD  
Open 24 Hours a  
day, 365 Days  
a year.

Order Now  
Toll Free

**800-423-5891**



**"THERE'S A NEW KING OF THE HILL"**

—PC MAGAZINE

"King of the Hill... Impressive... The best price-performer... An outstanding value... A steal... The number one contender..." We couldn't have said it better ourselves. The experts love the new ZEOS Notebook. And you will too. At only \$1995 for our '286 version and \$2295 for our new 386SX, you simply can't find a better notebook anywhere!

As PC Magazine said, the ZEOS Notebook "offers a top notch combination of power, weight, features and price..." And you can pick your power! Choose our '286 version or go for the incredible new ZEOS '386SX. Combine either with our high speed hard disk, built in 1.44MB floppy drive, VGA and more—you've got the greatest notebook going at any price!

**INCREDIBLE DESKTOP FEATURES IN A NOTEBOOK.**

In fact, it's really like owning a 6.5 pound desktop that you can take with you anywhere! Look closely at the details. Like our crisp 10" VGA display. The ultimate in sparkling clarity, it features advanced fluorescent backlighting for vivid VGA graphics. Then, the drives.

Two drives are better than one! First, your notebook will include our whisper quiet high speed, high capacity hard disk. It will read and write your data so fast chances are you'll hardly know it's there. Then we're building in an industry standard 1.44 Megabyte 3.5 inch floppy as well.

While most notebooks don't include a floppy drive at all, you're really going to appreciate your ZEOS notebook's industry standard 3.5" floppy. It makes loading software and transferring files a breeze. Simply toss in your 1.44 and it's done. Anyway, can you imagine a desktop system without a floppy? We couldn't either. That's why your ZEOS notebook has one. It's great!

But the features of your incredible new ZEOS Notebook don't just stop there. Detail after detail we're giving you more than anyone else. Much more, for much less. Take a closer look.

**DETAILS MAKE THE DIFFERENCE!**

For instance, the battery system of your new notebook is the most advanced on the market. You can quick charge, or trickle charge, any time your system is plugged in. You can also take the battery out and use the optional charging stand if you wish.

Either way, you're sure to appreciate

# Light Load

# From

Now, you can  
computing po  
The incredible



'286 AND 386SX

t and  
ded.

our light weight snap-in, snap-out battery packs. They're so light and easy to use, you can easily take an extra one with you on those really long trips. You can get even more life out of a single charge by using our programmable power management system. Hour upon hour of Notebook computing power!

**CONNECTIVITY TOO!**

Your new ZEOS notebook is a great connectivity tool. Utilizing our optional built-in 2400 baud MNP Class 5 modem, connectivity buffs will find themselves

logging on at every turn. And speaking of connectivity, we've kept the I/O easy to use too. Because unlike many of the others, your new ZEOS notebook has the same industry standard port connectors you'll find on your larger desktop system. Completely compatible! Serial and Parallel ports; even an external VGA connector. All industry standard and ready to go the minute you receive your system.

It's attention to detail that makes the difference. Tens of thousands of hours of development time have been invested. We've been thinking and re-thinking exactly what you want in a notebook, and now we're building it for you. We think you'll agree, it's an incredible product. Plus, your new notebook is backed by the best support in the industry, 24 Hours a Day.

\$1995!

**ZEOS 24 HOUR A DAY SUPPORT.**

After all, it was ZEOS that invented 24 Hour a Day Toll Free Sales and Technical Support. We're always here to help. Any time you need us your telephone is a Toll Free Hotline—direct to your own personal Technician. 24 Hours a Day, 365 Days a Year. Now that's ZEOS value. But we don't stop there either.

Your new notebook is also backed by our 30 Day Absolute Satisfaction Money Back Guarantee, One Full Year Limited Warranty and Express Replacement Policy. You're going to be very satisfied. We don't just say it. *We Guarantee It.*

**ORDER YOUR OWN ZEOS NOTEBOOK NOW!**

You can order your new ZEOS notebook *right now*. Simply pick up the phone and give us a call now at 800-423-5891. At last, a full featured notebook that lets you compute anywhere. You're going to love it. That's a guarantee!

**ORDER NOW TOLL FREE:  
800-423-5891**

take desktop  
power anywhere!  
ZEOS Notebook.



**NOW. YOUR COMPLETE '286 NOTEBOOK! VGA, 20MB HARD DRIVE, 1.44MB FLOPPY AND MORE. LIGHT AND LOADED! INCREDIBLE.**

**ONLY \$1995  
386SX ONLY \$2295!**

- **Genuine Intel® 80286-12 or 386SX-16 CPU.**
- **1MB DRAM, expandable to 3 or 5MB.**
- **20MB High Speed HDD.**
- **Built in High Density 3.5" 1.44MB floppy drive.**
- **High Resolution VGA display. Fluorescent backlit 640x480, 32 grey scales. Bright and clear!**
- **Removable quick charge NiCad battery. Two hour plus battery life typical, more using Programmable Power Management!**
- **Quick charge or trickle charge using included AC power adapter.**
- **Extra battery packs and external charging stand available.**
- **82 key keyboard. True 101 key emulation.**
- **Industry standard Serial and Parallel Ports.**
- **VGA port for external VGA color display. Great for demos!**
- **Total system weight under seven pounds with battery!**
- **30 Day Absolute Satisfaction Money Back Guarantee and ZEOS Customer Satisfaction Package.**
- **One Full Year Limited Warranty.**
- **24 Hour a Day Toll Free Technical Support, 365 Days a Year.**

**ORDER NOW TOLL FREE:  
800-423-5891**

**FAX Orders: 612-633-1325  
Minnesota: 612-633-4591  
Hearing Impaired (TDD)  
Orders: 800-228-5389  
Outside US and Canada:  
612-633-6131  
MasterCard, VISA, Am Exp,  
Z-CARD and COD  
Open 24 Hours a Day,  
365 Days a year!**



Available. All prices and specifications are subject to change without notice. Please call to confirm pricing, specification (Intel Corporation). © 1990, ZEOS International, Ltd., 530 5th Avenue, N.W., St. Paul, MN 55112 USA.

# A few expert opinions:

*"There's a new king of the hill—the ZEOS Notebook..."* — **PC Magazine** ■ *"This notebook is a*

*steal."* — **InfoWorld** ■ *"In this category I'm most impressed with the ZEOS Notebook...it has to be the number one contender."* — **John C. Dvorak**

■ *"The best price performer in its category."*

— **Mobile Office** ■ *"An outstanding value."*

— **PC Week** ■ *"Impressive"* — **PC Sources**

## Impressive Indeed!

## And The Price?



Your New ZEOS Notebook.  
Take your pick!

As a '286  
Only \$1995!

As a '386SX  
Only \$2295!

80286 or 80386SX, Hard Drive, Floppy Drive,  
VGA, Under 7 lbs., Beautiful!

Unbelievable.  
Believe It!

Call Now!  
800-423-5891

# The ZEOS Guide to the Perfect Notebook:

 **PROCESSOR:** PC Magazine recommends a '286 or '386SX processor pointing out that "8086- and 8088-based portables have only half to a third of the computing power of a 286." That's why ZEOS offers you your choice, '286 or 386SX! More power for you. After all it's just like a 6.5 pound desktop!

 **DRIVES:** *Two drives, built in!* A whisper quiet high speed 20 Megabyte hard disk *plus* a 1.44 Megabyte 3.5 inch floppy. Remember, with a built in floppy drive you don't need to fool around with strange interfaces to load and transfer files.

 **VIDEO:** ZEOS raises the ante to VGA! We're talking about bright and crisp VGA displayed on one of the largest notebook screens in the industry. The display also features advanced fluorescent backlighting, 32 grey scales and 640 x 480 resolution. Plus, it can be adjusted to any position over a 135° angle and features easily adjustable brightness and contrast controls. Easy viewing under virtually any lighting conditions. You can connect to an external VGA color monitor too!

 **GREAT BATTERY FEATURES:** Every battery feature you want. You can plug your notebook in and "quick charge" the battery in less than one hour or you can "trickle charge" while in use. Plus, your battery easily snaps out allowing the quick installation of an optional replacement battery. It's great to be able to carry a light weight spare for those especially long trips. An optional battery charger stand is available as well.

 **INTELLIGENT POWER MANAGEMENT:** Your new ZEOS notebook features an intelligent programmable power management system if you wish to use it. Based on the length of time since your last keystroke, you may reduce CPU speed, display screen backlighting etc. Full power is immediately restored at the stroke of any key. The system even knows *not* to use the power management system when you are operating on AC power!

 **SYSTEMS STATUS AT A GLANCE:** Yes, monitor eight key system components at a glance! We've equipped your new notebook with eight LED indicators which monitor disk access, keyboard functions and power status. There is even an audible alarm

which may be programmed to inform you of a low battery condition and to let you know if the cover is closed with the power on. Now that's one smart notebook!

 **DESKTOP KEYBOARD FEATURES:** We're talking 82 full size keys with full 101-key emulation. And the keyboard isn't squeezed either. The distance between the "Q" key and the "[" (left bracket) key measures 7.5 inches, just as PC Magazine suggests. The keys are of standard size, plus touch typists will love our full 3.5mm keystroke. Type for hours and love it!

 **CONNECTIVITY AND I/O:** Keeping in touch is easy when you order our internal 2400 baud MNP Class 5 modem. Simply plug in the phone line and dial away. How about I/O ports? Many notebooks don't have them and if they do they're often non-standard. But your ZEOS notebook has *industry standard* I/O—serial, parallel and VGA. Just like your desktop!

 **FCC & UL APPROVALS:** Your new ZEOS notebook features both FCC Class B and UL approvals. We've also met CSA and VDE requirements too, just for good measure. Quality and reliability.

 **WATCH THE DETAILS TOO:** Like memory expandability. One Meg comes standard, you can also order a total of 3 or 5MB as a factory option. And lots of other details. Like a recessed power-on reset button, a soft carrying handle, built in speaker and more. You're going to love it! And there's no reason to wait.

**CALL NOW TOLL-FREE:  
800-423-5891**

## CHECK IT OUT!

**Now, you can take desktop computing power anywhere! Your ZEOS notebook has many features of obvious importance. Also, there are a number of features that are subtle yet critical to your ultimate satisfaction. We'll go over them here one by one. We think you'll agree your new ZEOS Notebook is the one for you!**

## REVIEW

## The Littlest SPARC



**Photo 1:** The Sparcstation IPC's tiny case is just large enough to hold up to 24 MB of RAM, one 3½-inch SCSI hard disk drive, one floppy disk drive, and two SBus expansion cards. The taller case is the expansion unit, housing a SCSI hard disk drive and a tape drive.

A colleague of mine recently quipped that the trend toward miniaturization of systems would result in a workstation contained in a mouse. That's a laughable concept, but the Sun Sparcstation IPC is an obvious embodiment of that same "smaller is better" spirit. Sun has crammed a complete workstation into a trademark-beige case roughly 4¾ by 9½ by 10½ inches (see photo 1). And when I say *crammed*, I mean it.

### Fill'er Up

The IPC that I reviewed arrived almost fully loaded: 24 megabytes of memory, 207 MB of internal hard disk storage, two serial ports, a thick Ethernet port, an external SCSI connector, an audio I/O connector, a color frame-buffer board, SunOS 4.1, and OpenWindows. The only internal expansion option left was a single SBus slot. This configuration will run you \$13,495, but the base machine

with 8 MB of RAM, a 207-MB hard disk drive, operating-system software, and a 17-inch monochrome monitor comes in at just \$7995.

As photo 2 shows, Sun has packed components into the IPC. The lid snaps to the top of the unit, secured by a single screw. This is no ordinary lid, however: It's lined from stem to stern with components. Sun fastened the hard and floppy disk drives, fan, and power supply to it. The IPC's designers thoughtfully made the cables attaching the top and bottom halves long enough to permit the opened assembly to lie flat for inspection or alteration.

Internally, there's room for only one 3½-inch SCSI hard disk drive. With storage densities on the rise, that won't be a limiting factor for long. The standard 207-MB internal hard disk drive has enough room to hold all of SunOS 4.1 and OpenWindows. That will get you

started, but you'll want to hook up another hard disk drive for applications and data files. Externally, the sky's the limit. The SCSI port on the back of the machine supports expansion devices such as Sun's combined disk/tape subsystem (the taller box in photo 1). Another option is to network to one or more Network File System- or Remote File System-based file servers.

I applaud Sun's ingenuity in designing a box that takes up practically no space on a desk, but I wonder if anyone needs something so small. The keyboard dwarfs the system unit, and the base of the 16-inch Sony Trinitron monitor is larger than the IPC—it hangs over on all sides. I would rather have had room for another internal drive or more than 24 MB of memory.

The rest of the hardware is what I've come to expect from Sun. The keyboard and mouse both operate smoothly (although some BYTE editors see the optical mouse, which requires a stiff plastic pad, as a throwback to the Dark Ages). The Sony monitor's clarity and color accuracy enhance every graphical user interface (GUI) the monitor displays. The front-mounted 3½-inch floppy disk drive is a high-density model with motorized eject—a nice touch. Using SoftPC from Insignia Solutions (not included with the IPC), I copied DOS files to and from the floppy disk drive and ran DOS applications on a software-emulated 286.

### Through OpenWindows

I wrote at some length in the Sparcstation 2 First Impression (see "Son of SPARCstation," December 1990 BYTE) about the beauty of Sun's SunOS 4.1 and OpenWindows 2.0. I had more time with it on the IPC, and Sun's software has earned my respect.

OpenWindows is an application environment that allows X Window System, Open Look, SunView, and News (and, optionally, DOS) programs to share a single display. News blends the flexibility of PostScript with the portability of X Window 11.4, making scalable fonts and graphics available to developers.

SunOS 4.1, whose engine purrs beneath OpenWindows, is also something of a melting pot. Sun has positioned it as a stepping-stone to Unix System V release 4. SunOS is now compatible with System V, as well as with POSIX 1003.1 and X/Open XPG2 specifications (both are based mostly on the System V Interface Definition). Separate directories contain commands whose behavior is specific to one of the supported flavors of Unix.

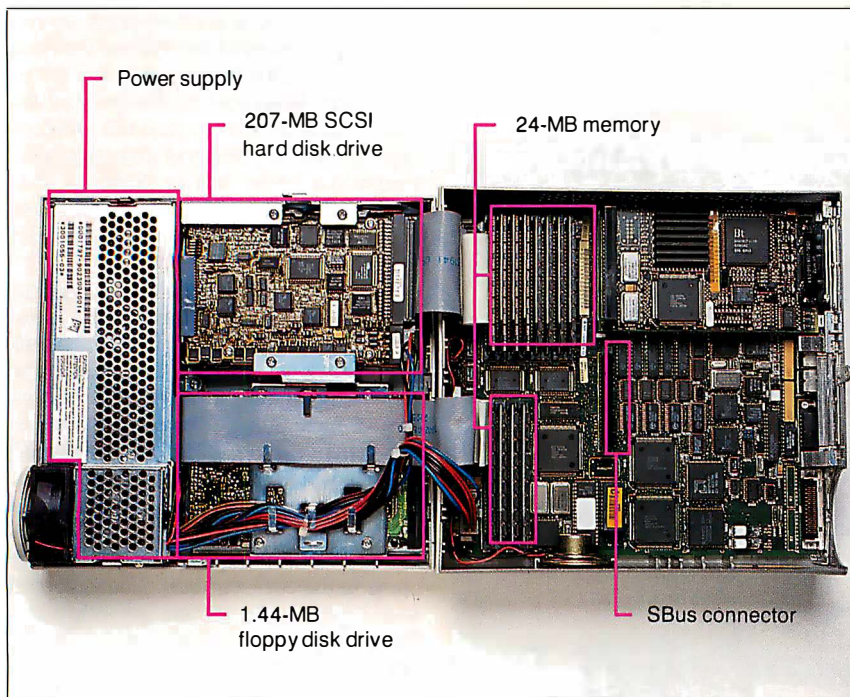

**Photo 2:** The interior of the Sparcstation IPC shows just how much Sun has packed into this tiny box.

## Sun Sparcstation IPC

### Company

Sun Microsystems, Inc.  
2550 Garcia Ave.  
Mountain View, CA 94043  
(415) 960-1300  
fax: (415) 969-9131

Sun Microsystems Europe, Inc.  
Bagshot Manor, Green Lane  
Bagshot, Surrey GU19 5NL, U.K.  
44-0276-51440

### Components (as reviewed)

Processor: 25-MHz SPARC  
Memory: 24 MB of RAM  
Mass storage: 207-MB SCSI hard disk drive; 3½-inch 1.44-MB floppy disk drive  
Expansion: Two SBus slots  
Display: 1152 by 900 pixels, 256 colors; 16-inch Sony Trinitron color display  
Keyboard: Sun-standard 107-key with optical mouse connector  
I/O Interfaces: SCSI, thick Ethernet, audio I/O, and dual serial ports

### Price

\$13,495

### Inquiry 1228.

You select your favorites by placing the appropriate directories in your shell's PATH variable. They all coexist, so if you want the System V behavior of `ls` but BSD Unix behavior for `ps`, you can arrange it. Existing Sun users are probably most accustomed to SunOS's BSD seasonings, but Sun's cooperation with AT&T in System V.4 development has resulted in a significant shift in focus.

The cross-environment compatibility simultaneously is and isn't all that it's cracked up to be. Can you execute X, SunView, and News/PostScript code on a single display? Yes, but there are a few "gotchas." One SunView application I tested, Island Graphics' Write, Draw & Paint, had trouble manipulating the mouse cursor. Moving it from the SunView window to an X window sometimes caused a phantom pointer to remain frozen in the SunView window. One SunView dialog box also had a small rectangle missing, through which the X root window was visible. Moving it, forcing a screen refresh, and iconifying and de-iconifying it all had no effect.

The other dent in OpenWindows relates to its handling of fonts. Technically, there's nothing that should keep you from being able to run OpenWindows applications on an X terminal or other display of your choice. The Open Look implementation on System V.4 stores the

needed fonts and bit maps in a format that allows X terminals and remote X servers to share them.

On the other hand, OpenWindows fonts are *not* in a shareable format. It took me an hour to figure out how to convert the OpenWindows cursor and glyph fonts and load them into the BYTE Lab's Altos System 5000 (running The Santa Cruz Operation's Open Desktop). I got them converted (Sun provides a `convertfont` utility) but had to build the needed `fonts.dir` font table file by hand. After all this effort, I was able to get an Open Look window manager session running on Open Desktop. This was good for amazing some BYTE editors (Open Desktop is OSF/Motif-based) but not much more; no OpenWindows applications would run. To manage that, I would have had to translate dozens more fonts, hand-tool a lengthy font directory entry for each of them, and fill holes in the color database.

What makes X Window so special is its effortless cross-platform global application environment. Sun should supply a directory with the needed font and bit-map files, translated for standard X servers and accompanied by a `fonts.dir` font database and an `rgb.txt` color database. X terminals and other servers could then mount this directory remotely, point the X server at it, and get run-

ning with minimal hassle.

Coming the other way, OpenWindows is flawless; any X application that you can run, even those that include OSF/Motif interface elements, runs on the X11/News server in OpenWindows. It includes the entire set of X11.4 fonts, a few extra ones, and even some that allow DECwindows applications to display on Sun screens (Sun has its own DECnet-compatible network software that makes connections to Ultrix and VMS systems).

### A Likable Development

Sure, the IPC is a cute little box, but can you do any *real* work with it? In this business, that's often codespeak for "what's it like to develop on?" To find the answer, I donned my developer's cap and went straight to work.

The BYTE Unix benchmarks compiled the first time without errors. That's not much of a feat, since we wrote them as generically as possible. To toss the system a curve, I chose a fairly complex X application: the superbly written `xv` X Window GIF file viewer. This application makes heavy demands at both compile and run time. I had to change the make file to look for the X libraries and header files in different directories. Convention dictates that they will be in `/usr/lib/X11` and `/usr/include/X11`, respectively. On the IPC that I tested, Sun

# The new look of power.



286 processing in a computer that's notebook size,  
1.4" thin and 4.4 lbs. light.

Introducing the TI TravelMate™ 2000 notebook computer — from the company that pioneered portable computing solutions.

Since inventing the first portable data terminal in 1969, TI has led the way in packing more and more functionality into smaller and smaller products. Now TI brings you the next generation in portable computing — the TravelMate 2000.

This sleek, 4.4-lb. notebook computer gives you the power of a PC-AT® in an ultrathin 8½" x 11" package. It's designed to fit your workstyle — wherever you work — in the office, at home or on the road. Just slip it in your briefcase with your file folders, journals and other business materials, and you're ready to go.

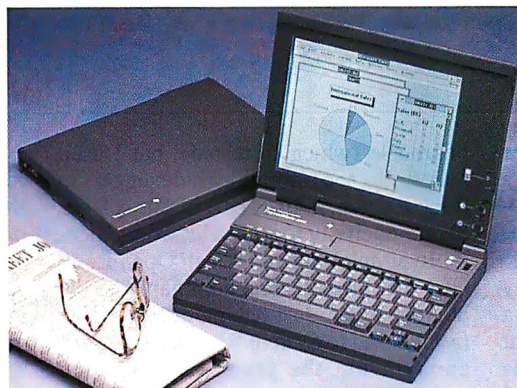

## Large VGA screen with leadership display technology.

You'll appreciate the technology behind the 10" diagonal VGA display. It's a remarkable feature for a computer that's notebook size. The high-resolution 640 x 480 supertwist screen easily handles demanding windowing and graphics applications.

## More features to meet your application needs.

The TM 2000 has the power to run your favorite software — 12 MHz 80C286 processor, 20MB hard disk drive and 1MB of RAM. A built-in, rechargeable battery lets you work up to two hours. With an optional add-on battery, you can work up to five hours — enough for coast-to-coast flights.

You also get a full-function AT enhanced keyboard, so you can work with the same feel of your desktop PC.

In addition, we've loaded MS-DOS® and LapLink™ in ROM, and preformatted the hard disk.

For more information call 1-800-527-3500.

  
**TEXAS  
INSTRUMENTS**



## UNIX BENCHMARKS

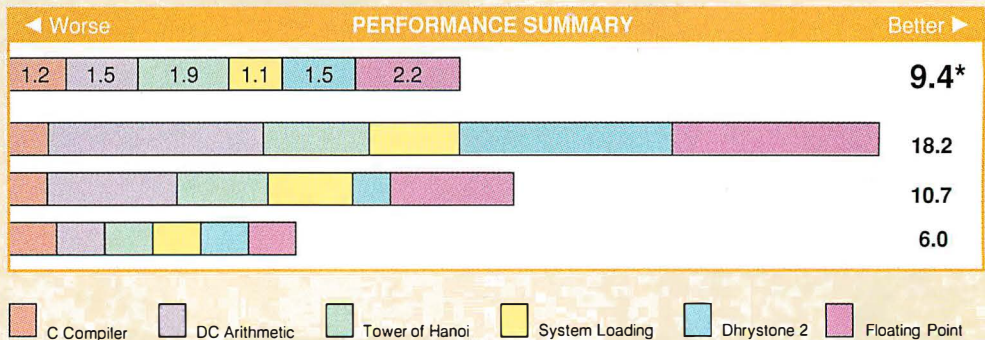

### HIGH-LEVEL PERFORMANCE

	Time	Index
* C Compiler	1.73	1.20
* DC Arithmetic	0.42	1.50
* Tower of Hanoi (17-disk problem)	0.30	1.87
<b>System Loading<sup>1</sup></b>		
1 concurrent background process	3.37	1.20
2 concurrent background processes	4.83	1.20
4 concurrent background processes	8.13	1.18
* 8 concurrent background processes	15.40	1.12

### LOW-LEVEL PERFORMANCE

	Time	Index		Time	Index
* Dhrystone 2 (without registers; Dhry./sec.)	21304	1.54	<b>Throughput</b>		
<b>Arithmetic</b> (10,000 iterations)			System call overhead (5 x 4000 calls)	0.80	1.38
Arithmetic overhead	0.18	4.00	Pipe throughput (read and write 2048- x 512-byte blocks)	0.80	1.15
Register	3.90	0.75	Pipe-based context switching (2 x 500 switches)	0.40	1.57
Short	4.20	0.84	Process creation (100 forks)	2.20	0.56
Integer	3.90	0.80	Execd throughput (100 execs)	4.90	0.70
Long	3.90	0.80	<b>Filesystem throughput</b> (10-second test in Kbytes/sec.)		
* Floating Point	5.40	2.21	Read	281	N/A
Double	3.97	3.33	Write	280	N/A
			Copy	265	N/A

\* Cumulative index is formed by summing the indexed performance results for C Compiler, DC Arithmetic, Tower of Hanoi, System Loading (with 8 concurrent background processes), Dhrystone 2, and Floating Point tests.

<sup>1</sup> System loading was performed using Bourne shell scripts and Unix utilities.

**Note:** All times are in seconds unless otherwise specified. Figures were generated using the BYTE Unix benchmarks version 2.6. Indexes show relative performance; for all indexes, an Everex Step 386/33 running Xenix 2.3.1 = 1. N/A = Not applicable. For a description of all the benchmarks, see "The BYTE Unix Benchmarks," March 1990 BYTE.

had installed them in a tree under /home/openwin. I could have built a symbolic link to make the directories appear where the make file expected them, but it was easier to change the make file.

A few minutes later, without any grumbling, the compiler kicked out a 147K-byte xv program. 147K? That same program occupied over 400K bytes when compiled under Interactive Unix. I thought something was wrong, but xv loaded and executed when asked. Ah, the wonder of dynamic binding. As for the execution, xv performed perfectly. Its complex manhandlings of the X toolkit all did what they were supposed to do.

Another test involved working up a short Open Look example. Again, Sun's directory assignments don't match those discussed in the System V.4 documentation, but all the libraries and header files are there. This application gave me a bit

of trouble (which I created), but I used Sun's dbxtool graphical debugger to track it down. This is part of Sun's Desk Set productivity tools, and it works nicely. In simplest terms, it's an Open Look GUI that feeds textual commands to the dbx debugger. Just having dbx available (as opposed to System V's sdb) is reward enough, but the graphical interface makes it a snap. I used the mouse to set a breakpoint, start the program, and step through to the trouble area. It took me no more than 5 minutes to learn the debugger and isolate the problem. *That's* user-friendly.

If you want to talk about developer-friendly, you have to look at a tool that Sun ships standard with the developer's release of OpenWindows: the Graphical User Interface Design Editor. GUIDE is a simple OpenWindows interactive design tool; you draw the graphical inter-

face you want, and GUIDE spits out an intermediate file. You then run that file through either gxv or gxv++ to produce C or C++ output.

Working with GUIDE couldn't be easier. The C code that gxv produces is split into two parts: One contains the nitty-gritty interface code (which you don't usually want to edit), and another contains the *stubs*—skeletal routines that set up handlers for interface objects. You edit the stubs file to make the objects behave the way you want and then compile the whole thing using the make file that gxv creates. What a breeze. The gxv\_merge program eases the task of adding new objects to your interface. It blends your custom code into a newly generated stubs file. And gxv supplies default stubs that let you compile and test your interface (you also can test it from within the interface builder). All objects are active,

# The new look of power just got more powerful.

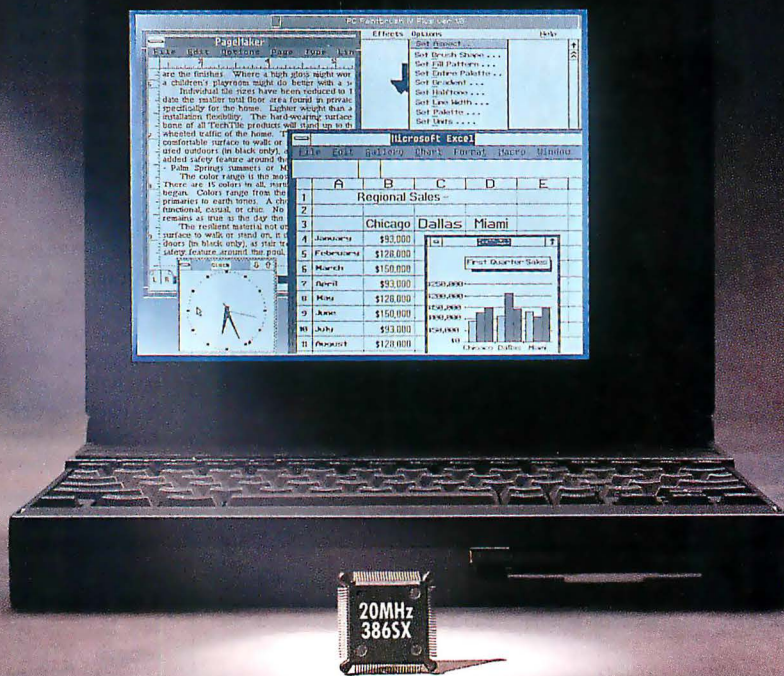

## The new TravelMate™ 3000 notebook computer packs 386™ SX power into 1.8" and 5.7 lbs.

Finally. A truly portable 386SX notebook computer attractively packaged in a sleek, breakthrough design that complements your workstyle — TI TravelMate 3000. This latest addition to TI's powerful new look of notebook computers packs 20 MHz, 386SX processing power into a convenient 1.8" thin, 5.7-lb. package.

**Portable power for power users.** Now you can easily carry desktop performance in an exceptionally lightweight package. Run power-hungry applications with 2MB of RAM (expandable to 6MB) and a 20MB, 40MB or 60MB hard disk drive. Get the full effect of Windows® and graphics-intensive software on the TravelMate 3000's big, bright 10" diagonal VGA display with 32 shades of gray.

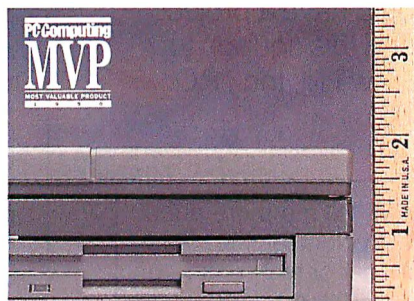

The new 20 MHz 386SX™ 3000 is just 8.5" x 11", a mere 1.8" thin and weighs an easy-to-carry 5.7 lbs. (including battery)!

Loading application software and file back-up are easy with the built-in 3.5" floppy diskette drive. The internal battery lets you

work up to three hours nonstop. Plus, the TravelMate 3000's full-function AT®-enhanced keyboard lets you do it in comfort.

**Call today for power without compromise.**

To see the new look of 386SX power, call TI for the name of a TM 3000 dealer near you. 1-800-527-3500

  
**TEXAS  
INSTRUMENTS**

**“We’re looking  
for retired  
managers  
who want to  
get back  
into action.”**

Harold W. McGraw, Jr.,  
Chairman,  
McGraw-Hill, Inc.

but they just display messages on the standard output when activated.

When I said that GUIDE is simple, I meant it as a compliment. However, while it's easy to use, it's also somewhat limited. Some important elements, such as frames around groups of objects, are missing entirely. Adding such things involves editing the “forbidden” interface code, and you'll lose those changes when you use GUIDE and trigger a C code regeneration.

However, these problems are not unique to GUIDE; managing user-supplied changes is the bane of any interface design tool. If you recognize its limitations, GUIDE is a helpful tool. It might not be as useful to developers of commercial applications as it is to in-house developers and others who need to build tools that help inexperienced users. [Note: *GUIDE's name has been changed to Developer's Guide, a name more fitting for a manual than for a programmer's tool.*]

#### Can I Have One?

It's hard to work with the IPC for any length of time without becoming attached to it. The size of the box—supposedly one of its strongest selling points—is meaningless to me. What I saw was an inexpensive color workstation that blew me away. Whether I wore my user's, developer's, or reviewer's hat, I found myself wrapped in an environment that I was loath to leave.

Sun has positioned the IPC well against other workstations and priced it so that its main competition is high-end PCs. The IPC's 25-MHz SPARC processor compares well with a 33-MHz i486 (see the benchmark table), although the i486 has a slight floating-point edge.

Performance aside, by the time you buy everything you need to support Unix and color graphics on an i486-based PC, you've spent at least as much as you would on the IPC, and the robustness of the operating-system and GUI software is nowhere near that of SunOS and OpenWindows. Even though this software is proprietary, both the operating-system and GUI components adhere to so many open standards that this issue is moot.

The IPC, and the similarly priced SPARC clones that will follow it, might place SPARC as a Unix commodity, a position that even Intel would envy. I can't imagine spending \$10,000 on any single-processor 386 or 486 system now that the IPC is here. ■

*Tom Yager is a technical editor for the BYTE Lab. You can reach him on BIX as “tyager.”*

I'm a volunteer supporter of the International Executive Service Corps, a not-for-profit organization with a vital mission:

We send retired U.S. managers overseas to help businesses in developing countries, which often respond by increasing their imports of U.S. goods. In fact, developing countries consume about 40 percent of U.S. exports.

As an IESC volunteer, you would not get a salary. But you would get expenses for you and your spouse, plus a world of personal satisfaction.

IESC leads the field in this kind of work. We've done over 9,000 projects in 81 countries. We could have a project that's just right for you. To find out, send this coupon to: Harold W. McGraw, Chairman, McGraw-Hill, Inc., P.O. Box 10005, Stamford, CT 06904-2005.



### International Executive Service Corps

It's not just doing good.  
It's doing good business.



**Dear Mr. McGraw:** Tell me more about becoming an IESC volunteer. I am a recently retired manager or technician—or am about to retire—from a U.S. company. I'm free to accept an overseas assignment. I understand that volunteers receive expenses for themselves and their spouses, but no salary.

Name \_\_\_\_\_

Address \_\_\_\_\_

City \_\_\_\_\_ State \_\_\_\_\_ Zip \_\_\_\_\_

M2



# AMONG THE WORLD'S GREATEST TIME-SAVERS

Now available:  
Whitewater Resource  
Toolkit™ 3.0

## A remarkably fast route to Windows™ 3.0

Complete Windows 3.0 applications in half the time

You don't need a miracle to complete Microsoft® Windows 3.0 applications quickly and easily.

Just the latest development tools from The Whitewater Group. They help you take advantage of all the features of Windows 3.0 with unprecedented speed.

No matter what kind of application you're developing... whether it's a prototype or a complete system... we have a time-saving Windows solution for you.

- **Actor,**® the complete development system named:
  - *Best in its Class*, InfoWorld, 1989
  - Finalist, *Technical Excellence Award*, PC Magazine, 1990
- **ObjectGraphics!**™ our portable graphics library...
- **Whitewater Resource Toolkit!**™ for creating and customizing Windows resources...
- **WinTrieve!**™ for indexed file management...

*"Whitewater's Actor 2.0, Resource Toolkit for Windows, and WinTrieve deliver benefits that any organization planning to use Microsoft Windows or the OS/2 Presentation Manager can ill afford to do without."*

**William F. Zachmann**

(Reprinted from PC Magazine, April 24, 1990. © 1990 Ziff Communications Company)

For more information including your copy of our detailed brochure "The Fast Route to Windows Development"

Phone 1-800-869-1144 today!

Or FAX your request for information to 708-328-9386



**The Whitewater Group**®

1800 Ridge Avenue, Evanston, IL 60201-3621 USA 708-328-3800

## REVIEW

# PS/2 Blues Disappear with First 16.7-Million-Color MCA Adapter

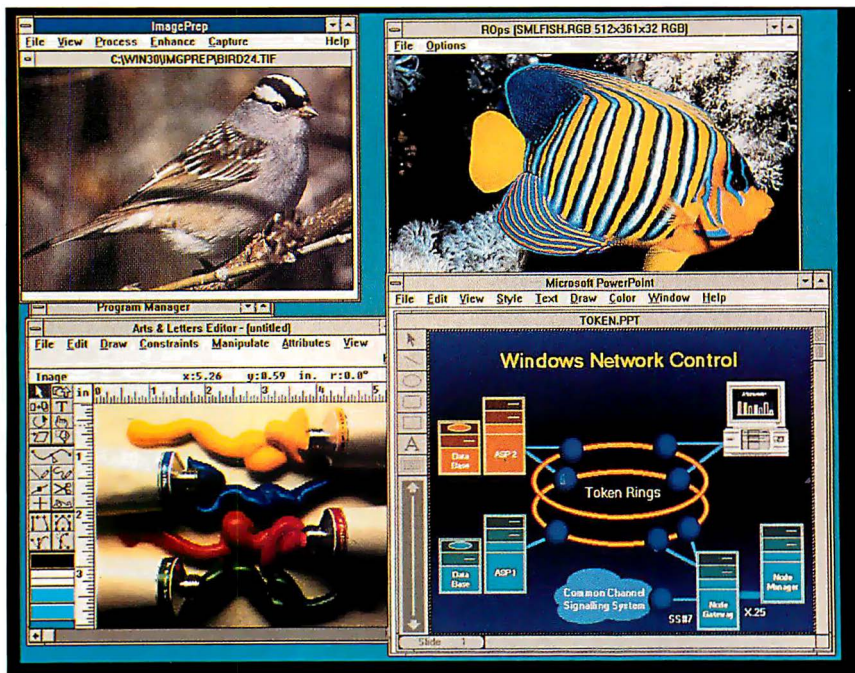

*I produced this image using the 1024MC Colorboard and a PS/2 Model 70 386 running Windows 3.0. Arts & Letters design and layout software imported the scanned 24-bit color TIFF image of an artist's oil paints. Microsoft's PowerPoint provided the network layout image. Finally, ImagePrep, which comes bundled with the Colorboard, imported a scanned 24-bit TIFF image of the small bird. I then used ImagePrep to capture the entire 24-bit, 1024- by 768-pixel display in ColorLab Processed Image (CPI) and TARGA (TGA) file formats for transmission to a slide service bureau. (Images courtesy of RasterOps, Computer Support, Microsoft, and Computer Presentations. Slide conversion courtesy of Image Center.)*

When IBM wanted to develop a 24-bit color display board for its Micro Channel architecture computers, it approached RasterOps, a leader in Macintosh-based 24-bit display technology. This overture produced a business partnership and RasterOps' new 1024MC Colorboard, the first 24-bit color adapter to use the PS/2's Micro Channel bus.

The Colorboard, although a bit pricey at \$4395, solves an old problem. Previously, design firms or graphic artists requiring 24-bit color (a must for photographic imaging or color prepress work) had to use a Macintosh or an ISA-bus machine equipped with a raster graphics adapter, such as Truevision's Targa series. With the Colorboard, previously "blue" PS/2 owners can now display

16.7 million colors on any standard multiscanning Super VGA monitor.

The Colorboard supports Windows 3.0-based 24-bit display applications and OS/2 Presentation Manager (PM)—although at press time RasterOps could not supply final OS/2 software drivers, so those were not tested. ImagePrep (\$295 from Computer Presentations), a 24-bit Windows 3.0 image-processing, conversion, and compression program, comes bundled with the unit.

I tested the Colorboard in two different PS/2 Micro Channel machines: a 16-MHz Model 55 SX with 2 megabytes of extended memory, and a 25-MHz 386 Model 70 with 8 MB of extended memory and an Intel 80387/25 math coprocessor. Both systems ran DOS 3.3.

I soon found that operating Windows

3.0 on the 16-MHz Model 55 SX was just too slow and cumbersome. Some windows, such as Program Manager, took a full 5 to 10 seconds to open. With the board installed in the faster Model 70 system, Windows 3.0 operations fared better, but it was still slower than running Windows 2.11 on my 386/25 ISA system in a 24-bit Texas Instruments Graphics Architecture (TIGA) environment. But despite this sluggishness, the Colorboard/Windows 3.0 environment is still functional, and the 24-bit color at the 1024- by 768-pixel Super VGA resolution is nothing but inspiring.

## Space-Saving PALs

The full-length, 16-bit Colorboard provides VGA pass-through for a one-monitor solution. The pass-through monitor must be a multiscanning display capable of 1024- by 768-pixel Super VGA resolutions. (A PS/2's standard on-board VGA circuitry, using IBM's mainstream 8512 or 8513 monitor, can only display 640 by 480 pixels by 16 colors or 320 by 200 pixels by 256 colors.) I used a Relisys RE1520 auto-switching Super VGA monitor to test the adapter and its VGA pass-through functions.

The Colorboard is essentially a frame buffer with 3 MB of on-board video RAM: It has no on-board graphics processor. The board carries six proprietary RasterOps chips—three 2400-0004 application-specific ICs and three programmable-array-logic (PAL) chips—to downscale the major 24-bit display component circuitry.

The PAL chips work with the board's software drivers to control video RAM and VGA bus I/O, capture, and pass-through functions. Unlike a TIGA display adapter's software/hardware interface, PAL chips cannot be updated with new driver software improvements.

In standard VGA pass-through mode, the Colorboard captures as graphics in VRAM the PS/2's 31.5-kHz VGA output signal (including text). The board does this via the PS/2's Micro Channel bus. It then converts the PS/2 VGA signal into a 48-kHz signal for redisplay by the Colorboard at its 1024- by 768-pixel non-interlaced Super VGA resolution. Unlike a Targa board, the Colorboard doesn't have video or scanner input connections. You must use a separate scanner or video camera I/O board to generate images.

## Flawless RGB

I installed RasterOps' Windows 3.0 software driver, 1024.EXE, in my AUTO-EXEC.BAT file, which, after I rebooted, switched the adapter and multiscanning

monitor into 1024- by 768-pixel by 24-bit color mode. Three flawless red, green, and blue 24-bit color gradations filled the screen as a board self-test.

At the DOS C> prompt, the VGA text pass-through at the 1024- by 768-pixel resolution was legible, but it was restricted to a 4- by 5-inch box on the 16-inch screen. I didn't find any mention of this in the manual, but RasterOps' technical support provided a quick solution: Enter the command 1024 MULTI at the DOS prompt to switch the board back to full PS/2 VGA pass-through display at 640 by 480 pixels by 16 colors at 31.5 kHz. I invoked this command for full-screen DOS operation of non-Windows applications, such as XTreePro Gold and WordPerfect 5.0.

CorelDraw 1.2 standard CDR drawings take on a whole new dimension of color with the board. However, in CorelDraw, color TIFFs are not viewable but simply represented as an outlined bit-map object. But using Computer Support's Arts & Letters design software, I could import, rescale, rotate, and view color 24-bit TIFF and bit-map images.

Since I couldn't run OS/2 or PM, I used Microsoft's PowerPoint to generate a 24-bit color slide show. I was impressed with ImagePrep's slick management of TGA, PCX, GIF, and BMP files, as well as its image-file cross conversions, true-color display, and 1024- by 768-pixel, full-screen, 24-bit capture capabilities (see the photo).

With the Colorboard in the 386 Model 70 running Windows 3.0, I simultaneously opened multiple 24-bit display windows at the 1024- by 768-pixel Super VGA resolution. Starting at the lower left and working counterclockwise, I used Arts & Letters design and layout software and imported a scanned 24-bit color TIFF image of an artist's oil paints. I later maximized this window and output the image as a four-color separation via four Encapsulated PostScript image files as used in prepress and printing applications.

Next, I opened an 8-bit "network layout" image from a PowerPoint slide show. I imported a scanned 24-bit RGB image of a fish, scaled it (no pun intended), and displayed the image using ROPS.EXE, a RasterOps display/demo utility. Finally, I used ImagePrep to import a scanned 24-bit TIFF image of a small bird. With ImagePrep, via a single hot key, I screen-captured the entire 24-bit, 1024- by 768-pixel Windows 3.0 display in both ColorLab Processed Image (CPI) and TARGA (TGA) file formats for the final image.

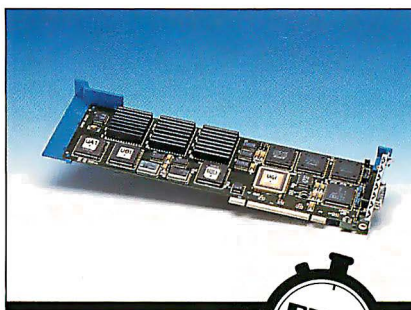

#### 1024MC Colorboard

##### Company

RasterOps Corp.  
2500 Walsh Ave.  
Santa Clara, CA 95051  
(408) 562-4200  
fax: (408) 562-4065

##### Hardware Needed

IBM PS/2 with 16-bit MicroChannel/VGA pass-through bus slot; 1024- by 768-pixel multiscanning monitor

##### Software Needed

Microsoft Windows 3.0

##### Price

\$4395

##### Inquiry 1221.

#### Expanding MCA's Color Range

Although the speed of Windows 3.0 on the Colorboard is slow at present, I still feel confident enough to recommend it because of the board's beautifully crisp 24-bit display at Super VGA resolutions. An updated 1.1 version of the Windows 3.0 driver and a Colorboard with reprogrammed PAL chips should arrive by the time you read this. This should greatly enhance speeds for all machines across the PS/2 Micro Channel platform.

Designers and artists currently using a PS/2 Micro Channel system should consider the Colorboard as an alternative to purchasing a new system just to work in 24-bit color. Thanks to hardware like this and Windows 3.0-based software like PageMaker 4.0, Arts & Letters, and ImagePrep, professional publishing and imaging on the PC platform in true 24-bit color is really here. ■

*Greg Loveria has worked with raster graphics imaging and display products for three years as a computer graphics and desktop publishing consultant, animator, and technical writer in Binghamton, New York. He can be reached on BIX c/o "editors."*



# Rack & Desk PC/AT Chassis

Integrand's new Chassis/System is not another IBM mechanical and electrical clone. An entirely fresh packaging design approach has been taken using modular construction. At present, over 40 optional stock modules allow you to customize our standard chassis to nearly any requirement. Integrand offers high quality, advanced design hardware along with applications and technical support *all at prices competitive with imports.* Why settle for less?

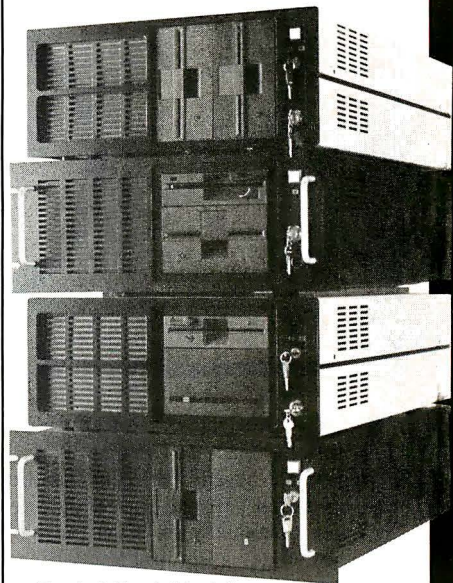

#### Rack & Desk Models

Accepts PC, XT, AT Motherboards and Passive Backplanes

Doesn't Look Like IBM

Rugged, Modular Construction

Excellent Air Flow & Cooling

Optional Card Cage Fan

Designed to meet FCC

204 Watt Supply, UL Recognized

145W & 85W also available

Reasonably Priced

Now Available  
Passive Backplanes

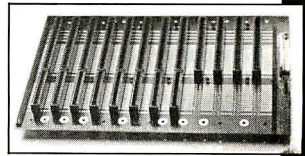

**INTEGRAND**  
RESEARCH CORP.

Call or write for descriptive brochure and prices:  
8620 Roosevelt Ave. • Visalia, CA 93291

**209/651-1203**

TELEX 5106012830 (INTEGRAND UD)

FAX 209/651-1353

We accept Bank Americard/VISA and MasterCard

IBM, PC, XT, AT trademarks of International Business Machines. Drives and computer boards not included.

## REVIEW

# An Artist's Old Tool Learns New Tricks

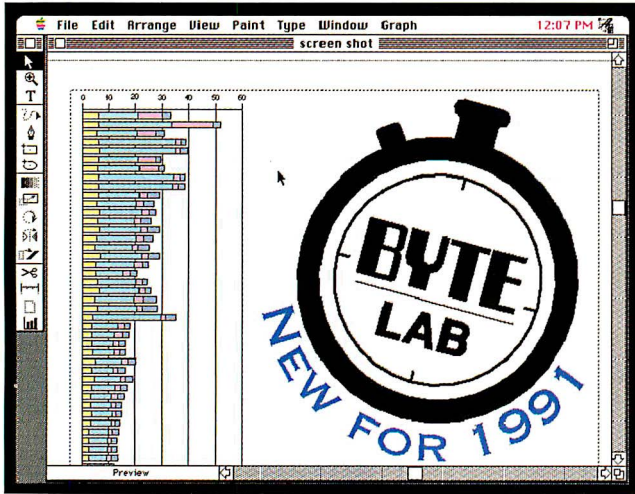

*Adobe Illustrator 3.0's graphing tool plotted the BYTE Lab data in the stacked bar chart. The text for the watch logo demonstrates how Illustrator can wrap characters around a curve.*

**A**dobe Illustrator, first introduced for the Macintosh in 1987, is an "object-based" drawing application, so called because it treats a drawing's components, such as curves, circles, and text, as geometric objects. Since the artwork is a set of mathematical objects, it reproduces accurately on high-resolution output devices such as laser printers or typesetters, a necessity for camera-ready work. Combined with a suitable high-resolution output device, Illustrator and the Mac made an unbeatable combination for professional graphics work. A later version, Illustrator 88,

provided color support.

Unfortunately, for the last year or so, Illustrator 88 has been showing its age. It didn't take kindly to 32-Bit QuickDraw at first, although numerous minor revisions (up to version 1.9.5) helped eliminate most of the sporadic crashes. But Illustrator 88 still didn't display artwork in the direct 16- and 24-bit color modes: You had to accept a dithered 8-bit color approximation.

Also, while Illustrator 88 had flexible drawing tools, its text-handling capabilities were poor. Entering text in a drawing meant a circuitous trek through a dialog box where you keyed in the text string (no longer than 255 characters, please), selected its typeface, and then got plopped back into a drawing window. You could not fit text to a curve, and you could not kern the characters. This text problem was acute enough that many artists used Illustrator to sketch a drawing and then imported the drawing into Aldus FreeHand (a competing object-based drawing application) to add the text.

### The Third Time's a Charm

Needless to say, Adobe Systems didn't let Illustrator languish too long. Illustrator 3.0 corrects the problems mentioned above while adding important new features.

First, Illustrator 3.0 works properly in the 32-Bit QuickDraw environment. This allows you to preview artwork in a 24-bit color window, giving you a better idea of how the artwork will appear in final

form. Second, the bottom scroll bar on the drawing window displays a text prompt that informs you of the function of the selected tool. Additional prompts appear here to guide you through using the tool. It's a nice touch that helps both the novice and occasional user make the best of a complex drawing application.

Third, Illustrator makes a quantum leap in text handling. Text processing has its own menu now, whereas before it was just a choice in another menu. Gone also is the cumbersome dialog box: You can type text directly into the drawing window. You can have the text wrap within an object (e.g., a circle) or around an object (perhaps a corporate logo within a block of advertising text). That latter example is important, because limits on text length are gone. You can actually flow large amounts of text into a drawing, wrapping text within hidden rectangles to lay out an entire ad page, and then add spiffy graphics as well.

You can also fit text along an arbitrary curve drawn with the Freehand tool. If you want the curve to be visible, you can specify an offset to displace the text above or below the curve. You can also generate outlines from text, which is useful for special effects. Note that Illustrator 3.0 requires Adobe Type Manager 2.0 (which is bundled with the program) to produce the outlines.

### Charting a New Course

Also new to Illustrator 3.0 is a Graph tool. With it, you can whip out professional graphs and charts in no time. Clicking on the Graph tool opens a spreadsheet-style window where you can type in numbers and text. Alternatively, you can import tab-delimited ASCII text from a file. This input text file must be "clean"—that is, composed of ordered data. The first row and column must consist of text (for the graph's labels). After that, the rest can be numbers. If one axis of a graph is "years," you must precede the value (1989, perhaps) with a non-breaking character (produced by pressing the Option key and space bar), or else Illustrator attempts to use the dates as graph data.

You have a choice of graphing styles: column (grouped or stacked), line, area, pie, and scatter. Illustrator creates the graph as a set of grouped objects, so you can easily scale the graph as a whole to fit, or change its colors. You can also assign complex graphical objects to the graph's bars. For example, using a single coin image, Illustrator can plot bars as stacks of coins in a graph that displays corporate profits. Be aware that such

## Adobe Illustrator 3.0

### Company

Adobe Systems, Inc.  
1585 Charleston Rd.  
Mountain View, CA 94039  
(415) 961-4400  
fax: (415) 961-3769

### Hardware Needed

Mac Plus or higher with 2 MB of RAM and a hard disk drive

### Software Needed

System 6.0.3; Adobe Type Manager 2.0 (provided with Illustrator)

### Price

\$595

### Inquiry 1000.



# I N T R O D U C I N G HARDLOCK™

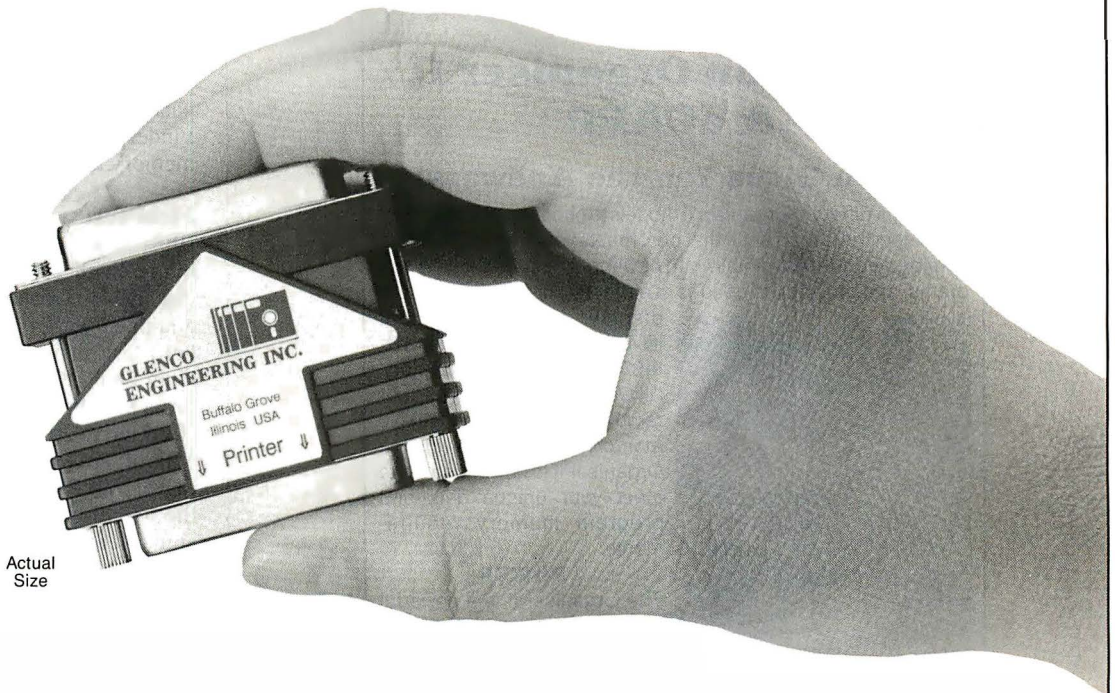

## The Ultimate in Hardware Based Copy Protection

### Compatible

Hardlock is designed for the "real world". Side effects from printers, laptops and technical issues such as static and true IBM printer port compatibility are virtually non-existent.

### Reliable

Our unique ASIC (Application Specific Integrated Circuit) extends the Hardlock's operating range below 2 volts. Since no idle current is required, there is no additional loading on the printer. Electronically erasable memory **requires no battery.**

### Flexible

Field programmability is now possible. Additionally our optional Crypto Programmer board permits the Hardlock to be uniquely programmed for your company.

### Space-Saving

Hardlock measures only 1.75". Three of our units fit in approximately the same space as only two others. Hardlock with Memory may also be purchased on the smallest PC board you've ever seen. Perfect for those who don't want the device on the exterior of the computer.

**Hardlock**  
**Hardlock with (128 bytes) Memory**  
**Hardlock with Memory on a Board**

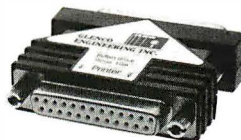

**Hardlock . . .  
Not Hardluck**

*The Security System You've Asked For.*

**GLENCO**  
**ENGINEERING INC.**

SERVING THE SOFTWARE INDUSTRY SINCE 1979

1-800-562-2543

Hardlock is a trademark  
of Fast Electronic GmbH.

270 Lexington Drive · Buffalo Grove, IL 60089 · 708-808-0300 · FAX 708-808-0313

Circle 89 on Reader Service Card

# THE SOLUTION

... to your data collection and data entry problems!

## The Psion Organiser II & dCAPP

### Psion Gives You the Answers!

With eight different Organiser II models to choose from, Psion lets you select the Organiser II that best meets your needs. Standard configurations are available with or without built-in software programs, and provide the options of either two or four lines of LCD display, several different keyboard designs, and from 32K to 96K of internal RAM memory.



All Organiser units can use our removable and interchangeable memory modules, allowing the Organiser II to be configured to meet your unique data and program memory requirements.

#### POWER

The Organiser II is a powerful hand held computer capable of running a broad range of pre-written programs. When an off the shelf program just won't due, you can custom program the Organiser II to the unique requirements of your application. From inventory control to remote sales order entry, the Organiser II has the power to do the job.

#### PERIPHERALS

For jobs ranging from simple data collection to an RS-485 factory floor network, the Organiser II has the right tools for the job. Peripherals include Bar Code Wands, Laser Scanners, Mag Card Readers, Portable Modems and Printers, Carrying Cases, all the way to a broad range of interfaces which include serial, parallel and multiple types of SPC devices.



### dCAPP Gives You the Solution!!

- dCAPP data collection software is completely user configurable allowing even non-programmers the ability to create their own custom data collection program for the Organiser II in a matter of minutes, including its own operating instructions manual.
- dCAPP data collection software is completely user configurable. Keyboard, Magnetic Card, or BAR CODE input.
- Direct Interface to most Database and Spreadsheet programs; (dBASE 3, dBASE 4, Lotus 123, D.I.F., and many others).

**TYPICAL APPLICATIONS:** Inventory Control; Stock Taking; Tools and Equipment Control; Sales Route Accounting; Quality Control and Inspection Reporting; Tank Farm Gauging; Stores Accounting; Plant Inspection; and More . . .

For more information, contact:

### KEC Products

13630 58th Street North, Suite #103  
Clearwater, Florida 34620  
(813) 531-1422

Lotus 123 is a registered trademark of Lotus Development Corp.  
dBASE is a registered trademark of Ashton Tate Corp.  
IBM-PC is a registered trademark of International Business Machines Corp.

## REVIEW

graphing operations are slow and memory intensive: On a Mac IICI with 4 megabytes of RAM, Illustrator couldn't plot such a chart in its 2-MB MultiFinder partition. I had to reboot the Mac under the Finder, giving Illustrator about 3 MB of memory to complete the graph.

### Field Test

Illustrator 3.0 runs on a Mac Plus or higher with 2 MB of RAM and a hard disk drive. I tried it out on a Mac IICI equipped with 4 MB of RAM, a 80-MB hard disk drive, and a SuperMac Spectrum/24 PDQ display board and monitor; a Mac Plus with 2 MB of RAM and a Hard Drive 20; and a Mac Classic with 2 MB of RAM and a 40-MB hard disk drive. While Illustrator 3.0 does run on the 68000-based Macs, complicated designs seemingly take forever (several minutes) to load and preview. You can manage simple designs and layouts on these systems, however. On the Mac IICI, complex color blends and text operations went smoothly and rapidly. Drawings with intricate blends looked superb when viewed in the 24-bit direct mode on the SuperMac monitor.

Version 3.0 still has a few warts, unfortunately. While the Blend tool is easier to use than in the past, it still creates unsightly blobs composed of black lines in the drawing window. While you can use a Hide Selection menu choice to get these black masses out of the way, I wish Illustrator could implement the blends transparently. Nor can you edit the artwork in the preview mode: You must constantly flip between the artwork and preview mode to check out the result. Both features are well implemented in Aldus FreeHand 2.0, and I wish that Illustrator could handle them as elegantly.

Illustrator 3.0 is a major improvement. It eliminates the limitations in text and color handling that hampered Illustrator 88. Now, graphic designers can create *entire* ad pages, complete with the text, within Illustrator. The Graph tool will have artists who do the charts for magazines and corporate reports doing handstands: Now the graphs can be done in record time, and they're typesetter-ready to boot.

For those who already own Illustrator, it's definitely time to upgrade. For those who are looking for a versatile drawing application that can tackle both text and graphs, as well as artwork, Illustrator 3.0 is an excellent choice. ■

*Tom Thompson is a BYTE senior editor at large. You can reach him on BIX as "tom\_thompson."*

# Rkjfs jdu kop qeiot ksi tcew tsot deg uf orjln.

(Buying anything but a new Toshiba color monitor makes about as much sense.)

The quality and innovation Toshiba is famous for in computers can now be found in our new 17" and 21" flat square color monitors.

You'll also find virtually every feature you could want: FS technology. A wide frequency range (30-65KHz) for complete compatibility with VGA through high-resolution graphics up to 1280 pixels x 1024 lines. A compact ergonomic design. And a whole spec sheet more.

All for much less than comparable monitors. Of course, if you still want to believe you have to pay more to get more, that's fine.

(But to us it sounds like kdsqatz.)

In Touch with Tomorrow  
**TOSHIBA**



Toshiba America Consumer Products, Inc., 1010 Johnson Drive, Buffalo Grove, IL 60089, (708) 541-9400

Circle 238 on Reader Service Card (RESELLERS: 239)

# BIG IS OUT.

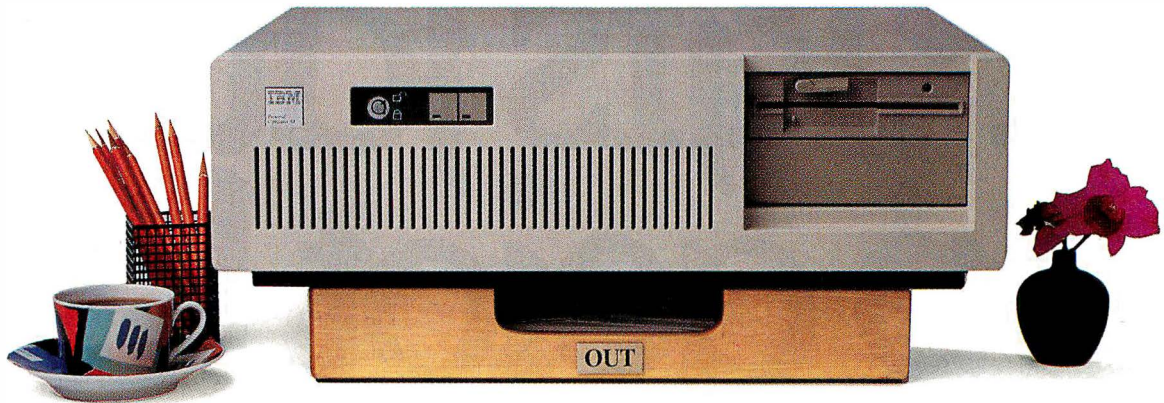

# SMALL IS IN.

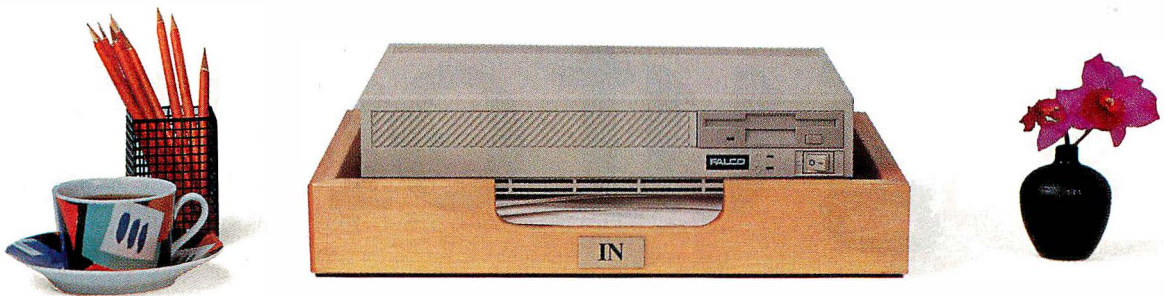

## Introducing the Falco Infinity Desktop Computer. The Smallest 386SX Desktop.

If you're sizing up desktop computers, you'll immediately see the advantage of the Falco Infinity™ Desktop. It gives you 386™SX power and performance without dominating your desk space.

Half the size of a standard PC, the Infinity Desktop has everything you need on-board: Peripheral interfaces like disk controllers. Memory expansion. Communication ports. And VGA® level graphics up to 1024 x 768 resolution. Plus, two AT® compatible, 16-bit expansion slots.

It runs DOS™ 4.0, UNIX™, OS/2™ and Microsoft®

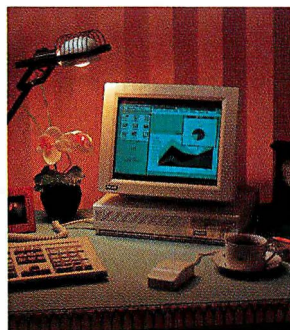

Windows 3.0. What's more, you can choose from four configurations, including a diskless network node and a full-featured model with 1.44MB floppy and the option of 40, 100 or 200 MB hard drive.

The only thing we left out is the noise. The Infinity Desktop runs so quietly, you'll hardly know it's on.

Whether you work in close quarters or spacious surroundings, the Falco Infinity Desktop covers all your needs. Without covering your desk. And that's about the size of it. To get one for your desk, call us today.

1-800-FALCO4U





## REVIEW

# Statistical Analysis for the Executive



*KnowledgeSeeker creates a tree structure of your database that depicts the major statistical splits it found using X<sup>2</sup> and F-tests.*

Every executive is involved in an endless quest for a magic formula to locate buyers for products. Some can afford to try to lure buyers with media ads, direct mail pieces, and troubadours at trade shows. Others must rely on dealers and hearsay. All these executives could easily fall under the spell of a sorcerer who could conjure up an image of potential buyers hidden in the marketplace.

KnowledgeSeeker is such a sorcerer. This package for IBM PC compatibles promises to reveal the secrets that are buried in your customer data and other places. Like any sorcerer, Knowledge-

Seeker does its work behind screens and with a "black box." But unlike a sorcerer, it achieves its effects not through mystical means but through statistical ones. You give it some basic descriptive data about individuals or institutions, and it identifies the most telling characteristics that distinguish the buyers from the nonbuyers.

For example, suppose you have a database of customer contacts that includes the source of the contact (e.g., telemarketing, "bingo" cards, or trade shows), the products of interest, the customer's identity (i.e., company and position), whether a purchase was made, and follow-up queries about the decision process. KnowledgeSeeker can take this database and, with a few key presses or mouse-clicks, produce a screen diagram classifying buyers and nonbuyers by the characteristics in the database that most differentiate them.

Like all true wizardry, this package has wide application; it's not confined to just business applications and market research. It can help medical researchers determine which presenting symptoms are most likely to lead to a serious illness and which patients benefit from which therapies. Engineers can use it to explore signal detection algorithms. Policymakers can delineate subgroups for whom to target programs.

## Statistical Intelligence

What distinguishes the statistical procedures in KnowledgeSeeker? The basic features are similar to those found in

other statistical packages: KnowledgeSeeker identifies differences in a key behavior among segments of the database, and it then uses one of two common statistical procedures to test the significance of the differences—X<sup>2</sup> tests of independence of pairs of categorical variables, and F-tests of differences between means of continuous variables for subgroups. KnowledgeSeeker differs from other packages in its degree of user involvement in applying the statistical tests, its method of applying the statistical procedures to the data, and its pictorial representation of the results in a tree diagram (see the photo).

The diagram depicts the total sample as a tree trunk. More detailed samples with distinctive patterns of the behavior of interest (e.g., buying behavior) appear as branches. To develop the tree, KnowledgeSeeker searches through tests of each database characteristic's impact on the behavior variable. It finds the characteristic that is most statistically significant and uses this characteristic for the first split in the tree.

For example, suppose that 51 percent of those who got a recommendation from a dealer bought the product, in contrast to 41 percent of those who marked bingo cards. If this difference of 10 percent between inquiry source subgroups is more significant than the difference between buyers' percentages for company type (e.g., manufacturing or accounting companies), then the first branches of the tree will represent the inquiry source subgroups. Furthermore, if two source subgroups are not significantly different, but both of them differ from a third, KnowledgeSeeker combines the two similar subgroups into one branch of the tree.

KnowledgeSeeker then repeats this process. It tests the impact of the database characteristics on the behavior within each of the subgroups formed by the first splitting. The variable that leads to the best split at one node may not be the one that splits best at a second node. For example, the way to distinguish the buyers among bingo card respondents may be to know the magazine that contained the card. Of those contacted by telemarketing, however, the most distinctive characteristic of buyers may have been their rating of the product. The end result of these splits is a tree whose branches depict, for a quick inspection, market segments with varying probabilities of buying behavior.

The advantages of KnowledgeSeeker over other statistical packages are clear. Other packages require the analyst to sift

## KnowledgeSeeker 2.0



### Company

FirstMark Technologies, Ltd.  
14 Concourse Gate, Suite 600  
Ottawa, Ontario, Canada K2E 7S8  
(800) 387-7335  
(613) 723-8020  
fax: (613) 723-8048

### Hardware Needed

IBM XT, AT, PS/2, or compatible with  
640K bytes of RAM and a hard disk drive

### Software Needed

MS-DOS 3.2 or higher

### Price

\$495

### Inquiry 1075.

VISA **COMPUTER IMAGES** MasterCard



## Super VGA

Also VGA/EGA/HGC/CGA and Animation

**1024 x 768 x 256**

Photographic Quality Real Color Images  
 ASTRONOMY • NATURE • SCENIC  
 FULL COLOR VIDEO MOVIES  
 HUGE ADULT SECTION • GIRLS

*You must be at least 21 for adult images.*

Now you can experience your computer's maximum graphics ability! We create the world's highest quality images and video movies. In business since 1979, we helped pioneer the color imaging market.

GIF images for MS-DOS, MAC II, Amiga, Atari and most other computers in your favorite GIF resolutions, EGA to VGA 320x200x256 to SVGA 1024x768x256 and all resolutions between. Viewing computer images is much easier than you might think. We have all the image utilities for printing, display and editing.

### TWO WAYS TO BUY OUR IMAGES

**32 Line BBS: 503-697-5100** • You'll have full unlimited access to 1400 megabytes of images and programs on our 24-hour 32-line BBS. Only \$10/hr., no uploading required, no time limits. No charge to look around. 9600 baud. Call for 9600 baud numbers.

Must be 21 for adult areas. Buy time online with credit card on the world's largest Online Graphics System!

**CATALOG MAIL ORDER: 503-697-7700** • Save long distance phone charges. Order anything found online through our Mail Order Catalog. Also ask about our Starter Packages, any resolution, category including adult: \$39 ea. World-wide shipment. Credit card, cash, check. Same day shipment, US Mail, UPS, FEDEX, anywhere.

**Disk Catalog:** If you don't have a modem or wish to order by mail and need more info then call for our MS-DOS CATALOG on diskette with full description of Images and Order Forms. Easy and fast. Call 503-697-7700 9am to 9pm. VGA images included.

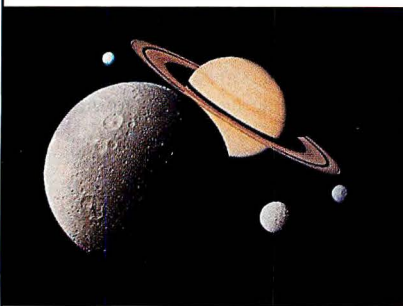

## Super VGA

### Event Horizons

311 Ave. B, Suite 209  
 Lake Oswego, OR 97034  
 Information 503-697-7700  
 BBS: 503-697-5100  
 Fax 503-636-0495 24 hrs.

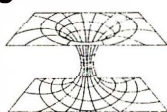

## REVIEW

### STATISTICAL ANALYSIS FOR THE EXECUTIVE

through reams of reports and cross-tabulations. The analyst then has to consolidate similar segments using a multistep, manual process of recoding categories after evaluating the numbers or checking the contribution to  $X^2$  for each cell in a table.

Splitting nodes is KnowledgeSeeker's automatic default method, but there are many more ways to explore the database. These options set the package apart from others that provide the tree techniques. For example, although the automatic mode may select the best splits at each node, KnowledgeSeeker lets you easily force particular splits at nodes by clicking on a node (with a mouse) and making a menu selection, so you can inquire about interactions among characteristics of concern.

In addition, although KnowledgeSeeker displays what it determines to be the best split, it also reports how many other splits at that node are statistically significant. With a menu selection, you can successively display each additional important split at a node. A split that statistically may be slightly less significant may be more important for your decision making.

Two other features in KnowledgeSeeker are rare in statistics software: a validation procedure and a translation of the tree into a series of decision rules. The validation procedure involves generating a random sample on which to base the tree formation and then testing the model's classification of the remainder of the database. The rule system generated for a tree can be in generic form, such as the following:

```
Rule_1 IF
    Inquiry source = Cards
    Magazine = BYTE
THEN
    Buy = Buyers 77.2%
```

Alternatively, it can be in Prolog expressions.

The quality of the tree graphics is excellent, especially when displayed on an EGA or VGA color screen. You can use menu selections, mouse pointing and clicking, and arrow keys to move the screen display easily to different parts of a tree. The graphics drawing and redrawing were fast on my 386-based system and VGA display. According to the company, a feature slated for a future upgrade will translate the trees into bar charts that can be exported to other graphics packages.

The quality of the printed output was also impressive. You can print to an

ASCII file, an ASCII (basic dot-matrix) printer, a LaserJet II, or a PostScript printer.

### Room for Improvement

Two aspects of the package need improvement: the manual and the speed of data management. Even though the software and manual are aimed at managers without strong statistical backgrounds, the documentation covering the statistical underpinnings of the techniques is inadequate. A paper about the statistical methodology (i.e., its relationship to CART [Classification and Regression Trees] and CHAID [Chi-squared Automatic Interaction Detector]) and other relevant material was sent on request, but more of this information should be included in an appendix.

In addition, the sample data analysis that is carried out throughout the manual is not adequate for depicting the software's full potential. The manual's instructions for using the package to perform all analyses were clear and concise, but the subtleties of the statistics and adjustments to methodology were glossed over.

The package's other inadequacy is the slow speed of data importing and database definition. KnowledgeSeeker can import WKS, WK1, dBASE III Plus and IV, and ASCII delimited or fixed-format files. After I specified the data file and fields, the program took 12 minutes (on a 20-MHz 386) to read and process a relatively small ASCII file of 2000 observations and 20 variables before it could create any tree. Variable labeling and data type definition took even longer—45 minutes of processing, after the labels were typed in.

These processes are done infrequently, however, and the speed of the more crucial feature, the tree construction, was adequate for a database of this size. The program does not currently use extended or expanded memory, although the company promises that the next upgrade will include this ability.

KnowledgeSeeker is a worthwhile addition to any data analyst's or manager's bag of tricks. Whether you use the package alone to aid decision making or as a guide for planning and evaluating other modeling, the analysis time that you'll save will be well worth the cost of the software. ■

*Minna Levine is a market research and statistics consultant with Alphastat Research Corp. of Belmont and Sharon, Massachusetts. She can be reached on BIX c/o "editors."*



# Take the Oops & Downs out of your next presentation.



Tired of fumbling with slides? Fiddling with transparencies? Losing your audience?

Well, it's time to use an LCD projection panel from In Focus Systems. It lets you project information just as it appears on your computer screen. Even bright, brilliant colors.

So you make stronger presentations. And easily hold any audience. What's more, the 640x480 display works with IBM<sup>®</sup> compatibles, and the Macintosh<sup>®</sup> family, too. For more information or the name of the dealer nearest you, call 1-800-327-7231, today.

Then take the oops and downs out of your next presentation. And put the audience in the palm of your hand.

1-800-327-7231.



See it. Believe it.

**IN FOCUS SYSTEMS, INC.**

Circle 110 on Reader Service Card

7770 Southwest Mohawk Street, Tualatin, Oregon 97062.  
1-800-327-7231. Oregon, 503-692-4968. FAX, 503-692-4476.

IBM and Macintosh are registered trademarks of their respective companies.

## REVIEW

# Concern for the Editing Environment

```

File: CIRCLE.CPP L: 38 C: 4 Lines: 86 Ins H 0: 33 I
1 CIRCLE.CPP Command had 3 Errors, 1 Warning
}
void Circle::Hide(void)
{
  unsigned int TempColor; // to save current color
  empColor = getcolor(); // set to current color
  setcolor(getbkcolor()); // set drawing color to background
  Visible = false;
  circle(X, Y, Radius); // draw in background color to erase
  setcolor(TempColor); // set color back to current color
}
Undefined symbol 'empColor' in function Circle::Hide()

2 FSTREAM.H
Class fstream : public fstreambase, public
public:
  _Cdecl fstream();
  _Cdecl fstream(const char*,
  _Cdecl fstream(int);
  _Cdecl fstream(int _f, char
  _Cdecl "fstream()";

  filebuf* _Cdecl rdbuf();
  void _Cdecl open(const char *, i

3 CONIO.H
file _Cdecl fstream(__COLORS)
#define _COLORS
enum COLORS {
  BLACK,
  BLUE,
  GREEN,
  CYAN,
  RED,
  MAGENTA,

```

*PIEdit brings its windowed, multifile interface to DOS, OS/2, and PC Unix. Here, the editor is highlighting errors in the code that were reported by the compiler.*

## PIEdit 4.00

## Company

The Iliad Group, Inc.  
77 Geary St., Fifth Floor  
San Francisco, CA 94108  
(800) 473-2053  
fax: (415) 563-2149

## Hardware Needed

DOS machines: 512K bytes of memory;  
OS/2 machines: 2 MB recommended;  
700K bytes to 1.2 MB of hard disk space

## Software Needed

DOS 3.0, OS/2 1.1, AIX, Xenix,  
or Unix System V release 3.2

## Price

386 Unix, Xenix, and AIX version, \$349;  
DOS version, \$195; OS/2 version, \$249

## Inquiry 1229.

When it comes to Unix programming, there are two camps: One believes that command-line interfaces and Spartan surroundings are the way to go, and another wants life made as easy as possible. PIEdit, a full-screen programmer's editor from The Iliad Group, falls somewhere in between. It is neither a boring, featureless editor nor a hand-holding, gushy interactive environment. The front of the manual says "Professional Programming Environment," though; does that mean that Iliad missed its mark?

By any standards, this is one heck of an editor. It operates in a full-screen mode, with text windows that can be moved and resized. There is no arbitrary limit on the number of windows and files you can have open at once, and there are facilities for easily moving data between windows. You can scroll-lock windows to each other so that they scroll together, making it easier to compare data.

PIEdit is a programmer's editor, and some of its features were obviously invented by developers who found other editors lacking. Automatic file saving, expression evaluation, unlimited undo, and on-line help have all been included. What makes PIEdit an *environment* is its ability to call up a compiler for application building and syntax checking. The error log is captured and interpreted; you can hop from one error to the next, the cursor moving to the erroneous line as each message is examined.

Finally, as one might expect, PIEdit is programmable. At the top level, it supports keyword expansion, key-map redefinition, and macros with conditionals

and loops. At a lower level, you can expand macros to drive the editor in any direction you like; every command that is available through the keyboard can be called up as a function in PIEdit's macro language (PML). PML supports structured statements such as `while` and `for`, making it possible to produce self-running scripts of enormous complexity.

Still, it is likely that most people using PIEdit will never delve that far into its advanced capabilities. One of PIEdit's strengths is that it offers a nearly identical set of functions to DOS, OS/2, AIX, and 386 Unix users. I decided to start by getting a feel for PIEdit as a basic editor.

### Editor Basics

To use PIEdit as just an editor is to ignore its advanced features, but there's no denying that the majority of your time running it will be spent simply entering and editing programs. Boring stuff, I know, but if an editor doesn't *feel* good, who cares if it can do your laundry?

I ran PIEdit on an Advanced Logic Research 25-MHz PowerVEISA 486 with 13 megabytes of memory, a Paradise 8514/A Plus card, an Orchid Pro-Designer VGA adapter, and a Seiko CM-1430 monitor. I installed it under Interactive Unix 2.2 and Interactive X Window System 1.2. PIEdit is not an X application; I tried running it that way because so many programmers work in that environment.

On my system, PIEdit was easiest to run on either `xpcterm` or the text console, Interactive's X terminal emulator with PC key mappings. PIEdit did not run well on a raw `xterm`, but it might

have with some changes to the `xterm` terminfo entry.

On any display medium that has the IBM-type line-drawing characters mapped, PIEdit will draw its windows and dialog boxes with smooth, single-width lines. It doesn't sense this capability; you need to provide a "-o" switch on the `pi` command line to make it happen. Scrolling under Unix was a little sluggish, owing mostly to the curses display routines and the bordered text windows. It is still quite usable, and Iliad claims that its DOS editor scrolls much more quickly.

With a typical PC keyboard, you should feel right at home. The special keys work as labeled, and F1 even calls up help. The context-sensitive version amounts to a single reverse-video line of text that appears near the cursor, describing acceptable actions. The broader type of help is menu-driven, with a sensible index and a scrolling window. PIEdit operations are split into types in the menu; I had no trouble zipping right to the topic that needed clarification.

There's also a quiescent sort of help that appears when you press one of the command prefix keys (e.g., Control-F for file, Control-B for block, and Control-G for goto) and do nothing for a couple of seconds. The editor assumes that you are confused and puts up a menu of possible commands. This feature saves you from having to remember every command sequence—if you can get in the neighborhood, PIEdit will find the right house for you.

PIEdit's strengths are mostly in the little things. Take filename completion, for



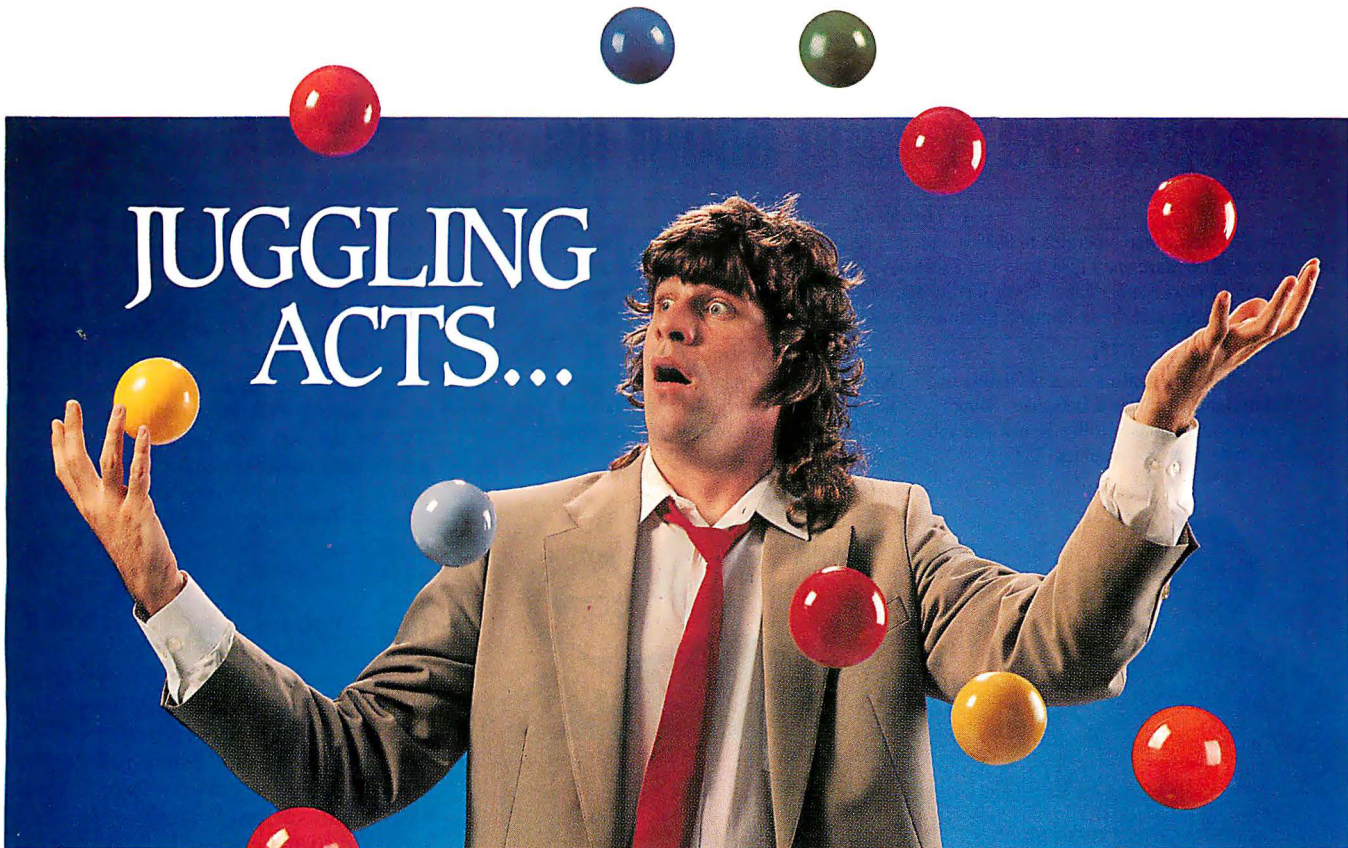

## ...ARE FOR CLOWNS

● **Juggling files, documentation, people and time is no way to manage a software project. You need to know who is working on what, which files are being changed and why. And your team should be moving ahead on development, not stuck in costly collisions.**

### **MKS RCS – Your Project Manager**

MKS RCS (Revision Control System) helps keep your project from becoming a juggling act by maintaining a complete history of changes to a file and giving you access to any of the changes. MKS RCS also automatically saves crucial descriptive information about each revision.

An advanced user interface and excellent documentation make MKS RCS extremely easy to use. Or if you prefer, you can operate from the command line. MKS RCS can automate every aspect of your project, handle both binary and text files with ease, provide unlimited branching and merging capabilities and compress log files to save valuable disk space.

### **The Bigger the Better**

The more complex your project, the more you need MKS RCS. In a multi-user environment, eliminate access conflicts

with locking options. Manage and track development to deliver your project on time, on spec and on budget.

For individual projects, MKS RCS handles the headaches of recording and retrieving files. Whether you are on a LAN or an individual PC, MKS RCS will make you more productive.

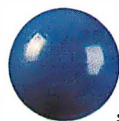

### **Price and Performance Leader**

MKS RCS has all the features you will ever need in a revision control system at a price that will fit your budget.

MKS RCS for DOS is just \$249; for OS/2, SCO or 386 Unix \$349. A 5-CPU LAN license for DOS is \$995; for OS/2, SCO or 386 Unix \$1,395.

Call MKS for LAN pricing for more than 5 CPUs.

### **MKS Software Management Team**

Reduce the juggling act even more with the MKS Software Management Team (MKS RCS and MKS Make). You set up the rules stating which files must be changed when other files are altered, and MKS Make automatically keeps those files in synch.

#### **TO ORDER, CALL:**

1-800-265-2797 (continental U.S. only)  
1-519-884-2251 (outside continental U.S.)  
1-519-884-8861 (FAX)

Full 30 day money back guarantee.

Australia 03-419-0300

03-555-4544

Belgium 02/736.60.64

England 0763 2441 14

0364 53499

071 833 1022

Finland 08-5054536

France

01 47 95 01 07

Germany

055-704800

0721 886 664

06126/595-0

30 852 00 45

020 14 24 63

Netherlands

0762 704 60

Sweden



35 King Street North  
Waterloo, Ontario  
Canada. N2J 2W9

MKS, MKS RCS and MKS Make are trademarks of Morise Kern Systems Inc. UNIX is a trademark of AT&T.

Circle 143 on Reader Service Card

# People are talking about us.

F77L-EM/32

Port 4GB mainframe programs to 80386s with this 32-bit DOS-Extender compiler. The Winner of *PC Magazine's* 1988 Technical Excellence Award just got better. New Version 3.0 and OS include: Editor, Make Utility, Virtual Memory Support, DESQview Support, New Documentation and Free Unlimited Runtime Licenses. F77L-EM/32 \$895 OS/386 \$395

F77L

The compiler of choice among reviewers and professionals. Includes a Debugger, Editor, Profiler, Linker, Make Utility, Weitek and 386 Real-Mode Support, Graphics. \$595

Lahey Personal Fortran 77

New Version 3.0: Full ANSI 77, Debugger, Editor, Linker, Library Manager, Microsoft and Borland C interfaces, 400 page Manual, Unbeatable Price. \$99



When people talk about FORTRAN the name mentioned most often is



Contact us to discuss our products and your needs. (800) 548-4778  
Lahey Computer Systems, Inc. P.O. Box 6091, Incline Village, NV 89450  
Tel: (702) 831-2500 FAX: (702) 831-8123 Tlx: 9102401256

**F O R T R A N I S O U R F O R T E**

## REVIEW

example. When you use Control-FO to open a file, you can use wild cards in the filename. Press Control-F, and PIEdit makes a menu of files matching the wild card (it also shows each file's size and modification date).

It's difficult in such limited space to relate what a solid basic editor PIEdit is. The default key bindings make so much sense that common ones became automatic to me after only a few sessions. The on-line help and quick-reference card helped me use the ones I hadn't memorized yet.

### Cross Platform and Compiler Sensitive

Beyond simple editing, PIEdit has quite a bit to offer, even if it is a little difficult to get to. To keep things as generic as possible (remember, this editor runs under several different environments, and it works with various languages), PIEdit's interface to the compiler, linker, make, lint, and other tools is fairly primitive. You need to fill PIEdit's environment with the command line you intend to use with each tool. This will take some fiddling to get just right, but once it is set, the editor will "understand" the error reports and help you work through them.

Working in C, the editor has a facility that lets you quickly check the syntax of the file you're working on. PIEdit calls the compiler, asks it to compile but not link, and pulls in any reported errors. This facility is so quick it almost seems like a part of the editor, and it is very handy.

The macro capability has two faces. One lets you capture keystrokes to a file and then play those keys back with a user-defined key press. You can insert holes for input and timed waits into your key stream.

This simple facility is supplanted by PML, which lets you mix editor commands with structured statements to create real programs. There are some limitations, of course, since the programs can't do direct file I/O or directly interface with other languages. Combined with the editor's ability to change its key mappings and other behavioral settings, PML rounds out PIEdit's versatile repertoire. PIEdit is a quality multi-platform programmer's editor, loaded with features, and one you should consider even if your environment already includes an editor. ■

*Tom Yager is a BYTE technical editor with 11 years of professional programming experience. He can be reached on BIX as "tyager."*

## PUT dBASE® ON TOP

**Dr. Switch-ASE** puts dBASE on top. On top of the charts, spreadsheets, word processors or on top of DOS. Right where it belongs, on top of any graphics or text program when you need it. Neatly tucked away when you don't. Dr. Switch-ASE turns any dBASE language program into a 16-20K RAM resident program. So now you can have dBASE power at the touch of a key, anywhere, anytime and from any program.

### dBASE TSR's, easy as ASE

With Dr. Switch-ASE you don't have to be an Assembly language whiz or a C code maven to create TSR's. The Doctor includes an integrated cut & paste feature for transferring data between programs. It also supports both Expanded and Extended memory and is fully network compatible.

### The doctor speaks your language

Dr. Switch-ASE supports all of the dBASE dialects. So it works directly from Clipper, dBASE III PLUS, dBASE IV, FoxBASE + and FoxPro. No need to learn a new dBASE syntax and no new environments to wrestle with.

When the doctor's in, dBASE is on top.

**Call and place your order today!**  
**212-787-6633**

**DR. SWITCH-ASE**  
**\$179.95\***



Black & White International Inc.  
PO Box 1040  
Planetarium Station  
New York, NY 10024-0541



Dr. Switch, Dr. Switch ASE, Dr. Switch OnCall and Dr. Switch TSRM are trademarks of Black & White International. Inc. All others are trademarks or registered trademarks of their respective holders.

\* Plus Shipping/Handling. U.S. orders add \$6.00 for 2nd Day Air. \$3.00 for Ground. Canadian and Foreign orders add \$8.00. COD add \$3.50. NY residents add sales tax. All payments U.S. funds/U.S. Banks only!

† Includes royalty free runtime version.

# THE ONLY COMPETITION FOR OUR NEW GRAY SCALE SCANNER REQUIRES A MUCH BIGGER HAND.



## SCANMAN MODEL 256 GRAY SCALE

New ScanMan® Model 256 puts professional gray scale scanning within everyone's grasp. It captures all the details in your originals, in 256 shades of gray. And does what a big, expensive scanner can do, for a fraction of the price.

**W**hat sets ScanMan Model 256 apart is its ingenious Ansel™ software (Windows™ 3.0 compatible). Ansel lets you scan and print 8" x 11" images by effortlessly stitching two 4" x 11" images together. You can also instantly realign, resize, flip and rotate images.



**I**n the evolution of gray scale scanning, new ScanMan Model 256 represents a more intelligent form of life. Naturally, it comes with Logitech's™

legendary quality and lifetime warranty.

**F**or more information call Logitech's Customer Sales Center: (800) 231-7717 ext. 348. In California: (800) 552-8885; in Canada: (800) 283-7717; In Europe: + + 41-21-869-9656.

### ZOOnews



Circle 128 on Reader Service Card (RESELLERS: 129) **Tools That Power The Desktop.**

©/™ trademarks of registered owners.



Reviewer's Notebook provides new information—including version updates, new test data, long-term usage reports, and reader feedback—on products previously reviewed in *BYTE*.

## Torture Test: Two 386/33 Systems Survive the BYTE Lab



During a six-month tour of duty in the *BYTE* Lab, Club American's Hawk I (left) and Arche Technologies' Legacy 386-33 held up remarkably well.

Unless it fits in your pocket, a 33-MHz 386 system no longer reflects cutting-edge technology. But as these machines lost groundbreaker status, they gained attributes that the latest and greatest systems can't possibly offer: proven reliability, mature designs, and affordable prices. In the year or so that desktop 33-MHz machines have been around, We've had a chance to see how they work in the real world.

We put two 33-MHz systems, an Arche Legacy 386-33 and Club American's Hawk I, under a heavy workload in the *BYTE* Lab over the last six months. The Lab staff used the Arche to test SCSI drives and caching disk drive controllers, and we configured it as a NetWare 386 file server; we used the Hawk in the SCSI and disk drive controller product focuses as well, and as a platform for testing math coprocessors and dozens of new Windows applications.

Test-bed duty in the *BYTE* Lab places excessive stress on a system. We disassembled and reassembled these machines dozens of times, we swapped countless boards in and out of the expansion buses, and we repeatedly slid hard disk drives in and out of the drive bays. We also ran in-depth tests with a wide variety of software. Extended lab duty loosens connections, wears out expansion slots, and occasionally results in major component failures. Both products stood up to this abuse remarkably well.

### Trivial Troubles

Each machine did suffer a minor problem during its stay. We had difficulty initially partitioning the Hawk's Maxtor 150-megabyte ESDI hard disk drive—the DOS 3.30 *fdisk* program only saw 40 MB and couldn't build a stable extended partition. DOS 4.0 had the same problem. As it turned out, Club had improperly formatted the disk at the factory. We fixed it by doing a low-level hard disk format using the hard disk drive controller's ROM-based format program. We remapped the drive for use with DOS (it has more than 1024 cylinders) and performed a reformat and remapping to get the drive, BIOS, and DOS in sync. After that, everything worked fine.

### Hawk I

#### Company

Club American Technologies, Inc.  
3401 West Warren Ave.  
Fremont, CA 94539  
(415) 683-6600

#### Components (as reviewed)

Processor: 33-MHz 386; 33-MHz 80387 math coprocessor  
Memory: 4 MB of SIMM RAM; 64K-byte static RAM processor cache  
Mass storage: 5¼-inch 1.2-MB floppy disk drive; 150-MB Maxtor ESDI hard disk drive  
Display: 16-bit Everex Viewpoint VGA; Eversion analog color monitor  
Keyboard: 101-key IBM Enhanced-style layout  
I/O Interfaces: Two serial ports; one parallel port

#### Price

\$4139

**Inquiry 1226.**

### Legacy 386-33

#### Company

Arche Technologies, Inc.  
48881 Kato Rd.  
Fremont, CA 94539  
(415) 623-8100

#### Components (as reviewed)

Processor: 33-MHz 386; 33-MHz 80387 math coprocessor  
Memory: 8 MB of SIMM RAM; 128K-byte static RAM processor cache  
Mass storage: 5¼-inch 1.2-MB floppy disk drive; 3½-inch 1.44-MB floppy disk drive; 120-MB QIC tape drive; 360-MB Maxtor ESDI hard disk drive  
Display: 16-bit Tseng Labs VGA; Arche analog color monitor  
Keyboard: 101-key IBM Enhanced-style layout  
I/O interfaces: Two serial ports; one parallel port

#### Price

\$10,755

**Inquiry 1225.**





## DOS BENCHMARKS

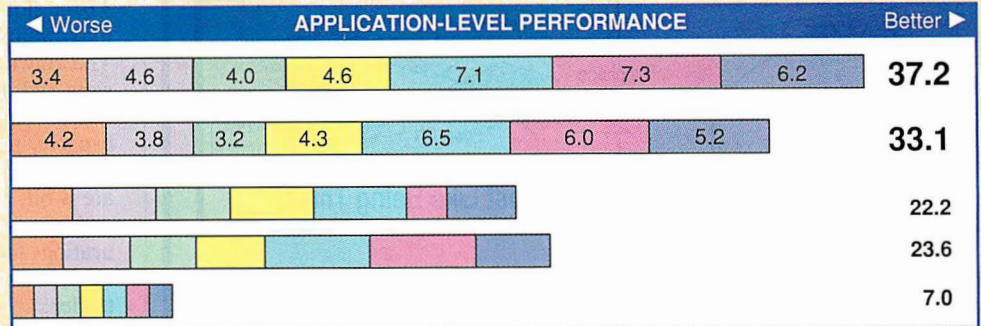

Word Processing Desktop Publishing Database Compilers CAD Scientific/Engineering Spreadsheet

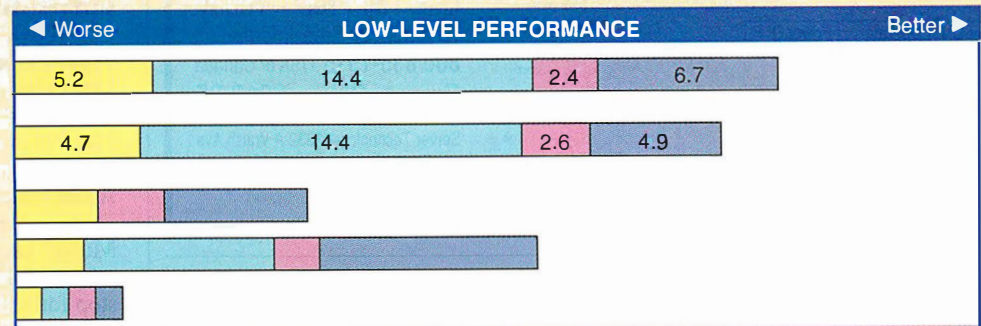

CPU FPU Disk Video

For all benchmarks, results are indexed and show relative performance; for each individual index, an 8-MHz IBM AT running MS-DOS 3.30 = 1. Higher numbers indicate better performance.

The BYTE low-level benchmark suite identifies relative performance at the hardware level; the application benchmarks evaluate real-world performance by running a standard test suite using commercially available applications. Application indexes include tests using the following programs: Word Processing: WordPerfect 5.0; Desktop Publishing: Aldus PageMaker 3.0; Database: Borland Paradox 3.0 and Ashton-Tate dBASE IV; Compilers:

Microsoft C 5.1 and Borland Turbo Pascal 5.5; CAD: AutoCAD release 10 and Generic CADD level 3 1.1.5; Scientific/Engineering: Stata release 2, MathCAD 2.5, and PC-Matlab 3.5f; and Spreadsheet: Lotus 1-2-3 release 3.0 and Microsoft Excel 2.1.

The BYTE Lab introduced version 2.0 of the DOS benchmarks in the August 1990 issue (see "BYTE's New Benchmarks: New Looks, New Numbers"). Benchmark results for machines reviewed under previous versions aren't directly comparable. To obtain a copy of the benchmarks, join the listings area of the byte.bmarks conference on BIX or contact BYTE directly.

The Arche Legacy 386-33's problem was more unusual: When we installed some caching hard disk drive controllers, the system took several minutes to boot from the hard disk drive. This occurred with the preliminary Arche BIOS that came installed on our test machine, which was one of the first out of the factory. We replaced the BIOS ROM in our Legacy with a later version and had no further problems.

With these exceptions, both machines handled all the tasks we handed them. But if reliability was roughly on par, performance wasn't equal; the Legacy is noticeably faster (see the benchmark graph). Our low-level benchmarks bear this out, rating the Legacy 10 percent better in CPU speed and 37 percent faster on the Video tests. Overall, the

Legacy was 12 percent faster on the application benchmarks.

In addition to the size of its processor cache—128K bytes versus the Hawk's 64K bytes—the Legacy employs a unique cache design that evidently improves performance. Arche claims that its proprietary approach to cache, DMA, and memory management enhances performance. Both Arche and Club use a write-back, rather than a write-through, cache design. Write-back caches buffer memory writes as well as memory reads.

Benchmarks sometimes report performance differences that don't show in day-to-day use. But there was a noticeable performance gap between these machines even without the objective tests. I found myself choosing the Legacy when I needed to run a demanding job.

The Legacy and the Hawk use Maxtor ESDI hard disk drives coupled with a track-buffering ESDI controller, and each turned in good low-level disk benchmark results. The Legacy included a 360-MB Maxtor XT-8380 hard disk drive and an UltraStor controller with a 32K-byte buffer (Arche refers to this controller as the Arche Breeze); Club supplied a 150-MB Maxtor XT-4170 and a Disk Technology buffering controller. Although the drives differ substantially in capacity, both offer roughly the same average access times—14 milliseconds on the Hawk and 14.5 ms on the Legacy. The BYTE low-level benchmarks ranked disk performance for these two systems as roughly equivalent.

Both systems accommodate up to 8 MB of single in-line memory module

# Power ON™

Telephone Activated Power Controller and Communication Software

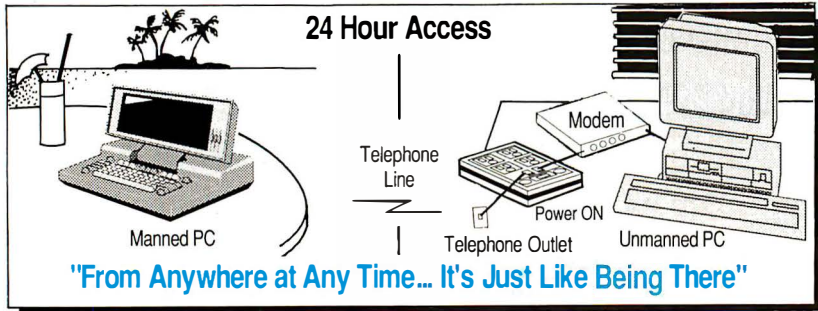

## Four Products In One

### Power-ON Highlights

1. Automatic Power On/Off Control Unit
2. Surge Protection Unit
3. Remote Operations Software
4. Communications Software for 2-PCs

Power ON Remote PC I.	Operate Remote PC II.	Power OFF Remote PC III.
-----------------------	-----------------------	--------------------------

Telephone Call is Sensed	Enter Password	Hang-Up
Power On the PC	Transfer Files	Power Off the PC
	Send Message	
	Print	
	Operate remote application	

## Save Electrical Utility Expenses

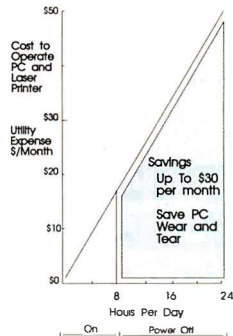

Call Toll Free - Today  
To Order, or Free Information  
**800/835-1515** USA or Canada  
**Power-ON — \$219.95**

Server Technology 2332-A Walsh Ave  
Santa Clara, California 95051  
Fax 408/738-0247 Tel 408/988-0142

## REVIEWER'S NOTEBOOK

RAM on the motherboard, and both let you expand memory using proprietary 32-bit memory cards. The Hawk has one 32-bit slot that, when filled, brings the maximum system RAM up to 16 MB. The Hawk also has six 16-bit expansion slots and one 8-bit slot. The Legacy has two 32-bit slots that bring total memory capacity to 32 MB. Four of the remaining expansion slots are 16-bit, and two are 8-bit. Each system used up one 8-bit and two 16-bit slots in its tested configuration—one for video, one for an I/O card, and one for the hard disk drive controller.

Comparing the machines' ergonomics doesn't provide much contrast. Both have similar keyboards—each with a better feel than typical mail-order clone keyboards, if you like your keyboards with stiff resistance (in the IBM style) as I do. The Hawk's Everex Evervision monitor worked fine, but the Legacy's Arche analog color monitor displayed colors inaccurately; it gave colors in some areas of the screen a faint brown hue. Also, the monitor's bezel makes the screen on the Arche look a little too round for my taste.

## Money vs. Power

After working with both machines non-stop for several months, I wouldn't hesitate to buy either one. Although both are at the low end of the 33-MHz 386 price spectrum, their pricing differs by a wide margin. The as-reviewed prices can't be used for fair comparisons in this case; the configurations are too different. But even when these systems are similarly equipped, the price difference is clear.

Configured with a VGA color monitor, 4 MB of RAM, a 150-MB hard disk drive, and a 5¼-inch floppy disk drive, the Hawk costs \$3449. The closest Legacy configuration includes a 104-MB hard disk drive and costs \$7380. The numbers aren't quite comparable (Arche sells through dealers and Club sells mail-order), but even assuming a street price for the Legacy that's 25 percent off list, the Hawk is considerably cheaper.

Clearly, the Legacy and the Hawk are built to last. To choose between the two machines, you must decide how much you're willing to pay for performance. On a dollar-for-dollar basis, the Hawk delivers more power for your money. The Legacy's faster video and CPU make it a better choice for CAD or other graphics-intensive applications. But you pay over 50 percent more for less than a 50 percent increase in power. The performance title belongs to the Arche Legacy, but the Club Hawk I wins at the bottom line. ■

—Steve Apiki

People like MKS Tools,  
but they love ours . . .

# The Berkeley Utilities

UNIX COMMANDS FOR MS-DOS

- ◆ 35 UNIX commands with all System V and BSD 4.3 options plus a number of DOS-specific enhancements
- ◆ Includes *awk*, *cp*, *diff*, *find*, *grep*, *ls*, *make*, *more*, *mv*, *rm*, and *sort*
- ◆ Each utility is stand-alone, uses video attributes, and has a built-in Help screen
- ◆ Demos available on our BBS or on disk

Requires 256K and DOS 3.0 or higher.  
A hard disk is recommended.

Order Now

**\$200**

**800-542-0938**

MasterCard, VISA  
and AMEX accepted

**30-Day Money-back  
Guarantee**

**OPENNetwork**  
POWER TOOLS FOR POWER USERS

215 Berkeley Place, Brooklyn, New York 11217  
Voice: 718-398-3838 BBS: 718-638-2239

# Cool, Quiet, Reliable Power.

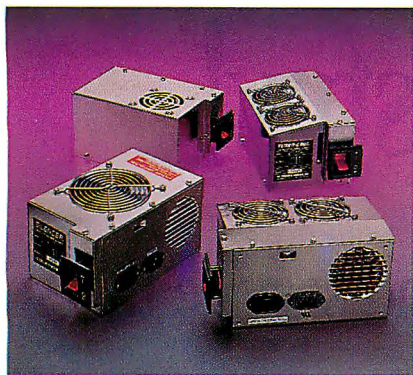

## PC/XT

**STAN AR 150** **\$69**

**Economical** This UL approved, fully tested unit is one of the best generic 150s available. Ideal for basic systems.

**SILENCER 150** **\$129**

**Ultra-Quiet** Stop that irritating noise with the Silencer 150. Its large, low speed, German fan keeps your system 5° to 15° cooler and 84% quieter. Virtually inaudible! Great in the executive suite or home office.

**TURBO-COOL 150** **\$149**

**High Performance** Upgrade your PC/XT with our popular, UL approved Turbo-Cool 150. Its patented twin fan, sloped-cover design keeps your system 25° to 40° cooler and 50% quieter. Prevents intermittent data errors and other heat-related problems. Meets the demands of a fully loaded system.

**TURBO-COOL 200** **\$189**

**Maximum Performance** Put AT power and 200% more cooling under the hood of your PC/XT with our UL approved Turbo-Cool 200. Its twin fans keep your system 30° to 45° cooler for maximum expandability. Perfect for hot rod PCs and Mini ATs!

Silencer, Turbo-Cool, Turbo 450, and InnerSource are trademarks of PC Power & Cooling, Inc. Compaq and Deskpro are registered trademarks of Compaq Computer Corporation.



## AT/386/486

**STANDARD 220** **\$99**

**Economical** This UL approved, fully tested unit is one of the best generic 220s available. Ideal for basic systems.

**SILENCER 220** **\$149**

**Ultra-Quiet** Unrattle your nerves with the Silencer 220. Its high-efficiency, adjustable-speed fan offers 69% less noise with standard cooling. Quieter than most hard drives. Great in the executive suite or home office.

**TURBO-COOL 300** **\$189**

**High Performance** Protect your investment! Upgrade your AT/386 with our powerful, wide-input Turbo-Cool 300. Its high-capacity, adjustable-speed fan keeps expansion cards, hard drives, and other valuable components 20° to 35° cooler for up to three times longer life. Perfect for a fully loaded system.

**TURBO 450** **\$349**

**Maximum Performance** The choice of PC professionals, our Turbo 450 features built-in line conditioning, autoselect input, independent regulation, external DC voltage adjustment, triple-stage output filter, remote switch option, 50cfm cooling fan, UL/CSA/TUV approval, 48 Hr. burn-in and 2 year warranty! Ideal for workstations and network file servers.

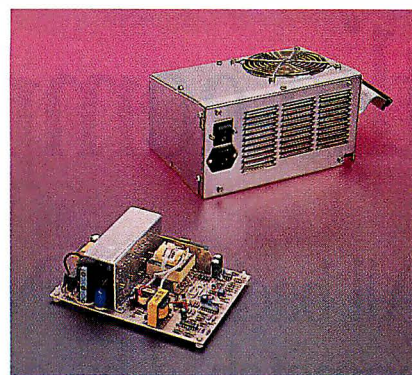

## COMPAQ

**CP160** **\$169**

**Original Portable Upgrade** Give your Portable greater reliability and 100% more power with our direct replacement CP160. Allows 286, 386, and hard disk upgrades.

**CD270** **\$249**

**Deskpro Upgrade** The power user's power supply! Our direct replacement CD270 gives your 8086/286/386 Deskpro up to 70% more power and the reliability it deserves. Prevents nuisance rebooting. Advanced design includes autoselect 110V/220V. 2-year warranty.

## INTERNAL UPS!

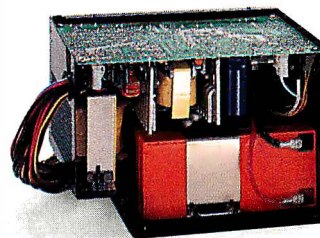

Our new InnerSource 2210 is the first AT/386 power supply with a *built-in* UPS. Its auto-recharge battery provides 5 - 10 minutes of reliable backup power for both your PC and monitor. This complete protection costs less than an equivalent 550VA external UPS and it doesn't take up *any* space. **\$449**

Most orders shipped same day. We accept Visa, MC, COD or PO on approved credit.

## PC POWER & COOLING, INC.

31510 Mountain Way, Bonsall, CA 92003 • (619) 723-9513 • FAX (619) 723-0075

Circle 169 on Reader Service Card (RESELLERS: 170)

# Systems that revolutionized the computer industry!

All backed by Northgate® support and service that's unmatched by any other company!

There are a lot of copy-cat "slim-line" systems out there, but don't be confused. These are the ORIGINAL SlimLine systems from the pioneer of this trend-setting technology: Northgate.

In just under a year, SlimLine has become our most popular system. And with good reason. Only SlimLine gives you full 286, 386SX™ and 386™ DX power in a package only 4.25" high and 16.5" square.

Now... four new SlimLine systems! "Northgate for 1991" features a SlimLine family that offers more choice than ever before: SlimLine 286/12, 386SX/16 and 20 MHz.

Our new powerhouse 386/33 rounds out our complete range of systems.

## Northgate SlimLine Common Features:

- Small footprint SlimLine case with room for two exposed and one internal half-height devices
- Intel® and Weitek® math coprocessor support
- 150 watt power supply
- Clock/calendar chip rated at five years
- Front mounted reset and high/low speed controls
- MS-DOS 4.01 and GW-BASIC installed
- On-line User's Guide to MS-DOS 4.01
- FCC Class B Certified
- 1 parallel and 2 serial ports
- Built-in VGA video adapter
- Built-in IDE hard drive and floppy disk controllers
- Five open expansion slots (three 16-bit full length, two 8-bit half-length)

Here's how we put full power into a performance package only 4.25" high!

**Revolutionary fully-integrated motherboard** with built-in IDE hard drive and floppy drive controllers, one parallel and two serial ports and 16-bit VGA controller

**Unique Northgate expansion tree** with three full-length 16-bit and two half-length 8-bit slots

**Drive bays** with room for two 5.25" and one 3.5" device

**150 watt power supply**

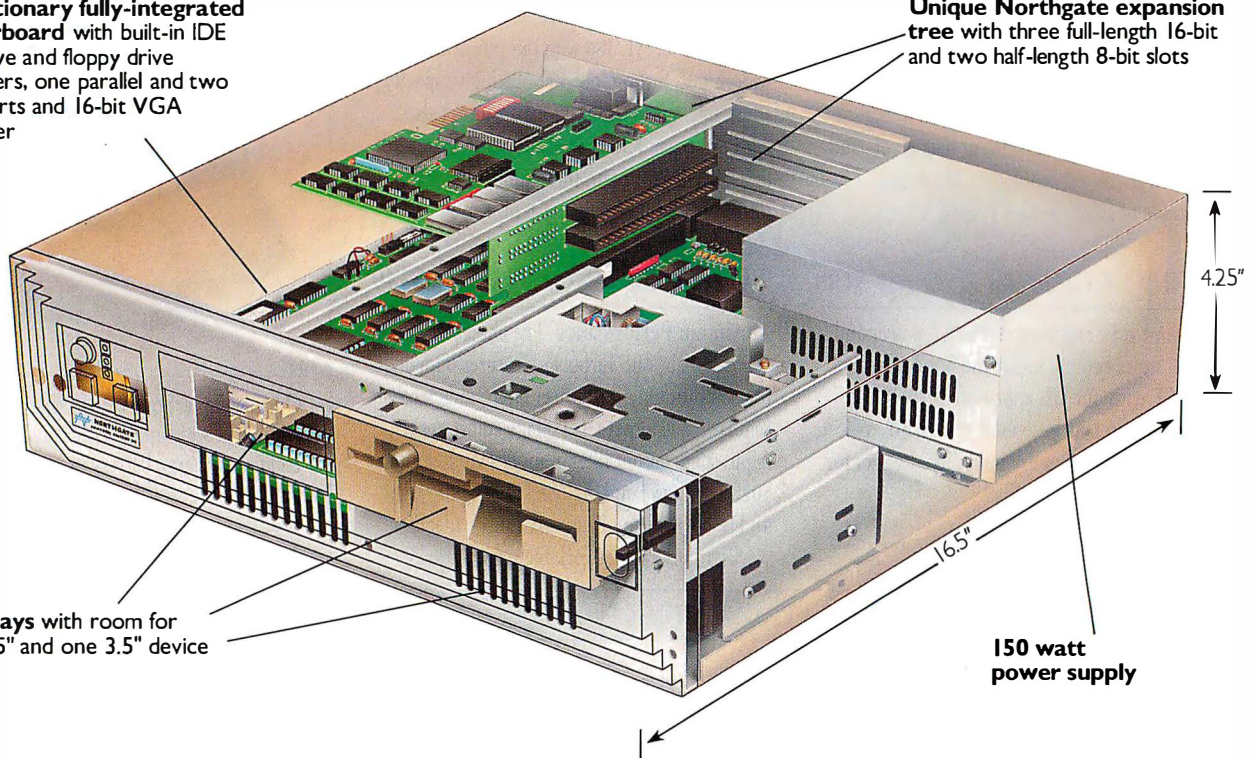

# Here they are...the Northgate family of Super SlimLines.™ One format, four sensational systems—take your pick!

## NEW! SlimLine 286/12 MHz

Ideal entry level system for use as network terminal or stand alone system for office and home use. Excellent for word processing, simple spreadsheet and light graphics programs.

- Intel® 80286/12 MHz processor
- 1.2Mb and 1.44Mb floppies
- 2Mb of RAM on motherboard
- 12" VGA gray scale monitor
- 40Mb hard drive
- OmniKey® keyboard

**\$1699<sup>00</sup>** Or as low as \$55<sup>00</sup> per month\*

## NEW! SlimLine 386SX/16 and 20 MHz with 64K cache

No ordinary SX! Northgate engineered these systems with 64K cache memory to allow you to run Microsoft Windows and other 32-bit software at quick cache-enhanced speeds. Handles database management, graphics and spreadsheet applications with ease. Choose 16 or 20 MHz models.

- Intel 80386SX 16 or 20 MHz processor
- 1.2Mb and 1.44Mb floppies
- 2Mb of RAM on motherboard
- 12" VGA gray scale monitor
- 40Mb hard drive
- OmniKey keyboard
- 64K SRAM read/write-back cache
- Microsoft® Windows™ 3.0 and mouse

386SX/16 **\$1999<sup>00</sup>** Or as low as \$65<sup>00</sup> per month\*

386SX/20 **\$2199<sup>00</sup>** Or as low as \$70<sup>00</sup> per month\*

## The system that started it all ... SlimLine 386/20 MHz!

SlimLine 386/20 zips through complex spreadsheets, moderate programming needs, desktop publishing and other demanding applications.

- Intel 80386/20 MHz processor
- 12" VGA gray scale monitor
- 4Mb of RAM on motherboard
- Microsoft Windows 3.0 and mouse
- 40Mb hard drive
- 1.2Mb and 1.44Mb floppies
- OmniKey keyboard

**\$2499<sup>00</sup>** Or as low as \$80<sup>00</sup> per month\*

## NEW! SlimLine 386/33 MHz powered up with 64K cache!

Now for the first time ever, you can get award-winning Northgate Elegance™ performance in our SlimLine case! SlimLine 386/33 is ideal for speeding through processor-intensive tasks like desktop publishing, CAD/CAM, large database and business programming applications.

- Intel 80386/33 MHz processor
- 1.2Mb and 1.44Mb floppies
- 4Mb of RAM on motherboard
- 12" VGA gray scale monitor
- 64K SRAM read/write-back cache
- Microsoft Windows 3.0 and mouse
- 40Mb hard drive
- OmniKey keyboard

**\$2899<sup>00</sup>** Or as low as \$90<sup>00</sup> per month\*



## Standard SlimLine Upgrades (Add to the base system price)

Hard Drives	12" Gold Star VGA Gray Scale 640 x 480	Gold Star 14" VGA Color 640 x 480	Panasonic 14" VGA Color 1024 x 768	NEC 3D 14" VGA Color 1024 x 768
40Mb IDE	\$ 0.00	\$300.00	\$ 400.00	\$ 650.00
80Mb IDE	\$200.00	\$500.00	\$ 600.00	\$ 850.00
100Mb IDE	\$300.00	\$600.00	\$ 700.00	\$ 950.00
200Mb IDE	\$600.00	\$900.00	\$1000.00	\$1250.00

Call for latest pricing and custom configuration specifications.

## "Northgate stops at nothing to please its customers" *PC Magazine* Sept. 25, 1990

- NEW 60-Day No-Risk Trial — if you aren't 100% satisfied, return it!
- Full one year warranty on systems, 5 years on *OmniKey*102 and *ULTRA* keyboards.
- Northgate responds to your needs with overnight shipment of parts — at our expense!
- Free on-site service to most locations for one year if we can't solve your needs over the phone.
- Free lifetime 24-hour technical support — the industry's best!
- For your convenience, we accept VISA, MasterCard and Northgate's Big 'N' card. We offer leasing and financing options, too!

CALL TOLL-FREE 24 HOURS EVERY DAY **800-548-1993**

New ... fax your order toll free! 800-323-7182

Notice to the Hearing Impaired: Northgate has TDD capability. Dial 800-535-0602.



*"We hear you!"*

7075 Flying Cloud Drive, Eden Prairie, MN 55344

©Copyright Northgate Computer Systems, Inc., 1990. All rights reserved. Northgate, SlimLine, OmniKey and the Northgate 'N' logo are registered trademarks of Northgate Computer Systems. 80386 and 80486 are trademarks of Intel. All other products and brand names are trademark and registered trademarks of their respective companies. Prices and specifications subject to change without notice. Northgate reserves the right to substitute components of equal or greater quality or performance. All items subject to availability. We support the ethical use of software. To report software copyright violations, call the Software Publishers Association's Anti-Piracy Hotline at 1-800-388-4108. \*When charged to your Northgate Big 'N' card: 18% A.P.R.

Northgate® Elegance™

# The industry's highest rated 386™ and 486™ systems!



When we say Northgate manufactures the highest-performing best-supported computer systems in the world ... it's a fact. Industry experts and customers worldwide agree!

In test after test, Northgate Elegance systems perform flawlessly. After the competition has been put through the same demanding paces, only Elegance 386 and 486 emerge as the winners.

And here's the proof! Northgate has won four *PC Magazine* Editor's Choice Awards, two *Computer Shopper* Best Buy Awards and received *InfoWorld's* Number One and Number Two Products of 1989.

PLUS ... Northgate received word from *Computer Shopper* that Elegance 486/25i won a 1990 Best Buy Award. That makes an unprecedented FOUR YEARS IN A ROW Northgate received *Computer Shopper's* prestigious honor!

We'd be fooling ourselves (and underestimating you) if we thought you'd buy based on performance alone. That's why Northgate has a corporate commitment to customer service that's equally impressive. No puffery here ...

**"...Northgate stops at nothing to please its customers." *PC Magazine* September 25, 1990**

- ◆ **NEW 60-Day No-Risk Trial!** To serve you better, Northgate has doubled its No-Risk Trial period to 60 days.
- ◆ **Full parts and labor warranties:** 1 year on systems; 5 years on *OmniKey*®102 and ULTRA keyboards.
- ◆ **Overnight shipment of replacement parts** — at our expense.
- ◆ **Northgate's free 24-hour lifetime technical support** leads the industry — most needs are met with just one call!
- ◆ **Free on-site service** to most locations for one year if we can't solve your technical needs over the phone.
- ◆ **Northgate makes state-of-the-art power affordable!** Charge your purchase to your Big 'N' card, VISA or MasterCard. Ask about financing and leasing options, too!
- ◆ **Call Northgate** before you decide to buy elsewhere. You'll be amazed at our new low pricing!

# “What WordPerfect® is to software support, Northgate is to hardware, and there are even a few things WordPerfect could learn from the folks in Minneapolis.”

Bernie Zilbergeld  
Bay Area Computer Currents  
August 14, 1990

## Select desktop or optional vertical power case.

Northgate's elegant desktop case features 5-bays with room for 3 exposed and 2 internal half-height devices. Comes with 200 watt power supply. For greater expansion capabilities, choose our vertical 7-bay powerhouse with a 220 watt power supply.

## Northgate Page Mode 386/20 MHz

As a cost-efficient, dependable network file server, Page Mode has no equal. Its reliability is confirmed by Novell® certification and by users of office networks every day. Northgate boosts performance of this 386/20 workhorse through the use of an efficient page mode memory management scheme. Other performance features include:

- ◆ Intel® 80386/20 MHz processor
- ◆ 4Mb of RAM (expandable to 16Mb)
- ◆ 40Mb hard drive
- ◆ 1.44Mb and 1.2Mb floppy drives
- ◆ 16-bit VGA video adapter
- ◆ Eight expansion card slots
- ◆ One parallel and two serial ports
- ◆ MS-DOS 4.01 and GW-BASIC installed
- ◆ Microsoft® Windows™ 3.0 and mouse
- ◆ 14" VGA gray scale monitor
- ◆ OmniKey keyboard
- ◆ FCC Class B Certified

**\$2499<sup>00</sup>** Or as low as \$800 per month\*

## Northgate Elegance 386/486 Common Features:

- ◆ American-made motherboard
- ◆ RAM expansion up to 8Mb on motherboard (16Mb total RAM with 32-bit memory card)
- ◆ 16-bit VGA video adapter
- ◆ One parallel and two serial ports
- ◆ MS-DOS 4.01 and GW-BASIC installed
- ◆ Microsoft® Windows™ 3.0 and mouse
- ◆ FCC Class B Certified

## Northgate Elegance 386/25 & 33 MHz

The best in their respective classes! Both are ideally suited for managing large databases (over 1000 records), full-time business accounting, multitasking and other demanding applications.

Northgate gives you a powerful standard configuration including high-speed 64K SRAM cache and 4Mb of RAM. Take a look at everything you get:

- ◆ Intel® 80386/25 or 33 MHz processor
- ◆ 4Mb of RAM
- ◆ 40Mb hard drive
- ◆ 64K SRAM read/write-back cache
- ◆ 3.5" 1.44Mb and 5.25" 1.2Mb floppy drives
- ◆ 16-bit VGA adapter
- ◆ 14" VGA gray scale monitor
- ◆ OmniKey keyboard
- ◆ Novell Certified

25 MHz **\$2999<sup>00</sup>**  
Or as low as \$95<sup>00</sup> per month\*

33 MHz **\$3299<sup>00</sup>**  
Or as low as \$105<sup>00</sup> per month\*



**FREE!**  
Informix® WINGZ™  
spreadsheet software  
with 386 or 486  
purchase!  
(2Mb RAM and above)

## Northgate Elegance 486/25 and NEW 486/33 MHz ISA

In addition to receiving an Editors' Choice and 1990 *Computer Shopper Best Buy Award*, Elegance 486/25i outscored all competitors in *InfoWorld Magazine's* 1990 reviews of 486 systems. Elegance "leads the pack by a comfortable margin", they said. "It offers impressive performance, exceptional expandability and it is tops in support and value."†

**NOW!** Northgate introduces the next generation—Elegance 486/33 ISA. Both systems are ideal for heavy-duty business applications like full time database management, CAD/CAM, financial planning, accounting and programming. Includes:

- ◆ Intel 80486/25 or 33 MHz processor
- ◆ 4Mb of RAM
- ◆ 40Mb hard drive
- ◆ 64K SRAM read/write-back cache
- ◆ 3.5" 1.44Mb and 5.25" 1.2Mb floppy drives
- ◆ 16-bit VGA video adapter
- ◆ 14" VGA gray scale monitor
- ◆ OmniKey keyboard

**\$5199<sup>00</sup>**

33 MHz **\$5799<sup>00</sup>**

Or as low as \$160<sup>00</sup> per month\*

Or as low as \$180<sup>00</sup> per month\*

### Standard Upgrades (Add to the base system price)

Hard Drives	14" NEC VGA Gray Scale 800 x 600	Gold Star 14" VGA Color 640 x 480	Panasonic 14" VGA Color 1024 x 768	NEC 3D 14" VGA Color 1024 x 768
40Mb IDE	\$ 0.00	\$300.00	\$ 00.00	\$ 650.00
80Mb IDE	\$200.00	\$500.00	\$ 600.00	\$ 850.00
100Mb IDE	\$300.00	\$600.00	\$ 700.00	\$ 950.00
200Mb IDE	\$600.00	\$900.00	\$1000.00	\$1250.00

Call for the latest pricing and custom configuration specifications.

**CALL TOLL-FREE 24 HOURS EVERY DAY 800-548-1993**

New... fax your order toll free! 800-323-7182

Notice to the Hearing Impaired: Northgate has TDD capability. Dial 800-535-0602.



*"We hear you!"*

7075 Flying Cloud Drive, Eden Prairie, MN 55344

©Copyright Northgate Computer Systems, Inc. 1990. All rights reserved. Northgate, OmniKey and the Northgate 'N' logo are registered trademarks of Northgate Computer Systems. 80386 and 80486 are trademarks of Intel. All other products and brand names are trademarks and registered trademarks of their respective companies. Prices and specifications subject to change without notice. Northgate reserves the right to substitute components of equal or greater quality or performance. All items subject to availability. We support the ethical use of software. To report software copyright violations, call the Software Publishers Association's Anti-Piracy Hotline at 1-800-388-PIRS. \*When charged to your Northgate Big 'N' card. 18% A.P.R. *InfoWorld*, July 30, 1990.

# Replace your "mushy" keyboard with the crisp touch Northgate® *OmniKey*!



Look...  
12 F-keys  
on top AND  
LEFT!

## *OmniKey/ULTRA* PC Computing Magazine's Most Valuable Product Of 1990!

PC Computing said: "keyboards don't get any better than this."† And it's no wonder! *OmniKey/ULTRA* gives you twice the features of ordinary keyboards! You get 12 F-keys on left—PLUS 12 switchable Special Function (SF)-keys on top. And, the greatest touch in keyboards.

See for yourself ... use one for 60 days RISK FREE! If you aren't convinced it's the best, return it. We'll refund every penny including ground shipping charges.

Look! More exclusive features!

- ALPS click/tactile mechanical key switches
- Interchangeable CTRL, ALT and CAPS LOCK keys
- Switchable right asterisk and backslash keys
- Exclusive period/comma lock key locks out these <>, locks punctuation in
- Repeat rate select key lets you change from 3-120 CPS from inside DOS or a program
- Unmatched compatibility with IBM®-type systems
- Lifetime quality double-injected keycaps
- FCC Class B certified
- Industry-leading five year warranty

Now! ONLY **\$129<sup>00</sup>**  
FOB Minneapolis, MN

HOURS: Mon. - Fri. 7 a.m. to 12 a.m.; Sat. 8 a.m. to 4 p.m. Central. Dealer and distributor prices available. Se habla español por su conveniencia.

Notice to the Hearing Impaired: Northgate has TDD capability: 800-535-0602

CHARGE IT!  
We accept VISA  
and MasterCard. FAX  
Your Order! 612-943-8332

## *OmniKey/102* with F-keys on the left

First keyboard to get back to the basics! 12 F-keys on left for fast one-hand combination commands. Readers of *Computer Shopper* named *OmniKey/102* their "Best Buy."



- Northgate's original 102 key design
- 12 function keys on the left
- Interchangeable ALT, CAPS LOCK, and CTRL keys
- Large L-shaped ENTER key
- Calculator-style numeric keypad with added equals key
- Five year warranty
- 60-day no-risk trial
- Separate inverted T cursor control pad
- Unmatched compatibility with IBM-type systems
- ALPS click/tactile mechanical key switches
- FCC Class B certified

*OmniKey/102* ONLY **\$89<sup>00</sup>**  
FOB Minneapolis, MN

### Inventory Reduction...Quantities Limited!

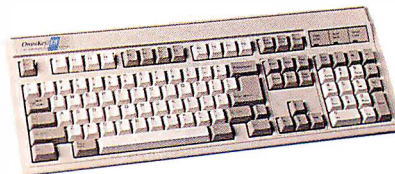

*OmniKey/101*  
with F-keys  
on top and  
20% smaller  
footprint

- Enhanced 101 key layout
- Interchangeable left CAPS LOCK and CTRL keys
- Calculator-style numeric keypad with added equals key
- Separate inverted T cursor control pad
- ALPS click/tactile mechanical key switches
- Unmatched compatibility with IBM-type systems
- FCC Class B certified
- 10-day no-risk trial
- One year warranty

*OmniKey/101-I* ONLY **\$69<sup>00</sup>**  
FOB Minneapolis, MN

CALL TODAY!  
**800-526-2446**

**NORTHGATE  
COMPUTER  
SYSTEMS**  
7075 Flying Cloud Drive, Eden Prairie, MN 55344



# You can afford award-winning Northgate® performance!



Northgate makes it easy for you to own award-winning 286, 386™ and 486™ computer systems ... just say "charge it" to your Northgate Big 'N' credit card.

It's easy! Simply fill in the Big 'N' information form and send it to Northgate for prompt attention. Once you're approved, call our systems consultants, toll-free, to select the Northgate that's right for you.

Northgate leases systems too! Choose from flexible terms up to five years. It's never been easier to get high-performance Northgate systems than it is right now!

Fill out and return this form today!

Call Northgate Now!  
**800-548-1993**  
 HOURS: Monday - Friday 7 a.m. - 8 p.m. CST

NORTHGATE COMPUTER SYSTEMS  
 7075 Flying Cloud Drive, Eden Prairie, MN 55344

## OPEN YOUR CREDIT CARD ACCOUNT BY FILLING OUT THE APPLICATION BELOW.

Please complete all appropriate sections, providing at least two years residence and employment history. If you are self-employed, please be sure to complete section d. **THIS IS NOT A CREDIT AGREEMENT!** One will be sent to you upon authorization of an account. (This Form Must Be Signed To Process Your Order.) All Financed Purchases Are Subject To Credit Approval. If You Have Any Credit Questions, Please Call For Assistance. Thank You!

A married person may apply for individual credit. I am applying for (check one box, please):

- JOINT CREDIT with another person. Complete entire application.  
 INDIVIDUAL CREDIT complete only individual section.  
 INDIVIDUAL CREDIT but rely on income of another. Complete entire application.

\*If you are a married Wisconsin applicant, you must provide your spouse's information as indicated, even though your spouse may not be signing the contract.

**NOTICE TO WISCONSIN APPLICANTS**  
 You must disclose your marital status:  
 married  
 unmarried  
 legally separated

### a. Personal Information

NAME \_\_\_\_\_ HOME PHONE (\_\_\_\_) \_\_\_\_\_  
 SOCIAL SECURITY NUMBER \_\_\_\_\_ DATE OF BIRTH \_\_\_\_/\_\_\_\_/\_\_\_\_  
 PRESENT ADDRESS \_\_\_\_\_ CITY \_\_\_\_\_ ST \_\_\_\_\_ ZIP \_\_\_\_\_  
 DATE OF RESIDENCE MD. \_\_\_\_\_ YR. \_\_\_\_\_ BUY  RENT  OTHER   
 PREVIOUS ADDRESS \_\_\_\_\_  
 EMPLOYER \_\_\_\_\_ DATE OF EMPLOYMENT MD. \_\_\_\_\_ YR. \_\_\_\_\_  
 MONTHLY GROSS SALARY \$ \_\_\_\_\_ BUSINESS PHONE (\_\_\_\_) \_\_\_\_\_  
 PREVIOUS EMPLOYER \_\_\_\_\_ DATES OF EMPLOYMENT \_\_\_\_\_ TO \_\_\_\_\_  
 Income from alimony, child support or separate maintenance payments need not be disclosed if you do not wish to have it considered as basis for repaying the obligation.  
 ADDITIONAL MONTHLY INCOME \$ \_\_\_\_\_ SOURCE \_\_\_\_\_

### b. Credit Information

PLEASE TELL US IF YOU HAVE: CHECKING ACCOUNT (Y/N) \_\_\_\_\_ SAVINGS ACCOUNT (Y/N) \_\_\_\_\_  
 BANK LOAN (Y/N) \_\_\_\_\_ HOW MANY? \_\_\_\_\_ VISA (Y/N) \_\_\_\_\_ HOW MANY? \_\_\_\_\_  
 MASTERCARD (Y/N) \_\_\_\_\_ HOW MANY? \_\_\_\_\_ FINANCE COMPANY LOAN (Y/N) \_\_\_\_\_ HOW MANY? \_\_\_\_\_  
 DEPT. STORE CHARGE CARD (Y/N) \_\_\_\_\_ HOW MANY? \_\_\_\_\_ CREDIT UNION ACCOUNT (Y/N) \_\_\_\_\_ HOW MANY? \_\_\_\_\_  
 OTHER MAJOR CHARGE CARDS (Y/N) \_\_\_\_\_ HOW MANY? \_\_\_\_\_

### c. Joint Applicant's Personal Information

JOINT APPLICANT'S NAME \_\_\_\_\_ HOME PHONE (\_\_\_\_) \_\_\_\_\_  
 SOCIAL SECURITY NUMBER \_\_\_\_\_ DATE OF BIRTH \_\_\_\_/\_\_\_\_/\_\_\_\_  
 ADDRESS \_\_\_\_\_ CITY \_\_\_\_\_ ST \_\_\_\_\_ ZIP \_\_\_\_\_  
 DATE OF RESIDENCE MD. \_\_\_\_\_ YR. \_\_\_\_\_  
 JOINT APPLICANT'S EMPLOYER \_\_\_\_\_ DATE OF EMPLOYMENT MD. \_\_\_\_\_ YR. \_\_\_\_\_  
 MONTHLY GROSS SALARY \$ \_\_\_\_\_ BUSINESS PHONE (\_\_\_\_) \_\_\_\_\_  
 NAME AND ADDRESS OF NEAREST RELATIVE NOT LIVING WITH YOU \_\_\_\_\_  
 RELATIONSHIP \_\_\_\_\_

### d. Self-Employment Information

BUSINESS NAME \_\_\_\_\_ BUSINESS PHONE (\_\_\_\_) \_\_\_\_\_  
 TYPE OF BUSINESS  Proprietorship  Partnership  Corporation IN BUSINESS SINCE \_\_\_\_\_  
 YOUR ANNUAL INCOME FROM BUSINESS Gross \$ \_\_\_\_\_ Net \$ \_\_\_\_\_  
 PERSONAL BANKER'S NAME \_\_\_\_\_ BANKER'S PHONE (\_\_\_\_) \_\_\_\_\_

### e. Customer Authorization

I authorize Northgate Computer Systems or its assignees to investigate credit records and to report my performance hereunder to credit agencies. I hereby certify that the following information is furnished to you for the purpose of obtaining credit and is true and correct of the best of my knowledge and belief. There are costs associated with the use of this credit card. To obtain more information about these costs, call us at 1-800-548-1993 or write to P.O. Box 59080, Minneapolis, MN 55459-0080.

NY—A consumer credit report may be requested in connection with this application or in connection with updates, renewals or extensions of any credit granted as a result of this application. If I subsequently ask for this information, I will be informed whether or not such a report was requested and, if so, the name and address of the agency that furnished the report.

OH—THE OHIO LAWS AGAINST DISCRIMINATION REQUIRE THAT ALL CREDITORS MAKE CREDIT EQUALLY AVAILABLE TO ALL CREDIT-WORTHY CUSTOMERS AND THAT CREDIT REPORTING AGENCIES MAINTAIN SEPARATE CREDIT HISTORIES ON EACH INDIVIDUAL UPON REQUEST. THE OHIO CIVIL RIGHTS COMMISSION ADMINISTERS COMPLIANCE WITH THIS LAW.

APPLICANT'S SIGNATURE \_\_\_\_\_ DATE \_\_\_\_\_

JOINT APPLICANT'S SIGNATURE \_\_\_\_\_ DATE \_\_\_\_\_

FOR MARRIED WISCONSIN APPLICANTS:

I acknowledge that the obligation described herein is being incurred in the interest of my marriage or family.

BUYER'S SIGNATURE \_\_\_\_\_ DATE \_\_\_\_\_

\*This is a credit application. Upon approval, a credit agreement will be sent to you for your signature. This agreement must be signed and returned to activate your account.

© Copyright Northgate Computer Systems, Inc. 1990. All rights reserved. Northgate, OmniKey and the Northgate Big 'N' logo are registered trademarks of Northgate Computer Systems. We support the ethical use of software. To report software copyright violations, call the Software Publishers Association's Anti-Piracy Hotline at 1-800-388-PRR.

# Laptop Technologies

- 203 Dynabook Revisited with Alan Kay**  
*by Bob Ryan*
- 211 The Point of the Pen**  
*by Robert M. Carr*
- 223 Touch-and-Feel Interfaces**  
*by Andrew Reinhardt*
- 229 LCDs and Beyond**  
*by Nick Baran*
- Displays—Down the DRAM Drain?**  
*by Frank Hayes*
- 239 Destination Laptop**  
*by Doug Gephardt and Mark C. Klonower*
- 251 Memories in My Pocket**  
*by John Reimer*
- 260 Resource Guide: Portable Sources**

The original, the dream of the laptop/notebook/hand-held computer of today—and of the future—came from Alan Kay, creator of the Dynabook concept. While the actual Dynabook machine itself has never been built, the concept bears within it the seeds of necessary technologies, some of which are coming to fruition today.

BYTE recently interviewed Alan Kay and asked him to comment on the Dynabook concept and on the future of laptop/notebook/hand-held computing. In “Dynabook Revisited with Alan Kay,” Bob Ryan presents information from that interview.

Laptop or desktop, each computer requires at least four primary capabilities: input, output, processing, and storage. The options for the laptop version, depending on its size, are more limited than those for the desktop version. However, new technologies are arising that work around these limits in each of the four primary areas.

Input methods for laptop/notebook/hand-held computers are particularly limited by the size of the device. For instance, the keyboard on a hand-held computer would be too small for touch-typing. Thus, other methods of input become more practical.

For one, pen-based input doesn't require a keyboard, doesn't make a tapping noise, but *is* mobile. In “The Point of the Pen,” Robert M. Carr discusses these and other advantages to using the pen for input and describes, in detail, PenPoint, GO's new operating system for pen-based computing.

For another, with the birth of the graphical user interface, present-day computing practically requires a pointing device, and mice are less than convenient in a mobile society. In “Touch-and-Feel Interfaces,” Andrew Reinhardt explores a variety of built-in pointing devices for laptop and smaller computers.

Output forms remain similar to those

for desktop computers, but the constraints under which they must operate differ. For example, a laptop display screen must be relatively flat and easily read in a variety of lighting conditions. Liquid-crystal technologies dominate the laptop market, but new options abound. In “LCDs and Beyond,” Nick Baran examines the state of the art in laptop display technologies.

As an aside, a suit has been filed claiming that some Japanese companies are “dumping” flat screens on the U.S. market. The implications for display manufacturers and laptop computer companies—and even for the U.S. economy—are serious and costly. In the text box “Displays—Down the DRAM Drain?” Frank Hayes explores the ramifications of this suit, for business and for buyers.

With processor speed increases and size decreases occurring quite regularly, what's new for laptops is the integrated processor, which combines all the components of an AT-compatible computer on a single chip. In “Destination Laptop,” Doug Gephardt and Mark C. Klonower describe this chip and how it meets the size and power restrictions of the laptop/notebook/hand-held world.

Size and power restrictions also affect the type of storage that is practical in a pocket-size computer. Would you rather carry a hard disk drive or a credit-card-size solid-state memory card? In “Memories in My Pocket,” John Reimer describes memory cards, storage that's small enough and light enough to be practical in notebook computers.

Faster, smaller, faster, smaller—is there an end in sight? Laptops, notebooks, and even hand-held computers are in a race to see which of them will become the fastest and the smallest computer around. In the process, a lot of new technologies are coming to the fore. This is, however, only the beginning. Today, the pen—tomorrow, the voice.

—Jane Morrill Tazelaar  
Senior Editor, *State of the Art*

# SAVINGS CERTIFICATE

This certificate entitles you to **BYTE** at a savings of over 40% off the cover price. You'll also receive the annual IBM PC Special Issue as part of your subscription.

**YES!** Please send me 1 year (12 issues) for \$24.95. (I'll **save over 40%** off the newsstand cost!)

**Payment enclosed**

**Bill me**

No-Risk Guarantee: If dissatisfied, cancel anytime for a full 100% refund. Your subscription will start in 6-8 weeks. Watch for it!

\_\_\_\_\_  
Name

\_\_\_\_\_  
Company

\_\_\_\_\_  
Address

\_\_\_\_\_  
City/State/Zip

IW12094

# BYTE

Save Over  
**40%**



NO POSTAGE  
NECESSARY  
IF MAILED  
IN THE  
UNITED STATES

**BUSINESS REPLY MAIL**

FIRST CLASS MAIL PERMIT NO. 42 HIGHTSTOWN, NJ

POSTAGE WILL BE PAID BY ADDRESSEE:

**BYTE**

Subscription Department

P.O. Box 558

Hightstown, N.J. 08520-9409



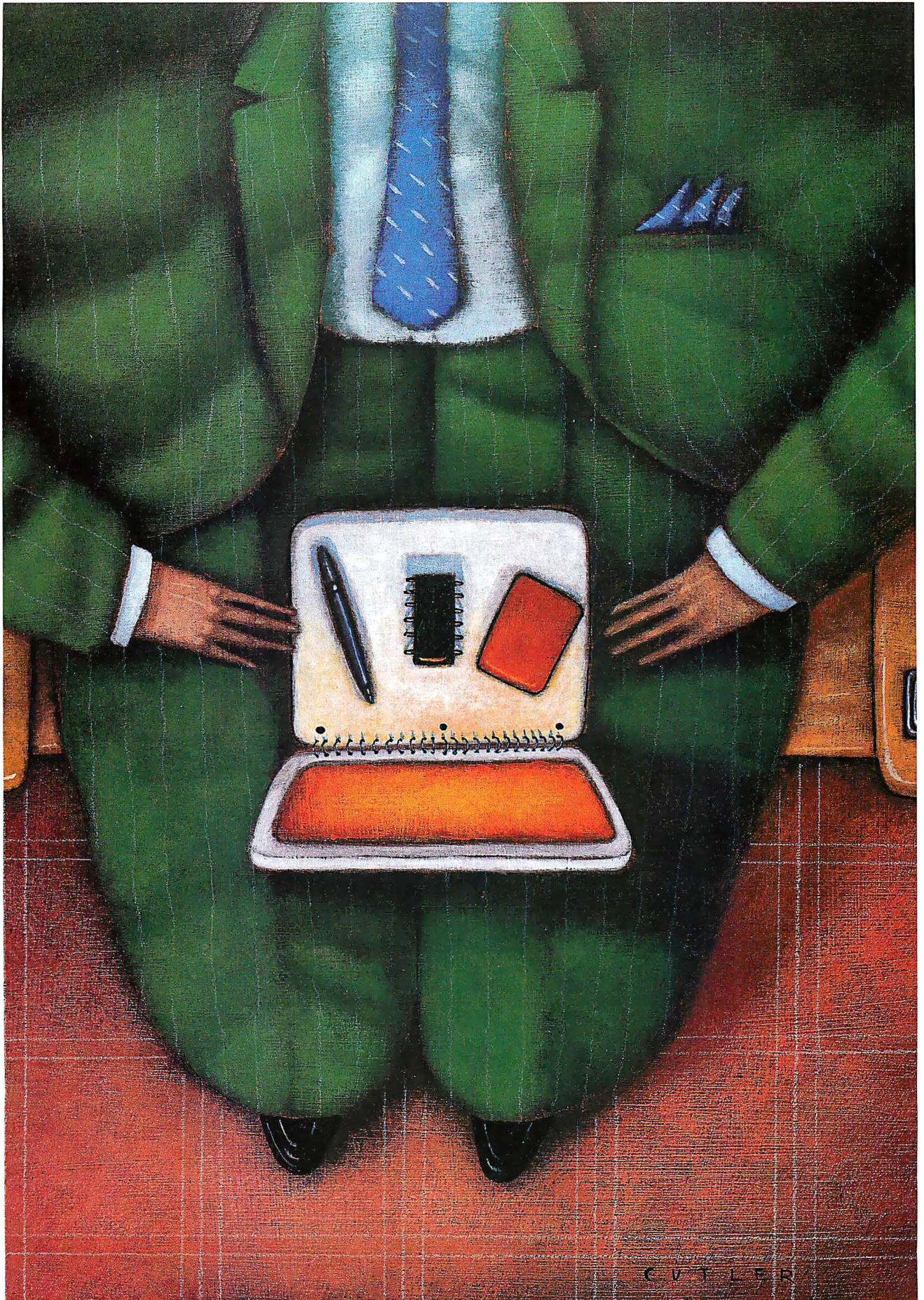



## Even This Is More Confining Than Clipper.

Just as the vast expanse of the American West gave its settlers a new perspective on opportunity, Clipper's open architecture lends unprecedented freedom to application development.

Unlike fixed systems, Clipper never forces you to "make do". Its language is fully extensible with user-defined functions and new user-defined commands. You can extend the language with routines written in Clipper itself, or integrate code from other languages like C, Assembler, dBASE® and Pascal. Odds are, you already have knowledge you can use with Clipper!

But if a customizable language isn't enough, there's even more elbow room. Database and I/O drivers can be supplemented or replaced. Even Clipper's linker knocks down barriers by allowing you to develop applications larger than available memory, without defining overlays! And when you're done, Clipper's compiler generates stand-alone, executable files for cost-free, unrestricted distribution.

So, don't let the bounds of fixed systems fence you in. Unleash your imagination in the wide-open spaces of Clipper. To find out more, give us a call today.

### **Clipper® 5.0**

*The Application Development Standard*

**213/390-7923**

**Ask For Department-A**

 **nantucket®**

Circle 146 on Reader Service Card

Nantucket Corporation, 12555 West Jefferson Boulevard, Los Angeles, CA 90066. 213/390-7923. FAX: 213/397-5469. TELEX: 650-2574125. Nantucket, the Nantucket logo and Clipper are registered trademarks of Nantucket Corporation. Other brand and product names are used for identification purposes only and may be trademarks or registered trademarks of their respective holders. Entire contents copyright © 1990 Nantucket Corporation.

# Dynabook Revisited with Alan Kay

*Is the reign of the desktop computer  
about to end?*

*Bob Ryan*

**Y**ou cannot talk about future laptops without talking about Alan Kay and the Dynabook. Kay, presently an Apple Fellow, has been one of the most influential figures in computing for the last 20 years. His work in user interface design has changed the way millions of people work with their computers.

The Dynabook name has been appropriated by more than one company to describe its laptop computer. These machines, however, have little in common with the Dynabook as defined by Alan Kay. In a recent conversation with BYTE, Kay gave us his views on computers of the future and their effects on society.

## Initial Concept

The Dynabook is a concept that Kay came up with in the late 1960s. It was the result of his realization that the computer is actually another form of media.

"In 1968 I saw two or three things that sort of changed my whole notion of computing. The way we had been thinking about it was sort of Doug Engelbart's view that the mainframe was like a railroad, owned by an institution that de-

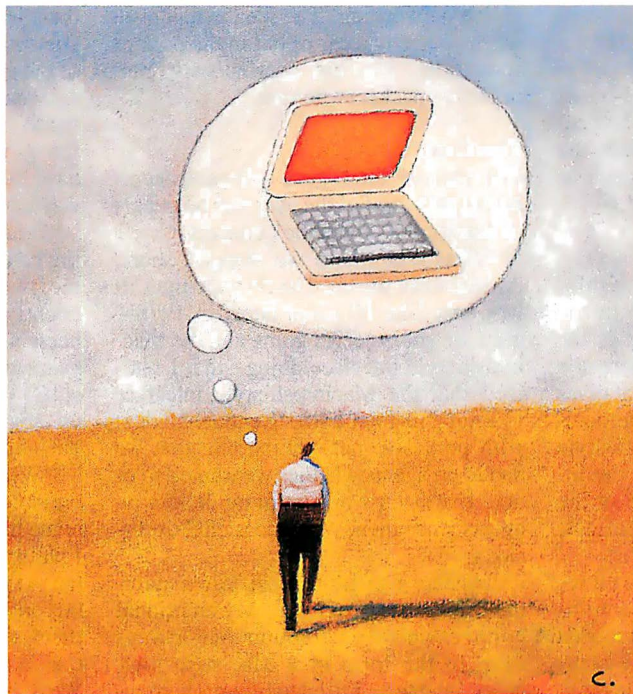

ecided what you could do and when you could do it. Engelbart was trying to be like Henry Ford. A personal computer, as it was thought of in the sixties, was supposed to be like an automobile.

"In 1968 I saw Seymour Papert's first work with kids and Logo, and I saw the first really great handwriting-character-recognition system at Rand. It's a fabulous system. And that had a huge influ-

ence on me because it had an intimate feel.

"When I combined that with the idea that kids had to use it, the concept of the computer became something much more like a supermedium. Something more like superpaper. And it was in 1968 that I made the cardboard model [of the Dynabook]. The reason I called it a Dynabook was I didn't want to use the word *computer*, and I wanted to suggest that it was something like a medium and that it would have something like the same impact that the Gutenberg technology had."

Kay originally conceived of three physical forms for future computers: a head-mounted display, the familiar notebook form, and a far-future wristwatch form suggested by the work of Nicholas Negroponte.

"In its Dynabook form, the computer of the future is a notebook with a million-pixel screen, eight processors, and both wireless and cabled networking."

Kay felt confident that such small forms were possible, given the work of Gordon Moore.

"The third thing that influenced me strongly was reading a paper by Gordon Moore, who of course went on to found

**T**he main  
job of the computer  
will be to learn  
from the user.

Intel. In this paper he formulated one of the versions of Moore's Law, which is the prediction that all good things [such as transistor density on a chip] would double every two years. I knew enough physics to understand some of the technical parts of it and was convinced that he was right. The game I played was, when could we have a Dynabook? The answer was sometime in the late 1970s, early 1980s, if we really worked on it.

"I started designing the machine in the late 1960s. I went to Xerox Palo Alto Research Center with the explicit purpose to make the machine. As it turned out, Xerox sort of punked out midway in the thing. All we did was invent workstations and Macintoshes, and stuff like that.

"Laptops in 1995 will be very much like the Dynabook model of 1968. We'll have digital cellular and other kinds of broadcast digital networks as well as wired networks; we'll have the computing power that we need; and we'll have the screens that we need. The user interface in 1995 will still be pretty much Mac-like—mostly a manipulation interface—but the end-user programming will be much better than it is with HyperCard. It will be something where a lot of the things you construct in a tool-based way will be agents. That's what I'm experimenting with right now with the school project I'm doing for Apple, and I'm convinced that that is possible."

### The Interface Factor

Kay envisions the Dynabook as the third paradigm in the evolution of human-computer relationships. The first is the timesharing/DOS paradigm, where the interface acts as a control panel that gives you access to the functions of the computer. The second is the Macintosh-style interface, where the main job of the interface is to make the user aware of the possibilities of the machine. In effect, the user learns from the computer.

"The Mac is like a magic mirror; it reflects the user's intelligence back at him. The big problem with DOS is that it tries to tell the truth by presenting the computer to the user as it exists at some technical level. What you really want to do is lie. The Macintosh shows you something that isn't actually true."

According to Kay, the third paradigm is intimate computing, where the main job of the computer is to learn from the user. "The Mac-style interface doesn't get thrown away; it's what makes the interface friendly. Then you start populating it with some active entities (agents) as well as the passive ones (data structures).

I trace agents back to John McCarthy in the late 1950s and his 'advice taker' paper. McCarthy's notion was that someday we are going to be hooked up to an information utility that is as pervasive as our power and lighting utilities. These resources will be so great that we'll have to employ artificially intelligent software agents that can take advice from us without having to be directly programmed.

"The forcing function for the main-frame computer was business need; the forcing function for the desktop computer was integrated circuits, and the forcing function for the Dynabook is pervasive networking. The idea is that even when you're in a car or out in the park or something, you are continuously connected to packet switching."

### The Case for Agents

The idea of intelligent software agents acting on behalf of the user was not a part of the original Dynabook concept.

"That was where we stopped short. Agents were too hard to do back then. It was only like 10 years later, in 1978—after we got Ethernet going and the Macintosh-style interface going—that I realized that the Macintosh-style interface was not going to be strong enough to deal with pervasive networking and that we had to do agents whether we wanted to or not. I've been working more or less on agents since then, with occasional excursions.

"Agents constitute a different paradigm for a user interface. My emotional connection to a computer has always been in the form of a Mac-style tool-based interface. I used to be a professional musician, and I'd rather play in the orchestra than be the conductor. But it's quite clear that delegation systems are going to be the big things in the nineties.

"Now the true agent-based interface is farther on out than 1995, but by the end of the century there will be commercial systems that will be agent based. The Macintosh-style interface, Windows 9.0, or whatever it is by then, is going to be dominant, but at some point the weight of

the potential resources you can get by employing agents over networks is going to start tipping the scales toward agents—just as it took four or five years for the Macintosh style to start dominating DOS. At some point, what you want to do starts forcing you to find better leverage."

### Agents and AI

To have intelligent agents that can learn from us and deal with the vast amounts of information made available by pervasive networking, Kay believes that we need a better way of doing AI.

"The Cyc project [headed by Doug Lenat at Microelectronics and Computer Technology in Austin, TX] says that while we can build problem-solving entities right now—that we're pretty good at it—such entities have no context. We don't want omnipotent genies solving problems with our information systems unless they live in our world socially. There is a famous story about the Unix agent at Berkeley. When someone typed 'I've just run out of file space, I need some more,' the agent responded 20 seconds later with 'Now you have plenty of file space.' The agent had deleted a third of the guy's files! From the standpoint of AI, you have to give it high marks—it made a correct interpretation and gave the guy what he wanted. But it didn't have the context to realize that what it did was inappropriate.

"The Cyc project is all about modeling common sense. Doug Lenat is one of the two or three smartest guys in the country in computer science, and he's been working on it for seven or eight years now, and he's done a lot of good stuff. He may fail—it's hard to succeed on something like this the first time out—but he's leaving a good trail.

"What we need in software agents is flexible competence, and the competence part is easier than the flexible part. Five or 10 years from now, we'll judge our AI systems not on how smart they are but on how well they are able to explain themselves to us. If you think about that, that is sort of the way we judge people. We don't want to work with an antisocial genius who may go off and blow up the world or something. Our trust is based on some sort of social interaction where we have some sense of what the other entity's motives are. That's going to extend very strongly into an AI interface. We'll be satisfied with stupider agents that can give us a good sense of what their strategies are when we set them out on some problem to solve.

"With an AI system you wind up with



# CSS:STATISTICA

**CSS/3™** Complete Statistical System with over 1,000 presentation-quality graphs fully integrated with all procedures and on-screen graph customization ■ The largest selection of statistics in a single system; in-depth, comprehensive implementations of: *Exploratory techniques; multi-way tables with banners; nonparametrics; distribution fitting; multiple regression; general nonlinear estimation; logit/probit analysis; general ANCOVA/MANCOVA; stepwise discriminant analysis; log-linear analysis; factor analysis; cluster analysis; multidimensional scaling; canonical correlation; item analysis/reliability; survival analysis; time series modeling; forecasting; lags analysis; quality control; process analysis; experimental design (with Taguchi);* and much more ■ Manuals with comprehensive introductions to each procedure and examples ■ Integrated Stats Advisor expert system ■ Extensive data management facilities (powerful spreadsheet with formulas; relational merge; data verification; flexible programming language) ■ Optimized (plain English menus/mouse) user interface: even complex analyses require just few self-explanatory selections (CSS can be run without manual; Quick Start booklet explains all basic conventions) ■ Macros, batch/commands also supported ■ All output displayed in Scrollsheets™ (dynamic tables with pop-up windows and instant graphs) ■ Extremely large analysis designs (e.g., correlation matrices up to 32,000x32,000) ■ Unlimited size of files; extended precision; unmatched speed (Assembler, C) ■ Exchanges data (and graphics) with many applications (incl. Excel®, Lotus 3®, dBASE IV®, SPSS®) ■ Highest resolution output on practically all printers (incl. HP, Postscript), plotters, recorders, typesetters ■ IBM compatibles, 640k or more ■ Price: \$595.

**Quick CSS™** Subset of CSS/3: all basic statistical modules (incl. data management) and the full, presentation-quality graphics capabilities of CSS/3 ■ Price: \$295.

**CSS:GRAPHICS™** A comprehensive graphics/charting system with data management ■ All graphics capabilities of CSS/3 and, in addition, extended on-screen drawing, 19 scalable fonts, special effects, icons, maps, multi-graphics management ■ Hundreds of types of graphs ■ Interactive rotation and interactive cross-sections of 3D graphs ■ Extensive selection of tools for graphical exploration of data; fitting; smoothing; spectral planes; overlaying; layered compressions; marked subsets ■ Unique multivariate (e.g., 4D) graphs ■ Facilities to custom-design new graphs and add them permanently to menu ■ Import/export of graphs and data, 15 formats ■ Optimized (menu/mouse) user interface; even complex graphs require few keystrokes: all graphs on this page can be produced from raw data in less than 20 minutes ■ Macros, batch/commands also supported ■ Unlimited size of files ■ Highest resolution output on all hardware (see CSS/3) ■ IBM compatibles, 640k or more ■ CSS:GRAPHICS is included in CSS:STATISTICA (available separately for \$495).

**Megafile Manager™** Comprehensive analytic data base management system ■ Unlimited size of files (up to 32,000 fields or 8 MB per record) ■ Megafile Manager is included in CSS/3 and CSS:STATISTICA (separately: \$295).

**CSS:STATISTICA™** A fully integrated system that combines all the capabilities of CSS/3 and CSS:GRAPHICS into a single extremely comprehensive data analysis system ■ Price: \$795.

Domestic sh/h \$7 per product; 14-day money back guarantee.

Circle 217 on Reader Service Card

 **StatSoft™**

2325 E. 13th St. • Tulsa, OK 74104 • (918) 583-4149  
Fax: (918) 583-4376

Overseas Offices: StatSoft of Europe (Hamburg, FRG), ph: 040/4200347; fax: 040/4911310, StatSoft UK (London, UK), ph: 0462/482822; fax: 0462/482855, StatSoft Pacific (Melbourne, Australia), ph: 613-866-1766, fax: 613-866-3318, StatSoft Canada-CO (Ontario), ph: 416-849-0737, fax: 416-849-0918 Available From: CORPORATE SOFTWARE and other Authorized Representatives Worldwide: Holland: LEXMA BV 02968-94210; France: Conceptel (1) 45669700; Sweden: Akademi Data 018-240035; Spain: ADDLINK, SRL: ph: 34-3-459-0722

CSS, CSS-3, CSS:GRAPHICS, Megafile Manager, Quick CSS, STATISTICA, StatSoft, dBase IV, Excel, Lotus, MacDraw, Macintosh, Postscript are trademarks of their respective companies; SPSS is a registered trademark of SPSS, Inc.

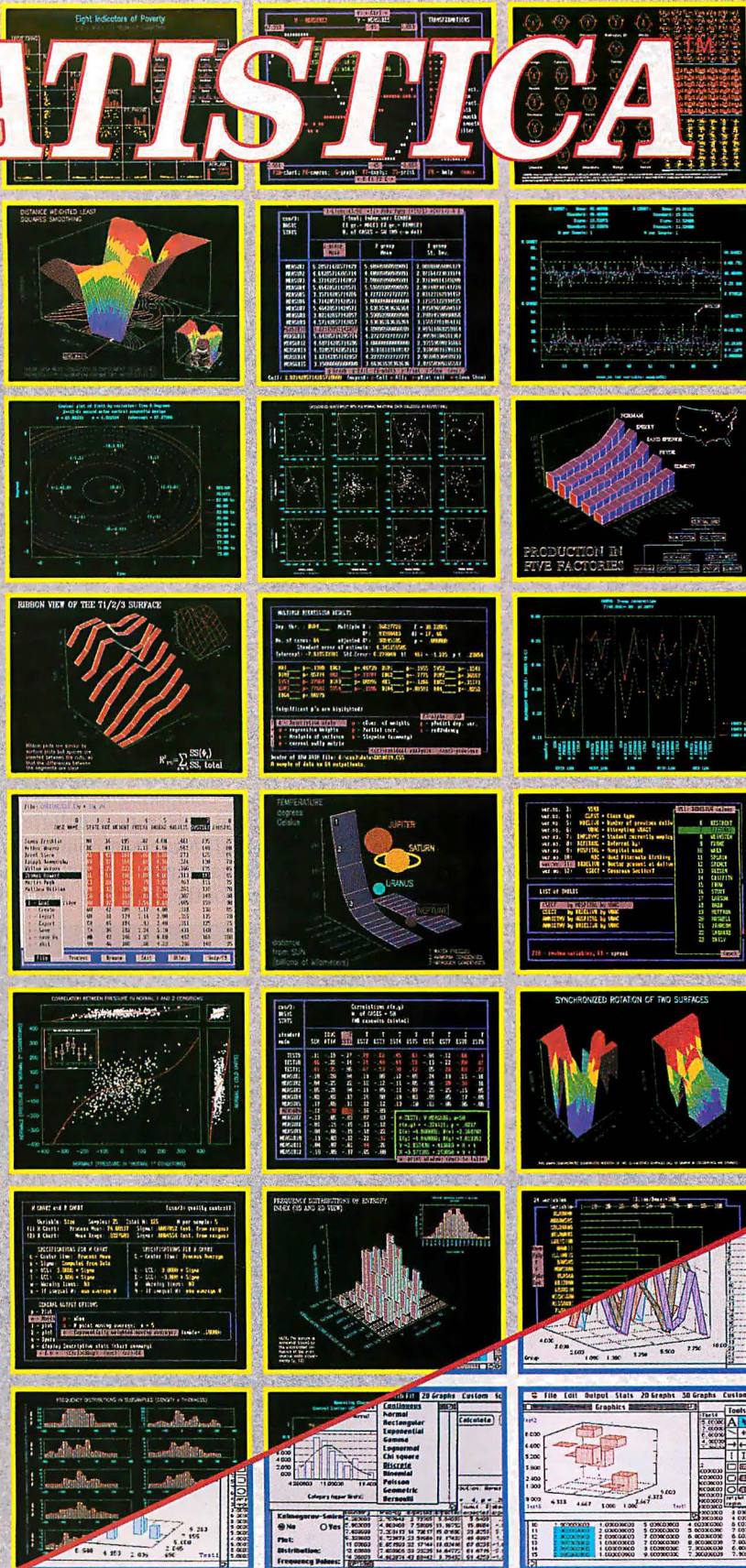

**STATISTICA/Mac™** A CSS-compatible, comprehensive data analysis and graphics system designed for the Macintosh ■ Large selection of statistical methods fully integrated with presentation-quality graphics (incl. EDA, multiplots, a wide selection of interactively rotatable 3D graphs; MacDraw-style tools) ■ Unlimited size of files ■ Exchanges data with Excel and other applications ■ Price: \$395.

**Quick CSS/Mac™** A subset of STATISTICA/Mac: all basic statistical modules and the full, presentation-quality graphics capabilities of STATISTICA/Mac ■ Price: \$245.

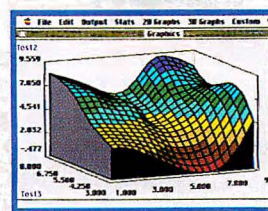

something that is tantamount to a personality. As McCarthy pointed out, at some point the complexity of the system becomes such that the best you can do is give advice."

Using agents as a n interface into a pervasively networked world is more than just a technical problem. Kay has even greater concerns about how humans will react to agents.

"When you start using agents, as a user-interface designer you put yourself behind the eight ball. You don't have anything nearly as intelligent as a human, so you have the possibility for the end user to get pissed off at the agent. The only thing like agents is humans, yet humans are a lot smarter. One of the goals of the user interface will be to get the user subliminally to understand the strengths and weaknesses of the interface.

"When you dump something a little like a human in there, your natural tendency is to start asking it questions about anything. Right away you put the poor AI in a place where almost certainly it can't give decent answers. So you have to do something in the user interface to temper

the expectations of the user.

"I think there is a progression where we start off with the agents doing retrieval—from a wide variety of sources—of things that are of interest to us. People will sell them [agents] like applications. And gradually, the agents will get more flexible, and very likely people will start coming out with majordomo agents post-1995 that can handle the other agents. And you wind up having something that is like Marvin Minsky's Society of Mind, where you have a variety of different mentalities. This is the kind of system that Doug Lenat's Cyc is designed to handle."

### The Impact of the Dynabook

To Kay, the true significance of the Dynabook is not the technologies that go into it—the displays, processors, input devices, AI-based agents, and so on—but the effect that intimate computing will have on our culture. He likens the effect of intimate computing to the effect that printing had on European culture.

"Marshall McLuhan pointed out that in the Renaissance a couple of things happened for the first time. One of them

was the invention of true perspective. For the first time in the history of art, the observer was put outside the picture.

"The other was science, which requires that you step outside your sensory environment. Nothing discovered in science in the last 350 years has been in accord with common sense. McLuhan's theory was that the thing that made us step out of the frame was cold type.

"McLuhan's notion is that the printed book created the individual. You could take it away with you. You didn't have to be educated socially if you didn't want to be. You could take a book away with you and learn it all by yourself. The whole idea of perspective says *I'm* standing over here, *I'm* looking this way."

According to McLuhan, a new medium takes its initial content from the old. Thus, the books that Gutenberg made looked like illuminated manuscripts. Kay sees the same progression with personal computers; the initial forms took their content from timesharing VDTs.

"The desktop computer to me, at least since 1968, has been a passing phase. It's not an aberration, but it's like Gutenberg in that you invent something new, but you

**486 EISA  
NOW SHIPPING**

# WE'RE CERTIFIED...

Novell  
Labs  
Tested &  
Approved™

SCO  
THE SANTA CRUZ OPERATION

Quarterdeck

BANYAN®

While many computer manufacturers say they are compatible, CSS Laboratories™ MaxSys™ file servers are certified to work with your network operating system. Our MaxSys 386MT/33, for example, has passed testing by Novell®, Banyan®, SCO® and Quarterdeck®. And our new 486 EISA line offers unsurpassed compatibility, while providing all the power and features to carry your network well into the future.

There are MaxSys systems with up to ten drive bays

and 400 watt power supplies, and all come with our exclusive 12-slot motherboard. If you need a heavy-duty file server, this is it. All of our 286, 386SX, 386 and 486 tower and desktop systems come with a full one-year warranty, a national 800 number for technical support, and optional on-site service. And they are all certified to provide uncompromising performance and reliability.

don't know what it is, so you put it in the old case.

"Aldus [Manutius] is my hero. He's the guy who wanted books that could fit into saddlebags, so he was forced not only to change the size of the book but also to invent a lot of modern typography in order to make the books legible. He couldn't use the imitation scripts that Gutenberg used for fonts. The really interesting stage was when Aldus realized that books had to be not just personal but intimate.

"So when I look at where we are right now with computers, it's somewhere between Gutenberg and Aldus, which means that nothing that has yet happened in computing actually counts. That's an interesting perspective. The laptop of the future is likely to be something much more like the final form of the computer. It will come into its own when the majority of software it runs isn't developed for desktops."

#### Dynabook and Skeptical Man

One effect Kay sees in the future is an extension of interest in simulations. He sees the Dynabook as a simulator that

you can access readily and easily.

"If you had something that was easier to work with than HyperCard or Smalltalk, people could be doing more mock-ups. Give them a tool like a spreadsheet, and they start using it for forecasting. That's what everyone wants to know—what the different possibilities are."

Kay thinks that future computers will let you move beyond McLuhan's individual.

"If you tie interest in simulations together with pervasive networking and ask what impact that is going to have on a culture as a whole, I would say that it creates skeptical man. When you have something on your person at all times that is as innocuous as pencil and paper, that is continuously connected to the information utilities of our culture, and that you can use to play what-if games based on the information, there's going to be far less you have to take on faith.

"The retrieval systems of the future are not going to retrieve facts but points of view. The weakness of databases is that they let you retrieve facts, while the strength of our culture over the past several hundred years has been our ability to

take on multiple points of view. That's what simulations allow you to do. Databases will be replaced by active simulations that no longer contain embalmed slices of a company at different points of time but active simulations of the company. You'll be able to test out the company in different environments based on competitive pressures and stuff."

Of course, the effects of skeptical man extend beyond business.

"Our basic drives are very similar to those of other animals, but we have this much stronger superstructure that, especially if used well, is able to channel all this energy into symbolic pursuits that are pleasurable. To me that's what civilization is all about. It's not repression, as Freud suggested. What you want in a civilization is a way for people to express their deep drives that is not destructive. Intelligence gives us another world that we can live in besides the physical world.

"To some extent we are symbol systems. The way that we see the world is different from the way an unselfconscious culture thinks about the world. Our whole notion of cause and effect is different. We have roughly the same mental

# THEY'RE SATISFIED.

"I would like you to know how pleased we are with the CSSLabs equipment installed on our network. Your unique design has allowed us to grow the services to our users beyond what was planned in our budgets." "... the higher performance and reliability has been commented on by the network users." "... Also, please extend my sincere thanks to your technical support staff for their fantastic response in resolving our recent compatibility issue."

"... My staff was amazed that the solution was delivered the next day! This type of service is rare in the industry."  
—Roger Spangler, Network Service Manager, Fujitsu America, Inc.

"... ample provisions for drive and add-on board expansion make this system a fine choice in network or multiuser applications."—PC Magazine

"Our records confirm that over 25,000 CSS boards are in the field now, and judging by the low rate of return, their performance and integration in our systems, is outstanding."

—Bob Ziegler, Purchasing Manager, Datamedia Corporation

"... the combination of large- and small-record test results makes it quite impressive over the full range of data-handling hurdles." "Apparently CSS has found some semi-magical combination of medium technology that will yield sterling performance..."

—PC Magazine

"... a great example of a PC on steroids." "This machine is more than the sum of its parts. Power file server builders should keep an eye on CSS."—LAN Times

When you're evaluating a new system, it helps to know what experience others have had. CSS Laboratories' customer list is a long and happy one. Not to mention the computer press, who have also had some nice things to say.

These people all agree, that CSS systems don't just perform well, they offer unsurpassed reliability and compatibility. Add to this our reputation for customer service, and you can see why people are recommending us. For dealer information, call 1-800-966-CSS1. Find out why we call CSS Laboratories "A Solid Investment."

Circle 62 on Reader Service Card  
(RESELLERS: 63)

CSS logo, CSS Laboratories, A Solid Investment, MaxSys are trademarks of CSS Laboratories, Inc. 386SX, 386, and 486 are trademarks of Intel Corp. All other brand names are trademarks of their respective owners. © 1990 CSS Laboratories, Inc.

**CSS**  
LABORATORIES, INC.  
A Solid Investment

In the U.S.  
Call Toll-Free  
1-800-966-CSS1

California  
CSS Tel (714) 852-8161  
Fax (714) 852-9464

New York  
CSS Tel (212) 605-0290  
Fax (212) 605-0286

Australia  
Hypec Tel (02) 808-3666  
Fax (02) 808-3596

Belgium  
Dan-B Tel (02) 468-1271  
Fax (02) 468-1282

Canada  
CSS Tel (416) 882-0260  
Fax (416) 881-0461

Germany  
MOPS Tel (02) 51-78-82-58  
Fax (02) 51-78-82-58

Autec Tel (02) 67-33-81-12  
Fax (02) 67-33-81-13

Switzerland  
Kuffer Tel (22) 48-69-20  
Fax (22) 48-27-14

**SUNDAY 10-5** **PROMPT DELIVERY**

**COMPUTERS**  
 386 SX 20 MH 1 MB RAM 40 HD 1799.99  
 1.2-1.4 FID VGA 1799.99  
 386 33 MH 5 MB RAM 80 HD 2594.99  
 1.2-1.4 FID VGA 80 HD 2994.99  
 386 33 MH Tower 1 MB 100 HD 4149.99  
 1.2-1.4 FID VGA 100 HD 4149.99  
 1.2-1.4 FID VGA 100 HD 4149.99

**Apple** 3799.99  
 Mac Port 40 MB CALL  
 Mac Ict 40 MB CALL  
 Macintosh Classic 2494.99  
 Macintosh IIs 2/40 449.99  
 Picomac M-150P CALL

**Canon** NAVIGATOR  
 HD40 CALL

**PACKARD BELL** 386 SX  
 1-1.2 FID 1.4 FID 1 MB 1599.99  
 40 MB VGA MTR 1799.99  
 80 MB HD 2294.99  
 40 MB VGA 999.99

**PACKARD BELL** 286-12 MHz  
 40 MB VGA 999.99  
 40 MB VGA 999.99

**MODEMS**  
 Hayes Ultra 96 849.99  
 Courier HS 9600 899.00  
 HST 9600 Dual 899.00  
 2400 ext. w/IMP 5 339.99

**FAX/MODEM** 449.00  
 Worldport 2496 for Tosh. 469.99

**FACSIMILE (FAX)**  
 220V Fax (Available)  
 Canon Fax 15 699.99  
 Canon Fax 15 724.99  
 Canon Fax 1150 649.99  
 Murella M-110 664.99  
 Pana. UF-170 1099.99  
 Pana. UF-270M 484.00  
 Pana. UF-307 675.00  
 Sharp FO-215 659.00  
 Sharp FO-510 674.99  
 Sharp UK-190 369.99  
 Smswinc 1010 50160

**NEC**  
 Desk Jet 510 489.99  
 Desk. Writer F/Mac 649.99  
 HP Laser IIP 1649.99  
 HP Laser III 1649.99

**HP** Hewlett Packard  
 Desk Jet 510 489.99  
 Desk. Writer F/Mac 649.99  
 HP Laser IIP 1649.99  
 HP Laser III 1649.99

**ONIDA** 639.99  
 Okil Laser 800 1294.99  
 Okil Laser 920 1294.99  
 Okil Laser 920 1294.99

**PANASONIC** 734.99  
 KXP 4420 109.99  
 KXP 4450 109.99

**LASER PRINTERS**  
 Hewlett Packard  
 Desk Jet 510 489.99  
 Desk. Writer F/Mac 649.99  
 HP Laser IIP 1649.99  
 HP Laser III 1649.99

**LANCASH**  
 Epc. Start. 10M Bps V.3.0 499.00  
 2M Bps Start. 10M Bps 350.00  
 2M Bps Adapter V.3.0 174.99  
 S.M.C. PC 500 FS 159.99  
 S.M.C. PC 500 FS 159.99  
 Tiana Lanie 8 Bit 249.99  
 Tiana Arctec 8 Bit 234.99

**NOVEL** In Store  
 Novell 386 31 499.99  
 Novell 386 31 1049.99  
 Novell 386 31 2699.00  
 Novell 386 31 4549.00

**PRINTERS** 284.99  
 Citizen GS1140 294.99  
 Epson FX-850 284.99  
 Epson FX-1050 369.99  
 Epson LO-510 174.99  
 Epson LO-1010 654.99  
 Epson LO-1050 369.99  
 Epson LO-2550 449.99  
 Epson QL-3400 399.99  
 Fujitsu 9124 399.99  
 NEC 6300 289.99  
 Okil 320 444.99  
 Okil 321 394.99  
 Okil 391 Plus 144.99  
 Okil 391 Plus 174.99  
 Panasonic KXP 1160 334.99  
 Panasonic KXP 1124 334.99

**SONY**  
 MITSUBISHI ELECTRONICS  
 MICROSOFT  
 TOSHIBA  
 NOVEL

**HARD DRIVES**  
 30 MB ST251-1 299.00  
 40 MB ST251-1 319.99  
 60 MB MS FII 249.99  
 60 MB IDE 459.99  
 80 MB IDE 375.00  
 80 MB IDE 375.00  
 Philipscard IXL 50 MB 319.99  
 Philipscard IXL 105MB 319.99

**PANASONIC PHONES**  
 Pana. KXT 308 10 174.99  
 Pana. KXT 308 30 164.99  
 Pana. KXT 1232 110 144.99  
 Pana. KXT 1232 80 174.99  
 Pana. KXT 616 20 99.99  
 Pana. KXT 3620 99.99  
 Cordless KXT 2910 89.99  
 Cordless KXT 4000 119.99  
 Pana. KXT 1470 159.99  
 Pana. KXT 2634 159.99  
 Pana. KXT 2740 159.99  
 Pana. KXT 2740 159.99

**AG POWERED** 2194.99  
 T-3100X 40 HD 3674.99  
 T-3200 SX 120 HD 4594.99  
 T-3200 SX 20 HD 5094.99  
 T-3200C 200 HD 309.99  
 T-3200C 200 HD 309.99  
 T-3200C 200 HD 249.99

**PRINTERS FLAPTOP**  
 Canon 150 Plus 309.99  
 Diconix 301 309.99  
 Toshiba 311 249.99

**MONITORS** 465.00  
 Nish Diam. Scan 914.99  
 NEC Multisync 3-D 914.99  
 NEC Multisync 5-D 1499.99  
 Princeton Ultrasync 14 499.99  
 Sony MultiScan 499.99

**IN USA & CANADA & P.R. INCLUDING NY STATE**  
**1-800-874-1235**  
 Fax: (212) 463-8335 (Include Voice & Fax #)  
**S & W COMPUTERS & ELECTRONICS**  
 31 West 21 Street, New York, NY 10010  
 NYC (212) 463-8330  
 Mon.-Thurs. 9-6 Fri. 9-1:45  
 Saturday Closed

**DISCOVER • M.C. • VISA • C.O.D. w/Deposit • No surcharge**  
 for credit cards. Ship. addnl. pending 2% Qty. Ltd.  
 Prices subject to change. Returns w/when  
 authorized. Free Pricing Sunday Meter  
 Parking available Prices for consumers

**PRICES HARD TO MEET — SERVICE HARD TO BEAT! World Wide Inquiries Promptly Filled**

structures we had a couple of hundred thousand years ago. What has changed is not our IQ but the representation systems we use to think about the world. Every time we change one of those significantly, we actually change ourselves.

"I think that when you start laying over these larger symbol systems, you start channeling the fairly direct impulses people have into art, invention, theater, sports, and all those kinds of things that are a good way of having cathartic experiences without going out and bashing people. It is very difficult to predict the kind of world that the computer is going to bring, but certainly, for me, it's the next big thing since Gutenberg. And yet, the sad thing is, if history repeats itself at all, it isn't going to affect most people in the way you'd really like it to. Of course, when we're in a transition period, it's very hard to draw curves about what the future will be like."

**The Future of Computers**  
 While Kay sees future computers as having a profound effect on our culture, he sees a more prosaic future for the computer itself.

"According to Moore's Law, and considering some of the fabrication technologies I've seen recently, we'll have 100 million instructions per second for the desktop by 1995 and a couple of thousand MIPS by the year 2000. Most computers will be smart-memory computers where the processors and memory are amalgamated. Because most of the cost of computers is in the packaging, the Dynabook might be something that is deposited. The whole thing could be one monolithic entity. There is nothing to fix on it; you melt it down when it doesn't work anymore.

"What that says is that the Dynabook is like something you buy in a stationary store or a clothing store. It was Aldus's notion that something isn't really in the culture until you can afford to lose it. It may not be made by any of the present manufacturers because they see the computer as one kind of thing, and its destiny appears to be very different.

"When I give a talk, I always ask everyone in the audience carrying a computer to hold it up. At some point, I won't be able to use that ploy, because everyone will have one, and it will be no big deal to carry it into a talk. You don't have to plan on taking notes; you just have it with you because you always do. I think that's the destiny of computers: to be mundane." ■

*Bob Ryan is a BYTE technical editor. You can reach him on BIX as "b.ryan."*

# BIOS SOURCE CODE

The AT BiosKit gives you a complete Bios with source code in C you can modify for your own applications! The BiosKit includes a Bios on diskette ready for programming Eproms, and includes the utilities you need to Rom the sources Code. The Bios also has a Rom Monitor/Debug and Setup. At last you have control over the core of your system. Over 380 pages, with diskette, \$199. The XT BiosKit is only \$99. The Intel Wildcard Supplement for the XT BiosKit is \$49. Software tools: You need MS C and MASM 5.1 for modifying the Bios.

**FREE** We'll include a free copy of the pocket-sized XT-AT Handbook by Choisser and Foster with each BiosKit if you mention this ad when you order. Of course, this \$9.95 value is also available by itself. Or buy five or more for only \$5.00 each.



**800-462-1042**  
619-271-9526



**Annabooks**  
 12145 Alta Carmel Ct., Suite 250  
 San Diego, CA 92128  
 FAX 619-592-0061  
**Money-back guarantee**

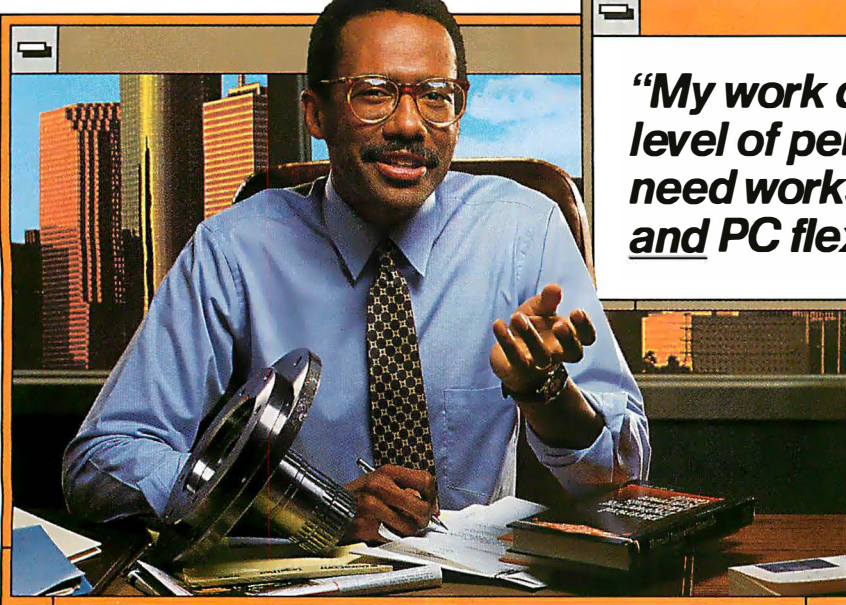

***“My work demands a higher level of personal power. So I need workstation performance and PC flexibility.”***

## **ZENITH DATA SYSTEMS INNOVATES AGAIN™**

**Get the Z-486/25E™ Personal Workstation—now pre-installed with the personal productivity tools you really need.**

Workstation power. PC convenience. That's why Zenith Data Systems' Z-486/25E PC is the most “personal” of personal workstations. And when combined with our high-resolution monitor, it's the perfect solution for high-resolution workstation graphics.

Zenith Data Systems' Z-486/25E delivers the best of the personal workstation because its exclusive 64-bit memory bus design increases the performance of the i486™ chip. It also includes a 1024 x 768 TIGA/VGA™ card\* making the Z-486/25E the perfect environment for engineering and design applications, scientific visualization, and medical imaging. And the throughput for any of these I/O intensive applications is further enhanced through its EISA architecture.

But the Z-486/25E is more than just powerful. It has all the convenience and flexibility of a PC. And now that it's pre-installed with Microsoft® Windows™ version 3.0—and comes standard with a Microsoft Mouse—the Z-486/25E adds up to *The Seamless Solution™* for your computing world.

So make the Z-486/25E Personal Workstation *your* personal choice. For more information and the name of your nearest

Zenith Data Systems  
Medallion Reseller,  
call: 1-800-523-9393.



**ZENITH**  
data systems 

Groupe Bull

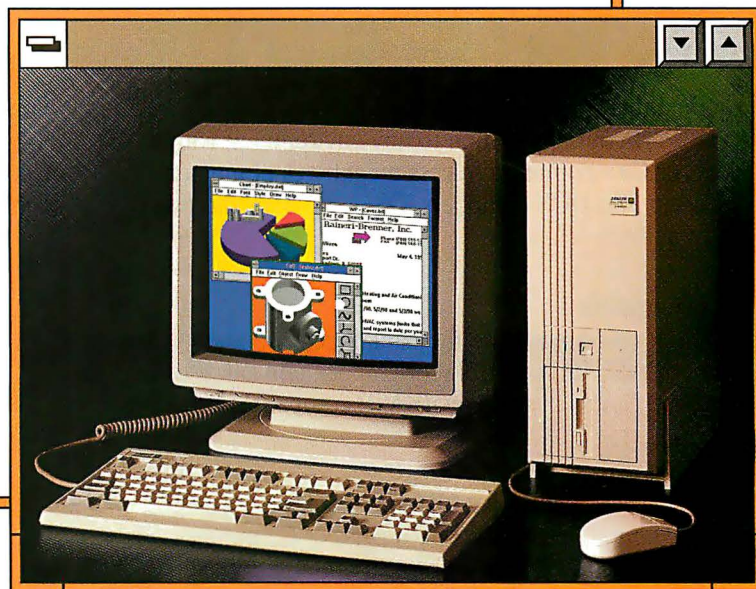

\*170MB model only.

Graphics simulate Microsoft Windows version 3.0, a product and trademark of Microsoft Corporation. i486 is a trademark of Intel Corporation. TIGA/VGA is a trademark of Texas Instruments Corporation.  
©1990 Zenith Data Systems Corporation

Circle 275 on Reader Service Card

# C Speed C Portability C Flexibility

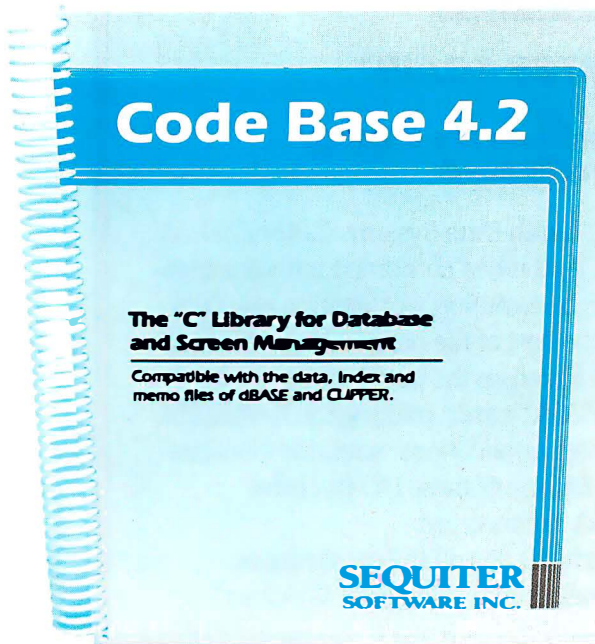

## dBASE Power

*Build a multi-user, dBASE compatible application which is several times faster than dBASE IV, Clipper or Fox Pro. Watch its windows and menus appear instantly on any computer.*

### **Portable**

Port your application to any environment with a C or C++ compiler. Access megabytes of memory using 386 DOS compilers, OS/2, Unix or Microsoft Windows.

### **Compatible**

As you directly use the data, index and memo files of dBASE III through IV or Clipper, you can use Code Base 4.2 with any dBASE compatible product.

### **Easy**

Consult examples in the 280 page user's guide as you interactively execute Code Base 4.2 routines from a learning utility. You will remember the routines which are named like dBASE commands.

### **Small**

Make stand alone executable files as small as 14K. Code Base 4.2 executables are 1/2 to 1/3 the size of corresponding Clipper executables.

### **Complete**

Enjoy the benefits of complete dBASE functionality, including browse, edit, menus, windows, multiple index files per database, dBASE expression evaluation, relations and filters.

### **Order Today**

Order the DOS-OS/2 version for \$295. Call (403) 448-0313 or fax (403) 448-0315. Discover why Sequiter Software Inc. and most software dealers offer a 60 day money back guarantee. Source is included and there are no royalties!

# The Point of the Pen

*GO's vice president of software examines the new PenPoint operating system*

*Robert M. Carr*

**T**he laptop computer, no matter how small it becomes, is still fundamentally a desktop computer. This makes laptops difficult for noncomputer initiates to learn and operate. In addition, it's hard to use laptops in a meeting, and it is nearly impossible to use them while standing up.

Pen-based computers, on the other hand, are powerful tablet-like devices that operate more like notebooks than computers. As their name implies, you control such computers with a special pen that the screen senses. You write directly onto the screen, and the computer translates the handwriting into ASCII text. You issue commands to the computer using familiar gestures such as insertion carets, circling, and scratching out.

If you're on the go, you operate a pen-based computer just like the traditional notebook it resembles.

PenPoint is a 32-bit, object-oriented, multitasking operating system designed expressly for the unique needs of mobile, pen-based computing. It packs the capabilities of operating systems such as OS/2 into a compact implementation that does not require a hard disk drive.

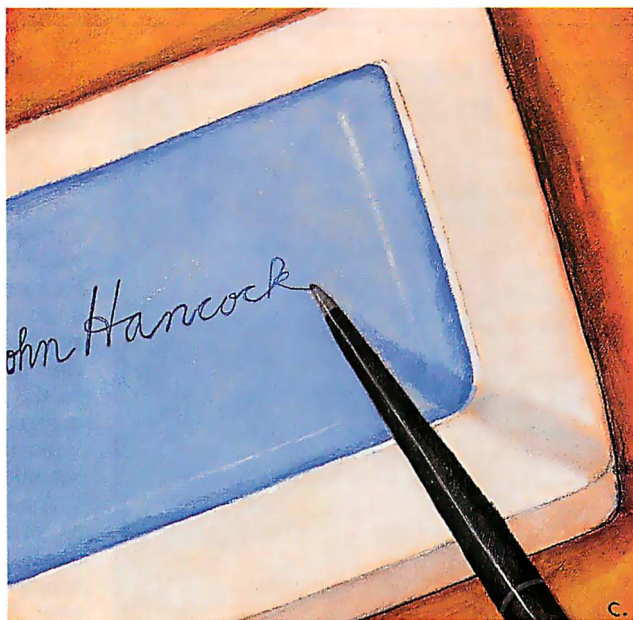

Why build a new operating system for pen-based computers? Because continuing advances in microcomputer electronics have made possible a dramatic change in the way computers are used. PenPoint is the first operating system specifically designed to be driven primarily by a pen. Because of this, PenPoint includes many new elements not found in traditional graphical user interfaces (GUIs). Two of

the most important elements are the *notebook user interface (NUI)* and *gestures*.

## The NUI

The notebook metaphor is PenPoint's major organizing interface. This interface provides a quick-reference style of access where you can find all the information that you need with just a few quick taps of the pen. PenPoint's notebook metaphor provides the familiar and flexible concepts of pages and sections (see screen 1).

A notebook *page* is synonymous with a document in a desktop computer. With pages, you never have to deal with separate files and programs (unless you transfer information to other computers). Instead, each document is itself a live piece of user data. You simply move

from page to page and always see the data just as it was when you last left it, scrolled to exactly the same location you exited from.

PenPoint notebooks can contain hundreds or thousands of pages. As this would be too many processes to have running simultaneously, PenPoint transparently performs the bookkeeping steps of starting and stopping processes (e.g.,

## Making Sense of Scribbles

PenPoint's input subsystem generates low-level event messages for all pen activity on the screen. These low-level events are grouped into higher-level aggregates called *scribbles* that are translated by the handwriting-translation (HWX) subsystem into either text characters or command gestures. These translations, in turn, are dispatched to the appropriate objects via an input distribution model that includes filtering, grabbing, inserting, and routing of input up and down the window hierarchy.

The current HWX engine runs as a background process. It operates in real time (i.e., 3 characters per second) on a 16-MHz 286 processor and occupies about 100K bytes of memory. Another 100K bytes is required to hold a general-purpose spelling dictionary. HWX tolerates characters that overlap, touch, or share strokes, and it handles inconsistent input from the same person (i.e., a user may shape the same character in different ways at different times).

The first version of HWX recognizes neatly printed random English-language text containing mixed uppercase

and lowercase letters, numerals, and punctuation. The text can also be both "boxed" and "ruled-line" handwriting (i.e., you have the option of writing into character boxes or on ruled lines).

After a small amount of training, users typically experience accuracy rates of four out of five words translated correctly, the fifth word having an easily correctable error (i.e., a word-level accuracy rate of 80 percent to 90 percent). This is equivalent to a raw character-accuracy rate of 90 percent to 97 percent.

The recognition process works as follows: The recognition engine is based on a *blackboard model*, where data from multiple knowledge sources is combined and sorted using a dynamic programming algorithm. These knowledge sources include predefined information, such as PenPoint's 100,000-word dictionary and standard rules for punctuation usage, and context-sensitive aids supplied by the application, such as specific word lists for a given input field. One of the default knowledge sources is the character-shape recognizer.

The recognition engine examines scribbles as it receives them. It performs character recognition by comparing character shapes against a set of prototypes for each character. PenPoint comes with a preinstalled set of hundreds of prototypes that work well for most writers. You can "train" the prototypes through a brief handwriting session, during which the operating system builds additional prototypes for your own unique style of shaping characters.

Under PenPoint, the pen is a respectable data-entry device. With time, it will only get better. Because PenPoint provides standard programming interfaces to all applications, it insulates them from the specifics of any particular handwriting-recognition algorithms. Therefore, the algorithms can be improved over the years without disturbing a growing base of applications.

Although PenPoint is designed primarily for pen-based input, you can use an optional keyboard for high-volume data entry. PenPoint also has a pop-up "virtual keyboard" that you use for text input by tapping on it with the pen.

**Screen 1: The PenPoint notebook user interface.** The page number is at the upper right; tapping the pen on it advances the notebook to the next page. To the right are tabs associated with pages or sections of the notebook. At the bottom is the bookshelf; the icons represent various PenPoint services.

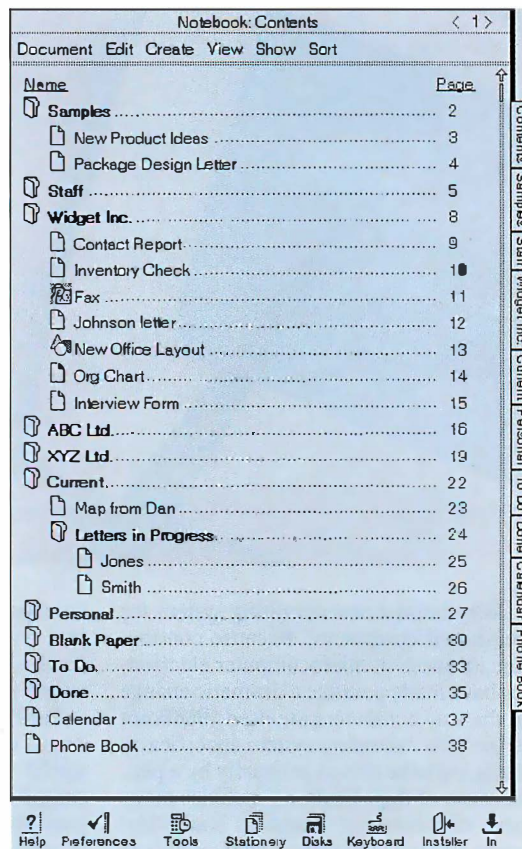

running applications) and loading and saving application data when pages are turned.

Pages are numbered in the top right-hand corner. You "turn" pages with a pen tap or pen flick on the page number. For visual feedback, page turns include a special graphical effect that resembles the turn of a physical page. Tabs appear down the notebook's right side and are attached to any page or section you desire. If there are more tabs than will fit on the screen, they overlap and can be dragged with the pen tip. Touching a tab turns immediately to that page in the notebook.

A notebook's first page contains a table of contents that looks and operates like its book equivalent. Touching a page number here turns the notebook to that page. If you wish, pages can be "floated" to achieve a traditional overlapping window display. You can create *sections* that contain a group of pages. Sections can also contain other sections. This allows you to organize information as you see fit.

At the bottom of the PenPoint screen is a *bookshelf* area where systemwide objects and resources are represented as icons. PenPoint's standard bookshelf includes objects for on-line help; "mail



support" functions (which are described later); functions for modifying the system's configuration to meet your preferences; a virtual keyboard; an installer for applications, fonts, and resources; and a disk viewer that provides a table-of-contents view when you access external file systems. You can place additional objects there, including documents and other notebooks.

### Gestures

Under PenPoint, the pen is the primary input device, although keyboards are supported as an option. The pen does not require an on-screen cursor, since the pen tip itself indicates the screen location. You use the pen for pointing (by touching the screen), data entry (by handwriting), and action (by using *gesture commands*).

PenPoint provides a standard, rich, gestural language that is based on common intuition about pen-editing marks. The heart of the gestural user interface is the set of core gestures shown in figure 1. These gestures work consistently across all applications, providing common commands such as select, insert, delete, options, move, copy, and help.

Look at the example of deleting a word in screen 2. In a mouse-driven interface, you double-click the mouse to select the word and choose Delete from a menu (or issue a keystroke equivalent, such as Control-X). But in PenPoint, you can simply draw an X over the word to delete it. Likewise, you can put a word in bold-face by drawing a B over it.

The pen can also perform editing and data-entry tasks. To modify existing text, you would draw a small caret where you want to insert text. In response, a gap opens in the text and a writing pad object appears (one of the many standard PenPoint support objects), as shown in screen 3.

While you print with the pen, PenPoint performs handwriting recognition as a background process. When you close the writing pad, the resulting ASCII text is then handed to the application. (For further information on the handwriting-translation subsystem, see the text box "Making Sense of Scribbles" at left.)

Under PenPoint, the location of a gesture controls its intended meaning. For instance, when you draw the letter O in a handwriting area, it is translated into ASCII 79 (a capital O). When you draw it over application data (e.g., a word), it is translated into an edit command. And when you draw the O into an object-oriented drawing program, it is translated

Tap	•	Select/Invoke
Press-hold	◐	Initiate drag (move, wipe-through)
Tap-hold	• ◐	Initiate drag (copy)
Flick (four directions)		Scroll/Browse
Cross out	X	Delete
Scratch out	≡	Delete
Circle	○	Edit
Check	✓	Options
Caret	^	Insert
Brackets	[ ]	Select object, adjust selection
Pigtail (vertical)	↯	Delete character
Down-right	L	Insert space

**Figure 1:** Basic pen gestures recognized by PenPoint. The gestures indicate both what you want to work with (the operand) and what to do (the operation) in the notebook. They are also location-dependent: A circle drawn on a writing pad has a different meaning than a circle sketched in a drawing application.

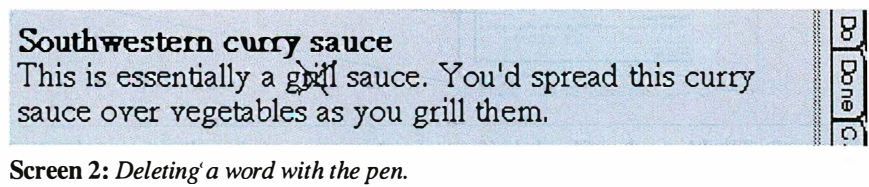

**Screen 2:** Deleting a word with the pen.

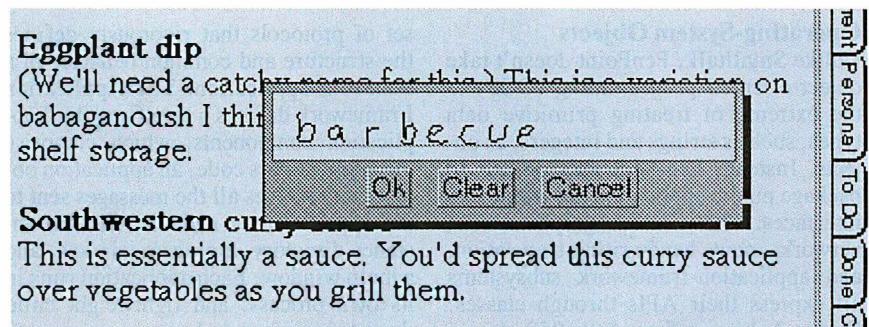

**Screen 3:** The writing-pad object, for inserting text. As you print on the writing pad, a background process performs character recognition.

into the command to create a circle object. Such location-specific gestures provide an intuitive interface style that's free of confusing modes.

Throughout this process, the application is in full control of the interpretation and meaning of the pen strokes. This allows it to control the translation and de-

termine which object the pen's "ink" should affect. However, applications do not have to deal with the interface at this level unless they have special needs. PenPoint system classes handle everything necessary for recognizing gestures. Applications can choose to receive just gesture messages.

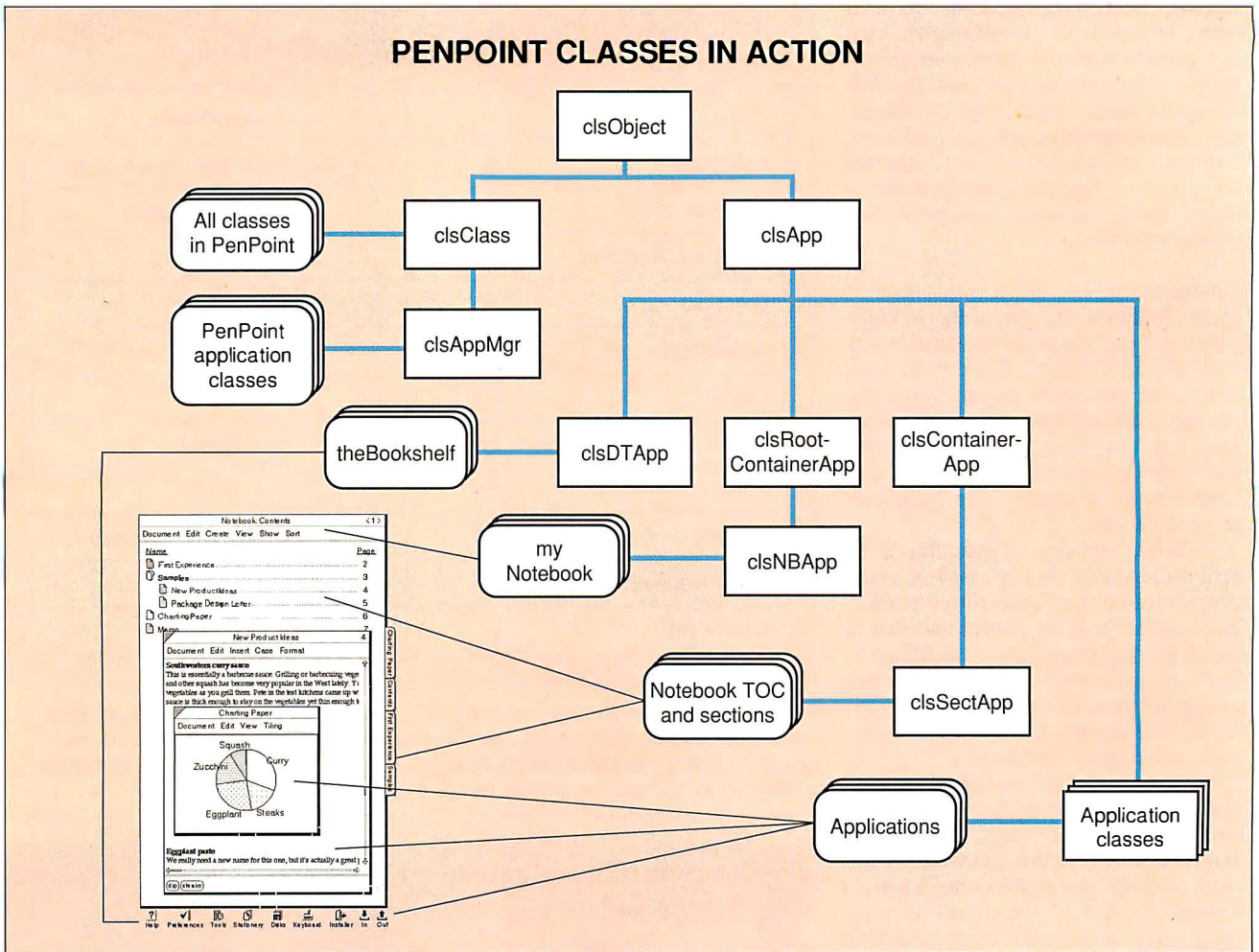

Figure 2: The hierarchy of bookshelf, notebook, section, and application in the PenPoint NUI is a direct reflection of the PenPoint class hierarchy.

### Operating-System Objects

Unlike Smalltalk, PenPoint doesn't take object-oriented programming (OOP) to the extreme of treating primitive data types, such as strings and integers, as objects. Instead, PenPoint uses objects to package public application programming interfaces. The window, graphics, file, network, input, handwriting-translation, and application-framework subsystems all express their APIs through classes. Figure 2 shows a few of the 250 classes and 1500 messages that are available in PenPoint.

Only PenPoint's lowest layer, the kernel, is accessed via function calls. The result is the best of both worlds: The architecture has the modularity and flexibility of an object-oriented system, while most subsystems and key algorithms are in traditional C code and benefit from its speed of execution.

All PenPoint applications must adhere to PenPoint's Application Framework, a

set of protocols that rigorously defines the structure and common behavior of a PenPoint application. The Application Framework defines a set of standard application components, which comprise the application's code, an application object that receives all the messages sent to the application, a resource file, an instance directory, a process window, and a main window. Each application runs in its own process, and lightweight child threads are supported.

Through the Application Framework, applications inherit a wide variety of standard behaviors. Some of these behaviors include document properties, gesture recognition and response, moving and copying data, live embedding of other applications, printing, spelling checking, search and replace functions, and on-line help. New code is required only to add new functions or to modify (i.e., override) specific aspects of an object's default behavior. Applications

automatically save their internal state in a directory. There is no need for you to save or load the application's state explicitly from one session to the next.

In addition to normal applications that run when you turn to their specific page, PenPoint provides a well-defined service manager architecture that supports background server applications, such as databases and network connections. Applications can query PenPoint as to the presence of services and then establish message-passing connections to them.

### Embedded Document Architecture

One unique aspect of PenPoint's Application Framework is its Embedded Document Architecture, which provides the ability to embed a live instance of one application inside other applications. For example, a text document can, without any special programming, embed any other PenPoint application, such as a spreadsheet or a business graphics

The Experts In Accessories

Manufacturing Company, Inc.

CURTIS



1449  
Listed  
TVSS

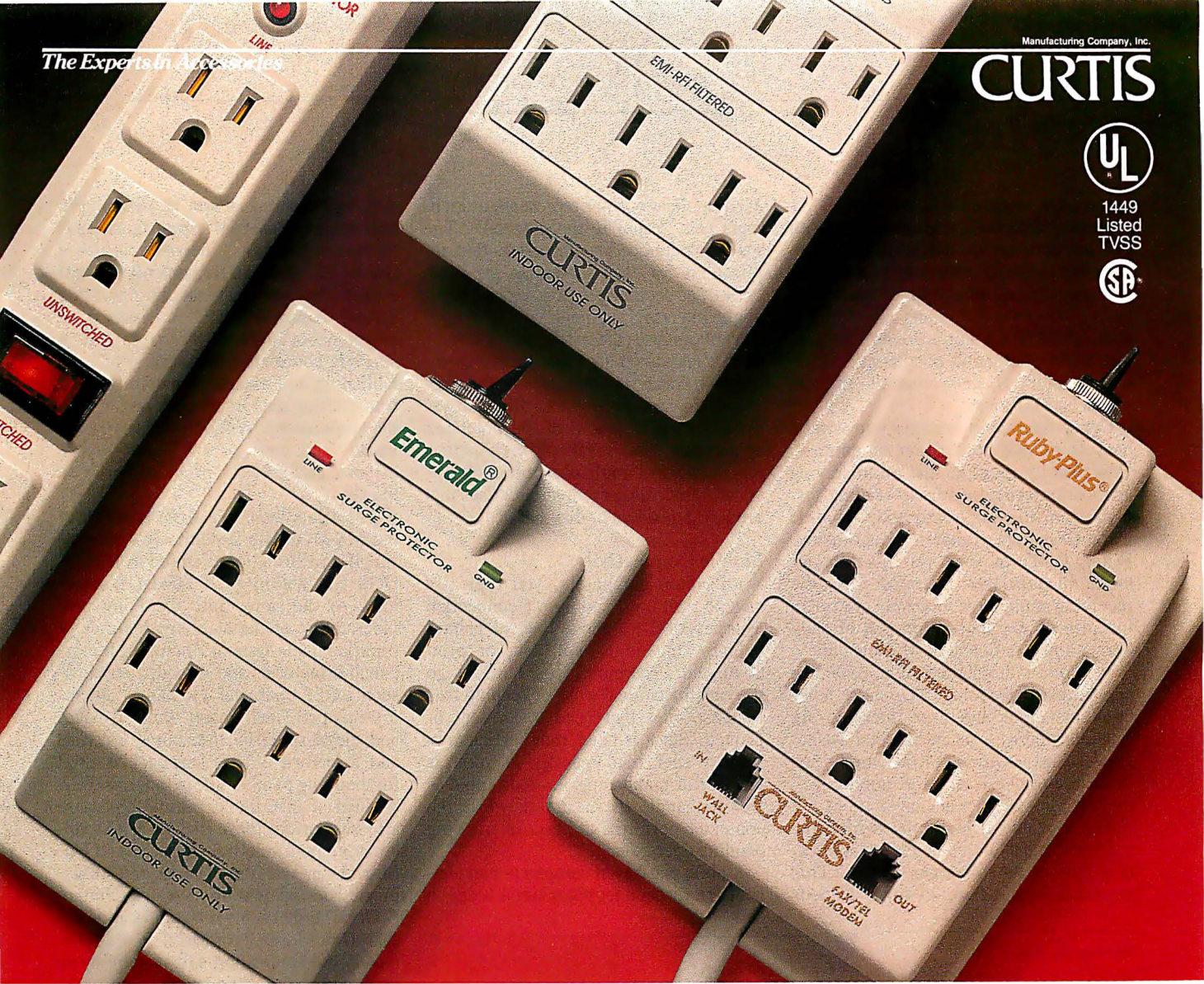

# You Can't Buy A Better Surge Protector Than Curtis

## Guaranteed Protection—Proven Performance

When it comes to protecting their valuable data and electronic equipment, more computer users rely on Curtis surge suppressors than any other brand. Here's why:

**UL 1449 TVSS Lowest Voltage Ratings—**Every Curtis surge protector has achieved a rating of 400 volts peak or less—the lowest ratings available—in tests by Underwriters Laboratories for maximum let-through voltage.

**Greater Selection—**Single or multiple outlets, switched or unswitched, remote control, EMI-RFI filtering, phone line surge protection—

choose the surge protector with the combination that best suits your needs.

**Guaranteed Protection—**Every Curtis surge protector is guaranteed to provide you with the protection you need. And most are backed by the industry's best warranty coverage—the Curtis Lifetime Warranty.

With all this going for them, no wonder Curtis surge protectors are owned by more computer users than any other brand.

Curtis. You can't buy a better surge protector.



Sug. Retail \$6.95-\$149.95

For the Curtis dealer nearest you call (603) 532-4123 Ext. 85

Manufacturing Company, Inc.

CURTIS

30 Fitzgerald Drive, Jaffrey, NH 03452

© Curtis Manufacturing Company, Inc.

An Insilco Company

application, within itself.

Screen 4 shows a text document with two applications embedded in it: a live, running drawing program and a live, running signature pad (the latter is a built-in object in PenPoint). The result is that all PenPoint applications can provide a true compound-document capability in which you can seamlessly mix and match applications.

Other operating systems copy static data from one application to another. This usually requires that the receiving application accept a variety of data formats from the Clipboard and Dynamic Data Exchange transfer mechanisms. While PenPoint supports this transfer mode for pure data, the norm is for the receiving application to simply embed an instance of the application that already knows how to edit and display the data.

PenPoint's implementation uses live application embedding. The entire notebook metaphor and user interface are implemented as a set of bundled system applications. Although you simply see these collectively as "the notebook," they are, in fact, distinct applications.

The application hierarchy behind the notebook starts with a notebook application that is the hierarchy's root. This notebook application, in turn, embeds

each application that represents a document (i.e., page) in the notebook. The notebook application embeds section applications for each section in the notebook. The sections, in turn, embed other applications and sections.

PenPoint uses the notebook for several of its specialized user interfaces that require structure and navigation: the Create, Help, and In Box/Out Box subsystems are all instances of the notebook application. The notebook architecture also supports multiple notebook instances, such as notebook subclasses that are RAM-resident or disk-based.

### Mobile Connectivity

With laptop computers, you typically have to wait until you have a connection to a network, telephone line, or printer before using an E-mail, fax, or print command. Therefore, you have to go through the clerical work of keeping lists of those files that need to be sent or printed. But it is much more efficient to address an E-mail message as soon as you finish composing it. Your mind is free to handle the next task while the computer performs the task of tracking pending operations.

Mobile pen-based computers can connect and disconnect many times a day to

different computers and networks. For this reason, PenPoint supports multiple "auto-configuring" network *protocol stacks* that you can dynamically install without having to reboot the operating system. A protocol stack is a layered set of protocols, each of which handles a specific communications task (e.g., establishing and maintaining connections, transporting data, and presenting data to the application). With PenPoint, you can install and configure devices, device drivers, and network protocol stacks on the fly.

The file system is a strict superset of the MS-DOS file system; all PenPoint-specific information is stored as an MS-DOS file within each MS-DOS directory. At the same time, PenPoint provides many of the standard features of traditional file systems, including hierarchical directories and extended features, such as 32-character filenames, memory-mapped files, object-oriented APIs, and client-specified attributes for files and directories. This approach is used for mapping to other file systems as well. Additional installable volume types are also supported; these include RAM volumes, remote volumes (for access to PC, Macintosh, and file servers), and a Macintosh Hierarchical File System volume.

Once PenPoint gives an application access to an MS-DOS or Mac file, it is ultimately the application's responsibility to read and write specific data formats. PenPoint builds in a standard import/export architecture and user interface to allow applications to share common file-format filters and to standardize the invocation of these filters. As a result, you can point to a desktop file right from PenPoint's screen, convert it automatically into a PenPoint application's internal format, edit the file, and then write the file back to the desktop computer in an existing format, all with just a few taps of the pen.

You can establish and break network connections at will by plugging in or unplugging cables or by walking in and out of the range of wireless communications. PenPoint provides automatic connection and detection management. Its applications handle breaks gracefully, suspending all interruptible operations until the connection is reestablished.

However, mobile pen-based computers are often incommunicado. PenPoint therefore builds in native support for deferred data transfer through its In Box and Out Box architecture and user interfaces. Out Box is a central extensible queuing service for all connection-dependent transfer operations. You can

**Screen 4:** Two applications, a drawing program and a signature pad, embedded in a text application.

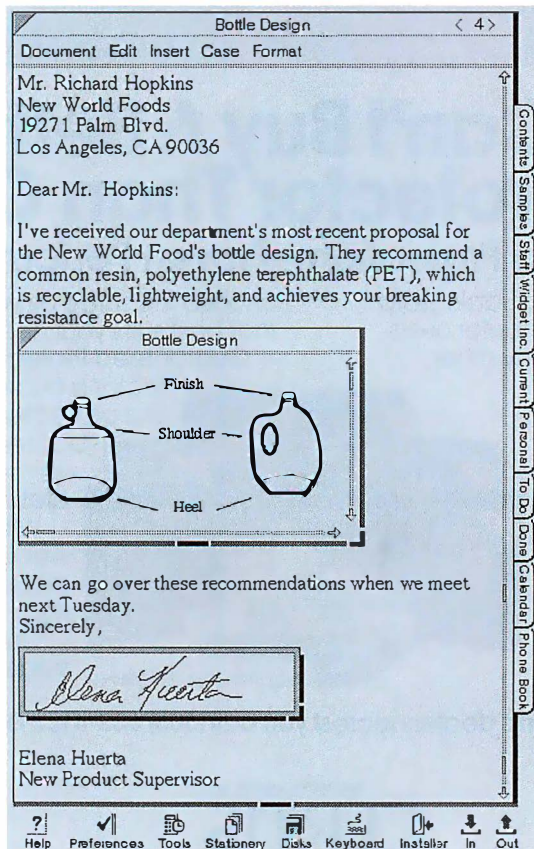

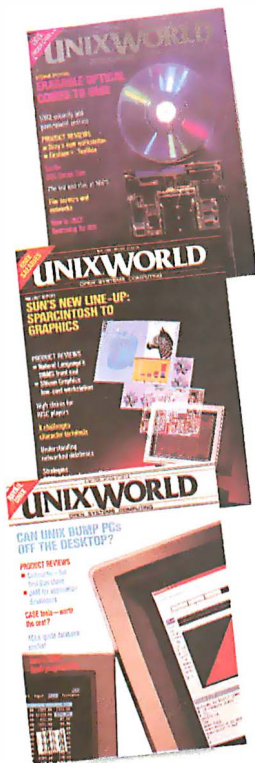

# EXPLORE UNIXWORLD... RISK FREE!

**YES!** Start my one-year (12 issue) subscription for only \$18.00, that's 50% off the newstand price.

NAME: (PLEASE PRINT) \_\_\_\_\_ TITLE: \_\_\_\_\_

COMPANY NAME: \_\_\_\_\_

ADDRESS: \_\_\_\_\_  HOME  OFFICE

CITY: \_\_\_\_\_ STATE: \_\_\_\_\_ ZIP: \_\_\_\_\_

BILL ME AT \$18.00\*  PAYMENT ENCLOSED. PLEASE CHARGE MY:  VISA  MASTERCARD  AmEx

CARD #: \_\_\_\_\_ EXP. DATE: \_\_\_\_\_ SIGNATURE: \_\_\_\_\_

\*U.S.A. ONLY. Canadian: 1 yr. \$24. Other Foreign: 1 yr. \$38. All Foreign orders must be prepaid in U.S. Funds.

Please complete all questions to qualify for the rates shown above. Subscriptions at the above rates are limited to persons with active professional, functional, and managerial responsibilities in UNIX or XENIX Computing. Other subscriptions: \$36 a year in U.S., Canada: \$48, Other Foreign: \$76.

CIRCLE ONE ONLY

**My Company's Primary Business**

- Mfg. of Comp./Comp. Equip.
- Mfg. (except Comp./Comp. Equip.)
- Systems Integrator/House
- Software Developer
- VAR, Dealer or Distributor
- Communications/Telephone
- Transportation/Utilities
- Mining or Construction
- Fin./Ins./Real Estate
- Wholesale or Retail Trade
- Consulting
- Government or Military
- School or University
- Other: \_\_\_\_\_
- Medical/Dental/Legal
- Research/Development

CIRCLE ONE ONLY

**My Primary Job Function**

- Corp. or Fin. Mgmt.
- MIS/DP Mgmt.
- Office Mgmt./Admin.
- Telecommunications
- Systems Integration
- Design or Dev. Eng.
- Prog./Software Dev.
- Research/Analysis
- Marketing or Sales
- Purchasing
- Mfg./Production
- Distribution
- Education/Teaching
- Consulting
- Gov./Public Admin.
- Other: \_\_\_\_\_
- Technical Staff/  
Engineering Support

CIRCLE ONE ONLY

**The Number of Employees At All Locations Of My Company**

- Under 10
- 10-49
- 50-249
- 250-999
- 1,000-4,999
- 5,000 or more

CIRCLE ALL THAT APPLY  
**I Purchase/Influence The Purchase Of The Following:**

- Mainframe Computers
- Minis/Superminis
- Micros/Supermicros
- Workstations
- Board Level Products
- Terminals
- Printers
- Disk Drives
- Tape Drives
- Modems/Multiplexors
- LAN Equipment
- Software

## SAVE 50%

EB1B50

Your No-Risk Guarantee: I may cancel at any time and receive a refund for the balance of my subscription. Please allow 6-8 weeks for processing.

\*TM of AT&T. UnixWorld is not affiliated with AT&T.



NO POSTAGE  
NECESSARY  
IF MAILED  
IN THE  
UNITED STATES



**BUSINESS REPLY MAIL**

FIRST CLASS MAIL PERMIT #42 HIGHTSTOWN, NJ

POSTAGE WILL PAID BY ADDRESSEE

**UNIXWORLD**

SUBSCRIPTION SERVICES

P.O. BOX 570

HIGHTSTOWN, NJ 08520-9328



# Up to date. Down to earth.

**Changing the world.** UNIX is changing the world of computers, the world of business—quite simply, changing the world. It's revolutionizing office automation. It's required for U.S. government computer contracts. It's the backbone of information strategies worldwide.

**The information you need.** That's why you need *UNIXWORLD*—the magazine that keeps you up to date on the rapidly changing world of open systems computing. Each issue brings you the latest product trends and technical advances that can affect your business. The inside story on some of the world's

biggest high-tech companies. Easy-to-understand programming tips and tutorials that can help you and your company use UNIX to its fullest. And unbiased hardware and software reviews to help you invest wisely when you buy.

**The whole UNIX-verse.** *UNIXWORLD*'s in-depth features go beyond dry technical facts, to show how the pieces fit together—to tell you what's important about the advances and the strategies that are changing your world. And *UNIXWORLD* consistently offers the freshest, most down-to-earth writing you'll find in any computer publication.

**Subscribe and Save.** Subscribe today, and receive the next 12 issues of *UNIXWORLD* for just half the regular newsstand price. Save even more by ordering for two or three years. You can't lose—every subscription to *UNIXWORLD* comes with a no-risk guarantee.\*

1 year \$18.00 (save 50%)  
2 years \$32.00 (save 55%)  
3 years \$42.00 (save 60%)

**Subscribe now! Call toll-free:  
1-800-341-1522**

**UNIXWORLD**

**If you're into UNIX, you need *UNIXWORLD* MAGAZINE.**

UNIX® is a registered trademark of AT&T. UNIX WORLD is not affiliated with AT&T.

\*UNIXWORLD's no-risk guarantee: If not satisfied, cancel and receive a full refund for the balance of your subscription.

A McGraw-Hill publication

# Impressions of GO and PenPoint

Owen Linderholm

To provide a platform for software development, GO Corp. has developed a pen-based notebook computer for developers to use with the PenPoint operating system. This GO hardware system looks exactly like a thick standard-size notebook—until you open it. Inside, it looks more like a large laptop LCD than a computer. You can also use a 386 system with a digitizing tablet with PenPoint.

## The Hardware

This development system is shaped like a sheet of paper with a screen on its surface. I/O connections and some simple controls are on the sides. The screen, approximately 5½ inches wide and 8 inches high, is on the front of the unit.

The computer also holds the input stylus, a cordless device that looks almost like an engineering pen or pencil. The stylus interacts with an electromagnetic field that passes across the surface of the screen. Thus, the system can tell where the stylus is and whether it is touching the screen.

The system I saw was based on a 16-MHz 286 with several megabytes of memory, and it had a port for plugging in an external floppy disk drive. GO expects final PenPoint-based systems to use the 386 architecture (perhaps initially the 386SX). These systems will require fairly large amounts of RAM, perhaps as much as 4 MB.

PenPoint itself takes up a lot of memory space, and the system will probably keep most of its data in RAM during daily use. Then when you return to your desktop system, you can save the data to a central or more permanent system. However, PenPoint stores application data very compactly, and 1 MB of RAM can hold about 100 pages of mixed textual and graphics data.

PenPoint-based systems will probably have some form of mass storage: either a small 2½- or 3½-inch hard disk drive, or perhaps flash-memory cards that you can remove and reinsert. Other possible peripherals include modems, fax modems, and LAN connections, both wired and wireless.

## The Software

A lot of the design of PenPoint and the systems that will use it is based on changing the status quo. Existing laptops are seen as cut-down versions of desktop systems that are not useful in situations calling for true portability.

GO's design for PenPoint presents a new paradigm. It completely eliminates the standard mode of input for existing computers—the keyboard. It is designed in such a way that using the system really is like writing on a notepad.

An idea that I heard discussed at GO is a note-taking application that would allow you to simply take notes as you would on a pad of paper. Those notes would appear on the screen exactly as written, including corrections, annotations, and sketches. The application would store them until later, when you could review and edit them and selectively convert them to computer form via the built-in handwriting recognition. You could also enter diagrams and sketches into a drawing package.

This type of application would allow the computer to literally function as a pad of paper while you use it in public. Then, at a later time, it would take advantage of the data storage and analysis capabilities of a desktop computer—something no traditional laptop system could hope to do.

Perhaps PenPoint's most impressive feature is its ease of use. Although advanced users may feel comfortable typing, far more people know how to use a pencil than know how to type. GO has added a few stylus "gestures" in PenPoint that correspond to standard pencil use. These gestures are intuitive and easily learned—crossing something out deletes it, for example.

## The Users

Using the system and its controls is difficult to describe, perhaps because it is so natural. The notebook metaphor with tabs and a table of contents is obvious and elegant. Just about the only concept that new users must grasp is that pointing the stylus at something is equivalent to saying "go right to this." Due to pen-based computers' ease of use and true portability, GO believes that by the end of the 1990s, the market for them will be as big as the market for desktop computers is now.

One area in which PenPoint systems will be used is for light data entry, which would entail writing letters rather than books, filling in forms with a mixture of words and multiple-choice selections, calculating totals on data entered into a form, and sketching basic designs rather than modeling them in exact detail. Where pen-based systems in general—and PenPoint in particular—will

excel is in the vertical applications area. Two of the software companies founded expressly to write software for PenPoint—Slate and PenSoft—both believe this strongly and are at work on applications to allow users to customize systems for their own particular vertical markets (see the text box "Pen-Based Applications" on page 220).

The object-oriented nature of PenPoint makes this customization easy to do. Applications can use services within PenPoint freely by instantiating them. In addition, applications can use each other. PenPoint uses the notion of pieces of stationery—virtual electronic paper that has a structure. Each piece of stationery can have areas within it that are designed so that different types of applications can use them.

For example, a piece of proposal stationery could have separate spaces for text entries and graphical or drawing entries. Any application that has been identified as being able to handle a particular kind of stationery could write to these areas—a word processor in the text-entry space, and a drawing package in the graphics area.

This object-oriented structure extends throughout the operating system, making it easy for applications developers to replace PenPoint services with customized services of their own. This makes it easy for developers to write applications that you can customize in many ways: for example, combining the flexibility of programming a spreadsheet with a database form-entry design that includes graphical data entry.

## A Computer for Everyone

All this flexibility in the applications software area is made possible by using a computer that really is as easy to use as a notebook—for everyone. There is still a long way to go, however. No other companies have produced compatible hardware systems yet, despite considerable help from GO, which lets them use the information it has gained from making its development system.

Nevertheless, GO has shown that pen-based computing is possible and that uses for such systems do indeed exist. What remains to be seen is whether people are ready for a truly usable portable computer.

---

*Owen Linderholm is a BYTE news editor. You can contact him on BIX as "owenl."*



install transfer-agent services that extend the Out Box to work with specific destinations, such as printers, file transfers to other computers, E-mail protocols (e.g., MCI Mail and Mail Handling System [MHS]), and faxes. The user interface for the Out Box is a small floating notebook that provides a section for each Out Box transfer service.

Outbound information needs addressing, and PenPoint has built-in standard Print and Send commands that allow communications services to be tightly integrated with PenPoint applications. The Send command brings up extensible addressing mechanisms that let you send a single document to multiple destinations. PenPoint provides a standard address-book API that lets you use your favorite address-book application to store E-mail and fax information along with any address-book information that you want to keep.

Few people have the time to read all their E-mail at their desk when they're plugged into the network. PenPoint's In Box accumulates all received E-mail and faxes so that you can disconnect from the network and peruse them during the odd moment between meetings or at home in the easy chair. The In Box architecture is symmetrical to that of the Out Box and is similarly extensible by installable transfer services.

#### PenPoint and Hardware

Within a few years, mobile pen-based computers will be available in a wide range of sizes and configurations. Standard sizes will start with today's classic notebook form factor: about 8½ by 11 inches, with a full-size screen. Smaller steno-pad and shirt-pocket sizes will become popular for those users who believe that ultimate portability is of utmost importance and page-size screens are not necessary. Larger desktop "visual tablets" that attach to standard PC architectures will serve the desktop pen-based market.

The smaller steno-pad and shirt-pocket pen-based computers will typically require a *one-tiered* memory architecture. That is, they will have RAM but no backing store (i.e., hard disk drive). The larger computers will often be more traditional *two-tiered* architectures with RAM and backing store.

Desktop computer operating systems were designed around a large, inexpensive backing store. Therefore, they run poorly (or not at all) in one-tiered hardware; or they require prohibitively expensive amounts of RAM, to simulate disk space, or ROM, which is difficult to



Reading  
worth  
writing  
for.

If you're looking for some good reading, you've just found it. The free Consumer Information Catalog.

The Catalog lists about 200 federal publications, many of them free. They can help you eat right, manage your money, stay healthy, plan your child's education, learn about federal benefits and more.

So sharpen your pencil. Write for the free Consumer Information Catalog. And get reading worth writing for.



**Consumer Information Center  
Department RW  
Pueblo, Colorado 81009**

A public service of this publication and  
the Consumer Information Center of the U.S. General Services Administration.

## Pen-Based Applications

Owen Linderholm

The pluses of pen-based computing are many. For one, a pen-based computer will make it easier for a wider range of people to gain access to computers than can use them today. However, the minuses exist as well. In fact, the biggest problem facing developers isn't hardware, it's software. It will take a revolution in mind-set to change software developers' thinking to address the issues raised by using a pen rather than a keyboard.

The major PC software companies, such as Word Perfect, Lotus, and Borland, have announced an interest in developing software for the GO PenPoint operating system. Currently, though, the most interesting developments in the new pen-based community are coming from start-up companies whose bread and butter depends solely on pen-based software.

Two of these, PenSoft and Slate, are tied very closely to GO; in fact, their offices are within 1 mile of GO's facility. Both are taking the same fundamental approach: Software for pen-based systems must be designed from scratch.

Perhaps the biggest reason for this approach is a simple but very fundamental observation: Pen-based software neither needs nor uses a cursor. The idea of a cursor, along with all its associated block operations, is redundant in pen-based systems. A new concept replaces it: directly manipulating objects with gestures.

Both PenSoft and Slate recognize that working with PenPoint requires adopting and adding to the object-oriented, layered nature of the operating system. Products for pen-based computing need

to be designed around pen entry rather than by simply trying to layer pen entry on top of an existing keyboard-based application.

Slate and PenSoft recognize three major arenas of applications that are suited to run on these systems. The first is software that already exists and will be ported. This is where such companies as Lotus and Borland are known to be working and is of the least interest to the new companies.

### PenSoft

The second arena is applications that currently exist on PCs but aren't yet truly successful. For instance, PenSoft is working on a personal information manager (PIM) that will make full use of the pen-based capabilities of PenPoint.

The big advantage of having a pen-based system as a PIM is that you can carry it around and use it all the time. Everything you write down is entered into the PIM, and you can rapidly and naturally keep track of all kinds of information, including notes, contacts, phone numbers, and so forth. (PenSoft's product won't be available until final hardware systems using PenPoint ship, hopefully sometime this year.)

### Slate

The third arena is for completely new software that either was impossible or had not been thought of before pen-based systems appeared. This is where Slate is headed with its Professional Application Development System (PADS). Slate expects that a great deal of the early demand for pen-based systems

will be generated by vertical market applications, especially those based on collecting and distributing data using forms.

PADS is intended as a framework for third-party developers to create custom pen-based applications for PenPoint. PADS is based on a sophisticated database engine that transparently recognizes, reads from, and writes to a wide number of database formats, including dBASE and several popular mainframe formats. This database-engine layer filters data between remote databases and individual PenPoint-based systems.

Pen-based systems accept data and use a forms-based interface to display it and interact with it. This forms interface consists of two parts: a user interface and a forms user-interface designer. The interface looks like a form that is truly electronic and smart. You can query it and have results displayed as collections of forms. You can fill in one field and have others filled in intelligently for you.

The designer section allows the developer to customize forms and lay them out, assign database fields, and perform sophisticated searches, links, and pattern matches. It also allows the addition of intelligent fields that look up data and perform calculations.

Slate wants all PenPoint programs to use the database engine for PADS. It is installed as a standard layer that uses the object-oriented capabilities of PenPoint. Thus, PADS makes all the features of the database engine available to all applications. This object-oriented technique lies at the heart of what GO is trying to do with PenPoint: make appli-

update. Although small applications exist for disk operating systems, most of the best-selling applications typically require several megabytes of disk space apiece.

In contrast, PenPoint is designed to run as a standard operating system on a full range of pen-based hardware, and it runs very well on both one-tiered and two-tiered memory architectures. PenPoint builds in paged virtual-memory support, allowing it to work efficiently in architectures that include backing store, such as desktop hard disk drive-based

systems. With PenPoint, you can choose between small RAM-only machines and slightly larger machines with or without hard disk drives.

### PenPoint Applications

Although the notebook metaphor may give you the impression that all installed applications and the operating system are part of a seamless whole, the two are, in fact, cleanly separated. This allows easy distribution, installation, and deinstallation of PenPoint applications by third parties.

PenPoint is a compact operating system, and its applications are even more compact. PenPoint's object-oriented design achieves its compactness through a high degree of code sharing. Furthermore, it keeps only a single copy of code in the computer. This is possible because PenPoint relocates executable code at application installation time, not at application load time, as is traditionally done.

For applications that are relocated into memory at load time, there must be an additional copy of unrelocated application code on the disk. This, in effect,

cations and services available across the PenPoint operating system to all other applications.

Slate took further advantage of the object-oriented nature of PenPoint in designing its user interface. The company has added a number of user-interface techniques to PenPoint that make the interface even more intelligent and easy to use. One of these techniques is called *targeting*. This technique helps PADS recognize where a gesture was intended to be, even when it is sloppy or too large.

For example, in PenPoint, you draw a cross to indicate a selection that you wish to delete. Slate has extended this so that a huge, hastily drawn cross can be interpreted as deleting a relatively small field on a form. The Slate technique recognizes where the center of the cross was drawn and what the closest field to that point is, and it can therefore ascertain what you wish to delete. Although this technique may not sound very useful, in practice it becomes easy to delete fields.

Another use of targeting is in data entry. It can be very tedious to fill in complex forms and always keep your writing in the small boxes provided. PADS lets you enter data by writing input letters that are much larger than the intended field and extend across the page. The program spots that the data starts in a particular field, and once you enter the data, the program puts it into the appropriate field. This is a great boon when you need to move around while entering data.

Slate also includes *smart fields* that pop up "pick lists" of available choices.

As you enter more data, these pick lists grow to include any recently entered values. They cut down on the amount of writing that you have to do. The programmed fields will look up data to go with values that you have already entered. In this way, PADS often allows you to complete complex forms by entering only a few data values.

These kinds of technical innovations are the sorts of changes that GO hopes will occur as pen-based computers become more accepted. They are also changes that are difficult for standard software companies to make, since they are concentrating on keyboard-based software.

The developer's version of PADS should be available by the time you read this. A commercial release intended for end users as a "pen-based dBASE" is planned for release later this year.

#### Ease of Use Is Key

Companies like PenSoft and Slate are relying on the pen-based market to be radically different from that of regular desktop, keyboard-based PCs. They are also doing their best to make sure that pen-based computing really is an intuitive and realistic alternative to keyboard-based computing.

If the pen-based market materializes, then companies like PenSoft and Slate will be well positioned for the future. However, the key to this lies in whether lots of first-time computer users will be attracted to them.

---

*Owen Linderholm is a BYTE news editor. You can contact him on BIX as "owenl."*

doubles the total storage requirement. In contrast, once PenPoint installs an application, only a single copy of its code (the relocated executable) resides in the PenPoint machine until you deinstall it.

PenPoint's standard for application distribution is 3½-inch 1.44-MB MS-DOS floppy disks. Every PenPoint-capable machine has access to a 3½-inch floppy disk drive (either built-in, via a base station, or through an MS-DOS desktop PC).

When you place an application-distribution disk into the floppy disk drive, the

operating system automatically senses it and brings up an application-installation dialogue. If you then confirm that you want to install or update the application, all the requisite application code and resources are installed in the PenPoint machine. Application code is relocated at this time. PenPoint will also ensure that all the classes that the application requires are installed and are of the correct version.

The bottom line is that PenPoint, with several installed applications and user data, runs very well on a computer with

only 4 MB of semiconductor memory and no backing store at all.

#### Current Status

The first commercial version of PenPoint runs on the Intel 386 processor in its native 32-bit flat-memory mode. The operating system provides basic software support for hardware connections through a high-speed serial link, an RS-232C port, a parallel port, and a SCSI port. The first remote file system to be implemented on PenPoint is TOPS, which provides strong connectivity to both PCs and Macs. (For a first-hand impression of PenPoint, see the text box "Impressions of GO and PenPoint" on page 218.)

PenPoint application programs are written in ANSI C using standard IBM PC development tools. You can debug the applications using a source code symbolic debugger with PenPoint running on either a desktop PC or on the target pen-based hardware.

You implement the OOP techniques by making C function calls into PenPoint's Class Manager subsystem. Because the operating system is written in C and is designed for portability, it can be transferred to a variety of other processor architectures, including high-performance, low-power RISC chips. (For a look at some newly announced applications for PenPoint, see the text box "Pen-Based Applications" at left.)

PenPoint was developed by GO, a company that was founded in 1987 to develop general-purpose, mobile, pen-based computing. To date, approximately 85 worker years of development effort have been invested in the operating system. GO's approach to developing the pen-based market is to form partnerships with a wide variety of computer hardware and applications software companies. In July 1990, GO announced that IBM was PenPoint's first licensee, and IBM announced that it was developing a computer designed expressly for PenPoint.

The only proposed alternative to PenPoint for mobile pen-based computing is to adapt existing desktop GUIs by adding a "pen-compatibility box" that would emulate the mouse and the keyboard. Such a minimally adapted GUI remains trapped by its heritage: It offers all the complexities of the keyboard and few of the benefits of the pen. In contrast, PenPoint proposes a fresh start: the simplicity of the pen. ■

---

*Robert M. Carr is vice president of software at GO Corp. (Foster City, CA). He can be reached on BIX c/o "editors."*

# RISC FREE!

## Free i860™ Processor and i860/APX Software!

By now, you've probably heard about our industry-first 486™ MotherBoard that packs the power of the Intel 80486 CPU with the Intel 80860 RISC processor (i486™ + i860 = 4860).

What you haven't heard is that, for a limited time, when you buy a 486 MotherBoard with 8MB of RAM, Hauppauge will give you an i860 RISC processor and the i860/APX operating system at no additional cost.

Why *give* you this capability? Because you'll enjoy a level of processor performance never before seen in a PC. Our bet is that you'll be so impressed, you'll come back for more!

**A PC Revolution:** In the PC environment, the 4860 is a 486-based MotherBoard with the new EISA I/O bus. It runs over 2 times faster than 386 computers and delivers mainframe power for applications including CAD, LAN and desktop publishing. This board is fully compatible with DOS, IBM's OS/2, Novell Netware and SCO UNIX. What's more, Hauppauge's 4860 supports up to 64 MBytes of memory *without* a RAM expansion board.

**RISC-Y Business:** The i860 processor is ideal in complex applications, performing up to 25 million floating-point operations per second. It adds to the power of the 486, so you can run rings around ordinary PCs.

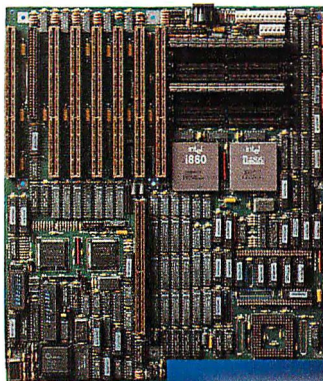

By adapting Intel's APX (Attached Processor Executive) software to our 4860 MotherBoard, we've created a way to exploit the power of the i860 to give you *practical* multiprocessing. In fact, i860/APX

provides a base for entirely new applications made possible by the advent of the i860 RISC processor.

**Technical Features:** 25 or 33MHZ  
486/860 • 4 Mbytes of high speed RAM expandable to 64 Mbytes shared between i486 and i860 processors  
• Socket for optional Intel Turbo Cache 485™ and Weitek 4167 • 7 EISA I/O slots • 64-bit expansion slot for optional high-speed graphic frame buffer • 1 parallel, 2 serial ports and a built-in PS/2-style mouse port.

Enjoy a RISC-free investment. Our 4860 MotherBoard is designed with the world's highest performing microprocessors. So you can have the world's highest performing PCs and workstations.

For more information, call 1-800-443-6284.

Hauppauge Computer Works, Inc.  
91 Cabot Court  
Hauppauge, New York 11788  
Telephone: 516-434-1600  
Fax: 516-434-3198  
In Europe (49) 2161-17063  
In Australia: (7) 262-3122

**Hauppauge!**

Available at your local computer dealer.

# Touch-and-Feel Interfaces

*Built-in pointing devices replace mice in notebooks and laptops*

*Andrew Reinhardt*

In comparison to the cumbersome toggle switches and punched-card readers of the past, the keyboard was a huge breakthrough in human-computer interaction. Typing is a fairly efficient and familiar process, and keyboards require relatively little processor overhead or esoteric, expensive technology.

But designers of notebook computers confront an inherent problem with keyboards that is a function of human physiology: Fingers are only so small. The tiny Poqet portable, measuring  $8\frac{3}{4}$  by  $4\frac{1}{2}$  inches, pretty well defines the minimum realistic size for a keyboard; anything less is impractical for word processing or other text entry. So, making computers still smaller and lighter will eventually require abandoning the keyboard for some other input scheme.

Equally important, the keyboard, for all its popularity, is still a very unnatural interface. Typing requires training, produces data-entry errors, and demands a lot of elbow room—and it's not well suited for increasingly prevalent graphical user interfaces. Laptops of the near future will have to include built-in pointing devices to support GUIs.



Aside from alternative pointing devices, there are also emerging *input* alternatives that will once again radically alter the nature of human-computer interaction. The most immediate is handwriting recognition, available now in the Grid Systems Gridpad, the Scenario DynaWriter, and a few other portables. A slew of new notebooks that recognize handwriting are expected this year from

companies such as GO, Momenta, Superscript, and NCR, and software start-ups such as Slate are aiming to develop a new class of pen-based applications. (For more on pen-based computing and GO, see "The Point of the Pen" on page 211.)

In the more distant future, desktop and portable computers may be able to recognize speech, which is the most intuitive interaction of all. Alternatives to keyboards need a lot more horsepower—in the case of speech recognition, perhaps hundreds of millions of instructions per second. Current research in digital signal processors and neural networks may reduce the raw processing power required by today's brute-force pattern-matching voice-recognition schemes, but, even so, it will be some time—perhaps five to 10 years—before it will be practical to talk to your laptop. (For more on voice recognition, see the State of the Art section on Computing Without Keyboards in the July 1990 BYTE.)

## **Making a Point**

The shift from character interfaces to GUIs implies the need for a pointing device on every computer. For desktop



**Photo 1:** The Mac Portable offers a built-in trackball, which can be moved to the left of the keyboard for left-handed users or replaced with a numeric keypad. Trackballs are gaining popularity on the desktop, but they may demand too much space to be feasible for notebook computers.



**Photo 2:** Psion's MC400 laptop incorporates a touchpad that lets you "point and drag" with your fingertip. The touchpad's aspect ratio is different from the screen's; it had to be squeezed in above the keyboard, so its horizontal resolution is about twice its vertical resolution.

systems, the choice is usually a mechanical or optical mouse, although space-saving stationary trackballs are also a popular option. One noteworthy trend is the increasing popularity of digitizing tablets or digitizer/mouse hybrids, such as the Wiz from CalComp (Anaheim, CA). These devices are gaining some acceptance outside of CAD/CAE as general-purpose pointers.

But for a laptop or notebook computer, a mouse or digitizer is often impractical. It's a hassle to carry around that extra piece of equipment, and a mouse requires a smooth surface to work on. Anyone who has ever seen a laptop user on an airplane rolling a mouse up his or her leg will understand the problem. System vendors are thus considering other, built-in pointing devices, including mini-trackballs, touchpads, touchscreens, the Isopoint, and the Home Key.

- **Trackballs:** The Mac Portable (see photo 1) was the first laptop designed explicitly to run a GUI, and the engineering trade-offs required to achieve that capability are evident. Apple needed a mouse substitute, so it provided a built-in trackball. To avoid the ghosting typical of conventional LCD screens, Apple used a cutting-edge active-matrix display that was thick, heavy, and expensive. The result was a machine that succeeded as a Mac but failed as a portable.

The problem with mini-trackballs in laptops is that they use a lot of space but don't perform as well as their deskbound cousins. To be effective, a trackball has to be large enough to roll around your palm and heavy enough to acquire momentum. Apple's trackball is a nice size, but if it were any smaller, it would become a fingertip device and require too many revolutions to move the cursor from one side of the screen to the other.

- **Touchpads:** Psion has taken a different approach with its MC200 and MC400 laptops (see photo 2). Built into each system above the keyboard is a 5½- by 1⅞-inch resistive-membrane touchpad that uses a finger as a pointer. The touchpad adds very little weight to the system, but it consumes a lot of surface area. Its main drawback may be lack of comfort. It can be awkward to use, since you have to reach up over the keyboard to get at it. And although the touchpad's resolution matches the screen's, pointing at individual items accurately can be difficult. The finger is, after all, a fairly blunt instrument. Psion isn't the only company to use touchpads. Key Tronic makes a standard keyboard that includes an optional multi-

mode touchpad for pointing and choosing or freehand drawing.

- **Touchscreens:** Scenario makes a 286 portable called the DynaVision (see photo 3) that packs a double punch: It includes a built-in CD-ROM drive, and it uses a touchscreen as its primary input device. (A keyboard and mouse are available as options.) Although the system runs DOS programs, Scenario also sells a development package for creating special touchscreen applications.

Scenario's touchscreen uses surface acoustic-wave technology. High-frequency acoustic waves are propagated over the surface of the glass screen, and the dampening of the waves by a fingertip determines the *x*, *y*, and *z* coordinates. The resolution is 25 dots per inch across the screen, or about 40,000 points, each of which can resolve up to 16 levels of pressure.

The primary benefit of touchscreens is directness of interaction. Your finger becomes the cursor, and you can make selections without the intervention of an external pointer. The drawbacks are, typically, added weight and power consumption, slower response times, and lower resolution, which makes touchscreens impractical for drawing applications.

Most problematic is that touchscreens can be awkward to use. Your arm is typically outstretched and can easily tire, while your fingertip obscures the display—you have to pull it away sometimes to read screen text and icons. And touchscreens are inadequate for sustained text entry. But, as their popularity in information kiosks attests, touchscreens are very nonthreatening to novice users.

- **Isopoint:** One of the most promising new pointing devices is the Isopoint, invented by Craig Culver of Culver Research (Woodside, CA). The Isopoint is a small, sliding cylinder positioned between two selection buttons. To move the cursor from side to side, you move the cylinder back and forth with your thumb; to move the cursor up or down, you spin the cylinder. The Isopoint, manufactured by Alps (San Jose, CA), is now being used in two portables: the Outbound Systems laptop (see photo 4) and the Gridcase 1550SX (see photo 5).

Outbound's ingenious Mac-compatible laptop takes a different approach than the Mac Portable, using a conventional LCD to reduce cost and weight, and employing an Isopoint to save space. The Outbound's Isopoint is an earlier version than the one used in the Gridcase

and is somewhat bigger and bulkier. The Isopoint used in the Grid looks to the system exactly like a Microsoft Mouse.

The Isopoint is a displacement, or position-sensing, device, which means that you can whip it from side to side and move the cursor equally fast. Yet Culver himself terms it only a partial success; he is working on other devices that will

provide even more tactile feedback and will be both easier to use and more precise, especially for drawing.

- **Home Row:** Another mouse alternative that is sparking interest among laptop makers is the so-called Home Row or KeyMouse (see the figure), a miniature joystick hidden beneath the *J* key. Under



**Photo 3:** The Scenario DynaVision (formerly the DynaBook) is a portable information retriever with a built-in CD-ROM drive, glass touchscreen, and "point-and-shoot" query environment. The screen resolves 40,000 touchpoints, each of which has 16 levels of pressure. The machine also runs DOS programs with an optional keyboard.

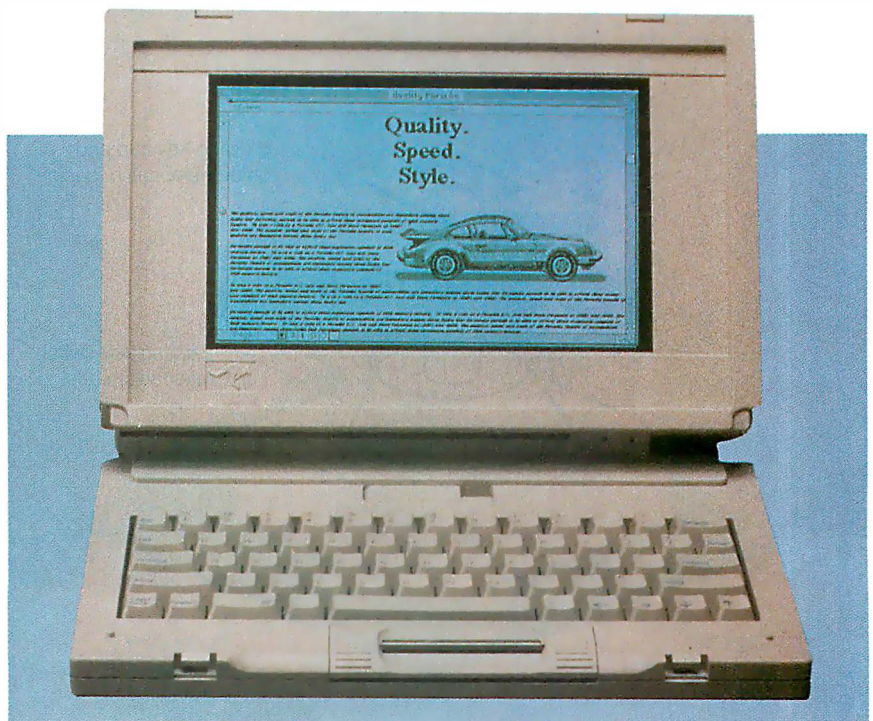

**Photo 4:** The Outbound Systems Macintosh-compatible laptop sacrificed the Mac Portable's cutting-edge display and trackball in favor of a normal LCD and the first use of the Isopoint pointer. Outbound's Isopoint is 4½ inches long and 1 inch high, and it resolves 101.6 pulses per inch of travel. Its low power usage keeps overall power consumption to a minimum.

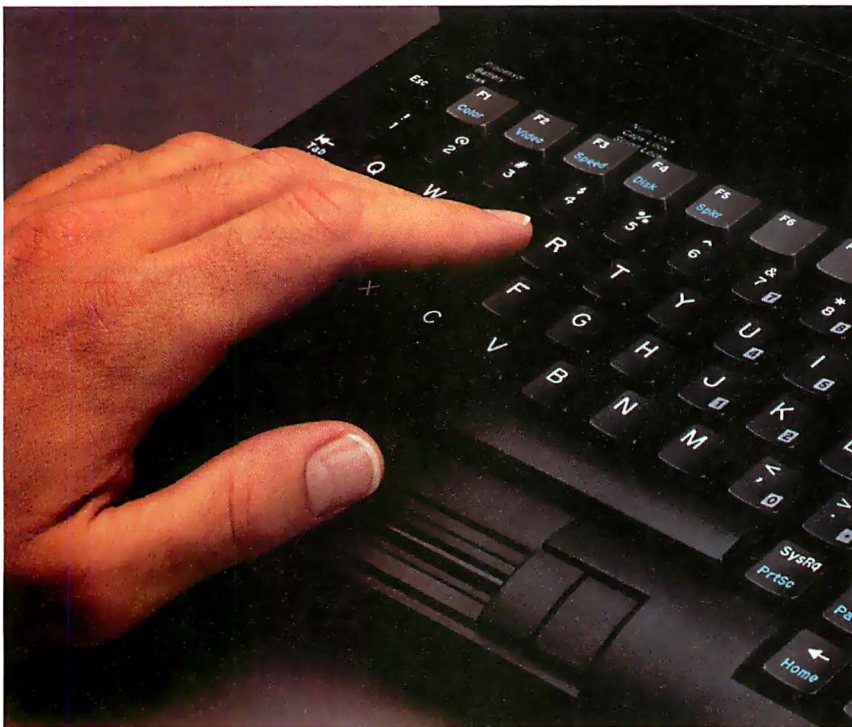

**Photo 5:** Grid Systems was the first company to deliver a laptop designed specifically to run Windows: The Gridcase 1550SX has a 386SX CPU and an Isopoint. Grid's Isopoint is a later iteration than the one on the Outbound, smaller in dimensions and higher in resolution. It emulates a Microsoft Mouse.

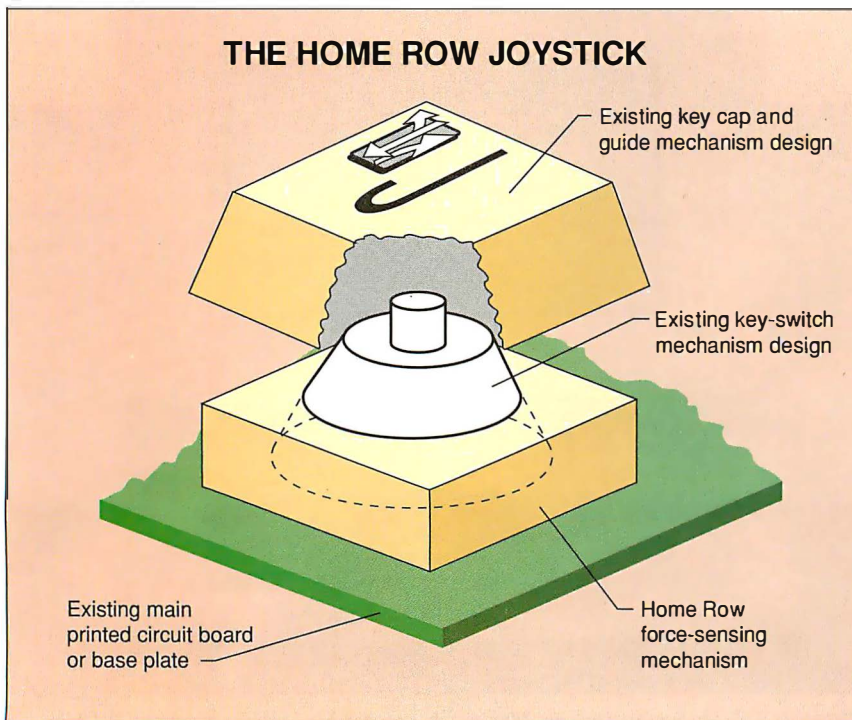

*This pointer-in-a-keyboard uses no real estate and costs nearly nothing. The Home Row is a joystick embedded in the J key; when another key is toggled, the J key rocks on its base, moving the screen cursor. Key Tronic is manufacturing OEM keyboards with this feature under the name "KeyMouse."*

normal circumstances, the *J* key acts as usual, but when you press a combination of keys (Control-*J*, Caps Lock-*J*, or Alt-*J*, depending on the keyboard design and desired mode), it becomes a joystick for moving the cursor or drawing on the screen. When the joystick is activated, the *S*, *D*, and *F* keys become "mouse buttons," letting you perform mouselike functions without removing your hands from the keyboard.

The Home Row device, developed by Home Row, Inc. (Clackamas, OR), is currently manufactured by Key Tronic under the name KeyMouse and has been incorporated into notebook computers from Astarte and AEG Olympia. Its obvious advantages are very low manufacturing cost, estimated by Home Row as \$3 to \$5 more than that of the normal keyboard, and space savings from not needing room for a separate pointer.

The disadvantage is that Home Row is a force-sense device: Like a cursor arrow key, it moves not in proportion to displacement (like a mouse or an Isopoint), but as a function of duration. Accelerator keys let you speed up cursor movement, but you can't really zip across the screen with a stationary pointer.

### A Means to an End

The trend in pointing devices, in Craig Culver's view, ought to be toward subtlety, comfort, and more complete sensory feedback. The mouse fails, because it requires gross movement of the whole arm. The trackball, like the mouse, steals a hand away from the keyboard and requires vigorous motion to move the cursor all the way across the screen.

Touchscreens and touchpads suffer from a lack of tactile feedback; they are stationary, and their surfaces are undifferentiated, so the feedback mechanism is purely visual. And none of today's options takes advantage of auditory feedback, which can subtly enhance the precision, comfort, and quality of your interaction with the computer.

It's also important to remember that these pointers, no matter what their technology, are simply designed to replace a mouse. In the words of Herman Pope, a senior engineer at Texas Instruments, "A pointing device is only a means to an end; the display itself is the user interface." Only when handwriting and voice systems come into common use will you see a shift in the fundamental user-interface paradigm. ■

*Andrew Reinhardt is an associate news editor for BYTE in New York. You can reach him on BIX as "areinhardt."*



# In college, you would have killed for MathCAD. So why aren't you calculating with it now?

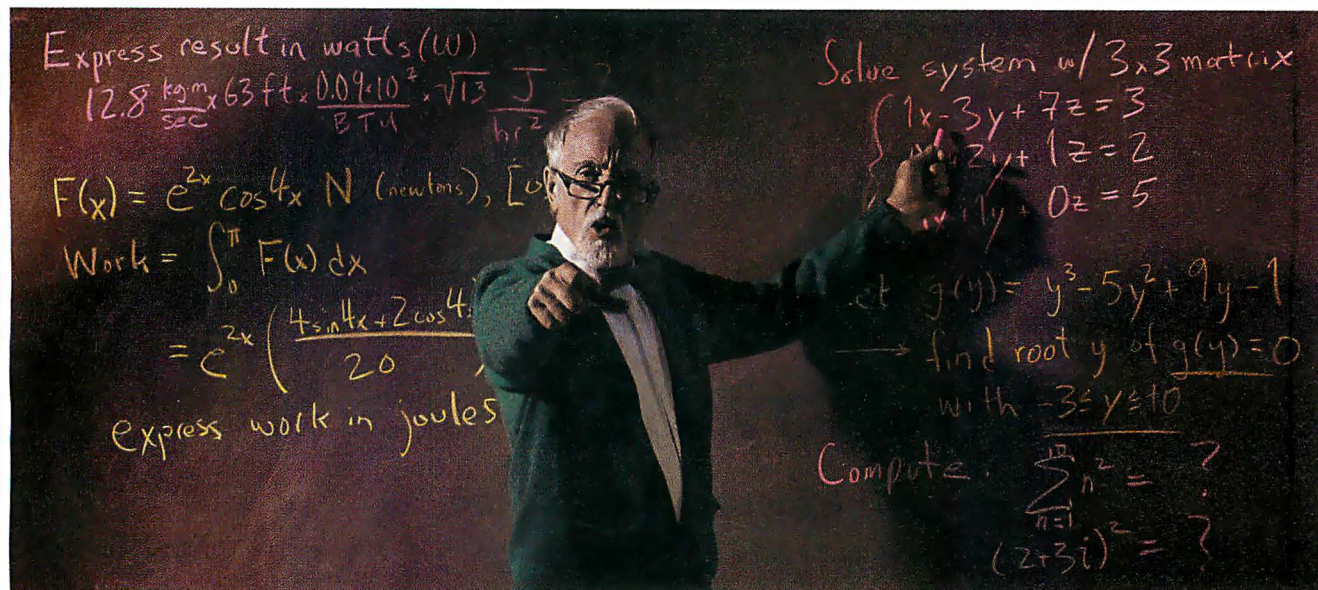

100,000 engineers and scientists already let MathCAD do their calculations for them.

Now that college is far behind you, perhaps it's time you graduated from spreadsheets, calculators and programming.

Because in today's working world of engineering and science, there's no time for anything less than MathCAD. The software that lets you perform engineering and scientific calculations in a way that's faster, more natural, and less error-prone than any calculator, spreadsheet, or program you could

write yourself.

Thanks to MathCAD's live document interface,\* you can enter equations anywhere on the screen, add text to support your work, and graph the results.



March 14, 1989 issue. Best of '88 Best of '87

It also comes complete with over 120 commonly used functions built right in. Perfect for creating complex equations and

formulas, as well as exponentials, differentials, cubic splines, FFTs and matrices.

You get three-dimensional plotting, vivid graphing, and the ability to import HPGL files from most popular CAD programs, including AutoCAD.®

Done calculating? MathCAD prints *all* your analyses in presentation-quality documents, even on PostScript® compatible printers.

All of which has made MathCAD far and away the best-selling math software in the world. In fact, it's used by over 100,000 engineers and scientists — just like you.

There's MathCAD for the PC. MathCAD for the Mac, written to

take full advantage of the Macintosh® interface. And a Unix® version that utilizes the speed and unlimited memory of your Unix workstation.

We also have Applications Packs for Advanced Math, Statistics, Mechanical, Chemical, and Electrical Engineering. Each is a collection of adaptable mathematical models, designed to let you start solving your real world problems right away.



For a free MathCAD demo disk, or upgrade information, dial 1-800-MATHCAD (in MA, 617-577-1017). Or see your software dealer.

Available for IBM® compatibles, Macintosh computers, and Unix workstations. TM and ® signify manufacturer's trademark or registered trademark, respectively.

1-800-MATHCAD

# MathCAD®

MathSoft, Inc., 201 Broadway, Cambridge, MA 02139

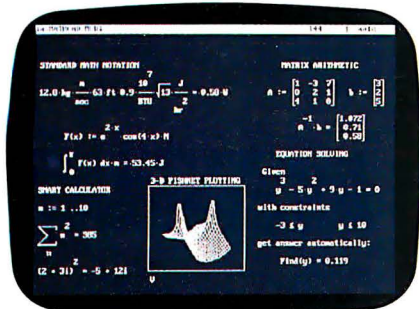

MathCAD 2.5 includes 3-D plotting, HPGL sketch import, and PostScript® out put.



# The joy of C-scape

*Elegant graphics and text*

**Supports  
DOS, OS/2,  
Unix, VMS.  
Call for demo.**

**The C-scape™ Interface Management System** is a flexible library of C functions for data entry and validation, menus, text editing, context-sensitive help, and windowing. C-scape's powerful Look & Feel™ Screen Designer lets you create full-featured screens and automatically generates complete C source code.

C-scape includes easily modifiable high-level functions as well as primitives to construct new functions. Its object-oriented design helps you build more functional, more flexible, more portable, and more unique applications—and you'll have more fun doing it.

**The industry standout.** Many thousands of software developers worldwide have turned to the pleasure of

C-scape. The press agrees: "C-scape is by far the best. . . . A joy to use," wrote *IEEE Computer*. Major companies have selected C-scape as a standard for software development.

C-scape's open architecture lets you use it with data base, graphics, or other C and C++ libraries. C-scape runs in text or graphics mode, so you can display text and graphics simultaneously. To port from DOS or OS/2 to UNIX, AIX, QNX, or VMS, just recompile. C-scape also

**Graphics.** Run in color in text or graphics mode. Read images from PCX files.

**Object-oriented architecture.** Add custom features and create reusable code modules. C++ compatible.

**Mouse support.** Fully-integrated mouse support for menu selections, data entry fields, and to move and resize windows.

**Portability.** Hardware independent code. Supports DOS, OS/2, UNIX, AIX, VMS, others. Autodetects Hercules, CGA, EGA, VGA. Supports Phar Lap and Rational DOS extenders.

**Text editing.** Text editors with word wrap, block commands, and search and replace.

**Field flexibility.** Masked, protected, marked, required, no-echo, and named fields with complete data validation. Time, date, money, pop-up list, and many more higher-level functions; create your own.

**Windows.** Pop-up, tiled, bordered and exploding windows; size and numbers limited only by RAM.

**Menus.** Pop-up, pull-down, 123-style, or slug menus; create your own.

**Context-sensitive help.** Link help messages to individual screens or fields. Cross reference messages to create hypertext-like help.

**Code generation.** Build any type of screen or form with the Look & Feel™ Screen Designer, test it, then automatically convert it to C code.

**Screen flexibility.** Call screens from files at run time or link them in. Automatic vertical/horizontal scrolling.

**International support.** Offices in Berlin, Germany, with an international network of technical companies providing local training, support and consulting.

supports Phar Lap and Rational DOS extenders.

**Trial with a smile.** C-scape is powerful, flexible, portable, and easy to try. Test C-scape for 30 days. It offers a thorough manual and function reference, sample programs with source code, and an optional screen designer and source



code generator. Oakland provides access to a 24-hour BBS, telephone services, and an international network of companies providing in-country support. No royalties, runtime licenses, runtime modules. After you register, you get complete library source code at no extra cost.

**Call 800-233-3733** (617-491-7311 in Massachusetts, 206-746-8767 in Washington; see below for International). After the joy of C-scape, programming will never be the same.

DOS, OS/2 (Borland and Microsoft support): with Look & Feel, \$499; library only, \$399; UNIX, etc. start at \$999; prices include library source. Training in Cambridge and Seattle each month. Mastercard and Visa accepted.

**OAKLAND**

BY291

**Oakland Group, Inc.** 675 Massachusetts Ave., Cambridge, MA 02139 USA. FAX: 617-868-4440. **Oakland Group, GmbH.** Alt Moabit 91-B, D-1000 Berlin 21, F.R.G. (030) 391 5045, FAX: (030) 393 4398. **Oakland International Technical Network** (training, support, consulting): **Australia** Noble Systems (02) 564-1200; **Benelux** TM Data (02159) 46814; **Denmark** Ravenholm (042) 887249; **Austria-Germany-Switzerland** ESM 07127/5244; **Norway** Ravenholm (02) 448855; **Sweden** Linsoft (013) 111588; **U.K.** Systemstar (0992) 500919. Photo by Jessica A. Boyatt; Karji by Kaji Aso. Picture shows a C-scape program combining data entry with video images loaded from PCX files. C-scape and Look & Feel are trademarks of Oakland Group, Inc.; other trademarks belong to their respective companies. Copyright © 1990, by Oakland Group, Inc. Features, prices, and terms subject to change.

Circle 159 on Reader Service Card

# LCDs and Beyond

*Although liquid crystal technologies dominate the laptop display market today, the future is an open question*

*Nick Baran*

**W**hen you think of an ideal laptop computer, you envision a machine with a high-resolution monochrome or color display readable in virtually all lighting conditions. You want one that consumes no more than a few watts of power and has large mass storage, low weight, and, most of all, a reasonable price. But this ideal laptop still does not exist. The biggest obstacle to be overcome (aside from lawyers and trade commissions; see the text box "Displays—Down the DRAM Drain?" on page 232) is the state of display technology.

Lightweight, compact, high-resolution color displays with minimal power consumption still elude display manufacturers. And the top-of-the-line displays that approach the ideal remain extremely expensive and in short supply.

For example, the Macintosh Portable uses a state-of-the-art monochrome thin-film transistor (TFT, also known as active-matrix) LCD that requires about 1 watt of power. It's a nice display, but the 68000-based machine costs around \$6000. That's a lot of money for a machine based on the same microprocessor



used in the original 128K-byte Mac. Compaq's new LTE 386 uses an edge-lit VGA-resolution supertwist LCD and starts at \$6499. Such prices are keeping high-performance laptop machines from gaining widespread acceptance.

#### **Supertwist and Thin Films**

Generally, higher-quality laptops still use supertwist LCDs with plastic-film

optical compensators that eliminate the bluish/yellow tinge that is common on standard supertwist LCDs. These "film-compensated" displays provide a white background and highly readable text and gray-scale capability. While most laptop displays offer VGA resolution of 640 by 480 pixels, Japanese display manufacturers have produced monochrome supertwist LCDs with resolutions of 1024 by 768 pixels.

Still, TFT LCDs offer major advantages over supertwist LCDs, particularly in color applications. While the conventional supertwist LCDs use strips of electrodes in the x and y directions that are shared by all the pixels on the screen, the TFT display has a separate transistor for each pixel, allowing direct addressing of each pixel and

much better contrast and performance than can be attained using conventional LCDs. (For a technical description of LCD and TFT technology and other display technologies, see the In Depth section in the September 1988 BYTE.)

#### **Shining Through**

Most LCDs include a backlighting mechanism to provide readability in most

## BBS Sysops

- Are you looking for ways to improve your board? Something that will set you apart from other boards in your area?
- Are your subscribers interested in Microcomputers? Listen to this!

### Announcing the Bulletin Board EXchange

The Bulletin Board Exchange allows you to become a publisher of Micro-BYTES Daily, an on-line news service from BYTE. Bulletin Board Exchange/MicroBYTES is a custom package of news and features designed especially for local BBSes, and is available only to sysops.

Every Monday through Friday you get articles about developments in micro-computing, telecommunications and selected new product announcements. Get the latest news about MS DOS machines, Macintoshes, Unix workstations, Amigas, Atari STs, peripherals and software. All the stories are reported, written, and edited by the staff of BYTE Magazine, BYTEweek and BIX, and our world-wide network of reporters and editors.

Not only do you get a great resource for your subscribers, but you also get access to BIX which will cut your cost of exchanging information and conducting BBS network business.

**All this is just \$49 a quarter.**

Your one-year subscription to the Bulletin Board Exchange (billed quarterly) may be cancelled any time without further charge; just notify us. If you prefer, you may subscribe for three months only, at just \$69.

If you call BIX direct, you pay no hourly telecommunications charge. If you call using Tymnet, the rates are only \$3/hour on evenings and weekends and \$6/hour on weekdays. You may also purchase unlimited off-peak Tymnet for just \$20 a month.

**Subscribe today.**

# BIX

One Phoenix Mill Lane  
Peterborough, NH 03458  
800-227-2983  
In NH 603-924-7681

lighting conditions. Backlighting, however, is the main source of power consumption in LCDs. Apple's TFT display for the Mac Portable is reflective rather than backlit; it thus allows low-power operation, but it also limits the lighting conditions under which the display is readable. Reflective displays are acceptable in black-and-white implementations like the Mac Portable, but backlighting is a must in color LCD applications.

The need for backlighting is perhaps the biggest hurdle facing the display industry. Says David Mentley, a consultant

**T**he need  
for backlighting is  
perhaps the biggest  
hurdle facing  
the display industry.

to the display industry for Stanford Resources, "the big power hog is backlight." For example, Mitsubishi's new TFT, 16-color, 640- by 480-pixel, 10-inch display requires 135 W. NEC's new color TFT, 640- by 400-pixel, 7-inch monitor demands 90 W.

In addition, TFT displays still face manufacturing and yield problems. They mount a separate transistor for each pixel on a glass substrate or panel. The transistor panel can therefore have as many as a million transistors. The complete display consists of layers containing the transistor electrodes and the photolithographic pattern, called the *matrix film*, which defines the color characteristics of the display. The process of manufacturing these layers is currently quite complex and time-consuming, and it's subject to high defect rates, resulting in yields of about 20 percent.

#### TFT and Color

A monochrome active-matrix display has one transistor associated with each pixel. With a color TFT display, each pixel comes with three transistors that define its red, blue, and green components. In addition, a TFT display adds a color filter to the LCD "sandwich."

A TFT color filter consists of alternating stripes of red, green, and blue filtering material. The stripes can be either

horizontal or vertical. They overlay the corresponding transistors that control red, green, and blue color characteristics of the pixel in the active matrix.

To produce a particular color at a particular pixel, the driver circuitry of the display activates the transistor that corresponds to that color. This untwists the nematic material in the liquid crystal, letting light from the backlight pass through the crystal to the overlying filter. The light then takes on the color of the corresponding filter before passing to the surface of the display. Because the light passes through a polarizing filter, it irradiates in just one direction from the display, producing a sharper image than conventional CRT technology.

With three colors per pixel, you can create any of eight colors, depending on the state of the transistors for each pixel. Future displays will be able to generate even more colors by varying the intensity of light transmitted through each color in the filter.

Because each pixel needs three transistors, the resolution of a color display will be one-third the monochrome resolution in either the horizontal or vertical direction, depending on whether vertical or horizontal stripes are used in the color filter. The action of the color-filter layer can be deactivated, resulting in a high-resolution monochrome display.

While color TFT LCDs exhibit the crispness of monochrome TFT displays, they are even harder to manufacture due to the additional two transistors per pixel and the presence of a color filter. They also require a more powerful backlight and therefore use more power. As a result, color TFT displays, which are hand-assembled, have very low manufacturing yields. They are available in low quantities and are extremely expensive. The price to an OEM for a typical color TFT display is several thousand dollars. Despite these obstacles, Japanese companies are developing this technology.

The manufacturing problems associated with color TFT technology, however, may keep prices high enough and quantities low enough to create an opportunity for other display technologies. In the laptop display arena, TFT technology still appears to be more promising than electroluminescent or gas-plasma displays, which are often mentioned as alternatives. These displays suffer from high power requirements and poor color fidelity. Gas-plasma displays have a red-orange tinge, while color EL displays still lack a good blue phosphor, which dampens their appeal in the commercial market.

COMING SOON...  
286DOS-Extender™...

Use Microsoft® C and  
CodeView® to build  
16-bit Multi-Megabyte  
Applications.

# PHAR LAP...WE OPEN A WORLD OF MEMORY

## Beyond 640K DOS.

Build multi-megabyte 32-bit programs with Phar Lap's 386DOS-Extender.™

If your world is limited by 640K DOS, get all the memory you want with 386DOS-Extender from Phar Lap.®

**Large-scale benefits.** By turning DOS into a true 32-bit operating system, 386DOS-Extender shatters the 640K barrier. It lets you create protected mode applications that use all the memory in the machine — up to 4 gigabytes. You work within a flat, 32-bit address space. No more suffering with overlays, banked-switched EMS, or segmentation.

With full 32-bit memory and power, you can finally build workstation-class applications for the PC. Your Extended-DOS programs will run considerably faster, have room for more features, and be more responsive than those in 16-bit DOS.

**Total compatibility.** Because 386DOS-Extender is embedded into your program, it is invisible to the end-user. Your program looks exactly like any other DOS application. There's no new operating environment for your end-users to buy or learn.

386DOS-Extender is backed by a full complement of 32-bit languages. Choose your favorite from among C, Fortran, Pascal, Ada, Assembler, and others. And with Phar Lap, you'll be using the finest, most widely used 386 software development tools in the world.

**Proven success.** AutoCAD 386, IBM Interleaf Publisher, and Mathematica are just a few of the hundreds of Extended-DOS applications already being shipped with 386DOS-Extender. Utilizing this exciting new technology, industry leaders are keeping their competitive edge by delivering the speed and power that 386 users have been waiting for.

So if DOS is looking smaller than ever, call Phar Lap today. And see what it's like beyond 640K.

**Phar Lap 386DOS-Extender.**  
*We open a world of memory.*

Phar Lap Software, Inc.  
60 Aberdeen Avenue  
Cambridge, MA 02138  
617-661-1510  
FAX 617-876-2972



## Displays—Down the DRAM Drain?

Frank Hayes

While flat-panel displays continue to advance technically, they're facing a big setback on the commercial front. A group of small U.S. manufacturers claims that Japanese companies are dumping flat screens in the U.S.—a charge reminiscent of dumping complaints made against foreign makers of DRAM chips in the late 1980s. At that time, the Department of Commerce slapped punitive tariffs on Japanese chip makers that forced the price of memory to skyrocket. Could the same thing happen with flat-panel displays? And if it does, what will it mean for laptop makers—and buyers?

### Seven Against Japan

The group of small U.S. companies behind the dumping complaint call themselves the Advanced Display Manufacturers of America. The seven ADMA members are Cherry Display Products, Electro Plasma, Magnascreen, Ovonix Imaging Systems, Photonics Technology, Planar Systems, and Plasmaco. In July 1990, the group filed a petition with two U.S. government agencies, the Department of Commerce and the International Trade Commission, claiming that a dozen Japanese companies had sold flat-panel displays for less than "fair-market value," in violation of the Tariff Act of 1930.

The Japanese companies named in the petition are Toshiba, Hitachi, Fujitsu, Matsushita Electric Industrial, Seiko Epson, Sharp, Hosiden Electronics, Kyocera, NEC, Optrex, Seiko Instruments and Electronics, and Matsushita Electronics. That list comprises a who's who of the LCD screen industry, while the American plaintiffs are small companies that for the most part make non-LCD screens like electroluminescent (EL) screens and gas-plasma displays.

The complaint involves only large flat-panel displays—those with at least 120,000 pixels. It thus includes laptop screens big enough to handle CGA or higher resolutions, but not displays for pocket calculators or those on some home appliances.

The ADMA companies claim they're in the same situation as the American chip makers whose prices were undercut by Japanese and other foreign semi-

conductor vendors half a decade ago. Then, demand for 256K-bit DRAM chips was heavy—so heavy that even the booming U.S. semiconductor industry couldn't supply enough.

Foreign chip makers began to master DRAM production techniques and joined in the market. In fact, between climbing PC sales and the prospect of a memory-hungry OS/2 on the horizon, the projected market was so great that in a matter of months, dozens of foreign chip factories began producing DRAM chips.

But when sales of PCs slacked off, there was suddenly an oversupply of DRAM chips. Memory chips glutted the market, sparking a price war—a bonanza for PC buyers, but a catastrophe for American semiconductor companies. Those chip makers complained to the government that the foreign chips were being dumped. Despite protests by computer companies, the government agreed, imposing tariffs and penalties against foreign chip makers that sent the price of DRAM chips temporarily skyrocketing.

However, the tariffs didn't revive the sagging U.S. DRAM-chip industry. Companies such as Intel, which had once done a sizable part of its business in memory, abandoned the market for more lucrative areas, such as microprocessors. A few large companies continued to turn out memory chips for their own use (most notably AT&T and IBM), but the only remaining major U.S. suppliers of DRAM chips are Texas Instruments, which sells much of its production to IBM, and Idaho-based Micron Technology.

In fact, so completely did American companies abandon the memory market that, when a government-sponsored consortium called Sematech was formed to manufacture American DRAM chips, U.S. companies refused to come up with sufficient funding to start production.

### No Price War

Unlike DRAM chips, where U.S. memory makers lost their market in a price war, flat-panel displays have never been a strong point for American companies. The most common displays—and the ones most in demand because of their

easy readability and low power requirements—are LCD screens. Liquid crystals were first discovered by researchers at RCA in 1963, but American companies didn't pursue the technology. The Japanese companies did, though—in particular Sharp, which introduced a calculator with an LCD screen in 1973.

Since then, the LCD market has largely belonged to Japan. American companies have introduced alternative flat-panel technologies, such as gas-plasma and EL displays. Except for sales to the Department of Defense, however, American companies haven't made much headway. Japanese companies have used their lead to develop LCDs into larger and easier-to-read displays: supertwist, active-matrix, and, most recently, color.

And unlike with DRAM chips, the flat-panel business has seen no price wars. In fact, until recently, the high cost of flat-panel displays made laptop computers significantly more expensive than comparable desktop models. Manufacturers have had trouble keeping up with the demand, especially for the higher-quality screens. Apple, for example, went to Japan for the Mac Portable's active-matrix LCD screen and still had trouble getting the quantities that it wanted.

Other U.S. computer companies also say they've had to go to the Japanese to get LCD technology in the size and quantity they need. And even Zenith, which has bought non-LCD flat-panel displays from U.S. manufacturers such as Planar Systems, says it has had trouble getting those screens in the quantities it requires.

Thus, if Japanese companies have dominated the flat-panel display business for years—and there's more business than Japanese or American companies can handle—why is there suddenly an antidumping complaint? American display makers say prices have dropped so low they can no longer make enough profit to stay in business. But other recent government actions may have as much to do with the petition as the continuing decline in prices.

First, until recently, some American flat-panel makers have contented themselves with selling primarily to the Department of Defense, whose "cost-

plus" contracts guaranteed a profit for military suppliers. But between deficit-trimming budget cuts and the easing of Cold War tensions, there haven't been as many military contracts available. In addition, some flat-panel makers were hoping they'd get government subsidies to help develop high-definition television. But hopes for government support of HDTV development were put on hold when Congress failed to vote for it in 1989.

### Dumpsters?

Are the Japanese companies dumping? That depends on your definition. The most common definition (and perhaps the least accurate) is "selling a product for less than it costs to produce." Actually selling a product at a loss is unusual, simply because it can't go on for long. If a company loses money on every item it sells, it will soon go out of business.

Another definition is "selling products for less than a fair price." What a fair price is, of course, is the big question when it comes to dumping complaints. If a Japanese company sells a display for less in the U.S. than in Japan, is the U.S. price unfair? (The accused companies say their pricing is based entirely on business issues such as market conditions and order size.)

Is the price too low if a company chooses not to soak early customers for the cost of developing the technology and earns back its development costs over, say, a decade instead of a year? (Japanese companies point out that, like many large American companies such as IBM and AT&T, they pay for long-term research over a long period of time. But the Department of Commerce insists that "fair pricing" requires that the development costs be paid off in a short time—sometimes as little as a year.)

The Japanese companies complain not only that they're penalized with a double standard, but that they can't even tell when they have violated fair-price guidelines. Under the Tariff Act of 1930 (a protectionist law passed at the start of the Depression in hopes it would shield American jobs from foreign competition), the Department of Commerce refuses to tell foreign companies—or

anyone else—the formula used for determining fair prices.

At the International Trade Commission's hearing on the dumping complaint last August, representatives of the Japanese companies also pointed out that LCD screens shouldn't be lumped in with gas-plasma or EL displays because the different technologies have different markets. The ITC rejected that argument. The Japanese makers also argued that active-matrix LCD screens—which aren't made by U.S. manufacturers—should be treated separately from passive-matrix LCDs. The ITC rejected that argument as well.

Several U.S. laptop computer makers testified against tariffs at the hearing, suggesting that they would make LCD displays too expensive to import into the U.S. If that happened, they hinted, they'd have to manufacture their laptop computers outside the U.S., thus dodging the tariffs by importing complete machines instead of the foreign LCD screens. (But those statements may have hurt more than they helped. One Japanese representative commented that the ITC commissioners hearing the case "seemed to feel the computer companies were just being selfish.")

In the end, a panel of four ITC commissioners ruled unanimously that there was evidence that U.S. flat-panel manufacturers were being hurt by the Japanese pricing policies. The case now moves to a Department of Commerce investigation, which may eventually recommend tariffs or other penalties.

### Tariffs, Higher Prices

What's likely to happen? If history is any guide, the results of the Department of Commerce investigation are a foregone conclusion. Both Japanese LCD makers and American computer manufacturers now expect that tariffs will be levied, resulting in higher prices for laptops and portable computers made in the U.S. using Japanese flat-panel displays.

As they did when tariffs were imposed on foreign DRAM chips, large American companies that can do so will move manufacturing of those products overseas to avoid the tariffs—shifting jobs from Texas and California to Taiwan and Korea. But the smaller companies that can't move jobs overseas will

not be able to compete.

The tariffs aren't likely to help U.S. flat-panel display makers, since they don't make the technology those large vendors want. But it may have a major impact on prices of laptops from Toshiba, NEC, Sharp, and other Japanese companies. If the Department of Commerce, as seems likely, decides to penalize the Japanese with tariffs on products other than just flat-panel displays—which happened in the case of DRAM chips—all Japanese laptops and portable computers could rise in price, and the tariffs might extend to other products (e.g., LCD-screen TVs) as well.

And there's another possible effect of tariffs: U.S. computer makers could face losing access to the state of the art in LCD screen technology for their own products. If Japanese companies can't sell their own laptops because of high tariffs, they could refuse to sell their best screens to American companies, insisting instead that American vendors contract out laptop production to Japanese manufacturers. That means that U.S. computer companies might have to choose between hiring a Japanese company to build their products or making do with second-rate technology.

In the long run, the cost to produce flat-panel displays—especially LCD screens—will continue to fall. Conventional monochrome LCD screens are getting cheaper to make. Top-of-the-line active-matrix and color screens are still expensive and in short supply, but they will also come down in price as manufacturers climb the learning curve for these products. And there probably won't be a glut in LCD screens comparable to the DRAM-chip glut that sparked the memory-dumping complaints, since LCD screens can also be used for portable TVs and other consumer products.

But although flat-panel displays are not in the same situation as DRAM chips, they're likely to follow the same path. And in the short run, tariffs will mean expensive laptops and exported jobs—and no real help for the U.S. flat-panel display industry.

---

*Frank Hayes is a former BYTE West Coast news editor. He can be reached on BIX as "frankhayes."*

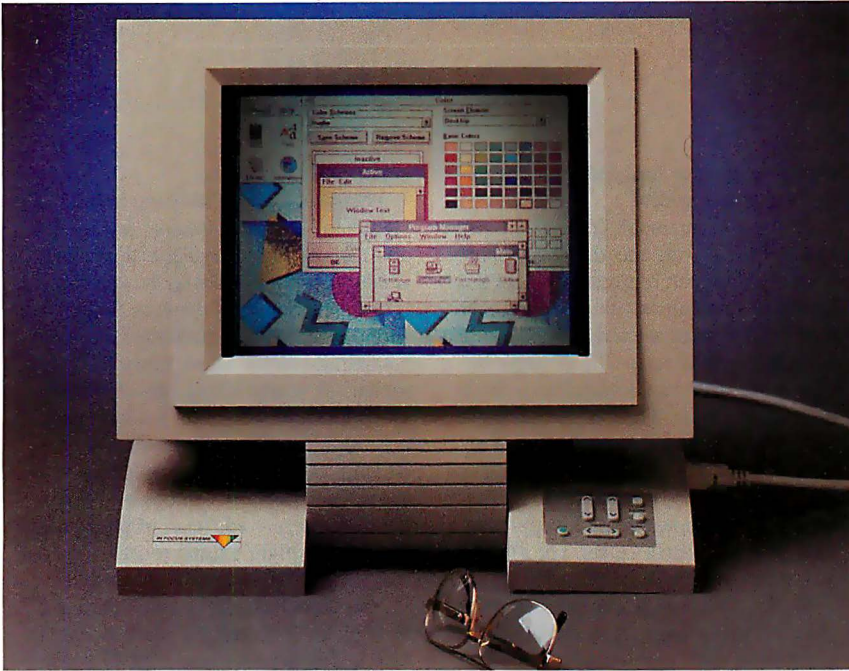

*The new stacked-panel passive-matrix LCD monitor from In Focus Systems, which was shown at the Fall Comdex '90.*

Although TFT color LCDs may dominate the laptop market in the next few years, competing technologies may give TFT a run for its money.

### Passive-Matrix Displays

One new technology contender in the PC display market is stacked-panel passive-matrix. It has been pioneered by In Focus Systems of Tualatin, Oregon. Until recently, the company specialized in the production of LCD projection panels, but it has now moved into PC displays.

According to In Focus Systems' technical backgrounder, "the display system is formed by stacking two or more LCD panels that are tuned to subtract different portions of the color spectrum from light passing through the stack. Together the panels cooperate to produce a full range of true colors."

In other words, rather than addressing each pixel by means of a separate transistor, as in TFT displays, this system uses conventional LCD panels aligned in a stack. Each panel is tuned to one of the subtractive primary colors: cyan, magenta, and yellow. When all pixels are off, a backlight provides a white background. Pixels are turned on in the LCD panels to subtract cyan, magenta, or yellow from the white background to obtain other colors.

In Focus Systems announced its first commercial implementation of the

stacked-panel concept at Comdex last November, introducing a 10-inch full-color display consisting of three super-twist LCD panels. The monitor (see the photo) offers VGA resolution of 640 by 480 pixels and can display up to 4913 colors, according to In Focus Systems. It uses a 50-W incandescent backlight and weighs about 6 pounds.

The passive-matrix display technology introduced by In Focus Systems has promise. Because it uses conventional LCD panels, it does not have the manufacturing problems that currently plague TFT technology. On the other hand, the passive display system requires a complex optical backlighting scheme involving mirrors and reflectors, which adds to the bulk and power requirements of the display.

According to Mentley, the display has considerable potential for desktop presentation applications, but it needs to be refined for use in laptop computers. There is also some question about the response time of stacked-panel passive-matrix displays. Currently, the response time (about 250 milliseconds) is not fast enough to display moving images on the screen, but In Focus Systems says that it's working on a threefold reduction in response time.

The full-color LCD introduced at Comdex will sell for \$1400 to \$2500 to OEMs. In Focus Systems says it has licensed the technology to an unnamed

laptop manufacturer. It will be interesting to see if In Focus Systems can gain enough support to compete with the manufacturing and engineering muscle of the Japanese manufacturers who back TFT display technology.

### Field-Emission Displays

Field-emission displays take advantage of the basic principle of the CRT. The major difference between FEDs and current CRTs is the replacement of the bulky, high-voltage "hot-cathode" electron gun with micron-size cone-shaped structures called "cold cathodes" or "field-emission cathodes," which can excite electrons with voltages much lower than those required by traditional CRT electron guns. (They also generate much less heat, which is why they are often called cold cathodes.) The typical operating voltage of a cold-cathode FED is about 1000 volts, versus 25,000 to 30,000 V in a conventional CRT.

The microscopic size of the cold cathode allows the production of very thin, flat CRTs using arrays of field-emission cathodes configured in an x,y matrix addressing scheme. While much of the R&D work on FEDs was performed at Stanford Research Institute, the leader in their commercial development is Coloray in Fremont, California.

The FED currently under development at Coloray consists of two pieces of glass separated by a space evacuated to a pressure of  $10^{-6}$  torr (1 torr is equal to 1/760 atmosphere). The faceplate contains a phosphor screen, as in a conventional CRT, while the rear plate (baseplate) contains the array of cold-cathode field emitters and the row and column driver chips. A diagram of the assembly is shown in figure 1.

A cross section of the FED is shown in figure 2. The cathode emitters are deposited on a pattern of row and column electrodes on the baseplate. From 10 to 100 emitter tips are deposited at each intersection of the row and column electrodes to provide redundancy, emitter uniformity, and, as a result, high manufacturing yields. The tips of the field emitters emanate electrons through holes in the baseplate that are only 1 micron in diameter. The resulting electron beams strike the phosphor dots on the faceplate in the same manner as in a conventional CRT.

The resolution of the display is controlled by the design of the phosphor pattern on the faceplate (the density of the cathodes on the baseplate exceeds the requirements of the highest CRT resolutions). According to Coloray, a typical



# DR DOS 5.0. WE COULDN'T HAVE SAID IT BETTER.



So what's all the hoopla about? MemoryMAX™, for one thing. A breakthrough in memory management that can give you more than 620K so you can run today's memory-intensive applications, including, for example, dBASE IV™ on Novell NetWare™.

In fact, John Dvorak calls MemoryMAX nothing short of "amazing."

The Press goes on to mention that because DR DOS 5.0 is fully DOS compatible, you can run all your current DOS applications. And because it is easy to install and requires no hard disk reformat-

ting, upgrading to DR DOS is simple. Since DR DOS 5.0 also includes ViewMAX™, a graphical interface, DOS is easier than ever to use.

Now if we could just get a word in edgewise, we would simply like to add that DR DOS 5.0 is available now. Call your local dealer today.

## DR DOS 5.0

 Digital Research®  
WE MAKE COMPUTERS WORK

(408) 647-6675

For Laptop and Notebook manufacturers, DR DOS 5.0 is fully executable from either RAM or ROM. And, it's available with BatteryMAX™, a battery-saving feature that can increase battery life 2-3 times (dependent upon OEM implementation).

Digital Research is a registered trademark, and the Digital Research logo, DR DOS, MemoryMAX, ViewMAX, and BatteryMAX are trademarks of Digital Research Inc. Copyright © 1990, Digital Research Inc.

Reprinted from PC Week May 14, 1990. Copyright © 1990 Ziff Communications Company.  
Reprinted with permission from The San Francisco Examiner. Copyright © 1990 The San Francisco Examiner.

Circle 70 on Reader Service Card

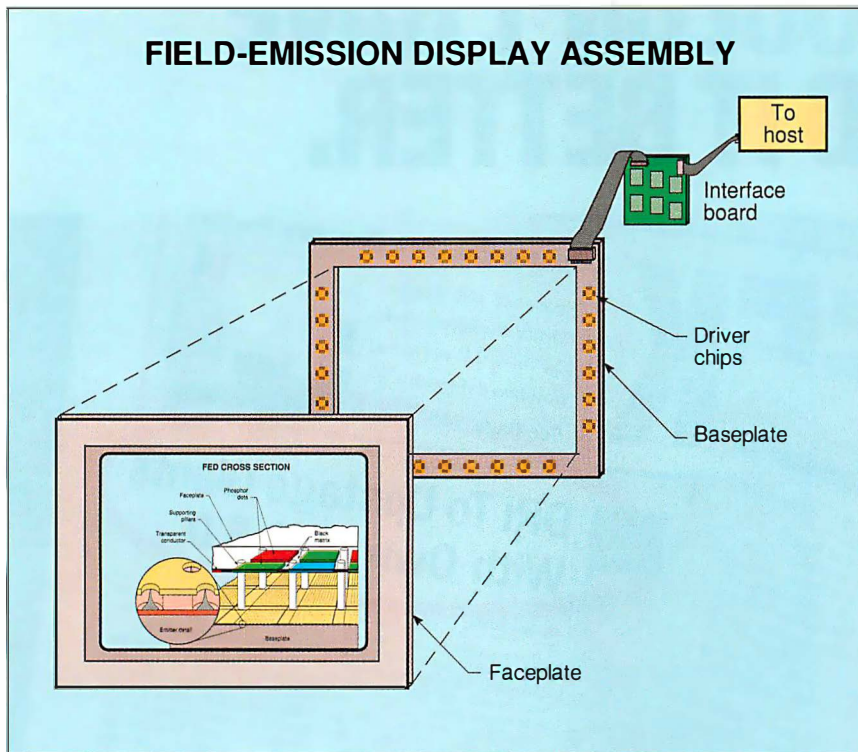

**Figure 1:** The faceplate contains a conventional phosphor screen. The baseplate contains the field-emitter cathode array. (Courtesy of Coloray Corp.)

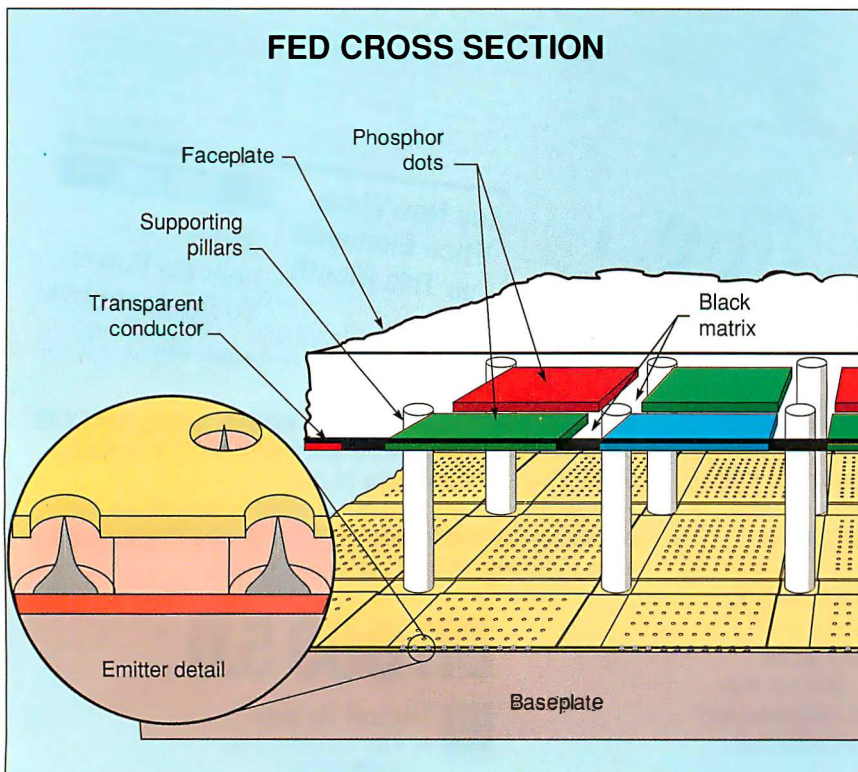

**Figure 2:** A typical PC display will have faceplate and baseplate thicknesses of 1.1 mm, with a spacing of only 0.1 mm. The emitter holes are only 1 micron in diameter. (Courtesy of Coloray Corp.)

PC display would have baseplate and faceplate thicknesses of 1.1 mm separated by a space of 0.1 mm.

Proponents of FED technology claim that it offers the best of both the CRT and flat-panel worlds. The FED is anticipated to provide about three times the brightness of current backlit LCDs, as well as high manufacturing yields and reliability. Coloray projects that a 10-inch FED monitor displaying 16 million colors will require only 2.4 W of power. Coloray also expects the FED to be priced competitively with other types of color displays.

The FED is a "very elegant, undernoticed technology," says David Mentley. However, Coloray doesn't expect to have commercial products ready for at least another two years. A French research laboratory, LETI, has demonstrated a prototype 6-inch FED monitor and has also performed durability testing for over 3000 hours. Basically, the technical feasibility of the FED has been demonstrated. The next step is to harness the resources needed to bring a commercial product to market. As Mentley says, "It's not a technology issue but a business-plan issue."

**Don't Hold Your Breath**

While promising developments are on the horizon, display technology is not changing as rapidly as other aspects of computing. High-yield manufacturing of TFT LCDs is still a few years away. The passive-matrix stacked-panel LCD has potential but faces technical hurdles. FED technology may be the most interesting, but even the greatest technologies can falter without sufficient funding and marketing presence. Clearly, Coloray hopes to attract investors and partners to help create the necessary momentum and funding to launch FED technology.

In the meantime, you'll have to make do with the less-than-ideal laptops available today—machines that scrimp on the display or cost an arm and a leg. The future, however, belongs to those technologies that will deliver CRT quality at a laptop price. ■

**ACKNOWLEDGMENT**

Thanks to David Mentley of Stanford Resources, Inc. (San Jose, CA), for his comments and observations noted in this article.

Nick Baran (Sandpoint, ID) is a consulting editor for BYTE and editor of Baran's Tech Letter, a newsletter about the Next computers. He can be reached on BIX as "nickbaran."

# EEF

## ELEX ELECTRONIC FILING

The ELEX Electronic Filing System (EEF) is a hardware/software system designed to reduce the frightening volumes of paperwork that burden businesses on a daily basis. As paper is eliminated, transactions are made in a fraction of the time required by traditional means, costly storage facilities are reduced, data security and integrity is enhanced, and work quality and quantity is increased. These factors all give companies and individuals the competitive advantage they need to excel in the business environment of the 90's.

### Filing vs. Archiving

Document image processing is a new technology which has just begun to evolve. The myriad of hardware devices on the market, and the lack of an industry standard protocol for communicating between them, make the integration of an electronic filing system a formidable task. And without intelligent software to control all aspects of the storage, management, and retrieval of documents, the filing system will be nothing more than a micro-fiche machine in disguise.

With these considerations in mind, EEF was designed as a turn-key solution which relieves the clients of all the intricacies involved in integrating a truly functional electronic filing system. Yet its flexible design allows continuous and smooth upgrade as the users needs grow and change.

### Open Architecture

EEF is designed as a totally open architecture system. Rather than being a closed package, EEF is composed of individual building blocks defined by their area of electronic

filing functionality. These blocks are not bound to specific hardware/software limitations. As such, they can be combined in a variety of forms on each of the following operating platforms, to achieve optimal satisfaction of an application's specific demands:

- A single user workstation under the **DOS** or the **OS/2** operating system.
- A local area network - **Novell NetWare 286** and higher or any **DOS 3.1** compatible network.
- A **host computer** under the **UNIX, VAX/VMS** or **IBM AS/400** system with a PC connection.

<b>Input</b>
Scanner, Fax, Word Processing, Host Computer, Etc.
<b>Processing</b>
Document Manager, Retrieval Engine, Hyper-Media, Database Application Generator, Turn-key Solution.
<b>Output</b>
Printer, Plotter, High Res. Display, Fax, Host Computer

### EEF Applications

The EEF system opens a vast new world of opportunities for you. The possible applications are limitless, and to name a few:

#### *Management Systems*

Any application which requires original documents and forms (e.g. verification of signatures and L/C in the banking area).

#### *Scientific and Engineering Data*

Any application in these fields that requires maps, charts, logs,

sketches, etc.

#### *Medical Uses*

The kind of visual information which is so essential for medical applications is handled by EEF in a natural, straightforward manner.

#### *Art Catalogs*

Making multi/media presentations of art works, for example at auctions, can provide an exciting new display method.

#### *Real Estate / Travel Agency*

EEF can be used to take the customers on an on-site electronic tour without ever leaving the office, thus shortening the process of selection.

### EEF Pilot System

For prospective clients wishing to enter the field, we have prepared a pilot system, enclosing in one package the full range of functions necessary for electronic filing. The system components are:

#### *Hardware*

386 base micro-computer at 33MHz with 64K cache, 8 MB RAM, 1.2GB with access time of 0.8MS (disk caching), proprietary scanner and printer interfaces, high resolution (1660 x 1200) CRT display, laser printer 300 dpi at 8 ppm, scanner 300 dpi with 100 page feeder.

#### *Software*

The EEF software package, including the document manager, the retrieval engine, the hypermedia interface, and 20 hours of customization services.

Total cost for the pilot system is 30,000 US\$.

For further details and literature, please contact:

### EUROPE: ELEX INFORMATION SYSTEMS SA

65, Rue de Lausanne 1202 Geneva Switzerland Tel. + 41 22 738 11 88 Fax. + 41 22 738 11 90

### USA: ELEX INFORMATION SYSTEMS INC.

125-127 North 4th Street Philadelphia, PA 19106 USA Tel. + 1 215 627 7202 Fax. = 1 215 627 2342.

Trademarks: DOS, OS/2, Microsoft Corp; NetWare, Novell, Inc.; UNIX, SCO Corp; AS/400, IBM Corp; VAX/VMS, Digital Equip. Corp.

# Death Taxes Software Piracy

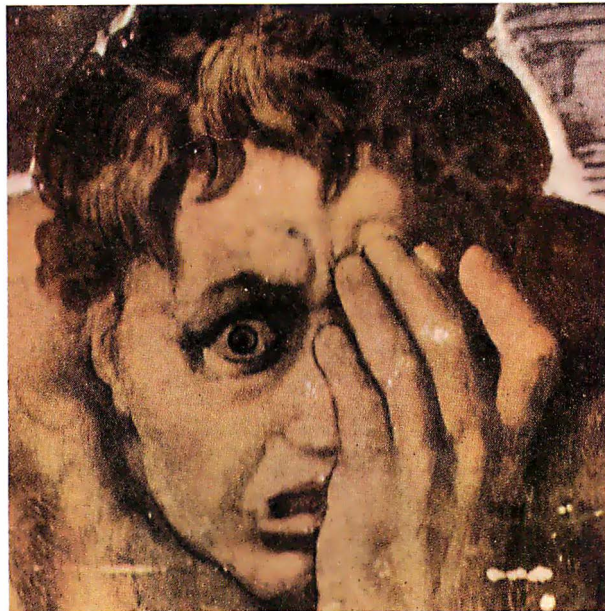

*We can save you from one of them.*

**S**orry. Death we can't do anything about. As for taxes, when you use our product you'll probably wind up paying more. But software piracy: there we offer some help. Our family of software protection devices (dongles) have improved unit sales for over 2,000 companies around the world. Our products can be used in the MS-DOS, OS/2 and Macintosh environments.

## **Build Your Own Custom Protection Environment**

Use our patented "dual-locking" ASIC chip as the basic building platform. Next, add options like: on-the-fly read/write memory, write-once or multiple-write locking codes, and encryption shells. Then add your

own programming creativity to build a protection environment best suited to your product.

Users attach the device to their parallel port, and programs won't run without it. Back-up copies, hard disk and LAN operation are not interfered with.

## **Your Intellectual Property Belongs To You**

And if you don't protect it, who will? Our products offer the most equitable way to protect your interests without sacrificing the rights of your customers. Call us today for information and demonstration units.

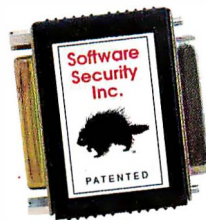

## **Software Security**

1011 High Ridge Road  
Stamford, CT 06905  
203-329-8870



Fax 203-329-7428  
BBS 203-329-7253  
AppleLink™ D2379

**1-800-333-0407 ext. 102**

AUSTRALIA 619 316 2873 • EUROPE 44 932 821 230 • FINLAND 358 0 505 33 55  
ITALY 39 2 21 30 450 • NETHERLANDS 31 34 026 77 77 • NORWAY 47 2 44 88 55  
SWITZERLAND 41 1 341 9550 • UK 44 784 430 060 • USSR 71 70 50

Macintosh is a trade mark of Apple Computer Inc.,  
Activator, Mactivator are trade marks of Software  
Security, Inc. illustration: detail from  
Michelangelo's Last Judgement

*Circle 212 on Reader Service Card*

# Destination Laptop

*AMD's "AT on a chip" takes personal computer integration to new heights while bringing power consumption to new lows*

*Doug Gephardt and Mark C. Klowner*

**D**o you remember your first hand-held calculator? You could pick it up and punch a few buttons, and in a matter of seconds your answer would pop up on one of those funny seven-segment displays. Before that, all calculators were large, cumbersome machines that sat on office desks. The evolution of calculators from large desktop behemoths to ever more powerful hand-held versions is a dramatic example of electronic integration—accomplishing more in a smaller space for less money.

Although calculators are perhaps a more familiar example, integration in personal computers has been equally dramatic. In the early days of the IBM PC, the only clones available were from manufacturers who simply duplicated IBM's discrete-chip design. There was little difference between machines, and prices were relatively high. The market changed radically, however, when many of the fundamental blocks of the system architecture were integrated into what are now called chip sets. These blocks include bus- and memory-control logic and the standard AT peripherals (counter/timer, real-time clock, and DMA and

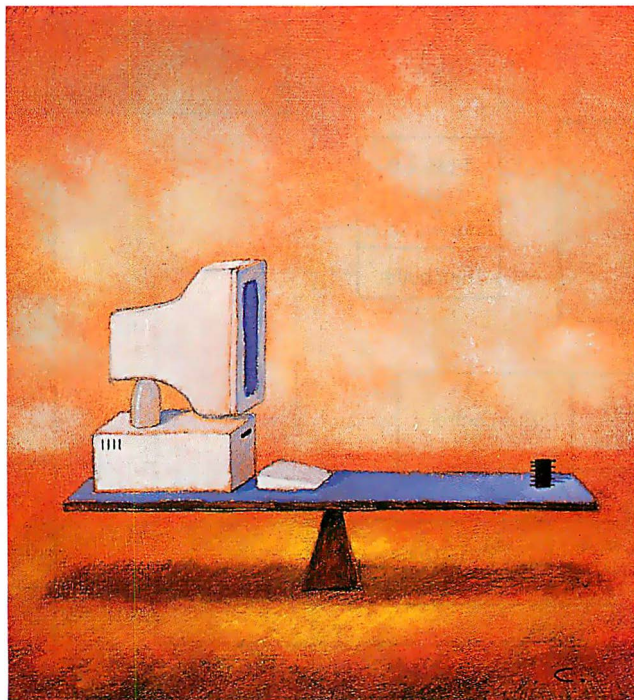

interrupt controllers).

The seemingly small change of the integration of system logic into chip sets has had an enormous effect on the PC industry. With a chip set, a company does not need the technical resources available to IBM to make a PC-compatible computer. It simply combines a chip set with a cookbook design, and voila—it has a PC.

Nowhere has the move to integration been felt more than in portable computers, where it has enabled the creation of battery-powered, DOS-based personal computers. Today, you'd be hard pressed to find a laptop (much less a notebook or a palmtop) that is not designed around an integrated chip set. The next logical step in this integration path is what Advanced Micro Devices (AMD) calls the integrated processor. Simply put, the IP integrates the basic chip set and the microprocessor onto a single piece of silicon. The first example of this integration technology to hit the market is the Am286LX/ZX IP.

## Design Goals

The goal in designing the Am286LX/ZX was to integrate all the non-memory-based functional blocks that are found on the original AT motherboard (i.e., everything but the DRAM chips, BIOS EPROMs, and ROM-based 8042 keyboard controller). In addition, the IP contains several enhancements that address the all-important power-consumption issue in the portable computing market. The IP was also designed for a fully static CMOS process to achieve the

lowest-power device possible. Figure 1 shows a block diagram of the Am286LX/ZX.

The functional blocks in the design of the Am286LX/ZX include an 80C286 microprocessor core, a counter/timer, DMA controllers, interrupt controllers, a real-time clock (RTC) with extended static RAM (SRAM), an enhanced clock generator, an enhanced bus controller, an advanced DRAM controller with full EMS 4.0 support, and direct-connect interfaces to an ISA system. In addition, the LX version has power-saving features needed for battery-powered systems. These include both staggered and slow refresh support and two clock-control modes to allow quick production of an AT-compatible portable system. This article focuses on the LX version.

### Am286LX Overview

In meeting the design goals described above, AMD had to include the core elements common to all AT-architecture systems, enabling the two most important facets of the integration dynamic—faster and easier system design and lower core-system cost.

The features of the LX can be grouped into three general sections: the 80C286 and standard peripherals, system-control block, and external interfaces.

### The CPU and Its Companions

The heart of an AT-class machine is the 286 microprocessor. The LX maintains the complete functional features of the standard CMOS 80C286, including the full 286 instruction set, address space, internal memory organization, and oper-

ating modes. In addition, the core has been designed to be fully static. Thus, you can operate the IP anywhere from its maximum speed down to DC conditions (completely stopping the clocks), depending on processing and power usage requirements.

Beyond the CPU, the IP features a three-channel, general-purpose, 8254-compatible 16-bit counter/timer. The timer conditions its frequency source input to produce the programmable events needed by the operating system. These include the system-timer tick, speaker output, and refresh request.

Two identical 9517-/8237-compatible DMA controllers and a page register are also integrated into the LX. These act together to perform processor-independent transfers of data between I/O and the

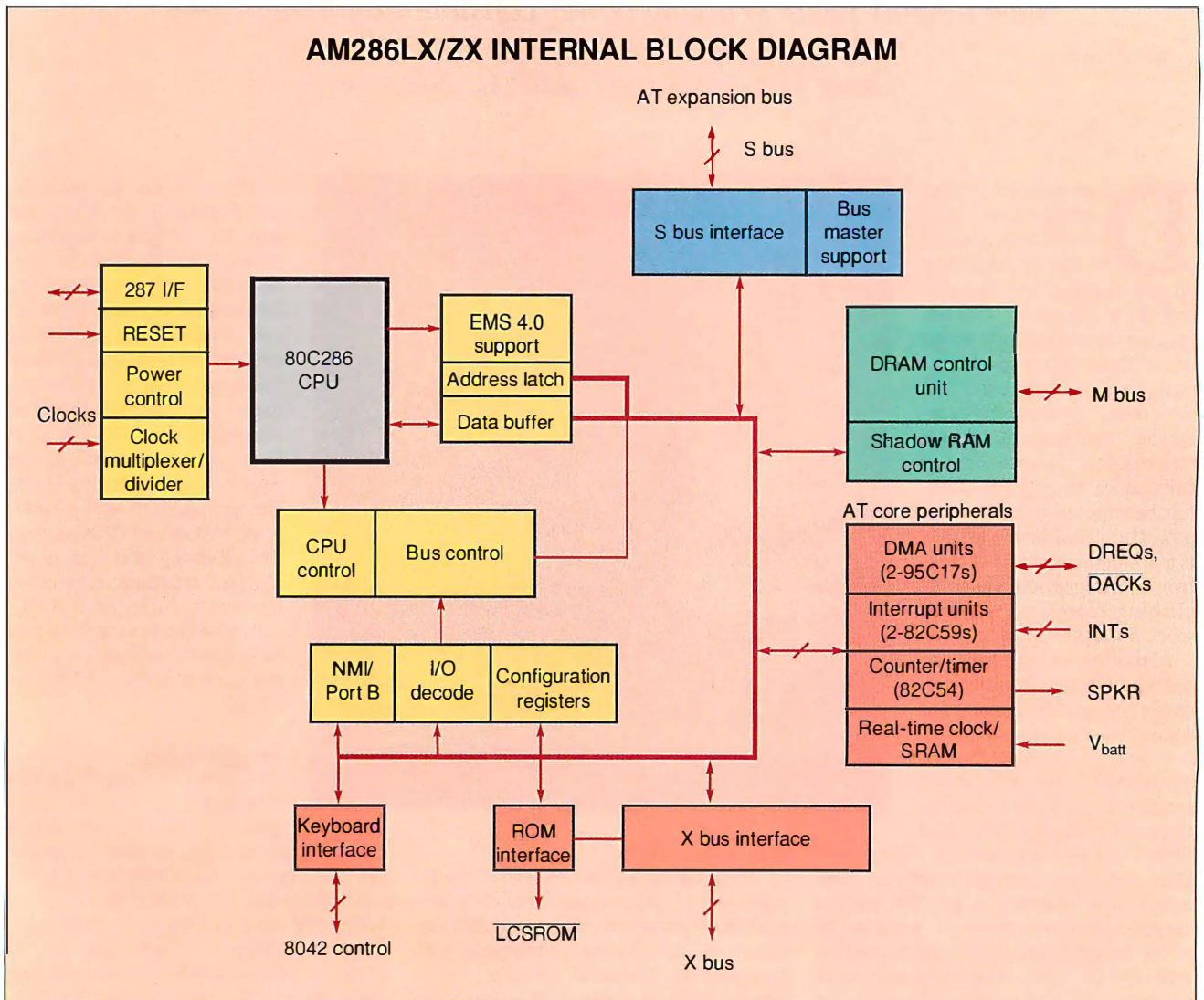

**Figure 1:** Add a BIOS, keyboard controller, and memory to an integrated processor, and you have an AT-class computer. The IP takes portable computing integration to a new level.

memory space, such as copying floppy disk data to local memory. These 8- or 16-bit transfers help decrease data transfer latency time and also free the CPU for other work.

The LX contains two 8259-compatible interrupt controllers that are cascaded to prioritize up to 15 completely asynchronous events. The controllers free the CPU from monitoring events by flagging it only after an event has occurred. These events could be anything from a keystroke to an incoming character from a modem.

The final standard peripheral implemented with the LX is an RTC. It combines a complete time-of-day clock with an alarm, a 100-year calendar, a programmable periodic interrupt, and 114 bytes of SRAM. The device serves not only the obvious function of keeping the system time, but also that of storing the system's configuration and other nonvolatile information when the system is turned off.

### System-Control Logic

The IP provides flexible clock selections for the CPU clock, 80C287 clock, AT expansion bus clock, and keyboard clock. Each of these has independent multiple sources and dividers available. The IP provides configuration registers to select and divide these clocks on the fly to meet a portable system's constantly changing demands.

In today's portable arena, these flexible clock dividers are mandatory. It is not uncommon to need the full speed and power of your system one second for a calculation or repagination, and the next second to find the processor simply waiting for a keystroke. You want these on/off transitions to be easily software-controlled and invisible. Two clock-stopping modes found in the IP, when combined with the flexible clocking scheme, provide this capability.

In addition to enhanced clock control, the LX supplies a bus controller that oversees the routing of the addresses and data through the device for every type of data transaction. An example of this routing is a CPU write to video memory on the AT expansion bus. In addition to these expected functions, the bus controller includes enhancements to transform the controller into a dual-state machine design—one for high-speed, synchronous transfers between the CPU and either DRAM or internal register locations, the other for the typically slower ISA expansion bus. The latter can operate either synchronously or asynchronously with the CPU.

### Working with Memory

The LX IP also supports robust and easily implemented memory systems, providing zero- or near-zero-wait-state performance while maintaining low system cost by the use of inexpensive, slower DRAM chips.

The DRAM controller supports four

**T**he LX  
contains two  
8259-compatible  
interrupt controllers  
that are cascaded  
to prioritize  
up to 15 completely  
asynchronous events.

16-bit banks (plus parity) of DRAM. These can be implemented using 256K-bit, 1-megabit, or 4-Mb DRAM chips for a maximum of 8 megabytes per bank, with 16 MB total for all banks. There are none of the limits placed on DRAM sizing and bank matching found in many memory controllers. Any size of supported DRAM can be put in any bank, regardless of the contents of any other banks, producing not only a simple initial design but also flexible upgrading. In keeping with the design goal of the lowest possible chip count for the system core, two banks, totaling as much as the full 16 MB, can be directly connected to the LX.

The processor supports page-mode memory accesses to decrease memory speed requirements. Decreasing the information normally sent to a DRAM chip eliminates the need for wait states or costly, faster DRAM chips. For example, a DRAM chip gets its addressing information in two sequential transactions. The first, associated with the row address strobe (RAS) line, tells the device which subsection or "page" is to be accessed. The second, controlled with the column address strobe (CAS) line, specifies the exact location or "word" on the page. Page mode is simply the protocol that states, "until you are told differently, use the previous page again." If adja-

cent banks are detected as having the same size DRAM chips, a two- and even four-way interleaving scheme (doubling or quadrupling the page size) is automatically invoked to decrease the number of times that a full address is needed. However, when a full address is required, wait states must be added to the access.

The standard RAS-only refresh has been implemented and enhanced with both slow and staggered refresh options. These two options help reduce the large power requirement associated with the continual recharging that a DRAM chip needs to retain its contents.

The LX provides two options for the 384K bytes of memory between A0000 hexadecimal (640K bytes) and FFFFFh (just under 1 MB). The first option is called *shadowing*. It lets you copy the BIOS or other typically slow memory devices into this RAM area. All future accesses to the BIOS would then be routed to the copy located in fast DRAM. If the system has 1 MB of total local memory, another option allows this 384K bytes to be relocated to the addresses starting at 100000h (1 MB). The system then appears to have 640K bytes of base memory and 384K bytes of extended or expanded memory. This can greatly accelerate and enhance such programs as Microsoft Windows 3.0. The IP provides full hardware support for EMS 4.0. Two full sets of 64 EMS registers allow quick task switching by multitasking software.

### Changing Processor Modes

The LX provides two features that enhance a system's ability to switch from protected mode to real mode: fast RESET and fast GATEA20. Normally, the system software calls a BIOS routine, which issues two commands to switch the processor from protected mode to real mode. Both these commands, RESET and GATEA20, are slowed by the inherent delay in the keyboard controller that executes them.

The LX bypasses the keyboard and implements these commands using the industry-standard port 092h location to perform the switch to real mode. These features greatly improve performance in operating environments, such as OS/2 and Windows 3.0, that frequently switch between protected and real modes during execution.

Although it is normally the main CPU of an AT-architecture motherboard, the LX contains a mode that allows it to act as a bus-master peripheral connected to the expansion bus of a host system. It can thus be the main CPU on a high-performance, bus-mastering add-in card, such

as an intelligent disk drive controller or a network adapter. It directly supports ISA bus mastering and, with external logic, Micro Channel architecture and EISA systems. Selecting bus-mastering mode changes the operating mode of some of the ISA expansion bus pins to allow the IP to directly connect to the expansion bus of another system.

### External Interfaces

All the external interfaces of the LX IP are designed for direct connection. No external "glue logic" is necessary to interface to a standard AT-architecture system. The LX controls the additional devices (e.g., DRAM, keyboard controller, and AT expansion bus peripherals) needed to complete a laptop without the space-consuming driver chips that are common in today's systems. This efficiency is critical to the portable market, where more and more functionality is integrated onto the motherboard itself. The LX also provides control signals to accommodate a docking bay or expansion box. In addition, direct connections are provided for both a math coprocessor (80C287 compatible) and keyboard interface (AT or XT type), as well as a full 16 MB of local memory.

The IP provides support for both 8- and 16-bit EPROM configurations. You can define this space to be as large as 256K bytes. The ability to write to the EPROM space has been added to support the new flash-type memories.

In addition to the EPROM and keyboard controller, the IP's X bus can be used to attach other I/O devices. Eight configuration registers are available to map any 8-byte I/O address range onto the X bus; it also supports 16-bit I/O. Any I/O devices such as serial ports, parallel ports, floppy disk drive controllers, and Intelligent Drive Electronics hard disk drive controllers can be attached to the X bus. Any of the four 8-bit DMA channels (0 through 3) can be mapped to the X bus as well. For example, a floppy disk drive controller would use DMA channel 2.

### The Integration Advantage

While the IP has significant ramifications for the entire PC industry, its most important application is in portable computing. It has specific advantages for the laptop, notebook, and palmtop form factors, although across the board it should have much the same impact as chip sets have had: more computer for your dollar.

Laptops typically put more of a premium on functionality than either the notebook- or palmtop-class machine.

These systems are expected to have the capability of a desktop. There is no compromise on expansion capability, disk size, display, keyboard, or performance. These features will be implemented even at the expense of battery life or system size and weight. By using the IP in a laptop design, the system basics take up less

**W**hile  
the IP has significant  
ramifications for  
the entire PC  
industry, its most  
important application  
is in portable  
computing.

space, leaving more room for the features considered necessary in a modern laptop. Furthermore, even though a system could be made fully loaded (with 16 MB of RAM, a modem, Ethernet, and so on), it generally makes more sense to market a minimum system that can be expanded via an expansion box or custom cards, or both. These options are supported through the LX's ability to connect directly to a large number of devices along with providing control signals for future expansion. (To see how you would design a typical laptop around the LX, see the text box "Inside a Laptop" on page 244.)

The next-smaller system is the notebook class. While a full set of on-board peripherals is becoming the norm for this class, it is never at the expense of battery life and system size. The only two subsystems that come close to breaking that rule (and together are the limiting factors for these machines) are the displays and keyboards. The small footprint and the elimination of external glue logic to connect peripherals is not only beneficial in achieving a small system, but essential in a world where power is measured in milliwatts.

### Power Savers

Three features of the LX are helpful in managing battery power. The first is the

fully static CMOS design. The nature of a good CMOS design is that its power usage is directly related to the chip's operational frequency. A device running at 8 MHz should use little more than half the power of a similar one operating at 16 MHz. Power consumption when a clock is not present (DC conditions) can be several orders of magnitude less than the power used at 10 to 20 MHz. The LX's ability to function under DC conditions, and thereby consume practically no power, is essential for power-sensitive designs.

The second feature that simplifies a notebook design is the IP's enhanced clock controller. Often, you don't need a computer's full power. For instance, you do not need the performance (and battery consumption) of a 16-MHz clock rate to enter data using your favorite word processor. Power management techniques monitor these activities and, with the use of the flexible clocking options of the IP, can change the system's performance as needed.

Two clock-stopping modes further enhance a system's power management abilities. The first is called CPU Stop Clock. When the CPU is not needed at all, the system can quickly enable a "doze" mode. This CPU clock-stopping mode can be used during disk accesses, DMA activities, program idle, or even between keystrokes, to extend a system's battery life far beyond its normal range.

A second clock-stopping mode is called System Stand-by. It is essential in implementing suspend/resume, which allows you to stop working on your system, close it up, and then at a later time continue your work simply by reopening your system case. The trick to this mode is not only saving power (it basically turns things off) but also remembering the system's previous state, including not only the memory contents but also the modes and contents of the on-board peripherals and the IP as well. The standby mode puts practically the entire LX processor into a state of suspended animation. This ultralow-power state freezes all actions of the IP except those that are necessary to perform DRAM refresh. It remains in this state until an interrupt is received, at which time it continues processing. All registers and modes are completely unaffected.

The final power-saving features the LX provides involve DRAM refresh. The power-saving modes are called *staggered* and *slow refresh*. The first relaxes the maximum system power requirement by staggering the refresh signal to the various RAM banks. The second allows



A close-up portrait of Boone Bucher, a man with short brown hair, wearing a light blue dress shirt and a dark patterned tie. He is looking directly at the camera with a slight smile.

BOONE BUCHER  
Vice President, Sales

“Hi. I’m Boone Bucher, VP of Sales at SSDC. I’m sure you’ve heard all the talk about math coprocessors. If you’ve discovered how much you can benefit from a math coprocessor, maybe I can help. Here are the facts. The IIT Advanced Math Coprocessor from SSDC is faster (in some cases only 5-10% faster, but usually 150% or more), has more capability (4X4 instructions plus three times the registers), guaranteed compatibility, the best warranty in the industry and costs

# FACT IS

less. But most important, the SSDC team is here to back you up. We were the first to give you diagnostic software. Toll free tech support is available. And if needed, we have field applications engineers all around the country to support you. All you need to do to have this team behind you is ask your dealer for the IIT Advanced Math CoProcessor from SSDC, or call 1-800-284-7732 for the dealer nearest you. Call today to get the best math coprocessor in the industry – and that’s a fact.”



1001 Capital of Texas Hwy. South, Bldg. 1 • Austin, Texas 78746  
512/327-8608 • FAX 512/327-5233

Circle 285 on Reader Service Card

## Inside a Laptop

Doug Gephardt

The Am286LX integrated processor (IP) is just one piece of a laptop or notebook system. The synergy of the hardware and software in the system should give you a high degree of desktop-level functionality while transparently managing the system's power consumption to maximize the time of operation from the battery.

The following structured walk-through of a typical laptop/notebook system based on the LX describes the design issues involved in providing the most computing power for the longest period of time.

Figure A is a block diagram of a hypothetical laptop system that uses an LX IP. A notebook system would have a comparable architecture.

### The AT Core

The IP is the brain of the system, providing all the functionality necessary to make this laptop a high-speed, 286-based AT compatible. It has direct interfaces to the system RAM via the memory, or M, bus. It accesses the ROM BIOS and controls the on-board I/O peripherals via the X bus, and it accesses the video subsystem and the rest of the AT-compatible world through the S bus (i.e., AT expansion bus).

The IP has two main functions relative to power management. It has to control its own power consumption by turning off internal clocks when so directed by the power management program, and it must perform the processing necessary for managing power in the system's peripherals. The peripheral power management logic in the system flags the processor with an interrupt when peripheral power management functions are needed.

### Memory Subsystem

The main system memory in a laptop is normally an array of DRAM chips directly connected to the IP. You can use slow-refresh DRAM chips to minimize power consumption during system inactivity.

Another way to form the memory system is to use static RAM chips. The benefit of SRAM devices is their ability to maintain data with a very low standby current. Their drawbacks are cost and density, relative to DRAM chips.

### On-Board Expansion Bus

The functional blocks accessed via the X bus include the BIOS; keyboard, floppy disk drive, and Intelligent Drive Electronics (IDE)-type controllers; numeric coprocessor; and peripheral power management.

The system BIOS ROM/EPROM is a nonvolatile, read-only storage device that holds the BIOS and the power management code, which hooks into the BIOS at critical places. This device could be implemented in a flash EPROM chip that can be updated or modified while still in the system.

The 8042 keyboard controller is a microprocessor with on-chip ROM and RAM. It receives scan codes from the keyboard and interrupts the IP at each keystroke. It can also handle a PS/2-style mouse port and can perform some power management functions, such as turning off the LCD backlight after a set period of keyboard inactivity.

The LX processor directly supports a numeric coprocessor. In the example, we chose the AMD 80EC287 not because it is made by our company, but because it features a power-saving auto-shutdown mode.

Several integrated floppy disk drive controllers are available that combine the basic 765-style controller with the phase-lock loops and driver logic necessary for a direct interface to a floppy disk drive. Some of these controllers support the new higher-density 2.88-megabyte floppy disks. "Combo I/O" chips integrate a serial port, a parallel port, and IDE hard disk drive interface functions. The LX device can be programmed to specify the I/O devices connected to its X bus. You could, in fact, connect an internal modem to one of the serial ports on the combo I/O chip. Modems are considered power hogs, so intelligent management of their power consumption is critical.

Peripheral power-control logic provides hardware support to control the power consumption of the system's peripherals. It monitors bus activity directed to the system's peripherals and detects when the system is idle. It then signals the IP (via a nonmaskable interrupt) to activate the power management code and slow down or stop the processor clock. The power-control logic can

also selectively cut the power to the system peripherals to conserve total system power.

### Using the AT System Bus

The display subsystem of the laptop in the example consists of an LCD VGA controller, a 640- by 480-pixel LCD flat-panel display, and a fluorescent backlight. The controller resides on the S bus and provides a VGA register-level-compatible display that has special features for driving LCDs. For example, it translates the "colors" into 16 or 32 levels of gray on the LCD. The main element of power consumption with the display controller is the constant accessing of the DRAM chips that hold the video data. The VGA controller should have power management features, including some kind of shutdown that stops video refresh and puts the controller into a low-power mode.

It is important also for the LCD flat panel to have power management control so that it can shut down into a low-power state as well. Normally, the fluorescent backlight consumes more power than any other single component in a system—sometimes as much as 40 percent of the total system power. Intelligent control of the power being fed to the backlight is critical in a battery-powered system.

You can include a half- or three-quarter-length AT expansion slot on the S bus. A notebook system might use a custom form-factor slot with a much smaller size. This internal slot could be used for a network interface or I/O port expansion. The power consumption of this card could significantly affect system battery life, so either the card itself or the system would have to control the power provided to the card.

An external docking bay is another use for the S bus. The most straightforward way to provide one is to place a connector on the system board that comes straight off the bus, possibly with some buffers to increase the drive capability of the signals. You can disable the LX's ability to map device I/O addresses onto the X bus, allowing docking-bay peripherals to supersede some of the motherboard peripherals (e.g., serial ports, parallel port, floppy disk drive) and take over their functions.

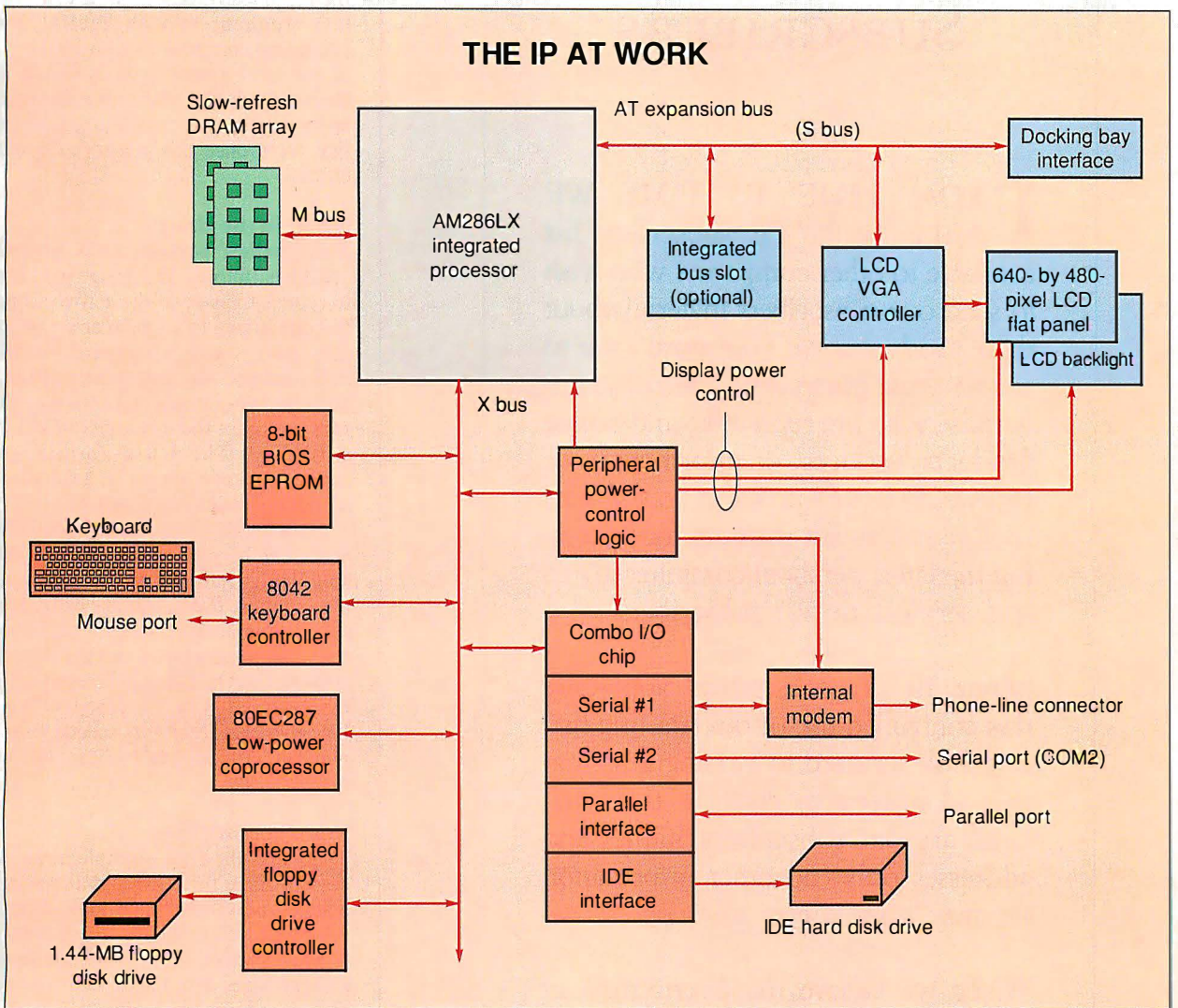

**Figure A:** The Am286LX communicates with the outside world via three buses. The M bus accesses system RAM, the X bus talks to motherboard peripherals, and the S bus communicates with ISA peripherals.

### The Role of System Software

The BIOS of this laptop system must do several things differently than that of a desktop system. The laptop BIOS must resolve issues such as when to turn on the display backlight and hard disk drive, relative to the system and memory tests performed at power-up, because they have an effect on battery life. The BIOS must also be able to detect the presence of a docking bay, an external keyboard, or an external VGA monitor.

The power management code and the BIOS reside in the same physical EPROM device. This code constantly monitors the system's use, controlling power consumption to maximize battery life. Its functions include keyboard and screen-update time-outs to control

the LCD backlight, modem power control, and hard disk drive power-down after a set period of inactivity.

The cutting edge of power management is the detection and handling of software-idle conditions. Here, the power management code performs such functions as slowing down or stopping the IP's clock when you aren't typing. The trick is detecting the idle state. Current software doesn't let the system know that the CPU is idle. Therefore, a combination of hardware and software methods must be employed to detect the idle state. Operating-system suppliers such as Microsoft and Digital Research are taking heed of the portable computing industry and are working toward solutions that will help power manage-

ment software control power consumption during system-idle periods.

### The Benefits of Integration

A block diagram of a laptop or notebook system is in many ways similar to that of a desktop system. The processor, memory, mass storage, display, and keyboard exist in both environments. But size and power constraints in the laptop/notebook arena introduce many behind-the-scenes design problems.

The LX provides a solution for the problem of size and power versus performance and functionality. The growing benefits of silicon integration and advancements in the area of system power management will make your future laptop a better one.

# A MESSAGE TO OUR SUBSCRIBERS

**F**ROM TIME TO TIME WE make the BYTE subscriber list available to other companies who wish to send our subscribers material about their products. We take great care to screen these companies, choosing only those who are reputable, and whose products, services, or information we feel would be of interest to you. Direct mail is an efficient medium for presenting the latest personal computer goods and services to our subscribers.

Many BYTE subscribers appreciate this controlled use of our mailing list, and look forward to finding information of interest to them in the mail. Used are our subscribers' names and addresses only (no other information we may have is ever given).

While we believe the distribution of this information is of benefit to our subscribers, we firmly respect the wishes of any subscriber who does not want to receive such promotional literature. Should you wish to restrict the use of your name, simply send your request to the following address.

---

**BYTE** MAGAZINE  
ATTN: SUBSCRIBER SERVICE  
P.O. BOX 555  
HIGHTSTOWN, NJ 08520



the support of DRAM chips that require less-frequent refresh cycles. These cycles can comprise a significant amount of the total power used by the system. Slow-refresh DRAM chips are quickly approaching power-consumption levels that were once the preserve of SRAM chips.

### **An IP in the Hand**

The smallest portable DOS computers are the palmtops. The design goal here is to reduce the size of the active circuitry. In comparison to a laptop or a notebook, they have smaller keyboards, smaller-still displays, and longer battery life. As with the other types of portables, palmtops maintain the essentials of PC compatibility. The LX's 28-millimeter square package assists in achieving the smallest possible form factor.

Here the IP's large read/write EPROM space can be used to put DOS or Microsoft Works into ROM. The space could also support flash memory or ROM disk cards. The ability to connect SRAM to the local memory bus and the simplicity of an XT keyboard interface, along with the essential core contained within the IP, give the flexibility needed for the nonstandard approach these miniature systems take.

### **Functionality Plus**

The LX is the first example of an IP—a device where the CPU and all its tightly coupled peripherals and logic functions are housed on one chip. For future laptops, it means ease of system design, smaller size, and longer battery life. It also means more efficient use of the limited circuit board real estate, making room for peripherals such as faxes, modems, and SCSI and network interfaces that significantly add to the functionality of the system. Manufacturers can concentrate on how to get more desktop functionality in a portable environment, and not on how to fit the core AT functionality within the target size.

This first IP starts a literal "space race" in processor integration. The challenge will be to integrate more and more peripherals onto the IP for increasing amounts of PC functionality on a single chip. It will enable AT-compatible systems that won't slow you down, either in speed, size, or weight. ■

---

*Doug Gephardt is a member of the technical staff and Mark C. Klonower is senior applications engineer of Advanced Micro Devices' Personal Computer Products Division (Austin, TX). You can reach them on BIX c/o "dgephardt."*

# "SPEED TO BURN"

## CLUB HAWK 486 SERIES



The time of DOS mainframe has arrived! Running at a blazing speed of 21 VAX MIPS, CLUB's award winning HAWK family, based on Intel's i486 CPU, achieve the mainframe horse-power that outperforms any RISC or SPARC based systems in their class.

With such extraordinary value, price/performance, and compatibility, the HAWK line of systems break through new benchmark barriers in UNIX/XENIX, DOS, and Novell environments. Combine this with our family of 386 based computers and peripherals, you receive the widest selection of systems from a single major world class manufacturer.

It's no wonder that hundreds of thousands of these systems have

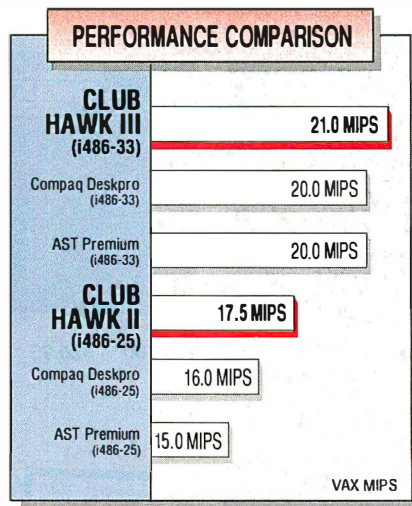

been installed in corporations world wide. That's why CLUB's systems are called the Ultimate Business Computers. Put yourself on the fast track and call today for more information.

"CLUB AT prides itself on being an authorized Novell reseller, making the tower model a good choice for LAN server applications. ... [ CLUB ] combines field-leading performance, solid construction, and knowledgeable technical support at an exceptionally low price." *PC Magazine, February, 1990*

"When it comes to the basics - price, performance, and ... capacity - [ CLUB ] delivers outrageous value."

*PC World, Best Buy Award 1989*

**For more information call:**  
Continental USA, Hawaii, and Alaska:  
**(415) 683-6600**

Fax: (415) 490-2687

CLUB Canada, Toronto: (416) 609-8121  
International Sales: (415) 683-6623

Call for Corporate and Educational Discounts  
GSA # GS00K90AGS5260

# CLUB

American Technologies, Inc.

The Ultimate Business Computers

Ad 9 v.1/9.90  
The above-mentioned brands and names are trademarks of their respective companies.

Circle 50 on Reader Service Card

# TAKE ANY 3 BOOKS

as your introduction to  
The Library of Computer and Information Sciences

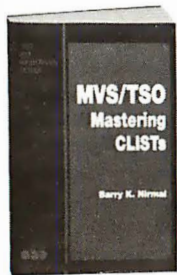

63249 \$34.95



80769 \$35.00

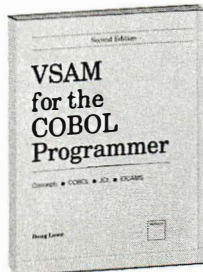

85944 \$17.50

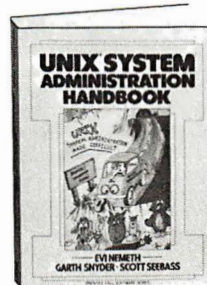

85378 \$35.40

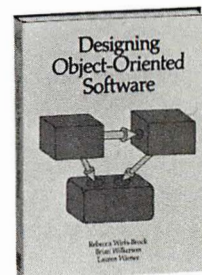

41827 \$36.40



60661 \$34.95

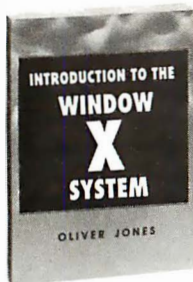

56530 \$32.00

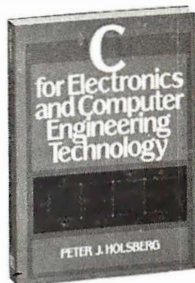

37167 \$33.40

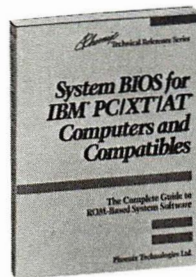

81690 \$26.95

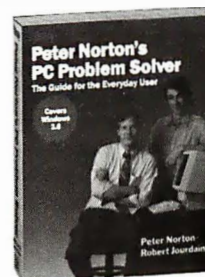

68223 \$24.95



79136 \$28.00

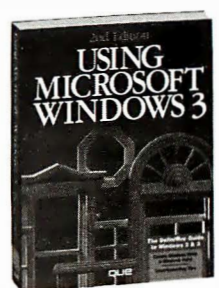

85643 \$22.95

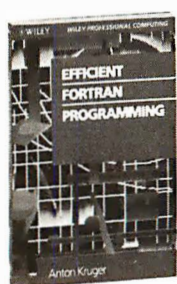

43901 \$34.95

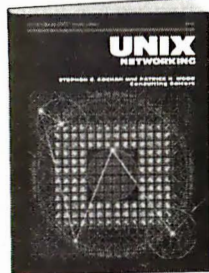

85371 \$29.95

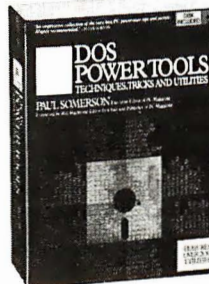

67420-2 \$49.95  
(counts as 2 choices)

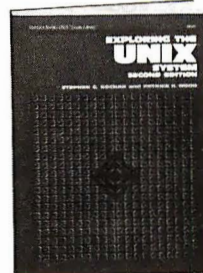

47180 \$26.95

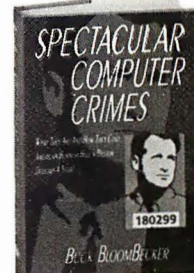

79930 \$22.95

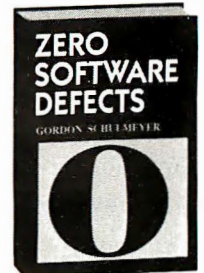

93030-2 \$44.95  
(counts as 2 choices)

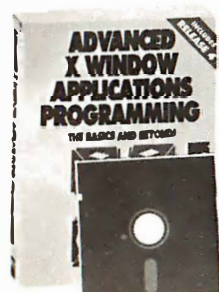

32249-2 \$59.95  
(counts as 2 choices)

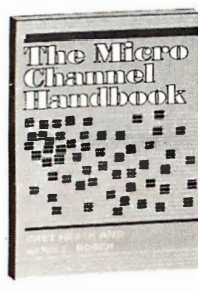

62626 \$29.95

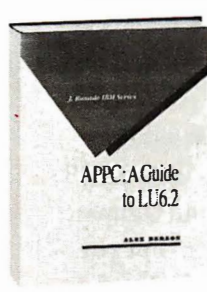

34113-2 \$44.95  
(counts as 2 choices)



82440 \$29.95

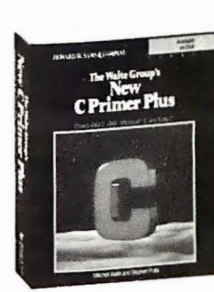

86080 \$26.95

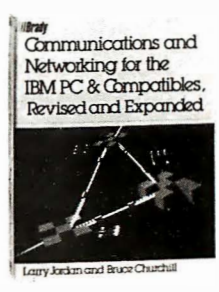

39681 \$24.95

# The Library of Computer and Information Sciences

A Division of Newbridge Communications, Inc.

Please accept my application for trial membership and send me the three volumes indicated, billing me only \$1.00 each, plus shipping and handling. I agree to purchase at least three additional Selections or Alternates over the next 12 months. Savings generally range from 15% to 30% off the publishers' prices. My membership is cancelable any time after I buy these three additional books. A shipping and handling charge is added to all shipments.

**No-Risk Guarantee:** If I am not satisfied—for any reason—I may return my introductory books within 10 days. My membership will be canceled, and I will owe nothing.

3 books for \$1.00 each:

--	--	--

Indicate by number the books you want. A few expensive books (as noted) count as more than one choice.

Name \_\_\_\_\_

Address \_\_\_\_\_ Apt. \_\_\_\_\_

City \_\_\_\_\_

State \_\_\_\_\_ Zip \_\_\_\_\_

(Books purchased for professional purposes may be a tax-deductible expense. Offer good in Continental U.S. and Canada only. Prices slightly higher in Canada.)

Byte 2/91 7-GF9

# The Library of Computer and Information Sciences

A Division of Newbridge Communications, Inc.

Please accept my application for trial membership and send me the three volumes indicated, billing me only \$1.00 each, plus shipping and handling. I agree to purchase at least three additional Selections or Alternates over the next 12 months. Savings generally range from 15% to 30% off the publishers' prices. My membership is cancelable any time after I buy these three additional books. A shipping and handling charge is added to all shipments.

**No-Risk Guarantee:** If I am not satisfied—for any reason—I may return my introductory books within 10 days. My membership will be canceled, and I will owe nothing.

3 books for \$1.00 each:

--	--	--

Indicate by number the books you want. A few expensive books (as noted) count as more than one choice.

Name \_\_\_\_\_

Address \_\_\_\_\_ Apt. \_\_\_\_\_

City \_\_\_\_\_

State \_\_\_\_\_ Zip \_\_\_\_\_

(Books purchased for professional purposes may be a tax-deductible expense. Offer good in Continental U.S. and Canada only. Prices slightly higher in Canada.)

Byte 2/91 7-GF9

**10-Day Free  
Examination**



**BUSINESS REPLY MAIL**

FIRST CLASS MAIL PERMIT NO. 230 RIVERSIDE, NJ

POSTAGE WILL BE PAID BY ADDRESSEE

**The Library of Computer  
and Information Sciences**

3000 CINDEL DRIVE  
DELRAN NJ 08075-9889



NO POSTAGE  
NECESSARY  
IF MAILED  
IN THE  
UNITED STATES



**10-Day Free  
Examination**



**BUSINESS REPLY MAIL**

FIRST CLASS MAIL PERMIT NO. 230 RIVERSIDE, NJ

POSTAGE WILL BE PAID BY ADDRESSEE

**The Library of Computer  
and Information Sciences**

3000 CINDEL DRIVE  
DELRAN NJ 08075-9889



NO POSTAGE  
NECESSARY  
IF MAILED  
IN THE  
UNITED STATES





# FOR ONLY \$1.00 EACH

You simply agree to buy 3 more books—at significant savings—within the next 12 months.

## values to \$106.81

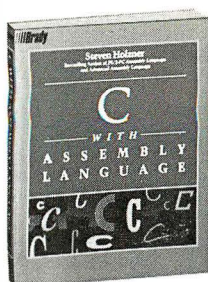

37160 \$29.95

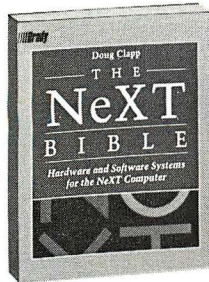

64654 \$29.95

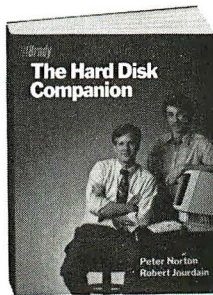

52373 \$21.95

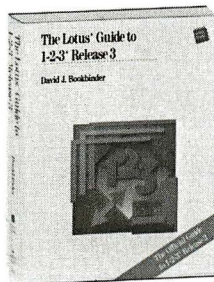

59015 \$22.95

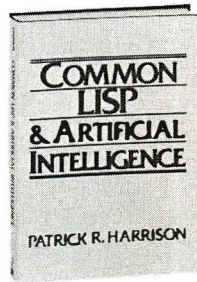

39667 \$30.00

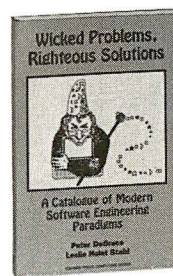

87137 \$29.00

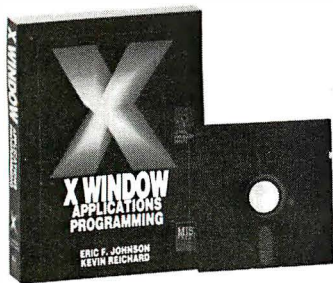

88052 \$34.40

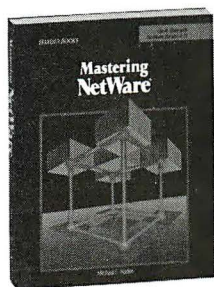

60650 \$24.95

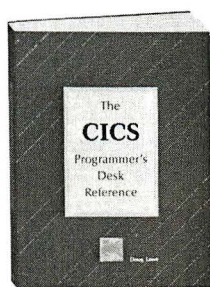

37969 \$35.00

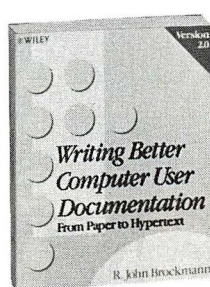

87963 \$29.95

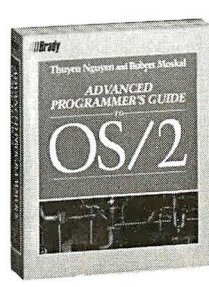

32264 \$29.95

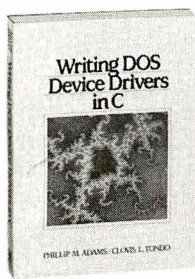

87959 \$25.95

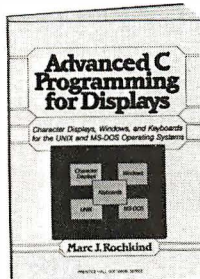

32274 \$35.95

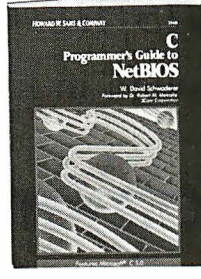

37172 \$24.95

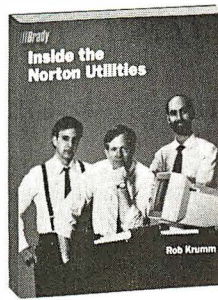

55510 \$24.95

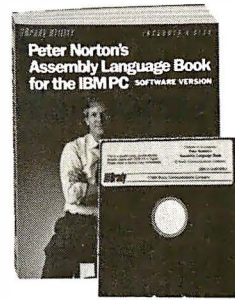

68426 \$24.95

## 4 Good Reasons to Join

**1. The Finest Books.** Of the hundreds of books submitted to us each year, only the very finest are selected and offered. Moreover, our books are always of equal quality to publishers' editions, never economy editions.

**2. Big Savings.** In addition to getting the 3 books for only \$1.00 each when you join, you'll receive discounts on the books you choose to purchase. Discounts range from 15% to 30% off the publishers' prices, and occasionally even more. (For example, your total savings as a trial member—including this introductory offer—can easily be over 50%. That's like getting every other book free!)

**3. Bonus Books.** Also, you will immediately become eligible to participate in our Bonus Book Plan, with savings of 60% off the publishers' prices.

**4. Convenient Service.** At 3-4 week intervals (15 times per year), you will receive the Library of Computer and Information Sciences News, describing the Main Selection and Alternate Selections, together with a dated reply card. In addition, up to two times a year, you may receive offers of Special Selections which will be made available to a group of select members. If you want the Main Selection, do nothing, and it will be sent to you automatically. If you prefer another selection, or no book at all, simply indicate your choice on the card and return it by the date specified. You will have at least 10 days to decide. If, because of late mail delivery of the News, you should receive a book you do not want, we guarantee return postage.

If reply card is missing, please write to The Library of Computer and Information Sciences, Dept. 7-GF9, 3000 Cindel Drive, Delran, NJ 08075, for membership information and an application.

Byte 2/91

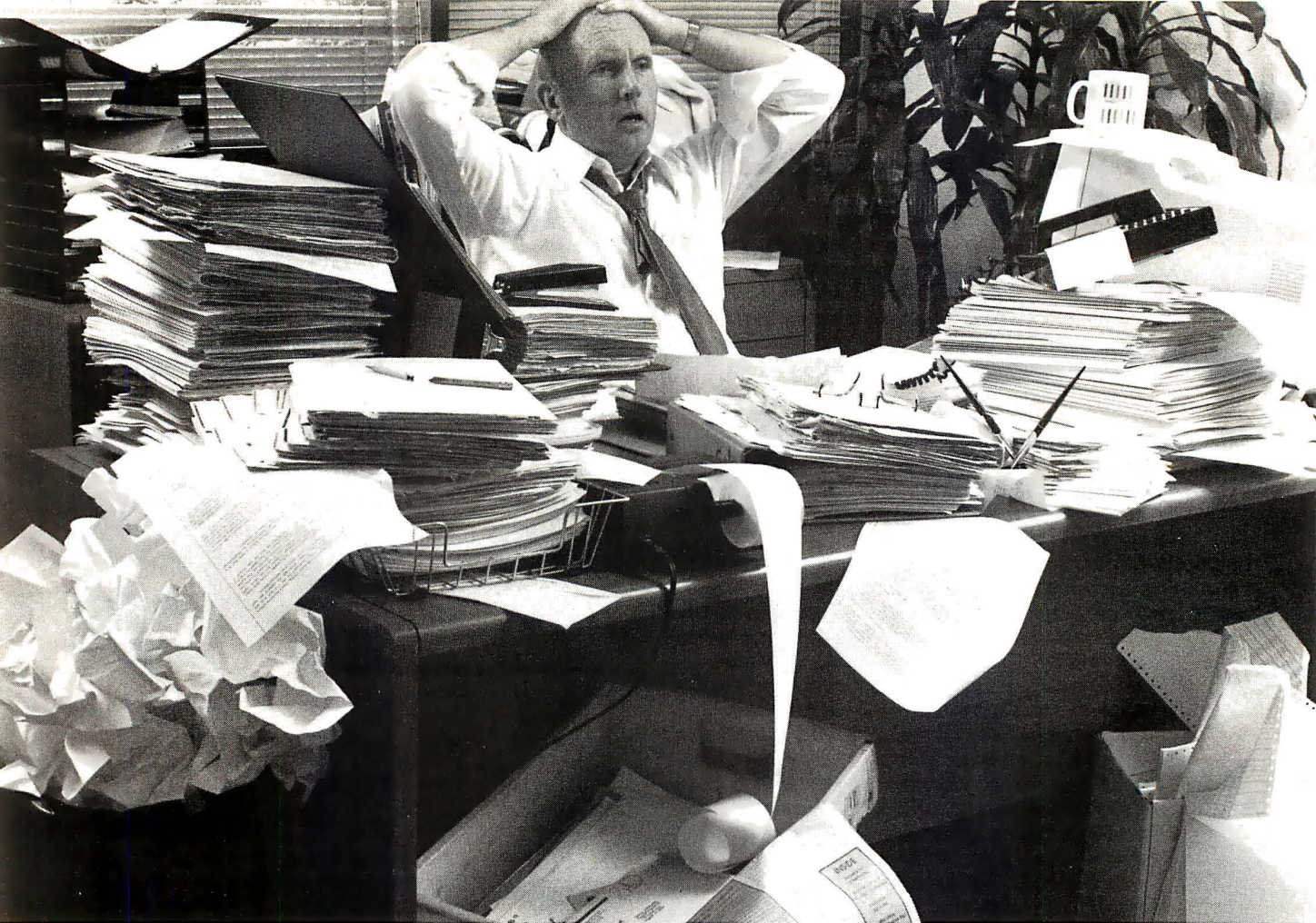

# DESK NOT BIG ENOUGH?

*17 million business documents  
are lost or misfiled each day.*

Announcing a major breakthrough in image storage and retrieval:

**Paper  
Tamer**

*PaperTamer* offers more power and flexibility than other existing document storage and retrieval systems—and *paperTamer* costs 1/10th of the price.

*PaperTamer* is designed to eliminate the need to run to the file room every time you need information. *PaperTamer* provides immediate access to over a million images, documents, memos and articles.

Flagstaff Engineering offers a complete line of peripheral products to provide complete image storage and retrieval systems including scanners, optical drives and mass storage devices.

No one delivers rock solid solutions like Flagstaff Engineering, the company that continues to help people read a world of information.



**Domestic Sales and Marketing**  
1120 Kaibab Lane  
Flagstaff, AZ 86001  
(602) 779-3341 / FAX (602) 779-5998

**International Sales**  
1930 S. Alma School #C202  
Mesa, AZ 85210  
(602) 831-5100 / FAX (602) 831-0684

GSA APPROVED

Circle 85 on Reader Service Card

# Memories in My Pocket

*Data storage has evolved from paper to magnetic media  
to optical media to silicon "credit cards"*

*John Reimer*

**W**hen your computer is finally small enough to fit in your pocket, the mass-storage memory device won't be a floppy or hard disk drive. It will be something far smaller, lighter, and less power-hungry. That "disk drive" won't be magnetic at all; most likely, it will be a solid-state memory card. With about the same dimensions as a credit card or a business card—just a little thicker—each memory card will be able to store several megabytes of data.

Actually, memory cards are here now. They have already found their way into laptop computers. And standardization is the key that has made the use of memory cards possible: the ability to interchange cards from different vendors among different computers. (For information on the standards process, see the text box "Toward a Standard" on page 252.)

## The Standard Choice

Two standards groups, the Japanese Electronic Industry Development Association (JEIDA) and the Personal Computer Memory Card International Association (PCMCIA), have settled on

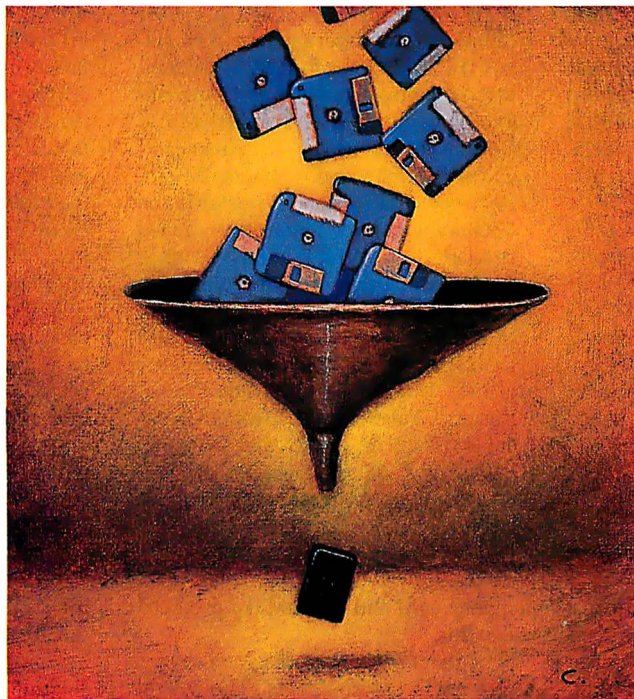

a 68-pin standard for memory cards. This number of pins directly accommodates both 8- and 16-bit bus widths and, with multiple reads and writes per word, can provide for wider buses.

With high-speed semiconductor memory, the extra time needed for multiple writes pales in comparison with the overall speed improvement of memory cards over magnetic media. In addition, 68

pins provide room for additional functions and I/O capabilities. The 68-pin memory card was also the first to be implemented with execute-in-place (XIP) capability (executing on the card itself), adding credence to the choice.

## Physical Issues

Once the 68-pin package was chosen as the PCMCIA standard, one important physical issue remaining unresolved was the question of hot insertions and withdrawals. The card, system, and data integrity must be protected in case someone should attempt to insert or remove a card while the system is powered up.

The pins on the plug that mates to the memory card are of three different lengths. The two 3.5-millimeter pins on the outermost edges are the shortest and are referred to as card-detect pins; the 4.25-mm pins are signal/data I/O pins; and the longest pins, measuring 5 mm, are for  $V_{cc}$  and ground. Ground is at the outermost edges of the connector, next to the card detect, and  $V_{cc}$  is in the center of the connector.

The ground and  $V_{cc}$  pins are the longest to ensure that, during insertion, power and ground are supplied before data can flow on or off the card. The early ground

## Toward a Standard

In the mid-1980s, the applications for memory cards were mostly in consumer products, especially in video games, such as the Sega that contained a single ROM chip on its memory card. This 32-pin memory card provided an easy and relatively indestructible way to handle the ROM chip while avoiding possible damage due to an electrostatic discharge. Then, Fujitsu developed a 38-pin memory card with an 8K-byte EPROM that was suitable for use in office machines, such as font cards for laser printers and fax machine telephone-number storage.

The next step was a 68-pin card, also from Fujitsu, containing a high-density printed circuit board capable of accommodating newer IC packages. These packages include the thin, small-outline package and the chip on-board in which the unpackaged IC dies are bonded directly to the board and then encapsulated. (COB is the favored mounting technique for calculators.)

Starting in 1985 in Japan, a group called JEIDA (for Japanese Electronic Industry Development Association) formed a working group to standardize memory cards for personal computers. JEIDA had no specific operating-system orientation in mind, not even DOS. It had, however, selected 68 pins as its standard and, by 1989, were in the process of defining pin assignments.

At about the same time, Poqet Computer and Fujitsu Microelectronics, a major Poqet investor, chose this card-based technology as the most attractive disk drive alternative to use in manufacturing a full DOS-based computer that would fit in a coat pocket. Such a silicon diskless drive would be rugged, reliable, and noise-free and would reduce

power requirements so that you could use small flashlight cells.

However, although the technology to produce such a computer was available, the lack of a memory-card standard would seriously inhibit its marketability. Imagine the confusion in a world where each diskless drive used different media and sector format as well.

Fujitsu and Poqet decided to start a standards effort for memory cards. First, they looked at existing standards groups to see if any were poised to set a standard for the card. The ideal group would have participation from companies in the mechanical, electrical, and software portions of the specification.

JEIDA had made considerable progress in the mechanical aspects but did not have adequate representation in the electrical and software aspects. Besides, it wasn't open to U.S. membership and was too far along to be open to alternate pin counts.

In 1989, the Personal Computer Memory Card International Association (PCMCIA) was formed, with members including electrical and semiconductor companies (Advanced Micro Devices, Mitsubishi, NEC, Amphenol, Chips & Technologies, Fujitsu Microelectronics, ITT Cannon, Intel, Micron Technology, OKI Electronics, Texas Instruments, AT&T, and National Semiconductor); software companies (Peter Norton Computing, Lotus, Microsoft, Traveling Software, and WordPerfect); and computer companies (IBM, Dell, Compaq, Databook, Epson, Grid Systems, Hewlett-Packard, MIPS, NEC, Poqet, and Sharp).

PCMCIA decided to approach the memory-card arena anew, to achieve international participation so that the

final standard would be adopted internationally. However, Fujitsu and several others were already committed to JEIDA's 68-pin effort. NEC had introduced its UltraLite computer using its proprietary 60-pin card. Mitsubishi was promoting two cards, a 50- and a 60-pin card (different from NEC's 60-pin version). Atari's Personal Portfolio had its own card. In short, the market was beginning to fracture.

PCMCIA faced two tasks: arriving at a card standard that was flexible enough for future expansion and trying to halt the fracturing process with that standard. It was vital that other standards groups be involved, including JEIDA (now a member of PCMCIA). PCMCIA would also seek JEDEC and International Standards Organization (Geneva) approval for the cards' physical characteristics and software protocols.

By December 1989, three proposals were under consideration (proposals submitted to PCMCIA had ranged from 40 pins for a serial-based card to 128 pins): the 60-pin card from NEC, the 50-/60-pin card from Mitsubishi, and the 68-pin proposal from Fujitsu. The mechanical card choice, for both size and number of pins, was Fujitsu's. On the Monday following the Friday of the PCMCIA-standard press release, Fujitsu, NEC, and Matsushita all introduced products using the 68-pin card.

JEIDA's 4.0 and PCMCIA's 1.0 specifications for the 68-pin memory card have been released independently of each other but are 100 percent compatible. And both organizations are committed to ensuring that future versions remain compatible. I cannot stress too strongly that the PCMCIA standard is a major milestone in portable computing.

also provides protection against electrostatic discharge. Likewise, during card removal, power and ground are maintained until the last possible moment. Placing the ground pins at the card edges also ensures that if the card is plugged in askew (i.e., leaning toward one side or the other), ground will always be made first.

The short card-detect pins, which are also placed at the card's edges, permit reads and writes once all the other pin connections are made. On withdrawal, the card-detect pins break, alerting the system that it is about to lose access to the

memory card and should take protective measures.

The memory card is designed to operate in harsh environments. The connectors meet the various environmental specifications, as well as the insertion/withdrawal force limits set by U.S. Military Standard 202F. You can expect to obtain 10,000 insertions and removals in an office environment, and 5000 in a harsh industrial environment rife with noxious fumes.

The PCMCIA cards come in two different thicknesses: The type 1 card is 3.3 mm thick, and the type 2 card is 3.3 mm

thick in the guide and contact area, while the rest of the card is 5 mm thick. The 3.3-mm thickness is sufficient for one-sided mounting of tape-automated bonding and chip-on-board (COB) mounted memory chips or for double-sided mounting of thin small-outline package (TSOP) devices. The 5-mm card provides extra thickness where needed. For example, such a card allows for the thickness required by the glass ultraviolet (UV) erase window used in an EPROM.

Two other physical issues also needed to be resolved: the location of the write-

# Serious Storage For OS/2<sup>®</sup> And OS/2 Networks.



## Ready To Go. Ready To Grow.

OS/2 is designed for serious business, particularly networking business. Now SpeedStor/2<sup>®</sup> storage systems let you tap all of the applications potential of OS/2 to achieve a whole new level of performance, productivity and growth.

Whether you're running Micro Channel,<sup>™</sup> AT<sup>™</sup> or EISA, SpeedStor/2 delivers the first full family of storage solutions for OS/2 and LAN Manager environments. Hard disk and optical. Internal and external. All plug-and-play — so you're ready to go, right now. With easy expandability from 200 megabytes to an unparalleled 24 gigabytes — so you're ready to grow, at your own pace.

**See us at *Networld Boston*, Booth #220.**

Only SpeedStor/2 supports the three leading bus platforms. Only SpeedStor/2 offers a one gigabyte erasable optical solution. And only SpeedStor/2 features hardware and software that is system engineered, system tested and performance matched<sup>™</sup> to your applications environment for optimum system throughput.

If you're serious about OS/2 applications and networks, you need more than just storage. You need Storage Dimensions. So get serious and call (408) 879-0300. Storage Dimensions, 2145 Hamilton Avenue, San Jose, CA 95125.



## STORAGE DIMENSIONS

©1991 Storage Dimensions. SpeedStor/2 is a registered trademark of Storage Dimensions.

*Call me I'm interested: circle 218*

*Please send literature: circle 219*

protect switch and the battery location for battery-backed static RAM (SRAM). PCMCIA members (see the text box) agreed that if you place the back of the card away from the connector, the write-protect switch should be on the right, and it should be in protect mode if it's pushed toward the edge of the card. The members also decided that the battery compartment should be opposite the write-protect switch on the left side of the card and facing up. This way, if the compartment is opened, the button-size battery won't drop out.

In addition, the card will have magnetic and x-ray interference specifications that will let you carry them through an airport metal detector or x-ray without

compromising their data integrity. And for those interested in protecting data in case of nuclear attack, a gamma-ray specification will be included in rad units.

### Electrical Issues

I/O capability is a major PCMCIA concern. The interface is robust enough to accept enhanced functionality for peripherals (e.g., modems, fax cards, and LANs). If the specification is implemented properly, you can have a computer with, for example, two PCMCIA-compatible slots and interchangeably plug in a memory card, a modem, or even expanded main memory.

Of course, with a business-card-size peripheral, one problem is where to put

the connectors. The connection could be to a virtual connector on the card, through an expansion slot bus on the computer, or even via a fiber-optic cable connected to the card (see the table). Some pins are reserved for future use and should be left inactive to avoid compatibility problems later on.

### Software Issues

Memory cards have three principal software-related issues:

1. selecting the file format to be used;
2. providing header information so that the system can identify the card (enabling the same card to be

## PCMCIA MEMORY-CARD PIN ASSIGNMENTS

*The 68-pin memory card that was chosen as the PCMCIA standard has a 16-bit-wide data path, as shown in signals D0-D15, and a 26-bit-wide address bus, A0-A25, for a maximum addressing range of 64 MB.*

Pin	Signal	I/O	Function	Pin	Signal	I/O	Function
1	GND		Ground	35	GND		Ground
2	D3	I/O	Data bit 3	36	CD1	O	Card detect
3	D4	I/O	Data bit 4	37	D11	I/O	Data bit 11
4	D5	I/O	Data bit 5	38	D12	I/O	Data bit 12
5	D6	I/O	Data bit 6	39	D13	I/O	Data bit 13
6	D7	I/O	Data bit 7	40	D14	I/O	Data bit 14
7	CE1	I	Card enable	41	D15	I/O	Data bit 15
8	A10	I	Address bit 10	42	CE2	I	Card enable
9	OE	I	Output enable	43	RFSH	I	Refresh
10	A11	I	Address bit 11	44	RFU		Reserved
11	A9	I	Address bit 9	45	RFU		Reserved
12	A8	I	Address bit 8	46	A17	I	Address bit 17
13	A13	I	Address bit 13	47	A18	I	Address bit 18
14	A14	I	Address bit 14	48	A19	I	Address bit 19
15	WE PGM	I	Write enable (program)	49	A20	I	Address bit 20
16	RDY BSY	O	Ready/busy (EEPROM)	50	A21	I	Address bit 21
17	V <sub>cc</sub>			51	V <sub>cc</sub>		
18	V <sub>pp1</sub>			52	V <sub>pp2</sub>		
19	A16	I	Address bit 16	53	A22	I	Address bit 22
20	A15	I	Address bit 15	54	A23	I	Address bit 23
21	A12	I	Address bit 12	55	A24	I	Address bit 24
22	A7	I	Address bit 7	56	A25	I	Address bit 25
23	A6	I	Address bit 6	57	RFU		Reserved
24	A5	I	Address bit 5	58	RFU		Reserved
25	A4	I	Address bit 4	59	RFU		Reserved
26	A3	I	Address bit 3	60	RFU		Reserved
27	A2	I	Address bit 2	61	REG	I	Register select
28	A1	I	Address bit 1	62	BVD2	O	Battery voltage detect 2
29	A0	I	Address bit 0	63	BVD1	O	Battery voltage detect 1
30	D0	I/O	Data bit 0	64	D8	I/O	Data bit 8
31	D1	I/O	Data bit 1	65	D9	I/O	Data bit 9
32	D2	I/O	Data bit 2	66	D10	I/O	Data bit 10
33	WP	O	Write protect	67	CD2	O	Card detect
34	GND		Ground	68	GND		Ground

- used in different operating-system environments); and
3. executing programs directly on the cards (XIP).

Like conventional magnetic-media drives, the data stored on a memory card must adhere to some file format. Instead of having the mechanical attributes of spinning media constrain the file format, the read/write/erase characteristics of semiconductor memory are the controlling factors. According to Mike Dreyfoos, chief engineer of Microsoft's MS-DOS division, the file format need not constrain the card to operate only within a particular version of an operating system.

PCMCIA recognizes that a large number of developers understand and have support software for the traditional floppy disk-type file-allocation-table system. PCMCIA adopted the basic MS-DOS FAT system on ROM and RAM cards. Since this approach imposes a block-oriented structure on a byte-oriented medium, it doesn't make the best use of the card's available space. But it is straightforward to implement, and the familiarity of this kind of storage speeds the development of early PC card products.

Flash memory, which is a promising semiconductor-memory technology (see "Store Data in a Flash," November 1990 BYTE), presents a thorny file management problem. Although it's byte-oriented for read/write, it is, at best, sector-oriented for erase. The FAT system must be modified.

To address flash memory, PCMCIA is adopting a special file system for it; it is essentially Microsoft's Flash File System, an extension of MS-DOS for use in a flash environment. Currently, FFS does not recover all memory used by erased files. To recover this memory, you must first copy all files from the card, erase the card, and then copy the files back. Future revisions will address this garbage collection problem.

The memory card's software header identifies its electrical capabilities without having to invent new DOS data structures or impose existing ones on other operating systems. The header distinguishes, for instance, between ROM and RAM, and it provides non-operating-system-specific information, such as error correction for card data and battery-installation date. This "meta-format" for header information describes both the card's logical and physical characteristics.

Architecturally, the card can be formatted into two memory spaces: the

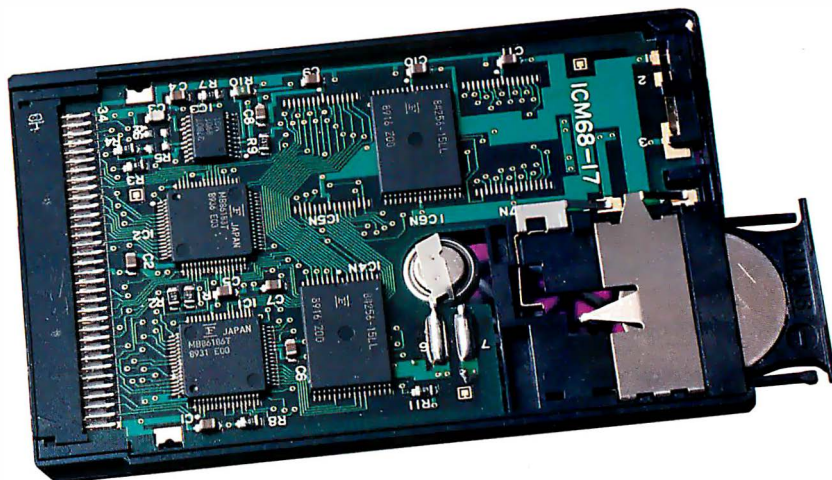

*PCMCIA-compatible SRAM cards are now being used in a variety of applications, including pocket-size personal computers. SRAM is a volatile memory; note the button cell used for memory retention.*

common memory and the attribute memory. The common memory is conventional storage and is always present, while the attribute memory that contains the header information is optional. A dedicated signal, REG, selects the attribute memory. This allows a system to determine a card's type, even for an unformatted card. The two spaces need not share the same IC memory type. For instance, an SRAM card may use SRAM for common memory and an on-board electrically erasable programmable read-only memory (EEPROM) for non-volatile attribute memory.

To ensure a future growth path, the memory card's meta-format supports several different file formats, both DOS-compatible and other file systems (e.g., Xenix). It also supports applications, such as data storage for VCRs or musical instruments, which might not use a traditional file system to record their data. Any computer system can query the card and determine its overall size, type, and other basic information.

The ability to read non-DOS cards on DOS-based systems will be significant. The ability to detect that a card is formatted (even if the computer it's plugged into can't read it) is particularly valuable. It lets system designers protect you against some mistakes. For instance, the system could prompt you during the format routine that the card is already formatted as a data-storage card for a VCR.

XIP is still under investigation. Its purpose is to execute the program directly (and quickly) on the card without first loading it into main memory. The program must execute equally well on both portable and desktop machines. The

problem is that the card's memory space exceeds what the microprocessor can address in real mode.

PCMCIA is addressing the XIP problem by providing EMS-like functionality to map portions of the card into the computer's address space. A program loader, tailored for the application, pages the program in and out of RAM. PCMCIA's memory map requires that three windows of 64K bytes each be available in the card's address space for mapping and that one of those windows be divisible into 16K-byte pages.

### Memory Types

Memory cards are really a packaging technique, and as such, they let you use any kind of semiconductor memory. Types of memory include ROM (and PROM), EPROM, RAM, EEPROM, and flash (see the photo).

- **ROM:** Programmed once and only mask-programmed during the chip-manufacturing process by etching the programming lines into the IC. When you buy a video game cartridge or a font card for a laser printer, ROMs are used.

PROMs are somewhat similar. Once they are programmed, they are read-only; however, they are supplied unprogrammed and are one-time-programmable (OTP), using a PROM programmer, so you can make your own program cards.

Mask ROMs are dense and yield the lowest cost per byte. Currently available mask ROM cards start at 512K bytes and get as dense as 16 MB. However, with future-density silicon chips, these cards are capable of holding up to 64 MB of

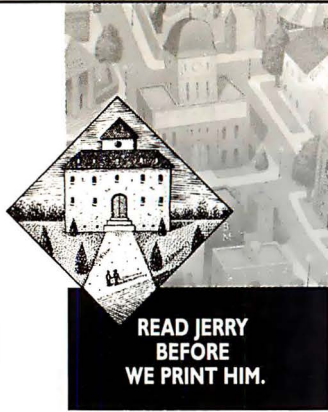

■ Goodnews from the BIX community:

You can read and talk with Jerry Pournelle about the unedited text of his *Computing At Chaos Manor* column—weeks before BYTE hits the newsstands—on your computer. (Why settle for writing letters to him *after* the fact, when you have a shot at influencing his thinking—and maybe the content of the column itself?) You can also take part in a variety of other discussions with Jerry—on such subjects as computers, science, space exploration and habitation, cognitive psychology, natural and man-made disasters, education, and mathematics. Any of which discussions could work its way into his next column or book. You can even cast your vote with Jerry for the best and worst products of the year. And download 147 programs—free. All it takes is a subscription to BIX. Call our special Customer Service number for more information: 1-800-227-2983 (in NH, call 603-924-7681).

**BIX**

**S**RAM  
*cards are the first  
memory cards to be  
used for both program  
and data storage.*

memory. The first major application of memory cards for pocket-size PCs will employ ROMs.

• **EPROM:** Similar to ROMs and OTPs except that exposing the surface of the IC die to a powerful UV light source will erase them. Then EPROMs can be reprogrammed.

They cannot, therefore, be reprogrammed on the fly. On a memory card, EPROMs present a unique problem: The card must contain a UV window so that it can be erased. Thus, a slightly thicker card must be used.

• **RAM:** You can write to and read from RAMs on the fly; thus, they typically are used for main system memory. They come in two main varieties: SRAMs and DRAMs. Both types are volatile (i.e., they lose data if they lose power). In addition, DRAM requires a frequent data refresh, since data is stored in minute capacitors that lose charge with time. For main-memory expansion, DRAM cards will replace the single in-line mount packages in vogue in desktop computers.

SRAMs are fast, with read/write times in the tens of nanoseconds or less. DRAMs are becoming extremely dense with 4-megabit chips about to ship and 16-Mb chips on the drawing board. However, they are not quite as fast as SRAMs; they have memory-access times below 100 ns. If you use either of them for removable mass storage, you will need some form of battery backup on the memory card, usually in the form of a button cell.

Battery-backed SRAM cards are the first memory cards to be used for both program and data storage. Although they are relatively expensive on a cost-per-byte basis, a single 2-MB SRAM card can typically contain, for instance, a word processing program, a spreadsheet program, and a database program, and still have room for data.

The reasons SRAMs are costly are

that the data-storage cell is larger than it is on DRAM cells, production yields are lower, and SRAMs have not been produced in the same quantities as DRAMs. Still, using an SRAM card eliminates the expense of having a floppy or hard disk drive and associated controllers.

While an SRAM card can cost hundreds of dollars, you'll only need one or two if you're a typical user. You'll be able to download the programs and data from your desktop PC onto an SRAM card for your laptop and take it on the road with you.

• **EEPROM:** The ability to electrically erase an EPROM on the fly makes the EEPROM a seemingly ideal replacement for magnetic disk drives. An EEPROM is nonvolatile memory (no battery backup needed), and you can erase it byte by byte and reprogram it. There are, however, several shortcomings.

While almost all ICs operate on a 5-volt power source, EEPROMs need a 12-V power supply to erase. Some chips, such as those from Texas Instruments, use an on-chip charge pump to produce the needed erase potential, but this greatly adds to the price of the chip.

EEPROMs have not yet achieved the density of DRAMs since their cells are larger and more complex. And there may be a problem with the longevity of the cells if they perform more than 10,000 read/write cycles.

The biggest obstacle, however, is cost. EEPROMs are about eight to 12 times more expensive than DRAMs on a cost-per-byte basis. They are often used in military applications where cost is less of an issue.

• **Flash:** Flash memory is a new nonvolatile memory technology that replaces EEPROMs in many diskless applications. Flash read/access times are on a par with DRAM's and represent a 100-fold improvement over magnetic media; write times are more on a par with those of disk drives. Although presently flash memory costs three times as much as volatile memory, it can theoretically achieve the same density as DRAM (or greater) at a comparable cost.

Flash memory's use in electronic still photography will also drive down its cost. For instance, with a charge-coupled device (CCD) of 540,000 pixels and a compression ratio of 5 to 1, a 2-MB flash card can store up to 20 pictures.

As CCD technology develops, so will the storage technology. With higher-resolution CCD, images made on a printer will resemble photographic-quality





# Turn it on and forget about it.

Forget about walking into work to find your message light blinking with last night's modem problems.

Forget about downtime. Forget about phone line problems and retransmitting. Forget about staying late to make sure your data gets through.

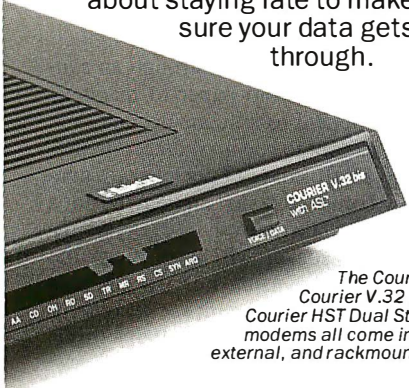

The Courier HST™, Courier V.32 bis™, and Courier HST Dual Standard™ modems all come in internal, external, and rackmount models.

A Courier™ high speed modem works so well, you can forget about it altogether.

It's reliable by design. The data pump has fewer parts. Less to go wrong.

And we test every Courier modem mercilessly before we send it out.

General Electric. Kodak. USWest. Forty-three of the Fortune 50 have relied on Courier modems for years, and they can't afford trouble any more than you can.

### Only Couriers give you ASL™ to keep you at maximum speed.

You'll notice the difference the first time you dial. Modems with ASL™ connect up to three times faster than other V.32 bis modems. That irritating, expensive wait for the connection is over.

ASL is U.S. Robotics' Adaptive Speed Leveling.

All modems have to slow down for line noise. But two high speed Couriers working

together will speed up again when conditions improve.

All other modems leave you stuck in "low" for the rest of the transmission. That can turn a \$1 call into a \$10 call.

So if you think a modem that gives you 38,400 bps throughput has to be temperamental, relax.

Nobody handles the hassle of dial-up lines better than U.S. Robotics®

We're proud to say we make the most forgettable modems in the world.

**U.S. Robotics®**

The Intelligent Choice in Data Communications

**Free Data Communications Reference Guide:** This 108-page illustrated book quickly answers your data communications questions.

Please Print  
Name: \_\_\_\_\_

Title: \_\_\_\_\_

Company: \_\_\_\_\_

Address: \_\_\_\_\_

City: \_\_\_\_\_

State: \_\_\_\_\_

Zip: \_\_\_\_\_

Phone: ( \_\_\_\_\_ ) \_\_\_\_\_

Mail to: U.S. Robotics, Inc., Attn: Marketing Dept., 8100 N. McCormick Blvd., Skokie, IL 60076, or call us toll-free at 1-800-DIAL-USR. In Canada: 1-800-553-3560. In the U.K.: Miracom Technology, Ltd. 0473 233-888.

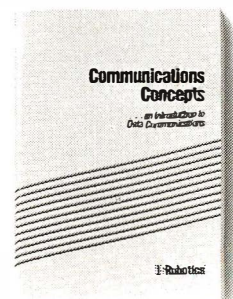

USRobotics and the U.S. Robotics logo are registered trademarks, and Courier, Courier V.32 bis, Courier HST, Courier HST Dual Standard and ASL are trademarks of U.S. Robotics, Inc.

pictures. However, even if flash cards are more expensive than ROM cards, you can update a program at minimal cost by reprogramming the flash memory, but you have to throw the ROM card away.

Flash memory does have one often-discussed (and misunderstood) limitation compared to EEPROM: You can't erase it on a byte-by-byte basis. It must be erased completely or, in some versions, on a sector-by-sector basis. One way you can deal with the sector-erase

problem is with hardware that treats any block device as if it were a tape or disk drive. Another way is with software where the file structure anticipates a block device. Since magnetic drives are formatted sector by sector, applying sector erase to flash memory seems reasonable.

According to Kurt Robinson, an Intel flash-memory guru, designers think that they have to erase at the sector level, but that's really not true. "You can write in sector-size chunks; you can read back in

sector-size chunks. All you have to do is make sure that you have blocks available that are already erased that you can write to. Even if time is required to swap data into and out of sectors, the flash is orders of magnitude faster than a disk drive to start with, so the user actually sees a significant increase in performance." With the availability of 1- and 2-Mb flash devices in TSOP packages, both Intel and Fujitsu now offer flash memory cards in 1- and 4-MB densities.

Flash-memory cards will greatly extend battery life in portables. The most clever power management schemes combine screen shutdown, CPU idle mode, and shutting off the hard disk drive when no reads or writes have occurred for a particular period of time. But it takes a lot of power to spin the drives back up.

The MC400 laptop computer from Psion already uses flash-memory modules to replace disk drives. It has four module slots, and each module contains four Intel 128K-byte flash ICs for a total of 2 MB of memory. Psion also makes an accessory that lets you plug the MC400's modules into any MS-DOS computer.

Standardizing flash-memory specifications is a particularly challenging task. PCMCIA has come to the conclusion that there are several technology variants. More specifically, a flash card informs a system of its particular erase/voltage level through the meta format.

#### Future Trends

Data storage has moved through an evolutionary cycle from paper to magnetic media to optical to silicon. Beyond this, you can expect to see an increase in modularity as all kinds of peripheral functions become easy to implement in a standard card format.

The card socket will look much the same as an expansion bus, so you can plug cards into any vacant socket regardless of card or computer manufacturer. Do you want to expand main memory? How about adding a modem, a video board, a coprocessor, a fax card, or a scanner? Just plug in the right card. ■

#### ACKNOWLEDGMENT

*I wish to thank Michael Bloom, president of Technology Communications Group (West Linn, OR), for his help in preparing this article.*

*John Reimer is chairman of the Personal Computer Memory Card International Association (San Jose, CA) and marketing manager for the memory card department at Fujitsu Microelectronics. You can reach him on BIX c/o "editors."*

# Some of the most enlightening articles in a magazine never make it to the table of contents.

Open to the table of contents in any publication and you can find some insightful stories. You'll also find some missing. Because the advertising isn't there.

Advertising is important. It's informative. It lets you know your options. And helps you to make decisions.

Like which car to buy. Which airline to fly. And what to serve for dinner.

So, next time you open a magazine, read it. From cover to cover.

Because what's on the back cover, may be just as important as what's on the front.

#### ADVERTISING.

Without it you wouldn't know.



AMERICAN ADVERTISING  
FEDERATION

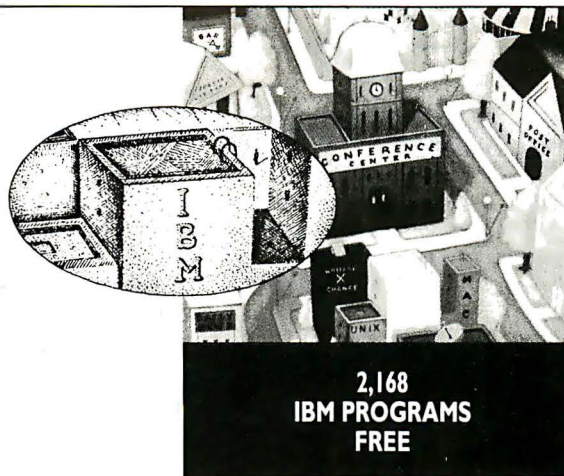

■ In the BIX community we take care of people who use IBM PCs or their compatibles. For example, our IBM Exchange offers a growing list of programs which you can download for free. These 2,168 programs are the cream of the crop. All of them are tested in advance by BIX moderators so you know you're getting top-quality, virus-free programs. Here are some of the most popular ones:

BIX FILE NAME	BIX CONFERENCE	DESCRIPTION
stars.zip	microsoft	Utility that turns your Windows desktop into a view of deep space. Choose impulse or warp speed and launch several Windows utilities from a floating pop-up menu.
e.arc	ibm.utils	Public-domain text editor, with source code.
secrets2.arc	ibm.dos	Condensed and edited messages from the ibm.dos/secrets topic. Tricks and undocumented internals of MS/DOS.
tetris2.zip	microsoft	KLOTZ, a Tetris® clone for Microsoft Windows 3.
2zip25.zip	ibm.utils	Converts a variety of archive formats (including ARC, PAK, ZOO, LZH) to PKWare's ZIP format.
w3icons.zip	microsoft	40 new icons for the Windows 3 Program Manager.
firework.zip	microsoft	Fireworks display in a window, for Windows 3.
monitor.arc	ibm.os2	Continuous display of CPU load for OS/2 Presentation Manager.
abort.exe	ibm.utils	TSR that aborts any program when you press Alt-C.
dis386.zip	ibm.utils	Full-screen interactive machine language disassembler for 8086, 80286, 80386, NEC V20.

Besides great free programs, the IBM Exchange offers dozens of informative and provocative conferences on OS/2, PC/DOS and MS/DOS operating systems, alternative 386 operating systems, utility software, communications programs, LANs and more. There's even a "Repairshop" conference, and maybe as a last resort, an IBM clearing house. Beyond our IBM Exchange, we provide industry news and product information that's essential to your performance as a microcomputer pro. All of these privileges are yours with a subscription to BIX. To find out more, call our special Customer Service number: 1-800-227-2983 (in NH call 603-924-7681).

# BIX

## Resource Guide: Portable Sources

*Classifying portable computers is a difficult task. New classes appear and old ones change as the technology improves. Hand-held computers are those you can fit in your pocket, notebooks are generally AT machines from 4 to 8 pounds (1.8 to 3.6 kilograms), laptops are more powerful machines in the 8- to 17-pound (3.6- to 7.7-kilogram) range, and transportables are full-featured, mobile machines over 17 pounds. Below is a list of portable computer suppliers.*

**Acer America Corp.**  
401 Charcot Ave.  
San Jose, CA 95131  
(408) 922-0333  
**Inquiry 1230.**

**AEG Olympia**  
Box 22  
Somerville, NJ 08876  
(201) 722-7000  
**Inquiry 1231.**

**Airis Computer Corp.**  
1824 North Besly Court  
Chicago, IL 60622  
(312) 384-5608  
**Inquiry 1232.**

**Altima Systems, Inc.**  
1390 Willow Pass Rd.,  
Suite 1050  
Concord, CA 94520  
(800) 356-9990  
(415) 356-5600  
**Inquiry 1233.**

**American Research Corp.**  
1101 Monterey Pass Rd.  
Monterey Park, CA  
91754  
(213) 265-0835  
**Inquiry 1234.**

**Apple Computer Corp.**  
20525 Mariani Ave.  
Cupertino, CA 95014  
(408) 996-1010  
**Inquiry 1235.**

**Arima Computer Corp.**  
4/F, No. 1, Nankang  
Rd., Sec. 3, Lane 50  
Taipei, Taiwan, R.O.C.  
886-2-785-9712  
**Inquiry 1236.**

**ArtDex Computers Corp.**  
8F, Lane 31,  
No. 3, Chung Hsin Rd.,  
Shi Chin Cheng  
Taipei, Taiwan, R.O.C.  
886-2-643-6050  
**Inquiry 1237.**



**BSI**  
9440 Telstar Ave.,  
Suite 4  
El Monte, CA 91731  
(818) 442-0020  
**Inquiry 1246.**

**Bus Computer Systems, Inc.**  
135 West 26th St.,  
Eighth Floor  
New York, NY 10001  
(212) 627-4485  
**Inquiry 1247.**

**Cache Computers, Inc.**  
46714 Fremont Blvd.  
Fremont, CA 94538  
(415) 226-9922  
**Inquiry 1248.**

**CAF Technology, Inc.**  
600 South Date Ave.  
Alhambra, CA 91803  
(818) 289-8299  
**Inquiry 1249.**

**Cari Computer Corp.**  
10F, 483,  
Minsheng East Rd.  
Taipei, Taiwan, R.O.C.  
886-2-508-4793  
**Inquiry 1250.**

**Chaplet Systems U.S.A., Inc.**  
252 North Wolf Rd.  
Sunnyvale, CA 94086  
(408) 732-7950  
**Inquiry 1251.**

**Chicony**  
1641 West Collins Ave.  
Orange, CA 92667  
(714) 771-6151  
**Inquiry 1252.**

**Chunk Shing Technics Corp.**  
12F, No. 123, Sec. 2,  
Chung Hsiao East Rd.  
Taipei, Taiwan, R.O.C.  
886-2-322-5088  
**Inquiry 1084.**

**Astarte Computer Systems, Inc.**  
1035 Pearl St.,  
Fifth Floor  
Boulder, CO 80302  
(303) 449-9970  
**Inquiry 1239.**

**AST Research, Inc.**  
16215 Alton Pkwy.  
Irvine, CA 92713  
(714) 727-4141  
**Inquiry 1238.**

**Atari Computer Corp.**  
1196 Borregas Ave.  
Sunnyvale, CA 94089  
(408) 745-2000  
**Inquiry 1240.**

**Austin Computer Systems**  
10300 Metric Blvd.  
Austin, TX 78758  
(512) 339-7932  
**Inquiry 1241.**

**Autonomy Computer Corp.**  
1674 Broadway,  
Suite 8-E  
New York, NY 10019  
(212) 265-7836  
**Inquiry 1242.**

**Bi-Link Computer, Inc.**  
11606 East Washington  
Blvd., Suites A & B  
Whittier, CA 90606  
(213) 692-5345  
**Inquiry 1243.**

**Bitwise Designs, Inc.**  
701 River St.  
Troy, NY 12180  
(518) 274-0755  
**Inquiry 1244.**

**Bondwell Industrial Co., Inc.**  
47485 Seabridge Dr.  
Fremont, CA 94538  
(415) 490-4300  
**Inquiry 1245.**

**Climax Technology Co., Ltd.**

11th Floor, No. 185,  
Yung Chi Rd.  
Taipei, Taiwan, R.O.C.  
886-2-764-6848  
**Inquiry 1253.**

**Commax Technologies, Inc.**

2031 Concourse Dr.  
San Jose, CA 95131  
(408) 435-5000  
**Inquiry 1254.**

**Commodore Business Machines, Inc.**

1200 Wilson Dr.  
West Chester, PA 19380  
(215) 431-9100  
**Inquiry 1255.**

**Compaq Computer Corp.**

P.O. Box 692000  
Houston, TX 77269  
(713) 374-4711  
**Inquiry 1256.**

**CompuAdd Corp.**

12303 Technology Blvd.  
Austin, TX 78727  
(512) 250-1489  
**Inquiry 1257.**

**Copam USA, Inc.**

45875 Northport  
Loop E  
Fremont, CA 94538  
(415) 623-8911  
**Inquiry 1258.**

**Cordata/Daewoo Electronics Co., Ltd.**

1055 West Victoria St.  
Compton, CA 90220  
(213) 603-2901  
**Inquiry 1259.**

**Core Pacific USA, Inc.**

197 Meister Ave.  
Branchburg, NJ 08876  
(201) 704-8383  
**Inquiry 1260.**

**Costar Electronics, Inc.**

No. 36, Chung Yang  
South Rd., Sec. 2  
Peitou, Taipei, Taiwan,  
R.O.C.  
886-2-894-0870  
**Inquiry 1261.**

**Crete Systems, Inc.**

12F-7, No. 391, Sec. 4,  
Shin-Yi Rd.  
Taipei, Taiwan, R.O.C.  
886-2-704-7072  
**Inquiry 1262.**

**C<sup>2</sup> Micro Systems, Inc.**

1205 Fulton Place  
Fremont, CA 94539  
(415) 683-8888  
**Inquiry 1263.**

**DAP Technologies**

955 Place Dufour  
Vanier, Quebec,  
Canada G1M 3B2  
(418) 681-9394  
**Inquiry 1264.**

**Data Entry Systems, Inc.**

701 Pratt Ave.  
Huntsville, AL 35801  
(205) 539-2483  
**Inquiry 1265.**

**Data General Corp.**

4400 Computer Dr.  
Westborough, MA  
01580  
(508) 366-8911  
**Inquiry 1266.**

**Dauphin Technology, Inc.**

1125 East  
St. Charles Rd.  
Lombard, IL 60148  
(708) 627-4004  
**Inquiry 1267.**

**Dell Computer Corp.**

9505 Arboretum Blvd.  
Austin, TX 78759  
(512) 338-4400  
**Inquiry 1268.**

**Delta Phase International**

22262 Chestnut Lane  
El Toro, CA 92630  
(714) 768-6842  
**Inquiry 1269.**

**Digitech, Inc.**

969 Route de l'Eglise,  
Suite 200  
Sainte-foy, Quebec,  
Canada G1V 3V4  
(418) 653-1662  
**Inquiry 1270.**

**Dolch Computer Systems**

372 Turquoise St.  
Milpitas, CA 95035  
(408) 957-6575  
**Inquiry 1105.**

**Epson**

23530 Hawthorne Blvd.  
Torrance, CA 90505  
(213) 373-9511  
**Inquiry 1106.**

**Ergo Computing, Inc.**

One Intercontinental  
Way  
Peabody, MA 01960  
(508) 535-7510  
**Inquiry 1107.**

**Everex Systems, Inc.**

48431 Millmont Dr.  
Fremont, CA 94538  
(415) 498-1111  
**Inquiry 1108.**

**First International Computer of America, Inc.**

1500 Skokie Blvd.  
Northbrook, IL 60062  
(708) 498-0992  
**Inquiry 1109.**

**Fora, Inc.**

3081 North First St.  
San Jose, CA 95134  
(408) 944-0393  
**Inquiry 1110.**

**GMC Technology, Inc.**

9682 Telstar Ave.,  
Suite 106  
El Monte, CA 91731  
(818) 401-3743  
**Inquiry 1111.**

**GoldStar Technology, Inc.**

3003 North First St.  
San Jose, CA 95134  
(408) 432-1331  
**Inquiry 1112.**

**Grid Systems Corp.**

47211 Lakeview Blvd.  
Fremont, CA 94537  
(415) 656-4700  
**Inquiry 1113.**

**HCI**

671 East Arques Ave.  
Sunnyvale, CA 94086  
(408) 733-0810  
**Inquiry 1114.**

**Hyundai Electronics America**

166 Baypointe Pkwy.  
San Jose, CA 95134  
(408) 473-9200  
**Inquiry 1115.**

**IBM Corp.**

P.O. Box 1328  
Boca Raton, FL 33428  
(407) 982-1975  
**Inquiry 1116.**

**Impulse Systems**

85 Burnett Ave.  
San Francisco, CA  
94131  
(415) 641-9197  
**Inquiry 1117.**

**Intelligence Technology Corp.**

16526 Westgrove  
Dallas, TX 75248  
(214) 250-4277  
**Inquiry 1118.**

**Jetta Computers Co., Ltd.**

3F-8, No. 7, Ching Tao  
East Rd.  
Taipei, Taiwan, R.O.C.  
886-2-341-1033  
**Inquiry 1119.**

**Kaimei Electronics Corp.**

3F-1, 57, Fu Hsing  
North Rd.  
Taipei, Taiwan, R.O.C.  
886-2-776-5922  
**Inquiry 1120.**

**KFC USA, Inc.**

1585 Sunland Lane  
Costa Mesa, CA 92626  
(714) 546-0336  
**Inquiry 1121.**

## Resource Guide: Portable Sources

**Kris Technologies**  
P.O. Box 2606  
East Grand Ave.  
South San Francisco,  
CA 94080  
(415) 875-6729  
**Inquiry 1122.**

**Laser Computer, Inc.**  
800 North Church St.  
Lake Zurich, IL 60047  
(708) 540-8086  
**Inquiry 1123.**

**Leading Edge  
Products, Inc.**  
117 Flanders Rd.  
Westborough, MA  
01581  
(508) 836-4800  
**Inquiry 1124.**

**Leading Technology,  
Inc.**  
10430 Southwest Fifth St.  
Beaverton, OR 97005  
(503) 646-3424  
**Inquiry 1125.**

**LHK Computer  
Manufacturer Pte., Ltd.**  
110 Paya Lebar Rd.  
07-03 Singapore  
Warehouse  
Singapore, 1440  
Singapore  
(065) 745-3883  
**Inquiry 1126.**

**Librex Computer  
Systems, Inc.**  
1731 Technology Dr.,  
Suite 700  
San Jose, CA 95110  
(408) 441-8500  
**Inquiry 1127.**

**Logicraft Products  
Manufacturing Pte.,  
Ltd.**  
21 Kallang Ave.  
05-169 Kalang Basin  
Industrial Estate  
Singapore, 1233  
Singapore  
(65) 293-9088  
**Inquiry 1128.**

**Logitech, Inc.**  
8F, No. 56, Sec. 4,  
Nanking East Rd.  
Taipei, Taiwan R.O.C.  
886-2-721-0235  
**Inquiry 1129.**

**Maxtron**  
1825A Durfee  
South El Monte, CA  
91733  
(818) 350-5706  
**Inquiry 1130.**

**Mega PC Technology,  
Inc.**  
3605 West Macarthur  
Blvd., Suite 704  
Santa Ana, CA 92704  
(714) 850-1044  
**Inquiry 1131.**

**Micro Palm  
Computers**  
13773-500 Icot Blvd.  
Clearwater, FL 34620  
(813) 530-0128  
**Inquiry 1132.**

**MicroSlate, Inc.**  
9625 Ignace St., Suite D  
Brossard, Quebec,  
Canada J4Y 2P3  
(514) 444-3680  
**Inquiry 1133.**

**Mitsuba Corp.**  
1925 Wright Ave.  
La Verne, CA 91750  
(714) 392-2000  
**Inquiry 1134.**

**Mitsubishi Electronics  
America, Inc.**  
991 Knox St.  
Torrance, CA 90502  
(213) 515-3993  
**Inquiry 1135.**

**Modern Computer  
Corp.**  
Rm. 813, 8F Chia Hsin,  
Building 2, No. 96,  
Chung Shan North Rd.,  
Sec. 2  
Taipei, Taiwan, R.O.C.  
886-2-551-1677  
**Inquiry 1136.**

**Modgraph, Inc.**  
149 Middlesex Tpk.  
Burlington, MA 01803  
(617) 229-4800  
**Inquiry 1137.**

**Monterey Electronics,  
Inc.**  
2365 Paragon Dr.,  
Suite D  
San Jose, CA 95131  
(408) 437-5496  
**Inquiry 1138.**

**Morse Technology,  
Inc.**  
17531 Railroad St.,  
Unit I  
City of Industry, CA  
91748  
(818) 854-8688  
**Inquiry 1139.**

**Myoda, Inc.**  
1053 Shore Rd.  
Naperville, IL 60563  
(708) 369-5199  
**Inquiry 1140.**

**Nan Tan Computer  
Co.**  
No. 17, 19 Yun-Chi Rd.  
Taipei, Taiwan, R.O.C.  
886-2-765-1222  
**Inquiry 1141.**

**NEC Technologies,  
Inc.**  
1414 Massachusetts  
Ave.  
Boxborough, MA 01719  
(508) 264-8000  
**Inquiry 1142.**

**Northgate**  
7075 Flying Cloud Dr.  
Eden Prairie, MN 55344  
(800) 548-1993  
(612) 476-4400  
**Inquiry 1143.**

**Ogivar Technologies**  
7200 TransCanada  
Hwy.  
Ville St. Laurent,  
Quebec, Canada  
H4T 1A3  
(800) 361-3694  
(514) 737-3340  
**Inquiry 1144.**

**Opus Systems**  
20863 Stevens Creek  
Blvd.  
Cupertino, CA 95014  
(408) 446-2110  
**Inquiry 1145.**

**Oscartech, Inc.**  
137 Hwy. 516  
Old Bridge, NJ 08857  
**Inquiry 1001.**

**Outbound Systems,  
Inc.**  
4840 Pearl East Cir.  
Boulder, CO 80301  
(303) 786-9200  
**Inquiry 1002.**

**Panasonic  
Communications &  
Systems Co.**  
Two Panasonic Way  
Secaucus, NJ 07094  
(201) 348-7000  
**Inquiry 1003.**

**Poqet Computer Corp.**  
650 North Mary Ave.  
Sunnyvale, CA 94086  
(800) 624-8999  
(408) 737-8100  
**Inquiry 1004.**

**Premier Innovations,  
Inc.**  
10310 Harwin Dr.  
Houston, TX 77036  
(800) 347-1777  
(713) 995-4433  
**Inquiry 1005.**

**Prince Information  
Systems Co., Ltd.**  
Fifth Floor, No. 50,  
Sung Chiang Rd.  
Taipei, Taiwan, R.O.C.  
886-2-537-2268  
**Inquiry 1006.**

**Psion, Inc.**  
118 Echo Lake Rd.  
Watertown, CT 06795  
(203) 274-7521  
**Inquiry 1007.**

# FREE Software Instantly On-Line With BYTE DEMOLINK



Download free demo software from top publishers directly to your computer. . .for just the cost of a phone call!

BYTE DEMOLINK lets you preview software instantly by calling the telephone number in the city nearest you. All you need to access BYTE DEMOLINK is a PC, a modem and a telecommunications program. The latest demo software is at your fingertips for your evaluation.

**Call BYTE DEMOLINK today to connect with these free software demos—It's only a phone call away!**

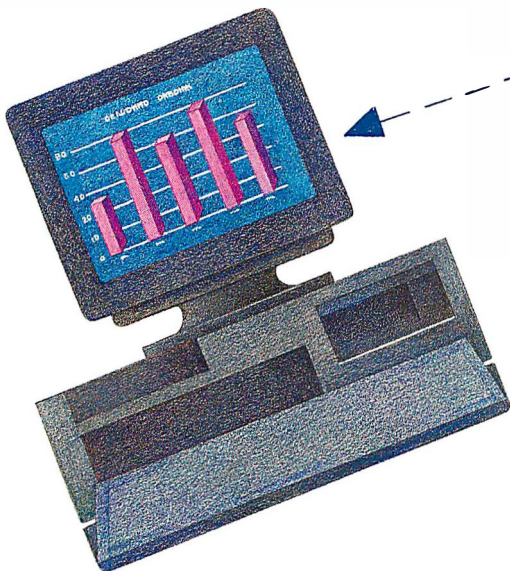

Here are the software packages available on DEMOLINK:

#### C-scape With Look & Feel

C-scape is a programming tool for C programmers. It is a powerful, object-oriented interface management system that includes a function library and a screen designer. The C-scape library is an extensive collection of functions for working with windows, data entry screens, input validation, menus, text editing, and hypertext context-sensitive help. The Look & Feel Screen Designer is an interactive screen editor that generates C source code for the screens or saves them in a file callable at runtime.

C-scape training is offered by Oakland Group each month in Cambridge, Massachusetts; Seattle, Washington; and Berlin, Germany, and at various times by the Oakland International Technical Network of companies that sell and support C-scape in countries around the world.

Select the file **cscope.exe**

#### Lotus Magellan 2.0

Lotus Magellan 2.0 lets you find, view and use all the information on your PC. You can view your files as they appear in your favorite program.

Explore your hard disk for concepts, files, or words—regardless of their location or which application was used to create it.

Launch into any application by pressing a single function key to automatically retrieve the file.

Lotus Magellan—instant access to all the information on your PC!

Select the file **magellan.exe**

#### Multi-Platform Zortech C++

Zortech's multi-platform C++ compilers provide all the benefits of industrial strength C++ with the speed and code size you would expect from the best C compilers.

Only Zortech can give you total portability to MS-DOS, Windows 3.0, OS/2, DOS 386, UNIX 386 and Macintosh. No matter what platform you choose a significant performance increase will be realized.

What platform will you be developing on next year? Zortech's quality line of multi-platform C++ products keeps your options exactly how they should be. Open.

Download our demo disk and see our multi-platform tools first hand.

Select the file **zortech.exe**

**BYTE  
DEMOLINK**

Free Demo Download  
**617-861-9767\***

\*Call the nearest DEMOLINK office after 6 pm for a reduced phone charge. Telecom settings: 2400 or 1200 baud, 8 data bits, 1 stop bit, and no parity. Enter DEMOLINK at the prompt.

Chicago 312-616-1071    Los Angeles 213-383-9856    New York 212-797-5620    San Francisco 415-434-4510    Toronto 416-960-3187    Washington, DC 202-463-4920

## Resource Guide: Portable Sources

**Sampo Corp. of America**  
5550 Peachtree  
Industrial Blvd.  
Norcross, GA 30071  
(404) 449-6220  
**Inquiry 1008.**

**Samsung Information Systems America, Inc.**  
3655 North First St.  
San Jose, CA 95134  
(800) 446-0262  
**Inquiry 1009.**

**Sanyo Business Systems Corp.**  
51 Joseph St.  
Moonachie, NJ 07074  
(201) 440-9300  
**Inquiry 1010.**

**Scantech Computer Systems, Inc.**  
12981 Ramona Blvd.,  
Units I & H  
Irwindale, CA 91706  
(818) 960-2999  
**Inquiry 1011.**

**Sharp Electronics Corp.**  
Sharp Plaza  
Mahwah, NJ 07430  
(201) 529-8200  
**Inquiry 1012.**

**Tandon Corp.**  
405 Science Dr.  
Moorpark, CA 93021  
(800) 800-8850  
**Inquiry 1013.**

**Tandy Corp.**  
1700 One Tandy Center  
Fort Worth, TX 76102  
(817) 878-4969  
**Inquiry 1014.**

**Tatung Company of America, Inc.**  
2850 El Presidio St.  
Long Beach, CA 90810  
(800) 827-2850  
(213) 979-7055  
**Inquiry 1015.**

**Texas Instruments**  
P.O. Box 2022230  
Austin, TX 78720  
(512) 250-7984  
**Inquiry 1016.**

**Top-Link Computer Co., Ltd.**  
No. 6, Lane 333, Hsin  
Hsu Rd., Hsin Chuan  
Taipei, Taiwan 242,  
R.O.C.  
886-2-901-3576  
**Inquiry 1017.**

**TOPPCs International**  
648 North Eckhoff St.  
Orange, CA 92668  
(714) 939-1416  
**Inquiry 1018.**

**Toshiba America Information Systems, Inc.**  
9740 Irvine Blvd.  
Irvine, CA 92718  
(714) 583-3000  
**Inquiry 1019.**

**Trans PC Systems, Inc.**  
11849 East Firestone  
Blvd.  
Norwalk, CA 90650  
(213) 868-6930  
**Inquiry 1020.**

**TriGem**  
2388 Walsh Ave.,  
Building B  
Santa Clara, CA 95051  
(408) 970-0844  
**Inquiry 1021.**

**Twinhead Corp.**  
1537 Centre Pointe Dr.  
Milpitas, CA 95035  
(408) 945-0808  
**Inquiry 1022.**

**Uniq Technology, Inc.**  
49090 Milmont Dr.  
Fremont, CA 94538  
(415) 226-9988  
**Inquiry 1023.**

**USIT**  
3023 Research Dr.  
Richmond, CA 94806  
(800) 543-2294  
**Inquiry 1024.**

**Veridata Electronics, Inc.**  
Fifth Floor, 19,  
Nanking East Rd., Sec. 3  
Taipei, Taiwan, R.O.C.  
886-2-506-9755  
**Inquiry 1025.**

**Zenith Data Systems Corp.**  
1501 Feehanville Dr.  
Mt. Prospect, IL 60056  
(708) 699-4800  
**Inquiry 1026.**

**Zeos International, Ltd.**  
530 Fifth Ave. NW  
St. Paul, MN 55112  
(612) 633-4591  
**Inquiry 1027.**

*Inclusion in the resource guide should not be taken as a BYTE endorsement or recommendation. Likewise, omission from the guide should not be taken negatively. The information here was believed to be accurate at the time of writing, but BYTE cannot be responsible for omissions, errors, or changes that occur after compilation of the guide.*

**GTEK<sup>®</sup>**, INC.

## We Have You Covered . . . Serial Solutions For ISA & Micro-Channel Computers

### PCSS-8I Eight Port Intelligent Coprocessor

The PCSS-8I is GTEK's popular, cost effective, intelligent 8 port serial I/O card for ISA computers. DYNAMEMORY™ allocates and deallocates on board buffer ram to transmit and receive queues as needed. Our low price makes this the intelligent choice for your serial I/O applications. The MCSS-9IM is the Micro-Channel equivalent.

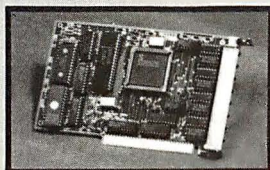

FULL  
1 YEAR  
WARRANTY



### PCSS-8TX Compact Eight Port Serial Board

The PCSS-8TX is GTEK's popular PCSS-8X on a half sized card. It provides 8 serial ports for an even *lower price* than the PCSS-8I. Modular RJ-11 jacks like those on the PCSS-8I provide 8 ports without any external brackets or spider cables. The MCSS-8TX is the Micro-Channel equivalent of the PCSS-8TX.

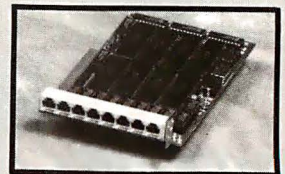

All trademarks are property of their respective companies.

**Order Now Toll Free 1-800-282-GTEK (4835)**

Development Hardware & Software • P.O. Box 2310 • Bay St. Louis, MS 39521-2310 • Fax 601-467-0935 • MS & Technical Support 601-467-8048



# Over 6,000 developer's products ...



**EDT+**  
by Boston Business Computing  
EDT+ 5.0, the only complete emulation of DIGITAL's VAX EDT, is 50% faster than its predecessor and features multiple windows, interfaces for EVE, EMACS, vi and WPS, 132-column mode, status line and ruler, keystroke macros and much more. 30-day, money-back guarantee and free customer support and updates for 60 days. For MS-DOS and UNIX systems.  
LIST: \$295 **PS Price:** \$279  
**FastFaxes 342-001**  
Circle 182 on Reader Service Card



**ESIX SYSTEM V 386**  
by ESIX Systems  
An enhanced UNIX/V 3.2 operating system with XENIX binary compatibility. Package bundled with X-Windows 11.3, EGA, 16-color VGA and high-resolution monochrome support, TCP/IP, STREAMS, RFS, TLI, plus device driver support for most industry standard peripherals. ESIX NFS for 386 STREAMS and ESIX GUI Toolkit also available as add-on packages.  
(Developer 2-User) LIST: \$595 **PS Price:** \$547  
**FastFaxes 780-003**

## 386 DEVELOPMENT

	Price
386 Max 5.0	\$109
386DOS Extender by Pharlapp	495
DESeqview 386	189
F77-EM32 + Lahey Ergo	1055
FoxBASE+/386	479
Metaware High C 386/486	919
NDP Fortran 386	829
QEMM 386	89
VM-386	229
WATCOM C8.0 386 Prof.	1155
WATCOM C8.0 386 Stand.	795
Zortech C++ 386 Dev.	865

dBASE IV	549
dBFAST/PLUS	315
dBXL	189
FoxPro	495
FoxBASE +- V2.1	279
<b>QuickSilver</b>	<b>384</b>

**DBMS**

CLARION Prof. Dev. V2.1	549
Magic PC	379
Paradox V3.5	553
<b>R:BASE 3.1</b>	<b>399</b>

## DBMS TOOLS & LIBRARIES

AdComm for Clipper	279
Artful.Lib	289
<b>CLEAR + for dBASE</b>	<b>81</b>
Comet Multiport	169
dBASE Online	129
BRIEF w/dBRIEF	Call
dBX/dBport w/source	725
dGE 4.0	279
dQUERY MU	179
dSalvage Professional	195
FLIPPER Graphics Library	179
FUNcky.LIB	179
<b>Genifer - code generator</b>	<b>220</b>
Net Lib	229
Pro Clip	149
R&R Relational Reportwriter	139
R&R Code Generator	129
SilverComm Library	229
SilverPaint	119
Steve Straley's Toolkit	169
Sunshow Adv. Image Toolkit	239
Tom Rettig's Library	85
<b>UI2 Developer's Release</b>	<b>449</b>

## AI-LANGUAGES

ARITY Combination Package	989
<b>Gold Hill GCLISP</b>	<b>314</b>
<b>PC Scheme</b>	<b>60</b>
TransLISP PLUS w/source	99
<b>PDC Prolog Compiler</b>	<b>204</b>

## ASSEMBLERS

MS MASM	105
Turbo Debugger & Tools	119

## BASIC & ADD-ONS

BAS-C Commercial	829
<b>dB/LIB Professional</b>	<b>169</b>
MS QuickBASIC V4.5	69
QuickPak Prof. V3.16	189

## C LANGUAGE COMPILERS

Instant C	769
Microsoft C 6.0	349
Microsoft QuickC	69

## CASE & PROTOTYPERS

Dan Bricklin Demo II	239
EasyCase Plus	266
EasyCase Plus Prof. Pack	353
EasyFlow	135
<b>Instant Replay III</b>	<b>91</b>
<b>Layout</b>	<b>239</b>
MetaDesign by Meta Software	287
Pro-C 2.0w/Workbench Combo	735
ProtoFinish by Genesis	211
Show Partner F/X	198

## COBOL

MS COBOL V3.0	639
Realia COBOL	859

## COMMUNICATIONS

<b>ADD-ONS</b>	
C Asynch Manager 3.0	139
Essential COMM by S. Mtn.	259
Greenleaf Comm Library	329
QuickComm	129

## DBASE

Clipper 5.0	550
-------------	-----

## DEBUGGERS/ DISASSEMBLERS

<b>DASM</b>	<b>180</b>
Dis Doc Pro	229
Periscope IV	Varies
<b>Soft Probe 86/TX</b>	<b>288</b>
Sourcer 486 w/BIOS pre-proc.	149
<b>Trapper</b>	<b>141</b>

## DEVELOPMENT TOOLS

ASMFLOW Prof.	179
C-DOC	139
<b>CLEAR+ for C</b>	<b>101</b>
Codan	349
Buzzwords dANALYST	269
<b>The Documentor</b>	<b>229</b>
INSIDE!	119
MKS RCS	175
PC-Lint	120
Plink/LTO	439

## The Key & the Memory Key

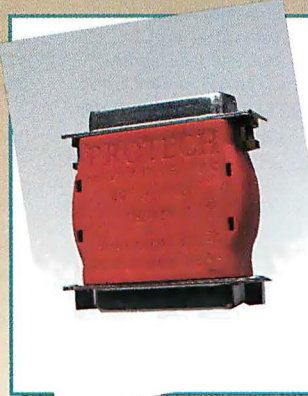

by ProTech Marketing, Inc.  
ProTech's copyright protection devices prevent the use of illegally duplicate software through a system of unique hardware and software specifically manufactured for each software developer. For PC's, Mini's, MACINTOSH and RS-232C ports. Interface software supports most major languages and environments. Designed to resist logic analyzers. Features full source interface in developer's language, encrypted assembler routine designed to recognize developer-specific hardware key and tools to destroy interrupt vectors.  
Call direct for pricing 800-843-0413.

Circle 183 on Reader Service Card

## Expert Help Expert Help Developers Kit



by SofSolutions  
Expert Help replaces The Norton Guides with 100% file compatibility and incredible features! With Expert Help you can build your own Hypertext Databases or get instant reference from over 100 Databases that are available commercially. The Expert Help Developers Kit even lets you distribute The Expert Engine with your Databases (no royalty). The Expert Help Engine is memory resident, requiring 1k (with EMS).  
LIST **PS Price**  
Expert Help \$ 79 \$ 75  
Expert Help LAN \$299 \$279  
Expert Help Developers Kit \$199 \$179  
**FastFaxes 876-023**

## OPEN ACCESS III

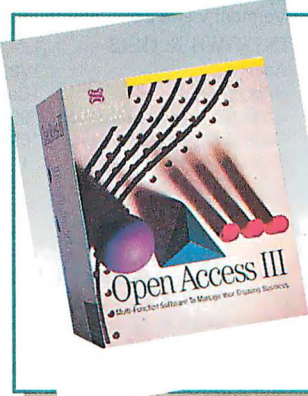

by Software Products Intl.  
Turn your ideas into market-ready applications in just weeks with Open Access III! Easily edit, run, and debug your programs in the integrated programming environment. Get data entry and report forms and support for windowing, light-bar menus, and 3-D graphics to make creating your applications a snap! Open architecture with a C language interface lets you add change or add features. And Open Access III even has its own compiler!  
LIST: \$695 **PS Price:** \$489  
**FastFaxes 1759-007**

RED products listed are specials while supplies last.

**THE PROGRAMMER'S SHOP 1-800-421-8006**

# The Programmer's Shop is



## WindowsMAKER™ Professional New!

by Blue Sky Software™/Candlelight  
The fastest way to create MS-Windows applications in C. Generates the Windows .EXE w/ complete source & production files (no royalties). Just Point & Click to define the Windows user interface. Lets you animate your design to instantly test look & feel and make changes on the fly without needing to compile. Custom code is perserved during code regeneration. This is the power-user version of the best-seller WindowsMAKER with a lot of added functionality.  
LIST: \$995 **PS Price: \$919**  
*FastFacts 2001-006*

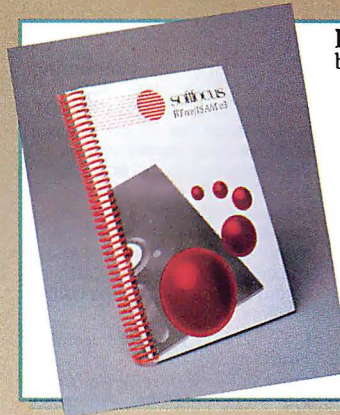

## BTree/ISAM v3 by Softfox

A powerful, portable indexed file manager for C programmers. Supports multiple indices, fixed or variable length records, rich assortment of key types, and single or multi-user operation. The latest release of a flexible, fully-functional and well documented product. Currently in use by thousands worldwide. All C source included along with complete documentation and example programs. Portable to all operating systems and C compilers, no royalties.  
LIST: \$179  
**PS Price: \$149 w/source**  
*FastFacts 209-002*

PolyMake	159
PVCS Professional	439
.RTLINK Plus - by Pocket Soft	419
<b>Source Print</b>	<b>62</b>
TLIB 5.0 Version Control	125

### EDITORS

BRIEF	Call
Epsilon	109
KEDIT	139
Sage Professional Editor	229
SPF/PC - V2.1	129
Vedit +	139

### FILE ADD-ONS

Accsys for Paradox w/source	739
CBTREE	179
<b>C-Data Manager</b>	<b>178</b>
CodeBASE 4	279
CQL - w/ source	365
c-tree Plus by Faircom	529
<b>C-TRIEVE</b>	<b>178</b>
<b>db_FILE/RETRIEVE - SU</b>	<b>159</b>
Faircom Toolbox Prof.	1159
WKS Library	149
XQL	649

### FORTRAN

FOR_C w/source	789
Lahey FORTRAN F77L	549
Lahey Personal FORTRAN	Call
MS Fortran Opt. Compiler	309
RM/FORTRAN	499

### GENERAL ADD-ONS

C Tools Plus - V6.01	98
C Utility Library	189
Greenleaf SuperFunctions	239
Opt-Tech Sort	119
Turbo C Tools by Blaise	109

### GRAPHICS

Essential Graphics v3.0	349
GraphiC	319
graphics-Menu	165
GSS Graphics Dev't Toolkit	699
HALO	279
MetaWINDOWS	259
MetaWINDOW/PLUS	369
PCX Programmer's Toolkit	229

### NETWORKS

<b>dBXL/LAN</b>	<b>486</b>
Btrieve for DOS	479
Network SQL	519
Network C Interface	239

### OBJECT-ORIENTED/C++

M++ by Dyad Software Corp.	279
Smalltalk/V	80

Smalltalk/V-286	91
Turbo C ++ Prof.	259
Zinc Interface Library	179
Zortech C ++ Dev. Edition	399

### OTHER PRODUCTS

Carbon Copy Plus	159
<b>Dan Bricklin's PageGarden</b>	<b>50</b>
<b>DESQview</b>	<b>109</b>
Duplicator Toolkit - Pro 3.0	104
Fast!	45
Flow Charting III	199
HEADROOM	89
HiJaak	139
LapLink III	129
<b>Link &amp; Locate ++ - ROM MSC290</b>	<b>348</b>
<b>Math Advantage</b>	<b>348</b>
Norton Utilities 5.0	149
pcANYWHERE IV	159
<b>PC Tools Deluxe 6.0</b>	<b>76</b>
PC-KWIK Power Pak	119
Remote2	139
SpinRite II	89
<b>System Sleuth</b>	<b>76</b>

### TURBO PASCAL

Turbo ASYNCH PLUS	119
Turbo Pascal 6.0 by Borland	109
Turbo POWER TOOLS PLUS	98
Turbo Professional	109

### TEXT SCREEN ADD-ONS

C Communications Toolkit	129
C Worthy	359
Greenleaf DataWindows	339
HI-SCREEN XL Professional	289
MEWEL Window System	169
<b>Vitamin C - source, menus</b>	<b>118</b>
<b>VC Screen - painter</b>	<b>96</b>
Vermont Views Obj. + source	819

### WINDOWS & OS/2

Actor 3.0	799
Brief for OS/2	Call
Case: W Corporate Version	905
Case: PM (for C or C++)	1899
C_talk/Views	419
<b>C-Trieve/Windows</b>	<b>238</b>
dBFAST/Windows	315
Graphics Server SDK	455
<b>Instant Windows</b>	<b>797</b>
KnowledgePro Windows	589
MS Windows 3.0	119
MS Windows SDK	365
<b>Multiscope OS/2 Debugger</b>	<b>265</b>
OS/2 PM Toolkit	369
<b>Smalltalk/V PM</b>	<b>433</b>



## CODAN by IMPLEMENTS, INC.

Integrated source code analyzer for professional developers working on large C projects. Lets you find what you want, any way you want. Use your favorite editor and CODAN source code browser to pinpoint things instantly. To find information you need regularly, use CODAN reports. Ideal for development, documentation, QA, systems analysis.  
LIST: \$395 **PS Price: \$349**  
*FastFacts 1621-001*

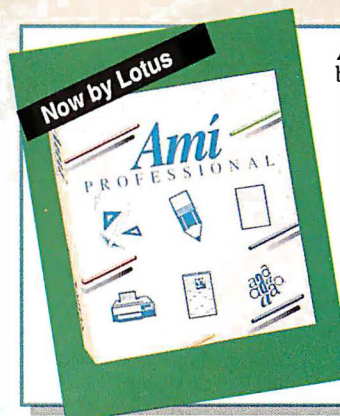

## Ami Pro by LOTUS Corp.

Ami Pro is the award winning word processor for Windows. Designed for the power user, Ami features ease of use combined with high-end features like macro programming, a thesaurus, tables, integrated drawing and charting capabilities and much more! Ami Pro has won most industry awards, including the #1 rating from Software Digest, PC Magazine's Editor's Choice, and PC Week's Poll of Corporate Satisfaction.  
LIST: \$495 **PS Price: \$399**  
*FastFacts 2068-003*

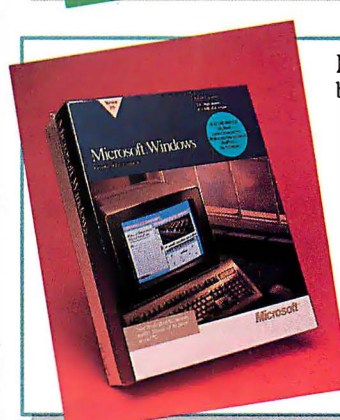

## MS Windows 3.0 by Microsoft Corp.

Microsoft Windows 3.0 transforms your one character-based application to a graphically oriented, multi-application environment for DOS. Simultaneously works with all the programs and files you need, breaking the 640K memory barrier. Device independent. Drop down menus, dialog boxes, and icons for intuitive interfaces. Move data between tasks or applications. Automatically determines operating mode from hardware configuration.  
LIST: \$149 **PS Price: \$119**  
*FastFacts 502-120*

RED products listed are specials while supplies last.

# THE PROGRAMMER'S SHOP 1-800-421-8006

# your source for solutions!



**Install**  
by Knowledge Dynamics  
Install 3.0 is a bullet-proof automatic installation program you can distribute-royalty free- with your product. Features include: 4.4 gigabyte file sizes, windowing/color interface, C source, hard and floppy disk installation, multiple source and target disks, and multiple sub-directories.

LIST: \$250      **PS Price:** \$219  
*FastFacts 1721-002*

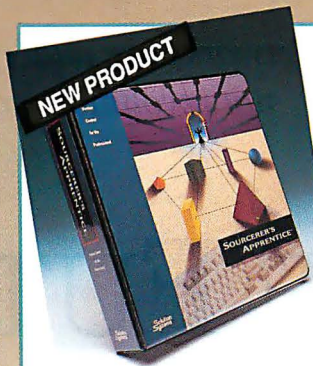

**Sourcerer's Apprentice—**  
Version Control for the Professional  
by Solution Systems

From the company that brings you BRIEF: version control with single keystroke accessibility from BRIEF. Sourcerer's Apprentice tracks all changes, who made them, when, and why. Easily recreate or combine previous versions of code. Experiment freely. Sourcerer's Apprentice can always bring you back. Teams take note: Sourcerer's Apprentice prevents simultaneous updates to the same files.

LIST: \$499      **PS Price:** \$459  
*FastFacts 732-137*

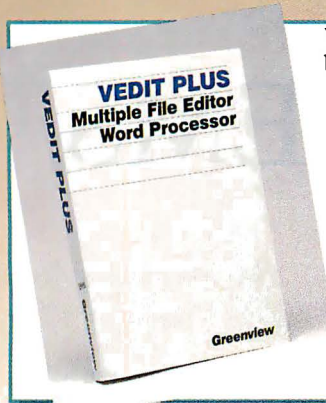

**VEDIT PLUS 3.40**  
by Greenview Data, Inc.  
The new VEDIT PLUS programmer's editor integrates your favorite compilers, assemblers, linkers, debuggers and Make programs to really speed development. Its unique memory manager swaps out TSRs and network drivers during compilation. Features multi-file editing, windows, pull-down menus, mouse support, undo, regular expressions, a powerful macro language, and complete configurability. Exceptional speed for editing even multi-megabyte text and binary files.

LIST: \$185      **PS Price:** \$139  
*FastFacts 25-007*

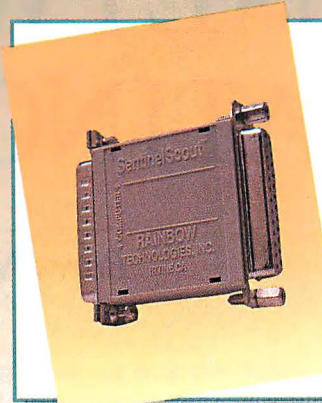

**SentinelScout**  
by Rainbow Technologies

The SentinelScout is a hardware key that attaches externally to the parallel port of an IBM PC or compatible to enable execution of authorized program copies. It does not interfere with printer operation, hard disk installs or backup copies. Featuring a fixed-response security system unique to each device, the economical SentinelScout offers a level of execution control perfect for lower-cost programs.

LIST: \$295 (kit of 10 keys)  
**PS Price:** \$265  
*FastFacts 1313-001*

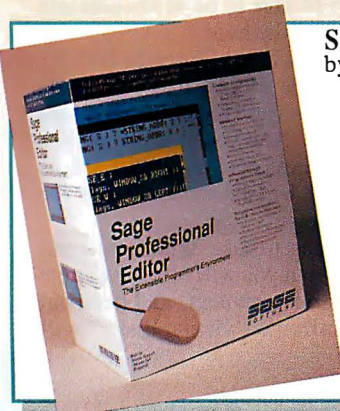

**Sage Professional Editor**  
by Sage Software  
The Sage Professional Editor is designed to create the applications of the 90's. It's highly configurable and has an advanced windowed user interface with integrated mouse support, on-line help and menu-driven commands. Has emulations for Brief, Vi, EMACS/Epsilon and WordStar, and a virtual memory system for large files. Includes MS-DOS, OS/2 and Dual Mode versions on 3.5" and 5.25" diskettes.]

LIST: \$295      **PS Price:** \$229  
*FastFacts 111-060*

## What is FastFacts?

Access literature on any of our products via FAX machine. **FREE!**

Call 617-740-0025 from any fax phone!

Follow the voice computer's instructions and enter your product's code number. Then await your instant print out of product literature.

**FREE Catalog!**

## THE PROGRAMMER'S SHOP CATALOG

is the definitive source book for serious software development professionals.

Over 1,700 development products listed, including:

- applications
- books/training
- communications
- hardware
- languages
- LANs
- libraries
- operating systems
- tools
- UNIX/XENIX
- utilities

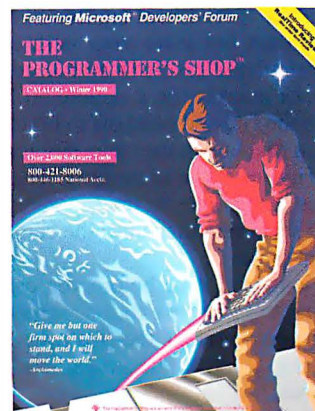

Call today for this valuable guide to programming productivity.

# THE PROGRAMMER'S SHOP

800-421-8006

National Accounts  
800-446-1185

MEMBER  
**MMC**  
of the Direct Marketing Association, Inc.

5 Pond Park Road, Hingham, MA 02043 • Canada 800-446-3846 • Mass. 617-740-2510 • FAX: 617-749-2018  
Credit card orders processed *only* when product is shipped. All prices subject to change. Int'l. prices will vary.

*Networks are undergoing evolution,  
not revolution, say the experts*

# THE FUTURE OF NETWORK OPERATING SYSTEMS

*Barry Nance*

**Y**ou turn to your computer and load the past month's figures into your spreadsheet program. A network file-server task awakens on one of your company's mainframes; it begins sending the pieces of the file to your computer.

Knowing it will take a few minutes to load the figures, you open another window and finish editing your weekly status report.

Satisfied, you electronically mail the report to your boss and send electronic carbons to the other project team members. An E-mail server distributes the files to each person's computer, one of which is located in Singapore.

When the spreadsheet figures have loaded, you adjust your schedule data but leave your cost estimates alone—for now. The recalculated result is still acceptable. The recalculation takes place quickly, on a remote 50-MHz 486 slave computer. You save the file and head off to lunch.

Fred, a Macintosh user who sits across the office, is also saving his figures at the same time. The spreadsheet software coordinates the updates to the separate portions of the file, locking each section in turn until the complete file is safely back on the mainframe.

How long will it be before you can use networks this way? According to industry experts, some features will be available in only a year or two. Other features may have to wait as long as five years to reach our desktops—and perhaps longer to become “standards.”

## Trends You'll See

The first and probably most important trend in networks is the cooling off of the war between the vendors. Instead of “Buy my LAN—I supply everything you need,” the vendors will say, “We're open—we coexist with anything and everything.” A

trend that's already started, this new direction means you will have fewer headaches with multivendor solutions. Naturally, it'll take some time for vendors to be able to point to successes in this area. Proprietary architectures die hard.

Do you hate having to remember that drive G is on SERVER1 but drive H is on SERVER3? Multiple servers that coordinate with each other are on their way. Soon you'll be able to treat the entire network as one large disk drive. And you'll see large files that span multiple servers. File access technologies such as Structured Query Language (SQL) will be embedded in the network operating system (NOS) itself.

Speaking of file access—it's going to take skull sweat and late hours from the LAN designers, but you will see transparent data access across mainframes, minicomputers, and personal computers become a reality. Mainframe “virtual disks” will

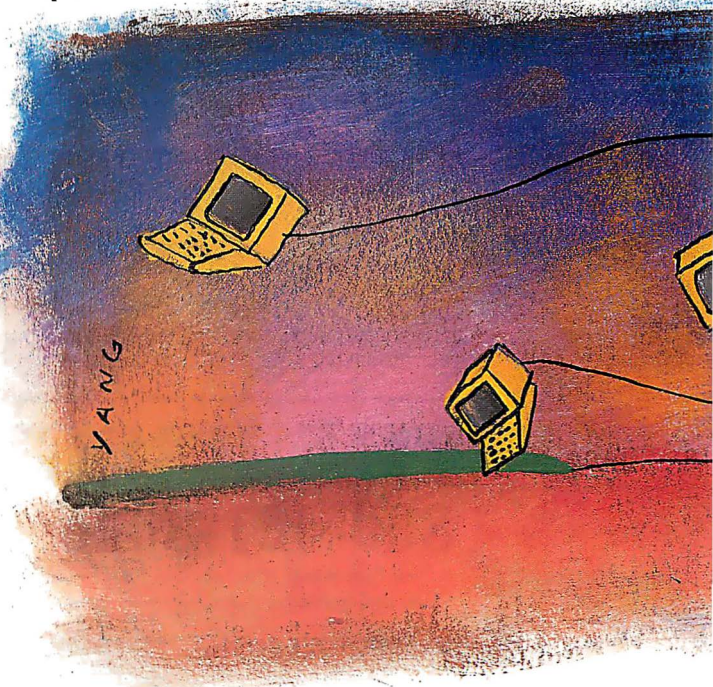

*Barry Nance is the author of Network Programming in C and is the exchange editor for the IBM Exchange on BIX. He can be reached on BIX as "barryn."*

be replaced by mainframe file-server technology. And it will be possible for both personal computer and mainframe applications to share the same data.

Network management is barely past the Lewis and Clark exploration stage now compared to where it will be in a few years. You'll have better interfaces and underlying expert systems that monitor, diagnose, and care for your network. New facilities within the NOS will be paired with administrative software tools; the result will be a network that advises you of corrective actions for problems and suggests improvements when performance degrades.

One software technology already emerging within some NOSes is the remote procedure call. RPC is a process in which an application subroutine on one computer calls another subroutine on a different computer to do some work. Vendors pro-

moting RPC realize that "transport independence" is necessary for this technology to take hold. Some subroutines may execute on a VAX, some on a PC. Token Ring may carry some passed function-call parameters; Ethernet may carry others. Transport independence (i.e., plug-and-play network protocols) lets these pieces process the data without regard for CPU architectures, calling conventions, or data representations.

Up to now, NOS technology has existed at the departmental level, where proprietary protocols could work in isolation. In the future, you'll see enterprise-wide LANs and wide-area networks. This migration is perhaps the rockiest road that NOS technology faces. Gursharan Sidhu of Apple Computer coined the term *polyglot hypothesis* to describe the need for NOS interpreters that translate, United Nations style, the different languages spoken by each vendor. I hope we get simultaneous translations.

### Impact of the New Technology

The picture I drew at the outset hints at the impact that new NOS technology will have on us. You may someday see NetWare or LAN Manager running on a mainframe. Excuse me, I mean you *won't* see it. The catchphrase "information at your fingertips" implies you don't need to know (or care) exactly where data resides.

Personal computers will be used to shoulder more and more of the computing workload. The new generation of NOSes will cause yet another explosion in desktop computing. And the computers won't necessarily have to be all the same brand.

Of course, this evolution will cause developers to rethink their designs and interfaces. One of these days, you may very well see a Macintosh front end to a SQL server application in which most of the processing is performed, unattended, by OS/2 database engines.

Companywide E-mail systems will become as pervasive as desk telephones; interoffice mail will never be the same. The NOS will help network administrators keep track of software versions and help distribute updates. Connectivity will improve to the point that you will even see mainframe applications that "reach down" to access records and tables that are located on a PC file server.

In a sense, NOSes are just glue to help us hold things together. Until now, we've had to read the label carefully to know what sticks to what, what combinations to avoid, and how to wash our hands when we accidentally get glue on them. The glue of the future will let us connect more things, but we'll still have to read labels to make sure we won't just wind up with a sticky mess. ▶

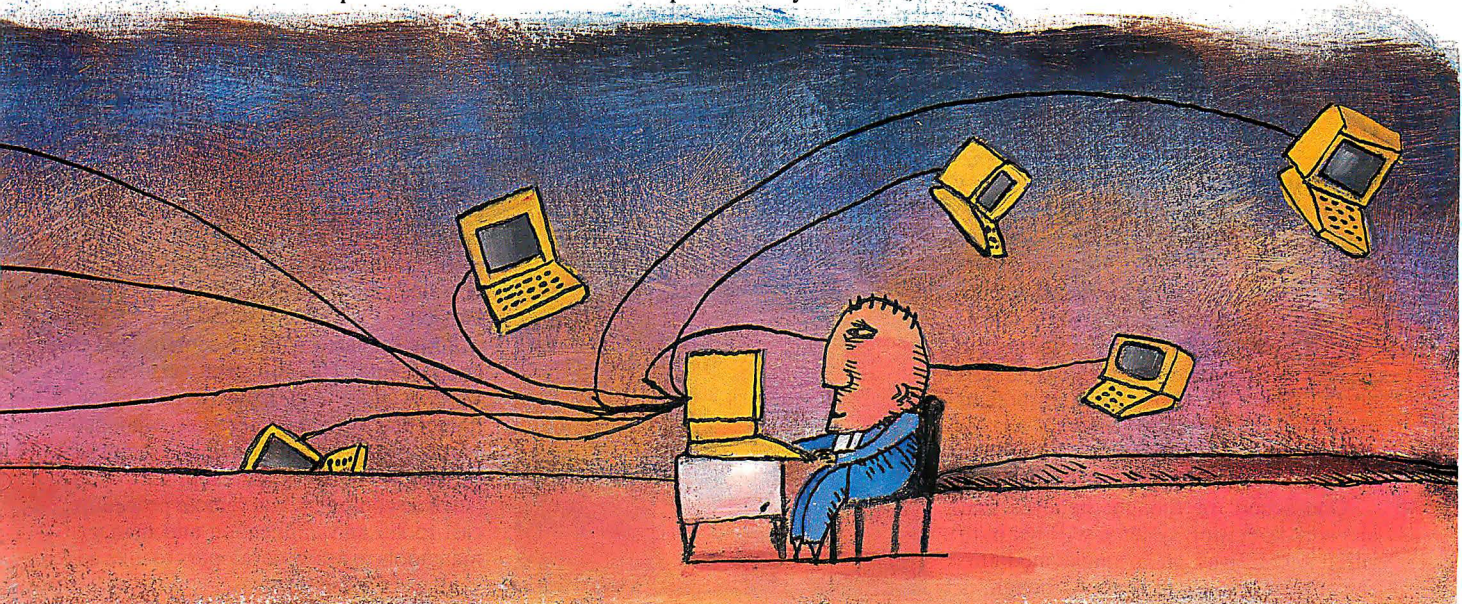

## DOWN THE LAN ROAD

*Just what is a network operating system? What kinds of developments will take place in the months and years to come? How do you plan for those developments? For answers to those questions, BYTE asked a diverse group of LAN experts to predict the future of NOSes. These folks, representing some of the major players in the LAN industry, are the people working to create the next generation of LANs. As such, they're in a unique position to predict what lies ahead.*

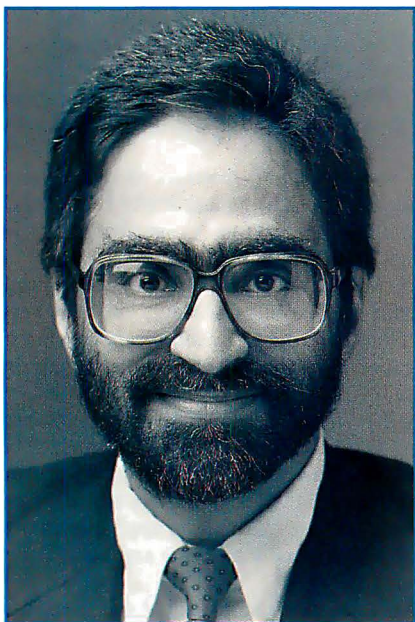

**Gursharan Sidhu**  
*Technical Director,  
 Collaborative Network Systems,  
 Apple Computer*

In some sense, the term *NOS* has been an attempt to identify a set of networking services, servers, and support software and give it the same kind of visibility and status that operating systems have.

I think we're going to move beyond isolated single servers. If you look at most systems today, you have one or more file or other type of servers installed on the network and each is sort of an independent entity. I think if people want group productivity with network systems, they will want to have these servers cooperate with each other. Also, I think that the tremendous emphasis that people have been placing on file servers might change. File services are an important sharing facility, but messaging,

directory, and security services will probably play more multiple roles.

It's going to be important that the focus go beyond real-time interaction between two programs to interaction in nonreal time—things like the counterpart of answering machines. A program sends a message to another program, and the other program may or may not be running then. The other program wakes up at a later time, picks up the message and handles it. I refer to that as "inter-program messaging."

For about 15 years or so, there's been this great emphasis on discovering a single network standard or protocol. There is not going to be just one single standard. There is a tremendous need to stop banking on the emergence of a single standard and start focusing on how to make the operation of networks harmonious even in the face of all these different standards that have to coexist and collaborate.

**Craig Burton**  
*CEO, Clarke Burton Corp.*

A NOS is an operating system that controls a given network computing environment (i.e., all the software, including the protocols, architectures, services, and so forth). There are two schools of thought regarding the direction in which NOSes will go. It is pretty clear that they will go toward the latter school.

One school of thought believes that network operating systems will begin to align themselves on a single medium. What's more likely to happen, though, is



that multiple versions and multiple types will remain in place. Operating-system designers will come up with some architectures that will evolve to these various versions and types as opposed to a single version.

This scenario will, of course, lead to fundamental file and print services, as well as store and forward messaging, name and directory services, and network management services. A lot of growth will be in development tools (such as compilers and remote procedure call tools) and application and management tools to allow developers to take advantage of these services.

**Russ Siegelman (right)**  
*Product Manager, LAN Manager;*  
**Eric Rudder (below)**  
*Program Manager,*  
*Network Business Unit,*  
Microsoft



The real trend in network computing is "information at your fingertips." That's the big theme for NOSes in the 1990s. It means that customers who are asking for something to fill a need can use a network to put information at their disposal.

What will the market require in the future? Well, enterprise computing is a year or two away. But the base technology that a NOS needs to provide includes security, distribution, and replication. The basic building blocks are there, and we can focus on the higher-level things today—such as scaling.

We do need standards. But just because they arrive doesn't mean we can do enterprise computing. Within the next couple of years, we will have the technology that will make it possible for a large part of the Fortune 500 companies to hook up a large part of their computers—not all, but we're headed in that direction.

A lot is going to happen in the next 10 years. We should see more than just improvements to the existing technology. We should see more ease of use, installation, network management, and software distribution.



One key thing that will have to happen with larger networks is that things will have to become more distributed and less central. The network will have to be well behaved to replicate [the adding of more nodes and servers]. The single biggest difference will be that it will be easier to use and easier to access. The NOS is only a piece of the puzzle. We see the client/servers, communication servers, and E-mail servers coming together.

**David Rosenlund**  
*Senior Product Manager,*  
*Distributed Computing,*  
Sun Microsystems

In the PC LAN world, the term *NOS* has come into being because that's exactly what you have. I'd say nine times out of 10 nowadays, people use that term generically to refer to the network itself.

If you look at the typical company today anywhere in the world, you'll find that it doesn't have all one computer platform—just PCs, or just Macs, or just VAXes. Networking should follow that computing model where people really want to network their VMS systems and their DOS systems and their Unix systems all together in one heterogeneous network.

Contrast that to NetWare, which is an operating system unto itself, explicitly and exclusively designed originally to be nothing more than an operating system that would act as a file and printer server to a bunch of PCs in a network. I'm just using Novell as an example. What NetWare was not designed to do was to be a great operating system on which you



would run a CAD or a database application. That's why you see a lot of slow growth in the NetWare marketplace relative to applications running on NetWare servers, because it is a separate operating system.

Sun's approach is what we call a distributed computing platform. It is soft-

ware technology that you can add to any operating system in existence today—from DOS PCs to Cray supercomputers, including IBM mainframes and DEC systems. The systems of many vendors can all be networked together and can run various applications and implementations. Basically, we follow the ISO model because it's a seven-layered architecture.

Most, if not all, of the implementations of ONC/NFS [Open Network Computing/Network File System] today are built on top of TCP/IP, so IP is the network protocol. And it just so happens that TCP/IP is also the standard for networking dissimilar systems from dissimilar vendors together at the protocol level. On top of that, you have several different session-level interfaces—many different choices.

Over the next year, "transport independence" will become a strong and clear direction. You need a transport-independent RPC so that people can develop applications to the RPC-level interface, and also so that, at run time, the application can determine what transport is being used on that system and run over that transport protocol.

*continued*



**Brad Friedlander**  
Senior Consultant,  
Arthur D. Little

The real NOS already exists to some extent in the larger machines, and we're seeing it going down into the smaller computers—the PC-based arena. In the future, a piece of the NOS will actually be running on each intelligent node, on every PC, on every Mac, on every server that's in the network.

The PC as a piece of iron can do it. The "platform" becomes the hardware plus all the environmental software (see the figure). Low-level protocols exist.

You can connect almost anything to almost anything today. But it will be five to 10 years before we get any universal high-level protocols. Sooner than that, companies will develop their own proprietary protocols. That's what we will see first. Once those are successful, people will begin to put on the pressure to make it a heterogeneous environment rather than a homogeneous environment.

In the next year, I don't expect any revolutionary changes. I expect just continued evolution. In five to 10 years, we'll have some standards so that we can really have a true heterogeneous environment. Before five years, we'll definitely have many proprietary-based NOSes.

*A way of looking at a NOS environment. The core is the hardware (PC) controlled by the next layer, the operating system. The operating system working with the next layer of software forms the environmental software, a general term meaning all the software running on a piece of hardware that is not application specific. The layer closest to the user consists of applications and applications packages. Thus, the hardware and all the environmental software make up a NOS platform.*

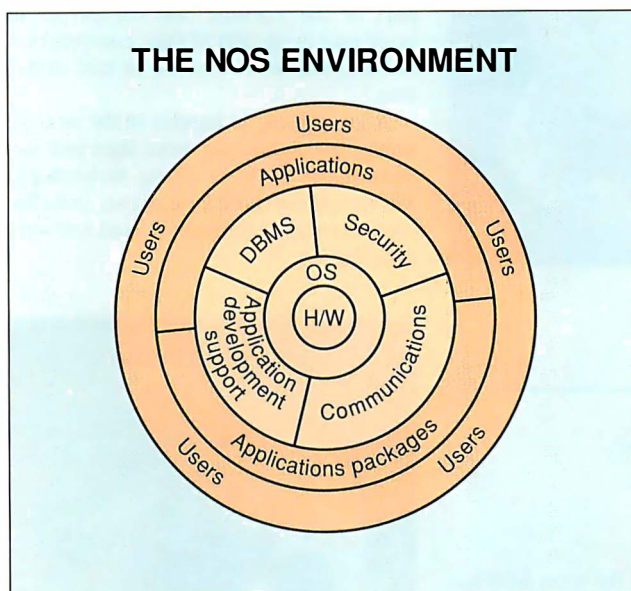

**John Edwards**  
Product Line Manager,  
Novell

A NOS is an integration platform that provides network services, such as database, communication, messaging, file, and print, to all popular desktops, such as DOS, Windows, OS/2, the Macintosh, and Unix, within their native environments.

In the past, many users relied on central control of information processing through a host mainframe or minicomputer. Today, that computing model continues to make sense for many companies, especially for such corporatewide functions as finance and accounting.

These same companies, however, now

find that the need for responsiveness within individual departments has resulted in a proliferation of decentralized computing resources, usually in the form of LANs that connect desktop systems. In the future, users will need help in bridging across these computing environments so that everyone in a company can work within the computing environment that he or she is used to, as well as share information with one another.

Typically, you might find an IBM mainframe in the MIS department, a Unix workgroup or minicomputer in the engineering department, a Macintosh workgroup in the marketing department, and a DEC or Hewlett-Packard system in manufacturing. Users need an integration platform that provides services that these dissimilar computing "cultures"

can share, as well as interconnectivity between these environments.

Through such an integration platform, desktop clients that are based on DOS, Windows, OS/2, the Macintosh, or Unix share services such as file and print, database, messaging, and communication with remote resources and extended environments such as IBM's SAA, DEC's NAS, Hewlett-Packard's New-Wave, and OSI. In addition, users need tools to manage their networks at the enterprisewide level.

Users need fundamental services and transparent connectivity. Developers need an open integration platform to provide them with the tools that they can use to create new applications that take advantage of the enterprisewide network resources.

*continued*



# SmartCache™ Plus: the grow-as-you-go approach to SCSI controllers

## START WITH THE BEST ...

DPT's entry level SmartCache Plus board offers unrivaled price/performance for single-user systems. It features ISA or EISA bus mastering, and universal SCSI disk compatibility for all PC operating systems. SmartDriver software supports SCSI-2 peripherals like tape and optical drives.

## NOW ADD CACHING!

Get DPT's award-winning caching technology in a plug-in module! Move up to disk caching speed without investing in a new controller. With an integral 512K cache, the module provides up to 5X performance gains for workstations, power users, and small multiuser systems.

## ADD MORE USERS, ADD MORE CACHE!

Plug in a 2 MB or 4 MB memory module and accommodate up to 18 users from a single card slot. Ideal for medium-sized networks or multiuser systems.

## HOW ABOUT DISK MIRRORING?

DPT's SmartCache mirroring module provides 100% disk fault tolerance by simultaneously writing all data to a second "mirrored" drive. No more data loss or costly system down-time due to disk failures. And unlike software mirroring schemes, fault tolerance is achieved with no performance penalties.

## PLUS STILL MORE CACHE, AND THEN SOME...

Cable over to DPT's 4 MB Cache Expansion Card, then grow your system to 16 MB by adding more plug-in memory modules—enough power for 64-plus users!

DPT has your solution—no matter how you grow. Performance, compatibility and upgradability make SmartCache Plus the only SCSI controller you'll ever need. For details, contact Distributed Processing Technology, 140 Candace Drive, Maitland, FL 32751. Phone (407) 830-5522; FAX (407) 260-5366. In Europe (UK) phone 44 (0) 488 4319.

The logo for DPT (Distributed Processing Technology) features a stylized blue graphic of vertical lines of varying heights to the left of the letters "DPT" in a bold, black, sans-serif font.

Circle 73 on Reader Service Card  
(RESELLERS: 74)



**James E. Allchin**  
Senior Vice President,  
Banyan Systems

A NOS is an independent operating system combined with a layer of distributed processing software that gives the user the illusion of a single combined system even though it is composed of several different machines and, in fact, several different operating systems.

People want information at their fingertips—access to it no matter where it is—whether it's on a server that they're connected to or on a VMS machine or wherever it is in the network. Administrators want a network that runs itself.

In my opinion, there's only one standard in the industry and that's POSIX, which is sort of a superset of Unix. That is the basis for the future of most applications. (OSF, X-Open, and Unix 5.4 all are driving to POSIX, and I believe that both Microsoft and Novell have committed to eventually going to POSIX.)

You will see transparent access to the same piece of data, the same file, whether it's sitting on DOS, OS/2, the Mac,

Unix, NetWare, or LAN Manager—while, at the same time, the NOS is running the application on the server going after that same piece of data. That same statement goes for print systems. These capabilities are all within our grasp within the next year and are significant steps along the way to interoperability.

We're also going to see more easily managed networks. A bunch of stuff will happen in network management—more and more tools, perhaps expert systems to help control these networks. And you will see new tools for network administration and new platforms for building distributed applications.

But in a year's time, we still won't have realized the total goal. Applications to take advantage of these application-computing platforms still will not be around (i.e., multimedia and moving of documents). Translation between the systems is still literally five years away. This is still a very young industry.

**Ralph Ungermann**  
President and CEO,  
Ungermann-Bass

My personal definition of NOSes is that they are extensions of the operating system provided for PCs, network stations. We are a system supplier that focuses on giving people choices (operating systems, applications, platforms in underlying technology, and so on) in building enterprise networks. Our focus is on the future of integration more than any particular operating system. We don't champion any particular NOS. Our customers are very interested in two things: IBM compatibility and porting client/server architectures across many platforms.

"Enterprise" means a company, a university, a government—a business unit in general—some kind of organization, which may include their customers and even their vendors. An enterprise network is one that extends throughout an entire organization into all aspects of the business—generally across wide geographies. And that's different from what networking has been over the last 10 years, which is more what you might call "departmental networking."

We're still a long way from having enough standards so that people developing distributed computing applications will be able to build products that can in-

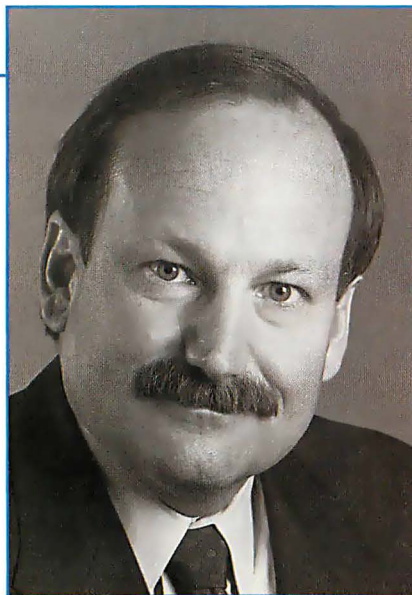

terconnect across Novell and Microsoft, LAN Manager and IBM. But that's the direction the industry is going in. In general, we will see more and more convergence on standards. But there are still not enough higher-level standards. Remote procedure calls, for example, need to be agreed on before we're going to get real interoperability. That will come about over the next year or two.

There are two new standards called NDIS and ODLI [Network Driver Interface Specification and Open Data Link Interface]. They make it a lot easier for workstations from different vendors us-

ing different adapter cards and different protocol stacks to connect into Novell or LAN Manager. NDIS is supported by IBM and Microsoft; ODLI is supported by Novell. In the future, you'll see those two standards combine into one standard so that it'll be even easier to write applications from different vendors that connect into Novell and Microsoft. Coexistence will be more and more common.

Customers have made it very clear that they're going to buy open systems (and they have to be truly open). I predict that the 1990s will bring the melting of the cold wars between vendors and there will be much more cooperation and openness. That's what this Houston 30 is all about. They don't want proprietary extensions to keep going, and they're making a lot of racket. They're threatening to make examples of some companies that are speaking standards and offering all their applications running on proprietary extensions.

NOSes have to become compatible. In my opinion, there are two operating systems in the world—the IBM/ Microsoft operating system and Unix. Novell will have to add value on top of those systems and become totally compatible with them, and not offer proprietary extensions. Anybody that plays in that industry in terms of operating systems, be it Banyan or Sun or Novell, must offer value on top of those standards. ■

# PC-MOS

## The Multiuser DOS Platform For The '90s

The 386 and now the 486 microprocessors have focused a lot of attention on the multiuser, multitasking possibilities of advanced PCs. A myriad of software and hardware manufacturers are promising a new age of multiuser options in the '90s.

But when you take a closer look, only one solution focuses on the features you want and anticipates the capabilities you need to use your PCs to their greatest potential. That solution is PC-MOS™ from The Software Link, the first DOS-compatible, multiuser, multitasking operating system.

### A Network Alternative

The advantage to the PC-MOS shared processing solution is its ability to maximize the available memory on your PC, taking full advantage of extended memory and sharing it with up to 25 users on inexpensive terminals or monitors. You can share data with the same speed and integrity of a network solution without the expense of network cards and the waste of under-utilized PCs. And no additional investment is required to get the multitasking capabilities inherent in PC-MOS.

### A Network Enhancer

For affordable network expansion, PC-MOS servers can be connected to other servers with The Software Link's LANLink or with the PC-MOS

PC-MOS is a trademark of The Software Link. All other products referenced are trademarks of their respective companies. Prices, policies and specifications subject to change without notice.

GATEWAY™ to Novell's NetWare®. This connectivity lets a business configure its automation systems for departmental efficiency and expand affordably as needs grow with LANs or even WANs.

### DOS Compatible

The PC-MOS alternative is clear: DOS compatibility means your users can continue to use all the popular software packages. And that means no investment loss, no retraining and no limitations in available applications.

### An Unbeatable Solution

The next decade of shared processing will be clouded with choices. Only one operating system was first to offer you DOS-compatible, multiuser, multitasking solutions. Only one operating system continues to provide unbeatable multiuser solutions for over 150,000 users. PC-MOS from The Software Link. Call today and set your computing sights on a more productive horizon.



**THE SOFTWARE LINK**

**1-800-451-LINK**

3577 Parkway Lane, Norcross, GA 30092  
(404) 448-5465 FAX: (404) 263-6474 TELEX: 4996147 SWLINK

**VARS and RESELLERS:**  
Ask about our Sales Support Program  
GSA Schedule/GSOOK 90 AGS6448

*Circle 232 on Reader Service Card (RESELLERS: 233)*

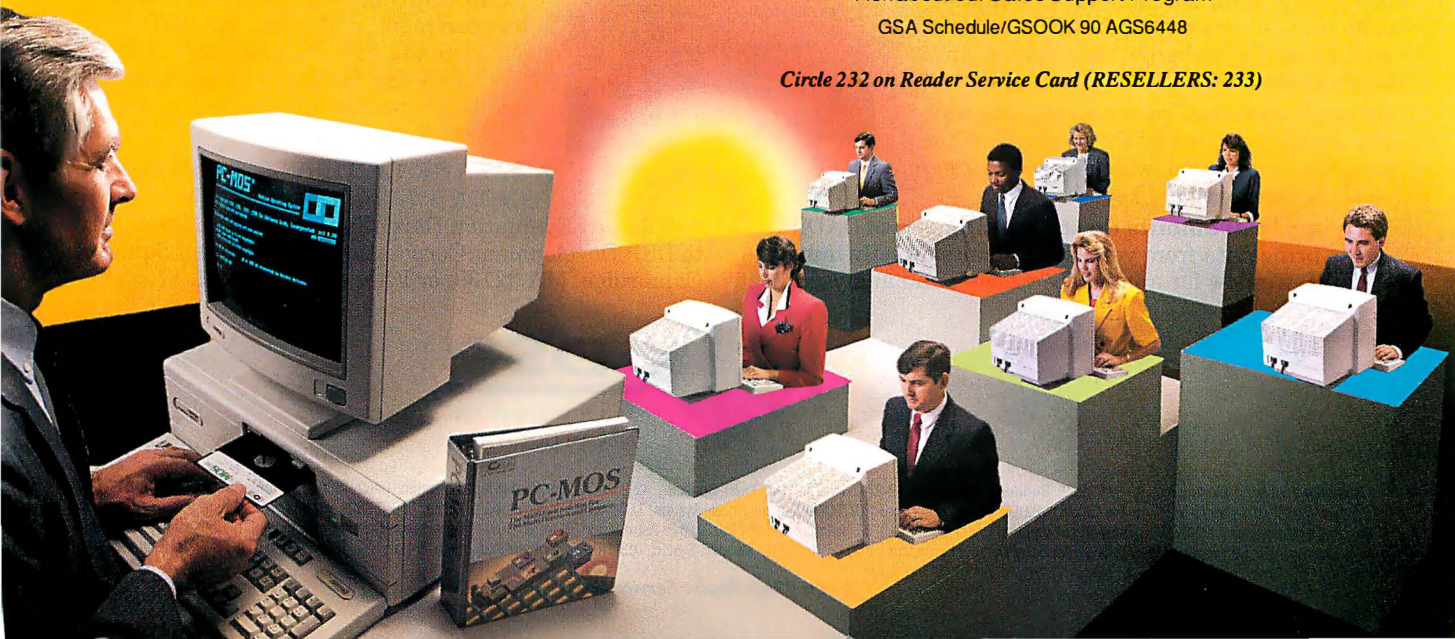

Now Under X-Windows

Introducing DADiSP 2.0

Now with Data-Acquisition Support



# DADiSP. The Big Picture in Data Analysis

**DADiSP** — interactive graphics and data analysis software for scientists and engineers. DADiSP 2.0 delivers unprecedented power, through easy-to-use menus. Choose from hundreds of analysis functions and graphic views — from tables to 3-D. Simultaneously display multiple windows, each with different data or analyses, for unlimited perspective on your toughest data analysis problems.

**Build your own analysis worksheets** — build and display an entire data analysis worksheet, *without programming*. And DADiSP's powerful graphic spreadsheet automatically recalculates and updates the entire worksheet if you change your data or an analysis step.

**Do serious signal processing...**the way you always pictured it! FFTs, digital filter design, convolutions, waterfall plots, and more — all at the press of a key.

**Let your instruments do the talking** — use DADiSP-488 to bring data from your instruments directly into a DADiSP window for immediate viewing and analysis.

**Flexible, expandable, customizable** — annotate your graphs and send them to printers, plotters, or publishing packages. Create your own macros, automate routine tasks, and run any program written in any language from within DADiSP. *DADiSP even lets you build your own menus.*

**A proven standard** — already used by thousands of engineers and scientists worldwide, in a whole range of applications like medical research, signal processing, chemistry, vibration analysis, communications, manufacturing quality control, test & measurement, and more. DADiSP supports the IBM PC and PS/2, SUN, DEC VAX, HP 9000 and Concurrent families of personal computers and workstations.

**GET THE PICTURE! 800-424-3131  
IN MA 617-577-1133**

Ask for our Evaluation Disk. For more information, write to DSP Development Corporation, One Kendall Square, Cambridge, MA 02139, or FAX: 617-577-8211.

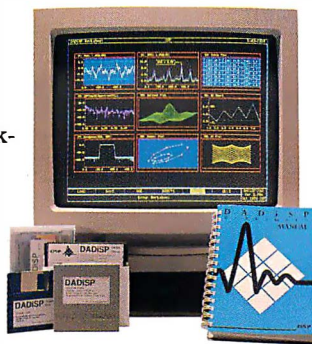

Australia-Interworld Electronics, 03-521-2952; Denmark-Dan Trade, 42-27-4511, Engberg Power Consult., 42-25-1777; England-Adept Scientific, 0462-480055; Finland-Mespek OY, 9-0-3511800; France-SM2i, 01-34-89-78-78; Germany-Datalog, 02166-46082, Digi-Logger, 0720-38022, Informatik System, 0631-46007, Ingenieurburo Kohler, 069-769829, Kontron Messtechnik, 08165-77-0; India-Dynalog Microsystems, 22-583908; Italy-BPS Computers, 2-61290221, BRM Italiana, 11-771-0010; Japan-Astrodesign, 044-751-1011; Netherlands-Computer Engineering Roosendaal, 01650-57417; New Zealand-GTS Engineering, 09-392-464; Scotland-Diagnostic Instruments, 0501-43031; Sweden-Systec, 013-110140; Switzerland-Urech & Harr AG, 061-611325; Taiwan-Advantech, 02-351-2177

Circle 77 on Reader Service Card

# AN EASIER INTERFACE

*Xerox PARC, originator of the computer desktop, unveils  
a vision for the future of user interfaces*

*Mark A. Clarkson*

**I**n the beginning was the command-line interface, that taciturn A> prompt that offered little assistance and even less encouragement to users of the first microcomputers. Then along came Xerox's Palo Alto Research Center (PARC), seeding the personal computer world with the now-ubiquitous windows/icon/mouse/pull-down menu user interface.

A decade later, the PARC System Sciences Lab has unveiled a new user interface, one that incorporates color and real-time, three-dimensional, interactive animation. PARC calls this new interface the *Information Visualizer*.

## The Information Visualizer

Developed as part of the Interactive Information Access project, the Information Visualizer is an experimental user interface. Its aim is to help users better manage jobs that entail vast amounts of information. It uses 3-D real-time animation to present information as 3-D interactive objects.

The Information Visualizer was designed with the business user in mind. Unlike 3-D visualizations that involve wearing special goggles and gloves to enter into an artificial world, the Information Visualizer uses the familiar mouse. This interactive interface relies on perceptual cues, such as light and shadow,

to draw you into an artificial reality that has been created on your screen.

Within the Information Visualizer, work is distributed throughout a collection of 3-D (and 2-D) rooms furnished with interactive objects such as walls and floating trees (see photo 1). To better understand the structure of the information that these objects represent, you can access embedded data and examine its structure from different angles by "flying" around or through it. The interface also features other objects, such as 3-D directory trees, which you can rotate, examine, prune, and rearrange (see the figure).

These animated visualizations are designed to shift work to your perceptual system, freeing the conscious mind to work on larger problems. Information Visualizer architects George Robertson, Stuart Card, and Jock MacKinlay quote Walt Disney: "Animation can explain whatever the mind can conceive."

A fast, compact experimental database system, called Text Database, underlies the Information Visualizer. This database system manages the storage, indexing, and search and retrieval of the information that the Information Visualizer displays. Text Database is being developed by the System Sciences Lab's Natural Language Theory and Technology group.



### How Much Is That Data in the Window?

PARC scientists believe that information retrieval and use will be to the 1990s what text editing was to the 1980s. Information retrieval is not an end in itself but part of some larger activity.

To ease the management of large amounts of information and projects, the Information Visualizer goes beyond the usual notion of an information retrieval system. It seeks to significantly reduce the total cost of using information—from its storage and retrieval to its management and use. The total cost of information depends not only on the cost of finding and retrieving it, but also on the cost of managing and assimilating it once it is at hand. Thus, a collection of information has a cost structure based largely on how you store and access that information.

In the context of the Information Visualizer, the words *inexpensive storage* and *expensive storage* do not have their usual meanings. Information readily at hand (e.g., on the screen or on your desk) is relatively inexpensive to use, whereas informa-

tion that is harder to retrieve (e.g., on a floppy disk, in your file cabinet, or in the downtown library) is more expensive. The difference in cost between inexpensive and expensive information can be several orders of magnitude.

In everyday dollars-per-byte terms, floppy disks are a less expensive medium of information storage than high-speed RAM. In terms of the cost to retrieve and use that information, though, just the opposite is true. Floppy disks are slower, more cumbersome, and more difficult to access than RAM is.

### The Problem with Small Screens

The more information you can keep readily available in inexpensive storage, the better. Unfortunately, the most inexpensive storage place turns out to be your computer's screen. The screen is one of the few computer resources that you can access directly. As a result, in overlapping window systems, electronic messy desks are common. You strive to keep as many tools as possible where they are easy to get at and manipulate—on the screen.

In an interactive setting, almost all information passing from the computer to you does so via the screen. To reduce your cost of using this information, the computer has to pass large quantities of information through the screen to you as efficiently as possible.

Unfortunately, the screen is also the computer's most constrained resource. The average computer screen is about the same size as a piece of typing paper. Processing speed, RAM, and mass-storage size can all increase by vast amounts. But current technology cannot produce displays larger than a few million pixels, and such large displays are extremely expensive. In addition, applications that require small, portable displays (e.g., notebook or wristwatch computers) will continue to proliferate.

Since the dimensions of the screen are unlikely to increase, PARC decided to increase the effective size of the workspace it represents (i.e., the inexpensive information storage area). Today's sophisticated user interfaces already exploit the existing workspace by alternating screen usage (e.g., swapping the screen between two applications) and providing distorted views (e.g., with icons and overlapping windows).

In an experimental window management system called BigScreen, PARC explored a third method of increasing effective screen size—large virtual workspaces. BigScreen distributes windows over the surface of a large virtual workspace, and the computer screen acts as a sliding viewport onto that larger space. Analysis of BigScreen revealed that users tend to form clusters of windows related to particular tasks (e.g., one group of windows for reading mail and another for Lisp programming). Rather than sliding the viewport over the workspace, users would jump directly from one cluster of windows to another as they performed various tasks. These little clusters are called *locality sets* or *working sets*.

Far from being unique to BigScreen, this clustering of information turns out to be a common phenomenon. The elements in such working sets do not change gradually over time; rather, users tend to work with one distinct working set for a time and then shift abruptly to another. For example, you might open all the windows required for the task of reading the mail, read the mail, and then open the windows required to write a Lisp program. Also, each task employs a specific set of disk files, programs, and memory locations.

### Rooms to Move Around In

Concentrating on this clustering of information, PARC developed a window management system called Rooms. Rooms is

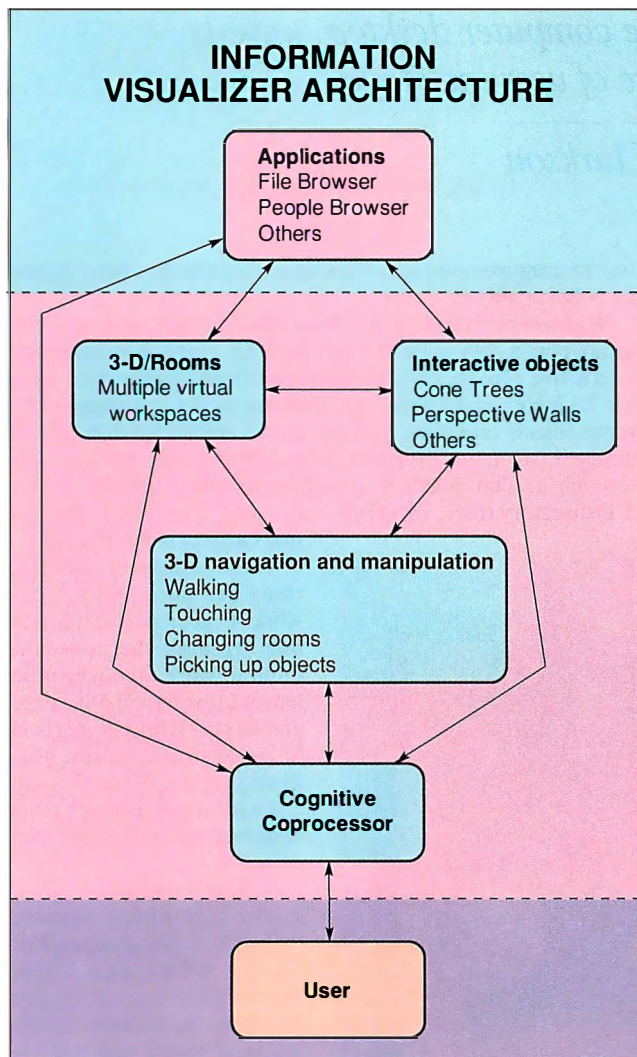

Applications run in 3-D/Rooms populated with interactive objects. The Information Visualizer provides tools for navigating within and among these rooms and for manipulating objects. The Cognitive Coprocessor ties all aspects of the system together and handles interaction with the user.

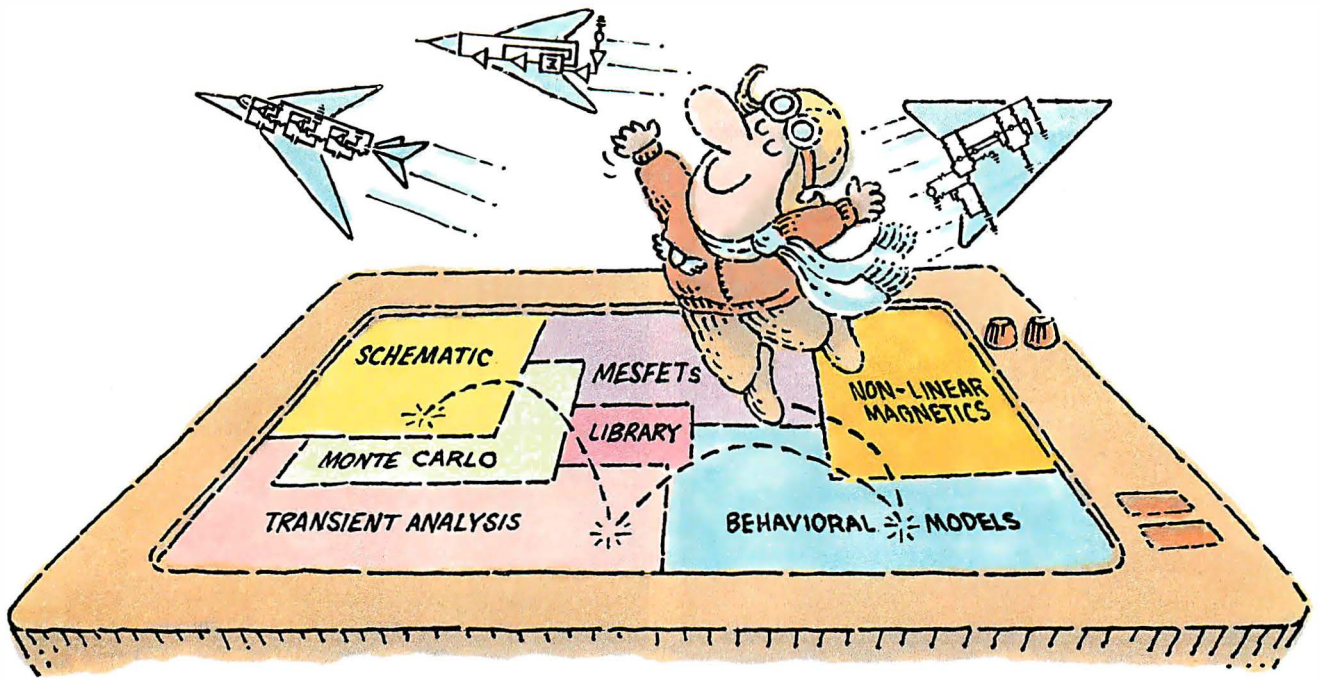

# THE NEW MICRO-CAP III.<sup>TM</sup> SO YOU CAN TEST-FLY EVEN MORE MODELS.

It wasn't easy. But we did it. Made the long-time best-selling IBM® PC-based interactive CAE tool even better.

Take modeling power. We've significantly expanded math expression capabilities to permit comprehensive analog behavioral modeling. And, beyond Gummel Poon BJT and Level 3 MOS, you're now ready for nonlinear magnetics modeling. Even MESFET modeling.

Analysis and simulation is faster, too. Because the program's now in "C" and assembly language. That also means more capacity—for simulating even larger circuits.

As always, count on fast circuit creation, thanks to window-based operation and a schematic editor. Rapid, right-from-schematics analysis—AC, DC, fourier and transient—via SPICE-like routines. The ability to combine digital/analog circuit simulations using integrated switch

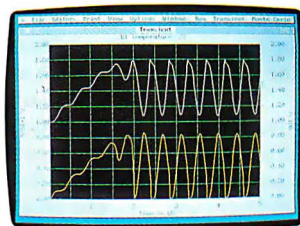

*Transient analysis*

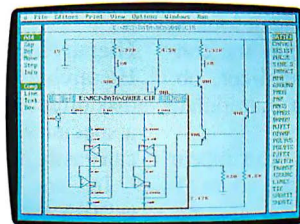

*Schematic editor*

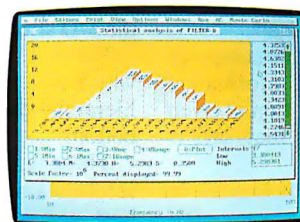

*Monte Carlo analysis*

models and parameterized macros. And stepped component values that streamline multiple-plot generation.

And don't forget MICRO-CAP III's extended routine list—from impedance, Nyquist diagrams and BH plots to Monte Carlo for statistical analysis of production yield. The algebraic formula parsers for plotting virtually any function. The support for Hercules, CGA, MCGA, EGA and VGA displays. Output for plotters and laser printers.

Cost? Still only \$1495. Evaluation versions still only \$150. Brochure and demo disk still free for the asking. Call or write for yours today. And see how easily you can get ideas up and flying.



1021 S. Wolfe Road  
Sunnyvale, CA 94086  
(408) 738-4387



**Photo 1:** In the Information Visualizer system, an Overview provides a high-level look at a collection of virtual workspaces called rooms. This Overview shows eleven 3-D rooms and one 2-D room, each of which represents an active application or object that can be run and manipulated directly from the Overview.

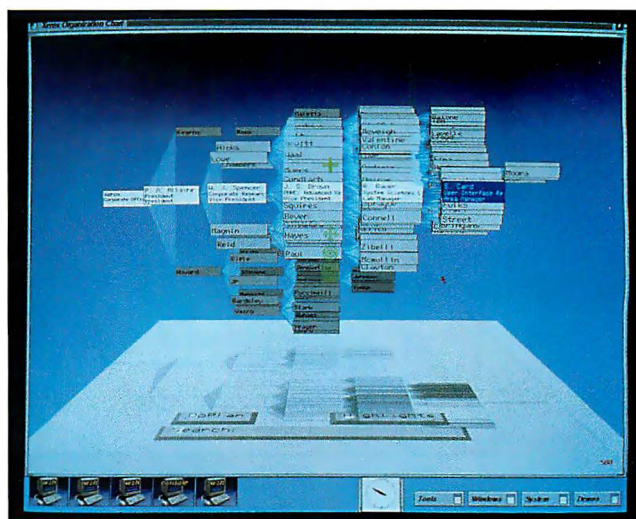

**Photo 2:** A Cam Tree is a hierarchy laid out in 3-D. The root node of the hierarchy is on the left, and the hierarchy proceeds to the right rather than from top to bottom. This Cam Tree represents the first 600 nodes of the Xerox organization chart, previously an 80-page document.

designed around the task-oriented clustering of information and provides multiple virtual workspaces (or *rooms*) that are furnished with windows and objects pertinent to some task.

Rooms helps manage information once it has been retrieved. By making it inexpensive to switch to a new set of windows and objects, Rooms encourages the user to keep less clutter on the screen. Because users switch from task to task, the computer anticipates their needs, more efficiently retrieving items from expensive storage (e.g., the disk or file server). The successor to Rooms, 3-D/Rooms, is a major component of the Information Visualizer.

Rooms are connected to each other by *doors*, through which the user walks. Leaving through the back door returns users to the room from which they came. The user can also jump directly to another room by name or enter a room from an Overview (see photo 1).

The Overview provides miniature versions of a user's rooms and their contents. Using the Overview, the user can look at several rooms at one time. Wiring diagrams display the connections between rooms. In the Information Visualizer, objects in the Overview are active, and a user can manipulate them from there.

In 3-D/Rooms, one object, or a group of objects, can appear in more than one room. Changes to the object in one room affect all copies of that object in all rooms. You can also put things into *pockets* and carry them from room to room.

### Visualize This

Another way to increase the effective size of the computer screen is to increase its density (i.e., the amount of information it displays). Obvious limits exist when the information is given in the form of text or numbers, but a picture, as they say, is worth a kiloword.

A common way in which a system, either biological or human-engineered, can improve information processing efficiency is by using methods called *abstraction* and *selective omission*. These terms refer to a way in which the lower levels of an information processing system (e.g., a computer) can

simplify and organize information. Without having to deal with so many details, you can process information more easily and in more universal terms.

Pictures are the obvious abstraction for the computer screen, and a 3-D representation can pack more onto a computer screen than a 2-D representation. Even 2-D structures benefit greatly from the added depth of 3-D graphics.

Three-dimensional computer visualization is usually reserved for objects and systems that are inherently 3-D in nature, such as models of molecules and airplanes. The Information Visualizer taps the power of 3-D real-time animation to show structures that are not typically thought of as 3-D objects—structures like organizational charts and calendars. PARC calls these representations *visualizations*.

The prototype Information Visualizer system has visualizations for three classes of information: linear structures, hierarchical structures, and unstructured information.

### Hierarchies Hanging in the Air

Hierarchies are everywhere, from business organizations to disk directory structures. The Information Visualizer provides a special visualization called the Cone Tree, with which you can easily deal with large hierarchies.

In Cone Trees, hierarchies are laid out in 3-D. They provide a "fish-eye" view of sorts—the closer nodes are larger and brighter than those farther away. Shadows on the floor provide another perceptual cue. They are, in effect, a 2-D projection of the 3-D structure, providing you with another perspective.

Photo 2 shows a related visualization called the Cam Tree, which resembles a Cone Tree laid on its side. The Cam Tree hierarchy proceeds from left to right rather than from top to bottom.

These animated trees can convey surprising amounts of information. One tree supports a File Browser displaying the host system's entire Unix directory structure at once—about 600 directories holding 10,000 files. Another is an organization chart containing 650 nodes—originally an 80-page document.



# Order BYTE Program Listings on Disk!

BYTE listings are available on disk if you want to compile or read the complete source code listings of programs. BYTE listings are available from December 1985 to the present at the prices stated on the adjacent order form.

Call Toll-free 800-258-5485  
(in N.H. 603-924-9281)  
Subscription Customer Service  
800-232-BYTE

**FOR DIRECT ORDERING CALL TOLL-FREE: 800-258-5485**

Call: M-F, 8:30 a.m. to 4:30 p.m. Eastern Time; (603-924-9281 for N.H. residents). *For credit card orders only.*



ORDER FORM: To place your order, fill out the card and mail.

**PLEASE COMPLETE IN FULL**

Name \_\_\_\_\_

Address \_\_\_\_\_

City \_\_\_\_\_

State \_\_\_\_\_ Zip \_\_\_\_\_

County or Parish \_\_\_\_\_ Country \_\_\_\_\_

Credit Card # \_\_\_\_\_ Exp. Date \_\_\_\_\_

Signature \_\_\_\_\_ Date \_\_\_\_\_

Please allow 6-12 weeks for delivery.

FEBRUARY

<b>5¼ Inch:</b> <input type="checkbox"/> IBM PC	<b>3½ Inch:</b> <input type="checkbox"/> Apple Macintosh <input type="checkbox"/> IBM PS/2	<ul style="list-style-type: none"> <li>• Please indicate the issue date below. If you are beginning an annual subscription, note the starting issue.</li> </ul>
<b>IN USA/Single Month (1 disk)</b>		
<input type="checkbox"/> BYTE Listings \$10.95	<input type="checkbox"/> BYTE Listings \$11.95	<b>BYTE Program Listings</b> Month _____ Year _____
<b>IN USA/Annual Subscription (13 disks)</b>		<input type="checkbox"/> Check enclosed <input type="checkbox"/> MasterCard <input type="checkbox"/> VISA <input type="checkbox"/> U.S. funds enclosed (If ordering from outside the U.S. please remit in U.S. funds drawn on U.S. bank. Thank you.)
<input type="checkbox"/> BYTE Listings \$89.95	<input type="checkbox"/> BYTE Listings \$99.95	
<b>OUTSIDE USA/Single Month (1 disk)</b>		
<input type="checkbox"/> BYTE Listings \$13.95	<input type="checkbox"/> BYTE Listings \$14.95	
<b>OUTSIDE USA/Annual Subscription (13 disks)</b>		
<input type="checkbox"/> BYTE Listings \$109.95	<input type="checkbox"/> BYTE Listings \$119.95	

**BYTE**



# Order BYTE Program Listings on Disk!



BYTE listings are available on disk if you want to compile or read the complete source code listings of programs. BYTE listings are available from December 1985 to the present at the prices stated on the adjacent order form.

Call Toll-free 800-258-5485  
(in N.H. 603-924-9281)  
Subscription Customer Service  
800-232-BYTE

PLACE  
POSTAGE  
HERE

## BYTE on Disk

One Phoenix Mill Lane  
PO Box 809  
Peterborough, NH 03458-0809

To help users focus on the interesting parts of these enormous trees, the Cone and Cam Trees also provide a set of gardening operations. Using these tools, you can prune or grow back extraneous branches with a simple gesture and move branches from one node to another.

When users select a node in one of these trees, it rotates so that the selected node and the path from the selected node to the root node are placed front and center and are highlighted. The cones rotate smoothly, like carousels, as fast as the eye can comfortably follow. As the cones turn, the human perceptual system automatically tracks the parts of the tree and their relationships. Users gain added insight into the relationships within the structure by seeing the tree from different angles as it rotates.

The benefits of animation then become clear. A selection can be complex, involving the rotation of as many as 10 levels of cones. With animation, your unconscious perceptual system automatically tracks the rotations as they happen, updating your mental model of the structure. Again, animation can shift some of the work to your unconscious perceptual system, freeing the conscious mind for higher-level cognitive work.

In the same way drivers remain aware of the other cars about them in traffic, needing only to check their mirrors occasionally to update their mental model, users are aware of objects that are "behind" them or occluded by other objects. These objects are effectively present, even though they need not be shown.

### A Search as Lovely as a Tree

To search a tree, you can select and examine individual nodes or perform a search on the entire visible structure. (You can perform a search only on the visible nodes of the tree.) When the search begins, all nodes become invisible. Then they reappear, one by one, showing the progress of the search through the tree.

When a node reappears, it is given a score in the form of a red underline—the longer the line, the higher the search score for that node. When the search terminates, the node with the highest score is selected, rotating smoothly to face you.

The Information Visualizer remains active during the search. You can continue to work and then end the search as soon as you have enough information. The catchphrase for it at PARC is "treating the human like a real-time device."

The faster you can perform each step of an iterative search, or the fewer steps there are, the faster you can complete the search. By always keeping you active, letting you move on as soon as you have the information necessary to take the next step, the Information Visualizer speeds the search. The Visualizer presents as much contextual information as possible and provides useful abstractions of the data and its structure. Thus, it shortens the search so that you can more completely understand and more effectively navigate the structure.

### Time on a Wall

It is often more convenient to look at information not as a tree, but as a long sequence, such as a collection of documents arrayed over time. The problem with visualizing large linear information structures is the extreme aspect ratio. A chart showing important milestones for a project, for example, can be only a few lines *tall*, but months, or even years, *long*.

If the details are made large enough to see and work with, the entire structure will not fit on the screen. And if the structure is shrunk to fit the screen, the details will be illegible. Yet an effective visualization should provide both detail and context. In the milestone chart example, you must be able to work with

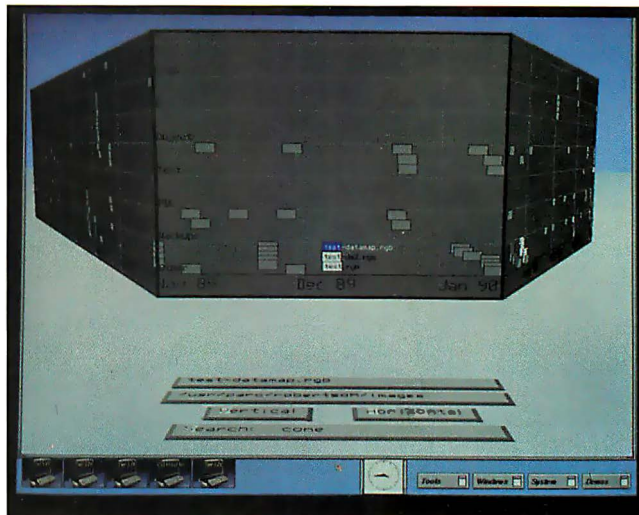

**Photo 3:** *The Perspective Wall displays information that is essentially linear. Selecting an item slides the wall around the corners like paper in a player piano, bringing the selected item into view.*

weekly or daily milestones while understanding their context within the larger structure.

The Visualizer designed to display linear information is called the Perspective Wall and resembles a gray slate wall folded into thirds (see photo 3). Like the tree visualizations, the Perspective Wall provides a sort of "fish-eye" view. The center panel provides a detailed view, while the two wings provide a contextual view. As with the trees, the closer objects, which are more likely to provide important contextual information, are larger and brighter than those farther away.

When you select an object, the wall slides around like a sheet of music in a player piano, bringing the selected item to the front. Objects bend as they go around the corner. One of the wings grows shorter, and the other grows longer, depending on the direction of the wall's movement. If the center panel becomes too cluttered, you can stretch it like a sheet of rubber so that fewer items are displayed there. Animation allows your perceptual system to track objects on the wall as it slides.

PARC has designed visualizations of other, less structured information. One system, called the *People Browser*, ties a floor plan to the photos, biographies, and project plans of the scientists who work there (see photo 4).

### Navigation and Manipulation in 3-D Space

In addition to simply spinning things from afar, the Information Visualizer lets you move about the room—flying through the nodes of a Cone Tree, for example, or walking around a Perspective Wall. You can pick up, move, examine, and drop objects.

PARC has developed a set of 3-D navigation and manipulation techniques that use the mouse—essentially a 2-D input device—to allow movement through 6 degrees of freedom (up/down, right/left, and forward/backward, plus a couple of rotations).

The Information Visualizer provides you with a virtual body. When you move around within a simulated room, your viewpoint moves as though you were walking within a real room. Virtual joysticks are associated with icons in the center of the screen. For example, selecting the walking joystick and then moving the mouse forward walks you through the room.

*continued*

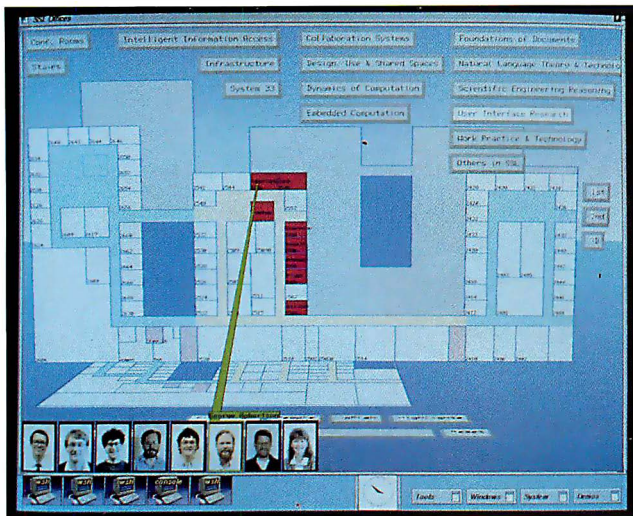

**Photo 4:** *The People Browser incorporates several databases. It ties a floor plan to the photos, biographies, and project plans of the scientists who work at Xerox PARC. Text searches could, for instance, reveal similarities between the work of various system researchers.*

The other joysticks move the viewpoint up, down, right, and left and rotate your virtual body and head.

To move in to examine details, you can select a point of interest on the surface of some object by clicking there with the mouse. Then, holding down a keyboard key flies you to that point; a second key flies you away.

Movement toward an object is logarithmic. The point of view moves a fixed percentage of the distance to the selected point per unit of time (e.g., half the remaining distance every second). The closer the viewpoint gets to the selected point of interest, the more slowly it advances. You cannot actually collide with an object.

Similarly, you can select an object with the mouse and then pick it up and bring it toward the viewpoint. The mouse moves the object in a plane parallel to the viewpoint. The two keyboard keys move the object toward you and away. The object moves toward the viewpoint, slowly at first and then accelerates rapidly. It finally slows again as it nears the viewpoint, making it impossible for the object to actually collide with the viewpoint.

Many 3-D objects in the Information Visualizer also respond to *gestures*. To gesture, you hold down one mouse button and then move the mouse, flicking it sideways, perhaps, or moving it as if you were drawing a check mark. For example, selecting a node on a Cam Tree and performing the "flick left" gesture prunes all branches below that node; flicking to the right grows them back again.

### The Cognitive Coprocessor—A Brain Prosthesis

The more tightly users are coupled with an application, the more effectively information can pass between them. The more effectively information is processed, the less expensive it is to use.

The Cognitive Coprocessor, the heart of the Information Visualizer, provides this tight coupling of user and application by supporting smooth animation and multiple asynchronous agents. Some examples of agents are a database program, a search routine, and the human user.

It is difficult for a system to provide smooth animation and

asynchronous agents simultaneously. Multiple asynchronous agents exhibit a wide range of computational requirements, and the overall system load can vary widely from time to time. Smooth animation, however, typically requires a fixed rate of guaranteed computer resources. The Cognitive Coprocessor compensates for the widely varying time constraints of the different agents in the system—including the human—and also translates between their different languages.

For example, animations are designed to run at a fixed rate per unit of time. An animated ball might roll some distance per second (e.g., 3 inches per second), rather than a certain distance per animation cycle. When the system runs more slowly, the ball moves farther on each cycle, and vice versa. The result is smooth animation over a wide range of system loads.

Smooth interactive animation fools your perceptual system. You perceive the on-screen structures as real objects with mass and dimension, reflecting light and casting shadows. These natural perceptual cues draw you in and aid you in assimilating and using the information.

The Information Visualizer user is always active. You never have to wait for the computer to finish a task before it accepts your input. PARC's User Interface Research Group calls this design philosophy "treating the human like a real-time device." You do not have to delay your work for any "Please wait . . ." prompts or little hourglass icons.

The Cognitive Coprocessor marries 3-D/Rooms, tools for navigating in the 3-D environment, real-time animation, and the interactive objects themselves. Using all these disparate parts, the Cognitive Coprocessor tightly binds you to the application inducing a state of effortless symbiosis—a computational *fahrvergnügen*, if you will.

### Goals Reached and Then Some

PARC scientists believe that managing large quantities of information will be the key to computer use in the 1990s. PARC is designing the Information Visualizer interface to let users deal with enormous problems by reducing the cost of using information. By providing highly coupled interaction, the Information Visualizer increases the efficiency of information exchange between the user and the application.

The Rooms system increases the effective size of inexpensive information storage—the workspace on the screen—through multiple virtual workspaces. These workspaces let you spread work out, relieving the clutter of some overlapping window systems. Rooms also allows the computer to anticipate your needs, retrieving items from expensive storage more efficiently.

Animated 3-D visualizations make the screen much denser, increasing the amount of information it can hold and exploiting your perceptual system to convey information subconsciously. With an entire structure visible at once, you can navigate it faster and more easily. And 3-D animation allows the representation and manipulation of objects too large or complex for only 2-D. By exploiting human experience and capabilities, the interface provides familiar, comfortable metaphors for information, navigation, and manipulation.

The Information Visualizer currently runs on a Silicon Graphics Iris graphics computer. But over the next three to five years, the falling prices of the hardware required to run similar interfaces should begin to penetrate the workplace, increasing the demand for other powerful new interfaces. ■

---

*Mark A. Clarkson, formerly a programmer and consultant, is a full-time writer living in Wichita, Kansas. He can be reached on BIX c/o "editors."*



# Discover Parallel Processing

## Quadputer™

The Microway Quadputer is the world's most popular PC Transputer development environment. It can be purchased with two to four Transputers and one to four megabytes of RAM per processor. The Quadputer runs all the popular Transputer development software, all of which is available from Microway. It is compatible with our Monoputer™ which provides 1 to 16 megabytes of RAM and a single T800, our Videoputer™ which comes in VGA and higher resolution versions and is powered by a memory mapped pair (T800 and 34010), and our Linkputer™ whose cross bar switching network can dynamically link up to 32 Transputers. Finally, all Microway Transputer products can be used with our Number Smasher-860 to provide out-of-this-world numeric performance!

For more information, please call 508-746-7341.

# Microway

The World Leader in PC Numerics

Corporate Headquarters, Research Park, Box 79, Kingston, MA 02364  
TEL 508-746-7341 • FAX 508-746-4678  
U.K. - 32 High St., Kingston-Upon-Thames, 081-541-5466 • Italy 02-74.90.749  
Holland 40 836455 • Germany 069-75-2023 • Japan 81 3 222 0544

## Number Smasher® 860

The highest performance coprocessor card to ever run in a PC, Number Smasher-860 delivers up to 80 million single precision floating point operations per second at 40 MHz and produces over 10 Linkpack megaflops. The board comes standard with an ISA interface, two Transputer Link Adaptors that allow it to interface with a Microway Quadputer or Videoputer, your choice of our NDP Fortran, C or Pascal for the 80860, plus 8 megabytes of high speed memory.

## NDP Fortran-860, C-860 and C++860

Microway NDP 860 Compilers make it easy to recompile your favorite mainframe, 80386 or PC application for the 80860. The resulting code runs on our XTEND-860™ environment under DOS, UNIX or XENIX.



# XGA: A NEW GRAPHICS STANDARD

*Combine a fast VGA, a graphics coprocessor,  
and bus mastering, and you have XGA*

*Jake Richter*

**T**

hree and a half years after introducing both the VGA and 8514/A graphics standards, IBM has finally unveiled its next-generation PS/2 graphics hardware—the XGA (Extended Graphics Array).

In 1987, the VGA was shipped standard with the newly announced PS/2 systems. Now the XGA is shipped as the default graphics display platform with IBM's newest PS/2s, the Model 90 XP 486 and the Model 95 XP 486. In the desktop Model 90, the XGA is on the motherboard; in the Model 95 (a tower unit), it is located on a separate Micro Channel architecture add-in board. The XGA Display Adapter/A is also available for other 386- and i486-based PS/2s.

IBM's replacement of the VGA with the XGA as a default graphics platform is remarkable. A couple of years ago, rumors were rampant about IBM's implementing its 8514/A advanced graphics technology on PS/2 motherboards. But the 8514/A lacked one major feature that was necessary for this to occur: backward compatibility. The XGA's full VGA hardware compatibility eliminates this problem; therefore, it is suitable for a motherboard implementation.

In some ways, the XGA is a merger between the VGA and 8514/A graphics platforms. The table shows a feature

comparison of several mass-market graphics hardware platforms demonstrating how the XGA has evolved.

## The XGA Is Born

The XGA was developed in the U.K. at IBM's Hursley Labs, as were the 8514/A and the niche-oriented Image Adapter/A. Therefore, it is not surprising that in its design the XGA maintains many of the 8514/A's features, although it accesses these features in a different fashion.

Some of the new features, such as bus mastering, are designed to take advantage of the Micro Channel architecture bus, which is standard in most PS/2s. Other features, such as a memory-mapped frame buffer and hardware cursor, provide greater flexibility over existing designs, easing the burden for software developers. Another boon to software developers is that IBM has released full register specifications for the XGA, unlike its tight-lipped approach to the 8514/A. An Adapter Interface comes with the XGA to provide backward compatibility for all those applications that supported the 8514/A via the Adapter Interface.

## Multiple Modes

The XGA has three distinct modes: VGA compatibility, 132-column VGA-compatible text, and extended graphics.

*continued*



## FEATURE COMPARISON

*A comparison of IBM-originated mass-market PC graphics standards features. Resolutions are listed as horizontal by vertical by color(s). The XGA combines the resolutions and capabilities of the original VGA with those of the 8514/A and adds some functionality.*

Platform	Resolution	Interlaced at 1024 x 768	Base compatibility	Graphics coprocessor	Memory-mapped	286-/8088-compatible	RAM type	Cost
PS/2 VGA	640 x 480 x 16 320 x 200 x 256	N/A	VGA	No	Yes	Yes	DRAM	N/A
Super VGA	800 x 600 x 16/256 1024 x 768 x 16/256	No <sup>1</sup>	VGA	No	Yes	Yes	DRAM <sup>2</sup>	\$69-\$800 <sup>3</sup>
8514/A	640 x 480 x 16/256 1024 x 768 x 16/256	Yes <sup>4</sup>	None <sup>5</sup>	Yes	No	Yes	VRAM	\$900-\$1500 <sup>6</sup>
XGA	640 x 480 x 2/4/16/256/65,536 1024 x 768 x 2/4/16/256	Yes	VGA	Yes	Yes	No	VRAM	\$1095-\$1445 <sup>7</sup>

<sup>1</sup> Some Super VGAs are still only interlaced at 1024 x 768, but with most, you can switch between interlaced and noninterlaced.

<sup>2</sup> A few Super VGAs use VRAM instead of DRAM.

<sup>3</sup> These prices cover generic ISA-based VGAs all the way to Super VGAs that can do 1280 x 1024 x 16 or 640 x 480 x 32,768.

<sup>4</sup> Clone 8514/A's offer 1024 x 768 noninterlaced.

<sup>5</sup> VGA compatibility is achieved via a pass-through, requiring an actual VGA to exist separately from the 8514/A.

<sup>6</sup> Clone 8514/A pricing is included. The top end is an IBM 8514/A with 1 MB of VRAM.

<sup>7</sup> \$1095 for an XGA Display Adapter/A with 512K bytes of VRAM; \$1445 for the XGA board with 1 MB of VRAM.

N/A = not applicable.

The extended-graphics mode is the most interesting, since it provides higher resolutions and substantial graphics acceleration.

In addition to maintaining full compatibility with the VGA standard it originally created, IBM learned some lessons from the vast number of VGA clones out there and implemented a larger data path. The VGA mode, while still having only an 8-bit internal data path, supports a 32-bit-wide bus. It also has an internal write cache that allows the chip to break down and write the bus data without holding up the rest of the system with unnecessary wait states.

According to IBM documents, when the XGA is in VGA mode, it is up to 90 percent faster than the original VGA under DOS and up to 50 percent faster under Windows. Except for performance improvements, there is no change in VGA functionality in this mode.

It's important to note, however, that while you can have up to eight XGAs in one system (the configuration software only supports up to six), you can only have one VGA active in the system at any one time. Therefore, if you switch an XGA into VGA mode, you must ensure that no other VGA is active in the system; otherwise, the system might crash due to I/O conflicts.

Using the 132-column text mode (a VGA extension), you can display and manipulate 132 characters per line of text on the screen. The character width is 8 pixels for a virtual horizontal resolution of 1056. Character height depends on the font used, which means that you can have text screen resolutions of 132 by 43, 132 by 50, or 132 by 60 pixels.

Currently, you can access the 132-column text mode only by manually manipulating the XGA registers. Ultimately, however, this mode will be accessible by switching into video mode 14 (hexadecimal). For all practical purposes, note that the 132-column text mode is a VGA mode and the same multiple-VGA caveat applies.

The extended-graphics mode has many exciting features, such as 65,536 colors (i.e., 1024- by 768-pixel resolution), bus mastering, drawing acceleration, and the hardware cursor. While some of this mode's features are available in the other modes, most of the XGA registers and functions are dedicated for use in the extended-graphics mode.

### XGA Registers

The XGA design consists of video RAM, a type of dual-ported RAM designed for use in graphics-display systems; glue logic; and two custom chips, the graphics coprocessor and the display controller, which are the core of the XGA (see the photo). The graphics coprocessor controls VGA compatibility, drawing functions, and memory management, and the display controller contains the RAM D/A converter (RAMDAC) with a color lookup table, the CRT controller, hardware cursor support, and a VRAM serializer (a device that extracts data from VRAM for display).

Access to the XGA is accomplished via two sets of registers: The first set is mapped into the system's I/O space, while the other set of registers is mapped into memory. The addresses of these registers vary, due to the configurability of the XGA. This variable addressing allows for multiple XGAs in the same system.

The I/O registers are mapped in at a hexadecimal I/O address of 21X0, where X is the *instance* (or occurrence) of the XGA. According to IBM, in systems with only one XGA, the instance is typically 6, resulting in a base hexadecimal I/O address of 2160.

The memory-mapped registers occupy 128 bytes of memory in the last kilobyte of an 8K-byte chunk. This chunk resides on an 8K-byte boundary anywhere between PC addresses 0C0000h and 0DFFFh. The purpose of having an 8K-byte chunk is that the first 7K bytes of the chunk contains ROM data, but only on an XGA Display Adapter/A. The motherboard implementation of the XGA does not require its own ROM, as the main motherboard ROMs contain all the necessary information, such as XGA initialization code. The XGA instance number determines the location of the 128 bytes within the 8K-byte chunk.

The I/O registers pertain predominantly to the XGA's display controller. The memory-mapped registers, however, refer primarily to the graphics coprocessor. The XGA's power-on self test routines set the base addresses for both registers, and by examining the PS/2 POST registers for the XGA in question, you can determine the addresses.

Many of the memory-mapped registers are 32 bits in size,





Screen image courtesy of Wavefront Technologies.

## Now engineers can fly first class at an economy price.

Who ever heard of a first class, 20" VGA monitor costing less than \$3,000?

A monitor with remarkable detail and brilliance. Scanning from 21 to 65KHz. Resolution up to 1280x1024. Plus VGA, SuperVGA 800x600, 8514/A™ and Mac II™ compatibility.

Now hear this.

It's called the OmniScan CM-2000™ ultra-high resolution, multi-frequency CAD/CAM monitor — the ultimate in Tatung video technology.

Perfect for even the most sophisticated CAD/CAM applications. And now for just \$2,799.

20" 1280x1024 Non-Interlaced CAD/CAM Monitor Comparison.

Mfr. and Model	Horizontal Scan Rate	TTL	Analog	List Price
TATUNG OmniScan CM-2000	21-65KHz	Yes	Yes	\$2,799
MITSUBISHI HL6905	30-64KHz	No	Yes	\$3,445
NEC Multi/Sync 5D	30-66KHz	No	Yes	\$3,699
HITACHI Accuvue 20-AP	30-65KHz	No	Yes	\$3,880

For more on the OmniScan CM-2000, call 1 (800) 827-2850, ext. 213. Or FAX 1 (213) 637-8484. Tatung Company of America, Inc., 2850 El Presidio Street, Long Beach, CA 90810.



**TATUNG®**  
Engineering at its best.

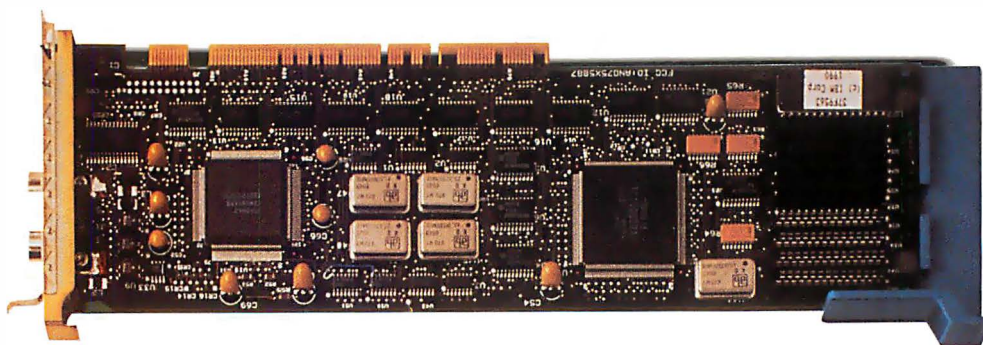

*IBM's XGA Display Adapter/A graphics board. The four key areas on this Micro Channel adapter are the VRAM (far left), the graphics coprocessor (large chip on left), the display controller (large chip on right), and the video-out connector.*

because the XGA is designed to fit into a 32-bit environment like that of the Intel 386 and i486. Also, due to the software support IBM developed for the XGA, it only works in a 386 or 386-based PS/2 (including 386SX-based PS/2s). The XGA also offers Motorola format addressing (a different byte ordering compared to an Intel format), which allows a Motorola 68000 or similar processor to take advantage of the XGA, assuming the XGA was ported to such hardware environs.

### Initialization

Initialization is a necessary step in using any graphics device. In the case of the XGA, initialization mainly involves setting the XGA into extended-graphics mode via the *operating-mode* register. You can then generate the proper CRT control register data for the desired resolution. Selectable resolutions are 640 by 480 and 1024 by 768 pixels. But you can only access the 640-by-480-pixel by 65,536-color and 1024-by-768-pixel by 256-color modes with 1 megabyte of RAM.

The 16-bit-per-pixel (65,536-color) resolution provides almost perfect photo-realistic output. Thus, you can scan or capture a full-color picture and, using this 65,536-color mode, see an almost exact replica on your XGA screen. The 16-bit pixel is laid out as 5 bits of red, 6 bits of green, and 5 bits of blue (5-6-5), or in other words, 32 shades of blue, 64 shades of green, and 32 shades of blue—in each pixel.

This configuration varies from the PC standard TARGA format of 5-5-5 (1 bit is used for overlay) and the i860 format of 6-6-4. According to a technical contact at IBM, the 5-6-5 approach was used because of other similar implementations already in place in various IBM installations.

Apparently, the eye is also more sensitive to variations in green than in red or blue. (The reason for the choice of red, green, and blue is that these are the three color guns found in all color monitors. The beams from the three guns combine to display just about any color, depending on the intensity of each gun.)

### The Display Controller

You use the display controller during initialization, but it has other uses as well. Two such uses are the color lookup table and the sprite. The sprite is a 64-by-64-pixel block that overlays the screen.

You use the lookup table to translate the 1-, 2-, 4-, or 8-bit-pixel value into appropriate RGB values. The pixel value is used as an index into the lookup table. The resultant RGB values are then converted from digital levels into analog voltage levels via a built-in DAC.

As with the VGA and 8514/A, the XGA's lookup table supports 64 levels (6 bits) of each primary color, for a total of 262,144 possible color combinations. Thus, in a 256-color mode, you can choose 256 colors from this palette of 262,144.

Each pixel in the sprite has four possible values: sprite color 0, sprite color 1, transparent, and complement. Special registers define the sprite colors, and they let you specify the RGB values for each color. These RGB values are passed directly to the DAC. Their use permits applications to fully modify the local color palette without having to save two entries for the cursor or your having to worry about the cursor changing color as it goes over various portions of the display.

The transparency setting allows cursors that are smaller than 64 by 64 pixels to be defined. Users who want a cursor that is always visible against any background can use the complement setting.

### Task Switching

One of the biggest headaches for systems software developers in creating a multitasking environment is saving the current state of the graphics hardware to allow another application to take over the graphics device. This *state save* also has to account for the possibility that the hardware might be in the middle of an operation or a palette update.

The XGA was apparently designed with task switching in mind, because it has extensive facilities for saving and restoring the state of the hardware, including interrupted operations.

### Defining Drawing Space

One of the XGA's features that is unique among current PC graphics standards is the use of bit maps, which must be defined to perform any drawing function. These bit maps are linear regions of memory that are defined with a pixel width, height, and depth (or bits per pixel). As such, an 8-bit-per-pixel bit map, with a width of 10 and a height of 6 pixels, would require 60 bytes of memory. The last pixel/byte of a given line of the bit map is directly adjacent in memory to the first pixel/byte in the following line.

The best feature of these bit maps is that they can exist anywhere in the system's address and memory space. Thus, if you define a bit map that resides in your program's data area, the XGA can draw into it or read from it, saving you the effort of manually copying data to and from the XGA (i.e., with your system processor).

The XGA VRAM is mapped into the system's address space so that when you want to specify it for a bit-map definition, you just use its address. The VRAM is usually located in the uppermost addresses of the 386's 4-gigabyte address space. As a result, there should never be a memory conflict.

### Bus-Mastering Pitfalls

When the XGA accesses a bit map, it determines whether the access is local (VRAM) or remote (system). For remote access, the XGA arbitrates for the bus and starts accessing system memory. Here is where the XGA's bus-mastering capability

XGA: A NEW GRAPHICS STANDARD

comes into play. There is additional overhead in the use of system memory for bit maps, beyond that being used for accessing local VRAM. But there is also the performance benefit of having the XGA processor manipulate memory while the system processor is doing something else.

This bus mastering has some potential pitfalls. The 386 and i486 processors support virtual memory via an internal page-mapping table. The page-mapping table allows control applications, such as expanded-memory managers, DOS extenders, and advanced operating systems, to create virtual PC addresses 4K bytes (or a page) at a time. So, while the software application thinks it is writing data to address WWWWW, the page-mapping table might translate that address to physical address QQQQQ.

In many cases, there is no way for an application to know that the address it is using is not the physical address. And, to properly bus master, the XGA requires a physical address; otherwise, it may copy data to and from an incorrect address, with disastrous results. There is a possible solution to this dilemma, however, with some control software environments.

If an application has access to the control software's page-mapping table, it can pass this information to the XGA, which then makes use of the page-mapping table, and it can do its own virtual-to-physical address translations. Unfortunately, many control programs and operating systems do not provide access to the page-mapping table. In any case, regular DOS applications have the best chance of using bus mastering, because the first 640K bytes of memory are generally the least likely to be virtualized.

In addition to always having the VRAM mapped into high memory, software can map the XGA into a 64K-byte bank at either A0000h or B0000h, the standard PC video-memory addresses. Accessing different 64K-byte banks in the XGA's VRAM via this approach requires only that an index value be written into the *aperture index* register. This banking mechanism is handy for real-mode applications. Alternatively, the whole 1-MB chunk of VRAM can be mapped somewhere in the first 16 MB of the system's memory, assuming there is no memory conflict. This type of mapping is useful only for protected-mode applications.

With respect to the bit maps, the XGA has three generic bit maps available for definition: maps A, B, and C. These maps are referenced when drawing commands are executed.

The drawing commands may require one or more bit maps: source, destination, and pattern. Source bit maps contain the data you want to either copy or use as a tile; destination bit maps are those into which you draw or copy data; and pattern bit maps contain a monochromatic (1-bit-per-pixel) pattern that you can use as an area pattern or a pixel-exclusion pattern.

The XGA also supports an additional map, referred to as the *mask map*. The mask map is a monochromatic bit map that you use to perform *arbitrary clipping* (i.e., a method of clipping to nongeometric shapes). When enabled, each 0 bit in the map indicates a pixel that should not be modified during a drawing operation, while a 1 bit is a signal to draw the applicable pixel. If the dimension of the mask map is smaller than that of the destination map for a given operation, then the outer edges of the mask map also define a clipping rectangle.

The mask map is extremely useful in windowing environments where you have overlapping windows, because you can draw on underlying windows without having to manually pre-clip all the objects you're drawing. Instead, you just define a mask map that permits drawing only in the exposed area of the desired window. A full-screen 1024- by 768-pixel mask map occupies only 96K bytes of memory. You can also partially

Current Drive Efficiency



Topology of Tokamak Banana Orbits

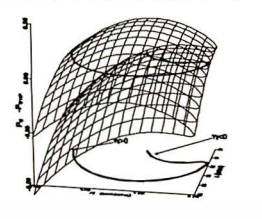



**TM**

**GraphicC**

**“gives you all the C language routines you need to write an impressive scientific graphing program of your own. Highly recommended.”**

**– PC Magazine**

Versions for  
PC and Mac

**Fresnel Integrals**

$$C(x) = \int_0^x \cos(0.5\pi t^2) dt$$

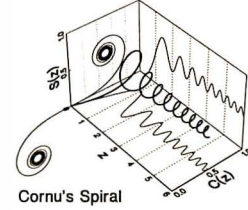
$$S(x) = \int_0^x \sin(0.5\pi t^2) dt$$

Cornu's Spiral

*Scientific Endeavors*

**508 N. Kentucky St., Kingston, TN 37763**

**(615) 376-4146      FAX: (615) 376-1571**

Don't Move!

without telling

BYTE

Clip out form below  
and mail to:

BYTE Magazine  
P.O. Box 555  
Hightstown, NJ 08520

---

At least 8 weeks *before* you move, please give us your  
new address and/or name change

(Please Print)

New address, name \_\_\_\_\_

Name \_\_\_\_\_

Address \_\_\_\_\_ Apt. \_\_\_\_\_

City \_\_\_\_\_

State \_\_\_\_\_ Zip \_\_\_\_\_

Print current name and address  
(or affix the mailing label from your current issue of BYTE here)

Current address, name \_\_\_\_\_

Name \_\_\_\_\_

Address \_\_\_\_\_ Apt. \_\_\_\_\_

City \_\_\_\_\_

State \_\_\_\_\_ Zip \_\_\_\_\_

enable a mask map so that it acts only as a clipping rectangle and does not perform the arbitrary pixel-by-pixel clip.

All four maps are defined via 5-pixel map registers. The first pixel in the bit map, which is in the upper left corner of a display bit map, has a coordinate of 0,0. The mask-map origin registers define the mask-map position over the destination map. All maps are limited to a height and width of 4096 by 4096 pixels.

**T**he XGA's added features—definable bit maps, bus mastering, memory mapping, and state saving—are well thought out. Software developers who want to get the most out of the XGA should find them quite useful.

#### Drawing with the XGA

Before you can draw anything with the XGA, you must at least define the destination map for the operation you want to perform. Some operations also require a source map, such as a BitBlt. A BitBlt is an operation that copies bits from one place to another. The available drawing operations on the XGA are lines, short vectors, filled rectangles, BitBlts, and area fills.

Unfortunately, drawing lines is not as simple as just providing an *x,y* coordinate pair. The XGA uses a Bresenham line-drawing algorithm, but you must first calculate the initial Bresenham parameters, a process that creates a bit of overhead when drawing short lines. Coincidentally, the method for calculating these parameters is virtually identical to that used in drawing lines on the 8514/A. A description of this algorithm for optimized line drawing on computer displays can be found in Foley and Van Dam's *Fundamentals of Interactive Computer Graphics* (Addison-Wesley, 1982).

The XGA's short vectors are similar to the 8514/A's short stroke vectors. These vectors can be up to 15 pixels in length, and they can point in any direction that is a multiple of 45 degrees (e.g., horizontal, vertical, and diagonal). The benefit of the XGA's short vectors is that the definition for each one consumes only a byte, and up to 4 bytes can be passed at a time, allowing for a quick data transfer rate and, therefore, a quick drawing rate.

Filled rectangles are quite straightforward. You just specify a width, height, and position, and off you go. BitBlts are similar to a filled rectangle except that you have to specify a source map as well as a destination map. The XGA also has the ability to perform a simple color-expansion BitBlt, one in which the source is monochromatic and each 0 bit is converted to one color and each 1 bit to another color. The destination map can be anything from 1 to 8 bits in depth. Color expansion is useful for displaying rendered fonts on a high-color-content screen or bit map.

Area fills are a modified rectangle fill in which the XGA

graphics coprocessor uses the pattern map as a guideline for a scan conversion. This type of fill uses 1-bit flags to toggle the fill state as it scans each line in the pattern bit map. Initially, for each line, the fill state is off. On hitting a 1 bit, each subsequent pixel (or bit) in the pattern map is filled until the next 1 bit is encountered.

Lines, short vectors, and filled rectangles can also use a source map and a pattern map. You can use the pattern map for line patterns and area patterns, while you can use the source map for tiling a region (in the case of a filled rectangle) or for providing a color line pattern for lines and short vectors.

All the drawing functions are also affected by four types of drawing modifiers: drawing colors, mixes, color compare, and the pixel bit mask. Drawing colors are simple to use. The foreground color specifies what color you would normally draw in, while the background color specifies the color you would use in color expansions (for a 0 bit).

Mixes, known as raster operations or raster ops on other graphics platforms, provide a mechanism by which the destination pixel (the one in the destination map at the current drawing position) and the source pixel (the foreground color or source map pixel) are mixed. A typical mix is XOR, the exclusive OR operation, which is used for cursors and highlights.

You can use color compare during normal pixel updates to determine whether a given pixel should be updated, based on its color. The destination pixel value (or color) is compared to the destination color-compare value register by using the compare-operation set in the destination color-compare condition. Therefore, if the result of the comparison is TRUE, the pixel is not updated.

There are eight compare conditions: always TRUE, always FALSE, greater than, less than, equal to, not equal to, less than or equal to, and greater than or equal to. This color comparison can be useful in cases where you need to protect a range of colors from being updated, such as background and foreground objects in graphical scenery.

The pixel bit mask controls which bits in a pixel can be modified. Its biggest use is in protecting binary color ranges and planes of color.

#### Why XGA?

From a technical standpoint, the XGA is a very elegant piece of work. It fixes just about all the problems that the 8514/A has had, except interlaced displays and simplified line drawing. The added features—definable bit maps, bus mastering, memory mapping, and state saving—are well thought out. Software developers who want to get the most out of the XGA should find them quite useful.

In addition, IBM has finally made the right move in providing full register-level documentation on the XGA. The lack of this type of documentation hurt the acceptance of the 8514/A. The fact that IBM has provided it for the XGA should increase the level of support it receives.

Because of its high-powered nature, the XGA will probably not have a serious effect on Super VGAs or 8514/A clones in the short term. But it is reasonable to expect XGA clones to be announced before the end of this year.

To obtain further technical information on the XGA, you can call IBM's technical books group directly at (800) 426-7282. ■

*Jake Richter is the president of Panacea, Inc., a graphics software development and consulting company located in Londonderry, New Hampshire. He can be reached on BIX as "jrichter."*

# KnowledgePro<sup>®</sup>

## ... a world beyond ToolBook?



ROBERT  
90 TINNEY

### The press decide...

**PC WEEK July 16, 1990...** "KPWIN is more responsive than ToolBook ... fully exploits the Windows environment... the result is extraordinary development productivity."

**PC MAGAZINE October 30, 1990...** "KnowledgePro's support for Windows objects is much richer than ToolBook's... doesn't suffer from the speed or bitmap size problems that ToolBook does..."

**INFOWORLD October 1, 1990...** "KPWIN runs faster than ToolBook ... so easy you'll think you've forgotten something. ... In the same class as Next Step and far above the clunkier competition..."



Circle 119 on Reader Service Card

### YOU decide...

If you buy KPWIN and choose to send it back within 60 days we'll refund your money.

KnowledgePro Windows (KPWIN) is fast, and it doesn't limit you to single windows with 64k boundaries. Interactive tools get you started and a rich OOP language gives you the control you need for serious applications. Hypertext and hypermedia give your applications depth and built-in expert systems technology lets you create smart programs. Links to the outside world are easy with DDE and DLL's.

KPWIN costs \$695 with no runtime fees for applications, Amex, Visa, M/C and COD accepted. Dealers welcome.

To order call **518-766-3000**  
**FAX 518-766-3003** or write to:

Knowledge Garden Inc.  
473A Malden Bridge Rd.  
Nassau, NY 12123, U.S.A.



# SX your AT



## THE WINDOWS™ 3.0 SOLUTION: Microway's FASTCache-SX™ replaces your intel® 286™ with a 386™ SX that triples your speed for just \$495!

FASTCache-SX is your most cost effective upgrade path to the world of 386-based computing. Designed to work in most ATs and compatibles, Microway's FASTCache-SX converts your 286 into a true 386SX powerhouse that outperforms all 386SX-based systems we've tested to date. You'll be able to run all your old 16-bit software plus new applications customized for the 386's speed and 32-bit memory, like Windows 3.0 in "386 enhanced mode." And, it's 100% compatible with your AT's hardware and software.

### Speed ... Memory ... Compatibility

Its large, four-way set associative cache gives your AT zero-wait-state performance accessing 16-bit memory. Most of your

- Features a genuine Intel 80386SX running at either 16 or 20 MHz.
- Quick and easy installation with our user friendly manual.
- Includes state-of-the-art four-way set associative 32K cache (optional 64K).
- Runs Windows 3.0 in "386 enhanced mode," DESQview-386, and OS/2.
- Landmark ratings of 21.3/27 MHz and Norton SI ratings of 18/22.4 at clock frequencies of 16/20 MHz.
- Outperforms all other 386SX-based motherboards and accelerators!
- Running with an optional Intel 80387™SX, FASTCache-SX delivers 5 to 10 times the numeric throughput of your old AT—up to 1.7 MegaWhetstones—making it ideal for boosting the speed of AutoCAD, Lotus 1-2-3, and PostScript interpreters such as Freedom of Press.

applications will run two or three times faster, providing the equivalent performance of more expensive 386/387DX-based systems. FASTCache-SX/16 gives you the power to run 386-specific multitasking programs on your AT or compatible for just \$495, plus cable! FASTCache-PLUS (available in January) includes 8 megabytes of extended memory.

**No Risk Offer:** FASTCache-SX comes with an unconditional, 30-day, money back guarantee and a 5 year warranty. Your complete-satisfaction is guaranteed — or your money back!

**Call (508)746-7341 to order your FASTCache-SX today!**



# Microway®

Corporate Headquarters,  
P. O. Box 79, Kingston, MA 02364 USA  
TEL 508-746-7341 • FAX 508-746-4678

U.K. 32 High St., Kingston-Upon-Thames, 081-541-5466  
Norway 9 876656  
Italy 02-74.90.749  
Japan 81 3 222 0544

286, 386, 387 are trademarks of Intel Corp.  
Windows is a trademark of Microsoft.  
FASTCache and Microway are trademarks of Microway, Inc.

# MAKING WINDOWS WORK

Feeling left out by the Windows revolution? Here are some tips that can get you up and running.

Since its announcement last year, Windows 3.0 has broken numerous software sales records. The number of Windows applications that have appeared over the last few months is truly astounding.

But what if you can't get Windows running or can't get it to run correctly? What is the source of these problems? Are there bugs in Windows 3.0? Is the PC environment itself to blame?

After months of working with Windows on a variety of system configurations, we have concluded that the culprit is indeed the PC environment. The primary strength of the DOS environment is also one of its greatest weaknesses. Its strength comes from the wide range of applications, bus cards, and peripherals that are available at low cost. Unfortunately, this array of third-party products introduces a certain amount of chaos into the PC architecture.

The chaos arises when third-party memory boards manage RAM in different ways, applications use different printer drivers, video cards require different system resources, and so on. As a result, system files such as AUTOEXEC.BAT and CONFIG.SYS must be carefully tailored to bring stability to a system. This burden usually falls on users, most of whom prefer not to deal with these matters.

Virtually all problems with Windows 3.0 are related to this third-party chaos. In fact, the most remarkable feature of Windows is that it actually works. But in some cases, Windows will run only after

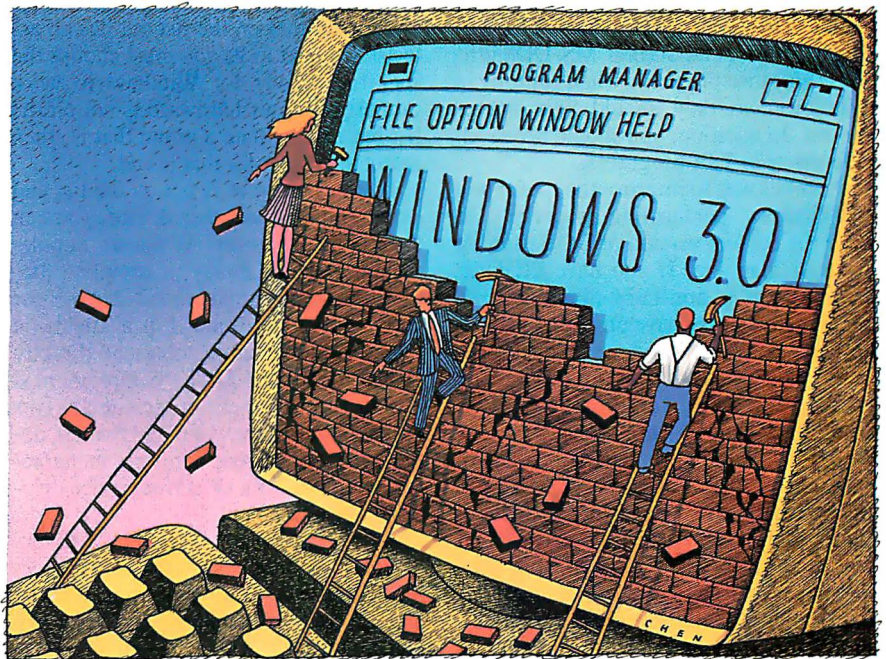

you've done a certain amount of fine-tuning to your system. Here are some pointers on how to get Windows working and how to achieve better performance once your environment is stable.

## Setup for SETUP

Windows 3.0 comes with an excellent installation program, SETUP. Microsoft has gone to great lengths to minimize the configuration problems that can arise both during and after installation. SETUP does a thorough job of interrogating the environment for information regarding CPU type, memory, drivers, and other factors. But SETUP may have some problems doing its job if you don't first take care of some potential conflicts between Windows and your applications environment.

Some memory-resident programs, such as TSRs, device drivers, and MS-DOS utilities, are incompatible with Windows. By simplifying your AUTO-

EXEC.BAT and CONFIG.SYS files before you run SETUP, you can increase the likelihood that the SETUP procedure will complete successfully and produce the correct system files (e.g., removing calls to third-party disk managers from system files). The operation of many nonstandard disk-partitioning schemes causes a direct conflict with Windows' SMARTDRV.SYS disk manager. This conflict has existed with all versions of Windows, but the popularity of Windows 3.0 has brought the problem to the forefront.

This type of problem occurs because SmartDrive allows Windows to bypass the disk services provided by DOS (or a third-party package) and write directly to the disk through the BIOS. Because these nonstandard disk managers modify the way a disk behaves through low-level formatting and interleave selection, there is bound to be conflict. After making copies of your system files, you should

#### PREDEFINED WINDOWS SYSTEM TYPES

*These are the predefined BIOS versions for Microsoft Windows. Most systems not listed will work using the Phoenix Cascade BIOS definitions (3).*

- |   |                                  |
|---|----------------------------------|
| 1 | IBM AT or 100 percent compatible |
| 2 | IBM PS/2                         |
| 3 | Phoenix Cascade BIOS             |
| 4 | HP Vectra (A and A+)             |
| 5 | AT&T 6300 Plus                   |
| 6 | Acer 1100                        |
| 7 | Toshiba T1600 and T1200XE        |
| 8 | Wyse 12.5-MHz 286                |

delete any references to nonstandard disk managers in your system files. The APPEND, JOIN, and SUBST MS-DOS utilities can cause problems when running in Windows, so they should also be removed. In addition, you should delete all references to TSR programs.

Another way to improve the likelihood of Windows' performing properly is to have the correct version of DOS running on your machine. If you have PC-DOS running on a non-IBM-manufactured machine, you may have problems installing and running Windows. This is because MS-DOS was custom-tailored by IBM specifically for the IBM BIOS. Running Windows on a clone with PC-DOS may yield unpredictable results. In fact, many OEMs modify MS-DOS to take advantage of proprietary aspects of their machines. If you have determined (by using the VER command) that your version of MS-DOS does not match your equipment, install the correct version according to your manufacturer's instructions.

#### Have Confidence

During installation of Windows, SETUP asks your permission to modify AUTOEXEC.BAT and CONFIG.SYS. In virtually all cases, it is wise to let Windows do this. According to Tim McCaffrey, a Windows program manager at Microsoft, "almost 90 percent of all post-installation problems are a direct result of not giving Windows access to your system files." SETUP does a good job of modifying statements only when necessary, and it makes a backup copy of the original files. However, if Windows cannot complete its SETUP procedure and your system halts (or you experience some other problems), there are a number of steps you can take.

With Windows, Microsoft provides a list of all known supported hardware. You should check to see that your hardware components are on this list. If your particular hardware is on the list, Windows has a compatible driver, and SET-

UP will display it as an option. If your system appears on the list but has an asterisk (\*) next to it, you must choose the specified driver for Windows to work properly. If your hardware is not on the list but can emulate a brand that is, then select the driver for that brand.

If your hardware is not on the list and cannot emulate another device, you can check the Microsoft Windows Supplemental Driver Library, a complete, up-to-date set of supplemental drivers for less common hardware. It is available on many BBSes or can be obtained directly from Microsoft. If the Supplemental Driver Library does not include a driver for your hardware, your only other option is to contact your hardware manufacturer and ask for a Windows device driver for the equipment.

By typing SETUP /i at the MS-DOS prompt, you can ensure that the correct SETUP configuration options will be chosen. SETUP /i enables you to verify and modify SETUP to match your system configuration at the second SETUP screen.

Other problems with SETUP involve mouse and network options. If SETUP fails on the first try, type SETUP /i to run SETUP again, and select "None" for the mouse and network options, even if your computer is on a network and has a mouse. When Windows is properly installed, you can add these options from SETUP within Windows.

#### Showstoppers

If you have successfully installed Windows but the system halts soon after you enter win to invoke Windows, it is probable that some software or hardware component in your system is in conflict. Again, this problem is not with Windows per se, but a result of different manufacturers marching to different drummers. If Windows continues to fail after you follow all the suggestions discussed above, there is still hope.

First, try running Windows in real mode by executing WIN /r. Real-mode

Windows 3.0 works just like Windows 2.1 and does not make use of the memory above 640K bytes. If your system halts at this point, it is likely that your video display configuration or system-type selections from SETUP are incorrect. If Windows works in real mode but not in standard mode (which you invoke by typing WIN /s) or enhanced mode (WIN /3), you must isolate each element of your current AUTOEXEC.BAT and CONFIG.SYS files with respect to their compatibility with Windows. Follow the suggestions mentioned earlier in the article about these files before trying the next two options.

In the majority of cases, Windows' HIMEM.SYS extended memory manager will detect what type of system you have so that it can map memory correctly. Sometimes HIMEM is not able to make this identification, and your system may crash. To eliminate this possibility, add the /M switch and the number associated with your system type to the HIMEM.SYS entry in CONFIG.SYS. For example, if your system has a Phoenix Cascade BIOS, your HIMEM command line should look like this:

```
DEVICE=C:\HIMEM.SYS /M:3
```

The table lists the system-type numbers you can use. If your PC is not listed, you should use 3, the number for the Phoenix Cascade BIOS.

According to McCaffrey, the single most effective tool to eliminate problems that crash Windows is the EMMEXCLUDE statement. The symptoms exhibited by these "showstoppers" can vary and include a frozen system or a scrambled full-screen display of a DOS application when switching back to Windows. The problem is that Windows is not recognizing that one or more of your hardware components is using additional memory—in this case, within the C000 to D000 address range—to enhance performance. When Windows operates in enhanced mode, it may try to access this memory and cause your system to crash.

Some systems map video memory to the memory-address range of C000 to D000. Many add-in boards also use these addresses. If you have a 386 or 486 machine with at least 2 megabytes of memory, you can resolve some problems by making the memory-address range of C000 to D000 inaccessible to Windows by modifying the SYSTEM.INI file in your Windows directory. You simply open the file with your text editor, find the [386Enh] section, and add the following line:



EMMEXCLUDE=C000-D000

This statement tells Windows not to use the specified range of addresses. You can experiment with this statement; for example, if you are experiencing trouble with a 386 system that has a VGA monitor running in enhanced mode, the statement should read as follows:

EMMEXCLUDE=C400-C7FF

This provides more memory to Windows than the EMMEXCLUDE statement and can solve the problem equally well.

Some 386 PCs may have trouble running EMM386.SYS when taking advantage of EMS memory, usually because of a conflict with a page-frame address. For example, there is a problem when the computer uses memory for its own hardware purposes, such as video memory. The Everex Step 386/25 and NCR PC925 have this problem. The solution is to change the setting for EMM386.SYS in your CONFIG.SYS file. The correct setting for the Everex Step 386/25 is

device=EMM386.SYS E600-C7FF

and, for the NCR PC925,

device=EMM386.SYS E000-EFFF

If you own a pre-1988 low-end 286 clone, you may have difficulty running Windows in standard mode. Microsoft says that almost 50 percent of these machines will experience this problem, because Windows is incompatible with the BIOS versions present in these machines. It was simply not possible to make Windows compatible with all previous versions of the BIOS.

The solution is to upgrade the BIOS ROMs and the keyboard controller. Why the keyboard controller? To operate in standard mode, HIMEM.SYS uses the A20 loader to get to the extended memory, going through the keyboard's 8482 chip to do so. If the system's controller does not match the system's BIOS, Windows will let you know (but not necessarily in a polite manner).

#### Stabilizing the Environment

Even if you successfully install and run Windows, you can still experience problems once you start working with your applications. Although these problems are rare, they can be difficult to resolve. Most regular DOS applications running in standard or enhanced mode under Windows will run as they do on a normal DOS-only machine after you create a

## Unique New Service Keeps Telecommunications Costs Under Control

No matter how complex your voice communications services are, no matter how many locations you manage, TRACKER™ from CCMi/McGraw-Hill can now give you the information you need to contain costs and save money.

Drawing on years of experience gathering and analyzing rate and tariff data, CCMi/McGraw-Hill created TRACKER to provide you with an instant look at your current services by location... and then compare your alternatives. Through this unique database, you can quickly identify where to reduce costs at a price that more than pays for itself.

TRACKER has proven itself to be the answer to lower costs in the increasingly complex telecommunications environment. To learn more, call today.

1 800 526-5307 Ext. 249



**CCMI/McGraw-Hill**

500 North Franklin Turnpike  
Ramsey, New Jersey 07446

Yes! I'm interested in discovering a proven new way to keep my telecommunications costs under control.

Send me more information about TRACKER.

I can't wait! Call me right away.

Name \_\_\_\_\_

Title \_\_\_\_\_

Company \_\_\_\_\_

Address \_\_\_\_\_

City \_\_\_\_\_ State \_\_\_\_\_ Zip \_\_\_\_\_

Telephone \_\_\_\_\_

Clip coupon and mail to: CCMi/McGraw-Hill,  
500 North Franklin Turnpike, Ramsey, NJ 07446

Program Information File (PIF) for them. If you run a DOS application while in Windows standard mode, the execution of Windows is suspended and the DOS application will run in real (or unprotected) mode. While running a DOS application in Windows enhanced mode, all other tasks continue operation and the DOS application will run in a virtual 8086 window. This simultaneous operation is the primary advantage of having a 386 CPU.

Programs that use the Virtual Control Program Interface will not work with the current version of EMM386.SYS, which emulates expanded memory in extended memory. Such programs include Lotus 1-2-3 release 3.0 and AutoCAD. Other applications, such as Lotus Freelance, simply require too much conventional memory to run in a DOS window.

One solution to this problem is to use a third-party memory manager, such as Quarterdeck's QEMM-386 version 5.1. QEMM-386, which is actually a portion of Desqview 386 version 2.3, is an extended memory manager for 386 machines that can be used by Windows without Desqview. QEMM-386 manages extended and expanded memory for almost all DOS applications by using the 386's paging and mapping hardware. Also, QEMM-386 does something the Windows memory manager, HIMEM.SYS, currently does not do: load device drivers and TSR programs into high memory, the area between 640K bytes and 1 MB.

For a time, the direction that Microsoft took with Windows 3.0 diverged from the directions that some vendors of memory management products were taking. However, Gary Saxer, director of technical services for Quarterdeck, says that his company's relationship with Microsoft is improving. "We've worked closely together to make sure that 386 memory managers, in general, work with Windows," he notes.

Microsoft technical account manager Kai Kaltenbach says that QEMM-386 can offer certain benefits to Windows users. He states, "If you're going to use DOS applications within Windows, QEMM provides more memory for these programs, but if you are not going to use DOS programs within Windows, QEMM provides few benefits." Windows 3.0 applications use extended memory and do not suffer from the 640K-byte limitation.

If you are going to run DOS applications that use EMS memory, such as Qmodem, you may run into trouble because protected mode is violated in these

**I**f you run  
DOS applications that  
use EMS memory, you  
may run into trouble.

cases. Some DOS applications that use expanded memory don't include checks to see that complete 64K-byte page frames are available. For example, if an application looks to write to memory starting at address C800 and does not verify that the whole 64K-byte page frame is available, the CPU sees a violation of system integrity and terminates the session with an error.

In this case, Windows is the messenger of bad news. To keep these kinds of applications running in Windows without crashing, you must modify the program's PIF so that EMS memory is set to 0, denying the application the use of EMS memory when it is run in Windows.

### Disk Managers

As mentioned earlier, if you are using Windows while operating in enhanced mode and running SMARTDRV.SYS, you may have problems using a third-party disk manager. According to Fred Huett, a computer consultant specializing in disk subsystems for Sunlight Data Systems (Portland, OR), "the conflict with third-party disk managers can vary, from the system not starting (most common) to disk corruption and loss of data (a rare circumstance)."

Windows requires your computer to adhere to the specifications set by the Standard Drive Table and the partitioning of FDISK. The result is that DOS currently invokes a 32-MB limit for disk-partition sizes. Some OEMs, such as Compaq, have followed the SDT specification, which allows them to create partitions larger than 32 MB without causing problems for SmartDrive. But some third-party packages, such as Disk Manager from Ontrack, do not follow the standard and operate in direct conflict with Windows.

In July 1990, Microsoft put out a technical bulletin on the subject of SmartDrive. The company is now working with these developers to come up with a solution, even though the issue is really with SmartDrive, not Windows.

In the meantime, you should check

with individual software vendors about compatibility with Windows and SmartDrive. If SmartDrive is not compatible and you want to continue using it in enhanced mode, you must switch the Windows swap-file capabilities from permanent to temporary (a procedure that is described in the Windows 3.0 manual) and modify the [386Enh] section of SYSTEM.INI by disabling the VirtualHdIrq setting. It should read as follows:

```
VirtualHdIrq=OFF
```

When VirtualHdIrq is enabled, Windows, in enhanced mode, can terminate interrupts from the hard disk drive controller, bypassing the ROM routine that handles these interrupts. When VirtualHdIrq is disabled, the ROM routine handles the interrupts, eliminating the problem with the conflicting software or hard disk drive. However, when VirtualHdIrq is disabled, the system's performance is reduced. You should note that a temporary swap file generally operates slower than a permanent swap file. In addition, a temporary swap file must be created each time Windows loads, which reduces performance even further.

### Device Dilemmas

Some DOS applications and certain hard disk drive devices have trouble in enhanced mode because of a conflict with interrupts from the hard disk drive controller; these devices include Borland's Reflex database package, the Plus Hard Card from Plus Development Systems, and all SCSI hard disk drives that use DMA. There are two solutions: The first is to run Windows in standard mode, and the second is to modify the [386Enh] section of SYSTEM.INI by disabling the VirtualHdIrq setting with the following statement:

```
VirtualHdIrq=OFF
```

However, as mentioned earlier, when VirtualHdIrq is disabled, the system's performance is slowed.

### Mouse Problems

Mice are rarely a problem with Windows, but setting up a mouse to run with Windows and DOS applications simultaneously can be a little confusing. Windows doesn't need to have a mouse driver loaded from the CONFIG.SYS file; it only needs to have the correct mouse identified in the SETUP file. DOS applications need to have the mouse driver loaded from the CONFIG.SYS file while

# BYTE BOOK CLUB®

## Membership Order Card

Please enroll me as a member and send the 3 choices listed below, billing me \$3.00. I agree to purchase a minimum of 2 additional books during my first year as outlined under the Club plan described in this ad. Membership in the club is cancellable by me any time after fulfilling my obligation. A shipping and handling charge and local sales tax is added to all shipments.

--	--	--

Signature \_\_\_\_\_

Name \_\_\_\_\_

Address/Apt. # \_\_\_\_\_

City/State/Zip \_\_\_\_\_

This order subject to acceptance by McGraw-Hill. All prices subject to change without notice. Valid for new members only. Foreign member acceptance subject to special conditions. BYCA-033

# BYTE BOOK CLUB®

P.O. Box 582 Hightstown, NJ 08520-9959

# BYTE BOOK CLUB®

## Membership Order Card

Please enroll me as a member and send the 3 choices listed below, billing me \$3.00. I agree to purchase a minimum of 2 additional books during my first year as outlined under the Club plan described in this ad. Membership in the club is cancellable by me any time after fulfilling my obligation. A shipping and handling charge and local sales tax is added to all shipments.

--	--	--

Signature \_\_\_\_\_

Name \_\_\_\_\_

Address/Apt. # \_\_\_\_\_

City/State/Zip \_\_\_\_\_

This order subject to acceptance by McGraw-Hill. All prices subject to change without notice. Valid for new members only. Foreign member acceptance subject to special conditions. BYCA-033

# BYTE BOOK CLUB®

P.O. Box 582 Hightstown, NJ 08520-9959



NO POSTAGE  
NECESSARY  
IF MAILED  
IN THE  
UNITED STATES



**BUSINESS REPLY MAIL**  
FIRST CLASS MAIL PERMIT NO. 42 HIGHTSTOWN, NJ

POSTAGE WILL BE PAID BY ADDRESSEE

**McGraw-Hill Book Clubs**  
**P.O. Box 582**  
**Hightstown, NJ 08520-9452**



NO POSTAGE  
NECESSARY  
IF MAILED  
IN THE  
UNITED STATES



**BUSINESS REPLY MAIL**  
FIRST CLASS MAIL PERMIT NO. 42 HIGHTSTOWN, NJ

POSTAGE WILL BE PAID BY ADDRESSEE

**McGraw-Hill Book Clubs**  
**P.O. Box 582**  
**Hightstown, NJ 08520-9452**



# Take any 3 books for only \$1<sup>00</sup> each

when you join **BYTE Book Club®**

**LOCAL AREA NETWORKS: Architectures and Implementations.**  
By J. Martin, with K. K. Chapman.  
An indispensable reference for all who buy, install, maintain, or manage LAN services. 353 pp., illus.  
584900-3 Pub. Pr., \$44.00

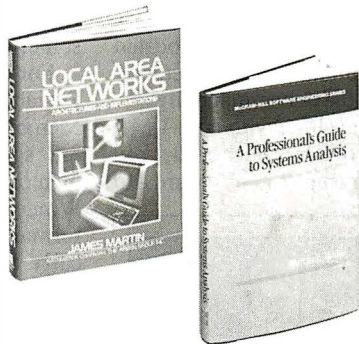

**A PROFESSIONAL'S GUIDE TO SYSTEM ANALYSIS.**  
By M.E. Modell.  
Detailed coverage of how to conduct a cost-benefit analysis, how to document and validate your findings—to design the best systems for your user's needs. 307 pp., illus.  
426/325 Pub. Pr., \$37.95

**ADVANCED TURBO C.**  
By J. T. Smith.  
Mastering Turbo C has never been easier. Coverage includes string processing, screen handling with Turbo C Tools, keyboard input, file handling, memory mgmt, interrupt services, and more. 256 pp., illus., Paperback  
587/078 Pub. Pr., \$28.95

**DATA EXCHANGE: PC/MS-DOS.**  
By S. Ross.  
Convert files quickly and painlessly with step-by-step instructions from word processing programs to spreadsheets to databases, then from databases to word processing programs. 426 pp., illus. Paperback  
539/235 Pub. Pr., \$24.95

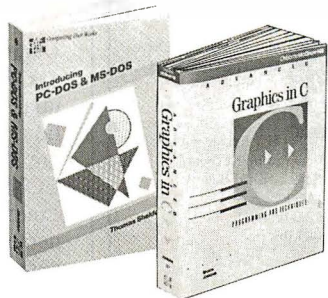

**ARTIFICIAL INTELLIGENCE USING C: The C Programmer's Guide to AI Techniques.**  
By H. Schildt.  
This hands-on guide shows you how to create your own AI applications and systems using C. 412 pp., 37 illus.  
881255-0 Pub. Pr., \$21.95

**DATA PROCESSING IN UNIX.**  
By R. S. Tare.  
The only guide you'll ever need to harness the full power of UNIX for database management. Examines such applications as INFORMIX, INGRES, and UNIFY. 438 pp., illus.  
628/858 Pub. Pr., \$39.95

**DATABASE SYSTEM CONCEPTS.**  
By H.F. Korth and A. Silberschatz.  
From fundamental concepts to advanced problem solving, this book provides a clear understanding of the design and use of database systems. 546 pp., illus.  
447/527 Pub. Pr., \$46.95

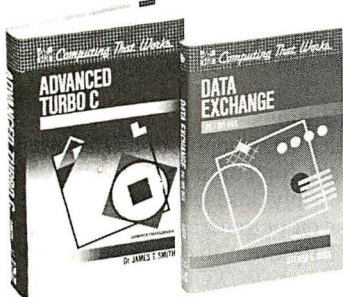

**INTRODUCING PC-DOS & MS-DOS, Second Ed.**  
By T. Sheldon.  
Covers all releases through 4.0, as well as Microsoft Windows and DOS-SHELL. Features a tutorial format, with expanded coverage of batch file techniques. 403 pp. illus. Paperback  
565/651 Pub. Pr., \$27.95

**ADVANCED GRAPHICS IN C: Programming and Techniques.**  
By N. Johnson.  
Now C Programmers can write crisp graphics programs for the IBM-PC using the IBM EGA or the AT&T Image Capture Board. 430 pp., illus. Paperback  
881257-7 Pub. Pr., \$22.95

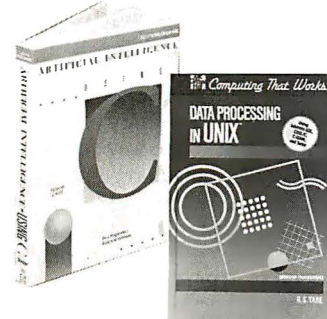

**PROGRAMMING USING THE C LANGUAGE.**  
By R.C. Hutchinson and S.B. Just.  
This practical authoritative book gives you the tools and guidance you need. Includes program organization, sorting algorithms, recursion, linked lists, and more. 519 pp., illus.  
315/418 Pub. Pr., \$29.95

All books are hardcover unless otherwise specified. A shipping/handling charge and sales tax will be added to all orders. If card is missing, use this address to join:  
©1991 BYTE Book Club® P.O. Box 582, Hightstown NJ 08520-9452

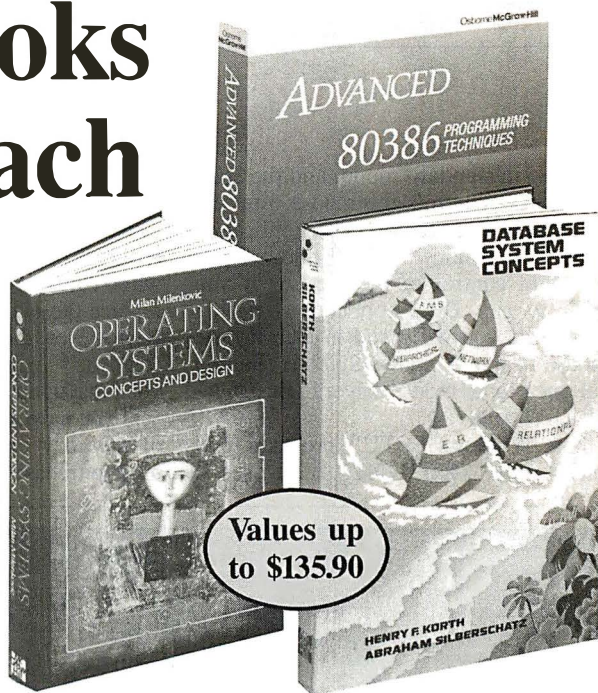

Your one source for computer books from over 100 different publishers

- 80386: A Programming and Design Handbook, 2nd Ed.**  
By P. Brumm and D. Brumm. 585077-X Pub. Pr., \$24.95
- 1-2-3 RELEASE 3: The Complete Reference.**  
By M. Campbell 881318-2 Pub. Pr., \$28.95
- ADVANCED 80386 PROGRAMMING TECHNIQUES.**  
By J.L. Turley. 881342-5 Pub. Pr., \$22.95
- C: The Complete Reference, 2nd Ed.**  
By H. Schildt. 881538-X Pub. Pr., \$28.95
- OPERATING SYSTEMS.**  
By M. Milenkovic. 419/025 Pub. Pr., \$44.95
- POWER GRAPHICS PROGRAMMING.**  
By M. Abrash. 585443-0 Pub. Pr., \$24.95
- A DOS USER'S GUIDE TO UNIX.**  
By D.W. Topham. 585537-2 Pub. Pr., \$27.95
- WINDOWS PROGRAMMING: An Introduction.**  
By W.H. Murray III and C.H. Pappas. 881536-3 Pub. Pr., \$28.95

**Here's how BYTE Book Club® works to serve you: Important information..we make it easy to get!** Today, professionals who perform best are those who are best informed. For reliable, hands-on information, turn to the BYTE Book Club. Every 3 to 4 weeks (12-15 times a year), members receive the Club Bulletin offering more than 30 books—the latest, most important books from all publishers.

**Dependable service. . .we're here to help!** Whether you want information about a book or have a question about your membership, just call us toll-free or drop us a line. To get only the books you want, make your choice on the Reply Card and return it by the date specified. If you want the Main Selection, do nothing—it will be shipped automatically.

**Club convenience. . .we do the work!** You get a wide choice of books that simply cannot be matched by any bookstore. And all your books are conveniently delivered right to your door. You also get 10 full days to decide whether you want the Main selection. If the Club Bulletin ever comes late and you receive a Main Selection you don't want, return it for credit at our expense.

**Substantial savings. . .and a bonus program too!** You enjoy substantial discounts—up to 40%!—on every book you buy. Plus, you're automatically eligible for our Bonus Book Plan which allows you savings up to 70% on a wide selection of books!

**Easy membership terms. . .it's worthwhile to belong!** Your only obligation is to purchase 2 more books—at handsome discounts—during the next 12 months, after which you enjoy the benefits of membership with no further obligation. You or the Club may cancel membership at any time thereafter.

running in standard mode, and the DOS application controls the mouse directly. In enhanced mode, the DOS application runs in a window, but Windows must maintain control of the mouse. If you want to run DOS applications within Windows, you will need to identify the mouse in the Windows SETUP file and call the proper mouse driver in the CONFIG.SYS file.

The Windows SETUP program will check your CONFIG.SYS file to see if

there is a call for a mouse driver and verify that it is the most recent version. Because older versions of mouse drivers do not work properly with DOS applications while running in Windows, SETUP will replace the old driver with the new one. If, however, the driver cannot be located (e.g., it's in a different subdirectory), you must update the driver manually.

If you have a machine with only 1 MB of memory on the motherboard, you must purchase memory add-in cards to

take advantage of protected mode. Although the presence of an add-in card does not necessarily mean there will be problems, configuring the card properly and setting up device drivers makes configuring Windows much more cumbersome.

For example, if you have a Compaq Portable III and the Compaq Expanded Memory Module (which uses the LIM 3.2 specification), you can make this memory available to DOS applications in Windows. However, to improve the performance of applications written specifically for Windows, you need extended memory. Adding an Intel AboveBoard with 2 MB of extended memory is a common alternative. (To use the board, you will also need the Compaq Expansion Chassis.) Be sure that the addresses for the boards don't conflict.

### Communications

If you have DOS applications that use a COM port for communications, they could possibly lose characters in data transmission or generate protection violations. To prevent these problems, you specify the XON/XOFF protocol with the following in your SYSTEM.INI file:

COMnProtocol=XOFF

where *n* is the number for the COM port.

Other problems can arise if you try to take advantage of multiple serial connections, such as a mouse and a modem, that are not utilized in sequential order (i.e., COM1, COM2, COM3, COM4). For example, if you have your mouse connected to the COM1 port, no device connected to the COM2 port, and a modem connected to the COM3 port, you may have transmission failure on the modem because the device is out of order.

Windows requires that the activation of serial ports is performed in logical order and that the mouse resides on COM1 or COM2. If you cannot meet this requirement because of the way your system is configured, you can try this solution from Clifford W. Martin. Martin had an American Megatrends 386/25 Mark III with two serial ports and a mouse on COM1 (IRQ4) and no device accessing COM2 (IRQ3). Due to system configuration limitations, he could not utilize COM3 and had to attach his internal modem to COM4 (also IRQ3).

When running his system in enhanced mode, Martin could not get Windows to recognize COM4. After working with both Microsoft and DCA (makers of Crosstalk) technical support, he added the following lines to his SYSTEM.INI

*"The Blackship 386SX/20 is a highly desirable system both in performance and price."*  
— PC Magazine, November 27, 1990

*"Of our seven contenders, the Blackship 486-25 earned the top value."*  
— InfoWorld, March 12, 1990

*"With its winning combination of quality off-the-shelf parts, the Blackship 386-33 offers solid performance at an affordable price."*  
— PC Magazine, February 13, 1990

*"The Blackship 386-33 offers low price 33-MHz performance... we rate it a very good value."*  
— InfoWorld, July 1989

*"... its price/performance ratio easily justifies PC World's Best Buy recommendation."*  
— PC World, August, 1988

**ONSITE SERVICE**  
GE Computer Service



Some of our recent awards.



Price/Performance Leader... Your "Best Buy" Company.

<p><b>NEW</b> <b>BLK486 SVGA Systems</b></p> <ul style="list-style-type: none"> <li>■ 64K Cache RAM</li> <li>■ 4 MB RAM</li> <li>■ 1.2 MB 5.25" Drive</li> <li>■ 1.44 MB 3.5" Drive</li> <li>■ 200 MB 15 ms IDE Drive</li> <li>■ 16-Bit VGA w/512K</li> </ul> <p>■ 14" 1024 x 768 Color Monitor ■ 1 Parallel, 2 Serial Ports, 1 Game Port ■ 101-Key Keyboard ■ MS DOS 3.3 or 4.01</p> <p><b>486/25 ISA \$3995</b> <b>486/25 EISA \$5295</b> <b>486/33 ISA \$5295</b> <b>486/33 EISA \$6895</b></p> <p><b>\$2595</b></p>	<p><b>NEW</b> <b>BLK 386SX/20 LAPTOP</b></p> <ul style="list-style-type: none"> <li>■ 1 MB RAM</li> <li>■ 1.44 MB 3.5" Drive</li> <li>■ 40 MB IDE Hard Drive</li> <li>■ 640 x 400 VGA LCD Display</li> <li>■ 2 Expansion Slots</li> </ul> <p>■ 81-Key Low Profile Keyboard ■ Internal Sealed Ni-Cd Battery ■ External AC Power ■ MS DOS 3.3 or 4.01 ■ Weight 14.7 lbs</p> <p><b>\$1895</b></p>	<p><b>NEW</b> <b>BLK 286SX LAPTOP</b></p> <ul style="list-style-type: none"> <li>■ 1 MB RAM</li> <li>■ 1.44 MB 3.5" Drive</li> <li>■ 20 MB IDE Hard Drive</li> <li>■ 640 x 400 Mono LCD Display</li> <li>■ 2 Expansion Slots</li> </ul> <p>■ 81-Key Low Profile Keyboard ■ Internal Sealed Ni-Cd Battery ■ External AC Power ■ MS DOS 3.3 or 4.01 ■ Weight 14.7 lbs</p> <p><b>\$1895</b></p>
<p><b>BLK 386/33 SVGA</b></p> <ul style="list-style-type: none"> <li>■ 64K Cache RAM</li> <li>■ 4 MB RAM</li> <li>■ 1.2 MB 5.25" Drive</li> <li>■ 1.44 MB 3.5" Drive</li> <li>■ 200 MB 15 ms IDE Drive</li> <li>■ 16-Bit VGA w/512K</li> </ul> <p>■ 14" 1024 x 768 Color Monitor ■ 1 Parallel, 2 Serial Ports, 1 Game Port ■ 101-Key Keyboard ■ MS DOS 3.3 or 4.01</p> <p><b>\$3495</b></p>	<p><b>BLK 386/25 SVGA</b></p> <ul style="list-style-type: none"> <li>■ 4 MB RAM</li> <li>■ 1.2 MB 5.25" Drive</li> <li>■ 1.44 MB 3.5" Drive</li> <li>■ 105 MB IDE Drive</li> <li>■ 16-Bit VGA w/512K</li> </ul> <p>■ 14" 1024 x 768 Color Monitor ■ 1 Parallel, 2 Serial Ports, 1 Game Port ■ 101-Key Keyboard ■ MS DOS 3.3 or 4.01</p> <p><b>386/25 SVGA \$2495</b> <b>With 64K Cache \$2895</b></p>	<p><b>BLK 386SX VGA Systems</b></p> <ul style="list-style-type: none"> <li>■ 2 MB RAM</li> <li>■ 1.2 MB 5.25" Drive</li> <li>■ 1.44 MB 3.5" Drive</li> <li>■ 40 MB IDE Drive</li> <li>■ 16-Bit VGA w/512K</li> </ul> <p>■ 14" 1024 x 768 Color Monitor ■ 1 Parallel, 2 Serial Ports, 1 Game Port ■ 101-Key Keyboard ■ MS DOS 3.3 or 4.01</p> <p><b>386SX/20 \$1995</b> <b>386SX/16 \$1795</b></p>

**BLK286 VGA Systems**

- 1 MB RAM
- 1.2 MB 5.25" Drive
- 40 MB IDE Drive
- 16-Bit VGA w/256K Monitor
- 101-Key Keyboard

■ 1 Parallel, 2 Serial Ports, 1 Game Port  
■ MS DOS 3.3 or 4.01

**286/25 \$1695**  
**286/16 \$1495**  
**286/12 \$1395**

**Standard Features**

- 30-Day Guarantee
- Unlimited Toll-Free Technical Support
- 1-Year Parts and Labor Warranty
- 1-Year On-Site Service by GE Computer Service
- Custom Configuration

**Call Blackship For All Your Other System and Networking Needs.**

*Prices are subject to change.*

**CALL TOLL-FREE**

**1-800-877-6249**



**BLACKSHIP**  
COMPUTER SYSTEMS, INC.  
4031 Clipper Court • Fremont, CA 94538  
Tel: 415-770-9300 • Fax: 415-770-8674

Mono system, deduct \$250

Buy with

# Confidence

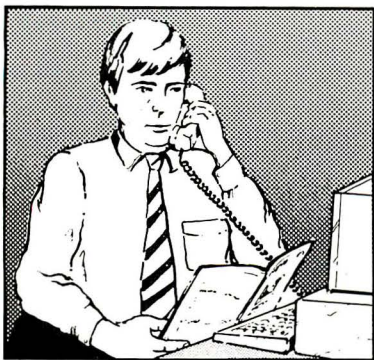

In an effort to make your telephone purchasing a more successful and pleasurable activity, The Microcomputer Marketing Council of the Direct Marketing Association, Inc. offers this advice, "A knowledgeable buyer will be a successful buyer." These are specific facts you should know about the prospective seller before placing an order:

## Ask These Important Questions

- How long has the company been in business?
- Does the company offer technical assistance?
- Is there a service facility?
- Are manufacturer's warranties handled through the company?
- Does the seller have formal return and refund policies?
- Is there an additional charge for use of credit cards?
- Are credit card charges held until time of shipment?
- What are shipping costs for items ordered?

Reputable computer dealers will answer all these questions to your satisfaction. Don't settle for less when buying your computer hardware, software, peripherals and supplies.

## Purchasing Guidelines

- State as completely and accurately as you can what merchandise you want including brand name, model number, catalog number.
- Establish that the item is in stock and confirm shipping date.
- Confirm that the price is as advertised.
- Obtain an order number and identification of the sales representative.
- Make a record of your order, noting exact price including shipping, date of order, promised shipping date and order number.

If you ever have a problem, remember to deal first with the seller. If you cannot resolve the problem, write to MAIL ORDER ACTION LINE, c/o DMA, 6 E. 43rd St., New York, NY 10017.

This message is brought to you by:

the MICROCOMPUTER  
MARKETING COUNCIL  
of the Direct Marketing  
Association, Inc.  
6 E. 43rd St.,  
New York, NY 10017

**MMC**  
MICROCOMPUTER  
MARKETING COUNCIL  
of the Direct Marketing Association, Inc.

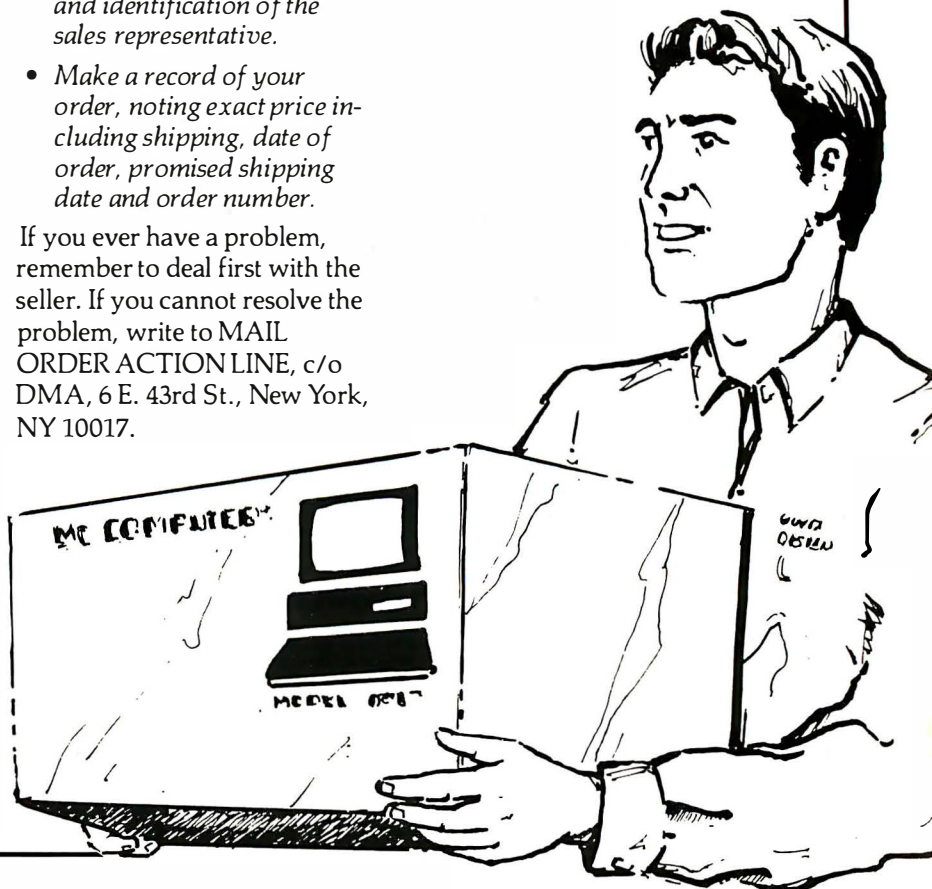

file at the end of the [386ENH] section:

```
Com3Base=3E8h  
Com4Base=2E8h  
Com3IRQ=4  
Com4IRQ=3
```

He then downloaded a file from CompuServe that contained a program called SetComm, which set his computer's BIOS to the proper base address. Adjusting the base address stopped the Windows error

messages but did not give him access to his modem. Then, realizing that COM2 needed to be loaded in some way, Martin got an old XT serial port test plug (the variety that loops pins 2 and 3) and connected it to COM2. The result was successful access to his modem, and everything has run smoothly since.

### Printing and Utilities

If you are using Windows with applications that produce large graphics files,

printing can be less than satisfying, especially if you have a sluggish PostScript device. One of the keys to faster printing (or, in some cases, printing at all) is the printer driver.

In some cases, you may encounter a problem that is not addressed by even the latest drivers. For example, early versions of the NEC LC890 PostScript printer occasionally stall when printing with the Windows Print Manager. When the Print Manager stalls, Windows will notify you. You can complete the print job by activating the Print Manager and resuming the print operation. For the moment, there is no acceptable technical solution for this problem.

The best action to take is to make sure that there is an existing Windows printer driver associated with the printer that you want to use. Older printer drivers that are not Windows-compliant simply will not work.

With regard to utilities, if you have an Epson computer that takes advantage of the screen-saving utility, you should be aware that the utility will sense that the screen is inactive—even when it is not—and clear the display while you are still in Windows. Technically, Windows is still functioning, but it will not display until you exit Windows and start up again. Epson provides documentation on how to disable the screen-saver driver.

### Refinements Take Time

Windows 3.0 is a fine product that does an excellent job of working within the complexities of the DOS environment. Over time, hardware and software manufacturers will deliver products that are better designed to cooperate with Windows, which should help minimize installation and configuration problems.

Once your system is properly configured, Windows should work fine. On most PCs, the SETUP program will take care of everything. On our own systems, we run four or five DOS and Windows applications simultaneously in enhanced mode, along with a variety of add-in boards from different companies. This somewhat hostile environment required tweaking configuration files. Considering what Windows can do, the inconveniences mentioned here are a small price to pay for the improved working environment you will gain. ■

*Jeffrey H. Lubeck and Bruce D. Schatzman are systems consultants based in the Seattle area. They provide systems design and implementation services throughout the U.S. They can be contacted on BIX c/o "editors."*

# LANDMARK/SuperSoft

pc diagnostics • preventative maintenance • benchmark testing • performance enhancement

## Speed Test Your PC

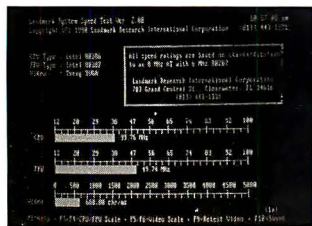

**BYTE Special - Only \$19**

You've seen the Landmark Speed Rating advertised by many major PC manufacturers, now you can have your own copy of the Landmark System Speed Test™.

Accurately measure the CPU, math, and video speeds to **make an informed purchasing decision**. Or, maybe you just want it to win some bets in the office on whose PC is **really faster!** Includes the Landmark AT CMOS RAM Setup program to update your system configuration **on-the-fly**.

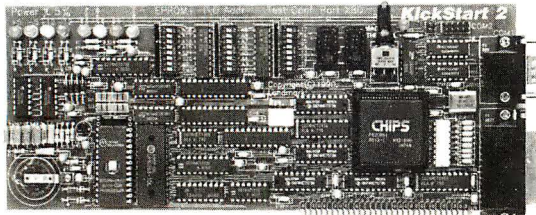

**KickStart 2 is ideal for permanent installation. Eliminates the need for an I/O card, provides remote diagnostic capabilities for quick repair times, and offers a hardware solution to unauthorized access with password protection.**

## The 5 Minute Solution to Floppy Drive Failure

With AlignIt™ you can **clean, diagnose, and align** your floppy drives in minutes **without a scope**. Patented technology requires only a screwdriver to perform ANSI-accurate alignments (.3 mil). Includes "GOLD" feature to align all your PCs to the same in-house standard, **guaranteeing that all your floppies are perfectly interchangeable** between PCs. 80% of all floppy drive failures can be fixed with AlignIt. Don't replace it, save time and money instead. Includes dual size floppies, (high and low density), and no-mess pre-lubricated cleaning diskettes (both sizes) good for 180 uses. Replacements available. For all PC and compatibles.

## Hard Core Testing for Professionals

Landmark/SuperSoft **Service Diagnostics™** is ideal for professionals requiring the **most exhaustive diagnostics**. Each module is CPU specific, **including PS/2s, CP/M, and MS-DOS**. Since 1981, major manufacturers like Wang, Xerox, Prime, Sony, and NCR have relied on **Service Diagnostics** to tackle the toughest operating problems. No utilities, no fancy user interface, just **hard-core diagnostics**. Tests all CPUs, math chips, all memory, floppy, fixed and non-standard disk drives, standard/non-standard printers, system board, video, comm ports and all keyboards. **Self-booting** version doesn't require DOS. ROM-based POST available. Manual offers troubleshooting tips to the component level.

**CALL (800) 683-6866**

**Int'l use FAX (813) 443-6603, Voice (813) 443-1331**

Visa • MC • Amex • CDOs Accepted • Dealer Inquiries Welcome

Copyright © 1981-1990, Landmark, SuperSoft, PC Probe, KickStart, AlignIt, JumpStart, and Service Diagnostics are trademarks and registered trademarks of Landmark Research International Corp. All Rights Reserved. Other names are trademarks of their associated owners.

## PC Probe Slashes Downtime, Frustrating Operating Problems

With PC Probe™ you'll save time and money when your PC starts acting up. In one easy-to-use package, you get: **Diagnostics, Benchmarks, Performance Enhancement Utilities, and System Information**. Combined, this arsenal of tools will keep your system up and running at peak performance and remove the mystery about what's inside.

PC Probe diagnostic testing quickly isolates the source of hardware problems, even locating bad RAM chips. It tests system board, RAM, video, keyboard, comm ports, floppy drive, hard drive, Ethernet card and more. Run PC Probe tests in batch mode or single pass, **remote** or on-site.

PC Probe will allow you to: **increase your data transfer rate** by determining optimum interleave and changing it, **prevent catastrophic data loss** by performing hard drive data revitalization, **reformat the hard drive, run external programs**, display and edit CMOS RAM on-the-fly, **prevent accidental hard drive data destruction** with passwords, and **run with your device drivers installed**. The on-line manual has over 200 pages with built-in table of contents, **topic/text search**, and troubleshooting tips. PC Probe comes with dual size floppies and serial/parallel loopback plugs. For PC XT, AT, 386, 486 and compatibles using DOS 2.0 or higher.

## PC Won't Boot? KickStart It!

Don't replace your motherboard, don't call service, use **KickStart 2™**. When serious hardware problems occur, nothing gets you up and running as fast. **KickStart 2 measures power** within 2.5% on those critical voltages, **shows Power-On Self-Test (POST)** failure codes, and features **on-board ROM-based diagnostics** allowing you to **determine and remedy the problem quickly, easily, and inexpensively!**

Built-in serial and parallel I/O allows for testing via modem, or simply logging results to a remote monitor, printer, or laptop. You can **configure your own test routines** and store them in KickStart 2's battery backed-up RAM saving valuable setup time. Includes loopback plugs and Landmark JumpStart ROM BIOS for testing PCs with BIOSes that don't issue POST codes. **KickStart 2 works in any system, regardless of O/S (even UNIX).**

On-board switches, LEDs, and digital displays allow complete control over testing in systems lacking video or disk (ideal for motherboard and system burn-in).

KickStart 2 is the ultimate **SECURITY CARD** too! With both supervisor and user levels of password protection, you can prevent unauthorized use of your PC and accidental running of destructive tests.

Need a **real inexpensive** solution for dead PCs? Try **KickStart 1™**. Shows power status and binary Port 80 POST codes. Error codes are translated in the manual for easy isolation of failed circuit. Includes JumpStart™ AT ROM BIOS.



**LANDMARK/SuperSoft**

First in PC Testing... Since 1981

East Coast: 703 Grand Central St. • Clearwater, FL 34616  
West Coast: 574 Weddell • Sunnyvale, CA 94089



# FAX FACTS

## A look inside PC-based and stand-alone fax devices

In the early 1980s, it looked as though E-mail would take off in a big way. E-mail vendors, including CompuServe, MCI, AT&T, and Telenet, spent millions of dollars on advertising intended to draw new users into the fold. But because E-mail wasn't good at sending pictures and required a certain amount of technical prowess to use, it never really caught on. By contrast, the fax revolution took the nation by storm toward the end of the same decade. Today, owning a fax machine or a PC fax board is de rigueur for even the smallest business.

The overwhelming success of the fax industry is due, at least in part, to effective application of digital technology to the problems of scanning, sending, receiving, and printing images of documents. In this installment of *Under the Hood*, I'll reveal the digital secrets inside fax devices and show you how to exploit them.

### The Pen and the Pendulum

The first fax machine bore little resemblance to modern implementations. Scottish inventor Alexander Bain patented it nearly 150 years ago. Bain had developed a system of synchronized clocks, similar to those used in schools and office buildings to this day. The pendulum of each "slave" clock could be caught and held by an electromagnet at the top of its swing to keep it from getting ahead of a "master" clock.

Bain cleverly realized that he could create all sorts of devices that relied on two synchronized pendulums. One, which he patented in 1843, was a simple facsimile system. Bain attached a metal

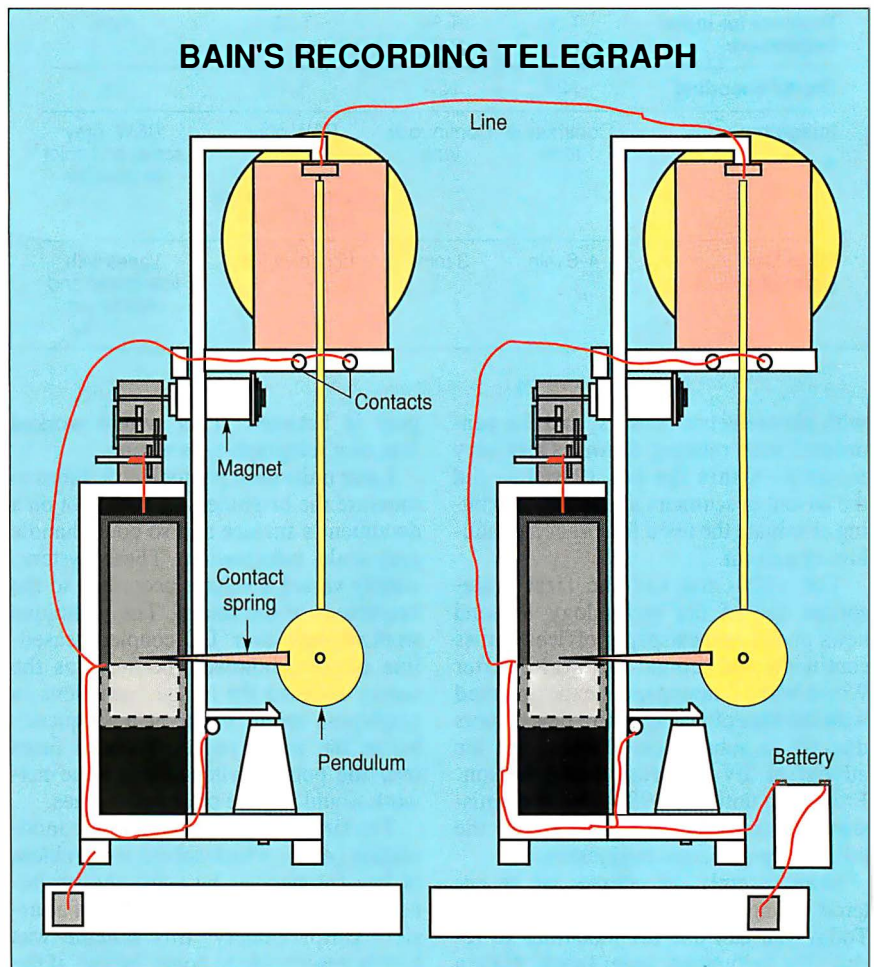

**Figure 1:** Synchronized pendulums drove the world's first fax machine. (Courtesy of Artech House, Inc., © 1989)

stylus to the pendulum of each of two synchronized clocks (see figure 1). He then rigged the stylus at the sending end so that it swept across a block of metal type, making contact wherever the type stood out from the block. This caused a voltage to be applied to a similar stylus at the receiving end, reproducing an arc of the image on a block holding an electro-sensitive recording medium. The blocks

at both ends were lowered a fraction of an inch after each sweep of the pendulum until the entire image was reproduced.

Primitive though it was, Bain's invention formed the basis for many later designs. Italian inventor Giovanni Casselli used an improved version of Bain's device to start a commercial fax network in France in 1865. In later decades, other inventors replaced the metal contacts

CCITT FAX STANDARDS

**Table 1:** While the Group 4 standard struggles for acceptance, vendors continue to improve already widely accepted Group 3-based products.

CCITT standards	Group 1	Group 2	Group 3	Group 4
<b>General</b>	T.2	T.3	T.4	T.5—apparatus T.6—coding T.62—control
<b>Modulation standard</b>	T.2 (tones or V.21 for initial handshake)	T.3	V.27ter V.29 V.21 (handshake only)	N/A
<b>Modulation schema</b>	AM or FM	VSB, PM	FSK, PSK, QAM	N/A
<b>Protocol for initial handshake</b>	T.30	T.30	T.30	N/A
<b>Digital encoding</b>	N/A	N/A	T.4	T.6
<b>Image type</b>	Continuous tone	Continuous tone	B&W only (possible extensions for discrete gray scale and color)	B&W, gray scale, and color all possible
<b>Page time (approx.)</b>	4-6 min.	3 min.	12 sec.-1 min.	Varies with line speed and resolution

N/A = Not applicable.

with photoelectric sensors, and the pendulums with rotating drums. Only very recently—within the last 12 years—did the advent of scanners and thermal printing eliminate the need for either a pendulum or a drum.

The 1920s marked the first widespread use of fax technology to send news photos to newspaper offices across continents and around the world. After World War II, newspapers experimented with the idea of faxing entire newspapers directly to subscribers' homes, but the advent of TV torpedoed that notion. From then until the 1980s, fax transmission primarily served journalists, the military, police, and businesses.

More recently, of course, we've entered the age of personal fax machines. Today you can use fax machines to receive the daily news, order lunch, place a personal or classified ad, submit a question to a radio talk show, apply for a job, or enter a contest. This trend is likely to continue as faxing becomes the method of choice for quick point-to-point message exchange. E-mail may catch up one day, but not until it's as simple as pushing a single button on a fax machine.

**Getting the Picture**

How do fax devices send and receive pictures? Bain's fax machine, like a telegraph key, was binary: It could indicate only black or white, with no shades of

gray in between. This system worked fine over telegraph-type wiring.

Later units used photoelectric tubes to measure the brightness of each spot on a document's surface and so could handle gray-scale information. These systems simply varied a voltage according to the brightness of the image. The technique worked only over DC-coupled leased-line circuits, however, because, as the sensor scanned the image, variations in brightness might occur at a frequency below the audio range. To send faxes over the public switched telephone network would require other techniques.

The first solution was amplitude modulation (AM), which solved the problem of low frequencies by using the brightness signal to vary the amplitude of a carrier. Unfortunately, this scheme was highly susceptible to noise. Worse, if the gain of the circuit changed during the transmission, light and dark bands appeared in the image. As a result, AM was used mostly on specially conditioned leased lines. Other modulation schemes followed, including frequency modulation (FM), phase modulation (PM), and vestigial sideband modulation (VSB), a form of AM that compresses the required bandwidth of an AM signal.

At first, analog fax technology wasn't standardized at all—you simply had to buy the sending and receiving units from the same manufacturer. But in 1966, the

Electronics Industries Association announced the first fax standard—RS-328; the CCITT followed shortly thereafter with the Group 1 and Group 2 standards.

**Digital Fax**

Fax didn't really come into its own, however, until the advent of Group 3—a digital fax standard that allowed high-speed, reliable transmission over ordinary telephone lines. All modern fax devices use Group 3. The availability of inexpensive modem modules that implement Group 3 made today's high-quality, under-\$1000 desktop units possible. Group 3 is covered in some detail below.

Group 4 is—at least for now—still a twinkle in the eyes of the CCITT fax standards makers. Primarily designed to work with ISDN, switched data networks, or dedicated digital circuits, Group 4 is a layered standard, laid out in terms of the Open Systems Interconnection Reference Model. It offers high-speed transmission, excellent control over errors, and room for advanced features such as gray-scale and color imaging. Alas, like many standards written before any real-life machine was ever built, Group 4 is so complex that only a handful of experts understand how to implement it. Furthermore, its popularity will almost certainly be limited, because there's no universal way (at least right now) to use it over ordinary voice-grade phone lines and because equipment from different manufacturers can't interoperate. Therefore, Group 4—if it succeeds at all—is likely to be used only in applications where high speed and other special features are important. Group 3—together with proposed extensions that may give it gray scale, color, and faster transmission—will be the primary fax standard for the foreseeable future. (See table 1 for a comparison of the CCITT fax standards.)

**Anatomy of a Group 3 Fax Call**

Here is a close look at how a Group 3 fax device works—from the initial telephone call and handshake sequence through the data encoding, transmission, and decoding. The CCITT T.30 specification divides a telephone call that includes a fax transmission into several phases, as shown in figure 2, beginning with call establishment (phase A) and ending with call release (phase E). (See table 2 for a breakdown of each phase.)

In phase A, the calling device dials a number and begins sending a signal called the Calling Tone (CNG). If you've ever accidentally received a fax call on your ordinary telephone, you've heard

this signal: It's an 1100-Hz tone that's on for half a second, then off for 3 seconds. An electronic voice/fax switch can recognize the CNG and automatically put a fax device on the line. It's also easy for a human to recognize the signal and do the same. Finally, two humans can manually switch their machines onto the line after a voice exchange.

When the called device answers, it, too, advertises its presence. As you probably know if you've inadvertently called one, a fax machine picks up the line with a shrill 2100-Hz tone that's known as the

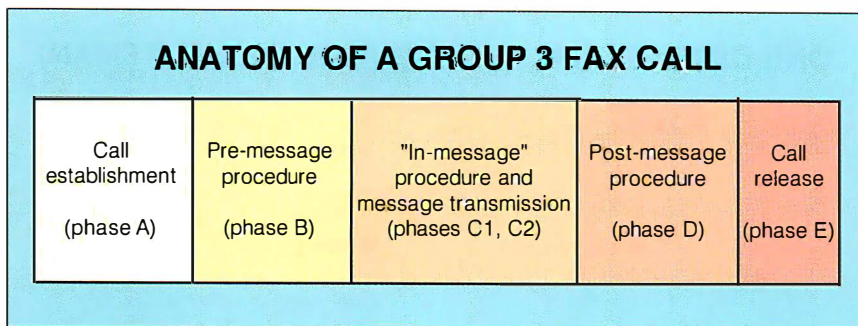
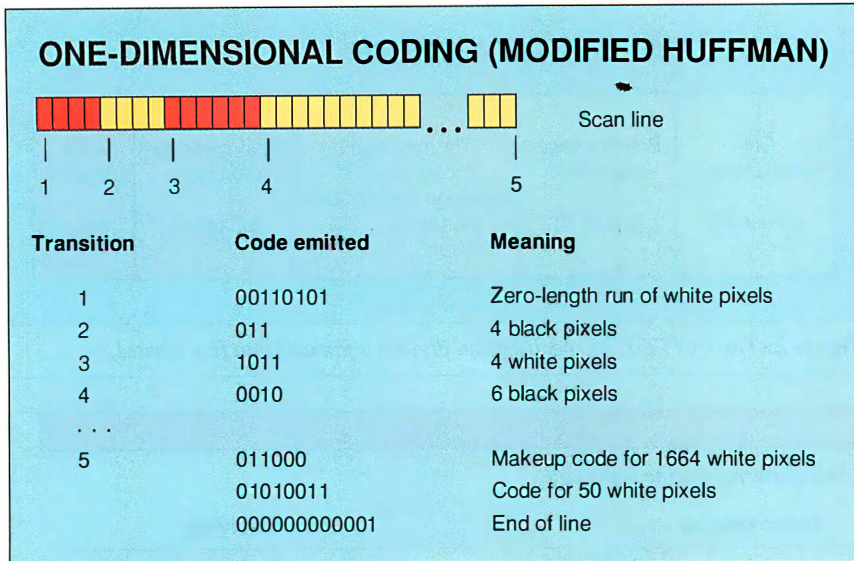

Figure 2: The CCITT T.30 specification divides a fax call into five phases.

PROGRESS OF A GROUP 3 FAX CALL

Table 2: Signals exchanged between caller and answerer during a fax call.

	Caller sending		Caller receiving	
	Caller (sending)	Answerer (receiving)	Caller (polling)	Answerer (sending)
<b>Call establishment (phase A)</b> Units are connected and recognize one another as fax machines.	Calling Tone (CNG)	Called Station Identification (CED)	Calling Tone (CNG)	Called Station Identification (CED)
<b>Premessage procedure (phase B)</b> <b>Identification section:</b> Answering machine identifies itself and describes capabilities.  <b>Command section:</b> Caller sends its own identifying information and a command to send or receive a fax. Signaling switches to new modulation scheme (2400 to 9600 bps).	Digital Command Signal (DCS) Transmitting Subscriber Information (TSI) Nonstandard Facilities Setup (NSS)  Modem phasing and training signals	Digital Identification Signal (DIS) Nonstandard Facilities (NSF) Called Subscriber Identification (CSI) Optional Group 2 and Group 1 tone signals  Confirmation to Receive (CFR)	Digital Transmit Command (DTC) Calling Subscriber Information (CSI) Nonstandard Facilities Command (NSC)  Confirmation to Receive (CFR)	Digital Identification Signal (DIS) Nonstandard Facilities (NSF) Called Subscriber Identification (CSI) Optional Group 2 and Group 1 tone signals  Digital Command Signal (DCS) Modem phasing and training signals
<b>In-message procedure (phase C1)</b> <b>Message transmission (phase C2)</b>	Fax message	Retransmission requests (only if ECM implemented)	Retransmission requests (only if ECM implemented)	Fax message
<b>Postmessage procedure (phase D)</b>  Transmission is confirmed, and units agree on what to do next.	Multipage Signal (MPS) or End of Message (EOM) or End of Procedure (EOP)	Message Confirmation (MCF)	Message Confirmation (MCF)	Multipage Signal (MPS) or End of Message (EOM) or End of Procedure (EOP)
<b>Call release (phase E)</b>	Disconnect (DCN) (Hangs up)			Disconnect (DCN) (Hangs up)



**Figure 3:** In one-dimensional coding, the sender looks for transitions from black to white (or vice versa) and reports the number of pixels since the previous transition. To prevent an unsightly blotch from appearing in the event of an error, the line must always start with a "white" run length (which can be zero if the first pixel is black, as shown above). The code for a run of black pixels is not the same as for an equal number of white pixels because they are not as statistically likely.

Called Station Identification (CED). Then, without waiting for a response, it starts phase B, the premessage procedure. If you're listening to the line at this point, you'll hear the machine that is answering emit a warble, sometimes followed by one or two lower tones. The machine repeats the tones (if any) and the warble until it receives a response or gives up.

What's going on? The distinctive warble is the frequency shift keying (FSK) signal from a 300-bps CCITT V.21 modem. (The standard also makes provisions for use of a 2400-bps V.27ter modem, although this arrangement is less common.) In either case, the burst of digital information tells the caller about the machine that answered the call. The data is packaged as frames that conform to the high-level data-link control (HDLC) standard. It always contains a frame called the Digital Identification Signal (DIS), which describes the standard CCITT features of the machine. It can also contain two other frames: a Nonstandard Facilities (NSF) frame, which tells the caller about vendor-specific features, and, almost always, a Called Subscriber Identification (CSI) frame, which contains the answerer's phone number. The NSF frame, which can be followed by more frames containing information about nonstandard facilities, lends the protocol a great deal of flexibility. It can be used, for instance, to imple-

ment features such as encryption and fax store and forward, which weren't contemplated in the original T.30 standard.

The optional tone signals are there for downward compatibility. They are an invitation to a Group 2 or Group 1 fax machine to make a connection using its native protocol. (Since these older machines don't use digital transmission, they can't decipher the digital information, but they will recognize the tones.) In either case, this first one-way message from the answerer to the caller is called the Identification section of phase B.

If the two devices are both Group 3 units, the caller will recognize the digital information and respond. (HDLC frames have check sequences built in, so this part of the transaction is protected against errors.) During the second part of phase B, the Command section, the caller responds—also using a V.21 modem signal—with information about itself and its intentions.

If the caller is transmitting, it will send a Digital Command Signal (DCS), which tells the answerer how to receive the fax. Modem speed, image width, image encoding, and page length are all included in this frame. (The caller knows the capabilities of the answerer because they were transmitted as part of the DIS.) The caller may also send a Transmitting Subscriber Information (TSI) frame with the caller's phone number (this may be used to screen calls). It

may also send a Nonstandard Facilities Setup (NSS) command, which is a response to an NSF frame.

If the caller is polling, the process is slightly different. The caller will send a Digital Transmit Command frame, which asks for a page to be sent and gives information about the caller's facilities. It may also send a Calling Subscriber Identification (CIG) frame (which gives the caller's phone number), with or without a Nonstandard Facilities Command (NSC), which is a response to an NSF frame. The machine that is answering will then take over, sending a DCS of its own. (Note that the machine that is sending ultimately has control over which features are used.)

Next, the device that's going to be sending fires up the higher-speed modem it's using to send the fax. Depending on the quality of the line and the capabilities of the machines, it may use either V.27ter (PSK) modulation (4800 or 2400 bps) or V.29 (QAM) modulation (9600 or 7200 bps). A training sequence (a series of signals designed to let the receiver adjust to line conditions) is sent, followed by a Training Check Frame (TCF). If the receiver successfully receives the TCF, it uses its V.21 modem to send a Confirmation to Receive (CFR) frame. Otherwise, it sends a Failure to Train signal. The sender may then send a new DCS frame requesting a lower transmission rate.

The sender transmits the fax during phase C, the in-message procedure and message transmission. Interestingly, in the original CCITT fax standards, this phase—unlike the earlier phases—had no error checking. Why? Because both V.27ter and V.29 are half-duplex protocols. Error checking requires turning the line around, which can take a lot of time and run up transmission costs. However, the CCITT has since added an Error Correction Mode (ECM) that encapsulates the data within HDLC frames, providing the receiver with an opportunity to check for, and request retransmission of, garbled data. (There's also an error-control mode that tries to limit the effects of errors, but it's not used much in practice.)

The CCITT T.30 specification describes two parts of phase C that go on simultaneously. Phase C1 includes synchronization, line monitoring, and detection of problems. Phase C2 includes the transmission of the data. Because the receiver may be anything from a slow thermal-printing unit to a fast computer, the data is paced according to the receiver's ability to process it. (The minimum time between lines has already been agreed to

# SALE! SALE! SALE!

\$3.00 each or 6 for \$15.00 U.S. includes shipping and handling.

\$4.00 each or 6 for \$20.00 Foreign includes shipping and handling.

## BYTE BACK ISSUES

Limited Quantities — Order Now!

	1979	1980	1981	1982	1983	1984	1985	1986	1987	1988	1989
January			■		■				■		
February		■									
March	■		■								
April											
May									■		
June			■								
July											
August		■	■		■						
September			■								
October		■									
November		■		■							
December		■									
Inside the IBM PCs	■	■	■	■	■			■	■		

BYTE '83-'84 Index \$2.00

BYTE '85 Index \$2.00

BYTE '88 Index \$2.00

Available Issues

### Special Bound Copies of BYTE

Volume III, Part 1— January 1978 through June 1978

Volume III, Part 2— July 1978 through December 1978

\$7.95 U.S. includes shipping and handling

\$9.95 foreign includes shipping and handling

Please indicate which issues you would like by checking (✓) the boxes.

Send requests with payments to:

BYTE Back Issues  
One Phoenix Mill Lane  
Peterborough, NH 03458  
(603) 924-9281

Check enclosed. Payments from foreign countries must be made in U.S. funds payable at a U.S. bank.

Name \_\_\_\_\_

Address \_\_\_\_\_

City \_\_\_\_\_ State \_\_\_\_\_ Zip \_\_\_\_\_

Postcode \_\_\_\_\_ City \_\_\_\_\_

Country \_\_\_\_\_

Charge:  VISA  MasterCard

Card # \_\_\_\_\_

Exp. Date \_\_\_\_\_

Signature \_\_\_\_\_

during the initial negotiations.)

After the fax is sent, phase D, the postmessage procedure, begins. Both sides revert to using HDLC packets as they did in phase A and phase B. If the sender has more pages to transmit, it sends a frame called the Multipage Signal (MPS). If the receiver confirms with a Message Confirmation (MCF) frame, phase C starts again for the next page. If the sender has no more pages, it sends either an End of Message (EOM) frame to indicate that the message is done or an End of Procedure (EOP) frame to indicate that it wants to end the call, and it then waits for a confirmation. Both sides can also send other kinds of frames that indicate problems or request manual intervention.

When the call is done, phase E, call release, occurs. The station that transmitted last sends a Disconnect (DCN)

frame just before hanging up; it doesn't wait for a response.

### Image Compression and Encoding

A typical Group 3 fax image might be 1728 pixels across and 1142 pixels from top to bottom—or 1,973,376 pixels in all. If the image were sent uncompressed at 9600 bps, with no delay between lines and no signaling overhead, the image would take roughly 206 seconds to send. If this were the only option, it would have rendered Group 3 uncompetitive with Group 2 (the so-called 3-minute fax). Fortunately, it is possible to reduce the time required to send a Group 3 fax by using one of two compression techniques. The first is a one-dimensional *modified Huffman code*; the second is a two-dimensional *modified READ* (relative addressing) *code*.

The first and most common Group 3

coding scheme is one-dimensional; that is, it takes advantage of similarities between pixels on the same line, but not between pixels on successive lines. It uses a combination of run-length and static (not adaptive) Huffman encoding.

Figure 3 shows a simple example of one-dimensional coding. The modified Huffman scheme allows runs of 0 to 63 pixels of the same color to be represented by a Huffman code up to 8 bits long (for runs of white pixels) or 12 bits long (for runs of black pixels). The codes for runs of white and black pixels are different because the statistical distributions are different (runs of black pixels tend to be shorter than runs of white ones in most printed documents).

If the run is longer than 63 pixels, a special code called a *makeup code* is prefixed to the code word. Each makeup code adds a multiple of 64 pixels to the run length. Only one makeup code plus one normal run-length code is needed to make a run of up to 2623 pixels long (wider than a normal fax transmission). The makeup codes constitute the modified portion of the Huffman encoding scheme.

The second, more powerful encoding scheme is 2-D, and it does take advantage of similarities between adjacent lines. The first line is sent with ordinary 1-D encoding, but the lines after that are represented by codes that describe the *differences* between the locations of transitions on the line (called the *reference line*) and those on the current one (called the *coding line*). The way these differences are represented is subtle (see figure 4). A pair of transitions on the reference line can be skipped (pass mode), a transition can be shifted a small amount to the left or right (vertical mode), or a new pair of transitions can be added (horizontal mode) to derive the new line from the old one.

One problem with 2-D encoding is that an error in the reference line will propagate to every line that's derived from it. Therefore, Group 3 fax devices typically allow no more than one code line per reference line in a standard-resolution fax and three code lines per reference line in a fine-resolution fax (which has double the number of lines per inch). This safeguard prevents an error from obliterating a feature that's more than two standard lines tall. Still, despite this restriction, 2-D coding can cut transmission time by as much as 50 percent if the receiver is fast enough. And, hopefully, by the time you read this, the CCITT will have eliminated the requirement to send frequent reference lines when ECM is being used.

*continued*

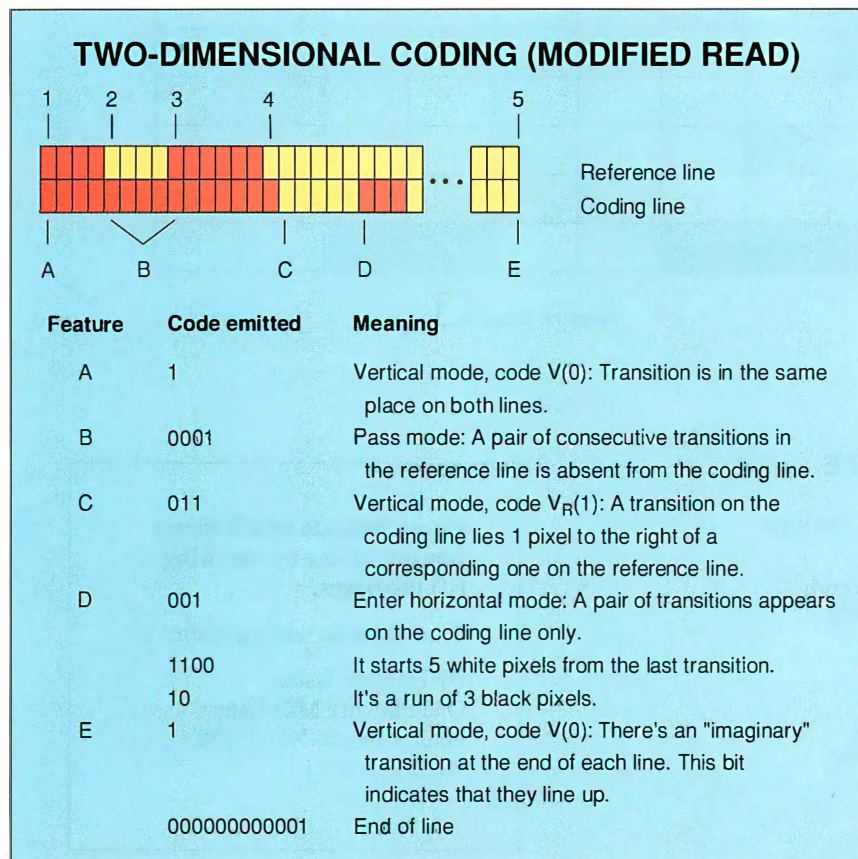

**Figure 4:** In two-dimensional coding (*modified READ*, or *relative addressing*), the sender looks for correspondences between the pixels on an earlier line (called the *reference line*) and the current one (the *coding line*). In vertical mode, the sender indicates that a transition is shifted up to 3 pixels left or right from one on the reference line. (This scheme is excellent for coding slanted lines.) In pass mode, the sender indicates that a pair of transitions on the reference line doesn't occur on the coding line and must be "passed by." Finally, in horizontal mode, the sender can indicate that there's a new pair of transitions on the coding line that wasn't there on the reference line.

### The Evolution of PC Fax

PC fax boards are now quite common, but few people know how they got their start. Interestingly, the first company to make a PC fax product—a firm called GammaLink—originally implemented it as an extension of a microcomputer-to-mainframe communications link. GammaLink had been using a Rockwell fax modem module in its two-board synchronous data-link control (SDLC) product because that module offered many features for automatic dial-up communications—something that was hard to find in other V.29 modems at the time. When the company began to explore using the fax modem as a fax device, it found a contractor who was interested enough in obtaining a PC fax interface to help fund the project.

GammaLink released its first fax product in December 1985 and followed up with a less expensive single-board unit in the summer of 1986. This was the time of the big office fax boom, and other companies (including Intel and Quadram) also saw the market window and quickly introduced their own products. By 1989, vendors were seeing large enough economies of scale to offer low-end boards for as little as \$150.

Most PC fax boards offer roughly the same capabilities. With such a board, you can receive faxes, print them, and store them on your hard disk. You can also create outgoing faxes from text and graphics files, as well as images you've scanned in. Many fax boards can act as fax servers for large networks of computers—sending, receiving, and routing faxes for an entire office.

Fax boards do many things better than ordinary fax machines. Text and graphics created on a PC almost always come out better at the other end than documents fed through a fax machine's scanner. Broadcasts are simple; all you need to do is prepare a list of numbers and let the computer do the calling. You can get clear, nonfading plain paper output from your laser printer, and you can save paper by previewing faxes before you print them out (a must if you get a lot of "junk fax"). Eventually, you may even be able to send binary files to anyone else with a computer and a fax board. (Currently, most manufacturers implement their own proprietary standards; however, the CCITT may soon approve a standard for binary file transfer.)

Still, the PC fax board will never replace the fax machine for many applications. A fax machine can wake up when the phone rings; by contrast, a computer might miss a call by the time it boots up

and so must be left on 24 hours a day. The fax machine comes with a built-in scanner and printer; there's no need to plunk down \$1000 or more each for good-quality computer peripherals. Certain brands of fax machines use the NSF feature of the T.30 protocol to offer superfine resolution, photo (gray-scale) mode, better data compression, and store and forward—features that are not often found on fax boards. And some vendors, such as Ricoh and Nippon Telephone and

Telegraph, now offer encrypted fax machines to combat corporate espionage.

Finally, if you're worried about communications charges, you may find that in some situations the fax machine is faster than a PC fax board. Unlike high-quality fax machines, most PC fax boards don't implement 2-D encoding, because some personal computers they fit into are not fast enough to encode the image on the fly while tending to the fax board's many other needs. (It might be

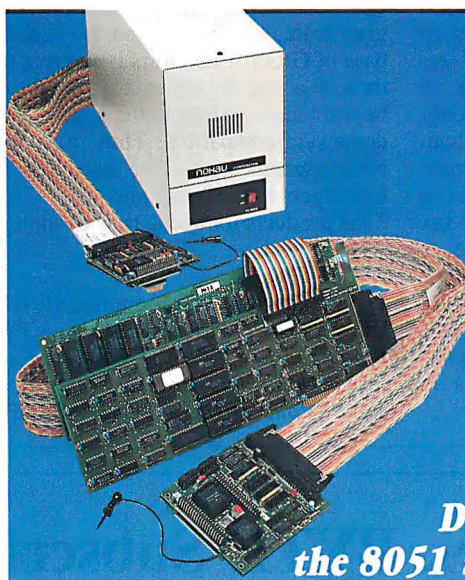

# 8051 & 68HC11

PC-Based  
In-Circuit Emulators

**Nohau**  
Covers All Your  
Development Needs for  
the 8051 and 68HC11 Families!

### Free Demo

You can start your debugging with this **FREE** demo simulator. You can load up to 512 bytes of code, assembler, C, or PL/M and do full debugging/simulation in assembly and source level. A great way to get started for **FREE**. Fantastic for schools! Just call and we'll send it!

### Full Simulator

The full-blown simulator is an extension of the DEMO. You can load up to 64K of code and use 64K of XDATA space. You can program an "external environment" to interact with your code to simulate your target system. The emulator is the hardware extension of the simulator!

### In-Circuit Emulation

The 24MHz real-time emulator has been the industry standard for years. With its complex breakpoint logic and advanced trace, nobody can beat it for performance. Plug-in or RS-232 configuration. All 8051 derivatives are supported!



**NOHAU**  
CORPORATION

51 E. Campbell Avenue, Campbell, CA 95008  
(408) 866-1820 • FAX (408) 378-7869

Australia (02) 654 1873, Austria (0222) 38 76 38, Benelux +31 1858-16133, Canada (514) 689-5889, Denmark (42) 65 81 11, Finland 90-452 1255, France (01)-69 41 28 01, Germany 08131-25083, Great Britain 0962-73 31 40, Hungary 01-137 2182, Israel (03) 48 48 32, Italy (011) 771 00 10 Korea (02) 784 784 1, New Zealand (09) 392-464, Portugal (01) 81 50 454, Sweden, Norway (040) 92 24 25, Singapore (065) 284-6077, Spain (93) 217 2340, Switzerland (01) 740 41 05, Taiwan (02) 7640215, Thailand (02) 281-9596, Yugoslavia 061-57 19 49.

possible to do the encoding in advance, but until the connection is made, the board does not know whether the receiving machine is equipped to receive the results.)

There's also one other option worth mentioning. Users who already have high-quality fax machines but want to send computer-generated faxes may opt for another inexpensive solution: a modem with the added ability to send faxes (but not receive them). These modems take advantage of a quirk of the V.29 modem standard: The receiver works much harder than the transmitter to adjust to the characteristics of the line and requires considerably more hardware to implement. Thus, by implementing only V.21 (which the modem's chip set can probably already handle) and a transmit-only V.29 chip, these modems can send faxes just as well as most computer fax boards can. The downside, of course, is that you lose the screening, forwarding, and digitizing capabilities provided by a full-featured fax board. And you can't use a fax machine as a scanner for signatures and letterheads because there's no way to transmit the image to the PC.

#### Future Fax

While Group 4—the fax standard that relies on all-digital communications—isn't finished yet, many experts say it's already outmoded. Consumers will likely opt instead for the graphics facilities of the X.400 E-mail standard, which provides automatic routing, store and forward, and other desirable features.

Group 3, on the other hand, continues to improve. Work is under way to implement a still-faster modem standard—V.17 (which runs at 14,400 or 12,000 bps)—as well as tighter compression, gray scale, and color. And the installed base of Group 3 fax users is so great that there's a big incentive to provide enhancements—so long as the machines are downward-compatible. Thus, no matter what happens with other standards, we can expect to see better and better Group 3 fax products for a long time to come. ■

#### REFERENCES

1. International Telecommunication Union. *CCITT Red Book, Volume VII—Fascicle VII.3: Terminal Equipment and Protocols for Telematic Services. Recommendations of the T Series.* Geneva:

CCITT 1985. (*Fax standards*)

2. International Telecommunication Union. *CCITT Red Book, Volume VIII—Fascicle VIII.1: Data Communication over the Telephone Network. Recommendations of the V Series.* Geneva: CCITT 1984. (*Modem standards*)

#### BIBLIOGRAPHY

McConnell, Kenneth R., Dennis Bodson, and Richard Schaphorst. *Fax: Digital Facsimile Technology and Applications.* Norwood, MA: Artech House, Inc., 1989.

#### ACKNOWLEDGMENTS

Many thanks to Ken Krechmer, principal of Action Consulting, and Hank Magnuski, cofounder of GammaLink, for their invaluable assistance in the preparation of this article.

L. Brett Glass is a freelance programmer, author, and hardware designer residing in Palo Alto, California. He can be reached on BIX as "glass."

Your questions and comments are welcome. Write to: Editor, BYTE, One Phoenix Mill Lane, Peterborough, NH 03458.

## Attention U.S. BYTE Subscribers

Watch for the next **BYTE DECK** mailing that will be arriving in your mailbox soon!

Use this as a fast, convenient tool to purchase computer products and services. It's loaded with essential hardware and software products that you should be aware of when making your buying decisions...and it's absolutely **FREE!**

If you have a computer product or service, and would like to reach 275,000 influential **BYTE** magazine subscribers, please give Ed Ware a call today at (603) 924-2596.

**BYTE  
DECK**

Here's what a **BYTE Deck** advertiser has to say:

*"Galacticomm does a lot of card-deck advertising, and the **BYTE Deck** has consistently out-pulled every other deck we have ever used."*

Timothy Stryker, Galacticomm, Inc., Fort Lauderdale, FL

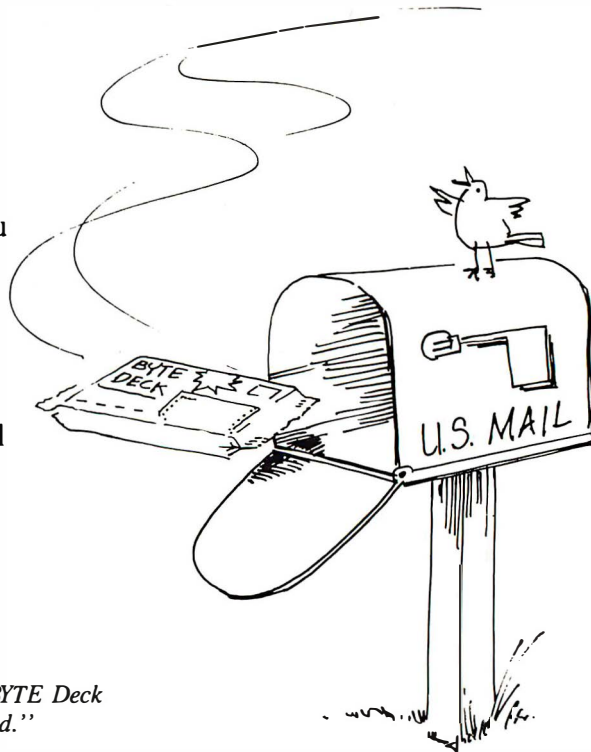





# A PRACTICAL GUIDE TO QUEUEING ANALYSIS

## Simple techniques that you can apply to many problems

**I**n the field of data communications and computer networking, you frequently need to predict the effects of some change in load or design. Perhaps the system's load is increasing, or maybe managers are contemplating a design change.

For example, suppose that an organization supports a number of terminals, personal computers, and workstations on a 4-megabit-per-second token-ring LAN. Another department in the same building is to be cut over onto the network. Can the existing LAN handle the increased workload, or would it be better to provide a second LAN with a bridge between the two?

There are other cases where, based on the expected demand, you may need to design an entirely new system. For example, a department intends to equip all its personnel with a PC and configure these into a LAN with a file server. Based on experience elsewhere in the company, you can estimate the load each PC generates.

In each case, the concern is system performance. In an interactive or real-time application, that usually means response time. In other cases, throughput is the principal issue.

To make performance projections, you need some sort of prediction tool. For networking and communications problems—and, indeed, for many practical real-world problems—analytical models based on queueing theory can often do the job.

### Why Queueing Analysis?

Although queueing theory is mathematically complex, its application to the anal-

ysis of performance can be remarkably straightforward. All you need is a knowledge of basic statistical concepts (means and standard deviations) and a basic understanding of the applicability of queueing theory. Armed with these, you can often make a queueing analysis on the back of an envelope using readily available queueing tables or simple computer programs that occupy only a few lines of code.

To get a handle on performance, you can do one of the following:

1. Do an after-the-fact analysis based on actual values.
2. Make a simple projection by scaling up from existing experience to the expected future environment.
3. Develop an analytical model based on queueing theory.
4. Program and run a simulation model.

Option 1 is no option at all: You wait and see what happens. This leads to unwelcome purchases and unhappy users.

Option 2 sounds more promising. You may take the position that it is impossible to project future demand with any degree of certainty and that it is therefore pointless to attempt some exact modeling procedure. In fact, though, a rough-and-ready projection will provide ballpark estimates. The problem with this approach is that the behavior of most communications systems is not what you would intuitively expect. When there is a shared facility (e.g., a network, a transmission line, a bridge, or a server), then that system's performance typically responds in an exponential way to increases in demand.

Figure 1 gives a typical example. The upper line shows what happens to user response time on a shared facility as the load on that facility increases. The load is expressed as a fraction of capacity. Thus, if you are dealing with a bridge that is ca-

pable of processing 1000 packets per second, then a load of 0.5 represents an input of 500 packets per second, and the response time is the amount of time it takes to retransmit any incoming packet. The lower line is a simple projection based on a knowledge of the behavior of the system up to a load of 0.5. Note that while things appear rosy with a simple projection, performance on the system will, in fact, collapse beyond a load of about 0.8 to 0.9.

Thus, a more exact prediction tool is needed. Option 3 is to use an analytical model expressed as a set of equations. The solutions to these equations yield the desired parameters (e.g., response time and throughput). Even though models based on queueing theory can provide a good fit to real-world problems, you must make some simplifying assumptions to derive equations for the parameters of interest.

The final approach is a simulation model. Here, given a sufficiently powerful and flexible simulation programming language, you can model reality in great detail and avoid making the many assumptions that are required of queueing theory. However, in most cases a simulation model is not needed, or at least it is not advisable as a first step in the analysis.

For one thing, both existing measurements and projections of future load carry with them a certain margin of error. Thus, no matter how good the simulation model is, the value of the results is limited by the quality of the input. In addition, despite the many assumptions required of queueing theory, the results that are produced usually come quite close to those that would be produced by a more careful simulation analysis. Furthermore, with this approach, you can create a queueing analysis in a matter of minutes for a well-defined problem, whereas simulation exercises can take days, weeks, or even longer to program and run.

*continued*

Accordingly, it behooves you to master the basics of queuing theory.

### The Single-Server Queue

The most basic queuing system is depicted in figure 2. The central element of the system is a server that provides some ser-

vice to items. Items from some population of items arrive at the system to be served. If the server is idle, it serves an item immediately; otherwise, an arriving item joins a waiting line. When the server has completed serving an item, the item departs, and if there are items

waiting in the queue, one is immediately dispatched to the server.

The figure also illustrates the basic parameters associated with a queuing model. Items arrive at the facility at some average rate (items arriving per second), denoted as  $\lambda$ . At any given time, a certain number of items (zero or more) will be waiting in the queue; the average number waiting is  $w$ , and the mean time that an item must wait is  $t_w$ . Note that  $t_w$  is averaged over all incoming items, including those that do not wait at all. The server handles incoming items with an average service time,  $s$ ; this is the time interval between the dispatching of an item to the server and the departure of that item from the server. Utilization,  $\rho$ , is the fraction of time that the server is busy, measured over some interval of time. Finally, two parameters apply to the system as a whole. The average number of items in the system, including the item being served (if any) and the items in the queue (if any), is  $q$ ; and the average time that an item spends in the system, waiting and being served, is  $t_q$ .

As the arrival rate in a system increases, the utilization increases, and with it, congestion. The waiting line becomes longer, increasing waiting time. At  $\rho = 1$ , the server is saturated, working 100 percent of the time. Thus, the theoretical maximum input rate that the system can handle is

$$\lambda_{\max} = \frac{1}{s}$$

However, waiting lines become very large near system saturation, growing without bound when  $\rho = 1$ . Practical considerations, such as response time requirements or buffer sizes, usually limit the input rate for a single server to from 70 percent to 90 percent of the theoretical maximum.

To proceed, you need to make some assumptions about this model:

- **Item population:** Typically, you assume an infinite population. If the population is finite, then the population available for arrival is reduced by the number of items currently in the system; this would reduce the arrival rate proportionally. Networking and server problems can usually be handled with an infinite-population assumption.

- **Queue size:** Typically, you assume an infinite queue size. Thus, the waiting line can grow without bound. With a finite queue, items can be lost from the system. In practice, any queue is finite, but in many cases, this makes no sub-

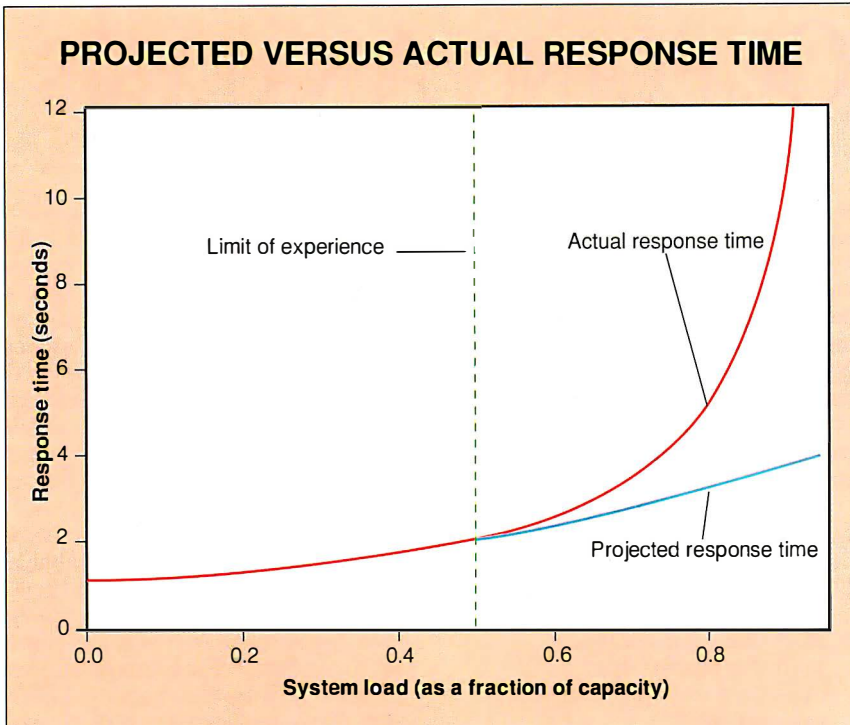

**Figure 1:** The upper line shows what happens to user response time on a shared facility as the load on that facility increases. The load is expressed as a fraction of capacity. Limited experience might lead you to project that response time will continue to be adequate when, in fact, performance on the system will collapse beyond a load of about 0.8 to 0.9.

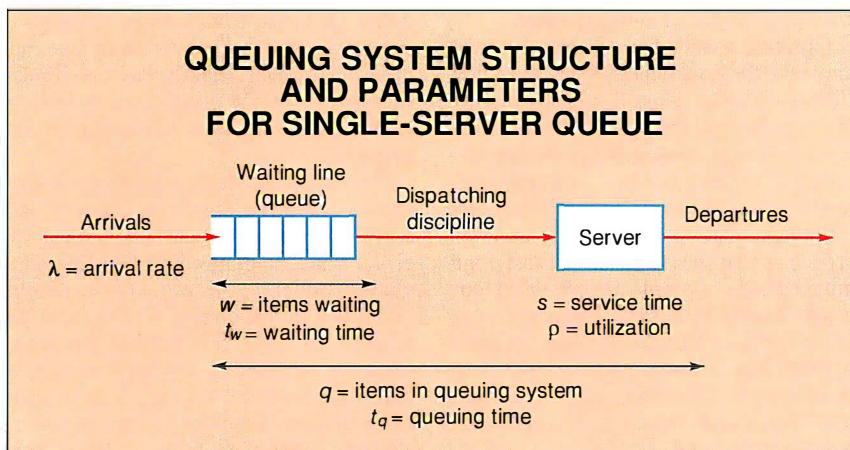

**Figure 2:** Shown here are the queuing system structure and parameters for a single-server queue. The central element of the system is a server. If the server is idle, an item is served immediately. Otherwise, the item joins the queue. When the server has completed serving an item, that item departs, and the next item (if there is one in the queue) is immediately dispatched to the server.

stantive difference to the analysis.

• **Dispatching discipline:** When the server becomes free, and if there is more than one item in the queue, a decision must be made as to which item to dispatch next. The simplest approach is first-in, first-out; this discipline is what is normally implied when the term *queue* is used. Another possibility is last-in, first-out. One that you might encounter in practice is a dispatching discipline based on service time. For example, a LAN bridge may decide to dispatch packets on the basis of shortest first (to generate the greatest number of outgoing packets) or longest first (to minimize processing time relative to transmission time). Unfortunately, a discipline based on service time is very difficult to model analytically.

Table 1 summarizes the notation used in figure 2 and introduces some other useful parameters. In particular, people are often interested in the variability of various parameters, and this is neatly captured in the standard deviation.

### The Multiserver Queue

Figure 3 shows the model that I have been discussing for multiple servers, all sharing a common waiting line. If an item arrives and at least one server is available, then the item is immediately dispatched to that server. It is assumed that all the servers are identical; therefore, if more than one server is available, it makes no difference which server is chosen for the item. If all servers are busy, a waiting line begins to form. As soon as one server becomes free, an item is dispatched from the waiting line using the dispatching discipline in force.

With the exception of utilization, all the parameters illustrated in figure 2 carry over to the multiserver case with the same interpretation. If you have  $M$  identical servers, then  $\rho$  is the utilization of each server, and you can consider  $M\rho$  to be the utilization of the entire system. Thus, the theoretical maximum utilization is  $M \times 100$  percent, and the theoretical maximum input rate is as follows:

$$\lambda_{\max} = \frac{M}{s}$$

### Basic Queuing Relationships

To proceed much further, you'll have to make some simplifying assumptions. These assumptions risk making the models less valid for various real-world situations. Fortunately, in most cases, the results will be sufficiently accurate for planning and design purposes.

There are, however, some relationships that are true in the general case, and these are illustrated in table 2. By themselves, these relationships are not particularly helpful.

### Assumptions

The basic task of a queuing analysis is as follows. Given the arrival rate and service time as input, to provide, as output, information concerning the following:

#### TABLE OF NOTATION

**Table 1:** Notation used in this article.

$\lambda$	=	mean number of arrivals per second
$s$	=	mean service time for each arrival
$\sigma_s$	=	standard deviation of $s$
$\rho$	=	utilization; fraction of time that the facility is busy
$q$	=	mean number of items in system (waiting and being served)
$t_q$	=	mean time an item spends in system
$\sigma_q$	=	standard deviation of $q$
$\sigma_{t_q}$	=	standard deviation of $t_q$
$w$	=	mean number of items waiting to be served
$t_w$	=	mean time an item spends waiting for service
$t_d$	=	mean waiting time for items that have to wait (not including items with waiting time = 0)
$\sigma_w$	=	standard deviation of $w$
$M$	=	number of servers
$m_x(r)$	=	the $r$ th percentile; that value of $r$ below which $x$ occurs $r$ percent of the time

#### QUEUING RELATIONSHIPS

**Table 2:** Although not particularly helpful by themselves, these basic relationships can be expanded to form the elements of models.

$\rho = \lambda s$	for a single server
$\rho = \frac{\lambda s}{M}$	for multiple servers
$q = \lambda t_q$	Little's formula
$w = \lambda t_w$	
$t_q = t_w + s$	
$q = w + \rho$	for a single server
$q = w + M\rho$	for multiple servers

### QUEUING SYSTEM STRUCTURE FOR MULTISERVER QUEUE

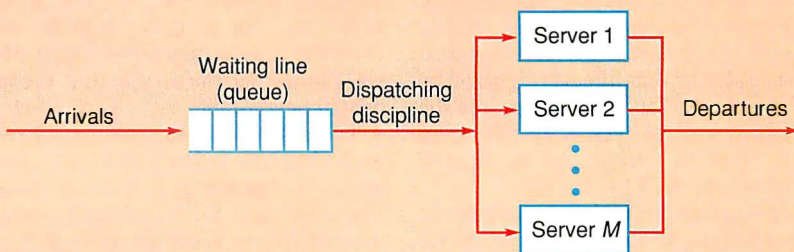

**Figure 3:** In this queuing system structure for a multiserver queue, all servers share a common queue. Arriving items are immediately dispatched to the first free server (assuming that all servers are identical). If all servers are busy, items join a waiting line and are dispatched as servers become free.

**SINGLE-SERVER QUEUES**

**Table 3:** The following assumptions have been made: (1) The arrival rate uses Poisson distribution; (2) the dispatching discipline does not give preference to items based on service times; (3) formulas for standard deviation assume first-in, first-out dispatching; and (4) no items leave the queue; in other words, all items are eventually served.

**(a) General service times  
(M/G/1)**

$$A = \frac{1}{2} \left[ 1 + \left( \frac{\sigma_s}{s} \right)^2 \right] \text{ useful parameter}$$

$$q = \rho + \frac{\rho^2 A}{1 - \rho}$$

$$w = \frac{\rho^2 A}{1 - \rho}$$

$$t_q = s + \frac{\rho s A}{1 - \rho}$$

$$t_w = \frac{\rho s A}{1 - \rho}$$

**(b) Exponential service times  
(M/M/1)**

$$q = \frac{\rho}{1 - \rho}$$

$$w = \frac{\rho^2}{1 - \rho}$$

$$t_q = \frac{s}{1 - \rho}$$

$$t_w = \frac{\rho s}{1 - \rho}$$

$$\sigma_q = \frac{\sqrt{\rho}}{1 - \rho}$$

$$\sigma_{tq} = \frac{s}{1 - \rho}$$

$$Pr[q=N] = (1 - \rho)e^{-N}$$

$$Pr[q \leq N] = \sum_{i=0}^N (1 - \rho)e^{-i}$$

$$Pr[t_q \leq t] = 1 - e^{-(1-\rho)t/s}$$

$$m_{tq}(r) = t_q \times \log_e \left( \frac{100}{100-r} \right)$$

$$m_{tw}(r) = \frac{t_w}{\rho} \times \log_e \left( \frac{100\rho}{100-r} \right)$$

**(c) Constant service times  
(M/D/1)**

$$q = \frac{\rho^2}{2(1 - \rho)} + \rho$$

$$w = \frac{\rho^2}{2(1 - \rho)}$$

$$t_q = \frac{s(2 - \rho)}{2(1 - \rho)}$$

$$t_w = \frac{\rho s}{2(1 - \rho)}$$

$$\sigma_q = \frac{1}{1 - \rho} \times R$$

$$R = \sqrt{\rho^2 - \frac{3\rho^2}{2} - \frac{5\rho^3}{6} - \frac{\rho^4}{12}}$$

$$\sigma_{tq} = \frac{s}{1 - \rho} \sqrt{\frac{\rho}{3} - \frac{\rho^2}{12}}$$

- items waiting
- waiting time
- items queued
- queuing time

What specifically do you want to know about these outputs? Certainly you would like to know their average values ( $q$ ,  $t_q$ ,  $w$ ,  $t_w$ ). In addition, it would be useful to know something about their variability. Thus, the standard deviation of each would be useful ( $\sigma_q$ ,  $\sigma_{tq}$ ,  $\sigma_w$ ,  $\sigma_{tw}$ ). Other measures may also be useful. For example, to design a buffer associated with a bridge or a multiplexer, it might be useful to know for what buffer size the probability of overflow is less than 0.001. That is, what is the value of  $N$  such that  $Pr[q < N] = 0.999$ ?

You must have complete knowledge of the probability distribution of the arrival rate and service time to answer such questions. And the resulting formulas are exceedingly complex. Thus, to make the problem tractable, you need to make some simplifying assumptions.

The most important of these assumptions is that the arrival rate obeys the

Poisson distribution, which is equivalent to saying that the arrivals occur randomly and independently of one another. Another way of expressing the same thing is to say that the interarrival times (times between arrivals) are exponential. This assumption is almost invariably made. Without it, queuing analysis is impractical. With this assumption, it turns out that you can get many useful results if you only know the mean and standard deviation of the arrival rate and service time. You can simplify matters even more and get even more detailed results if you assume that the service time is exponential or constant.

There is a convenient notation for summarizing the principal assumptions made in developing a queuing model. The notation is  $X/Y/N$ , where  $X$  refers to the distribution of the interarrival times,  $Y$  refers to the distribution of service times, and  $N$  refers to the number of servers. The most common distributions are denoted as follows:

$G$  = general independent arrivals or service times

$M$  = negative exponential distribution  
 $D$  = deterministic arrivals or fixed-length service.

Thus,  $M/M/1$  refers to a single-server queuing model with Poisson arrivals and exponential service times.

**Models and Details**

Table 3a provides some equations for single-server queues that follow the  $M/G/1$  model; in other words, the arrival rate is Poisson. If you make use of a scaling factor,  $A$ , the equations for some of the key output variables are straightforward. Note that the key factor in the scaling parameter is the ratio of the standard deviation of service time to the mean. No other information about the service time is needed.

Two special cases are of some interest. When the standard deviation is equal to the mean, the service time distribution is exponential. This is the simplest case, and the easiest one for calculating results. Table 3b shows the simplified versions of equations for  $\sigma_q$ ,  $\sigma_{tq}$ ,  $\sigma_w$ , and  $\sigma_{tw}$ , as well as some other parameters of in-

# NRI's new at-home training gives you the computer, the software, and the hands-on skills to start a high-paying career as a computer programmer



**Rick Brush**  
Programmer/Analyst  
NRI Schools

Now NRI gives you hands-on experience in computer programming with a powerful IBM AT-compatible computer system and software you keep. One easy step at a time, you build full-featured, powerful programs in BASIC, Pascal, C, and COBOL — today's hottest computer languages. One easy step at a time, you train to be a high-paid computer programmer!

**Your NRI training includes an AT-compatible computer and programming software you keep**

Unlike any other course, NRI's at-home training in Computer Programming gives you hands-on experience with a powerful, IBM AT-compatible West Coast 1010ES computer system, including 2400 baud Hayes-compatible modem, a full megabyte of RAM, disk drive, monitor, and invaluable programming software — BASIC, Pascal, C, and COBOL — all yours to train with and keep.

With NRI, you get the skills and the confidence, the computer and the software to build real-world, working programs for a wide variety of business, personal, and professional applications ... in all, everything you need to step into today's top computer programming jobs.

**No previous experience necessary**

No matter what your background, NRI ensures you get the know-how you need to take full advantage of every exciting opportunity in computer programming today.

With your experienced NRI instructor always available to help, you quickly cover the fundamentals, then move on to master all four of today's key computer languages — BASIC, Pascal, C, and COBOL — step by step. Before you know it, you have what it takes to handle any programming task with confidence.

**Now, as never before, you can succeed as a computer programmer**

The best news comes from the Bureau of Labor Statistics: As a

programmer trained in a variety of computer languages you can land the programming position of your choice, even make it on your own as an independent programmer. There's no doubt about it — with NRI's complete, at-home, four-language training in Computer Programming, you can write your own ticket to success in this high-paying, top-growth computer career field!

**See other side for highlights of your NRI hands-on training in BASIC, Pascal, C, and COBOL** →

## SEND CARD TODAY FOR FREE NRI CATALOG

**YES!** Please rush me my FREE catalog describing NRI at-home training.

### Check One Course Only

- |  |  |
|--|--|
| <input type="checkbox"/> <b>Computer Programming</b>     | <input type="checkbox"/> Bookkeeping and Accounting          |
| <input type="checkbox"/> Microcomputer Servicing         | <input type="checkbox"/> TV/Video/Audio Servicing            |
| <input type="checkbox"/> PC Systems Analysis             | <input type="checkbox"/> Telecommunications                  |
| <input type="checkbox"/> PC Software Engineering Using C | <input type="checkbox"/> Electronic Music Technology         |
| <input type="checkbox"/> Word Processing Home Business   | <input type="checkbox"/> Industrial Electronics and Robotics |
| <input type="checkbox"/> Desktop Publishing and Design   |  |

For career courses approved under GI Bill  check for details.

Name	(Please Print)	Age
Address		
City	State	Zip

**Your NRI training in Computer Programming includes an IBM AT-compatible West Coast 1010ES computer with internal modem, 1 meg RAM, disk drive, monitor, and programming software — BASIC, Pascal, C, and COBOL — all yours to train with and keep!**

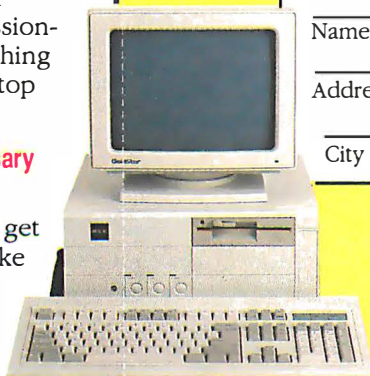

# Now, with NRI, you can learn to program in today's hottest computer languages — BASIC Pascal, C, and COBOL

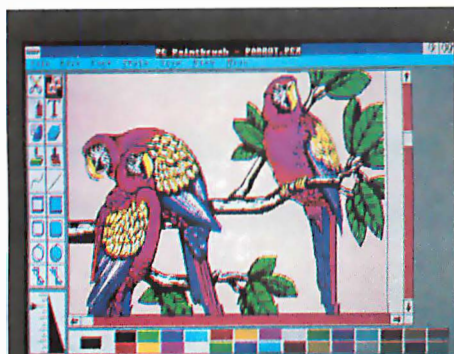

You start with BASIC, an extremely popular language used for graphics, teaching, personal, and small business applications.

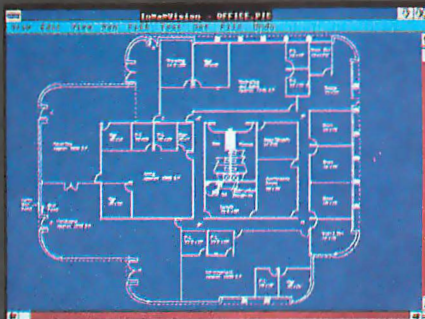

Next, you master Pascal, a multipurpose language often used to develop software for computer-aided design (CAD).

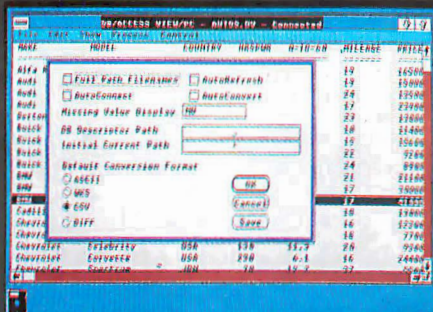

You move on to C—hands down, today's hottest computer language—used for everything from systems programming to artificial intelligence.

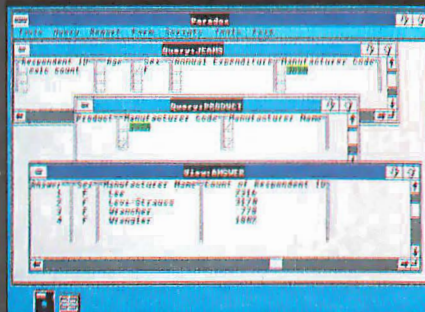

You wrap up your training in programming with COBOL, the language of business and the most widely used computer language in the world.

NRI's new at-home training in Computer Programming starts by walking you step by step through the fundamentals, easing you into programming with brilliantly detailed instructions, charts, and diagrams.

In no time at all, you have a complete understanding of the programming techniques used every day by successful micro and mainframe programmers. And then the fun really begins.

With your personal NRI instructor on call and ready to help, you use the computer system included in your training to actually design, code, run, debug, and document programs in BASIC, Pascal, C, and COBOL. Then, following easy-to-read instructions, you use your modem — also included — to "talk" to your instructor, meet other NRI students, even download programs through NRI's exclusive programmer's network, PRONET.

**Send for your FREE catalog today**

For all the details about NRI's at-home training in Computer Programming, send the postage-paid reply card today. Soon you'll receive NRI's fascinating, information-packed, full-color catalog.

Open it up and you'll find vivid descriptions of every aspect of NRI training. You'll see the IBM AT-compatible computer included in your course up close in a special, poster-sized foldout section. And, best of all, you'll find out how your NRI training will make it easy for you to build a high-paying career — even a business of your own — in computer programming.

If the card is missing, write to NRI at the address below.

IBM is a registered trademark of the IBM Corporation

**SEND CARD TODAY FOR FREE NRI CATALOG**



NO POSTAGE  
NECESSARY  
IF MAILED  
IN THE  
UNITED STATES

**BUSINESS REPLY MAIL**

FIRST CLASS MAIL PERMIT NO. 10008 WASHINGTON, D.C.

POSTAGE WILL BE PAID BY ADDRESSEE

**NRI SCHOOLS**

McGraw-Hill Continuing Education Center  
4401 Connecticut Avenue NW  
Washington, D.C. 20077-3543

**NRI Schools**

McGraw-Hill Continuing Education Center  
4401 Connecticut Avenue, NW  
Washington, DC 20008



terest. The other interesting case is a standard deviation of service time equal to zero, that is, a constant service time. The corresponding equations are shown in table 3c.

Figures 4a and b plot values of average queue size and queuing time versus utilization of three values of  $\sigma_s/s$ . Note that the poorest performance is exhibited by the exponential service time, and the best by a constant service time. Usually, you can consider the exponential service time to be a worst case; an analysis based on this assumption will give conservative results. This is nice, since tables are available for the  $M/M/1$  case, and values can be looked up quickly.

What value of  $\sigma_s/s$  are you likely to encounter? Consider four regions:

1. **Zero:** This is the rare case of constant service time. If all transmitted messages are of the same length, they fit this category.
2. **Ratio less than 1:** Since this ratio is better than that in the exponential case, using  $M/M/1$  tables gives you queue sizes and times that are slightly larger than they should be. Using the  $M/M/1$  model would provide answers on the safe side. An example of this category might be a data-entry application from a particular form.
3. **Ratio close to 1:** This is the most common occurrence, and it corresponds to the exponential service time—in other words, service times are essentially random. Consider message lengths to a computer terminal: a full screen might be 1920 characters, with message sizes varying the full range. Airline reservations, file lookups on inquiries, a shared LAN, and packet-switching networks are examples of systems that often fit this category.
4. **Ratio greater than 1:** If you observe this, you need to use the  $M/G/1$  model instead of relying on the  $M/M/1$  model. The most common occurrence of this ratio in a communications system is a bimodal distribution with a wide spread between the peaks. An example is a system that experiences many short messages, many long messages, and few that are in-between.

The same consideration applies to the arrival rate. For a Poisson arrival rate, the interarrival times are exponential, and the ratio of the standard deviation to the mean is 1. If the observed ratio is much less than 1, then arrivals tend to be evenly spaced (i.e., have not much variability), and the Poisson assumption will overestimate queue sizes and delays. On

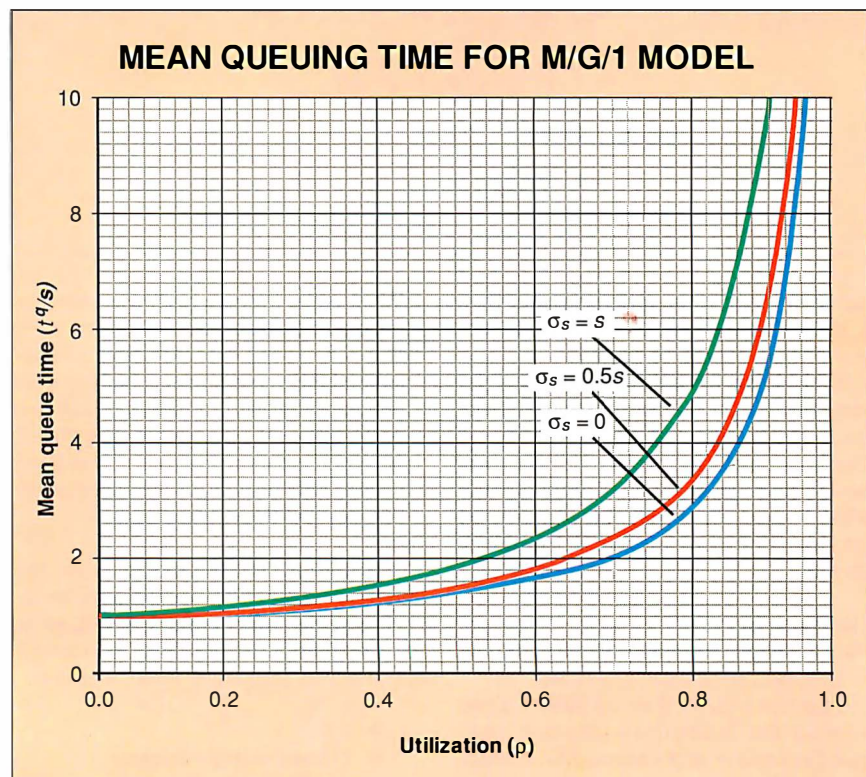
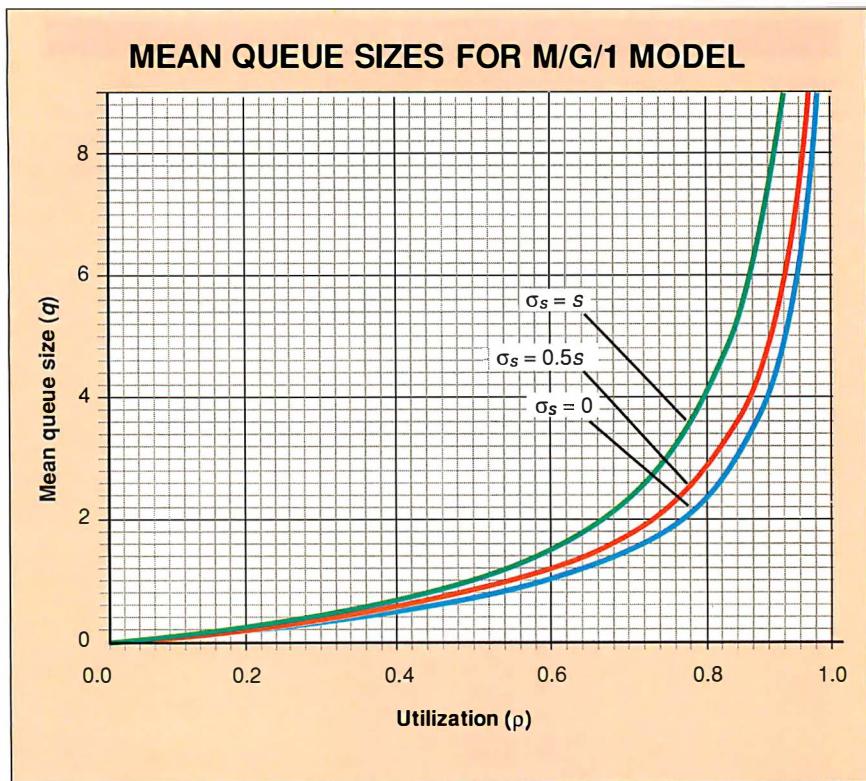

**Figure 4:** The change in (a) queue size and (b) queuing time for different rates of utilization (the fraction of time that the server is busy), at service times that vary from constant ( $\sigma_s = 0$ ) to exponential ( $\sigma_s = s$ ). Note that constant service time (which is rarely seen) provides the best performance, while exponential service time provides the poorest performance.

**MULTISERVER QUEUES**

**Table 4:** The following assumptions have been made: (1) The arrival rate uses Poisson distribution; (2) services times are exponential; (3) all servers are equally loaded; (4) all servers have the same mean service time; (5) formulas for standard deviation assume first-in, first-out dispatching; and (6) no items leave the queue; in other words, all items are eventually served.

$$K = \frac{\sum_{N=0}^{M-1} \frac{(M\rho)^N}{N!}}{\sum_{N=0}^M \frac{(M\rho)^N}{N!}} \quad \text{useful parameter}$$

**Probability that all servers are busy =**

$$B = \frac{1-K}{1-\rho K}$$

$$q = B \frac{\rho}{1-\rho} + M\rho$$

$$w = B \frac{\rho}{1-\rho}$$

$$t_q = \frac{B}{M} \frac{s}{1-\rho} + s$$

$$t_w = \frac{B}{M} \frac{s}{1-\rho}$$

$$\sigma_{t_q} = \frac{s}{M(1-\rho)} \sqrt{B(2-B) + M^2(1-\rho)^2}$$

$$\sigma_w = \frac{1}{1-\rho} \sqrt{B\rho(1+\rho-B\rho)}$$

$$Pr\{t_w > t\} = Be^{-M(1-\rho)t/s}$$

$$t_d = \frac{s}{M(1-\rho)}$$

$$\begin{aligned} t_q &= \frac{s}{(1-\rho)} \\ &= \frac{0.6}{(1-0.2)} \\ &= 0.75 \text{ second} \end{aligned}$$

The second value is more difficult to obtain. Indeed, as worded, there is no answer, because there is a nonzero probability that some instances of response time will exceed 1.5 seconds for any value of utilization. Instead, say that you would like 90 percent of all responses to be less than 1.5 seconds. Then, you can use the equation from table 3b:

$$\begin{aligned} m_{t_q}(r) &= t_q \times \log_e(100/(100-r)) \\ m_{t_q}(90) &= t_q \times \log_e(10) \\ &= \frac{s}{1-\rho} \times 2.3 \\ &= 1.5 \text{ seconds} \end{aligned}$$

You have  $s = 0.6$ . Solving for  $\rho$  yields  $\rho = 0.08$ . In fact, utilization would have to decline from 20 percent to 8 percent to put 1.5 seconds at the ninetieth percentile.

The third point is to find the relationship between increases in load versus response time. Since a facility utilization of 0.2 is down in the flat part of the curve, response time will increase more slowly than utilization. In this case, if facility utilization increases from 20 percent to 40 percent (a 100 percent increase), the value of  $t_q$  goes from 0.75 second to 1.0 second, an increase of only 33 percent.

**A Multilink Protocol Problem**

The multilink protocol is part of X.25; a similar facility is available in System Network Architecture. With MLP, a set of links exists between two nodes and is used as a pooled resource for transmitting packets, regardless of virtual circuit number.

When a packet is presented to MLP for transmission, any available link can be chosen for the job. For example, if two LANs at different sites are connected by a pair of bridges, there may be multiple point-to-point links between the bridges to increase throughput and reliability.

The MLP approach requires extra processing and frame overhead compared to a simple link protocol. A special MLP header is necessary for the procedure. The alternative would be to assign each of the arriving packets to the queue for an outgoing link in round-robin fashion.

the other hand, if the ratio is greater than 1, then arrivals tend to cluster, and congestion becomes more acute.

Table 4 lists formulas for some key parameters for the multiserver case. Note the restrictiveness of the assumptions. Useful congestion statistics for this model have been obtained only for the M/M/N case, in which the exponential service times are identical for the N servers.

**Database Server**

Here are a few examples to give you some feel for the use of these equations.

Consider a LAN that has 100 PCs and a server that maintains a common database for a query application. The average time for the server to respond to a query is 0.6 second, and the standard deviation is estimated to equal the mean. At peak usage times, the query rate over the LAN reaches 20 queries per minute. You would like to find the following information:

- What is the average response time, ignoring line overhead?
- If a 1.5-second response time is considered the maximum acceptable, what percent of growth in message load can occur before the maximum is reached?
- If 20 percent more utilization is experienced, will response time increase by more or less than 20 percent?

Assume an M/M/1 model, with the database server as the server in the model. Ignore the effect of the LAN (assume its contribution to the delay is negligible). Facility utilization is calculated as

$$\begin{aligned} \rho &= \lambda s \\ &= (20 \text{ arrivals per minute}) \\ &\quad \times (0.6 \text{ second per transmission}) / (60 \text{ seconds per minute}) \\ &= 0.2 \end{aligned}$$

The first value, the average response time, is easily calculated:



This would simplify processing, but what kind of effect would it have on performance?

Here's a concrete example. Suppose that there are five 9600-bps links connecting two LAN bridges and that the average packet size is 100 octets. Thus, the average service time is  $(100 \text{ octets} \times 8 \text{ bits/octet}) / (9600 \text{ bps}) = 0.0833 \text{ second}$ . Assume that the standard deviation of service time is observed to be 0.079 second. Note that this is about 95 percent of the mean; you can thus assume exponential service time. During peak load time, packets arrive at the rate of 48 packets per second.

### The Single-Server Approach

If arriving packets are evenly distributed among the outgoing links, then the load for each link is  $48/5 = 9.6$  packets per second. Thus,

$$\begin{aligned} \rho &= \lambda s \\ &= 9.6 \times 0.0833 \\ &= 0.8 \end{aligned}$$

The queuing time is then easily calculated:

$$\begin{aligned} t_q &= \frac{s}{1-\rho} \\ &= \frac{0.0833}{0.2} \\ &= 0.42 \text{ second} \end{aligned}$$

### The Multiserver Approach

Using the multilink protocol, you now have an aggregate arrival rate of 48 packets per second. However, the facility utilization is still  $0.8(\lambda s/M)$ . To calculate the queuing time from the formula in table 4, you first need to calculate  $B$ . If you have not programmed the parameter, it can be looked up in a table under a facility utilization of 0.8 for five servers, to yield  $B = 0.554$ . Substituting,

$$\begin{aligned} t_q &= 0.0833 + \frac{(0.544)(0.0833)}{5(1-0.8)} \\ &= 0.13 \end{aligned}$$

So the use of MLP has reduced average queuing time from 0.42 second down to 0.13 second—a reduction greater than a factor of 3. If you look at just the waiting time, the difference is 0.047 second compared to 0.34 second, which is a factor of 7.

Although you may not be an expert in queuing theory, you now know enough to be annoyed when you have to wait in a line at a facility with single-server queues.

### Calculating Percentiles

Consider a router that connects a LAN to a wide-area packet-switching network. Let's look at the traffic from the LAN through the router.

Packets arrive with a mean arrival rate of five per second. The average packet length is 144 octets, and it is assumed that the packet length is exponentially distributed. Line speed from the router to the wide-area network is 9600 bps. The following questions need to be answered:

1. What is the mean queuing time in the router?
2. How many messages are in the router center, including those waiting for transmission and the one currently being transmitted (if any), on the average?
3. Same as (2), for the ninetieth percentile.

*continued*

## B Y T E B A C K I S S U E S F O R S A L E

	1990	1991
January		
February		
March		
April		
May		
June		
July		
August		
September		
October		
November		
December		
Inside the IBM PCs		

Issues Available

1990-'91 BYTE Issues \$6.00\*

The above prices include postage in the US. \*Please add \$.50 per copy for Canada and Mexico; and \$2.00 per copy to foreign countries (surface delivery). European customers please refer to Back Issue order form in International Advertising section of book.

Please indicate which issues you would like by checking (✓) the boxes. Send requests with payment to:

BYTE Back Issues, One Phoenix Mill Lane, Peterborough, NH 03458  
(603) 924-9281

Check enclosed      Charge:  VISA    MasterCard

Card # \_\_\_\_\_

Exp. Date \_\_\_\_\_

Signature \_\_\_\_\_

Name \_\_\_\_\_

Address \_\_\_\_\_

City \_\_\_\_\_

State \_\_\_\_\_ Zip \_\_\_\_\_

All orders must be prepaid. Please allow four weeks for delivery.

SOME ASSEMBLY REQUIRED

**IME COMPUTERS**  
EST. 1981 *Quality Products at Liquidation Prices*

**XEROX 19" TWO-PAGE DISPLAY**  
FOR CAD, DTP, SPREADSHEETS  
■ Res. to 1216 x 925  
■ Paper-white screen  
■ HGA & MDA  
Includes adapter card, utility drivers, manual. 30-day IME warranty. Used. **\$299**  
(List \$1,995)

**WINDOWS 3.0 DRIVERS NOW AVAILABLE!**

**TAKE YOUR PICK OF PC DISKS**

**MAXTOR LXT-100 HARD DRIVES**  
96MB • 26ms • SCSI 3.5" • Half-Height  
1-Yr. IME warranty  
**\$299** - Internal External - **\$499**

**NEW ITEM!** **30DIME 3055 45MB Hard Drive**  
MFM (ST-506) interface  
26ms seek • 3.5" • Half-Height  
■ 45MB formatted (55MB uniform.) **\$249**  
■ 30-day IME warranty

**MICROPOLIS HARD DRIVES**

**Model #1654-7 — 160MB**  
16ms average seek time  
ESDI interface  
5.25" • half-height **\$599**

**Model #1653-5 — 106MB**  
16ms average seek time  
ESDI interface  
5.25" • half-height **\$379**

**XEROX 2700-II HEAVY-DUTY Laser Printer**  
■ 300 x 300dpi ■ 12 pages/minute  
■ 500-sheet offsetting stacker—safely stores output!  
■ Portrait & Landscape modes supported  
■ Equivalent to DEC LN01 laser printer  
■ 60,000 pages/month duty cycle **\$999**

**NOVELL NETWORK**

**386 Network (Software Ver. 3.1) \$4200**  
Supports 250 logical users and 100,000 concurrent open files per server. Available in 5.25" & 3.5" diskette sizes. 30-day IME warranty.

**286 Advanced Network (Ver. 2.0A) \$399**  
Upgradeable to version 2.15 (list price: \$3295!)

**VGA COLOR AT B&W PRICES!**  
**Zenith 13" VGA Color Monitor**  
■ Private Label: "Data General"  
■ 0.31 Dot Pitch ■ 15-pin "D" connector  
■ Graphics & Text Modes supported  
TILT/SWIVEL STAND AVAILABLE FREE!  
(minimal shipping charge)  
(last List Price: \$695.00) **\$259**

**FUJITSU GCR Reel-to-Reel Tape Drive**  
■ Model M2444AC ■ Streaming & Start/Stop modes  
■ Pertec interface ■ Vacuum-assisted easy load  
■ Rack-mounted ■ 100 ips **\$3499**  
■ 1600/6250 bpi ■ 1-Yr. IME Warranty

**Call (800) 999-1911 NO SURCHARGE**  
FAX (617) 254-0392 • BOSTON, MA

4. Same as (2), for the ninety-fifth percentile.

The information available is as follows:

$$\lambda = 5 \text{ messages per second}$$

$$s = \frac{144 \text{ octets} \times 8 \text{ bits/octet}}{9600 \text{ bits per second}}$$

$$= 0.12 \text{ second}$$

$$\rho = \lambda s$$

$$= 5(0.12)$$

$$= 0.6$$

Mean queuing time is as follows:

$$t_q = \frac{s}{1 - \rho}$$

$$= 0.3 \text{ second}$$

Mean queue length is as follows:

$$q = \frac{\rho}{1 - \rho}$$

$$= 1.5 \text{ packets}$$

To obtain the percentiles, you use the equation from table 3b:

$$Pr[q=N] = (1 - \rho)e^{-N}$$

To calculate the *r*th percentile of the queue size, you write the above equation in cumulative form:

$$\frac{r}{100} = \sum_{k=0}^{m(r)} (1 - \rho)e^{-k} = 1 - e^{-1+m(r)}$$

Here, *m*(*r*) represents the maximum number of messages in the queue expected *r* percent of the time. In the form given, you can determine the percentile for any queue size. You want to do the reverse: Given *r*, find *m*(*r*). So, taking the logarithm to the base 10 of both sides:

$$m(r) = \frac{\log(1 - \frac{r}{100})}{\log \rho} - 1$$

If *m*(*r*) is fractional, take the next higher integer; if it is negative, set it to 0.

For the example, *r* = 0.6 and you want to find *m*(90) and *m*(95):

$$m(90) = \frac{\log(1 - 0.90)}{\log(0.6)} - 1 = 3.5$$

$$m(95) = \frac{\log(1 - 0.95)}{\log(0.6)} - 1 = 4.8$$

Thus, 90 percent of the time there are fewer than four packets in the queue, and 95 percent of the time there are fewer than five packets. If you're designing to a

ninety-fifth percentile criterion, a buffer is needed to store at least five packets.

**On Your Own**

Queuing analyses provide a reasonably good fit to reality. They are therefore valuable for making all kinds of predictions, especially in the area of data communications.

You can address scores of questions with queuing analysis, as it touches on virtually every aspect of data communications. With the information provided in this article, you should now be able to do your own basic queuing analyses.

**Recommended Reading**

Perhaps the most useful reference that you could acquire is *Systems Analysis for Data Transmission* by J. Martin (Prentice-Hall, Englewood Cliffs, NJ, 1972). Despite this book's age, it is a valuable practical source. It provides a number of graphs and tables that can be used to perform quick queuing analyses. It also provides detailed guidance for the application of queuing analysis, plus a number of worked-out examples.

In addition to Martin's book, there are several obscure but readily available publications of great practical assistance. *Analysis of Some Queuing Models in Real-Time Systems* (IBM Document GF-20-0007, 1971; available from IBM document distribution centers) is an excellent, concise treatment of queuing analysis applied to computer and communications problems, with many examples, plus graphs and tables. *Tables for Traffic Management and Design* by T. Frankel (ABC TeleTraining, P.O. Box 537, Geneva, IL 60134, 1976) is a good collection of tables for various queuing models. *Experimental Statistics* (National Bureau of Standards Handbook 91, Government Printing Office, GPO Stock No. 003-003-00135-0, 1963) is an excellent guide to the practical application of statistics; it has tables, formulas, and examples that aid in determining the proper procedure for estimating values from samples and evaluating the results. ■

*William Stallings (Prides Crossing, MA) is an independent consultant and author of 14 books on data communications and computer networking. This article is based on material in the author's latest book, Data and Computer Communications (Macmillan, 1991). He can be reached on BIX c/o "editors."*

*Your questions and comments are welcome. Write to: Editor, BYTE, One Phoenix Mill Lane, Peterborough, NH 03458.*



**\$19.95**

"Power C is a heavy-weight contender - at a bantamweight price"

Stephen Davis  
- PC Magazine

"On sheer audacity for price-performance ratio, we loved Mix's products"

Tim Parker - Computer Language



**\$19.95**

"The Ctrace debugger is where Mix really shines. It is magnificent."

David Weinberger  
- Computer Shopper



**MIX**  
software

**Power C**

combines a high-performance C compiler with superb documentation, at a price that brings chuckles from over 50,000 satisfied customers. That's because Power C performs favorably against compilers costing 10 times as much. And you can't buy a compiler that's more reliable or easier to use - at any price. Perhaps that's why Power C has won Computer Shopper's Best Buy award for three years running.

- compatible with ANSI C standard
- integrated Make utility
- library of over 450 functions
- IEEE software floating point
- supports 8088/286/386/486 CPU
- memory resident program support
- supports 8087/287/387 math chips
- small/medium/large memory models
- mixed model with near/far/huge
- allows arrays larger than 64K
- CGA, EGA, VGA & Hercules graphics
- 650 page manual with tutorial

**\$10.00**

**Power C Library Source**

includes our Power C assembler, plus the C and assembly language source code to over 450 functions in the Power C library. Unlike our competitors, who charge \$150.00 or more for library source code, we've made ours very affordable.

**\$10.00**

**Power C BCD Business Math**

includes binary coded decimal floating point routines and financial functions to calculate interest, depreciation, etc.. BCD routines are used for dollars and cents calculations to eliminate inaccuracies caused by rounding.

**Power C requires DOS 2.0 or later, 320K memory, 720K disk space. Master C requires DOS 3.0 or later, 384K memory, hard disk.**

**Power Ctrace**

combines state-of-the-art technology with a friendly interface, making it very easy to find and correct your programming mistakes. No time consuming edit/compile cycles are needed to trackdown bugs. Simply compile your program once with the trace option, and Power Ctrace does the rest. Multiple windows display your C source code, the values of all your program variables, program output, watch points, and assembly instructions. Put Power Ctrace to work for you, and we guarantee that you'll be a more productive C programmer.

Order line:

**1-800-333-0330**

Technical Support:  
1-214-783-6001

Fax: 1-214-783-1404

Mix Software, 1132 Commerce Drive,  
Richardson, TX 75081

**Get a FREE copy of Master C (limited time offer)**

**\$44.95 value FREE**

Mitchell Waite  
Stephen Prata  
Rex Woodland

Published by the highly acclaimed Waite Group, Master C is a revolutionary book/disk package that turns your PC into a C instructor. Master C teaches you, quizzes you, notices problems you are having, and recommends action. In a pilot study at IBM, students using Master C retained 19% more knowledge than students who learned from a lecturer. Now you can receive this \$44.95 package absolutely FREE when you purchase all four Power C products described above. Just ask for the Master Pack.

"Master C eschews flash for elegant competence, and it works!"

Jeff Dunteman - PC Techniques

**60 day money back guarantee**

Name \_\_\_\_\_  
Street \_\_\_\_\_  
City \_\_\_\_\_  
State \_\_\_\_\_ Zip \_\_\_\_\_  
Telephone \_\_\_\_\_

Please send me a free brochure

**Paying by:**  Check  Money Order  
 MC  Visa  Amex  Discover  
Card # \_\_\_\_\_ Exp \_\_\_\_\_

**Disk Size:**  5 1/4"  3 1/2"

**Product(s) (Not Copy Protected)**

Power C (\$19.95) \$ \_\_\_\_\_  
 Power Ctrace (\$19.95) \$ \_\_\_\_\_  
 Power C Library Source (\$10) \$ \_\_\_\_\_  
 Power C BCD Business Math (\$10) \$ \_\_\_\_\_  
 Master Pack (\$59.90) \$ \_\_\_\_\_  
(includes all of the above plus Master C)  
Add Shipping \$ \_\_\_\_\_  
(\$5 USA - \$10 Canada - \$30 Foreign)  
Texas Residents add 8.25% Sales Tax \$ \_\_\_\_\_  
Total amount of your order \$ \_\_\_\_\_

## SmartLynx-MC

### Intelligent Eight Port RS 232 Micro Channel Adapter for PS/2 Systems and Compatibles.

Supports AIX, UNIX, XENIX,  
QNX PC-MOS and DOS.

Call for Special  
Introductory Offer

**1-800-553-1170**



662 Wolf Ledges Parkway  
Akron, OH 44311

Circle 240 on Reader Service Card

## Eight Serial Ports One Board

Quatech's ES-100 provides eight  
RS/232 serial ports in a single AT  
slot. RJ-11 modular connectors.  
16450 UARTS are standard. Optional  
buffered 16550 UARTS. PC-AT, ISA,  
or EISA compatible. Priced below  
\$500! Quantity Pricing Available!

Call for our PC Interface Handbook:  
**1-800-553-1170**



662 Wolf Ledges Parkway  
Akron, OH 44311

PC-AT is a trademark or  
registered trademark of IBM Corp.

Circle 241 on Reader Service Card

## RS-422/RS-485 Boards for AT, Micro Channel

RS-422/RS-485 asynchronous  
serial communication boards from  
Quatech! available in 1 to 4 ports  
for PC-AT and compatibles and 1  
to 4 ports for PS/2 Micro Channel.

Call for our free  
PC Interface Handbook:  
**1-800-553-1170**



662 Wolf Ledges Parkway  
Akron, OH 44311

PC-AT, Micro Channel, and PS/2 are trade-  
marks or registered trademarks of IBM Corp.

Circle 242 on Reader Service Card

## Synchronous Communication Boards for AT

Quatech synchronous/  
asynchronous serial boards for  
PC-AT and compatibles support  
RS-232, RS-422, and RS-485  
communication.

Call for our free  
PC Interface Handbook:  
**1-800-553-1170**



662 Wolf Ledges Parkway  
Akron, OH 44311

PC-AT and PC are registered  
trademarks of IBM Corp.

Circle 243 on Reader Service Card

## Communications Data Acquisition

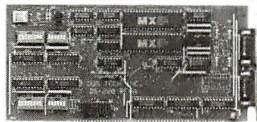

"PC-AT (ISA) Interfaces"

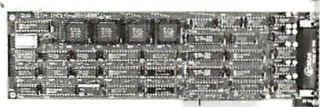

"PS/2 Micro Channel Interfaces"



Phone: (216) 434-3154 • FAX: (216) 434-1409  
TELEX: 510-101-2726

PC-AT, PS/2 and Micro Channel are  
registered trademarks of IBM Corporation.

Circle 244 on Reader Service Card

## Digital I/O Board

Single-slot Quatech PXB-721 for  
PC-AT has 72 digital I/O lines.  
Connect three choices of data  
acquisition modules. Supports  
Labtech Notebook™

Call for our free  
PC Interface Handbook:  
**1-800-553-1170**



662 Wolf Ledges Parkway  
Akron, OH 44311

LabTech Notebook is a trademark of  
Laboratories Technologies Corp.

Circle 245 on Reader Service Card

## PXB-160 16-BIT TRUE PARALLEL DIGITAL I/O

- Two eight bit ports
- Latched I/O
- DMA and I/O Modes
- Handshakes for 16 Bit I/O Transfer
- Programmable timer for Interrupt or DMA Transfer
- External interrupt and data transfer request inputs
- List Price Below \$400.00

Call the Order Line  
**1-800-553-1170**



662 Wolf Ledges Parkway  
Akron, OH 44311

Circle 246 on Reader Service Card

## 2 parallel, 2 serial, 1 board

Quatech DSDP-402 for PC-AT  
has two parallel ports, and two  
serial ports for any combina-  
tion of RS-232, 422, and 485  
communication. DSDP-100,  
two parallel and two RS-232  
ports, available at lower cost.

For order info, call:  
**1-800-553-1170**



662 Wolf Ledges Parkway  
Akron, OH 44311

Circle 247 on Reader Service Card

## Wave Form 20MHz - 32K \$1290

The WSB-100 Wave Form Synthe-  
sizer Board from Quatech has the  
best set of numbers in the market.  
With speed to 20MHz and a 32K  
memory at \$1290, it's making  
waves in more ways than one. The  
WSB-100 is also a star performer  
as a digital pulse/word generator  
with the optional digital module.

Call for our free  
PC Interface Handbook  
**1-800-553-1170**



662 Wolf Ledges Parkway  
Akron, OH 44311

Circle 248 on Reader Service Card

**BYTE**

---

# PRODUCT SHOWCASE

---

- BUYER'S MART
- BYTE BITS
- PRODUCT SPOTS
- MICRO PRODUCT CENTER
- CATALOG SHOWCASE



# Catalog Showcase

Advertisers: For more information contact Ellen Perham at (603) 924-2598.

## Programmers Connection

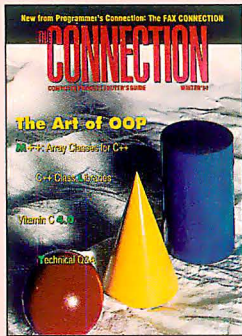

### "An Indispensable reference"

THE CONNECTION is your Ultimate Buyer's Guide to the highest quality software available for your IBM PC. You'll find its easy-to-use cross references will guide you to a description of EVERY product including its system requirements, cross product compatibility, version numbers and more. THE CONNECTION is the *Only* software reference guide you'll ever need.

Call for your FREE copy!

USA 800-336-1166  
CANADA 800-225-1166  
FAX 216-494-5260

Circle 181 on Reader Service Card

## Intel Corporation

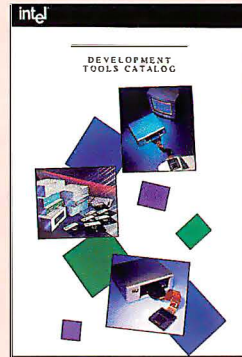

Choosing the right architecture and development support are two of the most important decisions you face today. For successful microcomputer development, Intel offers you the total solution with the most up-to-date and powerful tools available.

And we also offer you the easiest way to buy. Our Development Tools Catalog lists all our tools products in one guide. Call us at 1-800-874-6835, or FAX us at 503-696-4633 to get your free copy today.

Intel Corporation, Development Tools Operation, 5200 NE Elam Young Parkway, JF1-15, Hillsboro, OR 97124

1-800-874-6835 FAX 503-696-4633

Circle 108 on Reader Service Card

## CAD Software

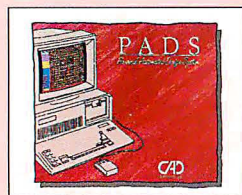

### Electronic Engineering Design System

PADS design systems are the logical solution to your engineering problems. They provide workstation level features and performance at a price within the reach of any company designing circuit boards. The balance between automatic functions and interactive tools makes PADS the choice for engineers and designers. With PADS, you can get your product to the market faster with designs that work the first time.

Call CAD Software today for your authorized PADS Reseller for a product demonstration or for free PADS Evaluation Software.

1-508-486-8929 1-800-255-7814

Circle 44 on Reader Service Card

## Annabooks

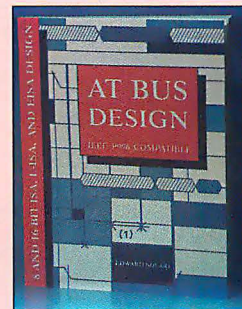

Send for Annabooks' free catalog of PC-compatible engineering products.

The newest publication, "AT Bus Design," has the official timing information for the AT bus and the 8- and 16-bit parts of the EISA bus. Over 200 pages and 100 diagrams. Author is member of IEEE P996. Available now for \$69.95. VISA, M/C, Amex, COD, P.O.s OK.

Annabooks, 12145 Alta Carmel Ct. #250, San Diego CA 92128

1-800-462-1042 FAX 619-592-0061

Readers Circle 21 on Reader Service Card  
Resellers Circle 22 on Reader Service Card

## National Instruments



Free 488-page full-color catalog describing instrumentation hardware and software products for personal computers and workstations. Application software for data analysis and presentation and for collecting data using instruments and plug-in boards. Features GPIB interfaces, data acquisition and DSP boards, driver level software, signal conditioning and VXI controllers.

1-512-794-0100

Circle 147 on Reader Service Card

## Best Power Technology, Inc.



FREE, money-saving literature tells you how to protect your computer from power problems such as surges, sags, spikes, noise, brownouts, blackouts and lightning. These power problems can damage delicate equipment and cause loss of valuable data. Learn how Best Power Technology's uninterruptible power systems, ranging from 500 VA to 18 KVA, can protect your computer. Contact: Best Power Technology, Inc., P.O. Box 280, Necedah, WI 54646.

1-608-565-7200, ext. 2229

Toll-free 1-800-356-5794, ext. 2229

Circle 31 on Reader Service Card

## Zericon



### Factory Direct Savings on Large Format Plotters

Zericon is the low-price leader, offering the following plotter lines direct from the factory. The Valuline series of "D" Size plotters offers moderate performance at 15 IPS for under \$2,000. The Designer series offers high performance at 25 IPS in Multi-Pen "A-E" sizes; prices under \$3,000. All Zericon products are sold with a no-risk satisfaction guarantee.

40491 Encyclopedia Circle, Fremont CA 94538

1-800-727-8380

Circle 277 on Reader Service Card

## The Card Shop



The Memory Board Experts at The Card Shop would like to introduce ourselves through some of our better-known associates, for example: PARITY PLUS by MEMREL, INTEL, AST and DFI.

We invite you to call and talk to our knowledgeable, courteous staff about any of your memory board needs.

You'll also appreciate the Ten-Day, Money-Back Free Trial, Generous Warranties and Commitment to Excellence in all of the product lines that we carry.

1-800-346-0055 FAX 602-948-8458  
Scottsdale, AZ

Circle 229 on Reader Service Card

# THE BUYER'S MART

## A Directory of Products and Services

THE BUYER'S MART is a monthly advertising section which enables readers to easily locate suppliers by product category. As a unique feature, each BUYER'S MART ad includes a Reader Service number to assist interested readers in requesting information from participating advertisers.

Effective January 1, 1991.

RATES: 1 issue—\$675 3 issues—\$625 6 issues—\$600 12 issues—\$525  
Prepayment must accompany each insertion. VISA/MC Accepted.

AD FORMAT: Each ad will be designed and typeset by BYTE. Advertisers must

furnish typewritten copy. Ads can include headline (23 characters maximum), descriptive text (250 characters is recommended, but up to 350 characters can be accommodated), plus company name, address and telephone number. Do not send logos or camera-ready artwork.

DEADLINE: Ad copy is due approximately 2 months prior to issue date. For example: November issue closes on September 8. Send your copy and payment to THE BUYER'S MART, BYTE Magazine, 1 Phoenix Mill Lane, Peterborough, NH 03458. For more information call Brian Higgins at 603-924-2656. FAX: 603-924-2683.

### ACCESSORIES

#### RADIOACTIVE?

Plot it on your PC with The RM-60 RADIATION MONITOR Serial or printer port. Detects: ALPHA • BETA • GAMMA • X-RAY. MicroR, 1000 times the resolution of standard geiger counters. Excellent for tracking RADON GAS. Find sources. Plot: • Background • Cosmic Rays • Clouds • Foods Call/Write for PC MAGAZINE review. • TSR • GM Tube VISA/MASTER Phone orders. Not satisfied? Full refund.

Tel: (302) 655-3800

Aware Electronics Corp.

P.O. Box 4299, Wilmington, DE 19807 \$149.50

Inquiry 701.

### ACCESSORIES

#### FREE DEMOS, VIDEOS!

Hundreds of freebies direct from top computer cos.—working models, VCR videos, books, valuable info., etc. All yours to keep. Demos work with most systems. Send \$6.99 (free p&h) for listing of over 200 companies—most with 800 nos. Check or M.O. payable to:

LOUIS PUCCIO

90 CHURCH ST., BOX 2517, NY, NY 10008

Inquiry 706.

### BAR CODE

#### LABELING SOFTWARE

On EPSON, IBM, OKI dot matrix or LaserJet. Flexible design on one easy screen. Any format/size. Up to 120 fields/label. 18 text sizes to 3" readable at 100'. AIAG, MIL-STD, 2 of 5, 128, UPC/EAN, Code 39. File Input & Scanned logos/symbols (PCX)—\$279. Other programs from \$49. 30-day \$\$ back.

Worthington Data Solutions

417-A Ingalls St., Santa Cruz, CA 95060

(408) 458-9938

(800) 345-4220

#### CUT RIBBON COSTS!

Re-ink your printer ribbons quickly and easily. Do all cartridge ribbons with just one inker! For crisp, black professional print since 1982. You can choose from 3 models: Manual E-Zee Inker — \$39.50  
Electric E-Zee Inker — \$94.50  
Ink Master (Electric) — \$189.00  
1000s of satisfied users. Money-back guarantee.

BORG INDUSTRIES

525 MAIN ST., JANESVILLE, IA 50647

1-800-553-2404

In IA: 319-987-2976

Inquiry 702.

#### The REMOTE BOOT Box

A Little Box that lets you turn on your computer (or anything) when you're not there by just calling it from ANY phone.

Use it with Carbon Copy®, PC Anywhere®, PC Remote®, etc.

\$139.95

MSF Computers Inc.

266 Breithaupt Street, Kitchener, Ontario, N2H 5H5  
(519) 749-0374

Inquiry 706.

#### BAR CODE READERS

For PC, XT, AT, & PS/2, Macintosh, and any RS-232 terminal. A ts like 2nd keyboard, bar codes read as keyed data. With steel wand—\$399. Top rated in independent reviews. Works with DOS, Xenix, Novell, Alloy, -ALL software. Lasers, magstripe, & slot badge readers. 30-day \$\$ back.

Worthington Data Solutions

417-A Ingalls St., Santa Cruz, CA 95060

(408) 458-9938

(800) 345-4220

EXTENDER: Attach KB/Monitor up to 600" from CPU

COMPANION: Add a 2nd or 3rd KB/Monitor—600" from CPU

COMMANDER: Control 2 to 96 CPU's with a single KB/Monitor

PHONEBOOT: Boot or reboot PC by Phone

FREE DEALER KIT

CYBEX CORPORATION

2800-H Bob Wallace, Huntsville, AL 35805

205-534-0011 International Fax 205-534-0010

Inquiry 703.

#### HEWLETT PACKARD

Buy — Sell — Trade

Laser Jet II/III Color Pro (7440)  
Laser 2000 2 Meg/4 Meg upgrades HP-7550A  
Desk Jet Draft Pro DXL/EXL  
Rugged Writer Draftmaster I/II  
Electrostatic Plotters C1600 (D Size)/C1601 (E Size)  
Science Accessories Corporation Sonic Digitizers  
36" x 48" (2750) 60" x 72" (3175)

T. E. Dasher & Associates

4117 Second Ave. S., Birmingham, AL 35222

Phone: (205) 591-4747 Fax: (205) 591-1108

(800) 638-4833

Inquiry 707.

#### PORTABLE READER

Battery-operated, handheld reader with 64K static RAM, 2x16 LCD display, 32-key keyboard, Real-Time-Clock. Wand or laser scanner. Program prompts and data checking through its own keyboard. Easy data transfer by RS-232 port or PC, PS/2 keyboard. Doubles as On-Line Reader. 30-day \$\$ back.

Worthington Data Solutions

417-A Ingalls St., Santa Cruz, CA 95060

(408) 458-9938

(800) 345-4220

### ARTIFICIAL INTELLIGENCE

#### NeuralWorks Explorer

NeuralWorks Explorer is a neural net tutorial that provides the novice user with a method of learning neural net theory as well as an environment in which to build practical real time applications such as targeted marketing, stock prediction, process control and more. PC and MAC. Price \$99.00. Visa/MC accepted. University discounts available.

NeuralWare, Inc.

412-787-8222

Inquiry 708.

#### PRINT BAR CODES/BIG TEXT FROM YOUR PROGRAM

Add bar codes and big graphics characters to your program. Print from ANY MS-DOS language. Bar codes: UPC, EAN, 2 of 5, MSI, Code 39. Epson, OKI, IBM dot matrix text up to 1/2". LaserJet up to 2". Font cartridges not required. \$179-\$239. 30-day \$\$ back.

Worthington Data Solutions

417-A Ingalls St., Santa Cruz, CA 95060

(408) 458-9938

(800) 345-4220

#### FREE CATALOG

A complete source for all your computer supplies — media, paper, cables, furniture, software, ribbons, laser, cleaning, FAX supplies, accessories & more!

Order Bulk Disks, 100% Warranty, 25, Minimum

5.25" DS/DD 25¢ 3.5" DS/DD 45¢

5.25" DS/HD 45¢ 3.5" DS/HD 99¢

GAAN COMPUTER SUPPLIES

186 B East Sunnyoaks Ave., Campbell, CA 95008

Call (800) 523-1238

8AM - 5PM, Mon-Fri, California time

Inquiry 704.

#### FOR 386, 286 & PC

Modem 2400BPI Int.	\$ 69	FaxModem 4800/9600INT	\$139/259
640K PC Memory Card	\$ 29	2M AT Memory Card	\$ 99
MSP Graphic card+P/ports	\$ 25	16 Bits 800x600 VGA Card	\$ 72
XT HD/DO FD Controller	\$ 32	AT HD/FD Card MF/MRL	\$89/119
XT IO (F/S/P/G/C)	\$ 29	AT IO (S/P/G), 15/25	\$19/25
XT-HD/286-12M/Board	\$65/130	386SX-16M/Board	\$360
386-25MHz M/Board	\$695/795	386-33 64K Cache M/Board	\$890

(Call for Complete Price List!!!)

KOPEC INTERNATIONAL CO.

838 N. Glenville Dr., Richardson, TX 75081

Order: 800-654-8008 Tech: 214-907-1958 Fax: 214-907-1963

Inquiry 705.

#### Software Engineer Do Your Own Windows!

At last a LISP programming environment which takes advantage of a GUI and protected mode on the PC. Software Engineer™ for Windows™ 3.0 is a complete programming environment. It includes a LISP-aware text editor, allowing quick, easy and interactive Windows development. Software Engineer supports DDE, GDI, the clipboard, dialog boxes and menus. Software Engineer is priced at \$249.95.

Raindrop Software Corporation

845 E. Arapaho, Suite 105, Richardson, Texas 75081  
(214) 234-2611 Fax (214) 234-2674

See our ad on page 96.

Inquiry 709.

#### BAR CODE READERS

Keyboard emulation for PC/XT/AT & PS/2's, all clones and any RS-232 Terminal. Transparent to your operating system. Available with Steel wands, Lasers, Slot & Magstripe Readers. Same day shipping, 30-day money-back guarantee. One-year warranty. Reseller discounts available.

AMERICAN MICROSYSTEMS

2190 A Regal Parkway, Euless, TX 76040

(800) 648-4452 (817) 571-9015 FAX (817) 685-6232

# THE BUYER'S MART

## BAR CODE

### BAR CODE PRINTING SOFTWARE

- MS/PC DOS SYSTEMS
- 9 & 24 PIN DOT MATRIX
- H-P LASER JET/PLUS/SERIES II
- MENU-DRIVEN or MEMORY RESIDENT
- CODE 39, I 2/5, UPC A/E, EAN 8/13
- BIG TEXT & BAR CODE SOFTONTS

### AMERICAN MICROSYSTEMS

2190 A Regal Parkway, Euless, TX 76040  
(800) 648-4452 (817) 571-9015 FAX (817) 685-6232

## BAR CODE

### PC BAR CODE SPECIALISTS

Bar code readers designed for fast, reliable, cost-effective data entry. They emulate your keyboard, so scanned data looks just like it was typed in! Choose from stainless steel wand, laser gun, card slot reader, and magnetic stripe scanner. Also, powerful Bar Code and Text printing software. Great warranty. Generous dealer discounts.

### Seagull Scientific Systems

15127 N.E. 24th, Suite 333, Redmond, WA 98052  
206-451-8966

## CAD

### CAD-DRAWING VIEWSTATION

Allows non-CAD users to view drawings on PCs, print, plot, attach personal notes, and hyper-link between files. Change views and layers. Accurate entity representation. Easy to use.

- Sirlin VIEW/DWG for AutoCAD DWG files: \$295
- Sirlin VIEW/PLUS for DWG, DXF, HPGL and dBase: \$395

Developers: ask about linkable Sirlin VIEW/LIB. Dealers welcome.

### Sirlin Computer Corporation

225 Lowell Road, Hudson, NH 03051  
(603) 595-0420 Fax (603) 595-7779

Inquiry 719.

## CAD/CAM

### STEPPER MOTOR CONTROL FROM A PRINTER PORT

NEW Indexer LPT™ software VERSION 2.0 \$249

- Controls up to six motors simultaneously
- Linear and Circular Interpolation.
- New features to accommodate machine control.
- Easy-to-use DOS device driver. Super Manual.
- CAD-CAM interface available.

**Ability Systems** Corporation, 1422 Arnold Ave.  
Roslyn, PA 19001 (215) 657-4338

Inquiry 720.

### BAR CODE PRINTING

Print bar codes from your custom program. ANSI C routines generate and print Code39, I25, Codabar, UPC A/E, EAN 8/13 and supplements. Supports LaserJet, OKI, and EPSON and custom printers. Works with UNIX/XENIX, MSDOS and others. All SOURCE CODE included. No royalties. Single pattern \$85. All patterns \$250.

### Infinity Computer Services, Inc.

P.O. Box 269, Coopersburg, PA 18036  
Voice: 215-965-7699 BBS: 215-965-8028

Inquiry 710.

### BAR CODE READERS

Among the best and most widely used bar code decoders. Reads all major codes (39, I 2/5, S 2/5, UPC/EAN/JAN, CODABAR, MSI). Connects between keyboard and system. IBM, PS/2, MAC, DEC-VT compatible. OS & software independent. Same day ship. 2 Year Warranty (pen incl).

Large Reseller Discounts

### Solutions Engineering

4705 Langdrum Lane, Bethesda, MD 20815  
(800) 635-6533 (301) 652-2738

Inquiry 714.

### PC-Wand Bar Code Solutions

Bar codes are easy with a FULL line of readers & printers. They plug & play with your existing systems, most all makes of CPU/printer/terminal/software in your office, store, truck, factory or warehouse. Our bar code DOS programs print on matrix or laser printers. 30 day refund, 1 year warranty.

### International Technologies & Systems Corp.

655-K North Berry St., Brea, CA 92621  
TEL: (714) 990-1880 FAX: (714) 990-2503

Inquiry 711.

### DATA INPUT DEVICES

Bar Code, Magnetic Stripe Readers & SmartCard Encoder/Reader for microcomputers & terminals, including IBM PS/2 & others, DEC, Macintosh, AT&T, CT, Wyse, Wang. All readers connect on the keyboard cable & are transparent to all software. UPC & 39 print programs, magnetic encoders, & portable readers are also available.

### TPS Electronics

4047 Transport, Palo Alto, CA 94303  
415-856-6833 Telex 371-9097 TPS PLA  
1-800-526-5920 FAX: 415-856-3843

Inquiry 715.

### CAD/CAM Developer's Kit

Save months writing AutoCAD ADS or standalone CAD/CAM applications!

(617) 628-5217

### Building Block Software

PO Box 1373 Somerville, MA 02144

Inquiry 721.

### BAR CODE READERS

Bar code readers designed for operating simplicity and reliability. PC wedge and RS232 readers distinguished by superior wand. Portable reader has a large keypad and doubles as a fixed reader.

Friendly advice given.

### PACIFIC MICROSYSTEMS

2560 9th Street, Suite 214M, Berkeley, CA 94710  
(800) 242-5271 Fax (415) 644-2731

### VARIANT MICROSYSTEMS BAR CODE READERS DELIVER

WAND/LASER/MAGNETIC CARD CONNECTIVITY

- Keyboard wedges (Internal/External) for IBM PC/XT/AT, PS/2 and portables.
- RS232 wedges for WYSE, Link, Kimtron terminals
- Bar code and label printing software
- Full two-year warranty
- 30-Day Money-Back Guarantee
- Extensive VAR/Dealer Discounts

3140 De La Cruz Blvd., Suite 200/Santa Clara, CA 95054/(408) 980-1880  
800-666-4BAR FAX: (415) 623-1372

Inquiry 716.

### DRAFTeasy • ONLY \$399

• Professional 3D CAD software •

• "Common-sense" menus • Unmatched ease of use • Written in Assembler • Very fast and compact • Powerful features only rivaled by software costing \$1000's • DXF compatible • Programmer's interface for BASIC, Pascal and C • TRY IT FOR ONLY \$10 • Manual, tutorial, and working copy (SAVE/PLOT disabled) provided\*

### COMPUTERS ETC.

46 O Chippewa Suite 204, St. Louis, MO 63118  
Phone: 314-351-2513 Fax 314-351-7256

Inquiry 722.

## CAD

### \$99 Electro-CAD \$99

- Do your own Schematics / 2xPCB's / SMT
- Rubber-Banding / Inter-trace FLOOD
- Context-sensitive Hypertext HELP
- Graphics libraries w/EDITOR
- Total control of EGA/VGA for layout

FREE DEMO DISK

### AEROUX Engineering

32 West Anapamu, Suite 228, Santa Barbara, CA 93101  
(805) 962-9695

Inquiry 717.

## CASE

### SELECT CASE Software

Personal-SELECT-\$995

Full function PC Analysis/Design tool for Yourdon, Ward-Mellor, Hatley or HOOD methodologies.

Project-SELECT-\$1995

Links Personal-SELECT users for true multi-user working.

### SELECT Software Ltd.

Ullenwood, Cheltenham, Glos. England, GL53 9QS  
Tel: +44 242 226553 Fax: +44 242 251491  
Dealer inquiries welcome

Inquiry 723.

## ENV

Prints bar coded envelopes for fast delivery E...easy to use, N...nationally listed by USPS, V...value packed EN V bar coded envelopes are quickly sorted and delivered by the US Post Office. Postage discounted when over 200 bar coded pieces. • Use with any Word Processor or Mail Merge package • ENV Batch, Popup and Mail Merge versions on disk • Print return address, special messages and logos • for HP LaserJets and EPSON LD series printers. No new equipment required. Great program for any type and size business, church, club or association. Order for MSDOS computers NOW \$49.95

### Pike Creek Computer Company

2 Galaxy Dr., Newark DE 19711-2920  
To Order: (302) 239-5113 Dealers call (800) SELL LOW

Inquiry 713.

### AutoCAD Users!!

Increase your VGA-based AutoCAD performance up to 10 times with GT Express software.

- Instant zooms, pans and redraws
- Supports Release 11
- 1024x768 resolution
- GT Flexicon user interface
- Bird's-eye view
- Single or dual screen configuration

Call **ARTIST SOFTWARE** (800) 999-9678 for your FREE demo diskette.

Inquiry 718.

## CD-ROM

### FREE CHINON CD ROM PLAYER

Purchase \$995 worth of Alde's workhorse CD ROM software and receive a Chinon CDS-430 External or CDS-431 Internal CD ROM drive, cable, card, and DOS extensions absolutely free. Other bundled combinations also available.

### ALDE PUBLISHING INC.

Box 1190, Glen Lake, MN 55345  
800/727-9724 (Voc) 612/934-2824 (Fax)

Inquiry 724.



# THE BUYER'S MART

## CD-ROM

**Largest Selection and Best Price**  
Microsoft Programmers Library & Drive \$949.  
Computer Library \$695 • Public Domain S/W \$49.  
NEC PC or Mac Drive Kit \$749 • Bookshelf-Best Price!  
Drives from \$499. Hundreds of titles from \$29.  
MC/VISA/AMEX/COD, Money-back Guarantee.  
Call or write for free 120-page catalog.  
**Bureau of Electronic Publishing**  
141 New Road, Parsippany, NJ 07054  
800-828-4766  
**THE SOURCE FOR CD-ROM**  
See our ad on page 104.

Inquiry 725.

## CD ROM, Inc.

CD-ROM, WORM, MAGNETO-OPTICAL DRIVES, CD-ROM DISCS  
FOR IBM AND MAC, OPTICAL CONSULTING SERVICES  
\* PUBLISHING \* DISTRIBUTION \* NETWORKING  
QUALITY PRODUCTS AND SERVICES AT COMPETITIVE PRICES  
FREE CATALOG  
**TEL. 303-231-9373**  
1667 COLE BLVD., SUITE 400, GOLDEN, CO 80401  
FAX: 303-231-9581, CIS: 72007,544  
VISA/MC/AMEX/GOV'T. Pcs

Inquiry 726.

## COMMUNICATIONS

### SDLC OR X.25 SUPPORT

Use Sangoma hardware and software to provide cost effective, robust and easy-to-use SDLC or X.25 links from MS-DOS, UNIX, PC-MOS, etc.

All real time communication functions performed by intelligent co-processor card.  
Full function SNA emulation packages also available.

**Sangoma Technologies Inc.**  
(416) 474-1990

Inquiry 727.

## COMPUTER INSURANCE

### INSURES YOUR COMPUTER

SAFWARE Computerowners coverage provides replacement of hardware, media and purchased software. As little as \$49 a year covers accidents, theft, power surges and more. One call does it all. Call 8 am-10 pm ET. (Sat. 9 to 5)

**TOLL FREE 1-800-848-3469**  
(Local 614-262-0559)

**SAFWARE, The Insurance Agency Inc.**

Inquiry 728.

## CROSS ASSEMBLERS

### CROSS ASSEMBLERS

Universal Linker, Librarian  
**Targets for 42 Microprocessors**  
Hosts: MS-DOS, UNIX, VAX VMS

**ENERTEC, INC.**

BOX 1312, 811 W. Fifth St.  
Lansdale, PA 19446

Tel: 215-362-0966 Fax: 215-362-2404

Inquiry 729.

### CROSS ASSEMBLERS/SIMULATORS

New unique full-function simulators for the 8096 and 80C196 controllers, featuring ALL MODES of interrupts, plus the HSI, HSO, and A/D functions.  
We also support the 8048/49, 8080/85, 8051/52, and Z80 controllers with excellent, reasonably priced Cross Assemblers and Simulators.

**Lear Com Company**

2440 Kipling St., Ste. 206, Lakewood, CO 80125  
(303) 232-2226 FAX: (303) 232-8721

Inquiry 730.

## CROSS ASSEMBLERS

### CROSS ASSEMBLERS

Relocatable  
Macros  
PC Compatible

**GUARANTEED,  
SUPPORTED**

DEBUG SIMULATORS • DISASSEMBLERS  
EPROM PROGRAMMERS

**MICRO COMPUTER TOOLS CO.**

Phone Toll Free (800) 443-0779  
In CA (415) 825-4200  
912 Hastings Dr., Concord, CA 94518

Inquiry 731.

## CROSS DISASSEMBLERS

### PROFESSIONAL PC SOFTWARE

- **CROSS-DISASSEMBLERS**  
Analytic. Automatic Label Generation
- **CROSS-ASSEMBLERS**  
Relocatable, Macro, Universal Linker + Librarian
- **C CROSS COMPILERS**
- **SOURCE TRANSLATION UTILITIES**  
Support for Intel, Motorola, Zilog, TI, RCA

Order Today: (408) 773-8465

**LOGISOFT**

PO Box 61929, Sunnyvale, CA 94086  
FAX: (408) 773-6466

Inquiry 732.

## DATA CONVERSION

### MEDIA CONVERSION/DATA TRANSLATION

*More than just a straight dump or ASCII transfer!*  
**Word Processing, DBMS, and Spreadsheet data on Disks or Tapes transferred directly into applications running on Mainframes, Minis, Micros, Dedicated Word Processors, Typesetters, and Electronic Publishing systems.**

IBM PS/2 & Macintosh supported  
#1 in the translation industry!

**CompuData Translators, Inc.**

3345 Wilshire Blvd., Suite 407, Los Angeles, CA 90010  
(213) 387-4477 1-800-825-8251

Inquiry 733.

### DBMS/COPY

#### CONVERTS YOUR DATA INTO INFORMATION

Now your favorite stat package can access any database. DBMS/COPY can directly convert any database or spreadsheet file (ORACLE, PARADOX, dBASE, LOTUS etc.) into any stat package file (SAS, SPSS, SYSTAT, etc.) and vice versa. The PLUS version allows sorts, selections, and recalculations. \$195. 30-day guarantee. VISA/MC/AMEX/PO/COD. Call for free limited version.

**CONCEPTUAL SOFTWARE INC.**

PO Box 56627, Houston, TX 77256  
(713) 667-4222 FAX: (713) 667-3FAX  
1-800-STATWOW

Inquiry 734.

### CONVERT TECHNICAL DOCUMENTS MATH EQUATIONS

- Convert WordPerfect documents to TeX, LaTeX or PageMaker
- Convert TeX or LaTeX to WordPerfect, MultiMate, Word or WordStar.

**K-TALK COMMUNICATIONS, INC.**

30 West First Ave. • Columbus, OH 43201  
(614) 294-3535 FAX (614) 294-3704

Inquiry 735.

☆ **America's Leaders in Data Conversion** ☆

**DISK ⇄ DISK • TAPE ⇄ DISK  
OPTICAL SCANNING**

**WE CONVERT MORE FORMATS THAN ANYONE ELSE!!!**  
IBM, DEC, VAX/VMS, APPLE, WANG, XEROX, NBI, LANIER,  
CPT, UNIX, Wordperfect, ...

**QUICK—RELIABLE—HIGHEST QUALITY**

**NATIONAL DATA CONVERSION INSTITUTE**

5 East 16th St., NY, NY 10003 (212) 463-7511

Inquiry 736.

## DATA RECOVERY

### CRASHED?

Your valuable data can be recovered!

- 95% success rate • Fast turnaround
- Servicing Novell, DOS, Macintosh, Unix, Xenix, OS/2, Bernoulli and more!

**ONTRACK DATA RECOVERY, INC.**

*Keeping you in business is our business.*

1-800-872-2599

Inquiry 737.

### DATA RECOVERY

**Data lost from 1/4" cartridges or 1/2" tape can be recovered almost every time.** We have helped Banks, Insurance Companies, Telephone Companies, Commodity Dealers, Hospitals, Software Houses, Government Departments. **The list is endless.**  
We charge a small fixed fee for investigation and then on a time and materials basis.

The QICPAK Cartridge Interchange People

**Vogon Enterprises Ltd.**

94 Easthamstead Road, Wokingham, Berkshire RG11 2JD ENGLAND  
Tel 44 + (0)734-784511 or -890042 Fax 44 + (0)734-890040

Inquiry 738.

## DATA/DISK CONVERSION

### BILLIONS OF BITS CONVERTED!

Disk Interchange Service Company specializes in transferring files between incompatible computers. Our direct disk-to-disk conversion service is fast, efficient, and cost effective.

**Disk Interchange Service Company**

2 Park Drive • Westford, MA 01886 (508) 692-0050

Inquiry 739.

## THE #1 CHOICE

**In disk & tape conversion**

for many leading corporations, government agencies, law firms, and companies in every industry—world-wide.

**Free test • Satisfaction guaranteed**

**Graphics Unlimited Inc.**

3000 Second St. North, Minneapolis, MN 55411

(612) 588-7571 or (612) 520-2345

FAX: (612) 588-8783

Inquiry 740.

### QUALITY CONVERSIONS

to or from virtually

**ANY TAPE OR DISK FORMAT!**

Horan Data Services converts over 2000 formats incl. 9-track tape, 3480 Cartridge and 8", 5 1/4" or 3 1/2" diskettes. All densities & most operating systems supported. Formats include EBCDIC, ASCII, databases, spreadsheets, and dedicated or PC word processors.

**Call 1-800-677-8885**

Hours 8:00 AM to 5:30 PM Eastern Time  
817 Main Street, Third Floor, Cincinnati OH 45202

Inquiry 741.

### IBM PC ⇄ TO ⇄ HP FILE COPY

**FASTER**

**EASIER TO USE**

Update version uses windows: Call for free demo! IBM PC <to> HP File Copy allows IBM PCs, PS/2, compatibles to interchange files with Hewlett-Packard Series 70, 80, 200, 300, 1000, 9000s.

**Oswego Software**

Box 310

Oswego, IL 60543

708/554-3567

FAX 708/554-3573

Inquiry 742.

## DATA/DISK CONVERSION

### CONVERSION SERVICES

Convert any 9-track magnetic tape to or from over 3000 formats including 3 1/2", 5 1/4", 8" disk formats & word processors. Disk-to-disk conversions also available. Call for more info. Introducing OCR Scanning Services.

**Pivar Computing Services, Inc.**  
165 Arlington Hgts. Rd., Dept. #B  
Buffalo Grove, IL 60089 **(800) Convert**

## DATABASE

### INFO-TRAK

INFO-TRAK is a new menu-driven database/cataloguer program for the professional and the beginner. Ideal for business, home inventory, collections (books, stamps, coins, artworks, etc.), investments etc. Features include SEARCH, add/delete lines, edit data, create custom formats, PRINT and more. (IBM XT, AT and compatibles, DOS 2.0 & up)

Only \$59. \$3 shipping/handling (check or money order only)

### JA-DAL TECHNOLOGIES

P.O. Box 611, Yaphank, NY 11980  
(NY res. add 7.5% tax)

Inquiry 743.

## DATABASE MGMT SYSTEMS

### SAVE TIME & MONEY!

**OCELOT2—THE SQL** is a stand-alone database engine with a complete DB2 compatible SQL interface for developers who use BASIC, C, PASCAL, or COBOL.

- packs the full power of SQL into a 640KB PC;
- requires only 320KB RAM for program development;
- outperforms the rest!

For IBM and clones: \$195 & up. Free info.

### OCELOT COMPUTER SERVICES INC.

#1502, 10025-106 Street, Edmonton, AB, Canada, T5J 1G7  
(403) 421-4187

Inquiry 744.

## DISASSEMBLERS

### 80x86 .COM/.EXE files: 'Reusable Software'!!!

**Automatic!**—Only input/output filenames are required! Exhaustive flow-analysis distinguishes data from code.  
**Accurate!**—Uses scientific methods, not "guesswork"! Locates even one-byte data items in instruction areas!  
**Complete!**—Fully-labeled 80(2)86 code, data, directives! Commented BIOS/DOS INTs give function & operands.  
**Compatible!**—ASM output file is MASM 5.x-compatible.  
**NEW!** PC-DISNDATA 3.2 (5 1/4" disk & manual) \$165

### PRO/AM SOFTWARE

220 Cardigan Road, Centerville, OH 45459  
(513) 435-4480 (9 A.M.-5 P.M. EST M-F)

Inquiry 745.

## DISK DRIVES

### BEST BUY!!!

HD Kits for AT: Drive, Controller, Rails & Cables

40MB - MFM - \$ 289  
65MB - RLL - 339  
80MB - MFM - 469  
150MB - ESDI - 1049

### NEW, ONE YEAR WARRANTY

### jb TECHNOLOGIES, INC.

5105 Maureen Lane, Moorpark, CA 93021

**(805) 529-0908 Fax (805) 529-7712**

Inquiry 746.

### HARD DISC DRIVES

Sales • EXCHANGE • Repair

Trade in your defective drive for NEW, with FULL WARRANTY!

TREMENDOUS SAVINGS!

TECHNICAL SUPPORT OF COURSE!

Large Inventory Hard and Floppy Drives

### jb TECHNOLOGIES, INC.

5105 Maureen Lane, Moorpark, CA 93021

**(805) 529-0908 Fax (805) 529-7712**

Inquiry 747.

## DUPLICATION

### SOFTWARE DUPLICATION

- DISKETTE & TAPE
- CUSTOM PRINTING
- CUSTOM PACKAGING
- FULFILLMENT

### MEGASOFT, INC.

P.O. Box 710, Freehold, NJ 07728

**(800) 222-0490**

**(908) 462-7628**

Inquiry 748.

## EDUCATION

### B.S. & M.S. in COMPUTER SCIENCE

The American Institute for Computer Sciences offers an in-depth correspondence program to earn your Bachelor of Science and Master of Science degrees in Computer Science at home. B.S. subjects covered are: MS/DOS, BASIC, PASCAL, C, Data File Processing, Data Structures & Operating systems. M.S. program includes subjects in Software Engineering and Artificial Intelligence.

### AMERICAN INST. for COMPUTER SCIENCES

2101-BY Magnolia Ave. South, Ste. 200, Birmingham, AL 35205

**800-767-2427**

**205-323-6191**

Inquiry 749.

## EDUCATIONAL TRAINERS

### Motorola Simulator

Learn microprocessor programming easily

Educational simulator for the 6800 and 6809 microprocessors is now available. This software, with user friendly features, makes it easier to learn while practicing: Window/menu driven • Speed control • Editor/Assembler • Mouse support • Instant help • Trace capability • Simulated I/O devices • Real access to serial port • Works with IBM PC compatible 256K and one disk drive. License fees: U.S. \$495. for 6800 or 6809; U.S. \$595 for both; U.S. \$25 for demo version.

### Computer Science Dept.

Universite du Quebec a Hull

P.O. Box 1250 Station B, Hull, Quebec, CANADA J8X 3X7

Inquiry 750.

## ENTERTAINMENT

### SHAREWARE

FOR IBM™ AND COMPATIBLES

**FREE 112 PAGE CATALOG  
OVER 3000 PROGRAMS**

CALL 1-800-245-BYTE (2983)

### BEST BITS & BYTES

P.O. Box 8225-B, Van Nuys, CA 91409

FOREIGN COUNTRIES SEND \$4.00 FOR SHIPPING

Inquiry 751.

### WHERE ADULTS COME TO PLAY! ODYSSEY BBS

• Designed for Adult modem users • Low cost local access numbers covering 850 cities! • Live online chat with other users! • Large software file library! • "Bulletin board" style Forums! • Interactive online games! • Matchmaker dating database! • And much, much more. 24 hours a day!

We also can provide your company with national BBS services. Call (818) 358-0936 for details!

Information and Signup By Modem

**(818) 358-6968** (3/12/24 Baud, 8/NA, Must be over 18)

Voice Information (818) 357-9570

Inquiry 752.

### SeXy Software

VGA Connoisseur Collection

SeXy Disk #CC1 - FIRST customizable movie allows you to be the star and write the script!

SeXy Disk #CC2 - FIRST SOUND MOVIE - 256 sizzling VGA color graphics with actual sound and dialog!

SeXy Disk #CC3 - Best XXX Movie - for serious collectors only. 1 set - \$29 2 sets - \$49 3 sets - \$65

**800-243-1515 Ext. 600QA** 24 hrs. 7 days

Add \$3 s/h Add \$2/set 3 1/2" or foreign

2880 Bergey Rd. Dept. 600QA, Hatfield, PA 19440

Inquiry 753.

## ENTERTAINMENT

### NEMESIS™ Go Master®

Go, a game of strategic elegance, has been a way of life in the Orient for over four thousand years. Many consider Go to be the secret of the Japanese businessman's success. "While chess is a game of war, Go is a game of market share" [President of Nikko Hotels].

**Chaos Manor 1989 User's Choice Award**  
BYTE 4/90, p.62

**Toyogo, Inc. The Leader in Computer Go.**

PO Box F, Dept. Y, Kaneohe, HI 96744

**(808) 254-1166 or 1-800-TOYOGO-9**

Inquiry 754.

## FLOW CHARTS

### WINDOWS FLOWCHARTER \$129

RFFlow 2.0 is a professional drawing tool for flowcharts & org charts. Requires Microsoft Windows 3.0. 100 shapes auto adjust in size. Diagonal lines and curves. Auto line routing and re-routing. Click on a shape to bring up a sub-chart. Move charts to other apps. via the Clipboard. Call for free trial disk.

### RFF ELECTRONICS

1053 Banyan Court, Loveland, CO 80538

Phone: (303) 663-5767 FAX: (303) 669-4889

Inquiry 755.

## GRAPHICS

### YOUR PHOTOS-SUPER VGA

Integrated Images can convert your photographs, slides, and VHS or 8 mm video tapes to 640 by 480 (or 320 by 200), 256 color images. Many file formats available, including PCX, GIF, CUT and others. Prices start at \$3.25 per picture. Discounts for quantity orders. Call or write for more information.

### Integrated Images Incorporated

P.O. Box 10021, Lansing, MI 48901

**(517) 485-6636**

Inquiry 756.

### EGAD Screen Print

Prints contents of VGA, EGA, CGA displays on variety of dot-matrix, inkjet, and laser printers. Prints in gray tones or color. Crop box lets you print any region of the screen. Enlarge graphics 1 to 4 times (reduction too). Setup program for picking printer colors, etc. \$35.00 Postpaid. Call or write for free catalog.

### LINDLEY SYSTEMS

4257 Berwick Place, Woodbridge, VA 22192-5119

**(703) 590-8890**

Inquiry 757.

### IMAGE CAPTURE BOARD

Capture images from any VCR or Camcorder. Resolution up to 512 x 480 pixels; 65,536 colors or 256 shades of grey. Images saved in GIF, PCX, TIFF formats and more. For XT/AT/PS2. Includes user friendly software and user's guide. One year warranty. VGA required. Can capture from live video (eliminates need for expensive digital video). Ideal for Desktop publishing, CAD, Animation, and Pictorial Databases.

**\$749 VISA/MC/AMEX/C.O.D.**

### PEGA Micrographics

P.O. Box 713, Westerville, OH 43081, (614) 885-1007

**1-800-477-PEGA**

Inquiry 758.

## HARD DRIVE REPAIR

### HARD DRIVE REPAIR

ALSO

### DATA RECOVERY

FAST TURN!! CALL FOR DETAILS

### H&W micro labs, inc.

528-C Forest Parkway, Forest Park, GA 30050

**404-366-1600**

Inquiry 759.

# THE BUYER'S MART

## HARD DRIVE REPAIR

Beat the cost of replacement

10% Off Discount **REPAIR** Coupon 10% Off

HARD DISC and FLOPPY DRIVES  
FULL WARRANTY PROTECTION

Fast Turnaround • Data Recovery

**jb TECHNOLOGIES, INC.**

5105 Maureen Lane, Moorpark, CA 93021

(805) 529-0908 Fax (805) 529-7712

Inquiry 760.

## DATA RECOVERY

SALES of new, remanufactured and removable disk drives

FULL TECHNICAL SUPPORT

ROTATING MEMORY SERVICE

1506 Dell Avenue, Campbell, CA 95008

(408) 370-3113

Inquiry 761.

## HARDWARE

### LATEST AWARD BIOS

User definable hard drives, 101/102 keyboard and 3.5" 1.44Mb floppy support are now available in Award BIOS Ver. 3.1 for the IBM AT, 286 and 386 compatibles.

**KOMPUTERWERK, INC.**

851 Parkview Blvd., Pittsburgh, PA 15215

Orders: 800-423-3400

Tech: (412) 782-0384

Inquiry 762.

## APPLE® II & MACINTOSH®

• Systems • Peripherals • Parts

**RODIME**  
140Mb 5.25"  
Internal \$599  
external \$699

Call for a CATALOG  
USA & Canada:  
**800-274-5343**  
International: 617-891-6851  
Fax: 617-891-3556

Save  
up to  
50%  
on Mac  
CPUs.

**Pre-Owned Electronics, Inc.**

30 Clematis Avenue • Waltham, MA 02154

Inquiry 763.

### ROM BIOS UPGRADES

For Your IBM or Compatible • A New BIOS Upgrade Will:

• Support Windows 3.0 • Support 360K, 720K, 1.2 MB & 1.44 MB Floppy Drives • User defined hard drive types • Supports VGA • Novell & Netware compatible • Expanded hard drive table • Enhanced 101/102 keyboard • 100% IBM compatible • Complete documentation • Latest version • Complete set up in ROM.  
Dealer/Distributor Inquiries Welcome Authorized Award Software Inc. Dist.

**800-800-BIOS Fax 508-683-1630**  
800-800-2467 508-686-6468

**Unicore Software**  
599 Canal Street, Lawrence, MA 01840

Inquiry 764.

## APPLE • LAPTOPS • SOFTWARE

Reasonable prices on Macintosh, IBM, Compaq, HP, Everex, Toshiba, NEC, Sharp, Panasonic, Seiko, Houston Instruments, Roland, Calcomp, CD-ROMs, Scanners. All products carry manufacturer's warranty.

Microsoft Windows 3.0 \$89 • Home Lawyer 1.0 \$68

Computer Books — Over 2400 Titles

Call **UCC 213-921-8900 Fax 213-802-0831**

13738 Arlesia Blvd. 150, Cerritos, CA 90701  
C.O.D. Cash Only  
INTERNATIONAL ORDERS WELCOME

Inquiry 765.

## HARDWARE/COMPUTERS

### TDS9092 Forth Embedded Computer

Priced correctly for building into products this board has small size, low power and high level language. It interfaces to LCD & keyboard and has on-board multiprocessing, interrupts, dual RS232 ports, RAM, non-volatile EEPROM, I<sup>2</sup>C bus and 35 I/O lines. Optional precision A-D and battery-backed RAM. A data logger can run 12 months on a small battery. Use for machine control, data logging, robotics instruments and automation. Call or fax for details. Now \$179 (25 qty)

**The Saelig Company**

1193 Moseley Road, Victor, NY 14564

Phone (716) 425-3753 Fax (716) 425-3835

Inquiry 766.

## INVENTORY MANAGEMENT

### STOCK-MASTER 4.0

Commercial grade inventory management software at micro prices.

- Supports all 12 transaction types
- Trend Analysis
- Quality Control
- Multiple Locations
- Purchase Order Tracking
- Open Order Reporting
- Serial/Lot # Tracking
- Stock Status Reporting
- Activity History Analysis
- Bill of Materials
- Purchase Order Writing
- Order Entry
- Material Requirements
- On Line Inquiry

**Appled Micro Business Systems, Inc.**

177-F Riverside Ave., Newport Beach, CA 92663 714-759-0582

Inquiry 767.

### dFELLER Inventory

Business inventory programs written in modifiable dBASE source code.

dFELLER Inventory \$150.00

Requires dBASE II or III, PC-DOS/CPM

dFELLER Plus \$200.00

with History and Purchase Orders

Requires dBASE III or dBASE III Plus (For Stockrooms)

**Feller Associates**

550 CR PPA, Route 3, Ishpeming, MI 49849

(906) 486-6024

Inquiry 768.

## LANS

### The \$25 Network

Try the 1st truly low-cost LAN

- Connect 2 or 3 PCs, XT's, AT's
- Uses serial ports and 5-wire cable
- Runs at 115K baud
- Runs in background, totally transparent
- Share any device, any file, any time
- Needs only 14K of RAM

Skeptical? We make believers!

**Information Modes**

P.O. Drawer F, Denton, TX 76202

817-387-3339 Orders 800-628-7992

Inquiry 769.

## LAPTOP COMPUTERS

### Laptop Savings

Laptops: Toshiba • Zenith • NEC • Sharp  
• Epson • Mitsubishi • Compaq • Leading Edge  
• Hyundai • Panasonic • Packard Bell  
• Texas Instruments • For • Tandem

Also: Full Range of Laptop Accessories  
**Computer Options Unlimited**

12 Maiden Lane, Bound Brook, NJ 08805

Phone: 201-469-7678 To order: (800) 424-7678  
9-9 M-F 9-5 Sat. 6 days Worldwide sales

Inquiry 770.

## IBM CONVERTIBLE

MEMORY-128K \$79 384K \$249

MODEMS—Standard \$75 Enhanced \$175

CRT ADAPTER—for monitors \$149

MONITORS—Monochrome \$115 Color \$349

COMPACT Carrying Case \$39

ENHANCED LCD—\$129

PRINTER—\$165 BATTERY—\$89

MORE ACCESSORIES AVAILABLE

**COMPUTER RESET**

P.O. Box 461782, Garland, TX 75046

Phone (214) 276-8072 BBS & FAX (214) 272-7920

Inquiry 771.

## LAPTOP PERIPHERALS

### LAPTOP PERIPHERALS

NEW LOW PRICES ON:

- Battery Powered Printers
- Portable Hard Drives
- Laptop Expansion Systems
- Backlites AND MORE!

Call for free catalog

**AXONIX CORPORATION**

(800) 866-9797

Inquiry 772.

### TOSHIBA LAPTOP ENHANCEMENTS

FAX/MODEMS: 9600/2400 bps, software, acoustic port  
MODEMS, INTERNAL: 2400 bps, acoustic or serial port  
MODEM, DEDICATED: 2400 bps (T1200, T1600, T3200SX)  
SERIAL IO CARDS: RS232, RS422, SCSI, HPIL, Barcode  
BATTERY PACKS: 12V external battery + vehicle adapter

Contact us for more information:

**PRODUCT R&D Corporation (Callf).**

805/546-9713, Fax: 805/546-9716

Inquiry 773.

## MAGAZINE INDEXES

### BYTE® INDEX

BIINDEX: the COMPLETE keyword index to BYTE magazine for IBM-compatibles. Easy-to-use, compact, comprehensive. Updated quarterly. 1990 & 1991 editions \$49.95 each. Tax, shipping included. Money-back guarantee.

**Esc**

6197 Highway E, Abrams, WI 54101

(414) 826-5362

Inquiry 774.

## MAILING LIST PROGRAMS

### YOURS FREE!

"How to Manage Your Mailing List" ArcList® & AccuMail® are two powerful programs for your IBM or compatible PC:

- Duplicate Recognition
- Postal Discount Presorts
- Label Design & Printing
- Carrier Route and Zip+4 Insertion
- Address Correction
- dBase® Compatible

Call 800-368-5806 for a FREE GUIDE

**Group 1 Software, Inc.**

6404 Ivy Lane, Dept. BIT-21, Greenbelt, MD 20770-1400

Inquiry 775.

### MAIL WITH MAIL MASTER...

It's genuinely easy to learn and use • Contains 200 pre-written letters • Uses zip codes to automatically enter cities and states • Prints labels, letters and reports • Eliminates duplicates • Holds unlimited records • Costs \$99.95

**ThinkSoft Corp.,** 1-800-533-3466

1220 Broadway, Suite 604, NY, NY 10001

Inquiry 776.

## MEMORY CHIPS

### PRICE MEETING & BEATING!

DRAMs

64K x 1-12, 10

64K x 4-80

256K x 1-15, 12, 10, 80, 70, 60

256K x 4-80

1MEG x 1-10, 80, 70, 60

INTEL/CYRIX/ITT MATH CO'S

80287-8, 10

80387-SX, 16, 20, 25, 33

Model 30 286

Model 50, 55, 60, 70, 80

Model 50, 55, 60, 70, 80

Model 50, 55, 60, 70, 80

Model 50, 55, 60, 70, 80

Model 50, 55, 60, 70, 80

Model 50, 55, 60, 70, 80

Model 50, 55, 60, 70, 80

Model 50, 55, 60, 70, 80

Model 50, 55, 60, 70, 80

Model 50, 55, 60, 70, 80

Model 50, 55, 60, 70, 80

Model 50, 55, 60, 70, 80

Model 50, 55, 60, 70, 80

Model 50, 55, 60, 70, 80

Model 50, 55, 60, 70, 80

Model 50, 55, 60, 70, 80

Model 50, 55, 60, 70, 80

Model 50, 55, 60, 70, 80

Model 50, 55, 60, 70, 80

Model 50, 55, 60, 70, 80

Model 50, 55, 60, 70, 80

Model 50, 55, 60, 70, 80

Model 50, 55, 60, 70, 80

Model 50, 55, 60, 70, 80

Model 50, 55, 60, 70, 80

Model 50, 55, 60, 70, 80

Model 50, 55, 60, 70, 80

Model 50, 55, 60, 70, 80

Model 50, 55, 60, 70, 80

Model 50, 55, 60, 70, 80

Model 50, 55, 60, 70, 80

Model 50, 55, 60, 70, 80

Model 50, 55, 60, 70, 80

Model 50, 55, 60, 70, 80

Model 50, 55, 60, 70, 80

Model 50, 55, 60, 70, 80

Model 50, 55, 60, 70, 80

Model 50, 55, 60, 70, 80

Model 50, 55, 60, 70, 80

Model 50, 55, 60, 70, 80

Model 50, 55, 60, 70, 80

Model 50, 55, 60, 70, 80

Model 50, 55, 60, 70, 80

Model 50, 55, 60, 70, 80

Model 50, 55, 60, 70, 80

Model 50, 55, 60, 70, 80

Model 50, 55, 60, 70, 80

Model 50, 55, 60, 70, 80

Model 50, 55, 60, 70, 80

Model 50, 55, 60, 70, 80

Model 50, 55, 60, 70, 80

Model 50, 55, 60, 70, 80

Model 50, 55, 60, 70, 80

Model 50, 55, 60, 70, 80

Model 50, 55, 60, 70, 80

Model 50, 55, 60, 70, 80

Model 50, 55, 60, 70, 80

Model 50, 55, 60, 70, 80

Model 50, 55, 60, 70, 80

Model 50, 55, 60, 70, 80

Model 50, 55, 60, 70, 80

Model 50, 55, 60, 70, 80

Model 50, 55, 60, 70, 80

Model 50, 55, 60, 70, 80

Model 50, 55, 60, 70, 80

Model 50, 55, 60, 70, 80

Model 50, 55, 60, 70, 80

Model 50, 55, 60, 70, 80

Model 50, 55, 60, 70, 80

Model 50, 55, 60, 70, 80

Model 50, 55, 60, 70, 80

Model 50, 55, 60, 70, 80

Model 50, 55, 60, 70, 80

Model 50, 55, 60, 70, 80

Model 50, 55, 60, 70,

# THE BUYER'S MART

## NEURAL NETWORKS

### NEURAL NETWORKS MADE EASY!<sup>®</sup>

Introducing THE VISIBLE NEURAL NETWORK<sup>®</sup> V2.0, the complete neural network package. Now includes fast integer math source code listing and Lotus 1-2-3 compatible application environment. Upgrades available. **SATISFACTION GUARANTEED** or your money back. \$49.95 + \$3.00 S/H to:

**The Visible Neural Network, Inc.**

4228 Weskan Court, Bridgeton, MO 63044-1317  
(314) 739-2654 MC/Visa (24 hrs)

Inquiry 778.

## OBJECT-ORIENTED

### Improve Your Productivity

Are your programming skills out of date? Get the facts you need. Object-oriented vocabulary, examples, vendors, bibliography. No hype, no editorials, just compact, complete explanations. Source code for C & C++ examples included on diskette. Satisfaction guaranteed. Send for free information.

#### buk-werm Information Services<sup>™</sup>

Dept B2, 16776 Bernardo Ctr. Dr., Ste. 110b, San Diego, CA 92128  
24 hr FAX: (619) 489-0778 VISA & MasterCard accepted

Inquiry 779.

## PROGRAMMERS' TOOLS

### HYPERINTERFACE<sup>™</sup> II

**Menu Creator<sup>™</sup>** — An interactive WYSIWYG editor to generate a menu-driven user interface for your software. **Screen Creator<sup>™</sup>** — An interactive WYSIWYG editor for quick and easy screen design and a screen database manager for your software. **Advanced Library** — Extended capability for data entry for your programs. FORTRAN, Pascal, C, BASIC supported.

#### Avanpro Corp.

P.O. Box 969, Pacific Palisades, CA 90272  
(213) 454-3866

Inquiry 780.

### QuickBASIC Dialog Boxes: \$95

DiaLogic creates SAA text dialog boxes exactly like those in Microsoft's current "Quick" environments.

Low-level assem routines ♦ Mouse support ♦ BASIC source code ♦ Crescent Software P.D.Q. 2.12 support ♦ Fully customizable ♦ Single-/Multi-tasking modes ♦ 2 compression utilities ♦ Supports BASIC 4.x, 6.x, 7.x ♦ Demo/tutorial ♦ 100+ pages of doc w/ examples

#### 800-DIALOG-1

VISA/MC/Check + \$6 s/h USA  
Dialog Software ♦ Box 9889 At 1101 Wilson Blvd.  
Arlington ♦ VA ♦ 22209-0889 ♦ USA ♦ 703-528-1505

Inquiry 781.

### PLOT= >SOURCE.PAS

Unique full-function viewer for HPGL files and automatic code generator (requires Turbo Pascal)

PLOT- >PAS ver. 1.0 Lit. 80000 (about \$67) plus S&H. Visa/ MasterCard Accepted

DRAW with AutoCAD, DesignCAD3D, Corel Draw, Freelance, Orcad, etc. . . . ; PLOT to file; RUN PLOT- >PAS; view, zoom, pan, scale, cut. . . and ENTER: your code is ready.

NEW: with source for custom output TPU, demo programs, 3.5" and 5.25" media, manual.

#### Ing. Marco Sillano

Via Massimi 154, I00136 — ROME, ITALY

Inquiry 782.

### YOUR SALES MESSAGE

about the special computer product or service that you provide belongs in print.

#### THE BUYER'S MART

can help you reach computer professionals and produce valuable inquiries for your company!

Call Brian Higgins for more information

603-924-3754

or

Fax: 603-924-2683

Inquiry 783.

326 B Y T E • FEBRUARY 1991

## PROGRAMMERS' TOOLS

### EDLIN Alternative

Frustrated using EDLIN? Switch to EdFile — A full-screen text editor with dozens of features like:

- WP Type Edit Features
- Files up to 6 MB
- Super Copy (Merge)
- 255 Char. Lines
- On Screen Help
- Undelete Lines

800-345-3808 (VISA/MC)\$49.00 + 3.00 S/H

MIPS, Inc. • Box 3072 • Hammond, LA 70404

Inquiry 784.

### C and C++ DOCUMENTATION TOOLS

- C-CALL (\$59) Graphic-trees of caller/called hierarchy.
- C-CMT (\$59) Create, insert, update comment-blocks for each function, listing functions and identifiers used.
- C-LIST (\$39) List, action-diagram, reformat programs.
- C-REF (\$49) Local/global/parameter cross-reference.
- SPECIAL (\$149) All 4, plus integrated C-DOC program.

#### SOFTWARE BLACKSMITHS INC.

6064 St. Ives Way, Mississauga, ONT Canada L5N-4M1  
(416) 858-4466

Inquiry 785.

## PUBLIC DOMAIN

### FREE SOFTWARE FOR IBM<sup>®</sup>/clones

TRY US! GET 15/5.25" or 6/3.5" Disks full of our best selling software—FREE. Great games, utilities, business, educational, and desktop publishing, plus our 3000 disk catalog. Pay only \$5.00 shipping/handling.

#### INTERNATIONAL SOFTWARE LIBRARY

619-942-9998

Inquiry 786.

### HUNDREDS OF NEW PROGRAMS

AS LOW AS \$1.29. LATEST VERSIONS

FREE CATALOG. 1-800-292-DISK (3475)

EVERY PROGRAM CHECKED FOR VIRUSES

#### PRINCETON SOFTWARE INC.

200 WALL STREET, PRINCETON, NJ 08540

Inquiry 787.

### 325 MEGABYTES Virus Free Share Ware

Dealers/Sysopts/Educators. Instant IBM Shareware Library for your Customers, user group or Students. Distributed in 25 Megabyte increments on HD 1.2/1.4 diskettes, \$39.00 for first 25 Megabytes, then add \$40.00 for each 25 Megabyte increment.

Add \$300 postage for each 25 Megabyte increment.

Add \$4.00/25 Meg increment for 1.44 diskettes.

Orders Only: 1-800-876-8496

Info/Tech: 1-405-524-5233

#### SHARE-NET

POB 12368, Okla City, OK 73157

No Surcharge for Visa/MasterCard

We gladly accept PO's from Educational, Fed'l, State Agencies

Inquiry 788.

### FREE CATALOG

FOR IBM PD AND SHAREWARE

SELECTED PROGRAMS

LATEST VERSIONS

Low as \$1.50

#### SOFTSHOPPE, INC.

TEL: 800-829-2378 • 313-761-7638

FAX: 313-761-7639

P.O. Box 3678, ANN ARBOR, MI 48106

Inquiry 789.

## SECURITY

### FIGHT PIRACY!

Since 1986, companies worldwide have been choosing Az-Tech security products. If you demand the strongest protection available, why not choose one of these "proven leaders":

- EVERLOCK Copy Protection
- EVERTRAK Software Security
- EVERKEY Hardware "Key" Software Security

For IBM and Compatibles. 30 day money back guarantee. Free info and demo disk available.

Az-Tech Software, Inc.

305 East Franklin, Richmond, MO 64085

(800) 227-0644 (816) 776-2700

Fax: (816) 776-8398

Inquiry 790.

### THE ULTIMATE COPY PROTECTION

- Completely Menu Driven
- Defeats all Hardware/Software Copiers
- No Source Code Changes
- Multiple Layering
- No Damaged Media
- Full Hard Disk Support
- Unlimited Metering
- FREE Demo Disk

Quite  
Simply  
The Best  
Way To  
Protect  
Your Valuable  
Software Investment

STOPVIEW<sup>™</sup> STOPCOPY PLUS<sup>™</sup>

BBI COMPUTER SYSTEMS<sup>®</sup> (301) 871-1094  
14105 Heritage La., Silver Spring, MD 20906 FAX: (301) 460-7545

Inquiry 791.

### BIT-LOCK<sup>®</sup> SECURITY

Piracy SURVIVAL 8 YEARS proves effectiveness of powerful multilayered security. Rapid decryption algorithms. PARALLEL or SERIAL port-transparent security device. Complemented by economical KEY-LOK<sup>™</sup> and multifeatured COMPU-LOCK<sup>™</sup> including countdown, timeout, data encryption, and multiproduct protection. (Dos/Unix/Mac). Also, access control.

#### MICROCOMPUTER APPLICATIONS

3167 E. Otero Circle, Littleton, CO 80122  
(303) 770-1917

Inquiry 792.

### CopyControl

#### YOUR POWER TO PROFIT

- Ultra secure • Cost effective • Choose where, when and usage rate • Change parameters by phone • No messy dongles or special disks • Hard disk and LAN support

Choose the NEW Generation Copy Protection

FREE Demo Disk and Info

1-800-237-8400 ext. 212

#### MICROCOSM INC.

40 Wall Street, Suite 2124, New York, NY 10005

Inquiry 793.

### HANDS OFF THE PROGRAM<sup>®</sup>

#### OPERATING SYSTEM SECURITY

Secures subdirectories, files, printers and floppies  
Keyboard lock — automatic or manual  
Log PC boot, program exec, file opens, login/logouts  
Prevents DOS FORMAT and most viruses  
Drive A: Boot Protection / Hard Disk Lock  
IBM PC or 100% comp. — DOS V.3.0+ — \$99.95 + \$3.75 S/H

#### SYSTEMS CONSULTING INC.

PO BOX 111209, Pittsburgh, PA 15238

(412) 781-5280

Inquiry 794.

## SHAREWARE

### FREE SOFTWARE FOR IBM<sup>®</sup>/clones

Monthly, get 5 disks with 10+ latest programs plus catalog — FREE! Pay only \$5.00 for 5/5.25" or \$6.95 for 3/3.5" disks. Join today for only \$19.95 membership fee and get your first volume of software—FREE!

#### SOFTWARE OF THE MONTH CLUB<sup>®</sup>

619-942-9939

Inquiry 795.

# THE BUYER'S MART

## SOFTWARE/ACCOUNTING

### dBASE BUSINESS TOOLS

- GENERAL LEDGER
- ORDER ENTRY
- JOB COSTING
- BILL OF MATLS
- PAYROLL
- PURCH ORDINVENTORY
- ACCOUNTS RECIVABLE
- JOB ESTIMATING
- SALES ANALYSIS
- ACCOUNTS PAYABLE

\$99 ea. + S&H

**DATAMAR SYSTEMS** Cred. Card-Check-COD  
4876-B Santa Monica Ave.  
San Diego, CA 92107 (619) 223-3344

Inquiry 796.

## SOFTWARE/BUSINESS

### DATA ENTRY SOFTWARE

Full featured, heads-down data entry with two-pass verification, edit language, operator stats, much more! Designed for the PS/2<sup>®</sup>, PC, XT, AT or compatibles. PC's from \$395 LAN version available  
**FREE 30 day trial**  
**Computer Keyes** Tel: 206/776/6443  
21929 Makah Rd., Fax: 206/776-7210  
Woodway, WA 98020 USA: 800/356-0203

### SPECIAL SPELL CHECKERS

BIZZ-WORDS for the Modern Business World; PETRO-WORDS for the Petroleum Industry. Each some 15,000 technical terms to supplement Wordstar, Wordperfect, DisplayWrite, Word, Manuscript, XYWrite, IWP, etc. on IBM, Mac, Wang, & compatibles. 5 1/4" 13 1/2" disk + manual. BIZZ \$69 PETRO \$99, all inclusive.

**IJK INFORMATICS Inc.**  
6 Denny Rd., Suite 104, Wilmington, DE 19809  
(302) 764-8796 Fax: (302) 764-8850

Inquiry 797.

### StaffMinder™

**Staff Administration Software—A must for all managers!** Named for its inherent ability to "keep an eye on your staff," StaffMinder™ handles the following:  
• Attendance tracking and analysis  
• Vacation planning and scheduling  
• Skills inventory  
• Salary, review, and bonus tracking  
• Compliance reporting  
• Employee information  
• Informative reports. Free serial mouse included with each order. Simple point and click interface allows for easy implementation. Source code available.  
List price \$395. Ask for details on current special pricing!  
**NEXT GENERATION SOFTWARE**  
Suite 1445, 3340 Peachtree Road, Atlanta, GA 30326  
CALL (800) 966-0707

Inquiry 798.

## SOFTWARE/BUSINESS SALES

### AWARE SALES LEAD SYSTEM

*More sales less time*

- Customer information
- Contact history
- Create customer lists
- Write/edit/merge letters
- Follow-up lists
- Reports
- Mail labels

FREE call forms/letters

**PNI**

**800-828-6826**

V/MC \$180 + \$2.50 S/H

Inquiry 799.

## SOFTWARE/ENGINEERING

### UNLIMITED SPICE MODELS

- Diodes, Transistors
- JFETs, MOSFETs
- Power Devices
- Any SPICE Program
- Fast, Easy To Use
- Uses Data Sheet Info

SPICEMod, The Modeling Spreadsheet, allows SPICE models to be developed from data sheet parameters in minutes. The models are compatible with any SPICE program on any computer. SPICEMod is available now for \$200.

**Intusoft**

The leader in low cost, full featured CAE tools  
P.O. Box 710, San Pedro, CA 90734-0710  
(213) 833-0710 FAX (213) 833-9658

Inquiry 800.

## SOFTWARE/ENGINEERING

### SIMULATION WITH GPSS/PC™

GPSS/PC™ is an MS-DOS compatible version of the popular mainframe simulation language GPSS. Graphics, animation and an extremely interactive environment allow a totally new view of your models. If you are contemplating the creation or modification of a complex system you need GPSS/PC to help you predict its behavior. Call now.

### MINUTEMAN Software

P.O. Box 171Y, Stow, Massachusetts, U.S.A.  
(508) 897-5662 ext. 540 (800) 223-1430 ext. 540

Inquiry 801.

### CIRCUITS: SPICE for PCs

Non-linear DC & Transient, Linear AC Analyses  
• Version 3C1 with BJT, MOSFET, JFET, diode, etc. models. NUTMEG postprocessor with Screen Graphics, Operating Shell, Hypertext Help & circuit file Editor included.  
• Version 2G6 now includes Operating Shell, circuit file Editor & NUTMEG compatibility.

### Northern Valley Software

28327 Rotroch Dr., Rancho Palos Verdes, CA 90274  
(213) 541-3677

Inquiry 802.

### ACTIVE™

*Versatile! • Fast! • Easy! • Thorough!*  
Menu driven Active filter design in 3 easy steps:  
1) Specify characteristics, 2) Select real components, 3) Analyze performance. Butterworth, Chebyshev, Bessel Realpole, etc. Full set of reports, graphs and tables.  
• IBM-PC • \$745 • Call for FREE demo

### Tatum Labs Inc.

3917 Research Park Dr. B-1, Ann Arbor, MI 48108  
313-663-8810

Inquiry 803.

## SOFTWARE/ GEOLOGICAL

### GEOLOGICAL CATALOG

Geological software for log plotting, gridding/contouring, hydrology, digitizing, 3-D solid modelling, synthetic seismogram, fracture analysis, image processing, scout ticket manager, over 50 programs in catalog. Macintosh too! Please call, or write, for Free Catalog!

### RockWare, Inc.

4251 Kipling St., Suite 595, Wheat Ridge, CO 80033 USA  
(303) 423-5645 Fax (303) 423-6171

Inquiry 804.

## SOFTWARE/GRAPHICS

### Graphics Gems

*edited by Andrew S. Glassner*

As seen at SIGGRAPH—this handbook provides practical solutions to graphics problems, and every graphics programmer will find it an essential tool in saving time and energy in their daily programming activities.

August 1990, 864 pp., \$49.95/ISBN: 0-12-286165-5  
**ACADEMIC PRESS**, Book Mktg. Dept. #02021  
1250 Sixth Ave., San Diego, CA 92101  
CALL TOLL FREE 1-800-321-5068

Inquiry 804.

### QuickGeometry Library

All the C geometry and DXF routines you expect... and more!

(617) 628-5217

### Building Block Software

P.O. Box 1373, Somerville, MA 02144

Inquiry 805.

## SOFTWARE/GRAPHICS

### The Ultimate CAD/CAM Engine

TurboGeometry Library 3.0. The most complete tool box of 2D & 3D routines available today! Over 300 routines. Surfacing, Solids, Hidden line, Volumes, Areas, Transforms, Perspectives, Decomp, Clipping, Tangents & more. 30 day guar., \$199.95 w/source S&H Incl. Foreign \$225.00. MS/PC DOS 2.0+. Turbo Pascal, Turbo C, MSC, MIX C, Zortec C++., VISA/MC, PO, Chk, USA funds only.

### Disk Software, Inc.

2116 E. Arapaho Rd., #487, Richardson, TX 75081  
(214) 423-7288, (800) 635-7760, FAX (214) 423-7288

Inquiry 806.

### RAINDROP™

FAST, compact PrtScr Utility for end users AND developers. Hardcopy as fast as 10 secs. Average binary size - 6 kbyte. 14 video graphic standards. Scale, rotate, colorize and more. 'CALL' from user-written programs. Complete 9- & 24-pin dot-matrix, inkjet, and laserjet library \$44.95+\$3 s/h.

### ECLECTIC SYSTEMS

8106 St. David Ct., Springfield, VA 22153  
(703) 440-0064

Inquiry 807.

### PEN PLOTTER EMULATOR

FPLot turns your printer into an HP pen plotter. Fast hi-res output, no jagged lines. Vary line width, color. Screen preview with zoom and pan. Stand-alone, background, and device driver modes. Works with most CAD and graphics programs. Supports most printers. New version 3. \$119+\$3 S&H. 30 day money back. VISA/MC/Check/MO.

### FPLot Corporation

24-16 Steinway St., Suite 605, Astoria, NY 11103  
718-545-3505

Inquiry 808.

### EGraph for ENGINEERS \$29

Pull-down menus for XY, Bar, Needle, DoublePie, Contour, HiloSlope, Value-Range, Triangle %, & Polar graphs using 2Y Linear, Log, PROBABILITY, Time Series & Vector scaling. 32,000 points from ASCII or Lotus WK1 files, output to Epson FX&LQ, HP LaserJet, HP plotter or HP & Lotus PIC files. Stats, Histogram, Cumulative, Moving Avg, Spline, 6 Regressions, Pearson III & Interpolation. CGA, EGA, VGA, MCGA, Hercules, 256K, DOS 2.1+

### Great Basin Associates

653 Ave M, Boulder City, NV 89005 702-293-5908

Inquiry 809.

### GRAPHICS PRINTER SUPPORT

AT LAST! Use the PrtSc key to make quality scaled B&W or color reproductions of your display on any dot matrix, inkjet, or laser printer (incl. Postscript) in up to 64 shades of gray or 256 colors. GRAFPLUS supports all versions of DOS with IBM (incl. EGA, VGA, Super VGA), Hercules, or compatible graphics boards. Linkable/OEM versions available. \$59.95

### Jewell Technologies, Inc.

4740 - 44th Ave. SW, Seattle, WA 98116  
1 (800) 284-2574 (206) 937-1081

Inquiry 810.

### FORTRAN GRAPHICS

GRAF/MATIC/PRINT/MATIC/PLOT/MATIC LIBRARIES  
GRAF/MATIC-FORTRAN callable graphics Library for creating 2-D and 3-D graphics, contour plots and solid models. PRINT/MATIC and PLOT/MATIC provide high resolution FORTRAN callable printer and plotter drivers for your graphics.

\$249.95 Supports Microsoft/Lahey/RM FORTRAN compilers.  
**Jewell Technologies, Inc.**  
4740 44th Ave. SW, Seattle, WA 98116  
1 (800) 284-2574

Inquiry 811.

## SOFTWARE/GRAPHICS

### GRAPHIC TOOLS LIBRARY

XGLIB: Very fast. User coordinates. User defined Window & viewpoints. Circles, ellipses, ovals, sectors, polygons & splines. Thick lines & arcs. Fill & hatch patterns. POLYARC engine. Plots and charts. Text scale, align. Screen print and TSR utility. All drawing and mouse functions work in Super VGA modes. Draw in bitmaps. Modes up to 1024x768x16-256. \$195. Most "C", MS Basic 4.0-7.1.

### NOVA INC.

2500 W. Higgins Road, #1144 CALL 708-882-4173  
Hoffman Estates, IL 60195 FAX 708-882-4175  
See our ad on page 96.

Inquiry 812.

### GRAPHICS LIBRARIES for C, FORTRAN, PASCAL & QuickBASIC

- Supports VIDEO, PRINTERS & PLOTTERS.
- Linear, log, polar, smith, bar & pie charts.
- Scalable fonts, line types, markers.
- Multiple plots on a page.
- Over 100 routines with full source code.
- 240 page manual. No royalties.

\$350.00 (713) 491-2088

### Sutrasoft

10506 Permian Dr. • Sugar Land, TX 77478

Inquiry 813.

## SOFTWARE/LANGUAGES

### IntegrAda

Standard Air Force PC Ada Compilers & environments for MS-DOS and UNIX. Integrated programming systems include validated Ada compilers, language sensitive editors, complete libraries and other Ada programming tools. FREE demo.

**AETECH, Inc.** From \$795

380 Stevens Ave., Ste. 212 Solana Beach, CA 92075  
(619) 755-1277 Fax: (619) 755-7540

Inquiry 814.

### DRUMA FORTH-83

Break the 64K barrier without speed/space penalty. Powerful, attractively priced. '83 Standard.

- IBM+ automated memory management
- Full OS interface, extensive utilities
- On-line documentation, ASCII/block files
- Other products: windows, modules, profiler
- IBM PC/XT/AT including 386 compatibles

FREE learn/utility disks with purchase

### DRUMA INC.

6448 Hwy. 290 East E103, Austin, TX 78723

Orders: 512-323-5411 Fax: 512-323-0403

Inquiry 815.

### FINAL LIQUIDATION!!

IBM \* Compilers, SAVE UP to 80%!

Title	Retail Sale
COBOL V2.0 (3 1/2" & 5 1/4")	\$900 \$100
Prof. FORTRAN V1.3 (3 1/2" & 5 1/4")	\$795 \$ 90
C Compiler (3 1/2" or 5 1/4")	\$395 \$ 50
BASIC Compiler V2.0 (3 1/2")	\$495 \$ 50
Macro Assembler V2.0 (3 1/2" or 5 1/4")	\$195 \$ 40
VISA, MC, Check accepted, S and H fee \$10 per order	

### THE COMPUTER PLACE, INC.

12105 Darnestown Rd. #9A Tel: (301) 330-6016  
Gaithersburg, MD 20878 Fax: (301) 926-3415

Inquiry 816.

## SOFTWARE/MARKETING

The "Software Success Reference Book (1987-1988)" is a MUST READ if you want to market your software products successfully. Written by David H. Bowen, publisher of Software Success, the monthly newsletter on successfully running a software business, the Reference Book is a 268-page guide, organized by topic. Covers Lead Generation, Promotion, Pricing, Distribution, Support, etc. Only \$25. Check or Credit Card (VISA/MC/AE).

100% Money Back Guarantee

### Software Success

P.O. Box 9006, San Jose, CA 95157

(408) 446-2504 FAX (408) 255-1098

Inquiry 817.

328 B Y T E • FEBRUARY 1991

## SOFTWARE/MATHEMATICS

### MATH EDITING FOR THE PC

$$x_i^2 = \sum_{k=0}^{\infty} [x_k^{2i} (t_k^i)] + \left( \frac{1}{\sqrt{\alpha \pm \beta x}} \right)$$

- MathEdit constructs math equations to be inserted into WordPerfect, Word, WordStar, and others.
- WYSIWYG interface—no codes need to be learned.
- MathEdit—\$199

### K-TALK COMMUNICATIONS

30 West First Avenue, Suite 100  
Columbus, Ohio 43201  
(614) 294-3535

Inquiry 818.

### DERIVE®

### A Mathematical Assistant

Makes math more inspiration and less perspiration! Combines the power of computer algebra with 2D & 3D plotting and a friendly menu-driven user interface. Does equation solving, calculus, trigonometry, vector & matrix algebra, and more. Derive requires a PC compatible computer & 512K memory.

### Soft Warehouse, Inc.

3615 Harding Ave., Suite 505, Honolulu, HI 96816  
(808) 734-5801

Inquiry 819.

## SOFTWARE/SCIENTIFIC

### FREE CATALOG 800-942-MATH

MicroMath Scientific Software  
Salt Lake City, UT 84121-0550

Inquiry 820.

## SOFTWARE/VOICE

### MULTI-VOICE® TOOLS

Multi-Voice Tools is a complete development Toolkit for Pascal or "C" to access all the features for most speech processing boards available today. It helps you write MULTI-LINE VOICE APPLICATION systems in minutes. A number of programming examples are provided. All programs and libraries are delivered with source code.

Dialogic, Rhetorex, Pks: \$599, Watson (Single Line): \$99. ALSO AVAILABLE: FAX Programmer's Toolkit (\$199). Based on CAS specifications. VISA/MC accepted.

### ITI Logistic

1705 St. Joseph E., Suite 4, Montreal, Can. H2J 1N1  
(800) 567-8765 or (514) 861-5988

Inquiry 821.

## STATISTICS

### Statistical Advisor Speaks English!

Statistical Navigator Professional™ lets you describe your research goal in plain English then guides you to the appropriate statistical analysis. Natural language interface, detailed report, extensive hypertext help, & pull-down menus. \$150+/\$h.

VISA, MC, AMEX, PO #, Check.

### The Idea Works, Inc.

607 Jackson St., Columbia, MO 65203

1-800-537-4866 FAX 1-314-875-5812

Outside USA: 1-314-875-5827

Inquiry 821.

### NCSS 5.x Series — \$125

Easy-to-use menus & spread sheet. Multiple regression. T-tests. ANCOVA (up to 10 factors, rep. measures, covariance). Forecasting. Factor, cluster, & discriminant analysis. Nonparametrics. Cross Tabulation. Graphics: histograms, box, scatter, etc. Reads ASCII/Lotus. Many new add-on modules.

### NCSS

329 North 1000 East, Kaysville, UT 84037

Phone: 801-546-0445 Fax: 801-546-3907

Inquiry 822.

## STATISTICS

### UNISTAT

Menu/mouse driven statistical package featuring a fully-fledged spreadsheet, a wide range of statistics and powerful graphics. Version 4.0. First released in 1984. Sold thousands of copies to universities, industry and resale. Export/Import Lotus, dBase 3&4, dBase III, fixed and free format ASCII. String data and missing data handling. Full array of 2D and 3D plots, charts and histograms, curve and distribution fitting. More than 40 parametric and nonparametric tests, cross-tabulation, breakdown, OLS, weighted, polynomial and stepwise regressions, balanced/unbalanced ANOVA, ANCOVA, etc. Demo system and 440pp. user's guide available separately. US & Canada: \$395 ADHOC Inc., Dept. BT, 26 Brunswick Woods Dr., East Brunswick, NJ 08816. Tel: 201-254-7300. Fax: 201-254-7310. Elsewhere: £295. UNISTAT Ltd., Dept. BT, PO Box 383, Highgate, London N6 5JP, England. Tel: 44-(0)81 883 7155. Fax: 44-(0)81 444 9512

Inquiry 823.

## TRANSLATORS

### 100% PASCAL → C

P2C translates Turbo Pascal 3/4/5 into C code (Turbo, Microsoft, TopSpeed, ANSI) and supports all TP features: sets, nested functions, with, variant records, strings, files, interrupts, const expressions, graphics, union, dynamic memory management, mem & port arrays, absolute variables; In short—everything except inline and object-oriented features. Comes with full TP runtime library emulation and automatically generates project, make, header, and C files. English manual (130+ pages) included. Professional Edition includes complete source code for emulation library.

Standard Ed. \$395 Professional Ed. \$595 (MC, VISA, AMEX)

LAUER & WALLWITZ GmbH, Erlangenweg 9,  
D-6200 WIESBADEN, West Germany, Phone +49 (611) 42771

Inquiry 824.

### FTN77 Conversion to QuickBASIC

Conversion program and guide. Performs the tedious part of converting, 100% translation for simple programs. Formatted I/O, simple and complex math libraries included (complete math code not converted). A guide to translation of problem code (ASSIGN, BACKSPACE, BLANK, COMPLEX, ENTRY, EQUIVALENCE, EXTERNAL, INTRINSIC, INQUIRE, RETURN #, Assigned GOTO) is provided. Also useful for non-FTN77 Fortran conversions. QB source code is included at \$295 (check or money order). Conversions are also available by contract.

### MSS Designs

P.O. Box 12734, Portland, OR 97212  
(503) 287-8072

Inquiry 825.

## TYPESETTING

### CATALOG \$99.99

Prepares typesettings for creating catalogues, brochures, etc., both in color and B&W. Imports text from a text editor and inputs color video pictures directly from OCULUS-10 (by Coreco) or from PCX color format files (mode 13h). Exports PCX color files. Supports HP PaintJet and LaserJet II printers. CATALOG requires the use of Pizazz Plus™ (by Applications Techniques) to print. For XT or AT compatibles with 640K RAM and mouse. Specify XT or AT when ordering.

### Backus Computer Services

P.O. Box 830793, San Antonio, TX 78213-0793  
(512) 433-4982

Inquiry 826.

## UNINTERRUPTIBLE POWER

### HOW TO PROTECT YOUR COMPUTER

#### And Make It Last Longer

FREE money-saving literature tells you how to protect your computer and make it last longer with an uninterruptible power supply. 500VA through 18KVA models from the world's largest manufacturer of single-phase UPS.

### Best Power Technology, Inc.

P.O. Box 280, Necedah, WI 54646

Toll-Free (800) 356-5794, Ext. 2221

Telephone: (608) 585-7200, Ext. 2221

Inquiry 827.

## UTILITIES

### Recover deleted files fast!

Disk Explorer now includes automatic file recovery. You type in the deleted file's name. Disk Explorer finds and restores it. Disk Explorer also shows what's really on disk; view, change or create formats, change a file's status, change data in any sector. MS-DOS \$75 U.S. Check/Credit card welcome.

### QUAD SOFTWARE LIMITED

45 Charles St. E. 3rd Fl.  
Toronto, Ontario, Canada M4Y 1S2  
(416) 961-8243

Inquiry 828.

## UTILITIES

### COPYWRITE

CopyWrite Removes Copy Protection No more diskettes, manuals or codewheels. 1000's of products copied. **US \$75**

**QUAD SOFTWARE LIMITED**  
45 Charles St. E. 3rd Fl, Dept. B  
Toronto, Ontario, Canada M4Y 1S2  
(416) 961-8243 Fax (416) 961-6448

### REMOVE HARDWARE LOCKS

Software utility allows for the removal of hardware locks. Don't wait for your lock or key device to fail or be stolen. **Guaranteed to work!** The following packages are available:

PCAD	\$199.00	CADKEY	\$ 99.00
MICROSTATION	\$99.00	PERSONAL DESIGNER	\$199.00
MasterCAM	\$250.00	Sms ICAM	\$250.00
TANGO PCB	\$ 99.00	CADVANCE	\$99.00

PLUS SHIPPING AND HANDLING  
PHONE (204) 669-4639 FAX (204) 668-3566  
VISA and MASTERCARD Welcome

### SafeSoft Systems Inc.

191 Kirlystone Way, Winnipeg, MB, Canada, R2G 3B6

Inquiry 828.

### A BLANK SCREEN IS GOOD!

- PROTECT SENSITIVE DATA FROM WANDERING EYES WITH USER SELECTABLE SCREEN BLANKING!
- STOP MONITOR BURN-IN AND HELP THOSE EXPENSIVE MONITORS LAST LONGER WITH AUTOMATIC BLANKING!
- REQUIRES LESS THAN 2K OF MEMORY!
- FOR IBM AND 100% COMPATIBLES, DOS 2.0 AND ABOVE
- SCREENSAVER IS ONLY \$19.95! SPECIFY 3.5" or 5.25"

### Signature Software, Inc.

P. O. Box 11755, Richmond, VA 23230-0155  
Virginia residents please add 4.5% sales tax

Inquiry 829.

### Why You Want BATCOM!

BATCOM is a batch file compiler that transforms your .bat files to .exe files to make them faster. BATCOM extends DOS with many new commands so you can read keyboard input, use subroutines, and much more. In addition, BATCOM protects your source code. No royalties! Only \$59.95. Order today!

### Wenham Software Company

5 Burley St., Wenham, MA 01984  
(508) 774-7036

Inquiry 830.

## WINDOWS TOOLS

### Hermes DDE Library

The Hermes DDE Library is a powerful library of high level routines for MS-Windows™ programmers. Hermes provides support for DDE at a much higher level than that provided in the Windows SDK. Your program attains added functionality by interacting and communicating with other Windows applications. Compared to the Windows SDK, Hermes reduces the code required to implement DDE by hundreds of lines of 'C'. Hermes is priced at \$295.

### Raindrop Software Corporation

845 E. Arapaho, Suite 105, Richardson, Texas 75081  
(214) 234-2611 Fax (214) 234-2674  
*See our ad on page 96.*

Inquiry 831.

## WORD PROCESSING

### FARSI / GREEK / ARABIC / RUSSIAN

Hebrew, all European, Scandinavian, plus either Hindi, Punjabi, Bengali, Gujarati, Tamil, Thai, Korean, Viet, or IPA. Full-featured multi-language word processor supports on-screen foreign characters and NLQ printing with no hardware modifications. Includes Font Editor. \$355 dot matrix; \$150 add'l for laser; \$19 demo. S/H in U.S. incl'd. Req. P.C. 640K, graphics. 30-day Guarantee. MC/VISA/AMEX

### GAMMA PRODUCTIONS, INC.

710 Wilshire Blvd., Suite 609, Santa Monica, CA 90401  
213/394-8622 Tlx: 5106008273 Gamma Pro SNM

Inquiry 832.

## BY HAND. OR BY NOON.

Announcing **Flow Charting™ 3:** Powerful new features— for greater speed, flexibility, and ease-of-use!

- Single-page, multi-page or canvas charts— portrait or landscape
- Custom fonts support high resolution laser and 24-pin dot matrix printers
- 35 standard shapes, 10 text fonts
- Suggested retail price: only \$250

**PATTON & PATTON**  
Software Corporation

See your dealer today! Or, for a "live," interactive demo disk, call:  
800-525-0082, ext 1202.  
International: 408-778-6557, ext. 1202.

Circle 167 on Reader Service Card

## UNIVERSAL PROGRAMMER

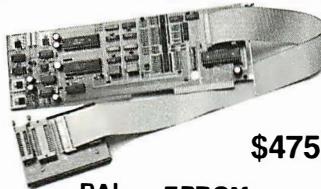

\$475

PAL EPROM  
GAL 8748/49  
PROM 87C51...  
EEPROM 87C751

5ns PALS  
4 Meg EPROMs  
16 bit EPROMs

Parts added at your request.

FREE software updates on BBS.  
Powerful menu driven software.

Call - (201) 994-6669

Link Computer Graphics, Inc.

4 Sparrow Dr., Livingston, NJ 07039  
FAX:(201) 994-0730

Circle 122 on Reader Service Card

## DATA ACQUISITION

- Systems for Lab, Factory & Field
  - PC Software Included
  - Serial, Modem, & Bus
  - Stand Alone Ability
  - Laptop & Handheld
  - PC & MAC Cards
  - Inexpensive
  - OEM & VAR
  - RTU's

FREE CATALOG & DEMO DISK!

Manufacturers of Measurement & Control systems for Laboratory, Industrial, & Field applications. Specialists in Battery-Powered systems.



Call for applications info: (201) 299-1615  
P.O. Box 246; Morris Plains, NJ 07950 U.S.A.

**ELEXOR**

Circle 79 on Reader Service Card

## VIDEO FRAME GRABBERS



MODEL	RESOLUTION	
HRT 256-4	256 x 256 x 4	495
HRT 256-8	256 x 256 x 8	795
HRT 512-8	512 x 512 x 8	995
HRT 512-24	512 x 512 x 24	1995

- IBM PC/XT/AT COMPATIBLE
- DIGITALIZE IN REAL TIME
- COMPOSITE VIDEO IN
- 24 BIT RGB OUT except model HRT 256-4 16 level gray scale out
- SOFTWARE LIBRARY OF IMAGE ANALYSIS ROUTINES
- FREE SOFTWARE UPGRADES TO REGISTERED OWNERS
- FULL CREDIT ON UPGRADE PURCHASE IN FIRST YEAR RETURN OLD BOARD AND JUST PAY DIFFERENCE



HIGH RES TECHNOLOGIES  
P.O. BOX 76  
LEWISTON, N.Y. 14092

PHONE 416-497-6493

FAX 416-497-1988

Circle 96 on Reader Service Card

## 200 MHz Logic Analyzer

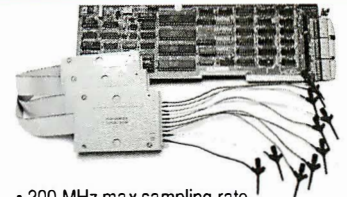

- 200 MHz max sampling rate
- 24 Channels Timing and state
- 16K samples/channel
- 16 Levels of triggering
- 3 External Clocks and 12 Quality lines
- Variable, TTL, ECL threshold levels
- FREE software updates on 24 Hour BBS

\$ 799-LA12100 (100 MHz)  
\$1299-LA27100 (100 MHz)  
\$1899-LA27200 (200 MHz)

Price is complete: Pads and Software included

Call - (201) 994-6669



Link Computer Graphics, Inc.

4 Sparrow Dr., Livingston, NJ 07039  
FAX:(201)994-0730

Circle 123 on Reader Service Card

## MEMORY UPGRADES

IBM PS/2, APPLE  
AST, COMPAQ  
HEWLETT PACKARD  
ZENITH, SUN MICRO  
STANDARD SIMMS

LAPTOP MEMORY  
(NEC, TOSHIBA, APPLE, COMPAQ)  
LASER PRINTER MEMORY  
(HP, CANON, TEC ENGINE)  
NO RISK, BEST PRICE, BEST QUALITY



A DIVISION OF ROHM CORPORATION  
433 N. MATHILDA AVE. SUNNYVALE, CA 94088  
TEL (408) 746-1590 FAX (408) 746-1593

1-800-292-7771

Circle 10 on Reader Service Card

# FAST PS/2 & AT DISKS.

## Failsafe Novell Subsystems

### Flawless Performance

The power user's first choice, Perisol's subsystems offer failsafe peak performance without stretching your budget. DOS, OS/2, Xenix, Netware 286 & 386 for both AT & PS/2s. No compatibility issues. No problems. It's that simple.

- ✓ Caching Controllers
- ✓ Disk Mirroring & Duplexing
- ✓ Torture-Tested Drives with 24-hour Burn-in

**1 GB  
Opticals**

**1 GB Erasable  
Optical Subsystem  
For Novell \$5249  
For DOS \$4851**

**5  
Years**

"We back our  
5.25" Drives  
for 5 Years!"

**Straight From  
the Box  
Integration!**

System	Capacity	Access	Interface	Price
AT	86 MB	18 ms	IDE	\$455
AT	120 MB	18 ms	ESDI	\$803
AT	120 MB	18 ms	IDE	\$549
AT	158 MB	14 ms	ESDI,SCSI	\$996
AT	200 MB	15 ms	IDE	\$871
AT	213 MB	15 ms	SCSI	\$961
AT	338 MB	16 ms	ESDI,SCSI	\$1443
AT	652 MB	16 ms	ESDI,SCSI	\$2065
PS/2	150 MB	14 ms	ESDI	\$1269
PS/2	330 MB	16 ms	ESDI	\$1736
PS/2	652 MB	16 ms	ESDI	\$2343

□ Drive, Controller, Cables and Software included with Subsystems.



Call for Perisol's Complete Product Catalog

**800-447-8226**

Fax: 408-988-4431 Support: 800-228-8489  
International Tel: 408-988-2232

## VOICE MASTER KEY® SYSTEM II

VOICE RECOGNITION & SPEECH RESPONSE  
FOR IBM PC/XT/AT/386, PS/2, LAPTOPS, COMPATIBLES



FOR PRODUCTIVITY, PRESENTATIONS, SOFTWARE DESIGN, ENTERTAINMENT, LANGUAGE TRAINING, EDUCATION, MORE...

**SPEECH/SOUND RECORDING AND PLAYBACK.** Desktop Audio sound editing allows you to create custom sound applications. Variable sample rate (to 20 KHz) and compression levels. A four-voice music synthesizer is included also!

**VOICE RECOGNITION TSR** utility allows you to add voice command keyboard macros to your CAD, desktop publishing, word processing, spread sheet, or entertainment programs. Up to 64 voice commands in RAM at once—more from disk.

**HARDWARE SYSTEM** contains built-in speaker with separate volume and tone controls, external speaker and headphone jacks. Enclosure made of sturdy vinyl-clad steel. Attaches to parallel printer port without affecting normal printer operation (U.S. Patent 4,812,847). Headset microphone, printer cable, 9 volt AC adapter (110 volt UL/CSA listed), and comprehensive user manual included.

**QUALITY THROUGHOUT. MADE IN USA. ONLY \$219.95**

**ORDER HOTLINE: (503) 342-1271 Mon-Fri, 8 AM to 5 PM PST**

Visa/MasterCard, company checks, money orders, CODs (with prior approval) accepted. Personal checks subject to 3 week shipping delay. Specify computer type when ordering. Add \$5 shipping charge for delivery in USA and Canada. Foreign inquiries contact Covox for C&F/CI/ quotes. OEM configurations available.

**30 DAY MONEY BACK GUARANTEE IF NOT COMPLETELY SATISFIED.**

**CALL OR WRITE FOR FREE PRODUCT CATALOG**



**COVOX INC.**  
675 Conger Street  
Eugene, Oregon 97402

TEL (503) 342-1271  
FAX (503) 342-1283  
BBS (503) 342-4135

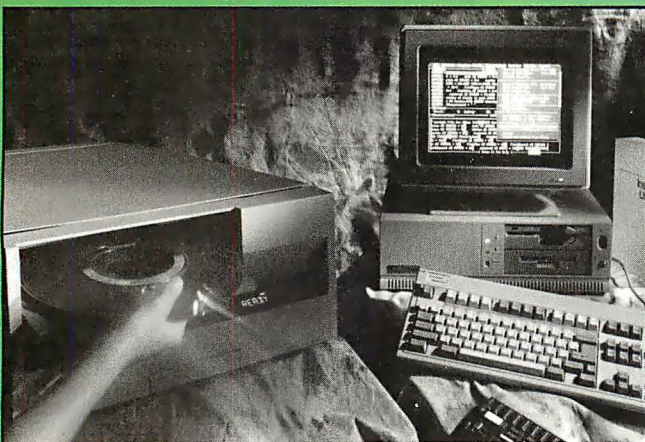

## Spectacular Performance. Now Playing On 9-Track Tape.

If you're looking to connect 9-track tape to your PC, Overland Data offers an all-star cast of complete subsystems. They are equally at home playing for all IBM PC compatibles or PS/2's, under DOS, UNIX, XENIX, PICK & NOVELL, 800 to 6250 bpi. They perform EBCDIC-ASCII conversions and backup brilliantly. And the supporting cast can't be beat. **Two year warranty on controllers**, one year on tape drives. Expert help by phone. 30 day, money back application guarantee. And ten years experience as founder and leader of the industry. All of which means spectacular performance play after play. To reserve your seat, call us at:

**1-800-PC9-TRAK**

**OVERLAND DATA**  
San Diego, CA

1-800-729-8725 • 1-619-571-5555 • FAX 1-619-571-0982 • TELEX 754923 OVERLAND

## A MESSAGE TO OUR SUBSCRIBERS

FROM TIME TO TIME WE MAKE THE BYTE subscriber list available to other companies who wish to send our subscribers material about their products. We take great care to screen these companies, choosing only those who are reputable, and whose products, services, or information we feel would be of interest to you. Direct mail is an efficient medium for presenting the latest personal computer goods and services to our subscribers.

Many BYTE subscribers appreciate this controlled use of our mailing list, and look forward to finding information of interest to them in the mail. Used are our subscribers' names and addresses only (no other information we may have is ever given).

While we believe the distribution of this information is of benefit to our subscribers, we firmly respect the wishes of any subscriber who does not want to receive such promotional literature. Should you wish to restrict the use of your name, simply send your request to the following address.

**BYTE** MAGAZINE

ATTN: SUBSCRIBER SERVICE  
P.O. Box 555  
HIGHTSTOWN, NJ 08520





# Only your imagination limits how you benefit from PERCON® keyless data collection.

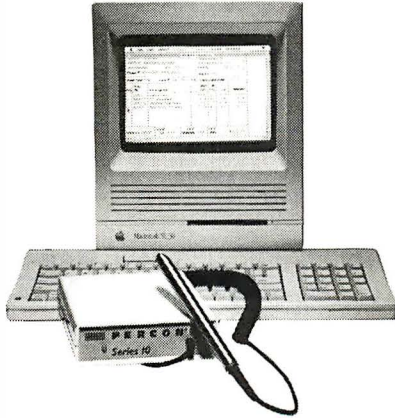

Checking out books or checking in employees—input data quickly and accurately using bar codes or magnetic stripes. PERCON has proven bar code solutions for IBM®, DEC™, and Apple Macintosh®. Call 1-800-8-PERCON.

## PERCON

1710 Willow Creek Circle, Eugene, OR 97402-9153  
(503)344-1189 FAX(503)344-1399

©1989 Percon, Inc. PERCON, IBM, DEC and Apple Macintosh are trademarks.

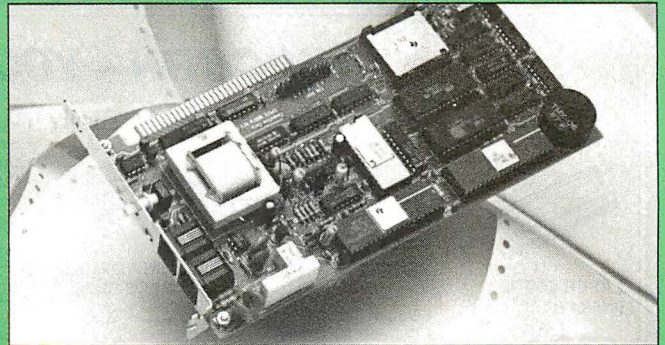

## COMPUCOM

# 9,600-38,400 bps MODEM+FAX...\$279

NOW you can afford a **SPEEDMODEM™**. Raw speed of 300 - 9600 bps and 4:1 data compression push throughput up to 38,400 bps. Dynamic Impedance Stabilization™ provides robust performance on noisy telephone circuits. A 9600 bps send/receive, full-featured FAX is included on the same card. Total communications capability—only \$279. It comes with a 30-day money back guarantee and a 5-year warranty. **BYTE** magazine said our 2400 bps modem was "a real deal"....well we've done it again... our **COMBO™** is setting a new standard for value and performance. See for yourself... \*3/89p.102

(408)732-4500 **CALL NOW 800 ACTONIT** (800)228-6648

## THE FASTEST 80486 & 80386 15 Mips, FASTER THAN EVEREXSTEP & ALR

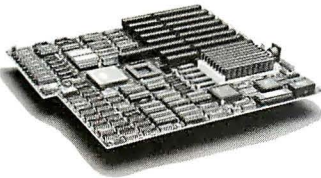

### FEATURE

- 64/256K Write Back Cache
- Transparent Refresh/Weitex
- 32 Bit Memory Expand To 16MB
- UNIX, OS/2 & NOVELL Compatible
- 1 Yr Full Warranty
- Complete Documentation

### SYSTEM BOARD

MODEL	CACHE	MIPS	OK	4M
486/33	64K	15.0	2695	2895
486/25	64K	11.4	1699	1899
386/33	64K	8.3	989	1189
386/25	64K	6.2	889	1089

\*256K Cache Available

### Complete Desktop System With 1.2 MB Floppy, HD/Floppy Controller, 101 Keybrd And 4MB Memory

MODEL	BASE	MONO	VGA
486/33	3195	3345	3595
486/25	2199	2399	2599
386/33	1489	1639	1889
386/25	1389	1539	1789

\* Tower Add \$200 & Hard Disk Available

### SUPER TOWER



\$335  
Qty. 5

- 5 Half Ht. Drive Bay
- 2 Full Ht. Drive Bay
- 250 Watt UL/Power Supply
- Dual Fans
- Double Security Lock
- Wheels / Caster
- Front Display Panel
- Excellence For UNIX & NOVELL Server
- UPS Optional

### MONITOR

VGA	315.00
MULTISCAN	415.00
SUPER VGA	345.00

### UNIVERSAL 3 1/2 - 5 1/4 KIT

FLOPPY	5.00
HARD DISK	5.00

### INTEL MATH-CO

80387-20	345.00
80387-25	435.00
80387-33	540.00

### DRAM

4M x 9 - 80	300.00
1M x 9 - 80	59.00
1M x 9 - 70	69.00

### HARD DISK

MAXTOR 4170E 150MB	899.00
MAXTOR 4380E 330MB	1349.00
MAXTOR 8760E 650MB	1994.00

47273 Fremont Blvd., Fremont, CA 94539  
Tel: 415-623-3818 Fax: 415-623-3840

TP ENTERPRISE INC.

## A MUST for Computers

# VIZIFLEX SEELS®



### The Ideal Keyboard Cover!

Protect your computer and **eliminate** downtime caused by liquid spills, contaminants, environmental hazards, etc. with VIZIFLEX SEELS - the only keyboard cover that:

- **Remains securely in-place** during the operation of the keyboard and will not interfere with computer performance in any way.
- **Is designed to "form-fit"** to the exact contours of the keyboard thus providing superior tactile sensitivity and feel for each individual key.
- **Consists of Ultraflex™ material, a transparent, flexible "film"** which allows all keytops and keyboard "markings" to be clearly visible.

Available for over 500 different keyboards, VIZIFLEX SEELS can also be custom designed for any keyboard or similar application.

Call, write or fax for free brochure. Dealer Inquiries Invited.

## VIZIFLEX SEELS, INC.

16 East Lafayette Street, Hackensack, NJ 07601  
Tel. (201) 487-8080 • Fax: (201) 487-6637  
In Canada, call: 1-800-668-6570

# UNICORN - YOUR I.C. SOURCE!

### COLLIMATOR PEN (INFRA-RED)

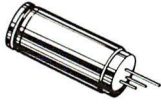

- Output: 2.5 mW (max.)
- Current: 90-150 mA
- Operating Voltage: 2.2-2.5V
- Wavelength: 820nm
- Collimation: .18mrad (typ.)
- Size: 11mm diameter

STOCK # PRICE  
**SB1052 \$39.99**

### LASER DIODE (INFRA-RED)

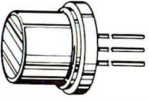

- Output: 10 mW (max.)
- Current: 90-150 mA
- Operating Voltage: 2.2-2.5V
- Wavelength: 820nm

STOCK # PRICE  
**SB1053 \$9.99**

### LASER DIODE (VISIBLE-RED)

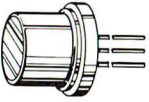

- Output: 5 mW (max.)
- Current: 65-100 mA
- Operating Voltage: 1.75-2.2V
- Wavelength: 780nm

STOCK # PRICE  
**LS022 \$19.99**

### LASER DIODE (VISIBLE-RED)

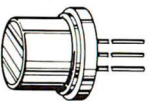

- Output: 4 mW (max.)
- Current: 20 mA
- Operating Voltage: 2.2-3.0V
- Wavelength: 665nm

STOCK # PRICE  
**LS3200 \$119.99**

### POWER SUPPLY



- Input: 115/230v
- Size 7" L x 5 1/4" W x 2 1/2" H
- Output: +5 volts @ 3.75 amps
- Output: +12 volts @ 1.5 amps
- Output: -12 volts @ .4 amps

STOCK # PRICE  
**PS1003 \$19.99**

### LASER DIODE (VISIBLE-RED)

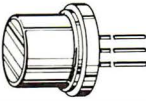

- Output: 3 mW
- Current: 85-100 mA
- Operating Voltage: 2.3-3.0V
- Wavelength: 670nm

STOCK # PRICE  
**LS9200 \$49.99**

### ANTI-STATIC SCREEN WIPES



- Individually wrapped
- Dispenser pack

STOCK # DESC. PRICE  
**SB1104 25 \$1.99**  
**SB1107 100 \$4.99**

### DISC DRIVE & COMPUTER CLEANING KIT

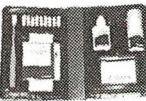

- Includes: Cleaning swabs, head-cleaning fluid, anti-static cleaner, screen wipes and cleaning diskette.

STOCK # DESC. PRICE  
**SB1099 3 1/2" kit \$6.99**  
**SB1100 5 1/4" kit \$6.99**

### EPROMS

STOCK #	1-24	25-99	100+	STOCK #	1-24	25-99	100+
1702	3.99	3.79	3.41	2764A	3.29	3.13	2.82
2708	6.49	6.17	5.55	TMS2564	6.79	6.45	5.81
2716	3.29	3.13	2.82	27C64	4.19	3.98	3.58
2716-1	3.79	3.60	3.24	27128-20	5.79	5.50	4.95
TMS2716	6.29	5.98	5.38	27128	5.09	4.84	4.35
27C16	3.99	3.79	3.41	27128A	5.79	5.50	4.95
2732	3.79	3.60	3.24	27C128	5.79	5.50	4.95
2732A-2	3.79	3.60	3.24	27256-20	5.29	5.03	4.53
2732A	3.69	3.51	3.16	27256	4.79	4.55	4.09
2732A-4	3.19	3.03	2.73	27C256	5.29	5.03	4.53
TMS2532	5.79	5.50	4.95	27512-20	7.49	7.12	6.41
TMS2532P	1.99	1.89	1.70	27512	6.99	6.64	5.98
27C32	4.19	3.98	3.58	27C512	6.99	6.64	5.98
2764	3.99	3.79	3.41	27C1024	17.99	17.09	15.38
2764A	3.79	3.60	3.24	68764	13.99	13.29	11.96
2764A-20	3.99	3.79	3.41	68766	14.99	14.24	12.82

### DYNAMIC RAMS

STOCK #	1-24	25-99	100+	STOCK #	1-24	25-99	100+
MK4027	.59	.56	.50	4464-100	4.79	4.55	4.10
4116-120	1.39	1.32	1.19	4484-120	4.19	3.98	3.58
4116-150	.99	.94	.85	4464-150	3.99	3.79	3.41
4116-200	.89	.85	.77	41256-60	4.79	4.55	4.10
4116-250	.59	.56	.50	41256-80	3.49	3.32	2.99
4164-100	2.59	2.46	2.21	41256-100	2.99	2.84	2.56
4164-120	2.29	2.18	1.96	41256-120	2.69	2.56	2.30
4164-150	1.99	1.89	1.70	41256-150	2.99	2.18	1.96
4164-200	1.59	1.51	1.36	511000-70	12.99	12.34	11.11
4116-120	5.99	5.69	5.12	511000-80	11.99	11.39	10.25
4416-150	4.99	4.74	4.27	511000-100	10.99	10.44	9.40



**UNICORN ELECTRONICS**



10010 Canoga Ave., Unit B-8 • Chatsworth, CA 91311  
OUTSIDE CALIFORNIA: (800) 824-3432 (Orders Only)  
IN CALIFORNIA: (818) 341-8833  
ORDER BY FAX: (818) 998-7975  
Minimum Order \$15.00

# UNIVERSAL ORDER 800-678-8648

## MEMORY PRODUCTS

FAX 714-751-2023

1378 LOGAN AVE SUITE E COSTA MESA CA 92626

WE ACCEPT VISA/MC/AMEX  
PO'S FROM QUALIFIED FIRMS UNIVERSITIES  
AND GOVT AGENCIES WESHIP COD  
OPEN M-F 7AM-5PM SAT 8AM-2PM  
20% RESTOCK FEE NONDEFECT RETURNS

### IBM PS/2 MEMORY

6450604.....\$139  
2MG MODULES FOR 55SX, 50Z, 70E61/121  
6450608.....\$149  
2MG MODULE FOR 70A21  
6450379.....\$247  
2MG FOR 80-111/311  
6450375.....\$135  
1MG MODULE FOR 80-041  
34F2933.....\$399  
4MG MODULES  
30F5360.....\$149  
2MG KIT FOR 30-286  
6450605.....\$460  
2-8MG BOARD W/2MG MODEL 70 & 80  
6451060.....\$550  
4MG FOR 80-A21/A31  
34F3011.....\$920  
4-16MB BOARD W/4MB MODELS 70&80

### COMPAQ MEMORY

DESKPRO 386 20/20E 25/25E 286E 386S  
1MG MOD.....\$119  
4MG MOD.....\$299  
1MG BRD.....\$199  
4MG BRD.....\$495

### SIMM SIPP MODULES

4X9-80NS.....\$355  
1X9-70NS.....\$59  
1X9-80NS.....\$53  
1X9-100NS.....\$52  
1X9-120NS.....\$51  
256X9-60NS.....\$29  
256X9-70NS.....\$24  
256X9-80NS.....\$19  
256X9-100NS.....\$17  
256X9-120NS.....\$15

### MAC/AMIGA SIMMS

1X8-80NS.....\$62  
1X8-100NS.....\$55

### HP LASERJET

#### SERIES II & IID

1MG.....\$99  
2MG.....\$165  
4MG.....\$295

#### SERIES IIP & 3

1MG.....\$100  
2MG.....\$169  
4MG.....\$299

### AST PREMIUM 1MG MODULES ONLY \$69

### DRAM CHIPS

**1MG X 1**  
1MGX1-80NS.....\$5.50  
1MGX1-100NS.....\$5.25  
1MGX1-120NS.....\$5.10  
**256K X 4**  
256X4-80NS.....\$5.75  
256X4-100NS.....\$5.50  
**256K X 1**  
256X1-70NS.....\$2.95  
256X1-80NS.....\$1.99  
256X1-100NS.....\$1.95  
256X1-120NS.....\$1.85  
256X1-150NS.....\$1.50  
**64K X 4**  
64X4-120NS.....\$2.25  
64X4-100NS.....\$2.50  
64X4-80NS.....\$2.95  
**64K X 1**  
64X1-150NS.....\$1.05  
64X1-120NS.....\$1.50  
64X1-100NS.....\$2.00  
**STATIC COLUMN**  
256X1-100NS.....\$2.50  
256X1-80NS.....\$3.00  
256X1-70NS.....\$3.95

### MATH CO'S

#### IIT

2C87-8.....\$169  
2C87-10.....\$199  
2C87-12.....\$255  
2C87-20.....\$289

#### CYRIX

83D87-16.....\$289  
83D87-20.....\$329  
83D87-25.....\$429  
83D87-33.....\$519  
**NEW CYRIX FOR 386SX**  
83S87-16.....\$270  
83S87-20.....\$350

#### INTEL

8087-2.....\$115  
80287-8.....\$179  
80287-10.....\$179  
80287XL.....\$220  
80387-16.....\$305  
80387-20.....\$350  
80387-25.....\$450  
80387-33.....\$549  
80387-SX.....\$299

### EXPANSION-BOARDS FOR ALL PC'S

#### BOCA RESEARCH

**BOCARAM AT..\$119**  
TO 2MG EXP FOR AT,S  
**BOCARAM XT..\$119**  
UP TO 2MG EXP FOR XT'S  
**BOCARAM.AT/IO+**  
2-4MG W/SER & PAR \$157

#### Acculogic

FULL LIM 4.0 POWER FOR WINDOWS OS/2 UNIX  
**RAMPAT.....\$129**  
2-16MG LIM 4.0 FOR AT'S  
**SIMMPLY-RAM.....\$179**  
2-8MG LIM 4.0 PC/XT/AT  
**PS/2-16.....\$199**  
2-8MG MDL 50, 60, 55SX  
**PS/2-32.....\$249**  
1-16MG MDL 70&80  
USES 1,2 OR 4MG PS/2 SIMMS  
**AST 6PAK 286... \$119**  
WITH 4MGs \$329

### TOSHIBA LAPTOP

1MG FOR T1000SE/XE..\$287  
2MG FOR T1000SE/XE..\$314  
2MG FOR T1200XE.....\$183  
2MG FOR T1600.....\$193  
2MG FOR T3100SX.....\$183  
4MG FOR T3100SX.....\$489  
2MG FOR T3100E.....\$183  
2MB FOR T3200SX.....\$183  
4MB FOR T3200SX.....\$489  
3MB FOR T3200.....\$274  
2MB FOR T5100.....\$193  
2MB FOR T8500.....\$183

### MONTHLY SPECIALS SAVE \$\$\$

**BOCARAM AT PLUS**  
2-8MG LIM 4.0  
**ONLY \$119 2MG \$227**

**3.5" FDD FOR COMPAQ ONLY**  
1/3 HEIGHT  
**ONLY \$129**

**AST RAMVANTAGE**  
UP TO 3MG  
EXTENDED MEMORY  
W/128K ONLY \$47

INTERNATIONAL ORDERS ACCEPTED  
5 YEAR WARRANTY ON ALL PRODUCTS  
CALL THE PC UPGRADE SPECIALISTS !!!

## Let Alpha Products Help with Your '91 Budget Squeeze!

### Save \$ \$ \$ Save

## Low Cost Data Acquisition and Control

### A-Bus Sensing & Measuring:

Read switch status. Detect or measure voltage. Read pressure, temp., weight and other sensors. For example:

- High-Speed 12-bit A/D converter: 8 10µs analog input, mV resolution \$179
- 8 Bit A/D: 8 inputs, 0-5.1V in 20mV steps, 7500 conversions/sec. \$142
- 12 Bit A/D: ±4V in 1mV steps, 130mS conversion, 1 input, expandable \$153
- Temperature Sensor: 0-200°F 1° Accuracy, 10mV/°F. \$12
- Digital Input: 8 opto-isolated. Read voltage presence, switch closure. \$65
- Latched Input: Each individually latched to catch switch closures or alarm loops. \$85
- Touch Tone Decoder: \$87
- Counter/Timer: 3 16-bit counters. Generate or count pulses. Timing. \$132
- Clock with Alarm: real time clock with calendar and battery backup. \$98

### A-Bus Adapters, Software:

Adapters connect A-Bus cards to your particular computer.

- Plug-in adapters for IBM PC/XT/AT/386 and compatibles (\$69), Micro-Channel (\$93), Apple II, Commodore, TRS-80.
- Serial adapters for Mac, PC, etc.
- Odin PC compatible software. Control relays from analog inputs or time schedules. Logging. Runs in background. \$129

### A-Bus Switching & Governing:

Switch any type of electrical device. Adjust level or position. A sampling:

- Relay Card: 8 controllable industrial relays, 3A at 120VAC, SPST. \$142
- Digital Output: 8 outputs: 250mA at 12V. For relays, solenoids... \$78
- Reed Relay Card: 8 relays. 20mA @ 60VDC, SPST. \$109

- Multiplexer: Switch up to 32 channels to a single common. \$83
- Smart Stepper Motor Control: Microprocessor controls 4 motors. English commands for position, speed, units, limits, etc. \$299
- Telephone Control Card: On/off hook, generate and decode touch tones, call progress detection. \$159
- X-10 Controller: Control and sense standard outlet power modules. \$149
- Voice Synthesizer: Unlimited vocabulary, text to speech software built in. \$159
- D/A: Four 8 Bit Outputs. Adjustable full scale. \$149
- 24 line TTL I/O: Connect 24 signals, 0/5V levels or switches. (8255A) \$72

**Call for a Catalog  
(800) 221-0916**

242-B West Ave. Darien, CT 06820 USA  
(203) 656-1806 Fax 203 656 0756



Circle 210 on Reader Service Card



## SIMPLE TECHNOLOGY, INC.

"Your PC Memory Upgrade Specialists"

**LOWEST PRICES**

**SAME DAY SHIPPING**

**FULL TECHNICAL SUPPORT**

**LIFETIME GUARANTEE**

**FULLY TESTED**

**100% COMPATIBLE**

COMPAQ		
PRODUCT	PART #	AMT.
1MB Module	113131-001	\$89
Deskpro 386/20E, 20.25&25E, 286E		
1MB Module	113646-001	\$89
Deskpro 386S/16		
4MB Module	113132-001	\$255
Deskpro 386/20E, 20.25&25E, 286E		
4MB Module	112534-001	\$255
Deskpro 386S/16		
1MB Exp. Board	113644-001	\$165
Deskpro 386/20E & 25E		
1MB Exp. Board	113633-001	\$165
Deskpro 386S/16		
4MB Exp. Board	113645-001	\$420
Deskpro 386/20E & 25E		
2MB Module	115144-001	\$130
Deskpro 386/33, 486/25 Compaq System Pro		
1MB Upgrade	118688-001	\$89
Deskpro 286N, 386N		
1MB Board	117081-001	\$129
Portable LTE286		
2MB Board	117081-002	\$209
Portable LTE286		
1MB Board	110235-001	\$185
SLT/286		
1MB Board	118303-001	\$189
SLT 386		
2MB Board	118304-001	\$329
SLT 386		
2MB Kit	107332-001	\$179
Portable III		

HEWLETT PACKARD		
PRODUCT	PART #	AMT.
1MB KIT	D2150A	\$99
VECTRA 486PC (Inst. In Pairs)		
4MB Kit	D2151A	\$489
VECTRA 486PC (Inst. In Pairs)		
8MB Kit	D1252A	\$989
VECTRA 486PC (Inst. In Pairs)		
2MB Kit	D1354A	\$165
VECTRA QS/16S & ES/12PC		
1MB Kit	D1540A	\$79
VECTRA QS/16S		
4MB Kit	D1542A	\$255
VECTRA QS/16S		
1MB Kit	D1640A	\$89
VECTRA QS/20PC, RS/25PC & 20C		
4MB Kit	D1642A	\$309
VECTRA QS/20PC, 20C, RS/25PC		

TOSHIBA		
PRODUCT	PART #	AMT.
1MB Cd.	PC14-PA8311U	\$259
T1000SE & XE		
2MB Cd.	PC14-PA8312U	\$349
T1000SE & XE		
2MB Cd.	PC13-PA8306U	\$209
T1200XE		
2MB Cd.	PC8-PA8302U	\$209
T1600		
2MB Cd.	PC15-PA8308U	\$209
T3100SX		
4MB Cd.	PC15-PA8310U	\$499
T3100SX		
512KB Cd.	PC9-PA8340U	\$149
T3100E		
2MB Cd.	PC9-PA8341U	\$209
T3100E		
2MB Cd.	PC12-PA8307U	\$209
T3200SX		
3MB Cd.	PC6-PA7137U	\$309
T3200		
2MB Cd.	PC7-PA8301U	\$209
T5100		
2MB Module	PC10-PA8304U	\$209
T5200 & Desktop T8500		
4MB Cd.	PC12-PA8309U	\$539
Port. 3200SX		

LASER PRINTER MEMORY		
PRODUCT	PART #	AMT.
1MB HP	IIP & III & IIID	\$85
2MB HP	IIP & III & IIID	\$135
1MB HP	II & IID	\$119
2MB HP	II & IID	\$145
4MB HP	II & IID	\$255
1MB IBM	4019 & 4019E	\$155
2MB IBM	4019 & 4019E	\$255
3.5MB IBM	4019 & 4019E	\$425
1MB Olivetti	PG108 & PG208	\$159
2MB Olivetti	PG108 & PG208	\$209
4MB Olivetti	PG108 & PG208	\$399

IBM		
PRODUCT	PART #	AMT.
128KB Kit	78X8955	\$16
Model 25		
512KB	30F5348	\$59
30/286, Adapt Bd.1497259,50z&60		
2MB Kit	30F5360	\$139
30/286, Adapt Bd.1497259,50z&60		
2MB Module	6450372	\$279
Adapter 6450367		
1MB Module	6450603	\$69
70-E61,121,Adapt Bd. 6450605, 6450609 & 34F30XX		
2MB Module	6450604	\$139
70-E061,121,50Z,55SX,P70,65SX Adapt.Bd.6450605,6450609 & 34F30XX		
2MB Module	6450608	\$139
70-A21,A61,B21,B61		
4MB Module Kit	34F2933	\$339
55SX,031,061,IBM/PN 34F077 & 34F3011		
1MB Board 80-041	6450375	\$119
6450379		\$199
80-111,311,121,321		
4MB Bd 80-A21,A316451060		\$469
2-8MB Exp. Bd.	6450605	\$419
W/2MB, 70 & 80		
2-4 MB Exp. Bd.	34F3077	\$449
W/2MB, 70 & 80		
4-16MB Exp. Bd.	34F0311	\$729
W/4MB, 70 & 80		
2-14MB Exp. Bd.	6450609	\$539
W/2MB, 50,502,55SX&60,65SX		

NEW IBM PS/1 MEMORY		
PRODUCT	PART #	AMT.
512K		\$39
2MB		\$79

AST		
PRODUCT	PART #	AMT.
2MB SIMM	500718-004	\$229
Premium 486		
1MB SIMM	500718-001	\$65
386/25, 386SX/16		
1MB SIMM	500718-002	\$70
Premium 386/33&486/33, 486/25T, 25TE, 25, 25E		
1MB Kit	500510-007	\$75
Premium 386C, 386/16		
4MB Kit	500510-008	\$255
Premium 386C, 386/16, Advanced Fastram Fast Board 386		
2MB Kit	500510-002	\$149
Premium W.S./386SX, 286, Bravo 286		
1MB Kit	50010-003	\$89
AST Premium/386		
512K Kit	500709-001	\$49
Advantages/2		
512KB Kit	500709-003	\$49
Rampage Plus/MC		
4MB Kit	500510-004	\$259
AST Premium/386, Rampage Plus/MC		

APPLE		
PRODUCT	PART #	AMT.
1MB Kit Mac Port.	M0248	\$259
2MB Kit Mac Port.		\$739
3MB Kit Mac Port.		\$1090
4MB Kit Mac Port.		\$1390
1MB Kit Mac II	M0218	\$75
Mac IICX, IIX		
2MB Kit Mac II	M0219	\$115
Mac IICX, IIX		
4MB Kit Mac IIC	M0292LLA	\$246
16MB Kit Mac IIC		\$1190
4MB Kit Mac IIFX	M0376LLA	\$259

SIMMS		
PRODUCT	PART #	AMT.
256 X 9-80 NS		\$18
256 X 9-100 NS		\$17
1 X 8-80 NS		\$50
1 X 8-100 NS		\$49
1 X 9-80 NS		\$55
1 X 9-100 NS		\$54
1 X 9-70 NS		\$65
4MB X 8-80 NS		\$299
4MB X 8-100 NS		\$293
4MB X 9-80 NS		\$345
FOR SIPPS ADD \$5 Call for Other Speeds		

D-RAM		
PRODUCT	PART #	AMT.
1 X 1-80		\$5.95
64 X 1		\$2.25
64 X 4		\$3.45
256 X 4-80		\$5.99
256 X 1-80		\$2.25
Other Speeds Available		

INTEL		
PRODUCT	PART #	AMT.
Math Co-processors		
80287-10		\$197
80387 SX-16		\$285
80387-SX20		\$285
80387-25		CALL
80387-33		CALL
Call for Other Models		

ZENITH		
PRODUCT	PART #	AMT.
2MB Exp.Cd.		\$329
Alpha Supersport SX		
2MB Exp.Cd.		\$329
Beta Supersport SX		
1MB Exp. Cd.		\$235
Turboport 386E		
4MB Exp. Cd.		\$525
Turboport 386E		
Call for More Zenith		

# MEMORY

AT THE RIGHT PRICES!

**TERMS:** MC, VISA, AMEX (Add 4%), C.O.D. Cash. Terms on P.O.'s from Qualified Firms, Universities, and Government Agencies 20% Restocking Fee on all non-defective returns. CA orders add 6.75% sales tax. Call for Speeds and Configurations you don't see. All Products Brand New & Guaranteed. We Buy Excess Inventory.

**WE WILL MEET OR BEAT ANY ADVERTISED PRICE! DEALER, VAR. AND OEM INQUIRIES WELCOME.**

**1-(800)-367-7330 EXT. 75**  
1625 E. 17th St., Suite 202 Santa Ana, CA 92701 FAX (714) 558-0997

All Trademarks and Registered Trademarks are of their Respective Companies. Prices Subject to Change without notice. Not Responsible for Typographical Errors.

COMPAQ (BOARDS & MODULES)			
Compaq Model	Memory Added	Compaq Part #	Your Low Price
DESKPRO 286	512K Kit	113012-001	59 <sup>00</sup>
DESKPRO 286N, 386N	1MB Module	118688-001	138 <sup>00</sup>
386S/20	2MB Module	118689-001	219 <sup>00</sup>
DESKPRO 386/16	4MB Module	118690-001	569 <sup>00</sup>
DESKPRO 386/16	1MB Board	108069-001	299 <sup>00</sup>
	2MB Board	108069 U/W 71	499 <sup>00</sup>
	4MB Board	108071-001	199 <sup>00</sup>
	4MB Board	108070-001	699 <sup>00</sup>
	4MB Kit	108072-001	449 <sup>00</sup>
DESKPRO 386s	1MB Board	113633-001	248 <sup>00</sup>
	4MB Board	113634-001	548 <sup>00</sup>
	1MB Module	113646-001	138 <sup>00</sup>
	4MB Module	112534-001	318 <sup>00</sup>
DESKPRO 386/20, 25 286E	1MB Module	113131-001	118 <sup>00</sup>
	4MB Module	113132-001	269 <sup>00</sup>
DESKPRO 386/20e	1MB Board	113644-001	229 <sup>00</sup>
	4MB Board	113645-001	479 <sup>00</sup>
DESKPRO 386/33, 486/25	2MB Module	115144-001	99 <sup>00</sup>
SYSTEMPRO	8MB Module	116561-001	999 <sup>00</sup>
	32MB Module	116568-001	599 <sup>00</sup>
PORTABLES			
PORTABLE III	512K Kit	107331-001	89 <sup>00</sup>
	INTFC BD	107808-001	99 <sup>00</sup>
	EXP BD	107811-001	249 <sup>00</sup>
	2MB Kit	110732-001	179 <sup>00</sup>
SLT/286	1MB Module	110235-001	819 <sup>00</sup>
LTE/286	4MB Module	110237-001	819 <sup>00</sup>
	512K Board	117077-001	199 <sup>00</sup>
	1MB Board	117081-001	149 <sup>00</sup>
	2MB Board	117081-002	249 <sup>00</sup>
PORTABLE 386	1MB Kit	107651-001	249 <sup>00</sup>
	INTFC BD	107707-001	99 <sup>00</sup>
	4MB Board	107653-001	799 <sup>00</sup>
	4MB Ext Board	107654-001	799 <sup>00</sup>
SLT/386S	1MB Module	108303-001	349 <sup>00</sup>
	2MB Module	108304-001	499 <sup>00</sup>

SIMM MODULES					
Description	120NS	100NS	80NS	70NS	60NS
256 x 9 IBM	19 <sup>00</sup>	24 <sup>00</sup>	29 <sup>00</sup>	26 <sup>00</sup>	39 <sup>00</sup>
1Meg x 8 Apple	58 <sup>00</sup>	61 <sup>00</sup>	64 <sup>00</sup>	71 <sup>00</sup>	79 <sup>00</sup>
1Meg x 9 IBM	55 <sup>00</sup>	57 <sup>00</sup>	59 <sup>00</sup>	69 <sup>00</sup>	74 <sup>00</sup>
4Meg x 9 IBM		339 <sup>00</sup>	349 <sup>00</sup>	399 <sup>00</sup>	

AST MEMORY			
AST Model	Memory Added	AST Equiv. Part #	Your Low Price
BRAVO/286 & PREMIUM WKST 286	128K Kit	500510-011	49 <sup>00</sup>
	512K Kit	500510-010	59 <sup>00</sup>
	2MB Kit	500510-002	169 <sup>00</sup>
	4MB Kit	500510-008	359 <sup>00</sup>
BRAVO/386SX	2MB Kit	500510-002	169 <sup>00</sup>
	4MB Kit	500510-008	359 <sup>00</sup>
PREMIUM 286 ADVANCE	512K Kit	500510-010	79 <sup>00</sup>
WKST 386SX	1MB Kit	500510-007	99 <sup>00</sup>
	2MB Kit	500510-002	189 <sup>00</sup>
	4MB Kit	500510-007	359 <sup>00</sup>
PREMIUM 386/16, C	1MB Kit	500510-008	149 <sup>00</sup>
	4MB Kit	500510-004	369 <sup>00</sup>
PREMIUM 386/25, 16sx, 586/33	1MB SIMM	500718-001-2	495 <sup>00</sup>
PREMIUM 486/25, 25T, 25E, 25E & 33	1-16MB	500722-004	89 <sup>00</sup>
	1MB SIMM	500718-002	249 <sup>00</sup>
	2MB SIMM	500718-004	249 <sup>00</sup>
	1-16MB	500722-004	495 <sup>00</sup>

IBM PS2 (BOARDS & MODULES)			
IBM PS/2 Model	Memory Added	IBM Equiv. Part #	Your Low Price
PS/2 25/286	512K Kit	30F5348	44 <sup>00</sup>
30-286, 50 & 60	2MB Kit	30F5360	149 <sup>00</sup>
PS/2 50/2 & 55-SX, 65SX	1MB SIMM	6450603	79 <sup>00</sup>
	2MB SIMM	6450604	129 <sup>00</sup>
55SX & 65SX	4MB Module	34F2933	389 <sup>00</sup>
50, 50/2, 55 & 60, 65SX	2-8MB Board	1497259	499 <sup>00</sup>
PS/2	1MB SIMM	6450603	79 <sup>00</sup>
70-E61, 061, 121	2MB SIMM	6450604	129 <sup>00</sup>
PS/2 70-A21 AX1,BX1	2MB SIMM	6450608	139 <sup>00</sup>
PS/2 80-041	1MB Module	6450375	129 <sup>00</sup>
PS/2 80-111,121,311,321	2MB Module	6450379	189 <sup>00</sup>
80-A21, A31	4MB Module	6451060	395 <sup>00</sup>
PS/2 ALL 70s & 80s	2-16MB Board	645605 OR	479 <sup>00</sup>
	4-16MB Board	34F3077	589 <sup>00</sup>
	8-16MB Board	34F3011	949 <sup>00</sup>

IBM HP & CANON LASER JETS			
Model	Memory Added	HP Equiv. Part #	Your Low Price
LASER JET II & IID	1MB Module	33443B	99 <sup>00</sup>
	2MB Module	33444B	149 <sup>00</sup>
	4MB Module	33445B	239 <sup>00</sup>
HP, HP3 & IID	1MB Module	33474A/B	109 <sup>00</sup>
	2MB Module	33475A/B	159 <sup>00</sup>
	4MB Module	N/A	249 <sup>00</sup>
CANON LBP 811, 811R, 811T	1MB Module	N/A	119 <sup>00</sup>
	2MB Module	N/A	169 <sup>00</sup>
	4MB Module	N/A	259 <sup>00</sup>
IBM LASER MODEL 4019	1MB Board	1039136	179 <sup>00</sup>
	2MB Board	1039137	239 <sup>00</sup>

BOCA AT PLUS MEMORY BOARD			
Description	150NS	120NS	100NS
64 x 1	1 <sup>00</sup>	1 <sup>00</sup>	2 <sup>00</sup>
64 x 4	1 <sup>95</sup>	2 <sup>95</sup>	3 <sup>95</sup>
256 x 1	1 <sup>90</sup>	1 <sup>95</sup>	1 <sup>95</sup>
256 x 4		5 <sup>00</sup>	7 <sup>00</sup>
1 Meg x 1		4 <sup>95</sup>	5 <sup>95</sup>

RAM CHIPS					
Description	150NS	120NS	100NS	80NS	70NS
64 x 1	1 <sup>00</sup>	1 <sup>00</sup>	2 <sup>00</sup>	—	—
64 x 4	1 <sup>95</sup>	2 <sup>95</sup>	3 <sup>95</sup>	3 <sup>95</sup>	—
256 x 1	1 <sup>90</sup>	1 <sup>95</sup>	1 <sup>95</sup>	1 <sup>95</sup>	2 <sup>95</sup>
256 x 4		5 <sup>00</sup>	6 <sup>00</sup>	7 <sup>00</sup>	8 <sup>00</sup>
1 Meg x 1		4 <sup>95</sup>	5 <sup>95</sup>	5 <sup>95</sup>	6 <sup>95</sup>

TOSHIBA MEMORY			
Toshiba Model	Memory Added	Toshiba Equiv. Part #	Your Low Price
PORTABLE T1000SE & XE	1MB BD	PC14-PA8311U	199 <sup>00</sup>
	2MB BD	PC14-PA8312U	299 <sup>00</sup>
PORTABLE T1200xe	2MB BD	PC13-PA8306U	179 <sup>00</sup>
PORTABLE T1600	2MB BD	PC8-PA8302U	169 <sup>00</sup>
PORTABLE T3100e	512K Kit	PC9-PA8340U	149 <sup>00</sup>
	2MB Kit	1PC9-PA8341U	199 <sup>00</sup>
PORTABLE T3100SX	2MB BD	PC15-PA8308U	169 <sup>00</sup>
	4MB BD	PC15-PA8310U	469 <sup>00</sup>
PORTABLE T3200	3MB BD	PC6-PA7137U	299 <sup>00</sup>
PORTABLE T3200SX	2MB Kit	PC12-PA8309U	469 <sup>00</sup>
	4MB Kit	PC7-PA8310U	179 <sup>00</sup>
PORTABLE T5100	2MB BD	PC10-PA8304U	179 <sup>00</sup>
PORTABLE T5200	2MB Kit	PC10-PA8304U	179 <sup>00</sup>
DESKTOP T8500	8MB Kit	PC10-PA8313U	995 <sup>00</sup>

ZENITH MEMORY			
Zenith Model	Memory Added	Zenith Equiv. Part #	Your Low Price
Z386/33	1MB Module	ZA3800ME	99 <sup>00</sup>
	2MB Module	ZA3800MG	199 <sup>00</sup>
Z386/25, 20	1MB Module	ZA3600ME	99 <sup>00</sup>
	2MB Module	ZA3800MG	199 <sup>00</sup>
	4MB Module	ZA3600MK	419 <sup>00</sup>
Z248, Z286LP, Z386SX	2MB Module	Z-605-1	229 <sup>00</sup>
TURBO SPRT 386.386e	1MB Kit	ZA3034ME	499 <sup>00</sup>
SUPER SPRT SX	2MB Kit	ZA180-64	449 <sup>00</sup>
	2MB Kit	ZA180-86	449 <sup>00</sup>
	2MB Kit	ZA180-87	449 <sup>00</sup>
SUPER SPRT 286 286e, SX	1MB Kit	ZA180-66	219 <sup>00</sup>
	2MB Kit	ZA180-64	399 <sup>00</sup>

EVEREX MEMORY BOARDS			
RAM Model	Memory Added	Everex Part #	Your Low Price
RAM 3000 DELUXE Up to 3 Meg (EMS) 4.0 DS/2	Back up base memory and expanded and/or extended memory. Uses 256K D-RAM	ZA3800ME	99 <sup>00</sup>
RAM 8000 0-8MG capacity base, extended or expanded memory any combination. Compatible w/Lotus, Intel, Microsoft, EMS 4.0, EFMS. Supports Multi-tasking & DMA Multi-tasking in hardware. Uses 1MG D-RAM		ZA3800MG	199 <sup>00</sup>
RAM 10000 0-10MB extended or expanded memory. Compatible with Lotus, Intel, Microsoft, EMS 4.0. Uses 1 MB D-RAM		ZA3800MK	179 <sup>00</sup>

### CALL FOR FULL SYSTEM QUOTE

**386SX - 25MHz**  
 1.2 MEG FLOPPY • 1 MEG MEMORY  
 101 KEYBOARD MINI CASE 200 WATT PWR SUPPLY  
 1 YEAR WARRANTY YOUR PRICE 879<sup>00</sup>

### CANON FLATBED SCANNER IX-12F

• 300 DPI • 16 Secs per page • 32 Level Gray Scale  
 • 1 year warranty • Ready to go interface card and cable included  
 List 1595 Your Price 799<sup>00</sup> w/o Interface 499<sup>00</sup>  
 OPTIONS: OCR, 199<sup>00</sup> PC Paint By Z-Soft 1.65 79<sup>00</sup>  
 Sheet Feeder (also works with HP) 299<sup>00</sup>

### WANGTEK TAPE BACKUPS

• 6.5MB per minute  
 • Wangtek 5099EN24 drive  
 • PC 36 Controller • Menu driven • Software  
 • DC600 cartridge • Easy installation  
 List 999<sup>00</sup> Your Price 379<sup>00</sup>  
 Wangtek 40MB backup works off floppy controller 189<sup>00</sup>

### CLEARANCE... ALL GOES BELOW COST

**386 - 25MHz**  
 1.2 MEG FLOPPY • 1 MEG MEMORY  
 101 KEYBOARD MINI CASE 200 WATT PWR SUPPLY  
 1 YEAR WARRANTY YOUR PRICE 999<sup>00</sup>



### DAISY WHEEL PRINTER

• 14CPS Letter Quality  
 • Manufactured by Silver Reed  
 • IBM Centronics Parallel Interface  
 • New 90 day warranty  
 List 1149<sup>00</sup> Your Price 99<sup>00</sup>  
 12 CPS version for 89<sup>00</sup> 6 ft. Cable 9<sup>00</sup>

**386 - 33MHz**  
 1.2 MEG FLOPPY • 1 MEG MEMORY  
 101 KEYBOARD MINI CASE 200 WATT PWR SUPPLY  
 1 YEAR WARRANTY YOUR PRICE 1379<sup>00</sup>

### FAX CARD w/2400 BAUD MODEM

• Automatic Group III Digital Fax • Background operation  
 • Send text, screen images, scanned pages  
 • Hayes compatible modem built on • Fax 9600/7200/4800/2400  
 • Software - telephone cord • New, factory sealed  
 List 6<sup>95</sup> Your Price 179<sup>00</sup>

### FULL PAGE SCANNER BY AT&T

• IBM Interface & Cable  
 • PagePower Software.  
 • A complete draw,  
 Scan, fax packages  
 • 200DPI • Automatic Sheet Feeder  
 OCR Software 199<sup>00</sup> List 999<sup>00</sup> Your Price 269<sup>00</sup>

MODEMS			
Model	Memory	Price	Warranty
Internal	79 <sup>00</sup>		2 Year
External	89 <sup>00</sup>		2 Year

VIDEO CARDS			
Model	Price	Warranty	Notes
EGA Card	69 <sup>00</sup>	1 Year	
MonoGraphics (Hercules Compatible) with Par. Port	29 <sup>00</sup>	1 Year	
Color Graphics (Hercules Compatible) with Par. Port	39 <sup>00</sup>	1 Year	
Mono Card Text Only	9 <sup>00</sup>	1 Year	
VGA Card 1024 x 768 (256K Exp 512K)	99 <sup>00</sup>	1 Year	
STB mono/color card	29 <sup>00</sup>	1 Year	

FLOPPY DRIVES			
Model	Price	Warranty	Notes
360K 1/2 Ht. 5 1/4"	59 <sup>00</sup>	1 Year	
12 Meg 5 1/4"	79 <sup>00</sup>	1 Year	
720K 3 1/2" Drive w/5 1/4" mounting	69 <sup>00</sup>	1 Year	
1.44 Meg 3 1/2" Drive w/5 1/4" mounting	79 <sup>00</sup>	1 Year	
360K Tandon TM100-2 Full Ht (The original IBM)	89 <sup>00</sup>	1 Year	

POWER SUPPLIES			
Model	Price	Warranty	Notes
150 WATT XT Comp. • UL Appr. • 110/220V input switch • 4 drives	49 <sup>00</sup>	1 Year	
200 WATT AT comp. • UL Appr. • 110/220V input switch	59 <sup>00</sup>	1 Year	

MONITORS			
Model	Price	Warranty	Notes
14" VGA MULTISCAN 1024 X 768 .28 Dot	389 <sup>00</sup>	1 Year	New 1 Year Warranty
14" VGA OEMD 1024 X 768 .31 Dot	289 <sup>00</sup>	3 Month	Looks New

INTEL COPROCESSORS			
Model	Price	Warranty	Notes
8087 8 Bit	79 <sup>00</sup>	5 Year	
8087-2 8MHz	114 <sup>00</sup>	5 Year	
8087-1 10MHz or less	179 <sup>00</sup>	5 Year	
80287 8MHz	149 <sup>00</sup>	5 Year	
80287-8 8MHz	189 <sup>00</sup>	5 Year	
80287-10 10MHz	205 <sup>00</sup>	5 Year	
80C287-12 Laptop	239 <sup>00</sup>	5 Year	
80387-16 16MHz	299 <sup>00</sup>	5 Year	
80387-20 20MHz	349 <sup>00</sup>	5 Year	
80387-25 25MHz	449 <sup>00</sup>	5 Year	
80387-33 33MHz	549 <sup>00</sup>	5 Year	
80387-SX	329 <sup>00</sup>	5 Year	
80387-SX20	299 <sup>00</sup>	5 Year	
80287-XL	218 <sup>00</sup>	5 Year	
80287-XLT	228 <sup>00</sup>	5 Year	

SEAGATE HARDDRIVE			
Model	Price	Warranty	Notes
ST125-0	20Mb 40msec 3.5"	1 Year	AT KIT \$249
ST125-1	20Mb 28msec 3.5"	1 Year	XT KIT \$299
ST138-0	30Mb 40msec 3.5"	1 Year	\$269 \$319
ST138-1	30Mb 28msec 3.5"	1 Year	\$289 \$339
ST125	20Mb 65msec	1 Year	\$309 \$359
ST238R (RL)	30Mb 65msec	1 Year	\$199 \$249

## There is a Difference!

Lifetime Free Updates

CP-1128  
\$1295



A programmer is not just another programmer. That is why BP Microsystems is committed to bringing our customers the highest quality programmers at an affordable price. This commitment is evident in our CP-1128 Combination PROM/EPROM/PLD Programmer supporting over 1800 devices up to 28-pins. Call today!

**BP MICROSYSTEMS**  
1-800-225-2102  
713/461-9430

Circle 282 on Reader Service Card

## ROM BIOS UPGRADES

### ROM BIOS FEATURES

THE ROM BIOS UPGRADES SUPPORT 360K, 720K, 1.2MB & 1.44MB FLOPPY DISK DRIVES, COMPLETE SET-UP IN ROM, EGA AND VGA SUPPORT, OPTIONAL BUILT-IN DIAGNOSTICS IN ROM (AMI ONLY), NOVELL AND NETWORK COMPATIBLE, SUPPORTS UP TO 48 DIFFERENT TYPES OF HARD DRIVES PLUS TWO USER DEFINED: 84, 101 & 102 KEY KEYBOARD SUPPORT, 100% IBM COMPATIBLE, SUPPORTS 01 OR 2 WAIT STATES, COMPLETE DOCUMENTATION, LATEST VERSIONS. WE ARE THE LARGEST STOCKING BIOS DISTRIBUTOR IN AMERICA!

### XT BIOS UPGRADES

AMI-XT BIOS ..... 49.95 PHOENIX-XT BIOS ..... 49.95

### AT 286 BIOS UPGRADES

AMI-286 INTEL BIOS ..... 69.95 AMI-286 VLSI BIOS ..... 69.95  
AMI-286 CHIP & TECH BIOS ..... 69.95 PH ENIX-286 INTEL BIOS ..... 69.95  
PHOENIX-286 AST BIOS ..... 69.95

### AT 386 BIOS UPGRADES

AMI-386 INTEL BIOS ..... 69.95 AWARD-386 CHIP & TECH BIOS ..... 69.95  
AMI-386 CHIP & TECH BIOS ..... 69.95 AMI-286 VLSI BIOS ..... 69.95  
AMI-386 VLSI BIOS ..... 69.95 PHOENIX-386 INTEL BIOS ..... 69.95  
AMI-386-SX INTEL BIOS ..... 69.95 PHOENIX-386 COMPAQ BIOS ..... 69.95  
AMI-386-SX CHIP & TECH BIOS ..... 69.95 PHOENIX-386 CHIP & TECH BIOS ..... 69.95  
AWARD-386 INTEL BIOS ..... 69.95 PH ENIX-386-SX INTEL BIOS ..... 69.95

### IBM BIOS UPGRADES

PHOENIX-IBM-PC BIOS ..... 79.95 PHOENIX-IBM-AT BIOS ..... 69.95  
PHOENIX-IBM-XT BIOS ..... 59.95 AWARD IBM AT BIOS ..... 59.95

### KEYBOARD BIOS UPGRADES

AMI-286/386 KEYBOARD BIOS ..... 34.95  
AWARD-286/386 KEYBOARD BIOS ..... 34.95  
PHOENIX-286/386 KEYBOARD BIOS ..... 34.95

**UPGRADES ETC.**  
INCORPORATED  
(800) 541-1943

15822 N.E. 165TH ST.  
WEDDING, WA 98052  
(800) 541-1943 - ORDERS  
(206) 882-3634 - TECH SUPPORT  
(206) 881-8294 - FAX  
VISA \* MC \* CDD

Circle 260 on Reader Service Card

## GET on the PC BUS

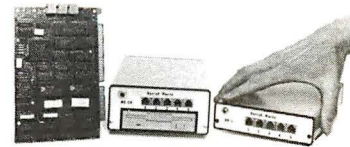

## DOS & .EXE in ROM AT Class Computers \$299

It's easy to run stand-alone applications from ROM! Develop and download your code from a PC, then follow our simple steps to burn .exe & DOS in ROM.

**CPU** NEC V50, 10mhz, cmos, runs PC/AT code  
1 M RAM, 256K ROM, 5 serial ports  
**Firmware** BIOS, Utilities, Monitor & Source code  
**Expansion** Standard PC/AT cards on a backplane  
Piggyback: Flop, Printer, Keyboard, SCSI

**Kila**  
SYSTEMS

Call!  
(303) 444-7737

655 Hawthorn Ave., Boulder CO, 80304 Fax 303-786-9983

Circle 118 on Reader Service Card

## DOS IN ROM!

ALWAYS WAITING FOR A PROMPT? SPEED UP WITH MVS ROM DRIVE!  
-BOOT 0.1 SEC  
-1/2 SIZE CARD  
-ANY PGMS, DOS  
-LANS, CONTROL  
64K.....\$95  
360K.....\$200  
1.44M.....\$300  
MVS  
(508) 792 9507

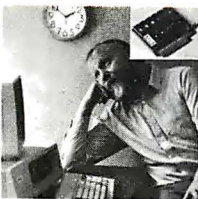

## 8088 SINGLE BOARD COMPUTER

PC ON A CARD!  
1. DEBUG ON PC  
2. TEST SBC RAM  
3. BURN EPROM  
-BATTERY, SOLAR  
-5YR WARRANTY  
-62 PIN PC BUS  
-2PAR, 3SER, RTC  
-LCD/KBD PORTS  
MVSBC1...\$95  
MVBIO...\$60  
PC CABLE...\$50  
PC CARD...\$85

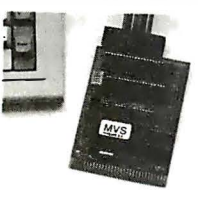

Circle 139 on Reader Service Card

X.25 SDLC  
QLLC HDLC  
ADCCP PAD

- C source code
- ROM-able
- Full porting provided
- No OS required



**GCOM, Inc.**  
1776 E. Washington  
Urbana, IL 61801  
(217) 337-4471

Specialists in Computer Communications  
FAX 217-337-4470

Circle 87 on Reader Service Card

## IEEE 488.2

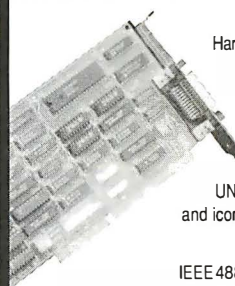

Hardware for IBM PC/AT, Micro Channel, Sun, Macintosh, DEC, and NeXT.

Software for DOS, UNIX, VMS, menu-driven and icon-driven environments.

IEEE 488 extenders, analyzers, converters, analog I/O, and digital I/O.

Call for your free IEEE catalog

**Iotech**

Iotech, Inc. • 25971 Cannon Road  
Cleveland, Ohio 44146 • (216) 439-4091

Circle 111 on Reader Service Card

## Custom Imprinted IBM Key Caps



Hooloon SnapCap Kits Supporting:

WordPerfect 5.0™ or IBM® 5251 Emulation

For 101-Key Keyboards

Customize Your Keyboard with:

- Custom Key Imprinting
- Keytop Label Kits for Software
- Relegendable Keys for Cherry™, Wyse™ & Key Tronic™
- Custom Keytop Label Imprinting
- Keyboard Protectors & More

Call for your FREE CATALOG!

800 937-1337

602 634-7515 FAX: 602-634-4620

**Hooloon CORPORATION** P.O. Box 230, Dept. BYTE  
Cornville, AZ 86325

Circle 98 on Reader Service Card

## DYNAMIC RAMS

4Mx9	80ns	\$220.00
PS2	2M 604/608	\$105.00
1Mx9	80ns	\$ 44.50
1Mx8	80ns	\$ 41.00
256x4	100ns	\$ 4.75
✓ 1Mx1	100ns	\$ 4.25
✓ 41464	100ns	\$ 2.35
✓ 41256	100ns	\$ 1.95
51258	80ns	\$ 2.75
4164	120ns	\$ 1.70

\* For quantity discount, high-speed parts, SIPP ..... Please Call!

80387-33	33mHz	\$335.00	3C87	ITIC/PIIX	\$ CALL
80387-25	25mHz	\$435.00	2C87-20	20mHz	\$235.00
80387-20	20mHz	\$350.00	2C87-12	12mHz	\$184.00
80387-16	16mHz	\$305.00	2C87-10	10mHz	\$176.00
80387SX	16mHz	\$275.00	2C87-8	8mHz	\$160.00
			✓ V-20	8/10mHz	\$8.5/15

## I.C. EXPRESS

15140 Valley Blvd. City of Industry, CA 91744  
Customer Service: (818) 333-8880 FAX: (818) 369-1236

ORDER: (800) 877-8188 (Mon.-Fri. 8-5 PST)

CALL FOR CURRENT PRICES & VOLUME DISCOUNTS.

Price shown for cash. MasterCard/Visa add 3%. Prices are in subject to change. Minimum order \$10.00. Shipping & Handling: UPS Ground \$5.00. Air \$7.00 (U.S.). ALL MERCHANDISE IS 100% GUARANTEED WITH PROMPT DELIVERY.

Circle 113 on Reader Service Card

## FREE CATALOG

### RS-232C INTERFACE & MONITORING EQUIPMENT CATALOG

WRITE or CALL for YOUR FREE COMPREHENSIVE B & B ELECTRONICS CATALOG TODAY! Pages and pages of photographs and illustrated, descriptive text for B&B's complete line of RS-232 converters, RS-422 converters, current loop converters, adapters, break-out boxes, data switches, data splitters, short haul modems, surge protectors, and much, much more. Most products meet FCC Part 15J. Your RS-232 needs for quality, service and competitive prices will be more than met by B&B ELECTRONICS, Manufacturer to you, no middleman! Money-back guarantee! Same-day shipment! One-year warranty on products! Technical support is available.



Order direct from manufacturer TODAY & SAVE!

Write For Your FREE Catalog Today!

**B & B electronics**  
MANUFACTURING COMPANY

4000 Baker Road P.O. Box 1040 • Ottawa, IL 61350

Phone: 815-434-0846

Circle 43 on Reader Service Card

Industrial & Lab Automation with PCs

# ADVANTECH

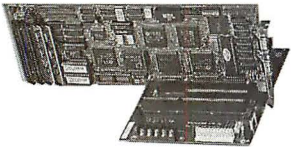

**All-in-One 80286-12 CPU Card**

**PCA-6125 \$395**

- 12MHz 80286 microprocessor
- Socket for 80287 math coprocessor
- AMI BIOS assures compatibility
- Memory configuration: 512K, 1M, 2M & 4M
- Built-in interface for 2 IDE H/D and 2 F/D
- On-board: 1 parallel/2 serial ports
- VLSI CMOS for low power consumption

**408-293-6786**  
1310 Tully Rd., #115, San Jose, CA 95122 FAX 408-293-4697

Circle 16 on Reader Service Card

Industrial & Lab Automation with PCs

# ADVANTECH

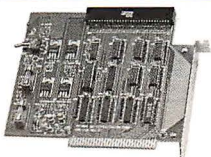

**PC-Bus Switch/Extension Card**

**PCL-756 \$195**

- No more PC power-off for removing or inserting add-on cards
- Protects mother board while trouble shooting or testing add-on cards
- Fully transparent PC/XT bus extension
- All bus signals buffered
- Easy-to-access ON/OFF control switch
- LED display for power & fuse status

**408-293-6786**  
1310 Tully Rd., #115, San Jose, CA 95122 FAX 408-293-4697

Circle 16 on Reader Service Card

Industrial & Lab Automation with PCs

# ADVANTECH

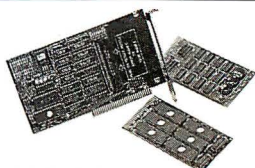

**RAM/ROM Disk Card for "Diskless" PC**

**PCL-790**

- Replaces mechanical disk drive by solid-state disk
- Interchangeable SRAM or EPROM memory module
- Supports up to 4 cards in a single PC with power-on autoboot capability
- Ideal for high speed, heavy duty access and high reliability applications

USA & Canada: San Jose, CA  
Tel: 408-293-6786 Fax: 408-293-4697  
Europe & Asia: Taipei, Taiwan  
Tel: 886-2-9184567 Fax: 9184566

Circle 16 on Reader Service Card

## EZ-ROUTE VERSION II

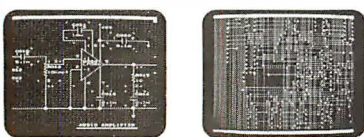

**SCHEMATIC TO PCLAYOUT \$500 INCLUDES AUTO ROUTER**

EZ-ROUTE Version II from AMS for IBM PC, PS/2 and Compatibles is an integrated CAE System which supports 256 layers, trace width from 0.001 inch to 0.255 inch, flexible grid, SMD components and outputs on Penplotters as well as Photo plotters and printers.

Schematic Capture \$100, PCB Layout \$250, Auto Router \$250.

**FREE EVALUATION PACKAGE**

**30 DAYS MONEY BACK GUARANTEE**

1-800-972-3733 or (305) 975-9515

**ADVANCED MICROCOMPUTER SYSTEMS, INC.**  
1321 N.W. 65 Place - Ft. Lauderdale, FL 33309

Circle 18 on Reader Service Card

## Intelligent Solutions



# SCSI CONTROLLERS FOR ISA & MCA

**The Only DCBs to Consider for NetWare!**

**NEW! PROCOMP F-DCB for NetWare** has on-board boot & floppy support.

**NEW! DRAVADD & DRANLM** deliver super hard disk & erasable optical performance under NetWare.

Use with NetWare 286 & 386. (Also, drivers for OS/2, DOS and XENIX.)

**NEW! Create fully NetWare Ready compatible drives using DCBSET 5.**

Phone: (216) 234-6387  
FAX: (216) 234-2233



The SCSI Professionals  
6777 ENGLE ROAD, CLEVELAND, OH 44130

Circle 178 on Reader Service Card

## 9 Track Tape Subsystem for PC/XT/AT/386/PS2



**\$1995 for 1600/3200 BPI**  
**\$4995 for 1600/6250 BPI**  
**\$6995 for 800/1600/3200/6250 BPI**  
CALL 1-800-266-4TAPE

**Laguna Conversion Systems**  
1401 South Pacific Coast Highway  
Laguna Beach, CA 92651  
Tel: 714-497-0660, Fax: 714-497-5567

Circle 120 on Reader Service Card

## 9-Track Tape Subsystem for the IBM PC/XT/AT



Now you can exchange data files between your IBM PC and any mainframe or mini-computer using IBM compatible 1600 or 6250 BPI 9-Track tape. System can also be used for disk backup. Transfer rate is up to 4 megabytes per minute on PCs and compatibles. Subsystems include 7" or 10 1/2" streaming tape drive, tape coupler card and DOS compatible software. For more information, call us today!

**QUALSTAR**

9621 Iroindale Ave., Chatsworth, CA 91311  
Telephone: (818) 882-5822

Circle 186 on Reader Service Card

## QIC 'n Easy Access to all your Data Everytime



AS/400 Sys 36/38 Apollo Everex Sun Sytos UNIX

Lotus 123 DBASE Mail Merge Secure Data Duplication XENIX UNIX

The QICPAK family provides unique facilities to access 1/4" (QIC) data cartridges created on a wide range of Micros, Minis and Mid-Range Systems using your PC. This gives you a secure, low cost, fast and high capacity alternative.

QICPAK's facilities cover all aspects of cartridge processing, including:

- Extracting data directly from the cartridge into packages such as Lotus 123 or DBASE or for use in Mail Merge applications.
- Data files can be extracted by QICPAK from cartridges recorded on many systems, including: IBM System 36/38, IBM AS/400, IBM PC-RT, Apollo, Everex, Maynard, Mountain, Sun, Sytos, UNIX and XENIX systems etc.
- QICPAK's High Speed Cartridge Duplication gives complete in-house control.
- QICPAK's Backup & Restore facilities are UNIX tar compatible.
- Custom applications, eg recorded information may be protected from unwanted access providing secure interchange of your confidential information.
- Source in Microsoft & Turbo C, TurboPascal and BASIC is provided.

We provide both QICPAK Kits for use with existing 1/4" cartridge drives and also complete internal & external solutions. Support is by the developers.

**VOGON**

VOGON ENTERPRISES LIMITED  
94 Eastthampstead Road, Wokingham, Berkshire RG11 2JD England  
Tel: (44) 734 784511/890442 Fax: (44) 734 890440



Circle 265 on Reader Service Card

## SuperSound TurboSound

SoundFX-III, -Stereo, -Mono, -Eng, -Jr SoundBytes, SoundJr, SoundCard, Digital Audio Authoring Workstation, MSC/TurboC/Windows 3.0 Libraries. Custom Sound Hardware/Software

**ALL WE DO IS SOUND!!**

**IBM-PC DIGITAL VOICE / SOUND**  
from only \$20 (player module) to \$640 (Developer's Kit)

**Pro Quality Software / Hardware - in use worldwide, even Japan!**

**30 Day Money-Back Guarantee if not Satisfied**

- Use for Foreign Language training / communications.
- For Business: Training, Slide Shows - with Grasp, ShowPartner FAX...
- For Engineering: Function Gen., Clear Voice Alarms, Storage Scope...
- For Fun: Create Your Own Sounds For Games, Alter Your Voice...

Orders: 800-969-4411 by **Silicon Shack** FAX: 408-374-4412

5120 Campbell Ave. #112, San Jose, CA 95130.

**Technical: 408-446-4521**

Ask for FREE PRODUCT CATALOG of IBM-PC sound products. Developers: Add TurboSound - PC audio engine to your product.

\*Silicon Shack, SoundFX, SoundFX-III, SoundFX-III, and TurboSound are trademarks of Silicon Shack, Ltd. Other product names are trademarks of their respective firms.

Circle 209 on Reader Service Card

# Trend Systems

T R E N D S Y S T E M S I N C .

## Memory Expansion Boards

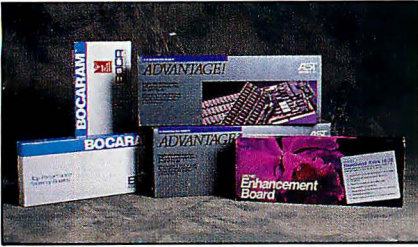

### ORCHID

RAMQUEST 8/16 Card expandable to 32MG. For IBM PCs, XTs, ATs, PS/2 Model 30-286 and compatibles. Supports 8 and 16 bit bus. Uses 256K, 1 MG or 4MG Modules. w/OK \$289

RAMQUEST EXTRA 16/32 0-8MG. 0 wait state card for PS/2 Mod 50, 60 & 80 fully supports 16 and 32-bit memory access. Includes 1 SER and 1 PAR port. Free serial cable. EMS 4.0 and OS/2 compatible. Uses 256K and/or 1MG SIMMS w/OK \$279.

### EVEREX

RAM 3000 DELUXE Up to 3MG. Selectable memory addresses, Expanded Memory Specifications (EMS) 4.0/ OS/2. Can be used to backfill base memory up to 640K and the rest as expanded and/or extended memory. Uses 256K D-RAM. w/OK \$ 89

RAM 8000 Up to 8MG capacity/support to base, extended or expanded memory in any combination. Fully compatible with Lotus, Intel, Microsoft, EMS 4.0, EEMS. Supports Multi-Tasking and DMA Multi-Tasking in hardware. Software configurable (no dip switches to set). Full 16MG window for future expansion. Zero wait state. Uses 1MG D-RAM w/OK \$189

### BOCA RESEARCH

BOCARAM/AT Provides up to 2MG LIM EMS 4.0 and/or 4MG of extended, expanded or backfill memory. For 16 bit bus. Operates up to 16MHz. Uses 256K D-RAM w/OK \$109

BOCARAM/AT PLUS Provides up to 8 MG of extended, expanded or backfill memory. Operates up to 33MHz and is set thru software. Uses 1MG D-RAM w/OK \$119

BOCARAM/AT II/O PLUS Provides up to 4MG of extended, expanded or backfill memory for 16 bit bus. Operates up to 33 MHz and is set thru software. Has serial and parallel port. Uses 1MG D-RAM w/OK \$145

### COMPAQ MEMORY

#### ADD-ON MODULES

MODEL	1MG	2MG	4MG	8MG
386/20/20E/25/25E				
DESK PRO 286E, 386S	\$135		\$375	
386/33, 486/25 & SYSTEM PRO		\$320		\$2,495

#### MEMORY EXPANSION BOARDS

MODEL	512K	1MG	2MG	4MG	8MG
386/16	\$349	\$449	\$799	\$1495	
386/20E/25E 386S	\$199	\$339	\$499		
Portable 386			\$849		
Portable LTE	\$159	\$219	\$395		
SLT/286		\$219	\$839		

#### MEMORY UPGRADE KITS

MODEL	512K	2MG	4MG
Portable III	\$49	\$149	
DESKPRO 386/16		\$219	\$599

## Fax Boards

### CALCULUS EZ-FAX

Now works with Windows 3.0! Manufactured CCITT Group III. Provides fully concurrent background operation. Allows user to transmit, receive and view documents on screen. Once in memory, the transmissions may be edited for retransmission, printed, stored for future, or discarded off your hard drive. SOFTWARE INCLUDED.

001FX (4800 baud)	Trend Price	\$189
002FX (9600 baud)	Trend Price	\$289

## Modems

	EVEREX		TREND	
Internal 1200 BAUD	\$ 69	Internal 1200 BAUD	\$ 59	
Internal 2400 BAUD	129	External 1200 BAUD	99	
Internal 2400 BAUD w/MNP 5	169	Internal 2400 BAUD	69	
External 2400 BAUD w/MNP 5	199	External 2400 BAUD	129	

## Laptop Memory

2MG Card-Toshiba Portable T1200e	\$435
2MG Card-Toshiba Portable T1600	179
2MG Card-Toshiba Portable T3100SX	179
4MG Card-Toshiba Portable T3100SX	465
512K Card-Toshiba Portable T3100e	149
2MG Card-Toshiba Portable T3100e	259
2MG Card-Toshiba Portable T3200SX	179
4MG Card-Toshiba Portable T3200SX	465
3MG Card-Toshiba Portable T3200	179
2MG Card-Toshiba Portable T5100	179
2MG T5200	179
2MG Module-Toshiba Portable	265
2MG Module-Toshiba Desktop T8500	345

## Memory Products

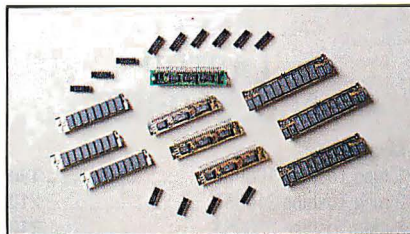

### SIMM/SIPP MODULES

	150ns	120ns	100ns	80ns	70ns	60ns
4MG X 9	—	—	—	\$415	\$385	—
1MG X 9	—	\$ 50	\$ 53	\$ 55	\$ 60	\$ 80
1MG X 8	—	\$ 62	\$ 60	\$ 69	—	—
256 X 8	\$ 16	\$ 24	\$ 39	—	—	—
256 X 9	—	\$ 13	\$ 16	\$ 20	\$ 24	—

### D-RAM

ALL PACKAGES & SPEEDS AVAILABLE

### 286 MATH CO-PROCESSORS

	6MHz	8MHz	10MHz	12MHz	12.5MHz	20MHz
IIT (2C87)	—	\$165	\$199	—	\$260	\$304
INTEL (80287)	\$120	\$183	\$208	\$280	—	—

### 8088 MATH CO-PROCESSORS

INTEL (8087)	5MHz	8MHz	10MHz
	\$88	\$115	\$165

### 386 MATH CO-PROCESSORS

	16MHz	20MHz	25MHz	33MHz	SX
CYRIX (83D87)	\$280	\$325	\$425	\$524	—
IIT (3C87)	\$280	\$325	\$425	\$524	—
INTEL (80387)	\$305	\$350	\$450	\$549	\$290

### HP MEMORY

HP II & II D	HP II P & III	
1 MB	1 MB	\$ 94
2 MB	2 MB	\$129
4 MB	4 MB	\$269
TONER	TONER	\$ 74

### IBM PS-2

34F2933 - 4MG Memory Module for 55SX; 65SX		
Memory Option IBM P/N 34F3077, 34F3011		\$409
6450375 - 1MG Memory Bd for 80-041		135
6450379 - 2MG Memory Bd for 80-111;311-121; 321		209
6450603 - 1MG Module for 70-E61; -121, Adaptor Board		79
IBM P/N 6450605, 6450609, 34F3011 & 34F3077		
6450604 - 2MG Module for 70-061; E61; -121, 502;		
55SX 65SX; P70		135
Adaptor Board IBM P/N 6450605, 6450609, 34F3011 & 34F3077		149
6450608 for Model 70A21		139
30F5360 (Kit-2 ea)		145
30F5348 (Kit-2 ea)		66



**WE WILL MEET OR BEAT ANY ADVERTISED PRICE**

**1-800-950-7599**

3955 South Wasatch Blvd.  
Salt Lake City, Utah 84124  
Local 801-278-5112 Fax 801-278-5471

TERMS AND CONDITIONS: NO SURCHARGE FOR MC OR VISA. TERMS: MC • VISA • COD • CASH • AMEX ADD 4%. PURCHASE ORDERS FROM QUALIFIED FIRMS. 20% RESTOCKING FEE ON NON-DEFECTIVE RETURNS. PRICES SUBJECT TO CHANGE.

## Trend 386-25 MHz COMPUTER SYSTEM



- DTK Motherboard
- Intel 80386-25 MHz Microprocessor
- Intel 80387 Socket
- 8/25 MHz Clock Speed
- Page Mode Interleave/Shadow RAM
- 8 Expansion Slots: 2x8 bit, 5x16 bit, 1x32 bit
- 1 MB On Board Expandable to 8 MB
- 1.2 or 1.44 Disk Drive
- IDE/1:1 Hard/Floppy Controller
- Serial/Parallel

- Baby AT Desktop Case w/200 W Switch Power Supply
- 101 Enhanced Keyboard
- Speed Rating: Landmark 31.7, Norton SI 27.1, Power Meter (MIPS) 4.35
- FCC Class B Approved/UL, TUV Listed

TREND PRICE  
**\$1159**

## Trend 386SX/16 COMPUTER SYSTEM

### 60MG Hard Drive/14" Monitor

- 14" VGA Paper White Monitor
- VGA Board w/ 256
- Phoenix Bios.
- 1 MG On/Bd Memory
- 1.2 Floppy Drive
- 60MB RLL Hard Drive
- 2 Serial Ports
- 2 Parallel Ports
- 1 Game Port
- 101-Key Click Keyboard
- 3 Button Mouse
- 3 Year Warranty

TREND PRICE  
**\$1259**

## Hard Drives

KALOCK 20MB XT 20 MB, MFM, 3.5 HH, 40 ms	\$169
MITSUBISHI 40MB, 5.25HH, MFM, 28ms	319
MITSUBISHI 60MB, 5.25HH, RLL, 28ms	349
SEAGATE 105MB, IDE, 25ms	479

## Video Adapters

	TREND
EGA CARD 640 X 480, 16 color EGA/MGA/CGA/Hercules	\$ 89
VGA CARD 1024 X 768, 16 color, VGA/EGA/MGA/CGA	99
MONO CARD w/parallel port	99
CGA CARD 2/parallel port	19

## Specials

DFI MOUSE	\$ 35
3-Button Mouse with Selectable Sensitivity. Software - up to 400	
STAR MICRONICS	\$159
Dot Matrix Printer 180 cps 34cps/nlq NX1000/2	
360K FLOPPY DRIVES	\$35
Panasonic & Mitsumi XT Only DS/DD	
MONO VGA MONITOR	\$79
14" Paper White, Tilt & Swivel Base	10 or more \$69

The Trend To Follow...



PS/2 model 30/286-30 meg .....	1795
PS/2 model 50Z/286-60 meg .....	2395
PS/2 model 55SX/386SX-60 meg .....	2695
PS/2 model 70/386-120 meg .....	5595
PS/2 model 80/121-120 meg .....	NEW
*** Monitor Extra ***	



Compaq 286E-40 meg .....	1995
Compaq 386/20E-100 meg with 4 meg memory .....	3595
Compaq 386S-100 meg with 2 meg memory .....	2795
Other models .....	CALL
*** Monitor Extra ***	

### NOVELL SPECIALS

ELS I .....	599
ELS II .....	1250
Advance 286 V 2.15 .....	2150
Advance SFT V 2.15 .....	2999

### WE STOCK

CITIZEN	GOLD STAR	NEC	PRINCETON GRAPHICS	AMDEK	TOSHIBA
OKIDATA	PC MOUSE	WYSE	HOUSTON INSTRUMENTS	HAYES	SAMSUNG
EVEREX	LOGITECH	SONY	MICROSOFT MICE	CALCOMP	MAGNOVOX
HITACHI	MITSUBISHI	ACER	IRWIN & ARCHIVE	TAXAN	TAPE BACK

### MONITORS

NEC Multisync IIA .....	499
NEC Multisync 3D .....	649
Emerson VGA .....	340
NEC Multisync 5D .....	2350
Sony 1304 .....	659
Sony 1302 .....	619

### SOFTWARE SPECIAL

dBase IV .....	455
Wordperfect 5.1 .....	260
Aldus Pagemaker .....	495
Ventura Publisher .....	525
Clipper .....	535
WordStar 5.5 .....	150
EasyExtra .....	40



**NOVELL**  
Authorized  
Dealer

### INTEL COPROCESSORS

8087-3 .....	105
8087-2 .....	145
80287-8 .....	225
80287-10 .....	249
80387-16 .....	395
80387-20 .....	425
80387-25 .....	495
80387-33 .....	599

### PACIFIC DATA PRODUCTS

P. Page II .....	395
P. Page IIP .....	365
P. 1-2-4 Mem II .....	140
P. One Meg IIP .....	160
P. 25 in One .....	250
P. Headlines .....	245

### LAN BOARDS

8 bit Arcnet .....	110
16 bit Arcnet .....	220
8 bit Ethernet .....	190
16 bit Ethernet .....	275
8 port Active Hub .....	325
Token Ring Card .....	399
Tokenhub 4-port .....	355
Call for other LAN Accessories	

### SPECIALS

HP Scan Jet .....	1425
Hp Paint Jet .....	965
Lotus Ver. 3.0 .....	355
Kodak 150P .....	355
Complete Fax Board .....	399
Okidata 391 .....	625
Epson LQ1050 .....	660
Panasonic 1124 .....	319
HP-7475 Plotter .....	1595
SummaGraphic .....	365

### LASER PRINTERS

HP Laser IID .....	2550
HP Laser 2P .....	995
HP Laser III .....	1650
Panasonic 4450 .....	1395
Brother HL-8-E .....	1895
NEC LC 890 .....	3195
Toshiba Laser 6 .....	1095

### MODEMS

Everex 2400 Int/Mnp .....	179
Hayes 2400B .....	315
Hayes 9600B .....	875
USRobotics Hst/Dual .....	1150
More in stock ..... Call	

Corporate Accounts  
Welcome  
**Call for Volume  
Discounts**  
Consultants Call  
for Pricing  
**Exports  
Available**

# Computerlane

**Outside California: 1-800-526-3482**  
**Inside California: 818-884-8644 • FAX: 818-884-8253**

22107 Roscoe Blvd., Canoga Park, CA 91304 • 1/2 Block west of Topanga  
**Hours: Monday - Friday 9 - 6 Saturday 10 - 6**

Compaq is a Registered Trademark of Compaq. IBM is a Registered Trademark of International Business Machines.

ALL QUOTED  
PRICES ARE CASH  
PRICES ONLY

Visa and MasterCard  
3% higher,  
American Express  
5% higher

Prices subject to change  
without notice.  
\*Quantities are limited

# LOW PRICE LEADER

SINCE 1983

### LAPTOP

Texas Instruments TM2000 .....	2595
Compaq LTE/286-40 .....	2975
Sharp 6220 .....	2595

CALL FOR OTHER BRANDS

### LAPTOP ACCESSORIES

Memory	
1 meg Toshiba 1000SE .....	190
2 meg Toshiba 3100SX .....	210
2 meg Toshiba 3200SX .....	210
2 meg Toshiba 5200 .....	220
1 meg Compaq SLT .....	280



### Everex System I 1545

Everex Step 286/12-1 meg  
40 meg VGA card and monitor

### Everex System II 2195

Everex Step 386SX-2 meg  
40 meg VGA card and monitor

### Everex System III 4850

Everex Step 386/33-4 meg  
150 meg VGA card and monitor

\* Call for models & configurations \*

### AGI COMPUTER

AGI 386SX-1 meg .....	1595
40 meg VGA card and monitor CALL FOR OTHER MODELS	



AST 386SX-2 meg .....	2195
40 meg VGA card and monitor CALL FOR OTHER MODELS	

### DISKS

DYSAN 5.25 HD/3.5 HD .....	13/26
MAXELL 5.25 HD/3.5 HD .....	12/25
Minimum 10 box order	



## MULTI FUNCTIONS IN ONE INSTRUMENT

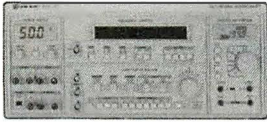

### DOA-141 FEATURES

- Frequency counter • Range: 1 Hz - 100 Mhz
- Sensitivity: 1 Hz - 60 Mhz (15mV) 60 Mhz - 100 Mhz (25mV) • Accuracy:  $\pm(1 \text{ Hz} + 1 \text{ dgt} + \text{Time base error})$  • Display: 8 digits LED w/units annunciator
- Function generator • Frequency: 0.02 Hz - 2 Mhz • Output waveform: Sine, Square, Triangle, Skewed sine, Ramp, Pulse, TTL level square • Output: 0.1 Vpp - 20 Vpp • Output impedance: 50 $\Omega$ /600 $\Omega$
- Digital multimeter: 3.5 digit LCD Display
  - Auto ranging (DCV, ACV,  $\Omega$ , DCA, ACA)
  - Basic accuracy:  $\pm(0.5\% + 2 \text{ dgts})$
- Power supply • Triple output, 0-50V, 0.5A Max; 15V, 1A; 5V, 2A

# XELTEK

TEL (408) 745-7974 FAX (408) 745-1401

## UNIVERSAL PROGRAMMER



- Programs PLD, E(E)PROM (up to 4MB), Bipolar PROM & Microcontroller
- Tests TTL/CMOS logic & D/S memory
- Software controlled 40-pin universal device programmer
- Interfaces with IBM PC/XT/AT/386 or compatibles
- Reliable and fast programming with Normal, Intelligent, Interactive, Quick pulse algorithms
- Accepts JEDEC, INTEL extended HEX, Motorola S, Tektronix HEX, Binary formats
- Manages 8, 16, and 32-bit word split
- Supports most compilers in JEDEC format
- High speed parallel Interface card to PC

# XELTEK

764 San Aleso Ave., Sunnyvale, CA 94086  
TEL (408) 745-7974 FAX (408) 745-1401

## COMPLETE DATA ACQUISITION CARD FOR IBM PC/XT/AT



### MCP-550 I/O MASTER CARD FEATURES

- High performance, low cost data acquisition card with multi-functions: A/D, D/A, D/I, D/O
- Maximum sampling rate of 100,000 samples/sec with option or 60,000 samples/sec (standard)
- Industry standard 12-bit resolution
- 16 single ended or 8 differential A/D channels
- Two 12-bit monolithic multiplying D/A channels
- TTL compatible 24 D/I & D/O channels
- Switch selectable analog input range: 0-10V or +10V
- Can be used with MCE-730: a versatile 16 channel analog input multiplexing and signal conditioning card
- Complete support of vendor application S/Ws such as Labtech Notebook, ASYST...

# XELTEK

TEL (408) 745-7974 FAX (408) 745-1401

Circle 272 on Reader Service Card

Circle 273 on Reader Service Card

Circle 274 on Reader Service Card

# 486

\$1995

Made in U.S.A.

## JC GOLD CARD

The JCS 486, the New Performance Leader in Personal 486 Systemboards

- Intel 80486/25(B5) CPU
- 8KB Cache integrated in CPU
- Math Coprocessor integrated in CPU
- Shadow RAM for Video & System BIOS
- Second Level Cache Memory expandable to 512KB
- Walkot 4167 numeric coprocessor socket
- 30 DAY MONEY BACK GUARANTEE

486 Complete System . . . . \$3385

Include 4MB Memory, 150MB ESDI HDD, ESDI Cache Controller, 12 or 1.44MB FDD, MS DOS, AT VO, 101 Keyboard

80386/20 CPU Bd, C&T chipset \$615  
80386/25 CPU Bd, C&T chipset \$665  
80386/25 Cache Bd, C&T chipset \$845

Dealer Inquiries welcome

Jemini Electronics TEL (408) 727-9986  
3400 De La Cruz Blvd, Unit T  
Santa Clara Ca, 95054 FAX (408) 727-7687

11.1 MIPS

Circle 116 on Reader Service Card



DriveGuard  
the personal technician

NOW — stop data loss before it strikes!

DriveGuard puts you on the offensive against sudden data loss disasters by detecting marginal conditions in your 5.25 in, high-density, floppy drive before they become a problem. At last you'll know when it's safe to store your valuable data on disk.

Selected features:

- Fast, accurate test of your floppy drive.
- Resolves interchangeability problems.
- Easy to use, menu driven interface.
- On-line help, mono and color support.
- Printed reports with test result history.

DriveGuard is an indispensable utility for anyone who owns or uses a PC/AT or 100% compatible computer with one or more 5.25 in, high-density, 1.2 meg floppy disk drives. 512k RAM required.

Send check or money order for \$89.95+\$4.00 S&H to Test Technology, P.O. Box 360118, Milpitas, CA 95036. California residents add sales tax. Call (408) 946-1722, 9am to 5pm PST.

"Don't boot up without it!"

Circle 228 on Reader Service Card

# RENTALS

Our unique service provides you a short-term solution to your computer needs!

- IBM
- MACINTOSH
- PORTABLES
- COMPAQ
- LASERS
- LAPTOPS

Next Day Delivery Available

PC Computer Rental

CALL TOLL FREE

# 800-785-4727

Circle 168 on Reader Service Card

## Free leaflets and catalogues

### Info# Topic

- 00011 Printer buffers. Perhaps the simplest way to speed up a computer system.
- 00021 The ideal interface is like a cable: Easy to install. Invisible in use.
- 00031 T-Switches and Auto-switches. Optimised for easy operation.
- 00041 Data cables. Highly flexible. Simple to install. A well thought-out system.
- 00051 Interface Cards. Carefully developed to eliminate application problems.
- 00401 ToolArt: Useful art for computer professionals.
- 00511 Brains beats money. Enhancements you can install yourself.
- 00521 UNIX-Installations. Tips&products.
- 00531 The right way to install a computer.

W&T Products Corp.  
2209 NE 54th Street  
Ft. Lauderdale, FL 33308  
Phone 1-800-628-2086  
Fax 1-305-351-9099

W&T  
PRODUCTS

Circle 267 on Reader Service Card

## FAST SCSI STORAGE

Compatible with 286/386 Laptop, Apple II, Atari, Amiga, Sun, Macintosh, Silicon Graphics, Next, IBM RS6000

A-Hive & Jr.(3.5") - Enclosure for SCSI Drives

- Room for 2-HH or 1-FH drive 30 Watts \$119.
- Incl. all internal cables 65 Watts \$169.



Half Shell-Compact Hard Drive (1.4"x5.5"x7.5")

low power 40MB-120MB from \$599

Hermit Crab-Portable Hard Drive (2.8"x5.5"x7.5")

32MB to 200MB 28ms to 12ms from \$399

Laptop SCSI Drive 32MB-1.5GB from \$595

SCSI Hard/Floppy Drive 2MB-1.5GB from \$159

Cartridge Hard Drive 44MB \$499

SCSI Tape Drive 50MB-1.3GB from \$389

2HD/4Floppy 286/386 Controller

XT/AT/286/386 SCSI/ESDI/MCA Controller

TULIN CORPORATION Tel:408-432-9025  
2156H O'Toole Ave, San Jose, CA 95131 Fax:408-943-0782

Circle 255 on Reader Service Card

## BLAST YOUR MESSAGE THRU!



VOICE MAIL • TELEMARKETING  
CALL PROCESSING

Let Powerline transform your PC/XT/AT/386 into a multi-line voice processing command center. Have your computer intelligently process your sales, inquiries and messages. Complete package.

Single Line (Bigmouth) . . . \$295.00

Multi-Line . . . . . \$895.00

(Developer/OEM packages available)

VISA - MC - AMEX - GOC

Call: (415) 522-3800

FAX: (415) 522-5556

TALKING TECHNOLOGY, INC. TTI  
1125 ATLANTIC AVE., ALAMEDA, CA 94501

Circle 223 on Reader Service Card

**ARC TANGENT PROFESSIONAL MAIL** \$695  
*Complete Mailing List Management Software*

The most advanced, professional-level mailing list management system available for IBM and compatible microcomputers. Save thousands of dollars on postage, printing, and processing costs.

- Unlimited number of names and addresses
- Sophisticated merge/purge duplicate detection
- Complete postal presorting and barcoding
- Custom letters, labels, reports
- Convert data from dBase, ASCII, other formats

Arc Tangent, Inc.  
 121 Gray Avenue  
 Santa Barbara, CA 93101-1831  
 (805) 965-7277

Circle 23 on Reader Service Card

Industrial Control Systems  
 LAN Terminals  
 Diskless Systems

**ROMDISK™**

For the IBM PC, XT, AT PC DOS\* or MS DOS\*

**SOLID STATE DISK AND DRIVE EMULATORS FOR DISKLESS SYSTEMS**

- Diskless systems with local DOS and program storage for client LAN terminals, and embedded and industrial control systems.
- Single or dual disk emulation of 5¼" or 3½" diskettes.
- EPROM, Flash EEPROM and SRAM technology. Flash EEPROM models are electrically erasable. SRAM models are battery backed. EPROM models are ultraviolet erasable.
- On-board EPROM programmer—simply copy a diskette to program the EPROMs or Flash EEPROMs. Flash EEPROMs remotely programmable on LANs.
- Two Autoboot modes, a File (read) and a Programming mode—automatic disk drive designation set-up during booting.
- Utilities and Users Manual included.
- List prices from \$195. OEM prices available.

**CURTIS, INC.**  
 2937 North Fairview Ave. • St. Paul, MN 55113  
 612/631-9512 Fax 612/631-9508

IBM PC, XT, AT, PS/2 and PC DOS are trademarks of IBM. MS DOS is a trademark of Microsoft.

Circle 64 on Reader Service Card

**IMAGING CARDS**

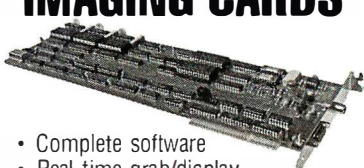

- Complete software
- Real time grab/display
- PC/XT/AT/386 compatible

**CV-512** Advanced 8 bit board. 512 x 480 or 256 x 240 (4 images), in/out LUTS, 4 inputs, "ping pong" buffers, 24 bit RGB output \$1.095

**CV-02** 256 x 240 x 8 bits, 2 inputs, cursor, 24 bit RGB output \$595

**CV-03** 6 bit CV-02, 8 bit output \$469

**Control Vision**  
 P.O. Box 596, Pittsburg, Kansas 66762  
 800/292-1160, 316/231-6647

Circle 57 on Reader Service Card

 **QUARTERHORSE**  
 High Capacity Tape Subsystems

for Disk Backup, Data Acquisition, and Archiving

Everything you need in a single, high-quality package: Drive, SCSI Host Adapter, Enclosure, and DSI's Backup Software.

- 320/520 Mb 1¼" CT . . . . \$1,495
- 1.2 Gb 4mm DAT . . . . . \$3,195
- 2.3 Gb 8mm HS . . . . . \$3,695

**New:** 450 Mb 3480 CT . . . . \$4,295

Optional Application Interface Library (in "C") available. **Full Support.**

Terms: U.S.-Visa, COD, pre-advd. credit.  
 Other: Prepaid wire transfer, International letter of credit.

**DATA STRATEGIES INTERNATIONAL, INC.**  
 9020 Capital of TX Hwy, Ste. 420, Austin, TX 78759  
 (512) 338-4745 FAX (512) 345-1328

Circle 65 on Reader Service Card

**!!!! NEW !!!!**  
**32 I/O <- -> RS-232**



- FINALLY ANY COMPUTER CAN HAVE I/O
- PLUGS INTO ANY STANDARD RS-232 PORT
- 16 DIGITAL INPUTS, 16 DIGITAL OUTPUTS
- ALL I/O OPTO-ISOLATED PROTECTED
- NO ADDITIONAL HARDWARE REQUIRED
- NO MORE SPECIAL PLUG-IN CARDS
- EASY TO PROGRAM IN ANY LANGUAGE
- UP TO 4 BOARDS CONNECT TO ONE RS-232
- IDEAL FOR REMOTE MONITOR & CONTROL
- USED IN INDUSTRY, SCHOOLS, LABS & HOBBY
- INDUSTRIAL VERSION AVAILABLE
- RS-422/485 VERSION AVAILABLE
- GRAFCET CONTROL SOFTWARE AVAILABLE
- COMES WITH PC BASIC PROGRAM DEMO DISK
- STANDARD UNIT PRICED AT ONLY \$ 349 QTY 1
- DEALER INQUIRIES ARE WELCOME

P. SHERMAN ENTERPRISES (514) 331-3712

Circle 185 on Reader Service Card

*the* **LOGIC™ LAB** \$499.00



*the* **LOGIC™ LAB** is a complete logic development system

- GAL Device Programmer and Logic Compiler Software Complete with Sample Devices.
- Supported Devices Include: 16V8 16Z8 20V8 22V10 20RA10 39V18 18V10 26CV12
- Allows Prototyping of 42 Different Standard PLD's
- Accepts All Standard JEDEC Download Files.
- Software Updatable.
- 30 Day Money Back Guarantee.

\* Visa and Master Card Accepted \*  
 CALL FOR FREE DEMO DISK

**Programmable Logic Technologies, Inc.**  
 P.O. Box 1567 Langmont, CO 80501 Ph. (303) 772-9059

MADE IN USA  
 GAL is a registered trademark of Lattice Semiconductor Corporation

Circle 179 on Reader Service Card

**Graph-XXX**  
 We've seen the rest... We're the BEST

These HOT graphics are for VGA only

301 - 23 Heart Stopping GIF Images	14.95
401 - Brilliant Color - Stunning Resolution	14.95
402 - Super Photographic Quality	14.95
501 - She's no angel in this movie	14.95
502 - Sizzling live-action movie	14.95
101 - CGA/EGA Combo - 3 disks	19.95
102 - VGA Movie Combo - 501 & 502	24.95
103 - \$75 Value Pack - all 5 VGA disks	49.95

SEND CHECK OR MONEY ORDER IN US DOLLARS TO:

**STARWARE PUBLISHING CORPORATION**  
 P.O. Box 340203 - DEPT. 10 BOCA RATON, FL 33434  
 407-479-0588

Must state age over 21

- Requires hard disk to install
- #101 CGA/EGA Combo uses three low capacity floppy
- All VGA disks require high capacity floppies
- Add \$1 per 3.5" disk
- Add \$1 per disk for foreign
- Please include \$3 S.H.T.
- FL residents add 6% sales tax

Circle 216 on Reader Service Card

**6809**  
 Single Board Computer

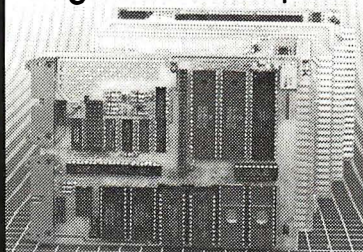

6809 MPU, 2 serial ports, 4 parallel ports, RAM, EPROM, real-time clock, watchdog timer, 44-pin 4.5" x 6.5" PCB

**EXPANSION MODULES:** RAM, EPROM, CMOS RAM/battery, analog I/O, serial I/O, parallel I/O, counter/timer, IEEE-488, EPROM programmer, floppy disks, cassette, breadboard, keyboard/display.

**WINTEK Corporation**  
 1801 South Street  
 Lafayette, IN 47904  
 317-742-8428

Circle 268 on Reader Service Card

**New Schematic and PCB Software**

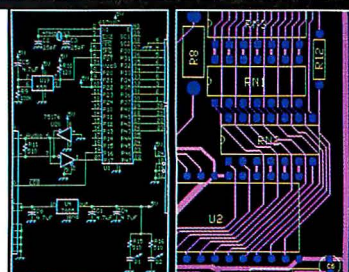

With support for extended and expanded memory, HiWIRE II can handle your most demanding schematic and PCB designs quickly and easily. The unique HiWIRE editor allows you to display and edit schematics and PCBs simultaneously, using the same commands for each. HiWIRE II is \$995, and is guaranteed.

**WINTEK Corporation**  
 1801 South Street, Lafayette, IN 47904  
 (800) 742-6809 or (317) 448-1903

Circle 269 on Reader Service Card

# MEMORY!

**FIRST SOURCE INTERNATIONAL, INC.**

WE ACCEPT PURCHASE ORDERS FROM UNIVERSITIES, QUALIFIED FIRMS AND GOVERNMENT AGENCIES.

**WE ACCEPT INTERNATIONAL ORDERS**  
3 day International delivery available via Federal Express or DHL!  
CALL (714) 588-9866 OR FAX 24-HOURS-A-DAY FAX (714) 588-9872

**100%**  
COMPATIBLE OR  
YOUR MONEY BACK

**GREAT PRICES, PRODUCTS AND SUPPORT!**

### IBM MEMORY

Model PS/1		
512K Kit	1057035	\$99.00
2MB	IBM PN N/A	\$399.00
Models 30-286, Exp. Board 1497259		
512K Kit	30F5348	\$49.00
2MB Kit	30F5360	\$139.00
Models 70-E61/121,55SX,65SX		
1MB	6450603	\$79.00
Models 70-E61/121,50Z,55SX,65SX		
2MB	6450604	\$139.00
Models 55SX, 65SX, 34F3077 & 34F3041		
4MB	34F2933	\$399.00
Model 70-A21		
2MB	6450608	\$149.00
Model 80-141		
1MB	6450375	\$129.00
Models 80-111/311		
2MB	6450379	\$239.00
Models 80-A21/A31		
4MB	6451060	\$549.00
All Models 70 and 80		
2-8MB Board w/2M		
	6450605	\$459.00
2-14MB Board w/2M		
	34F3077	\$539.00
4-16MB Board w/4M		
	34F3011	\$825.00
Models 90, 55Z, 60 & 65SX		
2-16MB Board w/2MB		
	6450609	\$589.00

### PRINTER MEMORY

Hewlett-Packard LaserJet IIP, III and IID		
1MB	33474B	\$89.00
2MB	33475B	\$159.00
4MB	33477B	\$279.00
Hewlett-Packard LaserJet II & IID		
2MB	33444B	\$169.00
4MB	33445B	\$289.00
Apple Laserwriter II and II/XTX		
1MB	M6005	\$89.00
4MB	M6006	\$299.00
IBM Laser 4019 and 4019e		
1MB	1039136	\$169.00
2MB	1039137	\$219.00
3.5MB	1038675	\$299.00
Canon LBP-8II, 8IIr, 8IIT		
2MB	S63-1880	\$179.00
4MB	PN N/A	\$289.00
Epson EPL6000		
2MB	IBS401	\$289.00
4MB	PN N/A	\$429.00
Panasonic 4450I and 4420		
1MB	KX-443	\$169.00
2MB	KX-441	\$229.00
4MB	PN N/A	\$349.00

Now accepting orders for NEW Canon LBP-4 Memory Upgrade!

### ZENITH MEMORY

Zenith Z-386/20/25/33 & 33E		
1MB	ZA36/3800ME	\$79.00
4MB	ZA3800MK	\$419.00
Zenith Z-386/25 & 33		
2MB	ZA3600MG	\$149.00
Zenith Z-386 SX		
2MB Kit	Z-605-1	\$149.00
Zenith TurboSport 386e		
1MB	ZA-3034-ME	\$259.00
4MB	PN N/A	\$589.00

### COMPAQ MEMORY

DeskPro 286-E,386-20/20E/25		
1MB	113131-001	\$119.00
4MB	113132-001	\$319.00
DeskPro 386S/16		
1MB	113646-001	\$119.00
4MB	112534-001	\$319.00
DeskPro 286N, 386N and 386SX and 20		
1MB	118688-001	\$79.00
4MB	118690-001	\$419.00
DeskPro 386N, 386SX and 20		
2MB	118689-001	\$149.00
DeskPro 386-33, 486-33 & SystemPro		
2MB	115144-001	\$169.00
8MB	116561-001	\$1299.00
DeskPro 386-20e and 25e		
1MB Board	113644-001	\$189.00
4MB Board	113645-001	\$489.00
DeskPro 386S		
1MB Board	113633-001	\$189.00
4MB Board	113634-001	\$489.00
DeskPro 386/16 (Popular In this order)		
1MB Kit	108071-001	\$135.00
1MB Board	108069-001	\$349.00
2MB Board	108069/71-001	\$449.00
4MB Board	108070-001	\$799.00
8MB Board	108070/72-001	\$1399.00

### AST MEMORY

Bravo/286		
128K Kit	500510-011	\$29.00
Premium 386C and 386-16		
1MB Kit	500510-007	\$85.00
4MB Kit	500510-008	\$289.00
Premium 386-20		
1MB Kit	500510-003	\$99.00
4MB Kit	500510-004	\$319.00
Bravo 386-SX, WS/286,386 and /2		
2MB Kit	500510-002	\$149.00
4MB Kit	500510-008	\$289.00
Premium 386-SX/16/25/33 & all 486 models		
1MB	500718-002	\$79.00
Premium 486		
2MB	500718-004	\$219.00
Premium II 386SX/20 & 386SX/16		
1MB	500780-003	\$109.00
4MB	500780-004	\$589.00
8MB	PN N/A	\$1169.00

### APPLE MEMORY

Apple Macintosh IxI		
4MB Kit	MO292LL-A	\$249.00
16MB Kit	Part # N/A	\$1199.00
Apple Macintosh IIfx		
4MB Kit	MO376LL-A	\$279.00

### HEWLETT-PACKARD MEMORY

Vectra QS/16S & ES/12PC		
2MB Kit	D1354A	\$139.00
Vectra QS/16S and RS/20PC		
1MB Kit	D1540A	\$79.00
4MB Kit	D1542A	\$279.00
Vectra QS/20PC, RS/25PC, 20C and 25C		
1MB Kit	D1640A	\$79.00
4MB Kit	D1642A	\$279.00
Vectra 486 PC		
1MB Kit	D2150A	\$89.00
4MB Kit	D2151A	\$419.00
Vectra 486PC and 386/25 PC		
8MB Kit	D2152A	\$829.00
Vectra 386/25 PC		
2MB Kit	D2381A	\$159.00

### BRAND NEW!

For IBM RISC/6000 320 and 530		
16MB	\$CALL	
32MB	\$CALL	
For IBM PS/2 Models 90 & 95		
2MB	\$249.00	
4MB	\$589.00	
For SHARP and TI Notebooks		
1MB	\$189.00	
For NEC TurboSport 386E		
1MB	\$259.00	
4MB	\$589.00	

### LAPTOP MEMORY

#### TOSHIBA

Model 1000SE, XE, LE and 2000SX		
1MB	\$269.00	
2MB	\$299.00	
Model 1000LE and 2000SX		
4MB	\$749.00	
8MB	\$1399.00	
Model T1200XE	2MB	\$179.00
Model T1600	2MB	\$179.00
Model T3100E	2MB	\$179.00
Model T3100SX	2MB	\$179.00
	4MB	\$499.00
Model T3200SX	2MB	\$179.00
	4MB	\$499.00
Model T3200	2MB	\$299.00
Model T5100	2MB	\$179.00
Model T5200,T8500	2MB	\$179.00
	8MB	\$1189.00

#### COMPAQ

Portable III	512K	\$39.00	
	2MB	\$135.00	
Portable 386/20	1MB	\$285.00	
	4MB	\$845.00	
Por able LTE 286	1MB	\$135.00	
	2MB	\$185.00	
	4MB	\$795.00	
NEW!	SLT-286	1MB	\$165.00
	4MB	\$795.00	
	1MB	\$225.00	
	2MB	\$395.00	
	4MB	\$875.00	

#### ZENITH

SuperSport 286 and 286e		
1MB	\$179.00	
SuperSport SX and 286e		
2MB	\$325.00	
SuperSport SX	2MB A or B	\$295.00
TurboSport 386e	1MB	\$259.00
	4MB	\$589.00

#### NEC

ProSpeed 286 and 386SX/16		
1MB	\$289.00	
2MB	\$442.00	
4MB	\$749.00	
ProSpeed SX/20	1MB	\$309.00
	4MB	\$709.00
ProSpeed 386	2MB	\$489.00
	8MB	\$1659.00

Memory upgrades manufactured by:



**Kingston**  
TECHNOLOGY CORPORATION

**PARAGON**  
MEMORY CORPORATION

### EXPANSION BOARDS

#### Everex RAM 3000 Deluxe

Up to 3MB of base, expanded and/or extended memory. EMS 4.0 compatible with no wait states. Uses 256Kx1 Dram.  
with 0K: SIM159 ..... \$99.00  
with 512K: SIM159-05 ..... \$139.00

#### BocaRam/XT

Up to 2MB of expanded memory for any IBM PC, XT and 8-bit PC bus compatibles running at CPU speeds upto 12MHz. LIM 4.0 compatible. Uses 256K Dram.  
with 0K: SIMXT00 ..... \$119.00  
with 512K: SIMXT05 ..... \$149.00

#### BocaRam/ATPlus

Up to 8MB for any AT or 16 bit compatible machines running up to 33MHz. Offers conventional, expanded and/or extended memory, provides a maximum of 8MB LIM/EMS 4.0. Uses 1x1 Dram.  
with 0K: SIMAT80 ..... \$119.00  
with 2MB: SIMAT82 ..... \$239.00  
Orchid 8/16

Up to 32MB for IBM AT, or 16 bit compatible. Use as conventional, expanded and/or extended upto 32MB using 256K, 1MB or 4MB industry standard SIMMs.  
with 0K: SIM1900 ..... \$239.00  
with 1MB: SIM1900-05 ..... \$299.00

### SIMMS

### DRAM

IBM TYPE	1MX1	
4Mx9-80	\$299.00	1MX1-12 ..... \$5.00
1Mx9-12	\$54.00	1MX1-10 ..... \$5.50
1Mx9-10	\$56.00	1MX1-80 ..... \$6.00
1Mx9-80	\$58.00	1MX1-70 ..... \$6.50
1Mx9-70	\$60.00	1MX1-60 ..... \$7.50
256x9-12	\$16.00	<b>256KX4</b>
256x9-10	\$17.00	256KX4-12 ..... \$5.00
256x9-80	\$18.00	256KX4-10 ..... \$5.50
256x9-60	\$20.00	245KX4-80 ..... \$6.00

### APPLE-MAC

256KX1	
4Mx8-80	\$279.00
1Mx8-12	\$48.00
1Mx8-10	\$50.00
1Mx8-80	\$52.00
256x8-12	\$14.00
256x8-10	\$15.00
256x8-80	\$16.00
256KX1-12	\$1.80
256KX1-10	\$1.90
256KX1-80	\$2.00
256KX1-70	\$2.50
256KX1-60	\$3.00
STATIC COLUMN ALSO AVAILABLE	

CALL TOLL FREE FROM ANYWHERE IN THE U.S. OR CANADA!

**ORDER NOW: 1-800-535-5892**

VISA

MasterCard

AMERICAN EXPRESS

✓ NO SURCHARGE ON MC OR VISA  
✓ Terms: AmEx (+4%), Visa, MC, COD/Cash, Net 30 on purchase orders from qualified firms.  
✓ 20% Restocking fee on all non-defective returns & refunded orders. RMA # required.  
✓ Manufacturers part numbers are for your convenience, all products third party.  
✓ PRICES AND AVAILABILITY SUBJECT TO CHANGE.

#### Order Desk Hours:

Monday thru Friday 8:00-5:00PM  
Use our 24 hour-a-day voice mail or FAX!  
PLEASE SEND ALL P.O.'S AND MAIL ORDERS TO:  
First Source International, Inc.  
36 Argonaut, Suite 140  
Aliso Viejo, California 92656  
Ph. (714) 588-9866 FAX (714) 588-9872

Why buy from First Source International?

We make a good price a GREAT price!  
When you buy from FSI the price includes EXCELLENT SERVICE and SUPPORT from our TRAINED SALES STAFF. And if there's a problem, we will be here to help you.

"The Only Source" for Memory!

Trademarks of their respective companies

**ONE YEAR  
WARRANTY**

# AMT INTERNATIONAL

**LOWEST PRICES  
SAME DAY  
SHIPPING**

2393 QUME DRIVE, SAN JOSE, CA 95131

**(408) 432-0552 • (408) 432-1790 • Fax: (408) 944-9801**

## COMPUTER SYSTEMS

### AMT 486-25 MHz w/128K Cache

1MB RAM  
90 MB SCSI HARD DISK  
MATH Co-PROCESSOR SOCKET  
1:1 2HD/FD CONTROLLER  
1.2 OR 1.44 FLOPPY DRIVE  
I/O 2S/P/G/PORT  
101 KEY BOARD  
FULL TOWER CASE  
w/230 P/S  
SUPPORT UNIX, XENIX,  
DOS, OS/2, NETWORK

**\$2899**

### AMT 386-33 MHz w/64K Cache

1MB RAM  
40 MB HARD DISK  
INTEL 386-33 MHz CPU  
MATH Co-PROCESSOR SOCKET  
1:1 2HD/FD CONTROLLER  
1.2 OR 1.44 FLOPPY DRIVE  
I/O 2S/P/G/PORT  
101 KEY BOARD  
MINI-TOWER CASE w/200 P/S  
SUPPORT UNIX, XENIX,  
DOS, OS/2, NETWORK

**\$1399**

### AMT 386-25 MHz w/40 MB Hard Disk

1MB RAM  
40 MB HARD DISK  
INTEL 386-25 MHz CPU  
MATH Co-PROCESSOR SOCKET  
1:1 2HD/FD CONTROLLER  
1.2 OR 1.44 FLOPPY DRIVE  
I/O 2S/P/G/PORT  
101 KEY BOARD  
AT CASE W/200 P/S  
SUPPORT UNIX, XENIX,  
DOS, OS/2, NETWORK

**\$1249**

### AMT 386SX-16 MHz w/40 MB Hard Disk

1MB RAM  
40 MB HARD DISK  
INTEL 386SX-16 MHz CPU  
MATH Co-PROCESSOR SOCKET  
1:1 2HD/FD CONTROLLER  
1.2 OR 1.44 FLOPPY DRIVE  
I/O 2S/P/G/PORT  
101 KEY BOARD  
AT CASE w/200 P/S  
SUPPORT UNIX, XENIX,  
DOS, OS/2, NETWORK

**\$1045**

**COMPUTER SYSTEMS: VGA MONITOR AND VGA  
16 BIT CARD (1024 x 768) ..... \$445**

## MEMORY UPGRADES

### COMPAQ MEMORY

DeskPro 286 E, 386-20/20E/25  
1MB 113131-001 ..... \$139.00  
4MB 113132-001 ..... \$369.00  
DeskPro 286N, 386N and 386SX  
2MB 118689-001 ..... \$225.00  
4MB 118690-001 ..... \$590.00  
DeskPro 386S  
1MB 113646 001 ..... \$139.00  
4MB 112534-001 ..... \$369.00  
DeskPro 386-33, 486-33 & SystemPro  
2MB 115144-001 ..... \$225.00

### AST MEMORY

Bravo-286, Workstation  
512K Kit 500510-010 ..... \$59.00  
2MB Kit 500510-002 ..... \$172.00  
Premium 386-16/20C  
1MB Kit 500510-007 ..... \$96.00  
4MB Kit 500510-008 ..... \$369.00  
Premium 386-20  
1MB Kit 500510-003 ..... \$150.00  
4MB Kit 500510-004 ..... \$369.00  
Bravo-386SX  
2MB Kit 500510-002 ..... \$172.00  
4MB Kit 500510-008 ..... \$369.00  
Premium 386-SX/25/33 & 486-25  
1MB 500718-002 ..... \$80.00

### HEWLETT-PACKARD MEMORY

Vectra QS/16S  
1MB D1540A ..... \$112.00  
4MB D1542A ..... \$349.00  
Vectra QS/20PC, RS/25PC and 20C  
1MB D1640A ..... \$126.00  
4MB D1642A ..... \$365.00  
Vectra 486PC  
1MB D2150A ..... \$115.00  
4MB D2151A ..... \$390.00

### IBM PS/2 MEMORY

Models 30-286, Exp. Board 1497259  
512 K Kit 30F5348 ..... \$54.00  
2MB Kit 30F5360 ..... \$175.00  
Models 70-E61/121, 55SX, 65SX  
1MB 6450603 ..... \$96.00  
Models 70-E61/121, 50Z, 55SX, 65SX  
2MB 6450604 ..... \$179.00  
Models 55SX, 65SX, 34F3077 & 34F3011  
4MB 34F2933 ..... \$485.00  
Models 70-A21  
2MB 6450608 ..... \$170.00  
Models 80-141  
1MB 6450375 ..... \$145.00  
Models 80-111/311  
2MB 6450379 ..... \$269.00  
All Models 70 and 80  
2-8MB w/2M 6450605 ..... \$499.00  
2-14MB w/2M34F3077 ..... \$599.00  
2-16MB w/4M34F3077 ..... \$999.00  
Models 50, 50Z, 55 SX & 60  
2-8MB 1497259 ..... \$599.00

### LASER PRINTER MEMORY

Hewlett-Packard Laser Jet IIP & III  
1MB 33474B ..... \$130.00  
2MB 33475B ..... \$150.00  
4MB 33477B ..... \$199.00  
Hewlett-Packard Laser Jet IIP & III  
1MB 33443B ..... \$135.00  
2MB 33444B ..... \$150.00  
4MB 33445B ..... \$199.00  
IBM Laser 4019 and 4019e  
2MB 1039137 ..... \$369.00  
3.5MB 1038675 ..... \$469.00  
Canon LBP-8II, 8IIR, 8IIT  
2MB S63-1880 ..... \$225.00  
4MB Part #N/A ..... \$439.00

### LAPTOP AND PORTABLE MEMORY

**TOSHIBA MEMORY**  
1MB Model 1000SE/XE ..... \$329.00  
2MB Model 1000SE/XE ..... \$469.00  
2MB Model T1200XE ..... \$289.00  
2MB Model T1600 ..... \$289.00  
2MB Model T3100E ..... \$175.00  
2MB Model T3100SX ..... \$175.00  
4MB Model T3100SX ..... \$689.00  
2MB Model T3200SX ..... \$175.00  
4MB Model T3200SX ..... \$689.00  
2MB Model 5100 ..... \$289.00  
2MB Model T5200, T8500 ..... \$185.00  
8MB Model T5200, T8500 ..... \$1300.00

**ZENITH MEMORY**  
1MB SuperSport 2 86 & 286E ..... \$199.00  
2MB SuperSport 286 & 286E ..... \$455.00  
2MB SuperSport SX/Alpha ..... \$455.00  
4MB SuperSport SX/Beta ..... \$455.00

**COMPAQ MEMORY**  
1MB Portable LTE 286 ..... \$195.00  
2MB Portable LTE 286 ..... \$299.00  
1MB SLT-286 ..... \$245.00  
4MB SLT-286 ..... \$1395.00

**NEC MEMORY**  
1MB Prospeed 286 ..... \$270.00  
2MB Prospeed 386 ..... \$450.00

### ZENITH MEMORY

Zenith Z-386/20/25/33 & 33E  
1MB ZA36/3800ME ..... \$99.00  
4MB ZA3800MK ..... \$675.00  
Zenith Z-386/20/20/25 & 33  
2MB ZA3600ME ..... \$199.00  
Zenith Z-386 SX  
2MB Z-605-1 ..... \$255.00

### MATH COPROCESSORS

**INTEL**  
8087-5MHz ..... \$80.00  
8087-2.8MHz ..... \$116.00  
8087-1.10MHz ..... \$155.00  
80287-6.6MHz ..... \$130.00  
80287-8.8MHz ..... \$185.00  
80287XL 8/10MHz ..... \$185.00  
80287XTL 12 MHz (Laptop) ..... \$210.00  
80287-10.10MHz ..... \$185.00  
80C287-12 12MHz ..... \$195.00  
80387SX-16 ..... \$285.00  
80387SX-20 ..... \$310.00  
80387DX-20 ..... \$340.00  
80387DX-25 ..... \$425.00  
80387DX-33 ..... \$525.00

**WEITEK**  
3167-20 20MHz ..... \$300.00  
3167-25 25MHz ..... \$350.00  
3167-33 33MHz ..... \$500.00  
4167-25MHz ..... \$800.00  
4167-33MHz ..... \$1050.00

**CYRIX**  
83087-16 16MHz ..... \$260.00  
83087-20 20MHz ..... \$295.00  
83087-25 25MHz ..... \$360.00  
83087-33 33MHz ..... \$440.00  
83SX87-16 16MHz ..... \$235.00  
83SX87-20 20MHz ..... \$260.00

**IT**  
8C87-8 ..... \$165.00  
8C287-10 ..... \$175.00  
8C287-12 ..... \$200.00  
8C287-20 ..... \$230.00  
8C387-20 ..... \$265.00  
8C387-25 ..... \$350.00

**AMD**  
80C287-10 ..... \$110.00  
80C287-12 ..... \$130.00

### DRAM

DRAM 1MGXI	DRAM 64X4	DRAM 256X4
1 MGXI-120NS \$5.00	4164-15 ..... \$1.50	256X4-120NS ..... \$5.00
1 MGXI-100NX 5.25	4164-12 ..... 1.99	256X4-100NS ..... 5.50
1 MGXI-80NX 5.50	4164-10 ..... 2.50	256X4-80NS ..... 5.75
1 MGXI-70NX 5.75	<b>256X1-STATIC COL</b>	
1 MGXI-60NX 7.50	256X1-150NS ..... \$1.79	51258P-10 ..... \$2.99
	256X1-120NS ..... 1.99	AAA 2800-08 ..... 3.00
	256X1-100NS ..... 2.00	AAA 2800-07 ..... 3.25
	256X1-80NS ..... 2.25	AAA 2800-60 ..... 4.50
	256X1-70NS ..... 2.35	1X4-80 ZIPP ..... 35.00
	256X1-60NS ..... 3.99	1X4-80ST ZIPP 39.00
		1X4-70ST ZIPP 39.00

### SIMM MODULES

IBM TYPE	256x9-10	16.00
4Mx9-80	256x9-80	18.00
1Mx9-60	256x9-60	23.00
1Mx9-10		
1Mx9-80	1Mx8-70	\$50.00
1Mx9-70	1Mx8-10	\$40.00
256x9-70	1Mx8-80	\$45.00
	4x8-80	\$250.00

### MICRO-PROCESSORS

68020 16MHz .....	\$129.00
20MHz .....	169.00
25MHz .....	179.00
33MHz .....	199.00
68030 16MHz .....	129.00
25MHz .....	199.00
68010 16MHz .....	60.00

### CPU CHIPS

80386DX-16 .....	\$250.00	80286-8 (PLCC) .....	15.00
80386DX-20 .....	275.00	80286-10 (PLCC) .....	18.00
80386DX-25 .....	325.00	80286-12 (PLCC) .....	20.00
80386DX-33 .....	355.00	82385-20 .....	60.00
80386sx-16 .....	230.00	82385-33 .....	75.00
80386sx-20 .....	235.00	V-20-8 .....	6.00
80486DX-25 (86) .....	650.00	V-20-10 .....	10.00
80486DX-33 (86) .....	1150.00	V-30-10 .....	10.00

**New, Improved!**

# 8051/8052 BASIC COMPILER!

Full floating-point numbers, integer, byte and bit extensions. Fully compatible with MCS BASIC 52. Runs on IBM-PC or compatible.

## \$295.00

Call Now! 603-469-3232



**Binary Technology, Inc.**  
Main Street • P.O. Box 67 • Meriden, NH 03770

**New**

## LPC Serial/2A HDLC/SDLC Data Communication Controller for IBM PC/AT Bus

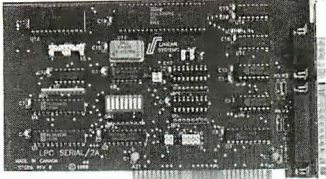

- Dual Channel Synchronous Controller (Z85C30)
- Runs 800K BAUD
- Full Duplex DMA
- HDLC LapB software option



**Computer Modules, Inc.**  
2348C Walsh Ave.  
Santa Clara, CA 95051  
Tel: (408) 496-1881  
Fax: (408) 496-1886

IBM PC/AT is a trademark of IBM, Inc.

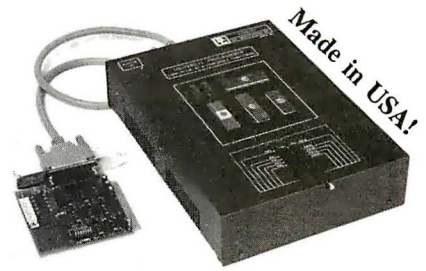

### PC BASED UNIVERSAL DEVICE PROGRAMMER \$695/895

- Programs EE/EPROMs, MICROs, BIPOLARS, PALs, GALs, EPLDs, PEELS. (current libraries support over 900 devices by over 35 manufacturers)
- Software driven pin drivers. DIA generated programming voltages (8 bit DACs used to generate voltages from 4-25V with 0.1V resolution for all pins)
- Fast device programming/verify/read via dedicated parallel interface
- Upgradable for virtually any future programmable devices up to 40 pins.
- Self-subsistent operation. No additional modules or plug-in adapters required.
- Includes user friendly MEMORY BUFFER FULL SCREEN EDITOR. Commands include: Fill, Move, Insert, Delete, Search. Data entry can be done in ASCII or HEX form. FUSEMAP EDITOR for Logic devices.
- Friendly Menu-Driven interface. Device selection by P/N and Manufacturer.
- Supports 8/16/32 bit data word formats.
- Programming algorithms: Normal, Intelligent I & II, Quick Pulse Programming. Automatic selection of fastest algorithm for any given part.
- Verify operation performed at normal & worst case operating voltage.
- Functional test: JEDEC standard functional testing for logic devices. TTL Logic functional test for 74xx/54xx series devices and memory devices. Test library can be updated by the user. User definable test pattern generation.
- File formats accepted: JEDEC (full), JEDEC (kernel), Binary, MOS Technology, Motorola Hex, Intel Hex, Tektronix Hex.
- Base price (\$695) includes Interface card, cable, Memory & Micro + Bipolar library, TTL/CMOS/MEMORY device test capability, one year free updates.
- Complete price (\$895) includes all of the above plus Logic Device Library.
- Library updates can be received via floppy or B&C Customer Support! BBS.
- Full 1 year warranty. Customer support via voice line, Fax & dedicated BBS.

Circle 55 on Reader Service Card

# PLD Design Software

Get Started with CUPL™ for only \$149.95



Now you can have a PLD Starter Kit that gives you all the horsepower that the CUPL PLD compiler offers, at a fraction of the cost. For more information, call 1-800-331-7766 or 305-974-0967.



Circle 124 on Reader Service Card (RESELLERS: 125)

# Program Your Chips

In Sets of 4 for \$495.00



**Special offer Now Includes:**  
Free UV eraser, CUPL starter Kit and a \$300.00 Factory Rebate with the PDT-1 EPROM, EPLD, Micro Programmer.



**1-800-331-7766**

Circle 126 on Reader Service Card (RESELLERS: 127)



**15th year** of discounting Tandy® computers, Fax and Radio Shack® products

**Radio Shack® Tandy®**

We will meet or beat... **GUARANTEED LOWEST PRICES**

**MARYMAC INDUSTRIES INC.**  
22511 Katy Fwy.  
Katy (Houston), TX 77450  
1-713-392-0747 FAX (713) 574-4567  
Toll Free 800-231-3680

Circle 134 on Reader Service Card

# VERBATIM SONY • BASF

**100% CERTIFIED LIFETIME WARRANTY**

5 1/4" DS/DD	\$ .39 each
5 1/4" DS/HD	.59 each
3 1/2" DS/DD	.59 each
3 1/2" DS/HD	1.09 each

Price based on mix/match qty. of 300 in bulk. Includes Tyvek sleeves and label kits.

**PREFORMATTED • COLORS • TAPES**

## MEGA Soft

P.O. Box 710, Freehold, NJ 07728  
**800-222-0490**  
In NJ 908-462-7628  
FAX 908-462-5658

Circle 136 on Reader Service Card

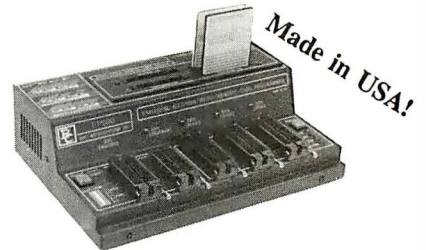

### UNIVERSAL RS-232 PROGRAMMER \$345/495

- Programs EE/EPROMs, ZPRams, Intel Micros, Flash EPROMs, Memory Cards.
- Stand-Alone Mode for EE/EPROM and Memory Card Duplication/Verify.
- All 24/28/32 pin EE/EPROMs to 4 MBits (upgradable to 32 megabits).
- Micros: 8741A, -2/A, -4, -8, -9, -51, -C51, -C51FA/B, -52, -53, -55, -C521, -C541, 9761.
- Model UP100 (\$345), Model UP200 (\$495) accepts dedicated modules.
- Motorola Micros (68705P3, U3, R3, S3) Programming Module - \$145
- Memory Cards Programming Module (Seiko/Epson) - \$145
- GANG Programming Module (4 sockets) - \$145
- Optional built-in Eraser/Timer module - \$50; Conductive foam pad.
- User friendly Menu-Driven Interface Program for IBM-PC and Macintosh.
- Can be operated with any computer containing an RS-232 serial port.
- OEM open board programmer configurations available (from \$245).
- One year free software updates and Customer Support.
- Customer support via voice line, dedicated BBS or fax; Full 1 year warranty.



### INTELLIGENT ROM EMULATOR \$395

- Emulates 2716 through 27512 EPROMs (2k to 64k bytes) with a single unit.
  - Megabit parts can be emulated with multiple units (Mega adapter required).
  - Connects to the standard parallel printer port. Uses standard printer cable.
  - FAST data loading via parallel printer port (64k bytes in less than 10 seconds).
  - Intelligent "In-Circuit-Emulator" type features include: Address Compare (with HALT output), Address Snapshot (for target addr. bus monitoring), Trigger Input (for external events monitoring), Programmable Reset Output.
  - Powerful Memory buffer editor. Selectable wordsizes (8,16,32).
  - User friendly software. Command set includes: Load, Write, Display, Run, Type, Edit, Fill, Run-Command-File, Monitor, Port, Reset, Hold, Calculator.
  - Cascodeable to 8 units. Includes target cable with Trigger, Halt & Reset clips.
  - CMOS model with NiCad rechargeable 9V battery backup - \$495 (Can be used in stand-alone mode; Built-in battery recharging circuitry.)
  - File formats accepted: Binary, Intel Hex, Motorola S.
- MC / VISA / AMEX Call today for datasheets!



**B&C MICROSYSTEMS INC.**  
750 N. PASTORIA AVE., SUNNYVALE, CA 94086 USA  
TEL.: (408) 730-5511 FAX: (408) 730-5521 BBS: (408) 730-2317



# Instant Microcontroller

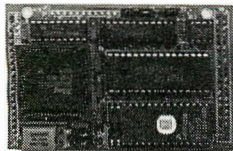

## Instant C Programming

Don't use a microprocessor, use a SmartBlock™ microcontroller module to build your custom controller. Our low cost Dynamic C™ makes programming a snap. 3.5 x 2.5 inch module includes microprocessor, memory, time/date clock, eeprom, watchdog, serial ports and more. As low as \$59. The efficiency of a custom design without the headaches.

### Z-World Engineering

1340 E. Covell Blvd., Davis, CA 95616

Tel: (916) 753-3722

Fax: (916) 753-5141

Circle 279 on Reader Service Card

# Little Giant™

## C Programmable Controller

This shirt pocket sized computer interfaces directly to the outside world. Use it to control anything. Instantly programmable using your PC with Dynamic C. ROM and battery backed RAM to 1024k bytes. 8 Channel, 10/12 bit, A/D with conditioning. High voltage and current drivers. Battery backed time and date clock. Watchdog and power fail. 4 serial channels. 24 parallel/Olines. Timers. Integral power supply. Terminations for field wiring. Expansion connector. Plastic or metal field packaging available. OEM versions from \$199.00.

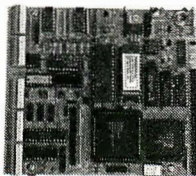

### Z-World Engineering

1340 Covell Blvd., Davis, CA 95616

(916) 753-3722

Fax: (916) 753-5141

Circle 280 on Reader Service Card

## LOW COST INTERFACE AND DATA ACQUISITION / CONTROL CARDS FOR PC/XT/AT

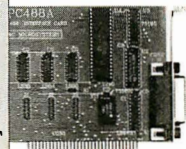

### RS-485/422 Card [PC485] \$95/125

- Serial Async. Communication up to 4000ft. 2 or 4 wires; NS16450 UART;
- Can be configured as COM1-COM4; Maximum Baud Rate 56KB;
- Flexible configuration options. RTS or DTR control of transmission direction.
- Full/half duplex operation. Supports hardware handshaking (RTS,CTS)
- Dual drivers/receivers. Handles 64 devices; Compatible with most comm. software.
- High speed version available (supports baud rates up to 256KB ) - \$165

### Dual-Port RS-485/422 [PCL743] \$175

- Two independent channels /UARTs; 2 or 4 wire operation. Max. Baud 56KB.
- Dipswitch configurable as COM1-4 (IRQ2-7). On board terminator resistor.

### IEEE-488 Card [PC488A] \$145

- Includes DOS Device Driver and sample Comu communication program in BASIC.
- Additional sample programs in C, Pascal & Assembly - \$50.
- IRQ (1-6). DMA channel 1 or 2. Up to 4 boards per computer.
- Compatible with most IEEE-488 Software packages for IBM-PC.
- I/O Addresses and Control Registers compatible with NI's GPIB-PCII.
- PC488C card version with Built-In Bus Analyzer hardware and software - \$445 (Allows Real Time 488 Bus Data Capture in background operation mode.)

### Digital I/O & Counter [PCL720] \$175

- 32 Digital Input and 32 Digital Output Channels, 3 channel programmable counter/timer. User configurable clock source. Bread board area.

### 144 Bit Digital I/O [PCL722] \$295

- 144 lines (24 bits x 6 ports) of TTL compatible digital I/O. Output buffers sink 24mA. source 15mA. Interrupt handling capability. Opto-22 module compatible

### Relay & Isolated D/I [PCL725] \$240

- 8 Relay actuator outputs; 8 Opto-isolated digital inputs. Relay driver circuits.
- LED indicators for activated relays. On board signal conditioning.

### 10 Channel Counter [PCL830] \$295

- 10 Independent 16 bit up/down counters. Programmable frequency output.
- 16 bit TTL input and 16 bit TTL output ports. Selectable interrupt channel.

### 6 Channel 12 bit D/A [PCL726] \$495

- Output Ranges: 0 to +5V, 0 to +10V, ±5V, ±10V or sink 4-20mA.
- Settling time: 70µs. Linearity: ±1/2bit. Voltage output driving capacity: ±5mA
- Digital I/O: 16 Input / 16 Output channels; All I/Os TTL compatible.

### 12 Bit A/D & D/A [PCL711s] \$295

- A/D converter: 8 single-ended channels; Device: AD574; Conversion time less than 25µsec; Input range: ±5V; Software Trigger Mode only.
- D/A converter: 1 channel; 12 bit resolution; 0 to +5V/10V Output Range.
- Digital I/O: 16 Input / 16 Output channels; All I/Os TTL compatible.
- External Wiring Terminal Board with mounting accessories included.
- Utility Routines and Demo/Sample Programs for BASIC and QuickBASIC.

### 12 Bit A/D & D/A [PCL812] \$395

- A/D converter: 16 single ended inputs; Device: AD574; Conversion time less than 25 µsec; Built-in programmable pacer; Input ranges: ±10V, ±5V, ±1V.
- D/A converter: 2 channels; 12 bit resolution; Output Range 0-5V.
- Digital I/O: 16 Input / 16 Output channels; All I/Os TTL compatible.
- Counter: 1 channel programmable interval counter/timer; Uses Intel 8254.
- DMA and interrupt capability. Utility software for Basic included.

### 12 Bit w/ Prgm. Gain [PCL812pg] \$450

- A/D converter: 16 single ended inputs; Device: AD574; Conversion time less than 25 µsec; Built-in programmable pacer;
- Software Programmable Multiple Input Ranges: ±10V, ±5V, ±2.5V, ±1.25V, ±0.625V, ±0.3125V.
- D/A converter: 2 channels; 12 bit resolution; Output Range 0-5V.
- Digital I/O: 16 Input / 16 Output channels; All I/Os TTL compatible.
- Counter: 1 channel programmable interval counter/timer; Uses Intel 8254.
- DMA and interrupt capability. Utility software for Basic included.

### Fast 12 Bit A/D/A [PCL718] \$745

- A/D converter: 16 single ended or 8 differential channels; 12 bit resolution; Programmable scan rate; Built-in interrupt and DMA control circuitry; Conversion speed 60,000 samples/sec (standard), 100,000 samples/sec (optional).
- Input ranges: Bipolar ±10V, ±5V, ±2.5V, ±1V, ±0.5V; Unipolar 10.5,2.1V.
- D/A converter: 2 channels; Resolution: 12 bits res; Settling time: 5µsec; ±5V.
- Digital I/O: 16 OUT; 16 IN; TTL compatible; All I/Os TTL compatible.
- Counter: 16 bit prog. interval counter/timer; Uses Intel 8254; Pacer clock;
- Software: Utility software for BASIC and QuickBASIC included. Supported by LabDAS (AS195/495), ASYST, LABTECH, UnkelScope

### Fast 12 Bit w/ Pgm Gain [818] \$845

- A/D converter: 16 single ended or 8 differential channels; 12 bit resolution; Programmable scan rate; Built-in interrupt and DMA control circuitry; Conversion speed 100,000 samples per second.
- Software Programmable Input Ranges: Bipolar ±10V, ±5V, ±2.5V, ±1V, ±0.5V; Unipolar 10.5,2.1V.
- D/A converter: 2 channels; Resolution: 12 bits res; Settling time: 5µsec; ±5V.
- Digital I/O: 16 OUT; 16 IN; TTL compatible; All I/Os TTL compatible.
- Counter: 16 bit prog. interval counter/timer; Uses Intel 8254; Pacer clock;
- Software: Utility software for BASIC and QuickBASIC included. Supported by LabDAS, ASYST, LABTECH, UnkelScope

### Stepper Motor Card [PCL738B] \$395

- Capable of independent and simultaneous control of up to 3 stepper motors.
- Speed: Programmable from 3.3 PPS to 3410 PPS. Built-in acceleration control.
- Output Mode: One clock (Pulse, Direction) or two clock (CW, CCW pulses)
- Step position Read-back; Opto-isolated outputs; Crystal backed timing.
- Includes 8 bit digital input/output port.

MC / VISA / AMEX Call today for datasheets!

Circle 30 on Reader Service Card



B&C MICROSYSTEMS INC.

750 N. PASTORIA AVE., SUNNYVALE, CA 94086 USA  
TEL: (408) 730-5511 FAX: (408) 730-5521 BBS: (408) 730-2317

## ICs PROMPT DELIVERY!!!

SAME DAY SHIPPING (USUALLY)

QUANTITY ONE PRICES SHOWN FOR DEC. 23, 1990

Memory For Almost ALL Computers

### DYNAMIC RAM

4M Board for hp LJ's w/2MB	\$160.00
SIMM 2M IBM PS/2 Model 70	145.00
SIMM 4Mx9 80 ns	295.00
SIMM 1Mx9 80 ns	45.00
4Mbit 4Mx1 80 ns	40.00
4MBzip 1Mx4 80 ns	55.00
1Mbit 1Mx1 80 ns	5.15
41256 256Kx1 100 ns	1.95
41256 256Kx1 120 ns	1.60
44256 256Kx4 100 ns	5.25
4464 64Kx4 100 ns	1.95
41264* 64Kx4 100 ns	5.95
<b>EPROM</b>	
27C1000 128Kx8 200 ns	\$14.00
27C512 64Kx8 120 ns	5.25
27256 32Kx8 150 ns	6.75
27128 16Kx8 250 ns	3.65
<b>STATIC RAM</b>	
62256P-10 32Kx8 100 ns	\$6.95
6264P-12 8Kx8 120 ns	4.25

OPEN 6 DAYS, 7-30 AM-10 PM. SHIP VIA FED-EX ON SAT.

SAT DEL ON FED-EX ORDERS RECEIVED BY: TH: 52 \$25.48 FR: 41 \$170.18 COD AVAILABLE

MasterCard/VISA or UPS CASH COD MICROPROCESSORS UNLIMITED, INC. 24,000 S. Peoria Ave., GEGGS, OK 74421 (918) 267-4961 No minimum order. Please note: prices subject to change! Shipping, insurance extra, up to \$1 for packing materials.

Circle 141 on Reader Service Card

## 486/25MHz 64K Cache Series \$1995



- i486/25MHz CPU w/8K Cache
- 64K External Cache Memory
- Expand 8Mb Memory On-Board
- Burst Mode for Max Throughput
- Baby-Size (8.5 by 13 in)
- AMI 486 BIOS w/Setup
- Intelligent Memory Refresh Scheme

### HOMESMART COMPUTING

800-627-6998

(713) 496-9110/Fax Info Line

14760 Memorial Dr. Houston, TX 77079

Prices Reflect Discount for Cash/MC/VISA All Prices Subject to Change Without Notice

Circle 97 on Reader Service Card

## DEC/TEK Terminal Emulation

### EM4105

- Tektronix 4105/4010/4014
- DEC VT320, VT220, VT102
- 16 color VGA/EGA support
- PostScript, HP Laserjet, plotter high resolution hardcopy
- Pan/Zoom, mouse support
- Extensive network support

### EM320

- DEC VT320, VT220, VT102
- True 132 column display
- Remappable keyboard
- KERMIT, Xmodem file transfer
- DOS hot key (only 170 Kb)
- Extensive network support

### Diversified Computer Systems, Inc.

3775 Iris Avenue, Suite 1B  
Boulder, CO 80301 (303) 447-9251  
FAX 303-447-1406

All Trademarks Acknowledged

Circle 75 on Reader Service Card

# EDITORIAL INDEX BY COMPANY

Index of companies covered in articles, columns, or news stories in this issue  
Each reference is to the first page of the article or section in which the company name appears

Company, Page #	Inquiry #
<b>A</b>	
Access Technologies, 50	1312
Acer America, 260	1230
Active Book, 19	
Adobe Systems, 178	1000
Advanced Micro Devices, 251	
AEG Olympia, 260	1231
Airis Computer, 260	1232
Alias Research, 68	1282
Alps, 223	
Altima Systems, 260	1233
American Research, 260	1234
Amphenol, 251	
Apple Computer, 101, 107, 223, 251, 260, 268	1235
Applied Concepts, 54	1315
Arche Technologies, 190	1225
Arima Computer, 260	1236
ARM, 19	
ArtDex Computers, 260	1237
Arthur D. Little, 268	
Asante Technologies, 50	1311
Ashton-Tate, 19	
AST Research, 260	1238
Astarte Computer Systems, 260	1230
AT&T, 107, 169, 229, 251, 301	
Atari Computer, 107, 260	1240
Austin Computer Systems, 260	1241
Autonomy Computer, 260	1242
Autotime, 48	1308
Axcelis, 62	1276
<b>B</b>	
Banyan Systems, 268	
Bechtel Software, 68	1283
Bi-Link Computer, 260	1243
Bitwise Designs, 260	1244
Boca Research, 46	1301
Bondwell Industrial, 260	1245
Borland International, 211, 293	
Brooks/Cole Publishing, 72	1285
BSI, 260	1246
Bus Computer Systems, 260	1247
Business Resource Software, 62	1277
BusTek, 46	1303
<b>C</b>	
Cache Computers, 260	1248
Cadam, 68	1280
CAF Technology, 260	1249
CalComp, 223	
Cari Computer, 260	1250
Channel Computing, 62	1275
Chaplet Systems U.S.A., 260	1251
Cherry Display Products, 229	
Chicony, 260	1252
<b>D</b>	
DAP Technologies, 260	1264
Data Entry Systems, 260	1265
Data General, 44, 260	1266
	1289
Data Technology, 46	1299
Databook, 46, 251	1302
Datapoint, 119	1227
Dauphin Technology, 44, 260	1267
	1290
Dell Computer, 251, 260	1268
Delta Phase International, 260	1269
DeScribe, 19	
Design Science, 72	1284
Digital Communications Associates, 50	1310
Digital Equipment, 119, 268	
Digital Learning Systems, 73	1155
Digital Research, 19	
Digitalk, 58	1274
Digitech, 260	1270
Dolch Computer Systems, 260	1105
Don Johnston Development Equipment, 48	1307
Dove Computer, 54	1314
Dyad Software, 164	1061
<b>E</b>	
Eastman Kodak, 45	1297
Echelon, 19	
Electro Plasma, 229	
Epson, 229, 251, 260, 293	1106
<b>F</b>	
Fujitsu Microelectronics, 229, 251	
First International Computer of America, 260	1109
FirstMark Technologies, 183	1075
Fora, 260	1110
<b>G</b>	
GammaLink, 301	
GMC Technology, 260	1111
GO, 223	
GoldStar Technology, 260	1112
Greenleaf Software, 164	1062
Grid Systems, 148, 251, 260	1107
<b>H</b>	
HCI, 260	1114
Hewlett-Packard, 251, 268	
Hitachi, 19, 45, 229	
Home Row, 223	
Horstmann Software Design, 72	1286
Houghton Mifflin Software, 73	1150
Hyundai Electronics America, 44, 260	1115
<b>I</b>	
IBM, 19, 95, 107, 127, 143, 211, 229, 239, 260, 268, 285, 293	977
	1116
	1168
ICD, 46	1300
Image Systems, 45	1295
Impulse Systems, 260	1117
Inductel, 73	1156
Infonet Services, 19	
Intel, 119, 251, 293, 301	
Intelligence Technology, 260	1118
Iterated Systems, 19	
ITT Canon, 251	
<b>J</b>	
Jetta Computers, 260	1119
<b>K</b>	
Kaimei Electronics, 260	1120
KFC USA, 260	1121
Kris Technologies, 260	1122
<b>L</b>	
Landcadd, 68	1281
Laser Computer, 260	1123
Leading Edge Products, 260	1124
Leading Technology, 260	1125
LHK Computer Manufacturer, 260	1126
Librex Computer Systems, 260	1127
Logicraft Products Manufacturing, 260	1128
Logitech, 260	1129
Lotus Development, 19, 101, 211, 251	1224
<b>M</b>	
Magnascreen, 229	
Mathsoft, 72	1288
Matsushita, 19, 229, 251	
Maxtron, 260	1130
MCI, 301	
Mega PC Technology, 260	1131
Micro Logic, 73	1154
Micro Palm Computers, 260	1132
Microelectronics and Computer Technology, 203	
Microlytics, 73	1161
MicroMath Scientific Software, 73	1157
Micron Technology, 229, 251	
MicroSlate, 260	1133
Microsoft, 19, 95, 136, 251, 268, 293	976
MIPS, 251	
Mitsuba, 260	1134
Mitsubishi Electronics America, 251, 260	1135
Modern Computer, 260	1136
Modgraph, 260	1137
Momenta, 223	
Monterey Electronics, 260	1138
Morse Technology, 260	1139
Motorola, 19, 285	
Myoda, 260	1140
<b>N</b>	
Nan Tan Computer, 260	1141
National Semiconductor, 251	
NCR, 223	
NEC, 229, 251	
NEC Technologies, 148, 260, 293	1108
	1142
New Media Graphics, 46	1298
New Video, 19	
Next, 19	
Nippon Telephone and Telegraph, 301	
Northgate, 260	1143
NovaComp Engineering, 72	1287
Novell, 19, 95, 268	
<b>O</b>	
Ogivar Technologies, 148, 260	1109
OKI Electronics, 251	1144



Opus Systems, 260 **1145**  
 Oscartech, 260 **1001**  
 Out of Your Mind . . . and Into  
 the Marketplace, 62 **1279**  
 Outbound Systems, 260 **1002**  
 Ovonic Imaging Systems, 229

**P**  
 Panasonic Communications &  
 Systems, 260 **1003**  
 Penncomp, 73 **1160**  
 Peter Norton Computing, 251  
 Photonics Technology, 229  
 Planar Systems, 19, 229  
 Plasmaco, 229  
 Poqet Computer, 19, 73, 223,  
 251, 260 **1004**  
**1159**  
 Practical Peripherals, 54 **1313**  
 Premier Innovations, 260 **1005**  
 Prince Information Systems,  
 260 **1006**  
 Psion, 148, 223, 260 **1007**  
**1110**

**Q**  
 Quadram, 301  
 Quarterdeck Office Systems,  
 73, 293 **1151**

**R**  
 Radius, 19  
 RasterOps, 176 **1221**  
 Reference Software, 89 **1222**  
 Rioch, 301  
 Rogue Wave, 164 **1063**

**S**  
 S&S International, 73 **1152**  
 Saber Software, 58 **1271**  
 Sampo, 260 **1008**  
 Samsung Information Systems  
 America, 260 **1009**  
 Sanyo Business Systems,  
 148, 260 **1010**  
**1111**  
 Scandinavian PC Systems, 89 **1223**  
 Scantech Computer Systems,  
 260 **1011**  
 Scenario, 223  
 Seiko, 229  
 Sharp Electronics, 148, 229,  
 251, 260 **1012**  
**1112**  
 Sony, 119  
 Square D, 48 **1305**

Stac Electronics, 127 **1170**  
 Stanford Research Institute,  
 229  
 Sun Microsystems, 169, 268 **1228**  
 Superscript, 223

**T**  
 Tall Tree Systems, 127 **1165**  
 Tandon, 260 **1013**  
 Tandy, 148, 260 **1014**  
**1113**  
 Tasco, 48 **1304**  
 Tatung Company of America,  
 260 **1015**  
 Taxan, 45 **1294**  
 Telenet, 301  
 Texas Instruments, 73, 148,  
 223, 251, 260 **1016**  
**1114**  
**1162**  
 The Iliad Group, 186 **1229**  
 Top-Link Computer, 260 **1017**  
 TOPPCs International, 260 **1018**  
 Toshiba America Information  
 Systems, 148, 229, 260 **1019**  
**1115**  
**1020**  
 Trans PC Systems, 260  
 Traveling Software, 251  
 TriGem, 260 **1021**  
 Twinhead, 260 **1022**

**U**  
 Ungermann-Bass, 268  
 Uniq Technology, 260 **1023**  
 Upsonic, 54 **1317**  
 USIT, 260 **1024**

**V**  
 Veridata Electronics, 260 **1025**  
 Vertical Software, 73 **1163**  
 VSI Telecommunications, 54 **1316**

**W**  
 Wallsoft Systems, 58 **1272**  
 Wolfram Research, 127 **1167**  
 WordPerfect, 19, 251

**X**  
 Xerox, 119

**Z**  
 Zenith Data Systems, 73, 148,  
 229, 260 **1026**  
**1116**  
**1158**  
 Zeos International, 148, 260 **1027**  
**1117**  
 Zinc, 164 **1064**

**Cross-Assemblers** from \$50.00  
**Simulators** from \$100.00  
**Cross-Disassemblers** from \$100.00  
**Developer Packages**  
 from \$200.00(a \$50.00 Savings)

**Make Programming Easy**  
 Our Macro Cross-assemblers are easy to use. With powerful conditional assembly and unlimited include files.

**Get It Debugged--FAST**  
 Don't wait until the hardware is finished. Debug your software with our Simulators.

**Recover Lost Source!**  
 Our line of disassemblers can help you re-create the original assembly language source.

**Thousands Of Satisfied Customers Worldwide**

PseudoCorp has been providing quality solutions for microprocessor problems since 1985.

**Processors**

Intel 8048	RCA 1802,05	Intel 8051	Intel 8096,196kc
Motorola 6800	Motorola 6801	Motorola 68HC11	Motorola 6805
Hitachi 6301	Motorola 6809	MOS Tech 6502	WDC 65C02
Rockwell 65C02	Intel 8080,85	Zilog Z80	NSC 800
Hitachi HD64180	Mot. 68k,8,10	Zilog Z8	Zilog Super 8

• All products require an IBM PC or compatible.

For Information Or To Order Call:  
**PseudoCorp**  
 716 Thimble Shoals Blvd, Suite E  
 Newport News, VA 23606  
 (804) 873-1947 FAX:(804)873-2154

Circle 287 on Reader Service Card

**Don't Move**  
 without telling  
**BYTE**

CLIP OUT  
 FORM BELOW  
 AND MAIL  
 TO:

BYTE Magazine  
 P.O. Box 555  
 Hightstown, NJ 08520

At least 8 weeks before you move please give us your  
 NEW ADDRESS: NAME CHANGE.

Name \_\_\_\_\_ Apt. \_\_\_\_\_  
 Address \_\_\_\_\_ Zip \_\_\_\_\_  
 City/State \_\_\_\_\_

Print CURRENT ADDRESS  
 (or affix the mailing label from your current BYTE Magazine here)

CURRENT ADDRESS: NAME \_\_\_\_\_  
 Name \_\_\_\_\_ Apt. \_\_\_\_\_  
 Address \_\_\_\_\_ Zip \_\_\_\_\_  
 City/State \_\_\_\_\_

# READER SERVICE

To get further information on the products advertised in BYTE, fill out the reader service card by circling the numbers on the card that correspond to the inquiry number listed with the advertiser. This index is provided as an additional service by the publisher, who assumes no liability for errors or omissions.

## Alphabetical Index to Advertisers

Inquiry No.	Page No.	Inquiry No.	Page No.	Inquiry No.	Page No.	Inquiry No.	Page No.
8	ABACUS	85		283	VIZIFLEX SEELS, INC.	331	
9	ABACUS	85		284	VLEEMUIS SOFTWARE FRESH	109	
10	ADD ON AMERICA	329		265	VOGON ENTERPRISES LTD	336	
15	ADVANCED MICRO DEVICES	161			* WATCOM PRODUCTS, INC.	155	
11	ALPHA PRODUCTS	333		266	WHITEWATER GROUP	175	
12	ALR	2,3		267	WIESEMANN & THEIS GMBH	339	
13	ALR	2,3		268	WINTEK	340	
14	ALTEC TECHNOLOGY CORP.	100		269	WINTEK	340	
16	AMERICAN ADVANTECH	336		270	XEC PRODUCTS	180	
16	AMERICAN ADVANTECH	336		271	XEC PRODUCTS	180	
16	AMERICAN ADVANTECH	336		272	XELTEK	339	
17	AMERICAN SMALL BUSINESS	129		273	XELTEK	339	
18	AMS	338		274	XELTEK	339	
19	AMT, INT'L	342		275	ZENITH DATA SYSTEMS	209	
20	ANNABOOKS	208		278	ZEOS INTERNATIONAL	168A-H	
21	ANNABOOKS	320		277	ZERICON	320	
22	ANNABOOKS	320		278	ZORTECH, INC.	93	
23	ARC TANGENT, INC.	340		279	Z-WORLD	345	
24	ARTISOFT	105		280	Z-WORLD	345	
25	ASHTON-TATE	7					
26	ASHTON-TATE	7					
28	B & C MICROSYSTEMS	343					
29	B & C MICROSYSTEMS	345					
30	B & C MICROSYSTEMS	345					
31	BEST POWER TECHNOLOGY	320					
	* BINARY TECHNOLOGY, INC.	343					
450	BIX	146, 147					
	* BIX	230					
	* BIX	258					
	* BIX	259					
32	BLACK & WHITE INT'L	188					
33	BLACKSHIP COMPUTER SYS., INC.	298					
34	BLAISE COMPUTING	8					
35	BLAST/COMM. RESEARCH	180					
38	BLAST/COMM. RESEARCH	180					
37	BORLAND INTERNATIONAL	11					
38	BORLAND INTERNATIONAL	11					
282	BP MICROSYSTEMS	335					
39	BUREAU OF ELECTRONIC PBLH	104					
40	BUREAU OF ELECTRONIC PBLH	104					
	* BUYERS MART	321-329					
	* BYTE BACK ISSUES	305, 315					
	* BYTE BOOK CLUB	287					
	* BYTE BOOK CLUB	297A-B					
	* BYTE CARD DECK	308					
42	BYTE PUBLICATIONS/DEMOLINK	283					
	* BYTE SUB MESSAGE	248, 330					
	* BYTEWEEK/NEWSLETTER	283					
43	B&B ELECTRONICS	335					
44	CAD SOFTWARE	320					
45	CAPITAL EQUIPMENT CORP.	86					
46	CAPITAL EQUIPMENT CORP.	87					
	* CCM/IMCGRAW-HILL	295					
47	CDA COMPUTER SALES	103					
48	CIC DISTRIBUTORS	110					
49	CIC DISTRIBUTORS	110					
	* CLEO COMMUNICATIONS	111					
50	CLUB AMERICAN TECHNOLOGY	247					
	* CNS, INC. (ZORTECH)	41					
	* COMPAQ COMPUTER CORP.	12, 13					
52	COMPUADD	68, 89					
53	COMPUADD	70, 71					
54	COMPUADD	331					
55	COMPUTER MODULES, INC.	343					
58	COMPUTERLANE	338					
57	CONTROL VISION	340					
	* COPIA INTERNATIONAL LTD.	110					
58	COREL SYSTEMS	37					
59	COREL SYSTEMS	37					
80	COVOX, INC.	330					
61	COVOX, INC.	330					
62	CSS LABS	208, 207					
63	CSS LABS	208, 207					
64	CURTIS, INC.	340					
	* CURTIS MANUFACTURING CO.	215					
65	DATA STRATEGIES INT'L	340					
88	DATALUX CORPORATION	102					
87	DATALUX CORPORATION	102					
89	DELL COMPUTER CORP.	CH, 1					
70	DIGITAL RESEARCH	235					
73	DISTRIBUTED PROCESSING TECH	273					
74	DISTRIBUTED PROCESSING TECH	273					
75	DIVERSIFIED COMPUTER SYS.	345					
76	DOLCH COMPUTER SYSTEMS	51					
77	DSP DEVELOPMENT	276					
78	ELEX INTERNATIONAL	237					
79	ELEXOR, INC.	329					
	* EPSON	22, 23					
281	EVENT HORIZONS	184					
80	EVERE X SYSTEMS	52, 53					
81	FAIRCOM CORP.	108					
82	FALCO DATA PRODUCTS	182					
83	FIRST SOURCE INTERNATIONAL	341					
84	FIRST SOURCE INTERNATIONAL	341					
85	FLAGSTAFF ENGINEERING	250					
88	FLYTECH TECHNOLOGY	145					
	* GALACTICOMM, INC.	345					
	* GATEWAY 2000	32A-D					
87	GCOM, INC.	335					
88	GENERIC SOFTWARE, INC.	87					
89	GENCO ENGINEERING	179					
90	GLOCKENSPIEL	187					
283	GRAPHIC SOFTWARE SYS., INC.	90					
284	GRAPHIC SOFTWARE SYS., INC.	90					
92	GREENVIEW	78					
93	GTEK, INC.	264					
94	GTEK, INC.	264					
95	HAUPPAUGE COMPUTER WRKS, INC.	222					
	* HEWLETT-PACKARD PERIP.	80, 81					
	* HEWLETT-PACKARD PERIP.	134, 135					
98	HIGH RES TECHNOLOGIES	329					
97	HOME SMART COMPUTING	345					
98	HOOLEON CORPORATION	335					
99	IBM-DISPLAY	15					
100	IYAMA ELECTRIC	55					
101	IME COMPUTERS	318					
102	IME COMPUTERS	318					
103	INTEGRAND RESEARCH CORP.	177					
106	INTEL CORP.	25-27					
107	INTEL CORP.	25-27					
108	INTEL CORP.	320					
110	IN-FOCUS SYSTEMS	185					
111	IO TECH	335					
112	IRWIN MAGNETIC SYSTEMS	99					
113	I.C. EXPRESS	335					
114	JAMECO	42, 43					
	6 JDR MICRODEVICES	353-355					
	7 JDR MICRODEVICES	353-355					
116	JEMINI ELECTRONICS	339					
117	KEA SYSTEMS, LTD.	80					
118	KILA SYSTEMS	335					
119	KNOWLEDGE GARDEN	291					
120	LAGUNA CONVERSION SYSTEMS	338					
121	LAHEY	188					
222	LANDMARK/SUPERSOFT	300					
	* LIBRARY OF COMP. AND INFO.	248, 249					
	* LIBRARY OF COMP. AND INFO.	248A-B					
299	LIBREX	146, 147					
300	LIBREX	146, 147					
122	LINK COMPUTER GRAPHICS	329					
123	LINK COMPUTER GRAPHICS	329					
124	LOGICAL DEVICES	343					
125	LOGICAL DEVICES	343					
128	LOGICAL DEVICES	343					
127	LOGICAL DEVICES	343					
128	LOGITECH	189					
129	LOGITECH	189					
130	LOTUS	49					
131	MAGEE ENTERPRISES	168					
132	MAGEE ENTERPRISES	168					
133	MAP INFO	185					
	* MARK WILLIAMS CO.	75					
134	MARYMAC INDUSTRIES	343					
135	MATHSOFT, INC.	227					
138	MEGASOFT, INC.	343					
138	MEGATEL COMPUTER CORP.	92					
139	MERRIMACK VALLEY SYSTEMS	335					
	* MICROCOMPUTER MKTG. CNCL.	299					
140	MICRO SOLUTIONS COMP/PROD.	92					
141	MICROPROCESSORS UNLTD.	345					
	* MICROSOFT	8, 9					
	* MICROSOFT	21					
	* MICROSOFT	29					
	* MICROSOFT	133					
	* MICROWAY	158					
	* MICROWAY	284					
	* MICROWAY	292					
142	MIX SOFTWARE	317					
143	MKS	187					
144	NANAO	163					
145	NANAO	183					
148	NANTUCKET	202					
147	NATIONAL INSTRUMENTS	320					
148	NATIONAL INSTRUMENTS	CHI					
149	NEC HOME ELECTRONICS	38, 39					
150	NEVADA COMPUTER	334					
151	NO NOISE CORP.	138					
152	NO NOISE CORP.	138					
153	NOHAW CORP.	307					
154	NORTHGATE COMPUTER	194, 195					
155	NORTHGATE COMPUTER	198, 197					
158	NORTHGATE COMPUTER	198					
	* NORTHGATE COMPUTER	199					
157	NOVA, INC.	98					
	* NRI/MCGRAW-HILL	312A-B					
158	NU-MEGA TECHNOLOGIES	78					
159	OAKLAND GROUP, INC.	228					
180	OPENNETWORK	192					
181	OVERLAND DATA	330					
	* PACIFIC DATA PRODUCTS	128					
185	PANASONIC DOT MATRIX PTR.	81-83					
186	PARASYSTEMS	79					
187	PATTON & PATTON	329					
168	PC COMPUTER RENTAL	339					
	* PC CONNECTION	112-117					
189	PC POWER & COOLING	193					
170	PC POWER & COOLING	193					
171	PERCEPTIVE SOLUTIONS, INC.	118					
172	PERCEPT						

# READER SERVICE

\* Correspond directly with company.

Inquiry No.	Page No.	Inquiry No.	Page No.	Inquiry No.	Page No.	Inquiry No.	Page No.
<b>INT'L DIRECT RESPONSE POSTCARDS</b>		566 ONYX INTERNATIONAL . . . . .	MW-18	598 PLAMAR COMPUTER SYS . . . . .	NE-8,7	828 TRANS PC SYSTEM . . . . .	PC-11
• ARNET . . . . .	IS	569 PLAMAR COMPUTER SYS . . . . .	MW-4,5	597 SAINT CROIX CORP . . . . .	NE-23	827 TRANS PC SYSTEM . . . . .	PC-11
• BIOSOFT . . . . .	IS	570 PLAMAR COMPUTER SYS . . . . .	MW-4,5	598 SAINT CROIX CORP . . . . .	NE-23		
• BYTEWEEK . . . . .	IS	571 SAINT CROIX CORP . . . . .	MW-15	599 TRANS PC SYSTEM . . . . .	NE-13		
• COMPUTER SOLUTIONS . . . . .	IS	572 SAINT CROIX CORP . . . . .	MW-15	600 TRANS PC SYSTEM . . . . .	NE-13		
• GATEWAY 2000 . . . . .	IS	573 TRANS PC SYSTEM . . . . .	MW-1	601 UNITED INNOVATIONS . . . . .	NE-17		
• JOURNAL OF OBJECT ORIENT PROG . . . . .	IS	574 TRANS PC SYSTEM . . . . .	MW-1	602 VICTORY ENTERPRISES . . . . .	NE-26		
• MASHOV . . . . .	IS						
• REASONABLE SOLUTIONS . . . . .	IS						
• TOUCHBASE SYSTEMS . . . . .	IS						
<b>REGIONAL SECTIONS</b>							
<b>Midwest</b>	72 MW1-20	<b>Northeast</b>	72 NE1-28	<b>Pacific Coast</b>	72 PC1-24	<b>South</b>	72 SO1-24
555 CAD WAREHOUSE . . . . .	MW-16	577 AITECH . . . . .	NE-24	605 ADTECH . . . . .	PC-13	629 ARIEL DESIGN, INC . . . . .	SO-1
558 CAD WAREHOUSE . . . . .	MW-18	578 AITECH . . . . .	NE-24	606 ADTECH . . . . .	PC-13	630 BI-LINK . . . . .	SO-20
551 CETDC . . . . .	MW-11	603 ARIEL DESIGN, INC . . . . .	NE-3	607 AITECH . . . . .	PC-16	• BIX . . . . .	SO-16
552 DATAWARE PRODUCTS, INC. . . . .	MW-19	• BYTE CARD DECK . . . . .	NE-20	808 AITECH . . . . .	PC-16	838 CAD WAREHOUSE . . . . .	SO-18
553 DERBYTECH COMPUTERS, INC. . . . .	MW-20	583 CAD WAREHOUSE . . . . .	NE-22	• BIX . . . . .	PC-22	837 CAD WAREHOUSE . . . . .	SO-18
554 DERBYTECH COMPUTERS, INC. . . . .	MW-20	584 CAD WAREHOUSE . . . . .	NE-22	• BYTE CARD DECK . . . . .	PC-20	631 CETDC . . . . .	SO-7
557 H.CO CDMPUTER PRODUCTS . . . . .	MW-13	579 CETDC . . . . .	NE-18	615 CAD WAREHOUSE . . . . .	PC-18	632 CHAUMONT & ASSOCIATES . . . . .	SO-14
558 H.CO COMPUTER PRODUCTS . . . . .	MW-13	• COMPUTER SALES PROF. . . . .	NE-5	616 CAD WAREHOUSE . . . . .	PC-18	633 DATAWARE PRODUCTS, INC. . . . .	SO-23
559 KANDU/COMPUTER SQ., INC. . . . .	MW-17	• COMPUTER SALES PROF. . . . .	NE-9	609 CETDC . . . . .	PC-15	634 DERBYTECH COMPUTERS, INC. . . . .	SO-24
560 KANDU/COMPUTER SQ., INC. . . . .	MW-17	560 DATAWARE PRODUCTS, INC. . . . .	NE-16	610 CM VENTURES . . . . .	PC-1	635 DERBYTECH COMPUTERS, INC. . . . .	SO-24
561 MICON COMPUTERS . . . . .	MW-3	581 DERBYTECH COMPUTERS, INC. . . . .	NE-28	611 CM VENTURES . . . . .	PC-1	638 FD MICROSYSTEMS . . . . .	SO-11
562 MICROCOM COMPUTERS . . . . .	MW-9	582 DERBYTECH COMPUTERS, INC. . . . .	NE-28	612 DATAWARE PRODUCTS, INC. . . . .	PC-21	639 FD MICROSYSTEMS . . . . .	SO-11
583 MYODA, INC . . . . .	MW-7	585 EVOLUTION COMPUTING . . . . .	NE-19	813 DERBYTECH COMPUTERS, INC. . . . .	PC-24	640 FIRST COMPUTER SYS., INC. . . . .	SO-19
584 MYODA, INC . . . . .	MW-7	586 FD MICROSYSTEMS . . . . .	NE-27	814 DERBYTECH COMPUTERS, INC. . . . .	PC-24	842 H.CO COMPUTER PRODUCTS . . . . .	SO-17
585 NCGA/NAT'L COMP. GRAPHICS . . . . .	MW-14	587 FD MICROSYSTEMS . . . . .	NE-27	828 EVOLUTION COMPUTING . . . . .	PC-23	843 H.CO COMPUTER PRODUCTS . . . . .	SO-17
566 NCGA/NAT'L COMP. GRAPHICS . . . . .	MW-14	588 GLASGAL COMMUNICATIONS . . . . .	NE-11	818 H.CO COMPUTER PRODUCTS . . . . .	PC-17	844 INTELEC CORPORATION . . . . .	SO-15
567 ONYX INTERNATIONAL . . . . .	MW-18	589 H.CO COMPUTER PRODUCTS . . . . .	NE-25	819 H.CO COMPUTER PRODUCTS . . . . .	PC-17	845 INTELEC CORPORATION . . . . .	SO-15
		590 H.CO COMPUTER PRODUCTS . . . . .	NE-25	819 METAWARE . . . . .	PC-7	648 MICROCOM COMPUTERS . . . . .	SO-5
		591 MANCHESTER EQUIPMENT . . . . .	NE-1	820 MICROCOM COMPUTERS . . . . .	PC-19	647 MYODA, INC . . . . .	SO-3
		• MANCHESTER EQUIPMENT . . . . .	NE-72A-B	621 MYODA, INC . . . . .	PC-9	848 MYODA, INC . . . . .	SO-3
		592 MICROCOM COMPUTERS . . . . .	NE-15	622 MYODA, INC . . . . .	PC-9	649 ONYX INTERNATIONAL . . . . .	SO-21
		593 MYODA, INC . . . . .	NE-21	623 TANGENT COMPUTERS . . . . .	PC-3	650 ONYX INTERNATIONAL . . . . .	SO-21
		594 MYODA, INC . . . . .	NE-21	824 THE PRINTER WORKS . . . . .	PC-4,5	651 RENTEC . . . . .	SO-22
		595 PLAMAR COMPUTER SYS . . . . .	NE-6,7	825 THE PRINTER WORKS . . . . .	PC-4,5	652 TRANS PC SYSTEM . . . . .	SO-13
						653 TRANS PC SYSTEM . . . . .	SO-13
						854 VERIDATA RESEARCH INC . . . . .	SO-9
						855 VERIDATA RESEARCH INC . . . . .	SO-9

## BYTE ADVERTISING SALES STAFF:

Steven M. Vito, Associate Publisher/V.P. of Marketing, One Phoenix Mill Lane, Peterborough, NH 03458, tel. (603) 924-9281  
 Arthur Kossack, Eastern Advertising Director, Two Prudential Plaza, 180 North Stetson Ave., Chicago, IL 60601, tel. (312) 616-3341  
 Jennifer L. Bartel, Western Advertising Director, 14850 Quorum Drive, Suite 380, Dallas, TX 75240, tel. (214) 701-8496  
 Liz Coyman, Inside Advertising Sales Director, One Phoenix Mill Lane, Peterborough, NH 03458, tel. (603) 924-2518

**NEW ENGLAND**  
 ME, NH, VT, MA, RI, CT, ONTARIO  
 CANADA & EASTERN CANADA  
 Dan Savage (617) 860-6344  
 Scott Gagnon (603) 924-2651  
 McGraw-Hill Publications  
 29 Hartwell Avenue  
 Lexington, MA 02173  
 FAX: (617) 860-6999

**EAST COAST**  
 NY, NYC, NJ, DE, PA  
 Kim Norris (212) 512-2645  
 Ariane Casey (212) 512-2368  
 Patricia Payne (603) 924-2654  
 McGraw-Hill Publications  
 1221 Avenue of the Americas—  
 28th Floor  
 New York, NY 10020  
 FAX: (212) 512-2075

**SOUTHEAST**  
 NC, SC, GA, FL, AL, TN, VA,  
 MS, AR, LA, DC, MD, WV, KY  
 John Y. Schilin (404) 843-4782  
 Patricia Payne (603) 924-2654  
 McGraw-Hill Publications  
 4170 Ashford-Dunwoody Road  
 Suite 520  
 Atlanta, GA 30319  
 FAX: (404) 252-4056

**MIDWEST**  
 IL, MO, KS, IA, ND, SD, MN,  
 WI, NE, IN, MI, OH  
 Kurt Kelley (312) 616-3328  
 MaryAnn Goulding (603) 924-2664  
 McGraw-Hill Publications  
 Two Prudential Plaza  
 180 North Stetson Ave.  
 Chicago, IL 60601  
 FAX: (312) 616-3370

**SOUTHWEST,  
 ROCKY MOUNTAIN**  
 CO, OK, TX,  
 Alison Keenan (214) 701-8496  
 Patricia Payne (603) 924-2654  
 McGraw-Hill Publications  
 14850 Quorum Drive  
 Suite 380  
 Dallas, TX 75240  
 FAX: (214) 991-6208

**NORTH PACIFIC:** San Francisco, CA  
**NORTHERN CA, OR, ID, MT,  
 WY, NORTHERN NV**  
 Roy J. Kops (415) 954-9728  
 McGraw-Hill Publications  
 425 Battery Street  
 San Francisco, CA 94111  
 FAX: (415) 954-9786

**NORTH PACIFIC:** Campbell, CA  
 SILICON VALLEY, HI, WA, AK,  
 W. CANADA  
 Bill McAfee (408) 879-0381  
 Leslie Hupp (408) 879-0381  
 McGraw-Hill Publications  
 1999 South Bascom Ave.  
 Suite #210  
 Campbell, CA 95008  
 FAX: (408) 879-9067

**SOUTH PACIFIC:** Los Angeles, CA  
 LOS ANGELES COUNTY, AZ,  
 NM, SOUTHERN NEVADA  
 Alan El Faye (213) 480-5243  
 Jonathan Sawyer (603) 924-2665  
 McGraw-Hill Publications  
 3333 Wilshire Boulevard #407  
 Los Angeles, CA 90010  
 FAX: (213) 480-5249

**SOUTH PACIFIC:** Costa Mesa, CA  
 ORANGE COUNTY,  
 SAN DIEGO COUNTY, UT  
 Ron Cordek (714) 753-8140  
 Jonathan Sawyer (603) 924-2665  
 McGraw-Hill Publications  
 15635 Alton Parkway  
 Suite 290  
 Irvine, CA 92718  
 FAX: (714) 753-8145

**BYTE BITS (2x3)**  
 Mark Stone (603) 924-6830  
 BYTE Publications  
 One Phoenix Mill Lane  
 Peterborough, NH 03458

**The Buyer's Mart (1x2)**  
 Brian Higgins (603) 924-3754  
 BYTE Publications  
 One Phoenix Mill Lane  
 Peterborough, NH 03458

**Regional Advertising**  
 James Bail (603) 924-2533  
 Barry Echavarría (603) 924-2574  
 Larry Levine (603) 924-2637  
 BYTE Publications  
 One Phoenix Mill Lane  
 Peterborough, NH 03458

**BYTE Deck**  
 Ed Ware (603) 924-2596  
 BYTE Publications  
 One Phoenix Mill Lane  
 Peterborough, NH 03458

**Catalog Showcase**  
 BYTE International Direct  
 Response Postcards  
 Ellen Perham (603) 924-2598  
 BYTE Publications  
 One Phoenix Mill Lane  
 Peterborough, NH 03458

**Peterborough, NH Office**  
 Inside Sales FAX: 603-924-2683  
 Advertising FAX: 603-924-7507

## International Advertising Sales Staff:

Uwe Kretzschmar, European Advertising and Marketing Manager, BYTE Publications,  
 McGraw-Hill Publishing Co., Wimbledon Bridge House, One Hartfield Road, Wimbledon, London, SW19 3RU, England, Tel: 44 81 543 1234, Fax: 44 81 540 3833

**GERMANY, SWITZERLAND,  
 AUSTRIA**  
 Uwe Kretzschmar (44-81-545-6268)  
**UNITED KINGDOM**  
 Roz Weyman (44-81-545-6269)  
 McGraw-Hill Publishing Co.  
 Wimbledon Bridge House  
 One Hartfield Road  
 Wimbledon, London SW 19 3RU  
 England  
 Tel: 44 81 543 1234  
 FAX: 44 81 5403833  
 TELEX: 892191

**BENELUX**  
 Ellen Pardeed  
 Batenburg 103  
 3437 AB Nieuwegein  
 The Netherlands  
 Tel: 31 34 02 49496  
 FAX: 31 34 02 37944

**FRANCE, ITALY**  
 Zena Coupé, Amanda Blaskett  
 A-Z International Sales Ltd.  
 4 Ashmount Road, Horsney Lane  
 Highgate, London N19 3BH  
 England  
 Tel: 44 71 281 4116  
 FAX: 44 71 281 8224

**ISRAEL**  
 Dan Ehrlich  
 Ehrlich Communication International  
 P.O. Box 11297  
 Tel Aviv 61112  
 Israel  
 Tel: (972) 3 449823  
 FAX: (972) 3 5468168

**JAPAN**  
 Masaki Mori  
 McGraw-Hill Publishing Co.  
 Overseas Corp.  
 Room 1528  
 Kasumigaseki Bldg.  
 3-2-5 Kasumigaseki,  
 Chiyoda-Ku  
 Tokyo 100, Japan  
 Tel: 81 3 581 9811  
 FAX: 81 3 581 4018

**SWEDEN**  
 Media Marketing AB  
 Karlbergsvagen 89A  
 S-10031 Stockholm  
 Sweden  
 Tel: 46 8 301280

**HONG KONG**  
 Stephen Marcopoto  
 Seavex Ltd.  
 503 Wilson Road  
 19-27 Wyndham St.  
 Central, Hong Kong  
 Tel: 852-868-2010  
 Telex: 60904 SEVEX HX  
 FAX: 852 810 1283

**SINGAPORE**  
 Jocelyn Domingo  
 Seavex Ltd.  
 400 Orchard Road, #10-01  
 Singapore 0923  
 Republic of Singapore  
 Tel: 65 734 9790  
 Telex: RS35539 SEAVEX  
 FAX: 65 732 5129

**TAIWAN**  
 Summer Chien  
 Tina Lai  
 Acer TWP Corp.  
 2 Fir., No. 19-1, Lane 231  
 Fu-Hsin North Road  
 Taipei, Taiwan ROC  
 Tel: 886-2-713 6959  
 Fax: 886-2-715 1950

# READER SERVICE

To get further information on the products advertised in BYTE, fill out the reader service card by circling the numbers on the card that correspond to the inquiry number listed with the advertiser. This index is provided as an additional service by the publisher, who assumes no liability for errors or omissions.

\* Correspond directly with company.

## Index to Advertisers by Product Category

Inquiry No.	Page No.	Inquiry No.	Page No.	Inquiry No.	Page No.	Inquiry No.	Page No.
<b>HARDWARE</b>							
<b>926</b>	<b>ADD INS</b>	<b>930</b>	<b>KEYBOARDS/MICE</b>	<b>936</b>	<b>PRINTERS/PLOTTERS</b>	<b>938</b>	<b>SCANNERS/IMAGE PROCESSORS</b>
402	404 TECHNOLOGIES, INC. IS-64	66	DATALUX CORPORATION 102	* HEWLETT-PACKARD PERIP 60,61	* HEWLETT-PACKARD PERIP 134,135	428	LOGITECH 189
15	ADVANCED MICRO DEVICES 161	67	DATALUX CORPORATION 102	446	MINOLTA GMBH IS-11	129	LOGITECH 189
11	ALPHA PRODUCTS 333	117	KEA SYSTEMS, LTD. 80	193	ROLAND DIGITAL GROUP 91	<b>939</b>	<b>SOFTWARE SECURITY</b>
16	AMERICAN ADVANTECH 336	* MICROSOFT 8,9		194	ROLAND DIGITAL GROUP 91	406	ALADDIN KNOWLEDGE SYS. IS-67
16	AMERICAN ADVANTECH 336	156	NORTHGATE COMPUTER 198	462	SURAH IS-78	430	FAST ELECTRONICS GMBH IS-57
16	AMERICAN ADVANTECH 336	* NORTHGATE COMPUTER 199		624	THE PRINTER WORKS PC-4,5	89	GLENCO ENGINEERING 179
29	B & C MICROSYSTEMS 345	173	PERCON 331	625	THE PRINTER WORKS PC-4,5	184	PROTECH MARKETING 131
30	B & C MICROSYSTEMS 345	<b>931</b>	<b>MASS STORAGE</b>	601	UNITED INNOVATIONS NE-17	212	SOFTWARE SECURITY, INC. 238
45	CAPITAL EQUIPMENT CORP 86	65	DATA STRATEGIES INT'L 340	<b>937</b>	<b>PRINTER RIBBONS/SUPPLIES</b>	<b>940</b>	<b>SYSTEMS</b>
46	CAPITAL EQUIPMENT CORP 87	85	FLAGSTAFF ENGINEERING 250	437	IQ ENGINEERING IS-25	605	ADTECH PC-13
55	COMPUTER MODULES, INC. 343	431	FLAGSTAFF ENGINEERING IS-48	438	IQ ENGINEERING IS-25	606	ADTECH PC-13
57	CONTROL VISION 340	112	IRWIN MAGNETIC SYSTEMS 99	* PACIFIC DATA PRODUCTS 126		12	ALR 2,3
64	CURTIS, INC. 340	120	LAGUNA CONVERSION SYS. 336	<b>938</b>	<b>SCANNERS/IMAGE PROCESSORS</b>	12	ALR 2,3
425	DIGIMETRIE IS-46	140	MICRO SOLUTIONS'S COMP. PROD 92	128	LOGITECH 189	12	ALR 2,3
73	DISTRIBUTED PROCESSING TECH 273	161	OVERLAND DATA 330	129	LOGITECH 189	12	ALR 2,3
74	DISTRIBUTED PROCESSING TECH 273	171	PERCEPTIVE SOLUTIONS, INC. 118	<b>939</b>	<b>SOFTWARE SECURITY</b>	12	ALR 2,3
433	GFK HAMBURG IS-38	172	PERCEPTIVE SOLUTIONS, INC. 118	406	ALADDIN KNOWLEDGE SYS. IS-67	12	ALR 2,3
263	GRAPHIC SOFTWARE SYS., INC. 90	176	PINNACLE MICRO 97	430	FAST ELECTRONICS GMBH IS-57	12	ALR 2,3
284	GRAPHIC SOFTWARE SYS., INC. 90	177	PINNACLE MICRO 97	89	GLENCO ENGINEERING 179	12	ALR 2,3
95	HAUPPAUGE COMPUTER WRKS, INC. 222	178	PROCOMP USA, INC. 336	184	PROTECH MARKETING 131	12	ALR 2,3
96	HIGH RES TECHNOLOGIES 329	186	QUALSTAR 336	212	SOFTWARE SECURITY, INC. 238	12	ALR 2,3
97	HOME SMART COMPUTING 345	463	TEAC IS-2	<b>940</b>	<b>SYSTEMS</b>	12	ALR 2,3
106	INTEL CORP 25,27	255	TULIN CORPORATION 339	605	ADTECH PC-13	12	ALR 2,3
107	INTEL CORP 25,27	<b>932</b>	<b>MISCELLANEOUS</b>	606	ADTECH PC-13	12	ALR 2,3
111	IO TECH 335	577	AITECH NE-24	12	ALR 2,3	12	ALR 2,3
439	JB DESIGN IS-18	578	AITECH NE-24	12	ALR 2,3	12	ALR 2,3
440	JB DESIGN IS-18	607	AITECH PC-16	12	ALR 2,3	12	ALR 2,3
441	JC INFO. SYSTEMS IS-5	608	AITECH PC-16	12	ALR 2,3	12	ALR 2,3
138	MEGATEL COMPUTER CORP 92	60	COVOX, INC. 330	12	ALR 2,3	12	ALR 2,3
139	MERRIMACK VALLEY SYSTEMS 335	61	COVOX, INC. 330	12	ALR 2,3	12	ALR 2,3
141	MICROPROCESSORS UNLTD. 345	* CURTIS MANUFACTURING CO. 215		12	ALR 2,3	12	ALR 2,3
* MICROWAY 158		421	CYBEX IS-70	12	ALR 2,3	12	ALR 2,3
* MICROWAY 264		424	DIETRICH POS EQUIPMENT IS-76	12	ALR 2,3	12	ALR 2,3
* MICROWAY 292		96	HOLEON CORPORATION 335	12	ALR 2,3	12	ALR 2,3
185	P. SHERMAN ENTERPRISES 340	101	IME COMPUTERS 316	12	ALR 2,3	12	ALR 2,3
240	QUA TECH 318	102	IME COMPUTERS 316	12	ALR 2,3	12	ALR 2,3
241	QUA TECH 318	103	INTEGRAND RESEARCH CORP 177	12	ALR 2,3	12	ALR 2,3
242	QUA TECH 318	110	IN-FOCUS SYSTEMS 185	12	ALR 2,3	12	ALR 2,3
243	QUA TECH 318	222	LANDMARK/SUPERSOFT 300	12	ALR 2,3	12	ALR 2,3
244	QUA TECH 318	136	MEGASOFT, INC. 343	12	ALR 2,3	12	ALR 2,3
245	QUA TECH 318	151	NO NOISE CORP 138	12	ALR 2,3	12	ALR 2,3
246	QUA TECH 318	152	NO NOISE CORP 138	12	ALR 2,3	12	ALR 2,3
247	QUA TECH 318	169	PC POWER & COOLING 193	12	ALR 2,3	12	ALR 2,3
248	QUA TECH 318	170	PC POWER & COOLING 193	12	ALR 2,3	12	ALR 2,3
209	SILICON SHACK 336	193	ROLAND DIGITAL GROUP 91	12	ALR 2,3	12	ALR 2,3
230	THE PERISCOPE CO 108	194	ROLAND DIGITAL GROUP 91	12	ALR 2,3	12	ALR 2,3
231	THE PERISCOPE CO 108	285	S' DEVELOPMENT CORP 243	12	ALR 2,3	12	ALR 2,3
250	TOUCHBASE SYSTEMS 74	223	TALKING TECHNOLOGY 339	12	ALR 2,3	12	ALR 2,3
464	TP ENTERPRISE, INC. IS-32	237	TOSHIBA AMERICA ELEC. CO 123-125	12	ALR 2,3	12	ALR 2,3
466	TRIANGLE DIGITAL IS-78	257	UNICORN ELECTRONICS 332	12	ALR 2,3	12	ALR 2,3
471	VDS IS-65	261	VERBATIM 16,17	12	ALR 2,3	12	ALR 2,3
274	XELTEK 339	262	VERBATIM 16,17	12	ALR 2,3	12	ALR 2,3
<b>927</b>	<b>DRIVES</b>	602	VICTORY ENTERPRISES NE-26	12	ALR 2,3	12	ALR 2,3
140	MICRO SOLUTIONS COMP. PROD 92	263	VIZIFLEX SEELS, INC. 331	12	ALR 2,3	12	ALR 2,3
174	PERISOL TECHNOLOGY 330	279	Z-WORLD 345	12	ALR 2,3	12	ALR 2,3
<b>928</b>	<b>HARDWARE PROGRAMMERS</b>	<b>933</b>	<b>MODEMS/MULTIPLEXORS</b>	<b>936</b>	<b>PRINTERS/PLOTTERS</b>	<b>938</b>	<b>SCANNERS/IMAGE PROCESSORS</b>
28	B & C MICROSYSTEMS 343	405	AIMSOFT INTERNATIONAL IS-23	428	LOGITECH 189	428	LOGITECH 189
* BINARY TECHNOLOGY, INC. 343		54	COMPUCOM 331	430	FAST ELECTRONICS GMBH IS-57	430	FAST ELECTRONICS GMBH IS-57
282	BP MICROSYSTEMS 335	422	DATATRONICS TECHNOLOGY, INC. IS-60	89	GLENCO ENGINEERING 179	89	GLENCO ENGINEERING 179
93	GTEK, INC. 264	466	UNIVERSAL DATA SYSTEMS IS-6	184	PROTECH MARKETING 131	184	PROTECH MARKETING 131
94	GTEK, INC. 264	469	UNIVERSAL DATA SYSTEMS IS-6	212	SOFTWARE SECURITY, INC. 238	212	SOFTWARE SECURITY, INC. 238
118	KLA SYSTEMS 335	* US ROBOTICS 257		<b>939</b>	<b>SOFTWARE SECURITY</b>	<b>940</b>	<b>SYSTEMS</b>
122	LINK COMPUTER GRAPHICS 329	<b>934</b>	<b>MONITORS</b>	406	ALADDIN KNOWLEDGE SYS. IS-67	605	ADTECH PC-13
126	LOGICAL DEVICES 343	* COMPAQ COMPUTER CORP 12,13		430	FAST ELECTRONICS GMBH IS-57	606	ADTECH PC-13
127	LOGICAL DEVICES 343	99	IBM-DISPLAY 15	89	GLENCO ENGINEERING 179	12	ALR 2,3
153	NOHAU CORP 307	100	IYAMA ELECTRIC 55	184	PROTECH MARKETING 131	12	ALR 2,3
179	PROGRAMMABLE LOGIC TECH 340	101	IME COMPUTERS 316	212	SOFTWARE SECURITY, INC. 238	12	ALR 2,3
273	XELTEK 339	102	IME COMPUTERS 316	<b>940</b>	<b>SYSTEMS</b>	12	ALR 2,3
280	Z-WORLD 345	144	NANAO 163	605	ADTECH PC-13	12	ALR 2,3
<b>929</b>	<b>INSTRUMENTATION</b>	145	NANAO 163	606	ADTECH PC-13	12	ALR 2,3
29	B & C MICROSYSTEMS 345	149	NEC HOME ELECTRONICS 36,39	12	ALR 2,3	12	ALR 2,3
30	B & C MICROSYSTEMS 345	449	PHILIPS CONSUMER ELECT. BV. 9	12	ALR 2,3	12	ALR 2,3
35	BLAST/COMM. RESEARCH 160	224	TATUNG 287	12	ALR 2,3	12	ALR 2,3
36	BLAST/COMM. RESEARCH 160	225	TATUNG 287	12	ALR 2,3	12	ALR 2,3
79	ELEXOR, INC. 329	238	TOSHIBA AMERICA CONS. PROD 161	12	ALR 2,3	12	ALR 2,3
123	LINK COMPUTER GRAPHICS 329	239	TOSHIBA AMERICA CONS. PROD 161	12	ALR 2,3	12	ALR 2,3
148	NATIONAL INSTRUMENTS CII	<b>935</b>	<b>NETWORK HARDWARE</b>	12	ALR 2,3	12	ALR 2,3
272	XELTEK 339	24	ARTISOFT 105	12	ALR 2,3	12	ALR 2,3
274	XELTEK 339	* CLECOMMUNICATIONS 111		12	ALR 2,3	12	ALR 2,3

# READER SERVICE

\* Correspond directly with company.

Inquiry No.	Page No.
<b>941</b>	<b>UPS</b>
404 AGCELECTRONICS CORP . . .	IS-61
48 CIC DISTRIBUTORS . . . . .	110
49 CIC DISTRIBUTORS . . . . .	110
166 PARA SYSTEMS . . . . .	79
213 SOLA ELECTRIC . . . . .	98

## SOFTWARE

<b>942</b>	<b>APPLE/MAC-COMMUNICATIONS</b>
35 BLAST/COMM. RESEARCH . . .	160
36 BLAST/COMM. RESEARCH . . .	160

<b>943</b>	<b>APPLE/MAC GRAPHICS</b>
565 NCGA/NAT'L COMP. GRAPHICS . . .	14
566 NCGA/NAT'L COMP. GRAPHICS . . .	14

<b>944</b>	<b>IBM/MSDOS APPLICATIONS</b>	
	<b>Business Office</b>	
23 ARC TANGENT, INC . . . . .	340	
25 ASHTON-TATE . . . . .	7	
26 ASHTON-TATE . . . . .	7	
* COPIA INTERNATIONAL LTD. . . . .	110	
78 ELEX INTERNATIONAL . . . . .	237	
432 GAMMA PRODUCTIONS, INC . . .	IS-31	
130 LOTUS . . . . .	49	
133 MAP INFO . . . . .	165	
* MICROSOFT . . . . .	133	
188 RAIMA . . . . .	47	
454 RAIMA . . . . .	IS-45	
192 RECOGNITA CORP . . . . .	122	

<b>945</b>	<b>IBM/MSDOS APPLICATIONS</b>	
	<b>Scientific/Technical</b>	
20 ANNABOOKS . . . . .	208	
411 COBALD BLUE . . . . .	IS-64	
77 DSP DEVELOPMENT . . . . .	276	
124 LOGICAL DEVICES . . . . .	343	
125 LOGICAL DEVICES . . . . .	343	
454 RAIMA . . . . .	IS-45	
651 RENTEC . . . . .	SO-22	
214 SPECTRUM SOFTWARE . . . . .	279	
217 STATESOFT . . . . .	205	
251 TOUCHSTONE SOFTWARE . . . . .	77	
252 TOUCHSTONE SOFTWARE . . . . .	77	
269 WINTEK . . . . .	340	

<b>946</b>	<b>IBM/MSDOS APPLICATIONS</b>	
	<b>Miscellaneous</b>	
39 BUREAU OF ELECTRONIC PBLH 104		
40 BUREAU OF ELECTRONIC PBLH 104		
281 EVENT HORIZONS . . . . .	184	
* MICROSOFT . . . . .	29	

<b>947</b>	<b>IBM/MSDOS APPLICATIONS</b>	
	<b>Word Processing</b>	
197 SAMNA CORPORATION . . . . .	139	
196 SAMNACORPORATION . . . . .	139	
199 SAMNA CORPORATION . . . . .	140,141	
200 SAMNA CORPORATION . . . . .	140,141	
201 SAMNA CORPORATION . . . . .	142	
202 SAMNA CORPORATION . . . . .	142	

<b>948</b>	<b>IBM/MSDOS — CAD</b>
17 AMERICAN SMALL BUSINESS . . .	129
18 AMS . . . . .	336
585 EVOLUTION COMPUTING . . . . .	NE-19
628 EVOLUTION COMPUTING . . . . .	PC-23
88 GENERIC SOFTWARE, INC . . . . .	67

<b>949</b>	<b>IBM/MSDOS COMMUNICATIONS</b>
35 BLAST/COMM. RESEARCH . . . . .	160
36 BLAST/COMM. RESEARCH . . . . .	160
414 COMPLEX . . . . .	IS-33
415 COMPLEX . . . . .	IS-33

<b>950</b>	<b>IBM/MSDOS GRAPHICS</b>
58 COREL SYSTEMS . . . . .	37
59 COREL SYSTEMS . . . . .	37
131 MAGEE ENTERPRISES . . . . .	168
132 MAGEE ENTERPRISES . . . . .	168
445 MICROGRAFX . . . . .	IS-41
565 NCGA/NAT'L COMP. GRAPHICS . . .	14
566 NCGA/NAT'L COMP. GRAPHICS . . .	14
157 NOVA, INC. . . . .	96
167 PATTON & PATTON . . . . .	329
196 ROYKORE . . . . .	88
204 SCIENTIFIC ENDEAVORS . . . . .	289
216 STARWARE PUBLISHING CORP 340	
* VERMONT CREATIVE SAW . . . . .	35

<b>951</b>	<b>IBM/MSDOS — LAN</b>
78 ELEX INTERNATIONAL . . . . .	237
208 SERVER TECHNOLOGY . . . . .	192

<b>952</b>	<b>IBM/MSDOS LANGUAGES</b>
37 BORLAND INTERNATIONAL . . . . .	11
38 BORLAND INTERNATIONAL . . . . .	11
81 FAIRCOM CORP . . . . .	106
121 LAHEY . . . . .	188
* MICROSOFT . . . . .	21
142 MIX SOFTWARE . . . . .	317
143 MKS . . . . .	187
146 NANTUCKET . . . . .	202
452 PROLOG DEVELOPMENT . . . . .	IS-35
453 PROLOG DEVELOPMENT . . . . .	IS-35
287 PSEUDOCORP . . . . .	347
191 RAINDROP SOFTWARE . . . . .	96
207 SEQUITER SOFTWARE . . . . .	210
* WATCOM PRODUCTS, INC . . . . .	155
286 WHITEWATER GROUP . . . . .	175
278 ZORTECH, INC . . . . .	93

<b>953</b>	<b>IBM/MSDOS UTILITIES</b>
32 BLACK & WHITE INT'L . . . . .	188
34 BLAISE COMPUTING . . . . .	6
409 CLARION SOFTWARE . . . . .	IS-13
410 CLARION SOFTWARE . . . . .	IS-13
51 CNS, INC. (ZORTECH) . . . . .	41
92 GREENVIEW . . . . .	78
436 IMT . . . . .	IS-68
119 KNOWLEDGE GARDEN . . . . .	291
158 NU-MEGA TECHNOLOGIES . . . . .	76
159 OAKLAND GROUP, INC . . . . .	228
160 OPENNETWORK . . . . .	192
175 PHAR LAP . . . . .	231
228 TEST TECHNOLOGY . . . . .	339
260 UPGRADES, ETC . . . . .	335
265 VOGON ENTERPRISES LTD . . . . .	336

<b>954</b>	<b>OTHER APPLICATIONS</b>	
	<b>Business Office</b>	
270 XEC PRODUCTS . . . . .	180	
271 XEC PRODUCTS . . . . .	180	

<b>955</b>	<b>OTHER APPLICATIONS</b>	
	<b>Scientific/Technical</b>	
90 GLOCKENSPIEL . . . . .	167	

<b>956</b>	<b>OTHER APPLICATIONS</b>	
	<b>Miscellaneous</b>	
48 CIC DISTRIBUTORS . . . . .	110	
49 CIC DISTRIBUTORS . . . . .	110	

<b>957</b>	<b>OTHER — CAD</b>
135 MATHSOFT, INC. . . . .	227

<b>958</b>	<b>OTHER — CROSS DEVELOPMENT</b>
87 GCOM, INC . . . . .	335
435 IXLTD . . . . .	IS-56

<b>959</b>	<b>OTHER — LANGUAGES</b>
* BINARY TECHNOLOGY, INC . . . . .	343
81 FAIRCOM CORP . . . . .	106
619 METAWARE . . . . .	PC-7
266 WHITEWATER GROUP . . . . .	175

<b>960</b>	<b>OTHER — UTILITIES</b>
92 GREENVIEW . . . . .	78
191 RAINDROP SOFTWARE . . . . .	96
264 VLEERMUIS SOFTWARE RES . . . .	109

## 961 EDUCATIONAL/INSTRUCTIONAL

8 ABACUS . . . . .	85
9 ABACUS . . . . .	85
* BYTE BACK ISSUES . . . . .	305
* BYTE BACK ISSUES . . . . .	315
* BYTE BACK ISSUES . . . . .	IS-72
* BYTE BOOK CLUB . . . . .	297
* BYTE BOOK CLUB . . . . .	297A-B
* BYTE CARD DECK . . . . .	308
* BYTE CARD DECK . . . . .	NE-20
* BYTE CARD DECK . . . . .	PC-20
* BYTE PUBLICATIONS . . . . .	IS-49
* BYTE SUB MESSAGE . . . . .	246
* BYTE SUB MESSAGE . . . . .	330
* BYTE SUB MESSAGE . . . . .	IS-74
* BYTEWEEK/NEWSLETTER . . . . .	283
* CCM/IMCGRAW-HILL . . . . .	295
610 CM VENTURES . . . . .	PC-1
611 CM VENTURES . . . . .	PC-1
* NRI/MCGRAW-HILL . . . . .	312A-B
* UNIXWORLD . . . . .	217
* UNIXWORLD . . . . .	217A-B
267 WIESEMANN & THEIS GMBH . . . .	339

## 962 MAIL ORDER/RETAIL

401 3EST-USA . . . . .	IS-76
10 ADD ON AMERICA . . . . .	329
407 AMDS, LTD . . . . .	IS-34
19 AMT, INT'L . . . . .	342
21 ANNABOOKS . . . . .	320
22 ANNABOOKS . . . . .	320
408 ATICO . . . . .	IS-36,37
31 BEST POWERTECHNOLOGY . . . . .	320
43 B&B ELECTRONICS . . . . .	335
44 CAD SOFTWARE . . . . .	320
555 CAD WAREHOUSE . . . . .	MW-16
556 CAD WAREHOUSE . . . . .	MW-16
583 CAD WAREHOUSE . . . . .	NE-22
584 CAD WAREHOUSE . . . . .	NE-22
815 CAD WAREHOUSE . . . . .	PC-18
816 CAD WAREHOUSE . . . . .	PC-18
636 CAD WAREHOUSE . . . . .	SO-18
637 CAD WAREHOUSE . . . . .	SO-18
632 CHAUMONT & ASSOCIATES . . . .	SO-14
416 COMPEX INTERNATIONAL . . . . .	IS-76
417 COMPUCLASSICS . . . . .	IS-26
418 COMPUSAVE . . . . .	IS-51
419 COMPUTER QUICK . . . . .	IS-60
* COMPUTER SALES PROF . . . . .	NE-5
* COMPUTER SALES PROF . . . . .	NE-9
58 COMPUTERLANE . . . . .	338
89 DELL COMPUTER CORP . . . . .	CI1, 1
553 DERBYTECH COMPUTERS, INC MW-20	
554 DERBYTECH COMPUTERS, INC MW-20	
581 DERBYTECH COMPUTERS, INC NE-28	
582 DERBYTECH COMPUTERS, INC NE-28	
613 DERBYTECH COMPUTERS, INC PC-24	
614 DERBYTECH COMPUTERS, INC PC-24	
634 DERBYTECH COMPUTERS, INC SO-24	
835 DERBYTECH COMPUTERS, INC SO-24	
427 ELEX INTERNATIONAL . . . . .	IS-77
586 FD MICROSYSTEMS . . . . .	NE-27
587 FD MICROSYSTEMS . . . . .	NE-27
638 FD MICROSYSTEMS . . . . .	SO-11
639 FD MICROSYSTEMS . . . . .	SO-11
83 FIRST SOURCE INTERNATIONAL 341	
84 FIRST SOURCE INTERNATIONAL 341	
434 GRY MATTER . . . . .	IS-75
108 INTEL CORP . . . . .	320
113 I.C. EXPRESS . . . . .	335
6 JDR MICRODEVICES . . . . .	353-355
7 JDR MICRODEVICES . . . . .	353-355
559 KANDU/COMPUTER SQ., INC MW-17	
560 KANDU/COMPUTER SQ., INC MW-17	
* LIBRARY OF COMP. AND INFO 248,249	
* LIBRARY OF COMP. AND INFO 248A-B	
* MARK WILLIAMS CO . . . . .	75

<b>963</b>	<b>MISCELLANEOUS</b>
134 MARYMAC INDUSTRIES . . . . .	343
581 MICON COMPUTERS . . . . .	MW-3
* MICROCOMPUTER MKTG. CNCL 299	
563 MYODA, INC . . . . .	MW-7
564 MYODA, INC . . . . .	MW-7
593 MYODA, INC . . . . .	NE-21
594 MYODA, INC . . . . .	NE-21
621 MYODA, INC . . . . .	PC-9
622 MYODA, INC . . . . .	PC-9
647 MYODA, INC . . . . .	SO-3
848 MYODA, INC . . . . .	SO-3
147 NATIONAL INSTRUMENTS . . . . .	320
150 NEVADA COMPUTER . . . . .	334
151 NO NOISE CORP . . . . .	138
152 NO NOISE CORP . . . . .	138
154 NORTHGATE COMPUTER . . . . .	194,195
155 NORTHGATE COMPUTER . . . . .	196,197
156 NORTHGATE COMPUTER . . . . .	198
* NORTHGATE COMPUTER . . . . .	199
* PC CONNECTION . . . . .	112,117
589 PLAMAR COMPUTER SYS . . . . .	MW-4,5
570 PLAMAR COMPUTER SYS . . . . .	MW-4,5
595 PLAMAR COMPUTER SYS . . . . .	NE-6,7
598 PLAMAR COMPUTER SYS . . . . .	NE-6,7
451 PROGRAMMERS ODYSSEY . . . . .	IS-24
180 PROGRAMMERS PARADISE . . . . .	63,65
181 PROGRAMMER'S CONNECTION 320	
182 PROGRAMMER'S SHOP . . . . .	265
183 PROGRAMMER'S SHOP . . . . .	265
* PROGRAMMER'S SHOP . . . . .	266,267
571 SAINT CROIX CORP . . . . .	MW-15
572 SAINT CROIX CORP . . . . .	MW-15
597 SAINT CROIX CORP . . . . .	NE-23
598 SAINT CROIX CORP . . . . .	NE-23
455 SCOTTSDALE SYSTEMS . . . . .	IS-59
210 SIMPLE TECHNOLOGY, INC . . . . .	333
211 SN'W . . . . .	208
* SOFTLINE . . . . .	IS-43
460 SOFTWARE CONSTRUCTION . . . . .	IS-47
228 TECHNOLOGY POWER ENTER . . . .	331
227 TELEPHONE PRODUCT CTR . . . . .	344
229 THE CARD SHOP . . . . .	320
253 TREND SYSTEMS, INC . . . . .	337
258 UNIVERSAL MEMORY PROD . . . . .	332
259 UNIVERSAL MEMORY PROD . . . . .	332
470 USA SOFTWARE . . . . .	IS-20
278 ZEOS INTERNATIONAL . . . . .	168A-H
277 ZERICON . . . . .	320

## 963 MISCELLANEOUS

403 ACRI/ADV. COMP. RESEARCH INST. 42	
551 CETDC . . . . .	MW-11
579 CETDC . . . . .	NE-18
609 CETDC . . . . .	PC-15
631 CETDC . . . . .	SO-7
* COMTEK '91 . . . . .	IS-73
75 DIVERSIFIED COMPUTER SYS. . . . .	345
426 ELECTRO SERVICE CORP . . . . .	IS-70
588 GLASGAL COMMUNICATIONS NE-11	
446 MICROPRESS, INC . . . . .	IS-68
447 MICROPRESS, INC . . . . .	IS-68
151 NO NOISE CORP . . . . .	138
152 NO NOISE CORP . . . . .	138
188 PC COMPUTER RENTAL . . . . .	339
281 VERBATIM . . . . .	18,17
282 VERBATIM . . . . .	16,17

## 964 ON-LINE SERVICES

450 BIX . . . . .	146,147
* BIX . . . . .	230
* BIX . . . . .	256
* BIX . . . . .	259
* BIX . . . . .	SO-16
* BIX . . . . .	PC-22
* BIX . . . . .	IS-79
42 BYTE PUBLICATIONS/DEMOLINK . . . .	283
* GALACTICOMM, INC. . . . .	345

## 965 OPERATING SYSTEMS

70 DIGITAL RESEARCH . . . . .	235
428 ESIX SYSTEMS . . . . .	IS-29
* MARK WILLIAMS CO . . . . .	75
203 SANTA CRUZ OPERATION . . . . .	59

# REQUEST FREE PRODUCT INFORMATION BY FAX

Just fax this page to 1-413-637-4343. Save time because your request for information will be processed *immediately*.

**1** Circle the numbers below which correspond to the numbers assigned to advertisers and products that interest you.

**2** Check off the answers to questions "A" through "E".

**3** Print your name, address, and fax number clearly on the form.

**4** Remove this page or copy this page clearly and fax it to the number above.

Fill out this coupon carefully. PLEASE PRINT.

Name \_\_\_\_\_  
 Title \_\_\_\_\_  
 Company \_\_\_\_\_  
 Address \_\_\_\_\_  
 City \_\_\_\_\_  
 State/Province \_\_\_\_\_ Zip \_\_\_\_\_  
 Country (\_\_\_\_) (\_\_\_\_)  
 Phone Number \_\_\_\_\_ Fax Number \_\_\_\_\_

**A. What is your primary job function/principal area of responsibility? (Check one.)**

- 1  MIS/DP
- 2  Programmer/Systems Analyst
- 3  Administration/Management
- 4  Sales/Marketing
- 5  Engineer/Scientist
- 6  Other

**B. What is your level of management responsibility?**

- 7  Senior-level
- 8  Middle-level
- 9  Professional

**C. Are you a reseller (VAR, VAD, Dealer, Consultant)?**

- 10  Yes
- 11  No

**D. What operating systems are you currently using? (Check all that apply.)**

- 12  PC/MS-DOS
- 13  DOS + Windows
- 14  OS/2
- 15  UNIX
- 16  MacOS
- 17  VAX/VMS

**E. For how many people do you influence the purchase of hardware or software?**

- 18  1-25
- 19  26-50
- 20  51-99
- 21  100 or more

Inquiry Numbers 1-495											Inquiry Numbers 496-990											Inquiry Numbers 991-1479										
1	2	3	4	5	6	7	8	9	10	11	496	497	498	499	500	501	502	503	504	505	506	991	992	993	994	995	996	997	998	999	1000	1001
12	13	14	15	16	17	18	19	20	21	22	507	508	509	510	511	512	513	514	515	516	517	1002	1003	1004	1005	1006	1007	1008	1009	1010	1011	1012
23	24	25	26	27	28	29	30	31	32	33	518	519	520	521	522	523	524	525	526	527	528	1013	1014	1015	1016	1017	1018	1019	1020	1021	1022	1023
34	35	36	37	38	39	40	41	42	43	44	529	530	531	532	533	534	535	536	537	538	539	1024	1025	1026	1027	1028	1029	1030	1031	1032	1033	1034
45	46	47	48	49	50	51	52	53	54	55	540	541	542	543	544	545	546	547	548	549	550	1035	1036	1037	1038	1039	1040	1041	1042	1043	1044	1045
56	57	58	59	60	61	62	63	64	65	66	551	552	553	554	555	556	557	558	559	560	561	1046	1047	1048	1049	1050	1061	1052	1053	1054	1055	1056
67	68	69	70	71	72	73	74	75	76	77	562	563	564	565	566	567	568	569	570	571	572	1057	1058	1059	1060	1061	1062	1063	1064	1065	1066	1067
78	79	80	81	82	83	84	85	86	87	88	573	574	575	576	577	578	579	580	581	582	583	1068	1069	1070	1071	1072	1073	1074	1075	1076	1077	1078
89	90	91	92	93	94	95	96	97	98	99	584	585	586	587	588	589	590	591	592	593	594	1079	1080	1081	1082	1083	1084	1085	1086	1087	1088	1089
100	101	102	103	104	105	106	107	108	109	110	595	596	597	598	599	600	601	602	603	604	605	1090	1091	1092	1093	1094	1095	1096	1097	1098	1099	1100
111	112	113	114	115	116	117	118	119	120	121	606	607	608	609	610	611	612	613	614	615	616	1101	1102	1103	1104	1105	1106	1107	1108	1109	1110	1111
122	123	124	125	126	127	128	129	130	131	132	617	618	619	620	621	622	623	624	625	626	627	1112	1113	1114	1115	1116	1117	1118	1119	1120	1121	1122
133	134	135	136	137	138	139	140	141	142	143	628	629	630	631	632	633	634	635	636	637	638	1123	1124	1125	1126	1127	1128	1129	1130	1131	1132	1133
144	145	146	147	148	149	150	151	152	153	154	639	640	641	642	643	644	645	646	647	648	649	1134	1135	1136	1137	1138	1139	1140	1141	1142	1143	1144
155	156	157	158	159	160	161	162	163	164	165	650	651	652	653	654	655	656	657	658	659	660	1145	1146	1147	1148	1149	1150	1151	1152	1153	1154	1155
166	167	168	169	170	171	172	173	174	175	176	661	662	663	664	665	666	667	668	669	670	671	1156	1157	1158	1159	1160	1161	1162	1163	1164	1165	1166
177	178	179	180	181	182	183	184	185	186	187	672	673	674	675	676	677	678	679	680	681	682	1167	1168	1169	1170	1171	1172	1173	1174	1175	1176	1177
188	189	190	191	192	193	194	195	196	197	198	683	684	685	686	687	688	689	690	691	692	693	1178	1179	1180	1181	1182	1183	1184	1185	1186	1187	1188
199	200	201	202	203	204	205	206	207	208	209	694	695	696	697	698	699	700	701	702	703	704	1189	1190	1191	1192	1193	1194	1195	1196	1197	1198	1199
210	211	212	213	214	215	216	217	218	219	220	705	706	707	708	709	710	711	712	713	714	715	1200	1201	1202	1203	1204	1205	1206	1207	1208	1209	1210
221	222	223	224	225	226	227	228	229	230	231	716	717	718	719	720	721	722	723	724	725	726	1211	1212	1213	1214	1215	1216	1217	1218	1219	1220	1221
232	233	234	235	236	237	238	239	240	241	242	727	728	729	730	731	732	733	734	735	736	737	1222	1223	1224	1225	1226	1227	1228	1229	1230	1231	1232
243	244	245	246	247	248	249	250	251	252	253	738	739	740	741	742	743	744	745	746	747	748	1233	1234	1235	1236	1237	1238	1239	1240	1241	1242	1243
254	255	256	257	258	259	260	261	262	263	264	749	750	751	752	753	754	755	756	757	758	759	1244	1245	1246	1247	1248	1249	1250	1251	1252	1253	1254
265	266	267	268	269	270	271	272	273	274	275	760	761	762	763	764	765	766	767	768	769	770	1255	1256	1257	1258	1259	1260	1261	1262	1263	1264	1265
276	277	278	279	280	281	282	283	284	285	286	771	772	773	774	775	776	777	778	779	780	781	1266	1267	1268	1269	1270	1271	1272	1273	1274	1275	1276
287	288	289	290	291	292	293	294	295	296	297	782	783	784	785	786	787	788	789	790	791	792	1277	1278	1279	1280	1281	1282	1283	1284	1285	1286	1287
298	299	300	301	302	303	304	305	306	307	308	793	794	795	796	797	798	799	800	801	802	803	1288	1289	1290	1291	1292	1293	1294	1295	1296	1297	1298
309	310	311	312	313	314	315	316	317	318	319	804	805	806	807	808	809	810	811	812	813	814	1299	1300	1301	1302	1303	1304	1305	1306	1307	1308	1309
320	321	322	323	324	325	326	327	328	329	330	815	816	817	818	819	820	821	822	823	824	825	1310	1311	1312	1313	1314	1315	1316	1317	1318	1319	1320
331	332	333	334	335	336	337	338	339	340	341	826	827	828	829	830	831	832	833	834	835	836	1321	1322	1323	1324	1325	1326	1327	1328	1329	1330	1331
342	343	344	345	346	347	348	349	350	351	352	837	838	839	840	841	842	843	844	845	846	847	1332	1333	1334	1335	1336	1337	1338	1339	1340	1341	1342
353	354	355	356	357	358	359	360	361	362	363	848	849	850	851	852	853	854	855	856	857	858	1343	1344	1345	1346	1347	1348	1349	1350	1351	1352	1353
364	365	366	367	368	369	370	371	372	373	374	859	860	861	862	863	864	865	866	867	868	869	1354	1355	1356	1357	1358	1359	1360	1361	1362	1363	1364
375	376	377	378	379	380	381	382	383	384	385	870	871	872	873	874	875	876	877	878	879	880	1365	1366	1367	1368	1369	1370	1371	1372	1373	1374	1375
386	387	388	389	390	391	392	393	394	395	396	881	882	883	884	885	886	887	888	889	890	891	1376	1377	1378	1379	1380	1381	1382	1383	1384	1385	1386
397	398	399	400	401	402	403	404	405	406	407	892	893	894	895	896	897	898	899	900	901	902	1387	1388	1389	1390	1391	1392	1393	1394	1395	1396	1397
408	409	410	411	412	413	414	415	416	417	418	903	904	905	906	907	908	909	910	911	912	913	1398	1399	1400	1401	1402	1403	1404	1405	1406	1407	1408
419	420	421	422	423	424	425	426	427	428	429	914	915	916	917	918	919	920	921	922	923	924	1409	1410	1411	1412	1413	1414	1415	1416	1417	1418	1419
430	431	432	433	434	435	436	437	438	439	440	925	92																				

# FREE PRODUCT INFORMATION

Want More Information About the Products and Advertisers Featured in this Issue?

- 1** Circle numbers on reply card which correspond to numbers assigned to items of interest to you.
- 2** Check all the appropriate answers to questions "A" through "E".
- 3** Print your name and address and mail.

Fill out this coupon carefully. PLEASE PRINT.

Name \_\_\_\_\_  
 Title \_\_\_\_\_  
 Phone \_\_\_\_\_ Fax \_\_\_\_\_  
 Company \_\_\_\_\_  
 Address \_\_\_\_\_  
 City \_\_\_\_\_ State \_\_\_\_\_ Zip \_\_\_\_\_

**A. What is your primary job function/principal area of responsibility? (Check one.)**

- 1 MIS/DP  
 2 Programmer/Systems Analyst  
 3 Administration/Management  
 4 Sales/Marketing  
 5 Engineer/Scientist  
 6 Other

**B. What is your level of management responsibility?**

- 7 Senior-level      9 Professional  
 8 Middle-level

**C. Are you a reseller (VAR, VAD, Dealer, Consultant)?**

- 10 Yes      11 No

**D. What operating systems are you currently using? (Check all that apply.)**

- 12 PC/MS-DOS      15 UNIX  
 13 DOS + Windows      16 MacOS  
 14 OS/2      17 VAX/VMS

**E. For how many people do you influence the purchase of hardware or software?**

- 18 1-25      20 51-99  
 19 26-50      21 100 or more

Please send me one year of BYTE Magazine for \$2495 and bill me. Offer valid in U.S. and possessions only. **FEBRUARY IRSD002**

Inquiry Numbers 1-493

Inquiry Numbers 494-986

Inquiry Numbers 987-1479

1	2	3	4	5	6	7	8	9	10	11	12	13	14	15	16	17	494	495	496	497	498	499	500	501	502	503	504	505	506	507	508	509	510	987	988	989	990	991	992	993	994	995	996	997	998	999	1000	1001	1002	1003
18	19	20	21	22	23	24	25	26	27	28	29	30	31	32	33	34	511	512	513	514	515	516	517	518	519	520	521	522	523	524	525	526	527	1004	1005	1006	1007	1008	1009	1010	1011	1012	1013	1014	1015	1016	1017	1018	1019	1020
35	36	37	38	39	40	41	42	43	44	45	46	47	48	49	50	51	528	529	530	531	532	533	534	535	536	537	538	539	540	541	542	543	544	1021	1022	1023	1024	1025	1026	1027	1028	1029	1030	1031	1032	1033	1034	1035	1036	1037
52	53	54	55	56	57	58	59	60	61	62	63	64	65	66	67	68	545	546	547	548	549	550	551	552	553	554	555	556	557	558	559	560	561	1038	1039	1040	1041	1042	1043	1044	1045	1046	1047	1048	1049	1050	1051	1052	1053	1054
69	70	71	72	73	74	75	76	77	78	79	80	81	82	83	84	85	562	563	564	565	566	567	568	569	570	571	572	573	574	575	576	577	578	1056	1057	1058	1059	1060	1061	1062	1063	1064	1065	1066	1067	1068	1069	1070	1071	
86	87	88	89	90	91	92	93	94	95	96	97	98	99	100	101	102	579	580	581	582	583	584	585	586	587	588	589	590	591	592	593	594	595	1072	1073	1074	1075	1076	1077	1078	1079	1080	1081	1082	1083	1084	1085	1086	1087	1088
103	104	105	106	107	108	109	110	111	112	113	114	115	116	117	118	119	596	597	598	599	600	601	602	603	604	605	606	607	608	609	610	611	612	1089	1090	1091	1092	1093	1094	1095	1096	1097	1098	1099	1100	1101	1102	1103	1104	1105
120	121	122	123	124	125	126	127	128	129	130	131	132	133	134	135	136	613	614	615	616	617	618	619	620	621	622	623	624	625	626	627	628	629	1106	1107	1108	1109	1110	1111	1112	1113	1114	1115	1116	1117	1118	1119	1120	1121	1122
137	138	139	140	141	142	143	144	145	146	147	148	149	150	151	152	153	630	631	632	633	634	635	636	637	638	639	640	641	642	643	644	645	646	1123	1124	1125	1126	1127	1128	1129	1130	1131	1132	1133	1134	1135	1136	1137	1138	1139
154	155	156	157	158	159	160	161	162	163	164	165	166	167	168	169	170	647	648	649	650	651	652	653	654	655	656	657	658	659	660	661	662	663	1140	1141	1142	1143	1144	1145	1146	1147	1148	1149	1150	1151	1152	1153	1154	1155	1156
171	172	173	174	175	176	177	178	179	180	181	182	183	184	185	186	187	664	665	666	667	668	669	670	671	672	673	674	675	676	677	678	679	680	1157	1158	1159	1160	1161	1162	1163	1164	1165	1166	1167	1168	1169	1170	1171	1172	1173
188	189	190	191	192	193	194	195	196	197	198	199	200	201	202	203	204	681	682	683	684	685	686	687	688	689	690	691	692	693	694	695	696	697	1174	1175	1176	1177	1178	1179	1180	1181	1182	1183	1184	1185	1186	1187	1188	1189	1190
205	206	207	208	209	210	211	212	213	214	215	216	217	218	219	220	221	698	699	700	701	702	703	704	705	706	707	708	709	710	711	712	713	714	1191	1192	1193	1194	1195	1196	1197	1198	1199	1200	1201	1202	1203	1204	1205	1206	1207
222	223	224	225	226	227	228	229	230	231	232	233	234	235	236	237	238	715	716	717	718	719	720	721	722	723	724	725	726	727	728	729	730	731	1208	1209	1210	1211	1212	1213	1214	1215	1216	1217	1218	1219	1220	1221	1222	1223	1224
239	240	241	242	243	244	245	246	247	248	249	250	251	252	253	254	255	732	733	734	735	736	737	738	739	740	741	742	743	744	745	746	747	748	1225	1226	1227	1228	1229	1230	1231	1232	1233	1234	1235	1236	1237	1238	1239	1240	1241
256	257	258	259	260	261	262	263	264	265	266	267	268	269	270	271	272	749	750	751	752	753	754	755	756	757	758	759	760	761	762	763	764	765	1242	1243	1244	1245	1246	1247	1248	1249	1250	1251	1252	1253	1254	1255	1256	1257	1258
273	274	275	276	277	278	279	280	281	282	283	284	285	286	287	288	289	766	767	768	769	770	771	772	773	774	775	776	777	778	779	780	781	782	1259	1260	1261	1262	1263	1264	1265	1266	1267	1268	1269	1270	1271	1272	1273	1274	1275
290	291	292	293	294	295	296	297	298	299	300	301	302	303	304	305	306	783	784	785	786	787	788	789	790	791	792	793	794	795	796	797	798	799	1276	1277	1278	1279	1280	1281	1282	1283	1284	1285	1286	1287	1288	1289	1290	1291	1292
307	308	309	310	311	312	313	314	315	316	317	318	319	320	321	322	323	800	801	802	803	804	805	806	807	808	809	810	811	812	813	814	815	816	1293	1294	1295	1296	1297	1298	1299	1300	1301	1302	1303	1304	1305	1306	1307	1308	1309
324	325	326	327	328	329	330	331	332	333	334	335	336	337	338	339	340	817	818	819	820	821	822	823	824	825	826	827	828	829	830	831	832	833	1310	1311	1312	1313	1314	1315	1316	1317	1318	1319	1320	1321	1322	1323	1324	1325	1326
341	342	343	344	345	346	347	348	349	350	351	352	353	354	355	356	357	834	835	836	837	838	839	840	841	842	843	844	845	846	847	848	849	850	1327	1328	1329	1330	1331	1332	1333	1334	1335	1336	1337	1338	1339	1340	1341	1342	1343
358	359	360	361	362	363	364	365	366	367	368	369	370	371	372	373	374	851	852	853	854	855	856	857	858	859	860	861	862	863	864	865	866	867	1344	1345	1346	1347	1348	1349	1350	1351	1352	1353	1354	1355	1356	1357	1358	1359	1360
375	376	377	378	379	380	381	382	383	384	385	386	387	388	389	390	391	868	869	870	871	872	873	874	875	876	877	878	879	880	881	882	883	884	1361	1362	1363	1364	1365	1366	1367	1368	1369	1370	1371	1372	1373	1374	1375	1376	1377
392	393	394	395	396	397	398	399	400	401	402	403	404	405	406	407	408	885	886	887	888	889	890	891	892	893	894	895	896	897	898	899	900	901	1378	1379	1380	1381	1382	1383	1384	1385	1386	1387	1388	1389	1390	1391	1392	1393	1394
409	410	411	412	413	414	415	416	417	418	419	420	421	422	423	424	425	902	903	904	905	906	907	908	909	910	911	912	913	914	915	916	917	918	1395	1396	1397	1398	1399	1400	1401	1402	1403	1404	1405	1406	1407	1408	1409	1410	1411
428	427	428	429	430	431	432	433	434	435	436	437	438	439	440	441	442	919	920	921	922	923	924	925	926	927	928	929	930	931	932	933	934	935	1412	1413	1414	1415	1416	1417	1418	1419	1420	1421	1422	1423	1424	1425	1426	1427	1428

# FREE PRODUCT INFORMATION

Want More Information About the Products and Advertisers Featured in this Issue?

- 1** Circle numbers on reply card which correspond to numbers assigned to items of interest to you.
- 2** Check all the appropriate answers to questions "A" through "E".
- 3** Print your name and address and mail.

NO POSTAGE  
NECESSARY  
IF MAILED  
IN THE  
UNITED STATES

## BUSINESS REPLY MAIL

FIRST CLASS MAIL PERMIT NO. 176 PITTSFIELD, MA

POSTAGE WILL BE PAID BY ADDRESSEE



READER SERVICE  
PO Box 5110  
Pittsfield, MA 01203-9926  
USA



Fill out this coupon carefully. PLEASE PRINT.

Name \_\_\_\_\_

Title ( ) \_\_\_\_\_ ( ) \_\_\_\_\_

Phone \_\_\_\_\_ Fax \_\_\_\_\_

Company \_\_\_\_\_

Address \_\_\_\_\_

City \_\_\_\_\_ State \_\_\_\_\_ Zip \_\_\_\_\_

**A. What is your primary job function/principal area of responsibility? (Check one.)**

- 1 MIS/DP
- 2 Programmer/Systems Analyst
- 3 Administration/Management
- 4 Sales/Marketing
- 5 Engineer/Scientist
- 6 Other

**B. What is your level of management responsibility?**

- 7 Senior-level
- 8 Middle-level
- 9 Professional

**C. Are you a reseller (VAR, VAD, Dealer, Consultant)?**

- 10 Yes
- 11 No

**D. What operating systems are you currently using? (Check all that apply.)**

- 12 PC/MS-DOS
- 13 DOS + Windows
- 14 OS/2
- 15 UNIX
- 16 MacOS
- 17 VAX/VMS

**E. For how many people do you influence the purchase of hardware or software?**

- 18 1-25
- 19 26-50
- 20 51-99
- 21 100 or more

Please send me one year of BYTE Magazine for \$2495 and bill me. Offer valid in U.S. and possessions only.

FEBRUARY  
IRSD002

Inquiry Numbers 1-493																Inquiry Numbers 494-986																Inquiry Numbers 987-1479																		
1	2	3	4	5	6	7	8	9	10	11	12	13	14	15	16	17	494	495	496	497	498	499	500	501	502	503	504	505	506	507	508	509	510	987	988	989	990	991	992	993	994	995	996	997	998	999	1000	1001	1002	1003
18	19	20	21	22	23	24	25	26	27	28	29	30	31	32	33	34	511	512	513	514	515	516	517	518	519	520	521	522	523	524	525	526	527	1004	1005	1006	1007	1008	1009	1010	1011	1012	1013	1014	1015	1016	1017	1018	1019	1020
35	36	37	38	39	40	41	42	43	44	45	46	47	48	49	50	51	528	529	530	531	532	533	534	535	536	537	538	539	540	541	542	543	544	1021	1022	1023	1024	1025	1026	1027	1028	1029	1030	1031	1032	1033	1034	1035	1036	1037
52	53	54	55	56	57	58	59	60	61	62	63	64	65	66	67	68	545	546	547	548	549	550	551	552	553	554	555	556	557	558	559	560	561	1038	1039	1040	1041	1042	1043	1044	1045	1046	1047	1048	1049	1050	1051	1052	1053	1054
69	70	71	72	73	74	75	76	77	78	79	80	81	82	83	84	85	562	563	564	565	566	567	568	569	570	571	572	573	574	575	576	577	578	1056	1056	1057	1058	1059	1060	1061	1062	1063	1064	1065	1066	1067	1068	1069	1070	1071
86	87	88	89	90	91	92	93	94	95	96	97	98	99	100	101	102	579	580	581	582	583	584	585	586	587	588	589	590	591	592	593	594	595	1072	1073	1074	1075	1076	1077	1078	1079	1080	1081	1082	1083	1084	1085	1086	1087	1088
103	104	105	106	107	108	109	110	111	112	113	114	115	116	117	118	119	596	597	598	599	600	601	602	603	604	605	606	607	608	609	610	611	612	1089	1090	1091	1092	1093	1094	1095	1096	1097	1098	1099	1100	1101	1102	1103	1104	1105
120	121	122	123	124	125	126	127	128	129	130	131	132	133	134	135	136	613	614	615	616	617	618	619	620	621	622	623	624	625	626	627	628	629	1106	1107	1108	1109	1110	1111	1112	1113	1114	1115	1116	1117	1118	1119	1120	1121	1122
137	138	139	140	141	142	143	144	145	146	147	148	149	150	151	152	153	630	631	632	633	634	635	636	637	638	639	640	641	642	643	644	645	646	1123	1124	1125	1126	1127	1128	1129	1130	1131	1132	1133	1134	1135	1136	1137	1138	1139
154	155	156	157	158	159	160	161	162	163	164	165	166	167	168	169	170	647	648	649	650	651	652	653	654	655	656	657	658	659	660	661	662	663	1140	1141	1142	1143	1144	1145	1146	1147	1148	1149	1150	1151	1152	1153	1154	1155	1156
171	172	173	174	175	176	177	178	179	180	181	182	183	184	185	186	187	664	665	666	667	668	669	670	671	672	673	674	675	676	677	678	679	680	1157	1158	1159	1160	1161	1162	1163	1164	1165	1166	1167	1168	1169	1170	1171	1172	1173
188	189	190	191	192	193	194	195	196	197	198	199	200	201	202	203	204	681	682	683	684	685	686	687	688	689	690	691	692	693	694	695	696	697	1174	1175	1176	1177	1178	1179	1180	1181	1182	1183	1184	1185	1186	1187	1188	1189	1190
205	206	207	208	209	210	211	212	213	214	215	216	217	218	219	220	221	698	699	700	701	702	703	704	705	706	707	708	709	710	711	712	713	714	1191	1192	1193	1194	1195	1196	1197	1198	1199	1200	1201	1202	1203	1204	1205	1206	1207
222	223	224	225	226	227	228	229	230	231	232	233	234	235	236	237	238	715	716	717	718	719	720	721	722	723	724	725	726	727	728	729	730	731	1208	1209	1210	1211	1212	1213	1214	1215	1216	1217	1218	1219	1220	1221	1222	1223	1224
239	240	241	242	243	244	245	246	247	248	249	250	251	252	253	254	255	732	733	734	735	736	737	738	739	740	741	742	743	744	745	746	747	748	1225	1226	1227	1228	1229	1230	1231	1232	1233	1234	1235	1236	1237	1238	1239	1240	1241
256	257	258	259	260	261	262	263	264	265	266	267	268	269	270	271	272	749	750	751	752	753	754	755	756	757	758	759	760	761	762	763	764	765	1242	1243	1244	1245	1246	1247	1248	1249	1250	1251	1252	1253	1254	1255	1256	1257	1258
273	274	275	276	277	278	279	280	281	282	283	284	285	286	287	288	289	766	767	768	769	770	771	772	773	774	775	776	777	778	779	780	781	782	1259	1260	1261	1262	1263	1264	1265	1266	1267	1268	1269	1270	1271	1272	1273	1274	1275
290	291	292	293	294	295	296	297	298	299	300	301	302	303	304	305	306	783	784	785	786	787	788	789	790	791	792	793	794	795	796	797	798	799	1278	1277	1278	1279	1280	1281	1282	1283	1284	1285	1286	1287	1288	1289	1290	1291	1292
307	308	309	310	311	312	313	314	315	316	317	318	319	320	321	322	323	800	801	802	803	804	805	806	807	808	809	810	811	812	813	814	815	816	1293	1294	1295	1296	1297	1298	1299	1300	1301	1302	1303	1304	1305	1306	1307	1308	1309
324	325	326	327	328	329	330	331	332	333	334	335	336	337	338	339	340	817	818	819	820	821	822	823	824	825	826	827	828	829	830	831	832	833	1310	1311	1312	1313	1314	1315	1316	1317	1318	1319	1320	1321	1322	1323	1324	1325	1326
341	342	343	344	345	346	347	348	349	350	351	352	353	354	355	356	357	834	835	836	837	838	839	840	841	842	843	844	845	846	847	848	849	850	1327	1328	1329	1330	1331	1332	1333	1334	1335	1336	1337	1338	1339	1340	1341	1342	1343
358	359	360	361	362	363	364	365	366	367	368	369	370	371	372	373	374	851	852	853	854	855	856	857	858	859	860	861	862	863	864	865	866	867	1344	1345	1346	1347	1348	1349	1350	1351	1352	1353	1354	1355	1356	1357	1358	1359	1360
375	376	377	378	379	380	381	382	383	384	385	386	387	388	389	390	391	868	869	870	871	872	873	874	875	876	877	878	879	880	881	882	883	884	1361	1362	1363	1364	1365	1366	1367	1368	1369	1370	1371	1372	1373	1374	1375	1376	1377
392	393	394	395	396	397	398	399	400	401	402	403	404	405	406	407	408	885	886	887	888	889	890	891	892	893	894	895	896	897	898	899	900	901	1378	1379	1380	1381	1382	1383	1384	1385	1386	1387	1388	1389	1390	1391	1392	1393	1394
409	410	411	412	413	414	415	416	417	418	419	420	421	422	423	424	425	902	903	904	905	906	907	908	909	910	9																								



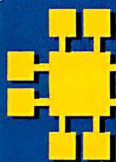

# JDR Microdevices®

ORDER TOLL-FREE 800-538-5000

BUY WITH CONFIDENCE FROM JDR!

- 30-DAY MONEY BACK GUARANTEE
- 1 YEAR WARRANTY
- TOLL-FREE TECH SUPPORT



## INTEGRATED CIRCUITS

### DYNAMIC RAMS



PART#	SIZE	SPEED	PINS	PRICE
4116-150	16384x1	150ns	16	1.49
4164-150	65536x1	150ns	16	2.49
4164-120	65536x1	120ns	16	2.89
4164-100	65536x1	100ns	16	3.39
TMS4464-12	65536x4	120ns	16	3.95
41256-150	262144x1	150ns	16	1.95
41256-120	262144x1	120ns	16	2.15
41256-100	262144x1	100ns	16	2.25
41256-80	262144x1	80ns	16	2.75
414256-100	262144x4	100ns	20	8.95
414256-80	262144x4	80ns	20	9.95
1MB-120	1048576x1	120ns	18	7.95
1MB-100	1048576x1	100ns	18	8.95
1MB-80	1048576x1	80ns	18	9.95
1MB-70	1048576x1	70ns	18	10.75

### SIMM/SIP MODULES



PART#	SIZE	SPEED	FOR	PRICE
41256A9B-80	256K x 8	80ns	SIMM/PC	33.95
421000A9B-10	1MB x 8	100ns	SIMM/MAC	79.95
421000A9B-10	1MB x 8	100ns	SIMM/PC	79.95
421000A9B-80	1MB x 8	80ns	SIMM/PC	89.95
421000A9B-60	1MB x 8	60ns	SIMM/PC	99.95
256K9SIP-80	256K x 9	80ns	SIP/PC	33.95
256K9SIP-60	256K x 9	60ns	SIP/PC	39.95
1MBx9SIP-10	1MB x 9	100ns	SIP/PC	79.95
1MBx9SIP-80	1MB x 9	80ns	SIP/PC	89.95

### MATH CO-PROCESSORS



- Manual
- Software guide
- 5 Year Warranty

8087	5 MHz	89.95
8087-2	8 MHz	129.95
8087-1	10 MHz	169.95
80287-XL	12 MHz	247.95
80387-16	16 MHz	359.95
80387-16	16 MHz	359.95
80387-20	20 MHz	399.95
80387-25	25 MHz	499.95
80387-33	33MHz	649.00
80387-SX	16 MHz	299.95
80387-SX20	20 MHz	399.95

\*FOR COMPAQ LTE/286, TANDY 2800  
\*\*FOR ALL OTHER 286-BASED SYSTEMS

### CYRIX CO-PROCESSORS

STATE-OF-THE-ART TO SAVE YOU LONGEVITY WORRIES!  
MANUAL & SOFTWARE GUIDE, FULL 5-YEAR WARRANTY!

83D87-16 16 MHz ... \$299.95    83D87-33 33MHz \$549.00  
83D87-20 20 MHz ... 349.95    83S87-16 (SX) 16MHz .. 269.95  
83D87-25 25MHz ... 439.95    83S87-20 (SX) 20MHz .. 329.95



### EPROMS

PART#	SIZE	SPEED	Vpp	PINS	PRICE
2716-1	2048x8	350ns	25V	24	4.95
2732A	4096x8	250ns	21V	24	3.95
2764	8192x8	450ns	12.5V	28	3.95
2764-250	8192x8	250ns	12.5V	28	3.95
2764-200	8192x8	200ns	12.5V	28	4.49
27128	16384x8	250ns	12.5V	28	3.95
27128A-200	16384x8	200ns	12.5V	28	4.95
27256	32768x8	250ns	12.5V	28	4.95
27256	32768x8	250ns	12.5V	28	4.95
27512	65536x8	250ns	12.5V	28	5.95
27C101-20	131072x8	200ns	12.5V	32	17.95

### EPROM PROGRAMMER

• PROGRAMS 27XX AND 27XXX EPROMS UP TO 27512 • SPLIT OR COMBINE CONTENTS OF DIFFERENT SIZED EPROMS (VARIOUS FORMATS AND VOLTAGES)  
• READ, WRITE, COPY, BLANK CHECK AND VERIFY • HEX TO INTEL HEX CONVERSION SOFTWARE  
MOD-EPROM

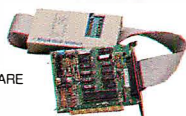

### DATASE II EPROM ERASER

• SMALL SIZE! • ERASES ALL SIZE EPROMS UP TO 4 AT A TIME • WALL PLUG POWER SUPPLY  
DATASE II



### LITHIUM BATTERIES

FOR 286/386  
• WITH CONNECTOR  
• VELCRO MOUNTING  
LITHIUM-6.0V  
**\$10.95**



### MCT'S MODULAR PROGRAMMING SYSTEM

USE 1 SLOT TO PROGRAM EPROMS, PROMS, PALS & MORE!

#### HOST ADAPTOR CARD/CABLE \$299.95

• UNIVERSAL INTERFACE FOR THE PROGRAMMING MODULES!  
• SELECTABLE ADDRESSES PREVENTS CONFLICTS  
MOD-MAC

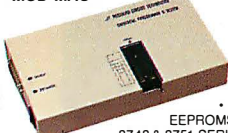

#### UNIVERSAL MODULE

\$499.95

• PROGRAMS EPROMS, EEPROMS, PALS, BI-POLAR PROMS, 8748 & 8751 SERIES DEVICES; 16V8 AND 20V8GALS(GENERIC ARRAY LOGIC) FROM LATTICE, NS, SGS • TESTS TTL, CMOS, DYNAMIC & STATIC RAMS  
• LOAD DISK, SAVE DISK, EDIT, BLANK CHECK, PROGRAM, AUTO, READ MASTER, VERIFY AND COMPARE  
• TEXT TOOL SOCKET FOR .3" TO 6" WIDE ICS (8-40 PINS)  
MOD-MUP ..... \$499.95  
MOD-MUP-EA 4-UNIT ADAPTOR ..... \$99.95

#### EPROM MODULE

\$119.95

• PROGRAMS 24-32 PIN EPROMS, CMOS EPROMS & 16K TO 1024K EEPROMS • HEX TO OBJ CONVERTER • AUTO, BLANK CHECK/PROGRAM/VERIFY • VPP 5, 12.5, 12.75, 13, 21 & 25 VOLTS • NORMAL, INTELLIGENT, INTERACTIVE & QUICK PULSE PROGRAMMING ALGORITHMS

MOD-MEP ..... \$119.95  
MOD-MEP-4 4- EPROM PROGRAMMER ..... \$169.95  
MOD-MEP-8 8- EPROM PROGRAMMER ..... \$259.95  
MOD-MEP-16 16-EPROM PROGRAMMER ..... \$499.95

#### PAL MODULE

\$249.95

• PROGRAMS MML, NS, TI 20 & TI 24 PIN DEVICES • BLANK CHECK, PROGRAM, AUTO, READ MASTER VERIFY AND SECURITY FUSE BLOW

#### MOD-MPL

#### PAL DEVELOPMENT SOFTWARE

\$99.95

ENTRY LEVEL PAL DEVELOPMENT KIT FROM CUPL  
MOD-MPL-SOFT

#### OTHER PROGRAMMING MODULES...

MOD-MMP MICROPROGRAMMER PROGRAMMER 179.95  
MOD-MIC DIGITAL IC & MEMORY TESTER 259.95  
MOD-MBP BI-POLAR PROM PROGRAMMER 499.95

### MOLDED CABLES

#### 100% SHIELDED

• 6, 12 OR 25' PRINTER CABLES  
• DB-25 TO 36-PIN CENTRONICS  
CBL-PRINTR 6 FT. CABLE ..... \$9.95  
CBL-PRNTR-12 12 FT. CABLE ..... \$12.95  
CBL-PRNTR-25 25 FT. CABLE ..... \$15.95



CBL-PRNTR-RA RIGHT ANGLE PRINTER CABLE ..... \$15.95  
CBL-DB25-MM DB25 MALE-DB25 MALE 6 FT. .... \$9.95  
CBL-DB25-MF DB25 MALE-DB25 FEMALE 6 FT. .... \$9.95  
CBL-9-SERIAL DB9 FEMALE-DB25 MALE 6 FT. .... \$6.95  
CBL-CNT-MM 36-PIN CENTRONICS/M/M ..... \$14.95  
CBL-KBD-EXT KEYBOARD EXTENSION ..... \$7.95  
CBL-MNT-9 9-PIN MONITOR EXTENSION ..... \$6.95

MANY MORE AVAILABLE—CALL US!

### SLIM GENDER CHANGERS

GENDER-25MM DB25 MALE/MALE ..... \$4.49  
GENDER-25FF DB25 FEMALE/FEMALE ..... \$4.49  
GENDER-9MM DB9 MALE/MALE ..... \$3.95  
GENDER-9FF DB9 FEMALE/FEMALE ..... \$3.95  
GENDER-VGA DB9-HIGH DENSITY DB15 ADAPTOR ..... \$4.95  
GENDER-9-25 DB9 TO DB25 SERIAL ADAPTOR ..... \$4.95  
GENDER-NM NULL MODEM ADAPTOR DB25P-DP25S ..... \$4.95

MANY MORE AVAILABLE—CALL US!

### BREAKOUT BOXES

RS-232 BOX W/24 SWITCHES, 12 LINE MONITORS • 10 BI-POLAR LEADS; JUMPER WIRES  
BRBOX-80 ..... \$34.95



### DATA SWITCHBOXES

RSS-2 2-WAY DB25S ..... \$24.95  
RSS-3 3-WAY DB25S ..... \$27.95  
RSS-4 4-WAY DB25S ..... \$29.95  
RSP-2 2-WAY FEMALE CEN36 ..... \$24.95  
RSP-3 3-WAY FEMALE CEN36 ..... \$27.95  
RSP-4 4-WAY FEMALE CEN36 ..... \$29.95  
RS9-2 2-WAY DB9S ..... \$24.95  
RS9-4 4-WAY DB9S ..... \$29.95  
RSS-XSERIAL CROSSOVER ..... \$29.95  
RSP-XPARALLEL CROSSOVER \$29.95



LET TWO OR MORE PC'S USE SAME DEVICE OR VICE-VERSA

MANY MORE AVAILABLE—CALL US!

### PROTOTYPE CARDS



#### 8-BIT SOLDERLESS8088 BREADBOARD WITH DECODE \$79.95

• ADDRESS DECODING LOGIC, DATA BUFFERING, 2 LSI CIRCUITS FOR PROGRAMMABLE DIGITAL I/O & COUNTER-TIMER FUNCTIONS • LOGICALLY GROUPED • ACCESS ALL 82 I/O SIGNAL CONNECTIONS • CLEARLY LABELLED BUS LINES  
• ACCEPTS UP TO 24 FOURTEEN-PIN ICS ACCEPTS 9, 15, 25 OR 37-PIN D-SUB CONNECTORS

PDS-501 ..... \$79.95  
PDS-600 ABOVE CARD WITHOUT DECODE ..... \$49.9  
PDS-611 16-BIT BUS BREADBOARD WITH DECODE ..... \$89.95  
PDS-610 ABOVE CARD WITHOUT DECODE ..... \$59.95



JDR-PR1

#### MORE PROTOTYPE CARDS:

FR-4 EPOXY GLASS LAMINATE WITH GOLD-PLATED EDGE-CARD FINGERS AND SILK-SCREENED LEGENDS  
JDR-PR1 8-BIT WITH +5V AND GROUND PLANE ..... \$27.95  
JDR-PR2 AS ABOVE, WITH I/O DECODING LAYOUT .. \$29.95  
JDR-PR2-PK PR2 BUFFERING/DECODE PARTS KIT ... \$8.95  
JDR-PR10 16-BIT WITH I/O DECODING LAYOUT ..... \$34.95  
JDR-PR10-PK PR10 BUFFERING/DECODE PARTS ... \$12.95  
JDR-PR16 16-BIT WITH I/O DECODING FOR PS/2 .... \$49.95  
JDR-PR16PK PR16 PARTS KIT ..... \$15.95  
EXT-8088 8088-COMPATIBLE EXTENDER CARD ..... \$29.95  
EXT-80286 286-COMPATIBLE EXTENDER CARD ..... \$39.95

### PCODE DIAGNOSES SYSTEM PROBLEMS! \$49.95

TO DIAGNOSE, PLUG IT INTO A CARD SLOT, READ THE INDICATOR DISPLAY & CHECK THE MANUAL FOR THE CORRESPONDING POWER-ON SELF-TEST CODE SWITCHLESS AND JUMPERLESS DESIGN. COMPATIBLE WITH 80286 AND 80386 BASED SYSTEMS.  
PCODE ..... \$49.95

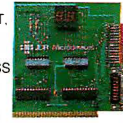

Once again software is driving hardware technology. Just as Lotus 123 drove sales of the Hercules Graphics Card, Windows 3.0 is creating demand for lower cost high resolution color displays. It is my observation that as sales increase in our industry, prices go down.

In the past year, standards have been created for display resolution. They have improved the display clarity 2.5 times over VGA, 3.5 times over EGA, and 12 times over the original color display. Along with stabilizing the technology, the standards simplified the work for software developers.

Not too long ago a work station with color resolution of 1024 x 768 could cost \$50,000 and would only run a few dedicated tasks at that resolution. Now programs in every major application put an emphasis on superb color displays.

Consider your next investment in display technology carefully. Even if your processing needs are moderate, the programs you buy from now on will probably take advantage of the new high resolution displays.

Derick Moore, Director of Engineering.

For more technical information, order the new JDR 1991 catalog

TERMS: Minimum order \$10.00. For shipping & handling include \$5.00 for ground and \$7.50 for air. Orders over 1 lb. and foreign orders may require additional shipping charges—contact our Sales Dept. for the amount. CA residents must include applicable sales tax. Prices subject to change without notice. We are not responsible for typographical errors. We reserve the right to limit quantities and to substitute manufacturer. All merchandise available to prior sales. A full copy of our terms is available upon request. Items pictured may only be representative. JDR, the JDR logo, JDR Microdevices, and the MCT logo are registered trademarks of JDR MICRODEVICES, INC. Modular Circuit Technology, Littlefoot, Minifoot and Superfoot are trademarks of JDR MICRODEVICES, INC. Copyright 1991 JDR MICRODEVICES.

KEY CODE #1014

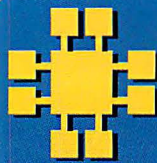

# JDR Microdevices®

ORDER TOLL-FREE 800-538-5000 KEY CODE 10

BUY WITH CONFIDENCE FROM JDR!

- 30-DAY MONEY BACK GUARANTEE
- 1 YEAR WARRANTY
- TOLL-FREE TECH SUPPORT



## YOUR MOTHERBOARD CONNECTION!

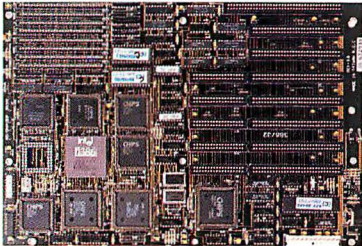

### MINI 25MHz 386 **\$799**

• NORTON SI 23.0 • LANDMARK AT SPEED 26.3

"THE FASTEST NON-CACHING MOTHERBOARD THAT WE TESTED." — BYTE MAGAZINE, APRIL 1990.

- MEMORY INTERLEAVING FOR NEAR ZERO WAIT STATES
- SOCKETED FOR 80387 CO-PROCESSOR • USES 80NS 256K OR 1MB SIMMS • 16MB RAM CAPACITY: 8MB ON BOARD, 8MB USING OPTIONAL RAM CARD (OKB INSTALLED) • FIVE 16-BIT SLOTS, TWO 8-BIT SLOTS, ONE 32-BIT SLOT FOR PROPRIETARY RAM CARD

MCT-M386-25 ..... \$799.00

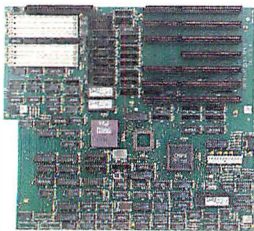

### 33MHz CACHE 386 **\$1195**

• NORTON SI 45.9 • LANDMARK AT SPEED 50.8

- 33MHz 80386 CPU • 64K ZERO WAIT STATE RAM CACHE
- EXPANDABLE TO 16MB ON BOARD USING 80NS 256K OR 1MB SIMMS (OKB INSTALLED) • SOCKETED FOR 80387-33 OR WEITEK MATH CO-PROCESSOR • 8 16-BIT EXPANSION SLOTS
- AMI BIOS ASSURES IBM COMPATIBILITY • 8/33MHz KEYBOARD ADJUSTABLE SPEEDS

MCT-386MBC-33 ..... \$1195.00

MCT-386MBC-25 25MHz VERSION ..... \$999.00

### NEW! CACHE 486 **\$2495**

• LANDMARK AT SPEED 114.5

- HIGH-PERFORMANCE STANDARD SIZE MOTHERBOARD FOR CAD/CAM/CAE WORKSTATION TASKS, LAN SERVER APPLICATIONS, MULTITASKING, MULTI-USER OR UNIX APPLICATIONS • INTEL 80486-25 CPU WITH INTERNAL 80387 FPU AND 8K CACHE • 128K CACHE MEMORY ON BOARD
- EXPANDABLE TO 16MB ON BOARD USING 1MB X 9 SIMMS OR 256K X 9 SIMMS (OKB INSTALLED) • SOCKETED FOR WEITEK 4167 MATH CO-PROCESSOR • EIGHT 16-BIT BUS SLOTS
- AMI BIOS • SOFTWARE SELECTABLE SPEEDS • FULLY COMPATIBLE WITH OS/2, NOVELL, DESQVIEW, UNIX, WINDOWS AND WINDOWS 3.0

MCT-486MB25 ..... \$2,495.00

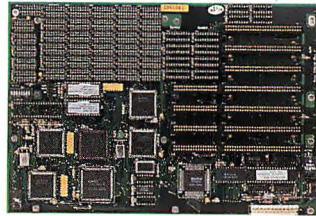

### 12MHz 286 **\$199.95**

• NORTON SI 14.0 • LANDMARK AT SPEED 15.9

- 12/6MHz KEYBOARD SELECTABLE SPEEDS • EXPANDABLE TO 4MB ON BOARD USING 80NS 256K OR 1 MB SIMMS (OKB INSTALLED) • FIVE 16-BIT, AND THREE 8-BIT SLOTS
- AMI BIOS • SOCKETED FOR 80287 MATH CO-PROCESSOR

MCT-M286-12 ..... \$199.95

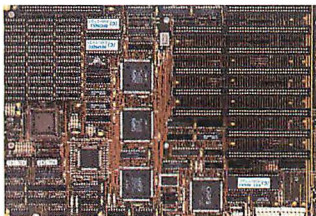

### 16MHz MINI 386-SX **\$399.95**

• NORTON SI 15.3 • LANDMARK AT SPEED 20.8

- USES 16MHz INTEL 80386SX CPU • EXPANDABLE TO 8MB ON BOARD • AMI BIOS • CHOOSE FAST 0 WAIT STATE OR 1 WAIT STATE FOR ECONOMICAL USE OF SLOWER RAM
- FIVE 16-BIT AND THREE 8-BIT EXPANSION SLOTS • CHIPS & TECHNOLOGY NEW ENHANCED ADVANCED TECHNOLOGY (NEAT) CHIPSET • SOCKET FOR 80387SX-16 CO-PROCESSOR
- 8.5" X 13" SIZE FITS IN MINI-286 AND FULL-SIZE 286 CASES

MCT-386SX ..... \$399.95

MCT-386SX-20 20MHz VERSION ..... \$499.95

### 20MHz NEAT 286 **\$389.95**

• NORTON SI 21.0 • LANDMARK AT SPEED 26.3

- EXPANDABLE FROM 8MB ON BOARD • 20/10MHz KEYBOARD SELECTABLE SPEEDS • AMI BIOS • CHIPS & TECHNOLOGY NEW ENHANCED ADVANCED TECHNOLOGY (NEAT) CHIPSET
- SHADOW RAM AND PAGE INTERLEAVED MEMORY • FAST 0 WAIT STATE OR 1 WAIT STATE FOR SLOWER RAM • FIVE 16-BIT AND THREE 8-BIT SLOTS • SOCKET FOR 80287-12 MATH CO-PROCESSOR

MCT-M286-20N ..... \$389.95

MCT-M286-16N 16MHz 286/NEAT CHIPSET ..... \$289.95

MCT-M286-12N 12MHz 286/NEAT CHIPSET ..... \$269.95

### 10MHz 8088 NORTON SI2.1 **\$99.95**

- 8088-COMPATIBLE; OPERATES AT 4.77/10MHz
- KEYBOARD SELECTABLE CLOCK SPEEDS • SOCKET FOR 8087-1 CO-PROCESSOR • 8 SLOTS • MCT BIOS • 640K RAM CAPACITY (OKB INSTALLED)

MCT-TURBO-10 ..... \$99.95

## MONITORS

### NEC-MULTI-3D **\$649**

• 1024X768 RESOLUTION • 28MM DOT PITCH • COMPATIBLE WITH 8514A, SUPER VGA, APPLE MAC II, VGA, EGA & CGA

NEC-MULTI-3D ..... \$649.00

JDR-MULTI MULTISYNCH MONITOR ..... \$429.95

CM-1440 SEIKO DUAL FIXED FREQUENCY ..... \$599.00

CM-1450 SEIKO 15" DUAL FIXED FREQUENCY ..... \$749.00

VGA-MONITOR VGA MONITOR ..... \$379.95

MONO-VGA PAPERWHITE VGA MONITOR ..... \$139.95

EGA-MONITOR EGA MONITOR ..... \$339.95

GM-1489 14" SCREEN MONOCHROME ..... \$139.95

MONO-SAMSUNG 12" FLAT SCREEN ..... \$129.95

### VGA PACKAGE **\$499.95**

VGA COLOR AND CLARITY AT AN EGA PRICE! • 8/16 BIT VGA CARD IS COMPATIBLE WITH IBM

VGA • 640 X 480

RESOLUTION IN 16 COLORS

• HIGH RESOLUTION ANALOG

MONITOR • EGA/CGA/MONO AND

HERCULES COMPATIBLE • DRIVERS FOR WINDOWS, GEM,

LOTUS 1-2-3, SYMPHONY, AUTOCAD & VENTURA

VGA-PKG ..... \$499.95



CUSTOMER SERVICE  
TECHNICAL SUPPORT  
LOCAL/INTERNATIONAL  
FAX

800-538-5001  
800-538-5002  
408-559-1200  
408-559-0250

MON.-FRI. 7 A.M. TO 5 P.M., SATURDAY, 9 A.M. TO 3 P.M.

# ORDER TOLL-FREE 800-538-5000

KEY CODE #1014

## INPUT DEVICES



101-KEY **\$69.95**

- 101-KEY WITH 12 FUNCTION KEYS • 286/386/486 COMPATIBLE
- BTC-5339 ..... \$69.95
- FC-3001 101-KEY, 12 F-KEYS & CALCULATOR ..... \$74.95
- BTC-5060 84-KEY WITH 10 FUNCTION KEYS ..... \$59.95

### DFI SCANNER & PC PAINTBRUSH **\$179.95**

- SCAN IMPAGES UP TO 4.1" WIDE AT 100, 200, 300 OR 400 DPI IN BOTH DIRECTIONS
- B&W, HALF-TONE (3 MODES); 32 GRAYSCALE LEVELS • HERCULES/CGA/EGA/VGA COMPATIBLE
- IMAGE EDITOR UTILITY • 8-BIT 8088 OR 286/386/486 COMPATIBLE CARD (NO SERIAL PORT REQ) • IMAGES TOOLS • PC PAINTBRUSH HS-3000 ..... \$179.95

### COLOR HAND SCANNER! **\$599**

- 400 DPI/16-COLOR DITHER MODE; 200 DPI/16-SHADE GRAY-SCALE MODE • MONO MODE FOR B&W LINE ART AT 100, 200, 300 OR 400 DPI
- ZSOFT PAINTBRUSH VI PLUS CHS4000 ..... \$599.00

### LOGITECH TRACKMAN **\$99.95**

- USES LESS SPACE BECAUSE IT'S STATIONARY! • RESOLUTION ADJUSTS TO 300 DPI • INCL MOUSEWARE UTILITIES, MENUS, MOUSE-2-3 • REQ. 256K MIN. MEMORY

TRACKMAN \$99.95

SERIAL VERSION—NO CARD REQ.

TRACKMAN-B \$95.95

BUS VERSION. INCL. SHORT BUS CARD FOR 8088, 286, 386

### LOGITECH MICE

- THREE-BUTTON SERIES 9
- 320 DPI RESOLUTION • SERIAL PS/2 COMPATIBLE
- LOGC9 SERIAL MOUSE ..... \$98.95
- LOGC9-P SERIAL MOUSE WITH PAINTSHOW ..... \$109.95
- \* LOGC9-CP SERIAL MOUSE WITH PAINTSHOW ..... \$89.95
- \* LOGC9-C SERIAL MOUSE ..... \$79.95
- LOGB9 BUS MOUSE ..... \$89.95
- LOGB9-P BUS MOUSE WITH PAINTSHOW ..... \$104.95
- \*NOT PS/2 COMPATIBLE

### 4800/2400 BPS FAX MODEM **\$119.95**

- 4800 BAUD GROUP III FAX TRANSMISSION ONLY • 2400 BPS DATA MODEM • W/MENU DRIVEN PROFAX SOFTWARE
- SENDS DOS TEXT, PCX & TIFF FILES TO FAX TRANS.

MCT-FAXM ..... \$119.95

MCT-241 INTERNAL 2400 BAUD DATA MODEM ..... \$89.95

### VIVA 2400 BAUD MODEM **\$119.95**

- 2400/1200/300 BAUD OPERATION • HAYES AT COMMAND SET COMPAT. • EXTENDED S-REGISTER PROGRAMMING • SPEAKER
- 2ND PHONE JACK • AUTO DIAL TONE/REDIAL • STD. RS-232C INTERFACE

VIVA-24E ..... \$119.95

VIVA-24MNP ..... \$149.95

ERROR CORRECTING VERSION

### FAX/PHONE SWITCHER

ROUTES CALLS FROM 1 PHONE LINE TO YOUR FAX, MODEM AND ANSWERING MACHINE! • OPERATES ON SINGLE OR MULTI-LINE SYSTEMS • AUXILIARY PORT

FAXM-SWITCH ..... \$109.95



# JDR Microdevices®

2233 BRANHAM LANE, SAN JOSE CA 95124

BUY WITH CONFIDENCE FROM JDR!

- 30-DAY MONEY BACK GUARANTEE
- 1 YEAR WARRANTY
- TOLL-FREE TECH SUPPORT



## UPRIGHT CASE

**\$249<sup>95</sup>**

- FOR STANDARD, FULL SIZE AND MINI-MOTHERBOARDS
- 250WATT POWER SUPPLY
- MOUNTS FOR 3 FLOPPY AND 4 HARD DRIVES
- TURBO AND RESET SWITCHES
- SPEED DISPLAY, POWER, DISK LEDS
- MOUNTING HARDWARE, FACEPLATES AND SPEAKER INCL.



### MORE CASES...

- CASE-200 UPRIGHT HOLDS 11 DRIVES ..... \$499.95
- CASE-120 MINI-UPRIGHT W/200 WATT PS ..... \$199.95
- CASE-70 FULL SIZE 286 STYLE CASE ..... \$89.95
- CASE-50 MINI-SIZE 286 STYLE CASE ..... \$59.95
- CASE-FLIP FLIP-TOP XT-STYLE CASE ..... \$39.95
- CASE-SLIDE SLIDE TYPE XT-STYLE CASE ..... \$39.95
- CASE-JR MINI SIZE CASE WITH 150W PS ..... \$149.95
- CASE-JR-200 MINI SIZE CASE WITH 200W PS ..... \$189.95

## REMOVABLE HARD DISK RACK \$69<sup>95</sup>



- FIXED RACK MOUNTS IN STD. 5.25" DRIVE SLOT
- REMOVABLE TRAY FITS STD. 3.5" DRIVE FOR ST-506 INTERFACE HARD DRIVES
- CABLES & CONNECTORS

**\$99<sup>95</sup>**

## 1.44MB 3-1/2" DRIVE



- 80 TRACKS • 135 TPI • HIGH DENSITY
  - READ/WRITE 720K DISKS, TOO
  - INCLUDES ALL NECESSARY MOUNTING HARDWARE
- FDD-1.44X BLACK FACEPLATE ..... \$99.95
  - FDD-1.44A BEIGE FACEPLATE ..... \$99.95
  - FDD-1.44SOFT SOFTWARE DRIVER ..... \$19.95
  - MF355A 3-1/2" MITSUBISHI 1.44MB, BEIGE ..... \$129.95
  - MF355X 3-1/2" MITSUBISHI 1.44MB, BLACK ..... \$129.95
  - FDD-360 5-1/4" DOUBLE-SIDED DD 360K ..... \$69.95
  - FD-55B 5-1/4" TEAC DOUBLE-SIDED DD 360K ..... \$89.95
  - FDD-1.2 5-1/4" DOUBLE-SIDED HD 1.2M ..... \$89.95
  - FD-55GFV 5-1/4" TEAC DOUBLE-SIDED HD 1.2M ..... \$99.95

"Thanks again for the high quality your company provides."

—D. DuBois, San Jose, CA

## Seagate HARD DRIVE KITS

20 MB **\$249** 30 MB **\$279**

KITS INCLUDE HARD DRIVE, DRIVE CONTROLLER, CABLES & MANUAL

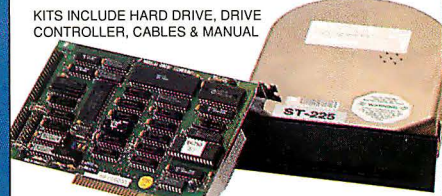

## Seagate HARD DRIVES

21 MB **\$199** 65 MB **\$349**  
 32 MB **\$219** 84 MB **\$449**  
 42 MB **\$299** 122 MB **\$699**

FORM	MODEL #	STORAGE	FORMAT	AVG. SPEED	PRICE
5-1/4"	ST-225N	21.3MB	SCSI	65MS	\$279
5-1/4"	ST-225	21.4MB	MFM	65MS	\$199
3-1/2"	ST-125	21.4MB	MFM	40MS	\$259
3-1/2"	ST-125A	21.4MB	IDE	28MS	\$259
3-1/2"	ST-125N	21.4MB	SCSI	40MS	\$299
3-1/2"	ST-138	32.1MB	MFM	40MS	\$269
3-1/2"	ST-138R	32.1MB	RLL	40MS	\$289
3-1/2"	ST-138A	32.1MB	IDE	28MS	\$269
3-1/2"	ST-138N	32.1MB	SCSI	40MS	\$299
5-1/4"	ST-238	32.7MB	RLL	65MS	\$219
5-1/4"	ST-251N	42.8MB	SCSI	40MS	\$399
5-1/4"	ST-251-1	43.1MB	MPM	28MS	\$299
3-1/2"	ST-157A	48.6MB	IDE	28MS	\$299
3-1/2"	ST-157N	48.6MB	SCSI	40MS	\$359
5-1/4"	ST-277N-1	64.9MB	SCSI	28MS	\$439
5-1/4"	ST-277-1	65.5MB	RLL	28MS	\$349
5-1/4"	ST-4096	80.2MB	MFM	28MS	\$569
5-1/4"	ST-296N	84.9MB	SCSI	28MS	\$449
5-1/4"	ST-4144R	122.7MB	RLL	28MS	\$699
3-1/2"	ST-1144A	125MB	IDE	19MS	\$649
3-1/2"	ST-1201A	180MB	IDE	15MS	\$799

## POWER SUPPLIES



**135 WATT FOR 8088 \$59<sup>95</sup>**

- PS-135 135 WATT FOR 8088 - U.L. APPROVED ..... \$59.95
- PS-150 150 WATT FOR 8088 - U.L. APPROVED ..... \$69.95
- PS-200X 200 WATT FOR 8088 - U.L. APPROVED ..... \$89.95
- PS-200 200 WATT FOR 286/386 - U.L. APPROVED ..... \$89.95
- PS-250 250 WATT FOR 286/386 ..... \$129.95

## MODULAR CIRCUIT TECHNOLOGY INTERFACE CARDS

### DRIVE CONTROLLERS

1.44MB FLOPPY **\$49<sup>95</sup>**

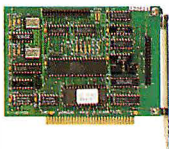

- 8088/286 COMPATIBLE
- SUPPORTS 2 FLOPPIES (360K, 720K, 1.2MB & 1.44MB)
- USER SELECT AS PRIMARY OR 2ND (3RD OR 4TH) FLOPPY
- MCT-FDC-HD ..... \$49.95

### HIGH DENSITY 4-FLOPPY CARD \$59.95

- INTERFACES UP TO 4 FLOPPY DRIVES • CABLES FOR 4 INTERNAL DRIVES • BIOS FOR ANY COMBO OF DRIVES
- MCT-FDC-HD4

### FLOPPY DISK CONTROLLER \$29.95

- INTERFACES UP TO 4 360K/720K FLOPPY DRIVES
- DB37 CONNECTOR FOR EXTERNAL DRIVES
- MCT-FDC

### HARD DISK CONTROLLER \$79.95

- SUPPORTS 16 DRIVE SIZES INCLUDING 10, 20, 30 AND 40MB • CAN DIVIDE 1 LARGE DRIVE INTO 2 LOGICAL DRIVES
- MCT-HDC
- MCT-RLL RLL CARD SUPPORTS 2 RLL DRIVES ..... \$89.95

### 16-BIT FLOPPY/HARD \$149.95

- 1:1 INTERLEAVE FOR IMPROVED PERFORMANCE
- CONTROLS 2 HARD & 2 FLOPPY DRIVES (360K/720K/1.2MB/1.44MB) • CONCURRENTLY USE HARD AND FLOPPY DRIVES
- MCT-FAFH
- MCT-AFH-RLL 16-BIT F/H RLL CONTROLLER ..... \$199.95

### 16-BIT IDE MULTI-IO \$89.95

- SUPPORTS 2 IDE HARD DRIVES & 2 FLOPPIES • 2 SERIAL & 1 PARALLEL PORT • SUPPORTS COM 1 & 2, LPT 1, 2 OR 3
- MCT-IDEIO

### DISPLAY CARDS

#### MONO GRAPHICS/PRINTER \$49.95

- 8088 OR 286/386/486 COMPATIBLE • HERCULES COMPATIBLE MONOGRAPHS • SUPPORTS LOTUS 1-2-3 • 720 X 348 DISPLAY • ADDRESS PARALLEL PRINTER PORT AS LPT1 OR 2
- MCT-MGP
- MCT-CGP CGA GRAPHICS FOR RGB MONITOR ..... \$49.95
- MCT-EGA EGA CARD WITH 256K RAM ..... \$149.95

### MULTIFUNCTION I/O CARDS

#### MULTI I/O CARD \$59.95

- SERIAL PORT • CLOCK/CALENDAR WITH BATTERY
- PARALLEL PORT IS ADDRESSABLE AS LPT1 OR LPT2
- MCT-IO

#### MULTI I/O FLOPPY \$79.95

- SUPPORTS UP TO 2 360K FLOPPIES
- SERIAL, PARALLEL, GAME PORT AND CLOCK/CALENDAR
- MCT-MIO

#### 16-BIT MULTI I/O CARD \$59.95

- SERIAL, PARALLEL AND GAME PORTS • USES 16450 SERIAL SUPPORT CHIPS FOR HIGH SPEED OPERATION
- MCT-AIO

#### 16-BIT ALL-IN-ONE-CARD \$129.95

- MONOCHROME GRAPHICS • SUPPORTS 2 IDE HARD DRIVES AND 2 FLOPPIES • 2 SERIAL AND 1 PARALLEL PORT
- MCT-MGEO

### MEMORY CARDS

#### 576K RAM CARD \$49.95

- USER SELECTABLE CONFIGURATION TO 576K • USES 64K AND 256K DRAMS (0K INSTALLED)
- MCT-RAM

#### 16-BIT EMS CARD \$129.95

- USER EXPANDABLE TO 2MB USING 1MB DRAMS • CONFORMS FULLY TO LIM EMS 3.2 • RAM DISK SOFTWARE
- MCT-AEMS ..... \$129.95
- MCT-AEMS-256 USES 41256 DRAMS ..... \$129.95
- MCT-EMS 8-BIT EMS CARD 2MB CAPACITY ..... \$129.95

#### 16-BIT EEMS CARD \$149.95

- EXPANDABLE TO 4MB USING 256K X 4 DRAMS IN INCREMENTS OF 512K • CONFORMS TO LIM 4.0
- MCT-EEMS

#### 8/16-BIT VGA \$149.95

- 8088 OR 286/386/486 PC COMPATIBLE • 800 X 600 IN 16 COLORS • 256K VIDEO RAM • SUPPORTS ANALOG AND TTL
- MCT-VGA
- MCT-VGA-8 8-BIT VERSION ..... \$149.95
- MCT-VGA-1024 1024 X 768 VGA ..... \$169.95
- MCT-VGA-1024+ 1024 X 768 IN 256 COLORS ..... \$199.95

## MICROPOLIS DRIVES

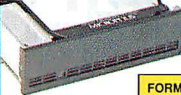

158 MB **\$949**

FORMAT CAPACITY	MODEL	AVE. SPEED	INTER-FACE	PRICE
• HALF-HEIGHT DRIVES -14-16 MS AVG. ACCESS TIMES -10MB/S TRANSFER RATE	161MB	1654	16MS	ESDI \$899
• FULL HT. DRIVE	158MB	1674	16MS	SCSI \$949
	345MB	1664	14MS	ESDI \$1449
	340MB	1684	14MS	SCSI \$1449
	676MB	1568*	16MS	ESDI \$2195
	668MB	1588*	16MS	SCSI \$2195
	1,034MB	1598*	14MS	SCSI \$3995

## BARGAIN HUNTER'S CORNER

### MICROPOLIS 157.5MB EASI HARD DRIVE KIT

**\$849**

- FULL HEIGHT 5-1/4" DRIVE WITH ESDI INTERFACE
- WESTERN DIGITAL WD1007-WA2 ESDI FLOPPY/HARD CONTROLLER WITH 1:1 INTERLEAVE AND LOOK-AHEAD CACHING • 23MS AVG. SPEED • 10MB/SECOND TRANSFER RATE • DRIVER SOFTWARE FOR NOVELL NETWORK 286 • INCLUDES MOUNTING HARDWARE AND EASY INSTALLATION GUIDE
- 1355-PKG LIMITED TO SUPPLY ON HAND EXPIRES 2/28/91

VISA  
MasterCard  
CUSTOMER SERVICE 800-538-5001  
TECHNICAL SUPPORT 800-538-5002  
LOCAL/INTERNATIONAL 408-559-1200  
FAX 408-559-0250

MON.-FRI. 7 A.M. TO 5 P.M., SATURDAY, 9 A.M. TO 3 P.M.

**ORDER TOLL-FREE 800-538-5000**

KEY CODE #1014

# CHAOS MANOR MAIL

*Jerry Pournelle answers questions about his column  
and related computer topics*

## Read to Me

Dear Jerry,

You've written about CD-ROM text, but I have never seen anyone discuss what I think is the next inevitable step: creating audio output of text on compact discs. I know there is such a thing for the blind, but I am talking about audio output for anyone who likes to be read to. Fairly sophisticated but not unreasonably expensive circuitry could be developed to enable people to put, say, the works of Homer and the Greek tragedians on a disc. You would be able to relax and be read to by the computer in excellent stereo sound. Maybe there could be some hypertext information about the history of the geographic area and maps and such, but the primary function of the disc would be to read to an individual.

I have always thought that, for "creative" reading, the very act of forcing my eyes across the page was detrimental to comprehension. I have always loved to be able to lean back and watch the action take place on the screen of my mind while I am read to, and I think a lot of other people feel the same way.

Sophisticated algorithms could capture inflections—the voice going down at the end of a sentence and up when there is a question mark. In the technology's infancy, you could manually enter inflections, stage directions, and any other necessary information with a joystick. In the future, as the technology matures, end-user software could let users tailor their programs to whatever level they want.

For the plays of Shakespeare, you could assign a particular type of voice to each member of the cast and include sound effects and music. A complete list of archaic terms and puns could appear on the screen beneath the spoken text. This would make certain discs more expensive, but they would be the exception. What I envision is a large body of work on discs with a voice ready to read any work at whatever speed the listener chooses.

People could also scan in documents themselves to make their own talking

books. This would certainly change a lot of the copyright laws, since it will be much easier to pirate books.

It would be easy to download E-mail and tape it to play on the stereo on the drive home. People who get volumes of E-mail on BBSes would be able to tape it and "read" their mail any time they could get to a stereo.

Right now, people don't see the point of transferring text to computer screens. This killer application would be a major force in making CD-ROMs an effective and necessary tool for the future.

Richard Hein  
New York, NY

*Well, I used to like to be read to also; perhaps you're right. I think I have seen some CDs of audio text, though.*

*However, I see what you're after. I know there are speech synthesizers that work fine reading the screen to people. Hmm.—Jerry*

## The Visually Impaired

Dear Jerry,

As regards Arni Fredrickson's letter (June 1990) and the choice of a computer for a person who is visually impaired, I suggest that Fredrickson's cousin first select his software and then choose the hardware.

It appears to be an unfortunate fact of life that eyesight problems get worse with age rather than better. Eventually, people with severe visual impairments may need to add speech systems to their machines, and they may find that they cope best with a combination screen reader and large display.

More software for the visually impaired (and associated add-in speech boards) seems available for PCs than for Macs, although a reasonable number of Apple II packages are also around. One popular item is the VERT system (Telesensory Systems, P.O. Box 7455, Mountain View, CA 94039), which reads the screen in an intelligent manner. *Intelligent* is the operative word here; it is no good having a screen reader that reads a row in Lotus 1-2-3 as "Five one one two

three point seven four one four point four zero" when the spreadsheet contains the values 112 and 3.7 and a formula that produced a value of 414.40 in cells A5 to C5.

Another factor involved in choosing a system is to remember that the Mac is a graphical user interface-oriented system. The visually impaired user with a screen reader generally prefers to stick with text-based systems, and PCs seem to provide the requisite capabilities at reasonable cost. There's not much need for these people to consider an upgrade next year to OS/2 or Windows. How would a speech system describe such screens? For these people, 8088 or 286 systems do nicely—although I would not recommend an 8088 machine unless money was a severe constraint.

Ironically, a VGA display card might be a better option than, say, a monochrome Hercules card. A Hercules card would be fine except that it doesn't support 40-column mode, which people with very limited vision can sometimes use to good effect with DOS commands. CGA or EGA cards would probably meet resolution requirements for those who need large-text displays, but VGA card prices have come down in recent months to the point where it doesn't make much sense to buy CGA or EGA.

Visually impaired students in my computer science classes at St. Johns River Community College in Florida generally opt for 12-MHz AT clones with 40-MB hard disk drives and VGA cards.

I suggest that Fredrickson's cousin contact local colleges, users groups, and agencies that provide services for the visually impaired so as to meet other people in similar situations. They should provide good practical advice on equipment and programs, because most blind and visually impaired people find computers almost essential in their daily lives.

Also, the National Federation of the Blind (1800 Johnson St., Baltimore, MD 21230), through its Job Opportunities for the Blind program, publishes a document titled *A Review of Speech and Braille*

*Software/Hardware Systems Designed to Permit Blind Persons to Access the Video Display of an IBM PC Computer (PC)* for those considering screen readers.

James M. Kennedy  
St. Augustine, FL

Thanks.—Jerry

### Quick/Turbo COBOL

Dear Jerry,

I have been reading and enjoying your columns for many years. I particularly appreciate your perspectives on education and American technological and industrial policies as they relate to our international competitiveness and productivity. Because these sorts of topics seem to be of interest to you, I am writing to share an opinion with you and perhaps get your perspective on my views.

For most of the 1980s, I have been employed as a mainframe programmer/analyst for a major university. During the same time period, I have been a PC enthusiast and have devoted countless hours to using and learning dozens of software packages for the PC. But the one capability on PCs that has consistently eluded me is the ability to readily program sophisticated applications in a high-level language.

This is not for lack of trying. I have bought and/or used dBASE III Plus, Turbo Basic, QuickBASIC, Turbo C, and Turbo Pascal. I have written quite a few minor programs for my own use in these languages, and they've worked fine. Indeed, they are wonderful languages and programming environments. But I have never been able to convince myself that these languages were what I wanted or needed to develop a large PC-based database system.

I've only recently admitted to myself the real reason for my reluctance to get deeply involved in any of these languages, although it's obvious. The reason is that my "native language"—the high-level language I use all day, every day, five days a week, 49 weeks a year—is COBOL. And I like it.

All these years, I've accepted as un-

fortunate but inevitable that COBOL is somehow too old-fashioned, too stodgy, or too something to be available for the PC. I know that Microsoft, MicroFocus, and Realia have COBOL products, but they are way too expensive and seem to be totally oriented toward giving mainframe shops the tools to offload mainframe development work onto PCs.

At the same time, I've wondered why companies such as Microsoft and Borland haven't done for COBOL what they have done for BASIC, C, and Pascal. ANSI COBOL '85 certainly lacks nothing in features or power, having adopted many of the more "modern" features of Pascal and C, and it always had a more robust file- and record-handling capability than any of these other languages. Not to mention its portability, self-documenting qualities, and all the other features that have made it the number-one high-level programming language in the world for over 30 years.

Either I'm missing something, or the powers that be in the PC world have deliberately chosen to ignore a vast resource pool of trained, experienced programming talent in developing these other languages. I think it's wonderful that Quick and Turbo Pascal, C, and BASIC have been developed, but it does elude me why BASIC is considered "rehabilitable" and COBOL apparently is not, given the far larger and generally more highly trained group of people who program primarily in COBOL, as opposed to those who program in BASIC.

I guess the assumption is that professional programmers are good at learning symbolic languages, so if you know COBOL, you can learn another language, too. And that's what we COBOL programmers have been doing for the past 10 years. But what a waste of the years of training and experience we've already accrued! For there is no way that one's skill at a language learned haphazardly on evenings and weekends can compare to the skill one develops using a language 40 hours a week.

The oddest thing is that I believe that if a Quick or Turbo version of COBOL

were developed by Microsoft or Borland and a comparable amount of advertising were devoted to pitching the product, along with a certain amount of high-level enthusiasm for the notion that programming in COBOL is a respectable activity, the product would likely be a smash hit in the marketplace. I may be wrong, but I'll bet there are many tens of thousands of professional COBOL programmers who would throw all their other Quick/Turbo PC languages in the trash and leap to buy COBOL, if a decent one were available. I know I would.

When a language like BASIC can be provided in a package with an integrated development environment, high-speed optimizing compiler, links to other languages, on-line help, space-age graphics, and all the other gee-whiz stuff that has come out in the past few years, there is no longer a reason why the millions of us from the mainframe world need to continue to be disenfranchised from being able to apply our skills in our native language in the realm of desktop computing. As the distinctions between the two computing realms continue to blur and overlap, this will become more true.

I would appreciate your thoughts on this subject. Thanks for your attention.

R. Wayne Parker  
Seattle, WA

*You know, I often wonder why there isn't a "quick" COBOL, too. Although I'm not so sure it would be as beneficial as you think, it is an opportunity.*

*I suppose my thinking is colored by Alex's phrase, Completely Obsolete Bad Old Language...*

*And, of course, I never learned it.*

*We are getting some of the tools you want for BASIC and Modula-2 and Pascal, though.—Jerry*

---

*Jerry Pournelle holds a doctorate in psychology and is a science fiction writer who also earns a comfortable living writing about computers present and future. He can be reached c/o BYTE, One Phoenix Mill Lane, Peterborough, NH 03458, or on BIX as "jerryyp."*

# PRINT QUEUE

Hugh Kenner

## Never-Never Land

*Computer simulations of bees? Frozen heads?  
What will those transhumanists think of next?*

In Samuel Butler's *Erewhon* (1872), disease is equated with crime; also, machines are taboo. Victorian machines, of course, competed with humans: They spun, wove, set type. But today's machines do much that humans can't, such as whooshing folk to Paris as they page through the latest BYTE. Humans merely restricted by their bodies, it grows easy to think, are nowadays plain incompetent, not to say underprivileged.

Human minds, though, working in ways that gave Butler pause—well, Ed Regis has a history of fascination with those. In *Who Got Einstein's Office?* (1987), he took readers on a lighthearted if somewhat skewed tour of the Institute for Advanced Study at Princeton. Now, in *Great Mambo Chicken & the Transhuman Condition* (Addison-Wesley, 1990, \$18.95) he's dealing with "the never-never land where science and lunacy collide." That wording is from a blurb by James (Chaos) Gleick, who goes on about "a place where building bacteria-size robots, tinkering with antigravity, and freezing human heads is all in a day's work." Also, Harvard's Nobel Laureate Sheldon Glashow calls *Great Mambo Chicken* "the first true 'unification' of science fact and fiction," and Timothy Leary, as often, can't contain himself: "I love it!"

Such enthusiasms, arrayed around a photo of the author looking askance at a fat white hen, may well arouse misgivings. But misgivings are unlikely to survive 10 minutes with the lively Regis prose. As a spectator of unlikely goings-on, he's Butler's worthy successor. Here's his opening paragraph:

"When Saul Kent had the suspension team at the Alcor Life Extension Foundation in Riverside, California, surgically remove the head of Dora Kent, Saul's mother, from her body, his hope was that she could eventually be restored to life and health, probably even youth. The last thing on

his mind was that they'd all wind up being investigated for murder."

The italicized word—that's a Regis mannerism; it denotes someone speaking under stress, also someone a little out of touch. Lopped heads, in the usual world, lead straight to murder charges, no question of that. But not in Saul Kent's expectations. And—"surgically remove the head": Has such a phrase ever appeared in print before? "Surgically!" Are normal surgeons head-removers? Regis has invented, and in this book is perfecting, a tone in which to discuss bizarre goings-on indeed. They have, yes, their rationale; though, no, it's not a rationale we're used to.

Let's draw back from surgical decapitations (elsewhere called "a rapid conversion to neuropreservation... using a high-speed electric chain saw") to enter the world of this book a bit more gently. About 1985, Dave Criswell had an idea for dismantling the sun to obtain a resource. And was that, asks Regis, "anything more than a large-scale extension of the schemes that had been proposed for the natural features of the earth?" He adduces things that people have wanted to do with icebergs: Make them into unsinkable aircraft carriers (*that* idea got as far as a prototype during World War II), or "tow them to Africa and melt them down for water" (that held allure as late as 1974).

As for Africa, couldn't the discharge of the Rhône be carried across the Mediterranean in a huge plastic pipe? Nothing came, either, of that 1975 proposal; but by 1983, "an enormous tube from the Amazon River, in South America, to the Sahara Desert, in Africa" was being proposed. It could be "150 feet in diameter, made of rubber or rubber-like plastic, held in place on the sea bottom by a cement ballast." Nothing came of that, either. But, heck, hadn't a transatlantic cable been laid as far back as the 1860s? So



what's the *matter* with everybody?

Also, how about damming the Straits of Gibraltar, and then draining enough of that puddle east of the dam (aka the Mediterranean) to give Europeans more living space? Crazy? Well, at this moment, half the population of Holland lives on land reclaimed from the North Sea. An odd experience Holland can offer is the sight of an ocean-size ship passing way above your head. For the Dutch it's commonplace.

So deciding—a priori—what's feasible, what isn't, is far from foolproof. Pointless to call a scheme "crazy." Those Dutch dams were "crazy." Now what was it Criswell had proposed? Saving lost solar stuff? Well, "All those high-quality photons and valuable solar element abundances, all of them winging their way off to nowhere and being lost forever"—what are those but raw material, like, say, Antarctic ice? Conserving them, though, means higher tech than simply building dikes. So—surround the sun with a gigantic circle of linked particle accelerators! Beams fired through those could tighten and loosen the belt in pulsating waves—like "a rubber band squeezing the sun at its equator and pushing solar plasma off toward the sun's poles, where it would fly off in spurts, as if through a rocket nozzle." That way, you'd be seeing celestial objects "for what they really were. . . gobs of brute matter awaiting intelligent transformation." Wow.

(You'd also be conserving the sun; a smaller sun could have a longer life span. So think of that as *stellar husbandry*. Wow.)

We're talking of a weighing of accident against design. "Should we humans be satisfied with what we'd been handed as the result of accidental circumstances, or should we go out and apply some critical intelligence, some engineering skill, some good old-fashioned hubristic science?" That buys, you'll notice, the paradigm that what's given at present is accident. God, who governed Western thought before—say—Darwin, has ceded place to a random-number generator. ("I believe," said Woody Allen, "in an intelligence pervading the universe, except for certain parts of New Jersey.") The protagonists of *Great Mambo Chicken* believe in no intelligence save their own.)

*Great Mambo Chicken*, by the way? Well, a man named Milt Smith at the University of California, Davis, wondered about prolonged greater-than-normal gravitational forces, and, noting that chickens (like humans) walk on two legs, he placed hundreds of chickens in huge centrifuges, where they lived in 2½ g's for months at a time. And lo, great mambo chickens strutted forth, low-fat, high heart-efficient, with three times the ability to do the work chickens do (beat wings, tromp treadmills). Good for what on 1-g earth? No one is saying. They do demonstrate that our technology can tamper with chickens.

And our 1-g earth seems not very smartly designed. Gravity holds the atmosphere to Earth's surface, yes; but the atmosphere of Mars has leaked away. Earth is simply lucky. Even so, earthlings are "gravitationally disadvantaged" once they essay space travel, which means "blasting out of our gravity well," a hole the depth of 600 Everests. You're thinking God could have been a tad more foresighted? Well, no; best think how much smarter are We than is Chance. For in the world of Chance, ours is the privilege of picking nits, dreaming up fixes. The amoeba is not so situated, nor is even the dolphin.

But back to the head of Dora Kent, since the classic misdesign is death, which was what the Alcor Life Extension Foundation hoped to exempt her from. She was 83 and "legally dead" when those surgeons removed her head. Maybe "a fresh, new body could be cloned from one of her old cells." Maybe her revived brain could be placed in that body; maybe she'd live a new life, perhaps hundreds, thousands, of years. Meanwhile, her head would rest in a tank of liquid nitrogen at -186°C,

**M**eanwhile,  
*beware of hype. Everything, it seems,  
is possible, as long as you don't  
demand to see and handle results.  
At an artificial life conference  
held last year, results were scanty.*

while science toiled away at the specifics.

Maybe. . . well—it's a long story—her head seems to have gotten lost. Scratch one resurrection.

Decades ago, Arthur C. Clarke inscribed Clarke's Law: "When a distinguished but elderly scientist states that something is possible, he is almost certainly right. When he states that something is impossible, he is very probably wrong." That would seem to imply that nothing is impossible. (Someone's counterexample: "Everest on roller skates.")

Meanwhile, beware of hype. Everything, it seems, is possible, as long as you don't demand to see and handle results. At an artificial life conference held last year in Santa Fe, results were scanty. Someone showed a videotape of a metal arm "juggling" a balloon. The balloon was attached to the arm by a piece of string. Discarding the string: That was said to be next on the research agenda. Thrillsville.

To the very first conference on artificial life, held three years earlier at Los Alamos, a lady from Holland had brought along "bioinformatic bumblebees." I do wish Regis had told us more about those, although from his wording one can guess that they were very likely computer simulations. The only hands-on working entities at that show seem to have been two little cars that sought light, moth-like. They seem trivial, not to say a long remove from a squeezing of hot solar matter out of the sun. But give the transhumanists a little time.

"Oh God! Oh Montreal!" was a phrase Sam Butler contributed to the rhetoric of bemused dismay. It popped into his head on finding a famous Greek statue stowed away in a Montreal attic as "indecent," and it's a useful phrase on occasions when plainer words fail. "O God! O Montreal!" Ed Regis's myriad-minded protagonists murmur, amazed that fellow humans put up with the lot that's dealt them. (Einstein, even, put up with that, and he's *dead*; cryonics subjects, more fortunate, are merely frozen). "O God! O Montreal!" may a reader well think, chin-deep in this broth of schemes and speculations.

*Science Slightly Over the Edge* is the book's apt subtitle. What saves it, end to end, is its scrupulous way of expounding every proposal, however bizarre. Ed Regis dismisses nothing as incomprehensible, never assumes we'll choose not to understand. And, given the subject matter, that's a rare compliment he's paying us. ■

*Hugh Kenner is a professor of English at Johns Hopkins University. He writes for publications ranging from the New York Times to Art & Antiques. His recent books include Mazes and Historical Fictions. He can be contacted on BIX as "hkenner."*

*Your questions and comments are welcome. Write to: Editor, BYTE, One Phoenix Mill Lane, Peterborough, NH 03458.*

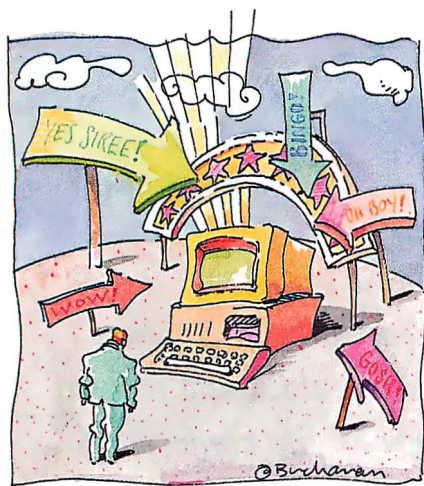

# GREAT EXPECTATIONS

## Don't set yourself up for disappointment when buying a computer system

If you're like many buyers of information systems, you're probably dissatisfied with a previous purchase that didn't meet your expectations. You may still have the same problems an expensive system was supposed to solve. Why? It may be because buyers and sellers often set up unrealistic expectations, and that you, the buyer, were inadvertently programmed to fail.

Here's how it happened. The salespeople made promises that they couldn't keep: lower inventory levels, improved cash flow, and improved profitability. They meant well. But they didn't see that neither they nor their systems could solve your problems. Only executives making good business decisions can do that. What the information systems companies could provide was information to help you better make those decisions.

But you can't just blame the vendor for your unhappiness with the system you bought. After all, you believed them and abdicated responsibility for solving your business problems.

Here are some tips on how to approach your next system purchase so you don't end up a dissatisfied customer again.

*Don't let an information systems company take responsibility for solving your*

Stop Bit is an open forum for informed opinion on topics related to personal computing. The opinions expressed are those of the author and not necessarily those of BYTE or its staff. Your contributions and comments are welcome. Write to: Editor, BYTE, One Phoenix Mill Lane, Peterborough, NH 03458.

problems. Many companies are faced with difficult problems they don't know how to solve. Profits are down, market share is declining. Even if vendors promise you a solution, resist the temptation to believe it. Running your business is your responsibility. Envision yourself solving the problem. What information and tools will you need to do this? These are what you want to ask the vendor for.

*Don't be distracted or dazzled by technology.* Technology is marvelous, but it isn't what you're buying. You're buying capabilities and information. Be sure that the system can deliver these capabilities. Try to separate the information, tools, and capabilities you need to solve your problem from how the system will provide them. Visit a company similar to yours that is using the system. While you're there, stay focused on capabilities when evaluating the system, not on the solution. The fact that another company was able to solve its problems doesn't necessarily mean that it needed, or got, the same capabilities you need.

*Don't expect miracles.* One of the reasons companies still have the problems that their system was supposed to solve is because they believed a miracle would happen. If you hear a vendor salesperson saying, "No problem; we can take care of that for you," recognize the statement for what it is: a promise of a miracle.

*Ask for proof.* Once you have envisioned yourself solving your own problem and determined what capabilities and tools you'll need to do it, you know exactly what to ask the vendor for. Don't let the vendor take you down the boring trail of a full product demonstration with hundreds of product features. You know what you need. Just make the vendor prove that the system can deliver it. Also, make sure that your potential vendor takes care of customers after they buy.

*Agree on written business objectives.* Don't spend money on a system until you're absolutely sure that it will pay for itself in spades. The problem you're try-

ing to solve affects a number of managers and departments, and so will the system you install to deal with that problem. All managers should identify the business objectives that they are having difficulty achieving, why they are having these difficulties, and the specific capabilities they will need to achieve them. Once you have decided to purchase a system, document productivity and payback areas and monitor progress regularly.

*Don't program your internal "buyers" to fail.* You may have to sell your system purchases to other departments in your organization. If so, do not promise to solve their problems. Help your internal buyers envision themselves solving their own problems. Help them articulate the capabilities and information that they'll need to do this. Then prove that the system you're proposing can deliver those capabilities.

*Don't let your expertise be your enemy.* As you're helping your internal buyers define their problems, you must stay in tune with their needs. Armed with your technical knowledge, you might tend to jump quickly to your idea of the solution while your buyer is still painting the problem picture. You see the solution; your buyer doesn't. In your enthusiasm, it's easy to offer to solve the problem yourself. Don't take responsibility for problems you can't solve.

You can avoid becoming another dissatisfied customer by making sure you know what you're buying and by making sure your expectations are realistic. As I said earlier, systems cannot solve business problems. Only executives making sound decisions can. Systems provide the information to make those decisions. It's time that we consciously acknowledged this. ■

*Mike Bosworth is a sales consultant specializing in the information systems industry. He lives in Rancho Santa Fe, California. He can be reached on BIX c/o "editors."*



# Integrated Solutions for Data Acquisition and Instrument Control...the Most Choices

## DATA ACQUISITION

GPIB  
Plug-in Data Acquisition  
VXI  
RS-232

## DATA ANALYSIS

DSP  
Statistics  
Curve Fitting  
Array Operations

## DATA PRESENTATION

File I/O  
Front Panel Graphical  
User Interface  
Hardcopy Output



IEEE-488.2 Interfaces

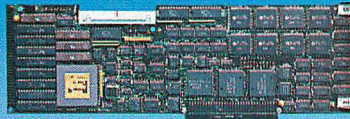

DSP Hardware

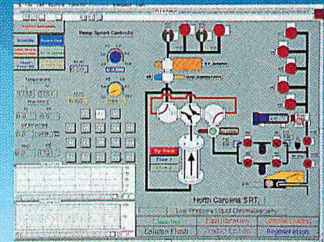

LabVIEW 2  
Graphical User Interface

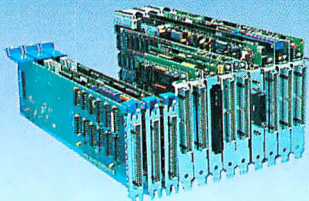

Plug-in Data Acquisition

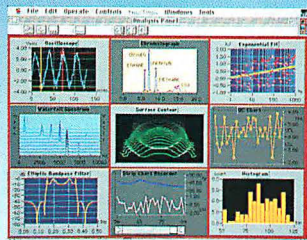

Macintosh Analysis Software

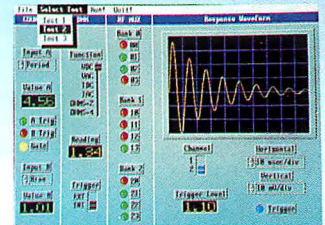

LabWindows 2.0  
Graphical User Interface

## VXI Controllers



Software  
for RS-232  
Instruments

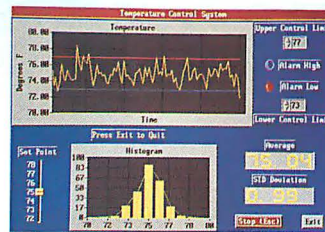

DOS-Based Analysis Software

## And Here Are Two Great Ways to Learn More About Your Choices!

### New 1991 Catalog

Use our new 1991 color catalog to learn about the latest instrumentation technology for personal computers and workstations. Our *How to Choose* section guides you through your product selection. Each section has a tutorial to help you evaluate your product choices to meet your application needs. In addition, cross references throughout the catalog assure that you select a well integrated system. *Call for a free catalog.*

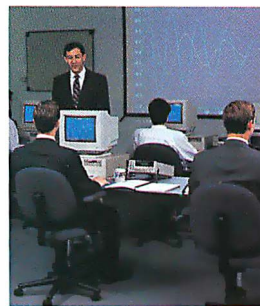
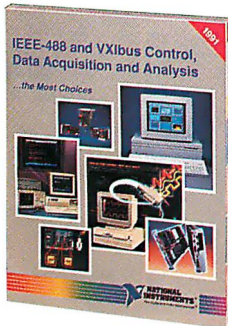

### New Technical Seminar

Attend our technical training seminar to learn about using personal computers for data acquisition, analysis, and presentation. This informative seminar teaches you how to identify signals, choose the most efficient way to acquire the signal, perform the correct analysis on them, and effectively present the results. *Call for scheduling information.*

(512) 794-0100  
(800) 433-3488 U.S. and Canada  
6504 Bridge Point Parkway  
Austin, TX 78730-5039



NATIONAL INSTRUMENTS FRANCE 1 48 65 33 70  
NATIONAL INSTRUMENTS GERMANY 089 436 1447  
NATIONAL INSTRUMENTS ITALY 02 4830 1892  
NIHON NATIONAL INSTRUMENTS K. K. (JAPAN) 03 788 1921  
NATIONAL INSTRUMENTS SWITZERLAND 056 45 58 80  
NATIONAL INSTRUMENTS UNITED KINGDOM 0636 523545

# LAPTOPS...WE STARTED IT ALL



In 1983, we introduced

the world's first laptop computer. We went on to engineer built-in software,



easy-to-read screens



and hard drives in notebook-size PCs.

## AND NOW...

# THE NEW TANDY® 2810 HD NOTEBOOK PC,

### 286 Power

The 80C286 micro-processor runs at 16 MHz for speed-intensive applications like Microsoft® Windows.

### VGA Graphics

Brilliant clarity with 640 x 480 graphics and a sharp 16/32-gray scale.

### Built-In Hard Drive

20 megabytes of internal storage for rapid access, plus a 3.5" 1.44MB floppy drive.

### MS-DOS® 4.01

The latest version of MS-DOS (4.01) comes already installed on the built-in hard drive.

### DeskMate® Interface

The DeskMate Graphical User Interface with ten applications is installed on the hard drive for instant-on ease of use.

### Resume Mode

Lets you shut off and come back right where you left off—also shuts down automatically to save battery life.

### External Support

Attach a 101-key keyboard, a VGA color monitor, a printer, an external floppy drive and more.

### 1MB Memory

Expandable to five megabytes.

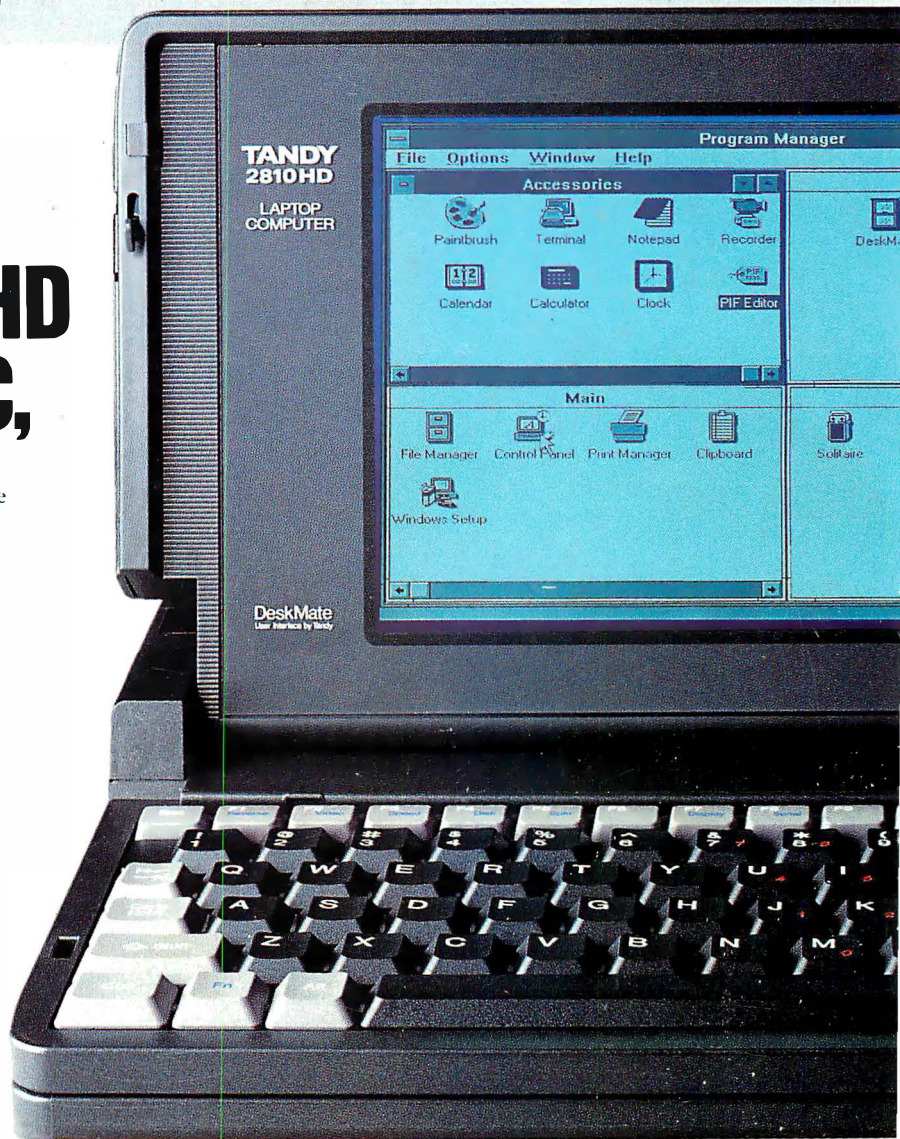

# DESKTOP PERFORMANCE IN A 6.7-lb. PORTABLE

Continuing our tradition of innovation, the Tandy 2810 HD is a lightweight laptop for heavy use—at the office, at home, or on the road. With extremely durable construction, it's built for travel—but it can also support a full-size keyboard and monitor for true desktop power. AT® compatibility, stunning VGA graphics and DeskMate® productivity software. Only at Radio Shack. Again.

**Radio Shack®**  
**AMERICA'S**  
**TECHNOLOGY**  
**STORE™**