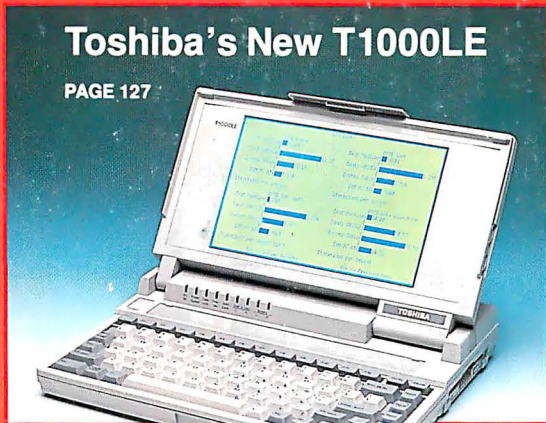


# BYTE

JANUARY 1991

A MCGRAW-HILL PUBLICATION



# THE BEST PRODUCTS OF 1990

*67 winners selected  
by the BYTE editors  
and columnists*



- Eliminate Disk Bottlenecks
- Inside the Intel i860
- The Gilbert Hyatt Controversy
- Ethernet—10 Years After
- The FlexOS Operating System
- "Genetic" Algorithms

- PLUS:**
- Turbo Pascal 6.0
  - Word 5.5 & Word for OS/2
  - Compaq SLT
  - Remote-Control LAN Software
  - Apple's new A/UX
  - MacRenderMan
  - Folio Views 2.0 & Agenda 2.0



\$3.50 U.S.A./\$4.50 IN CANADA  
0360-5280



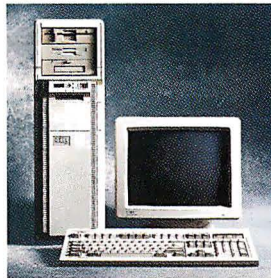
**THE NEW DELL SYSTEM 433TE**  
33 MHz: EISA i486.™

- i486 microprocessor running at 33 MHz with 128 KB external cache.

**\*\*Commercial Lease Plan. Lease for as low as \$377/month.**

330 MB Super VGA Color System (800 x 600) \$10,499

Price listed includes 4 MB of RAM.\* 80, 100, 190 and 650 MB hard drive configurations also available.



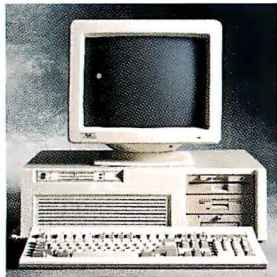
**THE NEW DELL SYSTEM 425TE**  
25 MHz: EISA i486.

- i486 microprocessor running at 25 MHz.

**Commercial Lease Plan. Lease for as low as \$278/month.**

190 MB Super VGA Color System (800 x 600) \$7,499

Price listed includes 4 MB of RAM.\* 80, 100, 330 and 650 MB hard drive configurations also available.



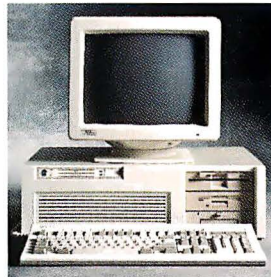
**THE DELL SYSTEM 433E**  
33 MHz: EISA i486.

- i486 microprocessor running at 33 MHz.

**Commercial Lease Plan. Lease for as low as \$307/month.**

100 MB Super VGA Color System (800 x 600) \$8,499

Price listed includes 4 MB of RAM.\* 80, 190, 330 and 650 MB hard drive configurations also available.



**THE DELL SYSTEM 425E™**  
25 MHz: EISA i486.

- i486 microprocessor running at 25 MHz.

**Commercial Lease Plan. Lease for as low as \$235/month.**

100 MB Super VGA Color System (800 x 600) \$6,499

Price listed includes 4 MB of RAM.\* 80, 190, 330 and 650 MB hard drive configurations also available.



**THE NEW DELL SYSTEM 325D**  
25 MHz: 386.™

- Intel 80386 microprocessor running at 25 MHz with 32 KB external cache.

**Commercial Lease Plan. Lease for as low as \$112/month.**

40 MB VGA Color Plus System \$2,999

Price listed includes 1 MB of RAM.\* 80, 100, 190, 330 and 650 MB hard drive configurations also available.



**THE DELL SYSTEM 316SX**  
16 MHz: 386SX.

- Intel 80386SX microprocessor running at 16 MHz.

**Commercial Lease Plan. Lease for as low as \$79/month.**

40 MB VGA Color Plus System \$2,099

Price listed includes 1 MB of RAM.\* 20, 80, 100 and 190 MB hard drive configurations also available.



**THE DELL SYSTEM 320LX**  
20 MHz: 386SX.

- Intel 80386SX microprocessor running at 20 MHz.

**Commercial Lease Plan. Lease for as low as \$104/month.**

40 MB VGA Color Plus System \$2,799

Price listed includes 1 MB of RAM.\* 80, 100, 190, 330 and 650 MB hard drive configurations also available.



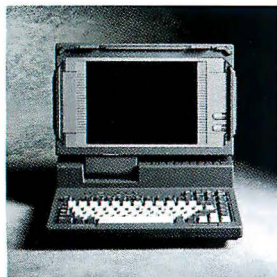
**THE DELL SYSTEM 210**  
12.5 MHz: 286.

- 80286 microprocessor running at 12.5 MHz.

**Commercial Lease Plan. Lease for as low as \$59/month.**

20 MB VGA Monochrome System \$1,549

Price listed includes 1 MB of RAM.\* 20, 80 and 100 MB hard drive configurations also available.



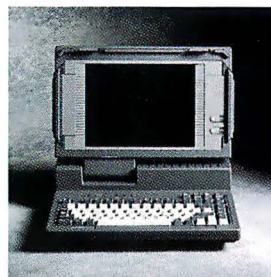
**THE NEW DELL SYSTEM 320LT**  
20 MHz: 386SX.

- Intel 80386SX microprocessor running at 20 MHz.

**Commercial Lease Plan. Lease for as low as \$131/month.**

20 MB, 1 MB RAM.\* \$3,599

40 MB hard drive configurations also available.



**THE DELL SYSTEM 316LT**  
16 MHz: 386SX.

- Intel 80386SX microprocessor running at 16 MHz.

**Commercial Lease Plan. Lease for as low as \$112/month.**

20 MB, 1 MB RAM.\* \$2,999

40 MB hard drive configurations also available.

The Dell System 433TE and 425TE are class A devices sold for use in commercial environments only. \*Performance Enhancements: Within the first megabyte of memory, 128 KB (316SX, 320LT, 316LT and 210) 96 KB (333D and 325D) or 384 KB (320LX, 425E, 433E, 425TE and 433TE) of memory is reserved for use by the system to enhance performance. Can be optionally disabled on 333D, 325D, 316SX and 210. All systems are photographed with optional extras. All prices and specifications are subject to change without notice. Dell cannot be responsible for errors in typography or photography. †Source: From Compaq October 15, 1990 press release. ‡Source: From Compaq July 23, 1990 press release. \*\*Payment based on 36-month open-end lease. †Leasing arranged by Leasing Group, Inc. In Canada, configurations and prices may vary. Dell and DELL SYSTEM are registered trademarks. 425E and SmartVu are trademarks of Dell Computer Corporation. Intel is a registered trademark and 386, 486, and i486 are trademarks of Intel Corporation. Other trademarks and trade names are used to identify the entities claiming the marks and names of their products. Dell Computer Corporation disclaims any proprietary interest in trademarks and trade names other than its own. †On-site service may not be available in certain remote locations. Shipping, handling and applicable sales tax not included in the price. For information on a copy of Dell's 30-day Total Satisfaction Guarantee, limited warranty, and Xerox's Service Contract, please write to Dell USA Corporation, 9505 Arboretum Boulevard, Austin, Texas 78759-7299. ATTN: Warranty. © 1990 Dell Computer Corporation. All rights reserved.

# TOP OF THE MARK.

So what do you get by paying the extra mark-up for a Compaq?

Not a better computer. Dell's new 386™ systems are as fast, expandable and compatible as Compaq's.

Not better service. In 8 straight *PC Week* polls of corporate customers, Dell's service rated much higher than everyone else's.



The new Dell 33 MHz and 25 MHz 386 computers. System includes: VGA Color Plus Monitor, 100 MB hard drive, 4 MB RAM.

Not better personal attention. From the

moment you first call us, and for as long as you own your computer, we'll work

with you custom configuring your computer and answering any questions—no matter how small—whether it be technical, sales or service related.

In fact, the only thing extra you get from Compaq is, well, mark-up.

**Our new 386's pull a fast one on pricier computers.** Both the 33 MHz Dell System® 333D and 25 MHz Dell System 325D are faster and more expandable than most higher priced systems.

The new Dell®325D is a fast, reliable machine with up to 16 MB of RAM on the

system board and a 32 KB cache designed into a compact footprint.

The new Dell 333D is as good as a 386 PC can get. Not only is it 33% faster than the Dell 325D, it has a 64 KB cache for an extra kick in performance.

**We design every machine to our specs, then build it to yours.** We design our computers; we know them inside out. So when you call us, we can talk to you about what you need a computer

TO ORDER, CALL  
**800-283-1170**  
HOURS: 6 AM-9 PM CT M-F 8 AM-4 PM CT SAT.

In Canada 800-387-5752. In the U.K. 0800 414535. In France (1) 30.60.68.00. In Germany 06103/701-0. In Sweden 0760-713 50.

## THE NEW DELL SYSTEM 333D 33 MHz 386 AND THE NEW DELL SYSTEM 325D 25 MHz 386.

### STANDARD FEATURES:

- Intel® 80386 microprocessor running at 33 MHz (333D) or 25 MHz (325D).
- Page mode interleaved memory architecture.
- Standard 1 MB of RAM,\* optional 2 MB or 4 MB of RAM expandable to 16 MB on system board.
- Integrated VGA controller with 1024 x 768 support.
- Integrated hard drive and diskette drive interface.
- 64 KB (333D) or 32 KB (325D) SRAM cache.
- SmartVu™ Advanced System Diagnostic Display.
- Socket for Intel 80387 or WEITEK 3167 math coprocessor.
- 5.25" 1.2 MB or 3.5" 1.44 MB diskette drive.

- 6 industry standard expansion slots (five 16-bit, one 8-bit).
- High-performance IDE (40 MB, 80 MB, 100 MB, 190 MB) and ESDI (330 MB, 650 MB) hard disk drives.
- 1 parallel port, 2 serial ports, PS/2 compatible mouse port, all integrated.
- 177 watt power supply.
- 12-month Xerox™ On-Site Service Contract.

	<b>333D</b>	<b>325D</b>
40 MB VGA Color Plus System	\$3,599	\$2,999

Prices listed include 1 MB of RAM\* 80, 100, 190, 330 and 650 MB hard drive configurations also available.

AD CODE 11EA1

# TOP OF THE MARK-UPS.



Compaq's 33 MHz and 25 MHz 386 computers.  
System includes: VGA Color Monitor, 120 MB hard drive, 4 MB RAM.

for, and then put together the most efficient, economical package for you. We take you through all the choices you have in memory sizes, monitors, storage devices, high performance controllers and accessories. Once you agree about exactly what you need, we immediately begin custom configuring your computer, perform a completed system test, then send it off.

Then you get 30 days to use it. If you aren't satisfied, send it back. We'll return your money, no questions asked.

**Even if something goes wrong, it won't wreck your day.** Actually, one of the nice things about our service is that you'll rarely need it. Another *PC Week* poll category we dominate is the one called "reliability"—due in no small measure to our extensive burn-in testing on each computer before it goes out the door.

But, for the sake of argument, let's suppose something does go wrong with your Dell computer. Both the Dell 333D and 325D come with our SmartVu™, the built-in diagnostic display that ingeniously identifies problems even if the monitor goes down.

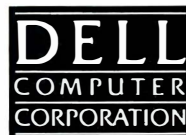
If you still need help,

our Dell toll-free technical support hotline solves 90% of all problems over the phone, often within 4 or 5 minutes. Or, if you use our new Dell TechFax line at 1-800-950-1329, we'll fax back technical information immediately.

If we still haven't solved the problem, we'll send trained technicians from the Xerox Corporation<sup>®</sup> to your desk the next business day with the solution in hand.

**For sale, for lease,<sup>o</sup> for less.** Call us. Talk to a computer expert whose only job is to give you exactly what you want in computers, service, software, printers and financing.

You'll get solid information that could save you time and money on computers with high marks, not high mark-ups.



# HERE'S OUR NEW STORE, SO YOU'LL NEVER HAVE TO GO TO THEIR STORE AGAIN.

When you buy a computer from a typical computer store, here's what you get:

A beefy retail mark-up.

Pressure to buy things you don't want.

That crummy feeling of not knowing what you're getting, because the salesman isn't sure what he's selling.

And, when there's a problem, some guy with a screwdriver taking your computer apart.

When you call Dell, on the other hand, here's what you get:

A frank talk with computer experts about what you need, and a recommendation about the best overall package for you.

Custom configuration, with options including monitors, memory sizes,

software, accessories and peripherals.

Service —

consistently voted the best in the industry — by computer experts who know our computers inside and out.

A variety of financing and leasing<sup>o</sup> options.

A firm promise to perform a fully configured



## THE NEW DELL SYSTEM® 333D 33 MHz 386.

### STANDARD FEATURES:

• Intel® 80386 microprocessor running at 33 MHz • Page mode interleaved memory architecture • Standard 1 MB of RAM\*, optional 2 MB or 4 MB of RAM expandable to 16 MB on system board. • Integrated VGA controller with 1024 x 768 support. • 64 KB high-speed SRAM. • Socket for Intel 80387 or WEITEK 3167 math coprocessor. • 5.25" 1.2 MB or 3.5" 1.44 MB diskette drive. • 6 industry standard expansion slots (five 16-bit, one 8-bit). • High-performance IDE (40 MB, 80 MB, 100 MB, 190 MB) and ESDI (330 MB, 650 MB) hard disk drives. • 1 parallel port, 2 serial ports, PS/2 compatible mouse port, all integrated. • SmartVu™ - Advanced System Diagnostic Display. • 12-month On-Site Service Contract provided by Xerox. • 40 MB VGA Color Plus System \$3,599

Price listed includes 1 MB of RAM. 80, 100, 190, 330, and 650 hard drive configurations also available.

AD CODE 11EA1

systems test, and ship by two-day air standard.

A 30-day, no questions asked, money back guarantee.

A one-year limited warranty.

And a great price.

Call us now. Why waste a trip when everything you need is right in front of you?

TO ORDER, CALL

**800-283-1170**

HOURS: 6 AM-9 PM CT M-F 8 AM-4 PM CT SAT.

In Canada 800-387-5752. In the U.K. 0800 414535. In France (1) 30.60.68.00. In Germany 06103/701-0. In Sweden 0760-713 50.

**Rip Your Competition  
to Shreds...**

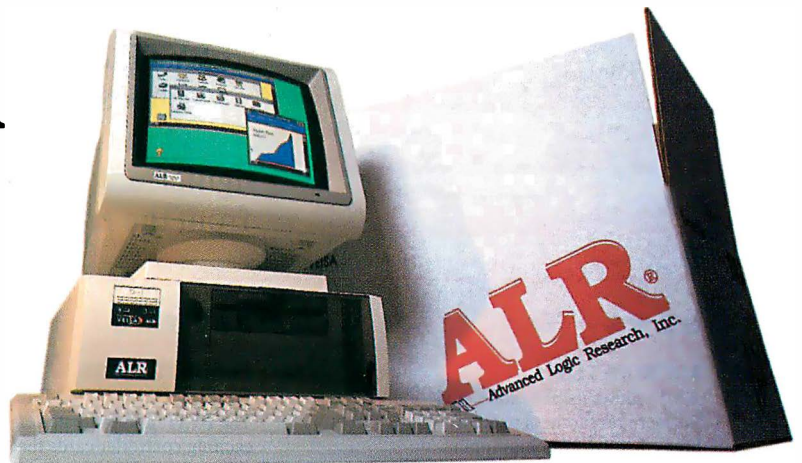


# 33-MHz 386DX™, EISA..\$1995

INTRODUCTORY  
SPECIAL!  
Rebates of up to  
**\$650**  
on great  
BusinessVEISA  
Peripherals till  
December 31, 1990.  
Contact ALR for details!

## The ALR BusinessVEISA

**It's What You Need  
to Thrive in Today's  
Hostile Business World**



It's a sink or swim world out there, and if you don't take advantage of the latest in today's technology, *your competition will*. To survive in a sea of reduced budgets and accelerated time schedules, you need a computer that's both inexpensive and fast. You need a system that will exploit the best of today's and tomorrow's technology without exploiting your budget. You need the ALR BusinessVEISA.

One of the easiest ways for your company to remain competitive is to reduce its spending; that's why we've priced the BusinessVEISA Model 101 at just \$1995. With its 33-MHz 386-processor and its advanced 32-bit EISA bus, the BusinessVEISA gives you all the power you'll need to devour today's most advanced business applications.

Designed to survive the changing tides of your business environment, the BusinessVEISA can take advantage of both standard 8- and 16-bit add-on boards and advanced 32-bit EISA enhancement products. This powerful system can feast on the latest in today's and tomorrow's high-speed I/O and multimastering technology.

As you conquer new territories, your BusinessVEISA can expand its jaws to accommodate i486 power. *Just Upgrade the CPU!*™ Simply plug in an ALR VEISA 25 or 33-MHz i486 CPU module to boost your performance up to 270%. Then watch your competition scatter.

Don't ignore your killer instinct. Call ALR today.

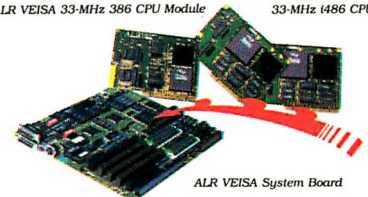
**1-800-444-4ALR**

**Hunt for the Real 32-bit System**

	ALR BusinessVEISA	AST™ Premium™
Architecture	386/33-101 VEISA	386SX/16-5V CUPID-32?
CPU Speed	33-MHz ✓	16-MHz
CPU	386DX ✓	386SX
Data Path	32-Bit ✓	16-Bit
Memory	1-MB	1-MB
Bus	32-Bit EISA ✓	16-Bit ISA
List Price	\$1995	\$2495
Price of 25-MHz i486 Upgrade	\$1995	\$4895

### **Just Upgrade the CPU!™**

ALR VEISA 25-MHz i486 CPU Module  
ALR VEISA 33-MHz 386 CPU Module      33-MHz i486 CPU Module



**ALR** 9401 Jeronimo, Irvine, CA 92718  
(714) 581-6770 FAX: (714) 581-9240

Available at these selected resellers:

**Connecting Point** COMPUTER CENTERS      **ENTRE**      **TBC**

Prices and configurations subject to change without notice. Prices based on U.S. dollars. System shown with optional monitor/graphics adapter and 3.5" floppy. VEISA, BusinessVEISA, and Just Upgrade the CPU! are trademarks and ALR is a registered trademark of Advanced Logic Research, Inc. All other brand and product names are trademarks or registered trademarks of their respective owners. Shark photo: Ron Taylor/ Tom Stack & Assoc. ©1990 by Advanced Logic Research. AST, we saw your mailer. Would you like some of our product literature so you can get your information right next time?

Circle 19 on Reader Service Card (RESELLERS: 20)

# CONTENTS

January 1991  
Volume 16, Number 1



## COVER STORY

### The BYTE Awards

PAGE 147

BYTE editors  
choose 67  
of the most  
significant products  
from the past year.

## NEWS

- 19 **MICROBYTES**  
AMD shows its 386 clone, and Bellcore researchers make a breakthrough in holographic memory technology.
- 44 **WHAT'S NEW**  
EISA and SPARC systems, along with a trio of mouse substitutes, take the hardware spotlight. On the software side, dBASE takes to the Sun, and EZCosmos watches the stars.

## FIRST IMPRESSIONS

- 126 **SHORT TAKES**  
**Turbo Pascal 6.0,**  
*Borland almost adds Windows*
- Volante AT1000,** *inexpensive high-end graphics from National Design*
- Toshiba T1000LE,** *a slimmer T1000*
- Word 5.5 and Word for OS/2,** *updated versions from Microsoft*
- Taste,** *Delta Point's composite package for the Mac*
- 134 **Citrix's New Multiuser OS/2**  
OS/2-based workgroup computing without a LAN.

## REVIEWS

- 168 **PRODUCT FOCUS**  
**Caching Cards Speed Data Access**  
The BYTE Lab evaluates eight caching controller cards that help relieve hard disk drive bottlenecks.
- 186 **LAN Remote-Control Software: Better Than Being There**  
The BYTE Lab examines eight communications programs that let you use workstations on a LAN via remote control.
- 201 **"Ultra" VGA Debuts on the MicroPaq**  
Monolithic's MicroPaq 452 Ultra uses the new Edsun chip to make VGA screens shine.
- 204 **TARGA + Lowers Cost of High-End Graphics**  
Truevision's new 32-bit TARGA + board makes raster graphics more affordable.
- 210 **The Compaq SLT: A Laptop Fit for the Desktop**  
The BYTE Lab tests how well the Compaq SLT laptop performs with its new 386SX engine and other enhancements.
- 213 **A Workstation in a Mac's Clothing**  
A/UX and the X Window System turn a Macintosh into a workstation in a near-seamless way.
- 218 **User Interfaces, C++ Style**  
Zinc's class library brings text and graphical interfaces to your C++ applications.

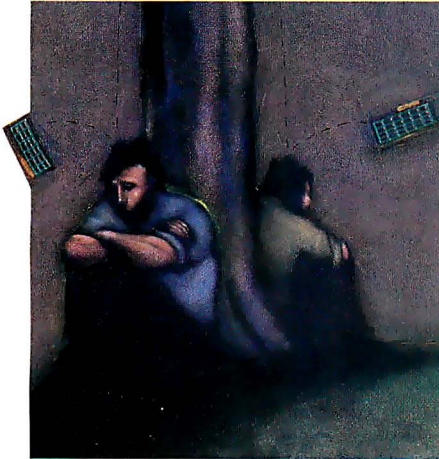
- 223 **Photo-Realism for Those with Time (and RAM) to Spare**  
Pixar's MacRenderMan brings photo-realistic rendering to the Mac.
- 227 **A New Angle on OS/2 and Windows**  
Wide Angle makes the virtual desktop a physical reality.
- 228 **Two Bumbling Detectives**  
Dariana Technology Group's WinSleuth and MacSleuth miss the mark.
- 230 **Reviewer's Notebook**  
New versions of Lotus Agenda and Folio Views make much-needed improvements that address user concerns.

## STATE OF THE ART

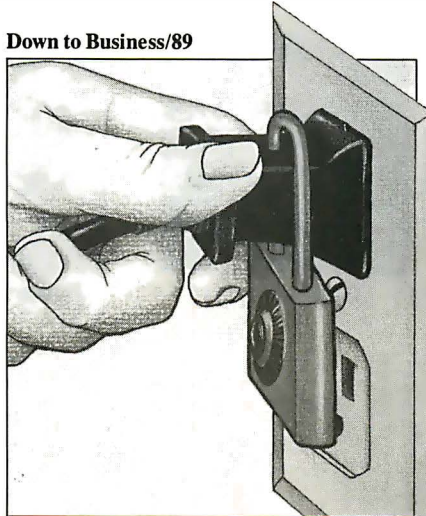
- 236 **AI: METAMORPHOSIS OR DEATH? Introduction**
- 239 **AI's Identity Crisis**  
Can AI provide the kind of intelligent systems that will make all the work, and all the introspection, worthwhile?
- 249 **Overturning the Category Bucket**  
Categorizing knowledge is one of the primary ways that an AI system can acquire "understanding."
- 259 **The Real-Time Expert**  
Expert systems designed to work in real-time environments can make complex systems easier to handle.
- 267 **AI in Practice**  
A real company's real-world use of AI techniques and methods.
- 281 **Putting the Experts to Work**  
The 1990s will see the walls between intelligent applications and conventional applications crumble.
- 289 **Real Artificial Life**  
Nature's skill and craftsmanship, when harnessed toward the creation of artificial life, presents a virtually unlimited reservoir of possibilities for engineering solutions.
- 300 **Resource Guide: Intelligent Software**  
A guide to expert systems and neural-network simulators.



Who Made the Micro?/304



Down to Business/89



**FEATURES**

- 304 **Micro, Micro: Who Made the Micro?**  
Is Gilbert Hyatt the father of the microprocessor, or just the most tenacious inventor in the U.S.?
- 315 **Ethernet: Ten Years After**  
Rich Seifert, one of Ethernet's designers, talks about its first 10 years.
- 323 **Alternative Operating Systems, Part 6: FlexOS's Muscle**  
Digital Research's FlexOS closes out our series.
- 329 **The Object-Oriented Amiga Exec**  
The design of the Amiga operating-system kernel follows the rules of object-oriented programming.
- 339 **Putting Waveforms to Paper**  
Here's how to get data from a Mac screen into a file or printout.

**HANDS ON**

- 347 **UNDER THE HOOD**  
**Personal Supercomputing with the Intel i860**  
Crunching numbers with the i860.
- 361 **SOME ASSEMBLY REQUIRED**  
**Genetic Algorithms**  
A novel technique crossbreeds algorithms to find the best programming solution.

**DEPARTMENTS**

- 6 **Spotlight**  
Inventors and developers highlight this month's feature articles.
- 10 **Editorial**  
The End of Intel's Monopoly?
- 33 **Letters, Ask BYTE, and Fixes**  
Some object lessons learned.

**PERSPECTIVES**

- 412 **CHAOS MANOR MAIL**
- 414 **PRINT QUEUE**  
**Math Reconstructed**  
Stealing glimpses at the numbers upon which the universe is built.
- 416 **STOP BIT**  
**Amateur Systems**  
Senior editor Ken Sheldon discusses the next step in AI.

**READER SERVICE**

- 402 Editorial Index by Company
- 404 Alphabetical Index to Advertisers
- 406 Index to Advertisers by Product Category
- Inquiry Reply Cards: after 408

**PROGRAM LISTINGS**

- From BIX: Call (800) 227-2985
- From BYTEnet: Call (617) 861-9764
- On disk: See card after 160

**EXPERT ADVICE**

73

**COMPUTING AT CHAOS MANOR**  
**Jukebox Computing**

by Jerry Pournelle

Jerry looks at new CD-ROMs and a CD-ROM drive, a brick of a computer, and a new trackball.

89

**DOWN TO BUSINESS**  
**The Power Man Cometh**

by Wayne Rash Jr.

The big orange power truck pulls up again, but this time Wayne's ready.

95

**BEYOND DOS:**  
**WINDOWS AND OS/2**  
**Embarrassment of Riches**

by Mark J. Minasi

A report from the future: living with OS/2 2.0 and Windows 3.0.

101

**THE UNIX /bin**  
**SCO Hot**

by David Fiedler

A brief look at the new SCO Unix and using PCs as X terminals.

105

**MACINATIONS**  
**The Mac and Personal Programming**

by Don Crabb

Don shows how the Mac's oldest true personal programming system gets even better.

119

**NETWORKS**  
**NetWare Troubles**

by Barry Nance

Whom do you call when NetWare acts up? With the right tools, you can do the job yourself.

BYTE (ISSN 0360-5280/91) is published monthly with an additional issue in October by McGraw-Hill, Inc. U.S. subscriber rate \$29.95 per year. In Canada and Mexico, \$34.95 per year. Single copies \$3.50 in the U.S., \$4.50 in Canada. Executive, Editorial, Circulation, and Advertising Offices: One Phoenix Mill Lane, Peterborough, NH 03458. Second-class postage paid at Peterborough, NH, and additional mailing offices. Postage paid at Winnipeg, Manitoba. Registration number 9321. Printed in the United States of America. **Postmaster:** Send address changes, USPS Form 3579, and fulfillment questions to BYTE Subscriptions, P.O. Box 551, Hightstown, NJ 08520.

# UNLEASH TURBO SPEED



The fastest way to create powerful programs with Turbo Pascal 5.5, Turbo C 2.0 and Turbo C++!

**POWER TOOLS PLUS™/5.1 – \$149**

– lightning-fast routines to help you:

- ◆ Add easy-to-use integrated mouse support for windows and menus
- ◆ Generate context sensitive help screens
- ◆ Resize and move windows and use drop shadows for that professional look
- ◆ Let users choose from window-oriented pick lists
- ◆ Create and access “huge” data structures
- ◆ Use multiple-line edit fields with fully configurable edit keys
- ◆ Add EMS support
- ◆ Write TSRs and ISRs easily
- ◆ Create powerful programs in Turbo Pascal 4.0, 5.0 & 5.5!

**Turbo C TOOLS™/2.0 – \$149**

– fast, high quality functions to help you:

- ◆ Add easy-to-use integrated mouse support for windows and menus
- ◆ Quickly include virtual windows and menus
- ◆ Integrate your windows and menus with Turbo C’s text windows
- ◆ Create context-sensitive help screens
- ◆ Provide multiple-line edit fields with fully configurable edit keys
- ◆ Write TSRs and ISRs easily
- ◆ Create powerful programs in Turbo C 1.0, 1.5, 2.0 and Turbo C++!

**FREE with these products!**

All source code, complete sample programs, and a comprehensive manual are included. We offer free technical support and a bulletin board dedicated to technical issues.

**Unleash your potential!**

We offer programming tools that are fast, flexible and affordable. Call now to order, or to ask for a free brochure on our full line of products for C and Pascal.

**Put Blaise tools to the test!**

If during the first 30 days you are not satisfied, we’ll refund your money.

**Call (800) 333-8087 today!**

**BLAISE COMPUTING INC.**

2560 Ninth Street, Suite 316 Berkeley, CA 94710  
(415) 540-5441 FAX (415) 540-1938

Trademarks are property of their respective holders.

## S P O T L I G H T



Gilbert Hyatt



Federico Faggin



Ted Hoff

# FATHERS OF INVENTION

*From processors and patents to Cabernet and coaxial cable in this month’s BYTE*

**T**his is a fascinating business. You never know whom you’re going to meet, or where you’re going to pick up a great story.

Case in point: Jeff Bertolucci is a member of the BYTE news staff, located in San Francisco. Last August, Jeff was attending a software developer’s conference, the kind of event that’s good for gathering background but generally not where you expect to find hot news.

At one point, a public relations person took Jeff aside and said he wanted to tell him the most incredible story to hit the computer industry in the past 10 years. He took Jeff to a corner of the hotel—far from the other reporters—and showed him a thick document: a recently issued U.S. patent for a microprocessor design. According to the PR person, the patent—which was originally sought in 1970—made an unknown southern California engineer named Gilbert Hyatt the father of the microprocessor.

On August 29, Hyatt announced his patent to an amazed computer world. By then, BYTE editors had already begun assembling an article on Hyatt’s patent and its possible effect on the computer

industry. Later, we interviewed Mr. Hyatt, as well as two of the people historically credited with inventing the micro-computer: Ted Hoff and Federico Faggin. We also talked with industry experts to get their opinions on the patent. You’ll find the resulting article (“Micro, Micro: Who Made the Micro?”) on page 304. Among other things, it shows that success sometimes requires a great deal of patience.

Of course, the ability to defer gratification for long-term benefit is one thing that differentiates humans from other creatures. It’s not always easy. Take, for example, holding onto a fine wine long enough for it to reach its peak. Rich Seifert knows how much self-control that takes. On September 30, 1980, Rich purchased a magnum of Cabernet Sauvignon from Heitz Cellars. That was the day he and other developers completed and signed off on the specification for a new networking standard called Ethernet.

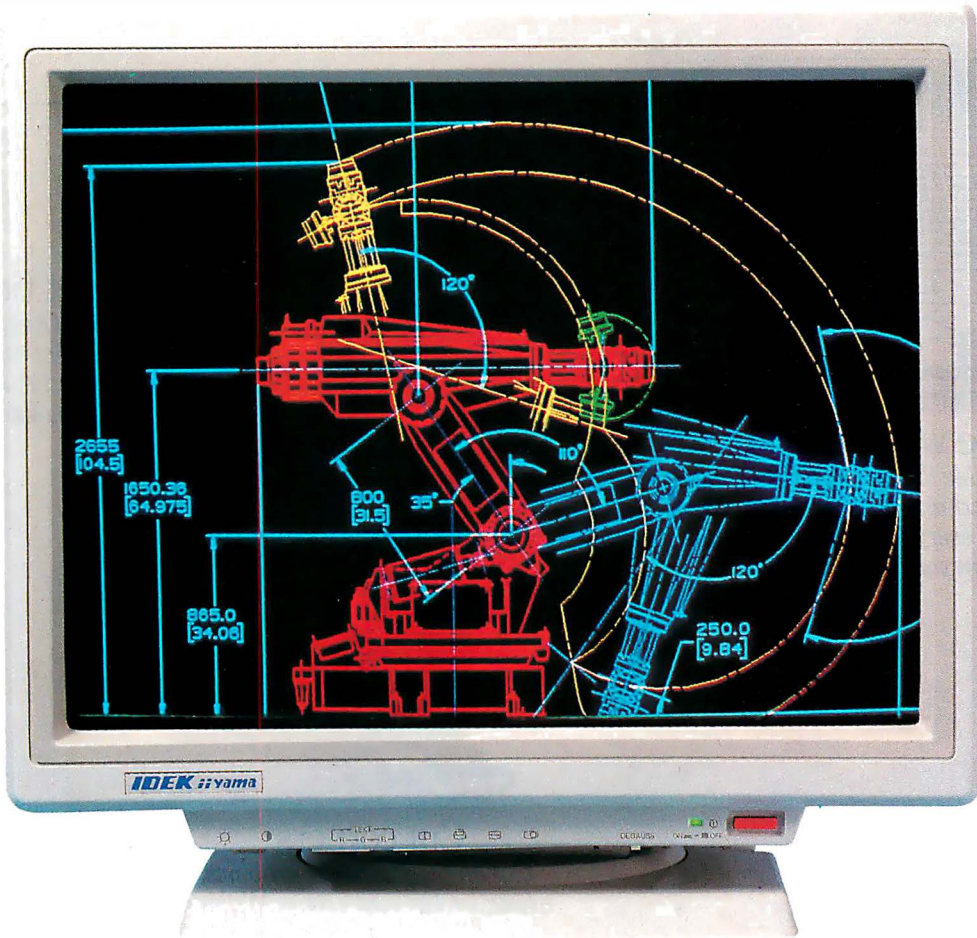
Last September, on Ethernet’s tenth anniversary, Rich opened that bottle at a gathering where the development team had reunited to celebrate and to reflect on the evolution of LANs over the past 10 years. Rich tells the story of Ethernet and its subsequent history in “Ethernet: Ten Years After” on page 315 of this issue.

We think you’ll find this month’s feature articles as fascinating as the people behind them. Stick with us—you never know who we’ll run into next. ■

—Kenneth M. Sheldon  
Senior Editor, Features

# IDEK

## IDEK — THE FIRST COMPLETE FAMILY OF FST COLOR MONITORS



### IDEK's MULTIFLAT Series of 21-Inch Color Monitors

IDEK's MULTIFLAT Series of 21-inch Color Monitors take full advantage of the remarkable properties of their Flat Square Tubes (FST) to deliver superior resolution and a sharper image that is easier on your eyes. A glimpse at our 21" Color Monitors reveals their matchless over-scanning capability that delivers a crisp, distortion-free display across the entire screen.

In addition, Automatic Frequency Scanning realizes outstanding performance for business graphics, CAD/CAM applications as well as desk top publishing on your Mac or IBM compatible system.

As you can see below, whether your requirements are simple or complex, IDEK has the Flat Screen Color Monitor that's just right for you. And priced right, too! See for yourself what a difference a Flat Screen Monitor from IDEK can make.

#### MULTIFLAT Series (21" Flat CRT Monitors)

Model	H. Frequency	Dot	Resolution
MF-5021	15 to 38kHz	0.31	1024 × 768
MF-5121	21 to 50kHz	0.31	1024 × 768
MF-5221	30 to 80kHz	0.31	1280 × 1280
MF-5321 (A.R.Panel)	30 to 80kHz	0.31	1280 × 1280
MF-5421 (A.R.Panel)	30 to 80kHz	0.26	1600 × 1280

IDEK also offers its new Model MF-5117 17" Flat Screen Color Monitor that delivers the same superior resolution and performance as the other members of the IDEK lineup.



# IDEK Iiyama

#### IYAMA ELECTRIC CO., LTD.

##### Overseas Division

7th Fl., US Hanzomon Bldg., 2-13, Hayabusa-cho, Chiyoda-ku  
Tokyo 102, Japan

Phone: (81) 03-3265-6081 Fax: (81) 03-3265-6083

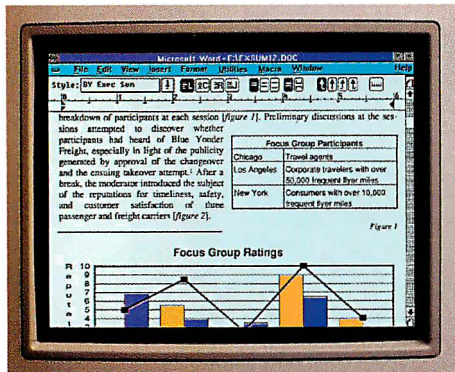
#### IDEK Europe (Germany)

Neumannstrasse 38, 6000 Frankfurt a.M. 50, Germany  
Phone: (49) 69-521 922 Fax: (49) 69-521 927

#### IDEK North America

650 Louis Drive/Suite 120, Warminster, PA 18974 U.S.A.

# Word for Windows redef

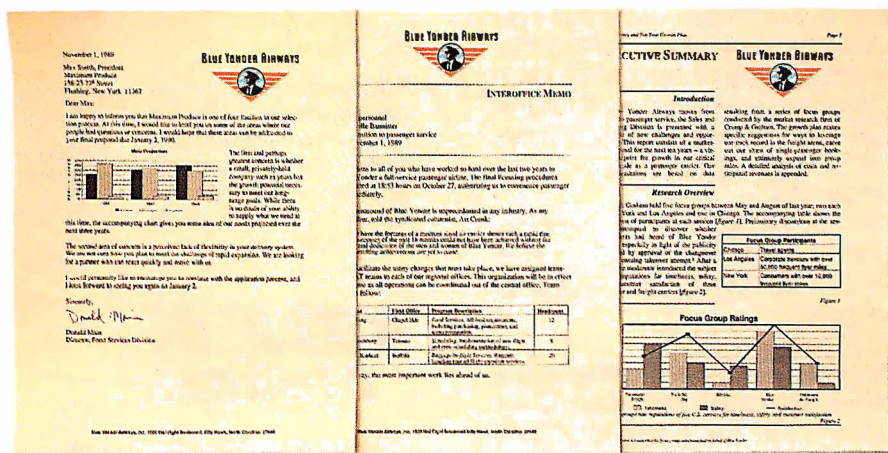


See what you do.  
 With editable WYSIWYG, you can see and edit text and graphics formatting. Virtually everything for that matter. Right on your computer screen.

Don't get tied up.  
 Tables make it easy to format numbers and words into rows and columns. All without using the tab key.

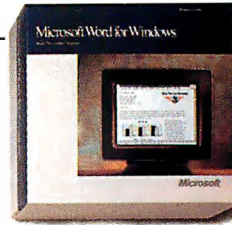


Cut corners.  
 Cut and paste words, graphics, whatever. On your screen. Without an endless string of commands.



Look like a professional.  
 Because we've taken the hard work out of the process, it's easy to create professional-looking documents. Making something else look professional. Like you.

# nes the word processor.



Just say the word.  
*Microsoft® Word for Windows.™ The best thing to happen to word processing in quite a while. Check it out.*

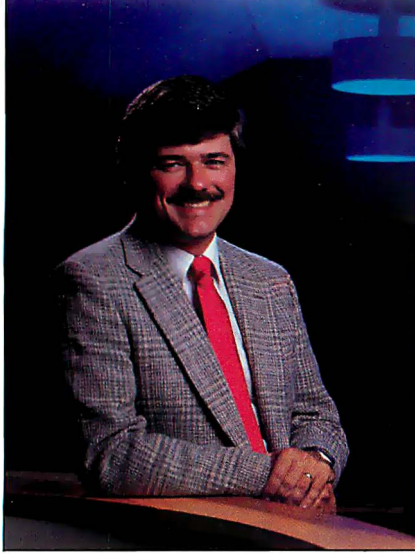
Save time.  
*Document Templates make it quick and easy to create standard letters, memos and more. Ensuring consistency. As well as company standards.*



Something for nothing.  
*Get a full-featured Working Model free.\* Call (800) 541-1261, Dept. M99.*

Tailor your documents.  
*With a point and click, icons on the Ribbon and Ruler allow you to fashion formats from basic to sophisticated. You can even save these formats as a personal style or company standard.*

**Microsoft®**  
Making it all make sense™



# THE END OF INTEL'S MONOPOLY?

AMD's clone of Intel's 386 chip has created stiff competition in the U.S. CPU industry—and you and I are the beneficiaries

**A** year and a half ago, Advanced Micro Devices formed two separate teams to legally circumvent Intel's attempts to maintain its (also legal) monopoly on 386 production. One AMD team worked from a systems analysis perspective, defining the full functionality of the Intel 386. The other team worked on reverse-engineering an i386 chip itself.

In July of last year, the two teams finished their work and merged their results into a single specification. AMD taped out the design in July and sent the chip masks to fabrication. Shortly thereafter, the first sample silicon was ready.

The long, careful preparations paid off. The first time out, at 20, 25, and 33 MHz, the new chip successfully ran OS/2, Windows, DOS, Unix, Xenix, and a variety of operating systems for embedded applications. Physically and functionally, except for the logos, the chips are essentially identical—clock for clock, state for state, and pin for pin.

I saw an Am386DXL demonstration at Comdex: Mike Webb, director of marketing for AMD's Personal Computer Products division, took a pair of off-the-shelf machines (a Compaq and a PS/2 bought at Businessland), pulled out the stock Intel 386s, plugged in AMD 386s, and started the machines. The computers ran exactly as they had before, even running the BYTE benchmarks identically.

What few differences there are between the Intel and AMD chips are all in

AMD's favor. For example, the AMD chip is entirely implemented in power-saving 0.8-micron-wide CMOS, unlike the partial-CMOS, 1-micron design of the i386.

This change to an all-CMOS design allows for a much lower power consumption, with enormous implications for battery-powered laptops and portables. For example, the AMD chip uses a scant one-third the power of the Intel 386 at 20 and 25 MHz, and two-thirds the power at 33 MHz. At the lower speeds, the Am386's power consumption is below that of an i386SX!

But there's more: The AMD chip can power down to a sleep mode that requires less than a milliamp of current, compared to the minimum current draw of 133 mA for an i386DX and 60 mA for the newly introduced i386SL.

Besides a true sleep mode, the Am386 offers ultra low-power, slow-speed operation for standby modes: You can slow the Am386 down to as little as 4 kHz (the i386 can't go slower than 8 MHz).

All this adds up to power consumption that's just a fraction of that of the equivalent Intel chips. What's more, the Am386's design protects your data in these low-power modes—the chip's registers and pipelines automatically remain intact. (If you shut down an Intel chip for maximum power savings, you must copy the registers' contents—usually out to expensive static RAM.)

The Am386's simple-to-implement low-power modes offer incredible power management flexibility for laptop designers. No longer will designers have to use the crippled SX chip to bring 386 power to portables: true 32-bit, no-compromise, no-bottleneck laptops with reasonable battery life are now possible. To top things off, AMD will offer its 386 in a plastic carrier ideally suited for space-saving surface mounting. Laptop and portable makers will eat these chips up.

Desktop units will also benefit from AMD's improvements on the 386. Al-

ready, AMD successfully has tested its chips at speeds of up to 50 MHz—and up to 40 MHz without special cooling.

Webb told me that he believes a 40-MHz Am386 will be faster in real-life applications than an i486 running at 33 MHz. Yes, some 486 instructions execute in fewer clock cycles, but most common instructions run about the same as on a 386, Webb says. Thus, the 21 percent speed increase to 40 MHz will deliver faster real-life performance to most users. Although pricing for the AMD line is not yet set, a 40-MHz Am386 should cost significantly less than a 33-MHz i486.

Better, faster laptop and desktop machines are the immediate short-term result of AMD's hard work to take on Intel head to head. There are longer-range benefits, too. For example, AMD is actively working on 0.65-micron fabrication, which it believes can be worked down to 0.25 micron with its current facility.

Sizes this small open up the opportunity for extremely high transistor-count devices—chips of unparalleled subtlety, power, and complexity, containing perhaps as many as 5 million transistors and operating at 50 or 60 MHz.

AMD is not the only CPU maker working at the frontiers of manufacturing—and that is the point. Intel's attempts to block production of legal clone 386 chips prevented healthy competition, delayed the performance increases and cost reductions users have come to expect from the computer industry, and forced too many of us to accept deliberately crippled chips, such as the SX, simply because there was no alternative.

Now, thanks to AMD, there are alternatives. Users everywhere will benefit from this competition. For more information on the Am386, see this month's Microbytes on page 19.

—Fred Langa  
Editor in Chief  
(BIX name "flanga")

# When the object is programming



## Be Objective Programming

(OOP) is programming in the '90s. It's the next step after structured programming and is the best way to write applications.

And Turbo C++ Professional is the first turbo-charged native code C++ compiler that brings Object-Oriented Programming to your PC.

## + ANSI C

Turbo C++ Professional also compiles ANSI C code, so you can stay productive with C now, and move to C++ at your own pace.

## Environment ++

The best compiler deserves the best environment, and our new Programmer's Platform™ environment makes you more productive. It features overlapping windows and mouse support. And sports a new multi-file editor, an integrated debugger, and a smart project manager. Its advanced open architecture lets you integrate the tools you need to feel right at home.

## VROOOM adds room

VROOOM™ (Virtual Runtime Object-Oriented Memory Manager) lets you break

the 640K barrier. Just select the application code you want to overlay, and VROOOM does the rest—swapping modules on demand. It's fast, easy, automatic.

## Another +

Turbo C++ Professional gives you all the tools you need to build fast, reliable C++ programs.

Turbo Debugger® 2.0 debugs your object-oriented programs. This powerful new version is the first and only debugger to support *reverse execution*. Letting you step backwards through your code to find the bugs you might have missed.

New Turbo Profiler™, the world's first interactive profiler, displays histograms of your program's performance. With it, you



can easily spot execution bottlenecks, and see where improvements or redesign of your code will yield maximum performance gains.

And Turbo Assembler® 2.0 lets you replace time-critical segments of your code using the world's fastest MASM-compatible assembler.

### Turbo C++ Professional Compiler

- C++ conforming to AT&T's 2.0 specification
- C++ class libraries
- Full ANSI C compiler
- VROOOM overlay manager
- Complete documentation and tutorials

### Programmer's Platform

- Open architecture for integration of your own tools
- Overlapping windows with mouse support
- Multifile, macro-based editor
- Smart project manager provides visual MAKE
- Integrated debugging and hypertext help

### Turbo Debugger 2.0

- Class hierarchy browser and inspectors
- Reverse execution provides "true" undo
- 286 protected-mode and 386 virtual-mode debugging
- Keystroke record and playback

### NEW Turbo Profiler

- Displays histograms of program execution
- Tracks call history, overlays, interrupts, file I/O

### Turbo Assembler 2.0

- Multipass assembler with NOP squishing and 486 support

## Special Offer

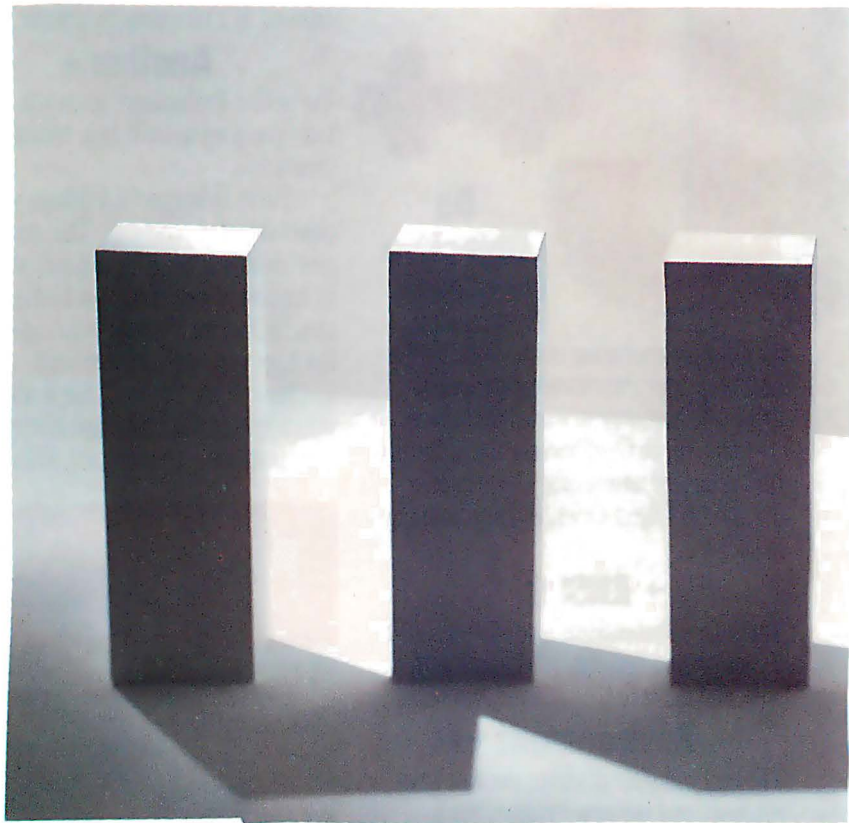
The suggested retail price for Turbo C++ Professional is \$299.95 (\$199.95 for Turbo C++). Borland is offering a special discount for registered Turbo C owners. So be objective, and **SEE YOUR DEALER** or call Borland at 1-800-331-0877 now!

**B O R L A N D**

CODE: MC27

# All the monitors you'll need for

What you see is the remarkable MultiSync® 3D color monitor from NEC. What you don't see is how this one monitor can accommodate not only the broadest range of current mainstream standards, but also the next standard to become mainstream—8514/A, with its brilliant color resolution of 1024 x 768.



Built around our award-winning multiple frequency technology, this

one monitor automatically adjusts to frequencies from CGA all the way up to 8514/A. Which means even if you haven't moved up to

MultiSync is a registered trademark of NEC Technologies, Inc.

8514/A yet, you have the opportunity to purchase a monitor through

IBM PCXT/AT, PS/2 and 8514/A are registered trademarks of the International Business Machines Corporation.

foresight, rather than hindsight.

Macintosh is a registered trademark of Apple Computer, Inc.

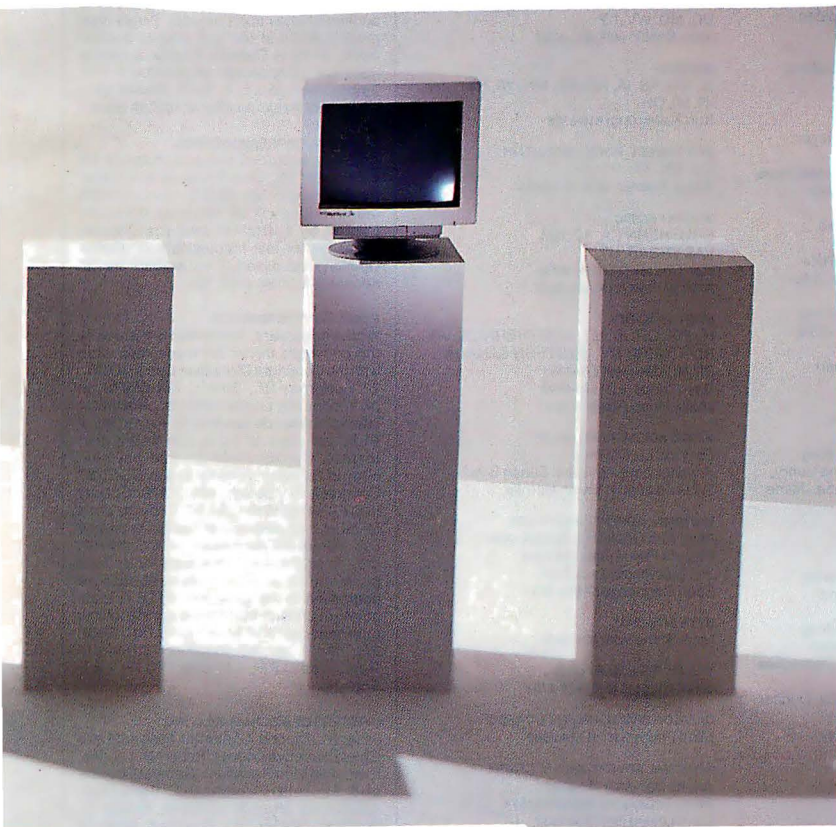
**C&C**

Computers and Communications



# all the resolutions you'll need.

Especially since the MultiSync 3D also has a microprocessor-based digital control system that provides automatic screen configuration, lets you select the ideal resolution for your software, and even has a



memory that recalls your preferred screen settings.

And it's also compatible with the IBM PC/XT/AT, PS/2 and the Macintosh computer systems.

Now, since NEC is ready

to accommodate even the newest graphics standard to emerge, maybe the real question is: Are you?

NEC is a registered trademark of NEC Corporation.

For literature call NEC at 1-800-826-2255. For details, call 1-800-

Macintosh compatibility includes Macintosh II, IIfx, IIfx and SE/30.

FONE-NEC. And in Canada, call 1-800-268-3997.

© 1989 NEC Technologies, Inc.

*Circle 213 on Reader Service Card*

**NEC**

# BYTE

**EDITOR IN CHIEF**  
Frederic S. Lange

**MANAGING EDITOR**  
Anne Fischer Lent

**NEWS**  
*New York:* Managing Editor: Rich Malloy  
Associate News Editor: Andrew Reinhardt  
*Peterborough:* Senior Editor, Microbytes:  
D. Barker, Senior Editor, New Products:  
Stan Miastkowski  
Associate News Editors, What's New: David  
Andrews, Martha Hicks, Carol Swartz  
Editorial Assistant: Amanda Waterfield  
*San Francisco:* News Editor: Owen  
Linderholm  
Associate News Editor: Jeffrey Bertolucci  
*London:* Senior Editor: Colin Barker

**BYTE LAB**  
Managing Editor: Michael Nadeau  
Technical Director: Rick Grehan  
Senior Editor: Dennis Allen  
Technical Editors: Alan Joch, Robert  
Mitchell, Tom Yager  
Testing Editors/Engineers: Stephen Apiki,  
Stanford Diehl, Howard Eglowstein,  
Stanley Wszola

**STATE OF THE ART**  
Senior Editor: Jane Morrill Tazelaar  
Technical Editor: Robert M. Ryan

**FEATURES**  
Senior Editor: Kenneth M. Sheldon  
Technical Editors: Janet J. Barron,  
Ben Smith

**SENIOR EDITORS, AT LARGE**  
Tom Thompson, Jon Udell

**SPECIAL PROJECTS**  
Senior Editor: Gene Smarte

**SENIOR CONTRIBUTING EDITOR**  
Jerry Pournelle

**CONTRIBUTING EDITORS**  
Don Crabb, David Fiedler, Hugh Kenner,  
Mark J. Minasi, Wayne Rash Jr.

**CONSULTING EDITORS**  
Jonathan Amsterdam, Nick Baran,  
Laurence H. Loeb, Trevor Marshall,  
Phillip Robinson, Peter Wayner

**COPYEDITING**  
Chief Copy Editor: Lauren A. Stickler  
Copy Administrator: Cathy Kingery  
Copy Editors: Susan Colwell, Jeff  
Edmonds, Margaret A. Richard,  
Warren Williamson

**EDITORIAL ASSISTANTS**  
Office Manager: Peggy Dunham  
Assistants: Linda C. Ryan, June Sheldon

**ART**  
Director: Nancy Rice  
Assistant Director: Joseph A. Gallagher  
Art Assistant: Jan Muller  
Technical Artist: Alan Easton

**BIX** BYTE INFORMATION EXCHANGE

**DIRECTOR**  
Stephen M. Laliberte

**MANAGING EDITOR**  
Tony Lockwood

**MICROBYTES DAILY**  
Coordinator: D. Barker Peterborough,  
Rich Malloy New York, Nicholas Baran  
Sandpoint, ID, Jeffrey Bertolucci  
San Francisco, Laurence H. Loeb  
Wallingford, CT, Stan Miastkowski  
Peterborough, Wayne Rash Jr.  
Washington, DC, David Reed Lexington,  
KY, Andrew Reinhardt New York,  
Jan Ziff Washington, DC

**PRODUCTION**  
Director: David R. Anderson  
Senior Editorial Production Coordinator:  
Virginia Reardon  
Editorial Production Coordinators:  
Barbara Busenbark, Denise Chartrand

**TYPOGRAPHY**  
Systems Manager: Sherry Fiske  
Applications Manager: Donna Sweeney  
Typesetter: Christa Patterson

**ADVERTISING SERVICES (603) 924-8448**  
Director of Advertising: Lisa Wozmak  
Assistant: Christine W. Tourgee  
Customer Service Supervisor: Linda Fluhr  
Senior Account Coordinator: Lyda Clark  
Account Coordinator: Dale J. Christensen  
Materials Coordinator: Karen Cilley  
Advertising Assistant: Roxanne Hollenbeck  
Creative Services Manager:  
Susan Kingsbury  
Production Artist: Lillian J. Wise  
Quality Control Manager: Wai Chiu Li  
Production Coordinator: Rod Holden

**ADMINISTRATION**  
Publisher's Assistant: Donna Nordlund

**MARKETING AND PLANNING**  
Director: L. Bradley Browne  
Marketing Communications Manager:  
Pamela Petrakos-Wilson  
Public Relations Manager: Dawn Matthews  
Assistant Promotion Manager: Lisa  
Jo Steiner  
Marketing Art Director: Stephanie  
Warnesky  
Associate Art Director: Sharon Price  
Senior Market Research Analyst: Julie  
Petron  
Copyrights Coordinator: Faith Kluntz  
Reader Service Coordinator: Cynthia  
Damato Sands  
Marketing Assistant: Carol Pitman

**FINANCIAL SERVICES**  
Director of Finance and Services:  
Philip L. Penny  
Business Manager: Kenneth A. King  
Assistants: Marilyn Parker, Diane Henry,  
Jo Ann Walter, Jeanne Gatcombe, Jaime  
Huber, Agnes Perry

**CIRCULATION**  
Director: Glyn Standen  
Subscriptions Manager: Paul Ruess  
Assistant Manager, Subscriptions:  
Margaret Liszka  
Subscriptions Assistant: Holly Zilling  
Newsstand Manager: Vicki Weston  
Distribution Coordinator: Karen Desroches  
Back Issues: Louise Menegus  
Direct Accounts Coordinator: Ellen Dunbar  
Direct Accounts Telephone Sales  
Representative: Karen Carpenter

**BUILDING SERVICES**  
Cliff Monkton, Gary Graham,  
Ed Codman

**PERSONNEL**  
Human Resources Administrator: Patricia  
Burke, Human Resources Assistant: Fran  
Wozniak, Receptionist: Beverly Goss

**EXCHANGE EDITORS**  
Macintosh Exchange: Laurence H. Loeb,  
IBM Exchange: Barry Nance, User Group  
Exchange: David Reed, Interactive Game  
Exchange: Richard Taylor, Amiga  
Exchange: Joanne Dow, Writers Exchange:  
Wayne Rash Jr., Tojerry Exchange: Jerry  
Pournelle, Telecommunications Exchange:  
Stephen Satchell

**PUBLISHER**  
Ronald W. Evans

**ADVERTISING SALES**  
Associate Publisher, Vice President  
of Marketing: Steven M. Vito  
Administrative Assistant: Carol Cochran

*Eastern Advertising Director:*  
Arthur H. Kossack (312) 616-3341  
*Sales Assistant:* Julie Watson  
*Western Advertising Director:*  
Jennifer L. Bartel (214) 701-8496  
*Sales Assistant:* Mary Lynn Heinritz

**NEW ENGLAND**  
ME, NH, VT, MA, RI, CT, ONTARIO,  
CANADA, & EASTERN CANADA  
Daniel D. Savage (617) 660-8344

**EAST COAST**  
NY, NY, NJ, DE, PA  
Kim Norris (212) 512-2645  
Ariane Casey (212) 512-2388

**SOUTHEAST**  
NC, SC, GA, FL, AL, TN, VA, MS, AR, LA,  
DC, MD, WV, KY  
John Schilin (404) 843-4782

**MIDWEST**  
IL, MO, KS, IA, ND, SD, MN, WI, NE,  
IN, MI, OH  
Kurt Kelley (312) 616-3326

**SOUTHWEST, ROCKY MOUNTAIN**  
CO, OK, TX  
Alison Keenan (214) 701-8498

**SOUTH PACIFIC**  
SOUTHERN CA, AZ, NM,  
LAS VEGAS, UT  
Ron Cordek (714) 557-8292  
Alan El Faye (213) 480-5243

**NORTH PACIFIC**  
HI, WA, OR, ID, MT, NORTHERN CA, WY,  
NORTHERN NV, WESTERN CANADA  
Bill McAfee (408) 679-0361  
Roy J. Kops (415) 954-9728  
Leslie Hupp (408) 679-0361

**INSIDE ADVERTISING SALES**  
Director: Liz Coyman  
Administrative Assistant: Susan Boyd  
Sales Secretary: Vivian Bernier

**NATIONAL ADVERTISING SALES**  
Mary Ann Goulding (603) 924-2884  
Patricia Payne (603) 924-2654  
Jon Sawyer (603) 924-2665  
Scott Gagnon (603) 924-2651

**BYTEBITS (2x3)**  
Mark Stone (603) 924-6830

**THE BUYER'S MART (1x2)**  
Brian Higgins (603) 924-3754

**CATALOG SHOWCASE/INT'L CARDS**  
Ellen Perham (603) 924-2598

**REGIONAL ADVERTISING SECTIONS**  
James Bail (603) 924-2533  
Barry Echavarría (603) 924-2574  
Larry Levine (603) 924-2837

**BYTEDECK**  
Ed Ware (603) 924-6166

**INTERNATIONAL ADVERTISING SALES STAFF**  
See listing on page 405.

**BUSINESS AND MARKETING**  
Secretary: Patricia Bausum, Marketing  
Services Coordinator: Denise A. Greene,  
Billing Services Coordinators: Tammy  
Burgess, Donna Healy, Editorial Assistant:  
Brian Warnock

**TECHNOLOGY**  
Programmer/Analyst: John Spadafora,  
Programmer: Peter Mancini, Systems  
Consultant: Gary Kendall

**EDITORIAL AND BUSINESS OFFICE:**  
One Phoenix Mill Lane, Peterborough, NH  
03458, (603) 924-9281.

**West Coast Branch Offices:** 425 Battery St.,  
San Francisco, CA 94111, (415) 954-9718;  
3001 Red Hill Ave., Building #1, Suite 222,  
Costa Mesa, CA 92626, (714) 557-6292.

**New York Branch Editorial Office:** 1221 Avenue  
of the Americas, New York, NY 10020, (212)  
512-3175.

**BYTEnet:** (617) 861-9764 (set modem at 8-1-  
Nor 7-1-E; 3000/1200 baud).  
**Editorial Fax:** (603) 924-2550. **Advertising Fax:**  
(603) 924-7507.

**SUBSCRIPTION CUSTOMER SERVICE:** Outside  
U.S. (609) 426-7676; inside U.S. (800) 252-  
9402 U.S. only, or write to BYTE Subscrip-  
tion Dept., P.O. Box 555, Hightstown, NJ  
08520. Subscriptions are \$29.95 for one  
year, \$54.95 for two years, and \$74.95 for  
three years in the U.S. and its possessions.  
In Canada and Mexico, \$34.95 for one year,  
\$64.95 for two years, \$87.95 for three years.  
In Europe, £29 (U.S. \$50) for fast surface  
delivery, £41 (U.S. \$70) for air delivery. All  
other countries, U.S. \$150 for fast surface  
delivery. Air delivery to selected areas at  
additional rates upon request. Single copy  
price is \$3.50 in the U.S. and its posses-  
sions, \$4.50 in Canada. Foreign subscrip-  
tions and sales should be remitted in U.S.  
funds drawn on a U.S. bank. Please allow  
six to eight weeks for delivery of first issue.

**EDITORIAL CORRESPONDENCE:**  
Address editorial correspondence to:  
Editor, BYTE, One Phoenix Mill Lane,  
Peterborough, NH 03458. Unacceptable  
manuscripts will be returned if accom-  
panied by sufficient postage. Not res-  
ponsible for lost manuscripts or photos.  
Opinions expressed by the authors are not  
necessarily those of BYTE.

**PHOTOCOPY PERMISSION:**  
Where necessary, permission is granted by  
the copyright owner for those registered with  
the Copyright Clearance Center (CCC),  
27 Congress St., Salem, MA 01970, to  
photocopy any article herein for personal or  
internal reference use only for the flat fee of  
\$1.50 per copy of the article or any part  
thereof. Correspondence and payment  
should be sent directly to the CCC, 27  
Congress St., Salem, MA 01970. Specify  
ISSN 0360-5280/91, \$1.50. Copying done  
for other than personal or internal reference  
use without the permission of McGraw-Hill,  
Inc., is prohibited. Requests for special  
permission or bulk orders should be  
addressed to the publisher. BYTE is avail-  
able in microform from University Microfilms  
International, 300 North Zeeb Rd., Dept.  
PR, Ann Arbor, MI 48106 or 18 Bedford  
Row, Dept. PR, London WC1R 4EJ,  
England.

**OFFICERS OF MCGRAW-HILL, INC.:**  
Joseph L. Dionne, Chairman, President and  
Chief Executive Officer; Robert N. Landes,  
Executive Vice President, General Counsel  
and Secretary; Walter D. Serwatka,  
Executive Vice President; Frank D.  
Penlagosa, Senior Vice President, Treasury  
Operations; Robert J. Bahash, Executive  
Vice President and Chief Financial Officer;  
Thomas J. Sullivan, Executive Vice  
President, Administration; Mary A. Cooper,  
Senior Vice President, Corporate Affairs,  
and Executive Assistant to the Chairman;  
Ralph R. Schulz, Senior Vice President,  
Editorial.

Founder: James H. McGraw (1860-1948).

Copyright © 1991 by McGraw-Hill,  
Inc. All rights reserved. BYTE and  
BYTE are registered trademarks of  
McGraw-Hill, Inc. Trademark registered in  
the United States Patent and Trademark  
Office.

 Member  
Audit Bureau of Circulation

# One of the Most Important Components Built Into our Computers.



...THE BEST MIX OF SUPPORT, SERVICE, AND CUSTOMER SATISFACTION POLICIES OF ALL THE COMPUTERS IN THIS REVIEW.

PC MAGAZINE  
JULY 1990



## FLASH CACHE

### FEATURES INCLUDE:

- ◆ Intel 386/486 25MHz or 33 MHz Processor
  - ◆ 4MB of High Speed 32-bit DRAM
  - ◆ 64K of Read/Write-Back SRAM Cache
    - ◆ 104MB Fast Access Hard Drive
    - ◆ 1.2MB 5.25-inch Floppy Drive
    - ◆ 1.44MB 3.5-inch Floppy Drive
- ◆ 16-bit SVGA Graphics Card w/512K VRAM
- ◆ 14" Multi-Scan 1024 x 768 Color Monitor
  - ◆ Microsoft DOS 4.01 & Windows 3.0
  - ◆ High Res 400 DPI Three Button Mouse
- ◆ Quality 101 Enhanced Tactile Keyboard
  - ◆ Two Serial Ports & One Parallel Port
  - ◆ Fully DOS, Unix & OS/2 Compatible

386/25  
\$2695

486/25  
\$3995

386/33  
\$2995

486/33  
\$4695

**Y**our looking at the strongest customer assurance program in the industry – Tri-Star's Customer Assurance Program. A customer assurance program that's second to none. No one else stands behind their product with as much confidence as Tri-Star. No one. A lot of companies talk about service – but with Tri-Star you get it in writing.

Tri-Star's confidence in the quality, workmanship and reliability of the Flash Cache is reflected by these five comprehensive guarantees: 2 Years Parts & Labor Warranty 60 Day Money Back Guarantee 1 Year On-Site Service Overnight Parts Replacement Life-time Toll Free Tech Support

Another Tri-Star exclusive ensures your new Flash Cache computer is fully prepared, extensively tested, and thoroughly inspected before delivery. In addition you will receive MS-DOS, Microsoft Windows, and a 400 DPI mouse completely installed and custom configured. Tri-Star Service, it is without peer.

Circle 338 on Reader Service Card

**TRI-STAR**  
COMPUTER CORPORATION  
1.800.678-2799

707 West Geneva  
Tempe, Arizona  
85282

Tech Support  
1.800.688-TECH  
Telephone 602.829-0584  
Fax 602.345.0110

Monday - Friday  
7:00am-7:00pm MST  
Saturday  
9:00am-4:00pm MST

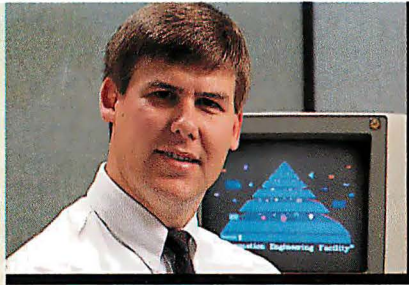
All prices and specifications subject to change without notice. Money Back guarantee does not include shipping charges. On-Site service available in most U.S. locations. 2 Year Warranty includes system and keyboard. All systems have been verified or certified to comply with part 15 of the FCC rules.

# The IEF™ can help you develop unprecedented quality, prod



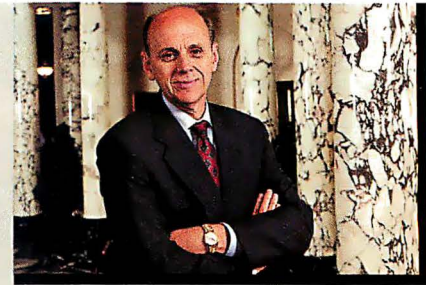
"The IEF is a superior tool for implementing Information Engineering because it integrates the entire process from planning through code generation. We're deploying the IEF throughout the corporation."

**David V. Evans**  
Vice President  
Director, Information Systems  
J.C. Penney



"Our On-line Banking system has been in production for more than 12 months—500,000 transactions a day—without a single code failure. And we had very few enhancements to do. Our users got what they needed the first time out."

**Mark Quinlan**  
Senior Programmer/Analyst  
Huntington National Bank



"To meet the dramatically reduced time-to-market requirements for our products, we need high-quality systems that can be changed fast. That's why we've chosen the IEF as the CASE solution for our entire organization."

**John Pajak**  
Executive Vice President  
Mass Mutual Life Insurance



"The strengths of the IEF are clear-cut. One obvious quality advantage is that application changes are made to diagrams, not code. This ensures ongoing integrity—the specification always matches the executing system."

**Paul R. Hessinger**  
Chief Technology Officer  
Computer Task Group



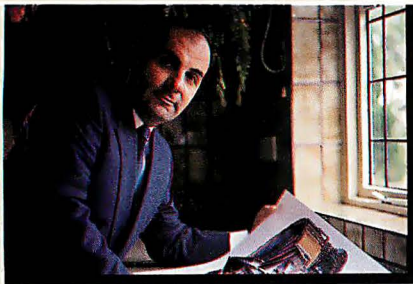
"I've seen other CASE tools fail, so I raised the bar high when we evaluated the IEF. It passed with flying colors. I could not be happier with my decision to adopt the IEF company-wide."

**John F. Mott**  
President  
AMR Travel Services



"Our users were extremely pleased when we finished our first project—a 60-transaction system—in one-half the budgeted time. We had tried interfaced CASE tools without success. IEF integration makes the difference."

**Giorgio Sorani**  
Division Head – MIS  
Lubrizol



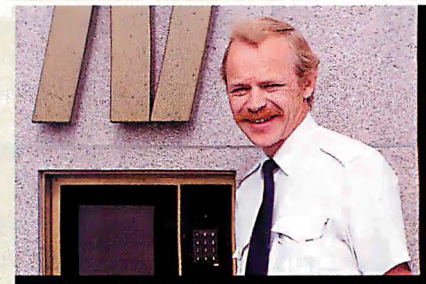
"We are using the IEF to develop a new generation of manufacturing systems replacing over 300 existing systems. We estimate that IEF will increase our productivity by between 2-to-1 and 3-to-1 for new systems development.."

**Wal Budzynski**  
Head of Operations, Systems/Computing  
Rolls-Royce



"We used the IEF to rebuild our aging Frequent Flight Bonus system. With DB2 tables of up to 52 million rows, we needed high performance. And we got it...98% of our transactions complete in less than 3 seconds."

**Cloene Goldsborough**  
Director of Data Resource Management  
TWA



"Our first IEF system was completed faster, and with fewer errors, than any system I've ever seen. If I had to go back to the old ways, I'd find another job...outside the DP world. It means that much to me."

**Mogens Sorensen**  
Chief Consultant  
Nykredit (Denmark)

# Top information systems with productivity and maintainability.

## The success of Texas Instruments CASE product is proven—in the field.

Major companies have used TI's CASE product, the Information Engineering Facility™ (IEF™), for everything from rebuilding aging high-maintenance-cost systems to development of new enterprise-wide strategic systems.

### Study shows zero code defects.

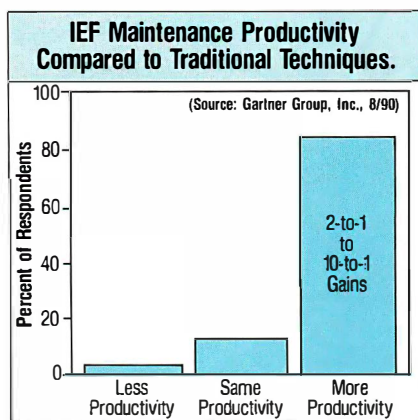
The quality of IEF-developed systems is remarkable. In recent CASE research by The Gartner Group, application developers were asked to report the number of abends they had experienced. (An "abend" is a system failure or "lock-up" caused by code defects.) *IEF developers reported zero defects—not one abend had occurred in IEF-generated code.*

### Maintenance productivity gains of up to 10-to-1.

In this same study, developers were asked to compare IEF maintenance productivity with their former methods. *Of those responding, more than 80 percent had experienced gains of from 2-to-1 to 10-to-1.* (See chart.)

### Specifications always match the executing application.

With the IEF, application changes are made to diagrams, not code. So, for the life of your system, specifications will always match the executing application. The Gartner Group research showed that *all* IEF users who reported making application changes made *all* changes at the diagram level.



*Developers were asked to compare IEF maintenance to former methods. Of those responding, more than 80% reported productivity gains of from 2-to-1 to 10-to-1.*

### Mainframe applications can be developed and tested on a PC.

With our new OS/2 toolset, you can develop mainframe applications, from analysis through automatic code generation, on your PC. Then, using the IEF's TP monitor simulator and the diagram-level testing feature, you can also test these mainframe applications without ever leaving the PC.

### More environmental independence coming soon—develop on PC, generate for DEC/VMS, TANDEM, UNIX.

The IEF has generated applications for IBM mainframe environments (MVS/DB2 under TSO, IMS/DC, and CICS) since early 1988. Soon you'll be able to develop systems in OS/2 and then automatically generate for other platforms. DEC/VMS, TANDEM and UNIX are scheduled for availability in 1991. More will

follow. We are committed to increased environmental independence in support of the Open Systems concept.

### We are committed to standards.

IEF tools and IEF-generated code will comply with standards as they emerge. We will adhere to CUA standards and to the principles of IBM's AD/Cycle and DEC's Cohesion—and we will support Open Systems environments centering around UNIX. In any environment, the COBOL, C and SQL we generate adhere closely to ANSI standards. Our presence on standards committees helps us keep abreast of ANSI and ISO developments affecting the CASE world.

### Full-service support.

Of course, our technical support, consultancy, training courses, satellite seminars, and other informational assistance will continue apace. We also offer re-engineering and template services. This full-service support will remain an integral part of the IEF product.

**For more information, including a VHS video demo, call 800-527-3500 or 214-575-4404.**

**Or write Texas Instruments, 6550 Chase Oaks Blvd., Plano, Texas 75023.**

**TEXAS INSTRUMENTS**





# Still writing code with the same old tools?

You're only as good as the tools you use. An excellent reason to acquire the new Microsoft® Windows™ Software Development Kit. Tools tailor-made to build applications for the huge new Windows market.



Including a specially made CodeView® debugger for Windows that easily debugs even the largest applications.

And all the "how to" help you'll ever need—from the extensive hard copy and online documentation to the sample source code to the comprehensive IBM® CUA style guide.

Plus some sophisticated analysis tools and improved resource editors.

All of which suggests that if you're not

using our SDK, then you're trying to write tomorrow's programs with yesterday's tools.

But that's a situation you can easily fix with the following official code numbers: (800) 323-3577, Dept. M24.

Call now to update your old kit with the Windows version 3.0 SDK at \$150 per kit. Or call us just to answer your questions.

The sooner you dial, the sooner you can really go to work on Windows apps.

Instead of just toying around with them.

## (800) 323-3577

**Microsoft®**  
Making it all make sense™

Offer good only in the 50 United States. Payable in U.S. funds (plus a \$7.50 shipping and handling fee and applicable sales tax). Please allow two to four weeks for delivery. ©1990 Microsoft Corporation. All rights reserved. Microsoft, CodeView and the Microsoft logo are registered trademarks and Making it all make sense and Windows are trademarks of Microsoft Corporation. IBM is a registered trademark of International Business Machines Corporation. CAPTAIN MIDNIGHT is the registered trademark of Sandoz Nutrition Corporation which does not endorse the Windows SDK and is not affiliated with Microsoft.

# MICROBYTES

Research news and industry developments shaping the world of desktop computing

Edited by D. Barker

## AMD's Replicant 386: It's Alive, It's Compatible

**A**fter what seems like years of negotiation, litigation, and speculation, Advanced Micro Devices (Austin, TX) has at last demonstrated its version of Intel's 386 processor. The company says its Am386DX, which clocks in at 20, 25, and 33 MHz, is completely pin- and instruction-compatible with Intel's archetype. AMD is also working on a version of the 386SX but said it's about three months behind the DX. If AMD can overcome legal and manufacturing difficulties, its replicant CPU will be the first real alternative source of Intel's popular, profitable chip.

AMD designed the processor by reverse-engineering the Intel 386 and then implementing its logic in a static CMOS design, company officials said. AMD made no changes to the instruction set or performance characteristics of the Intel chip but did try to build a device that consumes less power. Ben Oliver, product-line director for AMD's Personal Computer Products division, said Intel's design for the 386 mini-mimized transistor count, often at the cost of raising power requirements. AMD implemented its design in 0.8-micron CMOS rather than Intel's 1-micron CMOS. The Am386DX consumes 69 percent of the power needed by the Intel 386DX, Oliver said.

Greater power savings will be possible using the Am386DXL, which has a zero-clock-rate standby mode, reducing power consumption to under 1 mA, Oliver said. An Intel 386 running at 8 MHz, its lowest speed, consumes 133 mA. AMD officials said the DXL chip will be a natural in the portable computer market; Intel has a low-power version of the SX, but not of the DX.

AMD plans to offer its 386 in a surface-mountable package as well as in the pin-compatible standard grid array package. The surface-mountable part is 40 percent smaller than the standard part, making it attractive to designers working on notebook and other diminutive computers.

During private meetings with BYTE, AMD showed engineering samples of its 386 running in two off-the-shelf

systems: an IBM PS/2 Model 70 and a Compaq Deskpro 386/33. AMD officials said they had been testing the chips, with coprocessors, for over a month and had not yet hit any compatibility snags with software. To ensure compatibility, AMD tested the pin-out values of all the pins on its chip, for every clock cycle of every instruction, against the Intel 386. The company said its engineers were also very careful with timing tolerances to make them more conservative than even Intel's.

BYTE's initial tests indicated that AMD has indeed developed a processor compatible with Intel's. The Am386 ran BYTE Lab benchmarks at exactly the rates expected from the Intel processors of the same speed. The Am386DX has run DOS, Windows 3.0, OS/2, Xenix, and several real-time multiuser operating systems without any problem, AMD officials said.

The other big question is whether AMD will be legally allowed to sell the chip. At press time, this issue was still not resolved, but an arbitrator had ruled that AMD could use "386" as part of its product name.

AMD had not decided on pricing or availability by press time. Company officials said AMD is not going to challenge Intel aggressively on price. "There is no reason to beat Intel on price; we have a better product," said Mike Webb, director of marketing for AMD's Personal Computer Products division. Intel's 386 prices currently range from \$180 to \$200.

AMD is proceeding with sampling and says it's ready to go into full production. The surface-mount chip will be available sometime this year, the company said.

At least 20 computer makers have been testing the 386 clone. While none was ready to commit to AMD's chip, most PC manufacturers interviewed by BYTE said that they're interested. Price, performance, and compatibility were the issues they all mentioned. "Tandy has always used multiple vendors of the 286, so I assume we'd use multiple vendors of the 386," said Tandy vice president John Patterson.

— Owen Linderholm

## NANOBYTES

**Eastman Kodak** (Rochester, NY) has come up with a series of development tools and utilities intended to guarantee that color images on a computer screen look exactly as they'll appear when put on hard copy. Kodak is hoping that vendors of computer software and hardware adopt its new technology, called PhotoYCC—essentially a **new method for representing color** in digital form—and that it becomes the industry standard for representing color in digital form across software applications, computer platforms, and peripheral devices. The new Color Management System software products define the way individual components in a color desktop graphics system—including scanner, monitor, CPU, and printer—read colors in a computer application, effectively calibrating the equipment to accommodate for the way people see color. Because the system resides individually in both the application and the hardware in use, a Kodak official explained, it is independent of device and operating system. Being able to predictably control the color space "has been lacking in the industry for 20 years," said John Warnock, chief of Adobe Systems.

**Turbo Windows: Borland International** (Scotts Valley, CA) is at work on a version of **Turbo Pascal** that will run under Microsoft **Windows** and produce true Windows applications. "Turbo Pascal for Windows is a hosted graphical interface for Windows," said Gene Wang, manager of Borland's languages unit; in other words, Windows provides the user interface. It uses the Multiple Document Interface for handling multiple files, he said. While a demonstration program was running in one window, Wang compiled and ran a Pascal adaptation of Charles Petzold's Hex Calculator application. The company will deliver Turbo Pascal for Windows sometime in the first half of this year, according to Wang.

## NANOBYTES

IBM has become the thirteenth company to join the coalition promoting the **DOS Protected Mode Interface**. The DPMI specification, first released last May, defines a standard for extended DOS programs to run in protected-mode, multitasking environments on Intel-based PCs, such as Windows, OS/2, Desqview, VP/ix, and Unisys CTOS. Microsoft and Intel are the two major forces behind DPMI; other supporting companies include Borland, Quarterdeck, Locus, Lotus, Phar Lap, Ergo, IGC, Phoenix Technologies, and Rational Systems. The group has sent out about 2000 copies of the specification, an Intel spokesperson said. DPMI-compatible products should be reaching users soon.

The **first laser printer to support PostScript Level 2** is slated to arrive in March. **Dataproducts** (Woodland Hills, CA) says its LZR 660 (\$2995) can output images faster because of changes made to PostScript, not to the print engine itself. (The machine uses a Weitek RISC processor and is rated at 6 pages per minute.) PostScript Level 2 supports compression and decompression, so files can be sent faster to the printer. There is one problem: Very few software programs are capable of driving PostScript Level 2. Dataproducts has a program to help developers get printers early so that they can work on drivers.

The **Open Software Foundation** (Cambridge, MA) has released its version of Unix to customer companies, but users won't see it until sometime later this year. In addition to the Mach kernel, OSF/1 incorporates "significant portions" of IBM's version of Unix (AIX v. 3.1), commands from both Unix System V and Berkeley BSD 4.3, symmetric multiprocessing features from Encore Computer, and security features from SecureWare. Many companies, including IBM, say they'll offer complete versions of OSF/1 or features from OSF/1 in their own versions of Unix but won't say when this will be. DEC could be one of the first, with an OSF/1-compatible version of its Ultrix variation of Unix by the middle of this year, DEC says.

## Breakthrough in Holographic Memory Could Transform Data Access

Researchers at Bellcore (Livingston, NJ) have developed a new laser-based system that represents a breakthrough in using holograms as computer memory and holds promise for dramatically faster information access. The researchers have built a laser semiconductor array for retrieving holographic images, stored on a glass crystal, at speeds up to 1 gigahertz.

Bellcore's research, aimed at changing the way holograms—recordings of light patterns that represent an image—are retrieved, has yielded a chip the size of a thumbnail that contains an array of over 1000 semiconductor lasers. The laser array replaces the single scanning laser beam currently used for retrieving holographic images. Single scanning laser beams require large and expensive optical equipment such as lenses, beam deflectors, and optical tables. According to Bellcore researcher Ann Von Lehmen, the new laser array will replace the 8- by 12-foot optical table and associated reflectors and lenses in her laboratory.

Bellcore has tested its laser array by retrieving holographic images from a photorefractive crystal made from lithium niobate and gallium arsenide. A single crystal, measuring 1 centimeter on a side, can store 10 million "pages of information," each page containing 100,000 bits (a capacity of 1 trillion bits). Each "micro-laser" in the array is associated with a single page of information and can retrieve it in less than a nanosecond. The information is recorded by dividing the light emitted from the laser into two beams of light and recording the phase and amplitude at their intersection in the photorefractive crystal. Only one beam from

the laser, called the "reference beam," is needed to retrieve the information from the crystal. Each laser measures 40-millionths of an inch across, allowing arrays to contain thousands of lasers.

The next step is to develop "optical/electronic interfaces" that convert the parallel data of the holographic image to a serial bit stream suitable for digital computers. However, Von Lehmen says, the development of microchip-size laser-retrieval systems also presents the opportunity to develop parallel data-access systems that would be much faster than serial interfaces in use today.

Although the researchers have demonstrated the retrieval of several images with high fidelity, they have not been able to retrieve more than a few. They hope to retrieve 500 to 1000 images from a single crystal while maintaining high fidelity.

Bellcore has not developed a way to store these images, but Microelectronics and Computer Technology (Austin, TX) is doing complementary research in that area (see the September 1990 Microbytes and the November 1990 BYTE). MCC is using crystallite arrays rather than single crystals for storing holographic data. These crystallites eliminate crosstalk and signal weakening problems associated with large photorefractive crystals. According to MCC's Jerry Willenbring, MCC is enthusiastic about the breakthrough at Bellcore. "We're working on a commercial optical system," says Willenbring, "and the use of a micro laser array is certainly a more advanced approach." It is possible that Bellcore's laser array will show up in a commercial product from MCC within the next few years.

— Nick Baran

## SPARC Is Turning into a Blaze

It's not the rabbit-like proliferation of DOS machines that IBM spawned with its PC, but this year will bring a substantial increase in the number of Unix systems based on Sun's SPARC architecture. At least 10 companies exhibited SPARC machines at the recent Comdex, and at least 10 more companies have SPARC machines in the works. These RISC computers will be compatible with Sun's Sparcstation 1 or 1+, but they will vary in price and performance.

Many of these systems will be based around the Sparkit chip set and processor from LSI Logic. CompuAdd,

Hyundai, Tatung, and RDI/TriGem expect to ship new desktop and laptop models soon. These systems will all be compatible with Sun's Sparcstation 1 and will be able to run DOS applications using Insignia Solutions' Soft-PC emulator. Some of the other companies planning to build computers around LSI Logic's chips include Northgate, Chicony Electronics, DCM Data Products, DTK Computer, Intelecsis, Sampo, and Twinhead. Opus, whose earlier RISC system was based on Motorola's 88000 chip, has moved to LSI Logic's SPARC CPU for its newest Unix workstation, as well as for an add-





## NOW YOUR SOFTWARE CAN TEST ITSELF.

**Y**our customers expect software that works. All the time. The key to software quality is exhaustive testing. It's also an engineer's worst nightmare. But it doesn't have to be. Because now you can automate your software testing.

Introducing the Atron Evaluator. The first and only non-intrusive automated PC-based software testing tool.

The Atron Evaluator automatically runs your software regression testing programs. All of them. All day. All night. Giving you thoroughly tested, higher quality software.

The Atron Evaluator is hardware-based. And since it's non-intrusive, software behavior is tested without the risk of alteration. Once your tests have run, you can refer to automatically generated test reports to double-check test results.

The Atron Evaluator saves time. And time makes you money. Development cycles are shortened, so your software gets to market sooner. And while your test programs are running, you can be more productive. Start a new project. Or go home.

For more information about the Atron Evaluator, call us at 1-800-733-6036. And put an end to your worst nightmares. Automatically.

## CADRE

Cadre Technologies, Inc.  
19545 N.W. Von Neumann Drive  
Beaverton, Oregon 97006

### In Europe, contact:

Elverex Limited, Enterprise House  
Plassey Technology Park, Limerick, Ireland  
Phone: 353-61-338177

QA Training Limited, Cecily Hill Castle  
Cirencester, Gloucestershire, GL7 2EF, England  
Phone: (0285) 655888

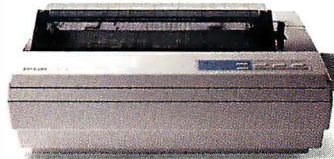
NOW AVAILABLE IN  
**VGA & PS/2**®



A

# Do anything and you would

For 25 years, Epson® printers have placed ink on paper with fine-crafted precision and ever-increasing speed. Each character as impressive as the last. A feat that Epson 24-pin printers have

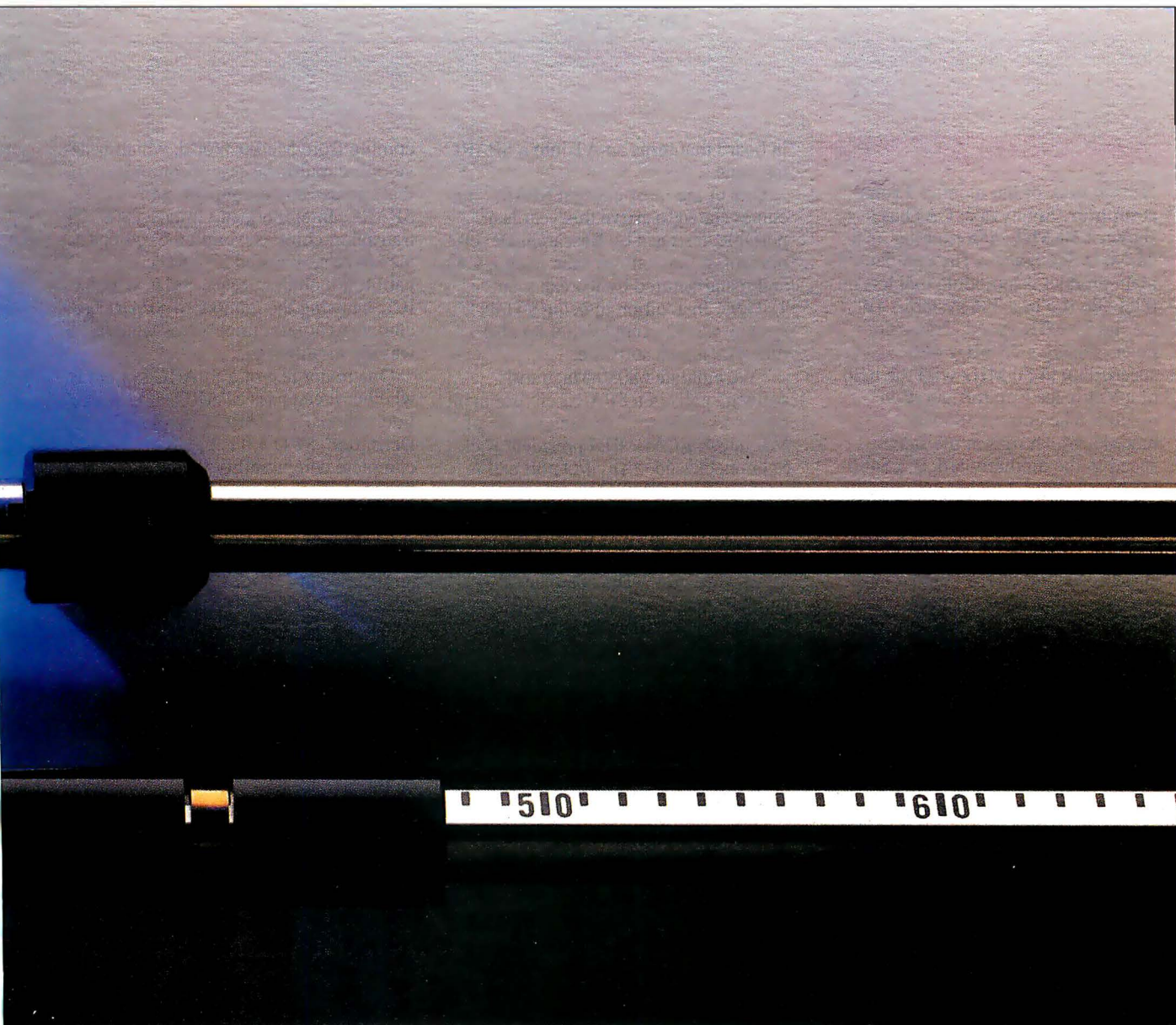


## **2 Year Warranty**

*Just one more measure of how dependable your Epson printer will be.*

accomplished 15 trillion times over.

Today, dot matrix is the most widely used printing technology in business. Of course, the most widely used dot matrix printers are made by Epson. The very



# 15 trillion times be good at it, too.

company that invented them two decades ago.

Epson printers—from dot matrix to laser to inkjet—are the epitome of reliability. But where there is brawn, there is also a brain. Consider Epson's ingenious SelecType™ control panel and

skillful SmartPark™ paper handling. These and other conveniences make operating an Epson as flawless as the printing.

We could go on. But you already have 15 trillion reasons to choose an Epson.

Engineered For The Way You Work.™

**EPSON**

## NANOBYTES

Neatest trick of the month? **Transcomputer** (Sunnyvale, CA) has shown a **50-MHz 486** running on a 25-MHz 386 board. (The company's main product is a module that lets an Intel 486 run in a 386 system.) To get the 50-MHz speed, Transcomputer is using a 25-MHz 486 speeded up to 50 MHz with the help of a Velox Ice Cap refrigeration module. The current 486-PX module, which runs at the same speed as the motherboard, is a \$486 PC board about 2 inches square with pins to plug into a 386 socket on the bottom and a 144-pin socket to take a 486 on the top. The logic and other chips needed to do the conversion are buried in a layer of epoxy. According to George Zweifler, vice president of sales and marketing at Transcomputer, the setup has run reliably in their tests. Zweifler admits the 50-MHz 486 is mostly an attention-getting device.

**JYACC** (New York City), maker of the JAM application development environment, plans to ship a **Motif-based development tool** sometime this quarter. The not-yet-named software will let you construct Motif interfaces and access underlying X widgets, but you will also be able to compile applications down to character mode. JYACC says the software will permit "seamless integration" to multiple databases; the current JAM product accesses Sybase, Oracle, Ingres, and Rdb. Later this year, JYACC plans to release versions of the tool for Open Look and Microsoft Windows.

**Edsun Labs** (Waltham, MA) is going to incorporate the Speedo font-scaling technology of type house **Bitstream** (Cambridge, MA) into its Continuous Edge Graphics chip (see the October 1990 Microbytes). The CEG chip is designed to plug into a VGA board and sharpen the images on the screen. With Bitstream's Speedo, the chip will be able to scale outline fonts for display and printing. The CEG chip will process Speedo-produced bit maps. The two companies are also working on an OEM version of FaceLift, Bitstream's commercial package for generating scalable type within Windows applications.

in board that turns an AT into a SPARC machine.

One of the most unusual SPARC machines slated to arrive this year is a portable designed by Research, Development & Innovations (San Diego, CA), and manufactured by Korean giant TriGem. In addition to being a Unix system, the 12-pound BriteLite also runs Macintosh software.

"We emulate 68030 Macintosh software calls in a SPARC environment purely in software," making no use of Macintosh ROMs, RDI president Rick Schrameck said. "Any I/O port call is done as if it's SPARC because we want to keep the speed up in there. . . . We make no calls the way the Mac does internally; we can't, because our I/O is totally different." The company also emulates the Mac ROMs in software, he said. RDI has not run into any incompatibilities yet, but some may exist with more hardware-dependent things like 32-bit software, Schrameck conceded. No one has yet managed to legally emulate the Mac except by using original Mac ROMs.

Schrameck said the system takes "a performance hit from 15.8 to 2.5 MIPS to do the emulation," which he said is better than with a plain Mac. The BriteLite can also run DOS software using Insignia Solutions' SoftPC.

Solbourne, the company that built the first SPARC clone and designed its own processor, recently brought out a new model. Toshiba has designed a SPARC laptop around its own chips. One of the most unusual (and expensive) systems is

coming from Meiko World, which is developing multiprocessing computers that can use any combination of SPARC, Intel i860, and Inmos T800 transputer chips. Several other companies have announced SPARC compatibles, including Mars, Solarix, and ICL—raising the number of SPARC cloners to at least three times what it was six months ago.

One major test of a SPARC system is whether it can pass SPARC International's SPARC Compliance Definition. SCD 1.0 is based on complete compatibility with the Sun Sparcstation 1. Some of the systems that have passed so far include the Solbourne S4000, the Mars Mariner 4i, and Tatung's color workstation, which was unwrapped at Comdex. Many of the other systems haven't passed yet because they're still in an early stage of development, said SPARC International president Bob Duncan. He expects that most SPARC clones will eventually be SCD-compliant. "It will not be long before an end user won't buy a system that doesn't have the compliance label on it," he added.

This wave of new SPARC adoptees could help establish SPARC as a standard architecture for Unix workstations. It's not just the numbers; the list of SPARC cloners includes companies from all over the globe. "What we see now in the SPARC market is a movement in reality from a proprietary architecture . . . to an open architecture," Duncan said.

— Owen Linderholm and Larry Loeb

## Chips' Chip Breaks High Cost of Video Windows

**A**t least one component of multimedia computing will soon drop in price. Chips & Technologies (San Jose, CA) has developed an IC that will drastically cut the cost of hardware for displaying windows of live, motion video on a computer screen. Companies adopting this new \$40 chip will be able to build video windowing boards for about \$150 instead of \$500, C&T officials say. That means users will be paying in the neighborhood of \$500 to \$800 to get capabilities that now cost more than \$2000. A C&T engineer said that the chip replaces about \$300 worth of gate arrays and other devices.

C&T's new PC Video chip incorporates all the logic for taking a digitized image, putting it in a window, and controlling its size, shape, and location. "We have integrated the logic

of a two-board device down to a single chip on a half-size card," said Steve Chen, vice president of C&T's Media Group. This one piece of silicon does the scan rate conversion, input cropping and scaling, memory timing, windows management, frame buffering, color keying, and other operations that require additional circuitry on current products. A board using the chip would also need a digitizing chip set, memory, and assorted logic.

One thing missing is a compression chip, which Chen said C&T is "working on." He wouldn't commit to a delivery date, but he suggested that it would be sometime in the first half of this year.

The prototype board that C&T demonstrated was able to take incoming live video (from a video camera), digitize it on the fly at 16-bit resolution, and then

# The IBM PS/2 can really get a presentation moving.

---

## ANNOUNCING AUDIOVISUAL ADRENALINE: FULL-MOTION VIDEO FOR THE PS/2.

---

If one picture is worth a thousand words, consider the impact of thirty pictures per second. That's the inspiration behind the IBM® PS/2 M-Motion Video Adapter/A™. It lets you import full-

motion, full-color video from a variety of video sources, and show it on your Personal System/2® display screen. A remarkable achievement, but it's only the beginning.

---

## THE STOPPING POWER OF A MOVING IMAGE.

---

Once it's on the PS/2® screen, your full-motion video image is as versatile as any other multimedia visual. You can window it, overlay text and computer graphics on it, and control the color, brightness, size and screen location.

With M-Motion video, the impact of any TV image, from news footage to a rap video, can be part of your multimedia presentation. You can use a wide variety of video sources: NTSC or PAL, videodisk, live camera or any VCR. Imagine a sports training program that queries an athlete about his recent performance, then shows him the appropriate workout sequence from a videodisk library. Or a new product presentation that combines videotape of your product in use, plus text,

overlaying graphics, narration, even an electronic order form.

---

## SOUND IS ALSO PART OF THE PICTURE.

---

The M-Motion adapter is a highly capable audio facility, too. You can capture sound and music, live or recorded, then mix and

synchronize it with your visuals, all without stepping away from your desk.

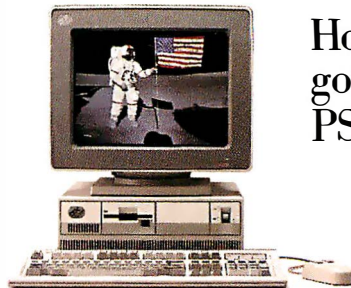
---

## LET IT TELL YOU ABOUT ITSELF, ITSELF.

---

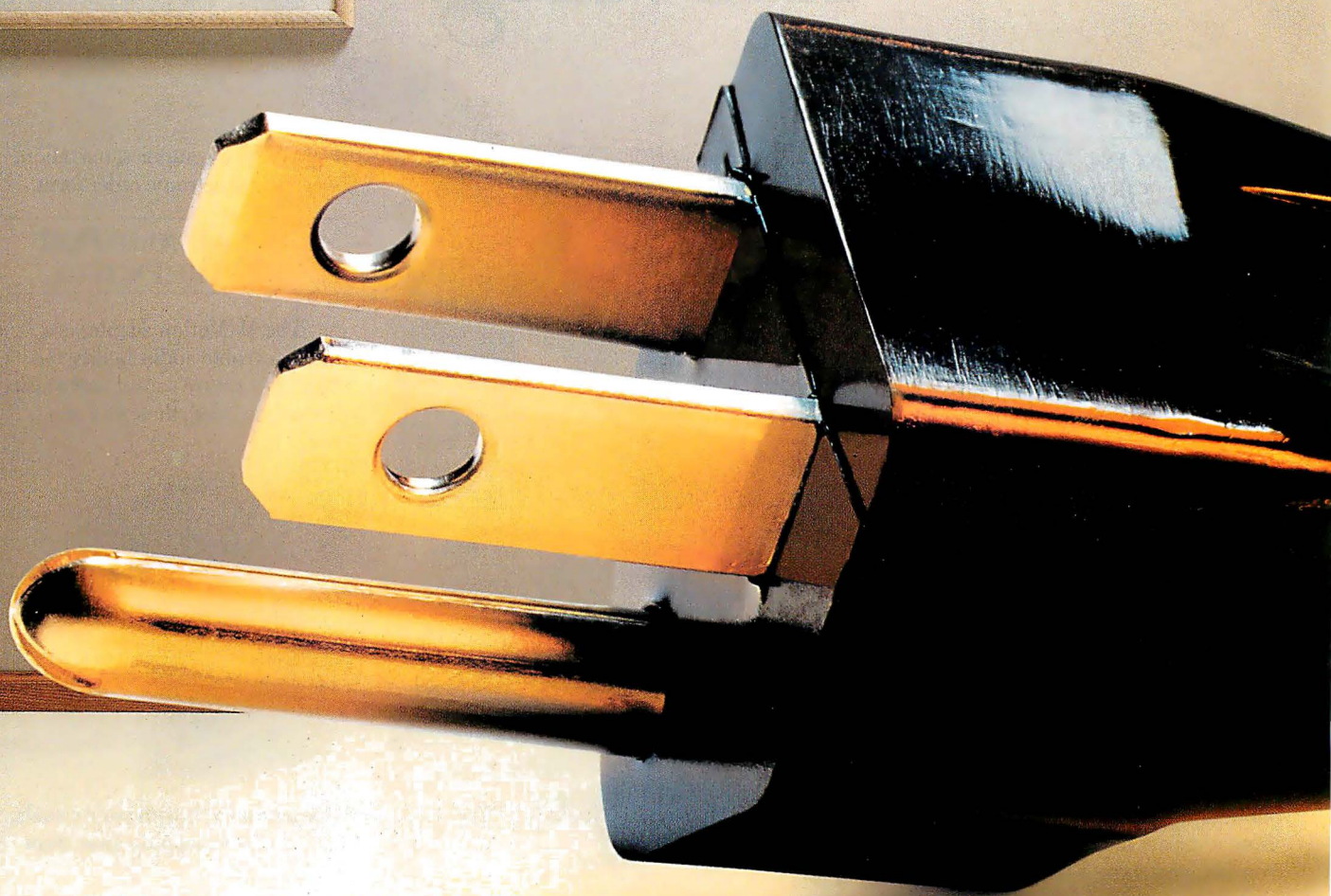
The IBM M-Motion Video Adapter/A, like the entire family of PS/2 MultiMedia products, is superbly qualified to tell you about itself in text, graphics, animation, music and sound. For a free videocassette demonstration, and the name of an IBM Authorized Dealer near you, call 1 800 255-0426, ext. 131.

How're you going to do it? PS/2 it!



IBM, Personal System/2 and PS/2 are registered trademarks and M-Motion Video Adapter/A is a trademark of International Business Machines Corporation. © 1990 IBM Corp. While PS/2 MultiMedia products do deliver a level of visual and aural excitement that defies description on the printed page, our lawyers have asked us to remind you that your PS/2 will not actually become airborne.

Circle 139 on Reader Service Card



# The 486™ PC. It may be a little

**486™** Never before has this much power been plugged into a business PC.

Presenting the Intel 486 microprocessor—a veritable powerhouse that's been harnessed for business.

A 486 microprocessor-based PC has everything it takes to run today's high-powered applications. And run them the way you need to—simultaneously and at lightning speed.

Plus, it's compatible with the hard-

# 1 YEAR FOR ~~\$42.00!~~

*Special Offer! \$24.95!*

Save over 40% off the single copy price by subscribing now to BYTE! Your paid subscription will include BYTE'S annual IBM PC Special Issue.

Payment Enclosed

Bill Me Later

Name \_\_\_\_\_

Company \_\_\_\_\_

Address \_\_\_\_\_

City \_\_\_\_\_ State \_\_\_\_\_ Zip \_\_\_\_\_

No-Risk Guarantee: If dissatisfied, cancel anytime for a full 100% refund.

Your subscription will start in 6-8 weeks.

# BYTE

IW11013



NO POSTAGE  
NECESSARY  
IF MAILED  
IN THE  
UNITED STATES

**BUSINESS REPLY MAIL**

FIRST CLASS MAIL PERMIT NO. 42 HIGHTSTOWN, NJ

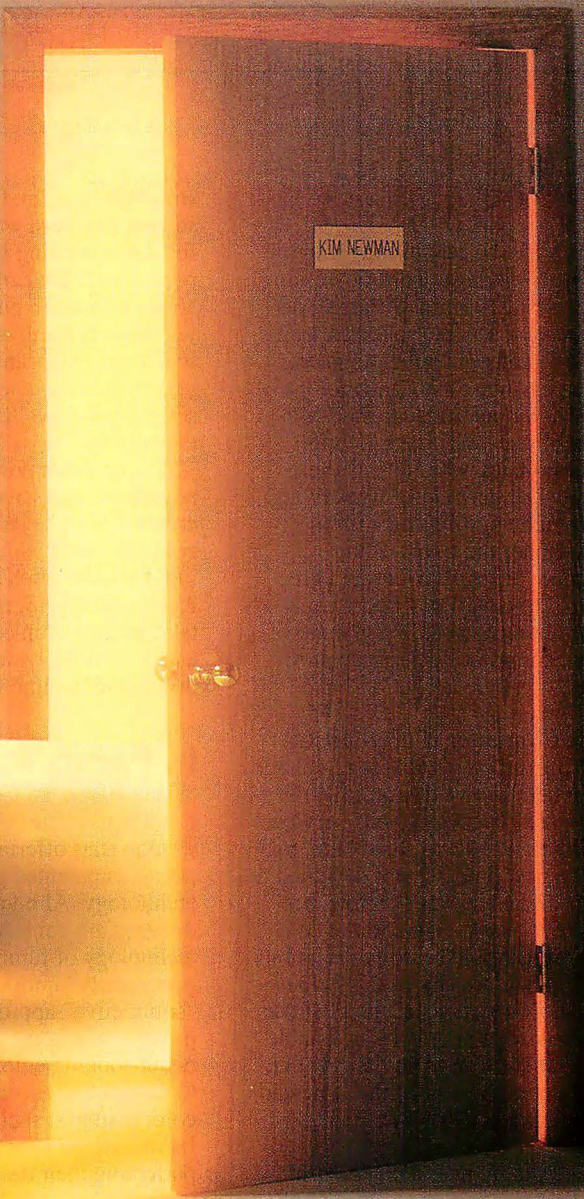
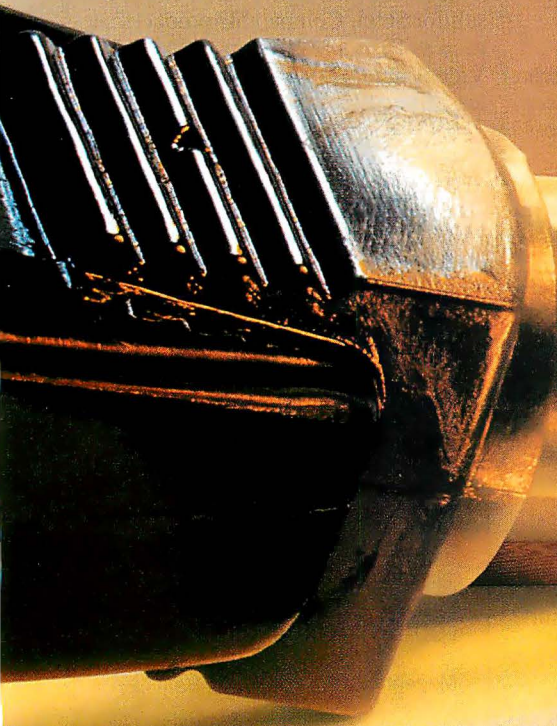
POSTAGE WILL BE PAID BY ADDRESSEE:

**BYTE**

Subscription Department  
P.O. Box 558  
Hightstown, N.J. 08520-9409







# more power than you're used to.

ware and business applications you already own, so you won't spend any extra time or money on training.

The 486 PC. Plug it in and start shocking the corporate world.

For additional information, call

1-800-548-4725 and ask for "The 486 Micro-processor Means Business" brochure.

**intel**<sup>®</sup>

The Computer Inside.<sup>™</sup>

486 is a trademark of Intel Corporation.

## NANOBYTES

Lotus hopes to buy its way into the world of Windows word processing by acquiring **Samna** (Atlanta), developer of the Amí programs. Lotus has no Windows applications yet; Samna has what's considered one of the best. Samna founder Said Mohammadioun was championing Windows back when it was the Rodney Dangerfield of windowing environments, shipping Amí in 1988. Under the terms of the proposed "definitive merger agreement," Lotus will pay approximately \$65 million (or \$18.84 per share of Samna common stock) to acquire Samna.

**Apple Computer** (Cupertino, CA) has switched on a toll-free telephone line to help "solve customer problems." The new phone service, available weekdays from 6 a.m. to 5 p.m. Pacific time, "is not designed to be a technical support hotline, but instead, is an extension to the comprehensive Apple customer relations effort," the company said. The new Customer Assistance Center "solves the problem of people being unable to get satisfaction from their dealer," Apple spokesperson John Cook said. The number is (800) 776-2333.

Multimedia pioneer **MacroMind** (San Francisco) plans to bring out software that allows **OS/2** users to "play back" presentations produced with the company's Director program. Right now, Director users can run Director presentations on a Macintosh or on a PC running Windows 3.0. Director is a Mac-based software package for integrating video, audio, still images, and other media. Plans call for player software for Unix platforms and for the Commodore Amiga.

Nice toys, eh? **DEC** founder Ken Olsen once **scorned personal computers** as "toys," but now DEC is coming out with a multiprocessing server system based on Intel 486 CPUs. The oddly named application DEC 433MP is designed to run SCO Unix with multiprocessing extensions, but there's no reason it couldn't use versions of NetWare or OS/2 LAN Manager in uniprocessor mode or when they support multiprocessing in the future.

smoothly scale and move it on the VGA screen. The card was pumping out the full-color moving video at 30 frames per second, C&T officials said. A PC Video board can put up multiple windows of various sizes, but only one window can be running motion video; if you want to have moving images in several windows, you can daisy chain the boards.

The chip can position a window anywhere on a screen, tied to an  $x,y$  coordinate or keyed to a particular color. A board using PC Video supports input formats such as NTSC, PAL, RGB, and SVHS, meaning that it can take images from common devices such as TVs, VCRs, video cameras, and laser disk players; input resolutions of up to

1024 by 512 pixels; and interlaced and noninterlaced outputs. PC Video can scale images in one-sixty-fourth increments, so you can have a picture as small as a postage stamp or as large as the full screen, rather than being limited to quarter-, half-, or full-screen video.

Chen said the company is "getting a lot of calls" from manufacturers interested in putting PC Video on their boards. The first product built around the chip will come from New Media Graphics (BillERICA, MA), whose Super VideoWindows digital video board will sell for \$695. Comparable products, such as IBM's M-Motion Video and VideoLogic's DVA-4000 boards, cost at least three times that.

— D. Barker

## In Focus Puts New Twist on Color LCDs

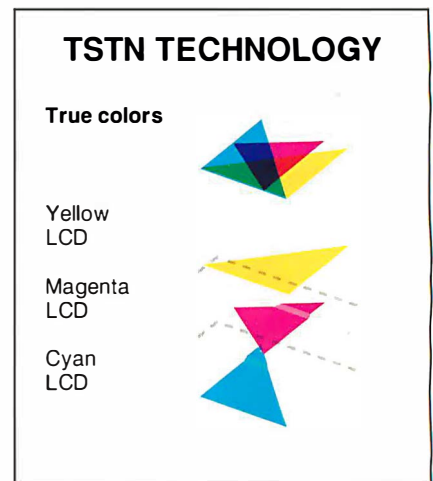
In Focus Systems (Tualatin, OR) will soon start offering monitors incorporating its patented passive-matrix LCD technology. Although active-matrix displays are considered the color display technology of future computers, particularly laptops, In Focus says its "subtractive" approach to the older passive-matrix technology delivers better-looking color LCDs today. Companies pioneering active-matrix color displays, such as Sharp and the IBM/Toshiba joint venture, are still perfecting their designs and manufacturing processes, and their costs are much higher.

In Focus's triple-supertwist-nematic (TSTN) LCD is based on three LCD panels—one cyan, one magenta, and one yellow—aligned and stacked together. When all pixels are off, the backlight shines through to produce white on the screen. As the .33-mm square pixels are turned on (darkened), they subtract different portions of cyan, magenta, or yellow from the white light to get other colors. In Focus says this produces sharper images and deeper colors. The new display demonstrated by In Focus appeared bright, viewable from all angles, and rich in color. The designers say that the color quality is partially due to each TSTN pixel being a single, fully saturated color.

The company's new monitors, compatible with IBM PC and Macintosh systems, are capable of displaying up to 4913 colors at a resolution of 640 by 480 pixels. There are two models, both with 10½-inch diagonal screens: One displays up to 4913 colors; the other, 64 colors. The display technology used is

based on that in In Focus's color overhead projector panels.

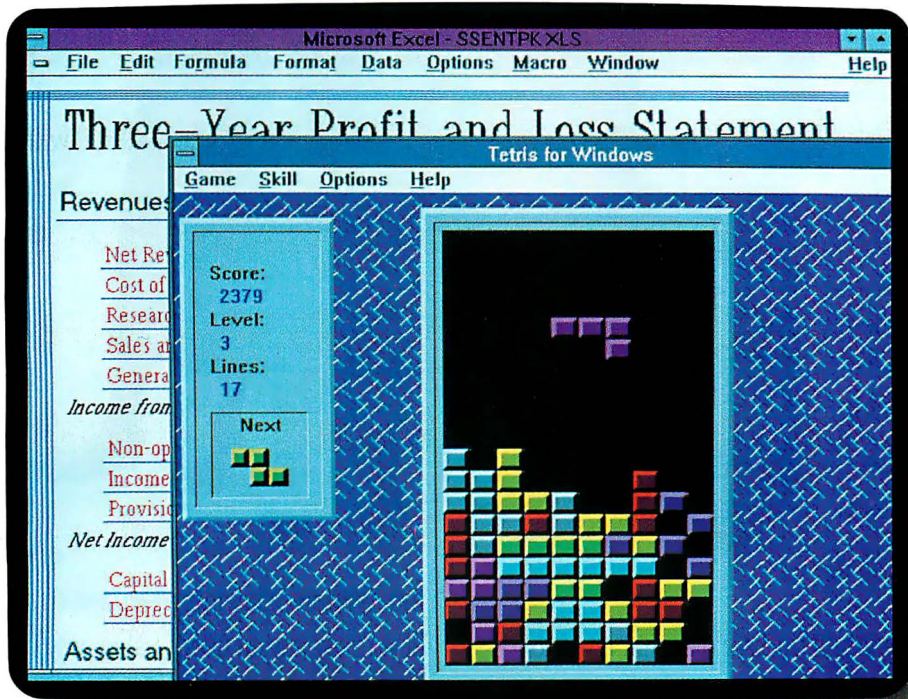
One advantage to this technique is that the displays are easy to manufacture, in quantity, using off-the-shelf



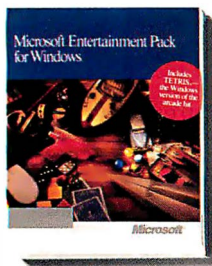
parts. They also don't bring the low-yield problems associated with active-matrix LCDs, says In Focus founder Steve Hix. Part of the problem, Hix says, is that each active-matrix panel incorporates a million interconnects; if one fails, you get a dead pixel on the screen. Another benefit of these monitors over regular CRTs is that they emit no extremely low frequency electromagnetic radiation, Hix said.

One disadvantage of TSTN is its slow response to moving video images. The response time of the display is between 200 and 250 ms. In Focus hopes to have reduced that to about 80 ms by the end of next year, a speed good enough to handle moving screen images. Also, the

# Now you can use the incredible power of Windows 3.0 to goof off.



The New Microsoft® Entertainment Pack for Windows™ gives you seven spiffy games. Each one designed for pure, unproductive fun. And all accessible in seconds from any other Windows product.



Which means you can go right from juggling numbers, to juggling those funny little blocks in TETRIS™. Another click of the mouse, and you can go from typing a letter to testing your nerves on Minesweeper. Or honing your skills on TicTactics.

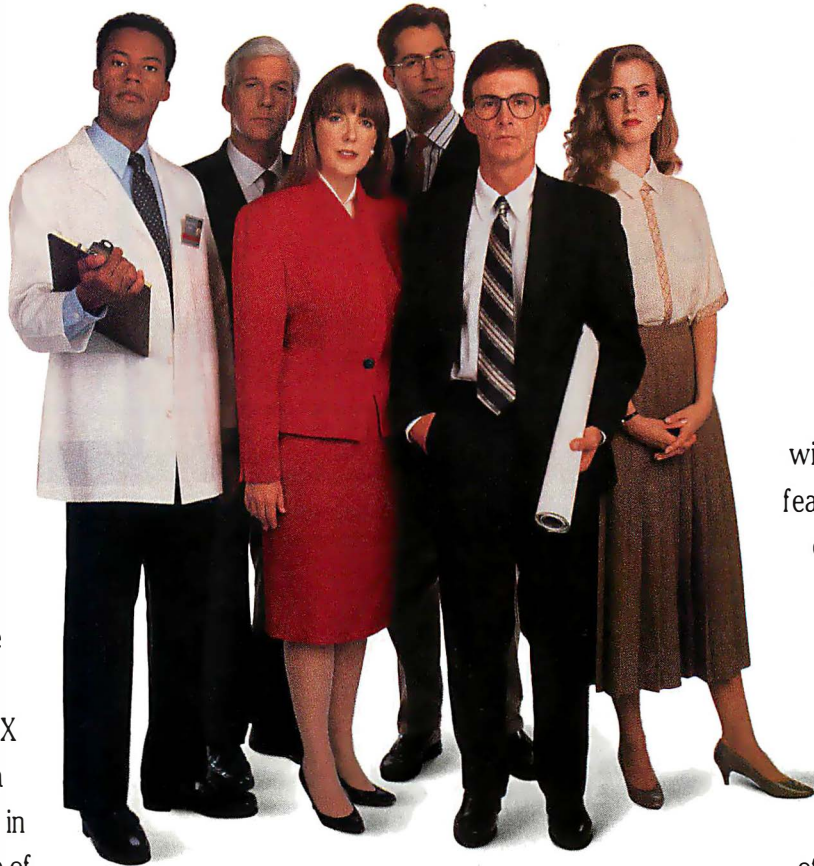
Or becoming seriously addicted to one of two new kinds of solitaire.

Equally entertaining is IdleWild, the screensaver with seven radical selections. From a race through space, to a pattern that slices, dices, and scrambles your screen.

Now get to work. Call us at (800) 541-1261, Dept. P11, and ask us all about the Entertainment Pack. We'll do our best to give you a completely frivolous answer.

**Microsoft**  
Making it all make sense

# What does Compaq give 386 users who expect the moon?



Giving demanding users the best PC possible is a tradition at Compaq. A tradition we upheld when we introduced the world's first PCs based on Intel's 386 and 386SX microprocessors. And a tradition that continues in our comprehensive line of desktop PCs.

Within this line you'll find six different levels of 386 performance and affordability. And a PC designed to give you the perfect balance of features and power. You'll find the reliability and compatibility you've come to expect from Compaq. Plus the flexibility to choose from a wide array of optional features.

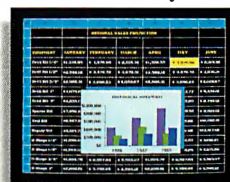
You'll also find an Authorized COMPAQ Computer Dealer, who's trained to match the right peripherals and software with the right PC. And to tailor a solution to your exact needs. All at prices that are more competitive than ever.

Come look at the COMPAQ DESKPRO 386N Personal Computer, for example. It's a full-function PC

with breakthrough features for networked environments. As a stand-alone PC, its 16-MHz 386SX microprocessor handles all of the general business applications our other 386SX-based PCs

run. With so many integrated features, you can take care of your expansion needs using only two slots.

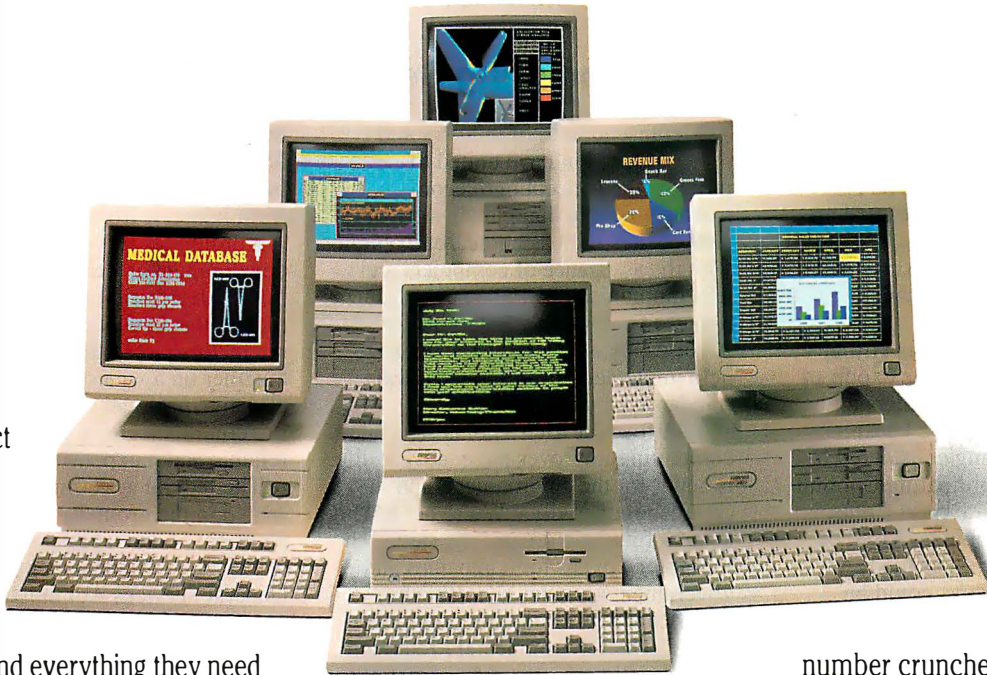
And it comes with a host of unique network features like multilevel security, making it the best full-function PC for connected environments. All of this fits neatly into a space-saving design.



The COMPAQ DESKPRO 386s Personal Computer is also designed to handle general business applications. Its 16-MHz 386SX microprocessor gives you exceptional 386 performance. And its 32-bit architecture lets you run today's popular business software. It also offers the flexibility to run tomorrow's advanced business software.



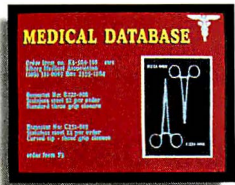
# The stars.



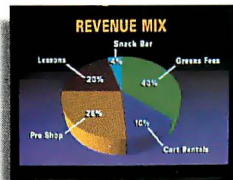
Project managers and other general business users will find everything they need

It's the perfect personal computer for people who are serious number crunchers, administrators

to manage databases and speed through complex spreadsheets in the COMPAQ DESKPRO 386s/20 Personal Computer. It delivers the maximum in 20-MHz 386SX performance and a broad range of integrated features.

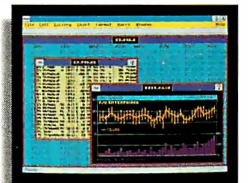


The COMPAQ DESKPRO 386/20e Personal Computer is for experienced users. It's perfect for demanding applications like presentation graphics. And it's loaded with high-performance features like an advanced cache architecture. So it runs up to 50% faster than other 20-MHz, non-cached 386-based PCs.



For users doing similar jobs, but with more stringent performance needs, we offer the COMPAQ DESKPRO 386/25e Personal Computer. Its 25-MHz 32-bit performance lets you fly through financial analysis as well as other demanding applications.

who manage massive loads of information and engineers who work on generating complex two-dimensional CAD drawings.



At the most demanding level of 386 computing are the power users who do graphic-intensive applications like 3-D CAD drawings and other performance-intensive applications. These people need the kind of high performance that the COMPAQ DESKPRO 386/33L Personal Computer delivers. It combines the fastest 386 chip with high-performance innovations. And it lets you easily upgrade to the power and performance of a 486 chip.



If you're looking for the 386 desktop PC that simply works better for whatever you do, call 1-800-231-0900, Operator 129. In Canada, call 1-800-263-5868, Operator 129.

**COMPAQ**

It simply works better.

## NANOBYTES

**RIP Z-1000: Zenith Data Systems** (Mount Prospect, IL) has abandoned its plans to sell a multiprocessing Unix system. The company announced the Z-1000 well over a year ago but has now decided to leave the multiprocessing business to its parent company, Groupe Bull.

**Hercules takes RISC:** Hercules Computer Technology (Berkeley, CA), known primarily for its PC monochrome cards, has teamed up with **AQuest** (Santa Clara, CA) to develop graphics cards using Intel's i860 64-bit RISC processor.

The **U.S. government** has virtually eliminated controls on the export of certain high-speed computers to the Soviet Union. Under the latest recommendations being considered by COCOM (the Coordinating Committee for Multilateral Export Controls), most personal computers based on the Intel 486, as well as many graphics workstations, could be exported to the Eastern Bloc.

**AT&T's Unix System Laboratories** is opening a center in Summit, NJ, where software vendors can certify System V release 4 applications on various hardware platforms, including Intel, MIPS, Motorola, and SPARC.

Looking for **scientific information from Japan**? The National Science Foundation (Washington, DC) is now offering free searches of Japan's National Science Center for Science Information System (NACSIS). The database contains information on research activities funded by the Ministry of Education, Science, and Culture, as well as development at universities. American knowledge seekers can request a search by phoning the NACSIS operator, between 1 and 4 p.m. (EDT), at (202) 357-7278.

**Virtual book:** Harcourt Brace Jovanovich (New York) plans to publish a book next year on **virtual reality** cowritten by one of its foremost explorers, **Jaron Lanier**. Lanier, founder of VPL Research, was paid a six-figure advance for the manuscript on "alternative sensory realities," the publisher said.

monitors require a 50-watt direct backlight rather than the diffuse backlight used in most portables today; the new cold cathode backlights aren't direct enough to work with the In Focus displays, which means that the displays currently use a lot of power.

In Focus has licensed its TSTN technology to an unnamed U.S. laptop manufacturer for products that are expected to appear in late 1991. Hix said the company will have a high-resolution color display later this year.

— Owen Linderholm

## Telecommuting Gets Boost from Industry, Feds

**R**epresentatives of industry and government have united to promote the concept of telecommuting—people doing their work at remote sites such as home, for example, with the assistance of computers and telecommunications. The new organization, Telecommuting Solutions for America (Washington, DC), hopes to help implement ideas and technical standards for telecommuting.

TSA founder Rich Thoma says telecommuting improves the quality of life, is better for the environment, and increases productivity. "We're not talking about a futuristic dream," he said. "The technology exists for companies and government agencies to establish significant telecommuting programs today." The Environmental Protection Agency estimates that if 5 percent of Los Angeles commuters telecommuted one day per week, it would eliminate 47,000 tons of pollutants and 205 million miles of travel annually.

Link Resources, a research firm, says

that over three million Americans spend 35 or more hours a week working from home, and some 22 million work partly from home or from satellite locations. According to Jeff Garbers, director of development at Crosstalk Communications, a telecommunications software maker, this is now possible because all the factors have "started coming together on a widespread basis: cost-effective personal computers, easy-to-use communications products, and reliable and inexpensive services."

The federal government is represented in the group by the EPA, the Department of Transportation, the Office of Personnel Management, and the General Services Administration. Each agency has pledged to encourage telecommuting both for its own employees and as public policy. Companies that support the new organization include MCI, Tigon (a subsidiary of Ameritech Corp.), U.S. Sprint, Novell, Hewlett-Packard, and Northern Telecom.

— Allan Davidson and Jan Ziff

## Superfloppy Drive Will Work with Regular Disks

**T**he first very high-density floppy disk drive to work with regular floppy disks is scheduled to arrive this month. Insite Peripherals (San Jose, CA) plans to start shipping limited quantities of its Floptical disk subsystem, which can store 20.8 MB on 3½-inch floppy disks. But the drive can also read and write 720K-byte and 1.44-MB floppy disks, the company said.

Insite's Floptical disk drive uses embedded optical tracks and a closed-loop servo motor to dramatically increase the storage capacity of a magnetic floppy disk. Because it can

both read from and write to 720K-byte and 1.44-MB media, it could become a standard A drive without making the installed base of drives and disks obsolete.

The drive offers an average seek time of 65 ms and a data transfer rate from the Floptical disk drive of 1.6 MBps, Insite says. When operating on older media, the transfer rate drops to 600 Kbps or 1.2 MBps.

Volume production is planned for April 1991, the company said. The OEM price is \$325.

— Andy Reinhardt

**MAKE THE NEWS IN '91.** *If you, your company, or your research group is working on a new technology or developing products that will significantly affect the world of microcomputing, we'd like to write about it. Phone the BYTE news department at (603) 924-9281. Or send a fax to (603) 924-2552. Or write to us at One Phoenix Mill Lane, Peterborough, NH 03458. Or send E-mail to "microbytes" on BIX or to "BYTE" on MCI Mail. An electronic version of Microbytes, offering a wider variety of computer-related news on a daily basis, is available on BIX.*

IN GOTHENBURG, SWEDEN...



IN WORLAND, WYOMING...



AND IN SOCORRO, NEW MEXICO...



*"You've got a friend in the business."*

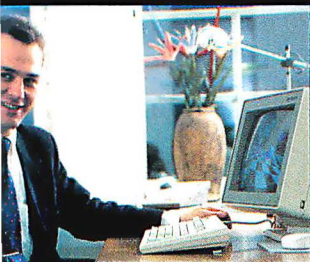
# People the World Over

Everywhere you look these days you'll find Gateway 2000 computers. That's because people everywhere know a good value when they see one. In all 50 states and in over 70 foreign countries, thousands of people are comparing price, quality and service – and choosing Gateway 2000.



## In Gothenburg, Sweden

Anders Bjernefors, a computer dealer and programmer, bought a Gateway 2000 25 MHz 486 system last April. "After many faxes and a lot of study, I selected Gateway 2000," said Anders. "I'm pleased with the machine. I received a very powerful, well-built computer for an astonishingly low price."

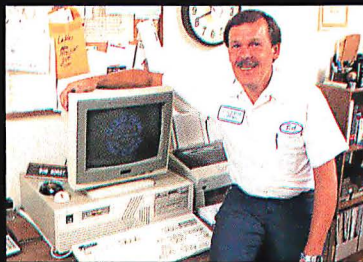


*Anders Bjernefors, Computer Link AB, and his Gateway 2000 25 MHz 486™ system.*

Anders was so impressed by his system and by the people at Gateway that he contacted the company about becoming a Gateway 2000 reseller. "I telephoned my salesman," Anders remembered, "and he told me I'd have to visit the factory to make the arrangements. I was on the next plane out of Goteborg on my way to North Sioux City, South Dakota."

## In Worland, Wyoming

Bob Borst, owner and operator of Cloud Peak Pest Control in Worland, spent two and a half months researching his computer purchase. He chose a Gateway 2000 386SX. "My final decision was based on people, not hardware," said Bob. "The Gateway people make you feel like you're the most important person in the world. I didn't buy a computer – I bought Gateway."



*Bob Borst, owner and operator of Cloud Peak Pest Control, and his Gateway 2000 386SX.*

Bob was equally impressed by Gateway's service people. "One time I got into a file and couldn't get out of it," Bob related. "Even though it was a software problem, I called Gateway and they talked me through it."

## In Socorro, New Mexico

Gordon Kane, Laboratory Associate at New Mexico Tech, runs a computer lab with 15 Gateway 2000 286 systems. "At first we bought Gateway's because of the good prices," said Gordon. "But now I buy them because of the technical support, which is very superior, and because the company is committed to improving its product line."



*Gordon Kane, New Mexico Tech, with his Gateway 2000 286 lab computers.*

NMT also uses Gateway computers in its research programs. "A Gateway 386 cache system will be used



# Choose Gateway 2000!

at Kennedy Space Center next summer," said Gordon, "as part of a large program of thunderstorm studies being conducted there by NASA and the Air Force."

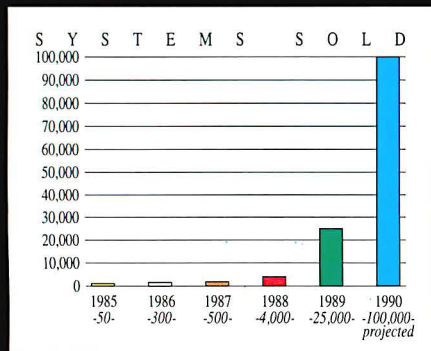
PC Magazine's survey about service and reliability confirms what these customers are saying:

"Gateway shared top billing with such heavy-weights as Compaq, IBM, and HP for those who would buy their products again...Overall, Gateway's high marks bode well for the company's future, as does its commitment to customer service."

PC Magazine  
September 25, 1990

## From the Heartland

The combination of price, quality and service makes Gateway 2000 the best value in the industry. But value alone doesn't explain how a little company in the Midwest, just celebrating its fifth anniversary, managed to outdistance hundreds of other companies, selling more systems through the direct market channel than any other PC manufacturer in the



Gateway 2000 sells more computers through the direct market channel than any other PC manufacturer in the country.

Computer magazine readers will remember the company's early ads featured a picture of the Waitt cattle farm with the headline, "Computers from Iowa?"



**"In the computer industry, longevity should be measured in dog years."**

country.

"It was the cows," laughed Ted Waitt, Gateway 2000 President and CEO. "Of course."

"We can't run that ad anymore," continued Ted, grinning, "because we built a new plant 14 miles down the road in South Dakota. But the cows really worked for us. They made the phones ring. From then on, though, we built our business on value – good prices on quality systems with old-fashioned, personal service."

Ted mentioned another reason for Gateway's success. "We take a long-term approach to customer service," he said.

"When you buy a computer from Gateway 2000, you become part of our family and we're going to be there for you as long as you own that machine."

As Ted talked about the company's fifth anniversary, he laughed again. "In the computer industry, longevity should be measured in dog years," he chuckled, "because everything's moving so fast. That makes Gateway 35 years old! But seriously, we've come a long way in five years. And I owe it all to the great people at Gateway and to our customers."

When you add it all up, you'll understand why you've got a friend in the business at Gateway 2000.



Gateway 2000 will be there for you 'til the cows come home.



8 0 0 - 5 2 3 - 2 0 0 0  
610 Gateway Drive • N. Sioux City, SD 57049 • 605-232-2000 • Fax 605-232-2023

# GATEWAY 2000 SYSTEMS

## 12MHZ 286VGA

- 80286-12 Processor
  - 1 MB RAM
  - 1.2 MB 5.25" Drive
  - 1.44 MB 3.5" Drive
  - 40 MB 17ms IDE Drive with 32K Cache
  - 16 Bit VGA with 512K
  - 14" 1024 x 768 Color Monitor
  - 1 Parallel/2 Serial Ports
  - 101 Key Keyboard
  - MS DOS 3.3 or 4.01
- \$1495.00**



## GATEWAY 386SX

- 4 MB RAM
  - 1.2 MB 5.25" Drive
  - 1.44 MB 3.5" Drive
  - 40 MB 17ms IDE Drive with 32K Cache
  - 16 Bit VGA with 512K
  - 14" 1024 x 768 Color Monitor
  - 1 Parallel/2 Serial Ports
  - 101 Key Keyboard
  - MS DOS 3.3 or 4.01
  - MS WINDOWS 3.0
- \$1895.00**



## 25MHZ 386VGA

- 4 MB RAM
  - 1.2 MB 5.25" Drive
  - 1.44 MB 3.5" Drive
  - 80 MB 17ms IDE Drive with 32K Cache
  - 16 Bit VGA with 1 MB
  - 14" 1024 x 768 Color Monitor
  - 1 Parallel/2 Serial Ports
  - 101 Key Keyboard
  - MS DOS 3.3 or 4.01
  - MS WINDOWS 3.0
- \$2395.00**

## 25MHZ 386CACHE

- 64K Cache RAM
  - 4 MB RAM
  - 1.2 MB 5.25" Drive
  - 1.44 MB 3.5" Drive
  - 80 MB 17ms IDE Drive with 32K Cache
  - 16 Bit VGA with 1 MB
  - 14" 1024 x 768 Color Monitor
  - 1 Parallel/2 Serial Ports
  - 101 Key Keyboard
  - MS DOS 3.3 or 4.01
  - MS WINDOWS 3.0
- \$2695.00**



## 33MHZ 386VGA

- 64K Cache RAM
  - 4 MB RAM
  - 1.2 MB 5.25" Drive
  - 1.44 MB 3.5" Drive
  - 200 MB 15ms IDE Drive with 64K Multi-Segmented Cache
  - 16 Bit VGA with 1 MB
  - 14" 1024 x 768 Color Monitor
  - 1 Parallel/2 Serial Ports
  - 101 Key Keyboard
  - MS DOS 3.3 or 4.01
  - MS WINDOWS 3.0
- \$3195.00**



## 25MHZ 486VGA

- 64K Cache RAM
  - 8 MB RAM
  - 1.2 MB 5.25" Drive
  - 1.44 MB 3.5" Drive
  - 200 MB 15ms IDE Drive with 64K Multi-Segmented Cache
  - 16 Bit VGA with 1 MB
  - 14" 1024 x 768 Color Monitor
  - 1 Parallel/2 Serial Ports
  - 101 Key Keyboard
  - MS DOS 3.3 or 4.01
  - MS WINDOWS 3.0
- \$3995.00**

## BEST BUY

- Same features as our 33 MHz 386 VGA system except this machine has an 80 MB 17ms IDE Drive instead of the 200 MB 15ms IDE Drive.
- \$2795.00**

## STANDARD FEATURES AND SERVICES

- Microsoft® WINDOWS™ and Mouse with all 386 and 486 systems
- 30-day money-back guarantee
- One-year warranty on parts and labor
- New leasing options now available
- Toll-free technical support for the life of the machine
- Free on-site service to most locations in the nation
- Free overnight shipment of replacement parts
- Free bulletin board technical support

*If our standard configurations don't fit your needs, we'll be happy to custom configure a system just for you. Due to the volatility of the DRAM market, all prices are subject to change.*



8 0 0 - 5 2 3 - 2 0 0 0  
610 Gateway Drive • N. Sioux City, SD 57049 • 605-232-2000 • Fax 605-232-2023



FORTRAN. Why? Because neither of those languages is appropriate to the task at hand.

A similar argument applies to the present "objective" craze. Object-oriented languages and techniques are useful for modeling object-oriented problems, like the manipulation of desktops or message-passing simulations. Does this mean that you can't use C++ to do numerical analysis? Of course not. But it does mean that C++ or Smalltalk or Xlisp may not be the appropriate tool for the job.

I liked the way your articles gave Objective-C equal time alongside C++. Many programmers think that Objective-C is in some way better than C++, and the debate is still not over.

Garrett A. Wollman  
*South Burlington, VT*

I read BYTE because it goes into advanced topics sufficiently to stretch my mind; the comprehensive object-oriented programming (OOP) material in your October issue puffed my mind up like a balloon.

In spite of my reverence for Edward Yourdon's knowledge and ability compared to mine, I disagree with some of his comments in "Auld Lang Syne." I approach analysis and programming by looking for the tool that will do the best job for what I want to do. I won't use a pipe wrench to drive a nail (well, I will in an emergency), and I won't use a hammer to put in a screw. If OOP in one area does the job better, I'll use it; if it does not, I won't. Saying that structured procedural programming is always right is as foolish as saying that OOP is always the answer.

However, I do believe that OOA (object-oriented analysis) is a very beneficial shift of paradigm. It forces us to be sure that we really understand the system. I can't design it if I don't understand what it does or how it does it.

Your articles on OOP and OOA/OOD (object-oriented design) really helped me understand the subject better.

Thomas J. McCarthy  
*Indianapolis, IN*

### More from the Summit

The quote from Bill Gates ("BYTE Summit," September 1990) saying that chaos "doesn't impact computers" absolutely flabbergasted me. That is the equivalent of saying that disease is irrelevant to the development and use of the microscope.

If not for the invention of computers, chaos would be nothing more than the constant annoyance that, despite our

"great" knowledge, seems to constantly foil the best computed predictions of mice-using people. Chaos is seeing the forest for the trees.

We in medicine have been constantly confounded by the perceived imprecision of nature. Why do some people with virtually identical environments develop cancer? Why do some survive while others perish?

Computers made the science of chaos possible. Computers are the microscope of the future. A science discovered on computers and that defines the universe certainly deserves more than a few gratuitous lines in BYTE's prediction of the future. Chaos theory is important to computing because it will yield ways to make computers do (not simulate) things of which we now just barely dream.

Thank you, BYTE; you've been my companion for 15 years. I hope you'll be here for many more years to come. Congratulations on your birthday.

Dr. Kenneth D. Hackmeyer  
*Cleveland, OH*

The BYTE Summit is about the future, and, according to the "experts," the future is bright. Computers will be more powerful, cheaper, faster, smaller, and so much a part of our lives that we won't even notice them anymore.

Come on, BYTE, tell us something we don't already know. You chose to talk with people involved with the industry for many years. Why didn't you ask those "experts" to take a look back and reflect on the impact of the work they have done? Better yet, why didn't you ask users about that impact or about what they would like to see in the future? That kind of feedback could be useful and healthy.

Although it makes a cursory nod to social issues, the BYTE Summit is mainly an ode to technological progress, by a bunch of insiders cheering themselves on to a bigger and better future. I can't believe I read the whole thing.

Sarah Brehm  
*Madison, WI*

### Recycling Rebuttal

"To Refill or Not to Refill" (July 1990, p. 142) contained inaccurate statements and did not tell the whole story.

As a result of the introduction of Canon laser printers and copiers that use a replaceable cartridge containing the drum and toner supply, an entire industry has sprung up since 1985 to recycle used Canon toner cartridges. There were problems in those early days, with most cartridge refillers using the "drill and

fill" method. This simply meant drilling a hole in the cartridge, dumping out the old toner, and filling the cartridge with new toner. The results were not always satisfactory, and the industry obtained a bad reputation.

"Drill and fill" was soon replaced by a remanufacturing process that was a vast improvement; however, the problem of parts wearing out (particularly the optical photo coupler [OPC] drum) was still an obstacle in consistently providing a quality product to the end user.

About a year ago, new technology caused some dramatic changes. You stated that the life of the OPC is limited. This is true, especially as it relates to the original OEM drum. However, cartridge recyclers now have available to them a new "super drum" that allows a cartridge to be recycled as many as 10 to 20 times with no noticeable drum wear. There are also replacement corona wires, wiper blades, and related products to ensure quality. Most cartridge recyclers indicate on the cartridge the date and/or the number of times a recycle is completed in order to monitor the life of the cartridge.

Because most cartridge recyclers guarantee their product (many even guarantee a minimum number of refills), it is not necessary to require that the recycler return the exact cartridge you sent him, although most recyclers will work with you should you require that the original be returned.

Regardless of what a manufacturer's service representative tells you, using a recycled cartridge will not void your warranty. Manufacturers' official policy [often] states that if a refilled cartridge causes any damage, the warranty won't cover repairs caused by that cartridge. There is no record of damage caused by properly recycled cartridges during the industry's five-year history. Properly recycled cartridges can cause no more damage than a brand-new cartridge. Most cartridge recyclers will provide a guarantee in the event that this should happen.

Cheryle White  
*President, American Cartridge  
Recycling Association  
Miami, FL*

### Alternative Operating Systems

Thank you for your reviews of alternative operating systems to OS/2, Unix, and DOS extenders. However, I was very disappointed in Ben Smith's review of OS-9000 ("From a Tiny Kernel..." September 1990). There were no comparisons of the size of the kernel, or of the

# We slash interface development time. (and we can prove it!)

## C-PROGRAMMERS: See for yourself how Vermont Views™ can help you create user interfaces the easy way.

If you want to start saving a *tremendous* amount of time and effort, call for your free Vermont Views demo kit and put us to the test. Vermont Views is a powerful, menu-driven screen designer that comes with a C library of over 550 functions. Which means you can create user interfaces in just a fraction of the time it takes to write the code yourself!

Why try to reinvent the wheel when Vermont Views lets you interactively create pull-down menus, window-based data-entry forms (with tickertape and memo fields), scrollable form regions, choice lists, context sensitive help, and a host of other interface objects.

Vermont Views combines the convenience of a fourth generation language with the power, flexibility, and blinding execution speed of native C code.

## Turn your prototype into the application.

Let's face it. With most systems, you have to throw away your prototype when coding begins. Which means you waste precious time

and effort. With Vermont Views, things are a lot different. In fact, the prototype actually *becomes the application*. So menus and data-entry forms are usable in the final application without change. Names of functions for retrieving, processing, and storing data can all be specified as the prototype is created. And that's just for starters.

## Here's a truly universal solution.

When you create an interface with Vermont Views, you can port it among PC-DOS, OS/2, UNIX, XENIX, and VMS.

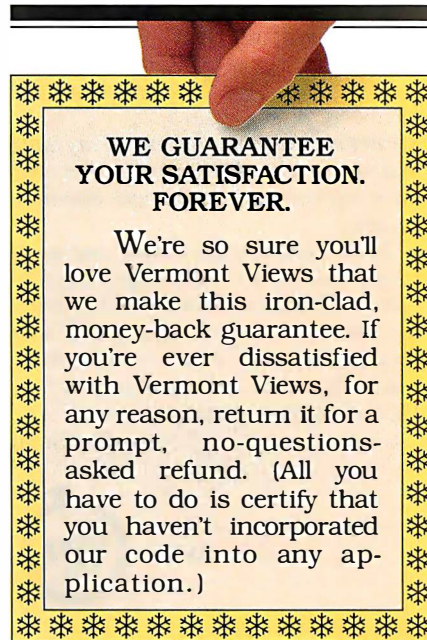
Vermont Views can be used with any database that has a C-language interface (most do), and will create interfaces for any roman-based language. Our form-locking version lets you develop quickly and safely on networks and multi-user operating systems, too.

If you need DOS graphics in your applications, we also have the answer. Vermont Views™ GraphEx allows all Vermont Views' windows, menus, and forms to work in CGA, EGA, VGA, and Hercules graphics modes. So you can use your favorite graphics package to create charts, graphs, and other images to enhance text displays.



Vermont  
Creative  
Software

Pinnacle Meadows,  
Richford, VT 05476  
Phone: (802) 848-7731  
FAX: (802) 848-3502

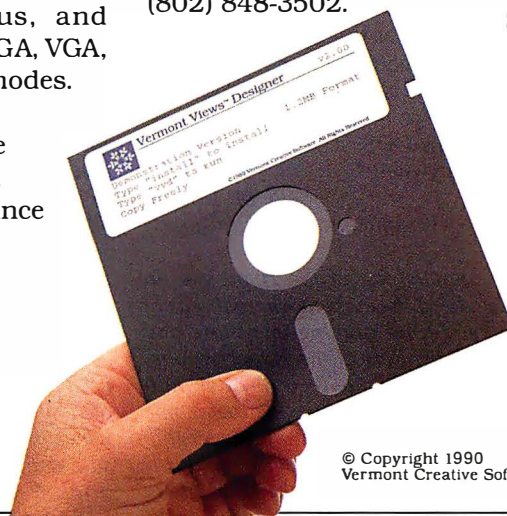


## Call for your FREE demo kit!

# 800-848-1248

(Please mention "Offer 086")

Don't take *our* word for it. Put Vermont Views to the test by calling for your personal, free demonstration kit. Or fax us at (802) 848-3502.



© Copyright 1990  
Vermont Creative Software

speed of doing common operations versus QNX, Xenix, or Unix. No mention was made of the ability to install, remove, or modify drivers without regenerating the kernel.

Also, Smith stated, "You probably won't be using OS-9000 for your common PC applications." Why not? The article was supposed to be about alternative operating systems, right?

Ramer W. Streed  
North Mankato, MN

*My article was not a review, so my intent was to give a brief description of an operating system, not to compare operating systems.*

*To do what you are asking, we would need to develop an independent set of operating-system benchmarks that tested the common advanced features of each operating system. That's a task that I would suggest as a doctoral project for a Ph.D. in computer science.*

—Ben Smith

ASK BYTE



### Hyperion Huzzahs

Once upon a time, there was a marvelous little machine called the Hyperion and a marvelous word processing program with it, called In:scribe. The program did all the basic things that most people want. It did not do a bunch of things that pretty sophisticated people want, but the trade-off was that the program was virtually idiot-proof and took only a few minutes to master. The secret was the use of softkeys that were displayed on-screen in a cascading sequence. It was a delight to use.

Do you know of any program now available that uses this system? If so, I'd like to know where I can get it. The nearest I have come is Microsoft Word. Also, is In:scribe for the more advanced versions of MS-DOS still commercially available anywhere?

P. M. Pitfield  
Westmount, Quebec, Canada

*Ahh... another fan of the Hyperion. In tracking down the current whereabouts of In:scribe, I keep running into more and more die-hard fans of the Hyperion portable. Dynalogic Info-Tech (the developer of the Hyperion) disappeared some time ago, changing its name and merging several times. The technology behind In:Scribe is currently part of the NTM Menu Manager interface from Diligence Tech-*

*nologies. Now known as Notemaker, the program has been turned into an ASCII system editor, and while it still uses function keys, it no longer has the cascading key sequences that were the Hyperion's trademark. Too bad, too, as that idea was a popular one used in a number of commercial products. Hewlett-Packard used it in its 64000 series development system, and when I worked for Coleco, we used it on the Smart software family for the Adam. Maybe we'll see it again someday.*

*In the meantime, Comterm (93 Hymus Blvd., Pointe Claire, Quebec H9R 1E2, (514) 694-4332) is still handling service on the Hyperion. The service division is undergoing a name change even as we speak, but if you contact the people there at the above address, they'll put you in touch with the right people.—H. E.*

### A Luggable Beast

As I read through "15 Years of Bits, Bytes, and Other Great Moments" (September 1990), I was surprised to see a reference to the IBM 5100 that was announced in 1975. I have one of these "luggable" machines collecting dust in my garage because my wife refuses to let me bring it inside. When I told her it originally sold for around \$9000, she was still not interested.

As I contemplate selling the beast, I am curious to know what you thought I could sell it for today. Is it a collector's item, or should I consider using it as a boat anchor?

Douglas G. Jones  
Valparaiso, FL

*I know exactly what you're talking about. I have a dozen or more machines, some dating back to before the 5100. They're neat to have, and it certainly seems like they should be worth something. Get a stout chain ready—I'll get to the 5100 in a second.*

*There's a fairly booming business in used equipment nowadays. If you're looking to buy or sell equipment, you can contact the Boston Computer Exchange (P.O. Box 1177, Boston, MA 02103 (800) 262-6399). The people there have set standard prices for common equipment, and for a \$25 fee, they will appraise any unusual stuff. The BCE didn't have a listing for the 5100.*

*Another place to check is in one of the used computer listing books. The National Association of Computer Dealers publishes the Computer Bluebook of wholesale and retail prices. You can order the book directly ((800) 223-5264) for \$15.95. A more detailed book is avail-*

*able from Orion Research (1315 Main Ave., Durango, CO 81301, (303) 247-8855) for \$124.95.*

*Back to the 5100. None of the listing books shows the 5100. A specialty machine like the 5100 has no real value as an everyday machine, unless you happen to need one specifically. That makes it hard to find a buyer. A curiosity seeker might give you \$25 for it, while someone who has built an entire testing facility around one might offer you \$1000 or more. You might take out an ad in the paper and see who bites. Basically, we're talking Boat Anchor City here.*

*Since the machine was built back in the 1970s, it's one hefty beast. It's probably worth a fair amount for scrap value. You might contact some scrap dealers and sell it for enough to buy you and your wife a nice dinner out. If you want to see it used by someone, the folks at Orion Research recommend that you contact the National Christina Foundation for the Blind and Disabled ((914) 738-7494). It's a charitable organization that helps get donations (i.e., used computers) directly to people who can use them. The group doesn't resell the equipment, but it finds a good home for it.*

*Someday, I expect we'll be getting letters from people who need to find out what their old 486s are worth. It's sad, isn't it?—H. E.*

### On Pascal's Trail

I am trying to learn Pascal. Can you recommend a few textbooks on the subject?

J. D. St. John  
Oak Creek, WI

*If you've made up your mind to learn Pascal, the first thing you should do is buy a good Pascal compiler. It will include your most important resource: the language reference. Many compilers also come with tutorial books or floppy disks.*

*A few popular compilers are from Borland International (1800 Green Hills Rd., P.O. Box 660001, Scotts Valley, CA 95066, (408) 438-8400); IBM (Old Orchard Rd., Armonk, NY 10504, (800) 426-2468); Jensen & Partners International (1101 San Antonio Rd., Suite 301, Mountain View, CA 94043, (800) 543-5202); MetaWare (2161 Delaware Ave., Santa Cruz, CA 95060, (408) 429-6382); Microsoft Corp. (1 Microsoft Way, Redmond, WA 98052, (800) 426-9400); and MicroWay (P.O. Box 79, Kingston, MA 02364, (508) 746-7341).*

*When you order, you should also ask about any companion books for the specific compiler you choose.*

*Pascal is no longer the hot language it*

# COREL DRAW! 2.0

It's **FAST**

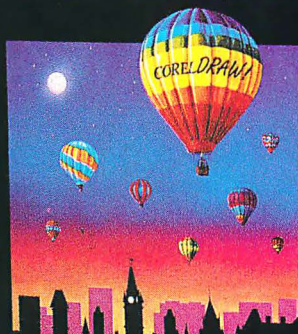
It's **FUN**

It's **POWERFUL**

...and  
it's easy  
to use!

**IF YOU'VE GOT  
WINDOWS 3.0  
YOU SHOULD HAVE  
CORELDRAW!**

**COREL DRAW!**



PASTOR'S  
LICENSE  
INCLUDED  
FREE!

WITH 150  
COREL  
CLIPART

OVER  
**150**  
FONTS

THOUSANDS  
OF  
SYMBOLS  
AND  
CLIPART

COREL  
TRAGEDY!



**COREL**

*The World's Finest  
PC Graphics Software*



TEL : (613)728-8200  
FAX : (613)728-9790

Circle 70 on Reader Service Card

There are  
three ways  
to get  
everything  
you expect  
from a laser  
printer.

*Printers, Computers, Peripherals,  
Copiers, Typewriters and Facsimiles*

**Panasonic**  
Office Automation 

When you want corporate-size features in a desk top package.

Speed, fonts, flexibility. Everything you want in a personal laser printer, in a package that fits comfortably in your office or home. The KX-P4420 prints at a fast 8 letter-sized originals per minute — up to twice the speed of some personal laser printers. And its standard features include a large-capacity paper cassette, 22 internal fonts available in 25 symbol sets (including legal), plus 512K of memory, expandable to a full 4.5MB. The 4420 personal laser printer. Corporate-size features. Personal price.

The Panasonic®  
Personal Laser.





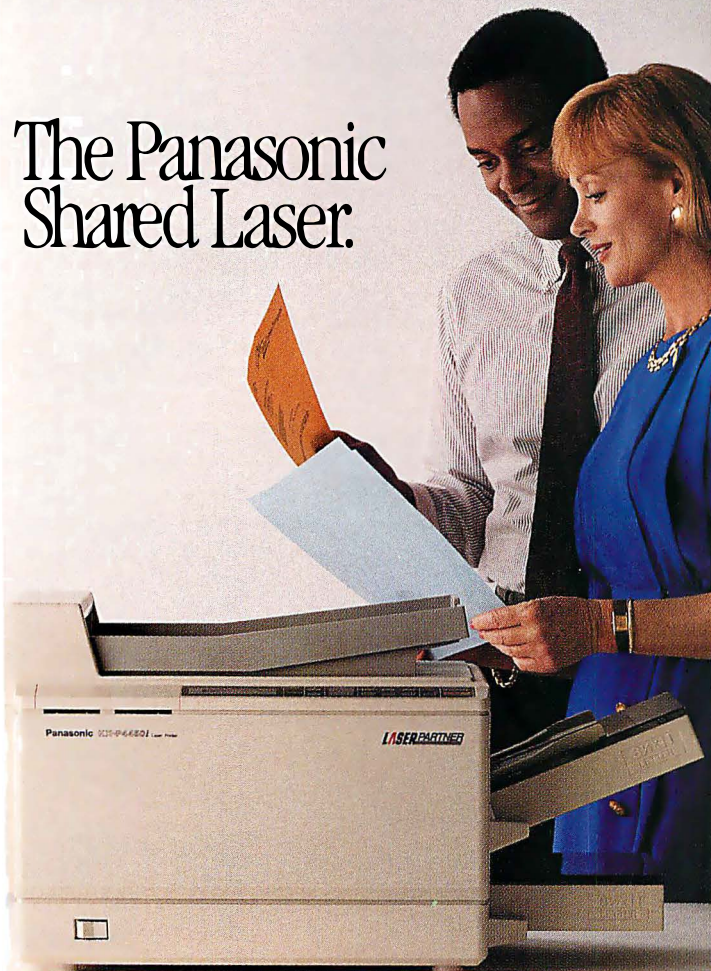
When you have several people in your department, you need a printer that can handle them all.

Lots of speed, lots of capacity, lots of emulations. The KX-P4450i is meant for the whole department. It has dual-bin, high-capacity paper cassettes. And does a full 11 pages per minute even if every page is different. Each page will be crisp and clear, no matter which of the 28 internal fonts you're using. And the 4450i emulates LaserJet Series II, as well as popular dot matrix and daisy wheel printers.\* This is one laser everyone will be happy to share.

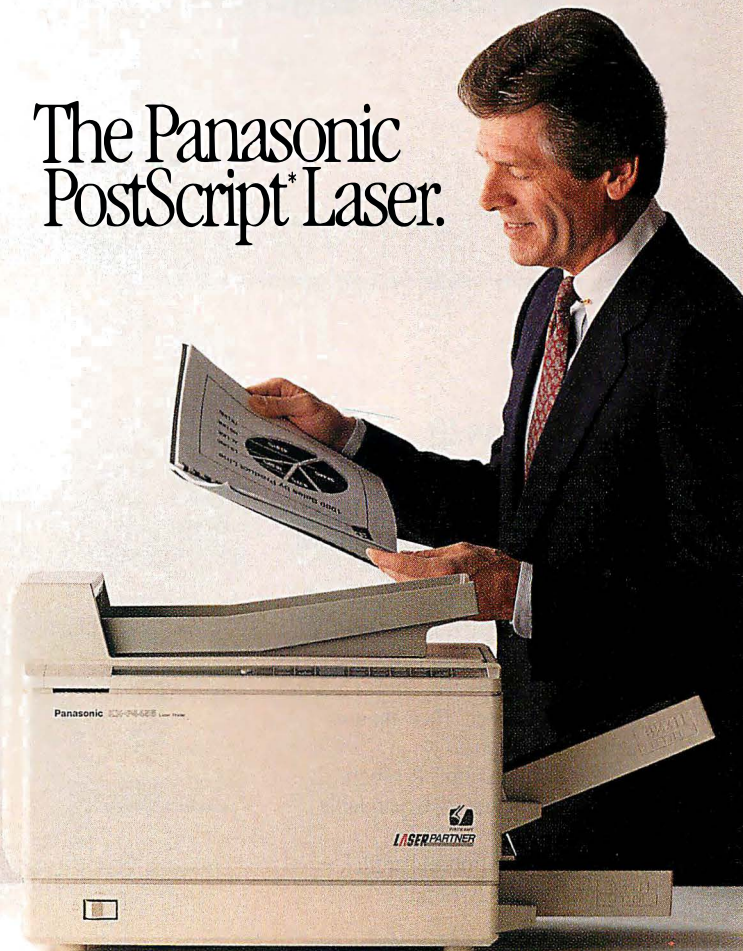
What makes the company look good makes you look good.

When appearance is all, choose the KX-P4455 with Adobe PostScript. With it, you can dramatically enhance every document with multiple fonts, varied type sizes, even images rotated and scaled to fit. At 11 pages per minute, and with superb print quality. The features you want most are standard. From 39 Adobe fonts, to dual-bin, high-capacity paper cassettes. Plus a wealth of optional typefaces. And its interfaces work beautifully with MS-DOS, UNIX or Apple environments.\* With the 4455, you don't just print your documents, you publish them.

## The Panasonic Shared Laser.



## The Panasonic PostScript\* Laser.



FOR FURTHER INFORMATION, SEE THE PRODUCT SPECIFICATIONS ON THE NEXT PAGE, OR CALL TOLL-FREE 1-800-742-8086.

# Three great laser printers. Designed specifically for the ways people do business.

## The KX-P4455 Panasonic PostScript Laser.

**Printing Speed:** 11 pages per minute.\* \*

**Compatibility:** Adobe PostScript, HP LaserJet Series II and Diablo 630 emulations.\*

**Fonts:** 39 Adobe Fonts.\*

**Paper Handling:** Two 250-Sheet Cassettes.

**Resolution:** 300 Dots Per Inch.

**RAM:** 2MB Standard, expandable to 4MB.

**Interfaces:** RS-232C/422A Serial, Centronics Parallel and Appletalk.\*



## The KX-P4450i Panasonic Shared Laser.

**Printing Speed:** 11 pages per minute.\* \*

**Compatibility:** HP LaserJet Series II, Panasonic, Epson, IBM and Diablo emulations.\*

**Fonts:** 28 Internal Fonts-14 available in both portrait and landscape. Two slots for optional font cards.

**Paper Handling:** Two 250-Sheet Cassettes with Manual Feed.

**Resolution:** 300 Dots Per Inch.

**RAM:** 512K Standard, expandable to 4.5MB.

**Interfaces:** Centronics Parallel and RS-232C Serial.

## The KX-P4420 Panasonic Personal Laser.

**Printing Speed:** 8 pages per minute.\* \*

**Compatibility:** HP LaserJet Series II emulation.\*

**Fonts:** 22 Internal Fonts-11 available in both portrait and landscape. Two slots for optional font cards.

**Paper Handling:** 250-Sheet Cassette with Manual Feed. Face-up and face-down output.

**Resolution:** 300 Dots Per Inch.

**RAM:** 512K Standard, expandable to 4.5MB.

**Interfaces:** Centronics Parallel; Optional RS-232C Serial.



*Printers, Computers, Peripherals,  
Copiers, Typewriters and Facsimiles*

**Panasonic**  
Office Automation 

\* HP and LaserJet Series II, Epson, IBM, Diablo, Adobe and PostScript, MS-DOS, UNIX and Appletalk are registered trademarks or trademarks of Hewlett-Packard Co., Seiko Epson Corp., International Business Machines Inc., Xerox Corp., Adobe Systems Inc., Microsoft Corp., AT&T, and Apple Computer Inc., respectively. \*\* Letter size, text mode, 55% image area, all originals. [Specifications are subject to change without notice.]

once was. Some publishers—such as the Waite Group, which put out very good Pascal books in the past—are no longer carrying titles on the subject.

Holt, Rinehart & Winston (301 Commerce St., Suite 3700, Ft. Worth, TX 76102, (800) 776-2606) has discontinued a fine book on Pascal by James Peters. The company still has some Pascal books in its catalog, so you can give the people there a call.

Osborne/McGraw-Hill (2600 10th St., Berkeley, CA 94710, (800) 227-0900) has some titles geared toward Borland's Turbo Pascal. Sybex (2021 Challenger Dr., Suite 100, Alameda, CA 94501, (800) 227-2346) has an introductory book on Pascal as well as titles covering Microsoft's Quick Pascal. For other books on Quick Pascal, call Microsoft Press (P.O. Box 97200, 10700 Northrup Way, Bellevue, WA 98009, (800) 888-3303). You can call any or all of these publishers and request a catalog.

—S. D.

### OOP Help

At British Steel, we are looking into object-oriented programming, and I need a comprehensive text for reference.

I have long been a convert to BYTE and would like to know if you could either recommend a sensible book or quote me a price for a collection of BYTE articles packaged up that I could refer to in my work on a pilot project.

Gary R. Pead  
South Yorks, U.K.

I love to answer reader requests that are so easy.

The October 1990 State of the Art section is devoted to object-oriented programming.

There are quite a few OOP books out. I suggest you browse through a bookstore's technical section. Here are some titles to look for:

- Designing Object-Oriented Software by Rebecca Wirfs-Brock, Brian Wilkerson, and Lauren Wiener (Englewood Cliffs, NJ: Prentice-Hall, 1990).
- Object Oriented Program Design with Examples in C++ by Mark Mullin (Reading, MA: Addison-Wesley, 1990).
- Object-Oriented Turbo Pascal by Alex Lane (Redwood City, CA: M&T Publishing, 1990).

—S. W.

### CAI Search

I am looking for authoring software for developing CAI courseware on the PC.

Would you please let me know the names and addresses of reputable manufacturers and the names of their products. I would also appreciate it if you could send me the address and telephone of Kinko Academic Software.

Dr. Ivan Tomek  
Nova Scotia, Canada

Authoring software continues to evolve on the PC. The coming year should bring some exciting products. For now, there is Authorware Professional for Windows (Authorware, 8500 Normandale Lake Blvd., Minneapolis, MN 55437, (612) 921-8555); Guide (Owl International, Inc., 2800 156th Ave. SE, Bellevue, WA 98007, (206) 747-3203; ask for Sharlene or Julie); IconAuthor (Aimtech Corp., 77 Northeastern Blvd., Nashua, NH 03062, (800) 289-2884); and Quest (Allen Communications, 5225 Wiley Post Way, Suite 140, Salt Lake City, UT 84116, (801) 537-7800).

I cannot find a listing for Kinko Academic Software. Perhaps one of our readers has the information. Any takers?

—S. D.

### Faster, Please

Help! I have an upgrade question that probably is answered in Computer Science 101, but for which I can't find an answer locally.

I own a Leading Edge Model D that works fine for me. I added an Amdek 600 color monitor, a 30-MB hard disk drive, and an Epson 24-pin printer. However, my wife has gotten the genealogy bug, and some of the sort routines on her program are taking too long to run. Ergo, I want to speed up the machine.

I considered using a 286 board, but I was told that I could double the operating speed by using a V20 CPU. I would probably have to upgrade the RAM chips and would need a new ROM, but I can't find out which one.

I wrote to Leading Edge in Westborough, Massachusetts, back in July but never received an answer. So, if someone at BYTE could run the solution by me, I surely would appreciate it.

Sure, a 486 or even a 386 would be nice, but I have neither the money nor the need for a new machine, so my D and the Heath H-89 will keep on doing fine.

Jose C. Cabanillas  
Orange Park, FL

You've been misinformed. The V20 CPU is a direct replacement for the 8088. You don't need faster RAM chips or a new ROM BIOS. At most, the new CPU would give you a 5 percent increase in comput-

ing power. Plugging a 286 speedup board into your computer may work, depending on how old your Model D is. Early models had bugs in the BIOS ROMs, and they may not work with speedup boards. You could try the speedup with the proviso that you could return the upgrade if it didn't work.

Leading Edge was bought out by Hyundai Electronics, and support for the Leading Edge is practically nonexistent. Good luck.—S. W.

### It Kept Going, and Now It's Gone

I have an Epson PX-8 laptop computer that I have used to good effect on business trips here and overseas since 1983. It is just the right size to fit in my briefcase and carry along without constantly reminding me of its presence.

My problem is that the rechargeable battery has finally given up the ghost. Where can I find replacement batteries for the PX-8 and for the separate 3½-inch floppy disk drive?

David M. Dacus  
Chantilly, VA

Epson still carries replacement batteries and parts in its catalog. You can bring your machine to any sales and service center and have the battery replaced. If you'd rather do it yourself, a number of service centers will sell you the parts directly. You can reach Epson's Accessories division at (800) 873-7766. The people there will give you the name of a service center in your area.

One place you might try is Transaction Equipment in Yorba Linda, California, at (714) 970-7881. The people there seem to know anything you'd ever want to know about the PX-8. Unfortunately, the PX-8 accessories are no longer available, but that machine was fairly popular, and service should be available for a long time to come. Just remember that as parts become more and less common, they become more and more expensive. That battery you need won't be cheap.—H. E.

### FIXES

• The price of a single-user PC license for the Pick operating system ("Pick: OS or DBMS?" November 1990) was incorrect. The correct price is \$495.

• As careful readers of the time line ("15 Years of Bits, Bytes, and Other Great Moments," September 1990) well know, the importance of the original IBM PC cannot be overstated. ■

# SUN PROUDLY ANNOUNCES THE ULTIMATE STRIVING MACHINE.

SPARCstation™ 2. If you think limits were made to be exceeded, this is your kind of machine.

After all, it exceeds all our own limits. Last year, SPARCstation 1 broke every record for price and performance. And became the best-selling workstation in history. By far. But we went right back to the drawing board. And created the entire SPARCstation 2 line.

---

POWER YOU CAN ACTUALLY USE.

To begin with, you get twice

the performance. For about the same price. 28.5 MIPS. 21 SPECmarks. And 4.2 MFLOPS. You can even have up to 96MB of RAM. And as much as 7.6GB of mass storage.

But more than just a hot engine, you get everything else you need to do your job. Unbelievably real graphics. Easy networking. A huge selection of software. And complete expandability.

Put all that together, and you get the kind of power you can actually use.

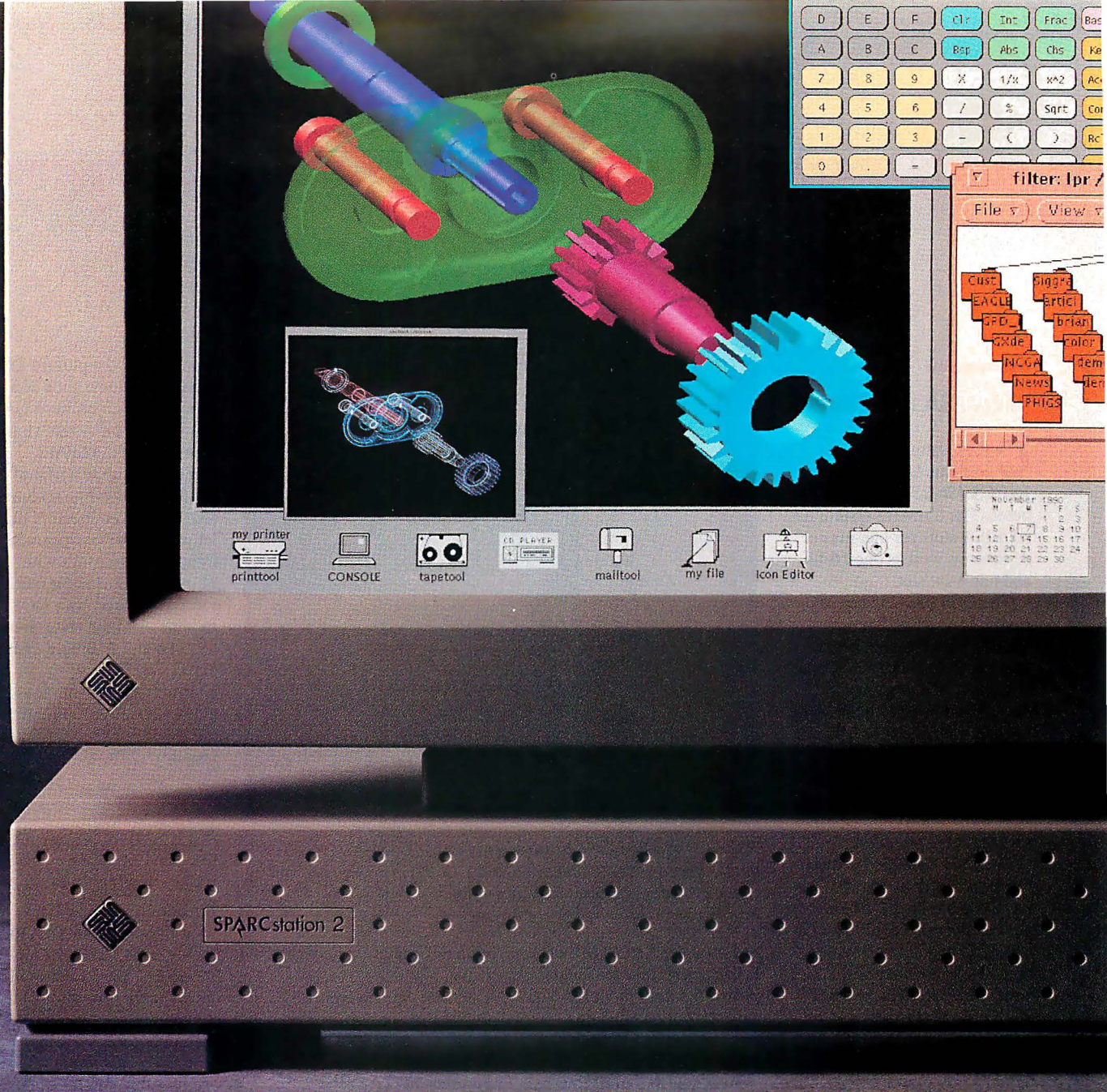
---

THE WHOLE LINE IS AWESOME.  
THE PRICES AREN'T.

---

Just look at SPARCstation 2GX. It gives you ultra-high speed at no extra cost. And brings a whole new level of performance to X-window applications. So it's ideal for electronic publishing. Financial analysis. And for anyone who has to work with 2-D and 3-D wireframe applications.

And that's just the most basic color model. We've also built SPARCstation 2GS. It lets



you create 3-D solid images in 24-bit true color. It's the kind of machine you hate to share. And from now on, you won't have to.

At the high end, there's SPARCstation 2GT. It does all the above, but it's been tuned especially for PHIGS, which is the highest standard for 3-D graphics on the planet. So it runs five times faster than the GS. With all this, it gives you a level of image quality you've never seen at anywhere close to its price.

---

THE WHOLE THING MAKES  
PERFECT STRATEGIC SENSE.

---

At Sun, we make a full line of SPARC-based systems. From the lowest-cost RISC/UNIX® workstation in the world to servers that support hundreds of users. They're all binary compatible. And they're built to run the most widely accepted standards for workstations.

On the subject of software, there are more than 2100 SPARCware™ applications. Including all the most popular

solids modeling programs. And the most popular PC software. And with our OPEN LOOK® interface, you'll spend less time learning the system. And more time on your real job. If you'd like to know more, callusat 1-800-821-4643. (From California, 1-800-821-4642.)

And we'll give you a better machine to strive with.



Computers that network people.™

are trademarks of SPARC International, Inc., licensed exclusively to Sun Microsystems, Inc. SPARC products are based on an architecture developed by Sun Microsystems, Inc. OPEN LOOK is a registered trademark of UNIX System Laboratories, Inc.

# WHAT'S NEW

HARDWARE • SYSTEMS

## 486 EISA in a Tower

**C**CS Custom Computer Systems has introduced its CCS 486-25c EISA computer. The 25-MHz system has six EISA slots for bus-master devices, as well as one 16-bit and one 8-bit slot.

The CCS 486-25c uses a Mylex MAE486-25 motherboard with a Phoenix BIOS. The board provides 128K bytes of static RAM write-back cache in addition to its 8K-byte internal cache. The 4-MB 80-ns single in-line memory modules on the board are expandable to 32 MB. A Weitek WTL4167 math coprocessor socket is also provided.

The CCS 486-25c has two floppy disk drives (one 5 1/4-inch, one 3 1/2-inch), a Conner Peripherals CP3200F 212-MB SCSI drive, and a real-time clock/calendar with battery backup. Housed in a 30- by 10- by 29-inch tower case with 12 half-height drive bays, the CCS 486-25c has a 375-W power supply. Options are available.

**Price:** \$9999.

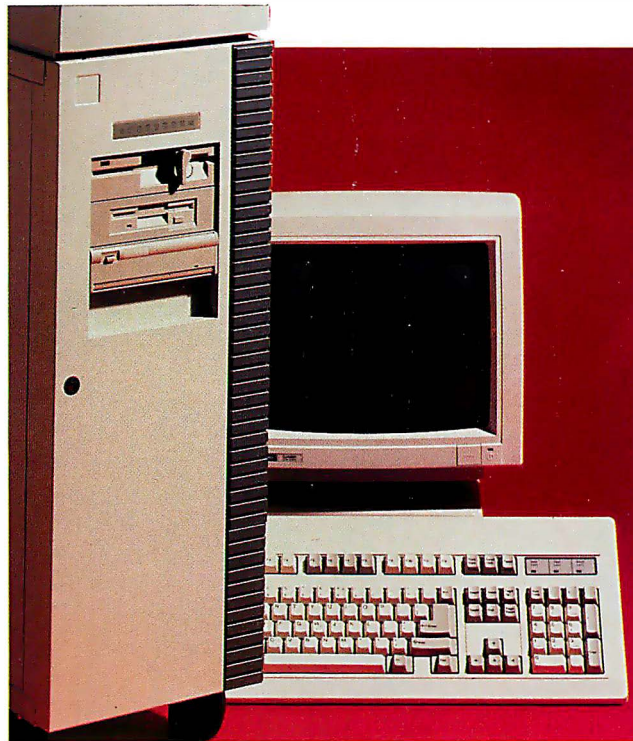
**Contact:** CCS Custom Computer Systems, Inc., 191 Woodport Rd., Sparta, NJ 07871, (201) 729-6762.

**Inquiry 1271.**

## Two SPARCs

**T**he 25-MHz Solarix/4 Personal Workstation Plus (Solarix/4 PW+) operates at 18 MIPS; by replacing its credit-card-size processor module, called the A-Module, you can upgrade to 40-MIPS performance.

The Solarix/4 PW+ uses both the SPARC 32-bit SBUS and the SPARC 64-bit MBUS



*The CCS 486-25c EISA features a Mylex MAE486-25 motherboard with a Phoenix BIOS. Its 128K bytes of write-back cache provides zero-wait-state operation.*

and provides 8 to 32 MB of RAM using standard single in-line memory modules. You have the option of adding from 64 to 128 MB with Solarix SIMMs.

Available as a mini-tower with an internal bay supporting up to six half-height peripherals, the Solarix/4 PW+ works as a stand-alone unit or as part of a network. It comes with 8 MB of RAM and a 17-inch monochrome monitor. A second configuration offers a 104-MB SCSI internal hard disk drive, a 17-inch monochrome monitor, 8 MB of RAM, and a 1.44-MB floppy disk drive.

**Price:** Standard configuration, \$6995; configuration

with SCSI internal hard disk drive, \$7995.

**Contact:** Solarix Systems, 46791 Fremont Blvd., Fremont, CA 94538, (415) 659-1544.

**Inquiry 1272.**

**T**he Mariner 4i is a workstation that combines the power of SPARC technology with DOS accessibility, all in one box. The heart of the Mariner 4i is a Sun-compatible SPARC workstation, but because it's based on a standard ISA bus, you can add an optional DOS module for full DOS compatibility.

According to Mars, the 25-MHz Cypress SPARC CPU provides 16.8-MIPS perfor-

mance. Add the plug-in DOS module, and you get a 386 processor with cache, VGA display capability that runs in a window of the SPARC screen, and up to 8 MB of RAM. The module includes four PC bus connectors that let you use AT peripherals.

**Price:** Diskless unit with 16-inch monochrome monitor, \$5995; unit with DOS module, 19-inch color monitor, and 207-MB hard disk drive, \$10,995.

**Contact:** Mars Microsystems, P.O. Box 1080, Mars, PA 16046, (412) 934-1040.  
**Inquiry 1273.**

## A Smaller EISA 386 for Small Businesses

**I**n addition to 33-MBps burst DMA transfers, the 25-MHz Micro Express ME 386-EISA system offers 14 independently programmable channels. It comes with 1 MB of RAM, a 1.2-MB floppy disk drive, and one serial and one parallel port. It is housed in a mini-tower case.

A Phoenix EISA BIOS is included on the motherboard, with an expanded memory manager and disk caching as standard features. The system and video BIOS are transferred to shadow RAM to increase performance. The standard 8 MB of RAM is expandable to 16 MB with an 8-MB add-in board.

The ME 386-EISA accommodates six 32-bit EISA expansion cards and two 8-bit ISA cards. It has a socket for an Intel 80387 or Weitek WTL3167 math coprocessor.

**Price:** \$1799.

**Contact:** Micro Express, 1801 Carnegie Ave., Santa Ana, CA 92705, (800) 642-7621 or (714) 852-1400.

**Inquiry 1274.**

## SPREAD THE WORD

*Your new product is important to us. Please address information to New Products Editors, BYTE, One Phoenix Mill Lane, Peterborough, NH 03458. Better yet, use your modem and mail new product information to the microbytes.hw or microbytes.sw conferences on BIX. Please send the product description, price, ship date, and an address and telephone number where readers can get more information.*

## A Hand Scanner for PCs and Macs

The M800 Plus, an 800-dpi hand scanner, lets you scan an image as small as a postage stamp and retain the full details of the image. For use with PCs and Macs, it produces 64 levels of gray and 12 halftone patterns.

With the M800 Plus's inverse image function, you can create special effects. The PC version includes PC Paintbrush Plus and CAT Reader OCR; a special PC version, M800W Plus, is compatible with Windows 3.0; the Macintosh version includes Digital Darkroom and Scanlink.

**Price:** PC version, \$459; Macintosh version, \$549.  
**Contact:** Marstek, Inc., 17795-F Sky Park Cir., Irvine, CA 92714, (714) 833-7740.

**Inquiry 1275.**

## Eight Keys to Easy Typing

Vatell is offering an alternative to the QWERTY keyboard: the Accukey. The 2-pound, eight-key unit is



Ergonomically designed, the Accukey is Vatell's alternative to the QWERTY keyboard.



Marstek's 800-dpi hand scanner works with PCs and Macs to let you scan stamp-size images and create special effects.

ergonomically designed and about half the size of a conventional keyboard. According to Vatell, an average user can learn to touch-type on it in 3 to 4 hours following the tutorial included with the unit.

Each key has three states: forward, backward, and neutral. You produce characters by using one finger of each hand to form two-finger chords. Your fingers always rest on the same keys, and your palms rest on the base of the unit.

The Accukey performs all the functions of other key-

boards and is compatible with all types of computers and CRT terminals, according to Vatell.

**Price:** \$500, including a multiuser tutorial.  
**Contact:** Vatell Corp., P.O. Box 66, Christiansburg, VA 24073, (703) 961-3576.  
**Inquiry 1276.**

## An Upgrade Kit Long on Compatibility

A hard disk drive kit for your PC that offers a total upgrade solution and easy installation is available, according to its manufacturer, Micropolis. Called the PC PAK (Performance Advantage Kit), each kit contains a high-speed ESDI controller or a SCSI host adapter, software, hardware, and an installation guide.

Compatible with PC-DOS, Novell, Xenix, and Unix systems, the PC PAK comes in half-height (180-MB or 380-MB) and full-height (760-MB or 1.2-gigabyte) capacities. The hard disk drives

feature read-ahead caching and command queuing. They carry a mean-time-between-failures rating of 150,000 hours, according to the manufacturer.

**Price:** \$1895 to \$5895, depending on configuration.  
**Contact:** Micropolis Corp., 21211 Nordhoff St., Chatsworth, CA 91311, (818) 709-3300.  
**Inquiry 1277.**

## Remote Audio Control for Your Mac

Based on VLSI technology, Mirror Technologies' CDR-10 CD-ROM/audio player offers full audio support and an embedded SCSI interface. The company packages the unit with its custom remote-control software, which controls the audio portion of the CD-ROM.

The CDR-10's 350-ms access rate lets you use it with any Macintosh. You can also attach it to an audio system via RCA jacks. The audio player has variable volume control and reads any disk written in HFS High Sierra ISO 9660 standard format. Each unit comes with a 30-day guarantee, a one-year warranty, and lifetime technical support.



**Price:** \$697.  
**Contact:** Mirror Technologies, 2644 Patton Rd., Roseville, MN 55113, (800) 654-5294 or (612) 633-4450.  
**Inquiry 1278.**

## Fly Through Your Graphics with These Cards

According to National Design, the Volante Series intelligent graphics controller cards, based on the Texas Instruments TMS34020 graphics processor, have a processing speed 50 percent faster than cards based on the TMS34010 processor. The cards are also equipped with application-specific ICs.

Volante cards are available for ATs and compatibles and for the VMEbus. They include an AutoCAD software driver and are designed to handle all major graphics environments. Able to support 256 active colors from a palette of 16.7 million, they have a maximum resolution of 1280 by 1024 pixels.

The cards' standard 512K bytes of DRAM is expandable to as much as 4 MB; their 1 MB of video RAM is expandable to 8 MB. The optional TMS34082 floating-point processor is capable of performing functions such as 3-D convolution.

**Price:** \$995 to \$3495.

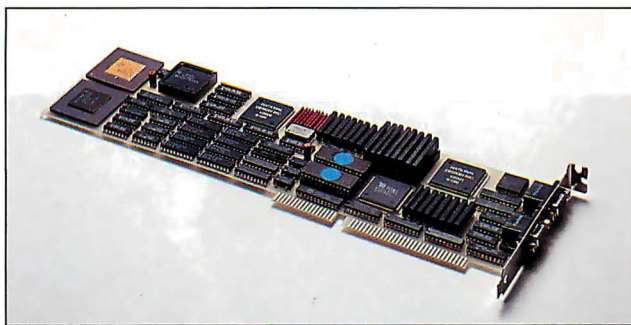
**Contact:** National Design, Inc., Houston Building, Suite 230, 9171 Capital of Texas Hwy., Austin, TX 78759, (512) 343-5055.

**Inquiry 1279.**

## Colorful Windows from Matrox

The M-WIN 1280 is the first of Matrox's new M-WIN series of graphics boards for 286 and 386 systems. It is also compatible with 486 EISA computers.

A high-resolution, single-slot controller, the M-WIN 1280 displays up to 256



*The Volante AT1000 video graphics card has an AutoCAD driver and supports 256 active colors.*

screen colors from a palette of 16.7 million. The board, based on Western Digital's 8514/A chip set, runs programs such as Lotus 1-2-3 and WordPerfect at a resolution of 1024 by 768 pixels. It has 1280 by 1024 drivers for running Windows 3.0, Presentation Manager, and X Window System 11.4.

**Price:** US\$2495.

**Contact:** Matrox Electronic Systems, Ltd., 1055 St. Regis Blvd., Dorval, Quebec, Canada H9P 2T4, (514) 685-2630. **Inquiry 1280.**

## The MAC-56 DSP System Lets You Be Original

A digital signal processing system based on Motorola's DSP56001 microprocessor is available for the Macin-

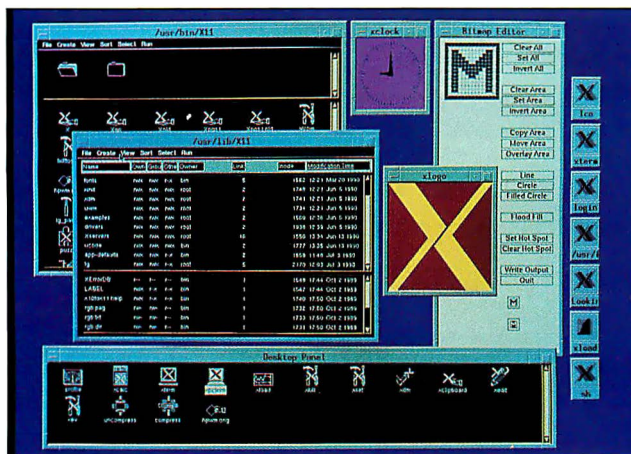
tosh. The system, a joint venture of Momentum Data Systems and Ariel, comprises a MAC-56 board and software that lets you develop your own programs for the DSP56001 chip.

The MAC-56 has 144K bytes of zero-wait-state memory, expandable to the chip's limit of 576K bytes. You can use DSPnet, the board's high-speed parallel interface, to interconnect multiple MAC-56 boards.

Bundled software includes a Motorola-compatible macro assembler and SCSI and DSPnet drivers. The MAC-56 incorporates a private SCSI bus for real-time signal I/O. For audio I/O, it includes a Next-compatible DSP port. **Price:** \$2995.

**Contact:** Ariel Corp., 433 River Rd., Highland Park, NJ 08904, (201) 249-2900.

**Inquiry 1281.**



*Matrox's M-WIN 1280 graphics card is compatible with Windows 3.0, Presentation Manager, and X Window System 11.4.*

## Cache Your Data Securely

The ESDI-Security Cache Controller from GSI accommodates up to four ESDI drives with up to 3 MB of cache per drive. The controller is designed for use with disk-intensive applications such as CAD and database and network server applications.

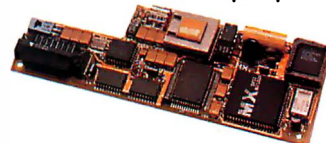
Features include a 20-MHz transfer rate, a 5-MBps bus transfer rate, vertical and horizontal skew, and an on-board BIOS with built-in utilities that supports drives with up to 2046 cylinders.

**Price:** \$495.

**Contact:** GSI, 17951 H Sky Park Cir., Irvine, CA 92714, (714) 261-7949.

**Inquiry 1282.**

## Fax/Modem Card for Toshiba Laptops



The MaxFax 9624LT-T is Macronix's new integrated fax/modem for Toshiba laptop and notebook computers. The 9600-bps fax and Hayes-compatible 2400-bps modem card fits into the dedicated internal modem slot on most Toshiba laptops.

Able to operate in the background, the MaxFax has an auto-direct function that determines whether an incoming call is for the fax or the modem. The MaxFax supports dot-matrix and laser printers and allows direct faxing from scanner input.

**Price:** \$599.

**Contact:** Macronix, Inc., 1348 Ridder Park Dr., San Jose, CA 95131, (408) 453-8088.

**Inquiry 1283.**



# DBMS Case Study:

## The Exxon Valdez Disaster



March 24, 1989. Exxon VALDEZ tanker runs aground, creating the worst oil spill in U.S. history. 11,000,000 gallons contaminate the pristine waters of Alaska's Prince William Sound.

### The Problem

Major disasters, like the Exxon Valdez spill, require quick response based on careful data analysis. Fortunately, an easy-to-use database was already being created which would help.

### The Application

The Alaskan Marine Contaminants Database lets oceanographic chemists easily access 60 megabytes of data covering the past decade. The database is provided free of charge on CD-ROM, and the Windows interface means they can get right to work, assessing damage to the ecosystems of Prince William Sound and other Alaskan waters.

### The Solution

db\_VISTA III is the only DBMS with the features this project required: C language support, Windows compatibility, royalty-free runtime distribution, quick performance in large databases, quality documentation and support. With the Alaskan Marine Contaminants Database, the difficult job of calculating the long-term effects of the Exxon spill is a little easier.\*

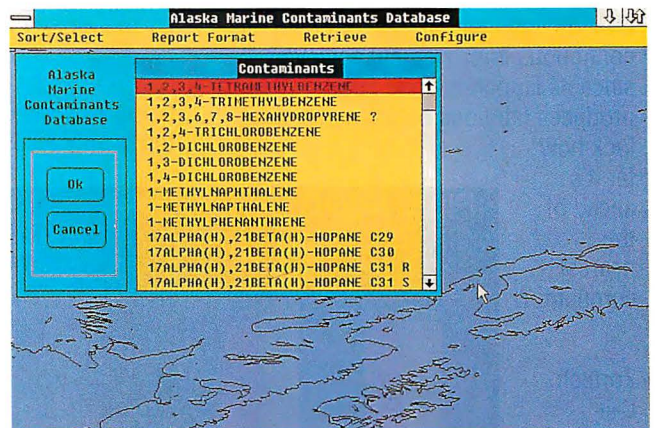
## db\_VISTA III™

### Database Management System

**Specifications:** Complete C source code available. No Royalties  
C Language Portability & High performance

Network Data Model. Relational B-tree indexing. Relational SQL query and report writer. Single & Multi-user. Automatic recovery. Built-in referential integrity. Complete revision capability. Supports: MS-DOS, MS Windows, UNIX, QNX, SunOS, XENIX, VMS, Macintosh.. OS/2 compatible. Most C Compilers supported. LANs: 3COM, Novell, Banyan, Appleshare. Call for other environments.

Raima Corporation 3245 146th Place S.E., Bellevue, WA 98007 USA (206)747-5570 Fax: (206)747-1991 Telex: 6503018237 MCI UW  
International Distributors: Australia: 61 2 419 7177 Austria: 43 022 43 81861 Brazil: 55 11 829 1687 Central America: 506 28 07 64 Denmark: 45 42 887249 France: 33 1 46092784  
Italy: 39 045 584711 Japan: 81 03 865 2140 Mexico: 52 83 49 53 00 The Netherlands: 31 2503 26312 Norway: 47 244 8855 Sweden: 46 013 111588 Switzerland: 41 064 517475  
Taiwan: 886 02 552 3277 Turkey: 90 1 152 0516 United Kingdom: 44 0992 500919 Uruguay: 598 292 0959 USSR: 01 32 35 99 07; 812 292 7210; 0142 437952 West Germany: 49 07022 34077  
Copyright ©1991 Raima Corporation. All rights reserved. db\_ is registered in the U.S. Patent and Trademark Office.



A Microsoft Windows front end lets chemists select regions from a map to retrieve data. And, db\_VISTA III's SQL-based query and report writer lets users perform complex SQL data searches.

Your DBMS problems may not make the headlines, but they are no less important and often no less challenging. If you develop applications for MS-DOS, MS Windows, UNIX, VMS, QNX, OS/2, Macintosh, and other environments, db\_VISTA III is your solution.

**Call 1-800-db-RAIMA (1-800-327-2462)**  
In Washington State call: (206)747-5570. Ask for extension 101.

\* Reprints of the story, as published in PC Week and Data Based Advisor, are available from Raima.

Power Tools For C Programmers



Circle 273 on Reader Service Card

**db\_VISTA III DBMS rated number #1**

For Performance and Flexibility of DBMS Programming Tools-  
PCWEEK Poll of Corporate Satisfaction, August 28, 1989.

# Multi - Platform

MS-DOS • WINDOWS • OS/2 • DOS 386 • UNIX 386

## MS-DOS

Zortech's industrial strength compiler provides all the benefits of C++, but with the speed and code size you would expect from the best C compilers.

The quality of the original Zortech C++ implementation together with the continuous improvement achieved since its launch in June 1988 produces fabulous benchmarks. Just look how far it's ahead of the nearest competitor.

Zortech C++ provides state of the art, USEFUL features, most of which are added in direct response to customer requests.

You can effortlessly cruise through the DOS 640K barrier using Zortech's Virtual Code Manager (VCM™). This allows you to develop applications up to 4MB in size whilst in real mode, without changing your C/C++ source code. Zortech's much acclaimed 'handle pointers' provide an elegant solution to processing EMS memory.

Zortech C++ also uses the Rational Systems™ DOS Extenders allowing you to easily compile and debug really large programs, even large MS-Windows 3.0 applications. If you want to purchase a Rational Systems license for your own applications, your Zortech code is Plug & Go.

Zortech's new C++ Workbench provides a cross platform development environment for C++. It

has really useful features including powerful source and grep browsers, to look at your handiwork.

In response to hundreds of requests, MS-Windows 2.1 support was added into the base DOS C++ Compiler in version 2.0. Now with Zortech C++ V2.1 development of C++ applications for Windows 3.0 is a reality not a promise.

Along with the C++ compiler comes a top quality ANSI C compiler. In fact,

after reviewing 14 C/C++ compilers in its May 1990 issue, Computer Language editor J. D. Hilderbrant said:

*"The pressure*

*to name an overall winner in the compiler sweepstakes is nearly overwhelming...it's an easy choice. We pick Zortech!"*

Thousands of our customers had existing C code they wanted to recompile, so we made it simple. In the words of BYTE Magazine:

*"I fed a Microsoft C specific version of the Micro-EMACS editor source to Zortech's compiler, and less than one hour later, I had a new (and smaller) program."*

Our C++ Debugger, which understands C and Assembler too, is

CodeView™ compatible, but that's where the similarities end. This feature packed tool can examine your program from 19 viewpoints and uses overlapping windows with full mouse support, icons and dialog boxes.

Debugging large programs is no problem with our DOS Extender, Virtual and Remote debugger versions. Quite simply, there's no better C++ debugger to use and no better C++ to debug.

Our C++ Tools package is the most comprehensive set available. All 25 class libraries are extensively documented and come with the full source code.

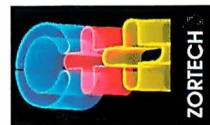
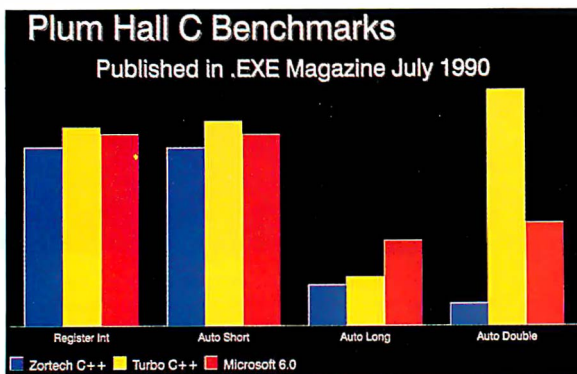
The Zortech C++ Developer's Edition V2.1 includes C and C++ Compilers, C++ Debugger, C++ Tools and the FULL Library Source Code (excluding Flash Graphics). That's right, you don't have to pay hundreds of dollars extra for source code - it's in the box!

## MS-WINDOWS

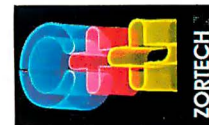
Improved support for MS-Windows (including new Windows 3.0 support) is provided in the base C++ DOS compiler, at no extra cost. With Zortech, you can now even compile from within Windows!

Support for new extended keywords `_loadds` and `_export` as well as the ability to create DLL's make programming in Windows with C++

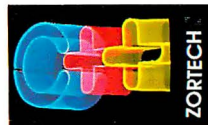
practical. We provide extensive documentation and 50K of sample code to illustrate development of



V2.1  
DEVELOPER'S EDITION



V2.1  
OS/2 EDITION



V2.1  
DOS 386 EDITION

# Zortech C++

MS-DOS • WINDOWS • OS/2 • DOS 386 • UNIX 386

applications in this exciting new environment. Do you need MS-Windows class libraries? Call for details of third party Zortech Validated Products.

## OS/2 **NEW**

The OS/2 Developer's Edition now provides a C++ Compiler and source level Debugger designed for C++. In the words of OS/2 Magazine:

*"Zortech C++ serves as a direct replacement for the Microsoft C Compiler in developing applications, allowing programmers to use object-oriented techniques in OS/2 development."*

The OS/2 Developer's Edition also includes C++ Tools, Flash Graphics and C++ Workbench for OS/2 together with the standard DOS Developer's Edition.

Upgrades for existing OS/2 Compiler Option owners now available. Please call for details.

## UNIX 386 **NEW**

Not a day passes at Zortech HQ without numerous requests for a UNIX version of Zortech C++. Now, DOS and OS/2 developer's can reach new markets by easily moving their code to SCO UNIX 386 and binary compatibles.

The Zortech C++ V2.1 UNIX 386 Compiler generates the same tight, fast code that Zortech's DOS and OS/2

and the C++ Workbench are also provided.

In line with the traditional Zortech Policy, owners of the Zortech C++ V2.1 UNIX 386 Compiler will be able to inexpensively upgrade to the forthcoming Zortech C++ V2.1 UNIX 386 Developer's Edition.

## DOS 386 **NEW**

Now, with the 386 you can address up to 4 Gigabytes of memory. Why spend so much money on 386 hardware and not use software which will take advantage of it?

On the other hand, you need to retain the facilities of standard MS-DOS too.

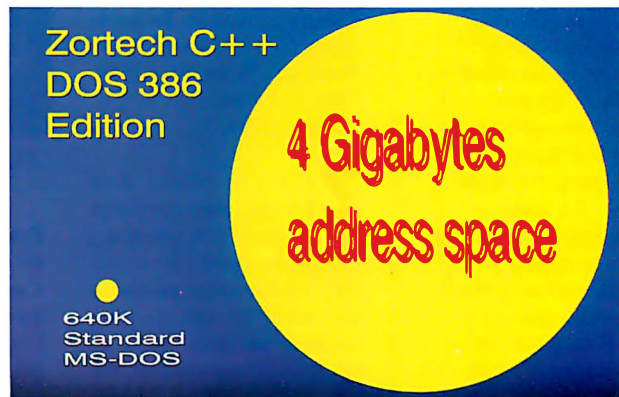
MS-DOS developers can now build true 32 bit C and C++ applications for 386 processors using Zortech's powerful 386 development system. The Zortech C++ V2.1 Developer's Edition for DOS 386, contains 32 bit versions of the C and C++ Compiler, Flash Graphics library, C++ Debugger and full standard library source code together with all the familiar features provided with the standard DOS Developer's Edition.

Using Phar Lapp's much acclaimed 386/DOS Extender Technology, you can build applications which access 4 Gigabytes of linearly addressable memory. Your applications will also be Plug & Go for use with Phar Lapp's 386 DOS Extender which may be purchased separately.

## C++ VIDEO COURSE

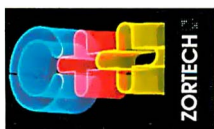
Zortech's C++ Video Course is all the training material you need to move a team of good C programmers into the world of C++. Many corporations have already done just this.

Cut the hotel bills, travel expenses and fees of outside training courses and seminars - not to mention the inconvenience and disruption to your normal routine.



Use a proven training tool, that in one hour a day, over a period of six weeks, can train your whole team in C++ for the price of one airline ticket.

The course consists of 32 tutorials on six one hour VHS tapes together with one 256 page workbook containing course notes and exercises. Unlimited additional course workbooks are available at modest cost. Compiler & hardware independent. NTSC or PAL format available.



**V2.1**

UNIX 386 EDITION

users have come to expect. UNIX specific versions of Flash Graphics

Circle 373 on Reader Service Card

**C++ for Macintosh**  
**Call for details**

## 3-D Viewing in Two Styles

**S**tereoGraphics is shipping its new CrystalEyes/PC eyewear. Designed for stereo 3-D viewing by PC and Macintosh users, the lightweight eyewear is geared for users of such specialized graphics applications as CAD/CAM, CAE, architectural, sensing/mapping, and medical image processing. The viewer is activated by infrared signals from an emitter on top of the display monitor.

CrystalEyes/Pro, another 3-D viewer, is an enhanced version of the company's CrystalEyes. Also activated by infrared signals, CrystalEyes/Pro has a Stereo/Pseudo switching option that gives users an enhanced visualization capability for applications with complex depth information, such as mapping. A multiple-range emitter permits viewing by single users or a group. The Brite Mode option allows users to make rapid transitions from stereo viewing to brighter, nonstereo viewing.

**Price:** CrystalEyes/PC, \$995; CrystalEyes Pro, \$1995.  
**Contact:** StereoGraphics Corp., 2171-H, East Francisco Blvd., San Rafael, CA 94901, (800) 247-8373 or (415) 459-4500.  
**Inquiry 1287.**

## For All Your Soldering Needs

**T**he Ungar Model 2110 is a soldering station with an electrically controlled heating element. The iron operates in a temperature range of 550°F to 850°F.

Features of the soldering station include a cool-grip handle, a burn-resistant cord, and a replaceable ceramic heater. The iron comes with

a thermal-thrust soldering tip. The station also includes a static-dissipative power unit, an on/off switch, a power-on LED indicator, a sponge, and an iron holder. An optional tip retainer is also available.

**Price:** \$132.50.  
**Contact:** Hub Material Co., 33 Springdale Ave., Canton, MA 02021, (617) 821-1870.  
**Inquiry 1288.**

## When a Mouse May Not Be a Mouse

Alternatives to the traditional mouse are available from several companies.

**T**he Icontroller is Suncom's mouse emulator for the PC. It sports speed selectability, three mouse function buttons, and a fingertip cursor-control knob with a selectable function button. Compatible with Microsoft and Mouse Systems software, the space-saving Icontroller attaches to either side of the keyboard.

**Price:** \$79.95.  
**Contact:** Suncom Technologies, 6400 West Gross Point Rd., Niles, IL 60648, (708) 647-4040.  
**Inquiry 1284.**

**Z**eny's cordless Zen Mouse uses urethane wheels in its two-wheel direct drive system to eliminate maintenance problems and allow smooth tracking on most surfaces. With an operating range of 4 feet, the Zen Mouse draws its power from three rechargeable nickel-cadmium batteries. A power-saving feature is activated when motion is not detected. Operating at from 10 to 1000 dpi, the Zen Mouse is compatible with Microsoft, Logitech, and Mouse Systems mice.



*The Icontroller mouse*



*The cordless Zen Mouse*



*The MousePenPortable*

**Price:** \$129; corded version for IBM PCs and PS/2s, \$89.  
**Contact:** Zen Computer Systems, Inc., 4033 Clipper Court, Fremont, CA 94538, (415) 659-0386.  
**Inquiry 1285.**

**T**he MousePenPortable, for use with IBM and compatible laptops, is Appoint's latest addition to its series of pointing devices. You can operate the 3.2-ounce MousePenPortable at any angle and on a variety of

surfaces. The device requires a serial port or a PS/2 mouse port, DOS 2.0, and 256K bytes of RAM. The MousePenPortable uses a built-in dynamic gain resolution of 50 to 1000 counts per inch and includes TelePaint, a color paint program.

**Price:** \$149.  
**Contact:** Appoint, Inc., 1332 Vendels Cir., Suite 101, Paso Robles, CA 93446, (800) 448-1184 or (805) 239-8976.  
**Inquiry 1286.**

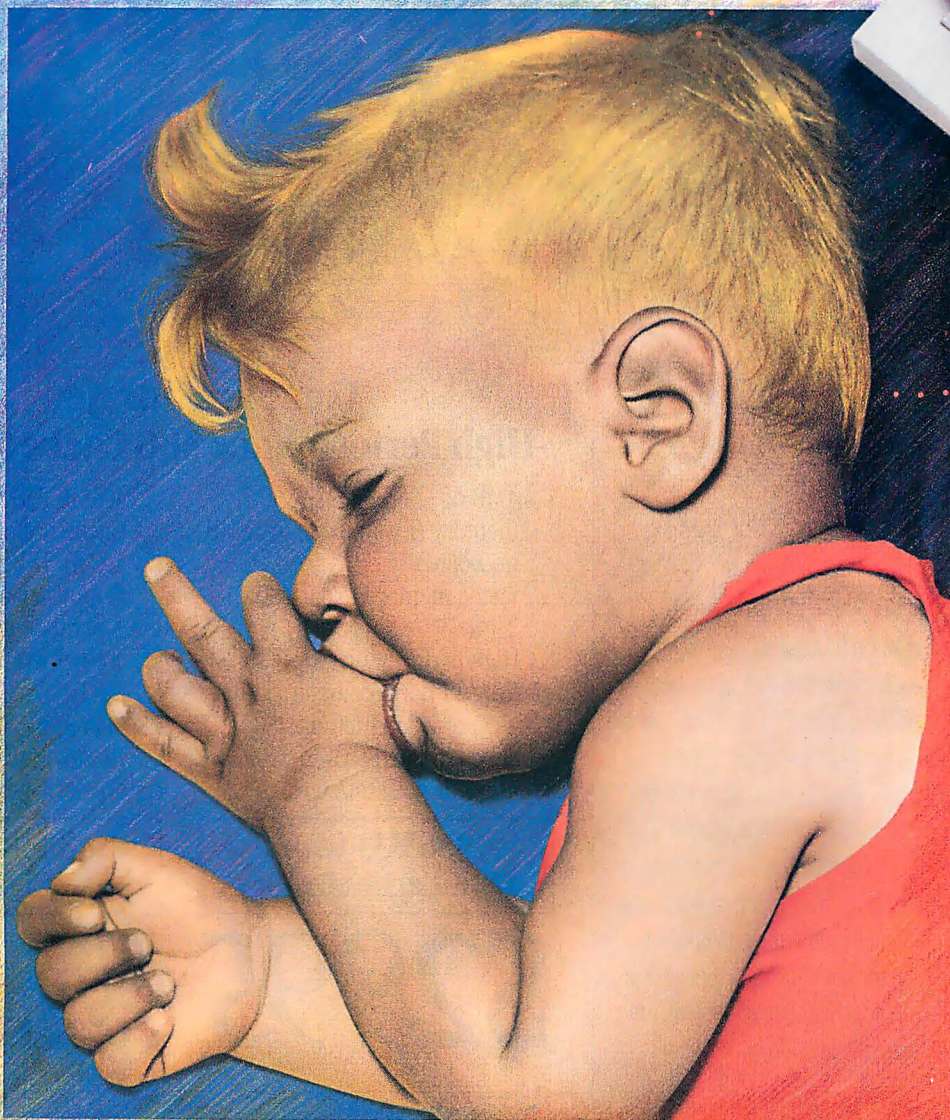
## From PC to Geiger Counter

**A**ware Electronics is marketing version 2.0 of its RM-60 Micro Roentgen Radiation Monitor. When plugged into a PC's serial or parallel port, the RM-60 monitors and plots background radiation, the presence of radon gas, atmospheric radioactivity, and alpha, beta, gamma, and x-rays.

Features of the RM-60 include a high-speed scrolling bar chart that lets you scan stored data for surges or trends, and an alarm system that you can set to activate between 1 and 30,000 micro-roentgens per hour. The company provides a five-year warranty on parts and labor.

**Price:** \$149.50.  
**Contact:** Aware Electronics Corp., P.O. Box 4299, Wilmington, DE 19807, (302) 655-3800.  
**Inquiry 1289.**

YOU ALWAYS KNEW THERE WAS SOMETHING SPECIAL ABOUT YOUR THUMB.



TRACKMAN



**Y**ou have a lot of power in your thumb. So we designed TrackMan™ — the world's most popular stationary mouse — to put that power to work. **T**rackMan's brilliant ergonomic design includes a lightweight, thumb-driven ball, three buttons at your fingertips and room to rest your hand. It is far more comfortable than any other stationary mouse. Because the thumb is far more agile and powerful than any finger. **W**ith TrackMan's adjustable resolution,

you command the cursor with exhilarating speed and precision, even in the most confining workspace. **A**nd you get all this for only \$139, including Logitech's™ life-



time hardware warranty. TrackMan works with any application on an IBM® PC (or compatible). **F**or more information call Logitech's Customer Sales Center: (800)231-7717ext.347. In California: (800) 552-8885; in Canada: (800) 283-7717; in Europe: + +41- 21-869-9656.

Circle 181 on Reader Service Card (RESELLERS: 182)

Tools That Power The Desktop.

®/™: trademarks of registered owners



# If You Want In A 386 System, Do

Selecting a new computer system can be a real challenge. That's where we come in. We have the knowledge, experience and the best value packed computer systems available. So, pick up the phone and check us out. Ask us about our quality. Our service. And especially our prices. You'll like what you hear.

## Let's Talk Features.

Then ask us about our new 386/25 and 386/33 systems. The list of standard features includes the latest that high technology has to offer. Like a 64 KB memory cache for the 386/25, and 128 KB for the 386/33, both expandable to 256 KB. Then there's the integrated VGA controller supporting 1024 x 768 resolution, with 256 vibrant colors and a 50% performance increase all made possible by 1 MB of 32-bit video memory. Plus support for interlaced and non-interlaced monitors. When it comes to features, we set the standard.

## How About Flexibility?

No one can beat our flexibility either. An integrated floppy controller and hard disk interface that support up to three floppy drives and two hard drives. Up to 16 MB of RAM on board using the new industry standard 32-bit memory modules leave all six expansion slots available.

## Look At Our Other Value-Packed Systems.

- |  |   |
|--|---|
| <p>All of these fully-loaded systems include:</p> <ul style="list-style-type: none"> <li><input type="checkbox"/> 2MB of 32-bit high speed memory (Expandable to 8MB on-board)</li> <li><input type="checkbox"/> High performance 1024 x 768 VGA with 256 colors including 1MB of video memory</li> <li><input type="checkbox"/> Super Hi-Res 14" VGA color monitor with tilt/swivel base</li> </ul> | <ul style="list-style-type: none"> <li><input type="checkbox"/> 40MB IDE Hard Disk Drive</li> <li><input type="checkbox"/> 1.2MB 5.25" &amp; 1.44MB 3.5" floppy drives</li> <li><input type="checkbox"/> 1 parallel and 2 serial ports</li> <li><input type="checkbox"/> 101-key enhanced keyboard</li> <li><input type="checkbox"/> MS DOS 4.01</li> <li><input type="checkbox"/> 386/SX includes Windows 3.0 and mouse</li> <li><input type="checkbox"/> Free one year on-site service</li> </ul> |
|--|---|

**386▼SX only \$1895.00    286▼16 only \$1595.00**

Shown with optional tape drive. 386 is a trademark of Intel Corporation.

## Compare Our New High Performance 386 Cache Systems.

- |  |  |
|--|--|
| <input type="checkbox"/> 4MB of 32-bit high speed memory (Expandable to 16MB on-board)                 | <input type="checkbox"/> 105MB IDE hard drive with Cache buffer    |
| <input type="checkbox"/> Cache memory expandable to 256K   | <input type="checkbox"/> 1.2MB 5.25" and 1.44MB 3.5" floppy drives |
| <input type="checkbox"/> High performance 1024 x 768 VGA with 256 colors including 1MB of video memory | <input type="checkbox"/> 1 parallel and 2 serial ports             |
| <input type="checkbox"/> Super Hi-Res 14" VGA color monitor with tilt/swivel base                      | <input type="checkbox"/> 101-key enhanced keyboard                 |
|  | <input type="checkbox"/> MS DOS 4.01                               |
|  | <input type="checkbox"/> Microsoft Windows 3.0                     |
|  | <input type="checkbox"/> Hi-Resolution mouse                       |
|  | <input type="checkbox"/> Free one year on-site service             |

**386▼33 with  
128K Cache Memory**

**\$2995**

**386▼25 with  
64K Cache Memory**

**\$2695**

Our small footprint chassis includes both 5.25" and 3.5" floppy drives and 1 parallel and 2 serial ports. And consider this feature, our new 386/25 and 386/33 systems come standard with 5 drive bays to hold up to one additional floppy drive or tape backup and 2 hard drives.

So, we can help you add on and update to your heart's content.

## We're Made In The U.S.A.

Since 1984 our R&D center has been designing our products, and all system boards are manufactured right here in the U.S. The latest surface mount and VLSI technology is utilized for the ultimate in product reliability and space saving design. If it's performance and quality you seek, we're the standard to beat.

# The Best Value The Standard Thing



We provide you with a complete system. Ready to use the minute you open the carton. Everything is loaded,

## 800/662-6111



tested, burned in, and ready to go. And, to help you easily handle the new multi-tasking, multi-screen programs, we preload MS DOS 4.01 and Microsoft Windows 3.0, and then throw in a high resolution mouse to boot. How's that for commitment!

### We Stand Behind Our Systems And Our Customers.

At Standard Computer, we manufacture everything from high performance 486™ and 386™ systems to low cost 386/SX and 286 systems. And our total customer satisfaction program begins with a 30 day money-back guarantee. If you're dissatisfied, simply return your system within 30 days for a full refund. No questions asked.

You're also covered by our complete one-year parts and labor warranty. And when you have a question, just call our customer service hotline. It's available to you toll-free for as long as you own your system. If you need help, we'll see that you get it. If you need a part, we'll express ship it.

We'll even include one year of on-site service at no extra charge.

### Value That's Easy To Afford.

We make it easy to own and use our products. Our Standard purchasing programs are designed to fit your needs. Qualified company purchase orders, personal checks and most major credit cards are accepted.

So, go ahead. Call us. Right now. Find out why we take so much pride in our exceptional products and services.

Why our repeat customer rate is one of the highest in our industry. And why our product reliability is so good. For us, it's just the Standard thing.

# STANDARD

C O M P U T E R

12803 Schabarum Avenue, Irwindale, CA 91706,  
phone: 818/3377711, FAX 818/3372626.

Circle 299 on Reader Service Card

## Neat, Simple, Instant Communication

If you're looking for a neater image at work, you might want to try GEC-Marconi's Verran AC DataLink. With this device, you can link your PC to a printer, plotter, modem, or other peripheral without using the cables normally required. You configure the device using DIP switches.

DataLinks work in pairs, one at the sending unit and the other at the receiving unit. They hook up via standard electrical outlets, allowing data to be transmitted over your building's AC circuit. ACDataLinks connect serial or parallel communications, with the capability of converting back and forth between the two. They have a 2K-byte data buffer and communicate at a rate of 840 cps.

Software for the DataLinks is built in, eliminating the need for additional software. For secure transmissions, you can encrypt your data prior to transmitting it and decipher it at the receiving end.

An accessory device, the AC DataLink DPS (dedicated printer sharer), is also available. When connected to a printer, it acts as a print spooler and can handle multiple print orders from as many as seven computers.

**Price:** AC DataLink, \$345; AC DataLink DPS, \$395.

**Contact:** GEC-Marconi Software Systems, 12110 Sunset Hills Rd., Suite 450, Reston, VA 22090, (703) 648-1551. **Inquiry 1290.**



*GEC-Marconi's Verran AC DataLink, which works in pairs, uses standard AC circuits to transmit data.*

## OS/2-PM Communications Package Available

KXCom, a communications package for OS/2, includes a full-fledged Presentation Manager interface. It also features an integrated dialing directory that supports the Hayes Smartmodem (and compatibles), single and multiple file transfer using the Kermit or XMODEM protocol, and file transfer rates of up to 19,200 bps.

KXCom simultaneously supports COM1 and COM2,

supports both color and monochrome video, and has a windowed command shell to the operating system. Additionally, the package automatically renames files in case of a name clash and offers on-line help. It also features a windowed command shell to the operating system.

The package includes complete source code in Stony Brook Professional Modula-2 and a user's manual.

**Price:** US\$30. **Contact:** KXCom, 5105 Lorraine Ave., Burnaby, British Columbia, Canada V5G 2S3, (604) 437-0893. **Inquiry 1291.**



*Able to double as a file server or a LAN station, the Super-386T works with OS/2 and Unix systems.*

## Remote-Control Network Program

Invisible Software has introduced Invisible NET Control, a remote-control program that works with any NetBIOS-compatible network. Capabilities include group broadcasts, two-way talk, and remote control of other workstations.

Invisible NET Control supports remote diagnostics and CGA, EGA, and VGA modes. It also lets you monitor other users' screens. The DOS overhead is 30K bytes. **Price:** \$279 per network site. **Contact:** Invisible Software, Inc., 1142 Chess Dr., Foster City, CA 94404, (415) 570-5967.

**Inquiry 1292.**

## A Versatile 386 File Server

The Super-386T 33-MHz desktop from Hyundai can be used as a network file server and as a LAN station. It is compatible with Novell NetWare and with OS/2 and Unix systems.

The small-footprint computer (16.1 by 16.3 inches) has 4 MB of RAM (expandable to 8 MB on the motherboard with single in-line memory modules), a 64K-byte memory cache (expandable to 256K bytes), and 64K bytes of ROM. The Super-386T includes a 16-bit VGA card that supports Super VGA and has a built-in mouse port. Hyundai ships a mouse with the unit. The computer's configuration includes two serial ports and one parallel port.

**Price:** \$4995 to \$8495, depending on configuration. **Contact:** Hyundai Electronics America, 166 Baypointe Pkwy., San Jose, CA 95134, (408) 473-9200. **Inquiry 1293.**





# INSTANT WORKSTATION. JUST ADD OPEN DESKTOP.

Take a look at the vast majority of graphical workstations developed over the past decade and you'll see something they all have in common:

An integrated UNIX® System environment.

Now take a look at the vast majority of businesses that have put computing power directly onto their office desktops over the past decade, and you'll see something they all have in common: Industry-standard personal computers.

It doesn't take a computer to forecast the platform that's going to put graphical workstations on the vast majority of business and engineering desktops in the next decade:

An integrated UNIX System environment for industry-standard personal computers.

And that's what Open Desktop™ is all about.

Open Desktop is the complete graphical operating system that's built on the most popular UNIX System platform of all time—SCO™. And it lets you create your own networked, icon-driven workstation environment using the industry-standard 386 or 486 computers and peripherals of your choice.

In a single, easy-to-use, fully supported—and completely integrated—package, Open Desktop delivers:

- the full 32-bit, multitasking computing power of SCO UNIX System V/386
- compliance with POSIX™ and X/Open® standards
- an OSF/Motif™-based, Presentation Manager-compatible, graphical user interface
- distributed SQL database management services
- compatibility with existing DOS, XENIX®, and UNIX System applications and data files
- NFS™, TCP/IP, and LAN Manager networking facilities

And all at an unbelievably affordable price.

Discover the complete graphical operating system that leading companies worldwide are choosing as their development platform for the '90s—and using to turn their 386 and 486 PCs into instant workstations today.

Open Desktop from SCO.

 **OPEN  
DESKTOP™**  
*The Complete Graphical Operating System™*

SEE US AT  
UNIFORM,  
BOOTH # 1005!

**SCO**   
THE SANTA CRUZ OPERATION

For more information, call SCO today and ask for ext. 8400

(800) SCO-UNIX (726-8649) (408) 425-7222 FAX: (408) 458-4227 E-MAIL: [!!uunet!scolinfo](mailto:!!uunet!scolinfo) [info@sco.COM](mailto:info@sco.COM)

SCO, the SCO logo, Open Desktop, and the Open Desktop logo are trademarks of The Santa Cruz Operation, Inc. UNIX is a registered trademark of AT&T in the USA and other countries. POSIX is a trademark of The Institute of Electrical and Electronics Engineers (IEEE). X/Open is a registered trademark of X/Open Company Ltd. OSF/Motif is a trademark of The Open Software Foundation, Inc. XENIX is a registered trademark of Microsoft Corporation. NFS is a trademark of Sun Microsystems, Inc. ©1989 The Santa Cruz Operation, Inc. All Rights Reserved. The Santa Cruz Operation, Inc., 400 Encinal Street, P.O. Box 9000, Santa Cruz, California 95061 USA The Santa Cruz Operation, Ltd., Crossley Centre, Hatters Lane, Watford WD1 8YN, Great Britain. ++44 (0)923 806544. FAX: ++44 (0)923 807781. TELEFAX: 907572 SCOLON1G

Circle 285 on Reader Service Card

To see all its advantages,



*NEC PowerMate 386/33E*

Combining great power and speed with the enhanced compatibility of EISA architecture, the PowerMate® 386/33E is just what farsighted businesses need. For CAD/CAM. Financial modeling.

\*The PowerMate 386/33E supports industry compatible graphics cards and displays. PowerMate, NEC, and CSC are registered trademarks of NEC Corporation.

PS/2 is a registered trademark and OS/2 is a trademark of International Business Machines Corporation.

# you'll need powerful specs.

## CPU

Intel 386™ microprocessor  
33 MHz processing speed  
(zero wait states)  
8 MHz compatibility mode  
(1 wait state)  
Optional Weitek WTL 3167  
or Intel 387 math coprocessor  
Calendar/clock (with battery backup)

## MEMORY

4 MB or 8 MB (80 ns)  
memory standard  
Dedicated 32-bit high-speed  
Concurrent Memory Bus  
architecture (33 MHz)  
Total high-speed memory  
expandable to 32 MB  
64 KB (20 ns) SRAM cache

## INTERFACES

Parallel printer port  
Two RS-232C serial ports  
PS/2®-style mouse port  
PS/2-style keyboard port

## EXPANSION SLOTS

One 32-bit full-size memory slot  
Five 8/16/32-bit ISA/EISA  
full-size slots  
One 8/16-bit full-size ISA slot  
One 8/16-bit half-size ISA slot

## STORAGE SLOTS

Five 5 1/4" half-height  
Support for alternate two  
full-height 5 1/4" and one  
half-height configuration

## KEYBOARD

101-key mechanical keyboard

Separate numeric and cursor  
control pads

## SYSTEM SECURITY

Power-on password  
Keyboard password  
Network password  
System cover lock (optional)

## SOFTWARE/NATIVE MODE

### SUPPORT

MS-DOS®  
Windows™ 3.0  
NEC-enhanced OS/2™ (optional)  
SCO™ UNIX® System V (optional)  
NEC-enhanced EISA  
configuration utility

## DATA STORAGE

Floppy disk drives  
—1.2 MB 5 1/4"  
—1.44 MB 3 1/2" (5 1/4" form factor)  
Hard disk drives  
—100 MB 3 1/2" ESDI  
( < 23ms, 5 1/4" form factor)  
—118 MB 3 1/2" SCSI  
( < 20ms, 5 1/4" form factor)  
—140 MB 5 1/4" ESDI ( < 18ms)  
—300 MB 5 1/4" SCSI ( < 18ms)  
—300 MB 5 1/4" ESDI ( < 18ms)  
—600 MB 5 1/4" SCSI ( < 16ms)

### Tape drives

—40 MB 5 1/4"  
—150 MB high-speed 5 1/4"

## DISK SUBSYSTEMS

EISA SCSI host adaptor (optional)  
—EISA bus master capability  
—support for 7 SCSI devices

—32-bit EISA bus interface

—33 MB/second burst rate

—scatter-gather transfer

—SCSI command queuing

—auto configuration

ESDI controller (optional)

## NEC DISPLAY OPTIONS\*

—MultiSync 2A

—MultiSync 3D

—MultiSync 4D

—MultiSync 5D

## NEC GRAPHICS OPTIONS\*

MultiSync® Graphics Engine™

—intelligent 50 MHz

· TMS34010 processor

—VGA compatible (640x480,  
16 colors)

—Super VGA (800x600, 16 colors)

—1024x768 (interlaced)

—1024x768 (non-interlaced)

—256-color version available

## DIMENSIONS

Width: 21.2" (538 mm)

Depth: 17.7" (450 mm)

Height: 6.3" (160 mm)

Weight: 51 lbs (23 kg)

## OPERATING ENVIRONMENT

Temperature—50° to 95°F

Relative humidity

—20% to 80% (non-condensing)

Power supply

—universal 115V/230V

—auto sensing

—325 watt maximum rated output

Multi-media. Presentation graphics. In short, for virtually any com-

MS-DOS and Microsoft are registered trademarks and Windows 3.0 is a trademark of Microsoft Corporation. 386 and 387 are trademarks of Intel Corporation.

plex application requiring the ultimate in 386 computing, it's a

SCO is a trademark of The Santa Cruz Operation. UNIX is a registered trademark of AT&T.

perfect fit. For more details, call 1-800-NEC-INFO.

MultiSync is a registered trademark and Graphics Engine is a trademark of NEC Technologies, Inc. © 1990 NEC Technologies, Inc.

# NEC

Circle 214 on Reader Service Card

## ChainLink Doesn't Fence You In

ConnectWorks' ChainLink uses standard telephone wire, a central switching unit, and software to link as many as 16 PCs and laptops or up to 48 printers. With a transfer rate of 115,000 bps and average throughput of 77,240 bps, the network requires DOS 3.1, a hard disk drive, and a serial port on each PC. It is mouse compatible.

Through its switching unit, ChainLink provides file transfer, peripheral sharing, E-mail, print spooling, and directory management capabilities for each linked PC. Since ChainLink remains resident in RAM, you can use a hot key to access it while you're working in another application.

**Price:** Four users, \$395; eight users, \$595; 16 users, \$795.

**Contact:** ConnectWorks Co., 110 Causeway Dr., P.O. Box 497, Wrightsville Beach, NC 28480, (800) 992-5465 or (919) 256-2366.

**Inquiry 1294.**

## Two for the Network from US Sage

Two networking products are new from US Sage. MainLan 386 equips 386-compatible PCs as network file servers; MainLan for PS/1 is a 10-Mbps Ethernet adapter card for networking PS/1 computers.

The MainLan 386 kit includes NetBIOS-compatible system software, 10-Mbps Ethernet cards, and cabling. Designed for systems of up to 255 users of cross-network transactions, the system re-



*ChainLink users can do such things as exchange files, send and receive E-mail, and share peripherals.*

quires a 386 or 386SX computer as a dedicated file server. MainLan 386 runs with Microsoft Windows 3.0 and is Novell NetWare compatible.

MainLan for PS/1 links a computer as a workstation or a file server. The card is available as part of a kit or by itself. The kit includes two 10-Mbps Ethernet cards, MainLan NetBIOS-compatible software, and cabling. Cards are compatible with MainLan's operating system as well as with Novell NetWare. MainLan for PS/1 also runs with Windows 3.0.

**Price:** MainLan 386 kit: two to four users, \$999; two to eight users, \$1399. MainLan software only: two to four users, \$599; two to eight users, \$999; unlimited use, \$1499; 8-bit Ethernet card with Novell drivers, \$249. MainLan for PS/1 kit, \$499; 8-bit PS/1 Ethernet card with Novell drivers, \$199; MainLan 3.12 peer-to-peer operating system software, \$199.

**Contact:** US Sage, Inc., 2005 Tree Fork Lane, Suite 113, Longwood, FL 32750, (407) 331-4400.

**Inquiry 1295.**

## Color Graphics in a Fax Board

The Communiqué Fax9600, a half-slot, 9600-bps fax board, combines the convenience of a stand-alone fax machine with the power of a personal computer, according to its manufacturer. Requiring a PC with 640K bytes of RAM, a hard disk drive, DOS 3.0 or higher, a graphics display card, and a mouse, the board's key feature is its user interface. You operate the system using mouse-activated icons, buttons, and scroll bars. It is compatible with VGA, EGA, CGA, and Hercules graphics modes.

To send a fax, you type in the text or load it from any ASCII text file; Communiqué automatically inserts a custom letterhead and personal signature. The system uses typefaces with proportional spacing. Other features include a Phonebook, which allows you to store and group names; mail-merge commands that automatically merge Phonebook information into your text; and a clipping function, which lets you save portions of a received fax to use as graphics in other documents. A hot key to pop up Communiqué from any DOS program and a TSR program requiring less than 9K

bytes of RAM round out the system.

**Price:** \$279.

**Contact:** Grey Matter Response, Inc., P.O. Box 3147, Santa Cruz, CA 95063, (408) 427-3678.

**Inquiry 1296.**

## High-Speed Modem for PCs and Macintoshes

A 9600-bps V.32 modem for IBM PCs and Macintoshes is available from Intel. Providing error-free throughput of up to 38,400 bps, the 9600EX conforms to international modem standards. A plug-and-play modem, it installs without jumpers or switches. The modem operates in synchronous or asynchronous mode over dial-up or two-wire leased lines and carries a five-year warranty.

The 9600EX supports the V.42 Link Access Procedure for Modems and MNP throughput level 5. Automatic speed selection allows you to use the 9600EX with 4800-, 2400-, 1200-, and 300-bps modems.

The 9600EX for the PC comes with Communications by Crosstalk; the Macintosh version includes Quick Link II by Smith Micro Software. **Price:** IBM version, \$799; Macintosh version, \$819.

**Contact:** Intel Personal Computer Enhancement Operation, CO3-7, 5200 Northeast Elam Young Pkwy., Hillsboro, OR 97124, (800) 538-3373 or (503) 629-7354.

**Inquiry 1297.**

Look for these products among the...

# Best Selling C Products of 1991!

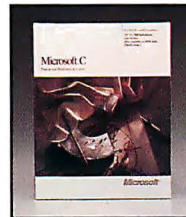
"The detail of CommLib is exceptional."  
- Telecomputing Magazine

## Microsoft C Professional Development System

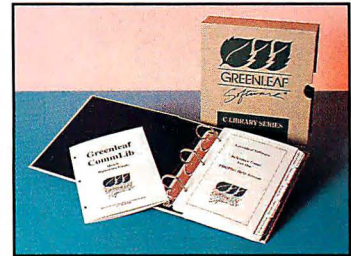
version 6.0 is simply the fastest, most productive professional C development environment for MS-DOS, Microsoft Windows, or Microsoft OS/2 Presentation Manager applications. 6.0 features include: The Programmer's Workbench, a new approach to development-integrating all tools into one environment; Source Browsing-interactively see any part of the project with the revolutionary project database, which can tell you where anything is located; CodeView 3.0-third generation of the industry-leading debugger which allows developers to use as little as 15K from DOS's 640K space.

List: \$495  
FAXcetera # 1269-0014

Ours: \$349



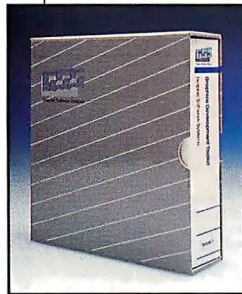
Microsoft®



NEW! Greenleaf's CommLib 3.1 now supports Intelligent Multiport boards and 16550 UARTS! Plus hundreds of C functions for communications: XMODEM, YMODEM, Kermit, XON/XOFF, and Hayes modem control. Free source. On-line help. 196 example programs. All major compilers supported.



List: \$359 Ours: \$249  
FAXcetera # 1035-0007



## Graphics that don't compromise performance

Get to the market quicker with graphics that don't compromise performance.

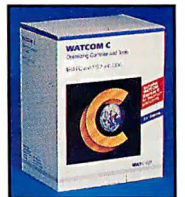
The GSS® Graphics Development Toolkit (GDT) for DOS gives you access to more than 100 high-level graphics functions and supports over 300 graphics devices. Choose from C, FORTRAN, Pascal, BASIC Compiler or Macro Assembler. IBM has licensed the GDT for three PC operating systems: DOS, OS/2, and AIX. SPC's Harvard Graphics and Ashton-Tate's Draw APPLAUSE use GDT technology. So do hundreds of other PC packages for science, business and engineering.

List: \$595  
FAXcetera # 1088-0001

Ours: \$499

## Unleash 386 power

on your Microsoft C code with WATCOM C8.0/386, a 100% ANSI C optimizing compiler and run-time library generating applications for 32-bit 386 protected mode. With C8.0/386, you can go beyond the 640K DOS limit. Library and source compatibility with Microsoft C simplifies porting 16-bit applications to the 386. Significant features include: full-screen source-level debugger; protected mode version of the compiler; execution profiler; linker; graphics library. Run-time compatible with WATCOM F77/386.

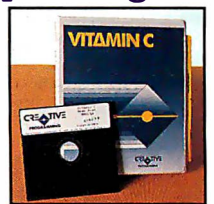


WATCOM

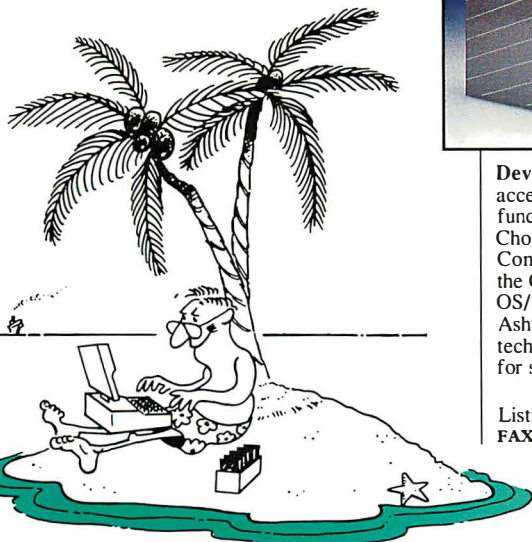
Standard List: \$895 Ours: \$639  
Professional List: \$1295 Ours: \$939  
FAXcetera # 1683-0001

## Vitamin C Supercharge

Supercharge your applications with windows, menus, forms, and a spectacular user interface. Vitamin C's powerful library of C functions includes overlapping virtual windows, data entry forms, dialog boxes, menus, context sensitive help, a pop-up text editor, mouse support, and more! Library source is included, and applications are royalty free. Available for DOS, OS/2, UNIX, XENIX and VAX.



CREATIVE PROGRAMMING List: \$225 Ours: \$165  
FAXcetera # 1437-0001



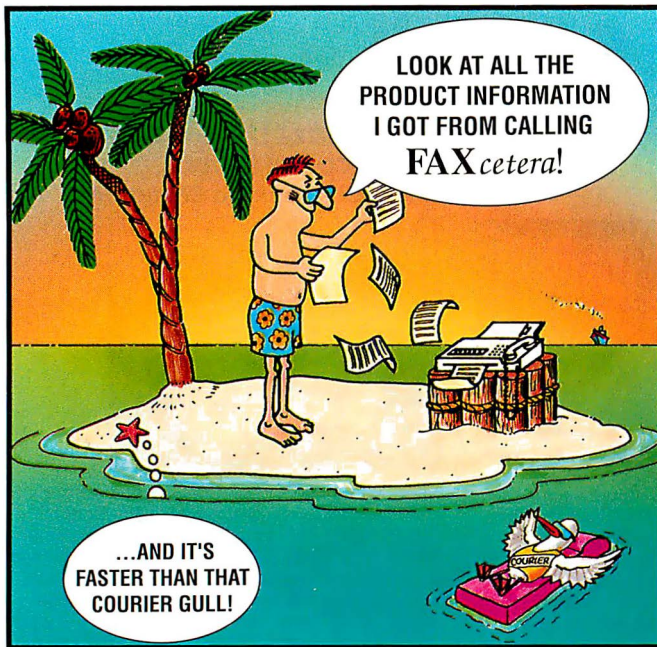
CALL

(800) 445-7899  
(201) 389-9228

Programmer's Paradise

A Division of  
Voyager Software Corp  
1163 Shrewsbury Avenue  
Shrewsbury, NJ 07702

# Programmer's Paradise® ...



**We'll Beat The Competition's Advertised Prices!**

LIST OURS		LIST OURS	
<b>386 CONTROL PROGRAMS</b>		<b>C++</b>	
DESQview 386 w/QEMM	220 169	C++/Views	495 419
Microsoft Windows 3.0	150 99	Data++/Windows	189 169
VM/386	245 209	Intek C++	495 CALL
VM/386 MultiUser	895 839	NDP C++	495 479
VM/386 MultiUser Starter	395 339	Rogue Wave Math.h++	200 179
		Rogue Wave Tools.h++	200 179
		Turbo C++	200 139
<b>386 DEVELOPMENT TOOLS</b>		Turbo C++ Professional	300 205
386 ASM/Link/Loc	1295 1159	Competitive Upgrade	150 139
386/DOS Extender	495 439	Zinc Library	200 179
C Windows Toolkit/386	200 179	Zortech C++	200 165
C-Terp 386	239 189	Zortech C++ Database	300 255
Lahey F77L-EM/32 (w/ OS/386)	1290 1035	Zortech C++ Debugger	150 129
MetaWare High C 386	895 849	Zortech C++ Developer's Edition	450 399
Novell C Network Compiler/386	995 799	Zortech C++ Tools	150 129
PC-lint 386	239 179	Zortech C++ Video Course	500 449
WATCOM C 8.0/386 Prof.	1295 1099		
w/ 386/DOS Extender	1790 1399	<b>C-COMMUNICATIONS</b>	
WATCOM C 8.0/386 Standard	895 719	Breakout II	249 189
WATCOM FORTRAN 77/386	1095 CALL	C Asynch Manager 3.0	189 139
Zortech C++ 386	995 849	C Communications Toolkit	150 129
		Essential Communications	329 259
<b>ADA</b>		Greenleaf CommLib	359 287
Academic IntegrAda	249 225	Greenleaf ViewComm	399 319
Ada Scope Debugger	495 445	SilverComm "C" Async Library	249 209
Ada Training Environment	895 805	View-232	189 149
Adagraphics	695 629		
IntegrAda	795 719	<b>C-FILE MANAGEMENT</b>	
Meridian Ada Developer's Kit	1195 1095	AccSys for dBASE or Paradox	395 349
		Btrieve Devel. System	595 449
<b>ASSEMBLY LANGUAGE</b>		Codebase IV	295 219
Advantage Disassembler	295 279	c-tree Plus	595 475
ASMFlow	99 89	dBc III Plus	500 439
MS Macro Assembler	150 105	db_FILE Bundle	295 249
OPTASM	150 129	Essential B-Tree w/ source	198 149
Re:Source	150 129	Paradox Engine	495 349
Sourcer w/ Pre-Processor	170 149	The Toolbox - Prof. Edition	1295 1035
Spontaneous Assembly	395 189	The Toolbox - Special	795 635
Turbo Debugger & Tools	150 105		
Visible Computer: 80286	100 89	<b>C-GENERAL LIBRARIES</b>	
		C Function Library	99 79
<b>BASIC COMPILERS</b>		C TOOLS PLUS/6.0	149 109
MS BASIC Prof. Devel. System	495 349	C Utility Library	249 199
Power Basic	129 89	Greenleaf Functions	229 179
QuickBASIC	99 69	Greenleaf SuperFunctions	299 239
		Turbo C TOOLS/2.0	149 109
<b>BASIC LIBS/UTILITIES</b>			
GraphPak Professional	149 129	<b>C SCREENS</b>	
P.D.Q.	129 115	C-Worthy	399 CALL
ProBas	159 149	Greenleaf DataWindows	395 315
ProBas Toolkit	99 94	Vermont Views	495 395
QBase	149 125	Vitamin C	225 165
QuickComm	149 119	VC Screen	149 125
QuickPak Professional	169 149		
QuickWindows Advanced	149 119	<b>C-UTILITIES/OTHER</b>	
		Bar Code Library	389 319
<b>C COMPILERS</b>		Clear for C	200 169
Lattice C 6.0	250 155	C Shroud	198 149
Microsoft C 6.0	495 339	Heap Expander	80 70
w/ Objective-C	699 539	MKS LEX & YACC	249 197
MS QuickC 2.5	99 69	Objective-C	249 225
MS QuickC w/ QuickAssembler	199 139	PC-lint	249 105
Turbo C 2.0	99 69	PCYACC Professional	495 459
WATCOM C 8.0 Professional	495 419	TimeSlicer	295 279
WATCOM C 8.0 Standard	395 335		

LIST OURS		LIST OURS	
<b>CASE TOOLS</b>		<b>COBOL LANGUAGE</b>	
EasyCASE Plus	295 265	Micro Focus:	
Professional Pack	395 355	COBOL/2 w/Toolset	1800 1499
Personal CASE	199 179	Personal COBOL	149 129
		MS COBOL	900 629
		Realia COBOL	995 849
<b>DATABASE DEVELOPMENT</b>			
Clarion 2.1	895 539	<b>DEBUGGERS (DOS)</b>	
Clipper 5.0	795 519	MultiScope	179 139
Data Junction Advanced	299 269	Periscope Debuggers	CALL CALL
dBASE IV	795 495	Trapper	200 179
dBFast/PLUS	345 295	w/ optional cable	240 219
dGE	295 249	Turbo Debugger & Tools	150 105
Dr. Switch-ASE	180 149		
Facelt	99 90	<b>DOCUMENTING/</b>	
FlashTools!	89 79	<b>FLOWCHARTING</b>	
Flipper	195 169	allCLEAR	300 229
Force 2.1	695 589	Clear for C or dBASE	200 169
FoxPro	795 489	C-Clearly	130 115
FUNCKY Library	195 179	Flow Charting 3	250 199
R&R Code Generator	150 129	Interactive Easyflow	150 125
R&R Report Writer	150 129	Source Print	99 74
Say What!?	50 39	Tree Diagrammer	99 74
SilverComm "C" Interface	99 89		
SilverComm Library 2.0	249 209	<b>EDITORS</b>	
The Documentor	295 245	BRIEF 3.0	249 CALL
Tom Rettig's Library	100 80	EDT+	295 269
UI2 Version 2	595 479	EMACS	395 315
		Epsilon	195 159
		KEDIT 4.0	150 125
		MKS Vi	149 129
		PI Editor	195 175
		Sage Professional Editor	295 249
		SLICK Editor	195 154
		Speed Edit	295 275
		SPF/PC	245 199
		SYNDIE	495 399
		VEDIT PLUS	185 CALL
		<b>EMBEDDED SYSTEMS</b>	
		C6tPROM	149 119
		Link & Locate ++	395 349
		Link & Locate ++ Extended	479 395
		<b>FORTRAN LANGUAGE</b>	
		Grafmatic	135 119
		Lahey F77L	595 535
		Lahey Personal FORTRAN 77	99 89
		MS FORTRAN	450 299
		Plotmatic	135 119
		RM/FORTRAN	595 499
		<b>GRAPHICS LIBRARIES</b>	
		Baby Driver	250 199
		Essential Graphics	399 319
		FontTools	150 119
		Graf/Drive Plus Developer's	299 269
		Graphic 5.0	395 319
		MetaWindow Plus	795 685
		GX Graphics	149 135
		HALO	395 279
		HALO Professional	595 419
		HALO Window Toolkit	595 419
		Icon-Tools/Plus	150 119
		Menuet	325 279
		MetaWindow	250 209
		MetaWindow Plus	325 289
		PCX Effects	99 89
		PCX Programmer's Toolkit	195 175
		PCX Text	149 135
		SilverPaint	129 109
		Slate w/ graphics	448 399
		Turbo Geometry Library	200 179
		<b>LINKERS/LIBRARIANS</b>	
		Overlay Toolkit	395 369
		Plink86+	395 335
		Plink/LTO	495 419
		Polylibrarian	249 209
		.RTLink	295 265
		.RTLink/Plus	495 359

LIST OURS		LIST OURS	
<b>OBJECT-ORIENTED TOOLS</b>		<b>OS/2 TOOLS</b>	
Objective-C	249 225	Brief	249 CALL
Smalltalk/V	100 85	CASE:PM for C or C++	1995 1799
Smalltalk/V 286	200 169	Epsilon	195 159
		MKS LEX & YACC	349 279
		MS OS/2 Pres. Manager Toolkit	500 349
		MultiScope for OS/2	449 345
		PCYACC	695 625
		PI Editor	249 225
		Smalltalk/V PM	495 369
		Vitamin C (OS/2)	345 279
		Zortech C++ OS/2 Devel. Ed.	600 509
		<b>PASCAL LANGUAGE</b>	
		Asynch PLUS	149 115
		B-tree Filer	125 109
		MS QuickPASCAL	99 69
		Object Professional	150 109
		ObjectVision	400 CALL
		Power Tools PLUS/5.0	149 109
		Topaz	99 89
		Topaz Multi-user	149 135
		Turbo Analyst	99 89
		TurboMAGIC	199 179
		Turbo Pascal 6.0	150 105
		Turbo Pascal 6.0 Professional	300 205
		Turbo-Plus 5.5	199 159
		Turbo Professional 5.0	125 109
		<b>SOURCE MAINTENANCE</b>	
		Codan	395 345
		CodeCheck	495 469
		MKS Make	149 119
		MKS RCS	189 149
		MKS Software Mgmt. Team	299 239
		PolyMake	179 149
		PVCs Professional	495 419
		SMS	495 399
		TLIB	139 109
		5 Station LAN	419 339
		<b>WINDOWS (MS) TOOLS</b>	
		Actor 3.0	895 719
		Asymetrix Toolkit	395 CALL
		Bridge Toolkit	695 659
		Case-V	995 CALL
		C-Talk/Views	450 375
		dBFast/Windows	395 335
		DialogCoder	499 435
		Drover's Toolbox for Windows	295 269
		w/ source	885 799
		More Power to You	395 339
		MS Windows Development Kit	500 349
		MultiScope for Windows	379 289
		ObjectGraphics	445 365
		PC-Connect	495 449
		ProView	695 625
		Resource Workshop	300 269
		Spinnaker Plus	495 349
		WindowsMAKER	795 635
		WinTriev	395 339
		WNDX GUI Toolkit	499 449
		XVision	449 399

## NEW RELEASES

**More Power To You**  
A Softelligence library that extends the Microsoft Windows SDK 3.0 to allow direct hardware access to video modes, memory and registers. Provides direct access to the DPMI (DOS Protected Mode Interface) services, bypassing the Windows 3.0 GDI for instantaneous control of video, memory, keyboard, mouse, joystick, etc. Includes examples of animation, arcade-style games, and MIDI. Source available. Requires Windows SDK 3.0, MS C 6.0.  
List: \$395 Ours: \$339

**Zortech C++ Database Library**  
A collection of C++ classes using OOP's techniques, to provide all that's needed to construct a single/multi-user b-tree database system. Comes with FULL SOURCE CODE and extensive documentation.  
List: \$300 Ours: \$255

**CASE:PM for C++**  
Caseworks CASE:PM for C++ Common View prototypes CUA compliant Presentation Manager interfaces, then generates the required Glocksenspiel C++ and Common View Object Classes for the graphical user interface of Presentation Manager applications.  
List: \$1995 Ours: \$1799

# Guaranteed Best Prices!

(800)  
445-7899

## FAXcetera

Want more product information on the items in the gold box to the right? Try **FAXcetera**!! Just pick up your FAX phone and dial **201-389-8173**. Enter the **FAXcetera** product code listed below each product description—information will be faxed back to you instantly!

### XENIX/UNIX

BLAST	495	395
Epsilon	195	169
Esix System V (2 user)	595	535
Unlimited	825	745
Informix Products	CALL	CALL
Interactive Products	CALL	CALL
LPI-COBOL	1495	1199
LPI-FORTRAN	995	799
MetaWare High C	895	849
Microport Products	CALL	CALL
MKS RCS	395	335
MKS Trilogy	119	105
Norton Utilities	295	235
PI Editor	349	319
RM/COBOL 85	2250	1895
SCO Products	CALL	CALL
SVS C	725	689
SVS FORTRAN	825	795
SVS Pascal	725	689
VEDIT PLUS	285	249
Vermont Views	1795	1489
Zortech C++ Compiler	500	425

### ADDITIONAL PRODUCTS

APL*PLUS	695	549
BalerXE	795	579
Dan Bricklin's Demo II	199	159
Dan Bricklin's Page Garden	100	69
dBx/dBPort	600	459
Guido	249	189
Jake Geller's Spell Checking Eng.	249	225
Lattice RPG	1600	1285
MKS AWK	99	79
Opt-Tech Sort/Merge	149	119
PC Scheme	95	79
Personal Rexx	150	139

### APPLICATION SOFTWARE

#### COMMUNICATIONS

BLAST II	250	225
Carbon Copy Plus	199	129
Laplink III	150	99
PC Anywhere III	145	99
Procomm Plus	99	63
SideTalk	120	99

#### DESKTOP PUBLISHING

Adobe Products	CALL	CALL
Corel Draw!	595	399
HALO DPE	195	139
PageMaker	795	509
Ventura Publisher	895	589

#### MATHEMATICS

Derive	200	179
MathCAD	495	315
Mathematica 386	695	625

### LIST OURS

### SCIENCE & ENGINEERING

AutoCAD Release 10	3000	CALL
AutoSketch	150	95
ChiWriter	150	129
CSS	495	469
DADISP	895	759
Design CAD 3-D	400	292
Drafix Windows CAD	695	CALL
EXACT	475	380
Generic CADD Level 3	350	289
LABTECH Acquire	195	179
LABTECH Notebook	995	799
MICRO-CAP III	1495	1269
Orcad PCB	1495	CALL
PC-MATLAB	695	659
PC TEX	249	229
SCHEMA III	495	449
Systat w/ Sygraph	895	759
Tango PCB Series II	595	559
TECH*GRAPH*PAD	395	319
T3	595	479

### SPREADSHEETS

Lotus 1-2-3 3.1	595	389
Microsoft Excel	495	319
Quattro Professional	495	329
SuperCalc5	495	319

### UTILITIES

386MAX5.0	130	114
above DISC	119	64
AboveMEM	80	75
Bootcon	60	55
Cache 86	50	39
Central Point Backup	99	69
FASTBACK Plus	189	119
HeadRoom 2.0	130	89
Hijaak v. 2.0	199	149
Hold Everything	199	159
HyperPAD	150	CALL
InfoSpotter	80	69
MACE 1990	149	105
Magellan	195	109
MKS Toolkit	249	199
MOVE'EM	89	79
Norton Commander	149	99
Norton Utilities 5.0	179	129
Paginate	100	79
PC Tools Deluxe 6.0	149	95
Pizazz Plus	149	79
PreCursor	96	79
Sidkick Plus	200	139
SitBack	99	90
Software Carousel	90	72
SpinRite II	89	75
Squish Plus	100	75
Switch-It	100	89
Tree 86	90	69
Turbo EMS 5.0	100	89
UpShot	95	89
XTreePro Gold	129	89
ZENO	269	239

### WORD PROCESSING

Ami	199	129
Microsoft Word for Windows	495	349
WordPerfect 5.1	495	CALL

## Programmer's Policies

#### Phone Orders

Hours Mon-Fri 8:30 AM-7 PM EST, Sat 9:30-2:30 EST. We accept MC, Visa, AMEX. Domestic shipments, please add \$5 per item for shipping/handling by UPS ground. For domestic COD shipments, please add \$3. Rush service available.

#### Mail or FAX Orders

POs are welcome. Please include phone number.

#### International Service

Phone number required with order. Call or FAX for additional information.

#### Dealers Welcome!

Call for information.

#### Corporate Accounts

Call CORSOFT, our corporate sales division at (800) 422-6507. Ask about volume purchase agreements.

#### Unbeatable Prices

We'll beat the competition's advertised prices. Prices subject to change without notice.

### LIST OURS

## Spontaneous Assembly

An assembly language library that lets you produce the fastest, tightest possible programs with the same ease you'd expect from a high-level language. It includes an impressive collection of over 700 functions and macros for high-speed text windowing, heap management, array searching and sorting, critical error management, 32/64 bit integer math, and much more! Comprehensive 750+ page manual. Full source code. No royalties. Easy integration with C. *"If you program in assembly language, you gotta have Spontaneous Assembly."* - Michael Abrash



**basetwo**  
DEVELOPMENT

List: \$395 Ours: \$189 FAXcetera #2614-0001

## DialogCoder

DialogCoder is a powerful "C" source code generator for MS Windows 3.0 application development. It provides a complete development environment for the creation, modification and maintenance of source code to support dialog boxes. With DialogCoder's simple point & click graphical interface, in just minutes source code is generated to support simple flat WYSIWYG dialogs to highly complex dialogs. Dialogs that used to take hours or days to program can now be programmed in minutes, eliminating endless hours of costly debugging and coding time. Supports custom code, automatic regeneration of source code, owner-drawn controls, optional generation of DLLs, edit field validation, and much more.



DialogCoder Set-up Window

List: \$499 Ours: \$479

FAXcetera #2939-0001



## .RTLink®/Plus 4.10 with VML™

### (Virtual Memory Linking)

Automatically execute large MS-DOS programs in as little as 100K, or execute in all available memory. No source code changes.

Supports Microsoft C, QuickC, MASM, FORTRAN, Pascal, CodeView, Clipper S'87, and Clipper 5.0.

List: \$495 Ours: \$359

FAXcetera #1987-0002

Pocket Soft, Inc.

## Hyper-Word™

Hyper-Word is a multi-window hypertext word processor and development system. Instantly create interactive tutorials and reference systems. Hyper-Word provides you with the necessary navigation tools to create and explore vast amounts of information. Includes context sensitive help, multi-level undo, pull-down menus. For the programmer: create program mock-ups, automatically display subroutine from any reference, interrelate all program source files. Full WYSIWYG word processing features; 120,000 word main dictionary plus user dictionary, recent reference list, multiple printers and font control. Uses standard text files. Works with or without mouse. Network compatible. Not copy protected.



List: \$149 Ours: \$109  
FAXcetera #2868-0001

**ZARON** SOFTWARE  
Since 1978  
SOFTWARE

### Our Guarantee...

Products listed here are backed by the following guarantee\*:

**Should you see one of these products listed at a lower price in another ad in this magazine, CALL US!**

**We'll beat the price, and still offer our same quality service and support.**

#### Terms of Offer:

- Offer good through January 31, 1991
- Applicable to pricing on current versions of software listed; Jan. issue prices only.
- Offer does not apply towards obvious errors in competitors' ads.

\* Subject to same terms and conditions.

International: 201-389-9228  
Customer Service: 201-389-9229  
Fax: 201-389-9227

Corporate: 800-422-6507  
Canada: 800-445-7899  
FAXcetera: 201-389-8173

Call or Write for Latest Free Catalog!

# 1-800-445-7899

## Programmer's Paradise

A Division of Voyager Software Corp  
1163 Shrewsbury Ave., Shrewsbury, NJ 07702

Circle 265 on Reader Service Card



## Develop DSP Applications on the Mac

**D**SP Designer 1.1, for developing digital signal processing applications, now includes Z, a C-like interpretive language for modeling. Zola says you can use Z to create a model of your DSP algorithm to make sure it's correct before you use it in a program. Z also provides floating-point filter simulation.

DSP Designer includes analysis and simulation capabilities for digital filters. You can use it to create, manipulate, and display real and complex-value test signals, as well as for generating filter code for the Motorola DSP56001 24-bit processor.

A DSP I/O Subsystem supports real-time evaluation of DSP56001 programs running on Digidesign's Audiomedia or Sound Accelerator cards.

DSP 1.1 works directly with MPW 3.0, letting you develop and test in a single environment.

**Price:** \$895.

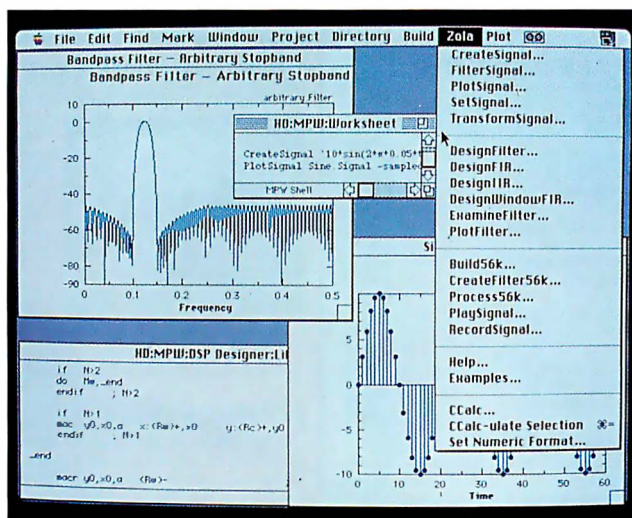
**Contact:** Zola Technologies, Inc., 6195 Heards Creek Dr. NW, Suite 201, Atlanta, GA 30328, (404) 843-2972.

**Inquiry 1298.**

## C Function Libraries for AutoCAD

**A** set of C function libraries that provides four components for CAD/CAM applications helps you write stand-alone applications or applications that can link into AutoCAD through release 11's new C-binding interface.

The components include DXF input and output, 2-D and 3-D geometry display and geometry operations, and list management. The CAD/



From within the MPW shell, a menu provides access to all DSP Designer commands.

CAM Developer's Kit supports a variety of C compilers.

**Price:** \$1295.

**Contact:** Building Block Software, P.O. Box 1373, Somerville, MA 02144, (617) 628-5217.

**Inquiry 1299.**

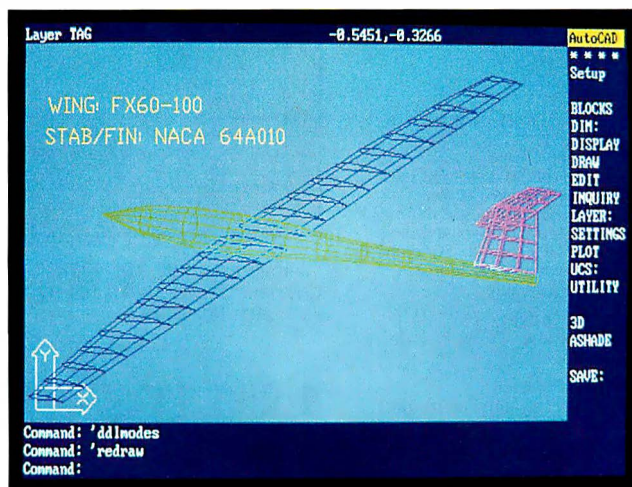
## Screen Manager for C Programmers

**S**creen Manager Professional (SMP) 2.0, an interface design library that supports a variety of C programming environments, in-

cludes functions for windows, menus, context-sensitive help, data entry, and keyboard and mouse support.

SMP 2.0 includes event-driven mouse support, according to Magee Enterprises. The program supports Personal's Ultra Vision, so that applications can display up to 120 columns by 63 rows.

A minimum configuration requires 13K bytes of RAM, with a maximum configuration using 34K bytes. SMP 2.0 supports Microsoft C 5.1 and 6.0, Turbo C and C++, Zortech C and C++ 2.0, Watcom C 7.0, and Lattice C 6.0.



The CAD/CAM Developer's Kit makes it easy to write parametric applications for AutoCAD, such as this sailplane design program.

**Price:** \$349.95 (royalty free).

**Contact:** Magee Enterprises, Inc., P.O. Box 1587, Norcross, GA 30091, (404) 446-6611.

**Inquiry 1300.**

## All-in-One Maintenance Tool

**W**hen you're involved in software maintenance, trying to unravel the structure and logic of someone else's program can be exasperating. Hindsight, Advanced Software Automation's software maintenance tool for Unix workstations, helps you evaluate code performance and understand code structure.

Hindsight generates graphical interactive structure charts and active logic diagrams from your existing C code. Functions and paths are color coded to clarify relationships. The program's assisted code tracing lets you follow function calls and references by pointing to a reference and jumping to the referenced line.

For software testing, Hindsight monitors the effectiveness of your quality-assurance methods as you test program code, providing resolution of test coverage results down to the procedural level, the company says.

Hindsight tracks changes from one version of a program to the next and automatically updates documentation.

Hindsight runs on Unix workstations (including Apollo, DEC, IBM, and Sun) running Motif, Open Look, or SunView.

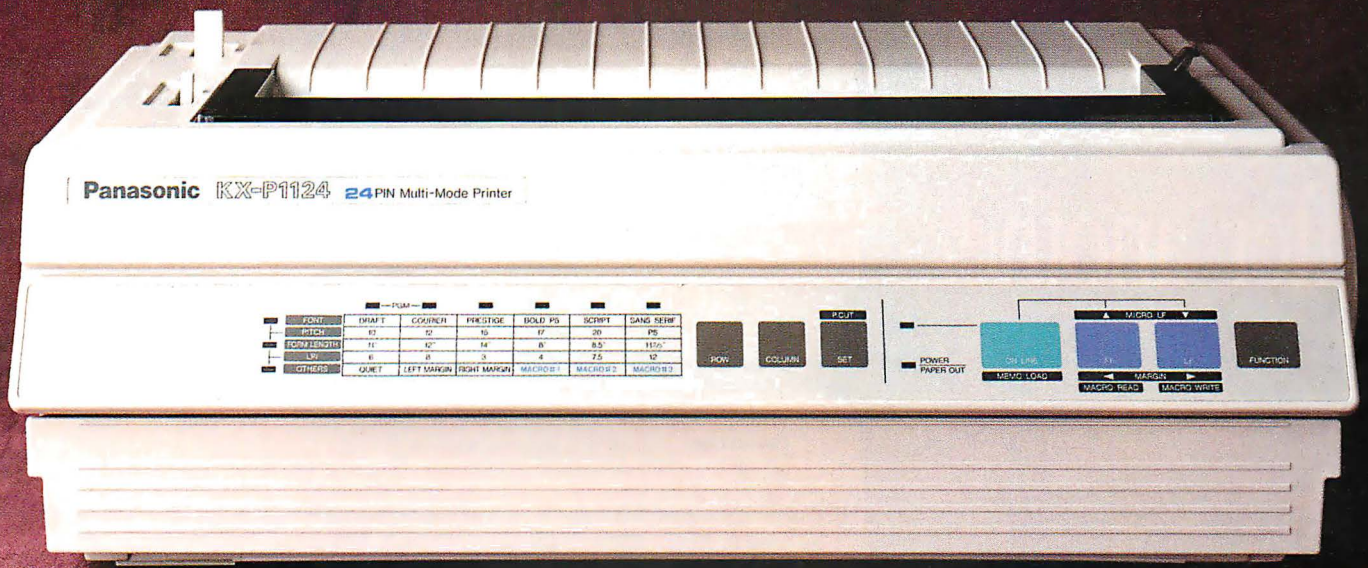
**Price:** \$12,000 to \$23,000.

**Contact:** Advanced Software Automation, Inc., 2880 Lakeside Dr., Suite 226, Santa Clara, CA 95054, (408) 492-1668.

**Inquiry 1301.**



To become  
 the hottest name  
 in dot matrix printers  
 you simply build  
 one terrific  
 printer



*The award-winning KX-P1124.*

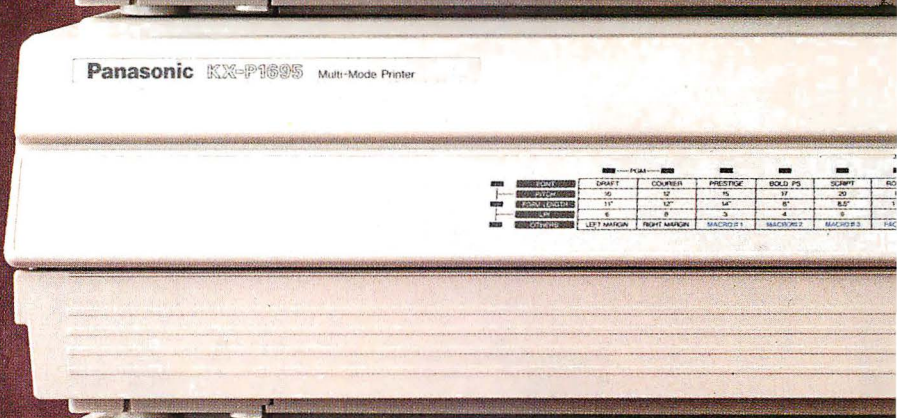
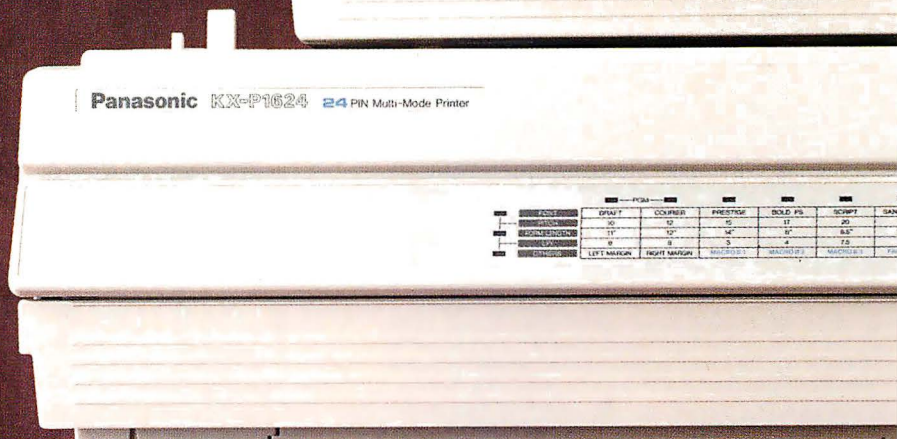
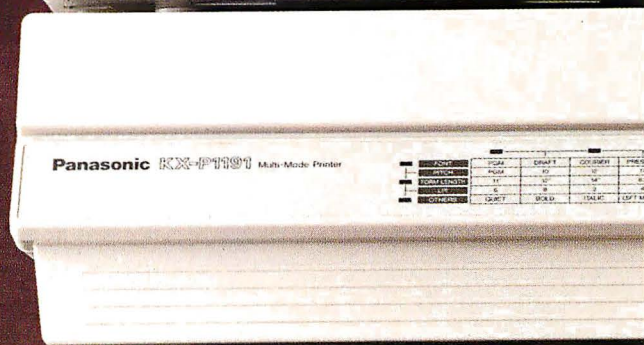
after another,

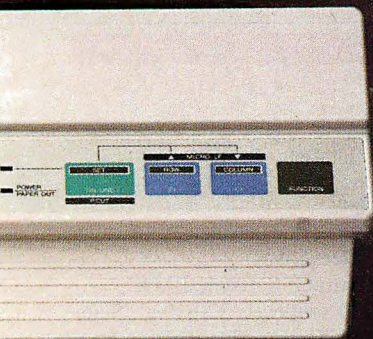
after another,

after another,

after another,

after another.

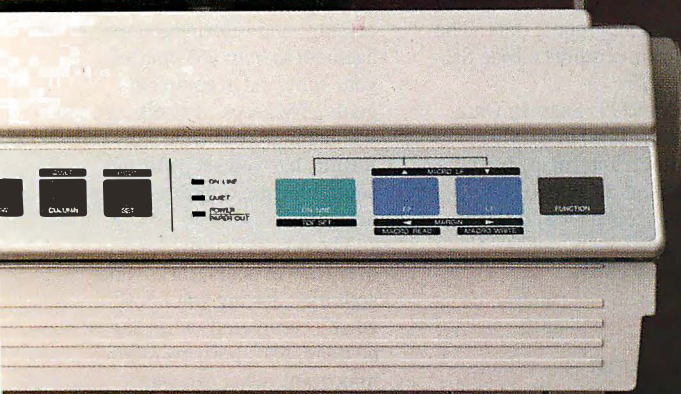




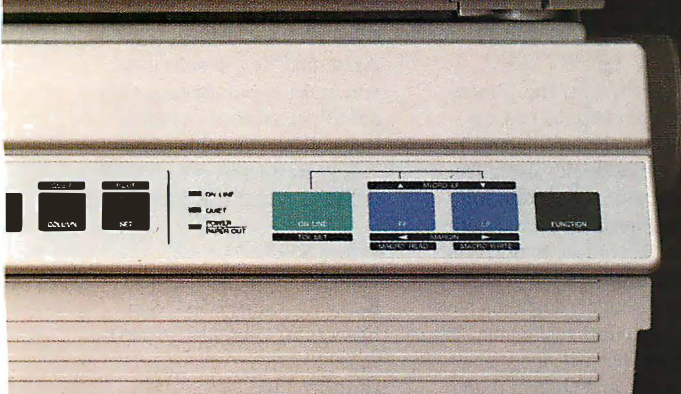
*If you want the perfect printer for the home.*



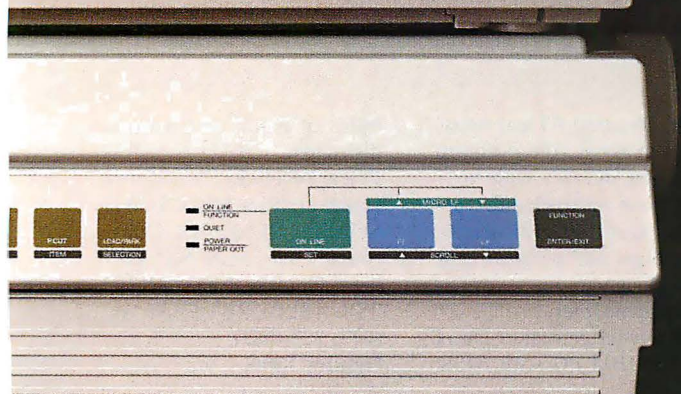
*If you want a little more speed for your home office printing.*



*If you want the same features as the 1124, but with a wide carriage.*



*If you want high speed, high volume for spreadsheets and financials.*



*If you want near laser quality at dot matrix prices.*

A few years ago, we redefined what people expect from a dot matrix printer. By creating a 24-pin as sophisticated as it is simple. And as affordable to buy as it is economical to own.

The KX-P1124 has won its share of awards. But it's not the only Panasonic®Dot Matrix to receive rave reviews. Now there's



a whole family to choose from. All with EZ Set™ operator panel, multiple paper paths, a variety of fonts, 2-year limited parts and labor warranty (see your dealer for details), and other features that typify our approach to price/performance for today's office environment.

There are feature-rich 9-pin models for every-day drafts. And superb 24-pins for important correspondence. In both regular and wide-carriage versions.

And we've just introduced what may well be the quintessential office printer for the 90's, the KX-P1654. A wide-carriage 24-pin that rockets along at up to 375 characters per second. With print quality approaching that of lasers.

Chances are, your first Panasonic printer will lead to another, and another, and another.

For further information on Panasonic Dot Matrix Printers, see your Panasonic dealer, or telephone toll-free **1-800-742-8086**.

*Printers, Computers, Peripherals,  
Copiers, Typewriters and Facsimiles*

**Panasonic**  
Office Automation 

*Engineered for the office. Designed for people.*

## A-T Moves dBASE into the Sun

For businesses that want to run DOS-based dBASE applications on Sun workstations, Ashton-Tate developed dBASE IV for Sun. The program lets you port a DOS dBASE application to the Sun without reprogramming or re-compiling, except for occasional hardware differences, the company says. dBASE applications that need to run on ASCII terminals or non-PC-standard keyboards may require slight modification, the company says.

dBASE IV for Sun is an implementation of dBASE IV 1.1, with enhancements to support multiuser and multi-tasking capabilities, virtual memory, and security. The program includes design tools that let you create screens, reports, menus, and other objects. The Automatic Code Generator can then produce documented code for the objects.

dBASE IV for Sun runs on the Sun-3, Sun-4, Sun386i, Sparcstations, and Sparc-servers with at least 4 MB of RAM. **Price:** \$995 for single-user license; multiuser package that adds up to four users, \$2995. **Contact:** Ashton-Tate Corp., 20101 Hamilton Ave., Torrance, CA 90509, (213) 329-8000. **Inquiry 1302.**



*dBASE IV for Sun includes the dBASE IV Control Center, from which you access the program's design tools and code generator.*

## Mac Mapping Program Has Its Own DBMS

Descartes, a business mapping program for the Mac, includes its own relational database, allowing you to combine your data with demographics and display it in maps and charts from one package.

The program comes with a core set of data that includes state and county demographics and boundaries, ZIP code and major city locations, and interstate highways. An importing tool lets you integrate data from other applications into the Descartes database.

The company also provides Snap-In Data geographic and statistics options such as Arbitron Areas of Dominant Influence, Nielsen Designated Market Areas, and re-

lated demographic data. The program requires a Mac SE or higher.

**Price:** \$795; Snap-In Data options, \$100 to \$3000. **Contact:** Intermap, Inc., 13 Dartmouth College Hwy., Lyme, NH 03768, (603) 795-4751. **Inquiry 1303.**

## Softsync's Accounting Entry Point for the Mac

Accountant, Inc. Professional uses a task approach to accounting and finance that shields users from having to learn accounting procedures they don't need to know, according to Softsync.

The program integrates general ledger, accounts payable, accounts receivable, inventory, payroll, a project manager, and financial anal-

ysis in one package.

**Price:** \$595. **Contact:** Softsync/BLOC, 800 Southwest 37th Ave., Suite 765, Coral Gables, FL 33134, (800) 955-1888 or (305) 445-0903. **Inquiry 1304.**

## Manage by Objective with Key Results

Key Results combines time and task management, planning, word processing, and information management to help you control your time and accomplish goals, TMI says. By helping you manage your time, Key Results lets you set priorities, communicate, coordinate, and delegate tasks.

The program provides an overview of goals, tasks, and activities, letting you know what's completed, what has to be done, and, perhaps more important, what can wait.

The program integrates all of its sections (Diary, Key Area, and Key Results). As you make appointments, they are allocated time in daily, weekly, and monthly plans.

Key Results works on the IBM PC with 512K bytes of RAM. **Price:** \$595. **Contact:** TMI, Inc., 185 Berry St., Suite 6504, San Francisco, CA 94107, (415) 957-1133. **Inquiry 1305.**

## FirstMark Seeks Out the Important Data

For managers who want to analyze data to make decisions without having to rely on the interpretations of an intermediary statistical analyst, FirstMark has developed KnowledgeSeeker. The program combines statistics and AI to provide a snapshot of important trends

and relationships in your business. It presents this information in an interactive graphical decision tree or in the form of decision rules.

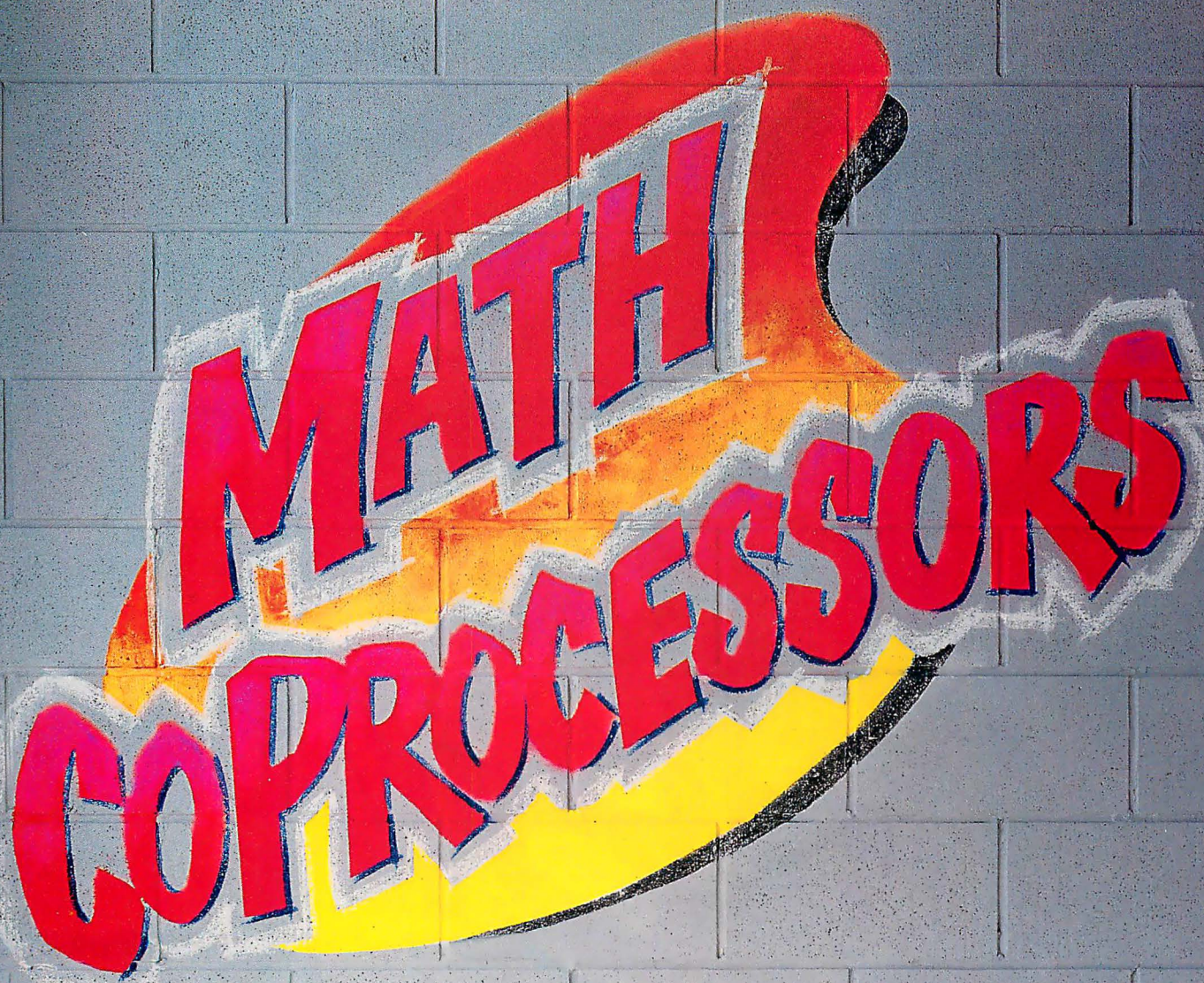
KnowledgeSeeker can automatically derive these snapshots from data stored in dBASE III, dBASE IV, Lotus 1-2-3, or ASCII for-

mat. By using AI and statistical analysis, the program lets you interact with your database or worksheet directly to cull out critical relationships and patterns that fall along geographic or demographic lines.

KnowledgeSeeker runs on the IBM PC with 640K

bytes of RAM and a hard disk drive.

**Price:** US\$495. **Contact:** FirstMark Technologies, Ltd., 14 Concourse Gate, Suite 600, Ottawa, Ontario, Canada K2E 7S8, (800) 387-7335 or (613) 723-8020. **Inquiry 1306.**

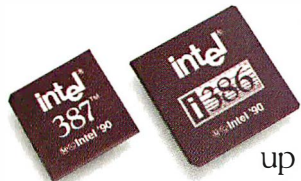


# MATH CO-PROCESSORS

You know what you need  
to speed up your  
power applications.  
There's just one more thing  
you should know.



Only one math coprocessor is a  
chip off the old block.



That's Intel's. And our new family of Math CoProcessors is faster—up to 50% for the 287XL.

In fact, working side by side with the Intel microprocessor already inside your computer, an Intel Math CoProcessor can increase the speed of your spreadsheet, graphics, CAD and

database programs by as much as 500%. That's good to know.

And the fact that it's made by Intel is also good to know.

Because Intel developed the first Math CoProcessor in 1982, and we've shipped millions since then. Each one is manufactured by Intel in the world's most advanced logic



facility, and then tested and retested against an exacting set of criteria.

And we can guarantee that every Intel Math CoProcessor lives up to the industry hardware standards we helped develop, delivering the same results regardless of what type of computer you're doing calculations on.

So call Intel at (800) 538-3373. Ask for

Literature Packet #F6 on Intel's new and improved Math CoProcessors. And put an Intel Math CoProcessor inside your computer. It's the only one with the Intel name to live up to.

**intel**<sup>®</sup>

The Computer Inside.™

©1990 Intel Corporation. 386 and 387 are trademarks of Intel Corporation.

Circle 151 on Reader Service Card (RESELLERS: 152)

## Bring Your Data to Life

**E**asyPlot 2.0, the interactive plotting and data-analysis package for the IBM PC, has a new windowing system for working with multiple graphs, expanded memory support, new editors, and improved analysis capabilities, its developer says.

As you enter data or equations, EasyPlot instantly generates a plot, complete with tick marks and labels. You can then customize any aspect of the graph, changing axis ranges, including log scales, position of axes, tick mark locations, fill patterns, and other attributes. The program updates graphs immediately after every change.

With EMS support, the program can now handle more than 100,000 points without having to do the disk shuffle. Text-based and graphical editors let you add, delete, or adjust data points.

The program's new curve-fitting algorithm works with any function of up to 20 unknowns. The new version supports dual axes, bar charts, and 3-D scatter plots that can rotate in real time.

EasyPlot requires 400K bytes of RAM.

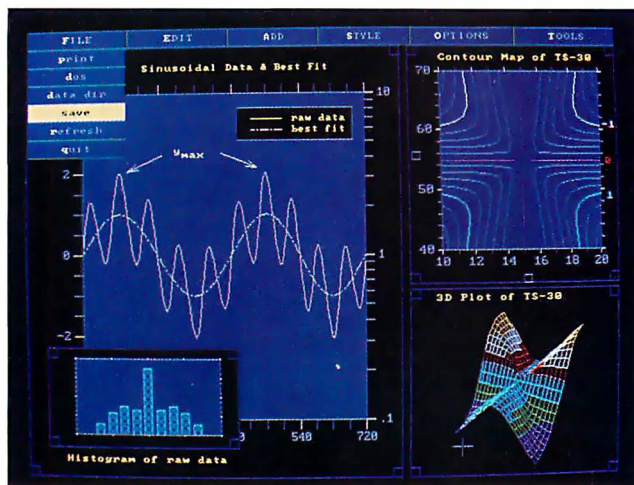
**Price:** \$349.

**Contact:** Spiral Software, 6 Perry St., Suite 2, Brookline, MA 02146, (800) 333-1511 or (617) 739-1511.

**Inquiry 1307.**

## The Program of 10,000 Stars

**T**he new version of EZ-Cosmos includes a database of 10,000 stars and other celestial objects. According to Future Trends Software, the program can display the sky as it would appear from any location on Earth be-



*EasyPlot's pull-down menus let you access functions while graphs appear on the screen. You can annotate the graph directly and reposition objects by clicking and dragging.*

tween 4000 B.C. and 10,000 A.D. You select a location by entering longitude or latitude or the name of a major city (more than 560 cities around the world are on file). Version 3.0 also includes over 35 digitized photos of NGC (New General Catalog) objects and the solar system.

You can search for celestial objects by common name, NGC designation, or constellation designation. You can also animate occurrences such as solar eclipses in intervals that you designate.

The program requires 512K bytes of RAM.

**Price:** \$69.95.

**Contact:** Future Trends Soft-

ware, P.O. Box 1418, DeSoto, TX 75115, (800) 869-3279 or (512) 443-6564.

**Inquiry 1308.**

## CCD Image Processing for the Mac

**F**or scientific imaging applications in medicine, microscopy, and astronomy, the IPLab line of imaging programs has been updated to work with the Photometrics Series 200 charge-coupled-device camera.

With IPLab-SU2, you can control the camera directly

from the program. IPLab (for gray-scale) and IPLab/Spectrum (for 24-bit color image processing) can both display and process image data with a dynamic range of more than 8 bits per pixel while retaining data integrity, Signal Analytics says.

The program provides image-processing operations such as fast Fourier transforms, linear and morphological filtering, and statistical operations.

IPLab-SU2 requires a Mac II with at least 4 MB of RAM, an 8-bit video card, and a hard disk drive.

**Price:** \$1099; with color support, \$1349.

**Contact:** Signal Analytics Corp., 374 Maple Ave. E, Suite 200, Vienna, VA 22180, (703) 281-3277.

**Inquiry 1309.**

## Easy Equilibrium Chemistry

**F**or aquatic chemists, biochemists, and geologists who are tired of spending hours on complicated aqueous equilibrium solutions, MicroMath Scientific offers Equil. The program's built-in equilibrium compiler automatically constructs mass balance relationships.

Equil 2.0 features an expanded database and now handles 300 reactions, over 100 chemical reagents, and 400 chemical species. You can now test reactions according to varying temperatures, and the program has several new methods for calculating the activity coefficient affecting equilibrium constant.

**Price:** \$249.

**Contact:** MicroMath Scientific Software, P.O. Box 21550, Salt Lake City, UT 84121, (800) 942-6284 or (801) 943-0290.

**Inquiry 1310.**



*This photo of the Trifid nebula, taken from the Kitt Peak Observatory, is one of many images included with EZCosmos.*





# Take the Oops & Downs out of your next presentation.

Tired of fumbling with slides? Fiddling with transparencies?  
Losing your audience?

Well, it's time to use an LCD projection panel from In Focus Systems. It lets you project information just as it appears on your computer screen. Even bright, brilliant colors.

So you make stronger presentations. And easily hold any audience.

What's more, the 640x480 display works with IBM<sup>®</sup> compatibles, and the Macintosh<sup>®</sup> family, too. For more information or the name of the dealer nearest you, call 1-800-327-7231, today.

Then take the oops and downs out of your next presentation. And put the audience in the palm of your hand.

1-800-327-7231.

See it. Believe it.

**IN FOCUS SYSTEMS, INC.**

Circle 157 on Reader Service Card

7770 Southwest Mohawk Street, Tualatin, Oregon 97062.  
1-800-327-7231. Oregon, 503-692-4968. FAX, 503-692-4476.

IBM and Macintosh are registered trademarks of their respective companies.



## Paint Landscapes on Your Monitor

Going beyond the shooting stars and flying animals found in most screen-saver programs, Dawn paints landscapes on your IBM PC monitor. With thousands of variations on a dozen themes, the program puts art on your monitor when it's not in use. The program requires EGA graphics capability or higher. **Price:** \$39.95.

**Contact:** Iron Mtn Software, P.O. Box 1676, Mariposa, CA 95338, (209) 742-5000. **Inquiry 1311.**

## No More Dirty Floppy Disk Drives

Viruses are bad enough, but how do you know if dirt and dust in your floppy disk drive aren't causing you to lose data? A program called Trackmate Generation 3.0 tests your floppy disk drive's read/write heads and loading rail assembly to see if cleaning is needed and recommends the length of the cleaning program.

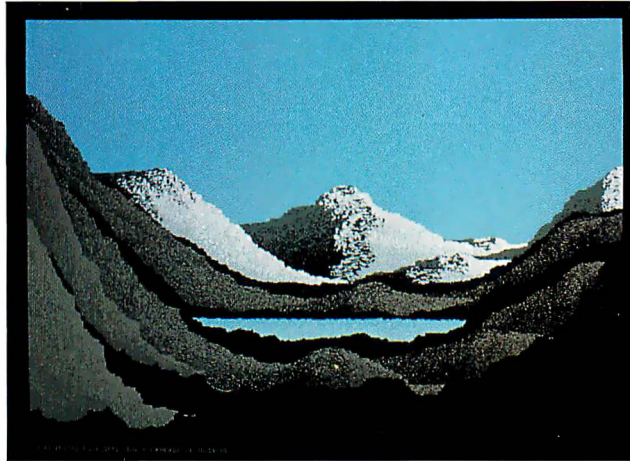
When you determine that there's too much dirt in your system, you insert a cleaning disk included with the software. The disk has 265,000 absorbent filaments that fit the read/write heads and remove dirt. Additional brushes clean the loading rails.

The program supports 3½- and 5¼-inch floppy disk drives on the Mac and IBM PC.

**Price:** \$34.95; \$44.95 for the 5¼-/3½-inch combination pack for PCs.

**Contact:** Trackmate America Corp., 14577 South Bascom Ave., Los Gatos, CA 95032, (408) 356-0795.

**Inquiry 1312.**



*Even if your office doesn't have a window, Dawn gives you a view of the great outdoors.*

## Take Stock of Your Office

In a large corporate environment, taking a PC census involves disrupting workers, pulling out boards, taking notes manually, and rekeying data into a database. PC Census makes it easier to tell who's got what and where it is.

PC Census provides a centralized inventory of the software and hardware in your installation, telling you what's on each system.

When you run PC Census on a PC, it scans the machine's internals and recognizes hardware add-ins, applications such as WordPerfect, and other components, eliminating the need to take apart the PC and search through subdirectories. With a remote-access program, you can use PC Census on a LAN.

**Price:** \$745 for a combined hardware-software module for 50 PCs.

**Contact:** Tally Systems Corp., Buck Rd., P.O. Box 70, Hanover, NH 03755, (800) 262-3877 or (603) 643-1300.

**Inquiry 1313.**

## Central Point Unbundles Its Backup Program

Central Point Backup is a stand-alone version of the backup program found in PC Tools Deluxe 6.0. The program lets you save options and selections for launching subsequent backups from the DOS command line.

A character-based program, Central Point Backup includes a graphical user interface that makes it easy to select files and options to

perform regular backups. **Price:** \$99.

**Contact:** Central Point Software, Inc., 15220 Northwest Greenbrier Pkwy., Suite 200, Beaverton, OR 97006, (503) 690-8090. **Inquiry 1314.**

## Get Up to Speed with Windows

Microsoft developed its Productivity Pack for those who want to learn Windows 3.0 and get the most out of the operating environment. A Windows application, the Productivity Pack offers three tools.

Learning Windows gets you up to speed while providing on-line help. Working Smarter provides hints, tips, and strategies while you're in another Windows application. The Quick Troubleshooter helps you diagnose and answer Windows support questions.

**Price:** \$59.95.

**Contact:** Microsoft Corp., 1 Microsoft Way, Redmond, WA 98052, (800) 426-9400 or (206) 882-8080.

**Inquiry 1315.**

## Virus Protection Around the Clock

This virus protection program works around the clock. Besides scanning for known viruses, HardDrive Overlord! seeks out activities often associated with viral attacks, such as a program's unauthorized attempt to stay resident in RAM. When it detects such activities, the program pops up a warning with options for stopping the function or continuing.

**Price:** \$99.95.

**Contact:** POP Computer Products, Inc., P.O. Box 1389, Evergreen, CO 80439, (303) 674-0200.

**Inquiry 1316.**

## Electronic Directory of Toll-Free Numbers

The Toll-Free Hotline contains more than 115,000 listings drawn from AT&T's roster of 1-800 customers. Each listing includes the company name, phone number, calling area, and demographic information. The program, which runs on the IBM PC, has a

database manager and auto-dial capabilities.

**Price:** \$59.95.

**Contact:** General Information, Inc., 11715 North Creek Pkwy. S, Suite 106, Bothell, WA 98011, (800) 882-3900 or (206) 483-4555.

**Inquiry 1317.**

# You Don't Have to be a Programmer to Develop Database Applications . . .

```
ZP:CODE = LD:ZIP  
SET(ZP_KEY,ZP_KEY)  
LOOP UNTIL BOF(ZIP)
```

```
PREVIOUS(ZIP)  
IF ZP:CODE <= LD:ZIP  
SL:CODE = ZP:SLSMN
```

```
GET(SLSMN,SL:SL_KEY)  
LD:SLSMN = SL:CODE  
DISPLAY(?LD:SLSMN)  
BREAK
```

FIRST NAME	LAST NAME	TITLE	COMP C/P
1. Jim	Brown	President	C
2. July	Smith	U.P. Operations	
3. John	Jones	U.P. Sales/Marketing	
4.			
5.			
6.			
7.		Material Contact	

## When You Use Nutshell Plus II!

Programmers, dealers and end-users alike love the power of Nutshell Plus II. Imagine setting up a relational database ready to go in a matter of minutes! Don't worry if you change your mind; the database is modifiable instantly! Whether you wish to create

a simple mailing list or sophisticated invoicing system that joins a master client file, the capability is all there—thanks to Nutshell's simplicity of setting up custom input screens, custom reports, form letters, labels. The list is endless!

### Features:

- Quick & easy design
- Fast execution
- Custom screen layouts
- Sophisticated reports, form letters, labels, etc.
- Relational lookups and information capturing
- Modifiable at any time

### New Features with Nutshell Plus II:

- More import/export formats: dBASE II, III and IV, FileMaker along with ASCII and DIF.
- More search/find capabilities
- International symbol support
- Runs up to 10 times faster than Ver. I.
- Special upgrade pricing available to existing Nutshell users

### And also Nutshell Plus II Professional:

- Nutshell Plus II full development version
- 4 run-time disks to distribute your applications
- Designed specifically for corporate users, VARs, consultants and resellers

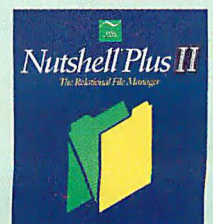
## Don't Create Another Database Without Trying Nutshell Plus II.

### IRIS Software Products™

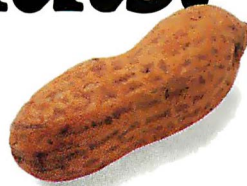
Visit your nearest retail dealer or call 1-800-582-IRIS to get the name of the dealer nearest you who sells Nutshell and Nutshell Plus II.

P.O. Box 57, Stoughton, MA 02072

Phone: 617-341-1990 FAX: 617-344-4640



# PostScript for peanuts.



At last, low-cost, high performance PostScript® printing! This complete solution for PC publishers is yours for peanuts — from The Printer Works.

For as little as \$995.\*

That's all it takes to command this powerful system consisting of a Canon CX™ printer for superb print quality. Plus a QMS JetScript™ controller which adds true Adobe PostScript, in 35 different fonts, for trouble-free compatibility with all your favorite applications.

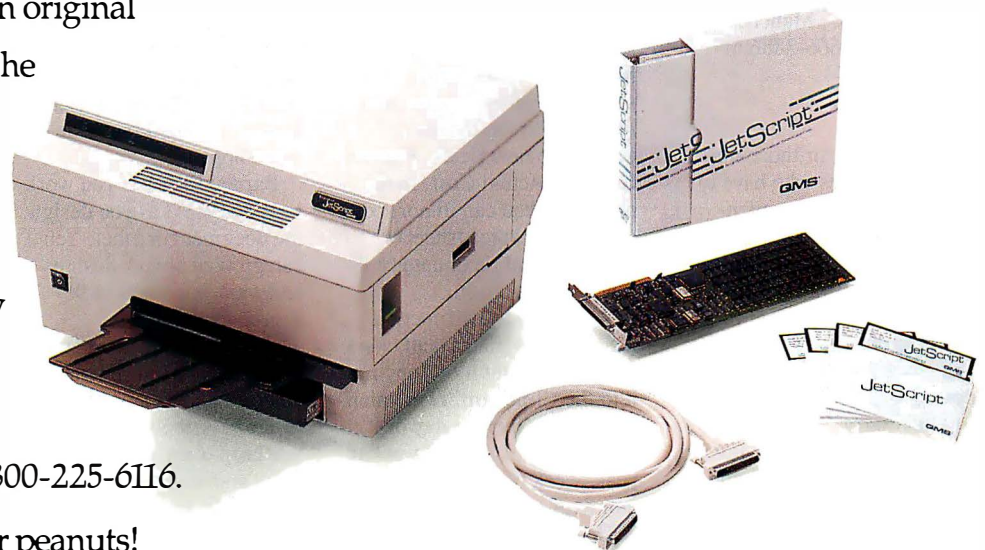
Now, for only \$995, you can easily produce stunning type and graphics that will make you look like a desktop wizard. And you can do it faster than with PostScript cartridges because JetScript has its own high speed processor and 3 megabytes of RAM.

JetScript was developed jointly by Adobe Systems, QMS and Hewlett-Packard to bring the power of PostScript to the HP LaserJet™ Series II. If you already have an HP LaserJet II, or an original

LaserJet, you can get the JetScript controller separately for as low as \$495. That's a whopping 80% below the list price!

Don't delay, call The Printer Works. 1-800-225-6116.

And get PostScript for peanuts!



- \* JetScript with refurbished Canon CX printer, \$995
- JetScript with NEW Canon CX printer, \$1295
- JetScript for original HP LaserJet or LaserJet Plus, \$695
- JetScript for OEM CX (Cordata Etc.), \$595
- JetScript for HP LaserJet II, \$495

Prices subject to change, quantities limited. Dealer Inquiries Welcome

**THE PRINTER WORKS**

3481 Arden Road, Hayward, CA 94545

PostScript is a trademark of Adobe Systems, Inc. JetScript is a trademark of QMS, Inc. Canon CX is a trademark of Canon, Inc. LaserJet is a trademark of the Hewlett-Packard Company.  
© 1990 The Printer Works

Circle 625 on Reader Service Card (RESELLERS: 626)

## Chart Drawing Under Windows 3.0 and the Mac

**K**idasa Software's newest release of Milestones, Etc., for creating Gantt charts, now supports up to 500 task lines and up to 40 milestone symbols per task line. An auto-connect option automatically connects every two symbols on a line with a default connector type. It can import Comma Separated Variable files from Microsoft Project.

Kidasa improved the program's metafile exchange to support Microsoft PowerPoint, Windows Write, Word for Windows, Corel Draw, Ami Professional, Designer, and PageMaker.

**Price:** \$149.

**Contact:** Kidasa Software, P.O. Box 1167, Manchaca, TX 78652, (800) 666-3886 or (512) 282-1544.

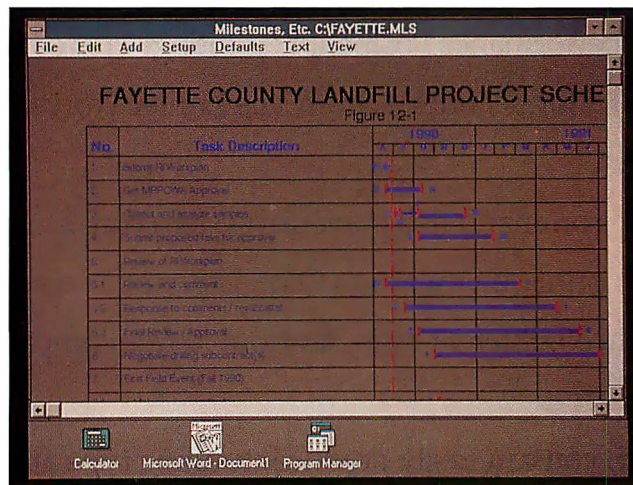
**Inquiry 1170.**

**A** program for those unlucky ones who have to update company organizational charts in these times of economic uncertainty, Instant Orgcharting! takes advantage of proportional fonts, multiple document interfaces, and other features of Windows 3.0.

The program lets you choose from nine organization tree structures. As you enter new personnel information, the program automatically redraws the chart. By clicking on an employee box, you can access detailed information about each person.

**Price:** \$149.

**Contact:** Roykore, Inc., 2215 Filbert St., San Fran-



*Milestones, Etc. 2.1 supports 300 more task lines and 30 more milestone symbols per task line than the previous version.*

cisco, CA 94123, (415) 563-9175.

**Inquiry 1171.**

**T**he new version of Great Gantt! for the Mac includes a dollar progress tool that lets you click on a bar to see how much money you've spent to date compared to how much you'd planned to spend. To allow for this new feature, Varcon Systems added two new fields, Planned Cost and Actual Cost, to the program. You can import cost data from a spreadsheet or other application or enter it directly on the chart.

A print preview function lets you view your Gantt chart before you print it by copying it to the Clipboard. New calendar options include day of year, day of schedule, week of year, week of schedule, and month of schedule.

Great Gantt! 1.3 also has two new commands that bring a chart to the front or send it to the back of another task bar. The program's MacProject reader lets you easily create charts from Claris's project management program, Varcon reports.

**Price:** \$195.

**Contact:** Varcon Systems, Inc., 10509 San Diego Mission Rd., Suite K, San Diego, CA 92108, (619) 563-6700.

**Inquiry 1172.**

## Bar Coding Design for Labels on the PC

**T**he Barney Ellis program integrates graphical design, information management, and printing for the production of labels, forms, and signs. The program comes with 101 character fonts and several standard bar code symbologies.

Barney Ellis lets you work in WYSIWYG as you design the document or label. You can grow or shrink designs and rotate elements in 90-degree increments.

You can queue and batch print jobs to achieve unattended printing on up to four printers. A report feature lets you keep track of printed material and who printed it. The program's data dictionary lets you access data in other spreadsheets, word processors, and databases.

**Price:** \$1695.

**Contact:** Integrated Software Design, Inc., 171 Forbes Blvd., Mansfield, MA 02048, (508) 339-4928.

**Inquiry 1169.**

## When Forms Meet a Database

**W**ith the EZ-Forms' Database, you can manage your business's information from one package, entering new information through a form input screen that's linked to a dBASE-compatible database. Once you've entered the information into the form and transferred it to the database, you can perform relational operations (e.g., query, browse, seek, or record finds).

EZ-Forms' Database loads a form that you've created with the included EZ-Forms Executive as an input screen. You can also use one of the program's predesigned forms as an input screen. By giving a common name to the input screen field of the database and a cell within the form, you can transfer information between forms and the database. In this way, information in the database is readily available for insertion into any type of business form, the company says.

The program can convert other file formats, such as fixed length, ASCII, or FileExpress databases, into a dBASE EZ-Forms' Database. Because it generates dBASE files, any third-party product that uses the dBASE format will work with EZ-Forms' Database, the company says.

Version 2.1 of the program is available in single and LAN versions. Both versions come with 10 applications for inventory, time billing, phonebook, cities, and other business functions.

**Price:** \$239; LAN versions start at \$795 for five users. **Contact:** EZX Corp., P.O. Box 58177, Webster, TX 77598, (713) 280-9900.

**Inquiry 1168.**




# Microcom Computers

A HRW Technologies Company



## All Systems with Free 4 Month On-Site Warranty

<b>Standard System Features:</b>						<b>Our Commitment to Service and Quality</b>																																									
<ul style="list-style-type: none"> <li>* 1MB RAM Standard (4 MB Standard on 486/25C Systems)</li> <li>* Teac 5.25" 1.2 MB or 3.5" 1.44 MB Diskette Drive</li> <li>* 1:1 Interleaved Hard/Floppy Drive Controller</li> <li>* Enhanced 101-key Keyboard</li> <li>* 2 Serial &amp; 1 Parallel Port &amp; Real Time Clock/Calendar w/Battery</li> <li>* High Capacity 200 Watt System Power Supply</li> <li>* Small Footprint Case (14.875" W x 16.25" D x 6.75" H)</li> <li>* Tower Case w/230 Watt Power Supply (386/25C, 386/33C &amp; 486/25C)</li> </ul>						<ul style="list-style-type: none"> <li>* Free 4 Month On-Site Servicing Nationwide</li> <li>* 1 Year Warranty on Parts &amp; Labor</li> <li>* Toll-free Technical Service &amp; Support</li> <li>* No Surcharge on Credit Card Purchases (VISA/MasterCard)</li> <li>* Comprehensive 72 Hour Burn-In Testing on All Systems</li> <li>* All Systems Made with pride in the USA</li> <li>* Guaranteed 100% IBM Compatible</li> </ul>																																									
<b>Microcom 286/12 Systems (1 MB RAM)</b>						<b>Microcom Holiday Mouse</b> <span style="float: right;">\$29.99</span>																																									
Standard System, Hard Drive, Monitor & Video Card						Hi-Resolution 3-Button Microsoft-compatible Mouse (up to 432 dpi)																																									
<b>286/12 Holiday Special (w/1 MB RAM)</b> <span style="float: right;">\$1,299</span>																																															
<table border="1"> <thead> <tr> <th>Hard Drives:</th> <th>IDE</th> <th>IDE</th> <th>IDE</th> <th>IDE</th> <th>ESDI</th> </tr> <tr> <th>MB/Ms</th> <th>42/25</th> <th>80/16</th> <th>105/16</th> <th>205/16</th> <th>340/16</th> </tr> </thead> <tbody> <tr> <td>Mono</td> <td>\$799</td> <td>\$1,024</td> <td>\$1,049</td> <td>\$1,449</td> <td>\$2,249</td> </tr> <tr> <td>VGA-Mono</td> <td>\$949</td> <td>\$1,174</td> <td>\$1,199</td> <td>\$1,599</td> <td>\$2,399</td> </tr> <tr> <td>Hires</td> <td>\$1,199</td> <td>\$1,424</td> <td>\$1,449</td> <td>\$1,849</td> <td>\$2,649</td> </tr> </tbody> </table>												Hard Drives:	IDE	IDE	IDE	IDE	ESDI	MB/Ms	42/25	80/16	105/16	205/16	340/16	Mono	\$799	\$1,024	\$1,049	\$1,449	\$2,249	VGA-Mono	\$949	\$1,174	\$1,199	\$1,599	\$2,399	Hires	\$1,199	\$1,424	\$1,449	\$1,849	\$2,649	<ul style="list-style-type: none"> <li>* 286/12 System w/42 MB 25 ms IDE Hard Disk</li> <li>* 5.25" 1.2 MB Drive &amp; 3.5" 1.44 MB Drive</li> <li>* 14" Color Hires Monitor (1024 x 768)</li> <li>* 16-bit Hires 1024 x 768 Graphics Card</li> <li>* Microsoft Windows 3.0 &amp; DOS 3.30 or 4.01</li> <li>* Free Holiday Mouse with This Special</li> </ul>					
Hard Drives:	IDE	IDE	IDE	IDE	ESDI																																										
MB/Ms	42/25	80/16	105/16	205/16	340/16																																										
Mono	\$799	\$1,024	\$1,049	\$1,449	\$2,249																																										
VGA-Mono	\$949	\$1,174	\$1,199	\$1,599	\$2,399																																										
Hires	\$1,199	\$1,424	\$1,449	\$1,849	\$2,649																																										
<b>Microcom 386SX/16 Systems (1 MB RAM)</b>						<b>386SX/16 Holiday Special (w/4 MB RAM)</b> <span style="float: right;">\$1,899</span>																																									
Standard System, Hard Drive, Monitor & Video Card						Hi-Resolution 3-Button Microsoft-compatible Mouse (up to 432 dpi)																																									
<table border="1"> <thead> <tr> <th>Hard Drives:</th> <th>IDE</th> <th>IDE</th> <th>IDE</th> <th>IDE</th> <th>ESDI</th> </tr> <tr> <th>MB/Ms</th> <th>42/25</th> <th>80/16</th> <th>105/16</th> <th>205/16</th> <th>340/16</th> </tr> </thead> <tbody> <tr> <td>Mono</td> <td>\$1,049</td> <td>\$1,274</td> <td>\$1,299</td> <td>\$1,699</td> <td>\$2,499</td> </tr> <tr> <td>VGA-Mono</td> <td>\$1,199</td> <td>\$1,424</td> <td>\$1,449</td> <td>\$1,849</td> <td>\$2,649</td> </tr> <tr> <td>Hires</td> <td>\$1,449</td> <td>\$1,674</td> <td>\$1,699</td> <td>\$2,099</td> <td>\$2,899</td> </tr> </tbody> </table>						Hard Drives:	IDE	IDE	IDE	IDE	ESDI	MB/Ms	42/25	80/16	105/16	205/16	340/16	Mono	\$1,049	\$1,274	\$1,299	\$1,699	\$2,499	VGA-Mono	\$1,199	\$1,424	\$1,449	\$1,849	\$2,649	Hires	\$1,449	\$1,674	\$1,699	\$2,099	\$2,899	<ul style="list-style-type: none"> <li>* 386SX/16 System w/42 MB 25 ms IDE Hard Disk</li> <li>* 5.25" 1.2 MB Drive &amp; 3.5" 1.44 MB Drive</li> <li>* 14" Color Hires Monitor (1024 x 768)</li> <li>* 16-bit Hires 1024 x 768 Graphics Card</li> <li>* Microsoft Windows 3.0 &amp; DOS 3.30 or 4.01</li> <li>* Free Holiday Mouse with This Special</li> </ul>											
Hard Drives:	IDE	IDE	IDE	IDE	ESDI																																										
MB/Ms	42/25	80/16	105/16	205/16	340/16																																										
Mono	\$1,049	\$1,274	\$1,299	\$1,699	\$2,499																																										
VGA-Mono	\$1,199	\$1,424	\$1,449	\$1,849	\$2,649																																										
Hires	\$1,449	\$1,674	\$1,699	\$2,099	\$2,899																																										
<b>Microcom 386/25 Systems (1 MB RAM)</b>						<b>386/25 Holiday Special (w/4 MB RAM)</b> <span style="float: right;">\$2,399</span>																																									
for 64 KB Cache (in Tower Case), add \$250						<b>386/25C Holiday Special (w/4 MB RAM)</b> <span style="float: right;">\$2,649</span>																																									
Standard System, Hard Drive, Monitor & Video Card						Hi-Resolution 3-Button Microsoft-compatible Mouse (up to 432 dpi)																																									
<table border="1"> <thead> <tr> <th>Hard Drives:</th> <th>IDE</th> <th>IDE</th> <th>IDE</th> <th>IDE</th> <th>ESDI</th> </tr> <tr> <th>MB/Ms</th> <th>42/25</th> <th>80/16</th> <th>105/16</th> <th>205/16</th> <th>340/16</th> </tr> </thead> <tbody> <tr> <td>Mono</td> <td>\$1,299</td> <td>\$1,524</td> <td>\$1,549</td> <td>\$1,949</td> <td>\$2,749</td> </tr> <tr> <td>VGA-Mono</td> <td>\$1,449</td> <td>\$1,674</td> <td>\$1,699</td> <td>\$2,099</td> <td>\$2,899</td> </tr> <tr> <td>Hires</td> <td>\$1,699</td> <td>\$1,924</td> <td>\$1,949</td> <td>\$2,349</td> <td>\$3,149</td> </tr> </tbody> </table>						Hard Drives:	IDE	IDE	IDE	IDE	ESDI	MB/Ms	42/25	80/16	105/16	205/16	340/16	Mono	\$1,299	\$1,524	\$1,549	\$1,949	\$2,749	VGA-Mono	\$1,449	\$1,674	\$1,699	\$2,099	\$2,899	Hires	\$1,699	\$1,924	\$1,949	\$2,349	\$3,149	<ul style="list-style-type: none"> <li>* 386/25 or 386/25C System w/105 MB 16 ms IDE Hard Disk</li> <li>* 5.25" 1.2 MB Drive &amp; 3.5" 1.44 MB Drive</li> <li>* 14" Color Hires Monitor (1024 x 768)</li> <li>* 16-bit Hires 1024 x 768 Graphics Card</li> <li>* Microsoft Windows 3.0 &amp; DOS 3.30 or 4.01</li> <li>* Free Holiday Mouse with This Special</li> </ul>											
Hard Drives:	IDE	IDE	IDE	IDE	ESDI																																										
MB/Ms	42/25	80/16	105/16	205/16	340/16																																										
Mono	\$1,299	\$1,524	\$1,549	\$1,949	\$2,749																																										
VGA-Mono	\$1,449	\$1,674	\$1,699	\$2,099	\$2,899																																										
Hires	\$1,699	\$1,924	\$1,949	\$2,349	\$3,149																																										
<b>Microcom 386/33C Tower Systems (1 MB RAM/64 KB Cache)</b>						<b>386/33C Holiday Tower Special (w/4 MB RAM)</b> <span style="float: right;">\$3,199</span>																																									
Standard System, Tower Case, Hard Drive, Monitor & Video Card						Hi-Resolution 3-Button Microsoft-compatible Mouse (up to 432 dpi)																																									
<table border="1"> <thead> <tr> <th>Hard Drives:</th> <th>IDE</th> <th>IDE</th> <th>IDE</th> <th>IDE</th> <th>ESDI</th> </tr> <tr> <th>MB/Ms</th> <th>42/25</th> <th>80/16</th> <th>105/16</th> <th>205/16</th> <th>340/16</th> </tr> </thead> <tbody> <tr> <td>Mono</td> <td>\$1,649</td> <td>\$1,874</td> <td>\$1,899</td> <td>\$2,299</td> <td>\$3,099</td> </tr> <tr> <td>VGA-Mono</td> <td>\$1,799</td> <td>\$2,024</td> <td>\$2,049</td> <td>\$2,449</td> <td>\$3,249</td> </tr> <tr> <td>Hires</td> <td>\$2,049</td> <td>\$2,274</td> <td>\$2,299</td> <td>\$2,699</td> <td>\$3,499</td> </tr> </tbody> </table>						Hard Drives:	IDE	IDE	IDE	IDE	ESDI	MB/Ms	42/25	80/16	105/16	205/16	340/16	Mono	\$1,649	\$1,874	\$1,899	\$2,299	\$3,099	VGA-Mono	\$1,799	\$2,024	\$2,049	\$2,449	\$3,249	Hires	\$2,049	\$2,274	\$2,299	\$2,699	\$3,499	<ul style="list-style-type: none"> <li>* 386/33C System w/205 MB 16 ms IDE Hard Disk</li> <li>* 5.25" 1.2 MB Drive &amp; 3.5" 1.44 MB Drive</li> <li>* 14" Color Hires Monitor (1024 x 768)</li> <li>* 16-bit Hires 1024 x 768 Graphics Card</li> <li>* Microsoft Windows 3.0 &amp; DOS 3.30 or 4.01</li> <li>* Free Holiday Mouse with This Special</li> </ul>											
Hard Drives:	IDE	IDE	IDE	IDE	ESDI																																										
MB/Ms	42/25	80/16	105/16	205/16	340/16																																										
Mono	\$1,649	\$1,874	\$1,899	\$2,299	\$3,099																																										
VGA-Mono	\$1,799	\$2,024	\$2,049	\$2,449	\$3,249																																										
Hires	\$2,049	\$2,274	\$2,299	\$2,699	\$3,499																																										
<b>Microcom 486/25C Tower Systems (4 MB RAM/256 KB Cache)</b>						<b>486/25C Holiday Tower Special (w/8 MB RAM)</b> <span style="float: right;">\$4,199</span>																																									
Standard System, Tower Case, Hard Drive, Monitor & Video Card						Hi-Resolution 3-Button Microsoft-compatible Mouse (up to 432 dpi)																																									
<table border="1"> <thead> <tr> <th>Hard Drives:</th> <th>IDE</th> <th>ESDI</th> <th>IDE</th> <th>ESDI</th> <th>ESDI</th> </tr> <tr> <th>MB/Ms</th> <th>105/16</th> <th>150/16</th> <th>205/16</th> <th>340/16</th> <th>650/16</th> </tr> </thead> <tbody> <tr> <td>Mono</td> <td>\$2,899</td> <td>\$3,299</td> <td>\$3,299</td> <td>\$4,099</td> <td>\$5,199</td> </tr> <tr> <td>VGA-Mono</td> <td>\$3,049</td> <td>\$3,449</td> <td>\$3,449</td> <td>\$4,249</td> <td>\$5,349</td> </tr> <tr> <td>Hires</td> <td>\$3,299</td> <td>\$3,699</td> <td>\$3,699</td> <td>\$4,499</td> <td>\$5,599</td> </tr> </tbody> </table>						Hard Drives:	IDE	ESDI	IDE	ESDI	ESDI	MB/Ms	105/16	150/16	205/16	340/16	650/16	Mono	\$2,899	\$3,299	\$3,299	\$4,099	\$5,199	VGA-Mono	\$3,049	\$3,449	\$3,449	\$4,249	\$5,349	Hires	\$3,299	\$3,699	\$3,699	\$4,499	\$5,599	<ul style="list-style-type: none"> <li>* 486/25C System w/205 MB 16 ms IDE Hard Disk</li> <li>* 5.25" 1.2 MB Drive &amp; 3.5" 1.44 MB Drive</li> <li>* 14" Color Hires Monitor (1024 x 768)</li> <li>* 16-bit Hires 1024 x 768 Graphics Card</li> <li>* Microsoft Windows 3.0 &amp; DOS 3.30 or 4.01</li> <li>* Free Holiday Mouse with This Special</li> </ul>											
Hard Drives:	IDE	ESDI	IDE	ESDI	ESDI																																										
MB/Ms	105/16	150/16	205/16	340/16	650/16																																										
Mono	\$2,899	\$3,299	\$3,299	\$4,099	\$5,199																																										
VGA-Mono	\$3,049	\$3,449	\$3,449	\$4,249	\$5,349																																										
Hires	\$3,299	\$3,699	\$3,699	\$4,499	\$5,599																																										

**Microcom Computers' Customers Include:**  
 Xerox, GTE, Motorola, Raychem, General Electric, Hewlett-Packard, Eastman Kodak, SEGA of America, Toshiba, Genetech, Bechtel, Siemens, Holiday Inn, Pacific Gas & Electric, Pacific Bell, Wells Fargo Bank, NASA, U.S. Court of Appeals, U.S. Food & Drug Administration, U.S. Dept. of Energy, U.S. Dept. of Agriculture, U.C. Berkeley, U.C. San Francisco, Stanford University, Princeton University, University of Pittsburg, University of Vermont, Lawrence Livermore National Laboratories, John Muir Medical Center and many, many more.

### To Order - Call Toll Free 1-800-248-3398

Open from 9:00 A.M. to 6:00 P.M. PST, Monday-Friday

### Microcom Computers

48890 Milmont Drive, Fremont, CA 94537 - Tel: (415)623-3628 - Fax: (415)623-3620  
 3650-18th Street, San Francisco, CA 94110 - Tel: (415)255-2288 - Fax: (415) 255-8873

Prices are subject to change without notice. Not responsible for typographical errors. CA residents please add 7.25% sales tax. No surcharge on credit card purchases. Personal and company checks require 2 weeks clearance. All trademarks acknowledged. Tower is a registered trademark of NCR Corporation. Microcom Computers reserves the right to substitute any and all items with equivalent or better parts. All benchmarks and specifications are for your information only and may vary from system to system. Prices do not include shipping and handling.

## Object Databases for Sun and DOS

Developers of applications for managing data stored as text, sound, images, and graphics are starting to turn to object databases for their needs.

Based on C++, ObjectStore for the Sun-3 and Sparcstation includes the run-time component, application interface, and C++ development tools. The application interface provides access from other programs to the run-time system using either a data-manipulation language (DML) preprocessor interface, a C library interface, or a C++ library interface.

The DML preprocessor supports parameterized types for defining container classes and developing reusable code. You can store C and C++ data in native format, allowing an application to work unmodified with both transient and persistent data.

Development tools include a debugger, a browser, and SchemaDesigner, a graphical tool for developing schemata and generating their associated C++ code.

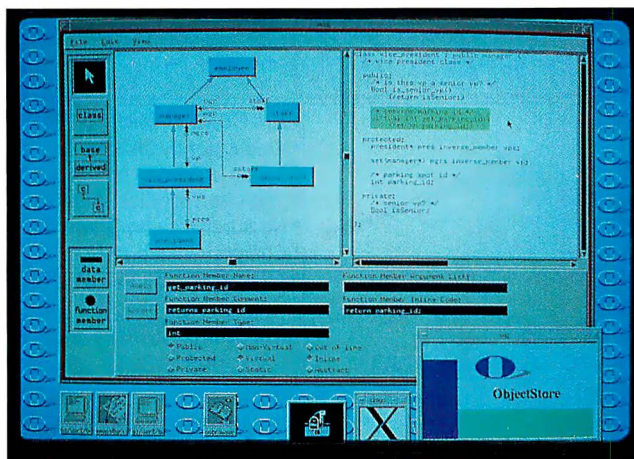
ObjectStore supports collaborative work among teams of design professionals. It supports the TCP/IP networking protocol.

**Price:** \$2000 to \$9000 per user.

**Contact:** Object Design, Inc., One New England Executive Park, Burlington, MA 01803, (617) 270-9797.  
**Inquiry 1180.**

Persistent Data Systems says that its IDB Object Database runs on DOS-based PCs, HP/Apollo workstations, and Sparcstations.

Through its Interface De-



*ObjectStore, the object database management system for the Sun-3 and Sparcstation, is based on C++.*

scription Language, the program lets you write applications using off-the-shelf C development tools. As you create an application, you use the IDL to describe the data. That information is mapped into C through the IDL translator. The program supports most popular C development tools, and support for other languages is planned.

The IDB Object Database supports dynamic binding, exceptions, and transactions for use in a workgroup environment.

**Price:** \$2500 for one license; \$6000 for workstations.  
**Contact:** Persistent Data Systems, Inc., 75 West Chapel Ridge Rd., Pittsburgh, PA 15238, (412) 963-1843.  
**Inquiry 1181.**

## Relational Capabilities Added to askSam

Relational capabilities have come to askSam, the free-form information tool that can function as a database, personal information manager, hypertext system, or text manager. However, unlike traditional relational databases, askSam doesn't require you to establish links between files through common fields, askSam Systems says.

Instead, askSam lets you

establish links through the common occurrence of letters, words, or groups of words. Version 5.0 of the program is also more flexible than a traditional relational DBMS, letting you repeat fields in the same file, according to the company.

For developers who want to create stand-alone applications that use askSam as a database engine, the company has also introduced a developer's edition.

Improvements to both programs include the ability to sort as much data as your system will allow and support for nested subroutines. This lets you write communications like dialog box requests, allowing you to send messages to end users to guide them in their operation.

Other new features include a controlled field editor, which lets you restrict data entry to specific fields and specify field length to control accuracy, and a time and date generator to stamp entries.

**Price:** askSam 5.0, \$395; developer's edition, \$695.  
**Contact:** askSam Systems, Inc., P.O. Box 1428, Perry, FL 32347, (800) 327-5726 or (904) 584-6590.  
**Inquiry 1178.**

## R:base Has dBASE Ad Hocs Without Programming

R:base 3.1, the latest upgrade of Microrim's relational DBMS, is now compatible with dBASE III and dBASE III Plus, letting you combine files from both programs in one database. Once you import your dBASE files into R:base, you can use the program's pull-down menus to produce ad hoc queries and reports without programming, the company says.

Microrim slimmed down version 3.1 from its previous version by 70K bytes. It now requires 450K bytes.

**Price:** \$795; five-user LAN pack, \$995.  
**Contact:** Microrim, Inc., 3925 159th Ave. NE, P.O. Box 97022, Redmond, WA 98073, (206) 885-2000.  
**Inquiry 1179.**

## Run dBASE IV Programs Very Fast

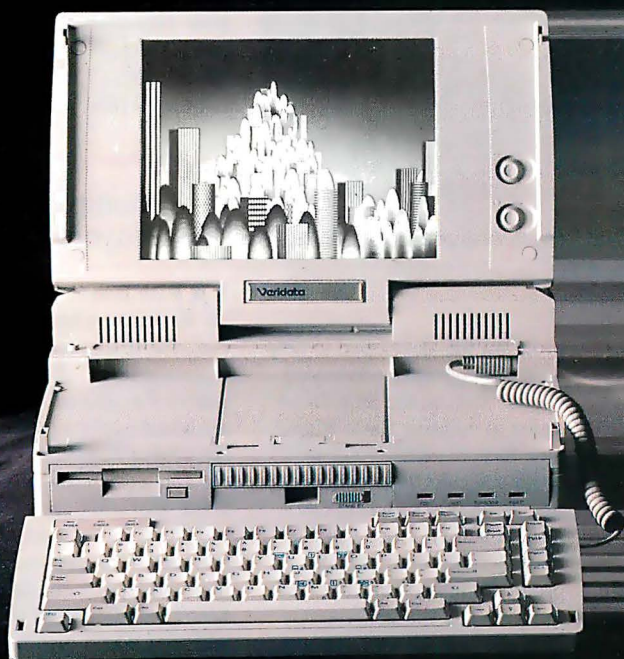
Arago dBXL 2.0 and Arago Quicksilver 2.0 combine dBASE IV compatibility with a Common User Access-compliant interface to speed execution, according to Wordtech Systems.

The Arago Quicksilver 2.0 compiler lets you create applications without run-time or licensing fees. Along with the compiler, screen painter/generator, and debugger, the compiler includes a Program Test Coverage Analyzer for revealing which portions of your application haven't been executed during testing.

**Price:** Quicksilver, \$695; dBXL, \$495.  
**Contact:** Wordtech Systems, Inc., 21 Altarinda Rd., Orinda, CA 94563, (415) 254-0900.  
**Inquiry 1182.**



# True 386 LAPTOP



## 386 DX (not SX), true 32 bit, upto 100MB HDD

### LAPPOWER™ 386 SPECIFICATIONS CPU AND MEMORY

#### Processor

- CMOS 80C386 DX (not SX) 32-bit processor 20/8 MHz, switchable. Socket for 80C387 numeric coprocessors.

#### Memory

- 2MB RAM standard expandable to 8MB support EMS 4.0.

#### DRIVES

- The internal 3.5" 1.44MB floppy disk drive, and one 40MB or one 100MB HDD with average access time less than 29ms.

#### VIDEO

##### Display

- A Double-STN Black and White display with VGA resolution. Adjustable contrast and brightness. Backlight timeout feature.

##### Display Graphics

- 640\*480 high-resolution text and graphic; 16 levels of gray scale.

##### Video

- VGA/EGA/CGA/MDA utilizing the laptop LCD video controller, higher resolution possible through Desktop Expansion Chassis.

#### POWER

##### AC

- 90/250 VA (50/60 Hz) autosensing with charging indicator.

#### Battery

- 40.6 Watt-Hr NiCad battery pack; easy changeable recharge, orange low power LED indicator plus audible warning beeps, overcharge protection.

#### Intelligent Power Management

- Power control of backlight, mass storage, internal modem and process speed.

#### PHYSICAL

##### Size

- 13.7"W\*8.5"D\*4.3"H (349mm\*316mm\*107mm)

##### Weight

- 14 lbs (6.4 Kg).

#### DESKTOP EXPANSION CHASSIS (OPTIONAL)

VERIDATA RESEARCH INC.

Unit A&B, 11901 Goldring Road, Arcadia, CA91006.

Tel: (818)303-0613 Fax: (818)303-0626

#### DISTRIBUTORS:

in CA Tech Power 714-979-1330 Matrix Digital. Products, Inc. 800-227-5723

in GA Computer & Control Solutions, Inc. 404-491-1131 818-566-8567

**Veridata**  
Where creativity thrives with ingenuity

## Dodging the Windows API

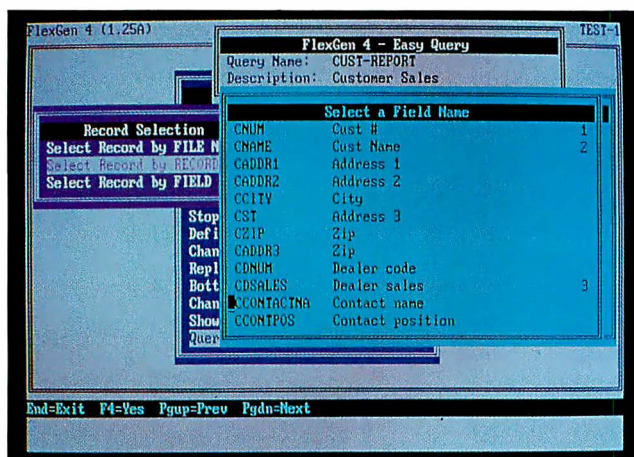
The latest addition to the Caseworks family of application generators lets you develop and prototype the graphical-interface portion of a Windows 3.0 application. Case:W 3.0 has extended code support for dialog-box controls, generating shell dialog message processors to program dialog-box functions, not just calls for the dialog boxes.

You can specify application variables that are logically associated to each dialog control. Then you use the variable as the link to the control instead of writing to the Windows application programming interface. With extended code support, Case:W can prototype the action that occurs when someone edits a field or activates a control.

The program includes a test view for animating the interface and testing its look and feel without compiling, Caseworks says. Case:W creates programs in a modular structure, taking full advantage of the Windows 3.0 memory management facilities. **Price:** \$795. **Contact:** Caseworks, Inc., 1 Dunwoody Park, Suite 130, Atlanta, GA 30338, (800) 635-1577 or (404) 399-6236. **Inquiry 1183.**

## Two Generators for COBOL

FlexGen 2.0 lets you generate forms and windows for your COBOL program. The program includes Easy Query, which guides you in providing 4GL query- and



*FlexGen 2.0 lets you put a pretty face on your COBOL program.*

report-writing capabilities in your application. Once you build the query, you can run it interpretively or incorporate it into the program, Sinc says.

FlexGen 2.0 has options for color, field-entry characteristics, auto-lookup windows, auto-browse mode, and others.

**Price:** \$550 to \$15,000. **Contact:** Sinc, Inc., 1299 LaVelle Dr., Xenia, OH 45385, (800) 543-4035 or (513) 372-4334. **Inquiry 1186.**

Flexus International, maker of the COBOL CICS spII and COBOL spII generators, has released versions of both tools for Sun workstations running Open Look. The company says the generators can reduce the time required to add menus, help screens, and I/O screens to mainframe communications and other applications.

With COBOL spII, you can run an application simultaneously on graphics- and character-based terminals, without having to run in character mode on the graphics terminal. The generator offers mouse support. As you debug a program, you can view the source code while monitoring screen interaction from multiple windows.

The CICS version of the

program was developed to help create cooperative processing applications on the Sun. In addition to painting Basic Mapping System maps, you can prototype the CICS application using spII's Dialog Definition Facility. Once you paint the user interface and prototype the system, the program lets you generate BMS macros, as well as command-level CICS procedural COBOL.

**Price:** COBOL spII, \$495 to \$795; CICS spII, \$795 to \$995.

**Contact:** Flexus International Corp., P.O. Box 9199, Morristown, NJ 07963, (201) 895-4724.

**Inquiry 1187.**

## Application Generator for dBASE

A code generator called dB Intuition lets you add form views, menus, and security levels to your dBASE, FoxBase, Quicksilver, or Clipper application.

The program lets you add shadowed menus and multiple page views to your application. A library editor lets you create your own library files,

while the linker is LAN-compatible, according to Integrated Database Technology. **Price:** \$119.

**Contact:** Integrated Database Technology, 300 Maple Ave., South Plainfield, NJ 07080, (201) 756-8665. **Inquiry 1185.**

## New Multiplatform Jam Flavors

With Jam 5, you can put features normally associated with a graphical user interface (e.g., virtual forms and viewports) into a character-based application. With the proper run-time libraries, the application can run on DOS, Unix/386, and OS/2.

JYACC has also announced a Motif-based tool that will let you construct Motif interfaces and access widgets. You'll also be able to compile applications down to character mode. JYACC says the program, the price of which was undetermined at press time, will permit seamless integration to multiple databases.

In addition to full mouse support, Jam has sibling windows, shrink-to-fit text windows, screen entry and exit routines, and other widgets, like radio buttons. Through 8-bit internalization, the program lets you easily customize it for international use.

Other JYACC tools include the Jam Graphics Interface, for integrating graphical images into the application; Jam/DBi ReportWriter; and the Jam DBi, for linking applications to relational databases.

**Price:** Jam for DOS, \$595; Jam for OS/2, \$1350; Jam for Unix/386, \$1950.

**Contact:** JYACC, Inc., 116 John St., New York, NY 10038, (212) 267-7722. **Inquiry 1184.**



## Now you can build more in a day.

HyperPAD® 2.0, a powerful software construction set for MS-DOS® systems, dramatically increases your productivity. Applications that might take months to build with tools like Pascal, C, or BASIC now take only minutes.

PC Week calls HyperPAD "the first PC program that can compare with HyperCard®." HyperPAD 2.0, now updated with over 100 new features and improvements, has almost limitless potential for creating and customizing tutorials, help systems, software prototypes, front ends to databases, networks, or CD-ROM devices, executive information systems, and dozens of other applications.

**It's easy.** HyperPAD's object-oriented environment gives you all the building blocks you need for maximum productivity. Its English-like scripting language is easy to use and learn, with dozens of samples to get you started.

**It's flexible.** HyperPAD will take you into the 90's with a full set of development tools. Its open architecture lets you easily use data stored in dBASE and ASCII files. If you need to, you can even write C or assembly language extensions.



**It works on your PC.** HyperPAD 2.0 is compatible with almost all PCs. You don't need a high-performance processor, multiple megabytes of memory, a graphics card, or a mouse. You get the benefits of a graphical user interface without investing in Microsoft® Windows™ or OS/2.

**And it's only \$149.95.** HyperPAD 2.0 is available from software dealers, or directly from Brightbill-Roberts, for only \$149.95. Runtime also available. 60-day money-back guarantee. VISA, MasterCard, American Express, or C.O.D.

**Call 1-800-444-3490 today.**

Try HyperPAD 2.0 on your next project. No one will ever know how much time you didn't spend.



120 E. Washington St., Syracuse, N.Y. 13202

## ButtonWare Updates PC-Type

The new version of PC-Type lets you process multiple files as one document. It supports a table of contents and index for large documents, where chapters and sections are automatically numbered.

PC-Type 4.0 adds a print-preview function and a 100,000-word customizable dictionary. The program requires 384K bytes of RAM on an IBM PC.

**Price:** \$99.95.

**Contact:** ButtonWare, P.O. Box 96058, Bellevue, WA 98009, (800) 528-8866 or (206) 454-0479.

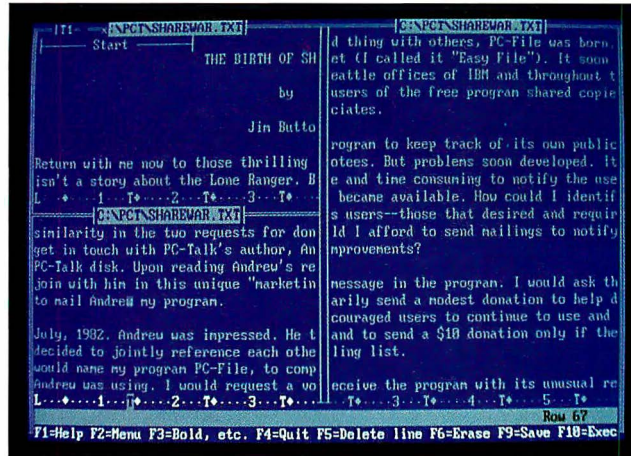
**Inquiry 1188.**

## Publish with Special Effects

Power Up Software says that Express Publisher 2.0 adds a module for creating headlines and logos with advanced typesetting effects. The TextEffects module lets you manipulate text to fill a polygon, bend along a curve, grow or shrink in size from one character to the next, or run along an angled line. In addition to special effects, the program adds text-formatting commands for justification, kerning, and character spacing.

The new version also adds five AGFA Compugraphic Intellifont scalable typefaces, bringing the total number of fonts in the program to eight. Express Publisher generates fonts on the fly in sizes from 6 to 144 points.

Other new features include landscape printing and the ability to import CGM files. It previously supported PCX, GIF, ART, IMG, MacPaint, Microsoft Paint, Print Shop,



*PC-Type 4.0's split-screen capability lets you open two files at once or view different parts of the same file.*

EPS, and TIFF file formats.

The program runs on the IBM PC with 640K bytes of RAM and a hard disk drive. It supports Hewlett-Packard LaserJet III, LaserJet, DeskJet, PostScript, and other laser and dot-matrix printers.

**Price:** \$159.95.

**Contact:** Power Up Software Corp., 2929 Campus Dr., San Mateo, CA 94403, (415) 345-5900; for upgrades, call (800) 851-2917.

**Inquiry 1190.**

## Screen Capture for Windows

Pizazz Plus, a program for capturing black-and-white or color Microsoft Windows 3.0 screen images, can export TIFF gray, TIFF color, EPS, PCX, and other popular file formats. Once you've captured the whole screen or just a portion of it, you can adjust color and grayscale brightness and contrast to obtain the best image in your document.

Pizazz Plus is a TSR program that requires 32K bytes of RAM.

**Price:** \$149.

**Contact:** Application Techniques, Inc., 10 Lomar Park Dr., Pepperell, MA 01463, (800) 433-5201 or (508) 433-5201.

**Inquiry 1192.**

## A Bridge Between CAD and Publishing

The new preview function in CADleaf, an engine for converting CAD files into several desktop publishing formats, lets you monitor the translation process as it occurs. It lets you view the file as it translates so you can ensure that you selected the correct file, which is helpful when you have to deal with thousands of CAD files, Carberry Technology says.

In addition to the preview function, CADleaf 2.0 lets you convert any CAD or drawing program that exports IGES, Hewlett-Packard Graphics Language, CalComp960, AutoCAD, or CGM format into CGM, EPSI, Sun Raster, Interleaf, or FrameMaker format. By supporting these formats and conforming to the Department of Defense MIL-D-2800 specification, the program is CALS-compliant.

CADleaf 2.0 runs on Sun, 386i, and Apollo workstations, and the AT&T 3B2.

**Price:** \$4995.

**Contact:** Carberry Technology, Inc., 600 Suffolk St., Lowell, MA 01854, (508) 970-5358.

**Inquiry 1191.**

## Ease the Text-Import Blues

Sooner or later, most people using a word processor have to incorporate data from another application into a document. This often means converting to ASCII, stripping out hard carriage returns, and reformatting the text. A program designed to ease that process is now available from Systems Compatibility.

Outside In instantly recognizes 57 file formats, letting you view, select, and import data stored in a host of applications and import it on the fly into your word processor.

Once you install Outside In as a TSR program, you can call it up from within your word processor and browse through spreadsheets, databases, and other word processor files and import the data in its native file format.

In addition to preserving boldface, underlining, tabs, and other attributes of the other application's data, the program lets you search for a word or phrase. You can scroll up and down or right to left through a file and mark that text for importing.

Outside In supports the marking of more than just a screen's worth of data. It also lets you select noncontiguous data that's stored in a spreadsheet or database.

The program runs on the IBM PC and uses 70K bytes of RAM. A version expected to ship later this year will require just 40K bytes. The program runs on any DOS-based network, the company says.

**Price:** \$99; network versions start at \$299.

**Contact:** Systems Compatibility Corp., 401 North Wabash, Suite 600, Chicago, IL 60611, (312) 329-0700.

**Inquiry 1189.**



## MYODA LT5200 SERIES

FREE: 3 BUTTON MOUSE  
WITH EVERY LT5200 ORDER

Flexibility of a Laptop with the true power and expandability of a high-performance Desktop computer. MYODA has designed & built these machines with the needs of today's demanding users in mind. Just look at our features & then compare them with other machines costing twice as much and you will see why we are the clear choice for professional users. We offer true expandability with **TWO FULL SIXTEEN BIT SLOTS**, MEMORY IS EXPANDABLE TO 8MB ON THE BOARD, VGA SCREEN, EXTERNAL VGA MONITOR PORT, EXTERNAL FLOPPY DRIVE PORT. There's even a true 386-25 running at 0 WAIT STATE available with 32 KB CACHE MEMORY. & they all come with a CONNER, 40 MB HDD & a 3.5/1.44MB FDD AMI or Award BIOS.



### Laptop Accessories

- External 5.25/1.2MB floppy drive
- Expansion chassis 2x8 bit, 2x16 bit (For LT-3500 only)
- Power inverter
- External battery pack with 12V inverter
- Numeric keypad
- Fax-modem card
- 12V inverter



## MYODA LT-3500 \$1499

Here is your chance to pick up on the biggest bargain in Laptops anywhere. The LT-3500 is packed with features. The 80286-12 MHz CPU runs at 0 wait state, ready to blaze through those tough applications. There is also a 40 MB fast HDD & an internal 3.5 / 1.44MB diskette drive

- Intel 80286 CPU 0 wait state
- 6/12 MHz clock speed
- EGA GAS plasma display
- 1MB installed 4MB max
- 3.5/1.44MB floppy drive
- 40MB(28ms) hard drive
- 2 serial/1 parallel/CRT port
- Free carrying case



Model	cpu	Internal Slots	Screen	FD	HD	EXT. FD Port	Max Memory	Price
5200CD	386-25	2x16 Bit	VGA, GAS plasma	3.5/1.44	40MB IDE	YES	8MB	\$3699
5200SX	386sx-16	2x16 Bit	VGA GAS plasma	3.5/1.44	40MB IDE	YES	8MB	\$2799
5200NV	286-16	2x16 Bit	VGA GAS plasma	3.5 1.44	40MB IDE	YES	8MB	\$2299



## MYODA MD3410

- Intel 80286-12 microprocessor
- Baby AT case
- Up to 4 MB RAM
- AMI BIOS



12" MONO	14" MONO	14" VGA	14" SVGA
\$539	\$579	\$895	\$969

### All Units Include:

- True intel CPUs
- 1MB RAM
- 1 year warranty
- 101 enhanced keyboard
- 2 serial, 1 parallel, & 1 game port
- Quality desktop cases & power supplies
- Dual FDD/ HDD AT BUS controllers

### Installed Hard Drives:

Installation with system purchase	
40 Meg.	\$249
65 Meg.	\$339
100 Meg.	\$599

### Case Upgrades

Mini tower, Mid tower and Large tower  
Call for special pricing



## MYODA MD7240

- Intel 80386-25 microprocessor
- 64KB cache memory
- 4MB RAM
- Full size case
- AMI designed motherboard up to 16MB RAM
- AMI BIOS
- Fully compatible: EMS, LIM 4.0, DOS, OS/2, UNIX, XENIX and NOVELL



12" MONO	14" MONO	14" VGA	14" SVGA
\$1599	\$1629	\$1969	\$2049



## MYODA MD5030

- Intel 80386SX-16 Microprocessor
- Baby AT case
- Up to 8 MB RAM
- Fully compatible: EMS, LIM 4.0, DOS, OS/2, UNIX, XENIX and NOVELL



12" MONO	14" MONO	14" VGA	14" SVGA
\$839	\$865	\$1169	\$1249



## MYODA MD7280

- Intel 80386-33 microprocessor
- 32KB cache memory
- 4MB RAM
- up to 16MB RAM
- Fully compatible: EMS, LIM 4.0, DOS, OS/2, UNIX, XENIX and NOVELL
- CALL FOR PRICE

Circle 623 on Reader Service Card (RESELLERS: 624)

# MYODA INC.

1053 Shore Road, Naperville Illinois 60563  
Tel: (708) 369-5199 Fax: (708) 369-6068

Dealers/Vars Inquires:

1053 Shore Road Naperville Illinois 60563  
TEL: (708) 369-5199 FAX: (708) 369-6068

OEM Inquire:

Alex Chen Taipei Office 3F No. 191 Sec. 3 Roosevelt Rd  
Taipei, Taiwan TEL: 886-2-3628445 FAX: 886-2-3626283

15 days money back guarantee. RMA requires on all return. No surcharge on VISA and MASTER CARD. We accept AMERICAN EXPRESS and DISCOVER CARD.

Mail Order Sales **1-800-562-1071**

## Slate Now Available on DECstation

**S**late, BBN Software Products' multimedia document communications program, lets workgroups create and share documents that contain text, spreadsheets, images, and voice annotations, while providing E-mail and real-time conferencing.

Recently released for the DECstation, the program is also available on the IBM RISC System/6000 and Sun Microsystems workstations running under SunView and X11.

**Price:** \$995 per license.

**Contact:** BBN Software Products Corp., 10 Fawcett St., Cambridge, MA 02138, (617) 873-5000.

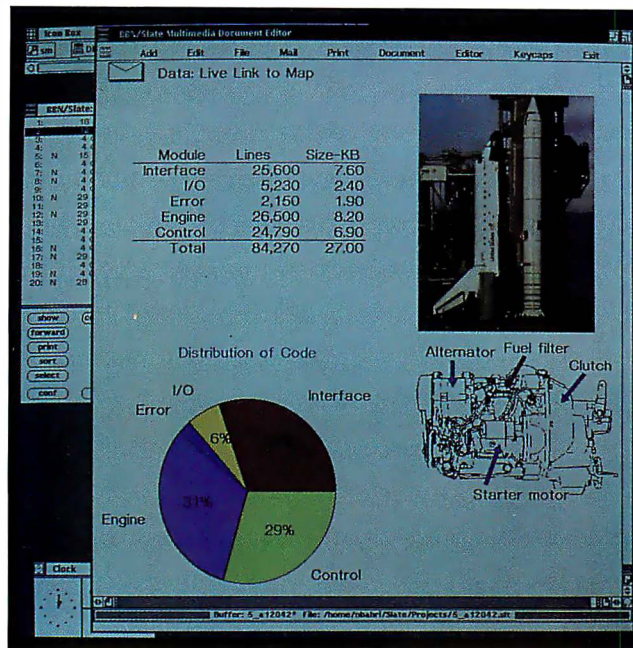
**Inquiry 1198.**

## DAT's the Ticket for Data Management Program

**D**ataImage's latest electronic data management program works with Sony magnetic digital data storage tape drives to let you convert sheets of microfiche into files that you can index, program, and search.

When you download information from the mainframe, DATwriter lets you designate identifiers that you use to search for certain documents. You can assign up to 16 identifiers per document.

Once indexed, the company says you can find records from a 1.3-gigabyte tape within an average of 25 seconds. After you've downloaded the data, DATwriter installs the index and a runtime version, so that the tape



*Slate lets workgroups create and share multimedia information on networked Unix workstations.*

is its own self-contained application.

**Price:** \$5000 (includes Sony drive).

**Contact:** DataImage, Inc., 628 Hebron Ave., Glastonbury, CT 06033, (203) 659-3980.

**Inquiry 1195.**

## Manage Documents Under Word for Windows

**T**he Viewz document program for Microsoft Windows combines the Saros Mezzanine network application platform with Microsoft's Word for Windows to let you manage all your documents without leaving Word.

Viewz supports network-wide retrieval and management of files, automated tracking of pages printed, file-revision tracking, audit facilities, security, and a template facility for creating standard forms and documents.

**Price:** \$345 per client; \$2950 per server.

**Contact:** Saros Software,

10900 Northeast Eighth St., Suite 7, 1515 Plaza Center Building, Bellevue, WA 98004, (206) 646-1066.

**Inquiry 1196.**

## A Document Administrator for PC Applications

**T**he Document Administrator, a program that provides document administration on PC-based networks, integrates a variety of applications (e.g., Microsoft Word, WordPerfect, DisplayWrite, and Lotus 1-2-3).

Version 2.0 supports automatic document numbering, configurable revision tracking, checkout protection to prevent simultaneous editing, and the ability to maintain forms and boilerplate items.

When searching for documents, the program supports Boolean conductors, proximity searches, word stems, and wild cards. You can use pro-

files to track graphical- and paper-based information.

The program runs on any DOS 3.1-based network.

**Price:** \$2495 for 10-user installation; \$150 for each additional workstation.

**Contact:** Interpreter, Inc., 11455 West 48th Ave., Wheat Ridge, CO 80033, (303) 431-8991.

**Inquiry 1194.**

## Turn Your PC into an Electronic Filing Cabinet

**T**he PaperLess Filer lets you scan single and multiple documents and compress them to reduce storage requirements without having to buy image-compression hardware.

Version 2.1 of the program lets you predefine a series of documents to be scanned into its database in a batch process and lets you fax documents in or out of the program using a PC fax board. Files stored in a batch process can be incrementally numbered as they print. You can also define queues for unattended printing.

The PaperLess Filer lets you search for a particular document by several criteria. Version 2.1 adds multiple filing cabinets for filing different types of documents using user-definable key fields.

The program is LAN-compatible and supports several levels of security. Version 2.1 can import and export files in the TIFF, PCX, or DCX formats.

PaperLess Filer 2.1 runs on a 286 computer with a hard disk drive.

**Price:** \$495; LAN version, \$795.

**Contact:** PaperLess Corp., 1750 North Collins, Suite 200, Richardson, TX 75080, (214) 235-4008.

**Inquiry 1193.**

# TODAY'S USERS ASK FOR MORE

Better Features, Better Quality, Better Price



 **HANNOVER FAIR  
CeBIT'91**  
World Center for Office, Information and Telecommunications Technology  
**MARCH 13-20, 1991**  
See us on Stand No. 036/1, Hall 8

MODEL NO:	DM-1431	DM-1435
High Resolution	640 x 480	800 x 600 (non-interlace) 1024 x 768 (interlace)
Vert. Scan Range	55-70Hz	55-90Hz
Horiz. Scan Range	31.5 KHz	31.5 KHz/35.5 KHz Auto Switch

Your customers require nothing less than crisp-clear displays. For their DTP, CAD, CAM, etc., they need monitors that are up to video standards such as VGA 8514A or MACII. If you require a reliable, reasonably-priced supply of high-class 100% compatible monitors, we should talk.



Manufacturer

**CHUN YUN ELECTRONICS CO., LTD.**  
351, Szu Yuan Road, Hsin Chuang, Taipei Hsien, Taiwan, R.O.C.  
Tel: 886-2-991-8480, 992-6363 Fax: 886-2-991-8483

Hsin Chuan Factory: No. 49-51 Szu Yuan Rd., Hsin Chuang City, Taipei Hsien, Taiwan, R.O.C.

Tao Yuan Factory: No. 32, Shin Bond Rd., Kwei-Shan Hsiang, Tao Yuan Hsien, Taiwan, R.O.C.

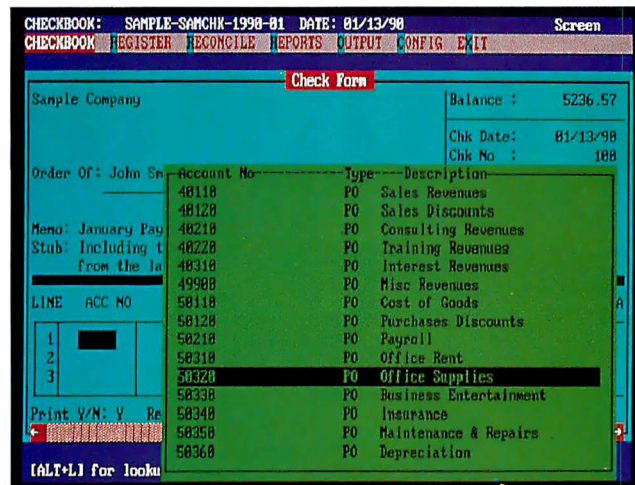
Circle 612 on Reader Service Card

## PC Accounting and Customer Database Program

**A**XS Accounting release 2 includes new modules, reporting capabilities, and enhancements that make the program suitable for large businesses, client write-up, and nonprofit organizations, its developer reports.

In addition to general ledger, checkwriter, accounts payable, and accounts receivable, the new version has modules for inventory, job costing and time billing, and payroll. Release 2 adds support for ratios, budgets, comparative statements, and cash flow reports.

Throughout the program, you can look up vendors, cus-



*Data entry in AXS Accounting release 2 is done in familiar business forms, such as checks and invoices.*

tomers, inventory, and other items by vendor, due date, discount date, amount, reference, or a combination of these. The mail manager lets you maintain a database of customers for generating mail-

ing labels and rotary cards.

**Price:** \$99.

**Contact:** Computer Trends, Inc., 116 East Washington St., Ann Arbor, MI 48104, (800) 544-2597 or (313) 662-4430.

**Inquiry 1173.**

## Job Tracking for Advertising and Design

**W**orking Computer has released a slimmed-down version of its Clients & Profits agency management program for the Mac. Clients & Profits ez is designed for the advertising agency or design studio with less than \$1 million in billings. You can use the program for job tracking, costing, and billing of established accounts.

Clients & Profits ez runs on the Mac Plus.

**Price:** \$1195.

**Contact:** Working Computer, P.O. Box 87, San Luis Rey, CA 92068, (619) 945-4334.

**Inquiry 1175.**

## Attention U.S. BYTE Subscribers

**Watch for the next BYTE DECK mailing that will be arriving in your mailbox soon!**

Use this as a fast, convenient tool to purchase computer products and services. It's loaded with essential hardware and software products that you should be aware of when making your buying decisions...and it's absolutely FREE!

If you have a computer product or service, and would like to reach 275,000 influential BYTE magazine subscribers, please give Ed Ware a call today at (603) 924-2596.

**BYTE  
DECK**

Here's what a BYTE Deck advertiser has to say:

*"Ten years ago we advertised in the very first BYTE Deck—the number of sales leads we received was enormous! The BYTE Deck was so successful for us, that we have continued to use it over the past ten years!"*

Lisa Tarpoff, Marketing Manager, Heath Company, Benton Harbor, MI





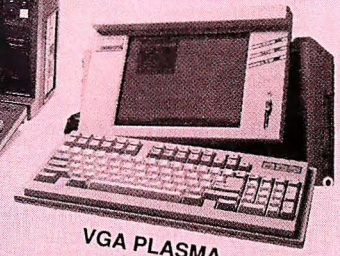
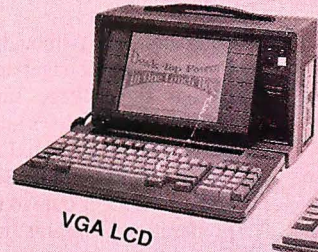
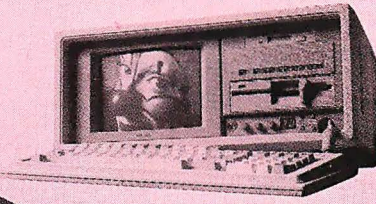
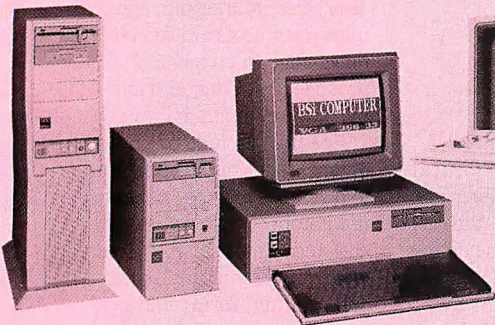
# VGA PORTABLE

## Color

### 5 YEARS PORTABLE EXPERIENCE

ALL SYSTEMS RUN UNIX, XENIX,  
LAN OS DOS AND OS/2.

LIGHTEST &  
SMALLEST  
CRT PORTABLE  
1024x768 RES, 256 COLOR



The BSI 386SX was the  
Fastest Machine  
in PC Magazine Review

See Aug. 1990 P. 109, 120

#### 386SX 40MB SYSTEM (Desk Top)

- 386SX-16 MHz CPU, 1MB Memory (To 4MB)
- 200W P/S, 110/220V
- 101 Enhanced Keyboard
- 1:1 Interleave Cont. Card
- 1.2 MB or 1.44MB FDD
- 40MB, 23ms. SCSI IDE Hard Drive
- 2 Serial/1 Parallel/1 Game Port
- Mono Graphic Card w/Printer Port
- 12" Amber Monitor (720x348 Res.)

\$1,059  
On Sale

#### 386-33 200MB SYSTEM (Desk Top)

- 386-33 MHz CPU, w/64K Cache Memory
- 1MB Memory on board (To 8MB)
- 200MB, 19ms, IDE Hard Drive
- 128K Cache Memory Optional
- 32MB Memory on Board Optional
- Other features like the same as 386SX

\$2,239

HDD	286-12	386SX	386/25	386/33	486/25
40MB	799	1059	1349	1629	2449
65MB	869	1129	1409	1689	2509
80MB	1139	1399	1679	1959	2779
100MB	1139	1399	1679	1959	2779
150MB	1396	1659	1939	2219	3039
200MB	1429	1679	1959	2239	3059
345MB	2219	2459	2739	3019	3839

- Upgrade to VGA (640 x 480 Res) + \$300
- Upgrade to VGA (1024 x 768 Res) + \$380
- Mini Vertical Case + \$50
- Regular Vertical Case + \$100

PORTABLE SKD KITS AND BAREBONE SYSTEMS AVAILABLE CALL FOR PRICING	MOTHER BOARD ON SALE	286-12	MB	\$100
	386SX	MB	\$355	
	386-25	MB	\$570	
	386-33	MB	\$830	
	486-25	MB	\$1,550	

Prices subject to change without notice.  
Call for return policy.



9440 Telstar Ave., #4, El Monte, CA 91731

For Order Only Call Toll Free

1-800-872-4547

1-818-442-0020 Information

Customer Support: (818) 442-7038

Fax: (818) 442-4527

#### 386-33 200MB COLOR VGA PORTABLE

- Built-in SONY 8.5" Color VGA Monitor
- 0.26mm Dot Pitch,
- Speed Digital Display, 3 Drive Bays
- 220W P/S 110/220V, 4 Exp. Slots
- 86-Key Detachable Keyboard
- 386-33 MHz CPU, w/64 K Cache Memory
- 1MB Memory on Board (To 8MB)
- 128K Cache Memory Optional
- 32MB Memory on Board Optional
- VGA Graphic Card (512K, 1024x768 Res.)
- External Monitor Adaptor
- 1.2MB or 1.44MB FDD
- 200MB 19ms HDD (To 500MB)
- Serial/Parallel/Game Ports
- Carrying Bag, Weight 27 Lbs.
- Dimensions: 17.5(W) x 14.1(D) x 6.8(H)
- Bigger Case with 7 Exp. Slots Optional

\$3,729  
(Special)

HDD	286-12	386SX	386/25	386/33	486/25
40MB	2149	2429	2719	3009	3899
100MB	2479	2759	3049	3339	4229
150MB	2839	3119	3409	3699	4589
200MB	2869	3149	3439	3729	4619
345MB	3779	4059	4349	4639	5529

#### VGA AMBER CRT PORTABLE 100MB AT

- Built-in 9" Amber VGA Monitor
- Speed Digital Display, 3 Drive Bays
- 205W P/S 110/220V, 4 Exp. Slots
- 86 Keyboard, Detachable Keyboard + \$30
- AT 12 MHz System, 1MB Memory (To 4MB)
- VGAGraphic Card (256K, 800x600 Res.)
- Run 48 Grey Scales VGA Internally
- Run Color VGA Externally
- 1.2MB or 1.44MB FDD
- 100MB 25ms HDD (To 500MB)
- Serial/Parallel/Game Ports
- Carrying Bag, Weight 26 Lbs
- Dimensions: 17.5 (W) x 14.1 (D) x 6.8 (H)

\$1,739

HDD	286-12	386SX	386/25	386/33	486/25
40MB	1409	1689	1979	2269	3159
65MB	1529	1809	2099	2389	3279
100MB	1739	2019	2309	2599	3489
150MB	2099	2379	2669	2959	3849
200MB	2129	2409	2699	2989	3879
345MB	3039	3319	3609	3899	4789

#### AMBER CRT PORTABLE 100MB AT

- Built-in 9" Amber Monitor
- Speed Digital Display, 3 Drive Bays
- 205W P/S 110/220V, 4 Exp. Slots
- 86 Keyboard, Detachable Keyboard + \$30
- AT 12 MHz System, 1MB Memory (To 4MB)
- Mono or Color Graphic Card
- Amber EGA Display (option) + \$100
- 1.2 MB or 1.44 MB Floppy Drive
- 100MB 25ms Hard Drive
- Serial/Parallel/Game Ports
- Carrying Bag Weight 26 lbs.
- Dimensions 17.5(W) x 14.1(D) x 6.8(H)

\$1,479

HDD	286-12	386SX	386/25	386/33	486/25
40MB	1149	1429	1719	2009	2899
65MB	1269	1549	1839	2129	3019
100MB	1479	1759	2049	2339	3229
150MB	1839	2119	2409	2699	3589
200MB	1869	2149	2439	2729	3619
345MB	2779	3059	3349	3639	4629

#### 386-33 200MB VGA PLASMA PORTABLE

- 640x480 VGA Plasma Display
- Detachable 101-key Keyboard
- 200W P/S, 110/220V, 3 Drive Bays
- 386-33 MHz CPU, w/64K Cache Memory
- 1MB Memory on Board (To 8MB)
- 128K Cache Memory Optional
- 32MB Memory on Board Optional
- 1.2MB or 1.44MB FDD
- 200MB 19ms HDD (To 500MB)
- Serial and Parallel Ports
- External Monitor Adaptor
- Carrying Bag, Weight: 26 Lbs.
- Dimensions: 16 \*(W) x 9.75\*(H) x 8.5\*(D)

\$3,199  
On Sale

HDD	286-12	386SX	386/25	386/33	486/25
40MB	1679	1959	2249	2539	3429
65MB	1789	2069	2359	2649	3539
100MB	1979	2259	2549	2839	3729
150MB	2279	2559	2849	3139	4029
200MB	2339	2619	2909	3199	4089
345MB	3159	3439	3729	4019	4909

#### CGA PLASMA PORTABLE 100MB AT

- 640X400 CGA Plasma Display
- Detachable 86-Key Keyboard
- External RGB Monitor Adaptor

\$1,699

HDD	286-12	386SX	386/25	386/33	486/25
40MB	1399	1679	1969	2259	3149
65MB	1509	1789	2079	2369	3259
100MB	1699	1979	2269	2559	3449
150MB	1999	2279	2569	2859	3749
200MB	2059	2339	2629	2919	3809
345MB	2879	3159	3449	3739	4529

#### 386-33 100MB VGA LCD PORTABLE

- 640x480 Res. Backlit LCD VGA Display with External Color Monitor Adaptor
- 200W 110/220V P/S, 5 Exp. Slots
- Detachable 89-Key Keyboard
- 386-33 MHz CPU with 64K Cache Memory
- 1MB Memory on Board (To 8MB)
- 128K Cache Memory Optional
- 32MB Memory on Board Optional
- 1.2MB or 1.44MB FDD
- 100MB 25ms HDD (To 500MB)
- Serial/Parallel/Game Ports
- 9.45"(H) x 7.9"(D) x 15.7"(W), 23LBS

\$2,519  
Best Buy

HDD	286-12	386SX	386/25	386/33	486/25
40MB	1359	1639	1929	2219	3109
65MB	1459	1749	2039	2329	3219
100MB	1659	1939	2229	2519	3409
150MB	1989	2269	2559	2849	3739
200MB	2019	2299	2589	2879	3969
345MB	2839	3119	3409	3699	4589

- LCD CGA 640X400 Res. Portable Less \$120

- LCD EGA Model Available ..... Call

#### LAPTOP 386ST 40MB VGA PORTABLE

- LT-5300 PLASMA W BATTERY \$2600
- LT-5400 PLASMA AC POWER \$2300
- LT-5600 LCD W BATTERY \$2350
- 100MB Hard Drive Model add \$400

All order FOB El Monte and will be shipped by UPS COD cashier's check. Company check on approval IBM PC XT/AT are registered trademarks of IBM Inc.

Circle 610 on Reader Service Card (RESELLERS: 611)

## Client Write-Up in OS/2

**F**inancial Software Associates has released two OS/2 packages designed for CPAs and accounting businesses. The Client Accounting Gold Series, for client write-up, includes modules for general ledger, after-the-fact payroll and form 1099 preparation, and custom reporting. As its name suggests, the second package, Practice Management Gold Series, is for managing time and billing for multiple clients.

Both packages take advantage of OS/2's multitasking capabilities, letting you perform several activities for one or more clients at once, the

company says. Although not Presentation Manager applications, the packages support overlapping windows and pull-down menus. TaxLink, which integrates Gold Series General Ledger data to tax-preparation programs, is also available.

The packages require at least a 286 running OS/2 1.0 or higher with 4 MB of RAM. A 386 with OS/2 1.1 or higher is recommended.

**Price:** Client Accounting: single-user, \$1995; multiuser, \$2495 to \$3995. Practice Management, \$1395 and \$1695 to \$2559, respectively.

**Contact:** Financial Software Associates Corp., 5150 Southwest Griffith Dr., Suite 200, Beaverton, OR 97005, (503) 626-8652.

**Inquiry 1174.**

## Contact Management for the PC

**C**ontact! Professional 2.3 has a word processor, calculator, telephone dialer, and support for multiple databases in which you can define up to 100 fields. You can use the program to sort contacts by name, company, ZIP code, or any other criteria and attach up to 16 pages of comments or historical information.

The program requires 640K bytes of RAM.

**Price:** \$195; LAN version, \$495.

**Contact:** Pyramid Solutions, Inc., P.O. Box 395, Stoughton, MA 02072, (800) 343-4677 or (617) 821-4673.

**Inquiry 1176.**

**E**mis I is an integrated sales, marketing, and telemarketing program. It combines client management, prospect tracking, and telemarketing functions.

Features include unlimited databases, custom forms, custom reports and letters, automatic follow-ups, unlimited call and contact history, word processing, mail merge, auto-dialing, form letter generation, and telescripting.

Emis II allows for unlimited databases.

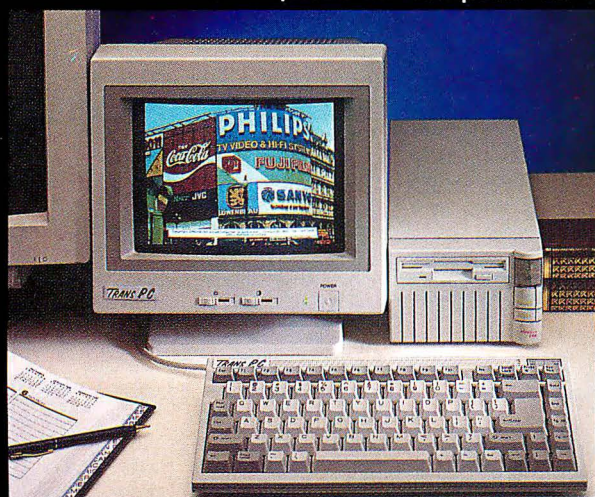
**Price:** Emis I: \$695; three-user license, \$995; Emis II: \$1995 and \$2995, respectively; each additional user, \$695.

**Contact:** Emis Software, Inc., 901 Northeast Loop 410, Suite 526, San Antonio, TX 78209, (512) 822-8499.

**Inquiry 1177.**

## TPS QT-1 ULTRA MINI WORKSTATION

Cute . . . but Powerful, Expandable, and Economical personal computer for business or home use.



- 80286-12
- 1 MB ram on board, up to 2.5 MB
- 1.44 MB FDD drive
- 20/40/80 MB HDD option
- External floppy interface
- CGA/MGA dual display
- NTSC-TV port
- VGA optional
- 2 S, 1 P, 1 G ports
- 84 keyboard
- 1 standard 16 bit expansion slot
- 5.5"(W) x 12.2" (D) x 3.6"
- 9 lbs.

10" Mini Multisync Color Monitor .....\$445.00

QT-1 w/12" TTL monochrome monitor.....\$575.00

QT-1 w/14" VGA color monitor.....\$895.00

**ITS YOUR CHOICE - YOUR PRICE -OUR RELIABILITY**

Servicing your computer needs since 1984

**TPS**

**TRANS PC Systems, Inc.**

11849 E. Firestone Blvd., Norwalk, CA 90650

Phone: 213-868-6930, Fax: 213-864-2249

**1-(800)876-9161** (order only)

Tech-support (213) 868-6970

# H. Co. Computer Products

Your #1 Source For All P.C. Memory Upgrades  
 Call Toll Free 1-800-RAM-CHPS Ext. 200

FULL TECHNICAL SUPPORT ★ LIFETIME WARRANTY ON ALL MODULES  
 BUY DIRECT ★ BEST PRICES ★ BEST SERVICE



Part # EQ	Works With	PRICE
30F5348 (512K)	30-286	\$ 49.00
30F5360 (2MB)	30-286	\$ 165.00
6450375 (1MB)	80-041	\$ 129.00
6450379 (2MB)	80-111, 311	\$ 219.00
6451060 (4MB)	80-A21, A31, 111, 311	\$ 559.00
6450603 (1MB)	502, 55SX, 70-E61, 70-121, P-70	\$ 79.00
6450604 (2MB)	502, 55SX, 70-E61, 70-121, P-70	\$ 150.00
6450608 (2MB)	70-A21, A61, B-21, B61	\$ 155.00
79X8955 (128K)	25	\$ 26.00
34F2933 (4MB)	55SX, 65SX	\$ 525.00
6450605 (2-8MB)	All 70's and 80's (Board)	\$ 525.00
6450609 (2-16MB)	50, 502, 55SX, 60, 65SX (Board)	\$ 599.00
1039136 (1MB)	Laser Printer 4019, 4019e	\$ 169.00
1039137 (2MB)	Laser Printer 4019, 4019e	\$ 299.00
1038675 (3.5MB)	Laser Printer 4019, 4019e	\$ 429.00

Call for Other IBM Upgrades

We Accept Purchase Orders  
 from Qualified Firms, Universities  
 and Government Agencies.

Trademarks are registered  
 with their respective companies.

We will match or beat  
 any advertised price.



NO SURCHARGE



Model	Memory Added	Part # EQ	PRICE
DESKPRO 386/33-486/25	2MB MODULE	115144-001	\$ 229.00
DESKPRO 386/20-25	1MB MODULE	113131-001	\$ 139.00
206	4MB MODULE	113132-001	\$ 339.00
DESKPRO 386/20e-25e	1MB BOARD	113644-001	\$ 189.00
	4MB BOARD	113645-001	\$ 479.00
	1MB MODULE	113131-001	\$ 139.00
	4MB MODULE	113132-001	\$ 339.00
DESKPRO 386s	1MB BOARD	113633-001	\$ 189.00
	4MB BOARD	113634-001	\$ 479.00
	1MB MODULE	113645-001	\$ 139.00
	4MB MODULE	112534-001	\$ 339.00
PORTABLE III	512K KIT	107331-001	\$ 70.00
	2MB KIT	107332-001	\$ 165.00
DESKPRO 386/16	1MB BOARD	108069-001	\$ 299.00
	2MB BOARD	108069-W/71	\$ 399.00
	4MB BOARD	108070-001	\$ 659.00
	8MB BOARD	108072-001	\$ 999.00
DESKPRO 386 PORTABLE	1MB KIT	107551-001	\$ 245.00
	4MB BOARD	107653-001	\$ 799.00
SLT/286	1MB MODULE	110235-001	\$ 209.00
LTE/286	1MB BOARD	117081-001	\$ 159.00
	2MB BOARD	117081-002	\$ 249.00

Ask About Other Compaq Upgrades



Model	Memory Added	Part # EQ	PRICE
MACII, Iix; Ilicx Ilicx & SE/30	1MB KIT	MO218	\$ 80.00
	2MB KIT	MO219	\$ 115.00
	4MB KIT	MO2707	\$ 225.00
	16MB KIT		\$ 1199.00
MACIicx	4MB KIT	MO292LL-A	\$ 1199.00
	16MB KIT		\$ 1199.00
MAC SE & PLUS	1MB KIT	MO218	\$ 80.00
	2MB KIT	MO219	\$ 115.00
	4MB KIT	MO2707	\$ 225.00
MAC PORTABLE	1MB KIT	MO248	\$ 249.00
	2MB KIT	N/A	\$ 729.00
	3MB KIT	N/A	\$ 999.00
	4MB KIT	N/A	\$ 1399.00
MACIix	4MB KIT	MO292LL-A	\$ 279.00
	16MB KIT	N/A	\$ 1299.00
LASER WRITER II/NTX	1MB KIT	M6005	\$ 85.00
	4MB KIT	M6006	\$ 289.00



Model	Memory Added	Part # EQ	PRICE
BRAVO/286	128K KIT	500510-011	\$ 40.00
	512K KIT	500510-010	\$ 60.00
	2MB KIT	500510-002	\$ 150.00
	4MB KIT	500510-008	\$ 300.00
PREMIUM/286 ADVANCED	512K KIT	500510-001	\$ 60.00
	1MB KIT	500510-007	\$ 120.00
	2MB KIT	500510-002	\$ 150.00
	4MB KIT	500510-008	\$ 300.00
FASTBOARD /386	1MB KIT	500510-007	\$ 120.00
	4MB KIT	500510-008	\$ 300.00
PREMIUM WKST/286	512K KIT	500510-010	\$ 60.00
	2MB KIT	500510-002	\$ 150.00
PREMIUM WKST	512K KIT	500510-010	\$ 60.00
	1MB KIT	500510-007	\$ 120.00
	2MB KIT	500510-002	\$ 150.00
	4MB KIT	500510-008	\$ 300.00
PREMIUM 386/16	1MB KIT	500510-007	\$ 120.00
	4MB KIT	500510-008	\$ 300.00
PREMIUM 386	1MB KIT	500510-003	\$ 160.00
	4MB KIT	500510-004	\$ 380.00
PREMIUM 386c	1MB KIT	500510-007	\$ 120.00
	4MB KIT	500510-008	\$ 300.00
PREMIUM 386/25/16sx	1MB SIMM	500718-001	\$ 79.00
PREMIUM 386/33	1MB SIMM	500718-002	\$ 82.00



Model	Memory Added	Part # EQ	PRICE
Portable T1000SE & XE	1MB KIT	PC14-PA8311U	\$ 319.00
	2MB KIT	PC14-PA8312U	\$ 444.00
Portable T1200XE	2MB KIT	PC13-PA8306U	\$ 199.00
Portable T1600	2MB KIT	PC-PA8302U	\$ 199.00
Portable T3100c	512K KIT	PC-PA8340U	\$ 135.00
	2MB KIT	PC-PA8341U	\$ 199.00
Portable T3100SX	2MB KIT	PC15-PA8308U	\$ 199.00
	4MB KIT	PC15-PA8310U	\$ 599.00
Portable T3200sx	2MB KIT	PC-PA8307U	\$ 199.00
Portable T3200	3MB KIT	PC-PA7137U	\$ 359.00
Portable T5100	2MB KIT	PC-PA8301U	\$ 199.00
Portable T5200	2MB KIT	PC-PA8304U	\$ 199.00
DESKTOP T8500	2MB KIT	PC-PA8301U	\$ 199.00

Ask About Other Toshiba Upgrades



Math Co-Processor

Up to 200% Faster Than  
 Intel Math Co-Processor  
 100% Compatible — 5 Year Warranty

Part #	PRICE	Part #	PRICE
83D87-16	Call	83D87-33	\$ 469.00
83D87-20	\$ 309.00	83D87SX-16	\$ 259.00
83D87-25	\$ 369.00	83D87SX-20	Call



HEWLETT  
 PACKARD

Model	Memory Added	Part # EQ	PRICE
LASER JET II & IID	1MB MODULE	H33443B	\$ 89.00
	2MB MODULE	H33444B	\$ 149.00
	4MB MODULE	H33445B	\$ 249.00
HP & III	1MB MODULE	H33474A	\$ 89.00
	2MB MODULE	H33475A	\$ 149.00
	3MB MODULE	N/A	\$ 199.00
	4MB MODULE	N/A	\$ 249.00

### STANDARD SIMMS

Part#	PRICE
256 X 8-12	\$ 17.00
256 X 8-10	\$ 18.00
256 X 8-80	\$ 19.00
256 X 9-12	\$ 17.00
256 X 9-10	\$ 17.00
256 X 9-80	\$ 18.00
256 X 9-70	\$ 21.00
256 X 9-60	\$ 26.00
1 X 8-10	\$ 50.00
1 X 8-80	\$ 51.00
1 X 8-70	\$ 60.00
1 X 9-10	\$ 55.00
1 X 9-80	\$ 56.00
1 X 9-70	\$ 57.00
4 X 8-80	\$ 299.00
4 X 9-80	\$ 329.00

### DRAM

Part#	PRICE
1 X 1-100	\$ 5.50
1 X 1-80	\$ 5.75
1 X 1-70	\$ 6.25
256-150	Call
256-120	\$ 1.85
256-100	\$ 1.90
256-80	\$ 2.00
256-70	\$ 2.30
256-60	\$ 3.00
256 X 4-10	\$ 5.75
256 X 4-80	\$ 6.00
464-10	\$ 2.20
464-80	\$ 2.40
464-15	\$ 1.40
464-12	\$ 1.85
464-10	\$ 2.00

EPROM/CPU/SRAM/VRAM Also Available



Ask for other NEC upgrades

Model	Memory Added	Part # EQ	PRICE
Power Mate SX Plus	1MB Board	APC-H850E	\$ 295.00
	2MB Board	N/A	\$ 495.00
	4MB Board	APC-852E	\$ 725.00
	8MB Board	N/A	\$ 1375.00



IIT Math  
 Co-processors

Part #	PRICE	Part # EQ	PRICE
8087-3	\$ 80.00	2C87-8	\$ 175.00
8087-2	\$ 117.00	2C87-10	\$ 185.00
8087-1	\$ 155.00	2C87-12	\$ 215.00
80287-6	Call	2C87-20	\$ 255.00
80287-8	Call	3C87-16	Call
80287-10	Call	3C87SX-16	Call
80287XL (12.5 MHz)	\$ 229.00	3C87-20	\$ 325.00
80287XLT (12.5 MHz)	Call	3C87-25	\$ 385.00
80387-16	\$ 305.00	3C87-33	\$ 485.00
80387SX-16	\$ 290.00		
80387SX-20	\$ 315.00		
80387-20	\$ 350.00		
80387-25	\$ 450.00		
80387-33	\$ 550.00		

We also carry memory upgrades for

- ACER • AT&T • DELL • DTK • EPSON • ZENITH
- EVEREX • HP Vectra • SAMSUNG • SUN • Canon Printer
- SILICON GRAPHICS • WYSE • and other AT & XT clones

1228 Village Way, Unit D • Santa Ana, CA 92714 • (714) 542-8292 • FAX (714) 542-8648 • Hours 8:00 AM-5:00 PM PST

DEALER'S INQUIRIES WELCOME

Prices are subject to change

Circle 617 on Reader Service Card (RESELLERS: 618)

## Faster Pizza Delivery Through Technology

You've probably heard of Query by Example, but a company in St. Louis has developed a system for determining the fastest pizza delivery route by example. Thanks to Fast Map, a trainable stand-alone system developed by Mid-America Technologies (Maryland Heights, MO), pizza lovers may soon get their pizza orders delivered to the home or office without delay, helping both customer and company.

The St. Louis Users Group for the Personal Computer saw a demo of the product, minus the actual pizza, at its November general meeting held in

Washington University's Simon Hall auditorium. The system is about to be released after a year and a half of development and testing.

Robert Covington, director of research and development at Mid-America, said the company developed Fast Map because geographical mapping products, although fine for demographic analysis, can't produce route maps in under 10 seconds.

Fast Map (\$5775) is a proprietary system that uses a touchscreen or mouse combined with a high-speed thermal printer. "After the call comes in—let's say it's 1524 Main St.—the clerk feeds in 1524 and the letter M," he said. "All the streets with the letter M with that street number potential show up on-screen. After another mouse or

touchscreen entry, the address is pinned down and the map is printed."

Fast Map actually prints out two 200-dpi maps, one of the district and another of the delivery locale, along with text instructions. The map can tell in feet how far down the block the target address is located.

Mid-America uses a variety of sources for its district maps, including the U.S. Census Bureau and the U.S. Postal Service. Changes to routes are updated monthly, and users of the system can make changes to a map themselves by tracing a new route with their finger on the screen. Although the system was initially targeted for pizza delivery, you can use it for fire departments, police, florists, and any other type of routing.

One of the benefits of the program is that you can train it by example to adapt to a manager's preference for routes. The expert-system portion of Fast Map can learn from a manager that it should avoid roads that have potholes or construction. Fast Map can also be trained to use the banzai delivery method of taking full advantage of shortcuts. After all, Covington says, "Some people like to go through the alleys."

—Howard de Mere and Dave Andrews

### What's the Scoop?

BYTE is interested in who said what at your latest users group meeting. Call (603) 924-2630.

Leasing  
Now Available

### Digitizers

<b>Calcomp</b>		<b>Kurta</b>
All Models, CALL for Savings		12 x 12, 4 Puck Stylus ..... 345
		12 x 12, 12-But Corded ..... 435
		12 x 17, Corded Puck ..... 585
		30 x 36, 16-But ..... 2015
		36 x 48, 16-But ..... 2394
<b>Summagraphics</b>		<b>GTCO</b>
Sketch II 12 x 12, 4-But ..... 340		Sketch Master 12 x 12 ..... 319
Sketch II 12 x 12, 16-But ..... 427		SL 24 x 36 ..... Super Pricing
Sketch Pro II 12 x 18, 16-But ..... 585		SL 36 x 48 ..... Super Pricing
Large Formats ..... Call		<b>Hitachi</b>
		Puma 12x12, 4 or 12-But ... 375
		Tiger 12x12, 12-But ..... 648

### Complete CAD Workstations

Each system fully configured including 2 Serial Ports, 1 Parallel Port, corresponding Math CoProcessor, Enhanced "AT" 101 Keyboard, 1.2MB Floppy, DOS 3.3, GW-Basic, **SUMMAGRAPHICS SUMMASKETCH PLUS, EVEREX VGA GRAPHICS CARD and EVEREX MODEL 300-01 (15-35KHz) MULTISCAN COLOR MONITOR.** Each system thoroughly tested prior to shipment and supplied with a Full One Year On-Site Warranty!!!

System Configuration	Cache Memory	44MB MFM	80MB MFM	92MB ESDI	150MB ESDI
Everex Step 486/33 w/8MB	128Kb	-----	-----	\$7895	\$8095
Everex Step 486/25 w/8MB	128Kb	-----	-----	6895	7095
Everex Step 386/33 w/4MB	64Kb	5795	5895	6395	6595
Everex Step 386/25 w/4MB	64Kb	4995	5195	5595	5795
Everex Step 386/20 w/4MB	64Kb	4595	4795	5195	5395

### Monitor & Card Combos

Graphics Card	Only	w/ Mitsuo 19" HL6905	Hitachi 21" 4320-21AP	Hitachi 20" CM2085M	Nanao16" 9070S	Nanao 9070U
Metheus 1228	\$1690	3689	4300	3585	-----	-----
Metheus 1224	1260	3259	3870	3155	-----	-----
#9 GX Level 2	785	2784	3395	2680	1770	1884
#9 GX Level 4	1295	3294	3905	3190	-----	-----
Rendition II/16VGA	1130	3129	3740	3025	2115	2229
Rendition II/25VGA	1505	3504	4115	3400	2490	2604
VMI Cobra 16HS	1350	3349	3960	3080	2335	2449
Video 7 VRAM 512	380	2379	3039	2275	1384	1479
Monitor Only		1999	2610	1895	985	1099

The above is a partial listing of our product line. Please inquire if you're interested in a product not listed. All names are trademarks and registered trademarks of their respective companies.

- Quoted prices reflect a 2% cash discount.
- Prices subject to change without notice.
- All manufacturers' warranties apply.

- Rated companies call for terms.
- C.O.D., VISA, Mastercard & Amex.
- Member Better Business Bureau.

### We Carry a Complete Line of Modems, Network Boards & Accessories, Math & Memory Chips, Surge Protection

#### INVENTORY REDUCTION

5% Discount on All Purchases thru 12/31/90

Plotters-All Models

Calcomp  
HP  
Houston Instruments  
Ioline  
Roland

#### CAD Buster \$12,750.00


EVEREX STEP 386/33 w/8MB SIMM, 150MB ESDI Hard Drive

Includes Renaissance Rendition II 16" Color with VGA Module, Hitachi CM-2085M or Mitsubishi HL-6905 19" Color Monitor, A thru D 8-Pen Plotter, 12 x 12 Digitizer your choice of three. \*5MB minimum requirement for AutoCAD/386. Delivery limited to continental U.S.A.

1-800-289-1650  
6760 Miller Road - Brecksville, Ohio 44141

CAD WAREHOUSE

© This ad copyright November 1990, ESI Automated Office Systems



# MetaWare Delivers The Essential Tool For C

Way back in 1986, MetaWare delivered the first 32-bit protected-mode DOS compiler for the 386. Our High C compiler set the standard for professional software developers. High C DOS 386/486, **Version 2.3**, brings important features to extended DOS that our UNIX C customers have come to rely on for creating lightning-fast executable code:

#### True Globally Optimizing Technology

Global Optimizations that increase speed of code execution include: constant and copy propagation, constant expression folding, local *and* global common subexpression elimination, removal of invariant expressions from loops, live/dead analysis, dead code elimination, global register allocation, and tail merging. We've also included faster libraries with ANSI conformance and greater Microsoft compatibility. These optimizations make Version 2.3 generate 46% better Whetstone code and 15% better Dhrystone code than our previous version. But one piece was still missing:

#### True 32-Bit Source-Level Debugging

Our customers really needed a MetaWare-quality 32-bit, source-level debugger. It had to offer a friendly user interface with color or monochrome windows, featuring pull-down and pop-up menus. They needed to watch or edit data, registers, and breakpoints through windows that displayed: flags, memory in any format, variables, stack data, 387 registers, locals, globals, structs, pointers, modules, and more! **We've delivered!** MetaWare's 386 protected-mode debugger features source-level symbolic debug capabilities. High C users can tackle even the largest DOS C programs and debug code on the host or a remote DOS machine, via a standard serial port.

In an ever-changing, puzzling, multi-platform world, it's reassuring to know that:

#### Your Code is Portable to Other Platforms

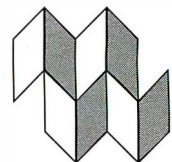
Many professional programmers are delighted to discover that their existing High C programs may be easily ported to many other popular platforms, including MS-DOS, FlexOS, OS/2, UNIX System V 386/486, Sun 386i, Sun-3, Sun-4, SPARC, and IBM AIX on PS/2, RT, i860, and 370, IBM AOS 4.3 on RT and 370, Am29K, Motorola 680x0, and Intel i860. And we're already talking with several of our OEMs about porting the debugger to these and other new platforms.

Our customers who are already using the combination of High C and the new debugger all agree that the new, 32-bit source-level debugger is *the essential tool* for the only compiler you need.



**32-Bit  
Source-Level  
Debugger**

**MetaWare**<sup>®</sup>  
INCORPORATED



*Compiler Products for  
Professional Software Developers  
High C<sup>®</sup> • Professional Pascal<sup>®</sup>*

2161 Delaware Ave. • Santa Cruz, CA • 95060-5706 • 408/429-6382 • Fax 408/429-9273

MetaWare, High C, and Professional Pascal are registered trademarks of MetaWare Incorporated. Other names are trademarks of their respective companies.  
© Copyright 1990 MetaWare Incorporated

Circle 621 on Reader Service Card

# BET ON A DERBY WINNER...



**HYPERTEXT**

## 386/33-200 PRO PLUS

- 80386-33, 32-bit
- 8M RAM, 64k Cache
- 200M Hard Drive 15ms
- Microsoft Windows 3.0
- Microsoft Mouse
- PLUS by Spinnaker

**\$3,995**

**AS SEEN AT COMDEX**

## ALL DERBY COMPUTERS FEATURE

- 1.2M 5.25" and 1.44M 3.5"
- 2 Serial/Parallel/Game Ports
- MS-DOS v4.01/GW BASIC
- KEYS feature desktop cases
- 16-bit VGA 1024X768 w/512K
- VGA 1024X768 Color Monitor
- 101 Key Tronics Keyboard
- PROS feature mid-size towers

### 286/12-40 KEY

- Intel 80286, 2M RAM
- 40 M Hard Drive, 28ms
- Eight-In-One by Spinnaker
- DEXXA Mouse w/ Paint

**\$1,495.00**

Add \$100 for 65M Hard Drive

### 386SX-40 KEY

- Intel 80386SX, 2M RAM
- 40M Hard Drive, 28ms
- Eight-In-One by Spinnaker
- DEXXA Mouse w/ Paint

**1,795.00**

Add \$100 for 65M Hard Drive

### 386SX-40 PRO

- Intel 80386SX
- 2M RAM
- 40M Hard Drive 28ms

**\$1,795.00**

### 386/25C-65PRO

- Intel 80386-25, 32-bit
- 4M RAM, 64K Cache
- 65M Hard Drive 25ms

**\$2,695.00**

### 386SX-65 PRO

- Intel 80386SX
- 2M RAM
- 65M Hard Drive 25ms

**\$1,895.00**

### 386/25C-100 PRO

- Intel 80386-25, 32-bit
- 4M RAM, 64K Cache
- 100M Hard Drive 25ms

**\$2,795.00**

### 386/25-65 PRO

- Intel 80386-25, 32-bit
- 4M RAM
- 65M Hard Drive 25ms

**\$2,495.00**

### 386/33C-100 PRO

- Intel 80386-33, 32-bit
- 4M RAM, 64K Cache
- 100M Hard Drive 25ms

**\$2,895.00**

### 386/25-100 PRO

- Intel 80386-25, 32-bit
- 4M RAM
- 100M Hard Drive 25ms

**\$2,595.00**

### 386/33C-200 PRO

- Intel 80386-33, 32-bit
- 4M RAM, 64K Cache
- 200M Hard Drive 15ms

**\$3,295.00**

Circle 613 on Reader Service Card  
(RESELLERS: 614)

- 30 Day Money Back Guarantee
- 72 Hour Burn-in Testing
- All systems built in the USA
- Hours: 9:00 to 6:00 M-Sat Cen
- Shipping Charge: Keys: \$35.00  
Pros: \$45.00
- 100% IBM Compatible
- Toll Free Tech Support
- One Year Warranty
- We Accept (no surcharge)



**DerbyTech**  
**Computers**  
Inc.

# 1-800-24-DERBY

718 - 15th Avenue / East Moline / Illinois / 61244 / (309) 755-2662

**DerbyTech**  
**Computers**  
Inc.



# JUKEBOX COMPUTING

## A sextet of CD-ROMs on-line makes for lively computing

It has been quite a month. First, we hosted two meetings of the Citizens Advisory Council on National Space Policy: we're supposed to provide some input to the Stafford and Augustine Commissions on Technologies for the Space Exploration Initiative and the general future of the U.S. in space. Council meetings are normally held at Larry Niven's home, but for a number of reasons they ended up here in Chaos Manor, which is *almost* large enough. The meetings were productive, but they generated a lot of material that has to be reported.

Then I was asked to be the dinner speaker at the annual meeting of the American Astronautical Association.

So, this weekend I have to write my part of the two Council reports; get this column in; turn in another journalism assignment; write my American Astronautical Association speech; and look up some data for the IRS. If that weren't enough, Niven and I have been going like gangbusters on two books, *Fallen Angels*, which is our gift to science fiction fandom, and *The Moat Around Murchison's Eye*, a sequel to *The Mote in God's Eye*. We expect to have finished and turned in both books by the time you read this. So, provided that I survive it, this may be the most productive month of my life.

### The Jukebox

We recently got, courtesy of the Bureau of Electronic Publishing, a Pioneer Electronic DRM-600 CD-ROM drive and changer. This is a box about the size of an external WORM (write once, read many times) drive (similar in shape to a somewhat long shoe box), which holds a six-

pack of compact discs in a neat little removable holder. It is fairly easy to install the drive interface card in your machine and install the software in your CONFIG.SYS and AUTOEXEC.BAT files. In our case, I installed the DRM-600 in the Arche Legacy 386/33. One way I test new stuff is to install it in new machines.

Pioneer's instructions are complete, if a bit dense; you may have to read them over a few times, but there shouldn't be any difficulty. You can also hook up the DRM-600 to your Macintosh; it hangs directly on the SCSI port (no internal card is needed). I haven't tried that, but I have no reason to doubt it will work.

The DRM-600 is a dual-purpose affair; that is, you can hook the output into your stereo system and have a CD player whose audio quality I can't tell from the CD player in my Technics system, and, of course, you can use it as a CD-ROM drive. The software has provision for doing both. You specify how many CD-ROM drives you want, and the remainder will be audio drives. Each CD-ROM is configured as its own virtual drive. They don't get mixed up, because the audio drives will start at the bottom, while the CD-ROM drives start with the top of the stack.

Pioneer bundled in a neat software package called Jukebox (JUKE.EXE) that will control the audio drives. It's quite intuitive: no instructions are required, although I probably should have read the instruction book. There are several button-like options, enough to make me wish for mouse support, but there's no real need; it can be controlled just fine with the arrow keys. Of course, it makes little sense to tie up your computer as a CD player. . . .

We usually leave the stereo amplifier turned off, but we flip it on when the DRM-600 is plugged into the stereo. Actually, all I've used the DRM-600 audio system for is to play a CD called The CD-ROM Chronicles, which is a "talking book" about the history and fu-

ture of the CD-ROM. It's well worth listening to for an overview of the subject.

There are quirks, though. For one thing, it's very difficult to get the DRM-600 to work with QEMM-386. It can be done, but finding out how took a few days. In fact, the procedure I followed was odd, and perhaps instructive.

I first got the DRM-600 running properly without Desqview. That done, I let the Desqview installer do its thing. This triggered an installer bug: the QEMM installation program tried to insert QEXT.SYS into my CONFIG.SYS file. That's all well and good if you have a 286 system, but for a 386 with 8 megabytes of memory, it's about as useful as a chocolate-covered wristwatch. I understand this happens more often than Quarterdeck Office Systems likes to admit. In any event, if the Desqview installation tells you it wants QEXT.SYS, eliminate the line.

When the installation was done, I had a system that appeared to run, but any attempt to access the DRM-600 CD-ROM drives locked up the machine and required hard reset. But as long as I ignored the DRM-600, the system worked. Sigh.

The next step was to run the Desqview Optimizer program. This diddled around and loaded various things in high memory. When it was done, I could get a directory off one of the CD-ROM drives—but invoking retrieval software locked up the machine.

About then I got disgusted and called Quarterdeck's technical support. Everyone was busy; not surprising. Eventually I got someone, and we went through some tests. I was advised to edit CONFIG.SYS to put the DRM-600 driver first, before QEMM.SYS. That eats up memory, and I didn't like doing it much; but it did work.

Then I took another look at the DRM-600 driver and realized that the DRM-600 installation had put an /E: switch in the configuration line. The DRM-600 can make use of expanded memory if it

finds any. Alas, it can't make use of it if that memory is managed by QEMM386.SYS. Eliminating the /E: parameter let me put the DRM-600 device after the DEVICE = QEMM386.SYS statement, which lets the Optimizer program load it high, freeing more memory.

The upshot is that I have the DRM-600 running not only with QEMM386.SYS, but inside Desqview windows, which has the amusing result that I can actually have several CD-ROM windows open at once. Now clearly there's only one physical drive for the six CD-ROMs, so you can't run them simultaneously; but it's surprising how fast you can switch back and forth among them.

Of course, there's a sense in which it doesn't matter: the DRM-600 works fine, and I intend to set it up on a network, as described in last fall's column in the *IBM Special Edition*, and I won't be running Desqview on the network server anyway. Until we get the network set up though, it's fun to have the DRM-600 running under Desqview. Naturally, I've told it that all six drives are CD-ROM drives.

The Pioneer DRM-600 isn't cheap,

but it works, and it's very convenient to have a bunch of CD-ROMs available without swapping. Recommended.

**It's History**

The Pioneer DRM-600 was interesting in its own right, but there was another, more urgent, reason for me to get it fired up: after five years, the Amdek Laserdek CD-ROM drive seems to have died, and I've just got a whole bunch of new CD-ROMs from the Bureau of Electronic Publishing.

The Bureau is a private firm, originally given a pretentious name in hopes that people wouldn't figure out that it was two guys in a garage; now, it's a fair-size outfit, and my chief source of information about CD-ROM events. If you don't have their catalog, send for it: even if you don't want to buy any CD-ROMs or drives, you'll be fascinated by the wide variety of stuff offered for sale in CD-ROM format.

The newest CD-ROM I got from the Bureau is their United States History. What they have done is take a hefty collection of books and documents on U.S. history, mostly in public domain, and

run them through the DiscPassage CD-ROM retrieval software. The result is uneven, but it's still pretty good, including an official history of the U.S. Army, with excerpts from speeches, maps, and suchlike.

Most of the material was chosen because it was available, and it includes public documents, history books published around the turn of the century, and so forth. That's no great defect: many of the high school history texts written back then are more detailed, and much more readable, than the pap they sacrifice trees for today. It includes some Revolutionary War histories that are plain fascinating; maybe it was just me, but I found myself reading about the Battle of Cowpens and much enjoying the experience.

Much of the material was obviously keyed in, and, alas, not well proofread. In some documents, hardly a paragraph escapes egregious errors, misspellings, missing words, and even missing sentences; even Patrick Henry's most famous speech doesn't escape its share of typographical errors.

It's still a good effort, something that all high schools and colleges ought to

# WorldPort compatibility, Toshiba™ portability.

Touchbase Systems

now gives Toshiba's complete line of low-power, super-highweight add-in modems. Even the new T1000LE™ All with high-power super-heavyweight WorldPort feature sequential send and receive fax at 9600 bps

super lightweight portables

a complete line of low-power super lightweight add-in modems. Even the new T1000LE™ All with high-power super-heavyweight WorldPort feature sequential send and receive fax at 9600 bps

with 2400 bps data or 2400 bps with MNP® 5.

**Touchbase Systems, Inc.**  
160 Laurel Avenue  
Northport, N.Y. 11768  
(516) 261-0423  
Fax (516) 754-3491

**Call Now For Details: 800-541-0345**

©1990 Touchbase Systems, Inc. MNP is a registered trademark of Microcom, Inc. WORLDPORT and TOUCHBASE SYSTEMS are trademarks of Touchbase Systems, Inc. Toshiba is a trademark of Toshiba America Information Systems, Inc., Computer Systems Division



# Everything You Ever Wanted In UNIX. And Less. \$99.95\*

OK. We know it's hard to believe. So just consider this. Coherent™ is a virtual clone of UNIX. But it was developed independently by Mark Williams Company. Which means we don't pay hundreds of dollars per copy in licensing fees.

What's more, Coherent embodies the original tenet of UNIX: small is beautiful. This simple fact leads to a whole host of both cost and performance advantages for Coherent. So read on, because there's a lot more to Coherent than its price.

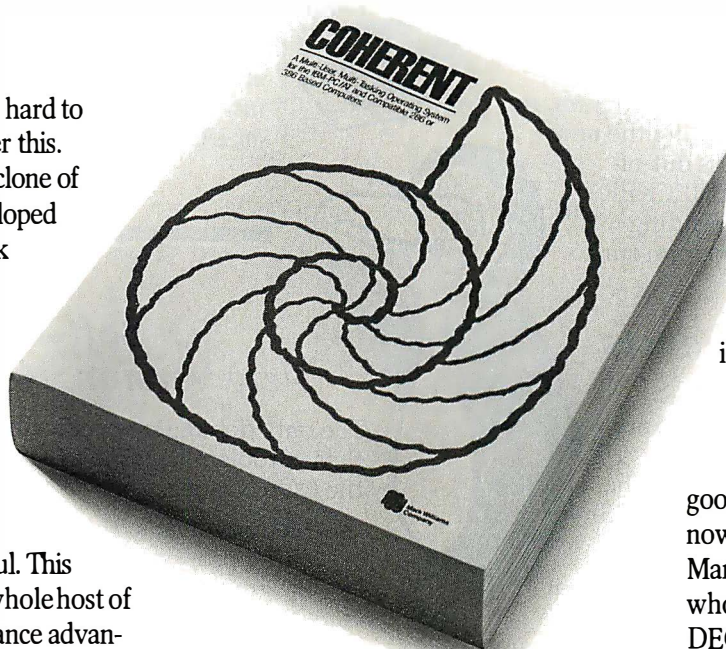
## SMALLER, FASTER... BETTER.

Everybody appreciates a good deal. But what is it that makes small so great?

For one thing, Coherent gives you UNIX capabilities on a machine you can actually afford. Requiring only 10 megabytes of disk space,

<b>LESS IS MORE!</b>	Coherent For the IBM-PC/AT and compatible 286 or 386 based machines.	Santa Cruz Operation's XENIX 286, Version 2.3.2
No. of Manuals	1	8
No. of Disks	4	21
Kernel Size	64K	198K
Install Time	20-30 min.	3-4 hours
Suggested Disk Space	10 meg	30 meg
Min. Memory Required	640K	1-2 meg
Performance*	38.7 sec	100.3 sec
Price	<b>\$99.95</b>	<b>\$1495.00</b>

\*Byte Exec benchmark, 1000 iterations on 20 MHz 386. Hardware requirements: 1.2 meg 5¼" or 1.4 meg 3½" floppy, and hard disk. SCSI device driver available soon. Does not run on Microchannel machines.



Coherent can reside with DOS. So you can keep all your DOS applications and move up to Coherent. You can also have it running faster, learn it faster and get faster overall performance. All because Coherent is small. Sounds beautiful, doesn't it?

But small wouldn't be so great if it didn't do the job it was meant to do.

## EVERYTHING UNIX WAS MEANT TO DO.

Like the original UNIX, Coherent is a powerful multi-user, multi-tasking development system. With a complete UNIX-compatible kernel which makes a vast world of UNIX software available including over a gigabyte of public domain software.

Coherent also comes with Lex and Yacc, a complete C compiler and a full set of nearly 200 UNIX commands including text processing, program development, administrative and maintenance commands.

And with UUCP, the UNIX to

UNIX Communication Program that connects you to a world-wide network of free software, news and millions of users. All for the cost of a phone call.

We could go on, but stop we must to get in a few more very important points.

## EXPERIENCE, SUPPORT AND GUARANTEES.

Wondering how something as good as Coherent could come from nowhere? Well it didn't. It came from Mark Williams Company, people who've developed C compilers for DEC, Intel, Wang and thousands of professional programmers.

We make all this experience available to users through complete technical support via telephone. And from the original system developers, too!

Yes, we know \$99.95 may still be hard to believe. But we've made it fool-proof to find out for yourself. With a 60-day money-back no-hassles guarantee.

You have to be more than just a little curious about Coherent by now. So why not just do it? Pick up that phone and order today.

You'll be on your way to having everything you ever wanted in UNIX. And for a lot less than you ever expected.

**1-800-MARK WMS**  
(1-800-627-5967 or 1-708-291-6700)  
**60-DAY MONEY BACK GUARANTEE!**



**Mark Williams Company**  
60 Revere Drive  
Northbrook, IL 60062

\*Plus shipping and handling. Coherent is a trademark of Mark Williams Company. UNIX is a trademark of AT&T. XENIX is a trademark of Microsoft.

# POWER DEBUGGING

## BOUNDS-CHECKER

*Finds out-of-bounds memory accesses —  
AUTOMATICALLY.*

Flush out those Nasty pointer problems and other out-of-bounds memory accesses — AUTOMATICALLY.

Each time you make a change to a program, run BOUNDS-CHECKER while testing the new code. If you accidentally access out-of-bounds memory, BOUNDS-CHECKER will pop up displaying the offending SOURCE LINE. And your program runs at full speed.

### Ship Bug-Free Products

You can run BOUNDS-CHECKER while testing your program. There are no additional steps to your testing cycle, but you can feel secure when the program has passed through BOUNDS-CHECKER with no reported problems.

Many over-write problems and other out-of-bounds memory accesses do NOT show up during normal testing. An out-of-bounds memory location may be modified, but that particular location doesn't happen to be important at the time. Once the program is in the field and a certain network is loaded or a certain T&SR or device driver is loaded, that memory location suddenly becomes very important... AND THE SYSTEM CRASHES.

You can prevent these problems by making BOUNDS-CHECKER a standard part of your testing procedure.

*Gives you the protection of a protected operating system under MS-DOS.*

BOUNDS-CHECKER uses the 386 virtual machine technology to provide real-time memory protection. In addition BOUNDS-CHECKER uses the symbolic information output by your compiler to differentiate CODE and DATA. When your program is running, BOUNDS-CHECKER protects the program's CODE and all memory outside your program.

Requires 386 PC.  
MS-DOS is a trademark of Microsoft Corporation.  
386 is a registered trademark of Intel Corp.



*"BOUNDS-CHECKER and Soft-ICE make sophisticated use of the most powerful versions of Intel's processor family to track down some of DOS programming's most insidious bugs. If you're developing programs for DOS, these are essential tools."*

PC Magazine  
July, 1990 pg. 48

## Soft-ICE 2.5 New Version, New Features

The only debugger specifically designed to solve those problems unique to MS-DOS that we call the DOS Nasties.

- Memory over-writes
- Hung programs
- Program too big to debug
- Debugging T&SRs and Loadable Drivers
- Multiple Symbol Tables
- Supports Microsoft C 6.0 & Turbo C++

## Windows Developers Run CODEVIEW for Windows on a Single Monitor

*Nu-Mega has done it again!*

**CV/1™ \$129**

*Call Today, Have it Tomorrow*

BOUNDS-CHECKER .....	\$249
Soft-ICE 2.5 .....	\$386
MagicCV 3.0 .....	\$199
CV/1™ .....	\$129

### Special Offer...

Buy BC & S-ICE .....	Save \$100
Buy S-ICE & MCV .....	Save \$86
Buy all three .....	Save \$186

*30 Day Money-Back Guarantee*



CALL TODAY (603) 888-2386 or FAX (603) 888-2465

P.O. BOX 7780 ■ NASHUA, NH ■ 03060-7780 ■ U.S.A.

have. That implies that high school and college libraries ought to have CD-ROM drives, and most don't, which is a real pity, because there is a great deal of material available on CD-ROM.

When CD-ROMs first came out, I thought this might become a way to put rare and original materials in the hands of scholars and students at smaller and less wealthy institutions; for instance, the Dead Sea Scrolls might be reproduced on a CD-ROM along with a good proportion of the material that has been published about them. Now that VGA is widely affordable, this becomes even more feasible, and I see the beginnings of it happening. The United States History CD-ROM is a long way from what I'd like it to have been, but it's a good start on where we ought to be going with this technology.

**More CD-ROMs**

When I began this column, I had the foolish conceit that I could keep up with the entire microcomputer world, hardware and software. I long ago lost that illusion. For a while, though, I thought I might be able to keep up with the CD-

**N**ow I can't even keep up with the CD-ROM explosion. Every month I get up to a dozen CD-ROMs, and I am not getting all that are published.

ROM explosion. Now I can't even do that. Every month I get up to a dozen CD-ROMs, and I am not getting all that are published. I can't even keep up with the CD-ROM drives now available. On that score, the Denon drives installed on the Zenith Z-386/25 continue to work fine.

Some recent (within the past six months) CD-ROMs in no particular order: Software Toolworks World Atlas,

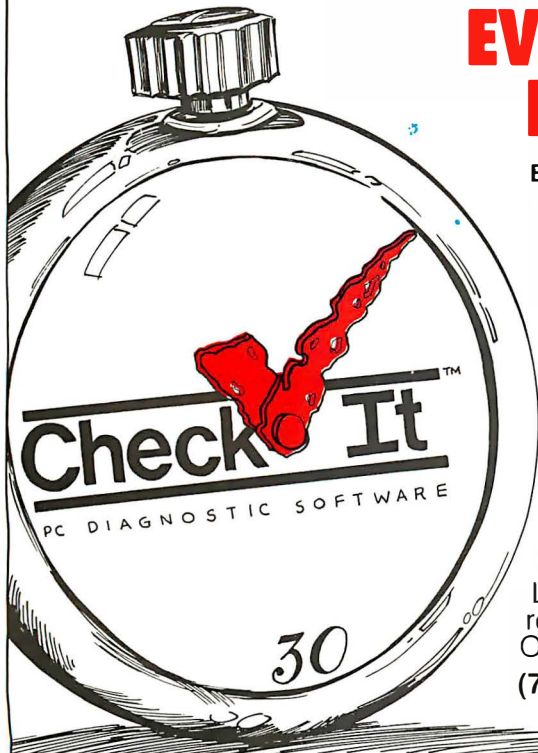
Oxford English Dictionary (older edition; no supplements), Grolier Encyclopedia Americana (illustrated), USA Factbook, CIA World Factbook, Agricola (the national database of agriculture), Multi-Media Birds of America, Quick Art (300-dot-per-inch TIFF images), Library of the Future, An Unabashed History of Photographic Erotica, Micro-Medex Medical Technology, Microsoft Programmer's Library (the new edition), and Word Cruncher.

I could list a lot more; but as I was making the list, I noticed a curious thing. I made the list by grabbing a bunch of CD-ROMs off the shelf where I keep them, plus looking about at some of the others I have been testing; and I discovered that of the above, after the first few, just about every one of them is worth a comment; most, alas, inspire negative commentary.

The Software Toolworks World Atlas is pretty good. It doesn't go into enough detail, and you'd be better off with the *Times World Atlas*, but for quick scans of geography it's neat, and the retrieval software is fairly easy to use. The only negative comment I have is that I wish it

**SAVE 30 MINUTES EVERY TIME YOU HAVE A PC PROBLEM!**

**NEW VERSION 3.0 Now Available!**



By using Check✓It® to find out if the problem is Hardware or Software

The second you suspect a problem with your PC, you should reach for Check✓It, the world's most popular PC diagnostic software. Running Check✓It should be the first thing you do -- because confirming or eliminating your PC's hardware as the source of the problem can save you time, money, and unnecessary repair calls.

Check✓It will test your PC's main system board, memory, hard disk drive and floppy disk drives, video subsystem, communication ports, printer, keyboard, mouse, or joystick. Check✓It will also display key software and setup data, including your PC's exact equipment configuration, current IRQ assignments, memory allocation, device drivers, and CMOS table.

Take a minute to run Check✓It the next time you have a PC problem. Then you'll know the answer to these key questions: Should you back it up, pack it up, and send it out for repair? Should you fix a hardware problem yourself? Or, should you concentrate on the software and configuration problems that you can correct?

The moment you suspect a PC problem, run Check✓It. It's about time!

Look for Check✓It at leading retail stores everywhere, Or call TouchStone TODAY! (714) 969-7746 or (800) 531-0450

**TouchStone**  
Software Corporation

2130 Main Street, Suite 250, Huntington Beach, CA 92648



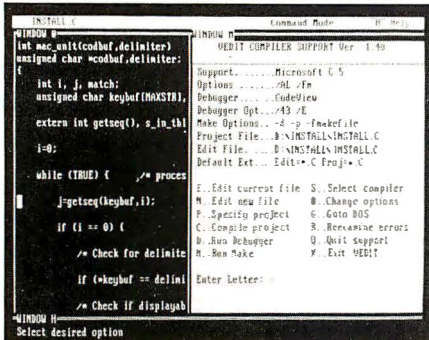
**NEW "Basic PC Maintenance" Hands-On Video Ask for it TODAY!**

Check✓It is a registered trademark of TouchStone Software Corporation. Copyright ©1990 TouchStone Software Corporation. ALL RIGHTS RESERVED.

## Finally, a fast, powerful text editor that integrates your favorite programming tools and uses no memory!

# VEDIT PLUS

favorite programming tools and uses no memory!



- Mouse support
- Pull-down menus
- Columnar blocks
- 1000 Level Undo
- Regular Expressions
- Small 70K, super fast
- DOS, UNIX/XENIX, FlexOS
- Also VEDIT \$69, VEDIT Jr. \$29



## FREE Evaluation Copy Call 1-800-45-VEDIT

The new VEDIT PLUS is the productivity breakthrough programmers have been looking for. Run not only popular compilers, but all of your favorite tools from within the editor. When shelling to DOS, VEDIT swaps itself and any desired TSRs out of memory to give you more memory than when you entered VEDIT.

Only VEDIT gives you the advantages of a powerful and flexible editor without giving up the convenience of an integrated environment.

VEDIT offers stunning performance, versatility and ease of use. Completely written in assembly language, it's small and lightning fast. Edit text and binary files of any size, even 100+ megabytes. Installation is trivial; VEDIT.EXE and an optional help file are all you need - no overlays, no configuration files.

Other features include multiple file editing, windows, unlimited keystroke macros, "hot keys", context sensitive help, word processing, automatic indenting and total configurability. VEDIT has been the choice of 100,000 programmers, writers and engineers since 1980.

VEDIT PLUS adds a powerful "off the cuff" macro programming language, complete with source level debugging.

VEDIT PLUS - \$185 for DOS, \$285 for UNIX/XENIX. Call for a free demo today.

## Greenview

P.O. Box 1586, Ann Arbor, MI 48106  
(313) 996-1299 \* Fax (313) 996-1308

78 B Y T E • JANUARY 1991

gave more information; for what it does, it's all right. One comment, though: you *must* run the installation program. Attempting to invoke the program direct from the CD-ROM will lock up your system and require a hardware reset. The installation program works fine.

The Oxford English Dictionary is well worth having in any library, and most wordsmiths will like it. The retrieval software is fast, but best described as obscure, and there are no words past 1937 or so since it doesn't have the supplements; but this one gets a permanent

with both Macs and PCs, but unlike what Quanta Press publishes, Grolier doesn't furnish both: you have to buy one or the other. Oh, well. They tell me they're redoing some of their software and will distribute updates for free.

The USA Factbook and the CIA World Factbook from Quanta use Textware retrieval software. The best thing you can say about this program is that it comes on the CD-ROM so you don't lose it. This stuff is slow enough to amuse you while you grow a beard. The installation program is truly horrible. First, it wants you to tell it precisely where you want everything. Next, it will not create a subdirectory: you must create that subdirectory and log onto it before going over to log onto the CD-ROM preparatory to running the installation. You also have to figure that out from the error messages you get when the system fails to install properly.

Once you install and run Textware, you get few clues as to what is on the CD-ROM, and invoking the index gets you a long wait, after which it solemnly informs you of how many entries there are for each of hundreds of numbers, like \$1,234,563,888 (1 entry). Doing page-down gets more lists of numbers, a very long wait again, and then more numbers. At this point, I wasn't even to the "A's" and gave up. Apparently, you must already know what's in the database to search for it; a curious concept indeed.

If you want the material that's in the database, you can try the Factbook CD-ROMs, which do have good information on them; but even on a 33-MHz 386 it's slow. Textware also leaves some memory-resident stuff in your machine, so you need to reset after using it. Trying to run a different Textware CD-ROM without resetting will get you memory errors, so you have to reset anyway. On the other hand, these CD-ROMs come with a separate disk to run the same CD-ROM on the Mac, where there are far fewer problems.

Agricola, the national database of agriculture, is also from Quanta, but the retrieval software is Romware, which works much smoother than Textware and is actually usable. There are some decent help screens and a general introduction to what you're doing. I wish the other databases Quanta publishes had used this instead of Textware.

The Multi-Media Birds of America CD-ROM uses DiscPassage retrieval software. I have many other CD-ROMs that use this system, including United States History and Sherlock Holmes on CD-ROM. CMC, which is the developer

**T**he best thing about Textware is that it comes on the CD-ROM so you don't lose it. It's slow enough to amuse you while you grow a beard.

place in my primary six-pack, if only for snob appeal.

The Grolier Encyclopedia Americana is another in my permanent six-pack. Indeed, its retrieval software is some of the best, and as I use it more, I have come to be reasonably fond of the encyclopedia. On the other hand, Grolier's paranoia about that software is a continued irritant: the network version apparently will not work *except* over a network (and will not work with my network in any event), while the usual version deliberately commits suicide if you have a network card in the machine even if you don't use it over a network.

Incidentally, the way you use it with multiple CD-ROM drives is weird: first you must put the Grolier CD-ROM as the *first* one in the six-pack. Then you must log onto the Grolier CD-ROM and get a directory; now, before you do anything else, go to the subdirectory on the hard disk where you have the Grolier retrieval software and invoke it. That—and *nothing else*—works fine.

Of course, the Grolier retrieval software comes on a separate floppy disk, and it must be installed from a floppy disk. The same Grolier CD-ROM works

# MINUTEMAN<sup>®</sup>

## UNINTERRUPTIBLE POWER SUPPLIES

### TOTAL POWER PROTECTION

- ★ BLACKOUTS
- ★ BROWNOUTS
- ★ OVERVOLTAGE
- ★ UNDERVOLTAGE
- ★ SURGES
- ★ SPIKES
- ★ EMI/RFI

### STANDBY UPS MODELS

- 250 VA To 2300 VA
- Sinewave output - 1 millisecond transfer time
- Communications interface and external battery packs available for extended run times

### ON-LINE UPS MODELS

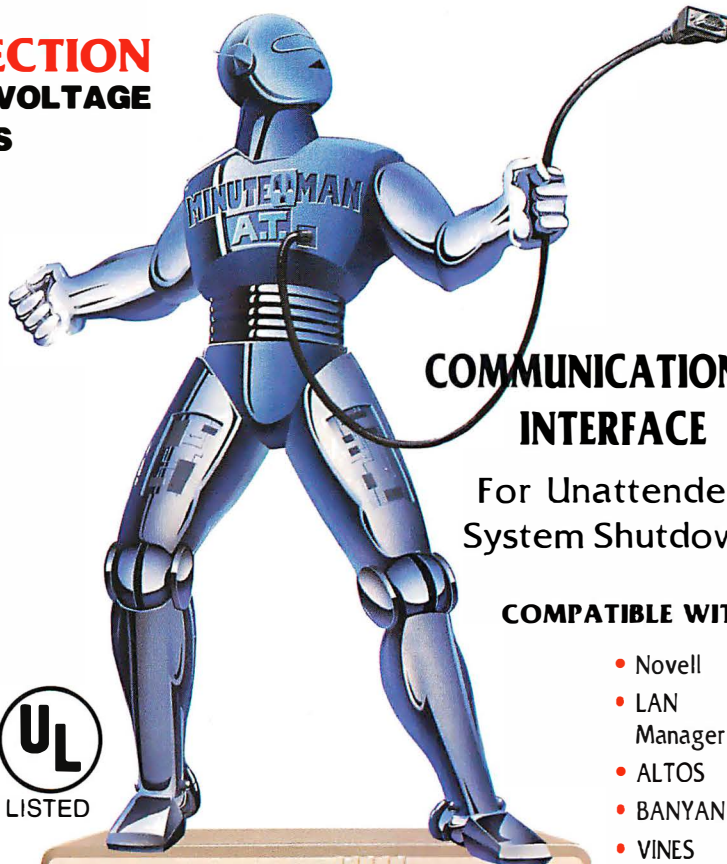
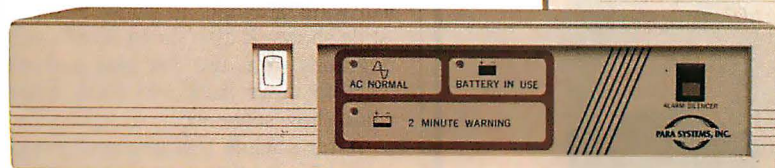
- 500 VA To 5,000 VA
- Static By-pass Standard
- True On-Line - Sinewave outputs
- Communications Interface and external battery packs available for extended run time



### NETWORK MANAGER

- Shutdown software for unattended operation
- Only software to communicate with LANs and WANs
- Novell 286 VAP and 386 NLM
- SCO Xenix

### SLIMLINE & UPRIGHT MODELS



### COMMUNICATIONS INTERFACE

For Unattended System Shutdown

### COMPATIBLE WITH:

- Novell
- LAN Manager
- ALTOS
- BANYAN
- VINES
- System V UNIX
- Custom Configuration Any System

**NOVELL**  
Monitor Boards Available

FOR L.A.N.  
NOVELL LABS  
TESTED AND APPROVED  
NetWare Compatible



1455 LeMay Drive  
Carrollton, TX 75007

Telephone:  
(214) 446-7363

FAX: (214) 446-9011 TELEX: 140275 OMEGA

**1-800-238-7272**

"Distributed in over eighty countries"

of DiscPassage, also publishes a line of medical literature CD-ROMs, which I believe is their major business. DiscPassage isn't elegant, but it is good enough. It needs better introductory screens, and I could improve the help screens. Even on the Arche Legacy 386/33, it's very slow in building VGA images, and, alas, many DiscPassage CD-ROMs begin with a VGA picture.

The DiscPassage system badly needs a quick way to find out from the CD-ROM

what data resources are on it, although that partly depends on the way in which the CD-ROM database developer arranged things. However, DiscPassage is able to handle illustrations (unlike Textware, which is as likely to have half the image off-screen as not, as I found when trying to examine the Great Seal of the State of Iowa). The DiscPassage search-and-retrieval indexing is good enough, and while it's not blindingly fast, it's not real slow either.

When you install DiscPassage, it creates a batch file. You need to edit that to tell it which drive the CD-ROM will be on, and you will have to change that if you move that CD-ROM. However, once DiscPassage has logged onto a DiscPassage CD-ROM, you can, from within DiscPassage, change to another CD-ROM drive or, alternatively, swap CD-ROMs in the present drive and log onto that. Again, it doesn't do this elegantly, but it does do it.

The Quick Art CD-ROM has 2200 images on it, but if there's any retrieval software for it, I've been unable to find it. Since the images are in TIFF, you can go looking for them with one of the Mace Grasp tools or one of the little public domain image-viewer programs, but finding an index to the images is a problem.

I have the same difficulty with the Library of the Future: it apparently has a lot of really nifty stuff, but what there isn't is retrieval software. I suppose I got a copy of that on some kind of floppy disk, but, if so, it has submerged itself in the chaos stream. Doubtless it will wash ashore one day, as may the Quick Art retrieval software.

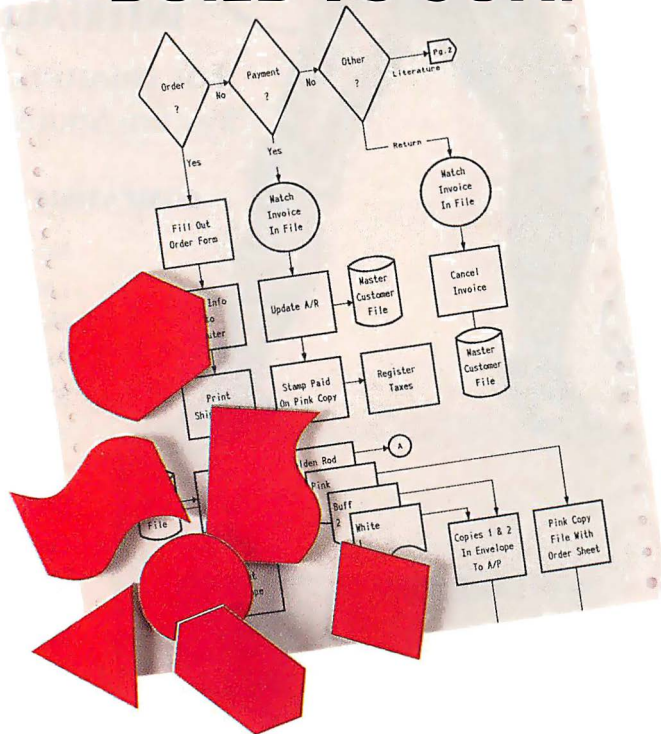
The moral of this story is easy to see: it doesn't hurt to put the retrieval software on the CD-ROM itself. It doesn't take up much room, and it won't get lost. DiscPassage comes that way; each new CD-ROM seems to have a later version, but they're all backward-compatible with all the earlier CD-ROMs, and if one ever weren't, you'd still be able to read all the earlier CD-ROMs with the programs that came with them.

The contents of An Unabashed History of Photographic Erotica weren't particularly noteworthy—I'd call them puerile rather than erotic—but the retrieval software is remarkable. It doesn't work very well, alas, but it's elegant, with VGA images as part of the control software. They come up surprisingly fast. The software attempts to show a series of slide shows. It also shows details of photographs. You use the plus and minus keys to move back and forth within a slide-show sequence.

After a while that gets pretty boring, or did for me, but part of that is the pictures shown: gross anatomy has never been one of my stronger interests. I really would like to see this software used to produce a CD-ROM of, say, the paintings in the Florentine Uffizi.

MicroMedex Medical Technology is interesting because it uses Reference Technology retrieval software. That's pretty good stuff. Alas, the latest Reference software I have is several years old,

## BUILD TO SUIT.



### Announcing Flow Charting™ 3

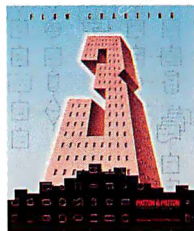
Now, you can create, update and print presentation-perfect flowcharts to your specifications—in no time!

Quick to master and a snap to use, Patton & Patton's flowcharting software is the standard of both large and small businesses around the world—and is available through all major software dealers.

See your dealer today! Or, for a "live," interactive demo disk, call: **800-525-0082, ext. BY31.**  
International: 408-778-6557, ext. BY31.

Works on IBM & 100% compatible PC's, supports CGA/EGA/VGA and over 150 dot matrix and laser printers, with multiple print densities and 10 font sizes. Creates multi-page charts, portrait or landscape, on most standard paper sizes. Mouse or keyboard controlled.

IBM is a registered trademark of International Business Machines Corporation.



**PATTON & PATTON**  
Software Corporation

*Excellence in charting the flow of ideas!*

# CSS: STATISTICA

**CSS/3™** Complete Statistical System with over 1,000 presentation-quality graphs fully integrated with all procedures and on-screen graph customization ■ The largest selection of statistics in a single system; in-depth, comprehensive implementations of: *Exploratory techniques; multi-way tables with banners; nonparametrics; distribution fitting; multiple regression; general nonlinear estimation; logit/probit analysis; general ANCOVA/MANCOVA; stepwise discriminant analysis; log-linear analysis; factor analysis; cluster analysis; multidimensional scaling; canonical correlation; item analysis/reliability; survival analysis; time series modeling; forecasting; lags analysis; quality control; process analysis; experimental design (with Taguchi);* and much more ■ Manuals with comprehensive introductions to each procedure and examples ■ Integrated Stats Advisor expert system ■ Extensive data management facilities (powerful spreadsheet with formulas; relational merge; data verification; flexible programming language) ■ Optimized (plain English menus/mouse) user interface: even complex analyses require just few self-explanatory selections (CSS can be run without manual; Quick Start booklet explains all basic conventions) ■ Macros, batch/commands also supported ■ All output displayed in ScrollSheets™ (dynamic tables with pop-up windows and instant graphs) ■ Extremely large analysis designs (e.g., correlation matrices up to 32,000x32,000) ■ Unlimited size of files; extended precision; unmatched speed (Assembler, C) ■ Exchanges data (and graphics) with many applications (incl. Excel®, Lotus 3®, dBASE IV®, SPSS®) ■ Highest resolution output on practically all printers (incl. HP, Postscript), plotters, recorders, typesetters ■ IBM compatibles, 640k or more ■ Price: \$595.

**Quick CSS™** Subset of CSS/3: all basic statistical modules (incl. data management) and the full, presentation-quality graphics capabilities of CSS/3 ■ Price: \$295.

**CSS:GRAPHICS™** A comprehensive graphics/charting system with data management ■ All graphics capabilities of CSS/3 and, in addition, extended on-screen drawing, 19 scalable fonts, special effects, icons, maps, multi-graphics management ■ Hundreds of types of graphs ■ Interactive rotation and interactive cross-sections of 3D graphs ■ Extensive selection of tools for graphical exploration of data; fitting; smoothing; spectral planes; overlaying; layered compressions; marked subsets ■ Unique multivariate (e.g., 4D) graphs ■ Facilities to custom-design new graphs and add them permanently to menu ■ Import/export of graphs and data, 15 formats ■ Optimized (menu/mouse) user interface: even complex graphs require few keystrokes: all graphs on this page can be produced from raw data in less than 20 minutes ■ Macros, batch/commands also supported ■ Unlimited size of files ■ Highest resolution output on all hardware (see CSS/3) ■ IBM compatibles, 640k or more ■ CSS:GRAPHICS is included in CSS:STATISTICA (available separately for \$495).

**Megafile Manager™** Comprehensive analytic data base management system ■ Unlimited size of files (up to 32,000 fields or 8 MB per record) ■ Megafile Manager is included in CSS/3 and CSS:STATISTICA (separately: \$295).

**CSS:STATISTICA™** A fully integrated system that combines all the capabilities of CSS/3 and CSS:GRAPHICS into a single extremely comprehensive data analysis system ■ Price: \$795.

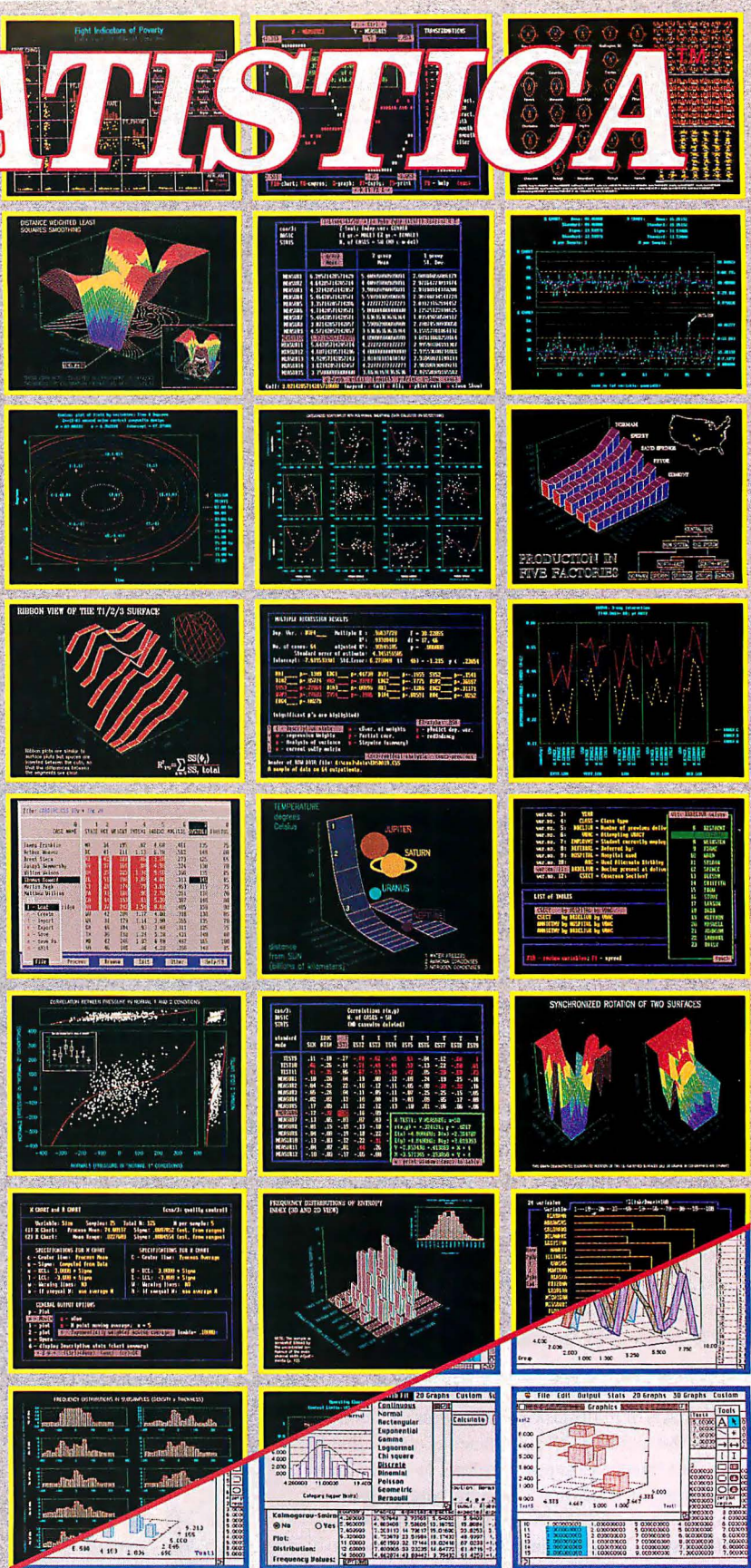
Domestic \$149 \$7 per product; 14-day money back guarantee.

Circle 300 on Reader Service Card



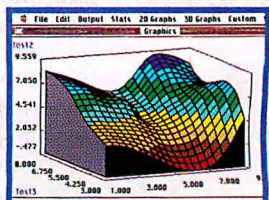
## StatSoft™

2325 E. 13th St. • Tulsa, OK 74104 • (918) 583-4149  
Fax: (918) 583-4376



**STATISTICA/Mac™** A CSS-compatible, comprehensive data analysis and graphics system designed for the Macintosh ■ Large selection of statistical methods fully integrated with presentation-quality graphics (incl. EDA, multplots, a wide selection of interactively rotatable 3D graphs; MacDraw-style tools) ■ Unlimited size of files ■ Exchanges data with Excel and other applications ■ Price: \$395.

**Quick CSS/Mac™** A subset of STATISTICA/Mac: all basic statistical modules and the full, presentation-quality graphics capabilities of STATISTICA/Mac ■ Price: \$245.



Overseas Offices: StatSoft of Europe (Hamburg, FRG), ph: 040/4200347; fax: 040/4911310. StatSoft UK (London, UK), ph: 0462/482822; fax: 0462/482855. StatSoft Pacific (Melbourne, Australia), ph: 613-497-4755; fax: 613-499-7410. StatSoft Canada (Ontario), ph: 416-849-0737; fax: 416-849-0918. Available From: CORPORATE SOFTWARE and other Authorized Representatives Worldwide: Holland: Lemax BV 02968-94210; France: Conceptel (t) 45669700; Sweden: AkademiData 018-240035; Spain: ADLINK, SRL: ph: 34-3-459-0722

CSS, CSS 3, CSS:GRAPHICS, Megafile Manager, Quick CSS, STATISTICA, StatSoft, dBASE IV, Excel, Lotus, MacDraw, Macintosh, Postscript are trademarks of their respective companies. SPSS is a registered trademark of SPSS, Inc.

Operate your own BBS  
with the world's most popular, expandable, flexible

# Multi-User Online Bulletin Board System



## The Major BBS® starter system:

A complete BBS software package for your PC, PS/2, XT, AT, 386, 486, or compatible. Includes electronic mail with binary and ASCII file "attachments", SIG conferencing or "forum" areas with configurable security level access control, file upload/download, message keyword searching, "quickscans" for fast access to new messages, message and file "threading", real-time multi-user "chat" and teleconferencing, "classified ad" and "user registry" databases, etc. Also includes accounting, Audit Trail, and timed usage-metering features, and hundreds of convenience features for the Sysop (System Operator), such as a full-screen configuration editor, the ability to import/export files to/from floppy without system shutdown, "SIG-Op" privilege delegation, and much more. Supports up to 2 simultaneous users (from a database of thousands) on a single CPU. Works with standard Hayes-compatible COM1/2/3/4 internal or external modems, or with serial ports up to 38,400 bps. Minimum RAM requirement 512K. Minimum disk requirement 20MB. Requires PC-DOS or MS-DOS 3.1 or later.

The Major BBS Standard Edition . . . . . \$ 59

## When you're ready to expand:

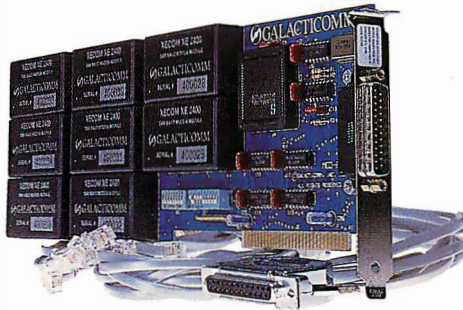
No LAN or multi-tasking OS necessary! Double the number of simultaneous users that your system can support, from 2 to 4, or 4 to 8, or any number up to 64 simultaneous users on a single CPU, for a flat \$300 software license fee per doubling. The upgrade process is quick, automatic, and fully upward-compatible — i.e. you can install an update or upgrade onto your existing system without disrupting any of your user account files, E-Mail messages, configuration variables, or any other aspect of your system. For up to 16 users, 640K RAM is sufficient; above 16 users, more than 640K may be necessary. Prerequisite: The Major BBS (any edition).

Users, per doubling (up to 64) . . . . . \$ 300

## If you need multi-modem hardware:

Our Model 2408 consists of up to 8 Hayes-compatible modems on a single circuit card, for the PC/XT/AT/386/486 family. Each modem operates independently at 300/1200/2400 bps (automatically switching to match the caller's bps rate). Built-in serial ports are not COM-port based, so this card can co-exist with other COM port hardware in the same machine (drivers for software other than The Major BBS are not included but may be written). RJ-11 telephone cables are included. MNP Class 4 (error correction) modems are available as an option.

	non-MNP	MNP Class 4
2408 w/2 modems . . . . .	\$ 1536	\$ 1696
2408 w/4 modems . . . . .	\$ 2090	\$ 2388
2408 w/6 modems . . . . .	\$ 2644	\$ 3080
2408 w/8 modems . . . . .	\$ 3198	\$ 3772



## When you're ready for source code:

With the C source code to The Major BBS, you can add 3rd-party software, such as The Major Database (a general-purpose, configurable database manager), various multi-player real-time adventure games, dial-out utilities, global command utilities, accounting enhancements, and much more. Also, you can maintain your own copy of the BBS, or you can modify it to suit your own unique requirements. The Major BBS C source code package is fully documented, and it includes the Galacticomm Software Breakthrough Library, plus all of the

utility object libraries, linker control files, and DOS "batch" files you will need, along with a detailed Programmer's Guide. Works with Turbo C 1.5, 2.0, or 2.01, Turbo C++, or Microsoft C 4.0, 5.1, or 6.0. Prerequisite: The Major BBS Standard Edition.

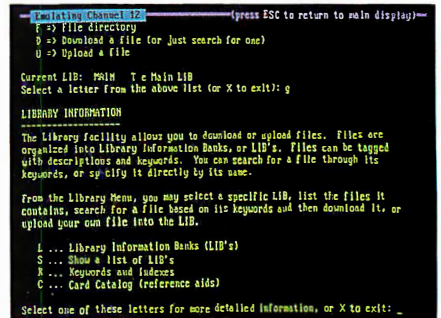
Standard Edition C source code . . . . . \$ 285

## For the ultimate in file transfer flexibility:

The File Library Edition of The Major BBS has everything that the starter system does, plus built-in ZMODEM, KERMIT, SuperKERMIT, YMODEM-g, and YMODEM (batch) file transfer protocols. Also, it offers super-fast pre-indexed keyword file searches, library-wide searches as well as constrained searches, special file upload/download accounting options, alternate DOS "paths" per sub-library, split paths for CD-ROM support, a transparent "DOS-only" sub-library option, and much more. This package is for you if the focus of your system will be the upload and download of large amounts of files. You can easily upgrade from the starter system to the File Library Edition, without losing any of your data files or configuration work you have already done. Prerequisite: The Major BBS Standard Edition.

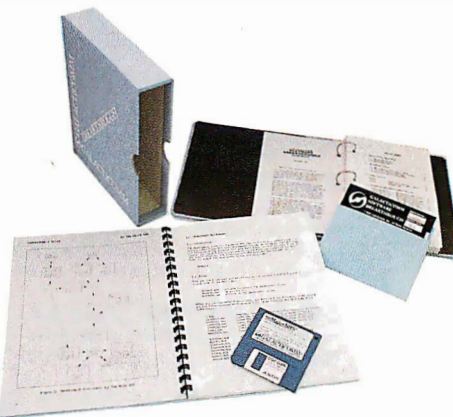
File Library extensions . . . . . \$ 199

File Library C source extensions\* . . . \$ 159



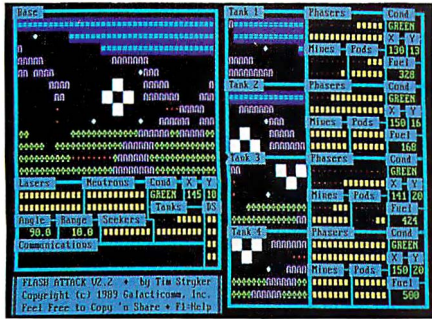
## If you decide to offer online games and amusements:

The Entertainment Edition of The Major BBS has everything that the starter system does, plus Quest for Magic (a multi-player interactive text adventure game), Androids! (a multi-player arcade-style ANSI-graphics game), Flash Attack (a futuristic tank and laser battle for multiple players with IBM PC's), and the Action Teleconference Link-Up, which includes private "chambers", action verbs (grin, wink, nudge, etc.), the ability to link to other systems for huge multi-system teleconferences, custom entry/exit strings, user-configurable profiles, and much more. This Edition supports the Flash™ Protocol (where most of the game functionality is on the user's





end of the phone line), for which dozens of incredible new multi-user games are now being developed. Upgrading from the starter system to the Entertainment Edition is quick



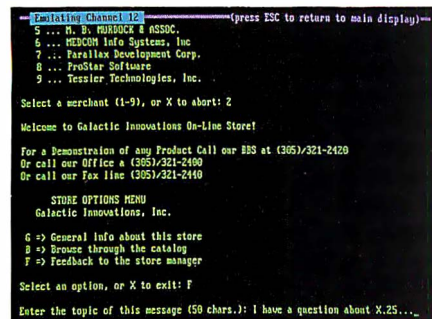
and easy and involves no loss of data or function. Prerequisite: The Major BBS Standard Edition.

Entertainment extensions . . . . . \$ 149  
Entertainment C source extensions\* . . \$ 129

**If your requirements include order entry and catalog sales:**

The Shopping Mall Edition of The Major BBS has everything that the starter system does, plus online shopping. Your online mall can have multiple "stores", each run by its own separate "merchant", if desired. Each merchant has control over his or her own product line, pricing, discount structure, store welcome message, sales tax handling, etc. Also, each merchant may create up to 6 different payment methods (e.g. VISA, MC, AMEX, C.O.D., "bill me", etc.), and up to 6 different shipping methods (e.g. UPS, FedEx, US Mail, etc.), each with its own rates (flat rate, percent of sale, 1st-ounce/add'l-ounce, or 1st-pound/add'l-pound). Users may browse product catalogs at no obligation, or order products and services directly online! Orders generate invoices that are posted to the individual merchant as attachments to E-Mail. To upgrade from the starter system to the Shopping Mall Edition takes only a few minutes. Prerequisite: The Major BBS Standard Edition.

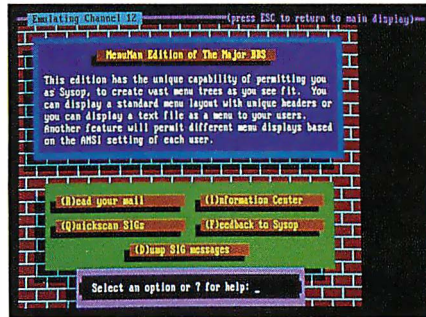
Shopping Mall extensions . . . . . \$ 249  
Shopping Mall C source extensions\* . . \$ 189



**For super-flexibility of menu trees and ANSI screens:**

The MenuMan Edition of The Major BBS can do everything that the starter system does, and in addition you as Sysop can create your own menu trees, with menus leading to menus leading to menus, as deeply "nested" as you like. The "leaves" of your menu trees can be ordinary ASCII or ANSI files, which are simply dumped to the user's display (with or without automatic screen breaks), or they can be any of the built-in functions of the BBS such as scanning the user's incoming E-Mail or firing up a SIG quickscan. Includes commands like *GO <pagename>*, *FIND <topic>*, *USERS*, and for the Sysop, the equivalent of the DOS commands *DIR*, *RENAME*, *COPY*, *DEL*, *MKDIR*, and *RMDIR*, as well as a set of privileged commands for editing and extending the menu trees, remotely, while the BBS remains fully online. Upgrading from the starter system to the MenuMan Edition takes only minutes. Prerequisite: The Major BBS Standard Edition.

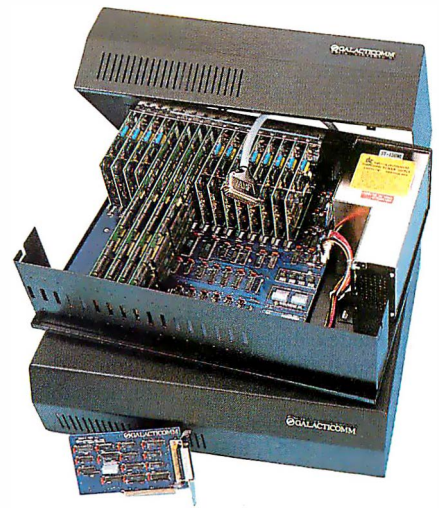
MenuMan extensions . . . . . \$ 149  
MenuMan C source extensions\* . . . . \$ 129



**As your system grows larger...**

The GalactiBox™ is our 16-slot "expansion chassis", for large-scale systems. It has the unique ability to address individual modems by slot number rather than just COM port address, so you can use up to 16 standard internal modems in it, side by side, without conflict. Includes built-in 150W power supply, interface card for your XT/AT/386/486, cables, and full documentation. Up to 4 boxes may be attached to one CPU, for a total of up to 64-channel expansion capacity. Prices shown below are for standard 300/1200/2400 bps Hayes-compatible internal modems. We also have 9600 bps V.32/V.42 MNP Class 5 modems available, call for prices.

GalactiBox (unpopulated) . . . . . \$ 1992  
GalactiBox w/4 modems . . . . . \$ 2416  
GalactiBox w/8 modems . . . . . \$ 2840  
GalactiBox w/16 modems . . . . . \$ 3688



...and that's not all! For advanced applications, we also offer an X.25 direct-connect software option, a protected-mode development toolkit, and special licensing arrangements for up to 256 simultaneous users! And don't forget the smorgasbord of 3rd-party add-ons available, such as The Major Database from Galactic Innovations. Custom programming and integration services are also available. Your system can grow in power and sophistication, far into the future, with The Major BBS.

**Here's How To Order:**

Just dial (305) 583-5990 and say, "I'd like to place an order!" We can generally ship your order within 48 hours. We accept major credit cards, or we can ship C.O.D. Prices shown do not include shipping or insurance.

For more information, you may either call the main order number and ask for a sales engineer, or dial (305) 583-7808 with your modem (8-N-1) for a free demo of most of our products. This demo system also contains an online Shopping Mall with many of the 3rd-party add-ons available for The Major BBS, operated by the 3rd-party vendors themselves.

Give us a call today!



The Major BBS, Flash Protocol, and GalactiBox are trademarks of Galacticcomm, Inc. PC, PS/2, XT, AT, and PC-DOS are trademarks of International Business Machines Corp. Hayes is a trademark of Hayes Microcomputer Products, Inc. The Major Database is a trademark of Galactic Innovations, Inc. Turbo C and Turbo C++ are trademarks of Borland International, Inc. MS-DOS and Microsoft C are trademarks of Microsoft Corp. UPS is a trademark of United Parcel Service. FedEx is a trademark of Federal Express Corp. MNP is a trademark of Microcom, Inc.

\*The C source code extensions are necessary, if you wish to combine multiple extended Editions together, or add 3rd-party software, or develop your own modifications. Prerequisites, in each case, are the Standard Edition C source code, and the corresponding extended Edition.

# GALACTICOMM

Galacticomm, Inc. 4101 S.W. 47 Ave.  
Suite 101, Fort Lauderdale, FL 33314

Modem: (305) 583-7808  
Fax: (305) 583-7846  
Voice: (305) 583-5990

Circle 115 on Reader Service Card

and it doesn't have drivers for either the Denon or the Pioneer CD-ROM drives, and thus I can't install either MicroMedex or the McGraw-Hill Science Encyclopedia, which also uses Reference. MicroMedex digests medical journals and has such things as the Poison Index. I gather it's considered indispensable in some emergency rooms. Our last update was about 1987, and there are no updates to the software, so you can't use these CD-ROMs on the newer drives. Pity.

Microsoft Programmer's Library is important to programmers. Microsoft now puts out their C development kits, programs and documents, on CD-ROM: if you're a serious programmer developing applications for OS/2 or Windows, or if you're a heavy user of any Microsoft compiler, get yourself at least one CD-ROM reader and the Microsoft CD-ROMs. You'll be more than glad you did. Microsoft Bookshelf is a permanent one on my basic six-pack; if I did more pro-

gramming, Programmer's Library would be another.

Finally, there is Word Cruncher Disc Volume One, subtitled "A meley of significant documents, literature, and information on CD-ROM." (I don't know if "meley" is a kind of pun on *medley* and *melody*; it's what they printed on the face of the CD-ROM.) A few issues ago, I was rather unkind to this retrieval software. After trying to work with some of the other stuff that's out there, particularly Textware, I revise my opinion.

Word Cruncher isn't elegant, but you can learn it, and at least it's not slow. Changing colors and manipulating the text is often awkward, and the text is generally presented on-screen in a less-than-aesthetic manner, but for all that, it works, and it doesn't drive you nuts to install it. I really would hate to have to read very much from it, though. I understand they are coming out with a new version shortly. If they can keep the speed and make the formatting more elegant, they will have something.

Anyway, that's a tiny sample of the CD-ROMs available now. This technology is coming of age.

### Decisions, Decisions

When microcomputers first came out, there was a spate of decision-aid software. Most of it was pretty crude. Some simply forced you to make a number of preferences and then took a weighted average; nothing you couldn't have done with pencil and paper. Some was more sophisticated but was harder to use.

Expert87 is sophisticated and also relatively easy to use. Mind you, it's not a toy, but a professional tool, and you won't learn it in 5 minutes. On the other hand, you can learn it by working with examples, not by reading a large boring manual.

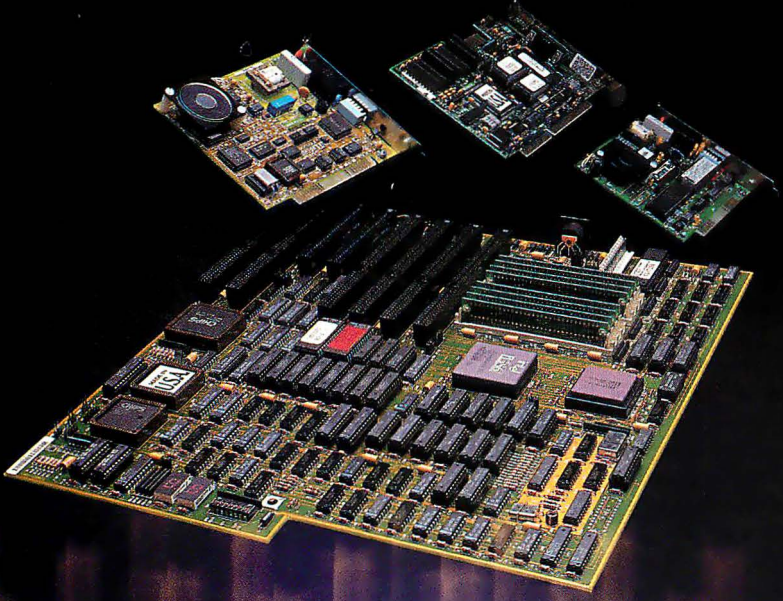
The program bills itself as "Artificial Intelligence." What it will do is make explicit the decision factors you use and form them into a rule-based system. I wouldn't call that AI, but then I've been reading Roger Penrose's *The Emperor's New Mind: Concerning Computers, Minds, and the Laws of Physics*, and I tend to agree that most of what is called AI isn't.

Anyway, Expert87 has provision for bringing in other experts and encoding their views, and then combining them into a consensus system. It has ways of examining a series of decisions to determine bias or inconsistency. As far as I know, these capabilities are unique to Expert87.

When, donkey's years ago, I learned

OmniTel

Solutions For Today And Tomorrow.



Featuring the world's smallest custom fax/data modem.

OEM and Standard Products

- 386/486 Motherboards
- Fax/Data, High Speed Modems
- VGA/Super VGA Adapters

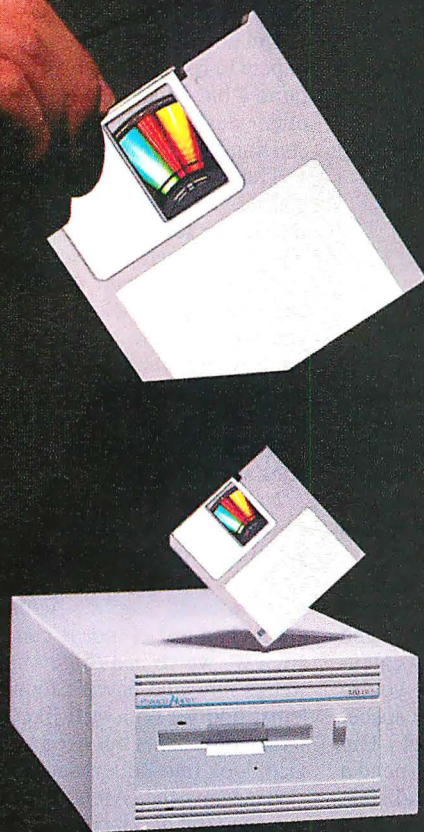
Made in U.S.A.

OmniTel Inc. U.S.A.

---

3500 W. Warren Avenue  
Fremont, CA 94538  
☎ (415) 490-2202  
FAX (415) 657-4079  
1-800-OMNITEL

# Pocket Power



The world's fastest 3.5 inch,  
Erasable Optical Drive.

## The world's first 3.5 inch, Erasable Optical Drive.

Pinnacle Micro, the leader in 5.25 inch optical storage systems, now brings you the first 3.5 inch erasable optical drive.

The new REO-130™ with its small size and quick 28 msec. speed is what the world's been waiting for in optical storage.

Each 3.5 inch disk holds 128 megabytes of valuable data, safe and secure.

You can hold the disk in the palm of your hand. You can put it in your pocket, or drop it in the mail.

If you need to distribute or archive large amounts of data, the REO-130™ is the perfect choice.

The drive system is available in both internal or external versions. Interface kits available for MAC, SUN, DEC, IBM and compatibles.

Pocket sized. Amazingly fast. Large capacity, is optical storage now.

Another first from Pinnacle Micro, the Optical Storage leader.

Call today for the name of your nearest authorized dealer.

☎ (800) 553-7070

Trademark Owners: BFO, IBM and Pinnacle Micro of Pinnacle Micro, Inc. Sun of Sun Microsystems, DEC of Digital Equipment Corp. IBM of International Business Machines Corporation. Macintosh of Apple Computer, Inc.

**PINNACLE MICRO**

THE OPTICAL STORAGE COMPANY™

15265 Alton Parkway • Irvine, CA 92718 • In CA (714) 727-3300 • FAX (714) 727-1913

Circle 252 on Reader Service Card (RESELLERS: 253)

**PS/2<sup>®</sup> MEMORY**

**Introducing OS/RAM8™.**

- ✓ 8 Mbytes of memory + 2 serial ports.
- ✓ Extended and expanded memory. LIM 4.0.
- ✓ Works with all of your programs.
- ✓ Run DOS or OS/2 effortlessly.
- ✓ Fast and simple switchless installation.
- ✓ Auto-configuration for all operating systems.
- ✓ Works in all Micro Channel™ computers.
- ✓ Expanded memory 10 times faster than Intel.
- ✓ Risk free guarantee. Two year warranty.
- ✓ IBM approved ID. Best price. Fast delivery.

**Call today 617-273-1818 or 1-800-234-4CEC**

**cec** Capital Equipment Corp.  
Burlington, MA. 01803

PS/2 and Micro Channel are trademarks of IBM

that a whole bunch of machines arrived in a series of decreasing sizes.

First was the Arche Legacy 386/33, very much a high-end machine. Ours has an 80387 math chip, 8 MB of fast memory, a 300-MB hard disk drive, both 5¼- and 3½-inch floppy disk drives, a 100-MB tape cartridge drive for backup, hardware disk caching, and a partridge in a pear tree. We set it up with the Pioneer DRM-600 and the Sound Blaster audio board.

When it came time to add a mouse—I confess that we always install a mouse now—I found we were out of mice, but there was a large trackball affair called a RollerMouse on the table, so Alex used that.

I'm not precisely sure why, but I didn't expect to like it, and I was wrong. I like it quite a bit. Indeed, if it would fit on my under-desk typing shelf, I'd consider installing it on my main machine.

The RollerMouse is Microsoft-compatible, meaning that it's a two-button mouse. In fact, it has four buttons: two big ones, which correspond to the usual mouse buttons, and two smaller ones, which activate click and drag mode, so you don't have to hold down a button to do drag operations. It takes just a bit of getting used to, but it's surprising how fast you not only learn to use this, but find it becoming natural; or at least both Alex and I found this to be true.

Naturally, Alex decided to do some extensive testing of RollerMouse compatibility, meaning that he put up Railroad Tycoon and built a big Western U.S. railroad empire. Actually, games are no bad test of mouse compatibilities; anyway, we've had this in use for a few weeks now and haven't found any problems, and we both still like it. If you're weary of rodents but need a pointing device, look into RollerMouse.

Anyway, the Arche Legacy 386/33 was the first and largest of the machines we've set up recently. Except for the Cheetah Gold 486, the Legacy is the fastest machine in the house; it's a lot faster than the Cheetah 386/25. This is a well-made, tough, sturdy, and powerful machine. You will definitely be hearing more about the Arche Legacy.

The Arche Legacy is a *big* machine, big enough to cover a desk. I gather it can be had in a tower configuration, and that might well be preferable for a machine of this size.

#### It's a Brick

The Ergo Brick is a computer you have to see to believe—indeed, some of the Citizens Advisory Council people didn't be-

operations research and systems analysis, I was taught that the major value of these disciplines was to make decision factors explicit: not just which airplane to send on what mission, but *why* this one was better than that one, or at least why we thought so. That led to some hairy fights in evaluation board meetings. I'd have much liked to have had this program available to help get out in the open precisely what each member thought was important and why.

It's a little hard to say just who needs this program. In a sense, no one does. On the other hand, anyone who's curious about the decision process, or who has to make a lot of decisions and doesn't always know why some are made the way they are, or who wants to try to build an expert system and hasn't the foggiest notion of how it's done, probably does need this.

Expert87 is unlike any other program that I've seen. Provided that you invest enough time in it to see what it's doing, and how, the payoff in your increased understanding of the decision process is likely to be worth the time and money; and you may use it to build a useful expert system to help make decisions.

#### Carpenter's Dream

Every so often I get a program that isn't fancy. Often the packaging is downright

hokey. Most such programs are worthless, but I do try to look at them, because once in a while I find one that is so good, and so useful, that I can't quite believe it.

This is one of them. It sure isn't fancy; but it sure does do what it says it will, and there's no trick to learning it, either.

Carpenter's Dream—for classroom use, there is also an expanded version called Remodeler's Dream—simply and efficiently makes all those pesky calculations that drive you nuts when you're trying to cut wood to fit a complex space. Want to put in stairs? Add a roof? Hip roof? Gables? Get this program, spend a few minutes thinking about it, and start plugging in numbers. The result will be a table of materials to buy (e.g., 21.5 sheets of plywood or 80 rafters at 16 feet each). Another part of the program calculates the sizes to cut to, exact sizes, to 1/16 inch.

Remodeler's Dream also estimates how much paint you need for a room of a given size and a bunch of other stuff.

Either of these programs will save a great deal of time and energy, not to mention wasted materials. If you're going to do construction or remodeling, get one. You won't be sorry. Recommended.

#### RollerMouse

For some reason, this seems to be the month for hardware. The odd thing is

## CHAOS MANOR

lieve it when they saw it. The Brick measures just 8 by 11 by 3 inches high; it will literally sit on a piece of letter-size paper.

Inside it is a full 386SX computer, with 1 to 8 MB of memory in standard single in-line packages (Ergo sells them for \$200 per megabyte, or you can shop around for a better price), a 44-MB hard disk drive (you can get larger ones, up to 212 MB), an optional math chip, a 2400-bps modem, an EGA/VGA port, two serial ports, an external bus port, an external power supply, and a whole mess of software all tuned up to run with the system. Ergo Computing believes in Desqview, and they have that all set up when you buy the machine: just turn it on.

The result is a machine you can carry around in a briefcase, which is what this was designed to do. Tom Spalding, Ergo's president, has a study that shows that most people use a laptop in only two or three places, and hardly ever use one while traveling. The Brick is intended to go home with you from work; to save carrying weight, you can keep a keyboard, monitor, and power supply in each location. In addition, by the time you read this, they'll have an LCD screen about the size of the computer.

The Brick looks like a toy, but it's a powerful machine, not quite the equal of the Arche Legacy or the Cheetah 386/25 I'm writing this on, but more than a match for any 286 and most 386SX machines. At 8 pounds, it's a lot less weight to carry than my Zenith SupersPort SX laptop, although that 8 pounds doesn't include keyboard and monitor.

You can buy a stripped-down Brick, but if you buy a fully loaded machine, Ergo will bundle it with a lot of software: QEMM-386 and Desqview, askSam, Borland's Sprint word processor, and the Quattro spreadsheet. It also comes with a mouse. I'm not fond of the keyboard, which has the Caps Lock next to the *A*, but we had no trouble installing a Northgate OmniKey keyboard on it.

I have had the Brick for only a few weeks, but everyone who sees it falls in love with it. We've got it set up with a Princeton Graphic Systems Ultra-14 monitor, and it fascinates visitors. The Brick isn't cheap, but if you have a kid going off to college, you might contemplate getting one of these; the 386SX will be current for another few years. Ergo has tuned up the Brick and its bundled software to be easy to use and understand (askSam will actually talk to you for a tutorial); and because the Brick is small and easily carried, it won't be any problem to move from place to place, and it

**PS/2<sup>®</sup> MEMORY**

Introducing OS/RAM32™

- ✓ 8 Mbytes of fast 32 bit memory.
- ✓ Works in all Micro Channel™ computers.
- ✓ Fast LIM 4.0 driver included.
- ✓ Provides extended and expanded memory.
- ✓ Easy switchless installation.
- ✓ Automatic configuration for DOS, OS/2 or UNIX.
- ✓ Risk free guarantee. Two year warranty.
- ✓ Accepted under IBM service contracts.
- ✓ From \$299 to \$998 with 8 Megabytes.
- ✓ "Best price performance", says PC Week .

Call today 617-273-1818 or 1-800-234-4CEC

**cec** Capital Equipment Corp.  
Burlington, MA. 01803

PS/2 and Micro Channel are trademarks of IBM

can even be carried home for the holidays. Recommended.

### MathCAD

I don't have space to do this program justice, but I wanted to mention it as a complement to the Brick: if you have a student going off to engineering school, run, don't walk, to your software dealer, get a copy of this program, and get that future engineer accustomed to using it. Engineering school math is tough, and while MathCAD can't do everything, it's amazing what it can do: not just in solving problems, but in helping you understand what you're doing.

There's a sense, though, in which liberal arts students need MathCAD even more than science majors: playing with this program is a sure cure for innumeracy, and the program is easy enough to use that if you get in the MathCAD habit, you may well find yourself playing with numbers. The program takes all the sting out of that.

Mathematica is more sophisticated and has better graphics capabilities, but for all-around usefulness, you simply cannot beat MathCAD. Highly recommended.

### Winding Down

I'm coming to the end of this column, and I haven't got started on the piles of

stuffing around here.

While we had the Arche Legacy open to receive the DRM-600 interface board, we put in a Sound Blaster board as well. This bills itself as the ultimate sound board for your PC, and for once that's not all hype.

This interface board not only plays stereo sounds such as are increasingly provided with games, but it comes with highly sophisticated software that will let you program in sound. You can make the program read ASCII files to you, for instance, and while you may have to fiddle with the spelling on complicated words, it's surprising how good you can make that text sound.

The Sound Blaster normally plays through a RadioShack speaker pair—the ones we use are their \$29.95 amplified speakers (Radio Shack part 40-1267) that run off four C batteries. I presume I could take the audio output of the DRM-600 and feed it into the Sound Blaster, and let that board run the speakers, but I haven't done that yet.

You can also play sounds into the board. It will digitize them. Then you can call those sounds back up. Have your computer talk to people in your own voice.

There's a lot more, and I hope to get to it next month; meanwhile, if you're looking at high-end sound boards for your

## ITEMS DISCUSSED

<b>Arche Legacy 386/33</b> ..... \$5625 Arche Technologies, Inc. 48881 Kato Rd. Fremont, CA 94539 (800) 422-4674 (415) 623-8100 <b>Inquiry 1151.</b>	<b>Expert87</b> .....\$495 Magic 7 Software 101 First St., Suite 237 Los Altos, CA 94022 (415) 941-2616 <b>Inquiry 1155.</b>	<b>RollerMouse</b> IBM XT, AT, and PS/2s .....\$129.95 IBM PC bus .....\$149.95 Apple II and Mac.....\$119.95 CH Products 970 Park Center Dr. Vista, CA 92083 (619) 598-2518 <b>Inquiry 1159.</b>
<b>Carpenter's Dream 3.0</b> ..... \$49.50 <b>Remodeler's Dream</b> ..... \$99 Workhorses, Inc. 805-B 14th St. Golden, CO 80401 (800) 777-2477 <b>Inquiry 1152.</b>	<b>Mass-Store Copy</b> ..... \$95 Informative Technologies 1718 M St. NW, Suite 292 Washington, DC 20036 (202) 675-4528 <b>Inquiry 1156.</b>	<b>Sound Blaster</b> .....\$239.95 <b>MIDI Connector Box</b> ..... \$79.95 <b>Voyetra Sequencer MIDI Software</b> .....\$129.95 Brown-Wagh Publishing 130-D Knowles Dr. Los Gatos, CA 95030 (800) 451-0900 (408) 378-3838 <b>Inquiry 1160.</b>
<b>The CD-ROM Chronicles</b> ..... \$18.95 Meridian Data, Inc. 5615 Scotts Valley Dr. Scotts Valley, CA 95066 (408) 438-3100 <b>Inquiry 1161.</b>	<b>MathCAD</b> .....\$495 <b>ApplicationsPacks</b> ..... \$99 MathSoft, Inc. One Kendall Sq. Cambridge, MA 02139 (800) 628-4223 (617) 577-1017 <b>Inquiry 1157.</b>	<b>United States History CD-ROM</b> .....\$395 Bureau of Electronic Publishing 141 New Rd. Parsippany, NJ 07054 (201) 808-2700 <b>Inquiry 1162.</b>
<b>DRM-600</b> ..... \$1495 Pioneer Electronic Corp. 1058 East 230th St. Carson, CA 90745 (213) 513-1016 <b>Inquiry 1153.</b>	<b>Office Star</b> .....\$199 Traveling Software, Inc. 18702 North Creek Pkwy. Bothell, WA 98011 (800) 343-8080 (206) 483-8088 <b>Inquiry 1158.</b>	
<b>Ergo Brick</b> ..... \$2495 Ergo Computing, Inc. One Intercontinental Way Peabody, MA 01960 (508) 535-7510 <b>Inquiry 1154.</b>		

PC, think hard about Sound Blaster.

There's Office Star, the small-office connectivity system from Traveling Software: it's a means for connecting LapLink or DeskLink to several computers at once, giving file transfer and printer-sharing capability up to 100 feet between machines. It works through serial ports, it's easy to set up, and, like everything else Traveling puts out, it works about the way you expect without your having to dig through manuals. More on this one next month.

Finally, there's Mass-Store Copy, a program to make copies of WORM and other optical cartridges even though you have only one WORM drive. You'll wear your arm out swapping disks to copy a really big one, of course.

This program desperately needs an EXCLUDE command; that is, copy all EXCEPT \*.BAK AND FOO.\*, as an example, because backup WORM drives tend to be cluttered up with files you don't really want to copy onto the new

WORM. We have two WORMs, on two separate machines, and use LapLink or Office Star to link them and copy from one to the other. If you don't have two WORM drives, you likely need to have this program.

The game of the Month is Centurion from Electronic Arts: you won't play it as long as you play Railroad Tycoon, but it's still fun and the graphics are great. The sound is awful, but so what.

I won't call it the book of the month, but *Falkenberg's Legion* by Jerry Pournelle is now out in paperback from Baen Books; this includes my CoDominium stories, the ones about the unlikely end of the Cold War and an uneasy alliance between the U.S. and the U.S.S.R. . . . The real book of the month is George Gilder's *Microcosm: The Quantum Revolution in Economics and Technology* (Simon & Schuster, 1989). Gilder was a bit late discovering the electronic revolution, and much of what he says won't be at all new to BYTE readers, but he does put it all

down in one place, and some of his arguments are interesting. (For a review of *Microcosm*, see the February 1990 Print Queue.)

Now it's 3:00 a.m., and Niven is due here at 11:00; we'll take a hike in the Hollywood Hills and talk over what we're doing, and we should have 4000 words done by dinnertime. *The Moat Around Murcheson's Eye is moving*. And I'm dancing as fast as I can. . . . ■

*Jerry Pournelle holds a doctorate in psychology and is a science fiction writer who also earns a comfortable living writing about computers present and future. Jerry welcomes readers' comments and opinions. Send a self-addressed, stamped envelope to Jerry Pournelle, c/o BYTE, One Phoenix Mill Lane, Peterborough, NH 03458. Please put your address on the letter as well as on the envelope. Due to the high volume of letters, Jerry cannot guarantee a personal reply. You can also contact him on BIX as "jerryp."*

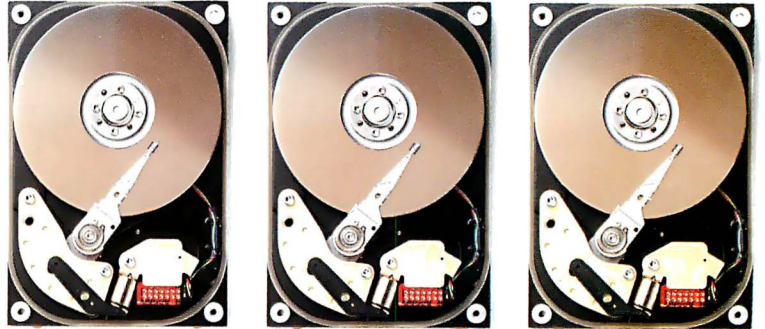
IT HAS BEEN  
BROUGHT TO  
OUR ATTENTION  
THAT NOT EVERYONE  
BELIEVES  
PORTABLE PCs  
CAN BE AS  
FUNCTIONAL AS  
DESKTOP PCs.



# THIS SHOULD



This may be hard to believe, but there really is such a thing as a portable PC that can do everything a conventional desktop can.



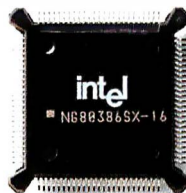
Some people can't imagine squeezing a 40,100 or even a 200MB hard disk into a portable PC. But when they take advantage of all that storage capacity, they find it hard to imagine life without it.

In fact, there's not just one, but an entire line of them. They're called Toshiba Portable Desktops™, and they'll forever change the way your company looks at power and productivity.

To get more information or a free Portable Desktop productivity survey, call 1-800-477-1616.

True, some business people may have trouble grasping the notion of desktop power in a portable, but when you give it some thought, it's the

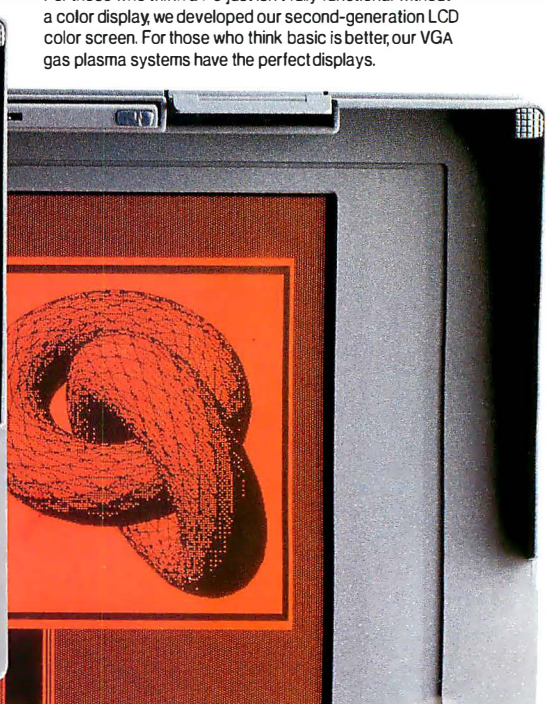
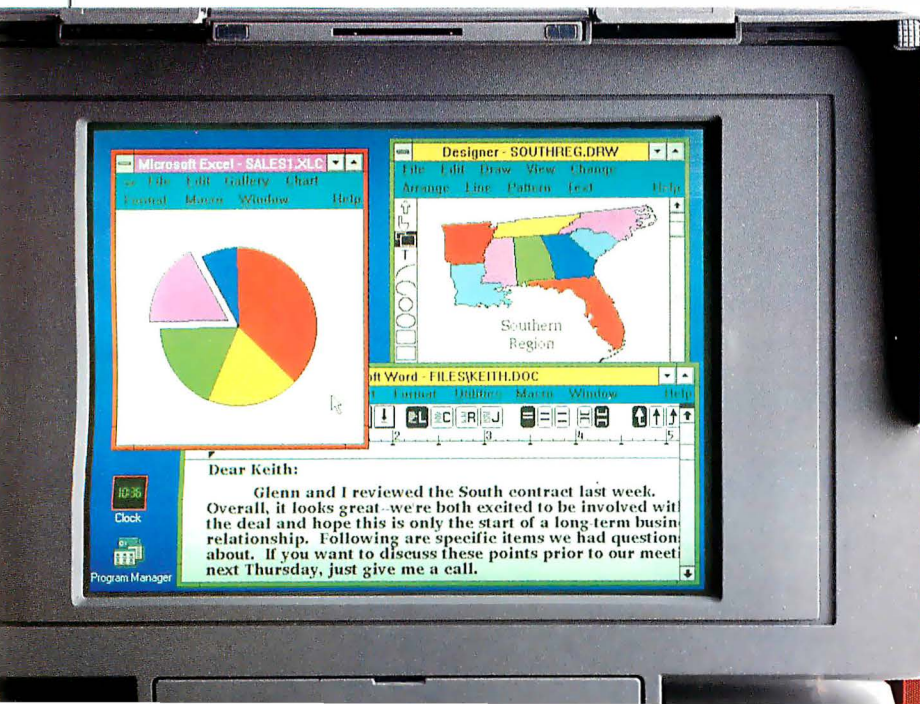
There once was a day when microprocessors this powerful were unheard of in a portable. Luckily for people who crave raw power and computing speed, that day is over.



next logical step in computers.

With 386™ and 386™SX microprocessors, our Portable Desk-

For those who think a PC just isn't fully functional without a color display, we developed our second-generation LCD color screen. For those who think basic is better, our VGA gas plasma systems have the perfect displays.





# REMOVE ALL DOUBT.



To anybody who doesn't expect a portable PC to have IBM-compatible expansion slots, we have just one thing to say. Raise your expectations.



tops run all of the same applications as your company's conventional PCs.

With hard disk

drives from 40 to 200MB, you have all the flexibility to configure a system the way you want it.

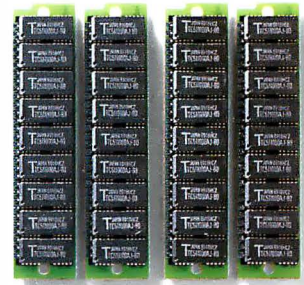


Anyone who insists portable PC users are doomed to cramped, undersized keyboards hasn't gotten their hands on a Toshiba. We use standard-size keys and standardized key spacing so your hands will feel right at home.

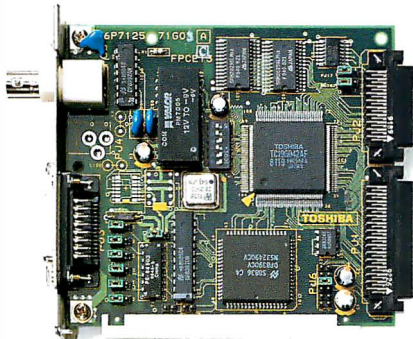
With the connectivity of our multiple expansion slots and ports, our Portable Desktops fit right in with your existing system and grow as your company grows.

And to remove the last possible barrier between your

needs and our portables, we've even designed one with a high-resolution VGA color screen.



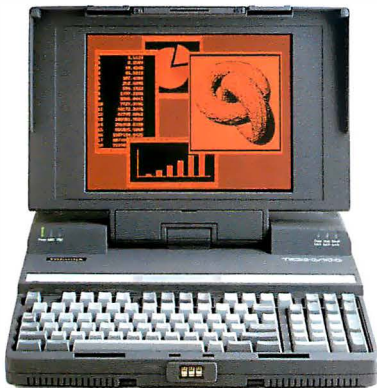
They say you can't squeeze much memory into a portable PC. But considering that our dedicated memory expansion slots let you add up to 12MB of RAM as your need for power grows, it looks like "they" were wrong again.



With an expansion slot for a LAN card, you get complete networking freedom without giving up all your other expansion slots.

In other words, it really is possible to have all the capabilities of a conventional desktop in a portable.

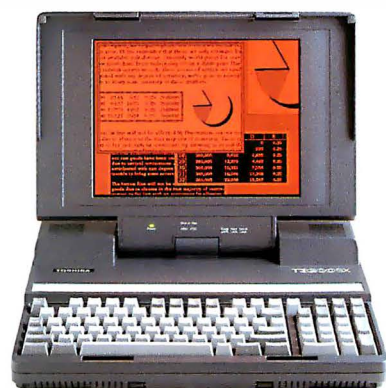
All you have to do is try one. And believe.



T5200. 386 microprocessor, 40, 100 or 200MB HDD, 2 to 14MB RAM, 2 IBM-compatible expansion slots (in addition to dedicated memory slots), VGA plasma display.



T5200C. 386 microprocessor, 200MB HDD, 2 to 14MB RAM, 2 IBM-compatible expansion slots (in addition to dedicated memory slots), VGA passive matrix color LCD display.



T3200SX. 386SX microprocessor, 40 or 120MB HDD, 1 to 13MB RAM, 2 IBM-compatible expansion slots (in addition to dedicated modem and memory slots), VGA plasma display.

# NOW THAT YOU'RE CONVINCED,



Okay, let's suppose you suddenly discover your company filled with powerful Toshiba Portable Desktops.

Now what?

First of all, your people can do everything around the office they've been doing with their desktop computers.

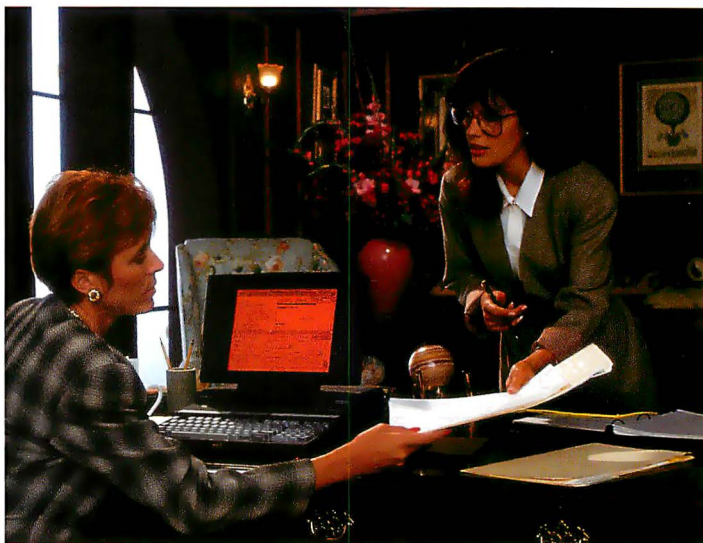
Then your key employees can turn after-hours time into productive time, since their dining room tables and breakfast nooks can serve as off-site workstations.

Your top people can add impact to their presentations with a

wealth of information and computing power at their fingertips. And the story can repeat itself—with equally impressive results—everywhere from an office 3,000 miles away to a conference room that's a mere 30 feet down the hall.



Giving your people instant access to vital information can keep them doing what they do best. Working smart.



Employees can even improve their productivity in the familiar surroundings of their own office. Only now they'll have more desk space to work with.

To get more information or a free Portable Desktop productivity survey, call 1-800-477-1616.

# WHERE DO YOU GO FROM HERE?



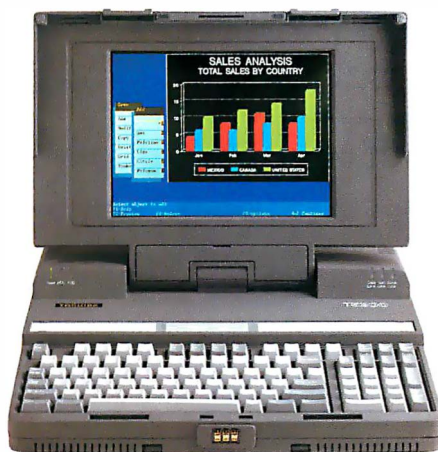
Giving your key employees a Portable Desktop means they'll have the flexibility to work when they need to, where they want to.



When people have access to computing power outside their office, presentations are more powerful and groups are more productive.

your best people can be doing a better job than they ever could when they were chained to conventional desktop PCs.

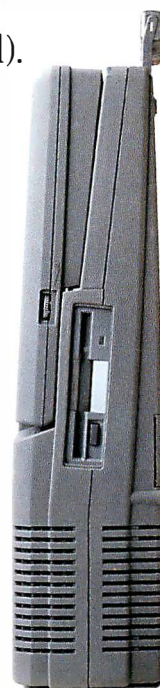
Better yet, they can do it without sacrificing power, functionality or expandability. Or anything else, for that matter.



And yes, all that productivity can even take place within the confines of your own office desk (while using up considerably less of your desk space, we might add).

All of which leads us to one very powerful observation.

Now all of



# THREE POWERFUL ARGUMENTS WHY YOUR NEXT



People said it was just a matter of time before someone built a line of portable PCs this powerful. They just didn't know it would happen so soon.

With our Portable Desktops, we've successfully combined the power and

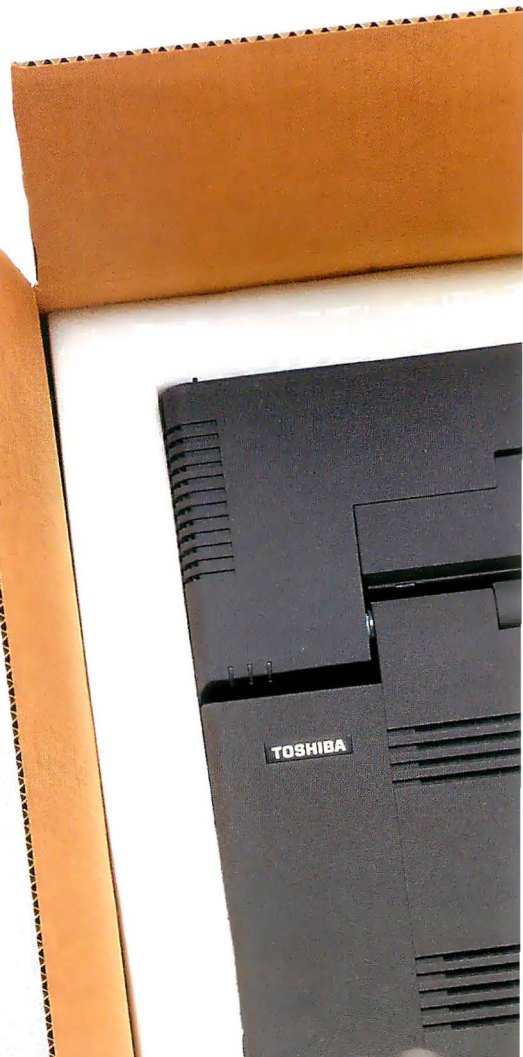
functionality of desktop PCs into slim, portable packages that give you everything you need to get ahead in business.

## T5200

18.7 pounds, 20MHz 80386 with 80387-20 coprocessor socket, 2 internal IBM-compatible expansion slots, 40MB hard disk with 25msec access or 100MB hard disk with 25msec access or 200MB hard disk with 16msec access, 2MB RAM expandable to 14MB, gas plasma VGA display with 16 gray scales, 1.44MB 3½" diskette drive.

## T5200C

18.9 pounds, 20MHz, 80386 with 80387-20 coprocessor socket, 2 internal IBM-compatible expansion slots, 200MB hard disk with 16msec access, 2MB RAM expandable to 14MB, passive matrix VGA full-colorscreen, 1.44MB 3½" diskette drive.



# DESKTOP PC SHOULDN'T BE A DESKTOP PC.

So you get the same power. The same functionality. And the same expandability it takes to keep pace with your company's needs. The big difference is that with a Toshiba Portable Desktop, you can easily

To get more information or a free Portable Desktop productivity survey, call 1-800-477-1616.

turn all that power into increased productivity. All thanks to something

no desktop PC could ever hope to offer.

The freedom to take it with you.

## T3200SX

17.0 pounds, 16MHz 80386SX with 80387SX-16 coprocessor socket, 2 internal IBM-compatible expansion slots, 1 dedicated modem slot, 5 built-in ports, 40MB hard disk with 25msec access or 120MB hard disk with 19msec access, 1MB RAM expandable to 13MB, gas plasma VGA display with 16 gray scales, 1.44MB 3½" diskette drive.



# DON'T TAKE OUR WORD FOR IT. GET A SECOND OPINION.



What do other companies know about our Portable Desktop PCs that you don't? If you had a copy of our free productivity survey, you'd know. For example, you'd know that 93 percent of portable users said that they'd never go back to using a conventional desktop. You'd know they've reported substantial increases in productivity.

And you'd know why they place so much value on the flexibility and freedom their portables have to offer. Toshiba Portable Desktops. They're no longer a matter of convenience, they're a matter of survival.

To get more information or a free Portable Desktop productivity survey, call 1-800-477-1616.



In Touch with Tomorrow  
**TOSHIBA**

Toshiba America Information Systems Inc., Computer Systems Division.



# THE POWER MAN COMETH

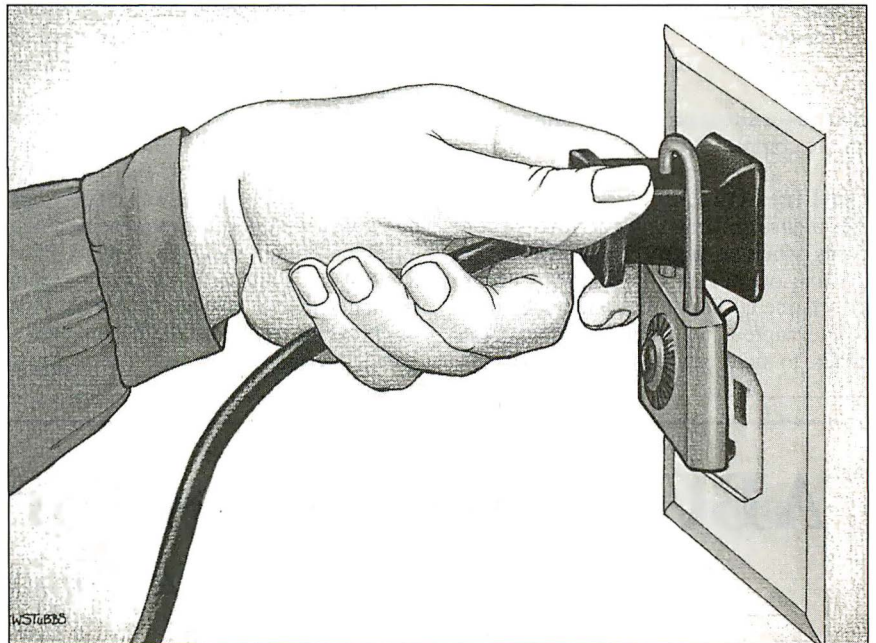
Do you need an on-line or off-line UPS to protect your LAN?

**T**here's no question that Virginia Power knows when I'm on deadline. Once before, the electric utility that serves Northern Virginia had frustrated delivery of Down to Business by parking down the street and killing the power each time I got about two-thirds of the way through my column. That was the day I discovered tape backup units. This time, though, I was ready for it.

Once again, I was well along in a project when the familiar orange truck drove up, the same crews opened access covers in the street, and the power went off. This time, though, I kept right on working. The Samsung/Novell 386AE file server kept right on running. The Gateway 2000 386/25 and the Zenith Z-386/33 kept on running, as well. Even the Telebit T2500 modem stayed connected to BIX. When the power returned 20 minutes later, I was still working, my productivity and my data unaffected.

In my office, I have the file server and the Gateway 2000 attached to a Para Systems Minuteman 1200SS uninterruptible power supply. The Zenith and the modem receive their power from a Vitec 386/LAN on-line UPS. During the time I've looked at these devices, both UPSes have supported the file server, as well as my other office equipment. This collection of devices has included the telephones, the fax machine, and (inadvertently) a laser printer.

Once upon a time, a UPS was considered an exotic piece of equipment. Mainframes used them, often in the form of a diesel generator out back, with a motor generator that used stored mechanical energy to smooth out any brief power



losses. Smaller installations used batteries and inverters, but all these devices were considered too expensive to be used with personal computers. That concept was fine, of course, until businesses discovered that they depended on personal computers as much as, or more than, they did on their mainframes.

Now, some (but not most) businesses are using UPSes to protect some of their personal computers. Now that many of these same businesses are installing LANs, the need has become greater, and the risk that businesses run by not using UPSes has likewise become greater. A network file server is more vulnerable to power loss than is an individual workstation.

## Server Vulnerability

Most network file servers are simply personal computers that have been loaded with file server software and modified by the addition of large hard disks and

some extra memory. It's not their design that makes them more vulnerable to power loss, but rather their use.

Because they support many users, file servers access their hard disks much more often than do individual personal computers. Thus, when the power goes out, there is a greater likelihood that the file server will be involved with writing information to the hard disk, or that the disk cache will contain information that needs to be written to disk.

There are times when a power loss during a disk write can trash the file server fairly effectively. Depending on the design details of the computer being used as the server, a very brief interruption may or may not be serious. Some computers can tolerate a brief flicker in the power supply; others are sensitive to any irregularity. Peripheral equipment, such as modems, are much more affected by power fluctuations. It's not unusual to see a modem go off-line due to a power

## ITEMS DISCUSSED

**Minuteman 1200SS** ..... \$1500  
 Para Systems, Inc.  
 1455 LeMay Dr.  
 Carrollton, TX 75007  
 (214) 446-7363  
 Fax (214) 446-9011  
**Inquiry 1221.**

**386/LAN**..... \$1895  
 Viteq Corp.  
 10000 Aerospace Rd.  
 Lanham, MD 20706  
 (301) 731-0400  
 Fax (301) 731-5995  
**Inquiry 1222.**

change—a situation that a computer will ignore completely.

**Off-Line? On-Line?**

An intense and ongoing controversy concerns whether engineers should design off-line or on-line UPSes. They design an off-line UPS for times when the power is interrupted and the switch to batteries needs to take place very quickly. The

idea is that if the changeover is fast enough, the equipment attached to it will never balk at the interruption.

Engineers design an on-line UPS for situations in which the battery will always supply the power. The power from the electric company simply charges the battery. When the power goes out, the battery charging stops, but you don't have to switch power supplies.

In theory, if your equipment is very sensitive to power fluctuations, then an on-line UPS is more likely to keep you operating smoothly. Most personal computers seem to be able to tolerate the brief fluctuations caused by the changeover to off-line battery power. Other devices with less hefty power supplies might have a problem, though.

In practice, however, I haven't noticed any difference between the way equipment functions on the off-line Para Systems Minuteman and the way it functions on the on-line Viteq. Despite the best that Virginia Power could do, both UPSes kept all the equipment attached to them up and running without a glitch. This might be partly due to the Minuteman's 1-millisecond switchover time. Most

equipment can't spot a power interruption that brief.

Incidentally, I was able to sustain a connection to BIX during the times when the power was off. This is a good indication that the transfer was a smooth one, because, in the past, I've found that even the smallest problem with power was sufficient to abort a modem connection.

**Amazing Grace**

Of course, in a network environment, there's more to a UPS than good batteries and a smooth transfer of power. A UPS just provides power for a relatively brief time during an interruption of electricity from the utility company. Eventually, the batteries run down and the file server is still left without power. You can extend the time that the UPS provides power by buying a larger one, but you must also spend a lot more money.

Fortunately, most network operating systems support monitoring the state of the UPS. Thus, when the power company disconnects you, the UPS will signal the network operating system, which will then signal the users and the network administrator.

*continued*

# ABC Flowcharter for Windows

*"Simply the easiest way to document procedures."*



ABC Flowcharter™ makes drawing and editing flowcharts easier than ever. It's loaded with features that help you make and edit charts in a fraction of the time needed with other flowcharting or drawing programs.

ABC Flowcharter's advanced link feature lets you break complicated procedures into smaller, more manageable steps. Just click on a shape to display a sub-chart or procedure. It's that easy.

Ask your dealer for a demonstration or call 1-800-227-0847 for more information. See for yourself why ABC Flowcharter is quickly becoming the standard flowcharting tool for the Fortune 1000. Retail price \$295.

## Roykore™

2215 Filbert St.  
 San Francisco, CA 94123  
 415-563-9175



# One Word About Your Hard Disk Controller

# SLOW

# One Word About the PSI hyperSTORE Controllers

# FAST

## *Intelligent Mass Storage Controllers*

Virtually all applications are disk bound. Today's PCs have over 60 times the power of their ancestors of just ten years ago, while hard disk performance has only just tripled. This makes mass storage the PC's worst bottleneck. PSI has eliminated this bottleneck with the hyperSTORE Caching Disk Controller, a sort of mass storage co-processor. The hyperSTORE

does for disk-intensive programs what a math co-processor does for number-crunching software. Databases, file servers, multiuser systems, and other disk-hungry applications start screaming . . . frustrated users stop screaming! Call (800)486-FAST now to find out more about PSI's line of intelligent controllers. All you have to gain is time.

### **hyperSTORE FEATURE HIGHLIGHTS**

- Data access in 0.28ms or less at 3-4MB/sec
- Works in any 286, 386, or i486 system
- Simultaneously control any drive interface: *MFM, RLL, ESDI, SCSI, or AT/IDE*
- Controls up to 28 physical disk drives
- 0KB to 20MB of SIMM-based cache memory
- Supports all PC-based operating systems: *DOS, Windows, UNIX/Xenix, Netware, etc.*
- Data mirroring option for fault tolerance
- **NO DEVICE DRIVERS REQUIRED**

# PSI

**Perceptive Solutions, Inc.**

2700 Flora Street · Dallas, Texas 75201  
800-486-FAST · 214-954-1774 · Fax: 953-1774  
*European Inquiries: 415-284-9505*

"Normally, it's a bit hard to pick the most impressive item at Comdex [Spring 1990], . . . This time it was easy, . . . the hyperSTORE/1600."  
-Jerry Pournelle, *Byte Magazine*, September 1990

"PSI has created the power user's ultimate Lego set for disk controllers: the hyperSTORE/1600"  
-Alfred Poor, *PC Magazine*, June 12, 1990

"The real-world result will be blazing record handling from within a data file as well as unstopably fast program loads."  
-Bill O'Brien, *PC Magazine*, February 13, 1990

Normally, this signal from the UPS also tells the network server to begin shutting itself down as gracefully as possible. The disk cache will be written to disk, open files will be closed, and processing will stop. You can then turn off the file server safely, or let it run down when the UPS batteries finally fade.

Monitoring is usually performed by a special card that you can install in the file server. Some Novell NetWare servers, however, can monitor the UPS

through a plug in their disk coprocessor board. In the case of the Minuteman, Para Systems provides special software that lets you connect the UPS to a serial port on the file server. The server and the UPS can communicate through the serial connection. In other words, once the file server has been shut down, the UPS can also shut itself down. Thus, it can preserve some of its power in case there's another power interruption before you can charge the UPS completely.

### Getting Charged

Most people who have LANs know that UPSes exist. Why, then, do so few protect their LANs properly? The reason, of course, is that many LAN users haven't figured out the true value of their network and the information it contains. In fact, the true value of your LAN may total almost as much as the entire value of your business.

When you figure the value of your LAN, you have to consider more than just the utility it provides. While the communications support is important, remember that after the LAN has been in use for a while, it begins to be the repository for the information your company needs to operate. Think where you'd be without your accounts receivable, your customer list, or your employee records. Spending less than two grand to protect these assets is cheap insurance.

### So Long, but Not Goodbye

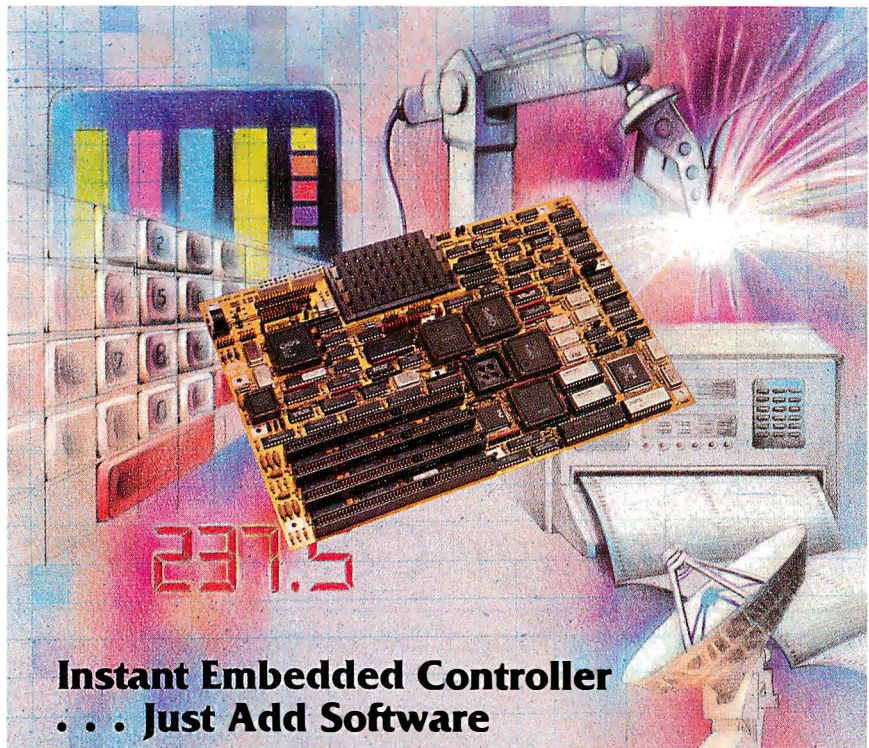
This is the next-to-last installment of Down to Business, which I've been writing for nearly three years. Don't get too excited; you're not getting rid of me that easily. Starting in March, Down to Business will be replaced by a new column called The Business Connection. I'll also be writing the new column.

This change is due to the interest you have shown in the business-related coverage in Down to Business. My new column will continue this tradition, but it will do so with an expanded format, giving you more information, more depth of coverage, and more business computing news, as well as opinions about what's happening in this environment.

One of the most exciting changes will be an expanded emphasis on the use of networks in business, especially in the rapidly growing field of enterprise computing. I hope that you will find these changes as exciting as I do. The years till now have been wonderful, and I'm looking forward to bringing you even more valuable information as BYTE's business coverage continues. ■

*Wayne Rash Jr. is a contributing editor for BYTE and technical director of the Network Integration Group of American Management Systems, Inc. (Arlington, VA). He consults with the federal government on microcomputers and communications. You can contact him on BIX as "waynerash," or in the to.wayne conference.*

*Your questions and comments are welcome. Write to: Editor, BYTE, One Phoenix Mill Lane, Peterborough, NH 03458.*



## Instant Embedded Controller . . . Just Add Software

High-level integration makes the MicroFrame 386S the perfect embedded controller. All you have to do is add software and expansion boards specific to your application. All basic system components and peripheral controllers are already on-board:

- 80386SX processor
- 80387SX math coprocessor socket
- Super VGA controller
- IDE hard disk interface
- Dual floppy disk controller
- Two serial ports
- One parallel port
- PS/2 compatible mouse port
- 512KB to 4MB of RAM
- Four AT expansion slots



Building with the MicroFrame 386S greatly reduces your design time. We've engineered in compatibility and reliability using industry-accepted standards. You can concentrate your development efforts on software.

Down time is reduced, too. Time-consuming troubleshooting is eliminated. One spare is all you need.

Backed by a five-year limited warranty, and Made in America, the MicroFrame 386S is in control. Call or write today!

**1-800-525-7661**



# WITNESS THE DAWN OF THE 9ms ERA.

## THE NEW HARDCARD II XL.

More speed, more room, more power, less price.

We developed a drive that delivers truly remarkable performance for 286/386 systems. With a price competitive to your typical, standard, everyday 28ms disk drive.

More speed. Hardcard II XL's™ 9ms effective access time<sup>1</sup> and 1.4 MB per second sustained transfer rate<sup>2</sup> mean your system runs 8 or 9 times faster than one with the typical 28ms drive.

More room. 50 and 105 MB capacity. More power to take Windows™ 3.0 and OS/2® to new performance heights.

More power. You'll literally feel the difference in your system.

It's more of everything. Except price.

For more information on your nearest dealer, call 800-624-5545 in the U.S.

and Canada. **Plus** 

INTRODUCING

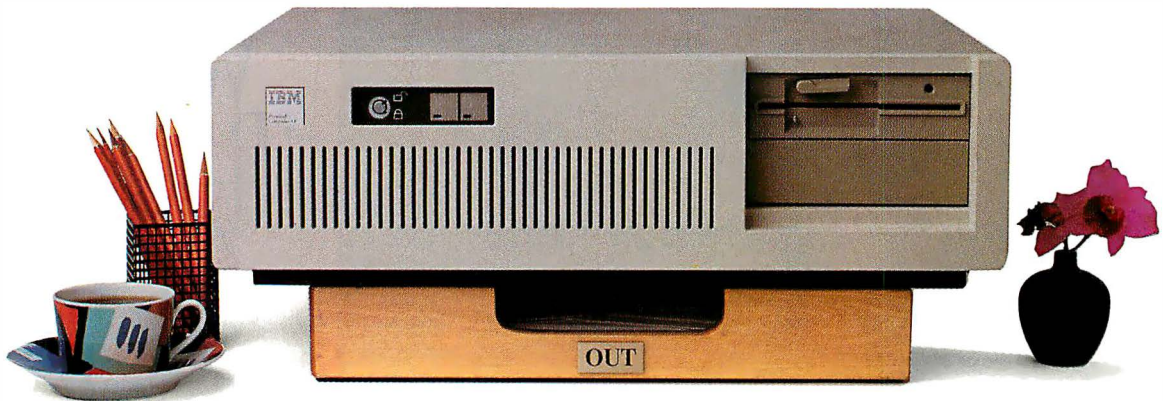
# **XL**

HARDCARD II XL

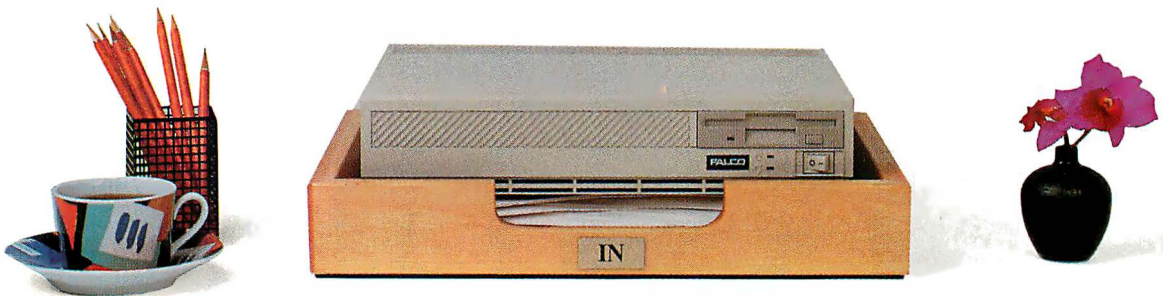
Circle 254 on Reader Service Card

1. Typical application access time using DiscCache®. 2. As measured by Power Meter on a Compaq Deskpro 386 33MHz system.  
© 1990 Plus Development Corp. Plus and the Plus Logo are registered trademarks and Plus Hardcard II XL is a trademark of Plus Development Corp. OS/2 is a registered trademark of IBM. Windows is a trademark of Microsoft Corporation.

# BIG IS OUT.



# SMALL IS IN.

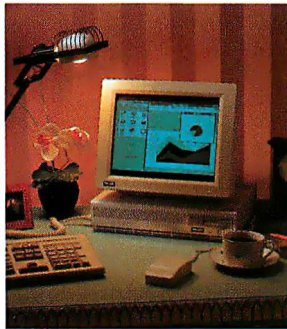


## Introducing the Falco Infinity Desktop Computer. The Smallest 386SX Desktop.

If you're sizing up desktop computers, you'll immediately see the advantage of the Falco Infinity™ Desktop. It gives you 386™SX power and performance without dominating your deskpace.

Half the size of a standard PC, the Infinity Desktop has everything you need on-board: Peripheral interfaces like disk controllers. Memory expansion. Communication ports. And VGA® level graphics up to 1024 x 768 resolution. Plus, two AT-compatible, 16-bit expansion slots.

It runs DOS™ 4.0, UNIX™, OS/2™ and Microsoft®



Windows 3.0. What's more, you can choose from four configurations, including a diskless network node and a full-featured model with 1.44MB floppy and the option of 40, 100 or 200 MB hard drive.

The only thing we left out is the noise. The Infinity Desktop runs so quietly, you'll hardly know it's on.

Whether you work in close quarters or spacious surroundings, the Falco Infinity Desktop covers all your needs. Without covering your desk. And that's about the size of it. To get one for your desk, call us today.

1-800-FALCO4U



# EMBARRASSMENT OF RICHES

## Living with Windows 3.0 and OS/2 2.0

This is a report from the future. By the middle of this year, people will be using both OS/2 2.0 and Windows 3.0. Since Windows 3.0 on a 386 and OS/2 2.0 both provide fairly stable platforms for DOS multitasking, as well as sporting a graphical user interface (GUI), there will be an obvious question of which to use. The PC trade magazines will all have cover stories about which is better.

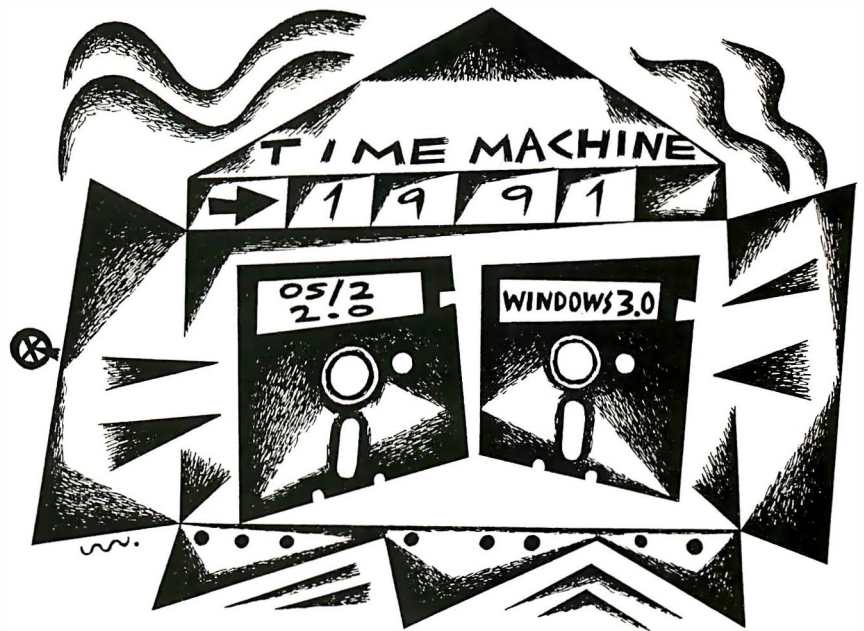
You don't see this happening now because OS/2 2.0 is still in beta testing; 99 percent of the current (September 1990) version 2.0 users are programmers.

I'm not sure why Microsoft is being so reticent about releasing OS/2 2.0—it's as stable as, if not more stable than, a good number of commercial products. In fact, I use it every day as my DOS launching pad. It's neat in that it not only lets me run my day-to-day OS/2 applications (WingZ and PageMaker, which is better under OS/2 than it is under Windows), but I can also run my DOS applications (e.g., the Q editor), either in a Presentation Manager (PM) window or a fully concurrent full screen.

### 721K-byte Free Space in DOS

But that's not all, not by a long shot. I can actually tell version 2.0 to emulate CGA video, giving my Q editor DOS session 721K bytes of memory. That means that once the Q editor is loaded, it shows me 647K bytes of free space—and recall, this is a simple DOS application that is not aware of OS/2.

Yes, yes, I know that any native OS/2 application could easily address megabytes and megabytes. But native OS/2 applications are still a mite scarce, and



besides, I already own my DOS applications. If OS/2 2.0 can let me stretch their useful lives out a bit, that's fine; it gives me a little more time while I'm waiting for the flood of OS/2 programs.

OS/2 2.0 lets you do more than tag on more conventional memory. It will *limulate*, attaching as much expanded memory to your session as you'd like. (I've seen an Extended Memory Specification emulator demonstrated, but it's not included in the beta version yet.) You can optionally copy ROMs to RAM for more speed. You can control idle detection, a feature whereby OS/2 puts inactive programs to sleep, saving CPU cycles. These are just a few of the options, and it's not finished yet.

The most amazing thing I have seen under version 2.0 is how it handles video games. Really. One sure way to find the soft parts in most multitaskers is to run highly graphical games or communications; they can stop the system dead.

I'm looking at a game called Star Control running in CGA mode as a window of about 3 by 4 inches. I can see the entire game screen, albeit reduced in size, in the window. When windowed, a graphical program does not run. But flip the program to a background full screen, and while I write this, computer-controlled armies wipe each other out. Try this with just about any other multitasker: instant lockup.

### So Why Do I Still Run Windows?

Like many of you, I hated Windows 1.0 and 2.0. I rely heavily on Micrografx Designer, however, and Designer does not run without Windows, so up to now I just grinned and bore it. But Windows 3.0, well, that's another story. You know something's different when it first comes up. Heck, I didn't even know my VGA could *make* that shade of blue! It's more than just silliness, however—the thing really is easy to look at.

*continued*

The ease of changing and storing color schemes is convenient. I use it all the time when I change to monochrome to capture Windows screens. In contrast, OS/2 just makes things harder than ever. Once you find a color scheme, you back it up by making a copy of OS2.INI, the configuration file that stores that kind of information. The OS2.INI file is kept open, however, and the file system won't even let you back it up: You've got to re-boot under DOS to copy the file.

That's my first reason for still using Windows: better aesthetics than OS/2 has. Again, the final version of 2.0 hasn't appeared yet, so I can hope that it will look as pretty as Windows.

Boy, would I be annoyed if I were an OS/2 developer! Pay all that money to develop for OS/2 and then have Microsoft drop a nicer-looking, cheaper GUI on the market. "Just trust us," Microsoft said to developers.

I still use Designer under Windows be-

cause, sadly, Designer's OS/2 version stinks. It's slow and lacks features such as auto-trace—an ideal application for memory-rich OS/2. The Windows version, on the other hand, is quick (as long as you avoid outline fonts and don't mind the bugs in the LaserJet font handling) and makes full use of the Windows 3.0 DOS extender. It can import 500K bytes of AutoCAD DXF files, although large imports are time-consuming.

Here's a case where it's a real shame that I've got to stay in Windows. Once the "importing..." box comes up, Designer is useless until the import is over. A hypothetical Designer under OS/2 could be designed to be multithreaded—one thread could handle the import while another could continue to accept and process user commands.

That's the big difference between the versions of PageMaker for Windows and OS/2. When they're run on the same machine, you end up spending more time looking at the hourglass when running the Windows version than you do under the OS/2 version. OS/2's multithreading capabilities in tandem with good OS/2 programming on Aldus's part makes the OS/2 PageMaker preferable. Sadly, the vast majority of OS/2 programs don't exploit this feature yet.

Discussion of PageMaker brings up the main sticking point for both Windows and OS/2: printing. Print a simple LaserJet graphic, and the print manager goes out to lunch. I dread printing large documents under either system, and I can't afford to outfit all my laser printers with PostScript to speed up the process.

The other reason I run Windows is memory. One of the machines on my desk has 4 MB of RAM, not enough to run the OS/2 2.0 beta version (it needs 6 MB—fear not, it's only temporary in the beta version). Under Windows, 4 MB gives me enough cushion for a 1.5-MB cache and plenty of memory left over for applications. This isn't as much of an obstacle as some writers make it out to be, however. With memory at about \$80 per megabyte, it's only laziness that keeps me from putting in another 4 MB.

Perhaps the most compelling current reason for Windows over OS/2 is its relative richness of applications. Again, both Windows 3.0 on a 386 and OS/2 2.0 will multitask normal DOS programs, but what about programs that exploit the GUI environment itself?

I end up using Crosstalk for Windows, because it's easy and I have used Crosstalk for years. It lets me do downloads while drawing with Designer, and when minimized, the Crosstalk icon even

## PC<sub>T</sub>EX Makes Your Best Work Look Its Best.

For professional publishing and the power to produce high-quality technical documents, scientific notation, mathematical formulas, and tables, rely on PC<sub>T</sub>EX to make your work look its best.

And with Personal<sub>T</sub>EX's Fontware Interface package, you have access to the complete library of Bitstream Fontware, for type selection and quality previously available only to professional typographers.

The next step beyond standard desktop publishing, PC<sub>T</sub>EX is the difference between average and expert. With PC<sub>T</sub>EX you'll get professional typesetting at amateur prices.

PC MAGAZINE wrote: "(With PC<sub>T</sub>EX)... you can achieve incredible precision in formatting text, especially mathematical expressions."

INFOWORLD said: "... No non-<sub>T</sub>EX-based program has such typographical aesthetics... enormously flexible..."

New PC<sub>T</sub>EX 3.0, with double the page-building capacity, is now available. For 386 computers, there's PC<sub>T</sub>EX/386 and Big PC<sub>T</sub>EX/386.

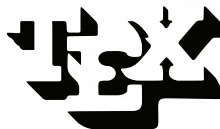
For a product catalog and free demo diskette, call

**415/388-8853. See the best for yourself.**

PC<sub>T</sub>EX is a registered TM of Personal<sub>T</sub>EX, Inc. <sub>T</sub>EX is an American Mathematical Society TM. Bitstream and Fontware are trademarks of Bitstream Inc. Site licenses available to qualified organizations. Inquire about PTI distributorships. This ad was typeset using PC<sub>T</sub>EX and Bitstream fonts.

Name	Definition
Gamma	$\Gamma(z) = \int_0^{\infty} t^{z-1} e^{-t} dt$
Sine	$\sin(x) = \frac{1}{2i}(e^{ix} - e^{-ix})$
Error	$\operatorname{erf}(z) = \frac{2}{\sqrt{\pi}} \int_0^z e^{-z^2} dz$
Bessel	$J_0(z) = \frac{1}{\pi} \int_0^{\pi} \cos(z \sin \theta) d\theta$
Zeta	$\zeta(s) = \sum_{k=1}^{\infty} k^{-s} \quad (\Re s > 1)$

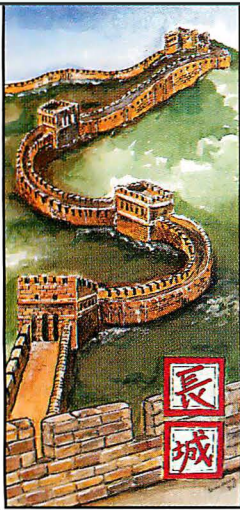
PERSONAL



INC

12 Madrona Avenue  
Mill Valley, CA 94941

Chinese characters translate as "Great Wall."



Times Change.  
The Need To Protect Doesn't.

SOFTWARE DEVELOPERS

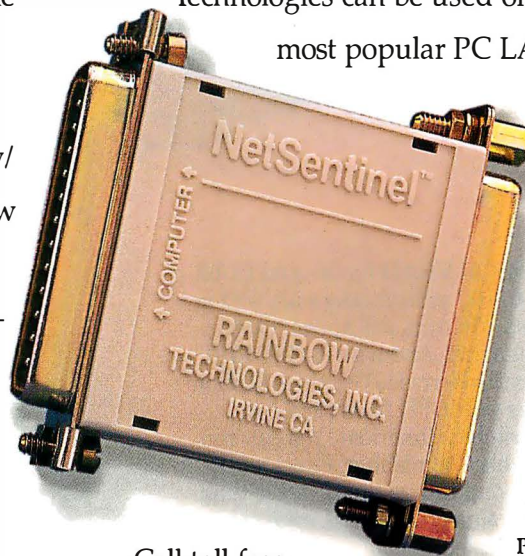
# How To Manage Your LAN Site Licenses. Every Day. Every Time.

**L**icensing software for use on a LAN used to mean "give-away." No matter what site license limits were set, there was really no way to manage actual usage of the software once it was installed on the network.

Now, with the NetSentinel™ security/license management system from Rainbow Technologies, developers can specify how many concurrent users will be permitted—with confidence that the limits will be observed.

Simply. Effectively. Economically.

Based on proven technology from the worldwide leader in PC software protection, the NetSentinel from Rainbow Technologies can be used on most popular PC LANs.



Site  
License  
Revenue  
Protection  
For LAN  
Applications.

Call toll-free  
today for more details.

With Rainbow's NetSentinel, your software need never again be a part of the "free distribution network."



**RAINBOW TECHNOLOGIES**

9292 Jeronimo Road, Irvine, CA 92718  
TEL: (714) 454-2100 • (800) 852-8569  
FAX: (714) 454-8557 • Apple Link: D3058  
Rainbow Technologies, Ltd., Shirley Lodge, 470 London Rd.  
Slough, Berkshire SL3 8QY, U.K. TEL: 0753-41512 • FAX: 0753-43610

NetSentinel is a trademark of Rainbow Technologies, Inc.  
Copyright ©1990 Rainbow Technologies, Inc.

# 24-bit Color is Just One of Our Strengths.



**The Hercules Graphics Station Card gives you the real picture and power to spare. Power to run Windows 3.0 and beyond.**

With 1024K of VRAM for 16- and 24-bit color, up to 16.7 million colors are within your grasp. Pictures will appear more lifelike than ever. And with its TI 34010 processor, the Hercules Graphics Station Card frees your CPU from time-consuming graphics functions. You can run programs like PageMaker, Excel and Corel Draw up to five times faster than the fastest super VGA card, even at 1024 x 768 resolution.

Only the Hercules Graphics Station Card combines VGA for today's applications, the TI 34010 for more power and future applications, and 16- and 24-bit color high quality photo realism. All at a surprisingly low price. Call 800 532-0600, ext. 722 for more information.

After all, 24-bit color is just one of our strengths.

**Hercules**



©Copyright 1990, Hercules Computer Technology, Inc., 921 Foster Street, Berkeley, CA 94710. Hercules and Hercules Graphics Station Card are trademarks of Hercules Computer Technology, Inc. All other product names are trademarks of their respective owners, who are not affiliated with Hercules.

Circle 132 on Reader Service Card

reports on download status.

I can scan an image into PC Paintbrush, Scanning Gallery, or a host of other programs under Windows, while there *still* isn't an OS/2 driver for my ScanJet Plus yet. And, yes, it seems a minor point, but when I'm waiting for something to finish under Windows, I'm now able to pull up Reversi and get shellacked again. I'm now putting some of my seminar presentations in ToolBook, and I plan to show them as VGA screens projected from a laptop. I sure wish there were a ToolBook for OS/2.

OS/2 should come with as many goodies as Windows does. Windows Write hasn't cost Microsoft one single Word for Windows sale—why not port Write to OS/2 and give it away with PM? Ditto Paint, Cardfile, Calculator, Terminal, and, yes, the games, too. Remember, OS/2 costs almost 10 times as much as Windows. If Microsoft is not going broke selling Windows, it certainly can bundle a few accessories with PM. Giving away a BASIC interpreter with DOS 1.0 didn't eliminate the market for compiler products—it *created* one by giving people a taste of what they could do on their PC.

Thus, I'm still between worlds. Ultimately, I'll spend more and more time in OS/2 2.0 rather than Windows. The 32-bit flat-memory structure (not available to Windows programmers) will swing the balance of program speed in its favor.

Programmers will finally figure out how to write multithreaded OS/2 code ("stamp out hourglasses in our time!"), and we will read about developers jealously speculating about the possibilities of threads for Windows 11.0. OS/2's native support of Bézier curves will mean a simpler life for those of us who are tired of having to generate (and store) megabytes of downloadable fonts. You get used to being able to name files BYTE.september.column.version.2, instead of BT0990V2.TXT; the High Performance File System is nice.

It looks more and more likely that version 2.0 will directly execute Windows 3.0 programs; that would be the best of both worlds. But for now, either Windows 3.0 or OS/2 2.0 is a whole lot better than what I had last year. ■

*Mark J. Minasi is a managing partner at Moulton, Minasi & Company, a Columbia, Maryland, firm specializing in technical seminars. He can be reached on BIX as "mjminasi."*

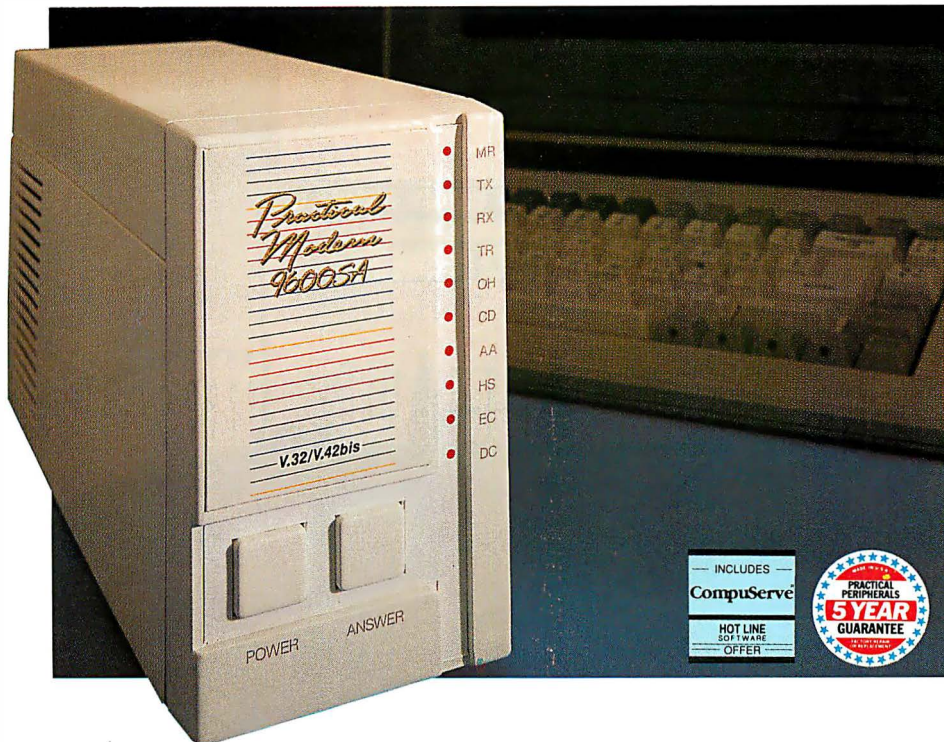
*Your questions and comments are welcome. Write to: Editor, BYTE, One Phoenix Mill Lane, Peterborough, NH 03458.*



# THE 9600 BPS V.32/V.42bis

*very Practical*

## \$699 BREAKTHROUGH



**Believe it. A true full duplex 9600 bps, CCITT V.32, V.42, V.42bis error correcting, data compressing modem for just \$699!**

The PM9600SA™ V.32/V.42bis supports high speed full duplex data transmission at 9600 bps data over common phone lines. Combined with V.42 and MNP/4 error detection and correction, V.42bis and MNP/5 data compression protocols deliver more effective throughput. In fact, automatic speed buffering allows data to flow from computer-to-modem at throughput rates up to 38,400 bps. And the PM9600SA V.32/V.42bis is compatible with the Hayes Ultra Smartmodem 9600.™ At just \$699, the PM9600SA just may be the most Practical buy in the industry...and it's backed by the Practical Peripherals 5 year guarantee: the PM9600SA performs for 5 years or we'll repair or replace it. FREE! It's that simple. That Practical.

**PRACTICAL PERIPHERALS®**

31245 La Baya Drive, Westlake Village, CA 91362. Sales Office: 1-800-442-4774  
Corporate Headquarters: 1-818-706-0333, Technical Support: 1-818-991-8200, FAX: 1-818-706-2474

All products and names trademarked are properties of their respective manufacturers.

© 1990 Practical Peripherals, Inc. All rights reserved.

Circle 257 on Reader Service Card

# UPGRADE TO

# UHC UNIX<sup>®</sup>

System V Release 4.0

**\$395**  
(713) 782-2700



Ready to move up to UNIX System V Release 4.0 on your 386™ or 486™ computer, but you've already spent a bundle on some other UNIX system?

UHC has the answer — a "4.0 Migration Package." Trade in the original diskettes for your current UNIX system and it's yours for only \$395!

UHC's 4.0 Migration Package consists of the UHC UNIX System V Release 4.0 Foundation Set, a two-user system license, on-line manual pages and a hard copy of the Installation Guide. Included in the software are the Base Operating System and 17 add-on packages, including BSD Compatibility, FMLI, FACE, Remote Terminal Utilities and XENIX® Compatibility.

The 4.0 Migration Package can be supplied on 3.5-inch or 5.25-inch floppy diskettes or 150 MB quarter-inch streaming tape.

**CALL (713) 782-2700**

# UHC

3600 South Gessner  
Houston, Texas 77063  
(713) 782-2700  
FAX (713) 782-3377

**UNIX**  
INTERNATIONAL

GENERAL MEMBER

UNIX is a registered trademark of UNIX System Laboratories, Inc. COMPAQ is a registered trademark of Compaq Computer Corporation. ESIX System V is a trademark of ESIX Computer, Inc. IBM is a registered trademark of International Business Machines Corporation. SCO and the SCO logo are trademarks of The Santa Cruz Operation, Inc. XENIX is a registered trademark of Microsoft Corporation. 386 and 486 are trademarks of Intel Corporation. 386/ix is a trademark of INTERACTIVE Systems Corporation. UHC is a trademark of U.H. Corporation.

Circle 344 on Reader Service Card



# SCO HOT

## Using PCs as X terminals, and the latest from SCO

**L**ast month's prediction about inexpensive PC-based workstations is already starting to come true, and you probably have most of the hardware right on your desk. This month I'll also take a brief hands-on look at the new and much-improved SCO Unix and a somewhat longer look at how VP/ix can keep DOS on your desk when you take the plunge into Unix.

### SCO Unix Update

Last January, I recommended SCO Xenix as a good platform for 386-based systems that didn't need true AT&T Unix compatibility because it was "extremely fast and stable." I still think that Xenix is a good, mature product that has benefited from numerous refinements over the years. But I didn't wax enthusiastic about SCO's Unix 386 product, because my experiences with it have been less than heartwarming.

However, virtually all the problems I had had with it, and some I hadn't even found yet, were solved last week when I received the latest update for SCO Unix. Officially called SCO Unix System V/386 3.2.2, it took a full year for SCO to write and test.

It was worth the wait. The new version is not only quite a bit faster than the previous version, it is almost as fast as Xenix, which is a much smaller operating system.

The kinds of improvements I found show that someone has been doing a lot of work on speeding up the internals of the kernel, since things like system calls, memory access, and disk throughput have improved markedly. The new version even supports SCSI CD-ROMs in



both High Sierra and ISO 9660 formats. They also give you more of an opportunity to relax some of the C2 security restrictions than before. (For more information on C2 security, see "Safe and Secure?" in the May 1989 BYTE.) Finally, release 3.2.2 comes with the Korn shell, a significant improvement over the regular Unix shell, which I am starting to really appreciate.

While I obviously haven't had the new Unix long enough to see whether it will stay up for a solid month without crashing, as Xenix does, it appears to be quite stable. I've been working with it carefully in an attempt to find unfixed or new bugs. What I've found instead are many small, subtle (and unheralded) improvements.

For example, there are more identical files that are delivered as links to each other, rather than copies. Also, shared libraries were used to rebuild the system's executable commands. Both of

these factors indicate a high degree of care in building the system for distribution (and, incidentally, save a great deal of disk space). It's the equivalent of a mechanic looking inside a car engine and finding stainless-steel Allen bolts instead of cadmium-plated hardware.

The only problem I have now is trying to figure out why I can no longer talk to my Telebit modem at 19,200 bps.

### DOS Good, Too

Some DOS and even Unix users might not realize it, but there is a way to move up to Unix and keep all your investments in DOS training, programs, and procedures. VP/ix, from Interactive Systems, runs on the company's 386/ix, as well as SCO Unix and Xenix. It uses the 386's built-in "virtual 8086" facility to emulate the complete IBM PC environment, including DOS 3.3.

You can simply type `vpix` at the Unix prompt to get the familiar `DOS C>`

## ITEMS DISCUSSED

**DOS/Merge**

Locus Computing Corp.  
9800 La Cienega Blvd.  
Inglewood, CA 90301  
(213) 337-5226  
**Inquiry 1004.**

**SCO Unix**

**SCO Xenix**  
The Santa Cruz Operation, Inc.  
400 Encinal St.  
P.O. Box 1900  
Santa Cruz, CA 95061  
(408) 425-7222  
**Inquiry 1005.**

**VP/ix**

Interactive Systems Corp.  
2401 Colorado Ave.  
Santa Monica, CA 90404  
(213) 453-8649  
**Inquiry 1006.**

**X-Pac**

Integrated Inference Machines  
1468 East Katella Ave.  
Anaheim, CA 92805  
(714) 978-6776  
**Inquiry 1007.**

prompt. Thereafter, for all intents and purposes, you are running DOS. You have all the commands normally delivered with DOS, including BASIC. You can also execute any Unix command from the DOS prompt, and even pipe the output of a Unix command into a DOS command (or vice versa).

If you have installed Unix properly on a system that was already running DOS,

you can switch to drive D and find that all your previous DOS files, applications, and directories are still there! Using the DOS ASSIGN command can fix even this small difference, mapping your DOS hard disk files to the familiar C drive. Then you can execute any of your commands in the normal manner, without even caring that you are running Unix. I have nicknamed `vpix` to the

name `dos`, so I can type either one of these commands.

Apart from bringing up the DOS prompt, which might be most comfortable for inveterate DOS users, you can also type something like `vpix -c 123` from the Unix command prompt. This gets VP/ix to load your DOS Lotus 1-2-3 executable immediately, so that you are literally running a DOS program from the Unix prompt. I go a step further on my system, by writing little six-line Unix shell scripts that do some housekeeping on the way in and out of DOS. Here's an example:

```
VPIXCNF="/ips/vpix/123.cnf"
export VPIXCNF
msg n
disable oki >/dev/null 2>&1
/usr/bin/vpix -c E:/123.bat
enable oki >/dev/null 2>&1
```

The first two lines set up a configuration file for VP/ix, telling it what devices will be needed by the DOS session and how to find them in the Unix file system. While it's unnecessary to create one for every application, I find it useful because I can

# Multiple-Choice



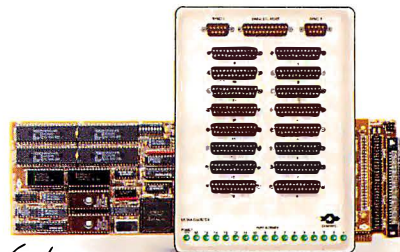
## 4-8

Our Hostess multiuser serial controllers are an excellent choice for up to eight occasional users. The Hostess 550 provides buffering for even higher performance. And for truly high performance, choose the Ultra 8.



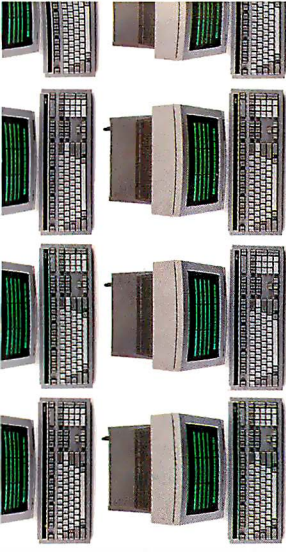
## 16

Expand up to 16 users with the Ultra 16 high performance intelligent serial controller. But if your multiuser requirements are more modest a 16 port Hostess 550 controller makes an equally intelligent choice.



## 64+

Our Ultra Cluster gives you the flexibility and power for virtually limitless growth. Starting with an Ultra 8 base board, you can expand 16 users at a time, while maintaining current levels of performance every step of the way.



## MULTIPLY YOUR CHOICES

At Control we pioneered multiuser technology. And we know that there are no single solutions to multiuser environments. That's why we offer more choices than any other company...from text to graphics...for modest users to over 64 users supported by a single PC. And we've not only multiplied your choices, we've multiplied performance, allowing you to expand without the high cost of adding computers.

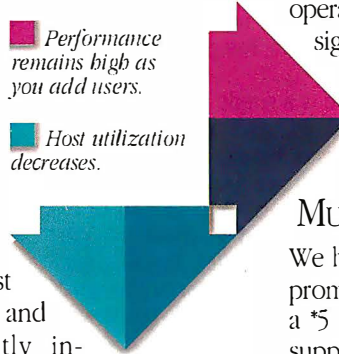
## MULTIPLIED PERFORMANCE

No company offers you more performance than Control. In fact, our new DT Express driver transforms our Ultra Series into the highest performing controllers available today. DT Express dramatically

reduces host utilization and significantly increases throughput by managing all data transmission and data transform functions on the controller. So now as you add users, no one gets caught in a wait state.

Performance remains high as you add users.

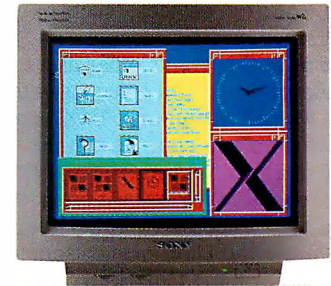
Host utilization decreases.



## MULTIVISION. FOR CHOICES BEYOND WORDS

When graphics enter the equation, MultiVision enters the picture. A fully functional multiuser system for up to 16 users, MultiVision speeds images to the screen at a blistering 100 megabits per second. As a result, you'll experience near instantaneous transmission of your graphics.

With software that enhances standard operating system graphics drivers, MultiVision is compatible with virtually any monitor, keyboard, mouse or VGA controller supported by the operating system. MultiVision can also run applications designed for the "X" environment. But unlike a LAN-based "X" terminal, MultiVision is a multiuser system that transfers data up to 100 times faster. When you compare that performance with the cost of an "X" terminal... MultiVision's advantages really compute.



## MULTIPLIED PROTECTION

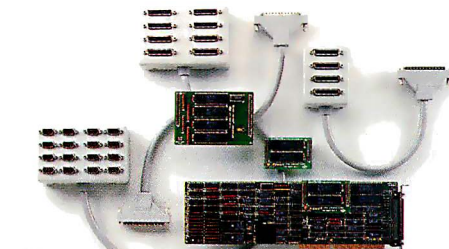
We back our products with an uncompromising 30-day satisfaction guarantee, a 5 year warranty, complete technical support, and most importantly...a company that's easy to do business with. It all adds up to the best protection plan available. And if you're a VAR, call us about our Reseller Program that provides you with options designed exclusively for your needs.



\*1 yr. MultiVision

See us at  
**UniForum**  
January 22-24, 1991  
Infomart  
Booth #3733  
Dallas, Texas

# for Multi-Users.



## Options

Our products offer serial port and memory options that are field upgradable; compatibility with ISA (AT), MicroChannel and EISA buses; RS232, 422, 485 and Current Loop interfaces and DB 9, DB 25 and RJ 45 connectors.



## Graphics

When your needs move beyond text, MultiVision moves into view--a high speed (100 megabits per second) communications controller that offers near instantaneous multiuser graphics like you've never seen before.



**Control**  
A Control Systems Company

Multiply your choices. Call Control today.  
**1-800-926-6876**

Control Corp., 2675 Patton Road, P.O. Box 64750 St. Paul, MN 55164  
© 1990 CONTROL CORPORATION. All rights reserved. All other brand names and product names are trademarks or registered trademarks of their respective holders.

Circle 69 on Reader Service Card

assign specific devices, such as laser printers, for specific purposes.

The `msg n` prevents other users from sending real-time Unix messages to my screen while I'm running a DOS application, which might confuse matters. Disabling and reenabling the particular printer-spooling device, as I do in lines 4 and 6, aren't necessary either, because you can use the Unix printer spooler as your DOS printer. Only line 5 is really required.

The beauty of this approach is the name of the shell file, in this case `/usr/local/123`. I merely have to type `123` from the Unix prompt, and I'm in the spreadsheet, without having to even know I'm working with DOS.

And what about drive E? That's another of my improvements. Drive E to DOS is mapped to `/ips/vpix`, and it's literally a directory in my Unix file system. Some versions of DOS might be limited to 32 megabytes, but drive E can be the size of my hard disk. Since all the files reside under the Unix file system, they can be backed up on tape as part of my regular backup procedure.

Even better, DOS applications benefit from the memory caching and structure of the Unix file system: Most run faster (especially file-oriented applications) and more stably than on native DOS. I've had VP/ix running for years with major applications such as Ventura Publisher (yes, even the new version with a bus mouse and extended memory), Quicken, and ArcList, a professional mailing package with 50,000 names and addresses on-line.

VP/ix isn't the only DOS solution on the market. There's a similar product called DOS/Merge from Locus Computing, which runs on other 386-based Unix systems, as well as SCO's Open Desktop. DOS/Merge's main claim to fame is that it's supposed to work as is with "foreign" devices, such as scanners: no device drivers needed.

**PCs as X Terminals**

OK, I *swear* I didn't know about this when I wrote last month's column. I predicted we'd see inexpensive PC-based workstations that could just plug into an Ethernet line and run X Window System software. So, this month I found out about X-Pac from Integrated Inference Machines.

The X-Pac is a single board that turns your normal PC (AT or higher, with EGA graphics or better) into an X terminal. The package includes a serial mouse, a serial port, 2 to 16 MB of extended memory, and an Ethernet port (both thick and thin cable). You also get a TCP/IP kernel, an Ethernet driver, an X server, and a copy of Check-It software to help set up the system.

It sounds like a lot of things to deal with, but they tell me it's been designed as a drop-in solution to the obvious problem of, "Now that we're using Unix and workstations, what do we do with all these PCs?" It works as a Windows application with Microsoft Windows 2.1 or higher, and you can set it up so that you just click on an icon, and—poof!—you're running an X terminal to Unix in a window. And, in case it's not obvious, you

still retain all the utility and software of your good old PC.

**Don't Call Me, Call Them**

It's been brought to my attention that some readers have been calling UUNET Communications Services for more information after reading last July's column. The only trouble is, they've been calling UUNET's voice line using their modems.

If you want to speak to someone at UUNET, call (703) 876-5050. To use the anonymous UUCP connection, you have to set your Unix system (in the `/usr/lib/uucp/Systems` or `L.sys` file) to call the organization at (900) 468-7727 with the log-in name of "uucp" (no password) and execute the following command on your system:

```
$ uucp uunet!/help /usr/spool/
  uucppublic
```

This will get you all the information you need. It should work at any data transfer rate, and will cost you 40 cents per minute. If you just want UUNET's fax, try calling (703) 876-5059. ■

*David Fiedler is executive producer of Unix Video Quarterly and coauthor of the book Unix System Administration. He has helped start several Unix-related publications. You can reach him on BIX as "fiedler."*

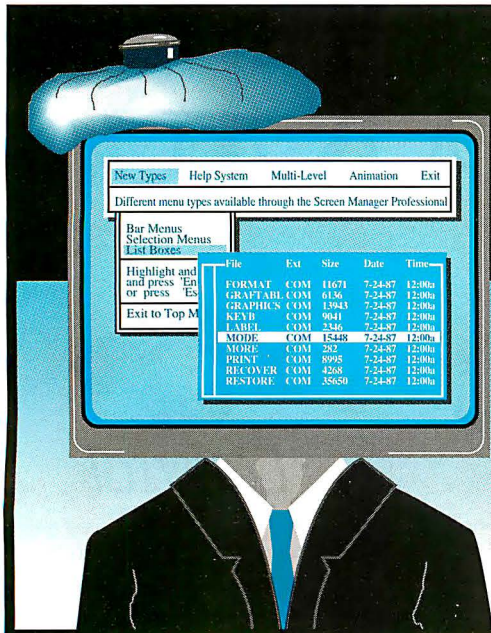
*Your questions and comments are welcome. Write to: Editor, BYTE, One Phoenix Mill Lane, Peterborough, NH 03458.*

# Avoid screen building headaches with SMP

**Screen Manager Professional, the advanced interface design library for C programmers, gives your applications:**

- Windows
- Keyboard Support
- Menus
- Context Sensitive Help
- Mouse Support
- Low RAM Overhead / High Speed

**To order SMP call: . Magee Enterprises, Inc. 1-800-662-4330**  
 Demo Available: 404-446-0271  
 BBS: 404-446-6650



Product Feature Summary	Lotus 1-2-3 Release 3.1	Microsoft PC Excel®	Borland Quattro Pro®
WYSIWYG Display	Yes	Yes	No
3D Multi-Page Worksheets	Yes	No	No
Text Styles per Sheet	100 +	4	8
Mix Text and Graphs on One Page	Yes	No	Yes
Word Wrap Around Graphs	Yes	No	No
Multiple Graphs on One Page	Yes	No	Yes
Print Multiple Worksheets at Once	Yes	No	No
Auto Compress to Print on One Page	Yes	No	No
Worksheet Zoom	Yes	No	No
Color Palette	224	8	16
Automatic Keystroke Recording	Yes	No	No
Relational Database	Yes	No	No
Virtual Memory Management	Yes	386 Only	No
24-Hour, 7 Day-a-Week Support	Yes	No	No

# Even our competition is 100% behind us.

Take a look at the chart above and you'll see what we mean. Or listen to actual comments from our customers about the new Lotus® 1-2-3®.

"The product's graphical and WYSIWYG features are great... It gives me professional-quality output with just a few keystrokes... It makes me look good... I wholeheartedly recommend it... It's a slam-dunk!"

They also love its unique way of integrating text and graphics. Its 3D capabilities. Its virtual memory

management system that lets them build larger worksheets more efficiently. Its mouse-support and formatting options. And its compatibility with Windows™ 3.0.

On the other hand, they can't say the same about other spreadsheets. Because the fact is, the new Lotus 1-2-3 is simply superior.

So call us today for a free demo disk. And see why the new Lotus 1-2-3 is already developing quite a following.

For a Free  
Lotus 1-2-3 Rel. 3.1  
Demo Disk or for  
Upgrade Information,  
please call  
**1-800-TRADE UP**  
ext. 547

## Introducing Lotus 1-2-3 **3.1**

© 1990 Lotus Development Corporation. Lotus and 1-2-3 are registered trademarks of Lotus Development Corporation. Excel is a registered trademark of Microsoft Corporation. Windows is a trademark of Microsoft Corporation. Quattro Pro is a registered trademark of Borland International, Inc.

Circle 183 on Reader Service Card

# Lease a Macintosh System for as little as \$43.<sup>43</sup>/month.

## Why You Should Buy Your Mac from CDA.

Over the last ten years CDA has worked hard to create something unique in the field of computer mail order—a company that could provide customers with the support they would expect from a local computer dealer, along with the convenience and economy of direct-order, by mail, fax or phone. Thus CDA has grown with the computer industry and, in the process, has earned a rock-solid reputation for providing superior-quality service and support. To insure you're 100% satisfied with your purchase, CDA offers a 30 Day Money-Back Guarantee as well as a full One Year Performance Guarantee on all orders.



### IBM/Macintosh Hardware

Orange 386 ..... \$1699  
DaynaFile Dual 5.25/1.2Mb ..... \$699  
Dayna Translation Software ..... \$89  
AccessPC by Dayna ..... \$85  
Soft PC by Insignia ..... \$129

### Printers (cables included)

Apple LaserWriter IINT ..... \$3395  
Personal LaserWriter NT ..... \$2475  
QMS PS 410 ..... \$2199

### Scanners

Microtek MSF 300GS w/SCSI .. \$1559

### Modems

DoveFax Desktop ..... \$279  
DataLink Mac Internal (Mac II) \$199

### Monitors

Mega Graphics 19" Rival ..... \$1199  
Magnavox 14" Color RGB ..... \$459  
E-Machines T-16 w/card ..... \$2149  
Ikegami 20" Trinitron w/card \$2799  
RasterOps 19" Trin w/card .... \$4569

*Please call for our complete list of Macintosh hardware & software.*

*Purchase Orders Welcome.*

Fax: (908) 832-9740 Ad#50-01  
In NJ/Outside US (908) 832-9004

US/Canada 800-526-5313

### Macintosh Classic System

- Macintosh Classic w/40 Mb Apple Hard Drive, Apple SuperDrive, Keyboard, Mouse, & 2 Megabytes of RAM
- HyperCard and MultiFinder
- Virex (anti-virus) Software
- Adobe Type Manager
- 6 Outlet Surge Protector
- 10 Diskettes
- Diskette Storage Box
- Mouse Pad

Ask for Package #9101

**CDA Price \$1,539**

**Only \$43.<sup>43</sup>/month\***

\*Based on 48 month FMV lease

### Macintosh IIsi System

- Macintosh IIsi CPU w/40 Mb Apple HD, Apple SuperDrive, and 2 Megabytes of RAM
- Microphone
- DataDesk Switchboard
- Magnavox 14" RGB Monitor
- HyperCard and MultiFinder
- Virex (anti-virus) Software
- Adobe Type Manager
- 6 Outlet Surge Protector
- Mouse Pad
- 10 Diskettes
- Disk Storage Box

Ask for Package #9110

**CDA Price \$3,769**

**Only \$90.<sup>23</sup>/month\***

\*Based on 60 month FMV lease

### Macintosh IICI System

- Macintosh IICI CPU w/built in Video Card, Microtech Nova 105 Mb HD Apple SuperDrive, & 4 Megabytes of RAM
- Magnavox 14" Color Monitor
- DataDesk SwitchBoard
- HyperCard & MultiFinder
- Virex (anti-virus) Software
- Adobe Type Manager Software
- Norton Utilities Software
- Total Recall Software
- Demo of Microsoft Excel
- 10 Diskettes
- Disk Storage Box
- Mouse Pad
- 6 Outlet Surge Protector

Ask for Package #9107

**CDA Price \$5,969**

**Only \$142.<sup>41</sup>/month\***

\*Based on 60 month FMV lease

# CDA Computer Sales

1 CDA Plaza, P.O. Box 533 Califon, NJ 07830  
Apple Macintosh & LaserWriter are registered trademarks of Apple Computer Inc.



# THE MAC AND PERSONAL PROGRAMMING



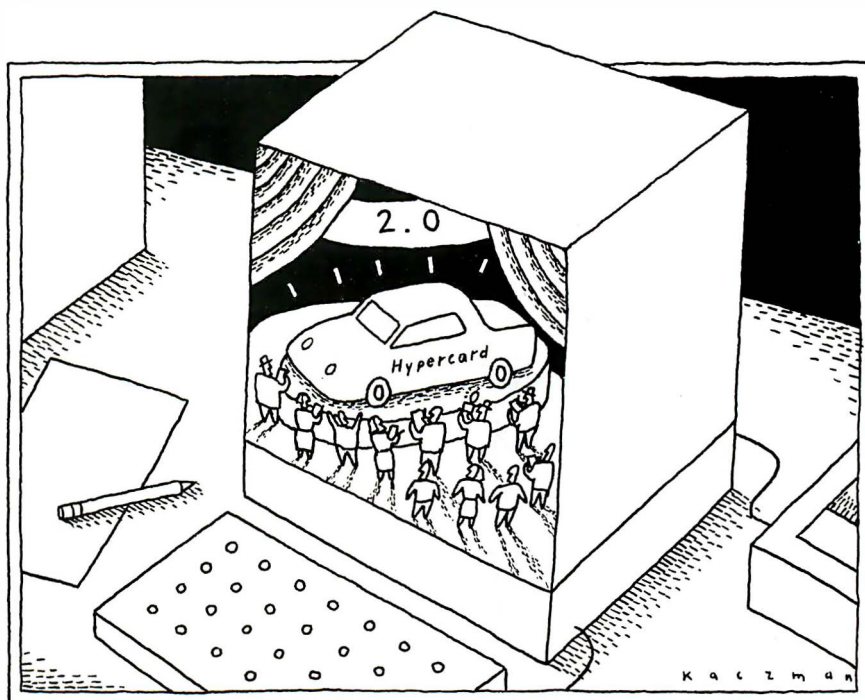
With HyperCard 2.0, users finally get the support they need

**B**y now the dust surrounding the introduction of HyperCard 2.0 has finally settled. Naturally, Apple couldn't upgrade its best software without stirring up a tempest in a teapot. All the hullabaloo that "Apple had abandoned its customer base" when it turned over the development and marketing of HyperCard to Claris has now calmed—and the truth is out. HyperCard 2.0 is so much better than version 1.2.5 that it's hard to understand how we got by using that earlier release.

Here are the facts, then, to clean up this controversy. Apple is still bundling "real" HyperCard 2.0 (i.e., you can write and edit scripts in HyperTalk) with every Mac sold. The only difference between the HyperCard 2.0 you buy from Claris (\$49 if you're upgrading from a previous version; it costs more for new customers and less for site licensees) and the bundled version is the support material, not the HyperCard 2.0 binary.

Apple has stripped down its giveaway version to fit on a single 1.44-megabyte floppy disk and packaged it with a slim 30-page getting-started manual. Apple has also hidden scripting from novices, so that you have to explicitly turn on user levels 4 and 5 (i.e., authoring and scripting). Otherwise, it's the same. Identical.

Claris's version 2.0 meets the needs of HyperCard programmers much better than earlier Apple versions. It has five floppy disks of help and support stacks, three big manuals, the official guide to scripting, and Claris's free and first-rate telephone customer support. Apple was ill-equipped to handle this support element on its own, and it's the biggest reason that serious HyperCard program-



mers have reason to rejoice, even if what used to be free now costs a few kopecks. Real software, with real support, has a nasty habit of costing real money.

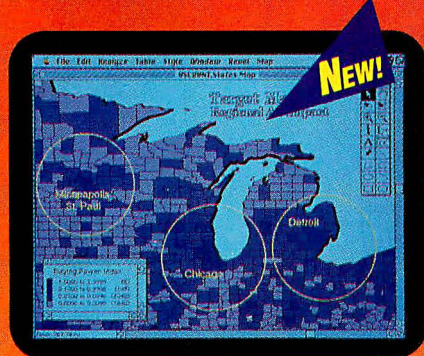
How good is HyperCard 2.0? Extremely fine, thank you very much. It's made me forget about pretenders to the throne of personal programming tools (e.g., Plus, ToolBook, and SuperCard). Sure, there are still things those systems can do that HyperCard 2.0 can't. But HyperCard has a momentum built up that's hard to stop, and version 2.0 helps reestablish that momentum. Consider the following version 2.0 improvements:

- An optimized file format makes stacks smaller and better behaved. (Earlier stacks require a conversion that is *not* backward-compatible.)
- Support for variable card sizes, ranging from 64 by 64 pixels up to 1280 by 1280 pixels in 32-pixel increments.
- Multiple, resizable, and scrollable card windows that follow the standard Macintosh document window style. You can open up to 17 stacks simultaneously.
- Styled fields that hold text of multiple fonts, sizes, and styles.
- Hot text—the ability to respond to a user's interaction with text within a field.
- A group text style that "glues" together words or characters within a script. This prevents a text string from being misinterpreted as several separate commands.
- A dramatically improved printing scheme (including individual field printing), which means you don't need third-party add-ons like Reports anymore.
- A HyperTalk "compiler." This is actually an incremental compiler that converts scripts into executable code. No stand-alone application is

# SEE YOUR DATA!



New MapInfo for Windows™ and MapInfo for Macintosh™ can find, display, and analyze your data geographically. Overlay data directly from spreadsheets, databases and ASCII files onto maps—from worldwide to street level. We can even supply maps and data for the entire U.S. Street maps, ZIP codes, counties, demographics, and more.



Work with your data in three ways: on maps, graphs, and in traditional rows and columns. Use the built-in SQL querying tools to perform powerful analyses. And now, you can share data across platforms. MapInfo looks and acts the same on Windows and Macintosh.

Now, there are more ways than ever to see your data with MapInfo. Whatever your platform—DOS, Windows™ or Macintosh®—MapInfo can help you see patterns, trends, and opportunities you may have otherwise missed.

## MapInfo® Corp.

Changing The Way The World Looks At Information®

200 Broadway Troy, NY 12180

Call 1-518-274-8673 or 1-800-FAST-MAP  
for a reseller near you.

MapInfo and Changing The Way The World Looks At Information are registered trademarks of MapInfo Corp. Others are trademarks of their respective owners.

## MACINATIONS

generated. You still need HyperCard to run a stack, but the compiled scripts run much faster than the old interpreter mechanism did.

To go with the compiler, you get a real script editor (actually, it's an XCMD) and an interactive debugger—complete with script checkpoints. These checkpoints can be made temporary or permanent, depending on your development needs. You can also peek at each message as it's generated with the Message Watcher; likewise, you can watch variable values change with the Variable Watcher. HyperCard 2.0 implements

**P**erhaps the most important change to HyperCard 2.0, helping it reclaim its position as the top personal programming tool, is user-definable message inheritance.

both watchers as external windows that look something like stripped-down message and variable inspectors.

Perhaps the most important change to HyperCard 2.0, though, and the one that helps it reclaim its position as the pre-eminent personal programming tool, is user-definable message inheritance. Unlike the previous versions, where you couldn't touch the cast-in-concrete inheritance path of HyperCard stacks, you can now insert your own stacks into the inheritance path that work the same way as the Home stack.

This way, these new stacks can make their stack scripts and resources available to any other stack in the path. The new HyperTalk command, `start using`, does this simply:

```
on openStack
```

```
start using stack ' 'Don's hard  
disk: My Test Stack ' '
```

```
end openStack
```

Similarly, you can remove a stack from the inheritance path with the `stop using` command:

```
on closeStack
```

```
if the stacksInUse contains ' 'My  
Test Stack ' ' then stop using stack  
— ' 'My Test Stack ' '
```

```
end closeStack
```

You can insert only 10 stacks this way.

HyperCard 2.0, you should note, is still just object-like, not a true object-oriented-programming (OOP) system. It still lacks polymorphism and unrestricted inheritance. Also, encapsulation can be violated as you see fit. And don't expect to find anything like true Class, Methods, or Object Browsers.

Still, HyperCard 2.0 has come a long way since its version 1.0 days. HyperCard 2.0 isn't Smalltalk or C++, and I'm glad it's not. It's much easier to use than these OOP languages, and you get some personal Mac programming done quickly.

Kudos to Apple for finally getting it out the door and into our hands. I look forward to many new services, special versions, and accessory stacks, now that Claris has taken over HyperCard's development. Stay tuned.

### Tips of the Month: Healthy Disks and Good Software

Several months back, I reported on a useful utility for keeping track of all the files on your hard disk—On Location. This program, which functions as a start-up INIT and is controlled by a desk accessory (DA), keeps an active index of all your files, updating itself in the background when necessary.

The beauty of this active index becomes clear the first time you use it. It's much faster than the mediocre Find File DA that Apple supplies, and it lets you search your files both by filename and file contents. The string-searching capabilities of On Location make it easy to find the exact file you want by zipping through their collective contents incredibly quickly.

Despite all its capabilities, On Location 1.0 was a flawed product. The most serious flaw was the unpredictable failure of indexes when you tried to use them. Since it could take On Location a few hours to generate a new index from scratch (for a big disk), you can imagine just how inconvenient this made using the software.

I'm happy to report that version 1.0.2,

# JMP™ to a Higher Level of Discovery

## With JMP Software for Statistical Visualization

Make a quantum leap in data analysis with JMP software for your Apple Macintosh®. JMP combines traditional statistics with today's most innovative graphics.

### Discover more.

▲ Fit regression and Analysis of Variance models, but see them in a new way with leverage plots, showing how each point contributes to each hypothesis test. ▲ Fit means, but see the significance of their differences visually with comparison circles. ▲ Analyze high-dimensional data and extract principal components, but see both the points and variables in the same graph with a biplot, one that spins in 3D. ▲ Examine a correlation matrix, but see more with a matrix of scatterplots with density ellipses. See high-dimensional outlyingness of points with Mahalanobis distance plots. ▲ See your data always displayed in a familiar spreadsheet grid.

### Interact more.

▲ Point and Click to view, edit, or manipulate your data...to get an analysis...to identify points...to customize...to get context-sensitive help...to choose colors and marker symbols for your points in every graph. ▲ Point and Click on a calculator panel to make formulas for variables. ▲ Point and Click on your data in one graph, and the corresponding points will be highlighted in all the other graphs instantly. ▲ Click and Drag to change the intervals for histograms instantly...to spin your 3D graph smoothly in real time...to resize any graph. Cut and Paste your data within JMP or to other applications. ▲ Cut and Paste reports to other applications or journal them to a file.

### Understand more.

▲ JMP is simple to use, so you can spend your time studying your data, not your software. ▲ JMP presents statistical results visually, so you are always

looking at graphs as well as numbers, finding patterns, and noticing points that don't fit patterns. ▲ JMP organizes its statistical methods in a unified way. You approach your data more directly with fewer frustrations regarding the statistical recipes. You always have a method that takes into account the variable's measurement level: nominal, ordinal, or interval.

MacWEEK says "JMP is powerful and easy to use. The programmers' delight in writing JMP is evident throughout and makes the program intuitive and a pleasure to use."

### A Free Video Preview

For a free video preview of JMP, call our JMP Sales Department at (919) 677-8000. In Canada, call (416) 443-9811. Or, write us at the address below.

 **From SAS Institute Inc.,  
the number one name in data analysis software.**

SAS Institute Inc. □ JMP Sales Dept.  
Box 8000 □ SAS Circle □ Cary, NC 27512-8000  
Phone (919) 677-8000 □ Fax (919) 677-8123

To use JMP, you need an Apple Macintosh with 1+ meg, 2 meg recommended.

JMP is a trademark of SAS Institute Inc., Cary, NC, USA.  
Apple and Macintosh are registered trademarks of Apple Computer, Inc.  
Copyright © 1990 by SAS Institute Inc. Printed in the USA.

# CD-ROM



**NEW!**

**Guaranteed  
Lowest Prices!**

## U.S. HISTORY ON CD-ROM

Full text of 107 U.S. History books  
with 1,000 images, tables & maps!

A Partial List of the books on this disc include:

- |   |   |
|---|---|
| A Century of Photographs, 1846-1946                         | History of the Women Marines                  |
| Air Force Combat Units of WWII                              | Iran-Contra Affair                            |
| Air Force Heroes in Viet Nam                                | Liberation of the Nazi Concentration Camps    |
| American Military History                                   | Manhattan: The Army and the Atomic Bomb       |
| America's Habit: Drug Abuse                                 | NASA, the First 25 Years                      |
| Apollo Expeditions to the Moon                              | On the Treadmill to Pearl Harbor              |
| Aviation in the U.S. Army                                   | Our Country, Volume 1: B                      |
| Bicentennial of the Constitution                            | Pearl Harbor: Why, How, Fleet Salvage         |
| Biology, Medicine and the Bill of Rights                    | Science, Technology and the First Amendment   |
| Black Americans in Defense of Our Nation                    | SkyLab, Our First Space Station               |
| Brief History of the American Labor Movement                | Story of the U.S. Patent and Trademark Office |
| Dept. of Defense: Dictionary of Military & Associated Terms | U.S. Budget in Brief, 1989                    |
| Eruptions of Mount St. Helens                               | U.S. Marines in Vietnam                       |
| Ethnic Heritage and Language Schools in America             | Viet Nam: From Cease Fire to Capitulation     |
| Exploring the American West                                 | Viet Nam: 10 Years Later                      |
| Ford's Theatre  | Watergate: The Nixon Tapes                    |
| Framing of the Federal Constitution                         | Wilderness Movement and the National Forests  |
| Gettysburg  | Wright Brothers                               |

U.S. History on CD-ROM disc \$395  
Pioneer Minichanger & U.S. History (save \$300) 1499

## 6 Disc CD-ROM Jukebox

Pioneer DRM-600 Minichanger

Complete CD-ROM drive kit, latest in CD-ROM technology, holds 6 CD-ROM discs for instant access \$1389

Buy the Minichanger, and SAVE \$\$\$ on these best selling CD-ROM titles

	regular	w/drive
Microsoft Bookshelf all time best selling title	\$229	\$149
Grolier's Encyclopedia 21 volumes, VGA pics	\$345	\$279
Birds of America includes pictures and sounds	\$99	\$79
Between Heaven & Hell II even stranger	\$99	\$79
U.S. History on CD-ROM 107 books, 1,000 pics	\$395	\$110

### CD-ROM Drives (ready to run)

Hitachi Drives- all models, PC and Mac	Call
NEC CDR-72 or 82 CD-ROM Drive ext.Int., PC & Mac	Call
Sun Moon Star CD-ROM Drive Bundle with 7 discs	Call
Philips CM50 CD-ROM Drive complete PC kit	\$489
800 MEGABYTE WORM less than \$0.18 per MB!	3495

Also: Denon, Chicon, & Sony drives, Best Price - Call!

### MIS / DP & Programmers

C Library or Ada or Shareware Grab Bag	\$89
PC-Sig Library new edition, version 8	465
Computer Library essential for MIS & PC managers	760

### Libraries and Science

McGraw-Hill Ref. Ser. 100,000 terms; 7,300 articles	\$245
Wordcruncher Disc entire works of 8 authors	249
Oxford English Dictionary over 250,000 headwords!	889
Medical Year Book on Disc full text of 1989 Year Books	195
Pediatrics on Disc 5 years of journal Pediatrics, 1983-89	395
Oxford Textbook of Medicine general medical reference	595

### Miscellaneous

Movie Directory Database/Software Potpourri	\$49
Sherlock Holmes or Shakespeare on Disc "complete"	99
CIA World Fact Book perfect for international "business"	99
World Atlas color maps and statistics throughout world	Call
Sporting News Baseball CD a sports fans dream	234
Guinness Book of World Records Multi-media PC & Mac Call	995
Telephone Directory East or West	Call

**\*\* MORE! Over 300 different titles available \*\***

Free CD-ROM Product Guide with every order  
Money back guarantee. Free tech support



## Bureau of

**Electronic Publishing, Inc.**

Dept. P, 141 New Road, Parsippany, NJ 07054  
Fax # 201-808-2676

**Call: 1-800-828-4766 orders only  
(201) 808-2700 information**

## MACINATIONS

### ITEMS DISCUSSED

**HyperCard 2.0**  
(Authoring version, a \$49 upgrade from any previous version.)  
Claris Corp.  
5201 Patrick Henry Dr.  
P.O. Box 58168  
Santa Clara, CA 95052  
(408) 987-7000  
**Inquiry 1146.**

**HyperCard 2.0**  
(Bundled version that lacks authoring manuals or example stacks; free with any Mac.)  
Apple Computer, Inc.  
20525 Mariani Ave.  
Cupertino, CA 95014  
(408) 996-1010  
**Inquiry 1147.**

**Nisus 3.01** .....\$395  
Paragon Concepts, Inc.  
990 Highland Dr., Suite 312  
Solana Beach, CA 92075  
(800) 922-2993  
(619) 481-1477  
**Inquiry 1148.**

**Norton Utilities for the Macintosh 1.0** ..... \$99  
Symantec Corp.  
10201 Torre Ave.  
Cupertino, CA 95014  
(800) 441-7234  
(408) 253-9600  
**Inquiry 1149.**

**On Location 1.0.2** .....\$129.95  
(Free to version 1.0 owners.)  
On Technology, Inc.  
155 Second St.  
Cambridge, MA 02141  
(617) 876-0900  
**Inquiry 1150.**

which is available free to all version 1.0 owners, fixes this damaged-index problem without any apparent side effects. If you own version 1.0 and haven't received your free upgrade yet, call On Technology to get fixed up right away.

Despite On Location's handy indexing prowess, keeping your hard disks organized and in good shape often requires more help. Over the last few years, I've put utilities like Disk First Aid, Symantec Utilities for Macintosh (SUM) I and II, and Mac Tools to good use in keeping my disks optimized or repairing ones that died.

This past summer, though, I needed something different: I tried to resurrect a Mirror Technologies 130-MB hard disk drive that had bellied up two years ago. All my old favorite utilities failed to revive this beast, until I found help from an unlikely source: Norton Utilities for the Macintosh. Although Peter Norton Computing is now owned by Symantec, Norton Utilities for the Macintosh offers different solutions to fixing disks than does SUM II.

In my case, I used the Format Recover, FileSaver, and Unerase utilities to recover a substantial portion of the old files (all MacWrite 4.6 and Microsoft Word 1.05 files) from the Mirror Technologies drive, which I quickly transferred to a brand-new GCC Technologies HyperDrive 430S.

I'll be putting Norton's other utilities to the test over the coming months. For

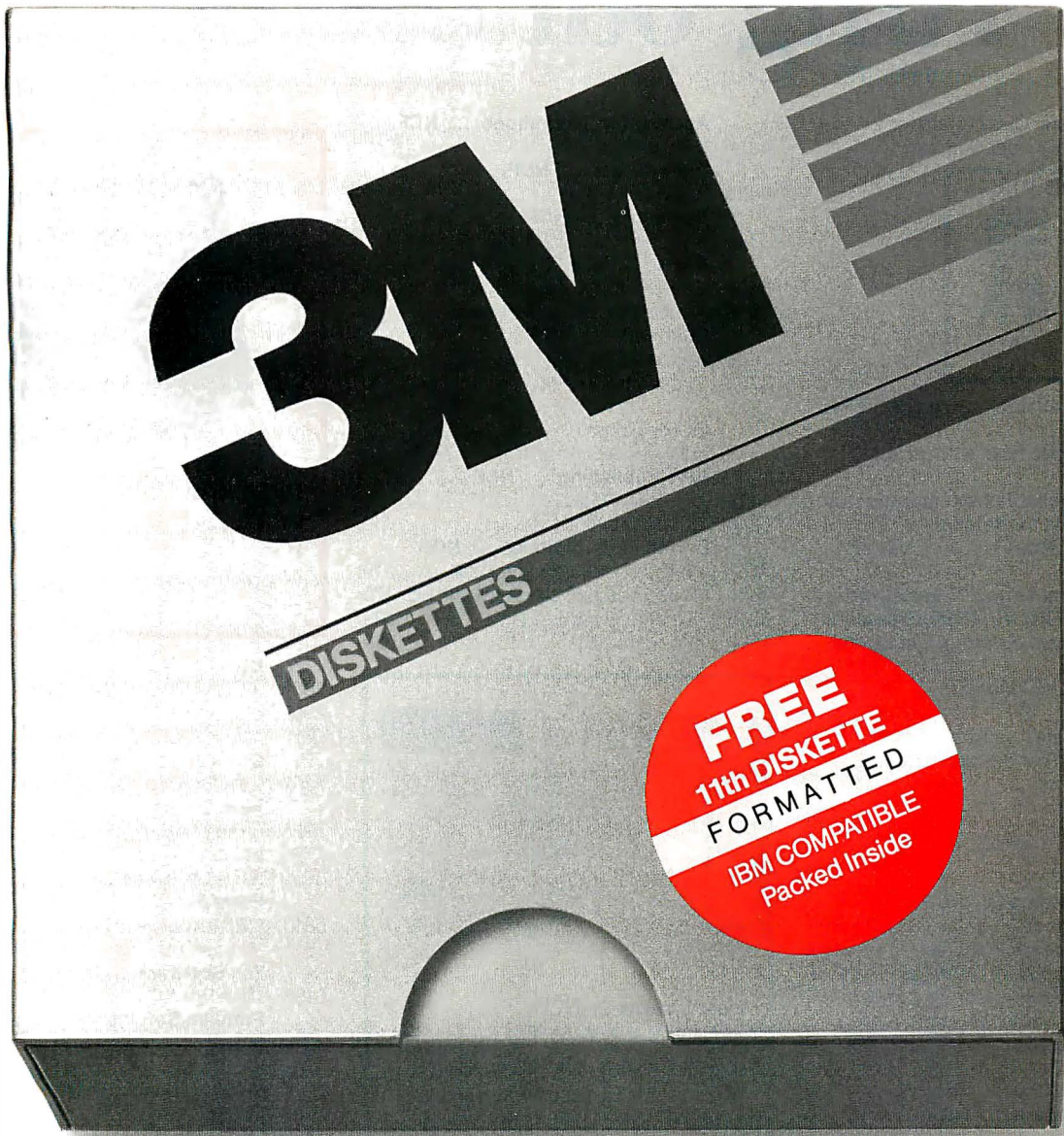
now, Norton has my thanks for letting me excavate "ore" from a mine I thought was long played out.

Finally, I've got good news for Nisus advocates. Nisus is fast, extensible, and programmable. It has a superb grep facility, and it even has good desktop publishing capabilities, if you have a need for such things. But it's never been perfect. Now, with version 3.01, perfection is several steps closer.

Nisus 3.01 fixes a slew of nagging little bugs, including some screwy screen updating, and it revamps the menus and ruler layout. George Lewak, Paragon Concepts' president, led the redesign. He has done a great job of listening to his die-hard customers by adding important new features and modifying the interface without stripping Nisus of its originality. If you'd like to try a word processor that doesn't forget that dealing with words is the first thing to get right, you should check out Nisus. ■

*Don Crabb is the director of laboratories and a senior lecturer for the computer science department at the University of Chicago. He is the author of a new book, Using Filemaker Pro (Simon & Schuster/Brady Books). He is also a contributing editor for BYTE. He can be reached on BIX as "decrabb."*

*Your questions and comments are welcome. Write to: Editor, BYTE, One Phoenix Mill Lane, Peterborough, NH 03458.*



# Shrewd business.

You can save time and money when you buy specially marked boxes of 3M diskettes.

Buy 10. Get 11. Not only do you get a free formatted\* diskette, you'll also get a chance to see how a formatted diskette can

save time without disrupting your work.

Think of your free, formatted diskette as one way to increase your productivity or your return on investment. Either way, it's shrewd business.

\*Formatted for IBM PCs and compatibles. May be reformatted for non-IBM compatible computers.

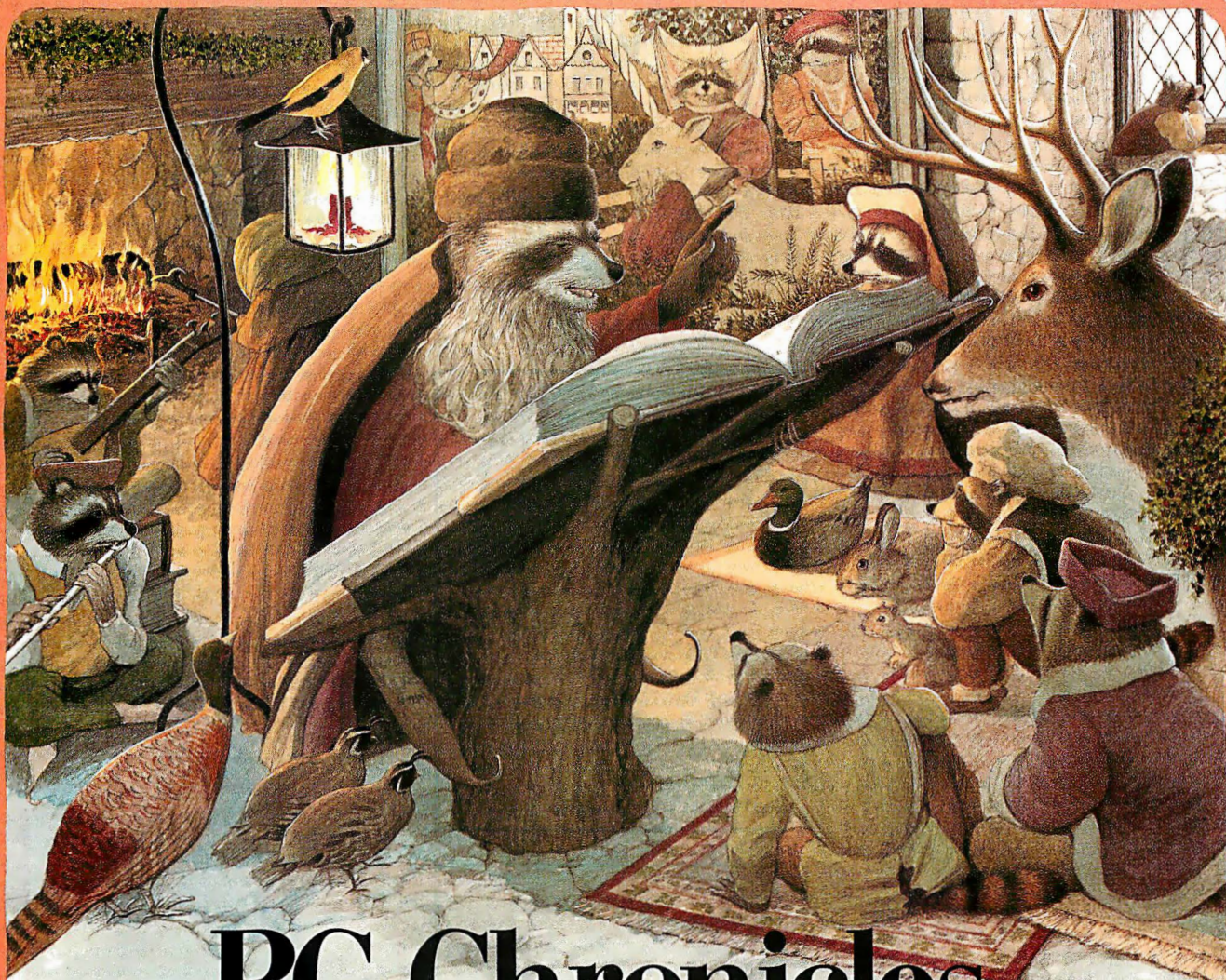
© 3M 1990.



Innovation working for you™

**3M** |   
Worldwide Sponsor 1992 Olympic Games  
36USC380

Circle 8 on Reader Service Card



# PC Chronicles.

Call me a lyre.

(Or, how we wrote the book on PC mail order.)

Truth tends to be stranger than fiction in the telltail town of Marlow, NH (pop. 564). That's why you'll often find the local color gathered 'round the ancient sage as he recounts in vivid detail how our forest glade was transformed into a PC paradise.

For, in days of yore, buying software and peripherals by mail was a perilous task, fraught with danger and uncertainty. Only those well versed in the black arts dared risk such unpredictable delivery and uncertain compatibility.

Then one day the enlightened Order of the Connection appeared majestically on the scene, bringing

the classic virtues of toll-free tech support, prompt shipping, and way-under-retail prices to the brave new world of the IBM PC. Since that glorious day our humble home has served as a beacon of light to noble users in cottages, condos, and corporations throughout America. **That'll be the day.**

It's not every day of the week you get offered your very own 1991 PC Connection Calendar. This very timely offer includes 13 classic illustrations of our legendary mascots, all your favorite holidays, and fascinating historical facts about the fiefdom of Marlow, NH. This wondrous wall calendar is free to everyone who places an order of \$750 or more between now and February 28.



Mark time with the PC Connection Calendar featuring our very own day-tripping mascots. Offer not available to accounts on net terms. One per customer.

# PC CONNECTION®

# Ring out the old

1990 World Class Award for Best Mail-Order Company



- 3 1/2" format available from us. Specify when ordering.
  - package includes both 5 1/4" and 3 1/2" disks.
  - 3 1/2" format available from manufacturer by request. Call us for details.
- CP—copy-protected; NCP—not copy-protected.

The four-digit number next to each product is the product's ITEM NUMBER. Please refer to this number when ordering. Thank you.

## SOFTWARE

We only carry the latest versions of products. Version numbers in our ads are current at press time.

Products listed here in red are Microsoft Windows Applications.

### Adobe Systems ... NCP

- 7547  Adobe Type Manager for Windows \$59.
  - 8367  ATM & Plus Pack Bundle . . . . . 169.
  - 7392  Adobe PostScript Cartridge . . . . . 249.
- (Entire Adobe Type Library, from 1 to 133 is available. Call for more information.)

### Aldus ... NCP

- 1332  PageMaker 3.01 . . . . . 499.
- 8000  Persuasion 2.0 for Windows. . . . . 399.

### Alpha Software ... NCP

- 5104  Alpha Four 1.1 . . . . . 319.

**Qualitas ... NCP**  
386MAX & BlueMAX let you run your 386 & Windows to the MAX! New! BlueMAX is the ultimate memory manager for 386 PS/2s!  
7539  386MAX 5.0 . . . . . \$75.  
7967 BlueMAX 1.0 (3 1/2" only) . . . . . 85.

- 1214  Pizazz Plus 2.0. . . . . \$69.
- Ashton-Tate ... NCP**
- 4450  dBASE IV 1.1 . . . . . 499.
- Asymetrix ... NCP**
- 7384  Toolbook 1.0 for Windows . . . . . 309.
- Avery ... NCP**
- 6006  Label Pro 1.0 (Laser) . . . . . 49.
- 7336  Label Pro 1.0 for Dot Matrix . . . . . 49.
- Bitstream ... NCP**
- 7568  FaceLift 1.0 for Windows 2.x/3.0 . . . . . 59.
- 8368  FaceLift 1.0 & Microsoft Windows Productivity Pack 1.0 . . . . . 99.
- Collections: . . . . . each 129.
- Typeface Packages . . . . . each 89.
- Bloc Publishing ... NCP**
- 1447  FormTool Gold 3.0 . . . . . 55.
- 6245  Pop Drop Plus 1.0 . . . . . 59.
- Borland International ... NCP**
- 7357  Turbo C ++ 1.0 Professional . . . . . 219.
- 7356  Turbo Pascal Professional 2nd Ed. 179.
- 6242  Quattro Pro 2.0 . . . . . 339.
- 1514  Paradox 3.5 . . . . . 569.

**Adobe Systems ... NCP**  
8367  ATM & Adobe Plus Pack Bundle—ATM converts Windows 3.0 screen displays & dot-matrix printed output to crisp, legible text at any point size. The Plus Pack includes 22 additional PostScript fonts . . . . . \$169.

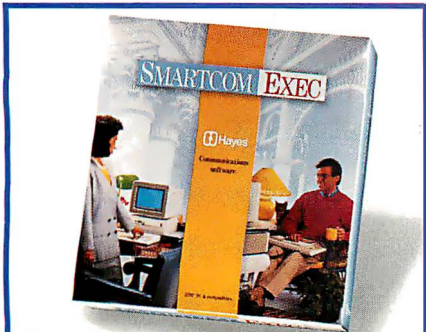
- Broderbund ... NCP**
- 1434  New Print Shop . . . . . 39.
- ButtonWare ... NCP**
- 6419  PC-File 5.0. . . . . 89.
- Caere ... NCP**
- 6004  Omnipage 386 2.1 . . . . . 599.
- Central Point ... NCP**
- 5039  PC Tools Deluxe 6.0. . . . . 95.
- 8114  Backup 6.0 . . . . . 65.
- Chipsoft ... NCP**
- 1663  TurboTax 8.0 for 1990 Taxes. . . . . 45.
- CompuServe**
- 7546 DOS Membership Kit . . . . . 23.
- Concentric Data Systems ... NCP**
- 6575  R & R Relational Report Writer 3B 109.
- Corel Systems ... NCP**
- 5506  CorelDRAW! 2.0 . . . . . 389.
- Custom Applications ... NCP**
- 7474  Freedom of Press 2.2. . . . . 255.
- Data Storm ... NCP**
- 4798  PROCMM PLUS 1.1 . . . . . 65.

**Corel Systems ... NCP**  
5506  CorelDRAW! 2.0—The award-winning PC graphics software. It gives you incredible type control, drawing power, and special effects in a value-packed package. . . . . \$389.

- DCA ... NCP**
- 7936  Crosstalk Communicator 1.0 . . . . . 59.
- 2908  Crosstalk XVI 3.71 . . . . . 119.
- 5611  Crosstalk for Windows 1.1 . . . . . 129.
- Delrina Technology ... NCP**
- 7351  PerFORMPRO 1.0 for Windows . . . . . 299.
- Fifth Generation Systems ... NCP**
- 7725  Direct Access 5.0. . . . . 65.
- 7795  Disklock 1.0. . . . . 109.
- 3950  Fastback Plus 2.1. . . . . 119.
- FormWorx ... NCP**
- 5810  FormWorx with Fill & File 2.5 . . . . . 85.
- 7311  Form Publisher for Windows 1.2. . . . . 145.
- Fox Software ... NCP**
- 6188  FoxPro 1.02. . . . . 489.
- Franklin Software ... NCP**
- 7071  Language Master 3.0 . . . . . 49.
- 7416  Language Master 3.0 for Windows 59.
- Funk Software ... NCP**
- 2228  Sideways 3.3 . . . . . 59.
- 7380  P.D. Queue 1.0 (print spooler) . . . . . 59.

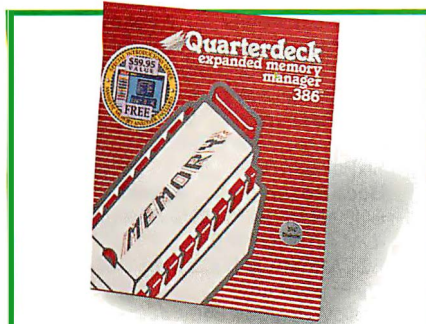
**Chipsoft ... NCP**  
1663  TurboTax 8.0 for 1990 Taxes—The best-selling, easy-to-use and complete software for preparing individual tax returns. TurboTax provides on-line help, IRS instructions and comprehensive tax assistance. . . . . \$45.

# bring on the new.



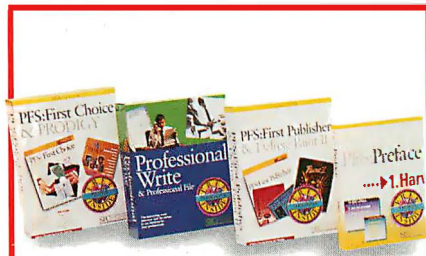
Hayes ... 2 years  
7983  Smartcom Exec 2.0—On-line editor, full scripting language, ZMODEM...support for all popular PC modems and high speed serial ports such as Hayes ESP. It also supports network operations on Local Area Networks \$79.

- Great American Software ... NCP**  
4879  One Write Plus Payroll Module . . . 89.  
4880  One Write Plus Acct. Sys. 2.06 . . . 189.  
5825  Money Matters 2.0. . . . . 42.
- Harvard Associates ... NCP**  
2324  PC Logo 3.0 . . . . . 59.
- Hayes ... NCP**  
7983  Smartcom Exec 2.0 . . . . . 79.  
2295  Smartcom III 1.2 . . . . . 149.
- hDC Computer Corp. ... NCP**  
7389  Windows Express 3.0 . . . . . 52.  
7383  First Apps 1.0 . . . . . 52.
- Hilgraeve ... NCP**  
2323  HyperACCESS/5 1.1 (DOS & OS/2) 115.
- IBM ... NCP**  
6599  Current 1.1 . . . . . 239.
- Individual Software ... NCP**  
6222  Resume Maker 1.1 . . . . . 29.
- Inset Systems ... NCP**  
7298  Hijaak 2.0 . . . . . 99.  
7300  Inset Plus Hijaak . . . . . 125.



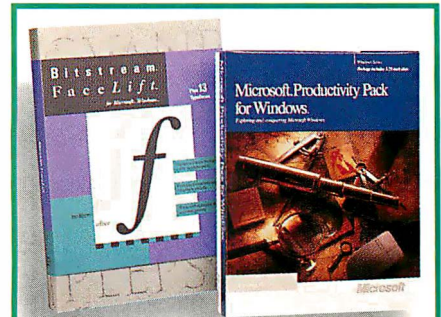
Quarterdeck ... NCP  
3221  Expanded Memory Manager 386 5.1—Now works in conjunction with Windows 3.0. Able to load TSR programs and DOS resources into high memory regardless of which Windows mode you're in. . . . . \$59.

- Insight Development ... NCP**  
8320  PrinTools 1.0 . . . . . \$85.
- Intuit ... NCP**  
2426  Quicken 4.0 . . . . . 39.
- Isogon ... NCP**  
7478  FontSpace 2.0 . . . . . 59.
- Laser Go ... NCP**  
7635  Go Script Plus 3.0 . . . . . 189.
- LaserTools ... NCP**  
6882  PrintCache 2.3 . . . . . 99.
- Lord Publishing ... NCP**  
5191  Ronstadt's Financials 1.02 . . . . . 75.
- Lotus ... NCP**  
5417  1-2-3 3.1 . . . . . 429.  
5653  1-2-3 2.2 . . . . . 349.  
5134  Magellan 2.0 . . . . . 119.
- MECA ... NCP**  
4603  Andrew Tobias' Tax Cut-1990 Taxes 49.  
2798  Managing Your Money 7.0 . . . . . 135.
- Microcom ... NCP**  
7649  Virex 1.1 . . . . . 79.  
6234  CarbonCopy Plus 5.2 . . . . . 119.



Software Publishing ... NCP  
Holiday Bundles—"Free for all promotion!"  
7769  Preface (with Viruscan). . . . . \$49.  
3499  First Publisher (with Deluxe Paint II). 99.  
3478  First Choice (with Prodigy). . . . . 105.  
3496  Professional Write (w/Professional File) 179.

- Micrografx ... NCP**  
7683  Charisma 1.0 . . . . . 349.
- Micro Logic ... NCP**  
6787  Info Select 1.1 . . . . . 55.
- Microsoft ... NCP**  
7010  Windows 3.0 . . . . . 99.  
7388  Project for Windows 1.0 . . . . . 469.  
7387  PowerPoint for Windows 1.0 . . . . . 329.  
2904  Works 2.0 . . . . . 99.  
2901  Word 5.0 . . . . . 209.  
6195  Word for Windows 1.1 . . . . . 329.  
2856  Excel 2.1 . . . . . 329.  
2853  C Compiler 6.0 . . . . . 339.  
8137  Office for Windows. . . . . 659.



Bitstream ... NCP  
8368  FaceLift 1.0 for Windows 2.x/3.0 & Windows Productivity Pack 1.0—Here's how to get great type in any size for any printer & all the Windows help you'll ever need at a great price. . . . . \$99.

- Multisoft ... NCP**  
4925  PC-Kwik Power Pak 1.5 . . . . . 79.
- Nolo Press ... NCP**  
2982  WillMaker 4.0 . . . . . 39.
- PC Globe ... NCP**  
5902  PC Globe 4.0 . . . . . 39.  
5900  PC USA 2.0 . . . . . 39.
- Personics ... NCP**  
4384  Ultravision 2.0 . . . . . 79.  
7048  Monarch 1.0 (Data Mgmt. Tool) . 319.
- PowerUp ... NCP**  
7860  Calendar Creator Plus 3.0 . . . . . 45.
- Precision Software ... NCP**  
6600  Superbase 4 for Windows 1.2 . . . 469.
- Qualitas ... NCP**  
7539  386MAX 5.0 . . . . . 75.  
7967  BlueMAX 1.0 (3 1/2" only). . . . . 85.
- Quarterdeck ... NCP**  
6422  QRAM 1.0 . . . . . 49.  
3221  Expanded Memory Mgr. 386 5.1 . 59.  
3220  DESQView 2.3 . . . . . 79.  
4586  DESQView 386 5.1 . . . . . 129.
- Reality Technologies ... NCP**  
6572  WealthBuilder 1.1 . . . . . 145.
- Reference Software ... NCP**  
4396  Grammatik IV 1.0 . . . . . 52.  
7483  Grammatik for Windows 1.0. . . . . 52.
- Revolution Software ... NCP**  
4480  VGA Dimmer 2.01 (screen saver) . 29.
- RightSoft ... NCP**  
4155  RightWriter 4.0 . . . . . 55.
- Samna ... NCP**  
5148  Ami . . . . . 129.  
5799  Ami Professional 1.2 . . . . . 309.
- Sitka/TOPS ... NCP**  
6675  TOPS Network Bundle 3.0 . . . . . 159.  
3720  Flashcard 2.1 (AppleTalk ntwrk. card) 155.
- Softlogic Solutions ... NCP**  
3542  Software Carousel 4.0 . . . . . 55.
- Software Publishing ... NCP**  
3499  PFS:First Publisher 3.0 . . . . . 99.  
3478  PFS:First Choice 3.1 . . . . . 105.  
3496  Professional Write 2.2 . . . . . 179.  
3482  Harvard Graphics 2.3 . . . . . 359.

1-800/776-7777

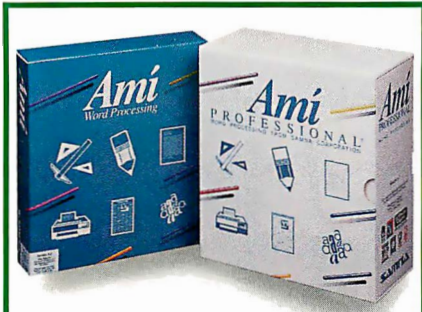
**MMC** PC Connection 800B  
6 Mill Street  
Marlow, NH 03456  
SALES 603/446-7721 FAX 603/446-7791



ALL ITEMS SUBJECT TO AVAILABILITY. PRICES SUBJECT TO CHANGE WITHOUT NOTICE.



# A little more speed



### Samna ... NCP

5799  Ami Professional 1.2—Word processing combines ease of use with features like tables, drawing and charting, & more! Windows 3.0 & HP NewWave compatible ... \$309.  
5148  Ami ... 129.

### Software Ventures ... NCP

- 6889  MicroPhone II for Windows. ... 215.
- Solution Systems ... NCP**
- 7977  Brief 3.0 (Programmer's Editor) . 189.
- Spinnaker ... NCP**
- 7604  PLUS for Windows 1.0. ... 289.
- Symantec ... NCP**
- 3152  The Norton Commander 3.0 ... 105.
- 6397  The Norton Backup 1.1 ... 105.
- 3146  The Norton Utilities 5.0. ... 125.
- 3425  Q&A 3.0 ... 229.

### Systems Compatibility ... NCP

- 8215  Outside In 1.0 ... 65.
- 6564  Software Bridge 4.1 ... 79.
- TIMESLIPS ... NCP**
- 2987  Timeslips III 4.0 ... 195.
- 6994  PercentEdge 1.0 ... 69.

### Timeworks ... NCP

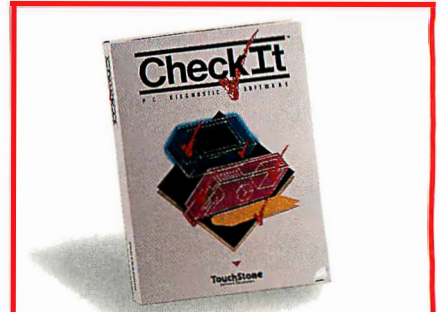
- 6253  Publish-It! 1.1 ... 115.

### Touchstone Software ... NCP

- 7420  Check It 3.0. ... 89.

### Traveling Software ... NCP

- 5179  LapLink III 3.0 ... \$95.
- Ventura Software (Xerox) ... NCP**
- 7796  Ventura Publisher for Windows 3.0 569.
- West Lake Data Corp. ... NCP**
- 7577  PC-FullBak + 1.12 ... 52.
- 7574  PathMinder+ 1.0. ... 79.
- WordPerfect Corp. ... NCP**
- 7781  LetterPerfect 1.0 ... 135.
- 3804  WordPerfect 5.1 ... 265.
- 6685  DrawPerfect 1.1 ... 279.
- WordStar International ... NCP**
- 6791  WordStar Prof. 6.0 ... 279.
- XTREE ... NCP**
- 6161  XTreePro Gold 1.4 ... 85.
- ZSoft ... NCP**
- 7016  PC Paintbrush IV Plus 1.0 ... 119.
- 7014  PC Paintbrush Plus for Windows 1.12 89.



### Touchstone Software ... NCP

7420  Check It 3.0—Diagnostic software will help find and get rid of system problems. Run over 160 tests on all major system components. Results can be logged to disk or printer with suggestions on fixing simple troubles ... \$89.



### Microsoft ... NCP

2858  Microsoft Aircraft and Scenery Designer for Flight Simulator 4.0—Fly a 747-400 or create your own aircraft. Design and customize buildings and scenery with this brand new companion to the classic program ... \$29.

### Spectrum Holobyte ... NCP

- 3467  Tetris ... 22.
- 5993  Welltris. ... 22.

### Software Toolworks ... NCP

- 4659  Chessmaster 2100 (CP) ... 35.
- 7372  World Atlas ... 42.

### Stone & Assoc. ... NCP

- 5231  Phonics Plus ... 22.
- 3433  Algebra Plus Vol 1 (ages 13+) ... 27.

### Toyogo ... NCP

- 7676  Nemesis Go Master Deluxe ... 88.

### True BASIC, Inc. ... NCP

- Kemeny/Kurtz Math Series. each 45.

## HARDWARE

**Manufacturer's standard limited warranty period for items shown is listed after each company name. Some products in their line may have different warranty periods.**

## RECREATIONAL/EDUCATIONAL

### Broderbund ... CP

- 8068  Where in the World is Carmen Sandiego Deluxe Edition ... 52.
- 5851  SimCity ... 33.

### Electronic Arts ... NCP

- 5804  Deluxe Paint II (Enhanced). ... 89.

### Microsoft ... NCP

- 7881  Entertainment Pk for Windows 1.0 29.
- 8270  Aircraft and Scenery Designer 1.0 (req. FS 4.0) ... 29.
- 2858  Flight Simulator 4.0 ... 39.

### Microsoft Press (Books)

- 8126 Running with DOS 4th Edition. ... 20.
- 8129 Running Windows (2nd Edition) ... 22.
- 8136 Running Microsoft Excel ... 22.

### Penton Overseas ... NCP

- VocabuLearn/ce Levels I & II (French, Italian, German, Spanish, Russian, Hebrew and Japanese). ... each 39.

### Sierra On-Line ... CP

- 5106  Space Quest III ... 39.
- 7972  King's Quest V ... 45.

### American Power ... 2 years

- 7108 Smart UPS 400. ... 339.
- 6811 360SX (stand-by power source) ... 219.
- 7106 520ES (stand-by power source) ... 329.

### AST Research ... 2 years

- 1299 SixPakPlus 384k C/S/IP ... 179.
- 8041 SixPak 286 0k. ... 105.

### Boca Research ... 5 years

- 7001 BOCARAMIAT PLUS (0-8 Meg) (LIM 4.0 extended) ... 125.
- 7061 BOCARAMI/XT 0K (0-2 Meg, LIM 4.0) 99.
- 6998 I/O Board for AT ... 59.
- 8380 BasicVGA (256K 640 x 480) ... 79.
- 8381 SuperVGA (1 Meg 1024 x 768) ... 145.

### Bravo Communications ... 2 years

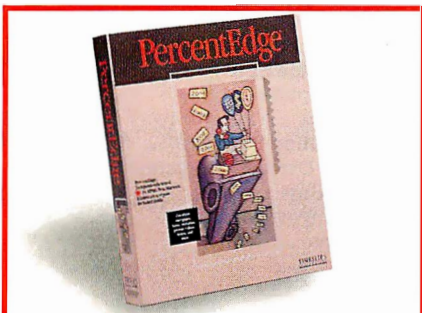
- 7400 2 Pos. Laser Compatible Switch Box 109.

### Canon ... 1 year

- 7894 BJ-10e BubbleJet Printer (4.6 lb.) . 349.
- 7896 Sheet feeder for BJ-10e ... 75.

### CH Products ... 1 year

- 8119 FlightStick w/Falcon & GameCard III . 79.
- 7345 RollerMouse (Trackball) serial 85. bus 99.



### TIMESLIPS ... NCP

6994  PercentEdge 1.0—Calculate mortgage rates, present values, annuities, savings & loan balances, and more. "Fill in the blank" interface completes the calculation once your data is entered. "Pop-up" mode available ... \$69.

# and memory would do.



**Systems Compatibility ... NCP**  
 8215 **Outside In 1.0**—Import text or data directly into your word processor from over 50 different word processor, spreadsheet, and database programs—without leaving your word processor. . . . \$65.

**Curtis ... lifetime**  
 704 Universal Printer Stand PS-1 . . . . . 18.  
 708 Ruby-Plus SPF-2 Plus . . . . . 65.  
 7358 Command Center. . . . . 89.  
 Glass Filter Plus (specify size) . . ea. 65.

**Datadesk ... 3 years**  
 6901 Switchboard . . . . . 175.

**Epson ... 1 year**  
 We are an authorized Epson Service Center.  
 906 FX-850 (80 col., 264 cps, 9 pin) . . . call  
 904 FX-1050 (136 col., 264 cps, 9 pin) . . call  
 5183 LQ-510 (80 col., 180 cps, 24 pin) . . 289.  
 930 LQ-850 (80 col., 264 cps, 24 pin) . . call  
 917 LQ-1050 (136 col., 264 cps, 24 pin) call  
 5184 LX-810 (80 col., 180 cps, 9 pin) . . . 185.  
 7775 Equity LT-286e Laptop . . . . . 1995.  
 7774 Equity LT-386SX Laptop . . . . . 3069.

**5th Generation ... 1 year**  
 7157 Logical Connection Plus 512k . . . . . 599.

**Hayes ... 2 years**  
 2307 Smartmodem 2400 . . . . . 349.  
 3049 JTFax 9600B . . . . . 499.  
 7391 Ultra 9600 Modem . . . . . 829.

**Hewlett-Packard ... 1 year**  
 6754 LaserJet III (w/toner) . . . . . 1699.  
 6582 LaserJet IIP (w/toner) . . . . . 1069.

**Intel ... 5 years**  
 6421 2400B MNP Internal Modem . . . . . 199.  
 4696 2400B Internal Modem . . . . . 159.  
 2352 2400B Internal Modem 2 (for PS/2) 249.  
 5119 2400 Baud External Modem . . . . . 179.  
 6420 2400EX MNP Modem . . . . . 229.  
 7880 9600EX Modem . . . . . 549.  
 2346 Inboard 386/PC w/1 Meg . . . . . 495.  
 5336 Above Board Plus 8 2 Meg . . . . . 599.  
 5342 Above Board Plus 8 I/O 2 Meg . . . . 629.  
 7782 SatisFAXtion (fax board) . . . . . 399.  
 7552 NetPort (3 year warranty) . . . . . 489.

**MATH COPROCESSORS**  
 7385 80287XL (16 MHz 80286 CPU's) . . . 199.  
 4750 80387SX (16 MHz 80386SX CPU's) 309.  
 2371 80387 (16 MHz 80386 CPU's) . . . . 349.  
 2372 80387-20 (2C MHz 80386 CPU's) 399.  
 1121 80387-25 (25 MHz 80386 CPU's) 429.

**Kensington Microware ... 1 year**  
 2582 Master Piece Plus . . . . . \$109.  
 7899 Expert Mouse serial . . 119. bus . . 129.

**Keytronic ... 3 years**  
 4518 101 Plus Keyboard . . . . . 99.

**Kraft ... 5 years**  
 5800 3 button Thunder Joystick . . . . . 29.  
 5813 Game Card/Thunderstick Bundle . . 55.  
 7862 TopTrack (Laptop Trackball) . . . . . 79.

**Logitech ... limited lifetime**  
 7768 C9 Mouse with Windows . . . . . 149.  
 6029 Trackman (Trackball) serial 85. bus 89.  
 4297 ScanMan Plus (hand scanner) . . . 185.  
 7975 ScanMan 256 . . . . . 319.

**Micron Technology ... 2 years**  
 7595 2 Meg Expansion for HP  
 LaserJet IIP or III . . . . . 165.  
 7012 Beyond Memory Board for PS/2  
 Model 70 (2 Meg) . . . . . 169.

**Microsoft ... lifetime**  
 7597 Microsoft Mouse . . . . . 89.  
 2897 Mouse with Paintbrush . . . . . 109.  
 2898 Mouse with Windows 3.0 . . . . . 149.

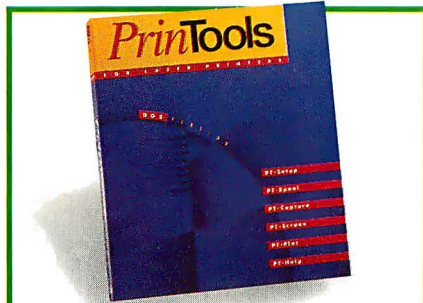


**Boca Research ... 5 years**  
**SuperVGA by Boca**—High-performance VGA upgradeable 1024 x 768 graphics in 256 colors. Interlaced & non-interlaced compatible.  
 6995 1024 x 768/16 Colors (512K) . . . . \$139.  
 8381 1024 x 768/256 Colors (1 Meg) . . . . 145.

**PC Power & Cooling ... 1 year**  
**REPLACEMENT POWER SUPPLIES**  
 3202 Turbo Cool 150 (25° - 40° cooler) . 129.  
 7915 Turbo Cool 300 . . . . . 165.  
 3200 Silencer 150 (84% noise reduction) 115.

**Pacific Data Products ... 1 year**  
 6779 25 Cartridges in One! (for LJ II, IIP, III) 275.  
 Memory upgrade for LaserJet IIP/III  
 7054 1 Meg . . . . . 149. 7055 2 Meg . . . 199.  
 7758 3 Meg . . . . . 279. 7759 4 Meg . . . 339.  
 7158 Pacific Page 4.0 (for LaserJet IIP/III) 379.  
 6834 Pacific Page with free 2 Meg  
 Memory Board (for LaserJet II) . . . 379.

**Practical Peripherals ... 5 years**  
 3103 2400 Baud Internal Modem . . . . . 135.  
 3102 2400 Baud External Modem . . . . . 179.  
 5286 2400 Baud Int. MNP Modem (Lev. 5) 175.  
 5285 2400 Baud Ext. MNP Modem (Lev. 5) 209.  
 4542 2400 Baud Internal Modem for PS/2 . 229.  
 8132 PM2400 Pocket Modem . . . . . 99.  
 7934 PM9600SA . . . . . 489.



**Insight Development ... NCP**  
 8320 **PrintTools 1.0**—Utilities for the HP LaserJet, DeskJet & compatibles. Includes Spooler, Screen Dump, Screen Capture, SetUp, Plot with HPGL/2 support, and Help utilities . . . . . \$85.

**MicroSpeed ... 1 year**  
 PC-TRAC Trackball  
 6007 serial . . . . . 75. 6008 bus . . . . . 89.  
 7271 Import . . . . . 79. 6330 PS/2 . . . . . 79.

**Mouse Systems ... lifetime**  
 5997 Trackball (1 yr. wrnty.) serial 75. bus 85.  
 7878 PC Mouse III . . . . . 99.

**NEC ... 2 years**  
 4799 Multisync 2A (VGA Monitor) . . . . 499.  
 5085 Multisync 3D Monitor . . . . . 689.

**Orchid Technologies ... 4 years**  
 7512 ProDesigner VGA II (1024 x 768) . . 299.  
 7888 ProDesigner/e (256k) . . . . . 209.

**1-800/776-7777**

**MIC** **PC Connection** **800B**  
 6 Mill Street  
 Marlow, NH 03456  
**SALES 603/446-7721 FAX 603/446-7791**



**Practical Peripherals ... 5 years**  
 7934 PM9600SA Modem—Practical Peripherals does it again by making communications affordable with their newest modem featuring the data compression & error correction of 9600bps V.32 & V.42bis operation . . . \$489.

# Happy New Year.

## PSION .. 1 year

- 7086 MC600 Mobile Computer . . . . . \$2149.
- 7090 512K Flash EPROM . . . . . 309.
- 7962 3 1/2" External Drive. . . . . 299.

## Reflection Technology .. 1 year

- 7127 Private Eye (virtual display) . . . . . 499.

## SAFE Power Systems ... 2 years

- 7913 Safe 650W . . . . . 459.

## Targus ... lifetime

- 6037 Premier Leather Carrying Case. . . 199.

## TheComplete PC ... 2 years

- 8082 TheComplete Half Page Scanner/400 w/ReadRight Personal OCR Software 289.

- 6797 TheComplete Fax Portable . . . . . 319.

- 5828 TheComplete Communicator . . . . . 449.

## Tripp Lite ... 2 years

- 6199 Isobar 4-6 (4 outlets, 6 ft. cord) . . . . 49.

- 6200 Isobar 6-6 (6 outlets, 6 ft. cord) . . . . 59.

## Video 7 ... 7 years

- 5883 1024i VGA (includes 512k) . . . . . 219.
- 4931 VRAM VGA 512k . . . . . 379.

- 2286 30 Meg Int. Hard Drive ST238R (w/controller and cables, 65 ms) . . \$269.

- 4554 40 Meg Int. HD ST251-1 (28 ms) . . 329.

## TEAC ... 1 year

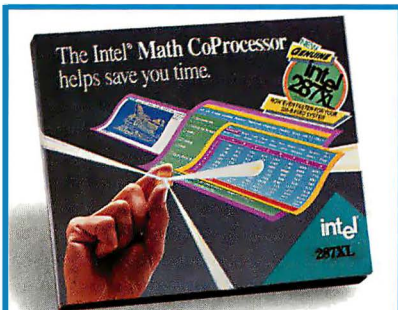
- 4951 720k Drive (specify XT or AT, 3 1/2") . . 75.
- 4670 1.44 Meg Drive for PC/XT (3 1/2") . . . 89.
- 4326 1.44 Meg Drive for AT . . . . . 109.

## MEMORY

- 6556 256k DRAMs (100 ns, set of 9) . . . \$29.
- 5510 1 Meg x 9 SIMMs (80 nanosecond). 69.
- 5746 1 Meg Chips (80 ns, set of 9) . . . . . 69.

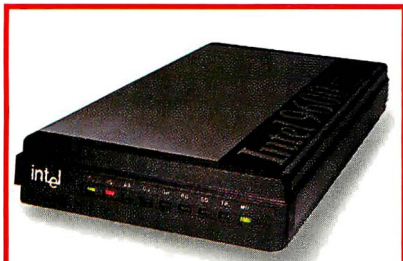
## OUR POLICY

- We accept VISA and MASTERCARD only.
- No surcharge added for credit card orders.
- Your card is not charged until we ship.
- If we must ship a partial order, we never charge freight on the shipment(s) that complete the order (in the U.S.).
- No sales tax, except Ohio residents (please add applicable tax).
- All U.S. shipments insured; no additional charge.
- APO/FPO orders shipped 1st Class Mail.
- International orders U.S. \$250 minimum.
- Upon receipt and approval, personal and company checks clear the same day for immediate shipment of your order.
- COD max. \$1000. Cash, cashier's check, or money order.
- 120 day limited warranty on all products.\*
- To order, call us Monday through Friday 8:00 AM to 1:00 AM, or Saturday 9:00 AM to 5:30 PM. You can call our business offices at 603/446-3383 Monday through Friday 9:00 AM to 5:30 PM.



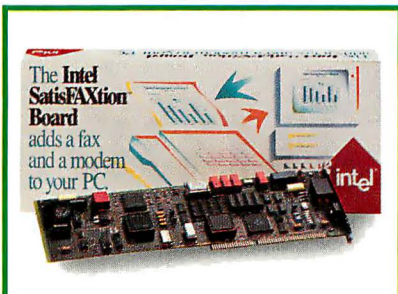
### Intel ... 5 years

80287XL & 80287XLT Math CoProcessors—Runs up to 50% faster than other 80287 math chips. The 80287XL works in virtually every 80286-based PC, and the 80287XLT is made especially for Compaq LTE/286.. each \$199.



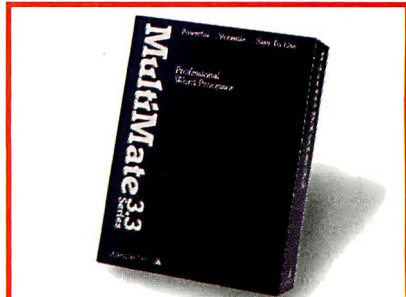
### Intel ... 5 years

7880 9600EX Modem—Provides ultra-fast data communications without sacrificing compatibility. Supports V.32 & V.42bis 9600 bps operation, as well as MNP Level/5 and Hayes compatible 2400/1200/300 bps modes . \$549.



### Intel ... 5 years

7782 SatisFAXtion—Send and receive faxes from within most applications using the print command. Built-in 2400 bps MNP modem standard. Includes coupons for free PC Tools and Fax-It software. . . . . \$399.



### Ashton-Tate ... NCP

6922 MultiMate 3.3—Upgrade to MultiMate 4.0 through Ashton-Tate for \$79.50. Total cost \$121.50 including shipping. Save over \$400 on list price of \$565. Call for details . . . . . \$39.

## DRIVES

### IOMEGA ... 1 year

- 7551 Bernoulli II Transportable 44 Meg . . . 997.
- 5113 44 Meg Cartridge Tripak (5 1/4") . . . 249.
- 2500 PC2B Controller . . . . . 229.

### Mountain Computer ... 2 years

- 2917 40-60 Meg Internal Tape Drive . . . 259.
- 5500 80-152M Int. Tape Drive . . . . . 629.
- 5190 DC2000 Pre-formatted Cartridges ea. 35.
- 6153 DC2120 Tape Cartridge (5 pack) . . 135.

### Pacific Rim ... 1 year

- 5010 1.2 Meg External (for PS/2's) . . . . 215.
- 6602 1.44 Meg External (for PC/XT/AT) . . 239.

### Plus Development ... 2 years

- 6424 Hardcard II 80 Meg (19 ms) . . . . . 599.
- 8304 Hardcard II XL 50 Meg (9 ms) . . . . 399.
- 8287 Hardcard II XL 105 Meg (9 ms) . . . 689.

### Seagate ... 1 year

- 2285 20 Meg Int. Hard Drive ST225 (w/controller and cables, 65 ms) . . . 255.

## DISKS

### Maxell ... lifetime

- 2789 5 1/4" MD2-D 360k Disks (Qty. 10) . . . 12.
- 2790 5 1/4" MD2-HD 1.2Mb Disks (Qty. 10) . . 19.
- 2792 3 1/2" DS/DD 720k Diskettes (Qty. 10) . . 14.
- 2793 3 1/2" DS/HD 1.44Mb Diskettes (Qty. 10) 27.

### Sony ... lifetime

- 3291 5 1/4" DS/DD 360k Disks (Qty. 10) . . . 10.
- 3292 5 1/4" DS/HD 1.2Mb Disks (Qty. 10) . . 19.
- 3297 3 1/2" DS/DD 720k Diskettes (Qty. 10) . . 13.
- 3298 3 1/2" DS/HD 1.44Mb Diskettes (Qty. 10) 22.
- 8185 QD 2040 Tape Cartridge . . . . . 19.

## SHIPPING

Note: Accounts on net terms pay actual shipping.

### Continental US:

- For heavy hardware items such as printers, monitors, Bernoulli Boxes, etc. pay actual charges. Call for UPS 2nd-Day & Next-Day-Air.
- For all other items, add \$3 per order to cover UPS Shipping. For such items, we automatically use Airborne Express at no extra charge if you are more than 2 days from us by UPS ground.

### Hawaii:

- For monitors, printers, Bernoulli Boxes, computers, hard drives, and power backups, actual UPS Blue charge will be added. For all other items, add \$3 per order.

### Alaska and outside Continental US:

- Call 603/446-7721 for information.



# Up to 32 Simultaneous PC-to-Mainframe Connections with *No Impact* on Your DOS or UNIX Applications!

Your applications shouldn't have to compete with 3270 communications for your PC's scarce resources.

That's why we deliver our

*Supports NetView, HLLAPI 3.0, and CLEO'S own API.*

DataTalker 3270 high-performance PC-to-mainframe connectivity software on powerful

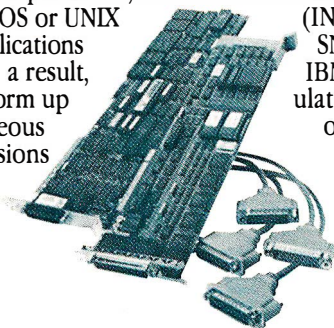
co-processor boards with on-board memory.

With DataTalker 3270, you can offload all communications processing and screen storage to the co-processor, freeing your DOS or UNIX system for applications processing. As a result, users can perform up to 32 simultaneous mainframe sessions

without affecting performance.

DataTalker 3270 provides full emulation of IBM 3278 terminals and 3274 controllers, along with 32 LUs, 512K

RAM, file transfer (IND\$FILE), BSC or SNA support, and IBM 3287 printer emulation. Line speeds of up to 56K baud are supported.



See us at Uniform '91, Dallas Infomart,  
January 22-24, Booth #1213

*Adds only 1K to DOS applications, 40K to UNIX*

To learn more, call us today at 1-800-233-2536. Or write to us at 3796 Plaza Drive, Ann Arbor, Michigan 48108. FAX: 313/662-1965.

**CLEO**  
CLEO Communications  
A Division of Interface Systems, Inc.

AVAILABLE WORLDWIDE!

In Europe, call Sintec Peripherals Ltd. in Slough, England, at 0753-811888 (FAX: 0753-811666).



# NETWARE TROUBLES

When NetWare works,  
it works well. But  
when it doesn't. . .

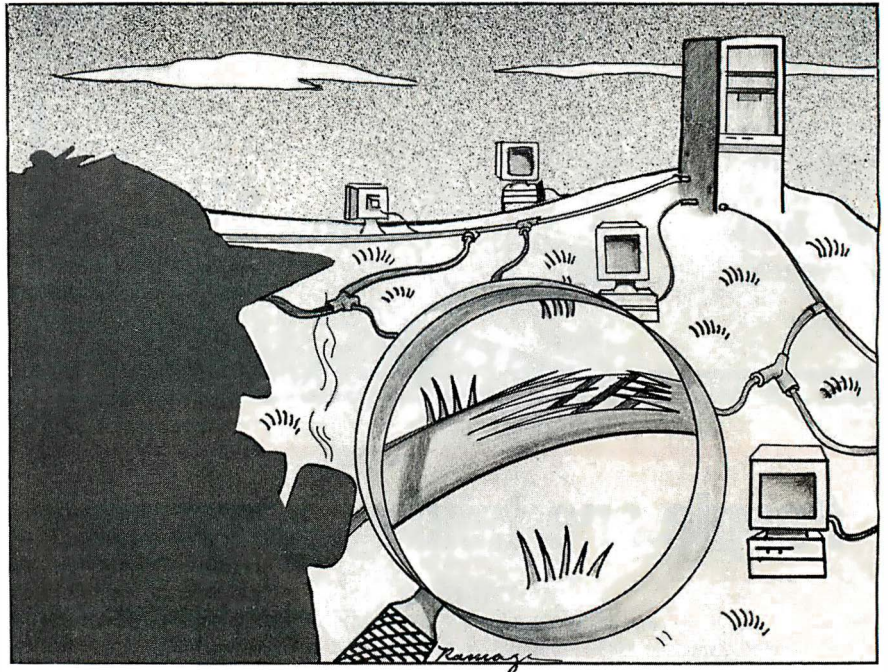
**S**omething's wrong. Users stream into your office, complaining that the network's not working properly. You walk over to the NetWare server monitor and see the message User RALPH exceeded outstanding NCP search limit. Or maybe you see Warning-FAT entry 0123 marked used with no file. If your luck has run out, you may see the dreaded General Protection Interrupt message—your file server has died. Now what?

Perhaps the problem is more subtle—and more insidious. Your network grows slower and slower as more users run more applications and create more network traffic. Cable or network adapter faults begin to occur intermittently, leaving you in the dark as to why some workstations get dropped from the network or why the network just seems to slow down once in a while for no apparent reason.

NetWare is an excellent network operating system. I use it both at home and at work, and I rarely have trouble. But when there are problems on a NetWare LAN, they can be difficult to diagnose and resolve. You can acquire a hefty toolbox of hardware and software to help locate and solve problems; no single product addresses all the common illnesses that befall a NetWare LAN. Even armed with a bulging toolbox, you will find that common sense and a methodical approach are your best tools when your LAN fails.

## The Server Goes South

NetWare tries to recover gracefully when you have to reboot a server with the power switch. But what if it refuses to reboot, or crashes immediately after the reboot? First, look for a failed power



supply or uninterruptible power supply (if you don't have one for your server, get one). Power problems are the source of many server failures. One symptom is a server lockup, often with a parity-check message, a General Protection Interrupt message, or another fatal error message at the server monitor.

In some situations, the batteries that sustain the CMOS setup information may be the culprit. Put in fresh batteries and reset the CMOS data if you get boot errors. The next thing to look for is a bad RAM chip, a bad motherboard, or a bad hard disk drive controller. Don't spend time looking for the bad chip; users are waiting for you. If you have a medium- to large-size LAN, you should have spare boards—perhaps even a spare server—that you can quickly substitute. If your LAN is small, find a local computer dealer who stocks parts for your server, and make friends with the repair people.

Another culprit may be the server hard

disk drive itself. Hard disk drives, especially the high-capacity drives designed for file server use, take a beating, and they're a common point of failure. Be prepared to replace the hard disk drive, if need be. And be sure you've got backup copies of the server data.

As preventive maintenance, or to help solve a disk/file problem on the server, brush up on VREPAIR, Novell's version of CHKDSK. It looks for problems in the NetWare file system, including bad blocks (i.e., disk surface faults) and corrupted file allocation tables.

The steps I've just mentioned are simply commonsense extensions of standard PC repair techniques. The NetWare server is, after all, a PC. What if you decide, however, that the problem lies somewhere in the network itself?

## Network-Level Problems

When a server seems to boot OK but doesn't attach itself to the network (e.g.,

**SUNDAY 10-5** **PROMPT DELIVERY**

<p><b>COMPUTERS</b></p> <p>Apple 3799.99 Mac Port. 40 MB 3575.00 Mac IIcx 40 MB 699.00 Macintosh Classic 449.99 Macintosh LC 2399.00 ALR 386/33 MHz 1 MB 1.2 FD 14 FD 80 MB HD VGA 1799.99 Packard Bell 386 SX 1.2 FD 1.4 FD 1 MB 80 MB HD 1399.99 EMM 40 HD 2 MB 40 HD 1399.99</p> <p><b>MODEMS</b> Hayes 1000 V.42 849.99 HST 9600 DIAL 575.00 2400 EX. W/IMP 5 339.99</p> <p><b>FAX/MODEM</b> Worldport 2499 Tox. 469.99 Fax/Modem 699.99</p> <p><b>FACSIMILE (FAX)</b> Canon Fax 23 774.99 Canon Fax 25 464.99 Murata M-1100 464.99 Murata M-1650 694.99 Sharp FO-215 694.99 Sharp FO-310 694.99</p> <p><b>HARD DRIVES</b> Worldport 2499 Tox. 229.00 20 MB W/CH 249.00 30 MB W/CH 274.99 40 MB 28 MS 359.99 60 MB 28 MS 449.99 80 MB 28 MS 549.99 80 MB IDE 499.99 90 MB IDE 549.99</p> <p><b>MONITORS</b> Mish Dash Scan 465.00 NEC Multisync 3-D 974.99 NEC Multisync 5-D 1999.99 NEC Multisync 5-D 499.99 NEC Multisync 14 199.99 Pricom Ultrasync 16 199.99 Sony Multi Scan 629.99</p>	<p><b>NEC</b></p> <p><b>LAPOPS</b> COMPAQ LTE 1794.99 LITE Model 20 2649.99 LITE 286/20 2649.99 LITE 386 2199.99 286 20 HD 2199.99 286 40 HD 2199.99</p> <p><b>PACKARD BELL</b> PC-6220 2499.00 NZ-100 2399.99</p> <p><b>SHARP</b> Travel Mate 2000 1064.99 Travel Mate 3000 1994.99</p> <p><b>TOSHIBA</b> T-1000 XE 1064.99 T-1000 SE 1994.99 T-3100 SX 40 HD 3994.99 T-3100 SX 90 HD 4149.99 T-3200 SX 40 HD 5094.99 T-3200 SX 120 HD 5094.99 T-5200 100 HD 324.99 T-5200 200 HD 309.99 Canon 5J-105 249.99 Gizmon 150 Plus 249.99 Toshiba 3011 249.99</p> <p><b>PRINTERS</b> Epson FX 850 294.99 Epson FX 1050 364.99 Epson LQ-510 364.99 Epson LQ-850 544.99 Epson LQ-1050 544.99 Epson LQ-2550 174.99 Epson LQ-810 449.99 Epson DL 3400 319.99 Fujitsu DL 3400 319.99 NEC 6300 449.99 Oki 320 294.99 Oki 321 294.99 Oki 390 294.99 Oki 391 Plus 494.99 Oki 393 Plus 444.99 Panasonic KXP 1180 274.99 Panasonic KXP 1124 144.99 Panasonic KXP 1624 334.99</p> <p><b>LASER PRINTERS</b> Epson EPL 6010 549.99 Hewlett Packard 494.99 Desk Jet 500 649.99 Desk Writer F/Mac 994.99 HP Laser II 1899.99 HP Laser III 1549.99 HP Laser III 1549.99</p> <p><b>Oki</b> Oki Laser 400 649.99 Oki Laser 800 1324.99 Oki Laser 840 1324.99</p> <p><b>Panasonic</b> KXP 4420 734.99 KXP 4451 734.99 KXP 4455 734.99</p> <p><b>LASER ACCESSORIES</b> 2 MB FHP II &amp; III 154.99 2 MB FHP II &amp; III 199.99 Pacific Outline 209.99 Pacific Print 309.99 Pacific Page FHP II 339.99 Pacific Page FHP III 249.99 25 IN. FHP 374.99 Mac page FHP II &amp; III 149.99</p> <p><b>HAND SCANNERS</b> HS 3000 Plus 174.99 Logi Scanner Plus 174.99</p> <p><b>PANASONIC PHONES</b> Pana. KXT 308 10 164.99 Pana. KXT 1232 10 164.99 Pana. KXT 1232 10 144.99 Pana. KXT 1232 80 144.99 Pana. KXT 616 20 80.99 Pana. KXT 616 20 80.99 Cordless KXT 3720 99.99 Cordless KXT 3910 80.99 Pana. KXT 1470 114.99 Pana. KXT 2346 114.99 Pana. KXT 2470 114.99 Pana. KXT 2524 114.99 Pana. KXT 2740 199.99</p> <p><b>NETWORKING</b> WD 8 Bit Ether 137.00 WD 8 Bit Blomrom Sock 189.00 WD 16 Bit Ether 174.99 WD 16 Bit Blomrom Sock 209.99 3 Com. 3C503 899.99 3 Com. 3C501 329.00</p> <p><b>Lantronic</b> Ethe. Start. 10M Bps V.3.0 499.00 Ethe. Adpt. V.3.0 10M Bps 229.00 2M Bps Start. Kit V.3.0 94.99 S.M.C. PC-130 174.99 S.M.C. PC-500 FS 279.99 Tiara Lanite 16 Bit 244.99 Tiara Lanite 8 Bit 69.99 Tiara Arnet 8 Bit 234.99</p> <p><b>NOVEL IN STORE</b> Hub &amp; Port 499.99 ELSI V.2 15C 1049.99 ELSI Adv. Net 2 15C 2699.99 SFT Metaware 2 15C 4549.00 Novell 386 3.1</p> <p><b>VIDEO BOARDS</b> Parade 125.00 VGA 256 149.99 VGA Plus 16 174.99 1024 256K 225.00 1024 256K 179.99 1024 256K 229.99 1024 512K 349.99 1024 512K 349.99 Orchid 289.99 Protektion II 512K 349.99 Hercules Graph. Stat. 629.99</p> <p><b>NEC</b> Graphic Engine 16 599.99 Graphic Engine 256 674.99</p> <p><b>FLATBED SCANNERS</b> HP Scanjet Plus 1399.99 Panasonic RS500 559.99 The Complete PC 1399.99 Microtek 300G 1499.99</p> <p><b>MATH CO. PROC.</b> 90387/20 569.99 90387/33 629.99</p>
---	---

**IN USA & CANADA & P.R. INCLUDING NY STATE**

**1-800-874-1235**

Fax: (212) 463-8335 (Include Voice & Fax #)

**S & W COMPUTERS & ELECTRONICS**

31 West 21 Street, New York, NY 10010

NYC (212) 463-8330

Mon.-Thurs. 9-6 Fri. 9-1:45 Saturday Closed

PRICES HARD TO MEET — SERVICE HARD TO BEAT! World Wide Inquiries Promptly Filled

you see initialization or configuration error messages at the server, or the SLIST command from a workstation doesn't display that server in the list of up-and-running servers), make sure that the server network adapter is securely installed. The next step is to swap another network adapter card into the server. If the adapter (including its cable connector) is not at fault, you will need to substitute a different network cable to the server. If the problem persists, backtrack to the hub/repeater/transceiver/Multistation Access Unit and try a different port or a completely different unit.

A time-domain reflectometer can locate cable faults quickly. A TDR evaluates the electrical characteristics of a wire with sonar-like techniques, telling you cable distance, impedance, susceptibility to noise, and, of course, the distance between you and a short circuit or a break. Microtest's \$1495 Cable Scanner is a good TDR that works on twisted-pair and coaxial cable and supports Ethernet, ARCnet, and Token Ring protocols.

**Meanwhile, Back at the Server**

The sometimes-cryptic messages displayed on the server monitor can convey information, a warning, or an actual error condition. How do you tell? Make sure you have a copy of the Novell *System Errors* manual in a handy place. The explanations that it provides go a long way toward telling you exactly how serious a particular problem is.

You should look critically at recent changes to your LAN if problems crop up. Despite Novell's valiant attempts to make the NetWare installation/setup process friendly and bulletproof, a configuration error during NETGEN can wreak havoc on your LAN at a later time. It is also possible that the NetWare system files have become corrupted. You may need to reinstall NetWare to fix a problem.

What if your file server hasn't crashed but has simply run out of disk space? Or your network has slowed to a crawl and users are complaining? Running out of space or directory entries will idle a server just as quickly as a failed RAM chip. You can use the NetWare utility VOLINFO to monitor disk space and the number of free directory entries. (The number of directory entries, specified at NETGEN time, is the maximum number of directories that you can create on a NetWare 286 server volume. NetWare 386 overcomes this limitation—it dynamically allocates them.) The trick, of course, is remembering to run VOLINFO on a regular basis.

continued

**People are talking about us.**

**F77L-EM/32**

Port 4GB mainframe programs to 80386s with this 32-bit DOS-Extender compiler. The Winner of *PC Magazine's* 1988 Technical Excellence Award just got better. New Version 3.0 and OS include: Editor, Make Utility, Virtual Memory Support, DESQview Support, New Documentation and Free Unlimited Runtime Licenses. F77L-EM/32 \$895 OS/386 \$395

**F77L**

The compiler of choice among reviewers and professionals. Includes a Debugger, Editor, Profiler, Linker, Make Utility, Weitek and 386 Real-Mode Support, Graphics. \$595

**Lahey Personal Fortran 77**

New Version 3.0: Full ANSI 77, Debugger, Editor, Linker, Library Manager, Microsoft and Borland C interfaces, 400 page Manual, Unbeatable Price. \$99

**When people talk about FORTRAN the name mentioned most often is**

**Lahey**  
Computer Systems Inc.

Contact us to discuss our products and your needs. (800) 548-4778  
Lahey Computer Systems, Inc. P.O. Box 6091, Incline Village, NV 89450  
Tel: (702) 831-2500 FAX: (702) 831-8123 Tlx: 9102401256

**FORTAN IS OUR FORTE**



# Our Printer Sharing Unit Does Networking!

## **An Integrated Solution**

Take our **Master Switch™**, a sophisticated sharing device, combine it with **MasterNet™** networking software for PCs, and you've got an integrated solution for printer and plotter sharing, file transfer, electronic mail, and a lot more. Of course you can also share modems, minis, and mainframes or access the network remotely. Installation and operation is very simple.

## **Versatile**

Or you can use the Master Switch to link any computer or peripheral with a serial or parallel interface. The switch accepts over 20 commands for controlling the flow of data. It may be operated automatically, by command, or with interactive menus. Its buffer is expandable to one megabyte and holds up to 64 simultaneous jobs. The

**MasterLink™** utility diskette for PCs comes with every unit and unleashes the power of the switch with its memory-resident access to the commands and menus.

## **Other Products**

We have a full line of connectivity solutions. If you just want printer sharing, we've got

it. We also have automatic switches, code-activated switches, buffers, converters, cables, protocol converters, multiplexers, line drivers, and other products.

## **Commitment to Excellence**

At Rose Electronics, we're not satisfied until you're satisfied. That's why we have thousands of customers around the world including large, medium, and small businesses, factories, stores, educational institutions, and Federal, state, and local governments. We back our products with full technical support, a one-year warranty, and a thirty-day money-back guarantee.



**ROSE  
ELECTRONICS**

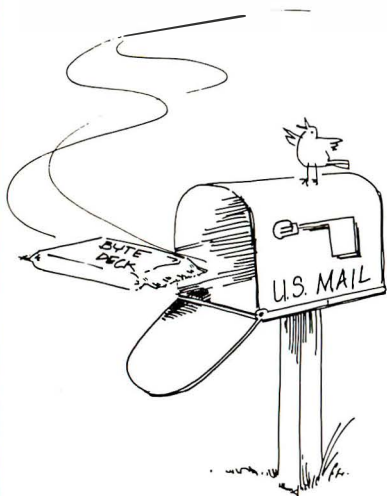
**Call now for literature or  
more information.  
(800) 333-9343**

*Give a Rose to your computer*

# Attention U.S. BYTE Subscribers

Watch for the next **BYTE DECK** mailing that will be arriving in your mailbox soon!

Use this as a fast, convenient tool to purchase computer products and services. It's loaded with essential hardware and software products that you should be aware of when making your buying decisions...and it's absolutely **FREE!**



If you have a computer product or service, and would like to reach 275,000 influential **BYTE** magazine subscribers, please give Ed Ware a call today at (603) 924-2596.

Here's what a **BYTE Deck** advertiser has to say:

*"Ten years ago we advertised in the very first **BYTE Deck**—the number of sales leads we received was enormous! The **BYTE Deck** was so successful for us, that we have continued to use it over the past ten years!"*

Lisa Tarpoff  
Marketing Manager  
Heath Company  
Benton Harbor, MI

# BYTE DECK

## NETWORKS

### ITEMS DISCUSSED

**Cable Scanner**..... \$1495  
Microtest  
3519 East Shea Blvd.,  
Suite 134  
Phoenix, AZ 85028  
(800) 526-9675  
(602) 971-6464  
**Inquiry 1105.**

**The Sniffer** ..... \$24,000  
(includes Compaq  
Portable 386)  
Network General Corp.  
4200 Bohannon Dr.  
Menlo Park, CA 94025  
(415) 688-2700  
**Inquiry 1106.**

**TXD Diagnostic  
Software**.....\$195  
Thomas-Conrad Corp.  
1908-R Kramer Lane  
Austin, TX 78758  
(800) 654-3822  
**Inquiry 1107.**

### Tools of the Trade

Performance troubles are the hardest to pin down and solve. They can also be the most expensive. The Sniffer, from Network General, costs about \$24,000; a typical unit consists of a Compaq 386/20 portable, capture/analysis software, and a set of protocol interpreters. (Network General sells the capture/analysis/interpreter software separately for \$12,500.)

The Sniffer stores message traffic as a disk file and lets you analyze the result. It can inject extra message traffic if you want to place a load on the network to see how it behaves. The software lets you filter and select message traffic by source, destination, and protocol type. You can see inside the messages. You can even see a skyline histogram of message traffic showing frame counts or byte counts by time period, along with network use. The Ethernet version can also reveal certain kinds of frame-level errors.

The Sniffer captures a wealth of data, but analyzing that data is a daunting project. In some cases, it can take several hours and a fairly complicated Lotus spreadsheet to figure out the cause of a performance problem.

Thomas-Conrad's TXD Diagnostic Software (which costs \$195 for a site license) operates at a higher level than the Sniffer. TXD uses the built-in diagnostic facilities of IPX/SPX to let you see frame counts, error counts, and other statistics regarding your NetWare LAN. (Internal-

ly, IPX/SPX maintains over 200 diagnostic and statistical data items that TXD can reveal.) TXD performs point-to-point tests, as well as broadcast tests, on a one-time or continuous basis. It does a good job of mapping your entire network—even across bridges.

Although TXD can produce a 300K-byte report file for a 50-node network, errors and problems are fairly easy to spot. The TXD manual includes a helpful chapter on specific network problems and suggested solutions.

TXD doesn't see message traffic at the same level as the network adapter; it has to rely on network errors being reflected in the IPX/SPX statistics that it gathers. Once you've located a workstation with excessive error counts, it's not difficult to swap network adapters or cables until you've located the problem.

If the network has a bottleneck—somewhere—and is just slower than it ought to be, you have your work cut out for you. You'll need to become familiar with how many users are concurrently logged on, the applications they're running, and the impact of those applications on the network. Major bottlenecks include the server hard disk drive, memory, processor, and network adapter; the network substrate itself; and even the workstation CPU and network adapter. How to track down these bottlenecks is best left to a future column.

### If It Ain't Broke...

If you are like me, all you want to do is get the network back up and running smoothly, or just speed it up a bit. But you need a grab bag of tools and techniques—and spare time—to even start the job. I'd like to see a single, simple tool that just watches for major events (e.g., a dead server, a cable fault, low disk space, or excessive traffic) and gives me advice on what I can do about the problem. A monitor program could highlight the problem, suggest steps to take, and provide an on-line reference that I could search. It could even tell me the other tools I need to use to pinpoint the problem. Such a NetWare-oriented tool would go a long way toward making me and my network users happy. ■

*Barry Nance manages a 50-node NetWare LAN. The author of Network Programming in C (Que Publishing Corp., 1990), he is the IBM Exchange editor on BIX—you can reach him as "barryn."*

*Your questions and comments are welcome. Write to: Editor, BYTE, One Phoenix Mill Lane, Peterborough, NH 03458.*



# You Expect A Lot From Your Portable PC



- 4.4 Pounds
- 1.4" Thin, Notebook Format
- 640 x 480 VGA Display
- Bright 10" Display
- 80C286 12MHz
- 20MB Hard Disk
- 1MB RAM
- MS-DOS and LapLink II Pre-loaded

You Should Expect Even More  
From The Company Behind It...



# But Don't Expect To Pay More Than \$2895

## CompuAdd Companion™ Exceeds Expectations

*"The critical test for any notebook computer is in  
the balance between size and processing power."*

— PC Computing, December 1989

CompuAdd has what the editor expects in a portable computer. At 4.4 pounds and 1.4" thin, the new CompuAdd Companion notebook computer is what portables ought to be—light, slim and fully featured.

*"Storage media may be the biggest challenge for  
notebook computers."*

The CompuAdd Companion sports a fast, built-in 20MB (23ms) hard disk drive. You'll never have to buy volatile, expensive, hard to find RAM disk memory cards. You'll have all the reliable storage you need for applications and data files.

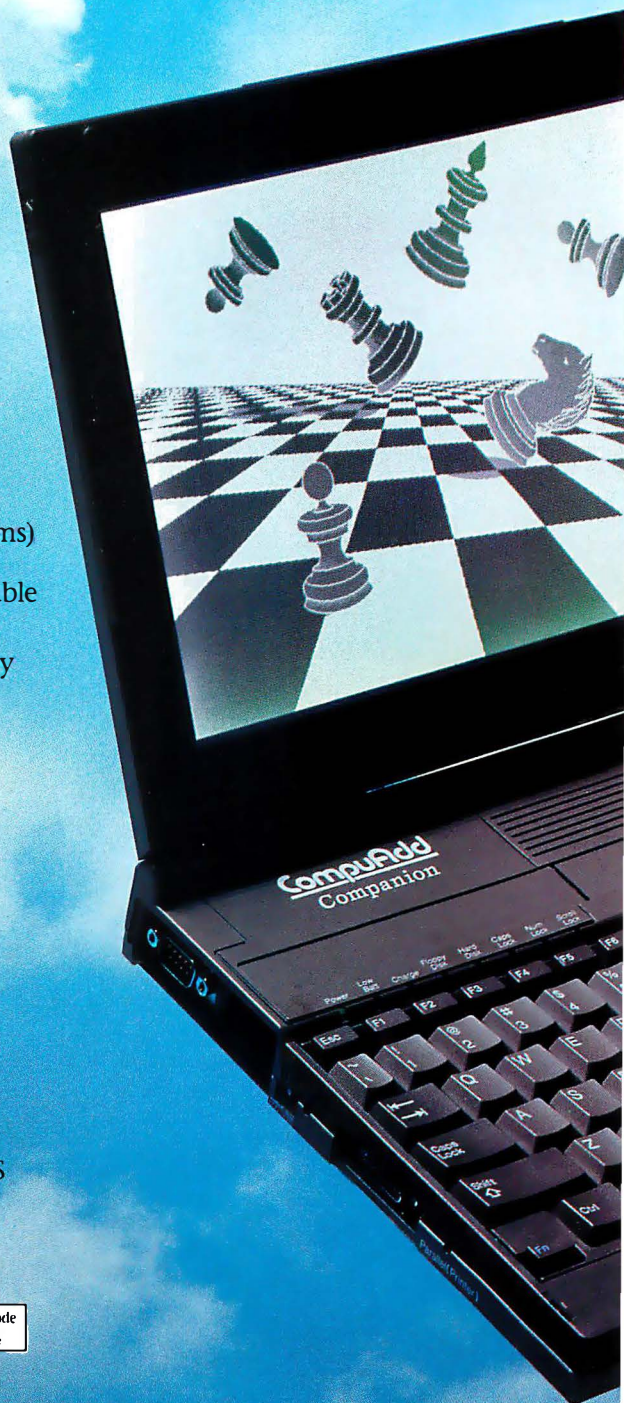
And using the pre-loaded LapLink II software, you can quickly and easily exchange files with your desktop system.

*"...today's notebook screens all offer CGA resolution or  
better and enough contrast to allow you to work on them  
for hours..."*

Why settle for less than a VGA display with the highest resolution and best contrast? The CompuAdd Companion has a bright, 640 by 480 pixel, 10-inch, sidelit LCD screen.

*"The PC must be large and powerful enough to do  
useful work but small enough to fit into a briefcase."*

The CompuAdd Companion uses the Intel™ 80C286 microprocessor running at 12MHz, and can handle sophisticated software applications, like Windows 3.0, Lotus 1-2-3™ and WordPerfect™ 5.1. It's compatible with MS-DOS and OS/2. The standard 1MB DRAM is expandable to 3MB.



Call TODAY or visit your CompuAdd  
Superstore for these savings!

Key Code  
814

# 800-456-6008

Hours: Monday - Friday 7:00am to 9:00pm CST; Saturday 9:00am to 5:00pm CST

# And Don't Settle For Less Than A Total Service Commitment!

## Value And Service Direct To You!

- 89 CompuAdd retail Superstores, each a complete sales and service facility
- 30-day, money-back guarantee
- Toll-free telephone support direct from the manufacturer
- On-site service through Memorex/Telex
- Local corporate sales representatives
- Major Accounts Program
- Government/Educational sales

CompuAdd gives you more, with our superior, exclusive method of product delivery and after-sale support that sets us apart from other manufacturers.

Only CompuAdd — and no other major competitor in the industry — owns the entire product delivery system. Our corporate structure eliminates the multiple layers of franchise management and the middleman overhead you encounter at other large computer manufacturers. When you deal with CompuAdd, you deal with the boss and bypass the middleman.

CompuAdd's unique corporate structure and delivery system means we maintain *low overhead and delivery channel efficiency to bring you the best price/performance ratio in the industry.*

The bottom line is CompuAdd's direct-supplier relationship and local, face-to-face contact. No other computer manufacturer has made a service commitment equal to CompuAdd.

### CompuAdd Companion Features:

- 80C286 microprocessor running at 6,7,16, or 12MHz
- Standard 1MB high speed dynamic RAM expandable to 3MB
- 1 wait-state page-mode memory
- Dedicated 80C287 math coprocessor socket
- Built-in serial, parallel printer, numeric keypad, and modular expansion ports can be used for external CVGA monitor or modem/fax interface modules
- High-resolution 640x480 VGA display
- 20MB hard disk drive with 23ms access time
- 79-key keyboard with 101-key emulation
- MS-DOS 4.01 and LapLink II in ROM
- Rechargeable/removeable internal battery pack
- Modular AC adapter
- Dimensions: 8.5"x11"x1.4"
- System Price: \$2895 (62280)

# CompuAdd®

Customer driven, by design.™

12303 Technology Boulevard, Austin, TX 78727

We accept MasterCard, VISA, money orders, certified checks and personal checks (please allow 10 days for processing), CODs (\$50 minimum order), company and institutional purchase orders (minimum initial purchase \$500, thereafter \$50), and wire transfers.

Please add 2% to all purchases for shipping and handling (minimum \$3, shipping outside the continental United States will increase cost). Add 8% for shipping and handling to APO/FPO addresses (minimum \$10). AZ, CO, CT, DC, FL, GA, IL, IN, KS, LA, MA, MD, MI, MN, MO, NC, NE, NJ, NM, NY, OH, OK, PA, RI, SC, TN, TX, UT, VA, and WI residents, please add appropriate local sales tax. Thirty-day money-back guarantee does not include return freight or shipping and handling. Opened software, videotapes and other consumables are nonrefundable. All return items must be accompanied by a return merchandise authorization (RMA) number. Prices and product descriptions are subject to change without notice. CompuAdd is not liable for damage due to omissions or typographical errors. Call 800-666-1872 for a copy of CompuAdd's complete warranty.

Circle 63 on Reader Service Card

# SHORT TAKES

BYTE editors' hands-on views of new and developing products

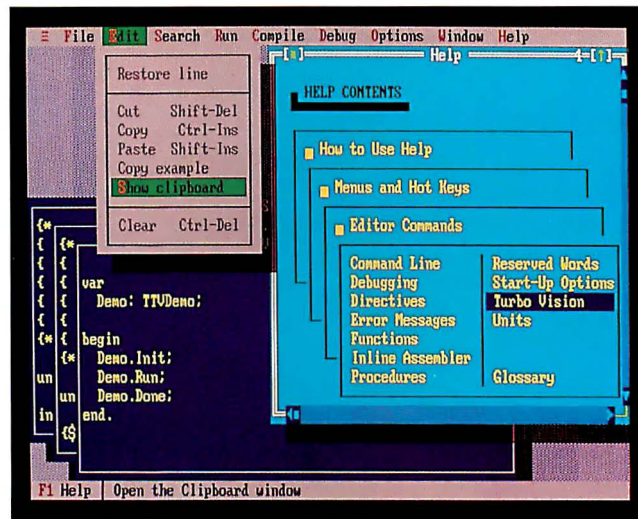
Turbo Pascal 6.0

Volante AT1000

Toshiba T1000LE

Word 5.5  
and Word for OS/2

Taste



## Turbo Pascal 6.0 Almost Adds Windows

**T**urbo Pascal 6.0 from Borland International lives in a nowhere land between the houses of DOS and Windows. One of the biggest requests Borland gets from Turbo Pascal programmers is for a Microsoft Windows version of the program.

Borland has made some vague commitments toward Windows for its programming languages, and the first signs of these show up in Turbo Pascal 6.0. The biggest single change to the language over version 5.5, which introduced object-oriented programming (OOP), is the addition of a powerful and flexible set of object-oriented tools, called Turbo Vision, for programming text-based windows, menus, and dialog boxes.

Turbo Vision is a truly revolutionary way to program text-based applications for PCs. It lets ordinary programmers make their programs look like those written by professionals (e.g., Microsoft Works or PC Tools). Turbo Vision provides a huge library of windows, menus, dialog boxes, and other interface features for the programmer to draw on.

As an example of their power, a program shorter than

200 lines can be used to open up multiple windows, each showing the text of any disk file. Any number of these windows can be opened at once, and they all are movable, resizable, and scrollable. They can be controlled by mouse or with the keyboard. The same program also includes menus and a status line with items selectable by pointing and clicking. The user interface is consistent, so that applications written using Turbo Vision will operate consistently and have the same "look and feel."

Programming Turbo Vision requires a good understanding of OOP principles, as well as an understanding of how an event-driven environment must operate. For that is what

Turbo Vision is: an event-driven environment, just like Microsoft Windows and the Macintosh user interface. Fortunately, Borland does a fair amount of hand-holding in the manuals to get new users up to speed, both in OOP and in how to make use of Turbo Vision. But don't expect to get up to speed too quickly. In its own way, Turbo Vision is almost as complex as Microsoft Windows.

Turbo Pascal 6.0 also has a new integrated development environment. Similar to the one in Turbo C++, it allows multiple windows with different files to be open at once. Not too surprisingly, the interface looks like it was created using Turbo Vision and has the same

status lines, background, menus, and windows. It operates quickly and retains all the Control and editing keystroke combinations of the previous version. I found the ability to work with multiple files at once and use a mouse helpful.

An in-line assembler lets programmers enter assembly routines using real assembly instructions rather than having to enter hexadecimal codes, as previously. Turbo Pascal 6.0 has better support for linking in object files, making it easier to add assembly routines of all kinds.

Other new features make Turbo Pascal even more suitable for use as a professional, robust language for developing DOS applications. One of these is a command-line compiler that works in protected mode on 286 and 386 systems and makes use of all the extended memory in your system to let you compile really big applications. This is available only in the Turbo Professional package, however.

Borland has also added a few new compiler directives. The most significant one causes the compiler to generate 286 code rather than generic 80x86 code. This results in smaller programs that run only on 286 or 386 systems. No check is made, so such applications will just crash on 8086-based computers.

Turbo Pascal 6.0 is a welcome extension to the line. It introduces powerful object-oriented and event-driven interface features to programmers, while continuing to improve the overall performance and effectiveness of the language. Making use of Turbo Vision will be good practice for any future version that may let us program in the even more complex Microsoft Windows environment.

— Owen Linderholm

### THE FACTS

**Turbo Pascal 6.0**  
\$149.95

**Turbo Pascal Professional 6.0** (with Turbo Assembler, Turbo Debugger, and Turbo Profiler)  
\$299.95

*Requirements:*  
IBM PC, PS/2,  
or compatible with 512K  
bytes of RAM.

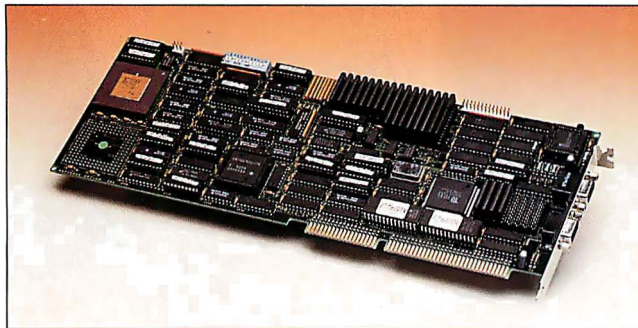
Borland International, Inc.  
1800 Green Hills Rd.  
P.O. Box 660001  
Scotts Valley, CA 95066  
(408) 438-8400  
**Inquiry 1163.**

## High-End Graphics for the Frugal

If you have the uneasy feeling that your speedy 386- or i486-based system isn't quite as fast as you expected, you've probably run into a phenomenon that might be termed "graphics indigestion." With today's emphasis on graphics-based applications (e.g., Windows 3.0 and OS/2), it's become increasingly evident that standard VGA cards are a drain on system speed. Since they share CPU cycles with your application, they slow everything down.

Faster graphics cards, such as those based on the 8514/A graphics standard, haven't exactly taken the market by storm, primarily because they are expensive and difficult to install. Graphics cards based on Texas Instruments' burly TMS34020 graphics processor have been available for a few years, but you've had to pay a high price for the power, with even the lowest-priced versions tipping the budget scales at about \$2500 each.

With the introduction of its **Volante AT1000** board, National Design has lowballed



### THE FACTS

**Volante AT1000**  
\$995

*Requirements:*  
IBM AT or compatible  
with a free 16-bit ISA  
slot.

National Design, Inc.  
9171 Capital of Texas Hwy.  
Houston Building, Suite 230  
Austin, TX 78759  
(512) 343-5055  
**Inquiry 1164.**

the competitors with a 34020-based graphics card that retails for a relatively paltry \$995. The preproduction board I tested brought a new dimension to Windows 3.0 (as well as other graphics applications), giving me 1024- by 768-pixel resolution and 256 displayable colors on my 8514/A-compatible monitor. But what was most dramatic was the overall increase in graphics speed. When I opened several windows and ran concurrent graphics applications, the display speed didn't slow down the way it would with a standard VGA board.

The Texas Instruments Graphics Architecture that's the heart of 34020 power (and compatibility) is a standard application interface that allows applications to upload all graphics code to the Volante board, speeding up the graphics and leaving your system's main CPU to do what it does best. As boards based on the 34020 (and its lower-cost cousin, the 34010) become available, TIGA drivers are slowly becoming more prevalent. The AT1000 comes with drivers for X Unix Windows, AutoCAD, and Windows 3.0; and you'll see more drivers

coming down the pike soon.

Installing the Volante was a bit more involved than installing a standard VGA board. A DIP switch controls interrupts and I/O address, and there's quite a bit of support software, although the installation utility is mainly automatic. The Volante also incorporates a VGA controller for applications that don't use TIGA or 8514/A, and you must run a utility that switches the board to TIGA.

To get 34020 power in a low-cost board, you have to make some compromises. The AT1000's 1024- by 768-pixel mode does rely on interlacing the display, meaning there is a discernible flicker. But I didn't find it objectionable. National Design has a higher-end board, the AT1200, that uses a noninterlaced display, but it costs \$2495. (A VMEbus version is also available.)

Of course, you'll need an 8514/A-compatible monitor to go along with your AT1000, but monitor prices have come down dramatically in the past year. All in all, the Volante AT1000 is a harbinger of the next generation of graphics boards that bring true graphics power to the PC platform. VGA, step aside.

—Stan Miastkowski

## The T1000 Slims Down

Most of the current crop of trendy little notebook computers weigh about the same, cost about the same, and sport the same standard features. So why look at the **Toshiba T1000LE**? Well, for years my road-time companion has been the 10-pound T1000 laptop, and we've always gotten along well. It's now time to lighten my luggage by trading a laptop for a

notebook, and I thought it would be nice to stay in the same respected family. Given that I was in for few surprises, my main considerations were power and quality of the display.

Incidentally, the T1000LE weighs 6.5 pounds and has 1 megabyte of RAM, a 20-MB hard disk drive, and a 3½-inch floppy disk drive—all you need to keep working on the

go. It also comes with an AC adapter and one internal rechargeable nickel-cadmium battery pack. DOS 3.3 is installed in ROM. You can add the usual extra RAM (up to 9 MB total), a replacement battery pack, an external 5¼-inch floppy disk drive, and a 2400-bps modem.

The T1000LE supports VDISKS (virtual disks), which let you use conventional and

expanded memory to simulate a disk drive. The advantages include increased speed and power savings. The system supports the standard DOS VDISK, as well as Toshiba's own Hard RAM (actually, CMOS RAM). The difference between the two is that Hard RAM will save its contents even when power is turned off—unlike VDISK, which loses all data when power is

lost. Hard RAM uses expanded memory, and you set it up using the simple utility program.

At the core of the T1000LE is the 8-bit CMOS Intel 80C86 running at 9.54 or 4.77 MHz. The ability to switch to slow speed came in handy as a power-saving feature, although it didn't buy me much time since I'd already run the battery down. Indicator lights along the front of the unit resemble those on its higher-end cousin, the T2000SX. The battery indicator lights glow green when all is well, but they switch to amber when you're running low or flash red when you're really running out of power. There's also an audible beep, but you can turn it off as a simple way to save power.

The display is a 640- by 400-pixel sidelit supertwist LCD with CGA-compatible graphics. I found it to be adequate—at least it's a vast im-



provement over the T1000. I was able to tolerate the display for hours at a time, as well as read it under poor lighting conditions.

If I were purchasing this system for writing on the road, I'd opt for the second battery pack, which goes where the

optional modem goes. Of course, I'd like to have both modem and second battery pack, but an external modem does just fine.

After using the T1000LE extensively for a week, I couldn't make it miss a beat. Running it at full speed (9.54

**THE FACTS**

**Toshiba T1000LE**  
\$2499

*Options:*  
2400-bps internal modem, \$349

Toshiba America Information Systems, Inc.  
Computer Systems Division  
9740 Irvine Blvd.  
Irvine, CA 92718  
(714) 583-3000  
**Inquiry 1165.**

MHz) without implementing any other power-saving features, it lasted for 3 hours on battery power alone, and I could fully recharge it overnight. I guess I have talked myself into it—this one's a keeper.

—Anne Fischer Lent

**A Pair of New Words from Microsoft**

**W**ith the release of **Word 5.5** and **Word for OS/2**, along with the existing Word for Windows, Microsoft is mounting a three-pronged attack on market-leader WordPerfect. Word 5.5 takes the bold step of tossing out the old user interface in favor of a new, incompatible, but more standardized appearance and behavior. With this new version, the labels have changed, but the concepts have not. At the same time, Word for OS/2 is only the second full-fledged word processor for that much-maligned "operating system of the nineties" (DeScribe was the first).

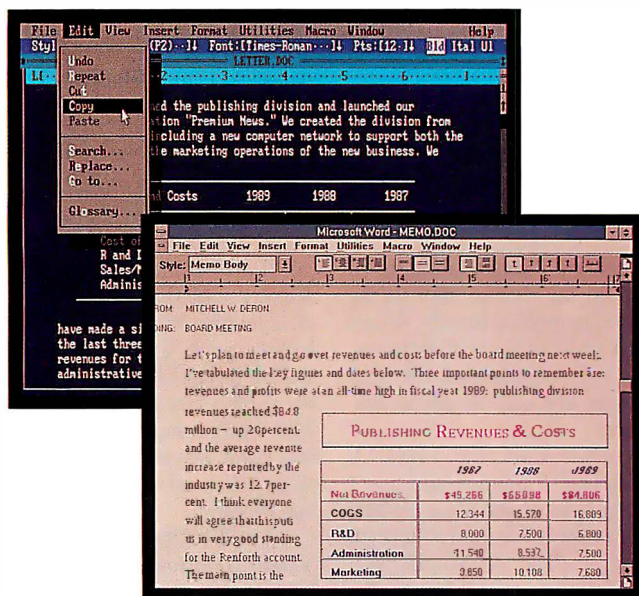
The previous release of Microsoft Word for DOS, version 5.0, used the same menuing scheme as all releases dating back to 1983, a two-level descending tree that sat at the bottom of the screen and was activated with the Escape key. In version 5.5, Microsoft has implemented a character-based interface, compatible

with the Common User Interface, that ties the three PC versions of Word (i.e., DOS, Windows 3.0, and Presentation Manager) together into a common fold, with compatible file structures.

Version 5.5 lets you access

pull-down menus at the top of the screen with the Alt key and includes terms familiar to anyone who uses a graphical user interface: File Open, Edit Paste, and so on. In fact, the top-level menus are identical to those in Word for Windows

and Word for OS/2. Once inside the menus, however, many dialog boxes contain options and syntax borrowed



**THE FACTS**

**Word 5.5**  
\$450; upgrades: \$50 from version 5.0; \$75 from versions 1.0 through 4.0

**Word for OS/2**  
\$495; upgrades: \$50 from Word for Windows; \$150 from Word for DOS

*Requirements:*  
Word 5.5: A DOS system with 384K bytes of RAM (512K bytes is recommended).  
Word for OS/2: OS/2 1.21 or higher.

Microsoft Corp.  
1 Microsoft Way  
Redmond, WA 98052  
(206) 882-8080  
**Inquiry 1166.**

# Here's How We Protect Your Software And Profits Better.

**SOFTWARE PROTECTION**

**Windows 3.0**  
Support Available

## We'll Never Tell...

... the world how we protect your hard work. But then, why should we? It's not that we're hard to get along with. On the contrary. We'll show you how our unworried approach to software protection can actually work better for you. We'll deliver the best balance of guaranteed copy control and cost-effective installation.

Unlike other manufacturers, our hardware is *uniquely custom-wired for each developer* and supplied with a specific *encrypted interrogation routine* for maximum security.

The precise routines assume responsibility for all hardware, software and timing issues so your time and money isn't wasted engineering protection schemes.

### The Products That Protect Your Revenues

▶ **PROTECH KEY**

Identically reproduced packages.

▶ **MEMORY KEY**

**MACINTOSH MEMORY KEY**

**NEC MEMORY KEY**

Active protection, modular packages, customized packages, serialization, demo control, access control.

▶ **MEMORY-ONE KEY**

Customized packages, modular packages

▶ **MICROPROCESSOR KEY**

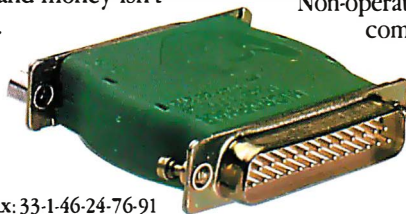
Non-operating system specific protection based on RS232C communications for minicomputers, workstations, etc.



**In EUROPE:**  
MICROPHAR, 122 Ave. Ch. De Gaulle 92200,  
Neuilly Sur-Seine FRANCE Tel: 33-1-47-38-21-21 Fax: 33-1-46-24-76-91

**For distributors in:**

- BELGIUM/NETHERLANDS. E2S (091 21 11 17) • SPAIN, (343 237 31 05)
- IRELAND, TMC (021 87 37 11) • GERMANY, Microphar Deutschland (06223 737 30)
- PORTUGAL, HCR (1 56 18 65) • UNITED KINGDOM, Clearsoft (091-3789393)
- SWITZERLAND, SAFE (024 21 53 86) • ITALY, Siosistemi (030 24 21 074)



**ProTECH**  
MARKETING, INC.

**1-800-843-0413**

**In the U.S., the AMERICAS & the PACIFIC:**  
PROTECH, 9600-J Southern Pine Blvd.,  
Charlotte, NC 28217 *Se Habla Español*  
Tel: 704-523-9500 Fax: 704-523-7651  
Hours: Mon-Thurs: 8:30-7:00 ET, Fri: 8:30-5:30 ET

FOR A DEMONSTRATION PACKAGE OR ADDITIONAL INFORMATION, PLEASE WRITE OR CALL.

\*Macintosh is a registered trademark of Apple Computer, Inc.  
\*NEC is a registered trademark of NEC Information Systems, Inc.

For Europe, circle 266 on Reader Service Card

For Americas & Pacific, circle 267 on Reader Service Card

from earlier versions of Word. The result is a hybrid that is surprisingly easy to use.

Microsoft is also hedging its bet for loyal Word users. The company ships two complete versions of Word for DOS in each package: one with the new interface, and one with the old. You can share files between the two, but you have to translate macros. In addition, Word 5.5 lets you selectively preserve some elements of the old interface (e.g., function-key assignments).

Version 5.5 offers few new features because Word was

already rich with them. One important addition is a "ribbon" at the top of the screen that shows at a glance which style sheet and fonts are in use. It lets you change the settings by pointing and clicking, without using the menus.

In Windows for OS/2, Microsoft is providing a logical upgrade path from the character-based interface of version 5.5 through Word for Windows to Presentation Manager. In fact, Word for OS/2 is virtually indistinguishable from the Windows version, with the same three-dimensional look

and feel and switchable ruler and ribbon displays that let you quickly switch among fonts, styles, and layouts.

What's different? Word for OS/2 is faster and smoother than version 5.5 or (especially) the Windows version. It obviously takes advantage of OS/2's multithreading capabilities; and, of course, you can use OS/2's true multiprocessing to run multiple copies of Word for OS/2. You can also use the OS/2 High Performance File System for even better speed, along with the long filenames.

Overall, the benefit for customers is a reduction of training time to move from version to version. Word offers all the advanced features that power users need, including outlining, indexing, style sheets, an integrated spelling checker and thesaurus, mail merge, page preview, and document management. But individual word processor preferences are highly subjective. Whether the three versions of Word will upset the WordPerfect juggernaut remains to be seen.

—Andrew Reinhardt  
and Stan Miastkowski

## Create and Lay Out Documents with Taste

It's hard to pin a label on **Taste**, a new \$150 Mac application from Delta Point, the folks who brought us MindWrite (a word processor) and DeltaGraph (a graphing/plotting application). It seems to be an amalgam of word processor, page-layout application, and database manager.

Taste resembles a word processor in that you can write or import text. A menu selection allows you to display a document's invisible characters, which eliminates those maddening problems that occur with embedded control characters when you import a file from another computer. It also does a word count on either the entire document or a selected text block.

As a page-layout application, Taste allows you to import various documents using XTND. Clicking on a layout icon at the bottom of the document window lets you assign the number of columns the document will have, determine if hairline rules separate the columns, and arrange the spacing of the page's columns, headers, and footers.

Taste uses text and draw layers to help you integrate graphics in a document. With a draw module active, you can import EPSF or PICT images and scale them to fit on a page. You can have text wrap around

or within a graphic element, and you can draw a colored box around text to highlight it, as in a text box. A page-preview selection lets you view one or more pages at a time, which can be useful for examining portions of the document as a thumbnail layout.

The database portion of

Taste is more of a personal data manager: It performs mail merge and can operate as an address book. Taste's address book can dial numbers for you. It can be handy if you don't have a modem connected to your Mac.

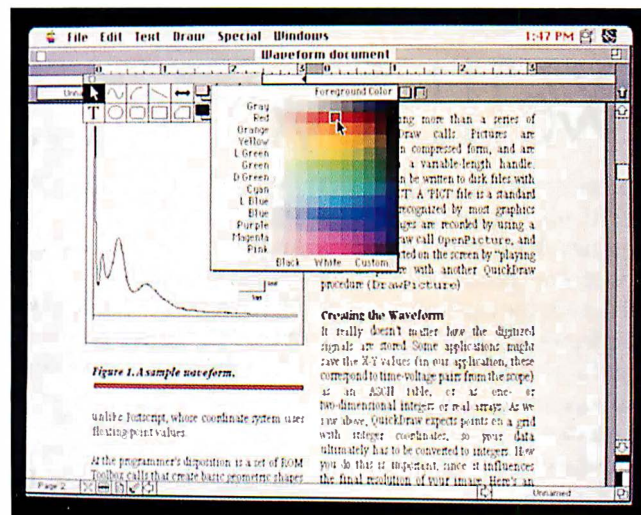
I tried Taste 1.0A3 on a Mac IICI with 4 megabytes of RAM,

a 80-MB hard disk drive, a SuperMac Technology Spectrum/24 PQD videoboard, and a 19-inch monitor; a Mac IISI with 5 MB of RAM, an 80-MB hard disk drive, and an AppleColor RGB monitor; and a Mac Plus with 2 MB of RAM and a 20-MB hard disk drive. It was able to import an Encapsulated PostScript Format (EPSF) file from Adobe Illustrator 3.0 and flow two-column text around it on all the machines. Taste had no problem operating in the 32-Bit QuickDraw environment and printing to a LaserWriter.

Taste balances three products in one by achieving modest goals. No, it's not a complete database application—nor does it try to be. But it lets you use a database as an address book.

It's not a complete word processor, but it has enough useful tools (e.g., word count) to make it a good one. Taste doesn't pose a threat to either Aldus PageMaker or Quark XPress, but its ability to place EPSF files and add graphics lets you create some good-looking documents at a fraction of the price. If Delta Point can get some of the rough edges out of the product, it will be worth a look by those who need premium output on a small budget. ■

—Tom Thompson



### THE FACTS

**Taste**  
\$149.95

**Requirements:**  
A Mac with 1 MB of RAM and a hard disk drive running System 6.0.2 or higher.

Delta Point, Inc.  
200 Heritage Harbor,  
Suite G  
Monterey, CA 93940  
(408) 648-4000  
**Inquiry 1167.**





# FROM TINY KERNELS MIGHTY SYSTEMS GROW

In the UNIX® world, microkernel architecture is still only a germ of an idea. With QNX®, it's been a reality for nearly a decade.

QNX's advanced design has certainly proved fruitful. Our installed base has now grown to over 100,000 systems in factories, laboratories, and offices throughout the world.

Why a microkernel? Because it gives you everything a monolithic "megakernel" can't. It's small, fast, and dedicated. While a typical UNIX kernel attempts to juggle everything under the sun, the QNX kernel concentrates only on scheduling tasks and coordinating message-passing activity. All other OS functions – file handling, device I/O, network management, etc. – are taken care of by separate server tasks.

The result is an efficient, extensible, and verifiable operating system.

You can even customize QNX on the fly. Since you can start and stop server tasks *dynamically*, you can easily add network support, install new devices, or incorporate entirely new system services – *without having to take apart and rebuild the entire OS*. Unlike most operating systems, a microkernel OS is designed to stay out of your way.

In the seamless environment of the QNX network, tasks can reside on any node and can transparently access any resource attached to any node. You can mix and match a wide range of Intel-based PCs, from vintage 8088s all the way up to 486 machines. And since an application can harness the processing power of all the CPUs throughout the LAN, the result is a level of distributed performance you never dreamed possible from a micro environment.

Which is why QNX developers can turn cost-effective platforms into such powerful systems. Like a pair of PCs that run a large-scale international

FAX service bureau. Or a dozen micros that replaced a \$500,000 mini system. With QNX, you can afford to think big.

Need realtime performance? QNX provides priority-driven, pre-emptive task scheduling, and reaches speeds usually reserved for dedicated realtime executives (27 µsec per task switch on a 33 MHz 80386).

Yet QNX is a fully integrated environment in which your development system and your target system are one and the same. With QNX, you can count on a complete OS that includes a robust file system, built-in peer-to-peer networking, and a rich set of development tools to boot. Add to this the appeal of **QNX Windows**, our new 3-D server-based *OPENLOOK* GUI, and your applications will take on a whole new dimension.

Are you ready for your next operating system? You could always wait and see what other systems may have in store someday.

Or you could join the growing community of QNX users and realize your potential right now.



For more information or a free demo disk, please phone (613) 591-0931.

Quantum Software Systems Ltd., 175 Terrence Matthews Crescent, Kanata, Ontario, Canada K2M 1W8

QNX is a registered trademark and QNX Windows is a trademark of Quantum Software Systems Ltd. UNIX is a registered trademark and OPENLOOK is a trademark of AT&T. Intel is a registered trademark of Intel Corporation. © 1990 Quantum Software Systems Ltd.

Circle 270 on Reader Service Card

# Born not to run.

Hewlett-Packard inkjet technology now gives you non-smear, water-resistant ink, easy and whisper-quiet operation, crisp and black 300 dpi resolution, portrait and landscape printing, multiple fonts through Windows support, 2+ pages per minute, full industry compatibility, and a three year, rain-or-shine warranty.

The new DeskJet 500  
\$729





**With water-resistant ink,  
the new HP DeskJet 500  
printer produces very dry  
documents.**

For just \$729\*, our 300 dpi ink-jet technology makes sure your output looks beautiful. And our new water-resistant ink makes sure it stays beautiful.

Our printer is made to last, too. It has a 10-year MTBF. With reliability like that, no wonder we can offer a 3-year warranty.

Despite its low cost, the HP DeskJet 500 gives you a lot of high-end features. Such as multiple fonts, scalable to 127 points through Windows support. Two print modes – portrait for letters or landscape for spreadsheets. And industry-standard compatibility that lets you plug in and start printing.

All these features come in a conveniently compact printer that works as quietly and easily as printers twice the price.

So call **1-800-752-0900, Ext. 1911** for your nearest authorized HP dealer. You'll see that it doesn't cost much to make even dry documents look exciting.



 **HEWLETT  
PACKARD**

\*Suggested U.S. list price.  
©1990 Hewlett-Packard Company PEI2044

# Citrix's New Multiuser OS/2

OS/2-based workgroup computing  
without a LAN

■  
Jon Udell

**M**ultiuser OS/2? It makes a lot of sense. Throughout its short life, OS/2 has been an operating system with an identity crisis. Billed originally as the heir apparent to DOS and then Windows, OS/2 has so far been unimpressive in that role. Mainstream PC users now stampeding to Windows 3.0 (and eagerly awaiting DOS 5.0) clearly prefer incremental change to the quantum leap that OS/2 represents.

More recently, the action has been shifting to the LAN arena. Here, OS/2 gets billed as a network operating system and as the platform for server-based applications with which DOS and Windows clients will communicate. In the long run, you'll likely see both kinds of OS/2 systems: high-end desktop workstations and network servers.

But there's a third way. Citrix Systems, a team of IBM refugees led by OS/2 guru Ed Iacobucci, has extended OS/2 into the multiuser territory occupied by Unix, Xenix, QNX, Theos, and a variety of DOS-based operating systems. And the fledgling company has taken the right approach. Citrix Multiuser starts with OS/2 1.21 sources licensed from Microsoft and weaves in a terminal subsystem, user-oriented security, resource auditing, and the ability to address up to 256 megabytes of memory.

Citrix comes on four disks—one less than OS/2 1.21 (and dozens fewer than SCO Unix). How can Citrix's beefed-up

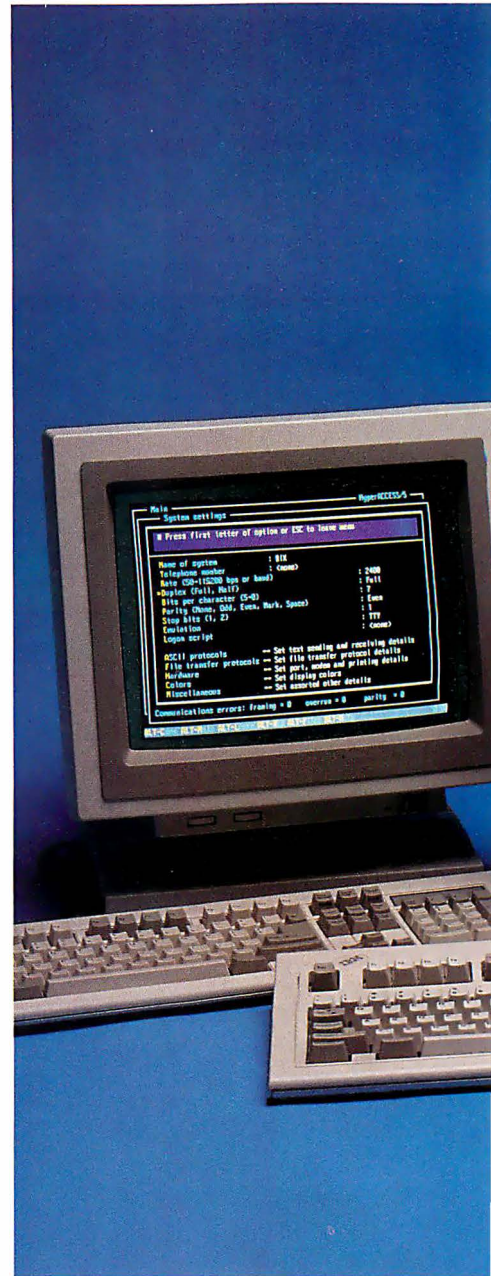
OS/2 be smaller than the standard IBM/Microsoft version? There is one conspicuous omission: Presentation Manager (PM). You won't be running WingZ, PageMaker, or Corel Draw under Citrix Multiuser. You'll have to stick with character-mode applications like WordPerfect, Lotus 1-2-3, Word, HyperAccess, Oracle, Paradox, and R:base.

Granted, these aren't the hottest programs available for OS/2. But, in combination with custom software, they're a good fit for the needs of small- and medium-size retail and service businesses. If that's your game, glamorous bit-mapped graphics may not be high on your list of priorities. You want low cost per seat, central control, simple installation and administration, and rock-solid stability. That's what Citrix has to offer.

## Setting Up Shop

I installed Citrix Multiuser on a 12-MB Compaq Systempro equipped with an eight-port Digiboard PC/Xi multiport adapter. The system uses unmodified OS/2 device drivers and should therefore support any multiport board for which an OS/2 driver exists. Citrix doesn't introduce any special disk utilities: You use FDISK and FORMAT, just as you normally do under OS/2.

The boot partition does have to be a High Performance File System partition, since Citrix (like LAN Manager) uses extended attributes to track access rights on a per-file, per-user basis. Secondary



partitions can be file allocation table or HPFS, but Citrix can secure only HPFS partitions.

Citrix supports a variety of PCTERM terminals (i.e., terminals with standard 84- or 101-key keyboards that transmit PC scan codes instead of ASCII characters). Terminals for which Citrix provides drivers include the ADDS 2025, the IBM Model 3151, the Kimtron KT-70, the Link Technologies MC2 and MC5, the TeleVideo Systems Models 950 and 965, and the Wyse WY-150.

The config terminal utility, a full-screen interactive program that works like all the Citrix configuration tools, makes quick work of tweaking RS-232C communications settings. When all goes well, the terminal you're configuring wakes up and presents a Login: prompt.



When it does not—as happened to me once—you’ve got some detective work to do. In general, Citrix makes setting up terminals at least as easy as the multiuser DOS systems I’ve seen—and that is, in my opinion, far easier than with Unix.

On the other hand, all these systems depend on cables and connectors, just as LANs do. Tracking down a faulty component isn’t necessarily any easier with a multiuser system than with today’s modular LANs.

PCTERM isn’t the only terminal option. Teco, a Taiwanese manufacturer, has developed a new species of terminal that implements some of the OS/2 video I/O functions in its ROM. Citrix provided me with an engineering prototype of this terminal, which should be available this quarter at a list price of about

\$800. The VIO protocol speeds operations like scrolling, since the host can simply send a `VioScrollUp` command to the terminal instead of a screen of data.

Citrix says additional optimizations reduce the load on the host and lessen communications traffic. For example, if an application calls `VioGetBuf` to get the address of the logical video buffer, changes the contents of that buffer, and calls `VioShowBuf` to redisplay it, the terminal and host will conspire to exchange only the data needed for the update.

Teco terminals also support color text. Color is important, even in character mode. Color-coded data-entry screens can make life a lot easier for the folks who have to use them.

I’m willing to buy Citrix’s argument that there’s a sizable market for charac-

ter-only multiuser systems, and I applaud the support for color text. I’m troubled, though, by the lack of mouse support. If you think that an effective graphical user interface (GUI) requires a bit-mapped screen, take a look at a program like FoxPro, which works just like FoxBase+ for the Macintosh.

Watching FoxPro users, I’ve noticed that those without mice seldom take advantage of one of the program’s best features: the ability to interactively resize and reorder columns of data. A version of FoxPro for OS/2 (there isn’t one yet, by the way) would lose much of its luster without mouse support. Some PCTERM terminals do come with extra serial ports that can drive mice, and Citrix agrees that it would be a good idea to put that capability to use in a future release.

*continued*

## Multiuser OS/2 from Overseas

Stan Miastkowski

As unique as it is, Citrix Multiuser is not the only player in the field. In fact, a company based in France has had a multiuser OS/2 available since January 1988. Memsoft now has set up a sales office in the U.S. (One Park Place, 621 Northwest 53rd St., Boca Raton, FL 33487, (407) 997-6655). It is now trying to carve out a market niche for its product, called PolyMod2.

Sales manager Gerard Gatt told me that Memsoft takes "a very different approach" from Citrix to bringing multiuser capabilities to OS/2. Where Citrix "reengineers OS/2," PolyMod2 exists as "a layer over OS/2"—as a separate program. Gatt says that this lets Memsoft's product "work with any version of OS/2, from 1.0 to the upcoming 2.0."

At first blush, PolyMod2's features and abilities look nearly identical to Citrix Multiuser's, letting you access multiple character-based OS/2 applications from ASCII terminals. But PolyMod2 does add some intriguing bells and whistles to the basic concept.

Gatt underlines PolyMod2's connectivity features, letting networked PCs (and even Macs) connected to a PolyMod2 OS/2 system run OS/2 applications using a 40K-byte TSR program. Even more interesting is that Windows 3.0 users can dedicate a window to PolyMod2's emulator and run OS/2 as a windowed application.

In addition, PolyMod2 can interconnect multiple OS/2 machines without the need for a network. This lets the system administrator equalize the load on the system, dedicating OS/2 machines to processor-hungry applications. Fur-

thermore, PolyMod2 can connect those multiple OS/2 machines via modem, resulting in a low-cost wide-area network.

PolyMod2 is slightly more expensive than Citrix Multiuser. A 10-user system sells for \$1600 (and you need a copy of OS/2). It also requires an additional 2 megabytes of RAM over OS/2 requirements. (The usual total is 6 MB.)

Memsoft has been around since 1979, first developing MEMDOS, a LAN for Apple II's. A privately owned company with 64 employees, it grossed a comparatively small \$10 million last year. Gatt claims that PolyMod2 is installed on over 10,000 OS/2 systems in France, representing (he says) 40 percent of that country's total installed base of systems running OS/2.

Ironically, Citrix's big-bucks rollout has the potential of increasing the overall market share for OS/2 multiuser systems; giving Memsoft a push in its hunt for market penetration.

Gatt also had some interesting things to say about the worldwide OS/2 market, confirming repeated rumors that OS/2 is considerably more popular outside the U.S. than in. He says that overseas, companies are "buying OS/2 as a solution" because users have a "longer-term orientation" than those in the U.S., expecting to "use existing systems for 5 to 10 years." Gatt also says that because Windows 3.0 is perceived as a "short-term solution," it hasn't generated much interest overseas.

*Stan Miastkowski is a BYTE senior news editor. He can be contacted on BIX as "stanm."*

### Batten Down the Hatches

Citrix's security subsystem models itself loosely on that of LAN Manager: The same user, group, administrator, and guest categories apply. Tight security is the norm for users. The default group membership confers rights to a home directory (\usr\username) and to a minimal set of OS/2 and Citrix utilities. With config access, you can elaborate those rights as needed. It represents files and directories in outline form—like a character-mode version of OS/2's File Manager. As with LAN Manager, you can control rights to directories or to individual files.

Wild cards add a nice flexibility to the basic scheme. Suppose you've got the groups Accounting and Sales and a user called Joe. For a given directory or file, you can adjust rights for Joe.Accounting (Joe, when using his Accounting log-in), \*.Accounting (everyone in Accounting), or Joe.\* (Joe, regardless of how he logged in).

Names of directories and files with implicit (i.e., inherited) rights show up between curly brackets; names with explicitly assigned rights appear between square brackets. That's helpful when you're trying to sort out transitive relationships. Another convenience is that

config access can always offer a pick list of user and group names, so you need never type the names.

Another tool, config profile, collects information about users and groups: passwords, resource limits, resource auditing, and log-in restrictions. As you'd expect, a user's profile inherits from a group profile and can then be customized. Adjustable limits include the number of log-ins, sessions, threads, file handles, and semaphores, and the amount of (virtual) memory. However, Citrix doesn't enable an administrator to limit the amount of disk space that a user or group can consume. A profile includes a "first program" field that defaults to a character-mode Program Selector (remember OS/2 1.0?).

If you want to create a single-purpose user account, you can substitute the name of an application. For example, when I specified Joe's first program as 123.exe, Joe could do nothing except run Lotus 1-2-3. When Joe quit 1-2-3, Citrix logged him off. Generally, you'll want to leave the Program Selector in place and use per-user start-up files to tailor users' environments.

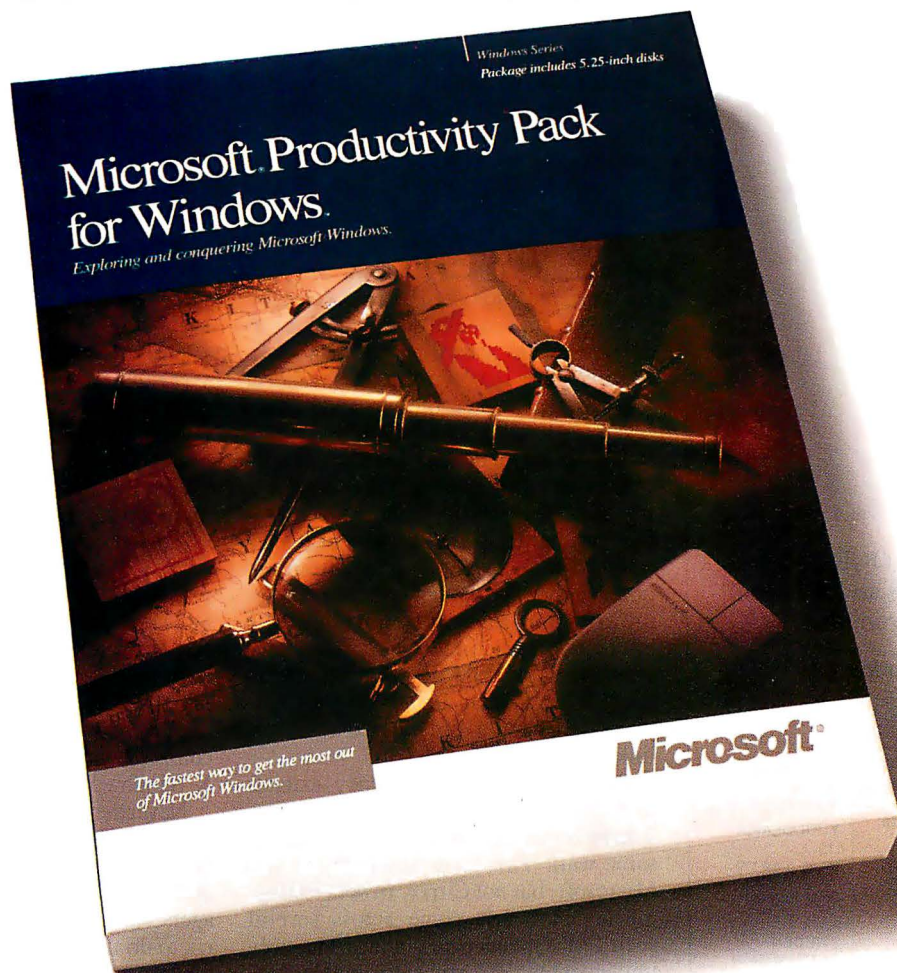
Citrix adds an interesting wrinkle to system security. A number of OS/2 application programming interface functions are secure under Citrix Multiuser. That's because even with strict user-oriented security, a program could conceivably become a rogue. Using an OS/2 function like DosOpen with the right (or wrong!) arguments, a program could gain unrestricted access to the disk. Citrix therefore protects such entry points. If a program must legitimately use them, you can create a "user alias" for it and grant the necessary API access by way of that alias.

### Pile On the Programs

I tested a number of programs, including Brief, Slick, WordPerfect, HyperAccess 5.0, Lotus 1-2-3, and Paradox. I also ran programs I compiled with the Microsoft C 6.0 and JPI Modula-2 compilers. Although everything ran without complaint, I did encounter a few quirks when transplanting single-user programs to the multiuser environment. It's sometimes necessary to distinguish between files that can be shared by all users and those that must be duplicated for each user. That's true when you run an application on a LAN, too; finding out what belongs where can involve a good bit of trial and error.

VIO can be an issue as well, depending on how a program handles the screen. When I compiled and ran a JPI

# The fastest way to break into Windows.



To get comfortable with the Microsoft® Windows™ environment, there's only one thing you have to do. Use it.

But now you can get even more out of Windows 3.0. Even faster. With the brand new Microsoft Productivity Pack for Windows.

It's really three tools in one:

Learning Windows, a colorful tutorial that lets you explore everything from the basics to the fine points.

Working Smarter, a section crammed with time-saving tips and strategies. (How *do* you create a RAM disk? The answer's here.)

And Quick Troubleshooter. Kind of a

built-in product support department that never closes. So you can get quick fixes any time, for many of your most common problems.

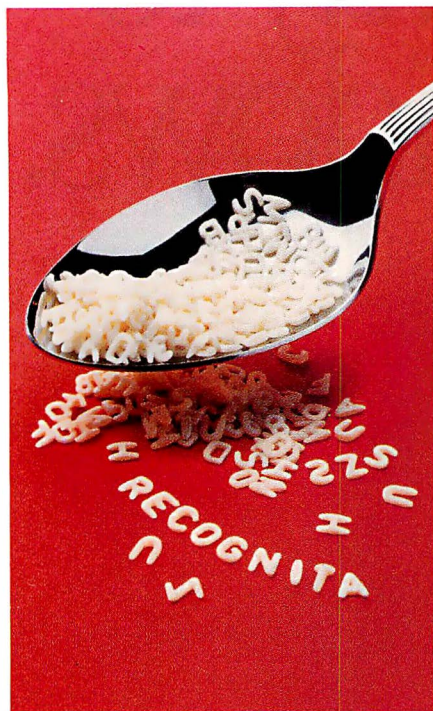
Best of all, every one of these tools is online. Which means you'll be able to learn while you work. Without quitting your applications. Or even cracking a manual.

For more information, call us at (800) 541-1261, Dept. P07. If you can't wait to get into Windows 3.0, the Microsoft Productivity Pack could be the break you need.

**Microsoft®**  
Making it all make sense™

# RECOGNITA PLUS

SPEED, ACCURACY AND FLEXIBILITY!



The fastest omnifont OCR Software  
operating in MS-DOS and Microsoft  
Windows environment

Dealers are welcome

Call for your demo diskette today:

(1-800-255-4-OCR), P.O. Box 0218 Los Angeles, CA  
90048 Tel: (408) 749-9935 Fax: (408) 730-1180

## Distributors:

### AUSTRALIA

\*Datasev  
Tel: 61-2/957-2066

### AUSTRIA

\*Artaker  
Tel: 43-222/588-05-0

### BELGIUM

\*Maxcom  
Tel: 32-2/526 9411

\*Tritech  
Tel: 32-2/466-7535

### CZECHOSLOVAKIA

\*V-Agency  
Tel: 42-2/840970

### DENMARK

\*Torsana-dtp data  
Tel: 45-43/43-35-99

### FINLAND

\*CommNec  
Tel: 358-0/493100

### FRANCE

\*Apsyllog  
Tel: 33-1/40 26 22 32

### GERMANY

\*Computer 2000  
Tel: 49-89/780-40-0

\*Frank Audiodata  
Tel: 49-7254/4091

\*Macrotron  
Tel: 49-89/42-08-0

\*Recognita  
Büroautomatisierung  
Tel: 37-41/7957-256

### GREECE

\*Electel  
Tel: 30-1/3607-521

### ICELAND

\*Höfudlausn  
Tel: 354-1/687033

### IRELAND

\*Saunders Acquisition  
Systems  
Tel: 353-1/366-522

### ITALY

\*Vecomp  
Tel: 39-45/577500

### JAPAN

\*Suehiro Koeki  
Kaisha, Ltd.  
Tel: 81-52/251-3721

### LUXEMBOURG

\*Burovision  
Tel: 352-470951

### MEXICO

\*Misermi  
Tel: 52-5/207-05-02

### NORWAY

\*ICT Databolin  
Tel: 47-2/79-58-80

### POLAND

\*FX Przedz. Inf.  
Tel: 48-12/56-57-76

### SPAIN

\*Computer 2000  
España  
Tel: 34-3-473-16-60

\*CSEI SA  
Tel: 34-3/336-33-62

### STI

Tel: 34-1/45-869-45

### SWEDEN

\*Isogon AB  
Tel: 46-8/732-87-37

### SWITZERLAND

\*ScanSet  
Tel: 41-56/96-49-83

### TURKEY

\*EKSPA  
Tel: 90-4-139-66-11

### UNITED KINGDOM

\*Intac Data Systems  
Tel: 44-709/547-177

\*MSL Dynamics  
(for Africa)  
Tel: 44-293/547-788

### YUGOSLAVIA

\*LTS  
Tel: 38-11/190-572

### OEM Partners:

\*Accret  
**SWEDEN**  
Tel: 46-766/355-30

\*Deutsche Nischen  
**GERMANY**  
Tel: 49-211/3551-202

\*EHG  
**GERMANY**  
Tel: 49-7451/7051-2

\*Future Technology  
**AUSTRIA**  
Tel: 43-222/866350

\*Getronics  
**HOLLAND**  
Tel: 31-20-5861509

\*Hewlett-Packard  
**AUSTRIA**  
Tel: 43-222/25-00-0

\*Microtek Electronics  
**GERMANY**  
Tel: 49-221/52607-0

\*Microtek International  
**TAIWAN**  
Tel: 886-35/772155

\*Mitsubishi Electric  
**GERMANY**  
Tel: 49-2102/486359

\*Pentax Europe  
**BELGIUM**  
Tel: 32-2725 0570

\*Ricoh Europe  
**GERMANY**  
Tel: 49-211/5285-0

## CITRIX'S NEW MULTIUSER OS/2

demonstration program that uses character-mode graphics to simulate automobile traffic, Citrix slowed noticeably. Three concurrent instances of the simulator brought the system practically to its knees.

Inspecting the program, I found that it writes characters and attributes one at a time in a tight loop. That's not a problem for single-user OS/2 communicating with the video buffer at bus speed, but for Citrix, which talks to terminals at 38,400 bps or less, it's disastrous.

The solution is to use line- and screen-oriented update routines. Of course, the JPI demonstration is far from a typical Citrix application. Still, some commercial OS/2 applications do operate a character at a time, according to Citrix. Software vendors interested in the multiuser OS/2 market will certainly want to avoid that pitfall.

Hidden dependencies on PM can also cause problems. I had no trouble installing SQL Server and firing up a server process, but I couldn't get any of the associated tools to work with it from another session. Although saf (Server Administration Facility) and isql (the interactive Structured Query Language interpreter) operate in character mode, they failed to load under Citrix, complaining about a PM-related dynamic link library (DLL).

Apparently, the dependency extends to dblib, SQL Server's C library, since a bare-bones test program ran into the same wall. This surprised both me and Microsoft, but not Citrix. In beta testing, the company has come across several such PM dependencies, and it has even implemented PM stubs to enable programs to run in spite of them. As of this writing, Citrix had tested Oracle successfully but had not yet tried SQL Server. Presumably, it will be a candidate for the stub treatment. Again, software developers interested in Citrix should take note.

Off-the-shelf OS/2 programs also derive unique benefits from Citrix Multiuser. Most notably, they're far more efficient in their use of memory. Although shared DLLs can help conserve memory under single-user OS/2, they typically don't serve that purpose. How often does a user need two instances of Lotus 1-2-3 or Microsoft Word? Under Citrix, however, multiple instantiation of programs is the norm. And the memory saving that shared libraries can realize is dramatic.

Lotus 1-2-3 release 3.0, for instance, gobbles nearly a megabyte of RAM when you start it up. But each successive in-

stance shares an 800K-byte chunk of common code and data, thus requiring only an additional 200K bytes of memory. To put it another way, five copies of 1-2-3 running on five separate single-user OS/2 machines will use 5 MB of RAM; five instances of 1-2-3 under Citrix will use less than 2 MB. That's an impressive feature that current incarnations of Unix and multiuser DOS can't match.

### Why Citrix?

In an era dominated by networks and GUIs, Citrix Multiuser may seem like an anachronism. But value-added resellers and consultants who earn their keep delivering packaged business solutions will see it for what it is: a practical option. Clearly, Citrix faces stiff competition. If you require DOS applications, you'll go with a multiuser DOS system. When IBM finishes OS/2 2.0, a future release of Citrix built on top of it could become the multiuser DOS system of choice, but there's no DOS support now.

Likewise, if you're already a Unix expert, I doubt that Citrix will persuade you to switch. While simpler to install and manage, Citrix lacks Unix's rich assortment of tools and applications. Moreover, until someone figures out how to make PM work with a remote display, OS/2 (and therefore Citrix) can't hope to compete with Unix's networkable GUI, X Window System.

Nevertheless, I suspect Citrix Multiuser will appeal widely enough to succeed. If you hired me to automate an ophthalmologist's office or a small travel agency, I'd seriously consider using Citrix to do the job. Why? Because I'm just the sort of person who'd seek out a middle ground between DOS and Unix. OS/2 has so far proven to be more of an operating system than most individuals need or want. But, as Citrix ably demonstrates, that extra capacity can well serve the needs of a group. ■

Jon Udell is a BYTE senior editor at large. You can reach him on BIX as "judell."

## THE FACTS

### Citrix Multiuser

\$995 for five users; \$495 for next five users; \$495 for each additional 10 users

### Citrix Systems, Inc.

210 University Dr., Suite 700  
Coral Springs, FL 33071  
(305) 755-0559  
Inquiry 1206.



# Intel 386<sup>™</sup>/486<sup>™</sup> C Code Builder<sup>™</sup> Kit

Development Tools for the 32-bit Environment.



## How to remove the last barrier to 32-bit programming.

Open Intel's new 386<sup>™</sup>/486<sup>™</sup> C Code Builder<sup>™</sup> Kit. And tear into the increased memory and performance of 32-bit DOS protected mode.

Inside, you'll find everything you need to develop 32-bit applications. That means you get a Microsoft and ANSI compatible C Compiler and Libraries, Linker, Librarian, Make Utility, and Source Level Debugger. We've even enclosed a DOS Extender that's DPMI-compliant. Compliancy that enables easy migration to Windows<sup>®</sup> and OS/2<sup>®</sup> from Microsoft.

To make moving up even simpler, we've also

included free Intel support and a \$695 price tag. With no royalties to pay. Ever.

Try it at no risk. Purchase it from your Intel dealer with a 30-day, money-back guarantee. Or call 1-800-525-3019 for fax document #9901, or Intel customer service at 1-800-538-3373. Because with Code Builder, the hardest thing about getting into 32-bit programming is opening the box.

intel<sup>®</sup>

©1990 Intel Corporation. \*DPMI compatibility with these operating environments is based upon publicly stated intentions of Microsoft Corporation. Intel is a registered trademark, and 386, 486, and Code Builder are trademarks of Intel Corporation. Windows is a registered trademark of Microsoft Corporation. OS/2 is a trademark of IBM.

Circle 153 on Reader Service Card (RESELLERS: 154)

# Systems that revolutionized the computer industry!

All backed by Northgate® support and service that's unmatched by any other company!

There are a lot of copy-cat "slim-line" systems out there, but don't be confused. These are the ORIGINAL SlimLine systems from the pioneer of this trend-setting technology: Northgate.

In just under a year, SlimLine has become our most popular system. And with good reason. Only SlimLine gives you full 286, 386SX™ and 386™ DX power in a package only 4.25" high and 16.5" square.

Now... four new SlimLine systems! "Northgate for 1991" features a SlimLine family that offers more choice than ever before: SlimLine 286/12, 386SX/16 and 20 MHz.

Our new powerhouse 386/33 rounds out our complete range of systems.

## Northgate SlimLine Common Features:

- Small footprint SlimLine case with room for two exposed and one internal half-height devices
- Intel® and Weitek® math coprocessor support
- 150 watt power supply
- Clock/calendar chip rated at five years
- Front mounted reset and high/low speed controls
- MS-DOS 4.01 and GW-BASIC installed
- On-line User's Guide to MS-DOS 4.01
- FCC Class B Certified
- 1 parallel and 2 serial ports
- Built-in VGA video adapter
- Built-in IDE hard drive and floppy disk controllers
- Five open expansion slots (three 16-bit full length, two 8-bit half-length)

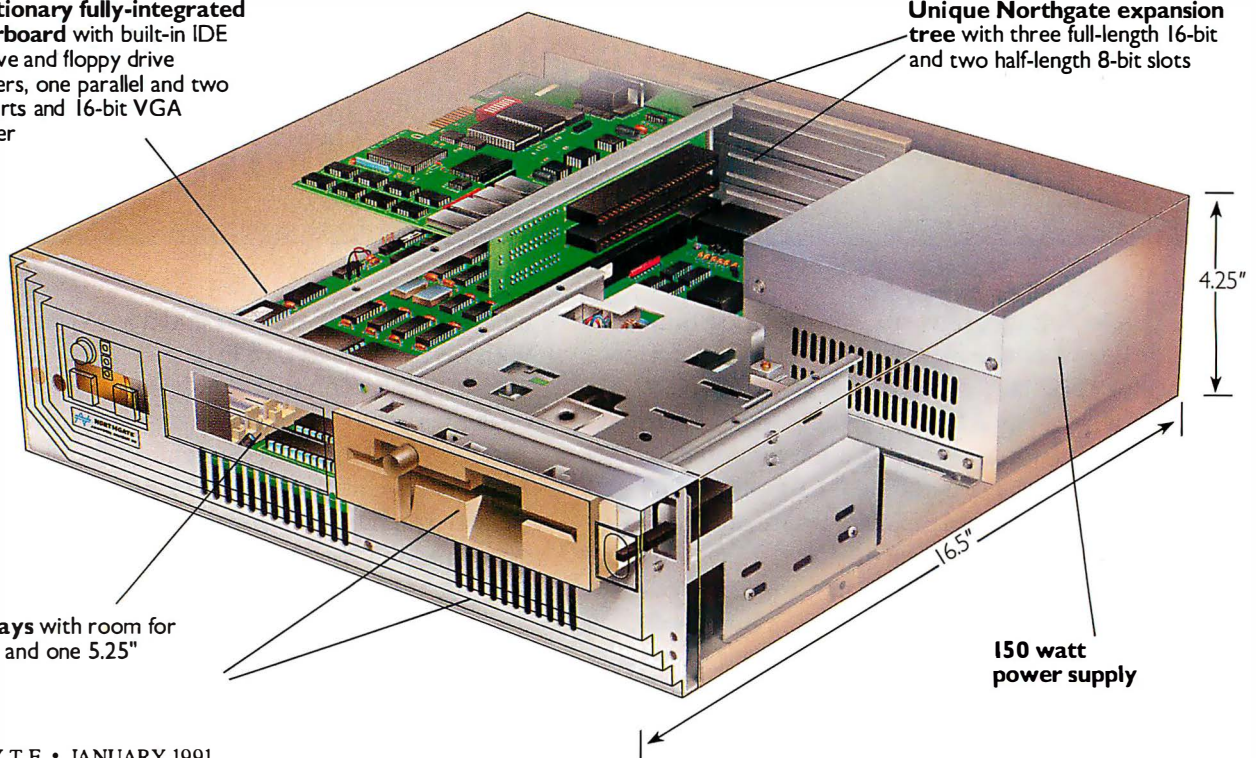
Here's how we put full power into a performance package only 4.25" high!

**Revolutionary fully-integrated motherboard** with built-in IDE hard drive and floppy drive controllers, one parallel and two serial ports and 16-bit VGA controller

**Unique Northgate expansion tree** with three full-length 16-bit and two half-length 8-bit slots

**Drive bays** with room for two 3.5" and one 5.25" device

**150 watt power supply**



# Here they are...the Northgate family of Super SlimLines™. One format, four sensational systems—take your pick!

## NEW! SlimLine 286/12 MHz

Ideal entry level system for use as network terminal or stand alone system for office and home use. Excellent for word processing, simple spreadsheet and light graphics programs.

- Intel® 80286/12 MHz processor
- 1.2Mb and 1.44Mb floppies
- 2Mb of RAM on motherboard
- 12" VGA gray scale monitor
- 40Mb hard drive
- OmniKey® keyboard

**\$1699<sup>00</sup>** Or as low as \$60<sup>00</sup> per month\*

## NEW! SlimLine 386SX/16 and 20 MHz with 64K cache

No ordinary SX! Northgate engineered these systems with 64K cache memory to allow you to run Microsoft Windows and other 32-bit software at quick cache-enhanced speeds. Handles database management, graphics and spreadsheet applications with ease. Choose 16 or 20 MHz models.

- Intel 80386SX 16 or 20 MHz processor
- 1.2Mb and 1.44Mb floppies
- 2Mb of RAM on motherboard
- 12" VGA gray scale monitor
- 40Mb hard drive
- OmniKey keyboard
- 64K SRAM read/write-back cache
- Microsoft® Windows™ 3.0 and mouse

386SX/16 **\$1999<sup>00</sup>** Or as low as \$70<sup>00</sup> per month\*

386SX/20 **\$2199<sup>00</sup>** Or as low as \$75<sup>00</sup> per month\*

## The system that started it all ... SlimLine 386/20 MHz!

SlimLine 386/20 zips through complex spreadsheets, moderate programming needs, desktop publishing and other demanding applications.

- Intel 80386/20 MHz processor
- 12" VGA gray scale monitor
- 4Mb of RAM on motherboard
- Microsoft Windows 3.0 and mouse
- 40Mb hard drive
- 1.2Mb and 1.44Mb floppies
- OmniKey keyboard

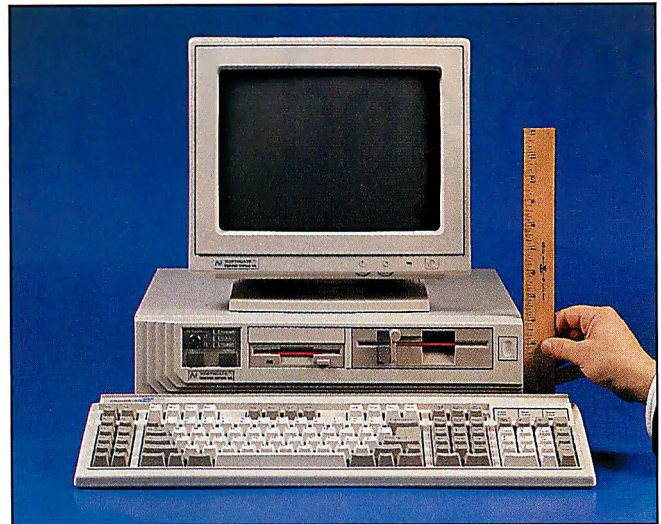
**\$2499<sup>00</sup>** Or as low as \$85<sup>00</sup> per month\*

## NEW! SlimLine 386/33 MHz powered up with 64K cache!

Now for the first time ever, you can get award-winning Northgate Elegance™ performance in our SlimLine case! SlimLine 386/33 is ideal for speeding through processor-intensive tasks like desktop publishing, CAD/CAM, large database and business programming applications.

- Intel 80386/33 MHz processor
- 1.2Mb and 1.44Mb floppies
- 4Mb of RAM on motherboard
- 12" VGA gray scale monitor
- 64K SRAM read/write-back cache
- Microsoft Windows 3.0 and mouse
- 40Mb hard drive
- OmniKey keyboard

**\$2899<sup>00</sup>** Or as low as \$105<sup>00</sup> per month\*



## Standard SlimLine Upgrades (Add to the base system price)

Hard Drives	12" Gold Star VGA Gray Scale 640 x 480	Gold Star 14" VGA Color 640 x 480	Panasonic 14" VGA Color 1024 x 768	NEC 3D 14" VGA Color 1024 x 768
40Mb IDE	\$ 0.00	\$300.00	\$ 400.00	\$ 650.00
80Mb IDE	\$200.00	\$500.00	\$ 600.00	\$ 850.00
100Mb IDE	\$300.00	\$600.00	\$ 700.00	\$ 950.00
200Mb IDE	\$600.00	\$900.00	\$1000.00	\$1250.00

Call for latest pricing and custom configuration specifications.

## "Northgate stops at nothing to please its customers!" PC Magazine Sept. 25, 1990

- NEW 60-Day No-Risk Trial—if you aren't 100% satisfied, return it!
- Free on-site service to most locations for one year if we can't solve your needs over the phone.
- Free delivery to your office or home.
- Unique 24-hour toll-free technical support—the industry's best!
- Full one year warranty on systems, 5 years on OmniKey keyboards
- For your convenience, we accept VISA, MasterCard and Northgate's Big 'N' card. We offer leasing and financing options, too!
- Northgate responds to your needs with overnight shipment of parts—at our expense!

CALL TOLL-FREE 24 HOURS EVERY DAY **800-548-1993**

New ... fax your order toll free! 800-323-7182

Notice to the Hearing Impaired: Northgate has TDD capability. Dial 800-535-0602.



7075 Flying Cloud Drive, Eden Prairie, MN 55344

*"We hear you!"*

©Copyright Northgate Computer Systems, Inc., 1990. All rights reserved. Northgate, SlimLine, OmniKey and the Northgate 'N' logo are registered trademarks of Northgate Computer Systems. 80386 and 80486 are trademarks of Intel. All other product and brand names are trademarks and registered trademarks of their respective companies. Prices and specifications subject to change without notice. Northgate reserves the right to substitute components of equal or greater quality or performance. All items subject to availability. We support the ethical use of software. To report software copyright violations, call the Software Publishers Association's Anti-Piracy Hotline at 1-800-388-PIRS. \*When charged to your Northgate Big 'N' card: 18% A.P.A.

Northgate® Elegance™

# The industry's highest rated 386™ and 486™ systems!



When we say Northgate manufactures the highest-performing, best-supported computer systems in the world ... it's a fact. Industry experts and customers worldwide agree!

In test after test, Northgate Elegance systems perform flawlessly. After the competition has been put through the same demanding paces, only Elegance 386 and 486 emerge as the winners.

And here's the proof! Northgate has won four *PC Magazine* Editors' Choice Awards, two *Computer Shopper* Best Buy Awards and received *InfoWorld's* Number One and Number Two Products of 1989.

**PLUS AT PRESS TIME ...** Northgate received word from *Computer Shopper* that Elegance 486/25i won a 1990 Best Buy Award. That makes an unprecedented **FOUR YEARS IN A ROW** Northgate received *Computer Shopper's* prestigious honor!

We'd be fooling ourselves (and underestimating you) if we thought you'd buy based on performance alone. That's why Northgate has a corporate commitment to customer service that's equally impressive. No puffery here...

**"...Northgate stops at nothing to please its customers."** *PC Magazine* September 25, 1990

- ◆ Free delivery to your office or home.
- ◆ **NEW 60-Day No-Risk Trial!** To serve you better, Northgate has doubled its No-Risk Trial period to 60 days.
- ◆ **Full parts and labor warranties:** 1 year on systems; 5 years on *OmniKey*® keyboards.
- ◆ **Overnight shipment of replacement parts—** at our expense.
- ◆ **Northgate's unique 24-hour toll-free technical support** leads the industry—most needs are met with just one call!
- ◆ **Free on-site service** to most locations if we can't solve your technical needs over the phone.
- ◆ **Northgate makes state-of-the-art power affordable!** Charge your purchase to your Big 'N' card, VISA or MasterCard. Ask about financing and leasing options, too!
- ◆ Call Northgate before you decide to buy elsewhere. You'll be amazed at our new low pricing!

# “What WordPerfect® is to software support, Northgate is to hardware, and there are even a few things WordPerfect could learn from the folks in Minneapolis.”

Bernie Zilbergeld  
Bay Area Computer Currents  
August 14, 1990

## Select desktop or optional vertical power case.

Northgate's elegant desktop case features 5-bays with room for 3 exposed and 2 internal half-height devices. Comes with 200 watt power supply. For greater expansion capabilities, choose our vertical 7-bay powerhouse with a 220 watt power supply.

## Northgate Page Mode 386/20 MHz

As a cost-efficient, dependable network file server, Page Mode has no equal. Its reliability is confirmed by Novell® certification and by users of office networks every day. Northgate boosts performance of this 386/20 workhorse through the use of an efficient page mode memory management scheme. Other performance features include:

- ◆ Intel® 80386/20 MHz processor
- ◆ 4Mb of RAM (expandable to 16Mb)
- ◆ 40Mb hard drive
- ◆ 1.44Mb and 1.2Mb floppy drives
- ◆ 16-bit VGA video adapter
- ◆ Eight expansion card slots
- ◆ One parallel and two serial ports
- ◆ MS-DOS 4.01 and GW-BASIC installed
- ◆ Microsoft® Windows™ 3.0 and mouse
- ◆ 14" VGA gray scale monitor
- ◆ OmniKey keyboard
- ◆ FCC Class B Certified

**\$2499<sup>00</sup>** Or as low as \$85<sup>00</sup> per month\*

## Northgate Elegance 386/486 Common Features:

- ◆ American-made motherboard
- ◆ RAM expansion up to 8Mb on motherboard (16Mb total RAM with 32-bit memory card)
- ◆ 16-bit VGA video adapter
- ◆ One parallel and two serial ports
- ◆ MS-DOS 4.01 and GW-BASIC installed
- ◆ Microsoft® Windows™ 3.0 and mouse
- ◆ FCC Class B Certified

## Northgate Elegance 386/25 & 33 MHz

The best in their respective classes! Both are ideally suited for managing large databases (over 1000 records), full-time business accounting, multitasking and other demanding applications.

Northgate gives you a powerful standard configuration including high-speed 64K RAM cache and 4Mb of RAM. Take a look at everything you get:

- ◆ Intel® 80386/25 or 33 MHz processor
- ◆ 4Mb of RAM
- ◆ 40Mb hard drive
- ◆ 64K SRAM read/write-back cache
- ◆ 3.5" 1.44Mb and 5.25" 1.2Mb floppy drives
- ◆ 16-bit VGA adapter
- ◆ 14" VGA gray scale monitor
- ◆ OmniKey keyboard
- ◆ Novell Certified

25 MHz **\$2999<sup>00</sup>**  
Or as low as \$105<sup>00</sup> per month\*

33 MHz **\$3299<sup>00</sup>**  
Or as low as \$115<sup>00</sup> per month\*



## Northgate Elegance 486/25 and NEW 486/33 MHz ISA

In addition to receiving an Editors' Choice and 1990 *Computer Shopper* Best Buy Award, Elegance 486/25i outscored all competitors in *InfoWorld* Magazine's 1990 reviews of 486 systems. Elegance "leads the pack by a comfortable margin", they said. "It offers impressive performance, exceptional expandability and it is tops in support and value."†

**NOW! Northgate introduces the next generation—Elegance 486/33 ISA.** Both systems are ideal for heavy-duty business applications like full time database management, CAD/CAM, financial planning, accounting and programming. Includes:

- ◆ Intel 80486/25 or 33 MHz processor
- ◆ 4Mb of RAM
- ◆ 40Mb hard drive
- ◆ 64K SRAM read/write-back cache
- ◆ 3.5" 1.44Mb and 5.25" 1.2Mb floppy drives
- ◆ 16-bit VGA video adapter
- ◆ 14" VGA gray scale monitor
- ◆ OmniKey keyboard
- ◆ Novell Certified (486/25)

25 MHz **\$5199<sup>00</sup>**  
Or as low as \$180<sup>00</sup> per month\*

33 MHz **\$5799<sup>00</sup>**  
Or as low as \$200<sup>00</sup> per month\*

Standard Upgrades (Add to the base system price)

Hard Drives	14" NEC VGA Gray Scale 800 x 600	Gold Star 14" VGA Color 640 x 480	Panasonic 14" VGA Color 1024 x 768	NEC 3D 14" VGA Color 1024 x 768
40Mb IDE	\$ 0.00	\$300.00	\$ 400.00	\$ 650.00
80Mb IDE	\$200.00	\$500.00	\$ 600.00	\$ 850.00
100Mb IDE	\$300.00	\$600.00	\$ 700.00	\$ 950.00
200Mb IDE	\$600.00	\$900.00	\$1000.00	\$1250.00

Call for the latest pricing and custom configuration specifications.

**CALL TOLL-FREE 800-548-1993**  
24 HOURS EVERY DAY

New... fax your order toll free! 800-323-7182

Notice to the Hearing Impaired: Northgate has TDD capability. Dial 800-535-0602.



*"We hear you!"*

7075 Flying Cloud Drive, Eden Prairie, MN 55344

©Copyright Northgate Computer Systems, Inc. 1990. All rights reserved. Northgate, OmniKey and the Northgate "N" logo are registered trademarks of Northgate Computer Systems. 80386 and 80486 are trademarks of Intel. All other products and brand names are trademarks and registered trademarks of their respective companies. Prices and specifications subject to change without notice. Northgate reserves the right to substitute components of equal or greater quality or performance. All items subject to availability. We support the ethical use of software. To report software copyright violations, call the Software Publishers Association's Anti-Piracy Hotline: 1-800-388-PIRB. \*When charged to your Northgate Big 'N' card: 18% A.P.R. *InfoWorld*, July 30, 1990.

# Replace your "mushy" keyboard with the crisp touch Northgate® *OmniKey*!



Look...  
12 F-keys  
on top AND  
LEFT!

## OmniKey/ULTRA

PC Computing Magazine's  
Most Valuable Product Of 1990!

PC Computing said: "keyboards don't get any better than this."† And it's no wonder! *OmniKey/ULTRA* gives you twice the features of ordinary keyboards! You get 12 F-keys on left—PLUS 12 switchable Special Function (SF)-keys on top. And, the greatest touch in keyboards.

See for yourself ... use one for 60-days RISK FREE! If you aren't convinced it's the best, return it. We'll refund every penny!

Look! More exclusive features!

- ALPS click/tactile mechanical key switches
- Interchangeable CTRL, ALT and CAPS LOCK keys
- Switchable right asterisk and backslash keys
- Exclusive period/comma lock key locks out these <>, locks punctuation in
- Repeat rate select key lets you change from 3-120 CPS from inside DOS or a program
- Unmatched compatibility with IBM-type systems
- Lifetime quality double-injected keycaps
- FCC Class B certified
- Industry-leading five year warranty

Now! ONLY **\$129<sup>00</sup>**  
FOB Minneapolis, MN

HOURS: Mon. - Fri. 7 a.m. to 12 a.m.; Sat. 8 a.m. to 4 p.m. Central. Dealer and distributor prices available. Se habla español por su conveniencia.  
 Notice to the Hearing Impaired: Northgate has TDD capability: 800-535-0602

CHARGE IT!  
 We accept VISA and MasterCard. FAX Your Order! 612-943-8332

CALL TODAY!  
**800-526-2446**

**NORTHGATE  
 COMPUTER  
 SYSTEMS**  
 7075 Flying Cloud Drive, Eden Prairie, MN 55344

## OmniKey/102 with F-keys on the left

First keyboard to get back to the basics! 12 F-keys on left for fast one-hand combination commands. Readers of *Computer Shopper* named *OmniKey/102* their "Best Buy."



- Northgate's original 102 key design
- 12 function keys on the left
- Interchangeable ALT, CAPS LOCK, and CTRL keys
- Large L-shaped ENTER key
- Calculator-style numeric keypad with added equals key
- Five year warranty
- 60-day no-risk trial
- Separate inverted T cursor control pad
- Unmatched compatibility with IBM-type systems
- ALPS click/tactile mechanical key switches
- FCC Class B certified

OmniKey/102 ONLY **\$89<sup>00</sup>**  
FOB Minneapolis, MN

### Inventory Reduction...Quantities Limited!



OmniKey/101  
 with F-keys  
 on top and  
 20% smaller  
 footprint

- Enhanced 101 key layout
- Interchangeable left CAPS LOCK and CTRL keys
- Calculator-style numeric keypad with added equals key
- Separate inverted T cursor control pad
- ALPS click/tactile mechanical key switches
- Unmatched compatibility with IBM-type systems
- FCC Class B certified
- 10-day no-risk trial
- One year warranty

OmniKey/101-I ONLY **\$69<sup>00</sup>**  
FOB Minneapolis, MN

©Copyright Northgate Computer Systems, Inc. 1990. All rights reserved. Northgate, OmniKey and the Big 'N' logo are trademarks of Northgate Computer Systems. IBM is a registered trademark of International Business Machines Corp. Other brand names are trademarks or registered trademarks of their respective owners. Specifications subject to change without notice. Subject to occasional inventory shortages. We support the ethical use of software. To report software copyright violations, call the Software Publishers Association's Anti-Pracy 1 hotline at 1-800-388-FURS. 1PC Computing, July 1990

# SAVINGS CERTIFICATE

This certificate entitles you to **BYTE** at a savings of over 40% off the cover price. You'll also receive the annual IBM PC Special Issue as part of your subscription.

**YES!** Please send me 1 year (12 issues) for \$24.95. (I'll **save over 40%** off the newsstand cost!)

**Payment enclosed**

**Bill me**

No-Risk Guarantee: If dissatisfied, cancel anytime for a full 100% refund. Your subscription will start in 6-8 weeks. Watch for it!

\_\_\_\_\_  
Name

\_\_\_\_\_  
Company

\_\_\_\_\_  
Address

\_\_\_\_\_  
City/State/Zip

IW11096

# BYTE

Save Over  
**40%**



NO POSTAGE  
NECESSARY  
IF MAILED  
IN THE  
UNITED STATES

**BUSINESS REPLY MAIL**

FIRST CLASS MAIL PERMIT NO. 42 HIGHTSTOWN, NJ

POSTAGE WILL BE PAID BY ADDRESSEE:

**BYTE**

Subscription Department

P.O. Box 558

Hightstown, N.J. 08520-9409





# You can afford award-winning Northgate® performance!



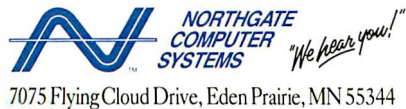
Northgate makes it easy for you to own award-winning 286, 386™ and 486™ computer systems ... just say "charge it" to your Northgate Big 'N' credit card.

It's easy! Simply fill in the Big 'N' information form and send it to Northgate for prompt attention. Once you're approved, call our systems consultants, toll-free, to select the Northgate that's right for you.

Northgate leases systems too! Choose from flexible terms up to five years. It's never been easier to get high-performance Northgate systems than it is right now!

Fill out and return this form today!

Call Northgate Now!  
**800-548-1993**  
 HOURS: Monday - Friday 7 a.m. - 8 p.m. CST



## OPEN YOUR CREDIT CARD ACCOUNT BY FILLING OUT THE APPLICATION BELOW.

Please complete all appropriate sections, providing at least two years residence and employment history. If you are self-employed, please be sure to complete section d. **THIS IS NOT A CREDIT AGREEMENT!** One will be sent to you upon authorization of an account. (This Form Must Be Signed To Process Your Order.) All Financed Purchases Are Subject To Credit Approval. If You Have Any Credit Questions, Please Call For Assistance. Thank You!

A married person may apply for individual credit. I am applying for (check one box, please):

- JOINT CREDIT with another person. Complete entire application.  
 INDIVIDUAL CREDIT complete only individual section.  
 INDIVIDUAL CREDIT but rely on income of another. Complete entire application.

\*If you are a married Wisconsin applicant, you must provide your spouse's information as indicated, even though your spouse may not be signing the contract.

**NOTICE TO WISCONSIN APPLICANTS**  
 You must disclose your marital status:  
 married  
 unmarried  
 legally separated

### a. Personal Information

NAME \_\_\_\_\_ HOME PHONE (\_\_\_\_) \_\_\_\_\_  
 SOCIAL SECURITY NUMBER \_\_\_\_\_ DATE OF BIRTH \_\_\_\_/\_\_\_\_/\_\_\_\_  
 PRESENT ADDRESS \_\_\_\_\_ CITY \_\_\_\_\_ ST \_\_\_\_\_ ZIP \_\_\_\_\_  
 DATE OF RESIDENCE MO. \_\_\_\_\_ YR. \_\_\_\_\_ BUY  RENT  OTHER   
 PREVIOUS ADDRESS \_\_\_\_\_  
 EMPLOYER \_\_\_\_\_ DATE OF EMPLOYMENT MO. \_\_\_\_\_ YR. \_\_\_\_\_  
 MONTHLY GROSS SALARY \$ \_\_\_\_\_ BUSINESS PHONE (\_\_\_\_) \_\_\_\_\_  
 PREVIOUS EMPLOYER \_\_\_\_\_ DATES OF EMPLOYMENT \_\_\_\_\_ TO \_\_\_\_\_  
 Income from alimony, child support or separate maintenance payments need not be disclosed if you do not wish to have it considered as basis for repaying the obligation.  
 ADDITIONAL MONTHLY INCOME \$ \_\_\_\_\_ SOURCE \_\_\_\_\_

### b. Credit Information

PLEASE TELL US IF YOU HAVE: CHECKING ACCOUNT (Y/N) \_\_\_\_\_ SAVINGS ACCOUNT (Y/N) \_\_\_\_\_  
 BANK LOAN (Y/N) \_\_\_\_\_ HOW MANY? \_\_\_\_\_ VISA (Y/N) \_\_\_\_\_ HOW MANY? \_\_\_\_\_  
 MASTERCARD (Y/N) \_\_\_\_\_ HOW MANY? \_\_\_\_\_ FINANCE COMPANY LOAN (Y/N) \_\_\_\_\_ HOW MANY? \_\_\_\_\_  
 DEPT. STORE CHARGE CARD (Y/N) \_\_\_\_\_ HOW MANY? \_\_\_\_\_ CREDIT UNION ACCOUNT (Y/N) \_\_\_\_\_ HOW MANY? \_\_\_\_\_  
 OTHER MAJOR CHARGE CARDS (Y/N) \_\_\_\_\_ HOW MANY? \_\_\_\_\_

### c. Joint Applicant's Personal Information

JOINT APPLICANT'S NAME \_\_\_\_\_ HOME PHONE (\_\_\_\_) \_\_\_\_\_  
 SOCIAL SECURITY NUMBER \_\_\_\_\_ DATE OF BIRTH \_\_\_\_/\_\_\_\_/\_\_\_\_  
 ADDRESS \_\_\_\_\_ CITY \_\_\_\_\_ ST \_\_\_\_\_ ZIP \_\_\_\_\_  
 DATE OF RESIDENCE MO. \_\_\_\_\_ YR. \_\_\_\_\_  
 JOINT APPLICANT'S EMPLOYER \_\_\_\_\_ DATE OF EMPLOYMENT MO. \_\_\_\_\_ YR. \_\_\_\_\_  
 MONTHLY GROSS SALARY \$ \_\_\_\_\_ BUSINESS PHONE (\_\_\_\_) \_\_\_\_\_  
 NAME AND ADDRESS OF NEAREST RELATIVE NOT LIVING WITH YOU \_\_\_\_\_  
 RELATIONSHIP \_\_\_\_\_

### d. Self-Employment Information

BUSINESS NAME \_\_\_\_\_ BUSINESS PHONE (\_\_\_\_) \_\_\_\_\_  
 TYPE OF BUSINESS  Proprietorship  Partnership  Corporation IN BUSINESS SINCE \_\_\_\_\_  
 YOUR ANNUAL INCOME FROM BUSINESS Gross \$ \_\_\_\_\_ Net \$ \_\_\_\_\_  
 PERSONAL BANKER'S NAME \_\_\_\_\_ BANKER'S PHONE (\_\_\_\_) \_\_\_\_\_

### e. Customer Authorization

I authorize Northgate Computer Systems or its assignees to investigate credit records and to report my performance hereunder to credit agencies. I hereby certify that the following information is furnished to you for the purpose of obtaining credit and is true and correct of the best of my knowledge and belief. There are costs associated with the use of this credit card. To obtain more information about these costs, call us at 1-800-548-1993 or write to P.O. Box 59080, Minneapolis, MN 55459-0080.

NY—A consumer credit report may be requested in connection with this application or in connection with updates, renewals or extensions of any credit granted as a result of this application. If I subsequently ask for this information, I will be informed whether or not such a report was requested and, if so, the name and address of the agency that furnished the report.

OH—THE OHIO LAWS AGAINST DISCRIMINATION REQUIRE THAT ALL CREDITORS MAKE CREDIT EQUALLY AVAILABLE TO ALL CREDIT-WORTHY CUSTOMERS AND THAT CREDIT REPORTING AGENCIES MAINTAIN SEPARATE CREDIT HISTORIES ON EACH INDIVIDUAL UPON REQUEST. THE OHIO CIVIL RIGHTS COMMISSION ADMINISTERS COMPLIANCE WITH THIS LAW.

APPLICANT'S SIGNATURE \_\_\_\_\_ DATE \_\_\_\_\_

JOINT APPLICANT'S SIGNATURE \_\_\_\_\_ DATE \_\_\_\_\_

FOR MARRIED WISCONSIN APPLICANTS:  
 I acknowledge that the obligation described herein is being incurred in the interest of my marriage or family.

BUYER'S SIGNATURE \_\_\_\_\_ DATE \_\_\_\_\_

# dTruth Comes Out.

**Software Digest** **RATINGS REPORT**  
 The Independent Comparative Ratings Report for Selecting IBM PC Business Software

Volume 7, Number 13

## MULTIUSER DATABASE PROGRAMS

Ratings Key: ■ 70-10.0 ■ 5.0-6.9 ■ under 5.0

Software Digest Rating	Overall Evaluation	Overall Power	Program Name	Version Tested	Performance	Versatility	Error Handling	Ease of Learning	Ease of Use	Memory Requirement	Price	Volume Purchase Agreements	Page
***	7.0	6.7	dBase IV	1.1	■	■	■	■	■	450KB	\$795	✓	28
**	6.8	5.1	Paradox	3.5	■	■	■	■	■	640KB	\$995	✓	32
**	6.8	7.1	FoxPro/LAN	1.02	■	■	■	■	■	512KB	\$1,095	✓	30
**	6.4	5.1	DataEase	4.2	■	■	■	■	■	640KB	\$750	✓	26
*	5.8	3.6	R:Base	3.0	■	■	■	■	■	520KB	\$995	✓	34
*	5.7	6.0	Clarion Professional Developer	2.1	■	■	■	■	■	512KB	\$845	✓	24
*	5.7	6.6	Advanced Revelation	2.01	■	■	■	■	■	640KB	\$995	✓	22

REPRODUCTION OR QUOTATION IN WHOLE OR IN PART IS PROHIBITED WITHOUT PRIOR WRITTEN PERMISSION  
 All rights reserved. © 1990 by NSTL, Inc., Plymouth Corporate Center, Plymouth Meeting, PA 19462, 800-223-7093

The new dBASE IV® version 1.1 has been rated the #1 Multiuser Database by Software Digest Ratings Report (Volume 7 Number 3, October, 1990).

Because Software Digest accepts no advertising whatsoever, subscribers pay hundreds of dollars a year to receive their reviews—which are considered highly unbiased and objective.

In summation, their 75-page report says: "Among the top ranking programs, dBASE IV (version 1.1) is the most well rounded, with solid performance, versatility, and usability." Commenting on speed, Software Digest points out that "dBASE IV produces all three test reports as fast as or faster than FoxPro/LAN." As for Ease of Use/Ease of Learning, dBASE IV scored as many times in the Excellent range as any other database product tested.

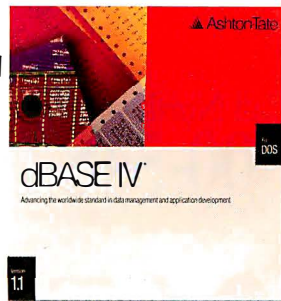
Of course, Software Digest is definitely not alone in its conclusions.

Because consumers have already made dBASE IV version 1.1 the #1 best-selling PC database in the world.

Call 1-800-437-4329 ext. 1407 for more information.

Better yet, call 1-800-2ASHTON now to upgrade.

The truth is, no other database can do so much to improve productivity.



**Ashton-Tate**

# THE 1990 BYTE AWARDS

The Winnahs!

More of them.

New category.

The economy may be slowing down, but 1990 proved that there has been no letup in the number of exciting, innovative new products and technologies for personal computers. In the past year, we've seen an extraordinary leap in the processing power of systems across every major platform, significant upgrades to proven products at lower prices, and emerging product categories that are opening up new applications to personal computers.

Most significantly, standard DOS faced its most serious challenges ever. Unix became more attractive—in looks, price, and ease of use—to rank-and-file end users. Apple introduced powerful systems on the high end and affordable ones on the low end. And Windows 3.0 sold over a million copies. Clearly, the personal computer industry is still a fascinating, dynamic enterprise.

The BYTE Award recipients are chosen by BYTE editors based on these criteria: It is a product or technology that is innovative, that has significant impact on its respective market niche, that advances the state of the art, or that provides a superior price-to-performance ratio. We have three award categories, which, in order of importance, are Awards of Excellence, Awards of Distinction, and Awards of Merit, the last of which is new this year. Award categories for each product listed here were assigned according to vote totals. Of all the products nominated, BYTE editors voted 67 worthy of awards—three times the number chosen last year. The new category accounts for only part of the number. The rest we attribute to a richer lineup of candidates.

Whatever your preferred computing platform, you'll find something to cheer about in the list of 1990 BYTE Award winners.

1990  
**BYTE**  
AWARD  
EXCELLENCE

1990  
**BYTE**  
AWARD  
DISTINCTION

1990  
**BYTE**  
AWARD  
MERIT

1990

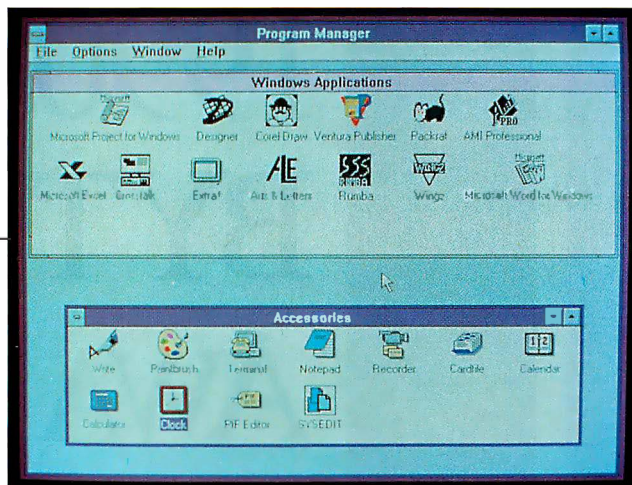
BYTE

AWARD

EXCELLENCE

### Windows 3.0, Microsoft

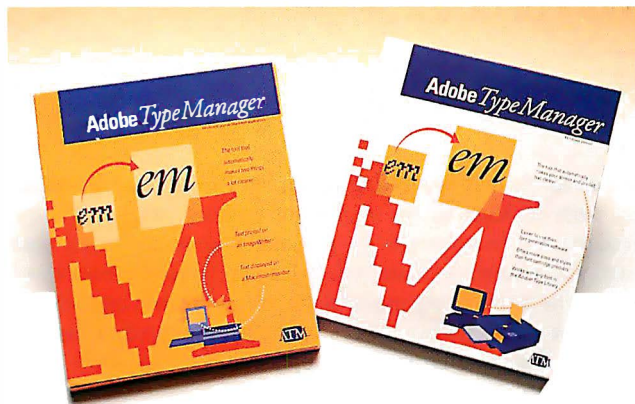
Windows 3.0 is the first usable graphical user interface for the IBM PC to meet with widespread, enthusiastic acceptance by the DOS-based computing public. Because of its achievement, developers now have a discernible platform and growing installed



base for which they can develop easier-to-use GUI applications.

The majority of nontechnical professionals and business users work faster, learn more quickly, and are generally more productive using a good GUI—something the Mac has already proven. Windows 3.0 isn't perfect, as many early users have discovered, but its potential is clear. The sheer strength of its presence ensures a lasting impact on the industry. And its bundled Solitaire game isn't half bad, either.

### Adobe Type Manager 2.0, Adobe Systems

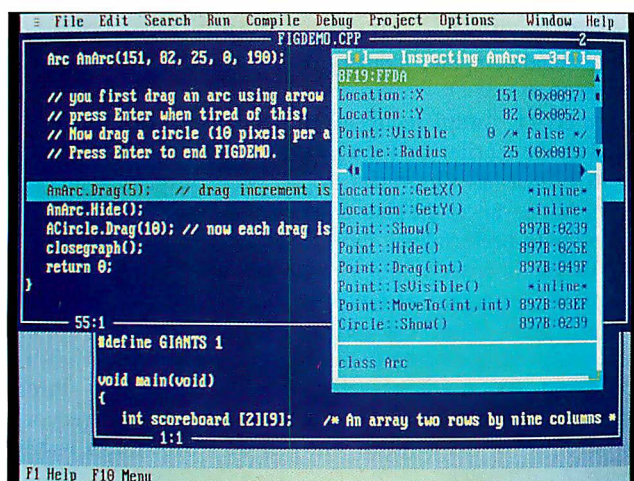


ATM displays PostScript Type 1 font outlines as high-quality bit-mapped text on a Mac screen at large resolutions. ATM 2.0 offers better performance on a 68000-based Mac. Besides being useful for page layout involving large typefaces, it's a boon to those using non-PostScript laser printers. ATM's large character bit maps can be sent to these printers, providing high-quality output. Those using fax boards on the

Mac can have their documents imaged at 200 dots per inch, producing excellent results at the receiving fax.

Furthermore, ATM recently jumped platforms to the Windows 3.0 environment. This version produces great-looking text on a Hewlett-Packard LaserJet. While you wait for TrueType in Apple's System 7.0 and Microsoft's OS/2, ATM 2.0 provides a solid, reasonably priced solution now.

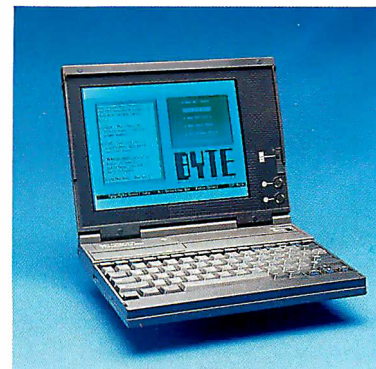
### Turbo C++, Borland International



Borland's introduction of Turbo C++ legitimized the language for thousands of PC C developers. Professional programmers have been avoiding C++ because of the lack of good tools, and Borland's Professional bundle includes everything that even the fussiest programmer has to create and debug commercial C++ code. The profiler isolates poor-performing sections of code—a must for large, performance-sensitive projects. The assembler brings low-level power to bear, and the robust debugger understands C++ classes. Once installed, all these tools combine to create what may be the most powerful single-vendor DOS development environment available.

### TravelMate 2000/ Sharp PC-6220/ CompuAdd Companion, Texas Instruments, Sharp Electronics, and CompuAdd

Despite minor problems with the casings, several BYTE editors consider these portables, all built in the same



1990

BYTE

AWARD

OF

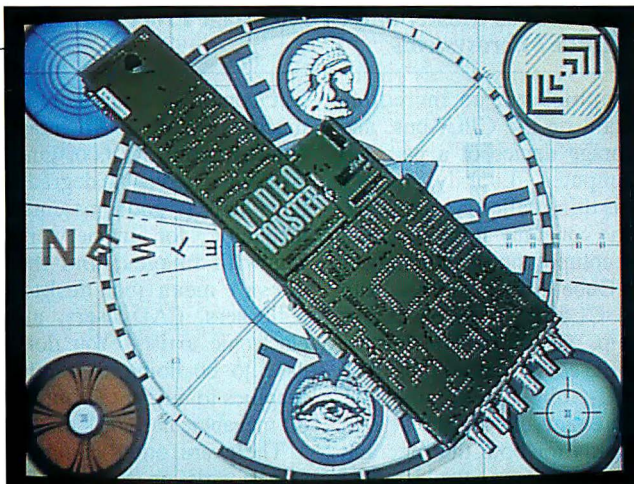
EXCELLENCE

**Video Toaster, NewTek**

One of the coolest video/graphics products of the year, NewTek's hardware/software package turns the Amiga into a sophisticated, broadcast-quality video-editing system. Video Toaster provides tools for real-time manipulation of incoming live video, including a frame grabber; a color-processing engine for producing color negatives, effects such as solarization and posterization, and color filters; dual frame buffers for rendering realistic three-dimensional images; 24-bit animation software; 24-bit paint software; a character generator for putting text on top of video frames; a production switcher to handle transitional effects; and more.

Thanks to its four custom chips, NewTek has packed all these studio facilities into one add-in board. All the computerized imagery and digital effects you see on TV can be done with this package. Turning a personal computer into a workstation for manipulating broadcast-quality video is no big deal anymore. But when the cost is only \$1595, it is a big deal. If you had to separately buy all the equipment to do everything that Video Toaster can do, you'd wish Ted Turner was your daddy.

Texas Instruments plant, to be the best they've ever used. Each has more than enough power for any reasonable laptop application, a very good screen, a fast hard disk drive, a great form factor (it really does fit inside a briefcase), lots of power/weight options (2, 3, or 5 hours of power, depending on the combination of internal/external battery you select), quick recharge, and a good price. These computers are winners. They may be the first laptops since the Tandy Model 100 to really deliver the promise of affordable, portable computing.

**Macintosh Classic, Apple Computer**

Apple has really delivered the Cheap Mac. Power users will sneer, but for \$1500, you can now get a Mac with 2 megabytes of memory, a fast 40-MB hard disk drive, built-in networking, the world's most stable graphical user interface, and the performance of an SE. (Historical aside: In 1984, the 128K-byte Mac cost \$2495.) You won't design the space station with this machine, but you can do most of the things people use personal computers for, and do them nicely. ▽



1990

BYTE

AWARD

EXCELLENCE

### Compression Master and CL550 Image Processor Chip, C-Cube Microsystems

**Editor's note:** Just as this issue was going to press, we learned that C-Cube is discontinuing the Compression Master board. It will continue to sell the chip to other developers, however.

Graphics put an incredible strain on the CPU, bus, and storage device of a personal computer. Luckily, there's this thing called compression. One company at the forefront of compression technology is C-Cube Microsystems, with its CL550 image processor chip, which implements the JPEG compression algorithm.

C-Cube has put its data squeezer chip onto add-in boards for both the Mac and IBM PC compatibles. The Compression Master boards

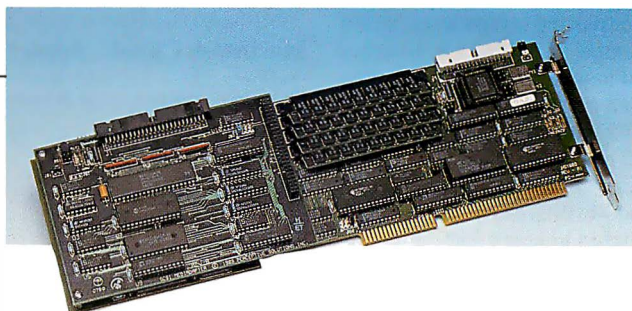
can compress images by as much as 75 to 1. An image file reduced to 1/24 its original size shows no visible degradation. This is good, essential technology for anyone working with images, and that doesn't mean just desktop publishers, CAD users, and electronic artists. You don't have to be doing four-color graphics to quickly fill up an 80-megabyte hard disk drive.

There are other compression boards on the market, many of which use the

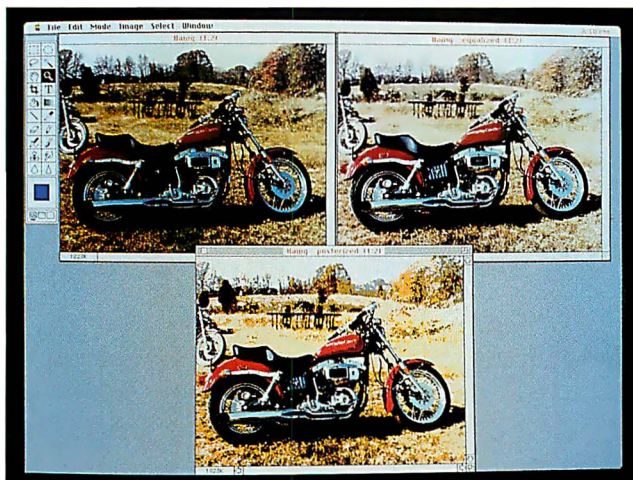
CL550. But none are as inexpensive as the Compression Master at \$995. C-Cube is quickly gathering a following. Major software houses have promised to support the company's Image Compression Interface, including Adobe, Quark, Autodesk, and Electronic Arts. If C-Cube can produce enough of the CL550 to meet demand (the chip has been in short supply), the company could set the standard in this user-helpful technology.

### hyperStore/1600 Caching Controller, Perceptive Solutions

The hyperStore/1600 is solid as a rock and *fast*. Caching is a complicated technology, and the folks at PSI seem to know more than any of their competitors. PSI's product has a unique design that lets you run any or all of the common hard disk drive interfaces from one controller board. Not only is it the fastest controller available, it's the most flexible, too.



### Photoshop, Adobe Systems

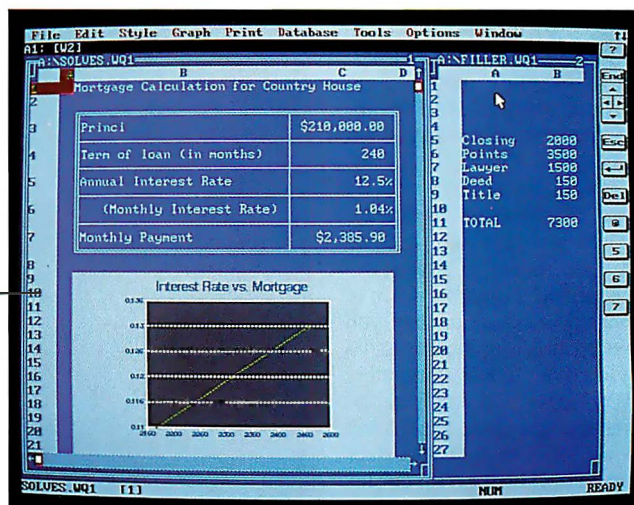


The best 24-bit pixel editing package of the year, Photoshop from Adobe Systems has excellent color-correction controls and a good set of editing tools for cropping, filtering, and resizing images. It's also very fast. In addition, it can import images of just

about every format, such as TIFF, Amiga HAM files, and CompuServe GIF. Once you've modified the image, you can then save the image in any of these formats. Photoshop makes the entrance requirement for any software for the 1990s.

### Quattro Pro 2.0, Borland International

Quattro Pro provides more features and better performance than Lotus 1-2-3 at a lower price, and yet it still runs on any DOS machine, including an 8088 XT with 512K bytes of RAM. Quattro Pro 2.0 adds a few significant enhancements: a solver capability (like the Solver in Lotus 1-2-3/G) and better printer support. In fact, Borland provides in Quattro Pro a group of features not found in any single version of the market leader 1-2-3.

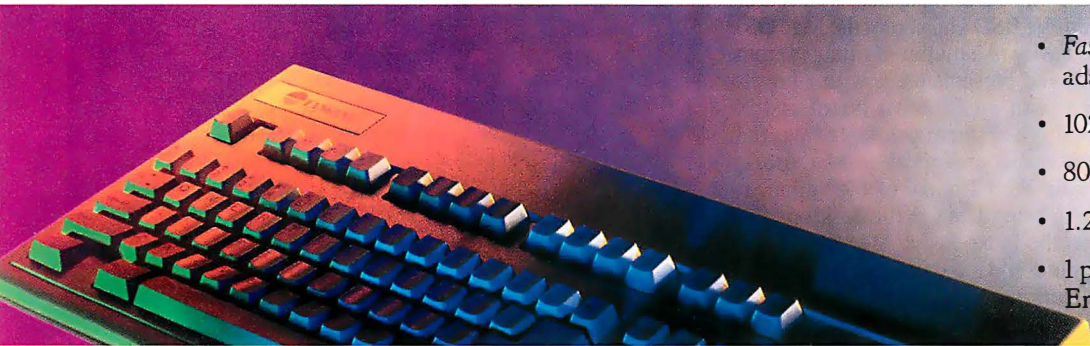




486/25  
\$4,860

- Intel 80486, 25 MHz, 4MB
- 128K SRAM cache

“Without a doubt, the Tangent is the overall price/



- Fastest Super VGA adaptor in the industry
- 1024 x 768 VGA monitor
- 80 MB (19ms), w/cache
- 1.2 MB or 1.44 MB Teac
- 1 parallel & 2 serial ports; Enhanced 101 keyboard

performance winner of the group, and perhaps even



386 SVGA Systems  
(2MB, 42MB HD):

- 80386SX, 20 MHz \$1995
- 80386, 25 MHz \$2295
- 80386, 33 MHz \$2995  
w/cache

of 486 systems in general.” (Personal Workstation,



For a Quote or to Order,  
Call 800-223-6677

415-342-9388

FAX 415-342-9380

Corporate P.O.s accepted



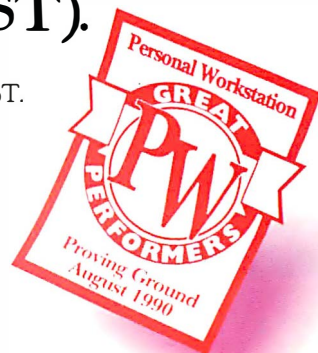
8/90 review of Tangent, Compaq, and AST).

In Personal Workstation's review, the Tangent 486/25 clearly outperformed both Compaq and AST. And Tangent was priced as much as 67% less! Get breathtaking graphics and unparalleled hard disk performance. Plus a 30-day unconditional money-back guarantee, and a lifetime, toll free technical support hotline. Call today, for this and other Tangent review reprints, and for a quote on a wide choice of EISA and ISA configurations.



Tangent Computer, Inc., 197 Airport Blvd., Burlingame, CA 94010.

© Copyright 1990 Tangent Computer, Inc.



Circle 313 on Reader Service Card

1990

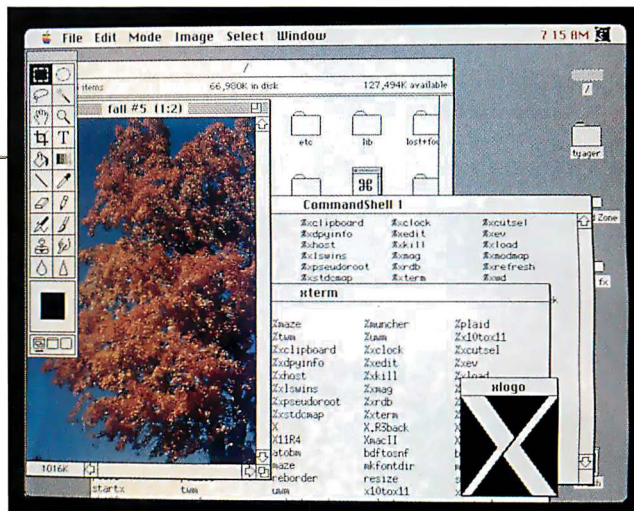
BYTE

AWARD

EXCELLENCE

**A/UX 2.0, Apple Computer**

By executing one of the most impressive ports of Unix we've seen, Apple managed to create an operating system that represents a merging of Unix System V, BSD Unix, and the Mac OS. The operating system installs easily in a matter of minutes from a CD-ROM (and other media) and presents users with a familiar Mac interface. Combined with an Ethernet board and X Window System 11 for A/UX (both optional), A/UX brings the benefits of workstation power and connectivity to Mac users, without forcing them to give up their library of Mac applications. This is the perfect way to bring Unix to the desktop, and with A/UX's ability to run on the inexpensive Mac SE/30 and the new Mac IIsi systems, Apple could make a name for itself as a provider of low-cost Unix solutions.

**LaserJet IIP, Hewlett-Packard**

The first laser printer to break the \$1000 street price barrier, the LaserJet IIP immediately became the price/performance benchmark for the new class of personal laser printers introduced in 1990. The IIP and its competitors not only made personal laser printers affordable, they also helped pull down the prices of more sophisticated PostScript laser printers and helped make dot-matrix printers more of a niche market.

In its standard configuration, the 4-page-per-minute



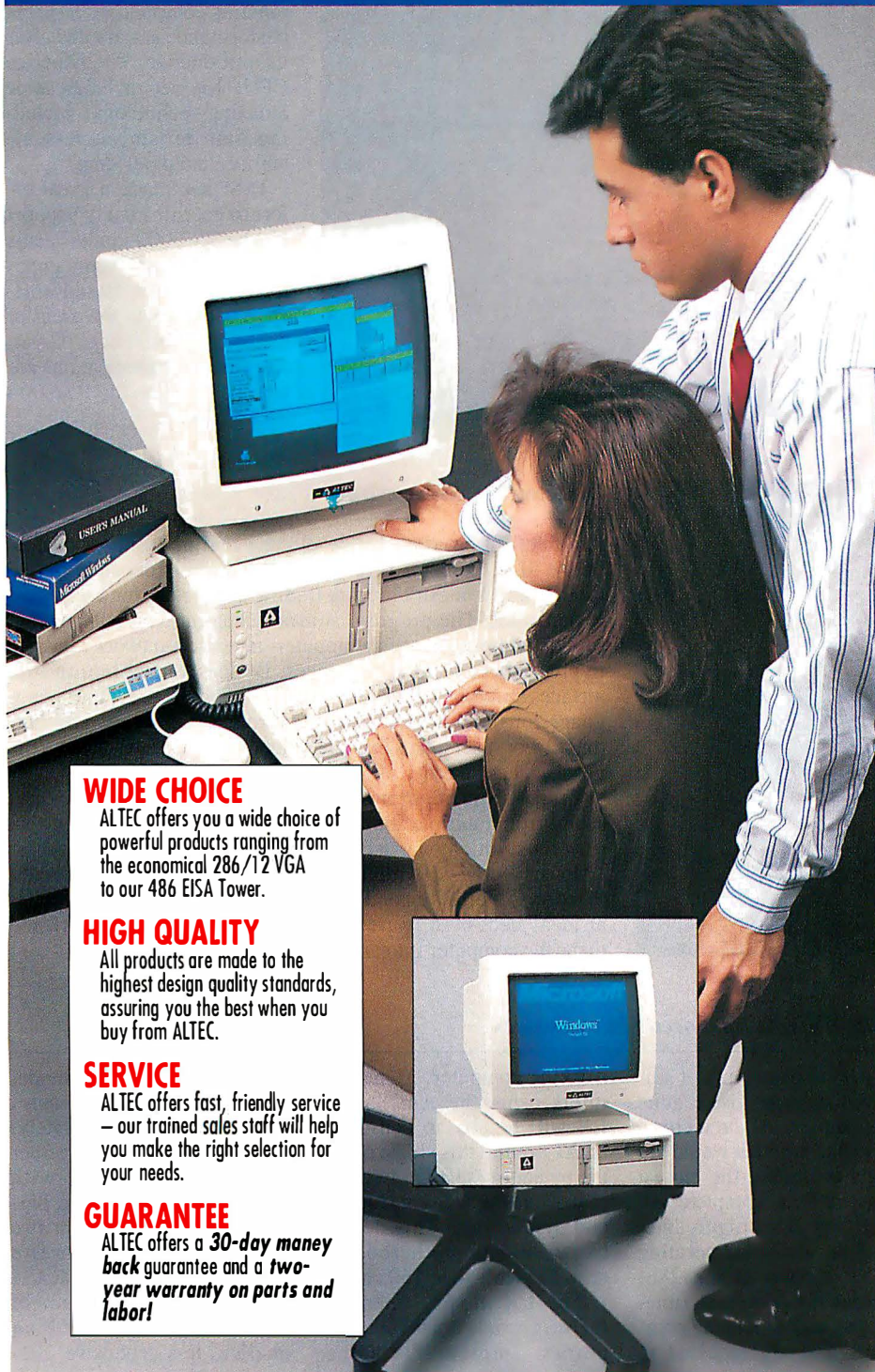
printer offers 512K bytes of memory and a solid 10-MHz 68000 processor. With memory upgrades and font cartridges, the IIP helped bring PostScript to general-business applications with a price tag that's under \$3000. Compared to its larger cousins, the IIP sacrificed some speed and duty volume, but it lost nothing in output quality and economy. For many users, this justified the cost of placing a laser printer on their desktops or beefing up their overall printing resources.

**LaserJet III, Hewlett-Packard**

For the last few years, Hewlett-Packard has effectively defined business printing by defining the laser printer market. As a result, the LaserJet II was the dominant force in laser printing and was priced below many other laser printers. So what did HP do? It redesigned its already excellent LaserJet II by adding more fonts, as well as scalable fonts, more standard memory, and Resolution Enhancement to smooth out the edges of images. And then HP dropped the price a little. By taking the unusual step of improving on excellence and then offering the customer a better deal, HP has defined the market once again.



# When You Buy ALTEC, You buy **POWER, PERFORMANCE,** **QUALITY** and **SERVICE!**



## WIDE CHOICE

ALTEC offers you a wide choice of powerful products ranging from the economical 286/12 VGA to our 486 EISA Tower.

## HIGH QUALITY

All products are made to the highest design quality standards, assuring you the best when you buy from ALTEC.

## SERVICE

ALTEC offers fast, friendly service — our trained sales staff will help you make the right selection for your needs.

## GUARANTEE

ALTEC offers a **30-day money back** guarantee and a **two-year warranty on parts and labor!**



## High quality design and Hi-Res VGA monitor — all at a low price!

### 486/33 ISA VGA **\$5,595**

64K Cache, exp to 256K • 4 Meg RAM • 1.2 MG 5.25" drive • 1.44 MB 3.5" drive • 150 MB 18ms ESDI hard drive • ESDI controller w/32K cache • 16 bit VGA card • 14" VGA monitor (1024 x 768) • 2 serial, 1 parallel & 1 game ports • 101-key Keyboard • Microsoft Window 3.0 • Hi-Res serial Mouse • MS-DOS 3.3 or 4.01  
CALL FOR EISA 486 CONFIGURATION

### 386/33 VGA **\$2,795**

64K Cache • 4 Meg RAM • 1.2 MG 5.25" drive • 1.44 MB 3.5" drive • 104 MB IDE hard drive • 16 bit VGA card • 14" VGA monitor (1024 x 768) • 2 serial, 1 parallel & 1 game ports • 101-key Keyboard • Microsoft Window 3.0 • Hi-Res serial Mouse • MS-DOS 3.3 or 4.01

### 386/25 VGA **\$2,595**

4 Meg RAM • 1.2 MB 5.25" drive • 1.44 MB 3.5" drive • 104 MB IDE hard drive • 16-bit VGA card • 14" VGA monitor (1024 x 768) • 2 serial, 1 parallel & 1 game ports • 101-key Keyboard • Microsoft Window 3.0 • Hi-Res serial Mouse • MS-DOS 3.3 or 4.01

### 386/SX VGA **\$1,895**

2 Meg RAM • 1.2 MB 5.25" drive • 1.44 MB 3.5" drive • 40 MB IDE hard drive • 16-bit VGA card • 14" VGA monitor (1024 x 768) • 2 serial, 1 parallel & 1 game ports • 101-key Keyboard • Microsoft Window 3.0 • Hi-Res serial Mouse • MS-DOS 3.3 or 4.01 • (20 Mhz version add \$150)

### 286/12 VGA COMBO **\$1,595**

1 Meg RAM • 1.2 MB 5.25" drive • 1.44 MB 3.5" drive • 40 MB IDE hard drive • 16-bit VGA card • 14" VGA monitor (640 x 480) • 2 serial, 1 parallel & 1 game ports • 101-key Keyboard • Serial Mouse • MS-DOS 3.3 or 4.01 • Panasonic 1180 printer w/cable • Surge Protector

## ALTEC'S GUARANTEE:

- 30-day money-back guarantee
- 2-year warranty for parts and labor
- **FREE** 4 month on-site service
- Lifetime toll-free technical support

**Policy:** Same day shipping with standard configuration for orders before 3 p.m. E.S.T. Shipping and handling are extra. P.O.s are welcome. Personal and company checks require 10 days to clear. Prices and specs are subject to change. Software, shipping and printer are not refundable. No surcharge for VISA & Mastercard. 2% American Express.



To Order:

**1-800-255-9971**

**Technical Support: 1-800-255-9968**

18555 East Gale Avenue • Industry, CA 91748  
(818) 912-8688 • FAX: (818) 912-8048

1990

BYTE

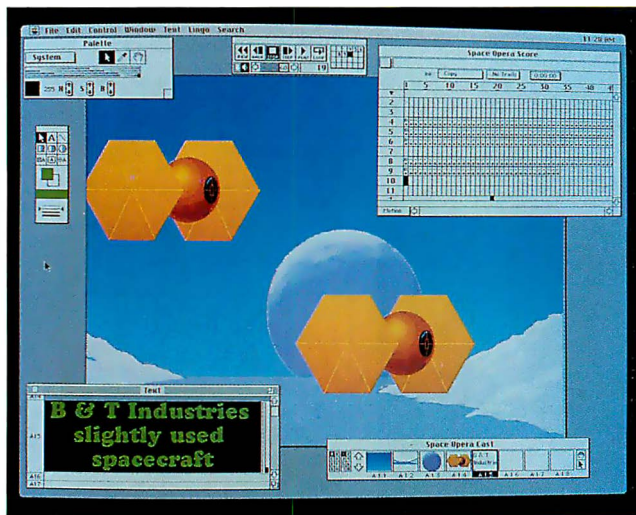
AWARD

EXCELLENCE

**RISC System 6000, IBM**

IBM has come out swinging in its effort to get back into the workstation market, and at the same time has made a strong commitment to the commercial Unix market as well. The RS/6000 is unmatched in performance and remains competitive in price/performance six months after its introduction. The America CPU chip set includes some amazing technology, including parallelism, superscalability, and pipelining.

IBM has made a great effort to get third-party support for the RS/6000, and it seems to have paid off. Many popular workstation-based software packages in the areas of desktop publishing, CAD, and scientific applications are now running on the RS/6000 under AIX.

**Director 2.0, MacroMind**

An excellent program for developing real multimedia content on the Mac, Director is fairly easy to use, it's decently priced (\$695), and it doesn't require trading in your car for some exotic hardware. The program shines at helping you put together sounds, scanned images, computer-generated artwork, and text in precisely controlled sequences. Besides a nice, intuitive interface, Director 2.0 has its own HyperTalk-like scripting language for building interactive controls (e.g., menus and buttons). For users lacking the talent of a Disney artist, the program has an easy-to-use animation generator.

Unlike some other programs for working with graphics and sound from multiple sources, Director is designed so well that it won't stymie nonartist types and won't limit artistic types. "Movies" created with Director will be playing soon under Windows, thereby extending the reach of this program. This is an ideal piece of software: It takes the drudgery out of work and turns the computer into an effective tool.

**Am286ZX/LX, Advanced Micro Devices**

This diminutive chunk of silicon and circuitry isn't quite the "complete AT on a chip" that we had hoped it would be, but it's definitely the closest thing yet to a complete AT motherchip. This highly integrated device, incorporating AMD's version of the 286, combines the processor functions and accompanying components that are required to turn that processor into a

working computer. Manufacturers using the Am286ZX/LX will be able to construct an AT around this single module by adding just the DRAM chips, keyboard controller, and system bus. This device can eliminate motherboards crowded with 50 to 150 chips.

The LX model, intended for very small portable computers, implements some power management features,

like a CPU shutdown mode, so computer vendors won't have to build them separately. A designer could put together a notebook computer with VGA display, serial and parallel ports, and a slot or two using the LX and four or five other devices, plus a DRAM chip. This amazing piece of engineering could result in smaller, less-expensive 286-based machines.



**"I run on fast forward  
all the time. So give me a  
downsized VGA laptop with  
full-size performance."**

## **ZENITH DATA SYSTEMS INNOVATES AGAIN™**

**The #1 laptop brand in America\* brings you the SlimsPort™ 286 laptop PC—for uncompromising 286 power and VGA graphics.**

Whether you're just waiting out a layover at LaGuardia or just laying down the groundwork for a new pet project, with SlimsPort 286, you're always ready to hit the ground running. At just 9¼ pounds, it's the perfect full-function laptop for the manager on the run.

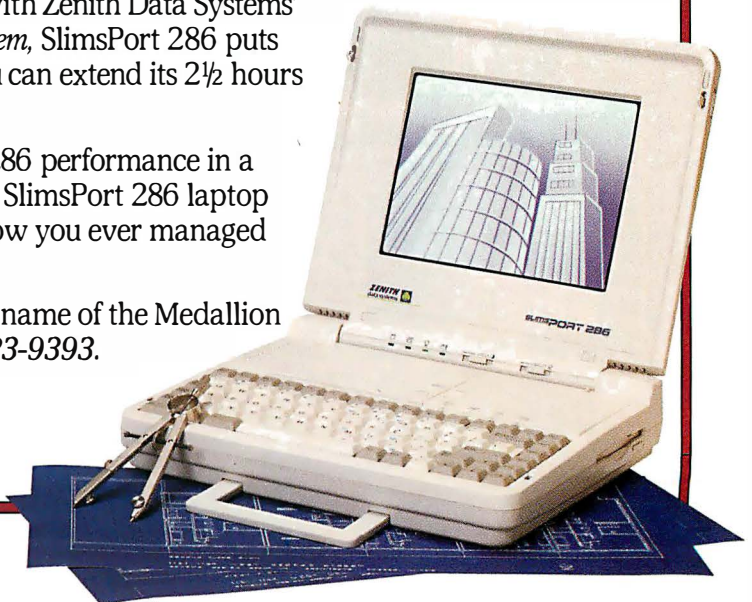
It offers VGA video and a backlit, fluorescent black-on-white, full-size LCD display that's ideal for graphical user interface computing. So you'll always have a bright, clear view of the big picture. And with Zenith Data Systems' *Intelligent Power Management™ System*, SlimsPort 286 puts power usage in your control so you can extend its 2½ hours of battery life even longer.

If your job demands full-size 286 performance in a downsized laptop, carry away the SlimsPort 286 laptop PC. Once you do, you'll wonder how you ever managed without it.

For more information and the name of the Medallion Reseller nearest you, call 1-800-523-9393.

**ZENITH**  
data systems 

Groupe Bull



\*Source: 1990 Dataquest estimate for U.S. battery-powered laptops. Graphics simulate Microsoft® Windows™ version 3.0, a product of Microsoft Corporation. *Intelligent Power Management* is a trademark of Zenith Data Systems Corporation.

©1990 Zenith Data Systems Corporation.

Circle 370 on Reader Service Card

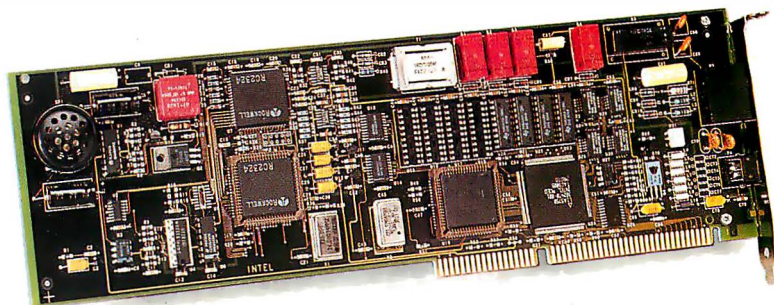
1990

BYTE

AWARD

OF

EXCELLENCE



### DOS Protected Mode Interface, *Microsoft*

DOS Protected Mode Interface will be a key component of future applications to allow them to peacefully coexist in protected mode, whether under the auspices of Windows or a DOS extender. However, Microsoft is apparently dragging its feet on letting other members of the DPMI group gain access to the Windows specifications. But DPMI will definitely supersede VCPI (Virtual Control Program Interface).

### SatisFAXtion, *Intel*

At under \$500 with a modem, fax management, a port for a scanner, and a coprocessor for communications, this add-in board is terrific. SatisFAXtion's best feature is its ease of use. You just install it and then set it up to act like an Epson-compatible printer. Once this is done, all you have to do is have your application print output to an Epson-compatible printer, and SatisFAXtion intercepts it, converts it to Group 3 fax format, and sends it.

The final fax looks as good as if it were printed from an Epson printer. Software is included and can manage telephone books of users, receiving faxes, and even receiving and immediately printing faxes. Because you can attach a hand-held scanner, SatisFAXtion truly allows a PC/fax-board combo to replace a stand-alone fax machine by letting you scan and send any document.



### RadiusTV, *Radius*

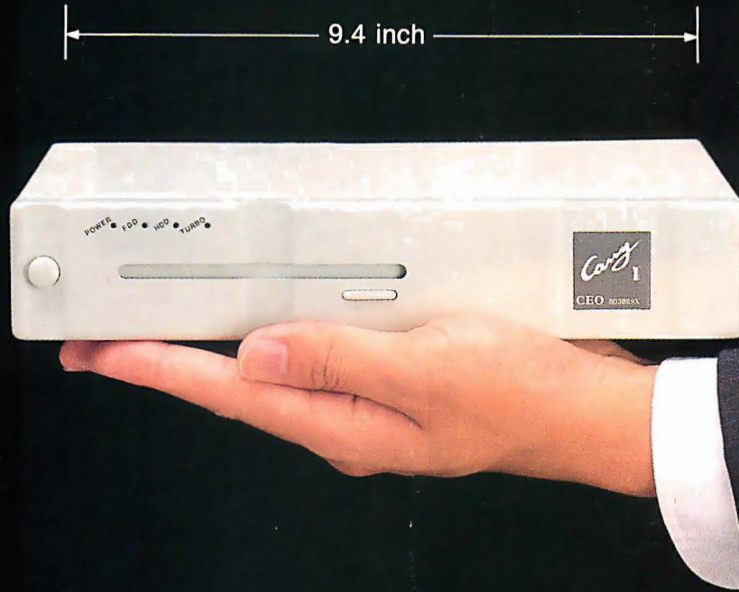
Radius was one of the last Mac display vendors to offer a video display and capture board. However, being the last entrant into this market didn't hurt, because RadiusTV does it best. An analog box conditions the video signal before digitizing it at a rate of 30 frames per second and placing the image in a resizable window on a Mac's screen. But RadiusTV not only digitizes the video signal, it also digitizes the audio component, piping the sound out of the Mac's speaker. Finally, RadiusTV can grab any close-captioned text present in the video signal and save it to a file for an immediate electronic transcript of a TV broadcast. The synergy of all these features makes RadiusTV a crucial engine in any multimedia work.

# WHAT IS THIS SMALL BOX ?

## A UNIX HOST!

## A LAN SERVER!

## A WORKSTATION .....



The Carry-I 9300 80386SX, 4M-byte RAM, 80M-byte Harddisk,  
One Expansion Slot, VGA...

Carry-I -the World's First & Original Book-Size Desktop Computer

The Carry-I 9000 series comes complete with 80386SX/80286-16/80286-12 microprocessor (Co-Processor optional), 1024 x 768 VGA/MGA & CGA display interface, 1/2/4 MB RAM, one 3.5" 1.44 MB FDD or one FDD plus one 40/80 MB HDD, one 8 bit expansion SLOT, one parallel and two serial I/O ports, and one 30W auto range switching power adapter, all in the traditional 240mm x 185mm x 45mm (9.4" x 7.3" x 1.8") casing of Carry-I. Each package includes two mini-tower stands and a carry bag. The 82 key mini keyboard and 9 inch color or monochrome VGA monitor are optional.

Other Carry-I products include the 8000 series XT & AT book-size personal computers and the 6000 series XT and AT book-size LANstations. ETHERnet pocket LAN adapter and Carry Mouse.

## CARRY-I

A Refreshing Idea...

A New Standard...

Computing Goes Better With CARRY-I



FLYTECH TECHNOLOGY CO., LTD.

HEAD OFFICE

2FL NO. 8, LANE 50, SEC. 3, NAN-KANG

RD, TAIPEI, TAIWAN R.O.C.

TEL# 886-2-7852556 FAX# 886-2-7852371, 7837970

W.C.

TEL# 89-69-746081 FAX# 89-69-749375

U.S.A.:

TEL# 1-408-7277373/4

FAX# 1-408-7277375

H.K.:

TEL# 852-3051268

FAX# 852-7968427

Circle 114 on Reader Service Card

#### DISTRIBUTOR

• CANADA: BUDGETRON INC. TEL# 416-564-7800 FAX# 416-564-2679 • FRANCE: M3C L'INFORMATION DU SUCCES TEL# 1-8271976 FAX# 1-42355916 • HONG KONG: PARKLY TECHNOLOGY LTD. TEL# 852-3051268 FAX# 852-7968427 • ISRAEL: MLL COMPUTERS SYSTEMS LTD. TEL# 3-7515511 FAX# 3-7516615 • ITALY: PRIMA COMPUTER TRADING ITALIA TEL# 522-518599 FAX# 522-518599 • MALAYSIA: COMMUNICATION TECHNOLOGY SDN BHD TEL# 03-2748888 FAX# 03-2749988 • NETHERLAND: KOPIEERSYSTEMEN NEDERLAND BV TEL# 2968-84141 FAX# 2968-97436 • NORWAY: SECUS DATA A/S TEL# 2-722510 FAX# 2-722515 • SINGAPORE: TRANSNIKO PTE LTD. TEL# 4758408 FAX# 4713803 • SOUTH AFRICA: PC MART COMPUTER GROUP TEL# 11-8043355 FAX# 11-8024153 • SPAIN: AT ELECTRONIC, S.A. TEL# 1-5645434 FAX# 1-4110869 • SWITZERLAND: ESS SOFTWARE TRADING SA TEL# 022-622020 FAX# 022-615650 • UNITED KINGDOM: CENTERPRISE INTERNATIONAL LTD. TEL# 256-463754 FAX# 256-843174 • WEST GERMANY: MACROTRON AG TEL# 89-4208233 FAX# 89-4237-15 • BELGIUM: CELEM S.A. TEL# 41-676434 FAX# 41-676515

1990

BYTE

AWARD

DISTINCTION

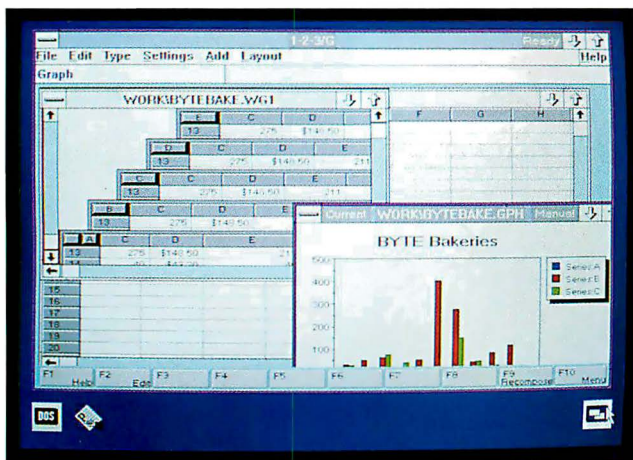
**LTE 386s/20, Compaq**

The LTE 386s/20 is a great improvement over Compaq's best-selling LTE 286. Compaq answered users' calls for a VGA screen, souped up the CPU to impressive levels, and sacrificed minimally on size, weight, and battery power consumption. The use of aerospace technology in producing the unit's motherboard shows Compaq's commitment as a leading-edge innovator.

Although powerful and



technologically innovative, the 386s/20's most important feature is its ability to double as a desktop system. With notebook computers getting more and more capable, there soon won't be much point in buying two systems; many users will just plug their portables into an expansion chassis while they're at the office. Compaq, by virtue of the LTE 386s/20's size and performance, is now leading that trend.

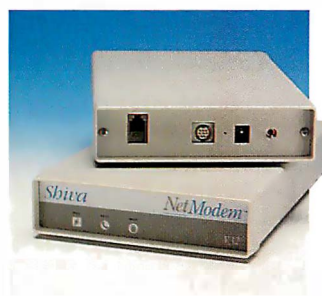
**Lotus 1-2-3/G, Lotus Development**

This is a state-of-the-art OS/2 Presentation Manager spreadsheet, with powerful multithreaded architecture, good graphics support, and the Solver goal-seeking utility. Especially praiseworthy is the WYSBYGI (what you see before you get it) preview mode for type and colors. By expanding the definition of Common User Access, Lotus managed to preserve keystroke and macro compatibility with earlier versions of 1-2-3.

**Continuous Edge Graphics (CEG) Chip, Edsun Labs**

This D/A converter chip, which plugs into a standard VGA board, brings sharper, more colorful graphics to regular PCs without jacking prices out of line. The device uses interpolation techniques to smooth dreaded jagged lines and blend colors on the screen, resulting in crisper images and a bigger palette. With its color-mixing engine, the chip can blend VGA's selection of 256 colors into more than 700,000 shades. Boards using the CEG chip will give standard IBM compatibles the power to generate photo-realistic graphics on VGA-type displays.

In OEM quantities, the chip is cheap at \$15 a pop; it will raise board prices by \$200 to \$300, a good price to pay for smoother, more vibrant images. Whether this chip finds a significant place in the market will be decided by companies making graphics boards and drivers. But the developers deserve recognition for their work in improving the look of VGA and bringing workstation-style graphics to low-cost PCs.

**NetModem V.32, Shiva**

Thanks to its built-in LocalTalk connector, this 9600-bps V.32 modem can be shared by every Mac on an AppleTalk network or can act as a router between networks. Mac users can easily transfer files, send E-mail, or access printers anywhere on either network, whether the LANs are next door or thousands of miles apart. Also, this modem gives traveling employees full dial-in access to the company's Macs and peripherals. At \$2000 each, it makes this wide-area-networking technology affordable for small businesses.

1990

BYTE

AWARD

DISTINCTION

### Nextstation and Nextdimension, Next

Steve Jobs has finally delivered on the original promise of the Next computer. These machines are fast and very inexpensive for what they do. Also, the applications coming out for them are, as promised, very hot. The Nextdimension, with its powerful graphics board incorporating an i860 and a C-Cube CL550, will set a new standard for video and graphics performance. The

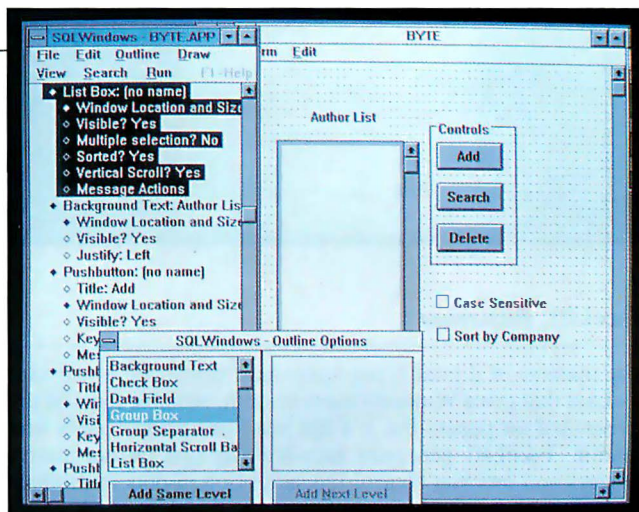


Interface Builder remains the most enticing aspect of these machines.

These new systems point the way for advanced use of color display PostScript. Next has taken a leading role in the migration of expensive, powerful workstation technology to cheaper, desktop platforms. The integration of sound and real video is another area in which Next is in the forefront.

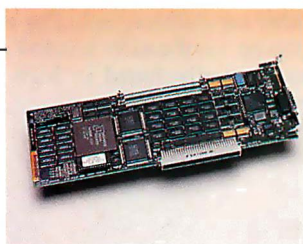
### SQLWindows, Gupta Technologies

Until now, Structured Query Language has always been a standard that was difficult to use and not very accessible. To use SQL, either you had to be a programmer or you had to know one. SQLWindows is the first product that's completely capable of supporting a major SQL application while at the same time offering an interface that even a beginner can use. To make SQLWindows even more useful, the Windows 3.0-based package supports various SQL databases on personal computers, database servers, minicomputers, and mainframes. Users can access several of these databases at the same time, and the process is transparent.



### 8•24 GC, Apple Computer

With the advent of 32-Bit QuickDraw, Macs can display and manipulate graphics with thousands (16-bit pixels) or millions (24-bit pixels) of colors. However, such graphics constitute a lot of data to muscle around—so much data that even screen updates on a Mac IIfx's 640- by 480-pixel monitor can be sluggish. Apple fixes this with its 8•24 GC, a 24-bit color board that uses an AMD 29000 RISC processor and on-board display buffers to accelerate Mac graphics. The 29000 processor offloads certain QuickDraw graphics primitives



from the Mac's CPU. The board's buffers store and manipulate bit-mapped images without the penalty of moving chunks of data from main memory to the display board. Both are a potent combination that allows high-end Macs to be versatile graphics workstations for scientific, engineering, and photo-imaging work.

### Desqview/X, Quarterdeck Office Systems

An enormous technical achievement, Desqview/X lets you run a DOS-based PC with a multitasking windowing shell that supports X Window System sessions. Other products may let you hot-key into X Window, but only as a view into sessions running on a remote client. Desqview/X could become the software glue that brings Unix to the DOS desktop.

What is significant here is that Desqview/X will allow X-based Unix systems to coexist naturally with DOS systems on a network, widening the options available to users. This means that your MS-DOS machine suddenly becomes part of the corporate X environment and is transparent to operating systems, just as the multitasking in DOS is transparent.

1990

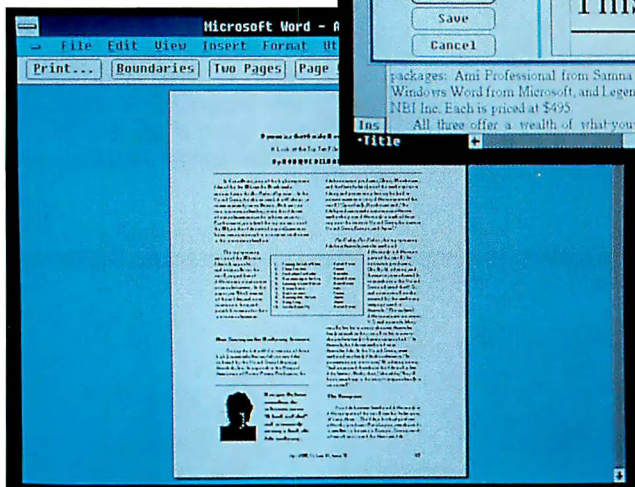
BYTE

AWARD

DISTINCTION

### Ami Professional, *Samna* Word for Windows, *Microsoft*

#### Word for Windows



#### Ami Professional

### WordScan, *Calera* Recognition Systems

Probably the best implementation of optical character recognition today, WordScan runs under Windows and makes use of its Dynamic Data Exchange capabilities. Therefore, it will make a natural partner for all kinds of imaging and word processing/desktop publishing applications under Windows. Its other capabilities, including a pop-up verification window, are typically found in high-end systems.

Word for Windows and Samna's Ami Professional make serious word processing a reality in Windows. In doing so, Microsoft and Samna have raised PC applications to a new level—one where applications don't have to be overly simple or unacceptably slow. Because of the technical success of these two word processors, the most often used application of BYTE readers on a PC need not be held back by a text-only environment. Their success also leads the way for scores of other products in Windows.

### FaceLift, *Bitstream*

The masters of digital typography have developed a software package that gives Windows users smooth, scalable fonts on the screen and on paper. But it's not just laser-printer users who benefit. FaceLift generates nice-looking text on dot-matrix printers and lets you control the saturation of dots to produce characters that are sharp, not muddy. FaceLift works with existing bit-map fonts if available; otherwise, it scales the characters to the size you specify. Not only does FaceLift generate nice type, it comes with 13 Bitstream fonts. The only thing wrong with this program is that it works only with Windows.

### DR DOS 5.0, *Digital Research*

PC users, particularly those whose PCs are tied to a network, are tired of running out of memory for applications in MS-DOS. Although several utilities have tried to take advantage of extended and upper memory by loading memory-resident programs and device drivers there, they often meet with mixed success. As one BYTE editor commented, everything above 640K bytes is a swamp. But DR DOS fixes that. It lets you move network device drivers and memory-resident programs out of the 640K-byte work space. It even relocates its own kernel in high memory, giving you the maximum amount of work space below 640K bytes for your applications. At least one company isn't willing to give the whole MS-DOS playing field to Microsoft.

### Looking Glass, *Visix Software*

This software comes closer than any to providing a Mac-like environment for Unix systems. Files, directories, and programs are all represented by unique (and changeable) icons, and a simple scripting language allows the program's behavior to be modified. Looking Glass is a boon for those administering large networks of systems, since administrators can develop custom scripts that give users easy point-and-click access to applications and services. This product, and others like it, will go far toward bringing Unix and X Window System to the general computing market.



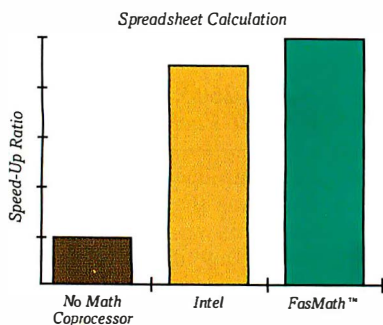
**"The math coprocessor  
PC Week rated #1!"**

# Get the FasMath™ Advantage.

Cyrix FasMath math coprocessors provide real advantages for all 386™ computer users.

## SUPERIOR PERFORMANCE IS OUR MAIN ADVANTAGE.

Performance is why you buy a math coprocessor. And, the entire line of Cyrix FasMath processors were developed with superior performance in mind. Cyrix engineers have designed FasMath utilizing new technology. The result — FasMath processors are the fastest, most accurate and consume the least amount of energy when compared to all other math coprocessors on the market today.



## THE ADVANTAGES OF SPEED, ACCURACY AND LOW POWER.

A math coprocessor offloads the complicated math functions from your computer's main processor, providing actual time savings. Depending on your application, FasMath can deliver up to three times the application performance of the Intel 80387. No other math coprocessor provides greater time-saving advantages than a Cyrix FasMath processor. In addition, FasMath computes results to 20 decimal digits of accuracy in the same time other coprocessors compute 7 digits. With FasMath, accuracy is never sacrificed for the sake of speed. Another FasMath advantage is that the FasMath processor runs cooler and uses less power than all other math coprocessors — a feature that is especially important to laptop users who can take advantage of extended battery life by using FasMath.

FasMath provides faster performance on many popular software programs.



## THE FASMATH ADVANTAGE WORKS WITH YOUR FAVORITE PROGRAMS.

If you thought that only scientists, engineers and programmers performing high-level mathematical calculations could benefit from the performance advantages that FasMath delivers, think again. FasMath helps hundreds of leading software programs work faster. These include spreadsheets, databases, accounting packages, and of course scientific, engineering and graphics applications. FasMath is easy to install in any 80386 or 80386SX system, is fully compatible with IBM® PC based software and socket standards, and is backed by a 5-year limited warranty and toll-free support hotline.



An unprecedented combination of performance and value. Cyrix FasMath is setting the standards for the 90s!

## THE ADVANTAGES OF FASMATH ADD UP TO EXTRAORDINARY VALUE AND DEPENDABILITY.

The entire line of Cyrix FasMath numerics processors offers the value-conscious buyer distinct advantages — faster performance, improved accuracy and low power dissipation, all at competitive prices. What's more, there are tens of thousands already in use today, attesting to the product's superior dependability.

So when it's time to choose a math coprocessor, get the one with *all the advantages* — FasMath by Cyrix. The world's most advanced numerics processors.

The Cyrix FasMath Processor  
High Performance Math CoProcessor For Use In All 80386 Systems



Cyrix manufactures a full-line of advanced processors for 386 systems at various clock speeds. For more information or where you can buy FasMath in the U.S.A. or Canada call 1-800-FASMATH (1-800-327-6284)

# Cyrix™

Advancing the Standards

© 1990 Cyrix Corporation. All rights reserved.  
FasMath is a trademark of Cyrix Corporation. All other products referenced are trademarks of their respective companies.

1990

BYTE

AWARD

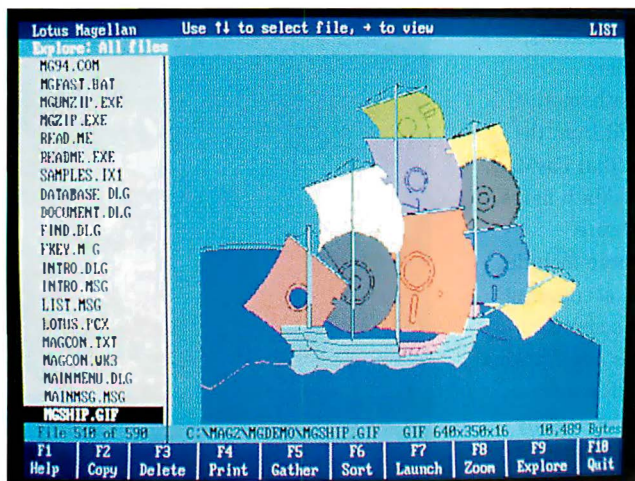
DISTINCTION

**X Window System release 1.2, *Interactive Systems***

With this release, Interactive Systems has created the fastest, most capable X implementation for PC Unix. It works with a wide range of graphics cards, supporting resolutions of up to 1280 by

1024 pixels in 256 colors. Interactive has also added support for 256-color VGA and 8514/A, making it possible to build color-rich Unix workstations at a lower cost than before. Interactive's unique

hardware-independent server architecture paves the way for support of new graphics technologies as they become available. Looking Glass, which also won a BYTE Award of Distinction, is included.

**Magellan 2.0, *Lotus Development***

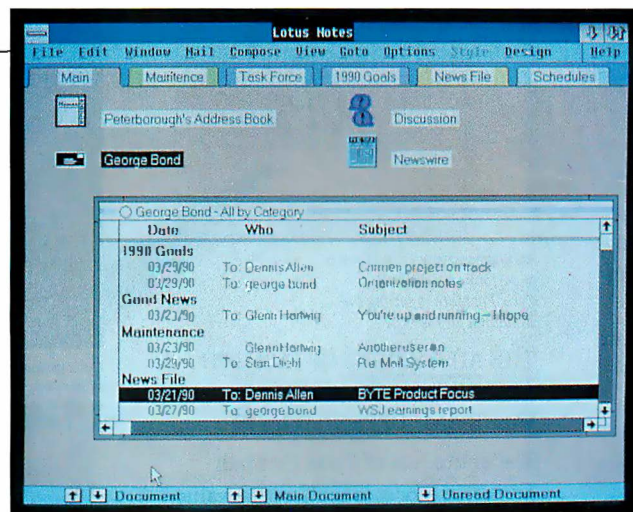
The strength of Magellan is its joining of two unrelated software technologies: industrial-strength data compression plus extremely powerful indexing. PKZIP gives you the same data compression (effectively doubling your hard disk capacity), but finding what's in a ZIP file is a pain; other programs have powerful indexing but can't tell you what's inside a ZIP file. Magellan lets you PKZIP any or all files, yet it retains a complete index of every word in the ZIPped (and unZIPped, for that matter) files. You can locate, browse, copy, and print text from inside the ZIPped files without having to unarchive them to disk.

**Apollo 2500, *Hewlett-Packard/Apollo***

At its introduction, the Apollo 2500 was the most inexpensive Unix workstation on the market, and its arrival forced other vendors to follow with low-end systems of their own. For under \$5000, the 2500 offered high-resolution monochrome graphics, 8 megabytes of memory, and a network adapter. Running Domain/OS, users could have the best of both Unix System V and BSD Unix, as well as full support for both X Window System and Apollo's Display Manager graphical interfaces. The low-end workstation market is now thriving, with Sun, DEC, and Hewlett-Packard all participating, but it was the Apollo 2500 that kicked it all off.

**Notes, *Lotus Development***

An ambitious project, to say the least, Lotus Notes is the first major product to bring together all workgroup activities for PC-based networks in a nonrestrictive way. Its support of LAN and wide-area-network activities with self-replicating file servers (so that branch offices are working with up-to-date data), as well as its text filters and manager, puts Notes in a class all by itself. Notes automatically sifts through mail and electronic conferencing messages in a way that's tailored for each user on the network.

**Gram·mat·ik™ IV****Grammatik IV, *Reference Software***

Considered by many to be the best proofreading package for the PC, Grammatik IV works with most major word processing programs. It allows on-the-fly style and grammar changes, and it adapts to the style of writing it is evaluating.

1990

**BYTE**

AWARD

OF

MERIT

**Adobe PostScript Level 2,  
Adobe Systems**

Major upgrade of the industry-standard page-description language.

**HyperCard 2.0,  
Apple Computer**

Significant revision of the hypertext development software for the Mac.

**Macintosh IIfx,  
Apple Computer**

High-performance 40-MHz 68040-based system.

**FileMaker Pro, Claris**

Flat-file database manager.

**Color MacCheese,  
Delta Tao**

Low-cost 32-bit color paint program for the Mac.

**Dragon Dictate,  
Dragon Systems**

Voice-recognition system for the PC.

**Hercules Graphics Station,  
Hercules Computer  
Technology**

Low-cost, high-resolution graphics card for the PC.

**American Heritage  
Dictionary, Houghton  
Mifflin Software**

On-line dictionary and thesaurus reference.

**M-Motion Video  
Adapter/A, IBM**

NTSC video board for the PC.

**ScanMan Model 32,  
Logitech**

Hand-held scanner with innovative software.

**MediaMaker, MacroMind**

Macintosh-based presentation-creation program for novices.

**R:base 3.1, Microrim**

Relational database manager for the PC.

**LAN Manager 2.0,  
Microsoft**

Network operating system for the PC.

**OS/2 2.0, Microsoft**

Multitasking operating system for the PC.

**Works 2.0, Microsoft**

Low-cost integrated software package for the Mac and PC.

**RMD-5100-S Rewritable  
Optical Disk Drive,  
Mass Optical Storage  
Technologies (MOST)**

The first rewritable 3½-inch optical drive.

**WaveLAN, NCR**

A wireless LAN for PCs.

**Personal  
Mainframe/8000,  
Opus Systems**

A set of 88000-based ISA bus cards that turn PCs into workstations.

**Nisus 3.01,  
Paragon Concepts**

Upgraded version of a popular Mac word processor.

**Stor/Mor, Q/Cor**

The first-to-ship ultra-high-capacity (20 MB) floppy disk drive for PCs.

**QMS-PS 410, QMS**

Innovative, low-cost PostScript laser printer.

**Desqview 386/QEMM-386,  
Quarterdeck Office  
Systems**

New version of the popular multitasking software for PCs.

**Sparcstation IPC,  
Sun Microsystems**

Small, fast, and inexpensive RISC workstation.

**TravelMate 3000,  
Texas Instruments**

Powerful 20-MHz 386SX-based notebook PC.

**Paradise 8514/A Plus Card,  
Western Digital**

A fast, inexpensive display adapter with VGA pass-through.

# THE SOLUTION

... to your data collection and data entry problems!

## The Psion Organiser II & dCAPP

### Psion Gives You the Answers!

With eight different Organiser II models to choose from, Psion lets you select the Organiser II that best meets your needs. Standard configurations are available with or without built-in software programs, and provide the options of either two or four lines of LCD



display, several different keyboard designs, and from 32K to 96K of internal RAM memory. All Organiser units can use our removable and interchangeable memory modules, allowing the Organiser II to be configured to meet your unique data and program memory requirements.

#### POWER

The Organiser II is a powerful hand held computer capable of running a broad range of pre-written programs. When an off the shelf program just won't do, you can custom program the Organiser II to the unique requirements of your application. From inventory control to remote sales order entry, the Organiser II has the power to do the job.

#### PERIPHERALS

For jobs ranging from simple data collection to an RS-485 factory floor network, the Organiser II has the right tools for the job. Peripherals include Bar Code Wands, Laser Scanners, Mag Card Readers, Portable Modems and Printers, Carrying Cases, all the way to a broad range of interfaces which include serial, parallel and multiple types of SPC devices.



### dCAPP Gives You the Solution!!

• dCAPP data collection software is completely user configurable allowing even non-programmers the ability to create their own custom data collection program for the Organiser II in a matter of minutes, including its own operating instructions manual. • dCAPP data collection software is completely user configurable. Keyboard, Magnetic Card, or BAR CODE input. • Direct Interface to most Database and Spreadsheet programs; (dBASE 3, dBASE 4, Lotus 123, D.I.F., and many others).

**TYPICAL APPLICATIONS:** Inventory Control; Stock Taking; Tools and Equipment Control; Sales Route Accounting; Quality Control and Inspection Reporting; Tank Farm Gauging; Stores Accounting; Plant Inspection; and More . . .

For more information, contact:

### KEC Products

13630 58th Street North, Suite #103  
Clearwater, Florida 34620  
(813) 531-1422

Lotus 123 is a registered trademark of Lotus Development Corp. dBASE is a registered trademark of Ashton Tate Corp. IBM-PC is a registered trademark of International Business Machines Corp.

## The Third Annual BYTE Award Winners

**Adobe Systems, Inc.**  
*Photoshop*  
*PostScript Level 2*  
*Adobe Type Manager 2.0*  
 1585 Charleston Rd.  
 P.O. Box 7900  
 Mountain View, CA 94039  
 (415) 961-4400  
**Inquiry 1138.**

**Advanced Micro Devices (AMD)**  
*Am286ZX/LX*  
 5204 East Ben White Blvd.  
 Austin, TX 78741  
 (512) 385-8542  
**Inquiry 1139.**

**Apple Computer, Inc.**  
*8\*24 GC Accelerator Card*  
*A/UX 2.0*  
*HyperCard 2.0*  
*Mac IIx*  
*Mac Classic*  
 20525 Mariani Ave.  
 Cupertino, CA 95014  
 (408) 996-1010  
**Inquiry 1140.**

**Bitstream, Inc.**  
*FaceLift*  
 215 First St.  
 Cambridge, MA 02142  
 (617) 497-6222  
**Inquiry 1141.**

**Borland International**  
*Quattro Pro 2.0*  
*Turbo C++*  
 1800 Green Hills Rd.  
 Scotts Valley, CA 95066  
 (408) 438-8400  
**Inquiry 1142.**

**Calera Recognition Systems, Inc.**  
*WordScan*  
 2500 Augustine Dr.  
 Santa Clara, CA 95054  
 (800) 544-7051  
 (408) 986-8006  
**Inquiry 1144.**

**C-Cube Microsystems**  
*Compression Master*  
*CL550*  
 399-A West Trimble Rd.  
 San Jose, CA 95131  
 (408) 944-6300  
**Inquiry 1143.**

**Claris Corp.**  
*FileMaker Pro*  
 5201 Patrick Henry Dr.  
 Santa Clara, CA 95052  
 (408) 987-7000  
**Inquiry 1145.**

**Compaq Computer Corp.**  
*LTE 386s/20*  
 P.O. Box 692000  
 20555 FM 149  
 Houston, TX 77269  
 (713) 370-0670  
**Inquiry 1009.**

**CompuAdd**  
*Companion*  
 12303 Technology Blvd.  
 Austin, TX 78227  
 (800) 531-5475  
 (512) 250-1489  
**Inquiry 1010.**

**Delta Tao**  
*Color MacCheese*  
 760 Harvard Ave.  
 Sunnyvale, CA 94087  
 (408) 730-9336  
**Inquiry 1011.**

**Digital Research, Inc. (DRI)**  
*DR DOS 5.0*  
 Box DRI  
 70 Garden Court  
 Monterey, CA 93942  
 (408) 649-3896  
**Inquiry 1012.**

**Dragon Systems, Inc.**  
*Dragon Dictate*  
 90 Bridge St.  
 Newton, MA 02158  
 (617) 956-5200  
**Inquiry 1013.**

**Edsun Laboratories, Inc.**  
*Continuous Edge Graphics Chip*  
 564 Main St.  
 Waltham, MA 02154  
 (617) 647-9300  
**Inquiry 1014.**

**Gupta Technologies, Inc.**  
*SQLWindows*  
 1040 Marsh Rd.  
 Menlo Park, CA 94025  
 (415) 321-9500  
**Inquiry 1015.**

**Hercules Computer Technology, Inc.**  
*Graphics Station*  
 921 Parker St.  
 Berkeley, CA 94710  
 (415) 540-6000  
**Inquiry 1016.**

**Hewlett-Packard Co.**  
*LaserJet IIP*  
*LaserJet III*  
 Peripherals Group  
 19310 Pruneridge Ave.  
 Cupertino, CA 95014  
 (800) 752-0900  
**Inquiry 1017.**

**Hewlett-Packard/Apollo**  
*Apollo 2500*  
 330 Billerica Rd.  
 Chelmsford, MA 01824  
 (508) 256-6600  
**Inquiry 1018.**

**Houghton Mifflin Software**  
*American Heritage Dictionary*  
 One Memorial Dr.  
 Cambridge, MA 02142  
 (800) 633-4514  
**Inquiry 1019.**

**IBM Corp.**  
*M-Motion Video Adapter/A*  
*RISC System 6000*  
 Old Orchard Rd.  
 Armonk, NY 10504  
 (914) 765-1900  
**Inquiry 1020.**

**Intel Corp.**  
*SatisFAXtion*  
 5200 Northeast Elam Young Pkwy.  
 Hillsboro, OR 97124  
 (503) 696-7086  
**Inquiry 1021.**

**Interactive Systems Corp.**  
*X Window System release 1.2*  
 2401 Colorado Ave.  
 Santa Monica, CA 90404  
 (800) 537-5324  
**Inquiry 1022.**

**Logitech, Inc.**  
*ScanMan Model 32*  
 6505 Kaiser Dr.  
 Fremont, CA 94555  
 (415) 795-8500  
**Inquiry 1023.**

**Lotus Development Corp.**  
*Lotus 1-2-3/G*  
*Magellan 2.0*  
*Notes*  
 55 Cambridge Pkwy.  
 Cambridge, MA 02142  
 (617) 577-8500  
**Inquiry 1024.**

**MacroMind, Inc.**  
*Director 2.0*  
*MediaMaker*  
 410 Townsend St.,  
 Suite 408  
 San Francisco, CA 94107  
 (415) 442-0200  
**Inquiry 1025.**

**Mass Optical Storage Technologies, Inc. (MOST)**  
*RMD-5100-S*  
*Rewritable Optical Disk Drive*  
 11205 Knofit Ave.,  
 Suite B  
 Cypress, CA 90630  
 (714) 898-9400  
**Inquiry 1026.**

**Microrim, Inc.**  
*R:base 3.1*  
 3925 159th Ave. NE  
 Redmond, WA 98052  
 (206) 885-2000  
**Inquiry 1027.**

**Microsoft Corp.**  
*DPMI*  
*LAN Manager 2.0*  
*OS/2 2.0*  
*Windows 3.0*  
*Word for Windows*  
*Works 2.0*  
 1 Microsoft Way  
 Redmond, WA 98052  
 (206) 887-8080  
**Inquiry 1028.**

**NCR Corp.**  
*WaveLAN*  
 Workstation Products Division  
 1700 South Patterson Blvd.  
 Dayton, OH 45479  
 (513) 445-5000  
**Inquiry 1029.**

**NewTek, Inc.**  
*Video Toaster*  
 115 West Crane  
 Topeka, KS 66603  
 (913) 354-1146  
**Inquiry 1030.**

## BYTE AWARDS

**Next, Inc.**

*Nextstation*  
*Nextdimension*  
 900 Chesapeake Dr.  
 Redwood City, CA 94063  
 (415) 366-0900  
**Inquiry 1031.**

**Opus Systems**

*Personal Mainframe/8000*  
 20863 Stevens Creek,  
 Building 400  
 Cupertino, CA 95014  
 (408) 446-2110  
**Inquiry 1032.**

**Paragon Concepts, Inc.**

*Nisus 3.01*  
 990 Highland Dr.,  
 Suite 312  
 Solana Beach, CA 92075  
 (800) 922-2993  
 (619) 481-1477  
**Inquiry 1033.**

**Perceptive Solutions, Inc.**

*hyperStore/1600*  
 2700 Flora St.  
 Dallas, TX 75201  
 (800) 486-7278  
 (214) 954-1774  
**Inquiry 1034.**

**Q/Cor**

*Stor/Mor*  
 One Meca Way  
 Norcross, GA 30093  
 (404) 923-6666  
**Inquiry 1035.**

**QMS, Inc.**

*QMS-PS 410*  
 P.O. Box 81250  
 Mobile, AL 36689  
 (205) 633-4300  
**Inquiry 1036.**

**Quarterdeck Office Systems**

*Desqview 386/QEMM-386*  
*Desqview/X*  
 150 Pico Blvd.  
 Santa Monica, CA 90405  
 (213) 392-9851  
**Inquiry 1037.**

**Radius, Inc.**

*RadiusTV*  
 1710 Fortune Dr.  
 San Jose, CA 95131  
 (408) 434-1010  
**Inquiry 1038.**

**Reference Software**

*Grammatik IV*  
 330 Townsend,  
 Suite 123  
 San Francisco, CA  
 94107  
 (415) 541-0222  
**Inquiry 1039.**

**Samna Corp.**

*Ami Professional*  
 5600 Glenridge Dr.  
 Atlanta, GA 30342  
 (404) 851-0007  
**Inquiry 1040.**

**Sharp Electronics Corp.**

*Sharp PC-6220*  
 Sharp Plaza  
 Mahwah, NJ 07430  
 (201) 529-9500  
**Inquiry 1041.**

**Shiva Corp.**

*NetModem V.32*  
 155 Second St.  
 Cambridge, MA 02141  
 (617) 864-8500  
**Inquiry 1042.**

**Sun Microsystems**

*Sparcstation IPC*  
 2550 Garcia Ave.  
 Mountain View, CA 94043  
 (415) 960-1300  
**Inquiry 1043.**

**Texas Instruments**

*TravelMate 2000*  
*TravelMate 3000*  
 P.O. Box 202230  
 Austin, TX 78720  
 (800) 527-3500  
**Inquiry 1044.**

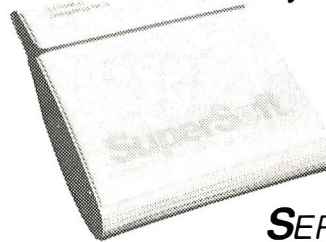
**Visix Software, Inc.**

*Looking Glass*  
 11440 Commerce Park Dr.  
 Reston, VA 22091  
 (703) 758-8230  
**Inquiry 1045.**

**Western Digital Corp.**

*Paradise 8514/A Plus Card*  
 2300 Main St.  
 Irvine, CA 92714  
 (415) 960-3353  
**Inquiry 1046.**

Want to save Time, Money,  
 & Headaches?



GET SUPERSOFT'S  
**SERVICE DIAGNOSTICS**

All the software, alignment diskettes, parallel/serial wrap-around plugs, ROM POSTs and extensive, professional documentation to provide the most comprehensive testing available for IBM PCs, XTs, ATs and *all compatibles* under DOS or Stand Alone. No other diagnostics offers such in-depth testing on as many different types of equipment by isolating problems to the board and chip level.

**NEW:** SuperSoft's **ROMPOST** performs the most advanced **Power-on-Self-Test** available for system boards that are compatible with the IBM ROM BIOS. It works even in circumstances when the Service Diagnostics diskette cannot be loaded.

**NEW:** 386 diagnostics for hybrids and **PS/2s!**

For over nine years, major manufacturers have been relying on SuperSoft's diagnostics software to help them and their customers repair microcomputers. End users have been relying on SuperSoft's Diagnostics II for the most thorough hardware error isolation available. Now versions of Service Diagnostics are available to save everyone (including every serious repair technician) time, money, and headaches in fixing their computers, even non-IBM equipment.

All CPUs & Numeric Co-processors	All Color Graphics & Monochrome Monitors
System Expansion & Extended Memory	Parallel & Serial Ports
Floppy, Fixed & Non-standard Disk Drives	Mono, CGA, Hercules & EGA Adapters
Standard & Non-standard Printers	All Keyboards & the 8042 Controller
System Board: DMA, Timers, Interrupt, Real-time Clock & CMOS config. RAM	

**"EDITOR'S CHOICE" — PC MAGAZINE August 1990**

Service Diagnostics for PC, PC/XT, and compatibles only	..... \$169
Alignment Diskette for PC, PC/XT and compatibles (48 tpi drives)	..... \$ 60
Wrap-around Plug for PC, PC/XT and compatibles (parallel and serial)	..... \$ 30
Service Diagnostics for AT and compatibles only	..... \$169
Alignment Diskette for AT and compatibles (96 tpi drives)	..... \$ 60
Wrap-around Plug for AT (serial)	..... \$ 15
ROM POST for PC, PC/XT and compatibles only	..... \$245
ROM POST for AT and compatibles only	..... \$245
<b>Service Diagnostics: The KIT (includes all of the above—save \$502).</b>	<b>\$495</b>
Service Diagnostics for PS/2 models 25/30 50/60 or 70/80 and compatibles (please specify)	..... \$195
Service Diagnostics for 386 or V2, V30, or Harris, etc. (please specify)	..... \$195
Diagnostics II is the solution to the service problems of users of all CP/M-80, CP/M-86 and MS-DOS computers	..... \$125
Alignment Diskette for PS/2 and compatibles (3.5 inch)	..... \$ 60

To order, call 800-678-3600 or 408-745-0234  
 FAX 408-745-0231, or write SuperSoft.

*your microcomputer repair solution*

# SuperSoft

FIRST IN SOFTWARE TECHNOLOGY P.O. Box 4178, Mountain View, CA 94040-0178  
 (408) 745-0234 Telex 270365

SUPERSOFT is a registered trademark of SuperSoft, Inc.; CDC of Control Data Corp.; IBM PC, AT & XT of International Business Machines Corp.; MS-DOS of MicroSoft Corp.; NEC of NEC Information Systems, Inc.; PRIME of PRIME INC.; Sony of Sony Corp.

# If you think the HP LaserJet III is great,

## ASTRONOMY IS LOOKING UP

THE HIRSCH REPORT OF THE SKIES VOL. 8, NO. 4, FALL 1990

**STAR SHORTS**

*Reported by The Star*

Every day billions of dust particles enter into Earth's atmosphere. New scientists are working to make me-

**You Can't See the Great Wall from the Moon!**

Everyone has heard that you can see the Great Wall of China from the Moon. Or from Earth orbit. Or even from Mars. Certainly you cannot see the Great Wall from the Moon. According to

tear-burst communication a practical and economical alternative to the use of tele-

(continued on page 2)

an astronaut, it's difficult even seeing continents. You may be able to see the Great Wall from orbit, but, in general, it's difficult even to see familiar objects; the planet's swift motion-

(continued on page 3)

**NO BLACK HOLES?**

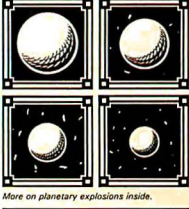
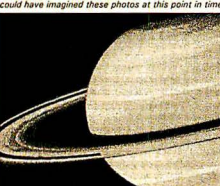
Scientists are still unable to confirm the existence of even a single black hole, despite widespread belief that such things should exist. Tracking down these invisible objects isn't easy, because they can only be studied indirectly by the effects they have on their surroundings. There are several types of places that

(continued on page 3)

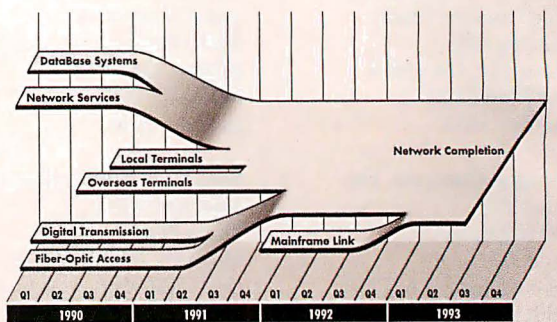
**MIRROR, MIRROR**

It's a chore, but all reflecting telescopes require cleaning their reflective mirrors. Eventually, the aluminum coating on their mirrors deteriorates and needs replacing. For large instruments, the process requires removing the tele-

(continued on page 4)

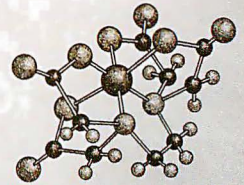
## LONGJUMP NETWORK INTEGRATION PROJECT PROPOSED TIMELINE



## CHAIN REACTION

SAGOT'S CHEMICAL LETTERS

JUNE 9, 1990  
VOLUME FOUR  
ISSUE THREE



**New Leaps in Metal-Organic Chemistry**

Metal-organic chemistry bridges the gap between organic and inorganic chemistry. It can lead to important new products for example, poison antidotes. A chelate, such as EDTA (which contains carbon, hydrogen, oxygen and nitrogen atoms) can surround ions of metals and remove them from unwanted places. (continued next page)

**What's New in Superconductivity?**

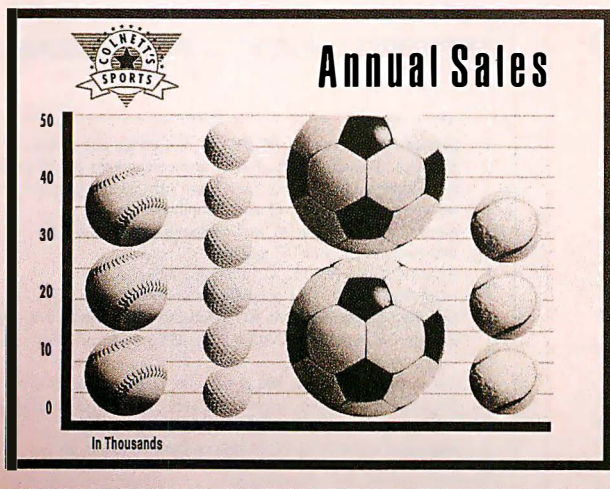
It was almost exactly three years ago that a ceramic material that superconducts above liquid nitrogen temperature was discovered. Within days of the discovery, electronics, power transmission, and transportation were being redefined in everyone's imagination. Yet superconductivity was not a new phenomenon. The effect was first observed in mercury in 1911, and since then, more than 500 elements, alloys, and compounds have been found to superconduct. (continued next page)

**Antimatter Bottled**

A device tested may give us a glimpse of what an antimatter world might look like. The device cools antimatter to a temperature a few degrees above absolute zero and stores it for several days at a time. (continued next page)

**Fifty Years Ago**

Remember that before WWII, our chemists were experimenting with a distilling process to lower the calories of ordinary beer. Abandoning the research at the onset of world war, researchers then pursued the development of a distillable D ration. Don't believe all rumors. (continued next page)



Introducing the new HP LaserJet IIID printer. The LaserJet that combines all of the advanced capabilities of the exciting LaserJet III with all of the paper-handling features required by today's busy office.

There's a lot to like. Like two paper trays for different types and sizes of paper. 200-sheet

capacity in each of those trays for less reloading. And two-sided printing that lets you easily condense your output. Even an optional automatic envelope feeder that eliminates manual feeding.

Equally impressive is HP's Resolution Enhancement technology.

Pioneered in the LaserJet III, this technology actually varies the sizes of dots. So curves really curve. Lines are never jagged. And you get resolution never before seen in a 300 dpi printer. Output has never looked so good.

Documents can be made even more elaborate thanks to our en-

# you'll automatically like the new HP LaserJet III D.

Two-sided printing means better paper usage and more professional-looking documents.

Resolution Enhancement technology actually shrinks dots to handle the finest curves.

The optional envelope feeder allows for up to fifty envelopes.

Enhancements to our HP-GL/2 language allow you to reverse, scale, and shade output.

Two paper trays allow for regular or legal correspondence while also increasing paper capacity.



hanced PCL5 printer language, which includes HP-GL/2 graphics language. You can print regular or reverse type. Shaded text. Even portrait and landscape on the same page.

Beyond this, all types of options are available for all types of users. Which means you can customize with Adobe® PostScript® software. Add memory. Or better express yourself with our MasterType

library of fonts and typefaces. You can even connect a Macintosh.

The best part is that the \$2,395\* LaserJet III and \$3,595\* LaserJet III D are both easily within any budget. So call **1-800-752-0900, Ext. 1586**. We'll tell you where to find your nearest authorized HP dealer.



# Caching Cards Speed Data Access

**The BYTE Lab tests eight caching controller cards that help relieve hard disk drive bottlenecks**

*Steve Apiki and Rick Grehan*

If you spend your days doing hard disk drive-intensive chores, you know all too well how a slow disk subsystem cripples an otherwise speedy computer. Even today's faster hard disk drives put only a dent in data bottlenecks. A drive's 12-millisecond access time may sound impressive, but that hardly keeps up with a 33-MHz CPU's voracious demand for data.

For many people, the solution to hard disk drive gridlock lies in caching controllers. This technology borrows from a decades-old idea: sandwich fast (primary) storage between the processor and the slow (secondary) storage. In this context, primary storage is the high-speed RAM that is sequestered to the controller, and secondary storage is the hard disk drive.

But caching controller manufacturers don't stop there. Semiconductor intelligence rides herd on all the RAM, and this intelligence ranges from 8032 microcontrollers all the way up to 68000s. The result: These boards aren't just fast, they're smart, too.

This month, the BYTE Lab evaluates eight of the fastest caching boards available for ATs (two other products, a Unix-based caching controller from Consensys and an ESDI controller from Ultrastor, did not arrive in time for testing). We chose ESDI and SCSI controllers because we believe that these interfaces will re-

main the mainstays for high-performance hard disk drives in the future.

To test these controllers, we wrote a pair of benchmarks that reflect activities that depend heavily on hard disk drive system performance. The tests are portable across operating systems, specifically DOS (see figure 1), Novell's NetWare 386 (see figure 2), and The Santa Cruz Operation's SCO Unix (see figure 3), so we could gauge controller performance in each environment. For benchmark details, see the text box "How We Tested Controllers Across Three Operating Systems" on page 172. To help you decide which card is right for you, see the text box "Choosing the Right Caching Controller" on page 180.

## Disk Caching

Hardware disk caches usually consist of 1 or 2 megabytes of RAM with an access time of about 100 nanoseconds (see the text box "Buffering: The Lower-Cash Alternative" on page 176). The disks that these products cache typically consist of a few hundred megabytes of magnetic media with access times of between 15 and 25 ms. Caches are pragmatic solutions to an economic, not a technical, problem. They dramatically improve the performance of slower, cheaper media (hard disks) with just a small amount of fast and expensive media (RAM).

The cache holds a copy of some data from the disk. When the system requests data from the caching controller, the controller first looks in the cache to determine if the cache contains the requested data. If it does, the controller processes the request almost immediately; if not, the controller gets the data from the disk at normal disk-access speeds. In general, the larger the cache, the better the performance, although there is a point of diminishing returns.

While the concept is simple, its implementation encounters some rather difficult technical problems. Using propri-

etary algorithms, the caching controller decides which sectors of the disk should be copied to the cache in anticipation of the system's next request. The controller then must organize the cache for efficient processing.

When the cache is full, the controller must decide which sectors can be discarded. The dedicated microprocessor, which may be as powerful as a 68000 or Z280 chip, helps solve these complex problems.

Each manufacturer jealously guards its caching algorithm because that's one of the main determinants in deciding a controller's performance. However, controllers share some techniques for solving performance problems. For example, when your system asks to read a sector that has not been cached, the controller copies that sector into the cache as well as fulfilling the request from the disk.

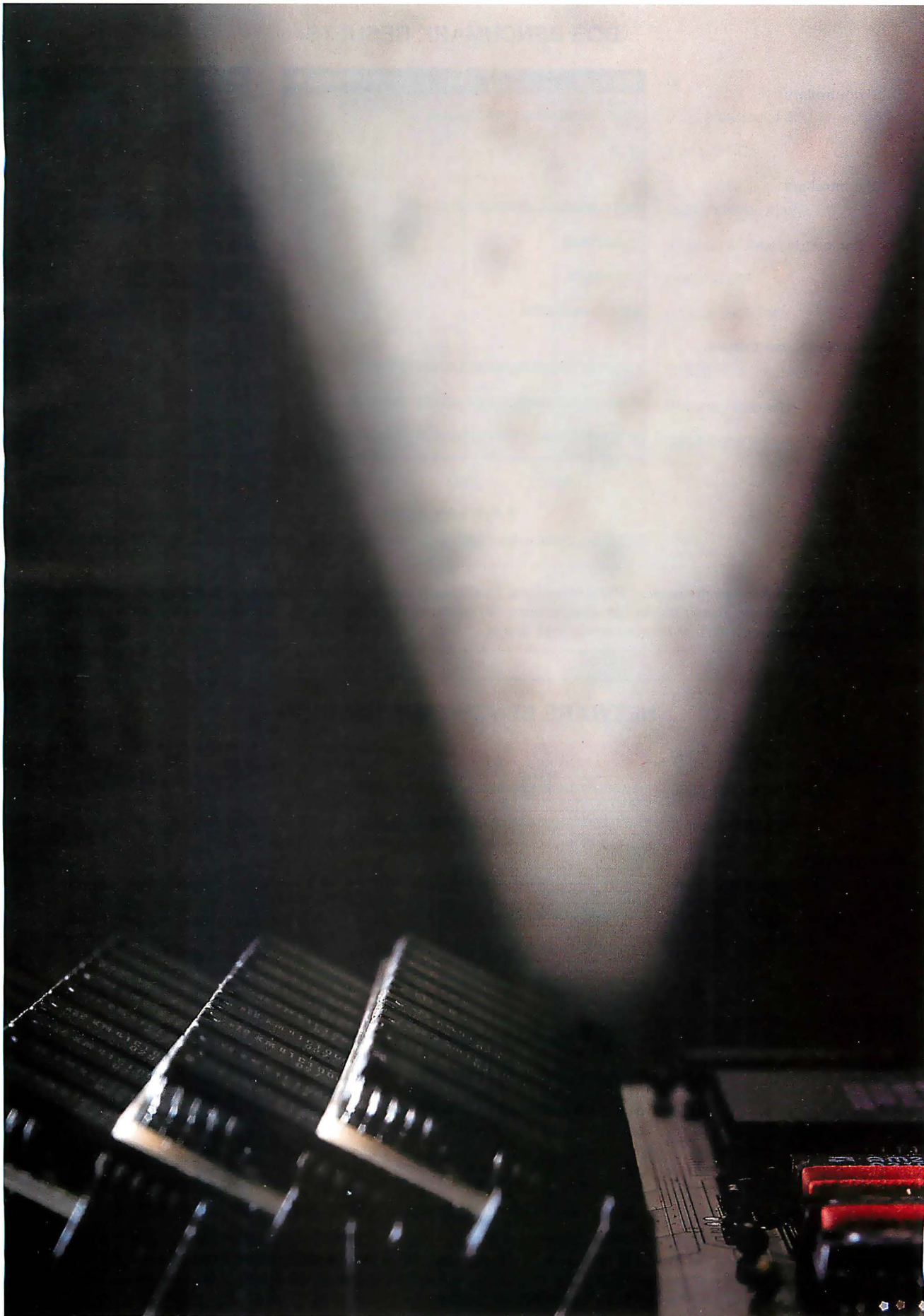
On a disk write, the controller may choose to buffer the write by writing to the cache only. The controller writes the cached sectors to disk later, after some period of inactivity or if the modified sector must be replaced in the cache. While buffered writes improve performance, there is a small chance that data will be lost in a power failure or other disaster.

Read-ahead is a method for improving read performance. On a read request, the controller reads more sectors than requested (sometimes a full track) and sends them into the cache. Because the system tends to read sectors in contiguous blocks, this optimization can save access time, although there is some overhead due to the additional information being read.

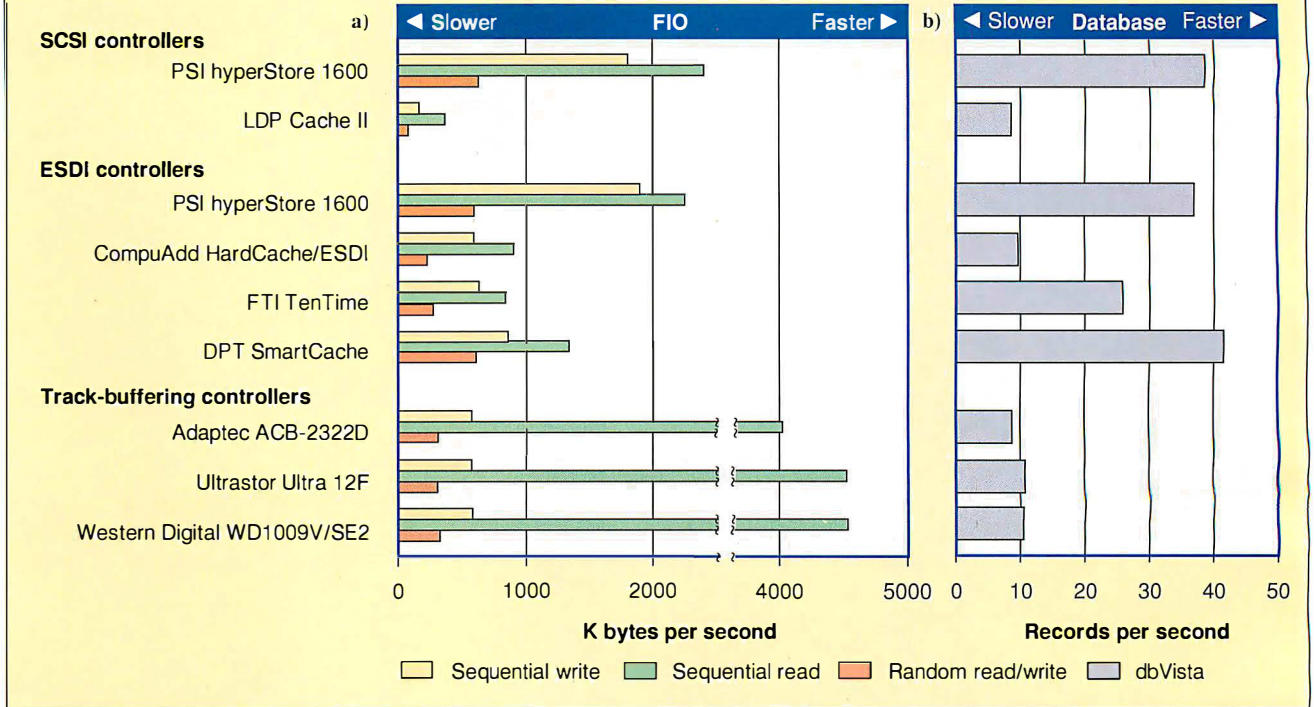
## Organizing the Data

Cache data is usually organized in a *set-associative* fashion. This means that each cache location can contain data only from a fixed set of disk locations. In a two-way set-associative cache, two cache



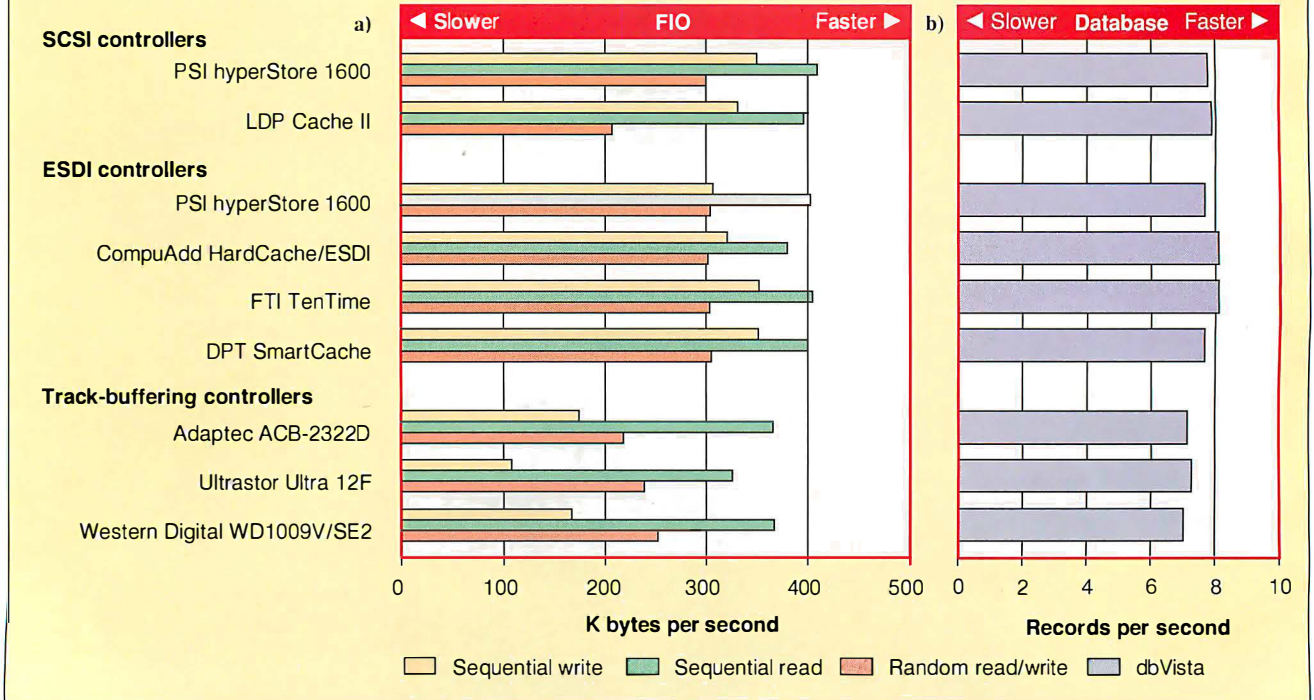


## DOS BENCHMARK RESULTS

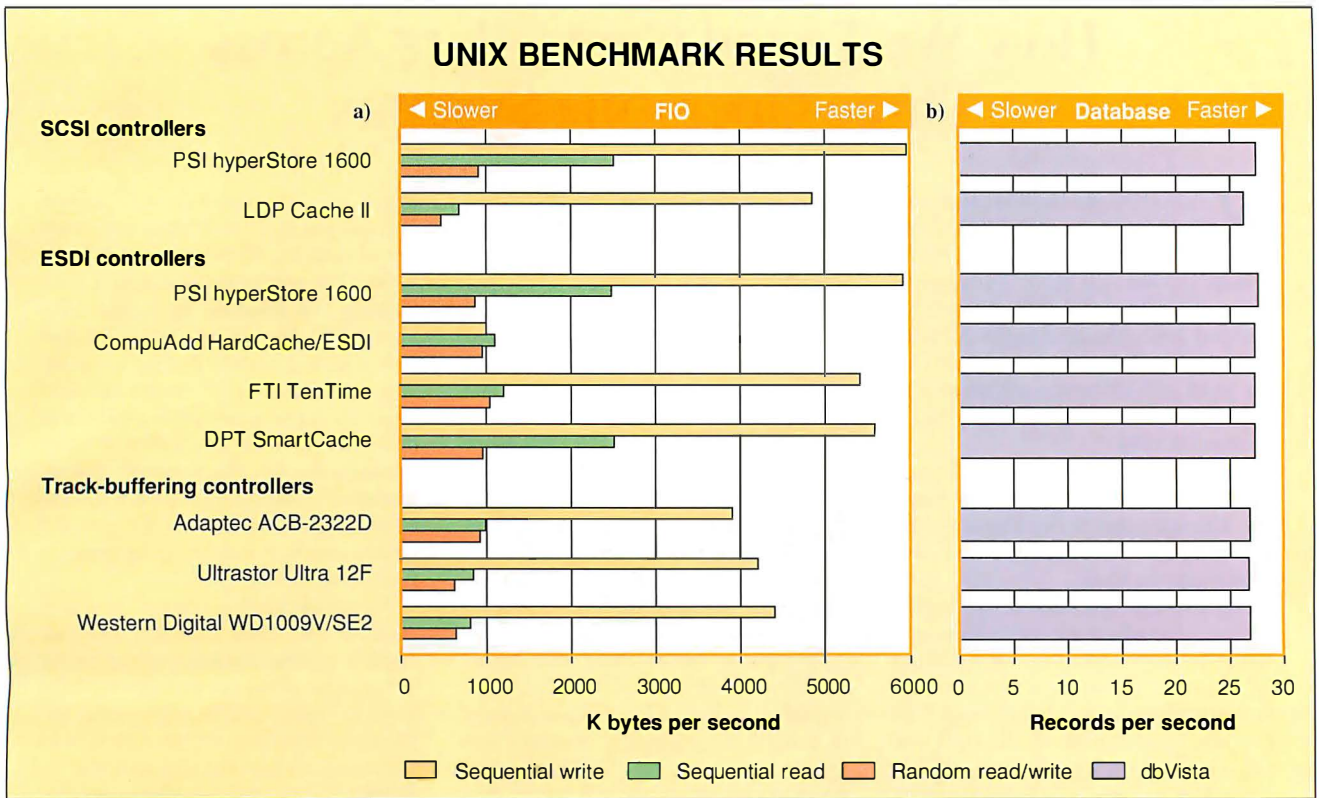


**Figure 1:** DOS benchmark performance. PSI's hyperStore 1600 clearly demonstrated superiority on sequential operations (a), while DPT's SmartCache edged it out on our random tests. (b) In our dbVista benchmark, the performance of CompuAdd's HardCache/ESDI suffered because of its write-through design.

## NETWARE BENCHMARK RESULTS



**Figure 2:** Performance under NetWare 386 version 3.10. Performance of all the boards was similar on all tests (a,b). Our four-user LAN simulation apparently did not push NetWare past its own cache; in small networks, even heavy random disk access may not show a measurable benefit from a caching controller.



**Figure 3:** Results of our benchmarks under SCO Unix. (a) Notice that the hyperStore 1600 continues to perform well. Also note that Unix's write-buffering scheme favors write operations over read operations. (b) SCO Unix's own buffers were able to handle most of the dbVista throughput (even the track-buffering controllers did well), so the results are tightly grouped. The hyperStore 1600 barely edges past the competition.

locations cache the same set of disk sectors. The controllers we evaluated offer up to eight-way set-associative caching. Fewer numbers of sets mean that more disk area can be held in the cache at one time, but the trade-off is that the cache locations must then be replaced more often.

In a multiple-set-associative cache, the controller must decide which cache location to discard when the cache becomes full. The most common strategy, known as *least recently used*, discards the location that has gone the longest time between accesses.

When these caching algorithms work and requested data is in the cache, the controller can return the data almost instantaneously. However, the access time is still limited by the I/O bus, which usually runs at 8 MHz. Most manufacturers test these boards at higher bus speeds, up to 16 MHz, and you may want to consider running them at speeds higher than 8 MHz.

**The Interface**

Internally, caching controllers have little in common with the Western Digital

WD-1003 controller, which set the interface standard for IBM ATs and clones. However, to maintain compatibility with PC operating systems, all the caching controllers that we tested mask their internal technology with a WD-1003 register-level interface.

Thanks to this interface, the caching controller looks like a WD-1003 to your PC. This means that any operating system that supports a WD-1003 (as virtually all do) can run these cards without device drivers.

Most of these cards also supply a built-in BIOS ROM, which handles INT 13 hexadecimal calls. Usually, BIOS calls use the controller in "native" mode, which is more efficient than going through the WD-1003 interface. Fast Technology, Inc., and Perceptive Solutions, Inc., supply operating system drivers that access the board's full capabilities and avoid the standard interface (PSI currently supplies drivers for Unix, NetWare, and DOS; FTI offers DOS drivers and says it is exploring Unix drivers).

DOS supports a maximum of 1024 cylinders for each of its drives. Some software expects that there will be only

17 sectors per track, in keeping with the usual MFM format. Because ESDI drive controllers often format their drives with many more sectors, and large drives can have more than 1024 cylinders, some translation is needed to ensure compatibility.

All the controllers we evaluated can map the physical geometry of the disk to some combination of heads, cylinders, and sectors that has fewer than 1024 cylinders. The controllers can also map to 17 sectors per track. If your BIOS table does not support the full capacity of your drive, these controllers can provide a drive type that will.

The ultimate limitation under DOS is 1024 cylinders, 16 heads, and 63 sectors per track, or 512 MB. Several caching controllers let you split a drive into multiple logical units to overcome this limitation on large drives and provide better organization.

**Other Considerations**

Two features of caching controllers—field upgradability and mirroring—don't enhance speed or compatibility, but they may help you decide whether or not to

## How We Tested Controllers Across Three Operating Systems

We ran DOS and NetWare tests on a Club American AT 386/33 with 4 megabytes of memory. The AT 386/33 runs its I/O bus at 8 MHz. To complete our small test network, we used two Compaq 286Ns hooked to the AT 386/33 through an Ethernet connection. Our test ESDI disk drive was a Maxtor XT-8380E, and our test SCSI drive was a Micropolis 1684.

For Unix tests, we used an Everex Step 33-MHz 386 with 8 MB of memory. The same disk drives that served as test units for DOS and NetWare also served time on Unix.

Our test suite consisted of two benchmarks: *fio*, which exercises rudimentary file operations, and a database benchmark that put the test systems through more complex calisthenics. The *fio* benchmark is one we have revived and revised from past system and disk drive reviews. The test simulates both random and sequential disk activity typical of applications in which one system may be called upon to perform several different types of tasks.

The *fio* test reports three results: throughput rates for sequential reads, sequential writes, and random I/O. The *fio* benchmark conducts sequential I/O with random block lengths to avoid favoring any single drive geometry or controller mapping. The only constraint is that the lengths of each access must be in whole sectors. This avoids unrealistic delays, since most disk transfers are

sector oriented, and non-sector-aligned transfers incur additional overhead. For these tests, the access lengths ranged from 512 bytes to 32K bytes.

The *fio* random tests are designed to represent the actions of one or more users using a random-access application—a database, for example. For our DOS tests, we set *fio* to simulate one user, using two files of 1 MB each. Files are accessed as sets of records, and the records vary in length from 512 bytes to 4K bytes. Under Unix and NetWare 386, we used two instances of *fio* to simulate four users, each with two 128K-byte files. Read-to-write ratios for the random tests were fixed at 3 to 1.

We wrote the database simulation benchmark using Raima's dbVista III database package. The dbVista system is actually a library of C routines that implement a combined relational- and network-model database system. We chose dbVista because it gave us control over the source code we wanted to generate and because DOS, LAN, and Unix versions of dbVista are available.

The database we constructed consisted of two data files and two index files. The first data file contained sales records composed of a sales representative's ID number, name, phone number, and department code. We indexed this file by the sales rep ID. The second data file contained customer records consisting of associated sales rep ID, customer ID, customer name, address,

phone number, and payment balance. We indexed this file using a compound key of sales rep ID plus customer ID.

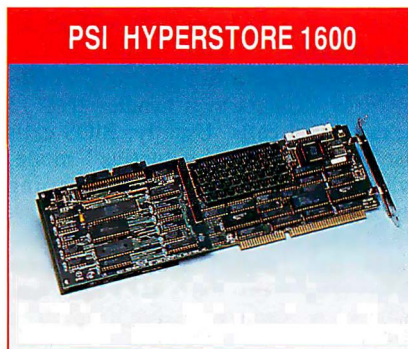
The test reads two raw ASCII files, building the database as it goes. The first ASCII file holds the sales rep data that is simply loaded into the database. The second ASCII file carries customer data. As the program reads each line of customer information, it first searches the sales rep key file to verify that the customer's associated sales rep already exists in the sales file. If the program finds a match, it inserts the customer information into the database.

We ran the LAN version of the benchmark on two client stations; each updated a central database stored on the server. One of the client stations ran the lock manager—a TSR program that coordinates multiuser access. Client tasks communicate with the lock manager via NetBIOS. (Extensive testing revealed that running the lock manager on a client station had no effect on the performance of that station.)

The test simply reports one number, an index indicating the number of records processed per second. Note that this figure combines sales rep and customer records for all clients operating simultaneously. (Our NetWare tests were apparently unable to stretch any controller to the point where differences become apparent. NetWare's built-in disk optimizations made each controller perform at the same level.)

use a caching controller. All but one of the cards reviewed can be field-upgraded using off-the-shelf memory parts. Cache capacities range beyond what most users will need—up to 16 MB—so you can start off with a minimal amount of memory and increase it as your disk requirements grow.

Finally, some of these boards support *disk mirroring* as a standard feature or as an option. Disk mirroring allows you to connect the controller to two drives, address them as a single drive, and have the contents of one duplicated exactly on the other. NetWare handles mirroring on its own, but hardware mirroring will give you enhanced reliability with any operating system.

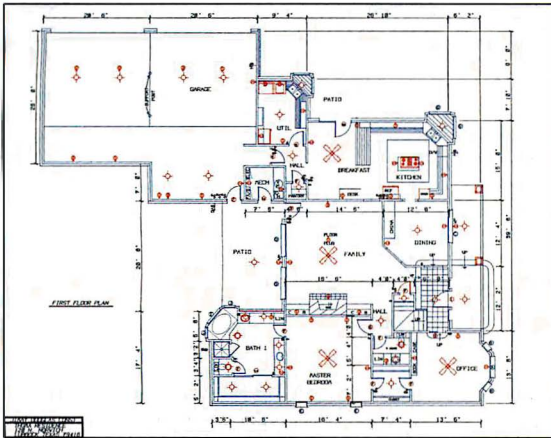


Our performance crown belongs to PSI's hyperStore 1600, a solidly built controller that displayed impressive speed on all our tests. In addition to performance, the

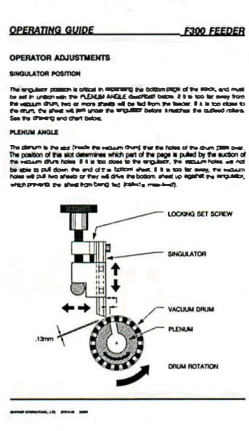
hyperStore offers expansion hooks for controlling an impressive amount of storage. The controller is not a bargain-basement item, but it combines an excellent price and performance balance in our tested configuration (\$1700). (The price—like that of FTI's TenTime controller—is approximate. PSI sells the board without RAM, so you add your own. The tested-configuration price is based on \$100 per MB for RAM; adjust it up or down according to the latest quotes from your favorite RAM vendor.)

Caching controller vendors usually tout their products as vehicles to boost random-access disk speed. On our random *fio* test, the SmartCache from Distributed Processing Technology (DPT)

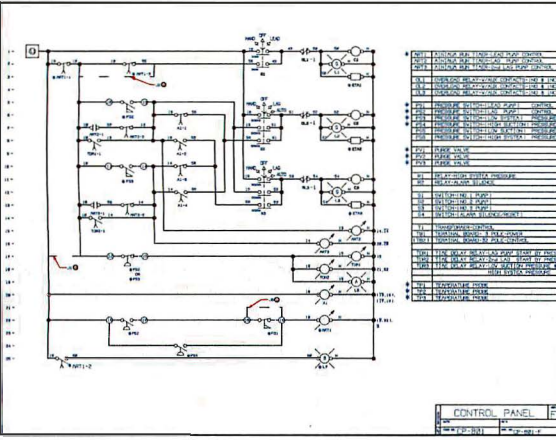
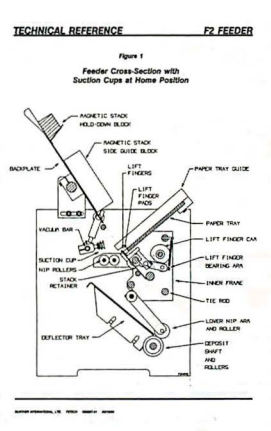
# WHAT MAKES A BEST SELLER A BEST SELLER?



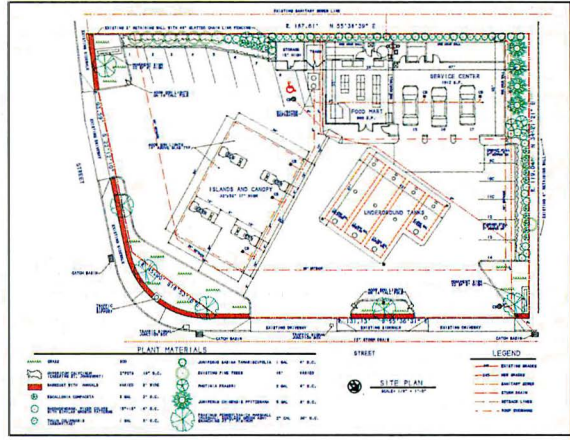
A great plot begins with a great idea, easily translated through every phase of design with Generic CADD 5.0.



Exchange your DXF files with other CAD systems or insert designs into desktop publishing programs to create technical illustrations.



No matter the complexity, symbols keep your work flowing uninterrupted. Tap our professional libraries or create your own symbols.



Need to fit a conventional design in a nonconventional space? Revise and improvise in less time with Generic CADD's one-stop convenience.

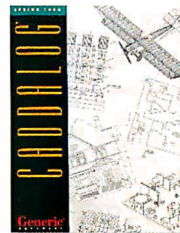
## A GREAT PLOT.

Ask any of over 250,000 users of Generic CADD.™ They've discovered CADD that's powerful without being complicated. And professional without being pricey.

Our latest version, Generic CADD 5.0, is just \$395. It's a complete design and drafting program backed by a support team that's drawing rave reviews.

Call us at 1-800-228-3601 for our free full-color CADDalog® and portfolio of CADD drawings.

You'll see every plot has a great ending.



**Generic**  
SOFTWARE  
An Autodesk Company

IT DOESN'T GET ANY EASIER.

ISA CACHING DISK CONTROLLERS

Both true caching controllers and track-buffering controllers are represented in this table. Although many of the basic features are similar, we found that all boards do not perform equally well (●=yes; ○=no).

	Full caching controllers					Track-buffering controllers		
	CompuAdd	Distributed Processing Technology	Fast Technology	Lomas Data Products	Perceptive Solutions	Adaptec	Ultrastor	Western Digital
<b>Model</b>	HardCache/ESDI	SmartCache	TenTime	LDP Cache II	hyperStore 1600	ACB-2322D	Ultra 12F	WD1009W/SE2
<b>Price<sup>1</sup></b>	\$895	\$2025	\$1990 <sup>2</sup>	\$1170	ESDI:\$1700 <sup>2</sup> SCSI:\$1700 <sup>2</sup>	\$163	\$195	\$292.50
<b>System interface</b>	WD-1003, INT 13h	WD-1003	WD-1003, INT 13h	WD-1003, INT 13h	WD-1003, INT 13h	WD-1003, INT 13h	WD-1003, INT 13h	WD-1003, INT 13h
<b>Disk interface</b>	ESDI	ESDI	ESDI	SCSI	SCSI, ESDI, ST506, IDE	ESDI	ESDI	ESDI
<b>Number of hard disk drives supported<sup>3</sup></b>	2	4	4	7	7 SCSI <sup>4</sup> 2 ESDI or ST506 2 or 4 IDE	2	2	2
<b>Number of floppy disk drives supported</b>	2	2	2	2	2	3	3	3
<b>Standard RAM</b>	256K	512K	2 MB	1 MB	0 MB	64K	32K	64K
<b>RAM configuration (as tested)</b>	4 MB	4.5 MB	4 MB	4 MB	4 MB	64K	32K	64K
<b>Maximum RAM</b>	4 MB	4.5 MB <sup>5</sup>	10 MB	16 MB	4 MB <sup>6</sup>	64K	32K	64K
<b>Memory type</b>	256K-byte SIMM, 1-MB SIMM	2-MB modules	1-MB SIMM	1-MB ZIP, 4-MB ZIP	256K-byte SIMM, 1-MB SIMM	DIP	DIP	DIP
<b>Memory speed (ns)</b>	80	100	100	100	100	70	100	70
<b>Bus speed compatibility</b>	12.5 MHz	16 MHz	16 MHz	16 MHz	12.5 MHz	11 MHz	16 MHz	11.5 MHz
<b>Processor</b>	80188	MC68000	SCC68070	80C188	Z280	8032B	Proprietary	80C196
<b>Disk mirroring</b>	○	Optional	Optional	●	Optional	○	○	○

<sup>1</sup> As tested; price includes RAM (see RAM configuration, below) and daughtercards, if required.  
<sup>2</sup> Price based on \$100 per MB for RAM; company does not have a list price that includes 4 MB of RAM.  
<sup>3</sup> Addressable disks; if disk mirroring is supported, additional drives may be required.  
<sup>4</sup> Numbers are given per daughtercard; up to four daughtercards can be attached.  
<sup>5</sup> Additional 12 MB available with additional bus card.  
<sup>6</sup> Additional 16 MB available with additional bus card.

clipped the hyperStore, but just barely (see figure 1a). Both the hyperStore and the SmartCache drives easily beat the CompuAdd Hard Cache/ESDI and FTI TenTime cards on random file I/O.

On sequential tests, where caching controllers do not usually fare much better than noncaching controllers, the hyperStore stood out (see figure 1a). Under DOS, both sequential read and sequential write times were far and away the best of any controller.

According to PSI, the hyperStore can detect access patterns and determine whether they are generally sequential or generally random. If the controller detects sequential accesses, it organizes the cache with a granularity greater than a single sector. This means that on large sequential reads and writes (as in our sequential benchmarks), the controller can cache strings of sectors or even an entire track. Obviously, the technique results in excellent sequential performance. CAD and image-file applications can probably get a big boost from PSI's design.

The hyperStore's Z280 runs its own disk-based multitasking operating system. When you first configure the controller, it copies the operating system from a floppy disk and writes it to a reserved area on the hard disk it controls. At boot time, the controller reads the operating system from the hard disk. Operating-system upgrades are trivial; you just download them from a floppy disk.

In addition to WD-1003 emulation, the hyperStore offers two native modes of operation, based on either block- or sector-based data transfers. While both are faster than WD-1003 emulation, the block-based mode of SSP (standard storage protocol), which we tested, provides a significant performance advantage over the other modes. It transfers data in blocks larger than a single sector. SSP-block mode is available to DOS users through the built-in INT 13h BIOS; PSI provides SSP drivers for NetWare 2.15 and for popular versions of Unix.

The hyperStore in its base configuration has no disk interface. Instead, the controller accepts daughtercards with

either ESDI, SCSI, IDE, or ST506 interfaces. Up to four daughtercards can be mixed and matched on a single controller. Each daughtercard has its own 32K- or 64K-byte track buffer for additional speed.

Since the controller runs a multitasking operating system, it can access multiple daughtercards simultaneously. In a large setup with multiple daughtercards, you could expect to see good performance because of this parallelism.

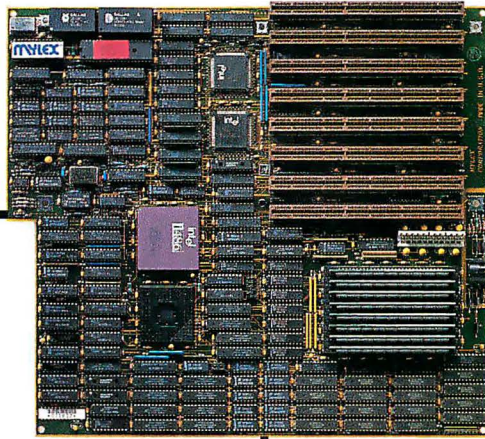
While the daughtercard scheme makes for a wide controller (it will prevent you from using several adjacent slots), it also provides access to a staggering amount of mass storage. PSI claims that the hyperStore's total storage capacity is 50.4 gigabytes.

In addition, the controller can address single disk drives as multiple logical units. With optional software, the hyperStore can be used to mirror one logical unit to another.

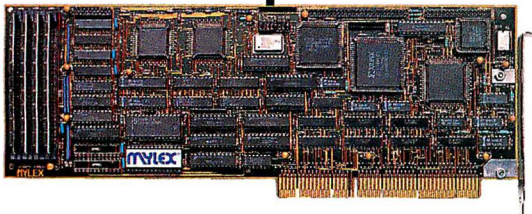
The card is complex: The setup software and preliminary documentation that we saw were downright confusing.

*continued*

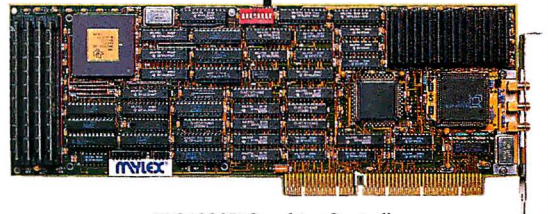
# Mylex has the best EISA solution. At least that's what people tell us.



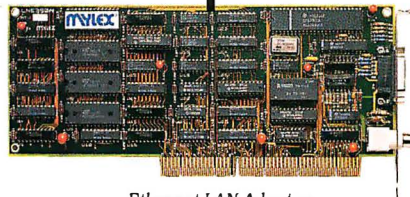
486™ 33MHz System Board



SCSI Caching Host Adapter



TI 34020™ Graphics Controller



Ethernet LAN Adapter

“The Mylex MAE486 with its 32-bit EISA SCSI controller kills the competition for reading large sequential files in the IOBench 2 tests under UNIX.” *Personal Workstation, June 1990*

“The GXE020A TIGA board ...scored as much as 45 percent higher on our low-level benchmark tests than any other TIGA board evaluated.” *BYTE, April 1990*

**“If I wanted to replace my entire system for optimum all-around performance, I’d build it from Mylex EISA-based boards.”**

*Personal Workstation, June 1990*

*“Mylex has done a lot of work with EISA, and we plan to use its motherboard and adapters in a LAN Labs ‘super-AT’ server.”*

*PC Magazine, May 1990*

Of course, we've tested our EISA peripherals for compatibility with major EISA systems. To see what our high-performance EISA solutions can do for your system, call us at 1-800-446-9539, or fax us at 1-415-683-4662.

**MYLEX**

# Buffering: The Lower-Cash Alternative

While we progressed through this Product Focus, we unearthed some alternative caching philosophies. A number of manufacturers of track-buffering controllers, which typically hold 32K or 64K bytes of RAM, showered us with some persuasive arguments. Specifically, don't put the cache memory on the controller board; keep it in the host. The reason: Once it's on the controller board, all memory can ever do for you is cache disk data. When it's in the host, you can control how much the operating system uses for disk buffers and how much is used for program code and data.

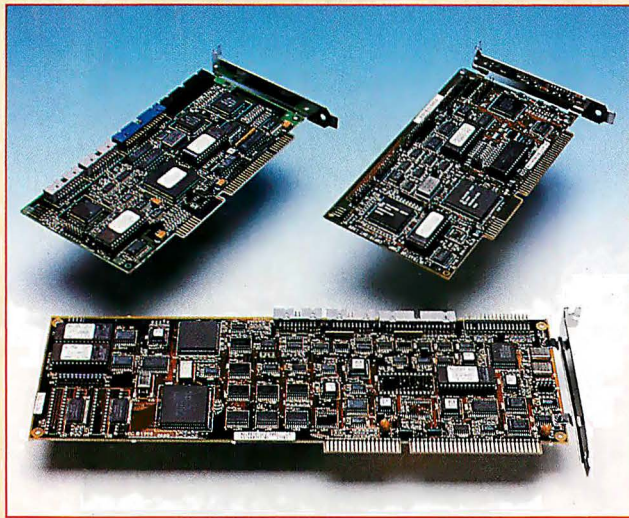
If you're going to spend money on memory, the argument continues, spend it on memory that can do double duty. Besides, there's plenty of good, inexpensive disk-caching software available. Examples often cited were PC-Kwik from Multisoft, Flash from Software Matters, and Fast from Future Computer Systems. And there's the SMARTDRV.SYS driver that Microsoft now includes with DOS 4.x.

Two track-buffering controllers, from Adaptec and Ultrastor, are short cards (the Western Digital controller is a full-length card). The differences between these boards and the "heavy-weight" caching controllers are not merely physical. Because the buffering controllers aren't weighted down with complex cache-management algorithms, installation code can live comfortably on a single EPROM. The result is that to perform a low-level format on your hard disk, you must use DEBUG as a way into the EPROM's initialization code. Fortunately, that's a once-only job, and all the boards we tested had sophisticated initialization programs that kept complexity to a minimum.

## ACB-2322D

Adaptec offers a pair of controllers: The ACB-2320D supports only an ESDI hard disk drive, while the ACB-2322D (our test controller) also carries an on-board floppy disk drive controller.

The ACB-2322D's on-board 64K-byte track buffer allows the controller to perform track read-ahead operations. So, when a read request comes in for a single sector, the ACB-2322D antici-



Three track-buffering controllers (clockwise from top left): the ACB-2320D, Ultra 12F, and WD1009V/SE2.

pates sequential operations by reading the four upcoming tracks.

Other interesting features of the ACB-2322D include *power sequencing*, which reduces current draw on the host power supply by spinning up the hard disks one at a time. *Sector sparing* lets you set aside one sector per track as a spare. If, during low-level formatting, a sector on the track is found to be defective, the spare will be used. *Drive splitting* lets you convert one large physical drive into two smaller logical drives. This allows DOS to handle a single drive of up to 1 gigabyte.

The ACB-2322D's manual is well designed and has plenty of diagrams and jumper location maps. We were happy to see a list of supported operating systems in an appendix—right down to the revision level.

## Ultra 12F

Ultrastor's Ultra 12 ships with only 8K bytes of cache memory (expandable to 32K bytes by replacing a single static RAM chip). We tested the 32K-byte 12F version.

The Ultra 12F's on-board configuration program allows sector and track mapping. *Sector mapping* enables DOS to accept drives that have more than 1024 cylinders; *track mapping* overcomes the 528-megabyte limit that the Adaptec 2322D handles via drive splitting. Finally, NetWare users will be pleased to discover that the Ultra 12F's manual outlines a technique whereby you can shorten the lengthy COMP-SURF procedure to a matter of minutes.

## WD1009V/SE2

The WD1009V/SE2 from Western Digital is a well-designed board. It's so easy to install that the instructions take up only three paragraphs in the manual. And because the controller comes from the developer of the WD-1003 interface, compatibility is not a concern.

Western Digital describes its on-board 64K-byte cache as "adaptive." The controller's on-board microcontroller constantly monitors incoming data, looking for patterns in how the data is retrieved. On the fly, the microcontroller optimizes the cache to the current pattern. Western Digital boasts

a 50 percent boost in throughput, thanks to the cache optimizing.

## Operating Cache-Free

The track-buffering controller cards fared surprisingly well in our benchmark tests, especially when you consider that they cost hundreds of dollars less than even the least-expensive caching controllers. In particular, note that the performance of the small caching controllers in the Unix leg of the db-Vista benchmark was so close to that of the large caching controllers that the difference is virtually negligible. This is an example of an application that runs well within the caching provided by the operating system.

On the DOS benchmarks, we ran the small caching controllers through the tests using SMARTDRV.SYS with 4 MB of cache enabled. We should therefore point out that the figures shown owe their values more to SMARTDRV.SYS and less to the operations of the boards. However, we consider this to be a good indication of small-caching-controller throughput.

Should you go the track-buffering controller route? The answer depends on the specifics of your application. Our tests indicate that the better-performing large caching controllers outperform the small caching controllers by at least a modest margin. You have to decide how critical that performance margin is and whether it will justify the cost. But when you compare \$163 to prices over \$1000, you may be willing to overlook a few seconds' delay here and there.



# Order BYTE Program Listings on Disk!

BYTE listings are available on disk if you want to compile or read the complete source code listings of programs. BYTE listings are available from December 1985 to the present at the prices stated on the adjacent order form.

Call Toll-free 800-258-5485  
in N.H. 603-924-9281)  
Subscription Customer Service  
00-232-BYTE

**FOR DIRECT ORDERING CALL TOLL-FREE: 800-258-5485**

Call: M-F, 8:30 a.m. to 4:30 p.m. Eastern Time; (603-924-9281 for N.H. residents). *For credit card orders only.*



**ORDER FORM:** To place your order, fill out the card and mail.

**PLEASE COMPLETE IN FULL**

Name \_\_\_\_\_

Address \_\_\_\_\_

City \_\_\_\_\_

State \_\_\_\_\_ Zip \_\_\_\_\_

County or Parish \_\_\_\_\_ Country \_\_\_\_\_

Credit Card # \_\_\_\_\_ Exp. Date \_\_\_\_\_

Signature \_\_\_\_\_ Date \_\_\_\_\_

Please allow 6-12 weeks for delivery.

JANUARY

<b>5¼ Inch:</b> <input type="checkbox"/> IBM PC	<b>3½ Inch:</b> <input type="checkbox"/> Apple Macintosh <input type="checkbox"/> IBM PS/2
<b>IN USA/Single Month (1 disk)</b>	
<input type="checkbox"/> BYTE Listings \$10.95	<input type="checkbox"/> BYTE Listings \$11.95
<b>IN USA /Annual Subscription (13 disks)</b>	
<input type="checkbox"/> BYTE Listings \$89.95	<input type="checkbox"/> BYTE Listings \$99.95
<b>OUTSIDE USA/Single Month (1 disk)</b>	
<input type="checkbox"/> BYTE Listings \$13.95	<input type="checkbox"/> BYTE Listings \$14.95
<b>OUTSIDE USA /Annual Subscription (13 disks)</b>	
<input type="checkbox"/> BYTE Listings \$109.95	<input type="checkbox"/> BYTE Listings \$119.95

• Please indicate the issue date below. If you are beginning an annual subscription, note the starting issue.

**BYTE Program Listings**

Month \_\_\_\_\_ Year \_\_\_\_\_

- Check enclosed
- MasterCard
- VISA
- U.S. funds enclosed (If ordering from outside the U.S. please remit in U.S. funds drawn on U.S. bank. Thank you.)

**BYTE**



# Order BYTE Program Listings on Disk!



BYTE listings are available on disk if you want to compile or read the complete source code listings of programs. BYTE listings are available from December 1985 to the present at the prices stated on the adjacent order form.

Call Toll-free 800-258-5485  
(in N.H. 603-924-9281)  
Subscription Customer Service  
800-232-BYTE

## BYTE on Disk

One Phoenix Mill Lane  
PO Box 809  
Peterborough, NH 03458-0809

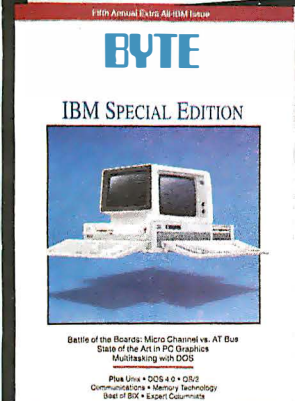
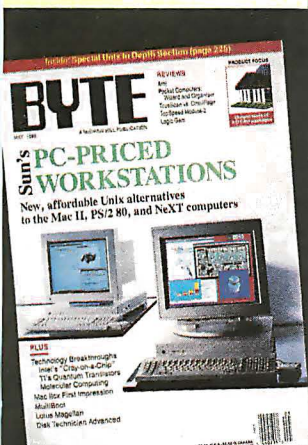
PLACE  
POSTAGE  
HERE

Subscribe to BYTE now and

**SAVE up to 52% PLUS,**

get the annual IBM PC Special Issue as an

**EXTRA BONUS!**



- Stay in the know on all major microcomputer products and innovations
- Save time and money—invest in the best equipment for your needs
- Harness the maximum power of your micro.

**Subscribe today and save!**

**In a hurry?  
Call Toll-Free  
1-800-257-9402**  
weekdays 9-5 EST.  
In NJ, call  
1-609-426-5535.

# Enjoy **MORE SPEED!** SAVE up to \$66.05 **PLUS**

get the extra IBM PC Special Issue

Send me BYTE for:

- 1 year (12 issues) for \$24.95  
(Save 40% off the newsstand cost)
- 2 years (24 issues) for \$44.95  
(Save 46% off the newsstand cost)
- 3 years (36 issues) – \$59.95  
SAVE 52% off the newsstand cost  
(20% off the basic subscription price)

Name \_\_\_\_\_

Company \_\_\_\_\_

Address \_\_\_\_\_

City/State/Zip \_\_\_\_\_

Payment enclosed  Bill me

No-Risk Guarantee: If dissatisfied, cancel anytime for a full 100% refund. Your subscription will start in 6-8 weeks. Watch for it!  
Single copy \$3.50. The basic annual subscription rate is \$29.95.

IB11079

# Profit from **MORE POWER!** SAVE up to 52% **PLUS**

get the extra IBM PC Special Issue

Send me BYTE for:

- 1 year (12 issues) for \$24.95  
(Save 40% off the newsstand cost)
- 2 years (24 issues) for \$44.95  
(Save 46% off the newsstand cost)
- 3 years (36 issues) – \$59.95  
SAVE 52% off the newsstand cost  
(20% off the basic subscription price)

Name \_\_\_\_\_

Company \_\_\_\_\_

Address \_\_\_\_\_

City/State/Zip \_\_\_\_\_

Payment enclosed  Bill me

No-Risk Guarantee: If dissatisfied, cancel anytime for a full 100% refund. Your subscription will start in 6-8 weeks. Watch for it!  
Single copy \$3.50. The basic annual subscription rate is \$29.95.

IB11079

# Gain **MORE APPLICATIONS!** SAVE up to 52% **PLUS**

get the extra IBM PC Special Issue

Send me BYTE for:

- 1 year (12 issues) for \$24.95  
(Save 40% off the newsstand cost)
- 2 years (24 issues) for \$44.95  
(Save 46% off the newsstand cost)
- 3 years (36 issues) – \$59.95  
SAVE 52% off the newsstand cost  
(20% off the basic subscription price)

Name \_\_\_\_\_

Company \_\_\_\_\_

Address \_\_\_\_\_

City/State/Zip \_\_\_\_\_

Payment enclosed  Bill me

No-Risk Guarantee: If dissatisfied, cancel anytime for a full 100% refund. Your subscription will start in 6-8 weeks. Watch for it!  
Single copy \$3.50. The basic annual subscription rate is \$29.95.

IB11079



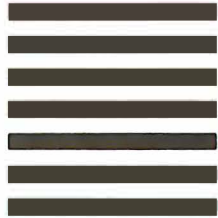
**BUSINESS REPLY MAIL**  
FIRST CLASS MAIL PERMIT NO. 42 HIGHTSTOWN, NJ

POSTAGE WILL BE PAID BY ADDRESSEE:

**BYTE**

Subscription Department  
P.O. Box 558  
Hightstown, N.J. 08520-9409

NO POSTAGE  
NECESSARY  
IF MAILED  
IN THE  
UNITED STATES



**BUSINESS REPLY MAIL**  
FIRST CLASS MAIL PERMIT NO. 42 HIGHTSTOWN, NJ

POSTAGE WILL BE PAID BY ADDRESSEE:

**BYTE**

Subscription Department  
P.O. Box 558  
Hightstown, N.J. 08520-9409

NO POSTAGE  
NECESSARY  
IF MAILED  
IN THE  
UNITED STATES



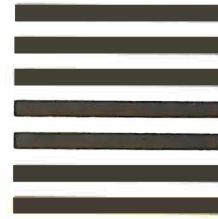
**BUSINESS REPLY MAIL**  
FIRST CLASS MAIL PERMIT NO. 42 HIGHTSTOWN, NJ

POSTAGE WILL BE PAID BY ADDRESSEE:

**BYTE**

Subscription Department  
P.O. Box 558  
Hightstown, N.J. 08520-9409

NO POSTAGE  
NECESSARY  
IF MAILED  
IN THE  
UNITED STATES



Detach and mail card  
now to

**SAVE up to  
52%**  
on BYTE . . .

**PLUS,**  
get the annual IBM  
PC Special Issue as  
an

**EXTRA  
BONUS!**



*Order even faster by  
phone:*

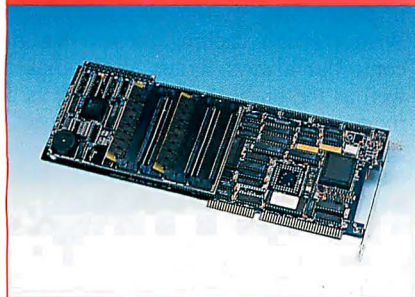
**Call  
Toll-Free**  
**1-800-257-9402**  
weekdays 9-5 EST.  
In NJ, call  
1-609-426-5535.

## PRODUCT FOCUS

## CACHING CONTROLLER CARDS

But after you choose your options and get the card running, its performance and addressing capability are more than adequate rewards for your trouble.

## FTI TENTIME



Like many other caching controllers, TenTime from FTI acts less like a controller and more like a dedicated coprocessor board. It has a 68070 CPU that executes a proprietary real-time, multi-threaded operating system. The operating system supports error correction and intelligent cache management (the details of which the people at FTI were understandably reluctant to reveal).

The result is a sophisticated combination of hardware and software. For example, if the TenTime acts up and you can't determine the problem, you can attach a special cable to an on-board diagnostic port, hook the cable to a modem, and FTI's technical-support people can call your board for an over-the-phone house call.

The basic TenTime board comes with 2 MB of RAM, which can be expanded to 10 MB via daughterboards. If you're worried about data integrity, you can choose an optional battery-backed static RAM "write safeguard." This circuit holds data that is on its way out to the disk, so if a power failure takes your system down during a write operation, the TenTime will complete the write when the power returns again.

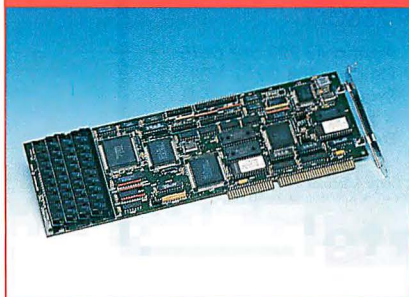
The TenTime operates in WD-1003-emulation mode. As of this writing, FTI was in the final stages of preparing a driver to bypass emulation mode under DOS. Drivers for NetWare and Unix may be on the way as well.

The TenTime's documentation was adequate for the comparatively easy controller installation. FTI provides an installation and diagnostic floppy disk drive with a simple menu-driven install procedure. There is also a utility for tweaking various parameters controlling the board's software. For example, you can disable caching when you're install-

ing Unix, so the Unix installation's surface scan can talk directly to the disk and identify questionable tracks.

Performance scores for the TenTime ranged in the middle of the pack. However, the controller's price stood near the top for the configuration we tested. This makes us hesitate before suggesting the TenTime over less expensive boards that performed as well or better. However, the TenTime's write-safeguard feature makes the product attractive in situations where data is critical, power is questionable, and an uninterruptible power supply is unavailable.

## COMPUADD HARDCACHE/ESDI



Based on its price alone, CompuAdd's HardCache/ESDI is instantly attractive. At \$895 in its tested 4-MB configuration, the HardCache costs less than half the price of comparable ESDI controllers. Although its performance lagged behind the others in this select group, the HardCache significantly improved performance over that of a standard controller.

The card's DOS utility lets you run a low-level format or a surface scan on the drive, and you can configure the physical parameters. You then use the DOS commands FDISK and FORMAT as usual. While this is standard procedure with other cards, too, the HardCache's utility was the easiest to use, and the drive worked on the first try.

You can fine-tune read-ahead parameters using another utility. CompuAdd's HardCache/ESDI utility (HCU) program lets you configure read-ahead using a read-ahead factor and a read-ahead cap. Each time the system makes a request, the number of sectors requested, multiplied by the read-ahead factor, determines how many sectors the HardCache will actually read. If the number is greater than the read-ahead cap, the controller uses the read-ahead cap value instead. While we didn't do any tuning for our tests, HCU should increase performance by tailoring reads to your application.

*continued*

## NO NOISE improves PC working environments.

**NO NOISE** removes the constant humming noise which is a daily irritation to PC operators.

It's not that the noise is high — it's more a matter of its constantly being there, from the moment you start up in the morning and until the office closes.

Constantly — for hours on end — day in and day out.

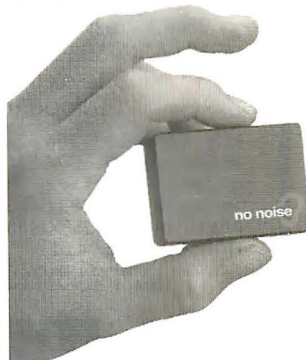
**This noise comes from the PC's cooling fan.**

The cooling fan is designed and constructed to function in air temperatures all the way up to 110°–120° F. It always runs at maximum speed. This is where the constant noise arises.

In our part of the world, we no longer need to put up with this irritating noise — thanks to NO NOISE.

**How to stop the noise.**

NO NOISE gradually reduces the speed of the fan until it corresponds with the surrounding temperature and your PC's cooling requirement. The fan is practically soundless at temperatures from 70°–90° F.



**Built-in safety**

If a fault should occur, a built-in safety circuit in the NO NOISE automatically ensures that the fan converts to maximum performance. This ensures the necessary ventilation/cooling under all conditions.

**NO NOISE suits all PC models.**

Thousands of units are already in use worldwide by computer manufacturers, major corporations and individual users, who realize that excessive noise in the work environment can lead to fatigue and stress, ultimately affecting performance and productivity.

NO NOISE is extremely simple to install; your customary PC dealer can provide you with further details and provide this service if required. NO NOISE comes with a five-year warranty and a 30-day trial.

**WHAT THE REVIEWS SAY**

"...it worked perfectly...noise level was dramatically reduced."

PERSONAL COMPUTER WORLD, U.K.

"...NO NOISE worked exactly as advertised, reducing fan noise to nil."

BYTE, International Section, February 1990

NO NOISE USA—NO NOISE UK—NO NOISE SWEDEN—NO NOISE AUSTRIA—NO NOISE NETHERLANDS—NO NOISE GREECE—NO NOISE AUSTRALIA

**no noise**™

**ORDER NO NOISE NOW at \$99.95 by calling 1-800-SILENCE (1-800-745-3623)**

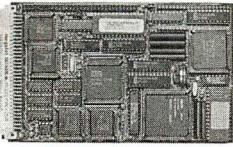
or contact your local dealer. We accept MC/ISA, P.O.s, Cashier and Personal Cheques. Please add \$4.95 for shipping and handling. All FL deliveries add 6% sales tax. VARS Dealers and OEMs call (407) 220-0100.

NO NOISE Inc., 3601 SE Ocean Blvd., Sewall's Point, Stuart, Florida 34996, Tel: (407) 220-0100 Fax: (407) 220-0101

©NO NOISE 1990

# Quark PC+®

## PC XT® Compatibility On a 4" x 6" Board



- 3 Serial Ports
- 3 watts (typical)
- XT® Bus Expansion
- Real Time Clock
- NEC V-40® Processor
- SCSI Hard Disk Control

- Up to 768k Main Memory
- Complete RS-232C Drivers
- Will boot PC, MS and DR DOS™
- Up to 10 Mhz CPU Clock Frequency
- Floppy Disk Control (1.44 M support)
- Hercules, Monochrome, CGA Video/Color LCD Controller

**Megatel Computer Corporation**  
(416) 245-2953 FAX (416) 245-6505  
125 Wendell Ave., Weston, Ontario M9N 3K9

**Densitron Corp**  
2540 West 237th St., Torrance, CA 90505  
(213) 530-3530 FAX (G2/G3) (213) 534-8419  
Telex II: 910- 349-6200  
Europe/UK 0959 76600

REPS: Italy 39 331 256 524	Austria 43 222 587 6475
W. Germany 49 6074 98031	Finland 358 0757 1711
U.K. 44 959 71011	Sweden 46 4097 1090
Netherlands 31 838 541 301	Norway 47 986 9970
Australia 61 03 568 0988	Denmark 45 244 0488
France 1 47 46 94 52	

Trademarks: IBM XT® - IBM Corp. V-40 - NEC Corp. Hercules - Hercules Corp.  
MS+DR DOS - Digital Research Ltd. Quark - F. + K. Manufacturing Co.

# megatel

PRODUCT FOCUS

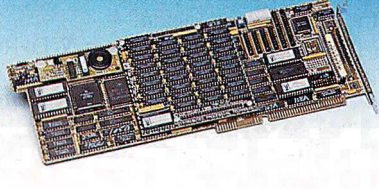
The HardCache uses a set-associative organization that ranges from two to eight sets. The number of sets is automatically determined by the amount of memory that's on-board.

While most of the controllers that we tested buffer writes as well as reads, CompuAdd takes a fail-safe approach in implementing a *write-through cache*. Write-through caching means that the controller always writes to the disk as well as the on-board cache. There is no increase in write performance over a standard controller, but if a power loss occurs, you'll have all the data you've written safely stowed on the disk.

This design hampered the HardCache on several of our benchmarks—most notably, on the dbVista benchmark under DOS, where the HardCache was easily outrun by its three competitors. The dbVista benchmark does a lot of writing, and it rarely reads back what it has written. This is a worst-case situation for the HardCache; it should perform better in most real-world applications.

The HardCache also performed near the bottom on the sequential-write portion of the fio benchmarks under Unix. Other DOS benchmarks put it well below the top-performing hyperStore and SmartCache boards but close to the Ten-Time. Under NetWare 386, however, any write performance differences evaporated. NetWare itself operates a delayed-write cache within the operating system, and the operating-system cache was enough to overcome any differences between controllers. Overall, the HardCache is an adequate performer at an excellent price. If affordability is one of your top criteria, the HardCache may well be the controller for you.

**DPT SMARTCACHE**



DPT's SmartCache is a caching controller pioneer. Although old by PC industry standards, the SmartCache is well designed and managed to outperform most of the other boards we tested.

We should note that DPT is planning to

# PUT dBASE® ON TOP

Dr. Switch-ASE puts dBASE on top. On top of the charts, spreadsheets, word processors or on top of DOS. Right where it belongs, on top of any graphics or text program when you need it. Neatly tucked away when you don't. Dr. Switch-ASE turns any dBASE language program into a 16-20K RAM resident program. So now you can have dBASE power at the touch of a key, anywhere, anytime and from any program.

### **dBASE TSR's, easy as ASE**

With Dr. Switch-ASE you don't have to be an Assembly language whiz or a C code maven to create TSR's. The Doctor includes an integrated cut & paste feature for transferring data between programs. It also supports both Expanded and Extended memory and is fully network compatible.


### **The doctor speaks your language**

Dr. Switch-ASE™ supports all of the dBASE dialects. So it works directly from Clipper®: dBASE III PLUS®, dBASE IV®, FoxBASE+™ and FoxPro®. No need to learn a new dBASE syntax and no new environments to wrestle with.

When the doctor's in, dBASE is on top.

**Call and place  
your order today!  
212-787-6633**

**DR. SWITCH-ASE  
\$179.95\*\***

 **Black & White International Inc.**  
P.O. Box 1040  
Planetarium Station  
New York, NY 10024-0541



Dr. Switch, Dr. Switch-ASE, Dr. Switch-OnCall and Dr. Switch-TSRM are trademarks of Black & White International, Inc. All others are trademarks or registered trademarks of their respective holders.  
\*Plus Shipping/Handling: U.S. orders add \$6.00 for 2nd Day Air. \$3.00 for Ground. Canadian and Foreign orders add \$8.00. COD add \$3.50. NY residents add sales tax. All payments U.S. Funds/U.S. Banks only!  
†Includes royalty-free runtime version.



# SERIES 400™

## High-Speed Caching Disk Controller

**Unprecedented Hard Drive Performance  
at an Unbelievable Low Price!**

### SERIES 400 Features

- Models available for SCSI, IDE, ESDI, MFM\* and RLL\*
- Supports two floppy drives (5.25" or 3.5")
- WD 1003 emulation for driverless installation
- All Networks, UNIX, OS/2 and DOS compatible
- Easy installation
- 512 Kb-to-4Mb on-board cache RAM
- Uses low cost 100 nsec SIMMs
- Read and write cache for best overall performance
- On-board 16-bit parallel processor, and data bus with 56-bit ECC
- Dealer upgrades for disk mirroring and more\*

### Affordable, Lightning-Quick Disk Access

In today's high performance PC's, disk access is the number one system bottleneck. The SERIES 400 from SSDC is a new class of hard drive controller with its own powerful on-board parallel processor and memory to independently manage disk drive data. The SERIES 400 actually anticipates what information the PC is going to need and stores the data in its own high-speed cache RAM. Disk accesses are 100 times faster and large file transfers are up to 10 times faster. This means applications load and execute *fast!*

Even the slowest and most cumbersome applications become lightning quick. All applications – Windows, CAD, large databases, desktop publishing – *become supercharged with near instant file access.* SSDC has broken the price barrier to hardware disk caching. No longer is powerful disk performance limited to mainframe systems.

### SERIES 400 Benefits

- Tremendous increases in system performance
- Accelerates disk access over 100 times
- Increases file transfer rate 5 to 10 times
- Speeds up ALL disk-intensive applications
- Frees up system resources for increased performance

### Across the Board Performance Advantage

	SERIES 400	DPT-3011	FTI 2410
Effective seek time	0.270 msec	0.520 msec	0.500 msec
Read data transfers	2230 Kb/sec	892 Kb/sec	1150 Kb/sec
Large record read	16.0 sec	25.0 sec	36.0 sec

### Feature Comparison

Retail Price	\$745.00	\$1195.00	\$1595.00
With 4-Mb RAM	\$995.00	\$2095.00	\$2190.00
Max memory on-board	4Mb	4Mb	2 Mb
Memory type	Std. SIMMS	Custom	Custom
WD-1003 Emulation	Yes	Yes	Yes
Custom drivers	Optional	No	Optional
Drive types supported	IDE,SCSI,RLL	ESDI, ESDI, MFM	ESDI, MFM,RLL

Networks, UNIX and multiuser systems	All	Most	Most
Boot drive	Any	"C" only	"C" only
1-to-1 interleave	Yes	No	No
Auto bad track repair	Yes	No	No
Parity check RAM	Yes	NO	Yes
I/O bus speed	12.5	10.0	10.0(12.5 opt)
Data look ahead	Track	Sector	Sector

# CACHE IN

### Call Today

Cash in on the time you'll save with the SERIES 400 High-Speed Caching Disk Controller from SSDC. You'll enjoy startling increases in system performance, at an affordable price. Installation is simple and the SERIES 400 is fully compatible with all 486, 386 and 286 systems. Call toll free 1-800-284-7732 for your nearest SERIES 400 dealer.

\* 2nd quarter 1991

**S<sup>2</sup>**  
DEVELOPMENT  
CORPORATION

1001 Capital of Texas Hwy. South, Bldg. I • Austin, Texas 78746  
512/327-8608 • FAX 512/327-5233

Circle 283 on Reader Service Card

## Choosing the Right Caching Controller

First, the obvious: Users whose applications are disk intensive will benefit the most from a caching controller. An installation that makes heavy use of databases is the most obvious target for a caching controller. Many tasks are CPU-bound: For example, a caching controller won't help an AutoCAD application draw any faster.

Tasks that might benefit from a caching controller include desktop publishing applications that allow you to spool printer output to disk. A caching controller that buffered write operations would allow the DTP application to complete the print job rapidly; you'd be

back editing your document quicker.

Price should certainly be a factor, particularly given the wide range present between the caching controllers and the track-buffering controllers. Our tests indicate that a Unix system of modest proportions will perform acceptably with the track-buffering controllers. Ditto for NetWare. Consequently, the operating system you use will surely affect the outcome of any buying decision.

Analyze the daily load on your disk system. If you have a friend willing to lend you a memory card for a week or so, try using that. See if caching in the host will give you the throughput you

need. If it does, simply adding to your system memory will certainly be a less expensive route to higher performance.

If you've decided that you *must* have a caching controller, don't focus solely on the performance. Think about flexibility and expandability. Most ESDI controllers that we looked at will handle at most two hard disk drives (some can handle four). SCSI controllers can accept up to seven; this capability may be important if the target machine is the server of an infant network. As the network grows and the disk requirements grow, the SCSI bus will go a greater distance.

release a new version of the SmartCache, with major revisions, by the time you read this. In addition to having bundled, native support for popular versions of Unix, DPT promises that the new board will be faster than the current model.

Not that the model we tested was any slouch. Its excellent performance was partly due to read-ahead buffering. However, rather than reading a whole track into a buffer for each read, as some other boards do, the SmartCache hands back the requested data before continuing with the read-ahead. While the main system CPU reads the data, the DPT's on-board 68000 continues to read a fixed number of sectors into the cache.

The SmartCache also buffers all disk writes. It installs data written by the host system into the cache and immediately acknowledges the data. During idle periods, or when a fixed percentage of the cache locations become dirty, the SmartCache dumps the data out to the disk. When dumping the data, the controller writes sectors according to disk geometry, minimizing seeks wherever possible. You can interrupt this disk write, and the read-ahead mentioned above, if the host system requires data that is not in the cache.

Under DOS, these performance features really show. The hyperStore 1600 blasted the SmartCache on sequential benchmarks, but on the random and db-Vista benchmarks, the SmartCache held a slight edge. The hyperStore's sequential optimizations helped in sequential operations, while the SmartCache's sector-oriented organization served it well on benchmarks with a more random ac-

cess pattern. (When comparing benchmark results, remember that the SmartCache had 4.5 MB of RAM, while the other cards had only 4 MB. We couldn't avoid this discrepancy because the SmartCache doesn't support 4 MB and the other boards don't support 4.5 MB. However, we believe that the difference in size did not give the SmartCache a significant edge on these tests.)

Installation and setup were straightforward. We had trouble with a buggy new version of the firmware but resolved the problem after calling DPT technical support. In addition to excellent phone support, DPT offers a full BBS service. The documentation was the best among the boards we reviewed.

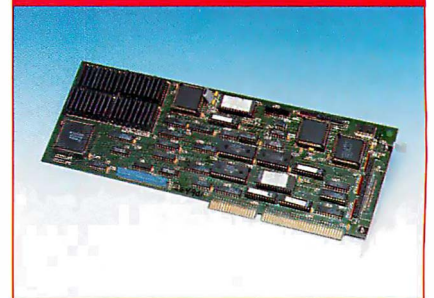
The first thing you'll notice if you test the board with the computer's cover off is a 10-position bar-graph LED, which constantly reports the drive's status. You can watch the controller go through its POST RAM tests, and if there's an error, you can determine the cause immediately.

DPT's format utility, which is appropriately called DPTFMT, lets you prepare the drive. When the low-level format is complete, the utility asks what operating system you intend to use with the controller. The software uses your answer to look up the best match available in the BIOS table. The board we tested had an optional BIOS expander ROM installed, which supplements the choices available through the BIOS.

The SmartCache has two drawbacks, however, and both involve money. At \$2025, the SmartCache is the most expensive board we tested. It's more than

\$300 costlier than the hyperStore, which closely paralleled its performance. The board's second weak spot will become apparent only if you need to upgrade your controller. DPT, unlike the other manufacturers, provides additional RAM on proprietary modules that must be purchased from the company. With off-the-shelf memory prices continuing to drop, upgrading the SmartCache could be significantly more expensive than upgrading the other boards.

### LDP CACHE II



Lomas Data Products may not be a well-known name among disk drive controller vendors, but it builds a good product that's available at a good price. Although the LDP Cache II's benchmark performance was generally disappointing, it offers built-in disk mirroring and the prospect of enhancing slower disk drives at about two-thirds the price of the other SCSI entry, PSI's hyperStore.

The hyperStore 1600 beat the LDP Cache II handily on all the benchmarks. Although the LDP Cache II buffers



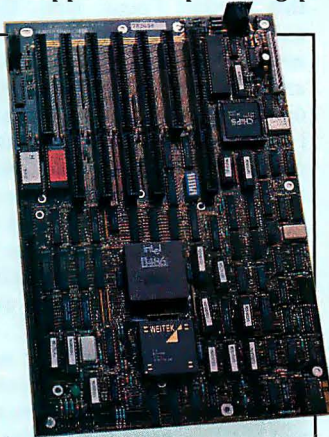
# WEITEK<sup>®</sup> makes the difference!



**The 4167's 10 MFLOPS performance delivers 3X the speed of the 486!**

The new Weitek 4167 coprocessor outperforms the 486 by 3 to 1 in numeric processing. Capable of 10 MFLOPS, the 4167 has sockets in some of the most sophisticated 486 systems on the market, including Compaq, Intel, Hewlett-Packard, and Microway. The 4167 is object-code compatible with the WEITEK 3167 FPU and Microway's mW3167-PS add-in card for the MicroChannel—offering easy access to a broad base of existing CAD/CAM, scientific and engineering applications like Mathematica, CADKEY, HOOPS and Microway's NDP compilers. And look for 4167 support on upcoming products from Autodesk!

**Number Smasher<sup>®</sup>-486** converts your old AT or 386 into a powerful 486 workstation. In a review of 25 MHz 486 motherboards, Mike George of *Personal Workstation* magazine wrote, "Microway's Number Smasher-486 gives you top 486 numeric performance for the best price...Number Smasher's numeric performance exceeds that of all 25 MHz 486 systems we've tested to date." Running the Microway Benchmark Suite, the 4167-equipped Number Smasher-486 achieves 11.9 MegaWhetstones. The board features a Burst Bus<sup>™</sup> memory interface that makes it stand out in numeric problems that involve large arrays. Burst cycle response in a 486 system is much more important than second level caches, which are usually too small to be of any use on the megabyte arrays found in real world problems.



The ideal solution for numerically or I/O intensive applications is Microway's new Number Smasher-486/33T workstation. Two configurations are available, each incorporating state-of-the-art power and cooling with 300 to 600 megabyte drives.

**NDP Fortran-486, NDP C-486 and NDP C++** are your keys to unlocking the power of the 4167. Each compiler generates globally optimized, main-frame quality code and has special features that take advantage of the 4167, such as register caching, loop unrolling and automatic inlining of small procedures. These optimizations are handed off to a code generator that is tuned for the 4167, and takes advantage of its advanced instructions like multiply accumulate. In addition, the 486 versions of NDP Fortran, C++ and C properly sequence 486 and 4167 instructions so that the 486's prefetch queue has time to "breathe." NDP compilers are also available for the 386SX, 386 and i860 under DOS, UNIX, XENIX and SunOS. Thousands of Microway's satisfied customers have discovered that you can't buy a better scientific Fortran or C compiler. And our technical support is the best in the industry.

For more information, please call 508-746-7341.

# Microway<sup>®</sup>

The World Leader in PC Numerics

Corporate Headquarters, Research Park, Box 79, Kingston, MA 02364  
TEL. 508-746-7341 • FAX 508-746-4678  
U.K. - 32 High St., Kingston-Upon-Thames, 081-541-5466 • Italy 02-74.90.749  
Holland 40 836455 • Norway 9 876656 • Japan 81 3 222 0544



writes, it obviously does not do it as well as its competitor. But the results may be skewed by the speed of our test SCSI drive, a Micropolis 1684. The Micropolis has a cache of its own, which attempts to buffer directories as much as possible. LDP pointed out that the controller's caching overhead may have offset any performance gains the card could have provided to the relatively fast drive.

On a slower drive, the LDP Cache II achieved better relative results. It clearly outperformed a standard SCSI controller on the test that is most representative of cachable applications, the random I/O benchmark. Nevertheless, its performance doesn't compare with that of the hyperStore 1600.

Installation and setup were easy, helped by LDP's utilities. Like the other controllers, the LDP Cache II provides the operating system with an appropriate number of heads, cylinders, and sectors based on the number of SCSI blocks it reads from the drive. Most controllers look up the geometry in a table in ROM and provide whatever table entry comes closest. LDP's strategy is to generate a table based on drive size and store it in EEPROM, so full utilization of a large disk drive is virtually certain.

LDP offers disk mirroring as a standard feature. The card's setup program lets you configure the controller to mirror one SCSI device to another. The utility can also format the drive and duplicate data from one drive to another.

When an error occurs, the controller

attempts to correct it. If the error cannot be corrected, the controller notes that the disk is bad in its internal EEPROM, and the disk is not used. The next time the system boots, the LDP Cache II's BIOS notifies you that one of the disks has failed and is no longer in use. Surprisingly, the controller board does not provide an audible alarm on drive failure.

We can't recommend the LDP Cache II strictly on performance, but only if high reliability is your primary goal and you don't already have a fast disk drive.

**Memorable Results**

We learned two important lessons from this Product Focus: first, that no two controllers are created equal (which is not as obvious as it sounds in this plug-and-play world); and second, that no two operating systems are created equal (which is much more obvious). During our testing, we discovered that those two facts wrapped themselves around one another. The result: Benchmark results for a controller running on one operating system won't adequately predict its performance while running on another operating system.

Unix and NetWare users will have a slightly more difficult decision to make than DOS users. That's because Unix and NetWare provide buffering and caching features built in. This raises two questions: Should you buy a controller with lots of RAM and hope the controller guesses right about buffer management? Or should you buy a less expensive (and

theoretically less capable) controller and put the difference into host RAM, where the operating system can use it and, in theory, make more informed guesses? We suspect that cost-conscious people will choose the latter route; the small (track-buffering) caching controllers can provide you with more than acceptable performance at unbeatable prices (see "Buffering: The Lower-Cash Alternative" on page 176). Throughput-conscious souls will likely choose the former route—if you've got to squeeze every byte per second you can out of that disk system, a 4-MB caching controller might be just what you need.

For overall price and performance, we prefer PSI's hyperStore. Its multiple-personality design is unique, allowing you to run any of the popular hard disk drive interfaces from a single controller board. Its performance is a winner, too. Its scores ranked at or near the top for all the tests across all operating systems. If you run a large installation that consists of LANs, Unix workstations, and DOS machines, the hyperStore 1600 should do well on them all. Flexibility like that is hard to find. ■

*Steve Apiki is a BYTE Lab testing editor/engineer. Rick Grehan is the director of the BYTE Lab. He has a B.S. in physics and applied mathematics and an M.S. in computer science/mathematics from Memphis State University. You can reach them on BIX as "apiki" and "rick\_g," respectively.*

**COMPANY INFORMATION**

**Adaptec**  
(ACB-2322D)  
691 South Milpitas Blvd.  
Milpitas, CA 95035  
(408) 945-8600  
**Inquiry 1113.**

**CompuAdd Corp.**  
(HardCache/ESDI)  
12303 Technology Blvd.  
Austin, TX 78727  
(800) 627-1967  
**Inquiry 1114.**

**Distributed Processing Technology**  
(SmartCache)  
140 Candace Dr.  
P.O. Box 1864  
Maitland, FL 32751  
(407) 830-5522  
**Inquiry 1115.**

**Fast Technology, Inc.**  
(TenTime)  
3204 South Fair Lane  
Tempe, AZ 85282  
(602) 438-0889  
**Inquiry 1116.**

**Lomas Data Products, Inc.**  
(LDP Cache II)  
182 Cedar Hill St.  
Marlborough, MA 01752  
(508) 460-0333  
**Inquiry 1117.**

**Perceptive Solutions, Inc.**  
(hyperStore 1600,  
ESDI and SCSI)  
2700 Flora St.  
Dallas, TX 75201  
(800) 486-7278  
**Inquiry 1118.**

**Ultrastor Corp.**  
(Ultra 12F)  
15 Hammond, Suite 310  
Irvine, CA 92718  
(714) 581-4100  
**Inquiry 1119.**

**Western Digital**  
(WD1009V/SE2)  
8105 Irvine Center Dr.  
Irvine, CA 92718  
(714) 932-5000  
**Inquiry 1120.**

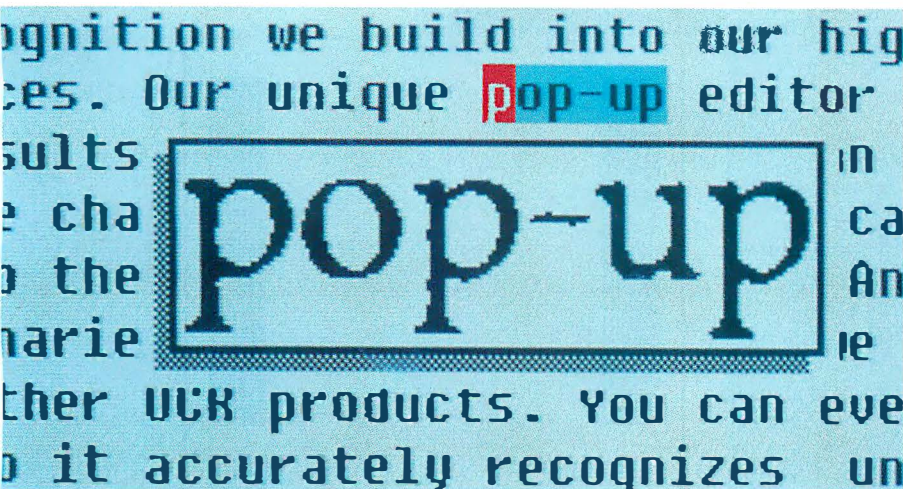
**Manufacturers of Other Products Used in this Review:**

**Maxtor Corp.**  
(XT-8380E)  
211 River Oaks Pkwy.  
San Jose, CA 95134  
(408) 432-1700  
**Inquiry 1121.**

**Micropolis Corp.**  
(1684)  
21211 Nordhoff St.  
Chatsworth, CA 91311  
(818) 709-3300  
**Inquiry 1122.**

# WordScan™ The Most Accurate OCR You Can Buy.

## And We'll Prove It.



*Our unique Pop-up Editor guarantees the most accurate results possible. Proof twice as fast without referring to the original document.*

We started with the lowest error-rate OCR technology in the industry. Then we added exclusive features to make WordScan even more accurate. With WordScan you get the same state-of-the-art recognition we build into our high-end systems, at desktop prices.

*Exclusive features make WordScan even more accurate.*

Our unique *Pop-up Editor* guarantees the most accurate results possible. It pops up an enlarged image of any questionable character or word so you can proof without referring to the original document.

And because WordScan uses dictionaries during recognition, we don't make mistakes common to other OCR products. You can even add your

**"WORDSCAN PLUS**  
**REDEFINES WHAT WE EXPECT**  
**FROM AN OCR PACKAGE. ITS**  
**EXCEPTIONAL ACCURACY, WEALTH**  
**OF FEATURES, AND HANDS-OFF**  
**DESIGN SET A**  
**NEW STANDARD!"**  
**—PC MAGAZINE**

own words so WordScan accurately recognizes unusual or specialized terms.

Zap figures or text right from a fax card to your word processor or spreadsheet. No fuzzy print-outs. No retyping. No errors. And only WordScan has built-in dot-matrix support to read even draft quality dot-matrix documents *accurately*. Most OCR products can't do this at all or charge you extra.

*Other unique WordScan features get the job done faster, better.*

*Clipping*, another WordScan exclusive, lets you choose just what you want on

the page. Text, image, or both. All in one pass.

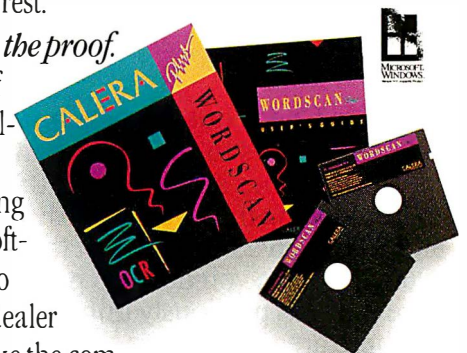
*Scan Now, Recognize Later* lets you scan large documents now, but do OCR later so your PC is not tied up.

Make different documents look the same with our unique *Style Sheet* feature.

Process multiple documents into separate files automatically. Just put a blank page between documents and WordScan does the rest.

*We'll send you the proof.*

To see the results of head-to-head, real-world comparison tests with the leading competitive OCR software products, or to get the name of a dealer where you can make the comparisons yourself, just give us a call at 800-544-7051.



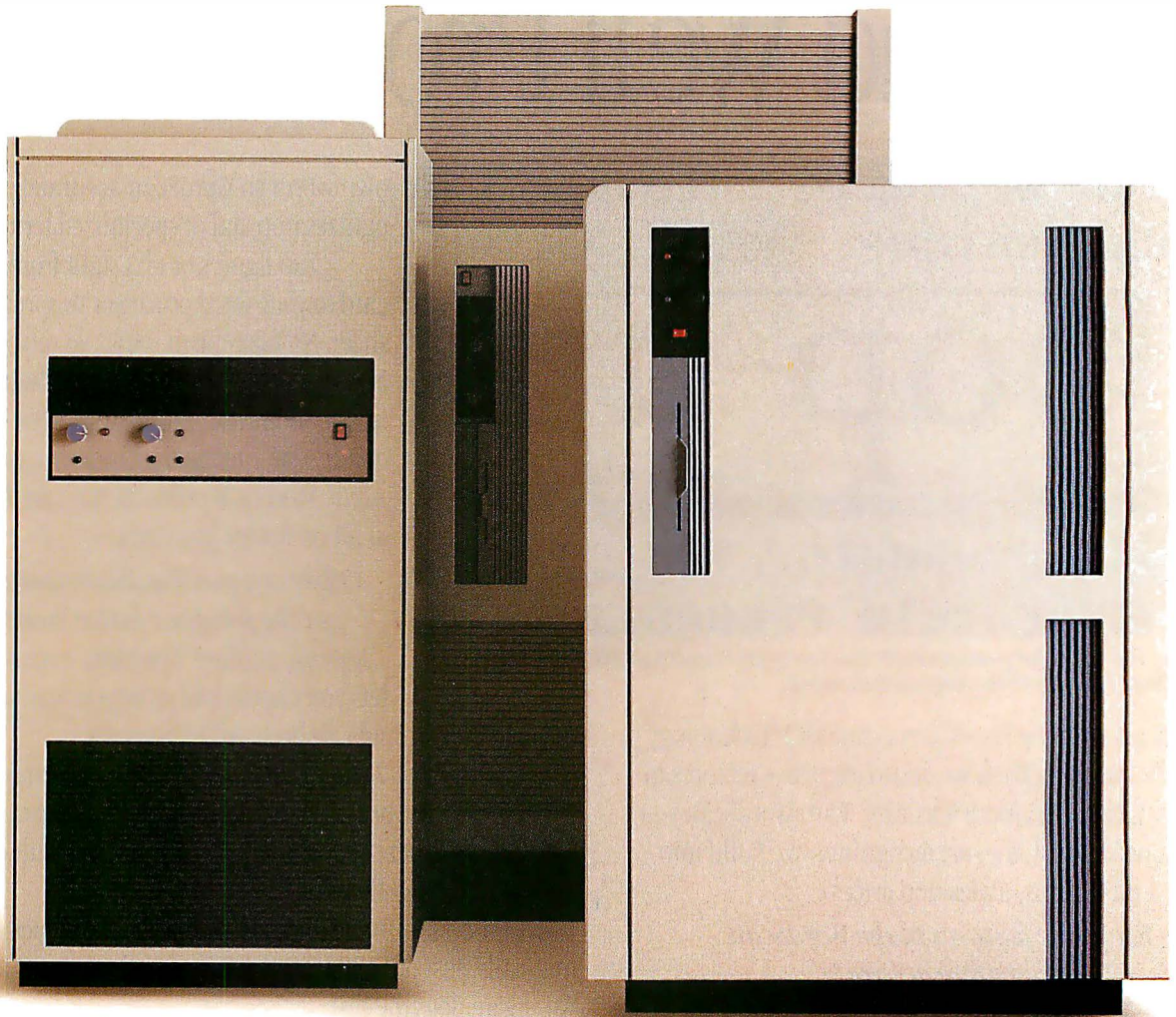
**CALERA**  
 RECOGNITION SYSTEMS

2500 Augustine Drive, Santa Clara, CA 95054 USA. 800-544-7051; outside USA, 408-986-8006; FAX 408-986-1440

© 1990 Calera Recognition Systems, Inc. Calera® is a registered trademark of Calera Recognition Systems, Inc. WordScan and TrueScan are trademarks of Calera Recognition Systems, Inc.

Circle 54 on Reader Service Card

# The Joneses.



Check out the benchmarks. When it comes to speed, pure and simple, mainframes are no longer the main attraction.

Introducing the Everex STEP 486/33 and STEP 486/25. Along with the STEP 486*is*, they give you desktop performance that was previously unheard of.

There are two reasons. The first, of course, is the 486™ chip. The other is AMMA™, Everex's proprietary Advanced Memory Management Architecture.

STEP 486/33	34,000 Dhrystones (19.4 MIPS)
CRAY X-MP/48	17,857 Dhrystones
IBM 3083	16,666 Dhrystones

AMMA uses "write-back" cache technology instead of the "write-through" technologies used in most PC's. The write-back cache was developed for mainframes. Everex was the pioneer in developing it for the PC. And in doing so, opened a whole new dimension in desktop performance.

With AMMA, you can write directly to the STEP 486's cache in nearly all cases. With write-through techniques, on the other hand, you lose most of the performance benefit of the cache.

# And how to keep up with them.



That's because write-through forces you to write to main memory much more often. And main memory is slower than the cache.

This is especially important in 486 computing, where the CPU performs as many as four times the write operations as in 386. Which makes AMMA's write-back architecture, combined with the 486's embedded cache, a powerful combination indeed.

But the STEP 486 machines give you more than just speed. They come with Programmable Drive Select. If your drive isn't listed on the set-

up table, PDS™ lets you custom-configure the BIOS. It's good for virtually any hard drive.

What's more, all STEP systems come with a one-year extendable warranty and a one year renewable on-site service contract that also covers all Everex peripherals in the system.

To find out more, call 1-800-334-4552\* for the name of your nearest Authorized Everex Reseller—every one a high performance expert.

Then you can let the Joneses try keeping up for a change.



## SOFTWARE

Robert Mitchell

### REVIEW

# LAN Remote-Control Software: Better Than Being There

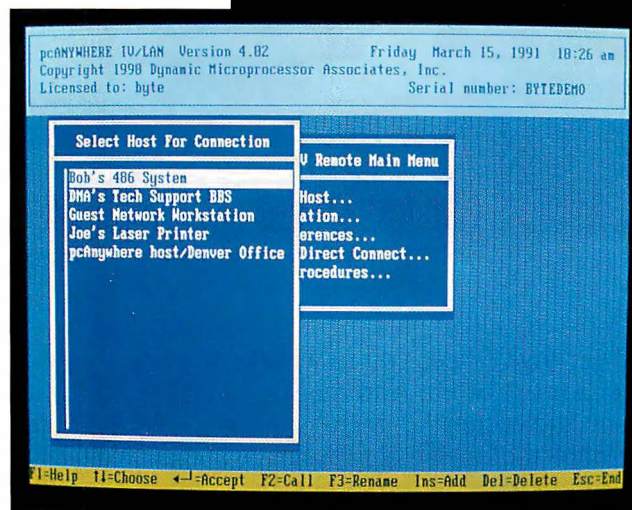
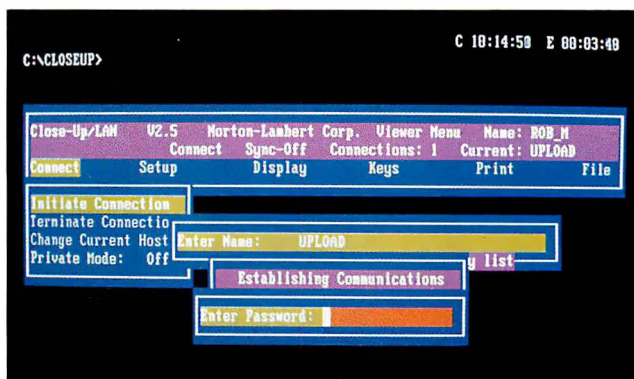
**R**emote-control programs have come a long way. The first programs worked exclusively with modems, but now remote users can exchange keystrokes and screen information with any other workstation on a LAN. These packages are handy tools for network administrators, technical-support personnel, or any user who wants to gain temporary access to another node's resources.

Some LAN remote-control packages support one-to-one connections exclusively; others let you simultaneously access many hosts and toggle between sessions. Still others let many remote users simultaneously control a single host machine. These one-to-many and many-to-one sessions are designed for training situations where a teacher wants to monitor each student's progress or wants all students to view the instructor's screen.

I reviewed six LAN remote-control programs that run on NetWare or NetBIOS PC LANs: Close-Up/LAN, Net-remote+, The Network Eye, pcAnywhere IV/LAN, R2LAN, and Screen Monitor. In addition, senior editor at large Tom Thompson tested two products for Macs on AppleTalk Phase II LANs: Carbon Copy Mac 1.0 and Timbuktu 3.1 (see the text box "The Macintosh Takes Control" on page 190). Each program has its own terminology that describes the controlling and controlled machines; for clarity, I'll refer to them as the remote and host machines, respectively. Table 1 lists important features for each PC LAN product.

In the PC's increasingly graphical world, remote support would be incomplete without the ability to view host applications running in VGA mode. Sur-

*Close-Up/LAN's simple pull-down menus make remote control easy.*



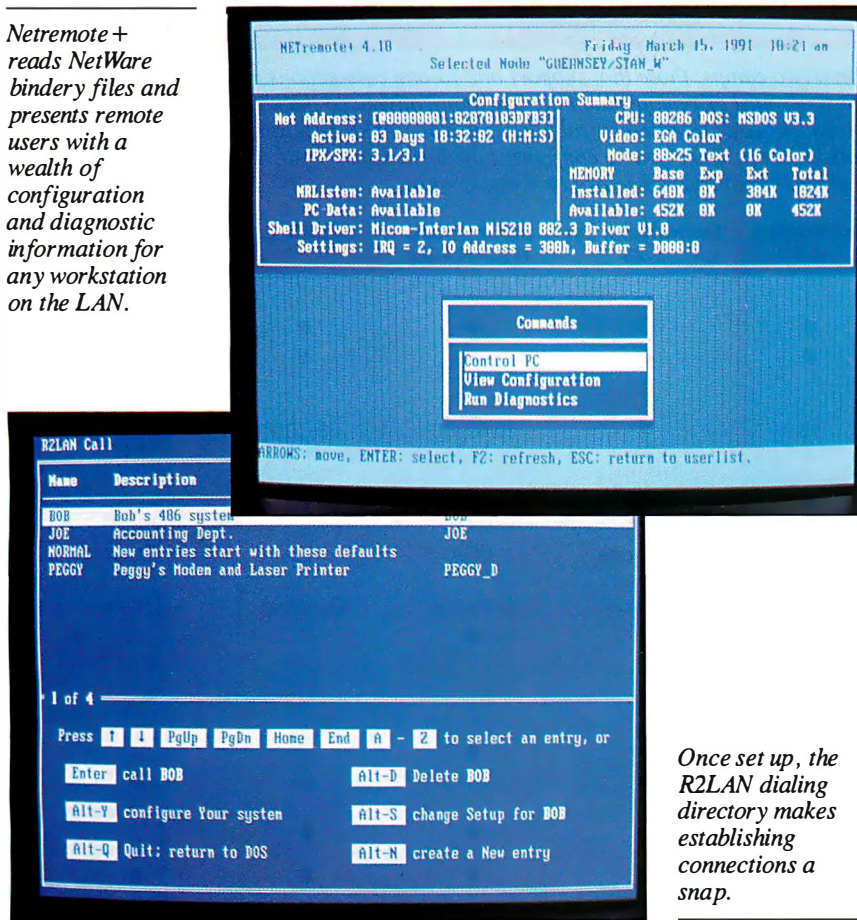
*System administrators can configure pcAnywhere IV/LAN host lists and tailor remote access rights for each user.*

prisingly, many packages offer limited or no graphics support. All run in the background on the host machine, with memory requirements ranging from 2K bytes to 100K bytes, depending on the configuration. Other key features include host and remote security, session

logs, chat windows, and performance-tuning options. At press time, no program supported a remote mouse on the PC, and sound support was limited to beeps generated through the BIOS.

My PC LAN test-bed consisted of a NetWare 2.15 LAN that was running

*Netremote+ reads NetWare bindery files and presents remote users with a wealth of configuration and diagnostic information for any workstation on the LAN.*



*Once set up, the R2LAN dialing directory makes establishing connections a snap.*

over a twisted-pair Ethernet. Test systems included a Club American 386SX, Gateway 386SX and 386/20 machines, and several Hyundai 286 systems.

I tested each package for compatibility with Quattro Pro 1.0, XyWrite 3.55, FoxPro LAN 1.1, Procomm Plus 1.1, and Windows 3.0. Windows posed the biggest challenge; the programs that ran it successfully required a special keyboard handler and supported Windows in real mode only.

To test host performance degradation I ran the BYTE low-level CPU benchmarks, first without the host software loaded and then with the software running and one remote connection active. At the remote machine, I measured screen response when running the applications suite; each package received a grade of pass or fail. Some programs update the remote screen at timed intervals; others perform updates only when the host screen changes. Dynamic updates create less network traffic and produce much faster screen response.

I judged each program by its ability to reproduce host graphics screens at the remote machine, performance, memory

requirements, ease of use, security, pricing, and other features.

### Close-Up/LAN

Norton-Lambert's Close-Up/LAN 2.5 is one of the most flexible and easy-to-use packages I tested. It has many advanced features, but you won't find them cluttering up the program menus; most run from the command line. Close-Up/LAN only supports text or CGA screens, and the \$795 eight-user license fee makes this package the most expensive of the group.

Close-Up/LAN's Viewer lets you control workstations running the Host software. Both programs reside in memory. Viewer consumed 80K bytes of RAM on my test machine. Host occupied 54K bytes, but a menuless version fits into just 10K bytes.

Using Viewer's pull-down menus, you start up to 16 simultaneous sessions. You then toggle between sessions or go back to viewing your local screen while other applications continue to run on the host machines. Hosts can accept up to 16 remote sessions. Viewers can set up exclusive connections and disable the host key-

board and screen for privacy. You can even set up a host to alert remote users when a process completes on the host.

Close-Up/LAN automatically uses NetWare user names when you run Viewer or Host. It lists how many LANs and Close-Up users are available, but it doesn't tell you who those users are; you must know the host user name. The program doesn't support file transfers, but you can hot-key to your local screen and then copy files to the shared area of the file server, where the host machine can access them.

The Host menu lets you establish a master password and a Viewer password for each host machine. You can restrict remote users to viewing only, or you can restrict access by user name. As a host, you can also alert a viewer when you want to begin a session.

You can increase the number of host connections beyond 16 by daisy chaining—connecting to a host and then running Viewer on the intermediate machine to connect to a second host. This works as long as you reconfigure the Host and Viewer on each machine so that each has unique hot keys.

Close-Up/LAN doesn't support asynchronous sessions; for that you need Norton-Lambert's Support/ACS remote program (\$245) and Customer/Terminal host program (\$195). By running Customer/Terminal and Viewer on the host machine, remote users can call into one network node and control any other host.

Close-Up/LAN successfully worked with all host applications. On the remote side, Viewer was unable to run under Windows 3.0's V86 mode. Close-Up/LAN performed well overall. With one remote connection, host CPU performance didn't degrade significantly. Screen response at the remote machine was somewhat jerky at the command line, but all applications ran smoothly. Adjusting the scan interval settings on the host side improves the response somewhat.

Close-Up/LAN is ideally suited for teaching and other environments that require one-to-many or many-to-one sessions and don't need VGA graphics support. Its simplicity also makes it a good choice for the average user who wants to remotely take over an idle computer's modem or printer.

### Netremote+

Brightwork Development's LAN remote-control package is a must for NetWare administrators, and its simplicity makes it ideal for other users as well. Netremote+ 4.1 supports one-to-one

PC LAN REMOTE-CONTROL SOFTWARE

**Table 1:** LAN remote-control packages fall into two camps: those that support one-to-one connections exclusively, and those that support many simultaneous sessions per host or remote machine. The more advanced packages let remote workstations view host VGA-mode applications. All LAN remote-control packages run as TSR programs on the host machine, but memory requirements vary considerably. Once you've configured the host, Close-Up/LAN and pcAnywhere IV/LAN let you run small versions of the host software to save memory (●=yes; ○=no).

	Close-Up/ LAN 2.5	Netremote+ 4.1	The Network Eye 1.23	pcAnywhere IV/LAN 4.02	R2LAN 2.0	Screen Monitor 5.1
Networks supported						
NetWare SPX/IPX	●	●	○	●	●	●
NetBIOS	●	●	●	●	●	●
Memory requirements (observed) (K bytes)						
Host TSR	10/54	15	2	20/62-80 <sup>1</sup>	68-100 <sup>2</sup>	18
Remote TSR	67-80	7	24	N/A	N/A	54
TSRs unload from memory	●	●	○	●	●	○
Graphics modes supported	CGA	VGA <sup>3</sup>	Text mode	VGA	VGA	EGA
Remote screen updates	Dynamic	Dynamic	Timed	Dynamic	Dynamic	Timed
Adjust screen update rate	●	●	○	●	○	○
Maximum concurrent sessions						
Per host	16	1	99	1	1	14
Per remote	16	1	32	1	1	14
Daisy chain sessions	●	●	●	●	○	○
Broadcast host screen	○	○	●	○	○	●
Host security						
Password access	●	●	●	●	●	○
Notify when connection made	●	●	●	●	●	●
Reject connection request	●	○	○	●	●	○
Terminate session	●	●	○	●	●	○
Restrict remote to view only	●	●	●	●	○	○
Allow/disallow host reboot	●	●	Always allowed	●	○	Always allowed
Set to reboot after each session	●	●	○	●	●	○
Remote security						
Disable host keyboard	●	●	○	●	●	○
Disable host display	●	○	○	●	●	○
Exclusive session	●	N/A	●	N/A	N/A	N/A
Asynchronous connections	Option	●	○	●	Option <sup>5</sup>	○
Chat window	●	○	○	●	●	○
File transfers	○	○	○	●	●	○
Redirect printing from host to remote	●	○	○	●	●	○
View list of available hosts	○	●	○	●	○	○
Host can initiate session	●	○	○	○ <sup>6</sup>	●	○
Remote diagnostics	○	●	○	●	○	○
Session log	○	●	○	●	○	○
Price	\$795 for 8 users	\$350 per server	\$295 per LAN	\$495 for 2 users; \$25 each additional user	\$795 per LAN	\$295 per server

<sup>1</sup> Small host requires 20K bytes. Standard host uses 62K bytes; file transfer capability requires an additional 18K bytes of RAM.

<sup>2</sup> Host requires 68K bytes; Chat feature and Guard security require an extra 21K bytes and 10K bytes of RAM, respectively.

<sup>3</sup> NetBIOS version supports CGA mode only.

<sup>4</sup> Supports one controlling machine on the network at one time but can broadcast screens to an unlimited number of workstations.

<sup>5</sup> Requires Remote 2, IBM Asynchronous Communications Server, or other protocol-compliant communications server.

<sup>6</sup> Host can initiate asynchronous sessions only.

N/A=Not applicable.



connections only, but it offers an easy-to-use interface for end users, as well as powerful remote diagnostics that will save network managers countless trips around the office. Netremote+ requires little memory, supports applications running in VGA mode, and includes Triton's remote-control dial-up software, Co/Session—all for \$350 per server. It's also the fastest product I tested.

The Netremote+ host module requires just 15K bytes of RAM. The remote module runs from the command line or as a 7K-byte TSR program.

There's no host menu; command-line switches let you set the host password, break a connection, or unload the host program from memory. The remote menu lists all network nodes and station numbers, and it highlights those running as hosts. You can search for hosts by user ID, network address, or internetwork address.

When you select a computer, Netremote+ displays configuration information that includes the node's SPX/IPX version, network interface card type and settings, and network address. If the machine is operating as a host, Netremote+ attempts to determine the host system's CPU type, DOS version, video adapter type, current video mode, and memory configuration. You can then control the host PC, view additional configuration information, or run diagnostic tests.

Once you connect to the host, a pop-up menu lets you hang up or change your control options. Additional system information includes a memory map of the host system that lists programs running, the amount of memory used, and interrupts used. Server and network information is equally detailed. Diagnostics exercise server connections, analyze the network traffic at the host, and display LAN adapter and IPX statistics.

Using Netremote+ didn't affect the host performance significantly. Remote screen performance was noticeably faster than with R2LAN or pcAnywhere IV/LAN when running graphical applications. Tuning options determine how much host processor time Netremote+ gets and how often remote screen updates occur. Netremote+ ran all the application tests without problems, although Windows 3.0 required special tuning.

Netremote+ doesn't offer all the bells and whistles of R2LAN or pcAnywhere IV/LAN. But it's fast on graphics, and it provides invaluable information for system administrators. Unfortunately, the NetBIOS-compatible version of Netremote+ isn't as exciting. It only sup-

ports CGA graphics and doesn't offer any remote diagnostics capabilities.

### The Network Eye

The Network Eye 1.23 is the only other product besides Close-Up/LAN that lets you control more than one workstation at a time. Artisoft's \$295-per-LAN licensing fee is the lowest in the group, and the program requires just 2K bytes of RAM

**T**he  
*Network Eye is the only  
product besides Close-  
Up/LAN that lets you  
control more than one  
workstation at a time.*

on the host. The program supports text mode only and works only with NetBIOS LANs (I used Novell's NetBIOS emulation program during testing).

The Network Eye doesn't have menus. To initiate a session you press the insert key, which brings up a window, and enter the name of the workstation that you want to control. By repeating this process, you can have a "master" system control up to 32 "workstations" simultaneously. Conversely, a workstation can have up to 99 masters and can restrict access to viewing only. Masters can move or resize windows and can toggle between them. The Clipboard window lets you capture host screen information and transfer it between hosts, but it doesn't work with the local screen.

You won't find many advanced features in The Network Eye. There's no chat window or session log, for example, and you can't remove the software without rebooting. The manual is short and not well organized.

Performance was fair. On a controlled workstation with one master connected, CPU performance declined about 15 percent. At the controlling workstation, screen response time was good.

The Network Eye ran all applications satisfactorily except for Windows 3.0, which requires graphics support. The program also doesn't like himem.sys and smartdrv.sys. For text-mode applications, The Network Eye works fine. But

with so many applications now requiring graphics screens, chances are that at least one user on your LAN will find this package inadequate.

### pcAnywhere IV/LAN

This new product from Dynamic Microprocessor Associates (DMA) integrates both node-to-node and remote dial-up connections in one package. Its gateway function enables off-LAN users to dial in through a gateway machine to control any host machine. Alternately, you can share the gateway machine's modem with all LAN users for outgoing calls. Operations take place in the background, freeing the gateway system for other tasks. pcAnywhere IV/LAN 4.02 also supports remote connections to NASI/NCSI-compliant asynchronous communications servers, such as Novell's ACS.

pcAnywhere IV/LAN translates between graphics modes so that a remote monochrome, EGA, or CGA system can view applications running in VGA mode on the host machine. The program supports one active host session at a time, but you can "suspend" sessions and switch between them fairly quickly.

LAN administrators create a shared set of configuration files that define host machines, gateway machines, and access privileges for each remote user. Alternately, users can maintain their own configuration files locally. Hosts can set passwords and session time limits, log calls, allow background file transfers, and even record sessions and play them back to see what remote users did. Remote users can also maintain session logs.

One menu system controls gateway, host, and remote operations. You start by entering a three-character user ID, naming your machine, and then selecting host, gateway, or remote operation. Remote users can select from a predefined list of host and gateway machine names, and they can list currently available host machines.

pcAnywhere IV/LAN's diagnostics utility generates basic system configuration information and tests the communications ports, video subsystem, and keyboard for your local machine. It doesn't give you the same level of detail as Netremote+, however, and you can't run the diagnostics tests remotely.

All test applications ran without incident. Establishing a session didn't affect host performance significantly, but remote screen response could have been better in VGA modes. pcAnywhere IV/LAN reproduced the host VGA mode screens at about the same rate as R2LAN

# The Macintosh Takes Control

Tom Thompson

The Mac LAN remote-control software market has two products: Farallon's Timbuktu 3.1 and Microcom's Carbon Copy Mac 1.0 (see table A). They function through various AppleTalk network implementations such as LocalTalk, EtherTalk, and TokenTalk. Both are TOPS-compatible. In the parlance of these products, the *host* is the Mac that is viewed or controlled, while the *guest* is the Mac that views or controls the host computer. Both host and guest use a single INIT and a desk accessory to provide remote-control services. The INIT installs critical drivers at start-up that manage the network connection, screen imaging, and mouse/keyboard control. The DA lets you set access rights and control file transfers. You also use this DA to select the host from a list of network names.

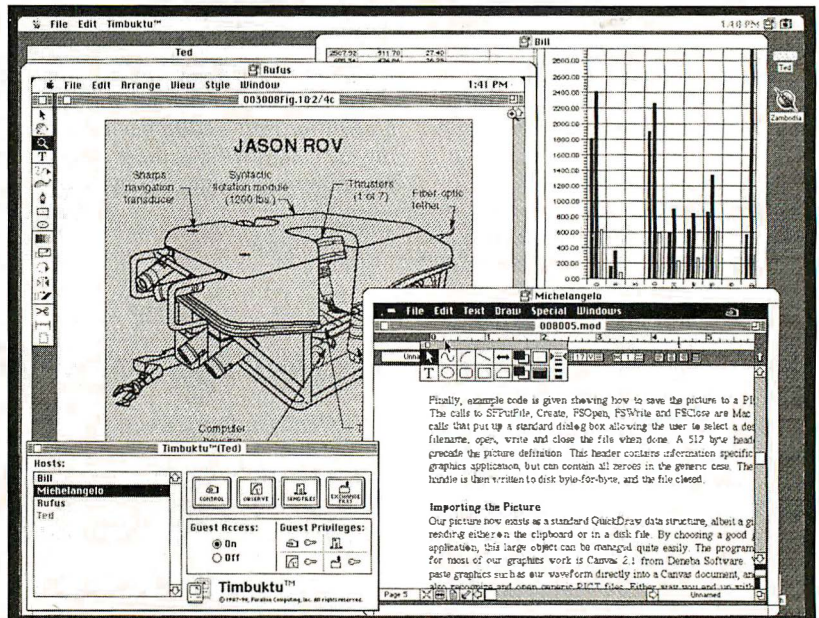
Timbuktu and Carbon Copy Mac let you passively view the host's screen or actively control the host using your own mouse and keystrokes. However, the host Mac always has the option of breaking the connection. Both provide peer-to-peer file transfer capabilities—that is, no server is required. Since a DA provides access control, you can connect and watch a host screen in a background window as you continue your work, even under the Finder. If the host has a larger screen than yours (e.g., if you're using a Mac SE to view a Mac II), the host screen is displayed in a draggable, scrolling window.

Only when the host screen changes does this software relay the changes to the guests. This lowers network traffic, but the overhead involved reduces the host's performance. On the Mac IIci, this performance penalty is scarcely perceptible; on a Mac SE, the system slows down noticeably when a guest connects.

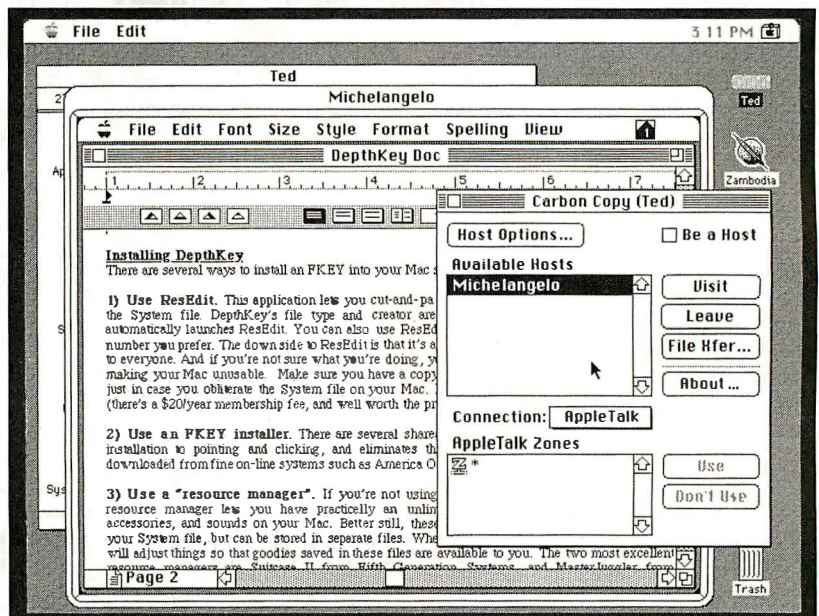
Both Timbuktu and Carbon Copy Mac relay only black-and-white screens to the guest, even if the host has a color display. This reduces the amount of data sent through the network, but it also makes remote work with color-imaging applications problematic. For the same reason, the host only relays beep signals to the guest; the actual beep sound is not reproduced on the guest Mac.

## Timbuktu 3.1

Timbuktu (\$298 for two users) lets you observe one or more host screens simul-



*Timbuktu monitoring several sessions simultaneously. The Timbuktu DA window in the lower left is used to create connections to each host. Clicking on certain icons determines whether you control or view the host.*



*You can connect to a host via Carbon Copy Mac's DA window, seen at the right of the screen. You can monitor only one host at a time, in this case a Mac IIsi with a low-cost screen.*

taneously. It provides a rich array of access controls for the network expert. A configurable password table lets you set varying levels of host access, as determined by the password that the guest uses to connect. Different passwords can provide combinations of control/view access and determine whether the guest can send, receive, or delete the host's files.

Timbuktu's menu-bar icon flashes when a guest connects to a host. This icon also provides a pull-down menu that supplies a guest log (i.e., who connected to the host); lets you modify the access rights (e.g., change a guest from a controller to a viewer); and disconnects a particular guest or all guests.

In a teaching environment, where dozens of Macs are guests to an instructor's computer, the host can "broadcast" its actions rather than maintain individual sessions with each guest. This reduces network traffic, but it can cause conflicts with routers or bridges that use the same broadcast socket (the network's logical address for broadcast data) to query the network for printers or other bridges. Timbuktu sidesteps this problem by allowing you to change the broadcast socket number.

### Carbon Copy Mac 1.0

Carbon Copy Mac uses a minimalist interface that effectively spares the user from network details. It displays only a single host screen at a time. A two-user package costs \$299.

A single password allows host access. The host configuration determines the guest's control privileges and file transfer capabilities. As a guest, you can select a specific network zone to search when looking for a host Mac.

You can set the host so that guests require the host's permission to connect. An alert box with the guest's name appears, and the host can approve or deny the connection. Unlike with Timbuktu, you can't be selective about disconnecting guests: Once you disable the hosting function, all attached guests are disconnected.

Carbon Copy Mac can also connect to a remote host via a serial connection. (Farallon offers a separate package, Timbuktu/Remote, to accomplish this.) A pop-up menu enables you to choose whether to use an AppleTalk or serial connection.

### A Choice of Pathways

I used a Mac Ici, Mac SE, and Mac II for my networking tests. The only problem I encountered was a conflict be-

MAC LAN REMOTE-CONTROL SOFTWARE		
<b>Table A: Both Carbon Copy Mac and Timbuktu support host graphics screens on the remote machine in black and white only. Timbuktu offers a broadcast mode that's handy in classroom situations. Carbon Copy Mac supports asynchronous dial-up connections as well as node-to-node sessions. Farallon supports asynchronous connections through its Timbuktu/Remote package.</b>		
Product	Carbon Copy Mac 1.0	Timbuktu 3.1
<b>Networks supported</b>	LocalTalk, EtherTalk, TOPS, TokenTalk	LocalTalk, EtherTalk, TOPS, TokenTalk
<b>Memory required</b> Host and guest	250K bytes <sup>1</sup>	90K bytes <sup>1</sup>
<b>Graphics support</b> QuickDraw/bit maps	Black-and-white viewing Both	Black-and-white viewing Both
<b>Maximum concurrent sessions</b>		
Per host	Limited by memory	Limited by memory
Per remote	1	Limited by memory
<b>Daisy chain sessions</b>	○	●
<b>Broadcast host screens</b>	○	●
<b>Host security</b>		
Password access	●	●
Notify when connection made	●	●
Reject connection request	●	○
Terminate session	●	●
Restrict remote to view only	●	●
Allow/disallow remote host reboot	●	●
Reboot after each session	○	○
<b>Guest security</b>		
Disable host keyboard	○	○
Disable host display	○	○
Exclusive session	●	●
<b>Asynchronous connections</b>	●	Option
<b>File transfers</b>	●	●
<b>Host can initiate session</b>	○	●
<b>Session log</b>	●	●
<b>Price</b>	\$299 for 2 users; \$199 each additional user; \$999 for 15 users	\$149 per user; \$1995 for 30 users

<sup>1</sup> Additional memory usage determined by screen size and operating mode.

●=yes; ○=no.

tween the Carbon Copy INIT and MasterJuggler 1.53 when booting the Mac Ici in the host mode. My typical workday host of applications—MindWrite, MacWrite II, Photoshop, Illustrator, and White Knight 10.10—operated without problems.

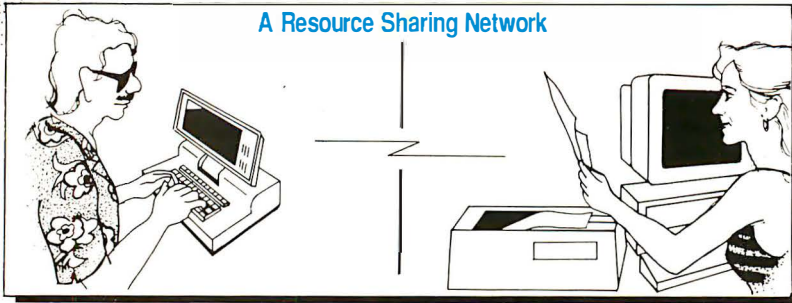
While both products worked flawlessly, I found Timbuktu's refined networking controls more to my taste than

Carbon Copy's minimal interface. My preferences are based on the fact that I maintain BYTE's AppleShare network; someone with less network experience might prefer Carbon Copy's setup to keep network matters simple.

*Tom Thompson is a BYTE senior editor at large. You can reach him on BIX as "tom\_thompson."*

# EasyLAN II™

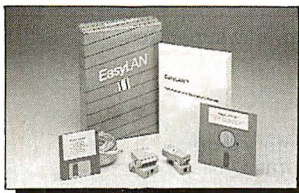
The Care Free Resource Sharing Network- For 2 PCs



The original EasyLAN has over 100,000 happily installed users. Now EasyLAN II is introduced.

**Highlights:**

- Supports Baud Rates to 115,000
- PC-to-PC Messaging
- Supports Remote Operations
  - Operate remote applications
  - Operate remote fax or modem
- Print Spooling/Sharing
- File Transfer
- Pop-up Menu
- Background Operations



Call Toll Free - Today  
To Order, or Free Information  
**800/835-1515** USA or Canada  
**EasyLAN II - \$149.95**

Server Technology 2332-A Walsh Ave  
Santa Clara, California 95051  
Fax 408/738-0247 Tel 408/988-0142

PC Magazine ...Cast Iron Reliable...

**REVIEW**

did. Adjusting the screen update rate didn't help.

pcAnywhere IV/LAN's many unique features come at a price. An eight-user license costs \$645. The program also takes its share of memory: It requires at least 62K bytes on a host—80K bytes with the background file transfer option. But once you've configured the host, you can run a small version of the software that uses just 20K bytes of RAM. And if you use a memory manager such as Quarterdeck's QEMM, you can configure pcAnywhere IV/LAN to automatically load into high memory on the host when the session begins. The remote software doesn't run as a TSR program. You can temporarily exit to DOS, but pcAnywhere occupies 465K bytes of RAM, leaving little room to run anything else.

pcAnywhere IV/LAN isn't as easy to use as Close-Up/LAN or Netremote+, but it's still one of the best programs I tested. Shared configuration files make administration a breeze, and its ability to support background gateway operations is a plus.

**R2LAN**

DCA's R2LAN 2.0 doesn't have fancy remote diagnostics capabilities, but it does support VGA screens and just about every feature you might want. It also has the most comprehensive security of any package I tested. R2LAN supports one-to-one connections only.

Setting up R2LAN takes some work up front. At each host you set up an account for each remote that includes a password and specific privileges. Only the host user or a remote user with system manager rights can work with these accounts.

At the remote machine, you set up a *dialing directory* that includes the host name, password, and a few caller options. A pop-up menu lets you end the session, transfer files, disable the host video and keyboard, redirect printing, and save text-mode host screens to disk.

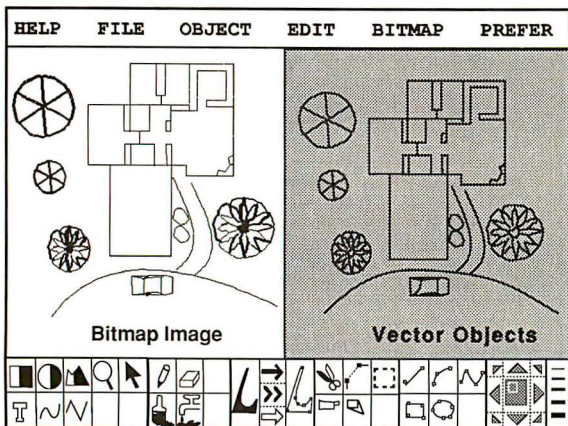
For extra security, you can load a rights mask that restricts each remote user's access to specific host drives or directories, and curtails their access rights within those areas. Remote users can have read, write, create, delete, search, open, or modify rights.

R2LAN ran the application test suite smoothly. Screen response at the calling machine was fast, except when running in VGA mode. R2LAN required about 20 seconds to draw a Quattro Pro pie chart that Netremote+ did in just 2 seconds. Establishing a remote connection

To get the best of both image and graphics worlds

# Xformer™

Work on bitmapped images, drawings schematics, blue prints, etc. as easily as on PostScript or DXF vector objects.



**AUTOMATED TRACING**  
Accurate

**OBJECT MANIPULATIONS**  
Bezier, B-Spline, Ellipse...  
Rotate/Scale/Shear...

**OBJECT RECOGNITION**

**BITMAP EDITING**

**IMAGE PROCESSING**

**FILE FORMATS**

- TIFF DXF
- PCX <=> EPS
- RLC ...

**FAST !  
INTELLIGENT !  
AVAILABLE NOW !  
\$449.-**

Use Xformer to quickly and automatically turn your scanned or bitmap images into vectorized objects for use in CAD and DTP applications

Xformer is a complete graphics package with extensive Menu Commands and Toolboxes for easy editing of bitmapped images and manipulation of vectorized objects

**Elcee Computek, Inc.**

500 NE Spanish River Blvd., Suite 102  
Boca Raton, FL 33431  
Ph (407)750-8061 Fax (407)750-8057



# The best got better.

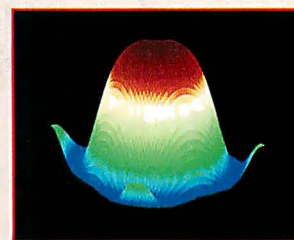
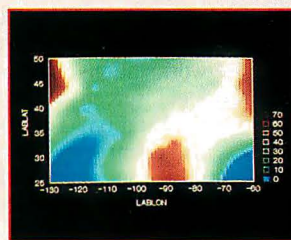
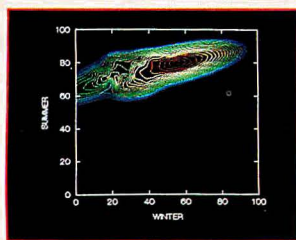
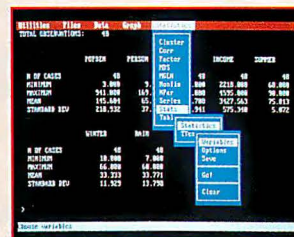
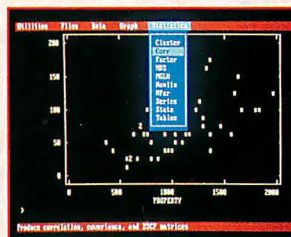
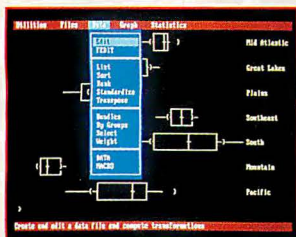
SYSTAT 5.0's new menus make the top-rated statistical program even easier to use.



v 4.1



SYSTAT is the *only* package to receive these three awards.



**New Features** Menus or commands — your choice ■ Rewritten documentation includes statistics tutorials ■ Fast, built-in drivers for SYGRAPH ■ Global mapping and many new plots ■ Multi way repeated measures ■ Means model for missing cells designs ■ Post-hoc tests ■ Interactive stepwise regression.

**Statistics** Basic statistics, frequencies, *t*-tests, post-hoc tests ■ Multi way crosstabs with log-linear modeling, association coefficients, PRE statistics, Mantel-Haenszel, asymptotic standard errors ■ Nonparametric statistics (sign, runs, Wilcoxon, Kruskal-Wallis, Friedman two-way ANOVA, Mann-Whitney U, Kolmogorov-Smirnov, Lilliefors, Kendall coefficient of concordance) ■ Pairwise/listwise deletion of missing values, Pearson correlation, SSCP, covariance, Spearman, Gamma, Kendall Tau, Euclidean distances, binary similarities ■ Linear, polynomial, multiple, stepwise, weighted regression with extended diagnostics ■ Multivariate general linear model includes multi way ANOVA, ANCOVA, MANOVA, repeated measures, canonical correlation ■ Principal components, factor analysis, rotations, components scores ■ Multidimensional scaling ■ Multiple and canonical discriminant analysis, Bayesian classification ■ Cluster analysis (hierarchical, single, average, complete, median, centroid linkage, k-means, cases, variables) ■ Time series (smoothers, exponential smoothing, seasonal and nonseasonal ARIMA, ACF, PACF, CCF, transformations, Fourier analysis) ■ Nonlinear estimation (nonlinear regression, maximum likelihood estimation, and more).

**Graphics** Overlay plots ■ Drivers for most graphics devices ■ *Two-dimensional*: Error bars ■ Scatterplots ■ Line and vector graphs ■ Vector, dot, bubble and quantile plots ■ Bar graphs (single, multiple, stacked, range) ■ Box plots (single and grouped) ■ Stem-and-leaf diagrams ■ Linear, quadratic, step, spline, polynomial, LOWESS, exponential smoothing ■ Confidence intervals and ellipses (any alpha value) ■ Smooth mathematical functions ■ Rectangular or polar coordinates ■ Log and power scales ■ ANOVA interaction plots ■ Histograms (regular, cumulative, fuzzy) ■ Stripe and jitter plots ■ Gaussian histogram smoothing ■ Scatterplot matrices ■ Voronoi

tessellations ■ Minimum spanning tree ■ Maps with geographic projections (U.S. state boundary file included, county and world boundary files available) ■ Chernoff faces ■ Star plots ■ Fourier plots ■ Pie charts ■ Contour plots on regularly and irregularly spaced points ■ Control charts and limits ■ *Three-dimensional*: Data plots ■ Smooth function plots ■ Vector plots ■ Linear, quadratic, spline, least squares surface smoothing ■ Typefaces that print in perspective.

**Data Management** Import/export Lotus, dBase, and DIF files ■ Full screen data editor ■ Full screen text editor ■ Unlimited cases ■ Missing data, arrays, character variables ■ Capability to process hierarchical, rectangular or triangular files, irregular length records ■ Character, numeric, and nested sorts ■ Merge and append large files ■ Unlimited numeric and character variable transformations ■ Subgroup processing with SELECT and BY ■ Value labels and RECODE statements ■ Macro processor with programming language, screen control, file manipulation, applications generation, and report writing.

SYSTAT operates on IBM PC's® and compatibles, MS-DOS® VAX®/Microvax and Macintosh®. Site licenses, quantity prices and training seminars available. No fees for technical support.



**SYSTAT. Intelligent software.**

For more information call or write: SYSTAT, Inc. 1800 Sherman Avenue, Evanston, Illinois 60201-3793 Tel: 708.864.5670 Fax: 708.492.3567  
For international representatives call: **Australia** 61.3.4974755, **Canada** 416.424.1700, **Finland** 358.0.6923800, **France** 33.1.40935000,  
**Germany** 49.61.265950, **Italy** 39.587.213640, **Japan** 81.3.5902311, **New Zealand** 64.71.562675, **Norway** 47.3.892240, **Sweden** 46.8.110620,  
**Switzerland** 41.31.416611, **The Netherlands** 31.3402.66336, **UK**: Letchworth 44.462.482822, London 44.81.6926636, London SE 44.0753.841686

Circle 310 on Reader Service Card (RESELLERS: 311)

didn't have a significant effect on host performance.

R2LAN supports remote dial-up connections on NetBIOS LANs that are running IBM Asynchronous Communications Server or compatible communications servers. Otherwise, you'll need Remote2 (\$195) for off-LAN connections.

The R2LHOST program gobbles up 68K bytes of RAM. Adding a chat win-

ent screen then appears, and a "Remote Controlling [station name]" message flickers atop the screen in reverse video. I couldn't remove this message, which blocked part of the Quattro Pro menu.

You can monitor a client screen or create client groups that you want to monitor. Screen Monitor dutifully cycles through these screens, pausing for 3 seconds at each. You can stop cycling by holding down the F1 key, but there's no option to step through the screens or change the cycle time.

Screen Monitor doesn't have many other features. There's no chat window or file transfer capability. Clients can't restrict access by password or prevent a controlling user from rebooting their workstations. You can't hot-key to your local screen while controlling another workstation. The memory-resident host and client software won't unload without rebooting. Screen Monitor only supports graphics modes up to EGA. Documentation is also poor. But Screen Monitor's biggest weakness is its performance.

Controlling a client cut its performance in half. At the host machine, response time was unacceptably slow. Key-strokes took 1 to 2 seconds to echo back to the host system, and screen updates were jerky. Except for Windows 3.0, all the applications I tested ran fine. A conflict between `client.exe` and `smartdrv.sys` caused Procomm Plus to fail. Removing `smartdrv.sys` from the `CONFIG.SYS` file solved the problem.

As a remote-control tool, Screen Monitor doesn't cut it. Other programs offer more features, better performance, and the ability to have many remote workstations controlling hosts on the network simultaneously. This product is best suited to one-to-many teaching situations where rapid screen updates aren't an issue. For those users, the program's \$295 per server price may make Screen Monitor worth considering.

### Controlling Factors

For one-to-one connections over NetWare, Netremote+ offers the best combination of features and performance at a good price. It supports host VGA screens at the remote machine, executes fast remote screen updates without degrading host machine performance, provides asynchronous, off-LAN connections through bundled Co/Session software, uses little host memory, and, above all, is easy to use. The program's extensive remote diagnostics capabilities under NetWare are an invaluable tool for LAN administrators and support technicians. And at \$350 per server, it's one of the

**R**<sub>2</sub>LAN  
is a good choice for  
LAN administrators  
who want to  
closely control access  
to host machines.

dow (21K bytes) and Guard (10K bytes) increases the memory hit to almost 100K bytes. R2LCALL doesn't run as a TSR program. You can hot-key to DOS during a session, but you lose 155K bytes of RAM. Both programs can run under Desqview.

In smaller, more informal LANs, R2LAN's extended features and fancy configuration menus are probably overkill—especially when you consider the \$795 per LAN price. But it's a good choice for LAN administrators who want to closely control access to host machines, and once set up, the package is easy to use. I liked R2LAN's well-organized and illustrated documentation and context-sensitive help screens. I'd like to see faster VGA screen updates and an option for callers to view a list of available host machines, but otherwise, the product is top-notch.

### Screen Monitor

D-Link's Screen Monitor 5.1 does things a little bit differently. Here a "host" controls one "client" or views many client screens. The host can broadcast its screen to all clients, or capture any client screen and broadcast it to other clients on the LAN.

The host software requires 18K bytes of RAM. Only one host system can operate on the network at a time. A hot key brings up the menu. To control another workstation, you enter its name. The cli-



## Multiuser Systems Make Sense in a Slow Economy

by Julie Caruso

Business automation needs do not change simply because a slowing economy threatens. The willingness of business to make the commitment to meet those needs, however, becomes more closely tied to the cost-effectiveness and efficiency of the technology available in light of an uncertain economic future.

This presents a challenge to the computer industry to provide solutions that are sensitive to both technological and economic concerns. An important example is the economics of connectivity. The need to provide employees with the technology to share data, hardware and software resources can actually increase in a slowing economy.

For companies who need a connectivity solution for an existing base of PCs, a LAN offers the ability to share information, printers and other resources while preserving the existing technology investment. In terms of performance, a LAN is most efficient in CPU-intensive activities like computer-aided design.

For companies who need to expand their computer resources, multiuser systems become an extremely effective choice. Providing the speed and power of 80386- and 80486-based PCs for an entire corporate department or small business can be enormously expensive. With a multiuser solution like The Software Link's PC-MOS, the speed and power of one PC can be shared by up to 25 users working on dumb terminals that can cost thousands of dollars less than individual computers. Existing PCs can still be used by installing PC EmuLink, a terminal emulation software product.

Because PC-MOS is a DOS-compatible operating system, the existing investment in software and training is not lost. And like a LAN, PC-MOS allows a business to share expensive resources such as laser printers. Because multiuser systems are generally easier to use and maintain than LANs, the expense of a network administrator is usually avoided. Multiuser system performance is generally best in disk-intensive environments like accounting.

In an uncertain economic environment, The Software Link is one company that expects the multiuser computing environment to gather even greater strength. The combination of performance and efficiency with the PC-MOS platform add up to a sound investment in the future.

*Julie Caruso is Managing Director and Director of Sales and Marketing for The Software Link, Inc. in Atlanta, Georgia. For more information, call 1-800-451-LINK.*

# PC-MOS

## The Multiuser DOS Platform For The '90s

The 386 and now the 486 microprocessors have focused a lot of attention on the multiuser, multitasking possibilities of advanced PCs. A myriad of software and hardware manufacturers are promising a new age of multiuser options in the '90s.

But when you take a closer look, only one solution focuses on the features you want and anticipates the capabilities you need to use your PCs to their greatest potential. That solution is PC-MOS™ from The Software Link, the first DOS-compatible, multiuser, multitasking operating system.

### A Network Alternative

The advantage to the PC-MOS shared processing solution is its ability to maximize the available memory on your PC, taking full advantage of extended memory and sharing it with up to 25 users on inexpensive terminals or monitors. You can share data with the same speed and integrity of a network solution without the expense of network cards and the waste of under-utilized PCs. And no additional investment is required to get the multitasking capabilities inherent in PC-MOS.

### A Network Enhancer

For affordable network expansion, PC-MOS servers can be connected to other servers with The Software Link's LANLink or with the PC-MOS

PC-MOS is a trademark of The Software Link. All other products referenced are trademarks of their respective companies. Prices, policies and specifications subject to change without notice.

GATEWAY™ to Novell's NetWare®. This connectivity lets a business configure its automation systems for departmental efficiency and expand affordably as needs grow with LANs or even WANs.

### DOS Compatible

The PC-MOS alternative is clear: DOS compatibility means your users can continue to use all the popular software packages. And that means no investment loss, no retraining and no limitations in available applications.

### An Unbeatable Solution

The next decade of shared processing will be clouded with choices. Only one operating system was first to offer you DOS-compatible, multiuser, multitasking solutions. Only one operating system continues to provide unbeatable multiuser solutions for over 150,000 users. PC-MOS from The Software Link. Call today and set your computing sights on a more productive horizon.



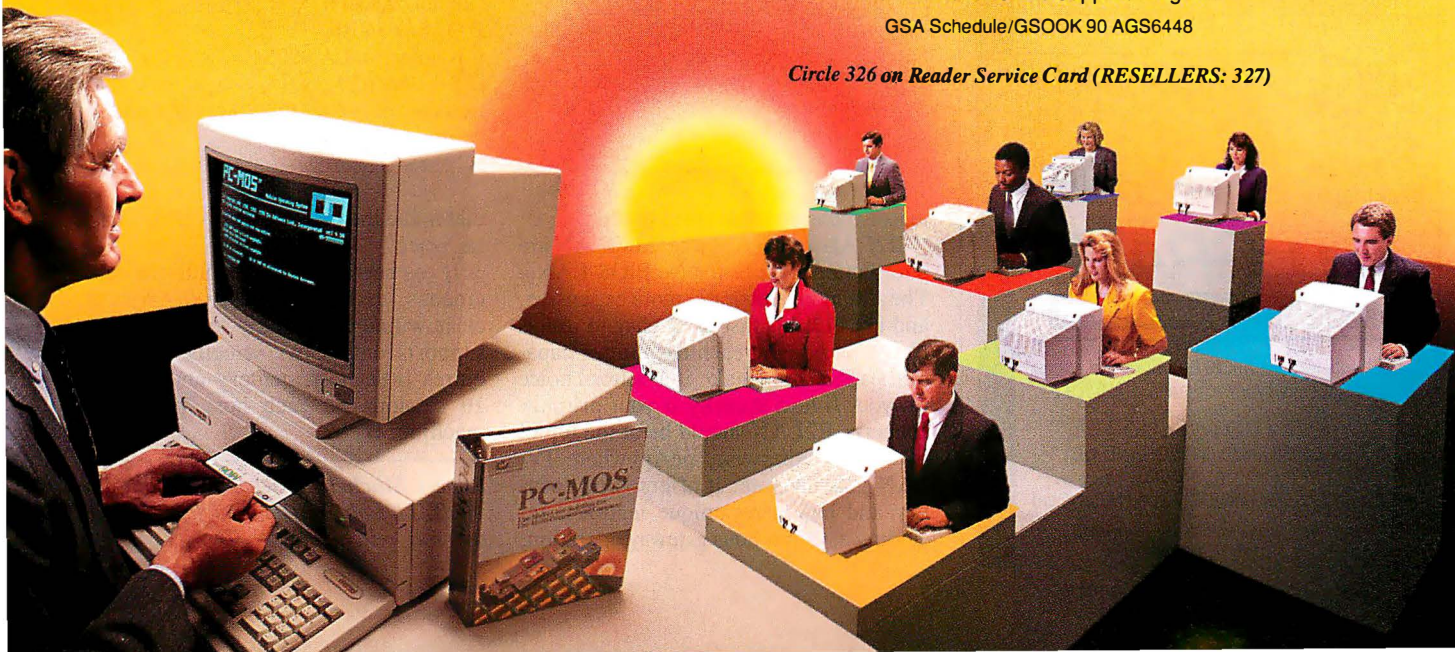
**THE SOFTWARE LINK**

**1-800-451-LINK**

3577 Parkway Lane, Norcross, GA 30092  
(404) 448-5465 FAX: (404) 263-6474 TELEX: 4996147 SWLINK

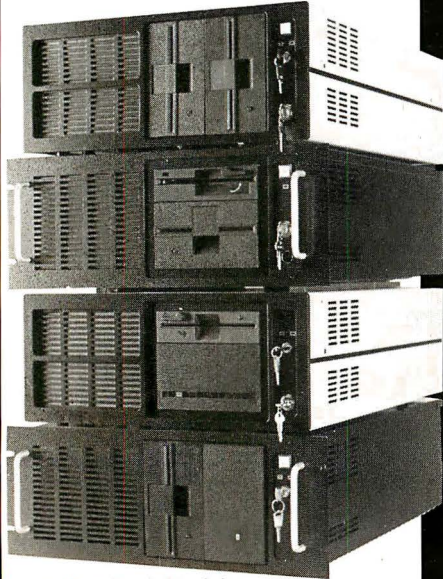
**VARS and RESELLERS:**  
Ask about our Sales Support Program  
GSA Schedule/GSOOK 90 AGS6448

*Circle 326 on Reader Service Card (RESELLERS: 327)*



# Rack & Desk PC/AT Chassis

Integrand's new Chassis/System is not another IBM mechanical and electrical clone. An entirely fresh packaging design approach has been taken using modular construction. At present, over 40 optional stock modules allow you to customize our standard chassis to nearly any requirement. Integrand offers high quality, advanced design hardware along with applications and technical support *all at prices competitive with imports*. Why settle for less?



## Rack & Desk Models

Accepts PC, XT, AT Motherboards  
and Passive Backplanes

Doesn't Look Like IBM

Rugged, Modular Construction

Excellent Air Flow & Cooling

Optional Card Cage Fan

Designed to meet FCC

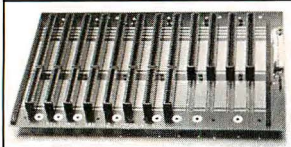
204 Watt Supply, UL Recognized

145W & 85W also available

Reasonably Priced

*Now  
Available*

Passive  
Backplanes



## INTEGRAND

RESEARCH CORP.

Call or write for descriptive brochure and prices:  
8620 Roosevelt Ave. • Visalia, CA 93291

**209/651-1203**

TELEX 5106012830 (INTEGRAND UD)

FAX 209/651-1353

We accept Bank Americard/VISA and MasterCard

IBM, PC, XT, AT trademarks of International Business Machines.  
Drives and computer boards not included.

## REVIEW

## LAN REMOTE-CONTROL SOFTWARE

### COMPANY INFORMATION

**Artisoft, Inc.**  
(The Network Eye 1.23)  
575 East River Rd.  
Tucson, AZ 85704  
(602) 293-6363  
**Inquiry 1076.**

**Brightwork Development, Inc.**  
(Netremote + 4.1)  
766 Shrewsbury Ave.  
Jerral Center W  
Tinton Falls, NJ 07724  
(800) 552-9876  
(201) 530-0440  
**Inquiry 1077.**

**DCA**  
(R2LAN 2.0)  
1000 Alderman Dr.  
Alpharetta, GA 30201  
(404) 442-4000  
**Inquiry 1078.**

**D-Link Systems, Inc.**  
(Screen Monitor 5.1)  
5 Musick  
Irvine, CA 92718  
(714) 455-1688  
**Inquiry 1083.**

**Dynamic Microprocessor Associates**  
(pcAnywhere IV/LAN 4.02)  
1776 East Jerico Tpk.  
Huntington, NY 11743  
(516) 462-0440  
**Inquiry 1079.**

**Farallon Computing, Inc.**  
(Timbuktu 3.1)  
2000 Powell St., Suite 600  
Emeryville, CA 94608  
(415) 596-9100  
**Inquiry 1080.**

**Microcom Systems, Inc.**  
(Carbon Copy Mac 1.0)  
500 River Ridge Dr.  
Norwood, MA 02062  
(617) 551-1999  
**Inquiry 1081.**

**Norton-Lambert Corp.**  
(Close-Up/LAN 2.5)  
P.O. Box 4085  
Santa Barbara, CA 93140  
(805) 964-6767  
**Inquiry 1082.**

*Although not included in this review,  
the following companies also sell  
LAN remote-control software:*

**Fresh Technology Group**  
(LAN Assist Plus)  
1478 North Tech Blvd., Suite 101  
Gilbert, AZ 85234  
(602) 497-4200  
**Inquiry 1084.**

**LAN Systems**  
(LANsight)  
300 Park Ave. S  
New York, NY 10010  
(800) 458-5267  
**Inquiry 1085.**

**MicroNet, Inc.**  
(LANshare)  
2356 Parkside Dr.  
Boise, ID 83712  
(208) 384-9137  
**Inquiry 1086.**

**Ultinet Development, Inc.**  
(Remote Access)  
P.O. Box 34016  
Los Angeles, CA 90034  
(213) 204-0111  
(remote control for OS/2 workstations)  
**Inquiry 1087.**

least expensive programs I tested.

R2LAN and pcAnywhere IV/LAN are both better choices for NetBIOS LANs. They're more elaborate, more expensive, and not quite as fast or as easy to use as Netremote+. But each has unique capabilities that may make it a better choice for you. If host security is your primary concern, R2LAN should be at the top of your list. Otherwise, pcAnywhere IV/LAN gets my vote. It offers good security and has many unique features, including asynchronous gateway operation,


that make the product worth DMA's asking price.

If you need to establish multiple simultaneous sessions, Close-Up/LAN is the clear winner. This easy-to-use program supports only CGA screens, but it requires little host memory and supports 16 sessions on each host and remote machine. ■

*Robert Mitchell is a technical editor in the BYTE Lab. You can reach him on BIX as "rob\_mitchell."*



# DOS Lives. Despite what you may have read.

 **Insufficient memory to run application;**  
**close one or more applications to increase available memory and try again.**

Windows 3.0 may have been a big step forward for some programs.

But it was a big step backward for DOS. Suddenly, it was 1987 all over again. Not enough room for DOS programs to run because TSRs, utilities, drivers and buffers were taking up room your DOS programs need.

## QEMM 5.1 to the rescue

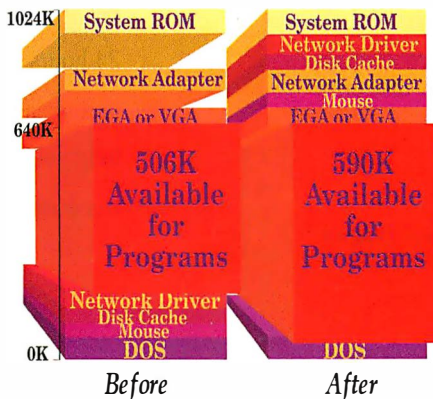
Now, we've updated QEMM to provide additional memory for DOS programs within Windows 3.0.

QEMM 5.1 works with the built-in capabilities of your 80386 or i486 processor to find and recover unused memory segments. As you can see in the chart, there are gaps in your PC's memory usage above 640K. QEMM 5.1 fills those gaps and provides more room for your DOS programs to run.

And of course, QEMM 5.1 still works with DOS when you're not running

*When Windows 3.0 says there's not enough room to run your DOS programs, it's just trying to tell you it needs QEMM 5.1.*

Windows. You get all the same benefits: up to 130K more memory to run the new generation of memory-hungry programs; space for larger spreadsheets and database files.



*Unused memory is like hidden gold in your PC. QEMM finds it and makes it available.*

## Introducing DESQview 2.3 and DESQview 386 2.3 for users of Windows 3.0

They said it couldn't be done, but DESQview 2.3 can run Windows 3.0 programs. Not just in Windows "Real mode" but in "Standard" mode. That means programs can be up to 16MB.

And it can run DOS programs and DOS-extended programs i.e., 1-2-3 Release 3, side-by-side.

DESQview 386 2.3 does all that and more. It lets you run 386 DOS extended programs like AutoCAD 386 and IBM Interleaf side-by-side.

DOS, extended DOS; Windows—whatever standards you set, we will support. We're committed to helping you get the most out of your hardware and software today. And tomorrow.

QEMM 386 System Requirements: 80386-based PCs and PS/2s and PCs with 80386 add-in boards. Operating system: PC DOS 2.0-4.0, MS DOS 2.0-4.0, Windows 3.0. Conventional memory requirement 15K.  
DESQview System Requirements: IBM Personal Computer and 100% compatibles (with 80386, 8088, 80286, 80386 or i486 processors) with monochrome or color display; IBM Personal System/2 • Memory: 640K recommended; for DESQview itself (6-155K • Expanded Memory (Optional): expanded memory cards compatible with the Intel AboveBoard; enhanced expanded memory boards compatible with the AST RAMpage; EMS 40 expanded memory cards • Disk: two diskette drives or one diskette drive and a hard disk • Graphics Card (Optional): Hercules, IBM Color/Graphics (CGA), IBM Enhanced Graphics (EGA), IBM PS/2 Advanced Graphics (VGA) • Mouse (Optional): Mouse Systems, Microsoft and compatibles • Modem for Auto-Dialer (Optional): Hayes or compatible • Operating System: PC-DOS 2.0-4.0; MS-DOS 2.0-4.0 • Software: Most PC-DOS and MS-DOS programs; programs specific to Microsoft Windows 1.03-3.0, GEM 1.1-3.0, IBM TopView 1.1 • Media: DESQview is available on either 5-1/4" or 3-1/2" floppy diskette.

Trademarks: Windows, MS-DOS: Microsoft Corporation; PS/2, Interleaf, TopView: IBM Corporation; 80386, 1486, AboveBoard: Intel Corporation; 1-2-3: Lotus Development Corporation, AutoCAD 386: Autodesk, Inc; RAMpage: AST Research; Hercules, MouseSystems; Hayes; GEM, Digital Research, Inc.

**Yes!** I need increased DOS productivity in Windows!

Payment method  Visa  MasterCard

Expiration  /

Card #

Name  *Please allow 3 weeks for delivery*

Address

City

State  Zip

Qty	Product	5-1/4	3-1/2	Each	Totals
	QEMM 386 5.1			\$99.95	
	DESQview 386 2.3 (includes QEMM)			\$219.95	
	DESQview 2.3			\$129.95	
Shipping & Handling \$5 in USA/\$10 outside USA					
California Residents add 6.75%					
Grand Total					



Quarterdeck Office Systems, 150 Pico Blvd., Santa Monica, CA 90405 (213) 392-9851 Fax: (213) 399-3802

# Freedom of Choice.

At Jameco, you have the freedom to choose from a complete line of starter, mid-range, and full powered computer kits. You also have the freedom to build and expand these kits by choosing the major components that best suit your individual needs: from memory, monitors, and disk drives; to scanners, mice, and trackballs; to cables, power protectors, and more.

*Take a look at two of our 80386 and 80386SX expandable computer kits:*

## Jameco 25MHz 80386 Computer Kit

Includes:

- 80386 25MHz Motherboard, 4MB RAM (expandable to 8MB)
- 101-key enhanced keyboard
- Multi I/O Card
- Toshiba 1.44MB, 3.5" DSHD floppy disk drive
- Desktop computer case
- 200 Watt power supply
- DR DOS 5.0 by Digital Research and Diagsoft's QAPLus diagnostic software

**\$1899.95** monitor extra  
JE3825

## Jameco 16MHz 80386SX Computer Kit

Includes:

- 80386SX 16MHz Motherboard, 2MB RAM (expandable to 8MB)
- 101-key enhanced keyboard
- Multi I/O Card
- Toshiba 1.44MB, 3.5" DSHD floppy disk drive
- Desktop computer case
- 200 Watt power supply
- DR DOS 5.0 by Digital Research and Diagsoft's QAPLus diagnostic software

**\$1199.95** monitor extra  
JE3816

Call us for our new 1991 catalog. In it you'll find an extensive offering of quality computer products and electronic components. You have the freedom to order 24 hours a day and if you need assistance, expert technicians are available from 7 am to 4 pm (PST) to help you with all your computing needs. Enjoy the freedom of choice. Call Jameco today at (415) 592-8097.

To place an order, call our  
24-hour order hotline  
**(415) 592-8097.**  
Or FAX us at (415) 592-2503,  
or (415) 595-2664.

**JAMECO**  
COMPUTER PRODUCTS

1355 Shoreway Rd., Belmont, CA 94002  
(415) 592-8097 FAX: (415) 592-2503

Terms: Prices are subject to change without notice. Items subject to availability and prior sale. Complete list of terms/warranties is available upon request. All trade names are registered trademarks of their respective companies.

© 1/91 Jameco Computer Products



Circle 162 on Reader Service Card

# 24 Hours a Day.



**JAMECO**

**JAMECO**

**JA**



## EFFICIENT DESIGN

Birds, turtles, crocodiles — just as the egg is nature's most efficient design for delivering complex life systems, DTK's KEEN-3300 Series is the ideal 386 computer with which to build your network or multi-user system. As a fileserver, workstation or standalone system, its unique write-back cache (64KB/256KB) and competitive price make it one of the most cost-efficient, high-speed systems available.

## HIGH DEPENDABILITY

Over 100 full-time design and manufacturing engineers work together to ensure that dependability is "built-in." Then, QC personnel scrutinize every DTK motherboard and system to the most stringent standards in the industry. Over 2,000,000 satisfied customers testify to our reputation for quality and dependability.

## GROWTH POTENTIAL

Like the egg, the basic KEEN-3300 is merely the beginning. Its 16 MBytes of high-speed RAM, 8 expansion slots and 7 drive bays (server) provide the flexibility you need to expand your system as your requirements grow.

The KEEN-3300 — a powerful beginning at a price that won't crack your budget. Call for the dealer nearest you, DTK Computer Inc., (818) 333-7533. 15711 E. Valley Blvd., City of Industry, CA 91744. Fax: (818) 333-5429.



**A reputation for success.**

CITY OF INDUSTRY, CA  
(818) 333-7533

SAN JOSE, CA  
(408) 436-6363

HOUSTON, TX  
(713) 568-6688

ELK GROVE VILLAGE, IL  
(708) 593-3080

EDISON, NJ  
(201) 417-0300

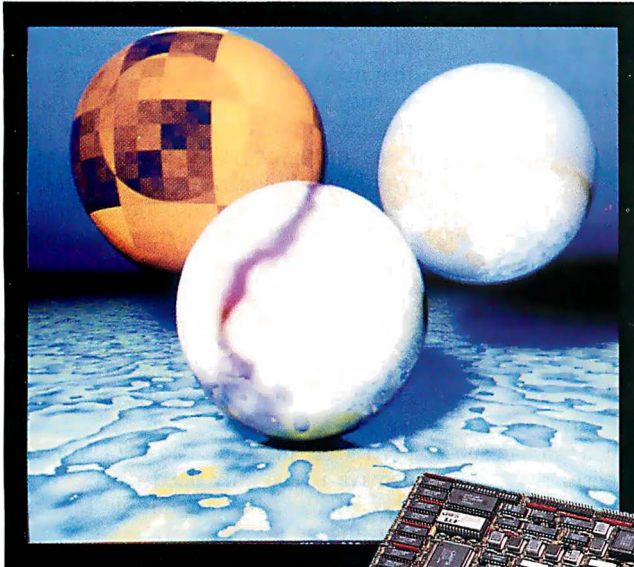
MIAMI, FL  
(305) 477-7440

DTK is a trademark of Datatech Enterprises Co., Ltd. 80386 is a trademark of INTEL Corp. ©DTK Computer Inc., 1990.

Circle 99 on Reader Service Card (RESELLERS: 100)

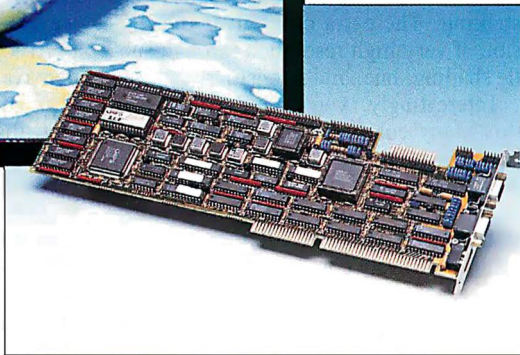
## REVIEW

# "Ultra" VGA Debuts on the MicroPaq



**Photo 1:** Monolithic's MicroPaq 452 Ultra uses a custom graphics chip from Edsun Labs to simultaneously display 700,000 colors on a standard VGA monitor.

**Photo 2:** A MicroPaq board with an Edsun Labs graphics chip displayed this 35,000-color demo image on a VGA monitor. At press time, drivers weren't available to run commercial software.



On the surface, Monolithic Systems' MicroPaq 452 Ultra looks like a handy multifunction board that enables you to install hard and floppy disk drive controllers, parallel and serial ports, and a graphics adapter into a single expansion slot. But run it with a custom software driver on a standard VGA monitor, and you'll see its secret. An Edsun Labs Continuous Edge Graphics (CEG) chip on the board displays graphics images on a standard PC that rival those seen on some high-end engineering workstations.

The Edsun CEG chip eliminates jagged oblique lines (aliasing) while displaying over 700,000 colors; standard VGA displays support a maximum of 256 simultaneous colors. You can think of the chip design as the "TV approach" to computer display. Even though screen resolutions are only 525 lines, broadcast TV images don't suffer from the jaggies, thanks to the large number of colors used in TV broadcasts. Instead of trying to achieve higher and higher actual resolutions, the Edsun design relies on thousands of colors and the ability to combine two colors in a single pixel. This fills in the edges of lines that would appear jagged

with conventional technologies.

The color approach to improving apparent resolution works because beyond resolutions of 400 lines or so, the human eye can't distinguish between actual resolution improvements and color enhancements that produce apparent improvements in resolutions. And because the images run on a standard fixed-frequency VGA display, there's no need to spend extra money on a high-resolution display.

## CEG Explained

Monolithic Systems is one of the first vendors to ship the CEG chip in production versions of motherboards and multifunction cards (see photo 1). Monolithic markets the \$765 MicroPaq 452 Ultra primarily for CAD, business graphics, and desktop publishing applications.

Edsun's CEG/DAC (D/A converter) is a pin-for-pin replacement for most of the popular RAM/DAC chips used in current VGA display adapters, including the Brooktree BT471/8 and Analog Devices ADV476 chips. Edsun supplies its chips in various packages to match different RAM/DAC configurations. The chip itself costs board manufacturers about \$20 and requires little or no hardware rede-

sign to reside on existing VGA boards, according to Edsun.

Although commercial versions of the hardware were shipping at press time, custom video drivers that support the CEG technology weren't available when we evaluated the board. Monolithic says it plans to be shipping drivers for Lotus 1-2-3, AutoCAD, and Windows 3.0 by the time you read this. Edsun is writing driver software for these environments and is releasing code to encourage developers to write for other applications. Edsun believes the technology could encourage software developers to combine graphics with databases, for example.

Software that takes advantage of the new chip does not store or "remember" every color to be used in an image. Rather, the application specifies some of the colors, and the chip calculates the rest. Separate red, green, and blue processors positioned between the color lookup table and the DAC output compute color points between known colors.

CEG images are generally conversions of existing files, such as TIFF or TARGA images. The CEG format reduces storage requirements yet retains image information down to  $\frac{1}{32}$  pixel, according to Monolithic. For example, a 640-pixel by 480-line VGA image with 75,000 colors requires only 308K bytes of space. Higher-resolution images require more storage space, but the CEG format can still be more efficient than some other formats for graphics images.

## Monolithic Achievement

Monolithic's implementation of the CEG chip is a good one. It turned our standard VGA monitor into a surprisingly capable graphics station. This full-size, 16-bit card includes dual serial ports, a parallel port, an Intelligent Drive Electronics



## MicroPaq 452 Ultra

### Company

Monolithic Systems Corp.  
7050 South Tucson Way  
Englewood, CO 80112  
(800) 525-7661  
(303) 790-7400

### Hardware Needed

IBM AT or full-size compatible with a VGA monitor

### Price

\$765

### Inquiry 1061.

(IDE) hard disk drive interface, a dual-floppy disk drive controller, and the Edsun-based display adapter.

The IDE interface is designed for the industry's AT intelligent drives. We ran the hard disk drive controller with a Control Data Imprimis 143-megabyte hard disk drive with no compatibility problems. Likewise, we used the floppy disk drive controllers with a variety of drives without a snag.

We configured the serial ports as COM3 and COM4 so we could use them in conjunction with the existing motherboard-based COM1 and COM2 ports. You can set the serial and parallel ports to address all DOS-supported locations through on-board jumpers. Monolithic supplies the cables and connectors you'll need to hook up all the I/O ports, including the IDE drive. You can use jumpers or switch settings to disable each of the ports individually if you have these facilities on your motherboard.

We plugged the MicroPaq 452 Ultra into a low-profile CompuAdd 386SX, and although the full-size card was a tight fit, it worked fine. Without any special software, the display is sharp and crisp—just what you would expect from a high-quality VGA card. When we turned on the MicroPaq's mode drivers, it looked like no other VGA display we have seen (see photo 2). Demonstration images from Edsun, supplied as part of the Monolithic package, shows scanned photographs, computer-generated art, line drawings, and even moving graphics with 75,000 colors displayed simultaneously.

The display adapter uses the Chips &

**T**he IDE interface is designed for the industry's AT intelligent drives.

Technologies 82C452 video controller for high-performance VGA graphics in resolutions of 1024 pixels by 768 lines (this requires a multisync monitor designed to support this resolution). But even at the standard 640-pixel by 480-line VGA resolution, the results were striking. The extra color gives the illusion of very high resolution through subtle shading, hue, and intensities.

Interestingly, you don't need nearly this many colors for truly striking displays. Some images with "only" 3000 or 4000 colors look like engineering drawings that we've seen on \$250,000 workstations. In addition, all these images were a relatively compact 308K bytes.

The MicroPaq did indeed remove the jaggies. It achieves straight lines primarily by filling in the ragged edges with extra color. This makes some lines appear a bit fatter than their jagged counterparts, but the results are impressive.

#### A WYSIWYG Natural

Monolithic Systems is targeting the MicroPaq 452 Ultra for three basic applica-

tions. One is CAD, where jaggies exist even at 1024-pixel by 768-line resolutions. Second, image displays, such as image databases or scanned-image presentations, could use the board's multi-color capabilities for more realistic displays. Finally, Windows applications that make use of WYSIWYG and graphics may also benefit from the antialiasing features. For example, italics and small fonts displayed in Excel or Microsoft Word for Windows are difficult or impossible to read on conventional displays.

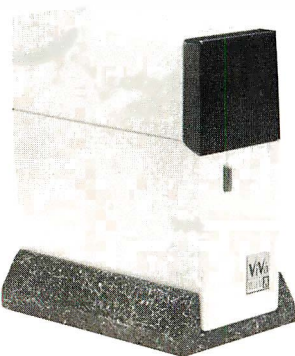
The biggest short-term problem with the MicroPaq is the lack of applications that take advantage of the board's capabilities. If third-party developers decide to support CEG technology, we could see some very significant and welcome changes in the looks of the applications we use.

At \$765, the MicroPaq 452 Ultra is expensive if you only need the video display adapter. But Monolithic says it is working on a video-only version of the board. For users whose systems are already configured with disk drive controllers and I/O ports, it is probably better to wait for that version to come out. However, if you're using separate plug-in cards for disk drive controllers and I/O ports, the MicroPaq saves slot space and can display images on a VGA screen that you truly have to see to believe. ■

*Tom Badgett and Corey Sandler review hardware and software products for Word Association, Inc., a consortium of high-tech authors. They can be contacted on BIX c/o "editors."*

# ViVa 2400 baud Modems

**FAX It - Compress It - Send It with ViVa!**



The ViVa 24, 24fx and 24m external modems expand your world with standard 2400 baud transmission rate, built-in FAX capability, or MNP 5 data compression.

All ViVa internal and external modems are 100% Hayes compatible and support the Hayes "AT" Command Set.

ViVa modems fit easily into your IBM PC, XT, AT, PS/2, 386, 486 and IBM compatibles and each is backed by a FIVE YEAR WARRANTY. **1-800-854-7600**

**COMPUTER PERIPHERALS, INC.**

667 Rancho Conejo Blvd. • Newbury Park, California 91320 • 805-499-5751

# They Left out Features.... We Left out the **COMMA!!**

## The only thing missing...

is the comma in the price. If you look at the chart on the right you will see prices charged by our competition. All but one contain a comma. **DesignCAD 3D** sells for \$399.00. Period. No Comma!

In order to draw the complex pictures shown below it is desirable to have the following 3D features:

- Interactive design with 3D cursor
- Blending of surfaces
- Boolean operations such as add, subtract, and intersection
- Complex extrusions
- Cross sectioning
- Block scaling
- On screen shading
- Shaded output to printers and plotters

All of these competitors left out one or more of these desirable features in their standard package. They didn't forget the most horrible feature - the comma.

**DesignCAD 3D** offers **ALL** the listed features plus many more!

If **DesignCAD 3D** has the power to create the 3D objects shown below, imagine how it could help with your design project!

**DesignCAD 3D** sells for \$399. We left out the comma. We didn't think you would mind!

### PC MAGAZINE SAYS...

*DesignCAD 3D, the latest feature-packed, low-cost CADD package from American Small Business Computers, delivers more bang per buck than any of its low-cost competitors and threatens programs costing ten times as much. For a low-cost, self-contained 3D package... DesignCAD's range of features steals the show."*

# \$399

American Small Business Computers • 327 South Mill Street • Pryor, OK 74361 U.S.A.

AutoCAD rel. 10	\$3,000.00	AutoCAD AEC \$1,000.00	AutoShade \$500.00
CADKEY 3.12	\$ 3,195.00	Solids \$995.00	IGES translator \$1,995.00
DataCAD with DC Modeler	\$ 3,990.00	DataCAD Velocity \$2,000.00	
<b>DesignCAD 3D ver. 2.0</b>	<b>\$ 399.00</b>	<b>NO expensive options! IGES Free, Shading Free</b>	
MaxxiCAD 1.02	\$ 1,895.00	N/A	
Mega Model	\$ 995.00	MegaDraw \$195, List \$295, MegaShade \$395	
MicroStation PC 3.0	\$ 3,300.00	Customer Support Libraries \$1,000.00	
ModelMate Plus 2.8	\$ 1,495.00	N/A	
VersaCAD Design 5.4	\$ 2,995.00	N/A	

Source: Byte Magazine

### BYTE MAGAZINESAYS...

*"At \$399, DesignCAD 3D was the least expensive package we saw, yet it was one of the more powerful. ..Don't be fooled by the remarkably low price, this program can really perform."*

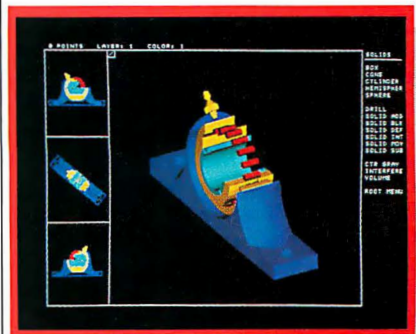
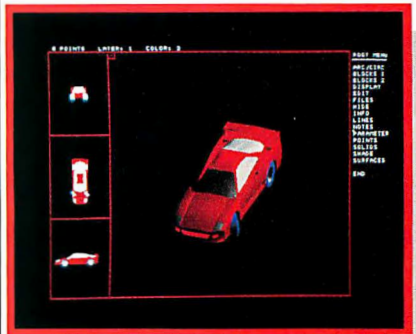
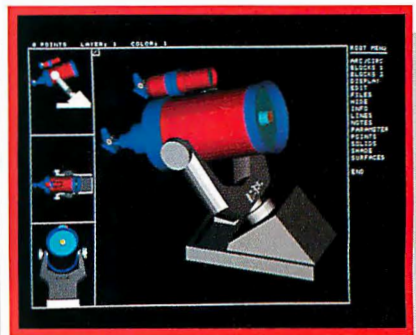
May 1989, page 178

Complete 3-Dimensional design features make it easy for you to construct realistic 3-D models. With full solid-object modeling capabilities you can analyze your drawing to determine the volume, surface area or even center of gravity! **DesignCAD 3-D** even permits you to check for interference between objects! Aeronautical Engineers can now find the center of gravity for a new airplane design with a couple of keystrokes. The Architect can determine the surface area of a roof for decking in a matter of minutes. The Civil Engineer can calculate the volume of a lake or dam in seconds. The Mechanical Engineer will know for sure if certain parts fit together without interference. The uses for **DesignCAD 3-D** are only limited by YOUR imagination!

### HOW DO I GET ONE?

**DesignCAD 3-D** and **DesignCAD 2D** are available from most retail computer stores, or you may order directly from us. If you have questions about which program to purchase please give us a call. All you need to run **DesignCAD 3-D** is an IBM PC or compatible computer with 640 K RAM memory and a hard disk. Both products support most graphics cards, printers, plotters and digitizers. Free information and a demo disk are available by faxing (918) 825-6359 or telephoning:

## 1-(918) 825-4844



## REVIEW

## TARGA+ Lowers Cost of High-End Graphics



*I produced this hypothetical Kennedy Memorial using the TARGA+ adapter's 32-bit and 16-bit modes with AT&T's Topas 3-D Modeler and Truevision's TIPS capture and paint software. The main structure was created as a DXF wire frame in AutoCAD (as shown in the lower left). This was converted to a Topas Model (MDL) file using AT&T's CAD translator. The model was then imported and rendered in the TARGA+ adapter's 32-bit mode using Topas. The still of the planned site was captured from videotape. The brass title plate, wood frame, and site still were reflection- and texture-mapped to 3-D objects created in Topas (original DXF file courtesy of Douglas Persson; file-image-to-slide conversion courtesy of Image Center).*

Since the mid-1980s, Truevision's TARGA (Truevision Advanced Raster Graphics Adapter) raster-graphics boards have stood as a cornerstone for professional-quality graphics and image generation. Medical imagers and TV stations were among the first to employ TARGA boards for creating and capturing images at the NTSC-compatible resolutions of 512 pixels by 486 lines in varying bit-plane pixels (bpp) and color depths. In short, a TARGA image doesn't look computer-generated; it is more akin to TV output.

Until now, to get such high-quality graphics, you'd have to spend about \$5000 to implement 32-bit color on TARGA 32 adapters, which can display over 16 million colors per image. TARGA adapters also required an NTSC composite or an RGB analog display monitor with a 15.5-kHz horizontal scanning frequency (the standard VGA frequency is 31.5 kHz at 640- by 480-pixel resolution). Total costs were out of reach for many enthusiastic, but budget-conscious, graphic artists or computer imagers.

Truevision's new TARGA+ series addresses all these issues and more. For example, the TARGA+ 64 board, with 2 megabytes of on-board memory, costs just \$2495, 50 percent less than previous

32-bit TARGA boards. Other TARGA+ adapters, like the TARGA+ 16 and the TARGA+ 16/32, retail for \$1795 and \$1995, respectively. Both boards have 1 MB of DRAM. They differ only in the number of colors they can display.

With the TARGA+ series boards' lower prices, many users formerly priced out of the market can now afford raster imaging. This includes advertising agencies and corporate art departments that can use TARGA adapters for advertising campaigns and layouts. Professional printers also use raster imaging for prepress work, such as electronic color separation of photographs, which traditionally is done by hand.

#### Imaging Plus

The TARGA+ 64 adapter that I tested is a full-slot, 16-bit ISA board. A Macintosh model, called the Nu Vista+, is also available, as is a Micro Channel architecture version, the first TARGA to support Micro Channel machines. Two nine-pin D-shell connectors serve as the analog video I/O ports for the ISA board.

Two proprietary on-board application-specific integrated circuits represent the major revisions in the "plus" line. The first, a CTL (for Condensed TARGA Logic) chip, helps reduce board component circuitry to lower manufacturing

costs and eliminate the daughterboard attachments found on earlier TARGAs. A second ASIC, the TVG-MIX-V2, provides software-controlled video mixing and special-effects functions. (Unlike a Texas Instruments Graphics Architecture graphics board, TARGA adapters have no on-board processor.)

The TVG-MIX-V2 chip supports a host of software-controlled video special effects that can simulate high-end video production techniques such as image fades, image reversal, graphics over live video, and chroma keying. In the latter, a foreground video object moves against a color-keyed background video image, as when a TV weather forecaster moves in front of a weather map. The chip also controls VGA pass-through. You can connect a TARGA+ adapter to a VGA card's feature bus to enable VGA text and graphics pass-through to the TARGA+ adapter's RGB output monitor.

For testing, I used an Associates Computer Supply 386/25 tower system running DOS 3.31 with 640K bytes of base memory and 8 MB of DRAM configured as expanded memory using QEMM software. A Relisys RE5120 monitor functioned as my primary VGA display. I also used a Relisys RE5155 multiscan monitor (operating at 15.5-kHz horizontal bandwidth) for RGB/TARGA output dis-



play and VGA text and graphics pass-through testing.

### Plug-and-Play

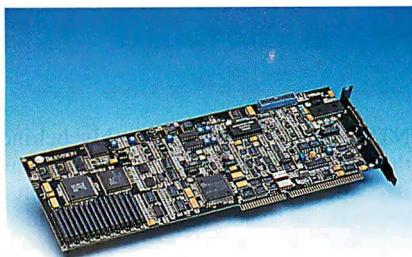
Two spiral-bound reference and installation manuals clearly explain the myriad settings for three on-board banks of DIP switches. The SW1 bank controls board I/O base address functions. I kept the default address setting at 0x220, although eight locations are possible. I left switch SW2 in the default down position to control horizontal/vertical sync output. In the up position, the board processes S-Video signals. S-Video (also known as S-VHS), which was originally developed for TV broadcasts, separates the signal luminance and color bandwidths, providing superior image quality—400 lines versus the 230-line VHS resolution. Bank switch SW3 controls interrupt requests; I left this in the shared interrupt default position, although five different IRQ settings are possible.

I currently use a TARGA 16 adapter for imaging and animation. After removing that board, I placed the TARGA + 64 in the empty 16-bit slot. To enable VGA overlay and pass-through features, I connected one of the two ribbon cables shipped with the unit from the TARGA + adapter's 26-pin male connector to my Trident VGA card's edge-card-type feature bus. The second ribbon cable ends in a 26-pin female connector. I used this cable to test Diamond Computer Systems' SpeedStar VGA card, which has a 26-pin male feature bus. Both cards functioned perfectly when connected to the TARGA + 64.

The TARGA + 64 adapter functions in two modes: standard TARGA board emulation and TARGA + mode. At the DOS prompt, I typed in TPLUSINI.T16 (you can replace "16" with 8, 24, or 32 to specify the proper emulation). The TPLUSINI command places the TARGA + into original TARGA mode. I then invoked my three-dimensional animation program, AT&T's Topas. I was extremely pleased to see the software function perfectly.

After exiting, I reinitialized the board to TARGA 32-bit emulation. When I reentered Topas, the TARGA + was running as a 32-bit adapter. I then used a commercial version of Truevision's TIPS paint and capture software to capture video images, as shown in the photo (a demo version of TIPS also comes with the TARGA + board).

Again, all the software and normal TARGA hardware features, such as zoom and image digitization, functioned perfectly. I didn't expect to see a difference



### TARGA + 64

#### Company

Truevision, Inc.  
7340 Shadeland Station  
Indianapolis, IN 46256  
(317) 841-0332

#### Hardware Needed

XT or AT with one free full-length 8- or 16-bit slot, VGA monitor, RGB multiscanning analog monitor, VGA card with feature bus I/O, and at least 640K bytes of RAM

#### Software Needed

TARGA applications software; applications software written specifically for TARGA+ required for TARGA+ mode

#### Price

\$2495

#### Inquiry 1108.

in the final 32-bit images, but I was wrong. In the 32-bpp mode, rendered objects appeared more realistic and fluid than duplicate objects rendered in the 16-bpp mode.

#### TARGA + Mode

To invoke TARGA + operation, I put the command `DEVICE=C:\DOS\TARGAP.SYS` into my `CONFIG.SYS` file and rebooted. TARGA + mode enables the VGA text and VGA graphics overlay and pass-through to the TARGA + adapter's RGB monitor. This gives you a one-monitor solution, but only if you're using TARGA + software specifically developed to run in TARGA + mode. The TARGA + will run all original TARGA software, such as TIPS and Topas, after you reinitialize the board with `TPLUSINI`, which disables VGA text and graphics pass-through.

At press time, Truevision offered two software packages that operate in the TARGA + mode: the TIPS paint and capture program and TIPS TypeRight, a font-generation program for TARGA images. Panorama+, from AT&T-Graphics Software Labs; i.m.a.g.e., from New Image Industries; Inscribe, from Image North Technologies, and are third-party applications that support "plus" mode. According to Truevision,

## BBS Sysops

- Are you looking for ways to improve your board? Something that will set you apart from other boards in your area?
- Are your subscribers interested in Microcomputers? Listen to this!

### Announcing the Bulletin Board EXchange

The Bulletin Board Exchange allows you to become a publisher of Micro-BYTES Daily, an on-line news service from BYTE. Bulletin Board Exchange/MicroBYTES is a custom package of news and features designed especially for local BBSes, and is available only to sysops.

Every Monday through Friday you get articles about developments in micro-computing, telecommunications and selected new product announcements. Get the latest news about MS DOS machines, Macintoshes, Unix workstations, Amigas, Atari STs, peripherals and software. All the stories are reported, written, and edited by the staff of BYTE Magazine, BYTEweek and BIX, and our world-wide network of reporters and editors.

Not only do you get a great resource for your subscribers, but you also get access to BIX which will cut your cost of exchanging information and conducting BBS network business.

**All this is just \$49 a quarter.**

Your one-year subscription to the Bulletin Board Exchange (billed quarterly) may be cancelled any time without further charge; just notify us. If you prefer, you may subscribe for three months only, at just \$69.

If you call BIX direct, you pay no hourly telecommunications charge. If you call using Tymnet, the rates are only \$3/hour on evenings and weekends and \$6/hour on weekdays. You may also purchase unlimited off-peak Tymnet for just \$20 a month.

**Subscribe today.**

# BIX

One Phoenix Mill Lane  
Peterborough, NH 03458  
800-227-2983  
In NH 603-924-7681

third-party manufacturers are developing or revamping original TARGA software to take advantage of the TARGA+ mode environment.

In the meantime, TDEMO.EXE is the program that really highlights the TARGA+ mode. I input an NTSC composite VHS video signal from my VCR into the TARGA+ video input connector. An extremely clean and smooth transitional fade between two TARGA Truevision logo images begins the demo.

NTSC video fades in smoothly behind the logos. After the logos fade behind the live video, the moving images perform a reversal, or color negative. All video movement was clear and fluid; it actually looked better on the RGB monitor than on TV. A live video then fades into VGA text overlaid on a still-frame capture from the videotape.

Finally, the demo displays multiple single-frame captures of video in rapid sequence. Live-video movement dis-

played with this FX feature appeared animated. The program grabs and displays a video frame for about a half-second, causing objects to jerk from one position to the next, an effect similar to that of a strobe light on moving dancers. Video production equipment that performs this frame grab/hold/display technique alone can cost several thousand dollars. The technique is also used in music videos.

TMODE.EXE is an interactive program that sets TARGA+ resolution, pixel depth, and video format. There are 20 possible NTSC/VGA resolutions and 14 possible PAL display resolutions. To execute PAL resolutions, you must use the European version of the TARGA+ adapter.

After setting my board to NTSC (512 by 486 pixels by 32 bits, noninterlaced) using TMODE, I used a small TSR program, TPLUSTSR.EXE, to switch among TARGA+ output, VGA output, VGA overlay, and overlay color selection. By keying Ctrl-Shift-F2 and then Ctrl-Shift-F3, I passed VGA text and graphics to the RGB monitor. I used a shareware GIF file viewer, VPIC, to view 640- by 480-bit and 800- by 600-bit by 256-color GIF pictures rescaled to the 512- by 486-bit resolution on the RGB monitor. Both VGA graphics and text were extremely clear and readable.

### TARGA Tally

At first, I was dismayed to find that the TARGA+ adapter's VGA pass-through/overlay modes and video-effects features don't function in the original TARGA software mode. However, this board creates very real possibilities for imaginative software developers. I would be thrilled to see software that incorporates the TARGA+ adapter's video mixing and graphics overlay capabilities into a videotape-editing software module. With a single-frame VTR controller board like DiaQuest's DQ-50P, you could emulate high-end mixing and editing consoles used in TV broadcast production via software-controlled insert-edit points.

Overall, I rate the TARGA+ a winner, not only because you can now do raster-graphics imaging in true 32-bit color at half the price, but also because I can't wait to see the new software that this board will inspire. ■

*Greg Loveria has used TARGA boards for three years as a computer graphics and desktop publishing consultant, animator, and technical writer in Binghamton, New York. He can be reached on BIX c/o "editors."*

## Bugs are expensive. Can you afford them?

**R**ichard Fink, President of RainTree Computer Systems, writes, "...What it [Periscope] offers is probably the most comprehensive debugging capability on the market today. And for you and me, that means getting to market sooner. Getting to market with a cleaner product. That's an objective we all know about."

### Periscope handles the level of debugging you need.

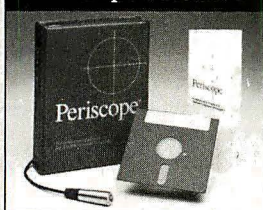
Whether you're developing applications written in a high-level language, doing low-level system development, or something in between, Periscope can help you find the bugs. Randy Brukaradt, a developer of the Janus Ada compiler, writes, "I couldn't imagine using anything else...it is just as useful debugging my Ada code at the source level as it is for finding bugs in assembler code, even TSRs and device drivers."

### There's just not much you can't debug with Periscope.

For example, you can debug device drivers and TSRs, child processes, and software interrupts. You can trace DOS and debug foreground and background programs in the same session. Large programs are no problem. Periscope supports Plink and RTLink overlays, and Windows

30 programs in real mode. You can monitor software running on another system. And you can debug the boot process, hardware interrupts, and real-time code. The Periscope software runs on 8088 through 80486 machines, supports 80386/80486 debug registers, and runs with 386 control programs in the system.

### Periscope Version 5



*Periscope Model II includes a break-out switch and the new Version 5 software. The new software, included with all models, features a menu system that makes Periscope easier than ever to learn and use.*

**Start saving money today. Call Toll-Free: 800-722-7006**

• **verseas, call:** UK - Roundhill Computer Systems, 0672 84 535; Germany - H.B. EDV, 07542 6353; ComFood, 02534 7093; Sweden - LinSoft, 013 124780; Denmark - Ravenholm Computing, 02 88 72 49; Australia - BJE Enterprises, 02 858 5611.

### There's a Periscope model for every budget.

Prices start at \$195 for software-only Model II-X. Model II with its handy break-out switch is \$225. Model I with 512K of write-protected RAM is \$595 for PCs and \$695 for PS/2s. Model IV with its real-time hardware trace buffer and breakpoints is \$1895 to \$2395, depending on your processor and its speed. We'll be happy to help you decide which model you need.

The Periscope Company, Inc.

1197 Peachtree St., Atlanta, GA 30361, USA • 404/875-8080 FAX 404/872-1973

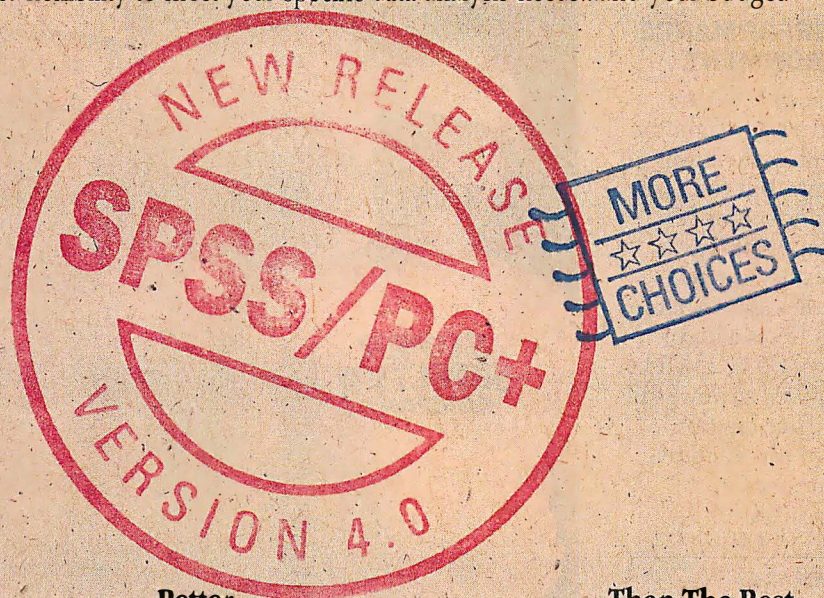
# A Welcome Edition.

## The most popular PC data analysis package is now even better.

Now when you choose SPSS/PC+™ 4.0, not only do you get the best-selling statistical data analysis software, you get a choice. A choice of the options you need. A choice of the options you want.

Powerful options for data entry, advanced statistics, forecasting, mapping, graphics and more.

Options to help you turn data into information. The newest edition of SPSS/PC+ has the flexibility to meet your specific data analysis needs...and your budget.



### SPSS/PC+ 4.0 is...

SPSS/PC+ 4.0 is a fully integrated, sophisticated group of software products designed to handle all your data analysis needs.

SPSS/PC+ allows you to organize, analyze, forecast and display data in countless ways, making it easier to identify patterns and trends that might otherwise go unnoticed. With SPSS/PC+, you gain added insight into the relationships and meaning of your data. And with its graphics and mapping options, SPSS/PC+ provides for a convincing presentation of your conclusions.

### Better...

Along with a choice of options, the new SPSS/PC+ 4.0 offers you something more. Like SURVIVAL for life table analysis, PROBIT for expected dosage modeling, and X11ARIMA for smoothed, seasonally adjusted forecasting. And improvements to procedures like REGRESSION and CROSSTABS. Plus, we've updated our Novell® and 3Com® network support and added Banyan V NES™. SPSS/PC+ 4.0 also supports the latest versions of dBASE®, Excel™ and Lotus®, and by adding Graph-in-the-Box Executive™ and MapInfo™ to our support for Harvard® Graphics and Graph-in-the-Box®, we've created more presentation options than ever before.

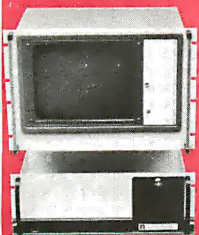
### Than The Rest.

Whether you only choose the options you need, or choose the options you've always wanted, with the latest edition of SPSS/PC+, you've chosen the best. And if you're in need of a comprehensive package, we offer the widest range of options. Of course, SPSS/PC+ still features a menuing and help system, as well as an on-line statistical glossary to help you interpret results as you go. And you'll always have the training and support you can expect from SPSS, suppliers of statistical software to over 2 million users worldwide.

For more information on SPSS/PC+ call 312-329-3318.

# SPSS

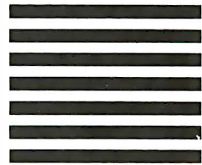




*Mission Critical  
Rack-mount 3014:  
14 option slots,  
5 drive bays and a  
95-130 VAC, 47-440  
Hz power supply,  
pictured with a  
model 1005R EGA  
monitor (optional).*



NO POSTAGE  
NECESSARY  
IF MAILED  
IN THE  
UNITED STATES



**BUSINESS REPLY MAIL**  
FIRST CLASS MAIL PERMIT NO. 2484 HOUSTON, TEXAS

POSTAGE WILL BE PAID BY ADDRESSEE

Texas Microsystems, Inc.  
10618 Rockley Road  
Houston, TX 77099



# Want more than just another pretty face? Send the card. Or call 1-800-627-8700.

Name \_\_\_\_\_ Title \_\_\_\_\_

Company \_\_\_\_\_ Phone \_\_\_\_\_

Address \_\_\_\_\_ City \_\_\_\_\_ State \_\_\_\_\_ Zip \_\_\_\_\_

Are you a  VAR  Consultant  Government Purchaser  Corporate Purchaser  DP/MIS Purchaser  End User

Type of Business \_\_\_\_\_

Type of Operating Environment/Application \_\_\_\_\_

1. How many PCs does your company plan to purchase?

Timeframe:  Within the next month  Within three months  Within six months

Quantity: \_\_\_\_\_

2. What type of configuration are you interested in?

Rack-mount workstation  Benchtop workstation  Tower system  Cards \_\_\_\_\_

3. Which processor do you require in your system?

286-based systems  386-based systems  486-based systems  Other \_\_\_\_\_

4. What operating system would you use? \_\_\_\_\_

5. How many expansion slots do you need? \_\_\_\_\_

6. Do you need assistance developing specifications?  YES  NO

7. What specifications are most important to your application?

Mean Time Between Failures  Mean Time To Repair  Heat \_\_\_\_\_  Dust \_\_\_\_\_  Shock \_\_\_\_\_  Other \_\_\_\_\_

8. What type of custom configuration do you need? \_\_\_\_\_

© 1990, Texas Microsystem Inc. "Mission Critical Micro" is a trademark of Texas Microsystems, Inc. Other trademarks mentioned are registered, trademarked or service marked by their respective manufacturers.

we're always here when you need us.

**NATION-WIDE SERVICE,  
FULL-TIME SUPPORT.**

We believe in offering exceptional support, including consultation during system design. After sales technical support 12 hours a day via an 800 number. On-site service from General Electric for a full year, including free parts and labor. A 30-day, no-questions-asked, money-back guarantee. And a way of ordering a Texas Microsystem that's most convenient and cost effective to you.

Opposite are two Texas Microsystems that offer an unsurpassed combination of price/performance. Order them direct or ask for a complete literature and information kit on all our systems by calling 1-800-627-8700 now.

**TWO EXTREMELY  
UNBEATABLE SYSTEMS.**

Here are two of our top selling systems for business environments that demand mission critical computing, regardless of operating conditions. Like all our systems they enjoy the same engineering pedigree that ensures a unique combination of performance, reliability and value. Which is, after all, what you should expect from America's leading industrial micro systems company.

And to put a little icing on the cake, each will include a one year, on-site, warranty.

To order, call the 800 number below and one of our representatives will discuss your needs with you, give you an instant quote on the configuration of your choice. Then the system will be built to your order, tested, and shipped.

Mission Critical Micros is a trademark of Texas Microsystems Inc., all other trademarks mentioned are registered, trademarked or servicemarked by their respected manufacturers.



Texas Microsystems, Inc.  
10618 Rockley Rd., Houston, Texas 77099  
Tel: 713-933-8050. Fax: 713-933-1029

# EXCEPT PRICE.



**TEXAS MICROSYSTEM 4108**  
MISSION CRITICAL OFFICE PC

*Features*

- Choice of 80286, 80386, 80486 processors.
- Perfect for data acquisition, communications and networking applications.
- 8 full length ISA slots for industry standard cards.
- Up to 16MB of RAM on CPU, three half-height 5.25" bays for floppy/hard drives and one 3.5" hard drive.
- Super VGA graphics (1024x 768 pixels) Also supports CGA, EGA.
- 1 parallel and 2 serial ports.
- 101-key enhanced keyboard with DIN connector on rear panel.
- 220 watt power supply.
- One year, on site warranty included.

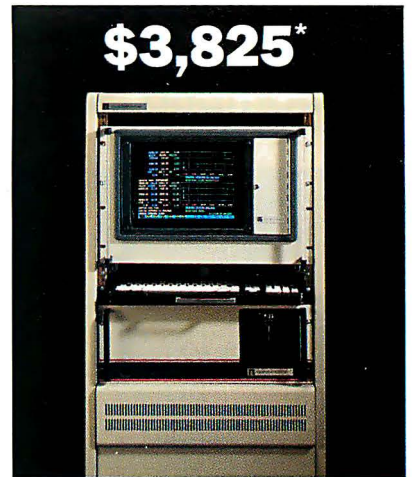
*Specifications*

- Dimensions: 6.5" x 17" x 16.5" 30 lbs.
- Power 220 Watt, 110 V.
- Operating environment.  
Temperature: 0°C to 55°C. (32°F to 131°F)  
Altitude: 15,000 feet equivalent

*System Prices*

Model	CPU/ MHz-RAM	Storage	Price
4216	286/16-1	40MB HD, 1.2 or 1.44MB floppy	\$2,900
4320	386/20-1	40MB HD, 1.2 or 1.44MB floppy	\$3,755
4325	386/25-1	104MB HD, 1.2 or 1.44MB floppy	\$4,530
4333	386/33-2	104MB HD, 1.2 or 1.44MB floppy	\$5,135
4425	486/25-4	104MB HD, 1.2 or 1.44MB floppy	\$5,995

\*From \$2,900. Monitor not included.



**TEXAS MICROSYSTEM 3014**  
RUGGEDIZED RACK-MOUNT PC

*Features*

- Choice of 80286, 80386, 80486 processors.
- 18-gauge nickel plated, steel chassis.
- 14 full length ISA slots for industry standard cards.
- Boards bracketed and braced on all four edges.
- Two 110 CFM fans.
- Up to 16MB of RAM on CPU, and five half-height storage bays for hard drives, floppy and/or tape backup.
- Super VGA graphics (1024x 768 pixels) Also supports CGA, EGA.
- 1 parallel and 2 serial ports.
- Built in speaker, door lock, power and CPU reset switch.
- 101-key enhanced keyboard with DIN connector on front panel.
- 225 watt power supply.
- One year, on site warranty included.

*Specifications*

- Dimensions: 19" x 22.18" x 6.96" Wt. 45 lbs.
- Power 95-132/180-264 VAC, 47 to 63Hz.
- Operating environment.  
Temperature: 0°C to 55°C. (32°F to 131°F)  
Humidity: To 95% at 40°C non-condensing  
Altitude: 15,000 feet equivalent  
Vibration: .25G, 5-100Hz operating  
5G, 5-100Hz non-operating  
Shock: 1.0G operating at 10 Msec duration

*System Prices*

Model	CPU/ MHz-RAM	Storage	Price
3216	286/16-1	40MB HD, 1.2 or 1.44MB floppy	\$3,825
3320	386/20-1	40MB HD, 1.2 or 1.44MB floppy	\$4,650
3325	386/25-1	104MB HD, 1.2 or 1.44MB floppy	\$5,430
3333	386/33-2	104MB HD, 1.2 or 1.44MB floppy	\$6,040
3425	486/25-4	104MB HD, 1.2 or 1.44MB floppy	\$6,895

\*From \$3,825. Rackmount monitor not included.

**EVEN ORDERING IS EXTREMELY EASY. CALL**

# 1-800-627-8700

Circle 319 on Reader Service Card

## REVIEW

# The Compaq SLT: A Laptop Fit for the Desktop



*Compaq's new SLT offers more power and expandability than any other laptop computer BYTE has tested.*

Compaq's SLT 386s/20 has blurred the line between laptop and desktop machines.

The original SLT's 12-MHz 286 CPU has given way to a 20-MHz 386SX processor that uses the same 4K-byte set-associative static RAM cache found in the Deskpro 386s/20. Compaq has increased the base configuration memory from 640K bytes to 2 megabytes, increased maximum RAM from 3.6 MB to 14 MB, and upped maximum hard disk drive storage to 240 MB—that's probably more than most users will ever need.

From the outside, the boxy-looking SLT, with its removable keyboard and fold-up VGA display, looks much the same. It still weighs in at 14 pounds, and the system's 4½-inch height (with the display folded down) makes it perhaps the tallest laptop on the market. It's also one of the most rugged.

## Name Your Price

The entry-level Model 60 includes a 2½-inch 60-MB Connor Peripherals hard disk drive, a 3½-inch high-density floppy disk drive, and 2 MB of RAM for \$6799. I tested the Model 120, which includes a 120-MB 19-millisecond Conner Peripherals hard disk drive and lists for \$7499.

Compaq offers a variety of options for the SLT. You pay the price for Compaq's proprietary memory modules; my test machine included an extra 2 MB that adds \$1299 to the list price. With the memory upgrade and a 20-MHz 80387 math coprocessor (\$699), the total price came to an astounding \$9497.

But don't pull out your checkbook just yet. The machine's confusing keyboard overlays make the external numeric keypad (\$149) a must for spreadsheet users. If you opt for the internal 2400-bps mo-

## SLT 386s/20

### Company

Compaq Computer Corp.  
20555 State Hwy. 249  
P.O. Box 692000  
Houston, TX 77070  
(800) 231-0900  
(713) 370-0670

### Components (as reviewed)

**Processor:** 20-MHz 386SX CPU; 20-MHz 80387SX math coprocessor  
**Memory:** 4 MB of system RAM; 4K bytes of processor cache SRAM  
**Mass storage:** 120-MB Conner Peripherals hard disk drive; high-density 3½-inch floppy disk drive  
**Display:** 10-inch VGA-compatible supertwist LCD with fluorescent backlighting  
**Keyboard:** 82-key IBM Enhanced layout  
**I/O interfaces:** Serial port; parallel port; external VGA monitor port; external floppy disk drive or tape drive port; expansion chassis port; external keypad port

### Size

4½ × 8½ × 13½ inches; 14 pounds

### Price

\$9497

### Inquiry 1112.

dem (\$599) you'll find that it cuts battery life to about 1½ hours, so you'll probably want an extra nickel-cadmium battery (\$149). And since the machine won't fit in your briefcase, you'll probably want to buy the carrying case (\$89).

## Projecting Growth

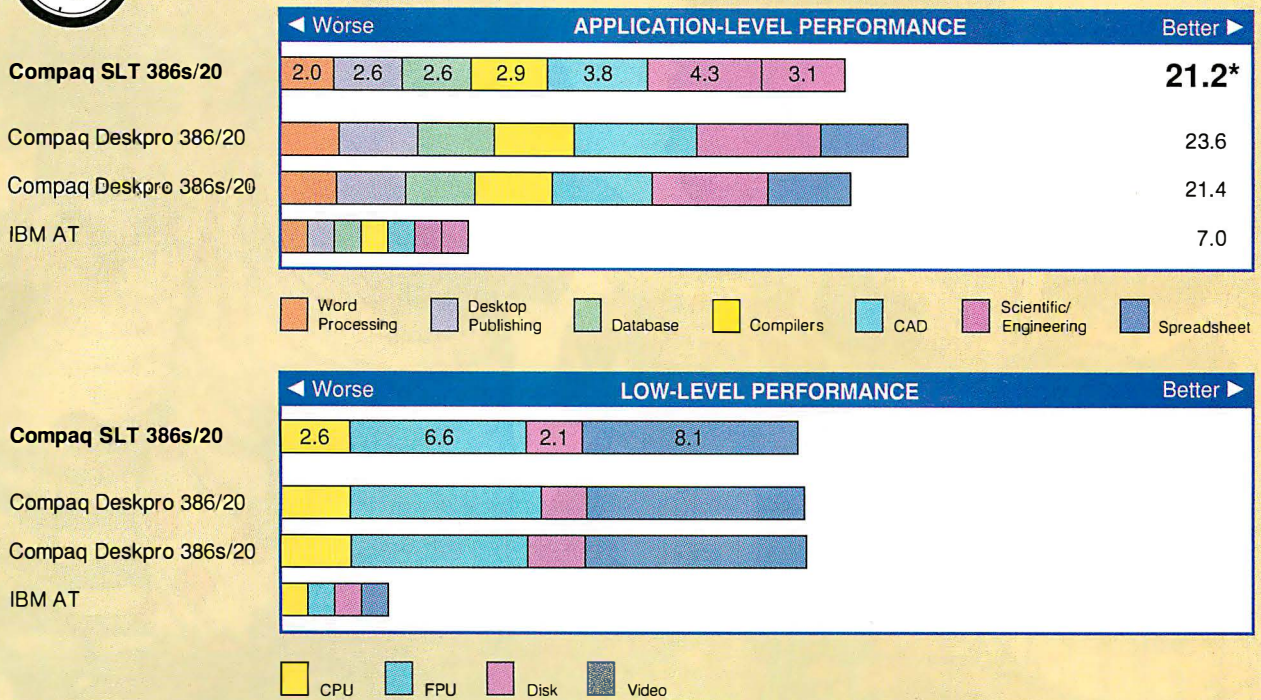
The SLT has plenty of room to grow. If 120 MB of disk storage isn't enough, a second device bay can hold another 60- or 120-MB hard disk drive. The machine doesn't have any expansion slots; for that, you need the expansion base (\$999), a rather large box that holds just two 8- or 16-bit add-in boards.

Compaq doesn't offer an internal network adapter, so if you need to access the office network, you may want the expansion chassis. But you can save space on the desktop by forgoing the expansion box, installing a Xircom or D-Link par-





## DOS BENCHMARKS



### CONVENTIONAL BENCHMARKS

	LINPACK (single) (MFLOPS)	Dhrystones (Dhry./sec.)
Compaq SLT 386s/20	0.15530	7934.6
Compaq 386/20	0.16970	8449.7
Compaq 386s/20	0.15560	7938.5
IBM AT	0.02105	2317.9

For application and low-level benchmarks, results are indexed and show relative performance; for each individual index, an 8-MHz IBM AT running MS-DOS 3.30 = 1. For all benchmarks, higher numbers indicate better performance.

The BYTE low-level benchmark suite identifies performance differences between machines at the hardware level; the application benchmarks evaluate real-world performance by running a standard test suite using commercially available applications. Application indexes include tests using the following programs: Word processing: WordPerfect 5.0; Desktop Publishing: Aldus PageMaker 3.0; Database: Borland Paradox 3.0 and Ashton-Tate dBASE IV; Compilers: Microsoft C 5.1 and Turbo Pascal 5.5; CAD: AutoCAD release 10 and Generic CADD level 3 1.1.5; Scientific/Engineering: Stata release 2, MathCAD 2.5, and PC-Matlab 3.5f; and Spreadsheet: Lotus 1-2-3 release 3.0 and Microsoft Excel 2.1.

The BYTE Lab introduced version 2.0 of the DOS benchmarks in the August 1990 issue (see "BYTE's New Benchmarks: New Looks, New Numbers"). Benchmark results for machines reviewed under previous versions aren't directly comparable. To obtain a copy of the benchmarks, join the listings area of the byte.bmarks conference on BIX or contact BYTE directly.

allel port network adapter, and hooking the office monitor and keyboard directly to the SLT.

### On the Test Bench

The SLT's VGA supertwist LCD is fast, but it could stand improvement. Newer displays, such as the one in Texas Instruments' 286-based TravelMate 2000, are sharper and brighter, and they offer 16 gray scales to the SLT's eight. Also, the SLT cuts power to the LCD when you hook up an external monitor—an annoyance for users who want to run desktop presentations.

During continuous operation, the battery life averaged from 1½ to 2½ hours. You can extend the life of the battery by turning off power to the modem and specifying time-outs that shut down the display, the hard disk drive, or the entire system during periods of inactivity.

Pressing the Stand By button on the front of the case also puts the machine into sleep mode. Pressing it a second time resumes operations where you left off.

The SLT 386s/20 is plenty fast; its low-level benchmark scores rival those of the Deskpro 386/20. But the identical CPU index scores don't tell the whole story. The Deskpro 386/20's true 32-bit CPU performed faster memory moves, but the 386s/20 made up for that with faster Sieve, Sort, and Integer Math results. The SLT also compares favorably with the 20-MHz 386SX desktop machines BYTE has tested (see "The SX Turns 20," October 1990). Compaq includes a disk-caching utility to squeeze out even better performance.

### Weighted Decision

Traveling with the SLT isn't much different from taking your fully configured

desktop machine on the road. It's well built and fast, although by today's size and weight standards, the SLT is a bit clunky.

I disliked the screen. Also, the placement of the Fn key on the lower left corner of the keyboard is awkward (see the photo). I found myself constantly hitting the Fn key with the palm of my hand, accidentally invoking unwanted control functions in my application programs.

If you're in the field for extended periods, the SLT's power and expandability can't be beat. Otherwise, I'd recommend that you get one of the new SX notebook computers and leave the rest of the hardware at the office. ■

*Rob Mitchell is a BYTE Lab technical editor for system reviews. He can be reached on BIX as "rob\_mitchell."*



# LANtastic's™ tiny RAM now has more cards to play with.

If the presence of Micro Channel machines has ever stood between you and the joy of running the award-winning LANtastic PC Network, this is your lucky day. Artisoft has just added three new Micro Channel adapters to its compliment of AE-2 Ethernet, 2Mbps and Voice adapters.

LANtastic AE-2 MC Ethernet for Micro Channel, a 16-bit adapter that can be used in either a 16-bit or a 32-bit slot, is in 100% compliance with IEEE 802.3 and Ethernet standards, and comes with on-board 16K RAM that is user expandable to 64K. Since

AE-2 MC Ethernet is software compatible with Novell's NE/2000 hardware, you can run Novell "out of the box."

LANtastic 2Mbps MC adapters



are the perfect way to economically network small or midsize businesses with Micro Channel computers. Each card includes a 10Mhz coprocessor and 32K of on-board dual-ported RAM, along with software-selectable IRQ and RAMBASE address settings. Artisoft's version of the NetBIOS standard can be loaded into and executed within the adapter. This plunges the NetBIOS draw on a PC's base RAM down to just 2K and off loads the network processing onto the adapter. The cards are easy to install and use inexpensive dual-twisted pair cable.

LANtastic Voice MC adapters let you save sound and speech onto disk for playback later on Micro Channel machines. Use them with LANtastic NOS 3.0 or above, and

you can send voice messages across your LANtastic network. Just pick up the telephone handset provided with each Voice Adapter, bring up a handy on-screen menu, and talk. Use Voice Chat to carry on a real time conversation, or save the message for playback later in your own voice — either through the handset or through the Micro Channel machine's internal speaker.

Now it's easier than ever to run LANtastic's award-winning Network Operating System on Micro Channel machines. Call 602-293-6363 or fax 602-293-8065.



**ARTISOFT**  
Revolutionizing Connectivity



## The Mac Side of Unix

Tom Thompson

**A**/UX 2.0 is a dramatic improvement over its predecessors. Earlier versions of A/UX were little more than a command-line-oriented Unix running on a Macintosh. With this new version, once you get past the log-in window that prompts you for a name and password, a Mac Desktop appears, complete with menu, windows, and icons. You launch your applications by double-clicking on them, print to a LaserWriter via LocalTalk, and select AppleShare file servers or other networked devices via the Chooser desk accessory. If you use a direct-color display board such as the RasterOps 364, you can work with 24-bit colors using either A/UX or Mac applications.

A clever sleight of hand is occurring here: A/UX is running a special version of MultiFinder (6.9) that supports the Mac environment. While other Unix processes (including MultiFinder) are preemptively shared (i.e., the CPU services each process for a certain time interval), the MultiFinder environment only supports cooperative multitasking (i.e., each application is supposed to yield control to MultiFinder at determined intervals). Thus, a poorly written Mac application could hog all of

MultiFinder's processing time.

When you launch an application, an alert—"The application <Application-Name> is not 32-bit clean; opening it may result in a crash"—appears, with buttons to OK or cancel the operation. This warning reminds you that the A/UX environment uses 32-bit addressing, and any Mac application that assumes a different addressing scheme (hence the moniker "32-bit clean") will die a horrible death.

How does A/UX know if an application is 32-bit clean? Through a bit set in the application's SIZE ID = -1 resource. This same resource also informs MultiFinder of the application's event-handling capabilities and memory requirements. Most Mac applications usually work. (In fact, some developers use A/UX to proof the 32-bit addressing capabilities of their application for another up-and-coming 32-bit operating system, System 7.0.)

Amazingly, some INITs, cdevs, and FKEYs work with A/UX 2.0. Installing the INITs and cdevs is simply a matter of dragging them to the /mac/sys/System Folder on the Unix volume. If you log out and then back into A/UX, the INITs install. You use ResEdit 2.0b2 to

copy and paste FKEY resources into the System file in this folder. How well these extenders work depends primarily on how well they cope with the Unix file system. For example, After Dark 1.1c and SuperClock 3.9 functioned properly, while Adobe Type Manager could not locate resources stored in other files and failed to install. Boomerang 2.0.2, which tries to navigate among deeply nested folders, functioned erratically.

Given these potential problems, the Mac environment still runs well. Many applications, such as Aldus PageMaker 4.0, Adobe Photoshop 1.0, a beta version of Adobe Illustrator 3.0, and Data Translation's VideoQuill 1.0.1, ran smoothly. Printing documents with the LaserWriter 6.0.1 driver was flawless: the PrintMonitor spooled the pages to an original LaserWriter, and the output looked as good as anything printed from a typical Mac. A/UX 2.0 lets Mac users have their cake and eat it, too. They have their familiar Mac environment, while access to a powerful Unix operating system is only a window away.

*Tom Thompson is a BYTE senior editor at large and Mac expert. You can reach him on BIX as "tom\_thompson."*

any points for keeping current on Unix developments. Grafted on top are some utilities, some libraries, and a file-system structure borrowed from BSD Unix. Again, the file system and other BSDisms are reportedly taken from version 4.2, which considerably predates Berkeley's latest efforts.

Underpinnings aside, the implementation is nearly complete. I missed only a few things. The UUCP implementation is based on older (release 2) software that isn't as secure or as easy to manage as later implementations. The System V networking calls (i.e., the Transport Layer Interface) are missing, as are the functions for the Extended Terminal Interface (an enhanced full-screen function library). It might seem as if I'm knocking holes in A/UX; not at all. In fact, some may prefer Apple's approach. A/UX just feels more like BSD than System V.

The TCP/IP utilities and job control in A/UX have been done elsewhere, but Apple also threw in a host of Berkeley-

specific utilities. Most notable are `lpd`, a network printer-sharing daemon; `sendmail`, a standard E-mail delivery mechanism; and `nroff` and `troff` text-formatting and typesetting languages.

One definite contribution from System V to A/UX is the Korn shell. Developed at AT&T, this follow-on to the ubiquitous Bourne shell is likeable almost to the point of being addictive. Job control is implemented in these and the C shell, so users can choose their favorite without losing features.

If you'd rather not deal with shells at all, A/UX's Commando facility comes in handy. Augmenting the on-line manual pages, Commando is a command completion program. If you enter a program name (or click on its icon in the file manager), Commando will open up a dialog box that represents the key options graphically. Click in the right places, and Commando builds and executes a command that gives you what you want. Nice.

For performance, my Mac IIfx was

neither a barnburner nor a lumbering cow. I'd place it about even with a fast (33 MHz) 386-based Unix system, faster in some measures and slower in others. For similar cost, a 486 Unix system could run circles around it. If performance is your main consideration, don't bother with A/UX.

### TCP/IP with X Window on the Side

Getting the system running on the BYTE Unix Lab's TCP/IP network was a bit of a challenge. The Apple Ethernet board I had was too old (revision C) to run with A/UX on a Mac IIfx, so Apple had to ship me a new one (revision K). Once the new board was in, however, the system came right up. A/UX works through MacTCP (which runs on the Mac OS side), and the system's network address and other particulars are set through a Control Panel dialog box.

A/UX comes standard with TCP/IP, Network File System, and Yellow Pages network services. Most of what I tested worked fine, but some of BYTE's other

“Time is money and  
I’m saving both with TARGA®.”



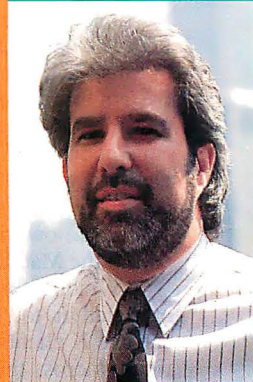
Graphic created by Stuart Warner using the TARGA board with TIPS®, RIO™ and TOPAS™. For more information contact Richard Pincus at (212) 633-2150.

And the new TARGA+ does even more. Our updated version has special effects you just can't find on any other board. Use the digital linear keyer to create new transitions, like fades and blended overlays. Or use the digital chroma keyer to superimpose live video on a computer generated background. With TARGA+, business graphics have never been tastier.

Introducing the Truevision TARGA+. The next generation TARGA for the next generation TARGA user.



7340 Shadeland Station, Indianapolis, IN 46256  
INTERNATIONAL: Canada 416/940-8727 France 33-1-3-952-6253 Italy 39-2-242-4551  
Switzerland 41-1-825-0949 U.K. 44-628-77-7800 West Germany 49-89-612-0010 Other 617/229-6900  
RIO and TOPAS are trademarks of AT&T. Circle 339 on Reader Service Card (RESELLERS: 340)



Richard Pincus  
State of the Art  
Productions  
New York, New York

“With TARGA, we can create high-quality business presentation graphics in a fraction of the time it would take using another product. And at a fraction of the cost. Truevision's TARGA is the smart way to do business.”

Call  
800-858-TRUE  
For more information

systems didn't want to run full-screen applications on Apple's weird terminal emulator. That could have been fixed by working up a `terminfo` entry, something I didn't take the time to do.

I also had two versions of X Window System for the Mac: The X Window System for A/UX, and MacX. The former runs under A/UX and replaces the Mac Desktop with a full-screen X root window. The latter runs on the MultiFinder side and allows monochrome X clients to run on the Mac Desktop.

X Window System for A/UX ran as I expected it to. Both color and monochrome X clients connected without difficulty across the network. Display performance was unacceptable until I used the Control Panel to set the display bit depth to 8 (256 colors instead of 16 million). Even then, performance was not up to workstation standards, but that could have been owing to the RasterOps card's lack of a graphics coprocessor. Nothing against RasterOps there: The 364 is not cut out for high-speed windowing system operations, but it performs well in Mac imaging applications.

Even if a video card has 24-bit capabil-

ity, both versions of Apple X Window are limited to a maximum of 8 bits. MacX has some additional limitations that combined to leave me feeling very uncertain about the product's stability. Its features are amazing in that it can support monochrome X clients on the Mac Desktop, and both monochrome and color clients in special scrollable windows. However, MacX's flaws became obvious from the first.

I asked our Opus 88000-based system to ship an `xgif` (a utility that displays GIF graphics images) window to a color MacX session. The `xgif` window came up blank and didn't paint until I selected it. When I overlapped the `xgif` window with something else, the GIF picture was displayed in a rectangle around the foreground window; it was repainted to black again when the overlapping window was removed. It was also painfully slow, taking several seconds to redraw a Motif window border. In general, MacX running in its own root window seemed flaky; I wouldn't use it in a commercial environment. Its most basic capability—putting up monochrome X windows on the Mac Desktop—worked very well,

however, and for that I can safely recommend it.

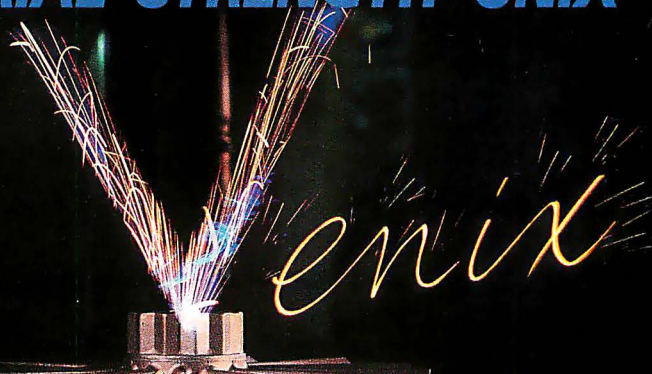
### It's a Wrap

I can't remember when I've seen something as appealing as A/UX 2.0. With the exception of MacX, Apple's integration of Mac and Unix is seamless and powerful. Clever developers should start putting out programs soon that take advantage of this blend, because it is truly not available anywhere else.

Before Apple can start gunning for workstations, however, it needs to pay more attention to two things: price and graphics performance. If you don't care about the ability to run Mac programs, A/UX would be a waste. Low-end workstations are more attractively priced and offer better graphics performance than even the fastest Mac. But if you need to run Unix without sacrificing your library of pet Mac programs, A/UX is the answer. It is a thoughtful, well-crafted mix of two good operating systems. ■

*Tom Yager is a BYTE Lab technical editor and Unix expert. You can reach him on BIX as "tyager."*

## INDUSTRIAL STRENGTH UNIX



VENIX is the only real time UNIX® rugged enough for your demanding acquisition and control applications. VENIX is a true AT&T UNIX, optimized for even the harshest industrial environments.

In addition to the functionality of a nonproprietary operating system, VENIX offers multiple hardware plat-

forms and off-the-shelf programs, plus the flexibility to develop and maintain your own programs. All this plus durability and real time. And you can design seamless dedicated applications with new Embedded VENIX.

VenturCom has been at the forefront of UNIX technology for over ten years. We

were the first and are still the only source for embedded UNIX and real time UNIX operating on AT bus microcomputers. Call (617) 661-1230 today to test the best. VENIX, the industrial strength UNIX.

**VenturCom**

215 First Street Cambridge, MA 02142  
UNIX is a registered trademark of AT&T.

# Write Once, Port Many.



## With new c-tree Plus™ when you've written for one platform you've written for them all.

**SPECIAL OFFER FOR CURRENT C-TREE® USERS!**  
Take advantage of the exciting features offered by c-tree Plus, at a special introductory price reserved just for you — call for details!

**c-tree Plus™**

- **Port to Over 100 environments!**  
Forget the tedious, time consuming and expensive reprogramming required to move from one environment to another. With c-tree Plus™ you don't change source code at all — just recompile, link and you're running on platforms ranging from Cray supercomputers to Zenith laptops! Over 100 environments are supported, including: ■ Windows 3.x ■ DOS ■ UNIX ■ OS/2 ■ VAX/VMS ■ Mac ■ SUN ■ RS-6000  
Forget byte order, memory model, integer size or data alignment hassles — c-tree Plus manages it all automatically, regardless of processor architecture. And c-tree Plus even provides a utility to port your pre-existing data files *in place*.
- **Flexible configurations — Single, multi-user, client/server or LAN!**  
Now you don't have to make a choice between configurations — c-tree Plus supports them all. The same application can use c-tree Plus as a powerful data management engine or as a client front-end to the FairCom Servers.
- **A new data management standard**  
Outstanding new features make c-tree Plus the developer's "product of choice." Features include: ■ True transaction processing\* ■ Superfiles ■ Resources ■ Full ANSI-standard SQL functionality\* ■ Batched operations ■ Ultra-high speed data & index cache ■ Row & key level locking ■ FREE FairCom™ Server (Developer's Version) ■ No run-time royalties ■ Full source code ■ Extensive tech support.
- **Order c-tree Plus today!**  
Start using c-tree Plus — the new file handling and data management standard.

**(800) 234-8180, Ext. 1**

\* — when used in conjunction with the FairCom Servers

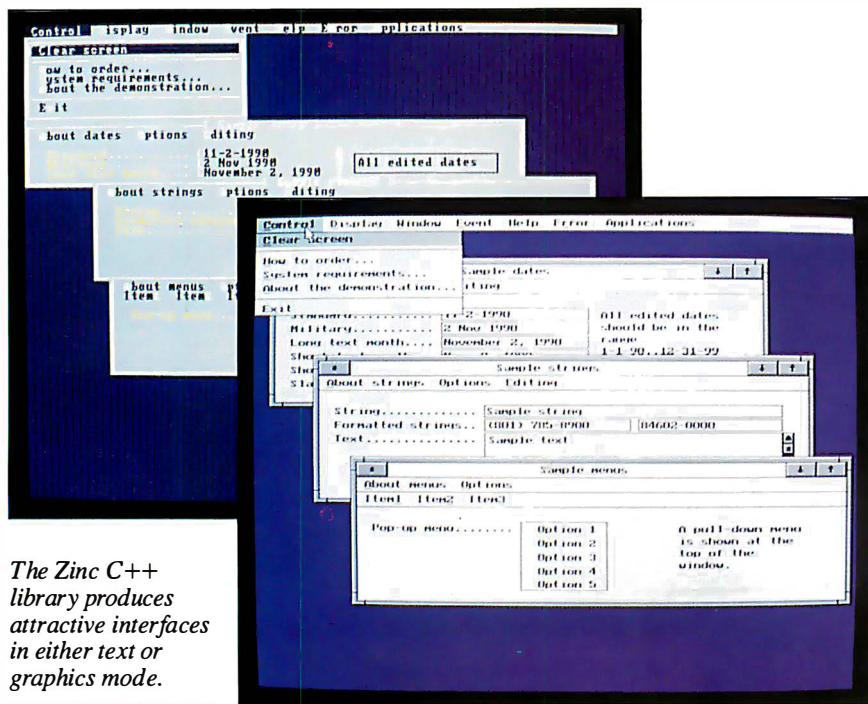


4006 WEST BROADWAY  
COLUMBIA, MO 65203  
PHONE 314.445.6833

Circle 109 on Reader Service Card

## REVIEW

## User Interfaces, C++ Style



The Zinc C++ library produces attractive interfaces in either text or graphics mode.

Are you embarrassed by the command-line interface to your PC program? Have you been looking enviously at the latest applications for Windows 3.0? Have you experienced the torture of programming a user interface in C? If so, the Zinc interface library may ease your suffering.

Zinc is a class library that uses the sophisticated features of C++, as well as the Borland graphical interface routines that come with Turbo C++, to minimize the notorious difficulty of user-interface programming. Zinc helps create user-friendly DOS programs, with either text or graphical interfaces. Currently, it works only with Turbo C++ on the IBM PC and compatibles.

### The Bird's-Eye View

Zinc includes a wide variety of C++ classes, 46 of them, that you can mix, match, and modify to create an application. (The source code for the package can be bought separately for \$200.) There are classes for using windows, title bars, pop-up and pull-down menus, fully editable text that supports cut/copy/paste, and selectable icons and bit maps. Zinc also includes classes designed to make it easy to input and validate numbers, dates, and times; for each, a wide variety of formats are handled automatically. Furthermore, if you have a novel type of input field—for instance, a field for inputting palindromes—it is easy to modify an existing input class to get what you want.

Two notable classes in Zinc are `help_system` and `error_system`. Your appli-

cation can easily have context-sensitive help screens using the `help_system` class. The help system is less impressive than that in Windows 3.0; the latter has a hypertext appearance, while Zinc's is more a scrollable text display. But the Zinc system should be adequate for most programs. The `error_system` class provides a consistent, simple way of reporting and responding to errors throughout your program.

### Getting the Picture

Zinc provides rudimentary support for graphics: Two-color bit maps, rectangles, lines, and text can be drawn on the screen. Unfortunately, Zinc does *not* make it easy to restrict drawing to a window, a fundamental service in most user interfaces. Also missing is a dialog editor, a graphical tool for designing screen layouts that can make user-interface design faster.

An important feature of Zinc is its ability to display on a wide variety of graphics boards, including various text modes, Hercules, CGA, EGA, and VGA, all from the same source code. In fact, Zinc includes a demonstration that switches display modes while the program is running. Zinc also provides an interface to the keyboard, cursor, and mouse that can be easily extended as new devices appear. C++ makes it easy to give different systems the same programming interface, and Zinc uses this capability extensively.

When running Zinc in graphics mode, you see a screen reminiscent of Windows 3.0 or Presentation Manager, including three-dimensional buttons and borders. The built-in editing commands were designed to be Systems Application Architecture compliant.

However, I found the font that is used throughout the user interface to be ugly and hard to read, and there is no documentation that explains how to change it. In addition, the toolkit does not enforce user-interface consistency to the same degree as Motif or Windows 3.0. For example, sometimes the "system button" in the upper left corner of a window will close a window, and sometimes it will bring down a menu of choices. These choices, of course, are under programmer control, so they can be fixed in your application.

### Putting It to the Test

An important criterion for judging a set of classes is how cohesive they are. Specifically, after learning to use one class, it should be easier for you to learn another. Zinc is exceptional in this regard.



### Zinc Interface Library

#### Company

Zinc Software, Inc.  
405 South 100 East, Suite 201  
Pleasant Grove, UT 84062  
(800) 638-8665

#### Hardware Needed

IBM PC compatible with 640K bytes of RAM and a hard disk drive; Microsoft-compatible mouse recommended

#### Software Needed

Borland Turbo C++; DOS 2.1 or higher (3.1 or higher recommended)

#### Price

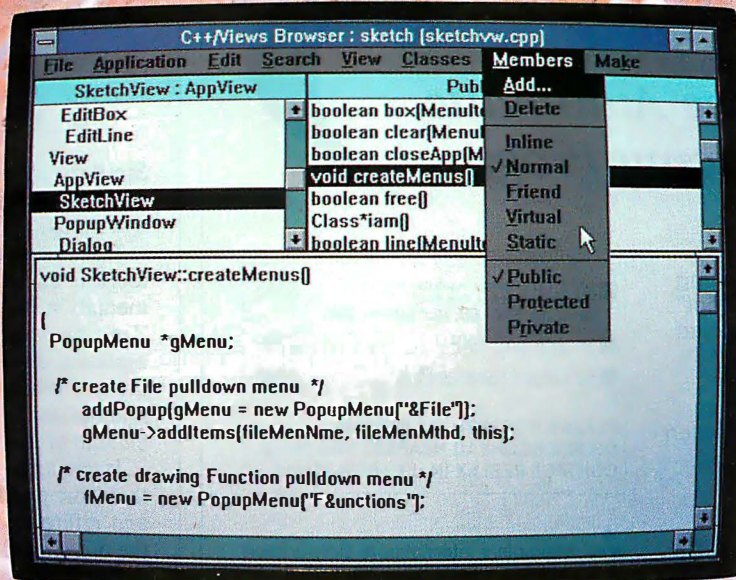
\$199.95  
Source code: \$200

#### Inquiry 1223.



# C++/Views™

for Microsoft Windows



## THE MICROSOFT WINDOWS 3.0 DEVELOPMENT TOOL THAT DELIVERS FROM START TO FINISH.

**C++/Views** is a development tool for C++ programmers that not only reduces the complexity of Microsoft Windows 3.0 but also slashes development time by up to 75%.

### **Delivers on the promise of Object-Oriented Programming (OOP).**

Encapsulates more MS Windows 3.0 functionality than any other tool on the market today. Get MS Windows applications off to a fast start with a framework of over 65 tested and ready-to-go C++ classes.

### **Has the most complete C++ class library for MS Windows Development.**

Get started with graphical user interface classes such as windows, views, bitmaps, dialog boxes, menus, popup menus, graphics, regions, pens, brushes, controls, buttons, listboxes, valuator, editors, printers and much more. Organize your data with foundation classes such as containers, collections, sets, dictionaries, files, strings, streams and so-on. Use other classes to manage the persistence of objects across files, to perform serial communications, and to activate timed events.

### **Provides support for the entire project.**

Comes with a complete OOP development environment including the first fully functional C++ class hierarchy *Browser*. Also includes an *Interface Generator* for building C++ dialog classes and a *Documentor* for automatically producing high quality documentation of your classes.

### **Works with Zortech C++.**

Combine C++/Views with the **Zortech C++** compiler for a cost-effective and highly productive development environment for building your next generation software systems.

### **Pays for itself on even the smallest project.**

Only **\$495.00** with no royalties.  
Comes complete with source code.

**C++/Views**  
from CNS, Inc.

CNS, Inc., Software Products Dept.  
7090 Shady Oak Road, Minneapolis, MN 55344  
(612)-944-0170 • FAX (612)-944-0923

© Copyright 1990 CNS, Inc. All rights reserved. Microsoft is a registered trademark of Microsoft Corporation.



# QuickTrace™

NCGA '91  
CONFERENCE  
&  
EXPOSITION  
Chicago, April 22-25

Vector Based  
Graphics

TIFF Bit Map

*The Automatic  
Tracing Program*

QuickTrace is an automatic tracing tool which converts scanned "dot" images into vector based graphics. Instead of drawing by hand, try QuickTrace. It will help you to easily and quickly enter graphics like logos, maps and clip art, which would otherwise be difficult and time-consuming on your PC.

- for DTP (Illustrator, PageMaker, Harvard Graphics, DrawPerfect) Convert into EPSF, CGM, Micrografx PIC, DRW ..... \$245
- for AutoCAD DXF ..... \$295
- for Lotus Freelance Plus ..... \$245

PLEASE CONTACT: 212-605-2339  
OR SEE EGGHEAD NEAREST YOU IN U.S.  
CONTACT REFLEX IN U.K.: 0734-314611

**ICL** Developed by  
Information & Control Lab. Co.  
Nakajima Bldg., 5F, 11-22, Shinjuku 5-chome,  
Shinjuku-ku, Tokyo 160, Japan  
Phone: 3-5379-7470 / Fax: 3-5379-7471

**M** Mitsubishi International Corporation  
Technology Affairs Dept.  
520 Madison Avenue, New York, NY 10022  
Phone: 212-605-2339 / Fax: 212-605-1847

● DrawPerfect of WordPerfect Corporation, Micrografx of Micrografx Inc., AutoCAD of Autodesk Inc., Lotus and Freelance of Lotus Development Corporation, Illustrator of Adobe Systems Incorporated, PageMaker of Aldus Corporation, harvard Graphics of Software Publishing corporation are registered trademark of each company  
● Quicktrace can input Images scanned by Nlscan, Logltec ScanMan and etc. ● OEM Inquiry welcome

REVIEW

For example, to add a title bar, resizable border, and close box to a window, you just have to write

```
myWindow + new UIW_TITLE(...)
+ new UIW_BORDER
+ new UIW_SYSTEM_BUTTON;
```

Similarly, you can add a window to the window manager with windowManager + myWindow.

Documentation is a crucial part of any toolkit, and the lack of adequate documentation is Zinc's greatest failing. The Zinc package includes two attractive manuals, an overview/tutorial, and a reference. While this documentation is well laid out and informative, there is just not enough of it.

If you are content to use the 46 classes that Zinc provides, then the Zinc tutorial and reference manual are adequate. On the other hand, trying to subclass a built-in class reveals glaring deficiencies in the documentation. For example, there is no explanation of the coordinate system used to locate items in a window or on the screen. Also, the UIW\_WINDOW\_OBJECT class—the most important base class—has 16 public and protected member functions declared in the header file, yet the documentation lists and explains only two of them.

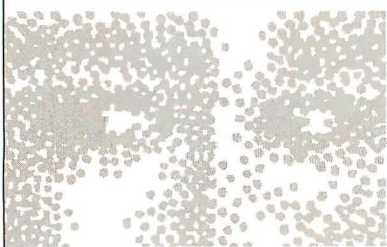
The event messages, through which windows communicate with each other and the window manager, are never described. There are many other examples, but the bottom line is that Zinc provides insufficient documentation for you to customize the classes.

Fortunately, Zinc Software is aware of the problem and promises supplementary documentation by the time you read this. The company's technical support is responsive, friendly, and knowledgeable—definitely above average.

Assuming that the documentation improves, Zinc seems to be most appropriate for Turbo C++ programmers who want to create modern-looking, easy-to-use DOS applications. It is especially suited for business applications requiring the user to enter and examine numeric, string, or date information. On the other hand, Zinc is much less useful for someone writing a graphical application, such as a draw program or graphics simulation. ■

*Steven Kearns received his Ph.D. in computer science from Columbia University. He is the president of Software Truth, developing a next-generation programming environment. He can be reached on BIX c/o "editors."*

# Video In.



Truly affordable video imaging for IBM PC and Macintosh computers. ComputerEyes includes everything you need to capture 8- or 24-bit color (or 8-bit gray scale) images from any composite or S-Video source.

Captured images can be used with all popular paint, animation, database, presentation, and publishing programs.

Call today for more information and free demo disk.

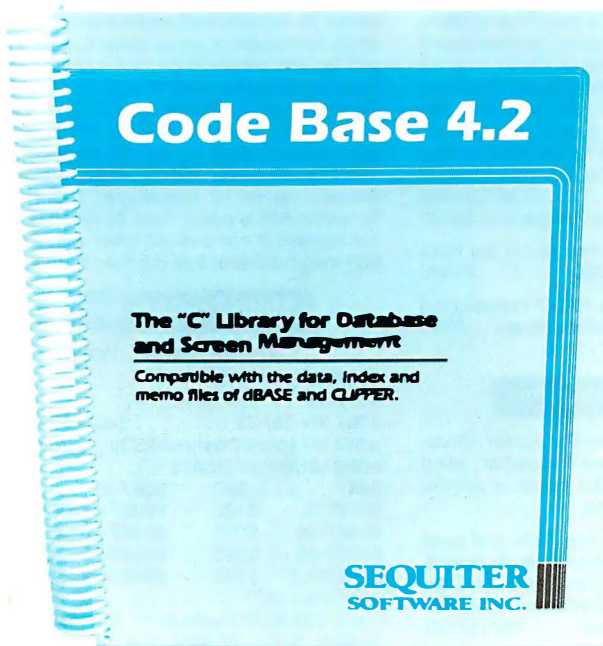
Digital Vision, Inc.  
270 Bridge St., Dedham, MA 02026  
(617) 329-5400  
To order call (800) 346-0090

**Professional  
Series  
Color Video  
Digitizers  
For Under  
\$ 450.**

**Digital Vision**

C O M P U T E R E Y E S™

# C Speed C Portability C Flexibility



## dBASE Power

*Build a multi-user, dBASE compatible application which is several times faster than dBASE IV, Clipper or Fox Pro. Watch its windows and menus appear instantly on any computer.*

### Portable

Port your application to any environment with a C or C++ compiler. Access megabytes of memory using 386 DOS compilers, OS/2, Unix or Microsoft Windows.

### Compatible

As you directly use the data, index and memo files of dBASE III through IV or Clipper, you can use Code Base 4.2 with any dBASE compatible product.

### Easy

Consult examples in the 280 page user's guide as you interactively execute Code Base 4.2 routines from a learning utility. You will remember the routines which are named like dBASE commands.

### Small

Make stand alone executable files as small as 14K. Code Base 4.2 executables are 1/2 to 1/3 the size of corresponding Clipper executables.

### Complete

Enjoy the benefits of complete dBASE functionality, including browse, edit, menus, windows, multiple index files per database, dBASE expression evaluation, relations and filters.

### Order Today

Order the DOS-OS/2 version for \$295. Call (403) 448-0313 or fax (403) 448-0315. Discover why Sequiter Software Inc. and most software dealers offer a 60 day money back guarantee. Source is included and there are no royalties!

# C++ Your 386, 486 & i860!

The key to taking full advantage of your Intel 32-bit CPU is a MicroWay globally optimized compiler. The latest, NDP C++, is ideally suited to writing numerically intensive applications. C++ makes it possible for the user to define his own types and specify how they get handled by the compiler. For example, where all C compilers automatically extend floats to double, thus slowing up coprocessors like the 3167 and 4167, NDP C++ (and Fortran) handles single precision library calls with no loss of speed. In addition, it is possible to define new types, and their operators, like complex numbers and matrices.

NDP C++ is a full AT&T release 2.0 compatible C++ that runs as a compiler as opposed to a preprocessor. Since C is a subset of C++, this

means NDP C++ can also compile C programs, and it, in fact, passes all the Plum Hall ANSI C conformance tests. NDP C++ is not designed to compile old style C programs. If you are compiling a C application which is not ANSI compatible, we suggest NDP C, which is both ANSI, System V UNIX, and K & R compatible.

MicroWay's compilers come with the features you need to simplify porting to the 32-bit mode of the 386, 486, or 860, including a 99% VAX/VMS compatible FORTRAN and a dual dialect C which is UNIX System V and ANSI compatible. Each NDP compiler is designed to take maximum advantage of 32-bit protected mode operation, including the 4 gigabyte address space of the processor, plus access to

coprocessors from Intel, Weitek, and Cyrix.

If you're burning up a lot of VAX or Cray time, you should seriously consider the Number Smasher-860. It delivers super-computer throughput, running in an ISA bus, for about the price of a 486 system. With Number Smasher-860 and NDP C- or Fortran-860, you can recompile all of your C or FORTRAN programs and run them in any 286, 386, or 486 AT system.

MicroWay is still your best source for numeric coprocessors and accelerators. Our FASTCache-SX is the most compatible AT upgrade available.

For more information, please call Microway's Technical Support Dept. at (508) 746-7341.

## 386, 486 & i860 Compilers

Our NDP family of compilers generate globally optimized, mainframe quality code that runs on the 386, 486 or i860 in protected mode under UNIX, XENIX, or extended DOS. The compilers address 4 gigabytes of memory while supporting the 80287, 80387, Weitek, and Cyrix coprocessors. Applications can mix code from all four compilers and assembly language. To simplify your ports, we have just released a full-featured, windowing symbolic debugger, ClearView-3/486, that works with DOS versions of NDP 386 and 486 compilers.

NDP Fortran™ is a full F77 with F66 and DOD extensions that is 99% VMS compatible.

NDP C™ runs in two modes—K&R with Sys V and MSC extensions or 100% ANSI as validated by Plum Hall.

NDP Pascal™ is a full ANSI/IEEE Pascal, with extensions from C and BSD 4.2 Pascal.

NDP C++™ is a fully AT&T v.2.0 compatible C++ compiler (not a preprocessor) that contains a full ANSI C compiler as a C++ subset.

NDP-860 compilers ..... each \$1995  
 DOS 386SX versions-NDP Tools Included \$595  
 DOS 386 versions-NDP Tools Included \$895  
 DOS 486 versions-NDP Tools Included \$1195  
 UNIX/XENIX versions ..... CALL  
 NDP VMEM Virtual Memory Manager \$295  
 Eclipse or Phar Lap Tools ..... \$495  
 NDP Link - Incremental Linker ..... \$295

ClearView™-3/486Debugger ..... \$395  
 NDP Windows™ Library: \$125, C Source: \$250  
 NDP Plot™ ..... \$325  
 NDP/FFT™ NDP or 80x87 version ... ea. \$250  
 Halo Professional ..... \$595

NDP NAG™ Workstation library is a subset of the NAG mainframe libraries. It contains 172 routines designed to solve differential equations and eigenvalue problems, perform matrix operations, fit curves, do statistics and regression analysis, etc. .... 386 Version: \$895

## RAMpak™ Your Compaq!

RAMpak™ - one or four meg 32-bit memory expansion module for Compaq Deskpro 386 20/25 One meg .. \$150, Four meg .. \$400

## Number Smasher-860™

Number Smasher-860 is the highest performance coprocessor card ever to run in an ISA or EISA bus or as part of a transputer system. Delivers up to 80 million floating point operations per second at 40 MHz and produces over 12 double precision Linpack megaflops. The board comes standard with an ISA interface, two transputer link adapters, your choice of NDP Fortran, C++, C or Pascal for the i860 running under MS-DOS, UNIX or SunOS, plus 8 meg of high speed memory. .... 33 MHz \$6995  
 40 MHz \$9200 32 MB version: add \$5000

NDP NAG/860 is a Microway port of the NAG workstation library to the i860 ..... \$1495

NDP HALO 860 includes HALO Professional plus the Microway 860 interface library. .... \$895

## Parallel Processing

MicroWay's IBM compatible Monoputer, Quadputer and Videoputer work together using Imros transputers to put the power of parallel processing on your desktop.

Monoputer™— Includes one T800 and up to 16 meg of RAM for parallel code development. The 4 MWhetstones T800 makes it the ideal FORTRAN engine for cost-effective execution of your mainframe programs. .... from \$1145

Quadputer™— This board for the AT or 386 can be purchased with 1 to 4 transputers and 1 or 4 meg of memory per transputer. Two or more Quadputers can be linked together to build networks of up to 100 or more transputers providing mainframe power. .... from \$1845

Linkputer™— Links up to 8 boards to provide dynamic transputer topologies. .... \$1500

## Transputer Compilers and Utilities

Logical Systems Parallel C ..... \$595  
 3L Parallel C, FORTRAN, or Pascal ... \$895  
 TBUG — debugger for 3L compilers .. \$330  
 ParaSoft EXPRESS — Includes transputer communications libraries, parallel code development library, C source level debugger, and system performance monitor. .... \$1500  
 Hellos PC/s ..... \$1250  
 Nexis Windows File Server. .... \$495  
 T800/NAG™ — Port of the complete NAG mainframe library. Contains 268 functions: \$2750

## Number Smasher-486™

Personal Workstation magazine, June 1990, said, "The Number Smasher-486 lives up to its name. Its numeric performance exceeds that of all 25-MHz systems we've tested to date. It gives you top 486 performance for the best price."

Number Smasher-486™, a 25 or 33 MHz replacement motherboard for ATs and 80386s, supports an optional Weitek 4167 numeric coprocessor and up to 16 megabytes of memory. Running with a 4167, our design delivers up to 10 megaflops. The Number Smasher-486 is priced from \$3195. It is also a component of our custom tower with a 330 or 668 meg hard disk that is priced from \$6450.

## Math Coprocessors

### WEITEK, INTEL, CYRIX

4167-25 ..... \$995  
 4167-33 ..... \$1295  
 3167-20/-25/-33 ..... \$495/\$795/\$995  
 mW3167 Micro Channel-25/33 .. from \$1295  
 mW3167/80387 Board ..... \$200  
 8087 ..... \$80 8087-2 ..... \$115  
 80287XL ... \$185 80387-16SX .. \$280  
 80387-16 .. \$295 80387-20SX .. \$300  
 80387-20 .. \$345 80387-25 ... \$439  
 80287XLT \$190 80387-33 .... \$540  
 287Tur o-20™ ..... \$345  
 Cyrix CX83D87FasMath™ SX-16MHz \$230  
 20 MHz: \$300 25 MHz: \$380 33 MHz: \$465

## 386 Your AT!

FASTCache-SX™— The most cost effective accelerator available for ATs. Plugs into the 286 socket, speeding up all applications by a factor of 3. Runs all 386 applications, OS/2 and Windows 3.0. Features 16 or 20 MHz 80386-SX, 4-way 32K cache (expandable to 64K) and a math coprocessor socket.  
 16MHz: \$495 20 MHz: \$595 Cable: \$95

NUMBER SMASHER-386™— This full-sized card replaces the 80286 on your IBM AT or compatible motherboard with an 86DX that runs at 20 or 25 MHz. It runs numerically intensive applications up to a factor of 60 times faster, while maintaining full hardware and software compatibility. Options include 64K of high speed cache memory, up to 8 megabytes of 32-bit memory, and an Intel 80387, Weitek, or Cyrix numeric coprocessor ..... from \$895

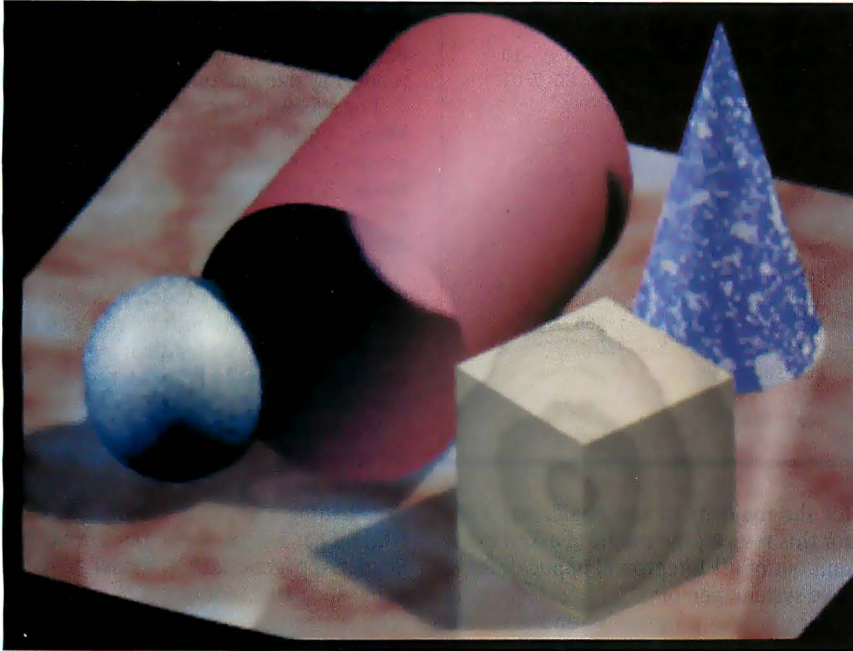
**MicroWay**

World Leader in PC Numerics

Corporate Headquarters: P.O. Box 79, Kingston, MA 02364 USA (508) 746-7341  
 32 High St., Kingston-Upon-Thames, U.K., 081-541-5466  
 USA FAX (508) 746-4678 Italy 02-74.90.749 Holland 40 836455 Japan 81 03 222 0541

## REVIEW

# Photo-Realism for Those with Time (and RAM) to Spare



*This image was created from the PhotoRealistic RenderMan component of MacRenderMan. Note the variety of surface textures and shadows used to create near-photographic-quality effects.*

**P**hoto-realism has come to the Macintosh with Pixar's MacRenderMan. Derived from RenderMan, Pixar's DOS-only rendering program, MacRenderMan is designed for serious Mac users who need extremely realistic three-dimensional renderings and have hardware powerful enough to fully exploit the program's capabilities.

MacRenderMan generates images of extraordinary quality by creating surfaces as realistic to the eye as those in a photograph. But achieving this quality is both a time- and RAM-intensive task: Although my system has 8 megabytes of RAM, I often ran out of memory when I rendered some relatively simple objects for this review. And although I used a 50-MHz accelerator, these small renderings took about 20 minutes. If you're running at a more typical 25 MHz, expect the time to be about 30 percent longer.

These drawbacks limit the current version of MacRenderMan to use by product designers, interior designers (e.g., for modeling a corner of a room), advertising designers, and others who usually work with small-scale objects. Architects and those who render larger,

more detailed models without benefit of a mainframe will probably find MacRenderMan too time-consuming and cost-prohibitive.

### Almost a Photograph

MacRenderMan lets you create a wide variety of surface textures, plus motion blur and other effects. Most important, the software lets you manipulate light—a key ingredient in photography—to portray exactly the right mix of multiple light sources, amounts and angles of reflections, artificial and natural effects, and shadow gradations.

To create finished renderings, MacRenderMan uses a translation file called RIB (RenderMan Interface Bytestream), which in the future you'll be able to create with the Save As selection in third-party modeling programs. The RIB file contains not only a geometric description of the objects in the scene, but also the material properties necessary to fully describe the objects. These include material characteristics, shadows, texture maps, shading parameters, and the viewing perspective.

Subtle changes in the contents of the RIB file can make dramatic differences

### MacRenderMan

#### Company

Pixar  
1001 West Cutting  
Richmond, CA 94804  
(415) 236-4000

#### Hardware Needed

Mac II, IIx, IIcx, IIci, or IIfx with at least 5 MB of RAM (8 MB recommended) and 5 MB of hard disk space

#### Software Needed

System Tools 6.0.3 or higher, MultiFinder, 32-Bit QuickDraw, and a modeling application program that outputs RenderMan Interface Bytestream scene-description data; a 24-bit color system is strongly recommended

#### Price

\$795

#### Inquiry 1060.



in the final image. You can use your text editor to change the RIB files created by your modeler to further define the qualities you would like displayed in your final rendering. You can also read the files as text and manipulate them in the text format.

Listing 1 shows a short section of a RIB file describing rendering setup information, positioning data, scene definitions (e.g., light sources), and the geometric form of objects. Sound simple? Not really. This is my main objection to the program: To change the attributes of a model using the RIB file format, you have to revert from the Mac's graphical user interface to an almost-DOS environment. Most of us Mac users bought our Macs to avoid doing just that. Also, there are additional commands that you will need if you want to modify shading and texturing.

### Five Components

The MacRenderMan package comes with five applications, plus some sample libraries and tutorial demos. One of the applications, called RenderMonitor, is similar to the Print Monitor Desktop application available under MultiFinder.

*continued*

**Listing 1:** A sample RIB file. Although it is versatile, changing code in the RIB file format requires Mac users to work in a DOS-like environment.

```

Display "New Slide" "framebuffer"
  "rgba"
Format 128 96 1
ShadingRate 10
PixelSamples 1 1

Projection "perspective" "fov" 30
Translate 0 0 25
Rotate -10 1 0 0
Translate 0 -5 0

WorldBegin

LightSource "ambientlight" 1
  "intensity" [.9]

AttributeBegin
Attribute "identifier" "name"
  "wallfloor"

Translate 0 0 2.5
Patch "bilinear" "P" [-20 -20 0
  20 -20 0 -20 20 0 20 20 0]
Patch "bilinear" "P" [-20 0 -10
  20 0 -10 -20 0 0 20 0 0]
AttributeEnd

AttributeBegin
Attribute "identifier" "name"
  "middlegroup"
Rotate -90 1 0 0
Translate 0 0 5
Sphere 1 -1 1 360
Disk -1 1.7 360
Cylinder 1.7 -1.4 -1 360
Cylinder 1 -5 -1.4 360
AttributeEnd

WorldEnd

```

After you install RenderMonitor into the System folder, the application allows you to render images in the background so that you can continue with other work in the foreground. This is a great idea, but

for the majority of the renderings I did for this review, the program asked me to quit out of all foreground applications to save system memory.

One of the program's renderers, the

picture-making application, is called PhotoRealistic Renderman. It accepts modeling data through the RenderMan interface specification format to generate rendered 3-D images. This application is a cdev, and as such, you install it in the System folder. PhotoRealistic Renderman gives you options for choosing rendering size and quality.

The second renderer is Vector RenderMan, which generates wire-frame images for quick evaluations of your model. This System-folder-residing cdev offers the same options as PhotoRealistic Renderman.

RenderApp is a Desktop application that lets you display rendered images on a color Macintosh monitor. You can also use it to display and save image files in the PICT format. The renderer can then use these files to generate texture maps.

ShaderApp is a Desktop application for compiling shaders written in the RenderMan Shading Language (.sl file) in the Shading Language Object file (.slo file). The source must be a text file. ShaderApp generates a shader with the name specified in the source file and the .slo suffix.

**486 EISA NOW SHIPPING**

**WE'RE CERTIFIED.**

Novell Labs Tested & Approved

SCO THE SANTA CRUZ OPERATION

Quarterdeck

BANYAN

While many computer manufacturers say they are compatible, CSS Laboratories™ MaxSys™ file servers are certified to work with your network operating system. Our MaxSys 386MT/33, for example, has passed testing by Novell®, Banyan®, SCO® and Quarterdeck®. And our new 486 EISA line offers unsurpassed compatibility, while providing all the power and features to carry your network well into the future.

There are MaxSys systems with up to ten drive bays

and 400 watt power supplies, and all come with our exclusive 12-slot motherboard. If you need a heavy-duty file server, this is it. All of our 286, 386SX, 386 and 486 tower and desktop systems come with a full one-year warranty, a national 800 number for technical support, and optional on-site service. And they are all certified to provide uncompromising performance and reliability.

### Easy Installation

Installing the program was a straightforward procedure; I just dragged the items noted as System documents into the System folder, and the rest into a file on my Desktop. You must be in MultiFinder for MacRenderMan to do background rendering, so I selected MultiFinder and restarted my Mac, and the program was ready to go. For this review, I used a Mac IIx with System 6.0.5, 8 MB of RAM, a DayStar 50-MHz accelerator, and 1 gigabyte of ROM. My monitor was a Radius 19-inch color display.

Unlike with most Mac programs, you will probably need to read the MacRenderMan manual to use the software effectively. But the program is fairly simple to operate as long as you don't want to make changes to the RIB files and your modeling program supports the RIB format. There weren't many applications that did support RIB files as this went to press, but third-party representatives that I talked to said that they expected to within the next few months. According to Pixar, vendors are currently working to incorporate RIB file support in such programs as Vidi's 3-D Modeler, Dyna-

ware's Dynaperspective, Intergraph's MicroStation Mac, MacroMind Three-D, Byte by Byte's Sculpt 3D, Strata's StrataVision 3D, Paracomp's Swivel 3D Professional, and Abvent's Zoom.

The actual rendering of a model from a RIB file is also straightforward. I first went to the Chooser to select a renderer (I used PhotoRealistic RenderMan for the image shown in the photo). I then configured the renderer by selecting the quality of the drawing (Quality or Preview) and the amount of RAM I wanted to assign to the renderer (4 MB in this case).

Next, I selected RenderApp from the utilities file on the Desktop and went to the Render menu and selected Render Setup. Here I named the image and selected where I wanted the finished image to reside: in a window, a PICT file, or a TIFF file. I chose a PICT file. I chose the Render A File selection from the Render menu and then selected a RIB file. Then I just sat back and waited while the Render Monitor processed the rendering (as I noted earlier, MacRenderMan asked me to exit from all other programs to save on system memory). With my 50-MHz ac-

celerator, rendering time was about 45 minutes.

### Small Projects Only

If you need photo-realistic rendering, this is the package for you, as long as you can wait for software developers to tuck on the RIB format to their programs and you can afford a fast Mac. The amount of ROM is not as important, because the finished files are not huge.

I personally would not be able to use MacRenderMan as much as I would like, because most of my work is architectural CADD and animation. As I stated earlier, the time the program takes to get your model just right would be too costly for architectural renderings. But for people who create simpler objects and who don't mind the DOS-like nature of the RIB format, the program gives great photo-realistic renderings with a moderate amount of time and effort on your part. ■

*Bill Calabrese is MIS/CADD director of Design Alliance, Inc. (San Luis Obispo, CA), an architectural design firm. He has been an avid Macintosh user since 1984. You can reach him on BIX c/o "editors."*

# THEY'RE SATISFIED.

"I would like you to know how pleased we are with the CSS Labs equipment installed on our network. Your unique design has allowed us to grow the services to our users beyond what was planned in our budgets." "... the higher performance and reliability has been commented on by the network users." "... Also, please extend my sincere thanks to your technical support staff for their fantastic response in resolving our recent compatibility issue." "... My staff was amazed that the solution was delivered the next day! This type of service is rare in the industry." —Roger Spangler, Network Service Manager, Fujitsu America, Inc.

"... ample provisions for drive and add-on board expansion make this system a fine choice in network or multiuser applications." —PC Magazine

"Our records confirm that over 25,000 CSS boards are in the field now, and judging by the low rate of return, their performance and integration in our systems, is outstanding"

—Bob Ziegler, Purchasing Manager, Datamedia Corporation

"... the combination of large- and small-record test results makes it quite impressive over the full range of data-handling hurdles." "Apparently CSS has found some semi-magical combination of medium technology that will yield sterling performance..."

—PC Magazine

"... a great example of a PC on steroids." "This machine is more than the sum of its parts. Power file server builders should keep an eye on CSS." —LAN Times

Circle 73 on Reader Service Card (RESELLERS: 74)

**CSS**  
LABORATORIES, INC.  
A Solid Investment

DEALERS CALL **(800) 966-CSS1**

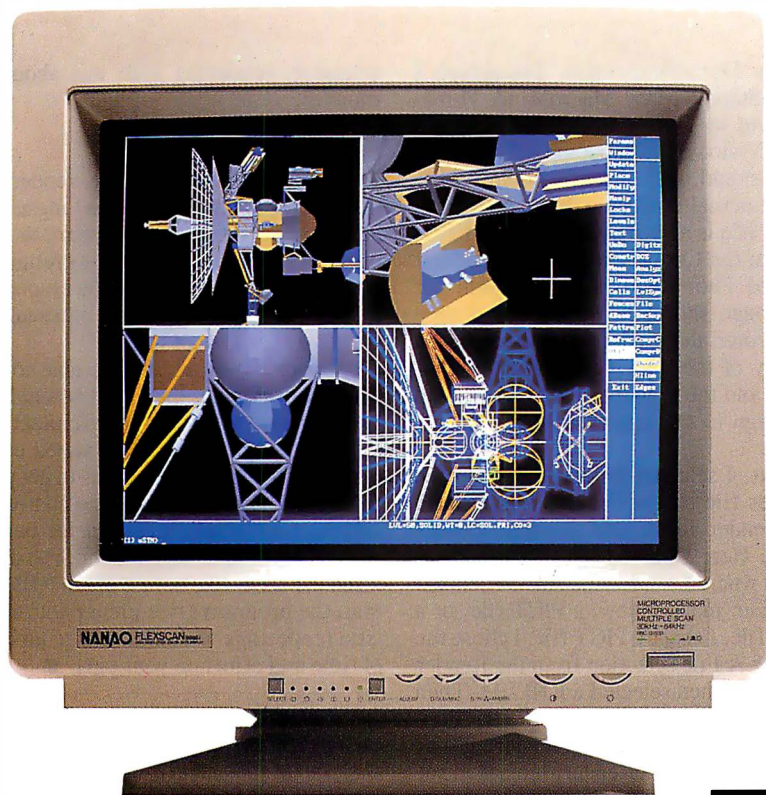
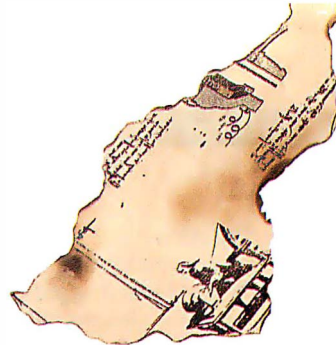
California (714) 852-8161 • New York (212) 605-0290 • Canada (416) 882-0260  
Australia 61-2-808-3666 • Germany 02-51-27-91-17

Ask About  
On-Site Service

When you're evaluating a new system, it helps to know what experience others have had. CSS Laboratories' customer list is a long and happy one. Not to mention the computer press, who have also had some nice things to say.

These people all agree, that CSS systems don't just perform well, they offer unsurpassed reliability and compatibility. Add to this our reputation for customer service, and you can see why people are recommending us. For dealer information, call 1-800-966-CSS1. Find out why we call CSS Laboratories "A Solid Investment."

CSS logo, CSS Laboratories, A Solid Investment, MaxSys are trademarks of CSS Laboratories, Inc. All other brand names and product names are trademarks or registered trademarks of their respective owners.  
©1990 CSS Laboratories, Inc.



# See the Future.

The ideal 16-inch ergonomic monitor for professional graphics and business applications.

Maximum performance for CAD/CAM, spreadsheets, databases, WYSIWYG word processors and desktop publishing. Designed for PCs and Macintosh II.

1024 × 768 resolutions. Supporting the new, higher refresh rate of 70Hz and above for a flicker-free display. No distortion. Sharply focused. Bright images across the entire screen.

An anti-static, non-glare screen. Low magnetic radiation. No interference between two monitors separated by a mere six inches, for dual-display applications.

Microprocessor-controlled configuration for your applications, memorizing size and position of the screen settings you prefer.

Other monitors compete against the standards.  
**FLEXSCAN® sets them.**

## NANAO®

**NANAO USA CORP.**

23510 Telo Ave., Suite 5  
Torrance, CA 90505 USA  
Phone (213)325-5202  
Fax (213)530-1679

Circle 207 on Reader Service Card (RESELLERS: 208)

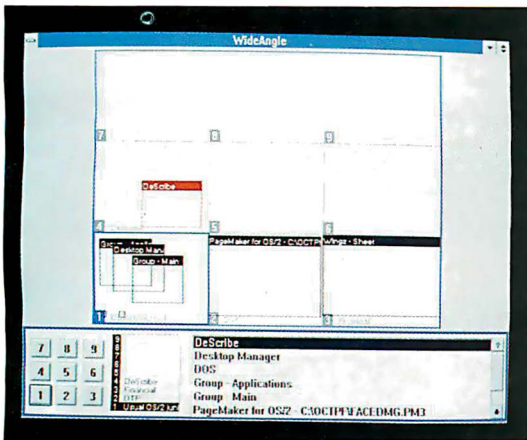
### FLEXSCAN 9080i

16" (15V), 0.28mm-dot pitch CRT  
1024 × 768 Super high resolution with 70Hz  
high refresh rate  
Scan Frequency: Automatic Adjustment  
H: 30-64KHz V: 50-90Hz  
VGA, 8514/A and Mac II Compatible



## REVIEW

# A New Angle on OS/2 and Windows



*Nine virtual OS/2 screens. Each outline represents an OS/2 window. You can move windows among virtual screens by simply dragging them to a new location. The nine buttons at the bottom of the screen let you select the active screen by simply clicking on either the button or the descriptive text.*

You can never be too rich, and your desktop in a graphical user interface environment can never be too big. That's the thinking behind Inner Media's Wide Angle, a virtual desktop manager for OS/2 or Windows.

If you use OS/2, you've seen the problem. You open the OS/2 File Manager and a group window or two, and you've used up most of a standard VGA monitor. Next, you open a word processor to write a quick memo, but you need to incorporate some data from a spreadsheet. OS/2 can handle that by simply putting WingZ or Excel's window over the top of everything else. By the time you have opened two applications and the "standard" OS/2 stuff, the cursor is lost in a sea of overlapping windows.

## Almost Like Having Nine Monitors

Wide Angle makes OS/2 Presentation Manager think your work area is nine times its actual size. It's almost like using a single monitor with a switch box and nine VGA boards.

You open applications as you normally would and put them in logical working groups. For instance, you might be working on a spreadsheet in WingZ while you are composing a sales brochure with DeScribe and PageMaker. WingZ likes to stretch out, so you might put it in a workspace of its own. Cutting and pasting text from DeScribe to PageMaker is considerably easier when the two applications are together in the same workspace. The photo shows Wide Angle's maximized window with this sample layout. Moving windows within a workspace or from one workspace to another is a simple matter of dragging the

picture of the window to its new location.

If you put WIDEANGL.EXE in your STARTUP.CMD file and place your applications together in a group named WIDEANGL, Wide Angle will automatically open all your applications and put them in their proper location. In addition to the maximized view, Wide Angle keeps a smaller, resizable window on-screen with nine push-button window controls and a verbal description of each window. To change active workspaces, you either click on buttons 1 through 9, click on the text description, or double-click on the picture's window.

I tested my copy of Wide Angle on a Compaq 386/20 running Compaq's OS/2 1.2 with 6 megabytes of RAM. On that machine with three or four applications active, the switch-over between windows was almost instantaneous. I ran a version for Windows 3.0 on a 16-MHz 386 system with 5 MB of RAM and a 1280- by 960-pixel Radius TPD/PC monochrome monitor. Wide Angle (the Windows version) handled the large screen with no trouble.

## Houdini Would Be Proud

Clever programming is sometimes indistinguishable from magic. Wide Angle manages to do its job in a mere 60K bytes of RAM under OS/2 or Windows, no matter what your system configuration is. How? Both OS/2 and Windows have some primitive capabilities for handling large screen areas, and the engineers at Inner Media have found a way, through the use of standard application programming interface calls, to get OS/2 to manipulate the virtual screens with little overhead.

## Wide Angle for OS/2 PM or Windows



### Company

Inner Media, Inc.  
60 Plain Rd.  
Hollis, NH 03049  
(800) 962-2949  
(603) 465-3216

### Hardware Needed

IBM AT or compatible

### Software Needed

OS/2 version: OS/2 1.2 or higher  
Windows version: Windows 3.0 or higher

### Price

Either version: \$129

### Inquiry 1111.

Another neat trick is Wide Angle's control panel. This is a window like any other, except that it likes to float automatically to the top of the current window stack.

You'll find that you'll want to use this AutoRise feature often; fortunately, it's always visible. If it gets in the way, you can reduce it to a minimized icon (the nine buttons shrink but stay active) or turn it off.

As far as I know, there's nothing quite like Wide Angle on any other platform. The closest product I'm aware of is Stepping Out on the Macintosh, from Berkeley Systems. Like Wide Angle, Stepping Out enlarges your usable screen area, but it treats the enlarged area as a single virtual screen without the logical groups. It's up to you to remember where things are, and you have to do lots of scrolling from place to place. I much prefer Wide Angle's approach. It's easier to arrange your applications in groups and press a single button.

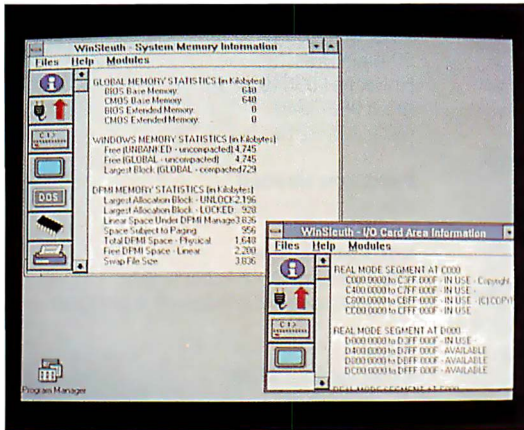
Best of all, Wide Angle works. The only problem I found is that it doesn't know anything about screen savers. Wide Angle kept popping up on the blank screen after my screen saver blanked the display. Disabling AutoRise solved the problem.

Priced at \$129, Wide Angle may be just the cure for what ails OS/2. No longer do you have to use the Task Manager to find a window or waste time minimizing applications to get them out of the way. ■

*Howard Eglowstein is a BYTE Lab testing editor. He can be reached on BIX as "heglowstein."*

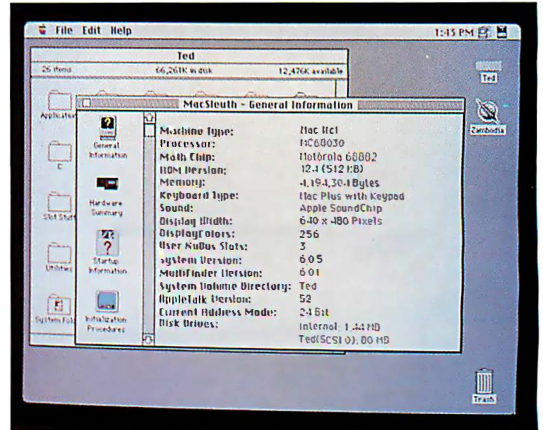
## REVIEW

## Two Bumbling Detectives



◀ WinSleuth's actions are selected through a scrolling set of icons, but the output window is not scrollable.

▶ MacSleuth can get confused. It reported that our Mac IIci had a Mac Plus keyboard with a keypad, an impossible combination.



Dariana Technology Group, creator of the venerable System Sleuth DOS utility, has recently branched out into two new areas: Windows 3.0 and the Macintosh. The company's goal was to create programs that could call out your system and software configuration in a flash. Our reviewers found both products disappointing.

### WinSleuth: A Solution in Search of a Problem

In my PC troubleshooting toolkit, I carry a copy of System Sleuth, Dariana Technology Group's handy snoop utility. It's a quick way to discover the amount of memory that is installed in a PC, the locations that are available for add-in boards, the type of video adapter and

disk drive, and whether the system includes a math coprocessor. WinSleuth carries on the tradition of System Sleuth and adds a picture of your PC from Windows' point of view.

WinSleuth is made up of 11 modules, most of which work just like their System Sleuth counterparts. The General Information module, for example, describes your CPU and FPU, gives the date of the ROM BIOS, and identifies the number and type of floppy and hard disk drives. If you want to check out some low-level aspects of the environment—things like the partition table, TSR programs, and device drivers—you have to run WinSleuth under real-mode Windows.

The Display Information module describes your Windows display driver. It reports the display resolution and color depth, and it queries the driver (i.e., calls the Windows GetDeviceCaps function) for a list of device capabilities such as underlining, scaling, and (in 386 enhanced mode) virtual memory under the control of the Windows memory manager. The Windows Information module lists the Windows tasks currently running and optionally lists the dynamic link libraries running in support of those tasks. Network Information summarizes the capabilities of the current Windows network driver.

But what's WinSleuth's *raison d'être*? You can boot DOS on a naked machine, run System Sleuth from a disk, and find out lots of useful information quickly. I often do just that. You *can't* use WinSleuth that way, because, of course, you have to install Windows first. In any case, WinSleuth does not handle the basics as comprehensively as does Sys-

tem Sleuth. Once you've got a Windows environment up and running, WinSleuth can tell you some interesting things, but I don't see it as the vital diagnostic tool that its progenitor is.

Frankly, WinSleuth looks like a program thrown together in a hurry to cash in on Windows 3.0's popularity. It's not even a polished Windows 3.0 application. Information panes aren't scrollable, for example, and in one case, you can generate more output than will fit. Screens are loaded with typos, and they lack intelligent refresh routines. Even the packaging is evidence of a rush job: It announces the company as "Dariana Technology." This isn't the best work that Dariana Technology Group can do.

—J. U.

### WinSleuth 1.0

#### Company

Dariana Technology Group, Inc.  
6945 Hermosa Cir.  
Buena Park, CA 90620  
(714) 994-7400

#### Hardware Needed

286-, 386-, or i486-based PC with 640K bytes of memory, a hard disk drive, and a compatible graphics adapter

#### Software Needed

DOS 3.1 or higher; Microsoft Windows 3.0

#### Price

\$149

#### Inquiry 1110.



### MacSleuth 1.0

#### Company

Dariana Technology Group, Inc.  
6945 Hermosa Cir.  
Buena Park, CA 90620  
(714) 994-7400

#### Hardware Needed

Mac SE, II, IIcx, or IIfx

#### Software Needed

System 6.0.2 or higher

#### Price

\$149

#### Inquiry 1109.



## MacSleuth:

### Full of Contradictions

MacSleuth 1.0 is supposed to be a diagnostic aid for Mac system woes. It's a Mac application that uses 13 diagnostic modules. These modules snoop through the Mac's innards and produce reports detailing the system's hardware configuration, INITs, cdevs, device drivers, interrupt queues, resources, and parameter RAM settings, to name a few.

Unfortunately, I found MacSleuth to be more of a hindrance than an aid in trouble-shooting. For example, it failed to recognize that a Mac IICI had a 24-bit color board (it insisted that the display had only 256 colors). On a Mac II with a paged memory management unit chip, the Resources module failed to work or crashed the machine. Network reports were incomplete at best on BYTE's LocalTalk network, which uses a Farallon StarController and one AppleShare file server.

As you click on the various module icons for additional information, MacSleuth's operation becomes more erratic. At certain times, opening a desk accessory while in MacSleuth confuses the application so much that it reports incorrect information. For example, on the Mac IICI, I got beeps when I tried to open a DA. MacSleuth reported that the IICI had a Mac Plus keyboard—an electrical impossibility, since the Plus uses a custom cable while the IICI uses an Apple Desktop Bus connection for its keyboard. By removing most of my INITs and the TMON debugger, I got better behavior out of MacSleuth, but isn't a diagnostic package supposed to deal with these things?

Free upgrades are promised for six months to correct MacSleuth's problems. However, a combination of freeware, shareware, and commercial utilities can provide the same information for far less than the \$149 that MacSleuth costs. For example, you could use Randy Dees' AT View DA (shareware, \$5) to examine your LocalTalk network, and Ken McLeod's freeware MacEnvy cdev to report on your system hardware, attached monitors, and parameter RAM. Symantec's SUM II disk utilities (\$149) has an application that gives you an exhaustive report on drivers, interrupt queues, and memory while providing hard disk drive recovery tools as well. ■

—T. T.

Jon Udell and Tom Thompson are BYTE senior editors at large. You can reach them on BIX as "judell" and "tom\_thompson," respectively.

# Space-Saver Keyboard



**S**ave an amazing 60% of the desk or counter space now taken by a standard keyboard and enjoy improved functionality at the same time. Actual size is 273 x 152mm (10.75" x 6.0"). The new MICROTYPE Keyboard is rapidly gaining acceptance as a truly advanced alternative to the original IBM layout for many applications. Reliability of the MICROTYPE has been amply proven through extensive use in trading areas of several major stock exchanges as well as in many banks, brokerages, stores and at factory work stations.

Space is saved by compressing rows (not columns) and eliminating wide borders. Re-arranging and elevating the auxiliary key clusters also saves space while improving accessibility with reduced eyescan and head movement. Keys have full travel with a light tactilely responsive touch. All standard features such as auto-repeat, caps, num and scroll lock are included on the MICROTYPE.

PC XT/AT, PS/2 IBM and clone compatibility. Available in US and most European language versions. Made in USA with 1 year warranty.

Order direct from stock with 15 day full return privileges. VISA, MasterCard, Eurocard charges and COD accepted.

USA	1-800-DATALUX	Fax 703-662-1682	\$124.50 + 6.00 s/h
EUROPE	44+306-76718	Fax 44+306-76742	£99.00 + VAT + P&P
CANADA	514-694-0870	Fax 514-694-0871	\$189.00 Cdn + s/h

OEM and reseller volume discounts available. Keytop legend and color customization offered.



A new Space-saver product from DATALUX — Microtype keyboard and LCD monitor combination. VGA resolution, backlight, supplied with adaptor card. Call for price and availability.

"... beautifully sensitive and handles both typists with light touch and those who really bang away..."

COMPUTER BUYER'S GUIDE

"... This could be the perfect layout for an enhanced keyboard that must fit into a small area..."

COMPUMAG

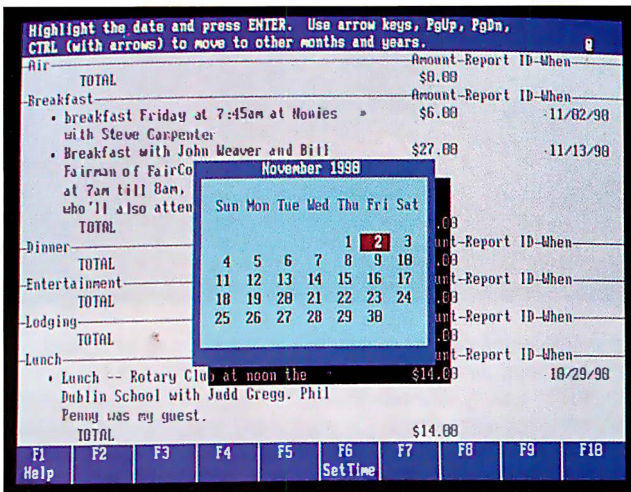
## DATALUX

**DATALUX Corporation**  
2836 Cessna Drive  
Winchester, Virginia 22601

**DATALUX INTERNATIONAL LTD.**  
Euro House  
Curtis Road, 11 Old Water Road  
Dorking, Surrey, UK

Reviewer's Notebook provides new information—including version updates, new test data, long-term usage reports, and reader feedback—on products previously reviewed in BYTE.

## Ease of Use in Lotus Agenda



*Agenda 2.0 now supports math to make filing expense reports easier, and its new streamlined date management includes a pop-up calendar.*

Lotus Development opened up new territory when it released Agenda, its personal information manager (PIM), two years ago. This was new territory in that pioneering users of the first release were assailed by arrows flaming with difficulty and encountered seemingly endless hardships as they navigated Agenda's learning curve.

It wasn't just that Agenda was challenging to learn: It was based on new database and information management concepts that were not easy to grasp.



### Agenda 2.0

#### Company

Lotus Development Corp.  
55 Cambridge Pkwy.  
Cambridge, MA 02142  
(800) 343-5414  
(617) 577-8500

#### Hardware Needed

IBM PC or compatible with 640K bytes of RAM and a hard disk drive

#### Software Needed

DOS 2.1 or higher

#### Price

\$395

#### Inquiry 1204.

Agenda stored data in *items*, which could have *assignments* to *categories*, which in turn could have *parent* or *child* categories. Agenda approached object orientation, yet it didn't completely fit the object-oriented model.

To make matters worse, Agenda applications were (at least at first) user-defined, impaling users with their own inabilities to understand Agenda.

Some pioneers survived, and others didn't. I was one of the survivors. For over a year and a half, I used Agenda to keep track of my contacts, telephone conversations, appointments, and other bits of information. I developed a love/hate relationship with Agenda.

I loved Agenda because it could compile lists of the information I put into it and otherwise make sense of it all automatically, as a good secretary might do. As my database grew, I hated Agenda for its clumsy way of handling a large list of categories—which sometimes made the program so slow that my 25-MHz 386 computer couldn't sort through my daily notes even if I left it running all night. In fact, without a good disk-caching program installed, the old version of Agenda would run my computer's hard disk drive almost constantly.

#### Canned Applications

To level out the learning curve, Agenda 2.0 includes four "starter" applications

that Lotus claims are so easy that you can become productive with Agenda in only 30 minutes. Even though that's a lot to promise, Lotus is probably right. Anyone should be up and running with one of the applications in very little time. Proficiency may come later, but that's fair.

The applications are Activities Planner for tracking tasks and appointments (an updated version of the planner application released with Agenda 1.01), Account Manager for tracking sales calls, People Manager for tracking the goals of people you manage, and Information Sifter for sorting information that comes from external sources like E-mail.

And that's what makes Agenda 2.0 so much easier to learn—it comes with applications ready to use. Now, new users can spend their time learning how to run an application, rather than having to learn the conceptual underpinnings of how Agenda does its magic.

With Activities Planner, for example, you might simply type in a note (Agenda calls a note an *item*) like "Meet Joe for lunch at noon next Tuesday." Agenda will automatically set the date to whatever day next Tuesday happens to be. That way, when you call up your schedule for next Tuesday, your lunch with Joe will be plugged in at 12:00. Agenda will file the note (in Agenda-ese, it *assigns the item*) to the activity mentioned in the note, so that later you'll be reminded to fill in the amount you spent to track your expenses. The only thing you might need to do is enter Joe's name in the people column. I say "might" because once Agenda recognizes a name in a note, it automatically files the note under the name.

None of this is new to Agenda—you could make the old version do the same things. But now you don't have to teach Agenda how to do them. Also, Agenda 2.0 now supports simple math (see the photo). Thus, when you enter the amount of that lunch with Joe, Agenda will automatically total an expense report for you by week, month, type of expenditure, and so on.

#### A Rewritten Agenda

Beyond the canned applications, Agenda 2.0 is a rewrite of the program that attempts to improve performance. No, it's not a redesign of the basic concepts of the original Agenda. And that's good news,

because those concepts, once you get the hang of them, work pretty well.

As for the problem of relentless disk access, a change in how Agenda manages memory dramatically improves performance on databases with large category lists. (The category list is all the individual things—such as people, activities, and tasks—that Agenda keeps track of.) Because Agenda is comparing the note text to the text of each category, it needs the complete category list in memory.

If the list was too large to fit into your computer's memory along with the program, as my list of over 3000 people and products was, the old Agenda had to swap parts of the list to and from the hard disk. Even using a disk cache, the swaps took an incredible amount of time—in my case, the better part of a day just to evaluate dates.

Thankfully, Agenda 2.0 takes advantage of more efficient expanded memory, if you have it (if you don't, you'll want it), to load the category list there. With my database, which has grown considerably, Agenda 2.0 uses a little more than a megabyte for expanded memory. Most important, though, it can evaluate all the dates in a fraction of the time of the old Agenda.

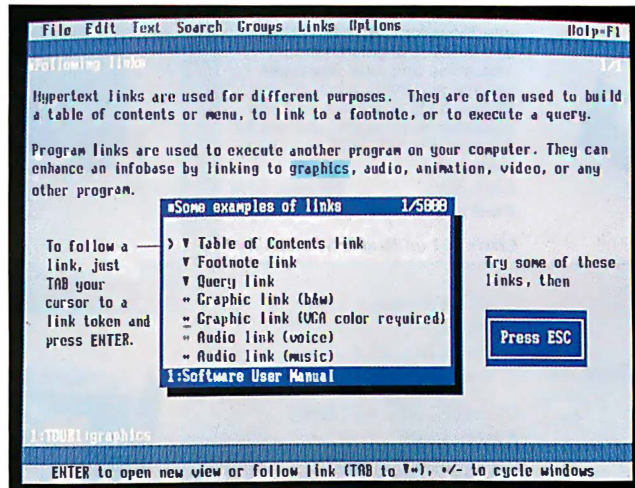
That's partly because Agenda 2.0 deals with dates in a more efficient way. In the earlier release, you had little control over dates, and many users programmed their own categories to handle dates. That typically increased the size of the category list by 365 (a category for each day of the year) just to have a schedule calendar.

Not only did that cause problems, creating more disk swaps for a larger category list, but every day Agenda would also try to evaluate each date category against the entire database. Agenda 2.0 solves the problem by introducing category types specifically for dates. The category types are so efficient that the "when" category can track all scheduling.

Combined, the enhancements in memory management and date handling make Agenda usable again on my database. My old love/hate relationship with it has ended—the hate part of it, that is. There are other good PIMs, like IBM's Current, you might consider. But neither Current nor any of the others will do so much categorizing for you automatically; nor will they allow you as much flexibility as Agenda 2.0—and none are that much easier to learn. Now, my biggest complaint with Agenda is that it doesn't fit into my coat pocket like a Day-Timer.

—Dennis Allen

## Expanded Linking in Folio Views



*Folio Views 2.0 adds hypertext linking to external sources so that you can link graphics or sound to an infobase.*

Another upgraded product worth considering is Folio Views 2.0, a program that manages very large amounts of textual information. In a nutshell, Folio Views fully indexes your text and then compresses the text and index into a single file typically half the size of the original ASCII text file. That alone was a remarkable feature in the first release, because a full-text index can easily exceed the size of the text file.

But Folio Views was not without its problems. First, it had its biggest problem with scrolling through text. Another problem was that although Folio Views offered some hypertext linking, it was limited to a single database (which Folio calls an *infobase*). And finally, preparing text for Folio Views' proprietary format took a great deal of time and patience, because you had to manually insert formatting commands and otherwise translate a document from its original format.

Folio Views 2.0 fixes all those problems. The text scrolling should be fast enough to keep any browser happy. Although you can't whiz through a Folio Views document as though it were a XyWrite (one of the fastest word processors) document, you can browse text comfortably—and even as fast as most ordinary word processors.

As for the hypertext linking, two new features in Folio Views 2.0 make all the difference. First, you can link to external sources, like another infobase. Second, because you can now exit Folio Views and run another program (leaving just a 10K-byte kernel behind), you can make a hypertext link to another program. In

other words, you could create a link to a CD-ROM or to a program (e.g., Viewer, which is included) that displays graphics or produces sound (see the photo). Maybe that doesn't make Folio Views a multimedia product per se, but it might make for interesting hypertext documents.

To make document conversions easier, Folio Views now automatically converts text and data from over 40 formats (e.g., XyWrite and other popular word processors).

When I first tested Folio Views (see "Text Retrieval with a Twist," July 1989 BYTE), I liked it a lot—even with its shortcomings. Now, with those shortcomings fixed in Folio Views 2.0, I like it even more. ■

—Dennis Allen



### Folio Views 2.0

#### Company

Folio Corp.  
2155 North Freedom Blvd., Suite 150  
Provo, UT 84604  
(800) 543-6546  
(801) 375-3700

#### Hardware Needed

IBM PC or compatible with 512K bytes of RAM

#### Software Needed

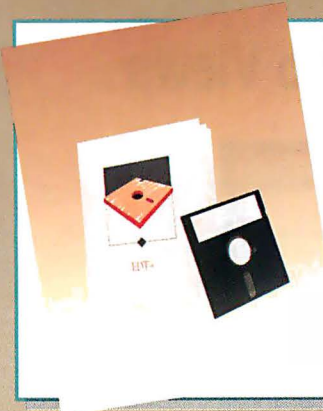
DOS 3.0 or higher

#### Price

\$495

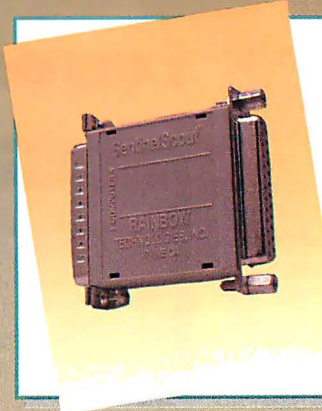
#### Inquiry 1205.

# Professional developers require



**EDT+**  
by Boston Business Computing  
EDT+ 5.0, the only complete emulation of DIGITAL's VAX EDT, is 50% faster than its predecessor and features multiple windows, interfaces for EVE, EMACS, vi and WPS, 132-column mode, status line and ruler, keystroke macros and much more. 30-day, money-back guarantee and free customer support and updates for 60 days. For MS-DOS and UNIX systems.  
LIST: \$295      **PS Price: \$279**  
*FastFacts 342-001*

Circle 262 on Reader Service Card



**SentinelScout**  
by Rainbow Technologies  
The SentinelScout is a hardware key that attaches externally to the parallel port of an IBM PC or compatible to enable execution of authorized program copies. It does not interfere with printer operation, hard disk installs or backup copies. Featuring a fixed-response security system unique to each device, the economical SentinelScout offers a level of execution control perfect for lower-cost programs.  
LIST: \$295 (kit of 10 keys)  
**PS Price: \$265**  
*FastFacts 1313-001*

## 386 DEVELOPMENT

	Price
386 Max 5.0	\$109
386DOS Extender by Pharlap	495
DESQview 386	189
F77-EM32 + Lahey Ergo	1055
FoxBASE+/386	479
Metaware High C 386/486	919
MetaWare Pascal 386/486	839
NDP Fortran w/VM	829
NDP C - 386	829
QEMM 386	95
VM-386	229
WATCOM C8.0 386 Prof.	1155
WATCOM C8.0 386 Stand.	795
Zortech C++ 386 Dev.	865

## AI-LANGUAGES

ARITY Combination Package	989
LISP	269
PC Scheme	85
TransLISP PLUS w/source	99
PDC Prolog Compiler	239

## ASSEMBLERS

MS MASM	105
Turbo Debugger & Tools	119
Visible Computer:80286	85

## BASIC & ADD-ONS

BAS-C Commercial	829
dB/LIB Professional	179
MS QuickBASIC V4.5	69
QBase	139
QuickPak Prof. V3.16	189

## C LANGUAGE COMPILERS

Instant C	769
Lattice C - 6.0 Compiler	189
Microsoft C 6.0	349
Microsoft QuickC	69
WATCOM C8.0 Prof.	439
WATCOM C8.0 Stand.	359

## CASE & PROTOTYPERS

Dan Bricklin Demo II	185
EasyCase Plus	275
EasyCase Plus Prof. Pack	365
EasyFlow	135
Instant Replay III	99
Matrix Layout	211
MetaDesign by Meta Software	287
Pro-C 2.0w/Workbench Combo735	
ProtoFinish by Genesis	211
Show Partner F/X	198

Visible Analyst	585
<b>COBOL</b>	
MS COBOL V3.0	639
Realia COBOL	859

## COMMUNICATIONS ADD-ONS

C Asynch Manager 3.0	139
Essential COMM by S. Mtn.	259
Greenleaf Comm Library	329
QuickComm	129

## DBASE

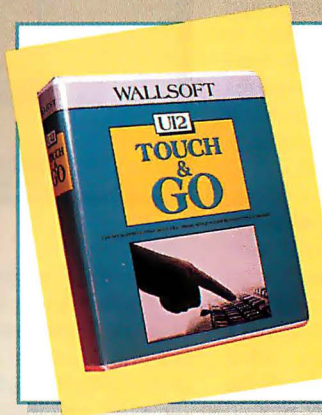
Clipper 5.0	550
dBASE IV	499
dFAST/PLUS	315
dBMAN V	178
dBXL	189
FoxPro	495
FoxBASE + - V2.1	279
QuickSilver	399

## DBMS

Cause Professional	499
CLARION Prof. Dev. V2.1	549
D the data language	199
Magic PC	379
Paradox V3.5	569
R:BASE 3.1	499

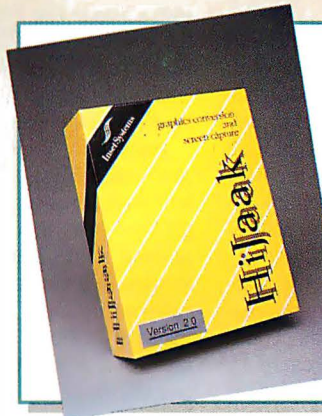
## DBMS TOOLS & LIBRARIES

AdComm for Clipper	279
Artful.Lib	289
BALER Spreadsheet Compiler	399
CLEAR + for dBASE	179
Comet Multiport	169
dBASE BlackBox	65
dBASE Online	129
BRIEF w/dBRIEF	Call
dBX/dBport	425
dGE 4.0	279
dQUERY MU	179
dSalvage Professional	195
FLIPPER Graphics Library	179
FUNCKY.LIB	179
Genifer - code generator	269
Net Lib	229
Pro Clip	149
R&R Relational Reportwriter	139
R&R Code Generator	129
Scrimage	139
SilverComm Library	229
SilverPaint	119



## UI2 Touch & Go

by Wallsoft  
UI2 Touch & Go is a subset of The UI Programmer 2, Developer's Release for less experienced programmers. It has a screen painter and integrated data dictionary and comes with the GENSYSS template system, customized application generation without programming. GENSYSS handles almost all application development needs, 'right out of the box'. UI2 Touch & Go generates dBASE III+ and IV, Clipper, FoxBASE+, FoxPro, Quicksilver and dBLX programs.  
LIST: \$395      **PS Price: \$319**  
*FastFacts 212-011*



## HiJaak Release 2.0

by Inset Systems Inc.  
HiJaak 2.0 is a graphics conversion and capture utility that translates more than 36 graphics file formats. HiJaak provides batch conversion capability from the DOS command line or from the user interface. Supported formats include GEM, PICT I&II, CGM, HPGL, PIC, DXF, PCX, MAC, TIF, and support for more than 16 group 3 fax devices. A 5K pop-up provides capture function of text screens, graphics screens, and laser printer output.  
LIST: \$199      **PS Price: \$189**  
*FastFacts 1085-003*



## BTree/ISAM v3

by Softfocus  
A powerful, portable indexed file manager for C programmers. Supports multiple indices, fixed or variable length records, rich assortment of key types, and single or multi-user operation. The latest release of a flexible, fully-functional and well documented product. Currently in use by thousands worldwide. All C source included along with complete documentation and example programs. Portable to all operating systems and C compilers, no royalties.  
LIST: \$179  
**PS Price: \$149 w/source**  
*FastFacts 209-002*

# more than just products...

## HARDLOCK Kit

by Glenco Engineering Inc.

Hardlock attaches externally to any printer port on an IBM PC/clone and permits execution of a protected application. Hardlock, the highest security in hardware keys, features a programmable variable response chip with an optional 128 bytes of memory. Kit includes: 5 Keys, unique Crypto-Programmer board, programmer's and non-programmer's software interface, demos, and application notes. Eight bit bus version available.

LIST: \$377 PS Price: \$359  
FastFacts 2994-001

## M++ 2.0

by Dyad Software Corporation

The M++ library is a complete, standardized, multidimensional array language extension to C++, giving you the same powerful array handling capabilities that have accelerated development in advanced scientific languages for years. Now in C++, DOS/Windows/Unix, C++ 2.0 compatible libraries. No Royalties. New! M++ Modules: M++ SUM, M++ LSM, and M++ OPTIM: Advanced statistical, generalized least squares, and optimization classes.

LIST: \$295 PS Price: \$279  
FastFacts 3138-001

## Architect Workstation Developer

by Interactive

When you need a high-performance graphical UNIX workstation for your development needs, see the company that sold the first commercial UNIX product! The Workstation Developer combines a PC's dedicated processing with the computing power of a minicomputer and provides the ability to create customized, networked

software for workstation applications. Other UNIX packages available.

LIST: \$1995 (1-2 Users) PS Price: \$1850  
LIST: \$1000 (Multi-user upgrade) PS Price: \$ 919 FastFacts 1614-103

## OPEN ACCESS III

by Software Products Intl.

Turn your ideas into market-ready applications in just weeks with Open Access III! Easily edit, run, and debug your programs in the integrated programming environment. Get data entry and report forms and support for windowing, light-bar menus, and 3-D graphics to make creating your applications a snap! Open architecture with a C language interface lets you add change or add features. And Open Access III even has its own compiler!

LIST: \$695 PS Price: \$489  
FastFacts 1759-007

Tom Rettig's Library 85  
UI2 Developer's Release 479

## DEBUGGERS/ DISASSEMBLERS

DASM 188  
Dis Doc Pro 229  
Multiscope for DOS 149  
Periscope IV Varies  
RE:Source by Genesoft 76  
SoftProbe 86/TX 345  
Sourcer 486 w/BIOS pre-proc. 149  
Trapper 189

## DEVELOPMENT TOOLS

ASMFLOW Prof. 179  
C-DOC 139  
CLEAR+ for C 169  
Codan 349  
Buzzwords dANALYST 269  
The Documentor 245  
Hyperinterface II Combo 239  
INSIDE! 119  
MKS Lex & Yacc 199  
MKS RCS 175  
PC-Lint 120  
Plink/LTO 439  
PolyMake 159  
PVCS Professional 439  
ROM-Link 339  
.RTLINK - by Pocket Soft 279  
.RTLINK Plus 419  
Source Print 67  
TLIB 5.0 Version Control 125  
Zortech C++ Tools Call

## EDITORS

BRIEF Call  
Cheetah 103  
Epsilon 109  
KEDIT 139  
QEdit TSR 89  
Sage Professional Editor 249  
SPF/PC - V2.1 129  
Vedit + 139

## EXPERT SYSTEMS

Eclipse 386 560  
Exsys Professional 478  
Logic Gem by Sterling Castle 89  
Personal Consultant Plus 1999

## FILE ADD-ONS

Accsys for Paradox w/source 739  
CBTREE 179  
C-Data Manager 279  
CodeBASE 4 279  
CQL - w/ source 365  
c-tree Plus by Faircom 529  
C-TRIEVE 229  
db\_FILE/RETRIEVE - SU 199  
Faircom Toolbox Prof. 1159  
WKS Library 149  
XQL 649

## FORTRAN

FOR\_C w/source 789  
Lahey FORTRAN F77L 549  
Lahey Personal FORTRAN Call  
MS Fortran Opt. Compiler 309  
RM/FORTRAN 499

## GENERAL ADD-ONS

C Tools Plus - V6.01 98  
C Utility Library 189  
Greenleaf SuperFunctions 239  
Opt-Tech Sort 119  
Turbo C Tools by Blaise 109

## GRAPHICS

Bar Code Library w/Source 369  
Essential Graphics v3.0 349  
GraphiC 319  
graphics-Menu 165  
GSS Graphics DevT Toolkit 699  
HALO 279  
HSC Sunscan 289  
LaserControl 139  
MetaWINDOWS 209  
MetaWINDOW/PLUS 289  
PCX Programmer's Toolkit 229

## HARDWARE

Aegis 55  
ALL Chargecard 399  
Capital Equipment Corp.  
OS/RAM32 0M 225  
OS/RAM8 0M 299  
OS/RAM4 0M 179  
DigiCHANNEL COM/8i 875  
DigiCHANNEL MC/8i 949  
DPT  
SmartCache ST506 1099  
SmartCache RLL 1099  
SmartCache ESDI 1099  
Disk Mirroring Module 685

Emerson UPS  
Model 10 UPS 169  
Model 20 UPS 319  
Model 40 UPS 699  
AccuCard 209  
AccuSaver 69  
EtherCard Plus 239  
EtherCard Plus/A 349  
Erasable Optical Drive Call  
Hardlock Kit by Glenco 369  
IIT Adv. Math Coprocessors  
3C87-25 450  
3C87-33 559  
2C87-20 329  
2C87-12 279

Intel Math Coprocessors  
80387-25 555  
80387-33 675  
J T Fax 9600 595  
Kickstart I 179  
KickStart II 399  
Kickstart III 689  
LANStor LAN150S 1599  
LaserStor WORM Drive 3295  
Personal Modem 2400 179  
QX/12K Modem 699  
QX/V.32c Modem 1349  
Seagate ST-125-1 20M 299  
Seagate ST-4096-1 80M 639  
Seagate ST-251-1 40M 339  
SentinelScout (kit of 10 keys) 265  
SpeedStor AT 320S 1999  
Smartmodem 2400 (Ext.) 359  
The Shadow SVGA1024K 319  
VGA WONDER 512K 359

# The Programmer's Shop is

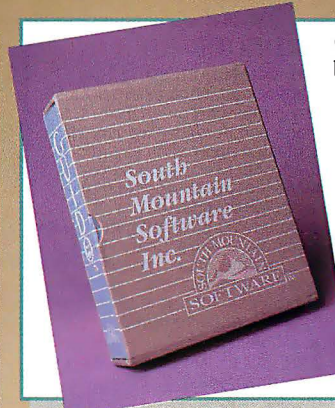


## ZORTECH C++ V2.1 UNIX 386 Compiler

by Zortech, Inc.

Zortech's C++ V2.1 386 compiler for UNIX makes it easy to port applications among DOS, DOS 386, OS/2, and SCO UNIX 386. With the same tight, fast, globally optimized code of the DOS and OS/2 versions, the compiler takes full advantage of the 386. Included is an ANSI/UNIX/Zortech C++ compatible library.

LIST: \$500 **PS Price: \$439**  
FastFacts 1108-045



## GUIDO

by South Mountain Software  
GUIDO is a powerful library of C functions which enables you to easily add graphical user interface objects to your application. Available objects include menus, windows, data entry, radio buttons, user definable objects and more. An event driven, object oriented windowing environment is also provided. GUIDO does not require any other graphics library and includes support for Borland Turbo C, Microsoft C and Quick C.

LIST: \$249 **PS Price: \$229**  
LIST: \$499 (w/so.) **PS Price: \$459**  
FastFacts 42-049

## NETWORKS

dBXL/LAN	519
Btrieve for DOS	479
Netware SQL	519
Netware C Interface	239

## OBJECT-ORIENTED/C++

Intek C++ 80386	298
M++ by Dyad Software Corp.	279
M++ w/source	449
Smalltalk/V	85
Smalltalk/V-286	185
Turbo C ++	159
Turbo C ++ Prof.	259
Zinc Interface Library	179
Zortech C ++ w/ source	269
Zortech C++ Debugger	150
Zortech C ++ Dev. Edition	399

## OS SUPPORT

DESQview	109
OS/286	589

## OTHER LANGUAGES

Logitech's Modula-2 Dev. Syst.	229
TopSpeed Modula-2	189
StonyBrookProf. Modula-2	249

## OTHER PRODUCTS

Carbon Copy Plus	159
Dan Bricklin's PageGarden	89
Fast!	45
Flow Charting III	199
HEADROOM	89
HiJaak	139
LapLink III	129
Link & Locate ++ - ROM MSC	349
Math Advantage	475
Norton Utilities 5.0	149
pcANYWHERE IV	159
PC Tools Deluxe 6.0	119
PC-KWIK Power Pak	119
Pre Cursor	57
Remote2	139
SpinRite II	89
System Sleuth	89
The Duplicator Toolkit-Pro 3.0	119
Time\$heet Prof.	76

## TURBO PASCAL

Turbo ASYNCH PLUS	119
Turbo Pascal 6.0 by Borland	109
Turbo POWER TOOLS PLUS	98
Turbo Professional	109

## TEXT SCREEN ADD-ONS

AEWINDOS	459
C Communications Toolkit	129
C Worthy w/Forms w/ARCH	359
Greenleaf DataWindows	339
HI-SCREEN XL Professional	289
MEWEL Window System	169
POWER SCREEN by Blaise	99
Vitamin C - source, menus	125
VC Screen - painter	109
Vermont Views Obj. + source	819

## UNIX/XENIX

C++ for Unix 386 by Zortech	43
Computer Innovations C++	469
db_FILE/RETRIEVE MU	399
ESIX Systems	
ESIX/V 386 Dev. (2 user)	569
ESIX/V 386 Dev. unltid	769
Informix SQL	Varies
Interactive Systems	
Architect Wrkstn Platform	1199
Architect Wrkstn Developer	1850
M++ for Unix by Dyad	679
M++ for Unix w/ source	939
Norton Utilities for Unix	249
SCO of Canada C++ for Unix	829
WordTech Quicksilver	839
XENIX 386 Dev. Sys.	689

## WINDOWS & OS/2

Actor 3.0	799
Brief for OS/2	Call
Case: W Corporate Version	905
Case: PM (for C or C++)	1899
C_talk/Views	419
C-Trieve/Windows	349
dBFAST/Windows	315
Graphics Server SDK	455
Instant Windows	895
KnowledgePro Windows	589
M++ by Dyan Software Corp.	279
M++ w/source	499
MKS Toolkit	229
MS Windows 3.0	119
MS Windows DDK	365
MS Windows SDK	365
Multiscope OS/2 Debugger	375
Multiscope Windows Debug.	315
Object/1	598
OS/2 PM Toolkit	369
Smalltalk/V PM	469
Tempo for Windows	89

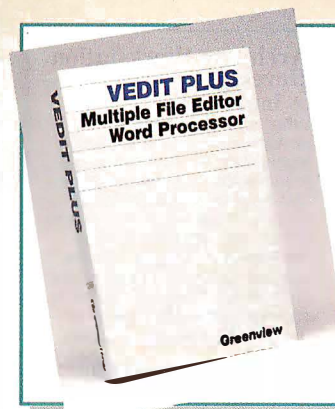


## Expert Help Expert Help Developers Kit

by SofSolutions  
Expert Help replaces The Norton Guides with 100% file compatibility and incredible features! With Expert Help you can build your own Hypertext Databases or get instant reference from over 100 Databases that are available commercially. The Expert Help Developers Kit even lets you distribute The Expert Engine with your Databases (no royalty). The Expert Help Engine is memory resident, requiring 1K (with EMS).

	LIST	PS Price
Expert Help	\$ 79	\$ 69
Expert Help Multi-User	\$279	\$259
ExpertHelp Developers Kit	\$199	\$185

FastFacts 876-023



## VEDIT PLUS 3.40

by Greenview Data, Inc.  
The new VEDIT PLUS programmer's editor integrates your favorite compilers, assemblers, linkers, debuggers and Make programs to really speed development. Its unique memory manager swaps out TSRs and network drivers during compilation. Features multi-file editing, windows, pull-down menus, mouse support, undo, regular expressions, a powerful macro language, and complete configurability. Exceptional speed for editing even multi-megabyte text and binary files.

LIST: \$185 **PS Price: \$139**  
FastFacts 25-007



## Multi-Edit

by American Cybernetics  
EASIER, FASTER & BETTER THAN EVER!  
Multi-Edit has always been your best text editing value. Now version 5.0 adds: Windows/SAA-style interface, seamless Mouse Support, expanded online help & manuals (LOTS of useful examples), full EMS support, plus hundreds of new features!  
Inexpensive - NOT CHEAP!  
You've gotta see this!  
FREE DEMO

LIST: \$99 **PS Price: \$95**  
FastFacts 1067-006



# your source for solutions!

## RM/FORTRAN

by Ryan McFarland

RM/FORTRAN is a high resolution ANSI 77 FORTRAN compiler for DOS and OS/2. It includes RM/Forte, an advanced programming environment giving you instant access to editing, compiling, linking, debugging, and file management utilities at a single keystroke. You easily move between tasks and the tools you need, productively developing your solutions.

LIST: \$595 **PS Price: \$499**  
FastFacts 437-009

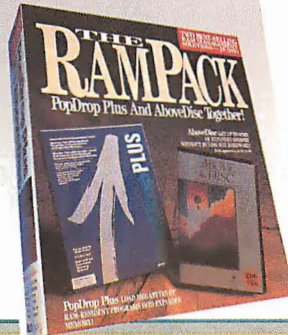


## The RamPack

by BLOCPublishing

It's the complete, easy to use solution to the crippling memory restrictions of DOS and the high cost of additional memory hardware. With Above DISC, utilize your hard disk to create 32 megabytes of Expanded Memory. With PopDrop Plus, efficiently load and manage RAM-resident programs and device drivers. It's the ultimate Memory Management team in one powerful, specially priced package.

LIST: \$139 **PS Price: \$129**  
FastFacts 1105-012

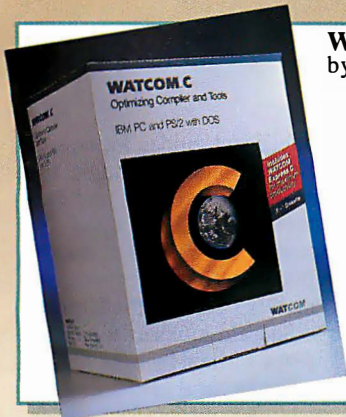


## WATCOM C 8.0/386 Prof.

by WATCOM

WATCOM C 8.0/386 is 100% ANSI C optimizing compiler/runtime library for Intel's 80386 architecture, generating applications for 32-bit protect mode. Features include: protected mode version of the compiler; VIDEO full-screen source-level debugger; MS library- & source-compatibility; execution profiler; high performance linker; graphics library; supports MetaWare High C 386 runtime calling conventions; SAA compatible.

LIST: \$1295 **PS Price: \$1155**  
FastFacts 1044-005

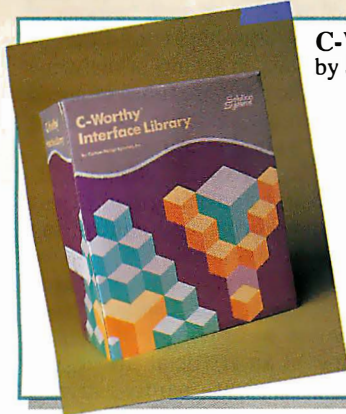


## C-Worthy Interface Library

by Solution Systems

Create a clear, high quality user interface with minimal overhead to your code. Benefit from 400 tight, ready-to-use functions for Windows, Menus, Text Editing, Message System, Mouse Support, Help and much more. **cwARCHITECT** is included to let you interactively design and test forms without coding. Best of all it's flexible to your needs, providing high level functions for immediate results, yet power and functionality for the long-term.

LIST: \$399 **PS Price: \$359**  
FastFacts 732-035



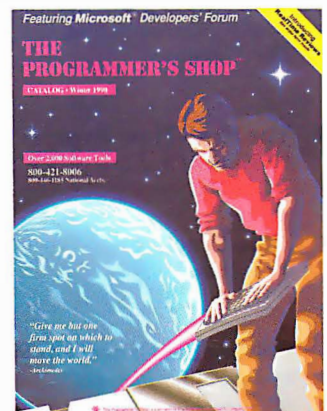
**FREE Catalog!**

## THE PROGRAMMER'S SHOP

**CATALOG** is the definitive source book for serious software development professionals.

Over 1,700 development products listed, including:

- applications
- books/training
- communications
- hardware
- languages
- LANs
- libraries
- operating systems
- tools
- UNIX/XENIX
- utilities



**Call today for this valuable guide to programming productivity.**

Circle 263 on Reader Service Card

## What is FastFacts?

Access literature on any of our products via FAX machine. **FREE!**

Call 617-740-0025 from any fax phone!

Follow the voice computer's instructions and enter your product's code number. Then await your instant print out of product literature.

## What is RealTime Reviews?

Access product reviews from leading publications via FAX machine!

(A charge of \$3.75 per article will appear on your next credit card bill.)

1. Call 617-740-0025 from your FAX machine's phone.
2. Follow the voice computer's instructions and enter your product's code number (listed next to products checkmarked in the Winter 1990 catalog).
3. Hang up the phone and await your printout of product literature.
4. Trailing the literature will be a bibliography of articles and product reviews.
5. Call again and, when prompted, enter the number of the article(s) selected as well as your credit card number.
6. Hang up and receive the latest review of up to three products!

# THE PROGRAMMER'S SHOP

800-421-8006

National Accounts  
800-446-1185

MEMBER  
**MMC**  
of the Direct Marketing Association, Inc.

5 Pond Park Road, Hingham, MA 02043 • Canada 800-446-3846 • Mass. 617-740-2510 • FAX: 617-749-2018  
Credit card orders processed *only* when product is shipped. All prices subject to change. Int'l. prices will vary.

BY191



# AI: Metamorphosis or Death?

- 239 AI's Identity Crisis**  
*by Bob Ryan*
- 249 Overturning the Category Bucket**  
*by Bill Thompson and Bev Thompson*
- 259 The Real-Time Expert**  
*by Thomas J. Laffey*
- 267 AI in Practice**  
*by Martin Heller*
- 281 Putting the Experts to Work**  
*by Daniel W. Rasmus*
- Solving the Unsolvable**  
*by Marge Sherald*
- 289 Real Artificial Life**  
*by Richard Marlon Stein*
- 300 Resource Guide: Intelligent Software**

Is artificial intelligence dead? If it's not, it is without doubt undergoing a major transition, but whether that change precedes a death or a rebirth into a different form, I cannot say. The chasms within the AI community are widening to create the appearance of various disciplines, rather than different branches of the same tree. Which way AI as a whole—if such a concept exists anymore—is headed is a good question.

Whatever happened to the promise of the past? AI was supposed to inherit the earth, according to its proponents. What is the nature of an intelligent system, anyway? AI was supposed to make the creation of intelligent machines possible. In "AI's Identity Crisis" Bob Ryan addresses the questions of definition, validity, and direction that plague AI today.

*Webster's* provides several definitions for intelligence, including "the ability to apply knowledge to manipulate one's environment" and "the act of understanding." These definitions are applicable to artificial intelligence as well. The ability to categorize knowledge is the primary means by which an AI system acquires its form of understanding. In "Overturning the Category Bucket," Bill and Bev Thompson discuss the classical view—and a new view—of categories.

One AI area that has born the brunt of early failures is expert systems. Some of the first attempts were so amateurish as to invite scorn. However, first attempts are often just that—attempts. Since those early days, expert systems have matured a great deal. In "AI in Practice," Martin Heller roams DEC's corridors and explores many practical applications of expert systems that are in use there—applications that may give you ideas of your own for applying expert systems.

Another application for expert systems is the "assistant" programs that

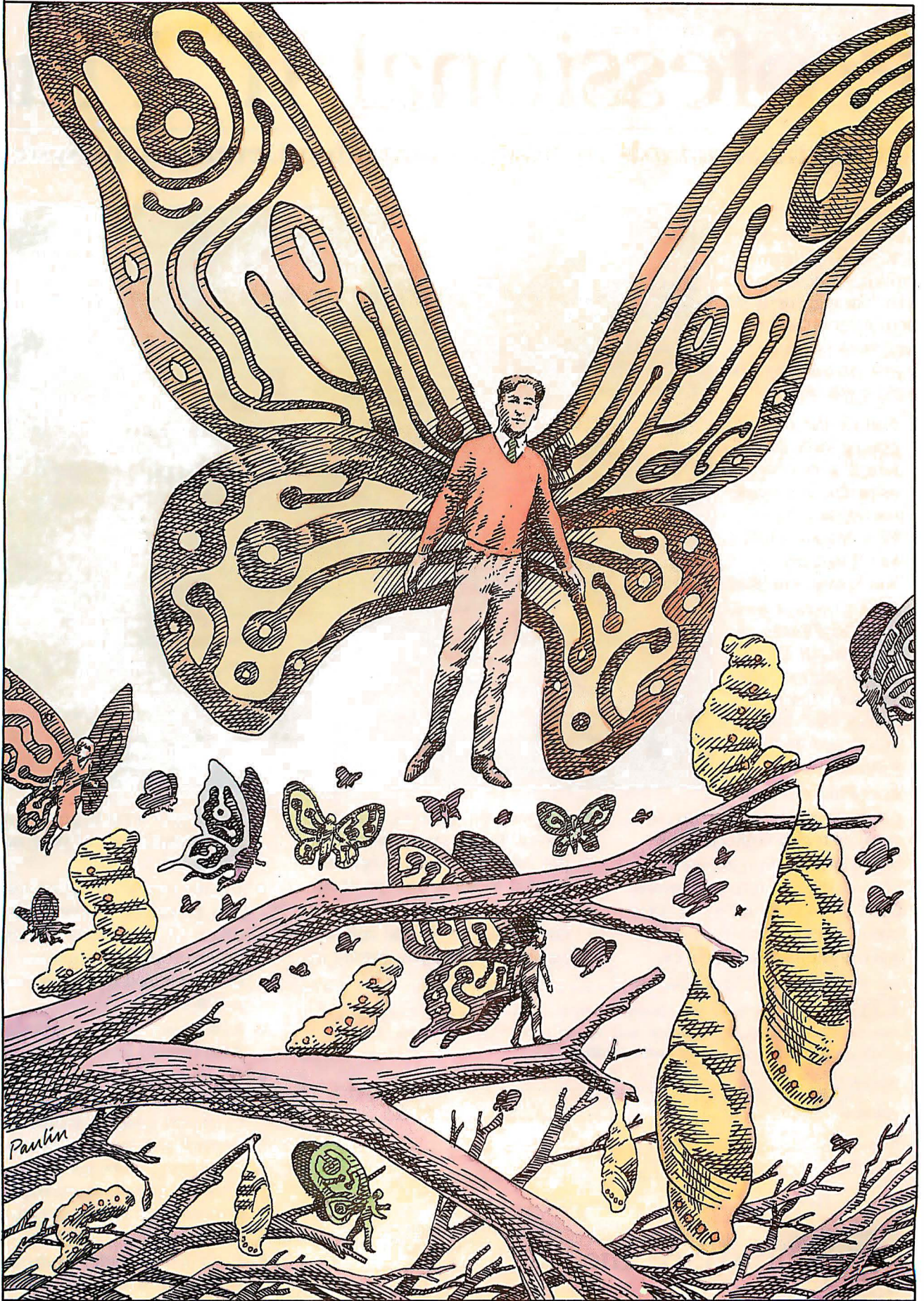
function as intelligent guides for new or unskilled workers and consolidate the knowledge of various experts. In "Putting the Experts to Work," Daniel W. Rasmus discusses some current microcomputer applications of expert systems. And in the text box "Solving the Unsolvable," Marge Sherald looks at the capabilities of systems formed by hybridizing expert systems and neural networks.

Expert systems have made inroads into a lot of areas, even such bastions of traditional programming as real-time environments. The constraints of real-time systems, and the response times required of them, make the advice of experts an increasingly valuable commodity. In "The Real-Time Expert," Thomas J. Laffey looks at the advantages of expert "help" in monitoring and controlling complex real-time systems.

One area that lies on the outer fringes of AI is artificial life. It does not, however, lie on the outer fringes of reality. One example of an artificial life organism is a computer virus—hardly a stranger to any of us. Artificial life as a field, however, is relatively unknown—but not for long. In "Real Artificial Life," Richard Marlon Stein takes the wraps off artificial life. Strange as it may seem, evolution, through its infinite variety, can provide an unlimited number of solutions to engineering problems.

Is AI dead? Not yet, but it's either going through the throes of a terminal illness or the agony of childbirth. Certainly some areas once considered the exclusive domain of AI are alive and well. But whether they will move out permanently on their own or regroup under AI's umbrella, I don't know. And I won't pretend to match my predictive powers against the likes of Minsky and Winograd.

—Jane Morrill Tazelaar  
Senior Editor, *State of the Art*

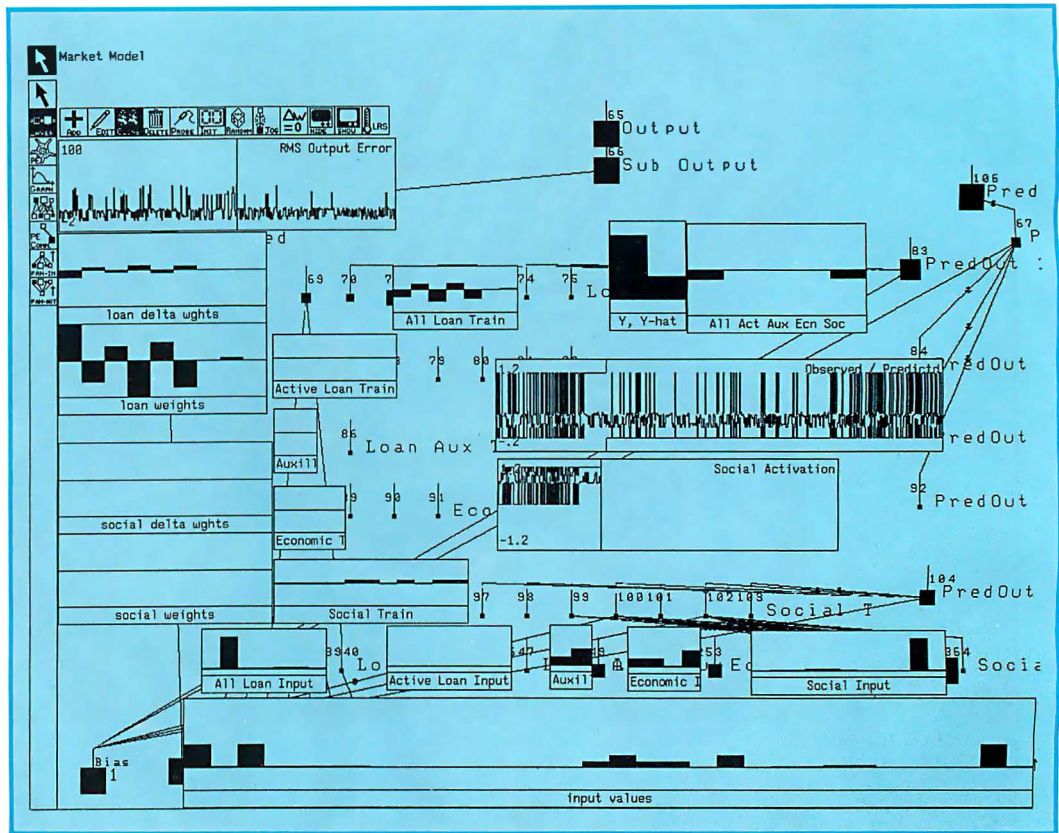


# Introducing NeuralWorks Professional II™ Plus

## Setting the Standards in Neural Computing Development Systems

NeuralWorks Professional II Plus: A complete solution from training, to development, through deployment. Everything you need to develop and deploy neural network-based applications:

- Reduce the cost of getting started with neural networks by using the hardware you already have: PC's, Macintosh II, Sun Sparc, Sun-4, Sun-3, and Sun-386i.
- For the power seeker, NeuralWorks Professional II Plus is available on IBM RS-6000, Transputers, i860 add-on board, and more soon to come.
- Inter-Platform compatibility protects your investment as technology changes.
- NeuralWorks Professional II Plus' Open Architecture means that the product grows as your needs grow for new network types and custom interfaces.



- Supports 31 network types and several variations, insuring that you have the range of options needed to solve your problem.
- Performance tuning through advanced diagnostic and analysis capabilities gives you graphic in-

sights into ways to get the most performance out of your networks.

- Interfaces with standard ASCII files produced by Lotus-1-2-3, dBase III, Excel and a variety of other products minimizes the time required to start solving a problem.
- Iconic user interface is designed with human factors in mind.
- Strategic relations with third party vendors to provide bridges to expert systems, industrial control systems, and Neuro-computing chips gives you options for system integration and performance not found anywhere else.
- Backed by a leader in the field with a reputation for quality and service.

**Yes**, send me your free booklet, *Applications in Neural Computing*, by Casey Klimasauskas, President and founder of NeuralWare, Inc. Please include \$2.00 for shipping and handling.

Name: \_\_\_\_\_

Address: \_\_\_\_\_

City: \_\_\_\_\_

State: \_\_\_\_\_ Country: \_\_\_\_\_ Zip: \_\_\_\_\_

Daytime Phone: (\_\_\_\_\_) \_\_\_\_\_



Penn Center West  
Building IV, Suite 227  
Pittsburgh, PA 15276  
Phone: (412) 787-8222  
FAX: (412) 787-8220

Circle 215 on Reader Service Card

# AI's Identity Crisis

*What's important and what isn't?  
What to keep? What to discard?*

*Bob Ryan*

**F**or an outsider, perusing some of the current literature in the field of artificial intelligence borders on voyeurism. One part of you wants to shut the blinds, to turn away from the evident soul-searching going on, while another part is fascinated by the skeletons that prominent AI researchers are starting to rattle.

Probably because it is such a young field—and in part because it was once overhyped to the point of absurdity—AI is undergoing an identity crisis. B. Chandrasekaran of Ohio State writes, “AI is internally in a paradigmatic mess. There is really no broad agreement on the essential nature or formal basis of intelligence and the proper theoretical framework for it” (see reference 1).

Roger Schank of the Institute for Learning Studies (Evanston, IL) puts it another way. Talking about the public's identification of AI with expert systems and the criticism of AI from researchers in related fields of study, Schank states, “AI is in a serious state of disruption” (see reference 2). The resolution of this crisis—if it can ever be resolved—will determine whether AI can provide the



kind of intelligent systems that will make all the work, and all the introspection, worthwhile.

## **What Is AI?**

Ask a dozen different researchers the question “What is AI?” and you get a dozen different answers. Such is not the case with more mature disciplines, such as physics, medicine, and chemistry. To

some people, this is evidence that AI can't be classified as a science and that it is, rather, simply a software-engineering discipline that has taken on airs. But this view discounts the fact that every mature science was once immature and groping for definition.

Patrick Winston, director of the MIT Artificial Intelligence Laboratory, has stated that the primary goal of AI is to make machines smarter (see reference 3), and many researchers agree. They see AI as a search for methods that will make computers far more intelligent (or at least make them *act* as if they were more intelligent) and, therefore, more useful.

Another oft-stated goal of AI is to investigate the nature of intelligence. From his work on robotics with Seymour Papert, Marvin Minsky of MIT developed the theory of agent-based intelligence that he laid out in his 1986 book, *The Society of Mind* (see reference 4). Minsky doesn't differentiate between human and machine intelligence; his work is as much an investigation into the psychology of humans as it is about the quest for intelligent machines.

Alan Bundy sees the confusion over

the definition of AI as a result of the many kinds of AI. He identifies three primary kinds: applied AI, which is the use of AI in commercial products; cognitive science, where AI is used to investigate the nature of intelligence; and basic AI, which is the exploration of computer-based techniques for simulating intelligent behavior (see reference 5).

According to this view, AI is an engineering discipline that develops commercial products—primarily expert systems;

it is an engineering science that develops computational techniques for simulating intelligence and discovers their properties and interrelations; and it is a natural science that investigates the mind.

The fact that there are many kinds of AI leads to confusion among observers and AI workers alike. The work being done by one researcher may have no relevance to an engineer trying to install an expert system for a client. Such divisions also make it difficult to judge the prog-

ress or even the validity of AI as a whole; each field of endeavor must be judged on its own merits and using its own criteria.

### Is AI Valid?

For much of its existence, the AI field has been dogged by questions about its basic validity. Some questions are motivated by the fact that, in the past, AI promised much more than it could deliver. Other questions concern the theoretical foundations of AI.

The fundamentals of AI were laid down in the decades preceding and following World War II. In "Computing Machinery and Intelligence," Alan Turing drew on earlier work that showed that formalized deduction—an aspect of intelligent reasoning—was a kind of computing, and that computing could be described as the manipulation of symbols. He came to the conclusion that, in theory, machines of the type we've come to call Turing machines can think (see reference 6).

This concept laid down the theoretical groundwork for the first researchers in AI, who equated Turing machines with computers and who came to identify computers not as muscle-bound numeric calculators but as symbol manipulators. The fundamental assumption of AI, as stated by two of its founding theorists, is that "a physical symbol system has the necessary and sufficient means for general intelligent action" (see reference 7).

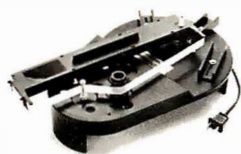
According to this view, any system, such as a computer, that can process and manipulate symbols can be intelligent. The underlying assumption is that the human mind is simply one instance of a physical symbol system, and that what is termed "intelligence" is an artifact of that system.

Almost from its inception, this assumption has come under attack. The attacks have taken two forms: emotional arguments made by those who don't want to share the special status accorded human intelligence with machines, and logical arguments aimed at the assumptions that AI makes about intelligence. Some of the latter have been motivated by what many think is the lack of general success in the AI field.

For example, Terry Winograd of Stanford University thinks the fundamental view of intelligence that underlies AI is "shallow and inadequate." The problem, according to Winograd, is not the "insufficient development of the technology," but the "inadequacy of the basic tenets." He states, "There is no reason but hubris to believe that we are any closer to understanding intelligence

## Never buy another ribbon!

Over 160,000 sold



Universal Cartridge unit shown with Epson cartridge

**\$75.00**

Shipping \$5.00

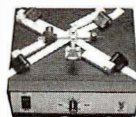
<b>Universal Cartridge</b> (includes one adapter) .....	<b>75.00</b>
<b>Multicolor Adapter (specify printer)</b> .....	<b>40.00</b>
<b>Epson only MacInker™</b> mod. 271EP .....	<b>45.00</b>
<b>Imagewriter only MacInker</b> mod. 234IM .....	<b>45.00</b>
<b>Universal Spool MacInker</b> .....	<b>75.00</b>
<b>Heat Transfer Adapter</b> .....	<b>25.00</b>
Extra Ink Bottle, black .....	3.00
Colored Ink Bottle .....	4.00
..... pint .....	18.50
..... extra reservoir .....	6.00

All models delivered complete with bottle of ink, ink meter, reservoir, reservoir cover.  
**Go color !!** Single & multicolor, standard and heat transfer cartridges available: red, green, blue, brown, purple, yellow, orange, white, silver and gold. Indelible and OCR ink cartridges available.

Over 24,000 printers supported. Better than new print quality. Extended printhead life thanks to lubricated ink. Average cartridge can be re-inked 60-100 times at 5 cents/re-inking. Multicolor adapters re-ink multiband cartridges. Documented customer savings of up to \$30,000/year. Detailed free catalog.

## MacBond II Auto-Ribbon Welder

Make your own ribbons! MacBond II splices and welds in seconds ribbons of any size and inked in any color. Real alternative to ribbon bonding machines costing thousands of \$\$\$.



Shipping \$9.00

**\$299.00 !!**

## Modems

4800 b throughput, full duplex. 9600, 4800, 2400, 1200 bps. CCIT V.22bis, V.22, Bell 212A & 103J modes • Auto speed selection • MNP cl. 5 error correction • Synch & asynchronous modes • Cable and software included ( PC or MAC) • 2 year warranty

**9600 baud mnp cl 5 v.32 .....599.00** **LightSpeed 2400LE**(MNP cl 5).....**159.00**

**LightFax 9624 faxmodem .....399.00** **Fax/Phone switch.....89.00**  
LightSpeed 9624E is a V.32, mnp 5, 9600 b modem. LightFax 9624 is a full featured group III, 9600 b fax & 2400 b modem combined, shipped with software & cable for PC or MAC (specify). Network software available. Fax/Phone switch automatically shares one line for fax, phone, phone recorder etc.



Shipping \$7.00

**2400b MNP cl 5 \$159.00 !!**

## Printer-Plotter Server

Shipping \$8.00

Printer/Plotter server, buffer, autoswitch, converter, all in one. Maximum versatility and economy in printer networking. All HP plotters supported. Cascade multiple units for unlimited networking options. Standard 256k upgradable to 3 MEG. Two models, UG-501P (3 par., 1 serial input), UG-501S (3 serial, 1 par. input). Both units have 1 ser., 1 par. output. UG-501, just one of our complete family of datacom products.



**New**

**\$359.00!!**

## Diskette Doublor

Increase 3.5" disk capacity to 1.44 Megs with this ingenious and simple device. Only \$15.00 !!

**Computer Friends, Inc.**  
14250 NW Science Park Dr.  
Portland OR 97229

Satisfaction or 30 day  
refund - Immediate  
shipment - Major credit  
cards - PO's from  
National Accounts

**Order Toll Free 1-800-547-3303**

In Oregon (503)626-2291  
fax (503)643-5379 telex 4949559 CF

## **The Peter Norton Library**

is yours for only **\$4.95**  
when you join the

**Small Computer Book Club**

*A Division of Newbridge Communications, Inc.*

Please accept my application for trial membership and send me The Peter Norton Library (00088) billing me only \$4.95, plus shipping and handling. I agree to purchase at least three additional Selections or Alternates over the next 12 months. Savings generally range from 15% to 30% off the publishers' prices. My membership is cancelable any time after I buy these three additional books. A shipping and handling charge is added to all shipments.

**No-Risk Guarantee:** If I am not satisfied—for any reason—I may return The Peter Norton Library within 10 days. My membership will be canceled, and I will owe nothing.

Name \_\_\_\_\_

Address \_\_\_\_\_ Apt. \_\_\_\_\_

City \_\_\_\_\_

State \_\_\_\_\_ Zip \_\_\_\_\_

(Books purchased for professional purposes may be a tax-deductible expense. Offer good in Continental U.S. and Canada only. Prices slightly higher in Canada.)

## **The Peter Norton Library**

is yours for only **\$4.95**  
when you join the

**Small Computer Book Club**

*A Division of Newbridge Communications, Inc.*

Please accept my application for trial membership and send me The Peter Norton Library (00088) billing me only \$4.95, plus shipping and handling. I agree to purchase at least three additional Selections or Alternates over the next 12 months. Savings generally range from 15% to 30% off the publishers' prices. My membership is cancelable any time after I buy these three additional books. A shipping and handling charge is added to all shipments.

**No-Risk Guarantee:** If I am not satisfied—for any reason—I may return The Peter Norton Library within 10 days. My membership will be canceled, and I will owe nothing.

Name \_\_\_\_\_

Address \_\_\_\_\_ Apt. \_\_\_\_\_

City \_\_\_\_\_

State \_\_\_\_\_ Zip \_\_\_\_\_

(Books purchased for professional purposes may be a tax-deductible expense. Offer good in Continental U.S. and Canada only. Prices slightly higher in Canada.)



**BUSINESS REPLY MAIL**

FIRST CLASS MAIL PERMIT NO. 230 RIVERSIDE NJ

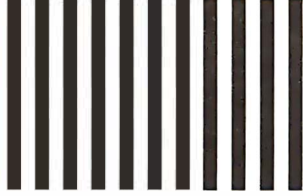
POSTAGE WILL BE PAID BY ADDRESSEE

**THE SMALL COMPUTER  
BOOK CLUB**

3000 CINDEL DRIVE  
DELRAN NJ 08075-9889



NO POSTAGE  
NECESSARY  
IF MAILED  
IN THE  
UNITED STATES



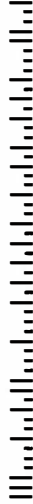
**BUSINESS REPLY MAIL**

FIRST CLASS MAIL PERMIT NO. 230 RIVERSIDE NJ

POSTAGE WILL BE PAID BY ADDRESSEE

**THE SMALL COMPUTER  
BOOK CLUB**

3000 CINDEL DRIVE  
DELRAN NJ 08075-9889



NO POSTAGE  
NECESSARY  
IF MAILED  
IN THE  
UNITED STATES





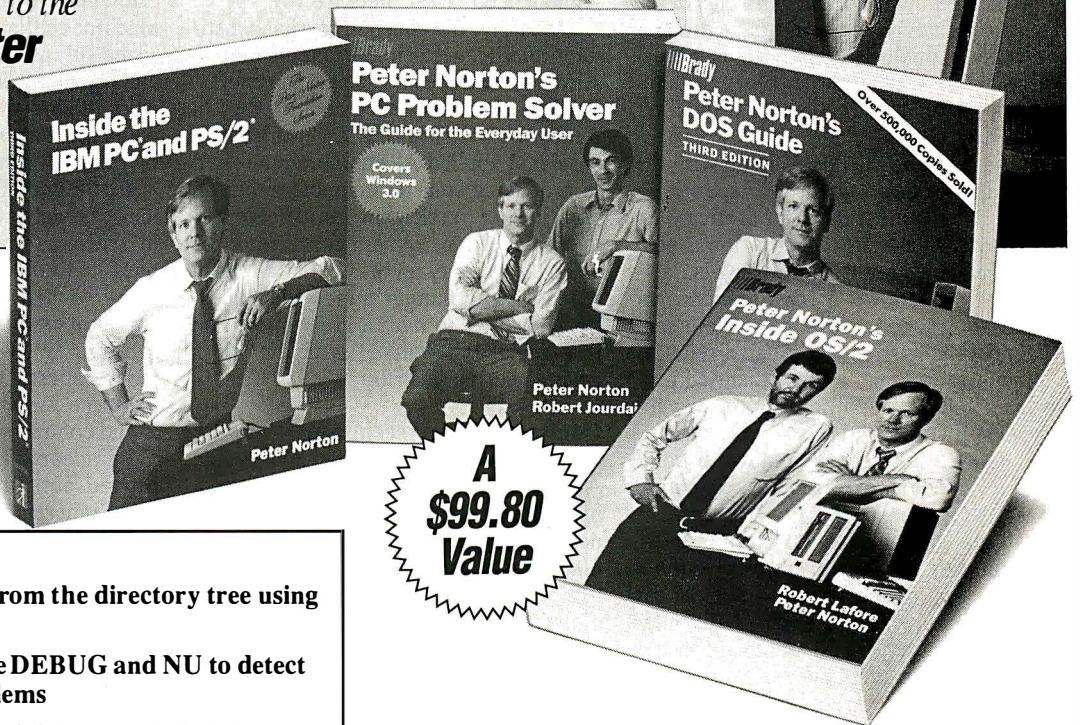
Let Peter Norton Solve Your PC Problems with...

# The PETER NORTON LIBRARY

Yours for only **\$4.95**

as your introduction to the  
**Small Computer  
Book Club**

You simply agree to buy  
three more books  
-- at significant savings --  
within the next 12 months



Learn how to:

- Start a program from the directory tree using Windows 3.0
- Use programs like DEBUG and NU to detect widespread problems
- Organize your hard disk using MKDIR, CHDIR, and TREE commands
- Master the Zen of MS-DOS batch files

A  
**\$99.80**  
Value

"Peter Norton has the unique ability to take even the most arcane PC information and present it clearly and simply, making it understandable in a way that benefits all classes of users."

— The New York Times

## INSIDE THE IBM PC AND PS/2.

*Third Edition.* THE classic guide to the IBM PC has been revised and up-dated to cover every generation of the IBM PC family including the PS/2. Peter Norton takes you on a fascinating journey through the inner workings of your PC as he shares with you hundreds of machine-enhancing and troubleshooting techniques. Using easy-to-follow examples and applications, he explores everything from 8088, 80286, and 80386 microprocessors and DOS commands to data storage pointers and programming short-cuts.  
Publisher's price: \$24.95

## PETER NORTON'S PC PROBLEM SOLVER.

*The Guide for the Everyday User, with Robert Jourdain.* Chock-full of time-saving tricks, tips on utility software, and good advice, this step-by-step problem solver explores 200 of the most common PC functions as it demonstrates how to handle almost every conceivable complication. Discover which DOS commands you really need, the nine ways to avoid a hard disk crash, how to ward off viruses, and much more. Covers networks, communications, and Windows 3.0.  
Publisher's price: \$24.95

## PETER NORTON'S DOS GUIDE.

*Third Edition.* This hands-on guide does more than explain the ins and outs of DOS. You get comprehensive information about all DOS versions up to 4.0 and hardware references to 286-, 386-, and 486-based computers as well as new material on hard disks, the DOS Shell, expanded and extended memory plus install procedures. Learn how to batch process with REM and PAUSE, work with internal vs. external commands and wildcards, and use advanced disk commands like VERIFY, ASSIGN, SUBST, and JOIN.  
Publisher's price: \$24.95.

## PETER NORTON'S INSIDE OS/2.

*with Robert Lafore.* Put the power of OS/2 at your fingertips. This example-filled guide takes you from the simplest OS/2 functions -- like writing text to the screen -- through to such powerful techniques as multitasking, virtual memory management, and interprocess communication. Create data spaces larger than physical memory, increase program efficiency by performing disk I/O along with other activities, and use a device monitor to create memory resident programs.  
Publisher's price: \$24.95.

The SMALL COMPUTER BOOK CLUB provides the best books on small computing from a wide range of publishers. It conveniently and inexpensively keeps you up-to-date with books on the latest software releases, programming tools, and much more.

**Membership Benefits.** In addition to getting the PETER NORTON LIBRARY for only \$4.95 when you join, you'll also receive discounts on books you choose to purchase. Discounts generally range from 15% to 30% off the publishers' prices, and occasionally even more. • Also, you will immediately become eligible to participate in our Bonus Book Plan, with savings of 60% off the publishers' prices. • At 3-4 week intervals (15 times per year), you will receive the Small Computer Book Club News, describing the coming Main Selection and Alternate Selections, together with a dated reply card. • In addition, up to two times a year, you may receive offers of Special Selections which will be made available to a group of select members. • If you want the Main Selection, do nothing, and it will be sent to you automatically. • If you prefer another selection, or no book at all, simply indicate your choice on the card and return it by the date specified. • You will have at least 10 days to decide. If, because of late mail delivery of the News, you should receive a book you do not want, we guarantee return postage.

If reply card is missing, please write to Small Computer Book Club, Dept. Y-CY6/00088, 3000 Cindel Drive, Delran, NJ 08075 for membership information and an application.

than the alchemists were to the secrets of nuclear physics."

In Winograd's view, "The very notion of 'symbol systems' is inherently linguistic and what [AI researchers] duplicate in [their] programs. . . is really a form of verbal argument, not the workings of the mind." Winograd believes that a broader understanding of intelligence is necessary before a machine can display creativity, insight, judgment, or even common sense (see reference 8).

Eric Dietrich also takes issue with the theoretical basis of AI. He sees it as "based on a mistaken theoretical assumption: the idea that we now know what kind of computing thinking is."

Dietrich believes a robust science of intelligent systems will be established, but not from current AI. Such a science, he states, would not assume that we know what kind of computing thinking is; instead, "It is the goal of such a science to tell us what thinking is, and if it is computing, to tell us what kind of computing it is" (see reference 9).

To many people in the field, however, the question of whether physical symbol systems are necessary and sufficient for intelligence—whatever that is—is irrelevant. Their goal is to make machines smarter by learning how to represent and manipulate real-world knowledge with a computer, without worrying about whether the thinking their machines do is in any way related to human thought.

Most of the practical advances in AI come from this group. Their attitude toward the debate over whether machines can ever be intelligent was summed up by

Ronald Brachman of Bell Labs in his overview of the knowledge-representation field in the 1980s, where he stated, "Regardless of the ultimate cogency of the arguments against formal AI, work in [knowledge representation] proceeded without heed" (see reference 10).

Certainly, the question of what constitutes intelligence is important not only to AI, but to science and society in general. But it is clear that those people who, in Bundy's classifications, are working in basic and applied AI are more interested in producing smarter computers than in creating an intelligent entity. So, although questions remain concerning the ultimate validity of symbolic AI as a model of the human mind, such questions have yet to have a great impact on researchers who pursue symbolic AI as an engineering science.

### Connectionism Ascendant

From its beginnings in the mid-1950s, AI has been divided into symbolic approaches to simulating reasoning and nonsymbolic approaches. The most popular of the latter type are neural networks, which use the physical structure of the brain as their basic model.

Neural networks consist of many simple processing units called *neurons* that are interconnected and work in parallel. Neurons are arranged in layers and are connected both to neurons in the layer above and to those in the layer below.

The network is then trained to associate certain inputs with certain outputs. Thus, neural networks don't use discrete symbols to represent knowledge, but rely

on weighted connections between neurons. The training provides the weighting factor. The importance of connections gives this field of study its name: *connectionism*.

In the 1960s, there was considerable excitement about a class of connectionist machines called *perceptrons*, which consisted of an input layer, a middle layer, and an output layer. Much of the excitement in perceptrons came from the 1962 publication *Principles of Neurodynamics* by Frank Rosenblatt (see reference 11).

By the end of the decade, however, the lack of practical results and the problems in scaling from small systems to large ones had cooled the interest in perceptrons within the AI community. The final knock on perceptrons came in *Perceptrons* by Marvin Minsky and Seymour Papert (see reference 12), who, at that time, were doing work with symbolic and connectionist systems.

In a clear analysis, Minsky and Papert proved conclusively that perceptrons were inherently limited. In their final chapter, they expressed the belief that extending the perceptron model to a multi-layer system would be fruitless.

No one disputes the conclusions that Minsky and Papert reached about perceptrons. Many connectionist researchers, however, still take issue with the inclusion of the conjecture about multilayer systems, even though Minsky and Papert did identify the investigation of multilayer systems as an important research goal. Connectionists blame Minsky and Papert for the tailspin connectionism as a whole went into in the 1970s, when

# Neural Networks are Solving Real Problems

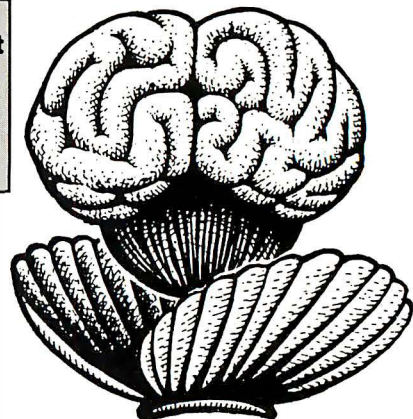
**Circuit board problem diagnosis ■ Psychiatric evaluations ■ Stock market predictions ■ Sales forecasts ■ Oil exploration ■ Optimizing biological experiment results ■ Price forecasts ■ Analysis of medical tests ■ Optimizing scheduled machine maintenance ■ Predicting student performance ■ Horse racing picks ■ Factory and shop problem analysis ■ Optimizing raw material orders ■ Spectral analysis ■ Selection of criminal investigation targets ■ Employee selection ■ Process control ■ Product quality control and much, much more.**

Since NeuroShell learns by example, handles fuzzy logic, can give tight data fits, and doesn't try to capture knowledge in rules, it is also being used as an alternative in many cases to expert systems, the ID3 algorithm, and regression analysis.

## Now anyone can use neural networks

NeuroShell is ready to use for real problems on your IBM PC or compatible, and still only \$195. No programming or Ph.D. required! Free telephone assistance (including setting up your problem). Free shipping by mail in US, Canada, and Mexico (\$12 elsewhere). Add 5% tax in MD.

**Ward Systems Group, Inc.**  
245 West Patrick St.  
Frederick, MD 21701  
(301) 662-7950 FAX (301) 663-6656



**NeuroShell™**

NeuroShell is a trademark of Ward Systems Group, Inc. IBM PC is a registered trademark of International Business Machines



## Even This Is More Confining Than Clipper.

Just as the vast expanse of the American West gave its settlers a new perspective on opportunity, Clipper's open architecture lends unprecedented freedom to application development.

Unlike fixed systems, Clipper never forces you to "make do". Its language is fully extensible with user-defined functions and new user-defined commands. You can extend the language with routines written in Clipper itself, or integrate code from other languages like C, Assembler, dBASE® and Pascal. Odds are, you already have knowledge you can use with Clipper!

But if a customizable language isn't enough, there's even more elbow room. Database and I/O drivers can be supplemented or replaced. Even Clipper's linker knocks down barriers by allowing you to develop applications larger than available memory, without defining overlays! And when you're done, Clipper's compiler generates stand-alone, executable files for cost-free, unrestricted distribution.

So, don't let the bounds of fixed systems fence you in. Unleash your imagination in the wide-open spaces of Clipper. To find out more, give us a call today.

### **Clipper® 5.0**

*The Application Development Standard*

**213/390-7923**

**Ask For Department-A**

 **nantucket®**

Circle 209 on Reader Service Card

Nantucket Corporation, 12555 West Jefferson Boulevard, Los Angeles, CA 90066. 213/390-7923. FAX: 213/397-5469. TELEX: 650-2574125. Nantucket, the Nantucket logo and Clipper are registered trademarks of Nantucket Corporation. Other brand and product names are used for identification purposes only and may be trademarks or registered trademarks of their respective holders. Entire contents copyright © 1990 Nantucket Corporation.

grants for that type of research were difficult to obtain.

But connectionist research did go on, ironically along the lines suggested by Minsky and Papert. People began investigating the capabilities of multilayer networks and developed new neuron types and connectionist architectures that overcame the limitations of perceptrons. Such developments, however, did nothing to mend the rift between connectionists and the rest of the AI community.

By the mid-1980s, the renaissance in connectionism was well under way, and the AI establishment began to take notice. Minsky and Papert reissued *Perceptrons* in 1987. In the new prologue, they state, "Some readers may be shocked to hear it said that little of significance has happened in this field." By significant, they mean that "there has been little clear-cut change in the conceptual basis of the field."

In the epilogue, however, they go on to state their belief that connectionism is an important part of their view of the brain as "large numbers of relatively small distributed systems arranged by embryology into a complex society that is con-

trolled in part (but only in part) by serial, symbolic systems that are added later" (see reference 12).

As connectionist machines continue to produce results in areas such as speech recognition and machine vision—areas formerly the exclusive reserve of symbolic AI—the debate about which method is best for representing and processing knowledge will intensify. Some AI researchers believe that, in some areas, the future belongs to connectionism.

Brachman writes that the fact that connectionist systems can handle noise better than symbolic knowledge-representation systems "seems to indicate that connectionist systems will eventually take over the role now being played by traditional [knowledge-representation] systems." In comparing connectionist and symbolic knowledge representations, he states, "When one looks at the natural world, it becomes apparent that the symbol-manipulation view of intelligence . . . is the more radical view" (see reference 10).

How will this symbolic/connectionist debate play out? That's an open question. With a decade of steady progress behind

it, connectionism, in the form of modern neural networks, is clearly here to stay and is perhaps better suited to acquiring and representing knowledge about the real world than is symbolic AI.

When it comes to manipulating that knowledge, however, symbolic AI still can't be beaten. Undoubtedly, as old antagonisms wear thin, there will be more research into systems that combine both approaches.

### Issues to Investigate

With all the controversy surrounding AI, it isn't hard to find lines of investigation. For the cognitive scientists, the questions revolve around the nature of intelligence, and how and if computers will ever be able to achieve it. Over the next decade, the question of the physical-symbol hypothesis, and of any theories that try to supplant it, will be uppermost.

In an interesting way, Schank has tied the issues he thinks are most important in AI to the definition of AI. His point is that AI is not defined by the methodologies it uses but by the problems those methodologies address. As he puts it, "A rule-based system is not an AI program

# Protects while you type!



- Remains in Place while you use your computer.
- Avoids Costly Repairs. Protects delicate electronics from dust, spills, smoke, ashes, staples.
- Soft, Flexible, retains normal keyboard feel.
- Washable, Durable High-Tech Polymer lasts years.
- Hundreds of Models. SafeSkin is available for most PCs, laptops, workstations and clone keyboards.
- Office • Home • Factory • Classroom • Laboratory

List Price \$29.95. Please call or write for free color brochure. Dealer inquiries encouraged.

**SafeSkin™**  
KEYBOARD PROTECTOR

Merritt Computer Products, Inc. 5565 Red Bird Center Drive  
Suite 150, Dallas, Texas 75237/(214) 339-0753 • FAX (214) 339-1313  
In Canada call 1-800-663-1061

## ABTECH VGA LCD LAPTOP

- 286-16 MHz
- 1 MB on Board
- Dim: 11.8" x 13" x 3.4"
- Wt: 11.9 lbs. w/battery & HD
- Conner 40MB HD, 28 ms
- 3.5" 1.44 MB FD
- VGA display w/32 gray scale
- 86 key keyboard
- 80287 socket
- 2 serial, 1 parallel ports
- External monitor port
- Rechargeable camera battery
- Car cigarette light adapter



Leasing & Networking Available

**LIMITED OFFER ORDER NOW.**

Offer ends January 31, 1991

**386-33 64K CACHE SYSTEM ONLY \$ 2,199**      **286-12 SYSTEM ONLY \$ 499**

- ABTECH own 386-33 64K Cache Motherboard
- 1 MB on Board
- 1.2MB or 1.44 FD.
- 139 MB H.D. w/IDE Controller
- 16 Bit VGA Card w/512K RAM
- 1024 x 768 0.28 Dot Pitch VGA Monitor
- Smallfoot Print Case 230 w/P.S.
- I/P/S/J/I/O
- 101 Key Keyboard
- ABTECH own VLSI MB w/Dallas Battery Chip
- 1 MB on Board
- 1.2MB or 1.44 MB
- H.D./F.D. IDE Controller
- Smallfoot Print Case 200W P.S.
- M.G.P.
- I/O Card
- 12" Mono Monitor
- 101 Key Keyboard

ONE YEAR PARTS &  
LABOR WARRANTY

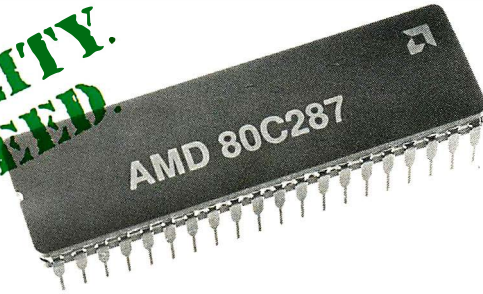
**ABTECH**  
INCORPORATED  
1431 N. POTRERO AVE. • SO. EL MONTE, CA 91733  
Tel: (818) 575-0007 • Fax: (818) 575-0007

**TEL 818-575-0007**  
**FAX 818-575-1500**  
**1-800-992-1978**

# Speed. Guarantee

Th

**AND  
COMPATIBILITY.  
GUARANTEED.**



## Here's a chance to buy our \$99 Math Coprocessor at no risk whatsoever!

### High Speed, Low Price.

The performance benefits of a coprocessor are enormous. Now they're affordable too. Before the AMD 80C287 you had no choice but to pay over \$200 for a fast math coprocessor. Now you can get a coprocessor compatible with the Intel® NMOS 80287 for a terrific price - direct from AMD.

### Speed up hundreds of software applications.

The AMD 80C287 increases the performance of general business software applications like 1-2-3®, dBASE™, Excel, and hundreds of others. You can expect calculations on your favorite software to run two to ten times faster with an AMD 80C287 installed. Your graphs will draw faster, your spreadsheets will recalculate faster - your work will get done faster.

### Compatible.

The AMD 80C287 is compatible with your 80286 based PC and the hundreds of commercially available software packages written for your 80286 PC. You'll also be glad to hear that it's compatible with the Intel NMOS 80287.

### Easy to Install.

The AMD 80C287 drops easily into a socket already inside your 80286 based PC. In five minutes you can be up and running. Just pop it in and go - FAST! The AMD 80C287 comes with free floating point and fractal software to show you the immediate performance boost you'll get.

### Here's Our Risk Free Triple Guarantee.

#### Guarantee #1

If the AMD 80C287 Math Coprocessor doesn't do everything we promise, if it doesn't double or triple the speed of mathematical calculations of your favorite software applications, or if you are unsatisfied for any reason, AMD will refund 100% of your purchase price within 30 days of your purchase.

#### Guarantee #2

If your AMD 80C287 Math Coprocessor ever fails to perform for any reason, AMD will replace it free of charge - no questions asked.\*\*

#### Guarantee #3

AMD guarantees that the AMD 80C287 Math Coprocessor is compatible with your 80286 based hardware and software. If you have any compatibility problems with the AMD 80C287 during the first year, we will gladly refund the purchase price.

To Order Call Now: **1-800-888-5590**

EXT. 2600



Outside of USA (512) 345-1728

I want to double or triple the calculation speed of software running on my 286 based PC. Send me an AMD 80C287 Math Coprocessor risk free for only \$99\*. I understand that I can return the AMD 80C287 for a full refund within the first 30-days if I am not completely satisfied.

Call for a free demo disk and literature

Name \_\_\_\_\_

Visa/MC # \_\_\_\_\_

Type of PC \_\_\_\_\_

C.O.D. orders accepted

**Advanced Micro Devices**

● 1990 Advanced Micro Devices, Inc.

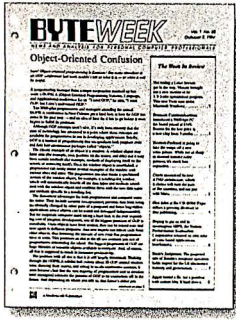
1-2-3 is a registered trademark of Lotus Development Corporation. dBASE is a trademark of Ashton-Tate Corporation. Intel is a registered trademark of Intel Corporation

\*Plus tax, shipping and handling. Volume or Dealer inquires welcome.

\*\*Limited to two lifetime replacements per person.

Circle 16 on Reader Service Card

# Ice Cream.



# The Crop.



There are plenty of places to get information in this industry. Too many. But if you want the best quality information, there's only one that rises to the top: **BYTEWEEK**, a weekly newsletter from the same professionals who produce **BYTE Magazine**.

Subscribe now and take advantage of a special subscription rate of \$395 (\$495 outside the U.S. and Canada). *Don't miss this opportunity!*

In the U.S. call **BYTEWEEK's** toll-free number: **1-800-258-5485**. In N.H. and outside the U.S. call **603-924-9281**.

**BYTEWEEK** offers a money-back guarantee if you are not completely satisfied.

**BYTEWEEK** 

One Phoenix Mill Lane  
Peterborough, NH 03458

just because it uses rules or was written with an expert-system shell. It is an AI program if it addresses an AI issue."

Because issues constantly change, Schank notes that the definition of AI is also changing. But he does point out 10 issues that he thinks will endure:

- **Representation:** At the heart of AI is the question of how to best represent knowledge in a computer.
- **Decoding:** How do you get real-world knowledge into an internal representation? In some AI fields, such as voice recognition or machine vision, decoding is the central issue. Schank thinks that decoding systems and representation systems must be considered together when building a system.
- **Inference:** AI systems must be better able to extract meaning from input. They must be able to infer meaning from limited clues.
- **Control of combinational explosion:** Putting it simply, an intelligent program must know when it knows enough about a subject.
- **Indexing:** Schank sees knowledge retrieval not as a search problem but as the optimization of the organization and labeling of memory. AI systems must be able to get at what they know.
- **Prediction and recovery:** An AI system should be able to make predictions about events in its area and be able to explain when the predictions go awry.
- **Dynamic modification:** In Schank's view, the ability of a system to change its internal representations based on experience—in other words, learning—is the quintessential AI issue.
- **Generalization:** AI programs need to be able to draw generalizations from different experiences.
- **Curiosity:** Schank believes that truly creative computers could surpass human beings and that AI must become familiar with investigations of creativity in other fields. (See reference 2.)

## Whither AI?

From fundamental questions of intelligence to the issues and characteristics an intelligent system must address, AI has many possible venues to explore. In the short run, however, sorting out what's important and what isn't, and what to keep and what to discard from the past, will keep AI in a state of turmoil. And the only way to decide what to keep and what to throw away is to find out what works. As Schank says, "The time to build is now."

What effect will this have on us? In the near future, it will simply mean better,

more intelligent expert systems. In time, it will mean computers that are better able to communicate with us, anticipate our needs, and solve our problems. ■

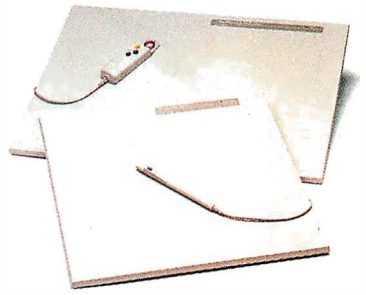
## REFERENCES

1. Chandrasekaran, B. "What Kind of Information Processing Is Intelligence?" In *Foundations of AI: A Source Book*. Edited by Derek Partridge and Yorick Wilks. Cambridge, U.K.: Cambridge University Press, 1990.
2. Schank, Roger C. "What Is AI Anyway?" *The AI Magazine*, vol. 8, no. 4, 1987.
3. Winston, Patrick H. "Artificial Intelligence: A Perspective." In *AI in the 1980s and Beyond*. Edited by W. Eric, L. Grimson, and Ramesh S. Patil. Cambridge, MA: MIT Press, 1987.
4. Minsky, Marvin. *The Society of Mind*. New York: Simon & Schuster, 1986.
5. Bundy, Alan. "What Kind of Field Is AI?" In *Foundations of AI: A Source Book*. Edited by Derek Partridge and Yorick Wilks. Cambridge, U.K.: Cambridge University Press, 1990.
6. Turing, Alan. "Computing Machinery and Intelligence." *Mind*. N.S. 59, 1950. Reprinted in *Computers and Thought*. Edited by E. Feigenbaum and J. Feldman. New York: McGraw-Hill, 1963.
7. Newell, Allen, and Herbert A. Simon. "Computer Science as Empirical Inquiry: Symbols and Search." *Communications of the ACM*, vol. 19, no. 3, 1976.
8. Winograd, Terry. "Thinking Machines: Can There Be? Are We?" In *Understanding Computers and Cognition: A New Foundation for Design*. By Terry Winograd and C. Fernando Flores. Norwood, NJ: Ablex, 1986. Reprinted by Addison-Wesley, 1987.
9. Dietrich, Eric. "Programs in the Search for Intelligent Machines: The Mistaken Foundations of AI." In *Foundations of AI: A Source Book*. Edited by Derek Partridge and Yorick Wilks. Cambridge, U.K.: Cambridge University Press, 1990.
10. Brachman, Ronald. "The Future of Knowledge Representation." Extended abstract in *Proceedings of the Eighth National Conference on Artificial Intelligence*. Menlo Park, CA, and London, U.K.: AAAI Press. Cambridge, MA: MIT Press, 1990.
11. Rosenblatt, Frank. *Principles of Neurodynamics: Perceptrons and the Theory of Brain Mechanisms*. Washington, DC: Sparta Books, 1962.
12. Minsky, Marvin, and Seymour Papert. *Perceptrons: An Introduction to Computational Geometry*. Cambridge, MA: MIT Press, 1969. Revised 1987.

*Bob Ryan is a BYTE technical editor. You can reach him on BIX as "b.ryan."*

# THE FIRST.

In 1972, Summagraphics introduced the first affordable desktop tablet. Eighteen years and more than 40 patents later, our SummaSketch® II is the industry standard in graphics tablets.



# THE MOST.

Our unsurpassed technology and proven reliability have made SummaSketch the best selling tablet in the world—with over 500,000 sold to date. More than any other manufacturer.

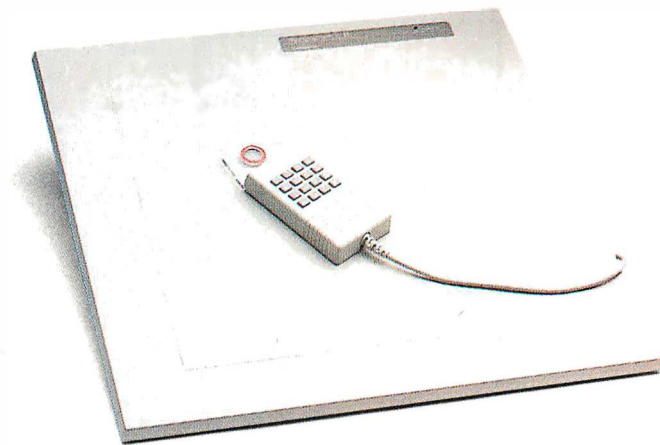
# THE BEST.



November 28, 1989  
SummaSketch II



SummaSketch has also won every major editorial accolade, including PC Magazine Editors' Choice, PC Week Corporate Satisfaction Poll, CADENCE's Blue Ribbon Best of 1989, and CADalyst's Dream Systems and Highly Recommended rating.



SummaSketch II. The people's choice. The critics' choice. And the easiest choice you have to make. For literature and the name of your local dealer call 1-800-888-2028, Ext. 304. For technical information call 203-881-5400.



## Summagraphics®

Every decision should be this easy.™

©1990 Summagraphics Corporation.  
Seymour, CT 06483 • All rights reserved.

For IBM/Compatible information circle 304; For Macintosh information circle 305,  
For Reseller inquiries circle 306 on Reader Service Card.



# THE CONCEPT BEHIND OUR CASE PRODUCT.

System Architect has the power to handle your most complex applications. And it's so easy to use, even beginners will be productive in no time.

*"The software's incredible ease of use belies the power hidden within."*  
Computer Language

System Architect works with such methodologies as DeMarco/Yourdon, Gane & Sarson, Ward & Mellor (real-time), entity relation diagrams, decomposition diagrams, object oriented design (optional), state transition diagrams, and flow charts.

*"System Architect stood out from many other prospects because it had the best core technology."*  
Toshiba Corporation

With System Architect, you get support for an integrated data dictionary/encyclopedia, and multi-user support both with and without a network. And System Architect's open architecture lets you easily import and export data to other products.

*"We're surprised with its flexibility and much taken with the idea of being able to link different kinds of diagrams..."* Cutter Information's CASE Strategies

System Architect is a pleasure to work with. It's Windows-based, has context-sensitive help, and a novice mode.

*"SA is an excellent value."*  
CASE Trends

At \$1,395, System Architect is quite affordable. And it runs on almost any PC.

*"...truly a price performance leader."* System Builder

For a powerful CASE product that's easy to use and affordable, look to System Architect. It's the right concept for CASE.

**FOR MORE INFORMATION,  
CALL (212) 571-3434**

Normal-ization      **RELEASE 2.1**      Super type/Sub type

Automated documentation      SQL-like custom Reporting

Multiple methodologies      Network version available

User-defined attributes      Matrix reporting

Requirements traceability      Integrated data dictionary

Rules & balancing      Import/export capability      Auto leveling

**POPKIN**  
Software & Systems Inc.  
11 Park Place, NY, NY 10007  
(212) 571-3434  
Fax: (212) 571-3436

MICROSOFT  
WINDOWS  
Version 3.11 Compatible Product



**Supporting IBM's AD/Cycle**

System Architect logo is a trademark of Popkin Software & Systems Incorporated. IBM is a registered trademark of IBM Corp. Microsoft is a registered trademark of Microsoft Corp. Price shown valid only for USA & Canada. Prices and specifications are subject to change without notice at the sole discretion of the company. Product delivery subject to availability. Please call for the name of the nearest international distributor.



# Overturning the Category Bucket

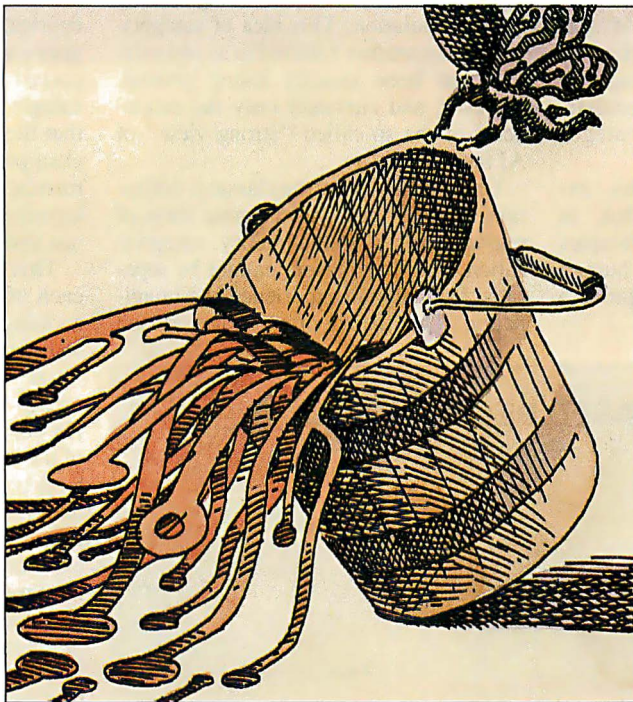
*Categories are central to a human being's picture of reality—  
and to knowledge representation and reasoning in AI*

*Bill Thompson and Bev Thompson*

**A**lthough Webster would have you believe differently, categorization and classification are not the same thing—at least not in AI. Classification methods, which assign objects to categories, are discussed in detail in numerous books and articles, but categorization is often not given the same attention. However, it is important not only to certain AI methods, but also to how human beings think and reason about the world.

We form categories about physical objects and abstract concepts. They help us make sense of the world we live in. Because of the fundamental connection that categories have with thought processes, a theory of categorization is central to our basic picture of reality. It is also central to knowledge representation and reasoning in AI.

Our own curiosity about categories began after reading *Women, Fire and Dangerous Things* by George Lakoff (University of Chicago Press, 1987), which provides a systematic discussion of what categories are, how they are used, and what they reveal about the mind. An awareness of the new views of categoriza-



tion, expounded by Lakoff and others in the fields of cognitive science, linguistics, anthropology, and psychology, forms a steady thread through much of the work in these fields.

## What Is a Category?

There was a time when you could simply present the definition of a category and encounter almost no dissent. In the clas-

sical view, a category is a group of objects whose members all share certain similar properties. The shared properties alone define category membership. A category is thus viewed as a kind of bucket with objects either inside or outside the container.

This classical view has been predominant for the past 2000 years in Western philosophy and science. Its applicability has been a background assumption that has formed a basic building block of many techniques and theories in many fields, including AI.

In this view, the properties that define a category are considered to be more primitive concepts than the category itself. This belief prompted theoreticians to search for ways to identify an ultimate set of primitives to which all other concepts could be re-

duced. For Aristotle, these primitives included substance, quantity, relation, time, position, status, activity, and passivity. However, it's basically impossible to define an ultimate set of primitives. Even Aristotle was unable to settle on one definitive set.

In 1629, Leibniz sought to represent primitives as prime numbers. He represented compound concepts by multiply-

ing the prime numbers of the primitive concepts together. (In fact, he invented the first calculating machine in order to simplify his computations.) A little less than 300 years later, with the availability of computers, Roger Schank's conceptual-dependency graphs and semantic-net theories in computational linguistics echoed a similar theme.

### A New Interpretation

The classical notion of a category as a container for objects sharing similar properties is now rapidly losing acceptance. The impetus behind this dissatisfaction came primarily from research in psychology, linguistics, and anthropology. Notably, Eleanor Rosch and her colleagues at the University of California at Berkeley were involved in pioneering work that questioned the basic definition of a category. Rosch examined certain implications of the classical theory.

Rosch's criticism of the classical view is described by Lakoff: "First, if categories are defined only by properties that all members share, then no members should be better examples of the category than any other members. Second, if categories are defined only by properties inherent in the members, then categories should be independent of the peculiarities of any beings doing the categorizing."

Contrary to these implications, experimental evidence indicated that, in general, categories have best examples called *prototypes* and also that human characteristics are integral to the process of categorization.

## The classical notion of a category is now rapidly losing acceptance.

### Categories and AI

The view of human reason that follows from the classical notion of a category is described by Lakoff as "the mechanical manipulation of abstract symbols which are meaningless in themselves but can be given meaning by virtue of their capacity to refer to things either in the actual world or in possible states of the world."

Once you accept this view, it is a easy next step to assume the possibility of a nonhuman or machine intelligence. This position holds that thought is disembodied; that is, it is not at all dependent on the characteristics of the "thing" doing the manipulation. This idea of categorization, sometimes referred to as *objectivism*, has been steadily losing ground, however, and currently only the proponents of the so-called "strong view" of AI favor it.

Once you question the classical definition of categories, an alternate view of reason emerges. In that theory, categorization, and thus reason, cannot be separated from human experience and imagination. This theory of embodied reason

implies some interesting propositions. Among them, the mind is not separate from the body, and there is not a correct "God's-eye view of the world." Lakoff has termed this philosophical position *experiential realism* or *experientialism*.

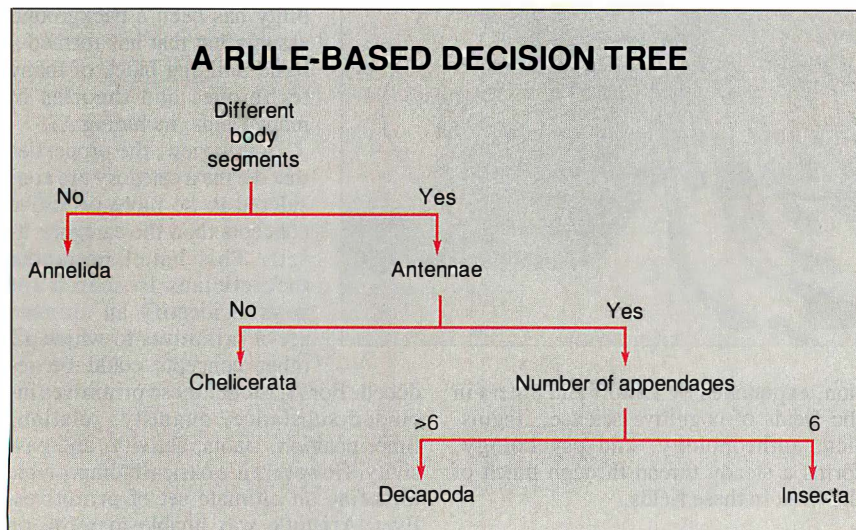
### Categorization and Classification

In AI, many of the most well known techniques deal with some type of classification of data. In classification, the goal is to identify the category or class to which an object belongs. It is assumed that the possible categories are known before classification begins. Methods commonly used for classification include rule-based expert systems, induction systems, neural networks, and genetic algorithms. In a rule-based system, you construct a decision system that represents the understanding of an expert. This knowledge either is already well defined or is massaged into an orderly structure by knowledge engineering. Many expert systems are based implicitly on decision trees.

It's easy to see how the decision-tree model follows the classical theory of categories. Each leaf of the tree is a category—a bucket into which you place a classified object. Membership in the category is based solely on properties that the objects in the bucket share. For example, in the tree shown in the figure, membership in the category *Insecta* is determined solely by the presence of antennae and six appendages.

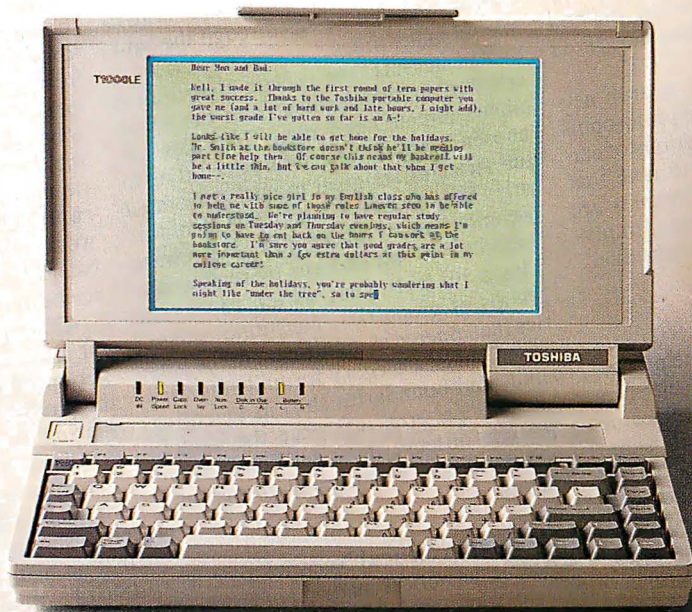
This representation suggests that for each of these objects, the properties describing them and their categories are well-defined "things" that exist in the "real world." Membership in the final category is an all-or-nothing proposition. No objects are better or worse members of the category. Although many schemes have been proposed to allow measures of uncertainty in the classification process, they are often poorly understood by the experts building the systems and thus have met with limited success.

Since building decision trees is such a labor-intensive process, many AI researchers attempt to construct methods that can learn rules from existing data. Induction systems, neural networks, and genetic algorithms are examples of such methods. In each of them, the system "learns" by being trained with sample data. This data usually contains a set of objects along with information describing selected characteristics of each object in the data set. In order to learn, these systems must also be provided with the known category in which each object belongs. The learning method uses the



With rule-based systems, you often classify objects using a decision tree. The limitation of such a system is that the structure of the tree predefines the categories available.

# THE NEXT TIME SOMEONE ASKS YOU ABOUT AN ENTRY LEVEL NOTEBOOK PC HAND THEM THIS.



**C**hances are, people who don't know about PC's are constantly asking you for advice. Especially when it comes to their first notebook PC. Which is precisely why this ad comes in handy.

With it, they can learn all about our T1000LE. An exceptional, six-and-a-half pound notebook PC that has a 3.5", 1.44MB floppy and a powerful 20MB hard disk that can store virtually anything from short stories to the complete works of Shakespeare. They'll see that it comes with an adjustable sidelit LCD screen and 640 x 400 bit-mapped graphics. All of which means that the T1000LE isn't only easy to read, but it's easy on the eyes as well.

**T1000LE**  
 6.5 pounds; 9.54MHz 80C86; 20MB hard drive with 23 msec access; 1.44MB 3 1/2" diskette drive; 1MB RAM expandable to 9MB; CGA compatible screen with 640 x 400 resolution; 82-key sculptured keyboard with eight dedicated cursor control keys; parallel port; serial port; removable, rechargeable battery; AC adapter; AutoResume.™

Add to that, a sleek full-function keyboard that feels just like a desktop PC. And, unlike many notebook PC's, the T1000LE allows them to work for up to three hours anywhere they want.

For more information call 1-800-457-7777.

So the next time someone asks you about a versatile notebook PC, you can do one of two things: Send them to their nearest Toshiba dealer. Or, simply hand them this ad.

©1990 Toshiba America, Computer Systems Division.

In Touch with Tomorrow  
**TOSHIBA**

Toshiba America Information Systems Inc., Computer Systems Division.

Circle 330 on Reader Service Card

sample set to construct a series of relationships that will allow the system to predict the categories of new objects. Table 1 shows a typical sample set for a learning algorithm.

Of the three techniques, induction is the closest to basic rule-based systems. Most induction systems examine each attribute used to describe the objects (the columns in table 1) and decide which one most evenly partitions the objects. Induction is basically a counting method that shares the classical bias for fixed categories.

Genetic algorithms and neural networks work in ways that are philosophically closer to the modern notions of categorization. It's interesting to note that even the names of these techniques are derived from biological systems, implying a search for a more "embodied" theory of learning.

### Genetic Algorithms

Genetic algorithms represent the properties of objects with a string of bits (see table 2). The algorithm first creates bit patterns—randomly or based on some heuristic—that represent a rule for classification. For example, using the scheme in table 2, you can encode the proposition "if there are more than six appendages and it's a sea creature with antennae, then it's of the order *Decapoda*" with the bit pattern 011010100 10.

Next, the algorithm tests the generated rules against a sample set. This testing may be somewhat complicated, forcing the generated rules to bid for the privilege of being tested against an element in the sample set. Based on bidding successes and failures, the algorithm assigns strengths to the generated rules. Because the strengths of the rules are constantly changing, this process is an iterative one that passes through the sample set many times.

At intervals, the genetic algorithm is invoked to select rules from the set to mate, mutate, and die. The rules are chosen based on probability according to the strength assigned to each generated rule. The operation of both phases of this technique tends to identify and reward "successful" bit patterns by replication. These bit patterns, which represent groups of properties, constitute categories that emerge as significant in the generated rules. Category formation is very fluid, and boundaries shift as emerging category patterns influence the model. You can observe these relationships by examining the evolution of the genetic system.

### Learning in Neural Networks

A neural network is made up of layers of neurons: an input layer, one or more middle layers, and an output layer. Neurons can be adapted to handle numeric, sym-

bolic, and image data. Each input neuron represents one property described in the sample set. The output is usually a classification category based on the internal state of the middle layers of neurons.

The training set of a neural network is a set of objects whose properties are presented as input to it. The algorithms used in the model adjust the strengths of the connections among the neurons until they achieve the desired output. Since the readjustment changes the response of previously tested objects, the method loops through the training set and refines the connections until it reaches some optimum conditions. Like the genetic algorithm, the operation of the neural network relates the objects' properties to categories in a manner difficult to describe in classical terms.

Although genetic algorithms and neural networks take the interesting first step of representing a category as something other than a single group of objects sharing similar well-defined properties, this doesn't mean that they approximate human reasoning methods. Researchers who subscribe to the nonobjective view of reasoning will be quick to remind you that no matter how clever the manipulation of symbolic representations, reasoning is not an abstract process separable from the "wetware" that performs it. Lakoff's book contains numerous examples of metaphors and image-schematic structures that illustrate this point.

### Forming Categories

All the learning systems described thus far require a sample set of objects that have already been classified. This implies that for a given set of objects, you already know which categories exist and how the objects are distributed among them. Category formation, on the other hand, involves analyzing a set of objects to find which subsets have enough similarity to be clustered into a category. There is no a priori knowledge of an optimal classification scheme. Category-

#### INDUCTION TRAINING SET

**Table 1:** *The induction learning method uses the sample set of data to construct a series of relationships. Knowledge of these relationships will enable the system to predict the classes of new objects.*

Object	Appendages	Habitat	Antennae	Usefulness	Classification
Horseshoe crab	>6	Sea	No	None	Chelicerata
Bee	6	Land	Yes	Food	Insecta
Spider	>6	Land	No	None	Chelicerata
Lobster	>6	Sea	Yes	Food	Decapoda
Silkworm	6	Land	Yes	Silk	Insecta

#### GENETIC TRAINING SET

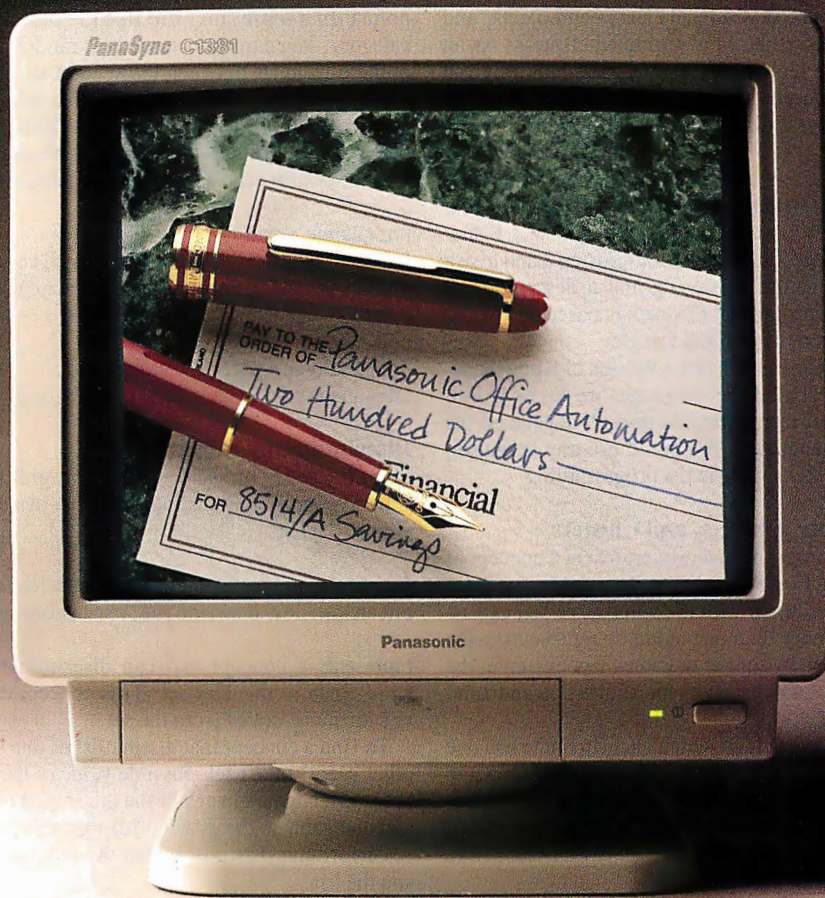
**Table 2:** *Genetic algorithms represent the properties of objects with bits. The algorithm begins by creating bit patterns that represent a rule for classification.*

Object	6 "legs"	>6 "legs"	Sea	Land	Antennae	No antennae	Food	Silk	None	Class
Horseshoe crab	0	1	1	0	0	1	0	0	1	01
Bee	1	0	0	1	1	0	1	0	0	00
Spider	0	1	0	1	0	1	0	0	1	01
Lobster	0	1	1	0	1	0	1	0	0	10
Silkworm	1	0	0	1	1	0	0	1	0	00

Classification values: Insecta = 00, Chelicerata = 01, Decapoda = 10

*Introducing the PanaSync™ C1381 Monitor.*

# 8514/A resolution. VGA® price.



If you want the ultimate VGA graphics standard, and you've resigned yourself to paying a premium of hundreds of dollars to get it, you'll find our newest monitor pleasant viewing indeed.

The PanaSync C1381 gives you a sharp 1024 x 768 pixels, with 0.28 dot pitch. And virtually infinite color resolution. It's compatible with the most popular VGA boards, as well as analog RGB, MCGA, SuperVGA, and — of course — 8514/A standards\*.

It's comfortable in virtually any IBM-compatible or Mac II environment.\*\*

And it's a masterpiece of ergonomics. With front-mounted controls, tilt/swivel stand, plus a non-glare tinted black-matrix screen.

All this at a suggested retail price comparable to many of the ordinary VGA monitors on the market right now. For more information, simply call toll-free **1-800-742-8086**.

*Peripherals, Computers, Printers,  
Copiers, Typewriters and Facsimiles*

**Panasonic**  
Office Automation 

PanaPro™ Monochrome Desktop Publishing Monitors with Video Adapters.



(Mac SE)

(Mac II)

(IBM XT/AT & PS/2 Model 30)

PanaSync™ Multiscanning Color Monitors.



- \* VGA, MCGA and 8514/A are trademarks of International Business Machines Corp.
- \*\* IBM XT, AT and PS/2 are registered trademarks of International Business Machines Corp. Macintosh is a registered trademark of Apple Computer Inc. An optional cable is required for Macintosh.

## Creating Conceptual Clusters

Conceptual-clustering methods start with a group of objects with certain known properties. A clustering algorithm then measures the amount of similarity between objects, and among groups of objects, to build meaningful clusters. As an example of one of these techniques, we've written a program called *Concept* that is based on a well-known program called *Cluster/2*, written by Ryszard Michalski and Robert E. Stepp (see reference 1).

*Concept* partitions a set of objects to form conceptual clusters. (*Cluster/2* also constructs a classification hierarchy, but we will concentrate only on the partitioning module.) Fisher and Langley (see reference 2) also describe *Cluster/2* and give a good overview of conceptual clustering and a description of several other clustering programs. *Concept* is based on the description of *Cluster/2* from Fisher and Langley.

We wrote *Concept* using the Windows version of Knowledge-Pro because, having designed the language, we know it intimately. However, the clustering method doesn't depend on the choice of a particular language. You could use any language, such as Lisp or Prolog, that supports list programming.

### Representing Concepts, Objects, and Clusters

Conceptual-clustering programs usually represent a concept as an attribute-value pair. For example, `appendages:six` associates the attribute `appendages` with the value `six`. You can associate attributes with more than one value by representing the values as a list surrounded by square brackets. For example, the concept `habitat:[sea,land]` assigns the values `sea` and `land` to the attribute `habitat`.

An object is a list of concepts in which each attribute has one and only one value. The objects we use in *Concept* are shown in table A. A cluster is a group of objects. You can describe a cluster by providing a list of its objects or the concepts associated with the objects in the cluster. For example, the cluster `[bee, lobster]` is defined by the concepts

```
appendages:[six,more_than_six]
habitat:[land,sea]
antennae:[yes,yes]
commercial_use:food
```

#### OBJECT DESCRIPTIONS

**Table A:** *Objects are lists of concepts in which each attribute has one and only one value.*

```
horseshoe_crab = [appendages:more_than_six, habitat:sea,
  antennae:no, commercial_use:none]
bee = [appendages:six, habitat:land, antennae:yes,
  commercial_use: food]
spider = [appendages:more_than_six, habitat:land,
  antennae:no, commercial_use:none]
lobster = [appendages:more_than_six, habitat:sea,
  antennae:yes, commercial_use:food]
silkworm = [appendages:six, habitat:land, antennae:yes,
  commercial_use:silk]
```

The first step in creating a conceptual cluster is to select two objects as *seeds*. You can think of seeds as cluster starting points. In a sense, they are like the prototypical members of a category. You can choose seeds at random or by some measure of the difference between the seed objects. Although choosing seeds that are as different as possible will usually improve the performance of the clustering algorithm, we randomly chose the first two objects, `horseshoe_crab` and `bee`, as seeds.

The seed objects, shown here as lists, are

```
horseshoe_crab
[appendages:more_than_six, habitat:sea,
antennae:no, commercial_use:none]
```

```
bee
[appendages:six, habitat:land,
antennae:yes, commercial_use:food]
```

### Discriminating Concepts

Once the seeds are selected, the program generates the most general concept that distinguishes the two seed objects. For example, the list

```
[appendages:more_than_six, habitat:sea,
antennae:no, commercial_use:[none,silk]]
```

represents a concept that can discriminate `bee` from `horseshoe_crab` in the data set. This concept contains all the non-`bee` attribute values from the set.

To find a concept that distinguishes one seed object from the other seeds, take each possible value of the attribute and check to see if it appears in any of the other seed objects. If it does not, add that value to the distinguishing concept.

Performing this process on the data set from table A gives you the list

```
[appendages:more_than_six, habitat:sea,
antennae:no, commercial_use:[none,silk]],
[appendages:six, habitat:land,
antennae:yes, commercial_use:[food,silk]]
```

which discriminates between `horseshoe_crab` and `bee` in the set of objects. The first sublist identifies non-`bee` objects; the second identifies non-`horseshoe_crab` objects.

Next you combine the items in the first sublist that discriminates a `bee` from a `horseshoe_crab` one at a time with each of the items on the sublist that discriminates `horseshoe_crab` from `bee`. For example:

```
[appendages:more_than_six, appendages:six],
[appendages:more_than_six, habitat:land],
[appendages:more_than_six, antennae:yes],
[appendages:more_than_six,
commercial_use:[food,silk]],
[habitat:sea, appendages:six], ...
```

This way, you create 16 concept pairs that you use one at a time to generate clusters. To form the clusters, select a pair of

concepts and find which one describes each object. If, for example, you select the concept pair `commercial_use:[none, silk]` and `commercial_use:[food, silk]`, you find the following: `commercial_use:[none, silk]` describes [horseshoe\_crab, spider, silkworm], and `commercial_use:[food, silk]` describes [bee, lobster, silkworm].

Because the goal is to partition the objects into disjoint clusters, remove any duplicates from the lists and place them in an exception list. In this case, remove `silkworm` from the list. Next, add the exceptions back into the clusters in a manner that keeps the clusters disjoint. To accomplish this, generate the maximally specific concepts that describe the disjoint clusters formed after `silkworm` is removed.

The concepts unique to [horseshoe\_crab, spider] are

```
[appendages:more_than_six], habitat:[sea,land],  
antennae:no, commercial_use:none]
```

The concepts unique to [bee, lobster] are

```
[appendages:six,more_than_six], habitat:[land,sea],  
antennae:yes, commercial_use:food]
```

Next, add the first exception into one cluster and find the unique concepts that describe it. Here, adding `silkworm` into the first cluster results in the clusters [horseshoe\_crab, spider, silkworm] and [bee, lobster]. The concepts that describe these two clusters are

```
[appendages:[more_than_six, six],  
habitat:[sea,land], antennae:[no, yes],  
commercial_use:[none, silk]]  
[appendages:six,more_than_six], habitat:[land,sea],  
antennae:yes, commercial_use:food]
```

Adding the `silkworm` to the second cluster forms the new clusters [horseshoe\_crab, spider] and [bee, lobster, silkworm]. The concepts that uniquely represent these clusters are

```
[appendages:more_than_six, habitat:[sea,land],  
antennae:no, commercial_use:none],  
[appendages:[six,more_than_six],  
habitat:[land,sea], antennae:yes,  
commercial_use:[food, silk]]
```

Next, evaluate the clusters in terms of their related concepts. There are various methods to evaluate the concepts, such as searching for similarity, intercluster difference, or simplicity. In the sample program, we attempt to build clusters that have a large intercluster difference among their related concepts.

The intercluster difference is the sum of the disjointness of all concept pairs. The disjointness of a pair of concepts is the number of attributes that do not intersect. If you look at the concepts in each of the competing clusters shown above, you will see that the first clustering has an intercluster difference of 1 because `commercial_use` is the only attribute with no overlap of values between the two clusters.

The second set has an intercluster difference of 2 because

both `antennae` and `commercial_use` fail to intersect. Thus, case 2—the clusters [horseshoe\_crab, spider] and [bee, lobster]—has the larger intercluster difference and becomes the selected representation. If there are more exceptions in the original clusters, add each exception to one of the successive clusters created.

The clustering algorithm repeats this process for each of the 16 original concept pairs. The cluster with the maximum intercluster difference becomes the best cluster for the set of objects. In selecting concept pairs, discard those that cannot describe all the objects, since they don't successfully partition the data set.

For example, the concept pair [antennae:yes, commercial\_use:[food, silk]] doesn't let you describe `bee`, `lobster`, or `silkworm`. In this set of data, this cluster has the maximum intercluster difference.

### Real-World Correlations

As it turns out, the cluster that the program chooses mirrors the biological classification of the actual creatures. Horseshoe crabs and spiders belong to subphylum *Chelicerata*; the other objects belong to subphylum *Mandibulata*. Although you might be tempted to say that this proves that the technique is useful for discovering some natural order existing in the world, you should remember that this partitioning depends on the attribute `commercial_use`, which is not a natural attribute.

Even though we have used intellectually loaded terms, such as *concept*, in describing its workings, the Concept program merely manipulates data structures. You must supply the meaning of the structures representing items like *concept*. Notice also that, philosophically, Concept is a classical method for creating categories. Membership in a cluster (i.e., a category) is based strictly on the similarity among shared values for attributes.

As you can see from the example, Concept extensively searches the space of possible partitions. Each step in the search is fairly expensive because of the amount of list manipulation involved. Michalski and Stepp describe some advanced heuristics that you can use to prune the search. Even using advanced heuristics, Fisher and Langley report that the partitioning system appears to run in time proportional to  $m^k$ , where  $k$  is the desired partition size and  $m$  is a linear function of the number of attributes and the average number of values for each one. However, because this method performs such an extensive search, it can usually discover relatively good clustering, even in poorly structured data.

Editor's note: *Concept* is available in electronic format. See page 5 for details.

### REFERENCES

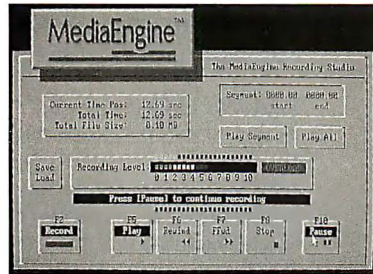
1. Michalski, R., and R. E. Stepp. "Learning from Observation: Conceptual Clustering." In *Machine Learning*, R. Michalski, J. Carbonell, and T. Mitchell, eds. Palo Alto, CA: Tioga Publishing Company, 1983.
2. Fisher, D., and P. Langley. "Conceptual Clustering." In *Artificial Intelligence and Statistics*, William A. Gale, ed. Reading, MA: Addison-Wesley, 1986.

OVERTURNING  
THE CATEGORY BUCKET

## True Multimedia Power for Autodesk Animator™ Users! Introducing MediaEngine™

Imagine a multimedia presentation system that provides *true multimedia functionality* on a standard IBM PC AT® or compatible desktop system for **only \$595!** The MediaEngine System includes three components: **MediaEngine™**, **The MediaEngine Recording Studio™** and **The MediaEngine Audio Processor™**, which is the hardware component that provides real-time digital audio capture and playback. The result is full-fidelity audio processing combined with a powerful authoring system that allows *exact synchronization* of PCX-format images, text and Autodesk Animator "flics" with spoken words, phrases or "events" in a musical score. Get the power of MediaEngine today. Call Genesis Development at 414-796-1005.

**Genesis Development Corporation**  
15850 West Bluemound Road, Suite 307  
Brookfield, WI 53005  
(414)796-1005



## BACKPACK. IT'S A DRIVE OF A DIFFERENT COLOR.



Add a disk drive without horsing around inside your computer—just plug Backpack into your parallel port! Connect your printer to the Backpack drive. No tools. No hassles. No interface cards. Backpack works with IBM and compatibles including PCs, XTs, ATs, PS/2s, PS/1s, and

laptops. It's available in 5.25" and 3.5" and comes complete with everything you need. So see your dealer or get it straight from the horse's mouth and call us about Backpack today!



**MicroSolutions**  
Computer Products  
132 W. Lincoln Hwy., DeKalb, IL 60115  
815-756-3411 Fax: 756-2928

formation techniques are often referred to as "top-down methods," in contrast to the "bottom-up methods" associated with classification systems.

You can use the output of a categorization system to create a hierarchical tree with which to classify the objects in an AI system. You can also use the output to analyze how a set of objects can share certain properties. One method for categorizing objects from the top down is *conceptual clustering*. (For information on this method and a program that will let you try it, see the text box "Creating Conceptual Clusters" on page 254.)

### Three Main Points

In sum, there are three main points to consider. First, categories are important in AI and deserve more study. Classification systems have been one of the most well known and commercially exploited technologies of AI. Even though categorization is related to classification, an explicit understanding of categories and their roles is not usually discussed when describing systems that use classification.

Second, the new view of categories points out that philosophy, AI, anthropology, linguistics, and psychology have much to say to each other if a common language can be found. Third, metaphysics matters. It can point in the direction of developing powerful new techniques, as well as illuminate the possible limits of existing ones. ■

### BIBLIOGRAPHY

- Goldberg, David E. *Genetic Algorithms in Search, Optimization and Machine Learning*. Reading, MA: Addison-Wesley, 1988.
- Holland, John H., Keith J. Holyoak, Richard E. Nisbett, and Paul R. Thagard. *Induction: Processes of Inference, Learning, and Discovery*. Cambridge, MA: MIT Press, 1986.
- Johnson, Mark. *The Body in the Mind*. Chicago, IL: University of Chicago Press, 1987.
- Romesburg, Charles H. *Cluster Analysis for Researchers*. Belmont, CA: Lifetime Learning Publications, 1984.
- Sowa, J. F. *Conceptual Structures: Information Processing in Mind and Machine*. Reading, MA: Addison-Wesley, 1984.

*Bill Thompson is director of R&D and Bev Thompson is director of knowledge-based systems at Knowledge Garden. They designed KnowledgePro, KnowledgeMaker, and MicroExpert and have written many articles in the AI field. They can be reached on BIX as "bbi."*



# The Pocket LAN Adapters: Lap To LAN In One Award-Winning Connection.

Now Supports  
3+ Open and Banyan

1989  
**BYTE**  
AWARD  
EXCELLENCE

Why all the excitement? Because Xircom lets your laptop access a network wherever, whenever, and however you need it. Whether it's Novell, 3-Com, Banyan or most other operating systems running on Token Ring, Ethernet or Arcnet, the Pocket LAN Adapter gives PC users a quicker, easier LAN solution.

Our philosophy of universal connectivity combined with innovative technology has earned the Pocket LAN Adapters industry-wide recognition in a very short time. It all adds up to a faster, simpler LAN solution for laptop users. By connecting through the parallel port, a Pocket LAN Adapter gives you the freedom to choose whichever laptop fits your needs. It means no more slot problems, no address or interrupt conflicts, and no jumpers to configure.

And with practically every protocol and operating system supported with certified drivers, there's a PocketLAN



Adapter that will fit your laptop and your pocket with its competitive price. So call (818) 884-8755 for an award-winning solution to your connectivity needs.



## Xircom

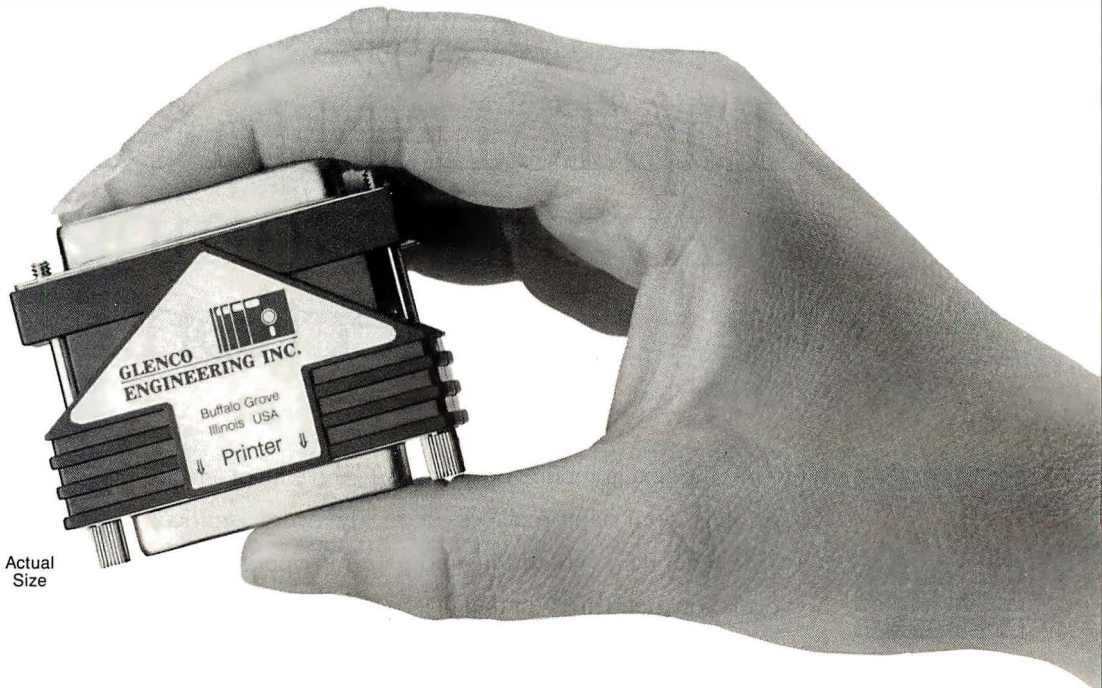
LAN solutions for laptops.

22231 Mulholland Highway, Suite 114 • Woodland Hills, CA 91364 • 818/884-8755  
Frankrijkei 28 • 2000 Antwerp, Belgium • 32(0)3 225.22.91

Circle 369 on Reader Service Card



# I N T R O D U C I N G HARDLOCK™



## The Ultimate in Hardware Based Copy Protection

### Compatible

Hardlock is designed for the "real world". Side effects from printers, laptops and technical issues such as static and true IBM printer port compatibility are virtually non-existent.

### Reliable

Our unique ASIC (Application Specific Integrated Circuit) extends the Hardlock's operating range below 2 volts. Since no idle current is required, there is no additional loading on the printer. Electronically erasable memory requires no battery.

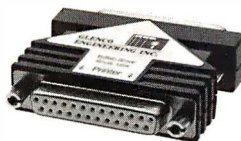
### Flexible

Field programmability is now possible. Additionally our optional Crypto Programmer board permits the Hardlock to be uniquely programmed for your company.

### Space-Saving

Hardlock measures only 1.75". Three of our units fit in approximately the same space as only two others. Hardlock with Memory may also be purchased on the smallest PC board you've ever seen. Perfect for those who don't want the device on the exterior of the computer.

**Hardlock**  
**Hardlock with (128 bytes) Memory**  
**Hardlock with Memory on a Board**



*Hardlock . . .  
Not Hardluck*

*The Security System You've Asked For.*

**GLENCO**  
**ENGINEERING INC.**

SERVING THE SOFTWARE INDUSTRY SINCE 1979

1-800-562-2543

Hardlock is a trademark  
of Fast Electronic GmbH.

270 Lexington Drive · Buffalo Grove, IL 60089 · 708-808-0300 · FAX 708-808-0313

Circle 121 on Reader Service Card

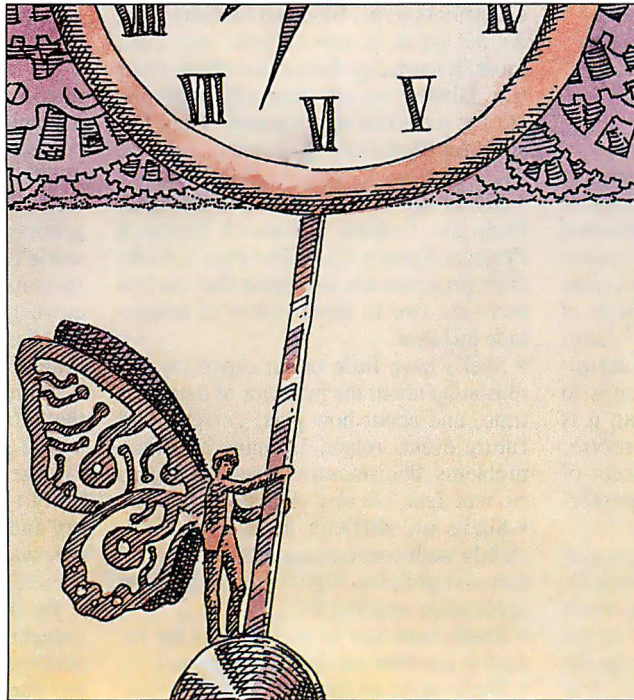
# The Real-Time Expert

*You can make the monitoring and control of complex, real-time systems a lot easier with some "expert" help*

*Thomas J. Laffey*

**W**e live in an age of information overload. The growing complexity of computerized systems, as measured by the volume of low-level information that they produce, in many cases outstrips the capacity of people to monitor and control them. Operators are overwhelmed with information; already some spectacularly expensive accidents (e.g., Three Mile Island and Bhopal, India) have been attributed to this "cognitive overload."

The profitability of a company, the quality of its products, and the safety of its operations can all be adversely affected by cognitive overload. Real-time computer systems, which are showing up in a growing number of applications ranging from the simple controllers found in household appliances to large, complex systems for industrial and military purposes, challenge even the most well trained experts with the sheer volume of information they produce. One possible solution to the problem is to use real-time expert systems that combine the subtlety and flexibility of human expertise with the speed and precision of the computer.



## **Problem Indicators**

The complexity of real-time computerized systems is increasing in many areas. Compared to systems available just a few years ago, real-time systems today control an increased number of functions at a faster rate and with a greater number of factors that you must consider before a control decision can be made.

Indicators that you might need a real-

time expert system, especially when conventional techniques have failed or are impractical, are many. They include problem-solving situations where people suffer from cognitive overload, fail to effectively monitor all available information, are unable to resolve conflicting constraints, are expensive or scarce, make high-cost mistakes, miss high-revenue opportunities, or cannot provide a solution quickly enough.

An example of a situation susceptible to operator overload is the control room of an oil-drilling platform, where an operator can be confronted with as many as 500 analog and 2500 digital signals. In the event of a system problem, this can result in a considerable cognitive load. And the problem is just getting worse. Future oil platforms will re-

quire that two or three operators monitor as many as 20,000 signals.

In other domains, such as satellite control, qualified personnel—those who are able to evaluate complex situations and recommend actions—are becoming increasingly difficult to find. For example, the Hubble Space Telescope has more than 6000 sensors that need to be monitored in real time. Similarly, in

financial markets, good traders who can quickly assimilate and evaluate information and act on it are scarce and expensive. Financial trading is a fast-moving activity that depends on a wide and complex scope of political, economic, climatic, and financial factors.

Used properly, a real-time expert system can result in more sophisticated monitoring and control strategies in such fields as

- space operations;
- military command and control;
- nuclear/electrical power-plant monitoring and control;
- air-traffic control;
- environmental systems;
- transportation systems;
- radar/signal understanding;
- aerospace systems (e.g., monitoring electrical, power-propulsion, and life-support systems);
- communications-network monitoring and control;
- factory monitoring and process control, including factory-wide decision support;
- medicine (patient monitoring); and
- econometric and financial areas (e.g., market monitors, advisers, and traders).

### What Is Real Time?

As discussed by O'Reilly and Cromarty (see reference 1), many definitions of real time exist. It is commonly assumed to mean "fast," in the sense that a system is considered real-time if it processes data quickly. Real time is also thought of as "perceptually fast," or at least "faster than a human can do it." A better definition states that "the system responds to incoming data at a rate faster than it is arriving." Although scarcely precise, this definition does link the concept of real time to problem-relevant performance measures.

J. A. Stankovic divides real-time systems into *hard* and *soft* (see reference 2). With a hard real-time task, the correct action or solution depends not only on the results of the computation but also on the time it takes to produce the results. For these tasks, the system must meet timing constraints. An example is a navigation system on board a missile, which requires responses within a certain time increment. Failure to produce a response during this time may cause the missile to go out of control. A response produced after the time increment is useless.

In soft real time, the tasks also have time constraints, but there is still some value in completing tasks after their

deadline, although typically the value of completing the tasks degrades monotonically over time. Most systems today have both hard and soft real-time requirements.

### Real Time and Traditional AI

Until recently, knowledge-based systems have been sheltered from real-time requirements. Historically, AI researchers have concentrated on problems where time is not a factor, such as medical diagnosis (MYCIN from Stanford University), computer configuration (XCON from DEC), and evaluation of geological sites (Prospector from Stanford Research Institute).

These systems are characterized by the fact that a human operator supplies the inputs, data does not change during the problem-solving session, and response times are generally slow, measured in minutes or hours. This contrasts with current real-time systems where data changes rapidly and response time is often measured in milliseconds.

Because a real-time expert system must satisfy demands and operate under constraints (e.g., time and memory) that do not exist in conventional domains, most knowledge-based building tools (i.e., shells) are not generally appropriate for real-time applications. They fall short for the following reasons:

- Shells are not fast enough. Research from the Defense Advanced Research Projects Agency (DARPA) Pilot's Associate program has indicated that current tools are two to three orders of magnitude too slow.
- Shells have little or no capability for reasoning about the behavior of data over time, and about how past, current, and future events relate. In many real-time problems, decisions are based not just on current data, but also on historical data.
- Shells are difficult to integrate efficiently with conventional software (e.g., data compression, signal processing, and application-specific I/O).
- Shells have few or no facilities for focusing attention on significant events.
- Shells offer no integration with a real-time clock. In a real-time system, you often need to link events to absolute times or specific time intervals.
- Shells have no facilities to handle asynchronous events.
- Shells cannot efficiently take input from external sources other than human operators.
- Shells don't provide reliable response times. Many AI algorithms are search-intensive and exponential in nature.

- Shells are not built to run continuously.
- Shells cannot adapt to changes in work load or resource availability.

To handle such requirements, the framework of a real-time knowledge-based system is fundamentally different from that of a traditional expert system. Rather than coming from people, inputs come from automatic sensors that monitor a process. The outputs of a real-time expert system go to effectors that perform a control action on the process of interest, with messages to the operators informing them about what's going on and possibly recommending desired actions.

### Tools for Real-Time AI

Recently, a few companies have developed specialized knowledge-based tools targeted specifically at the vertical real-time market. For example, my company, Talarian, offers R\*Time, a family of products optimized for intelligent monitoring and control. Like other real-time expert systems, R\*Time has extended many of the traditional knowledge-representation methods to handle the real-time domain.

To achieve high performance and maximum modularity, R\*Time breaks its major tasks into three types of processes: inference-engine processes, used to analyze dynamic data by means of objects, classes, and rules; data acquisition processes, used as links to the external world (these acquire, filter, and send the incoming sensor data to other processes); and human-machine-interface processes that provide point-and-click graphical user interfaces.

With a traditional expert-system shell, the inference engine, data acquisition, and user interface would all be grouped together into one large process, potentially tying up resources, such as memory and CPU, and making it difficult for the system to react quickly to critical events.

By breaking these key functions into independent processes, a real-time expert system can distribute its processes anywhere on a LAN and exploit the inherent asynchrony in the system to maximize throughput and response. Such a distributed architecture also has the advantage of being able to exploit multiple CPUs if performance requirements call for it. Figure 1 shows an example of R\*Time processes distributed across six workstations to monitor the electrical-power, pointing-control, and thermal subsystems of a satellite in real time.

Besides a distributed architecture,

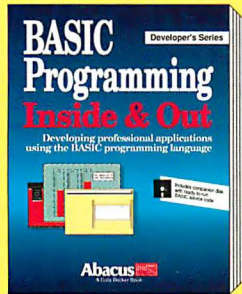
# Programming Books

from the Computing Know How experts.

## BASIC Programming Inside & Out

In depth coverage for all BASIC, QuickBASIC, GW-BASIC, and Turbo BASIC programmers. Explains sound and graphics, creating help screens, pull-down menus, managing windows in BASIC, using ML with BASIC, business presentation graphics, printing multiple columns and sideways for professional results, programming serial and parallel interfaces. Dozens of demo programs and routines you can easily adapt to your own programs. 600 pages with companion disk.

#B084 ISBN 1-55755-084-0 \$34.95

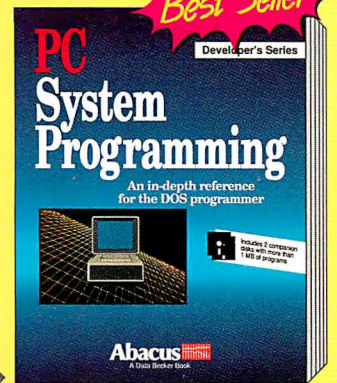


Includes companion disk

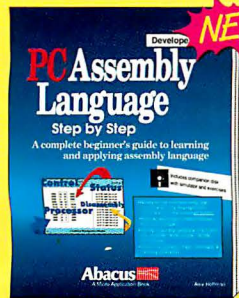
## PC System Programming

An encyclopedia of PC technical and programming knowledge. Features parallel working examples written in Pascal, C, assembly and BASIC. Explains memory layout, DOS operations, using extended and expanded memory, writing device drivers, hard disks, PC ports, mouse drivers, fundamentals of BIOS, graphics and sound, TSR programs, complete appendices. 920 page book includes 2 companion disks with over 1 meg. of programs.

#B036 ISBN 1-55755-036-0 \$59.95



Includes 2 companion disks

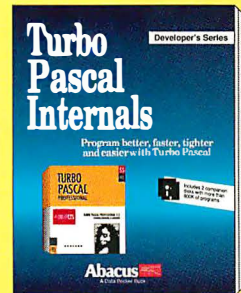


## Assembly Language Step by Step

Teaches you PC assembly and machine language from the ground up. You'll learn at your own pace using the unique simulator which shows you how each instruction works as the PC executes it. 360 pages with 2 companion disks. Also includes evaluation versions of A86 Assembler and D86 Debugger.

#B096 ISBN 1-55755-096-4 \$34.95

Includes 2 companion disks



## Turbo Pascal Internals

Gives you "know how" to program faster, easier, tighter and better. Find out how to use Turbo for system programming tasks-writing TSRs, performing multi-tasking, using SAA windowing, implementing expanded and extended memory. Learn how Turbo generates machine code, handles the mouse, scans the keyboard, uses UNITES and OOPS, performs fast screen display and more. 750 pp and 2 disks of more than 800K of source code.

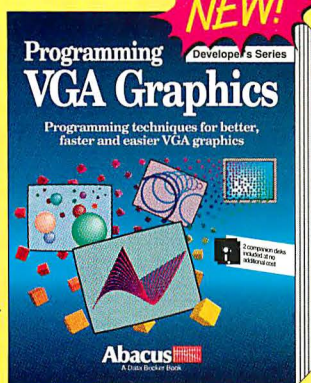
#B080 ISBN 1-55755-080-8 \$49.95

Includes 2 companion disks

## Programming VGA Graphics

VGA is becoming the standard display mode for PC applications. Learn the techniques for writing using the flexible and powerful VGA hardware and software. Includes new, unique DOS commands to perform dozens of VGA functions. Turbo Pascal and BASIC extensions for VGA display modes. 670 pages with 2 companion disks.

#B099 ISBN 1-55755-099-9 \$39.95



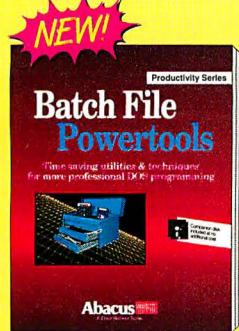
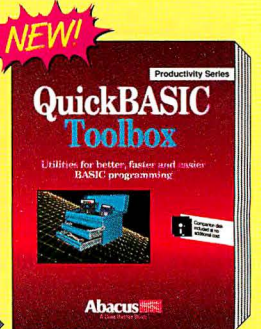
Includes 2 companion disks

## QuickBASIC Toolbox

Packed with powerful, ready-to-use programs and routines to write your own programs faster and better. Topics include: complete routines for SAA interfacing, pull-down menus, windows, dialog boxes and file requestors, descriptions of QuickBASIC routines and a BASIC Scanner program for printing completed project listings. Includes companion disk. Available January

#B104 ISBN 1-55755-104-9 \$34.95

Includes companion disk



## Batch File Powertools

Boost your computing productivity with this package for making truly powerful batch files. Includes dozens of new batch commands for writing time-saving, easy-to-use "power" batch files. Book with companion disk containing our new "Batch BASIC" commands for writing even more useful batch programs. Includes companion disk. Available January.

#B102 ISBN 1-55755-102-2 \$34.95

Includes companion disk

In US & Canada Order Toll Free 1-800-451-4319 EXT.21

For fast delivery Order Toll Free 1-800-451-4319 EXT.21 or FAX (616) 698-0325

Yes, please rush the following items  Yes, please rush your PC catalog  
Apply to my:  Visa  Master Card  Am. Express /  I have enclosed a check / M.O.

___ Assembly Language Step by Step	\$34.95	___ Programming VGA Graphics	\$39.95
___ BASIC Programming Inside & Out	\$34.95	___ Turbo Pascal Internals	\$49.95
___ Batch File Powertools	\$34.95	___ QuickBASIC Toolbox	\$34.95
___ PC System Programming	\$59.95		

In US and Canada add \$4.00 Postage and Handling. Foreign orders add \$12.00 postage per book.

Card# \_\_\_\_\_ Expires \_\_\_\_\_

Signature \_\_\_\_\_

Phone# \_\_\_\_\_

Name \_\_\_\_\_

Address \_\_\_\_\_

City \_\_\_\_\_ State \_\_\_\_\_ Zip \_\_\_\_\_

Available at B Dalton Booksellers, Waldensoftware, and Software Etc. and at other bookstores nationwide. In the UK contact Computer Bookshops 021-706-1188. In Canada contact Addison Wesley 416-447-5101.

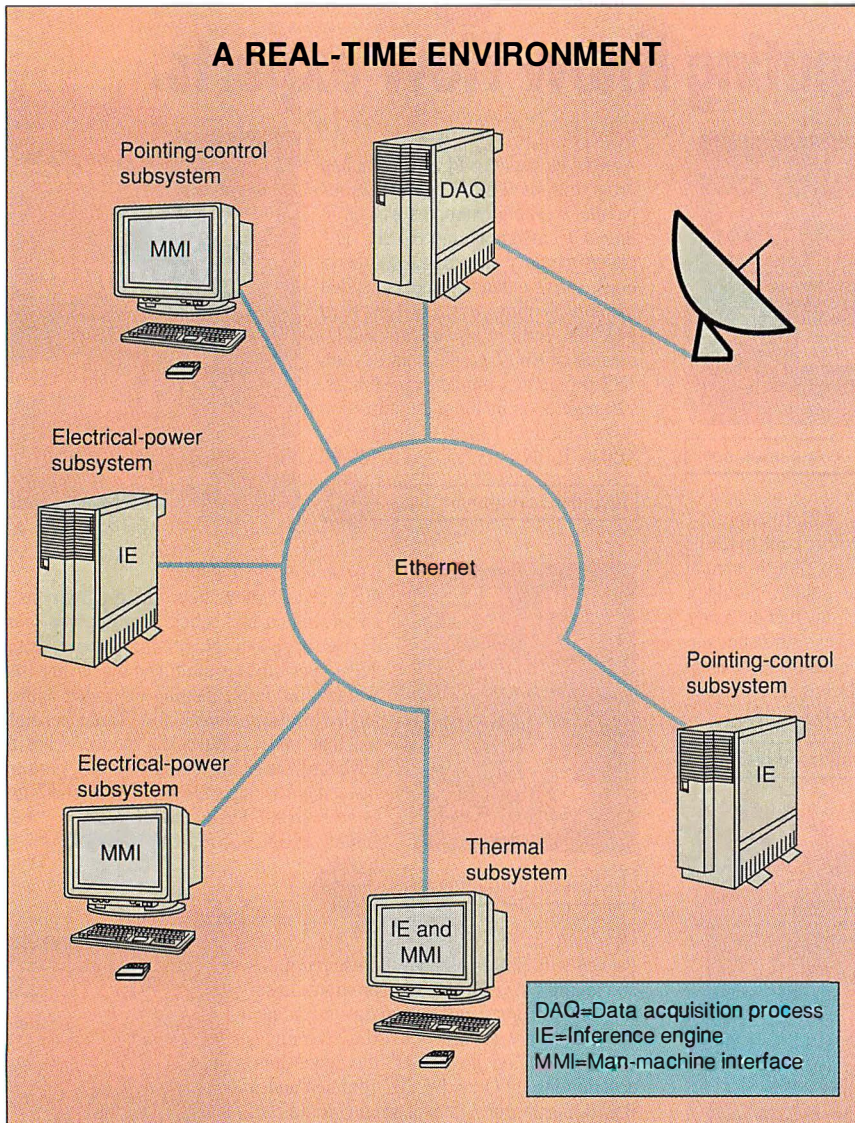
# Abacus

Dept. B1, 5370 52nd Street SE, Grand Rapids MI, 49512

Orders: 1-800-451-4319 • Phone: (616) 698-0330 • Fax: (616) 698-0325

In US and Canada add \$4.00 Postage and Handling. Foreign orders add \$12.00 postage per book. We accept Visa, Master Card or American Express. Call or Write for your free catalog of PC Books.

Circle 9 on Reader Service Card (RESELLERS: 10)



**Figure 1:** By distributing different functions to different processors, a knowledge-based system cuts down the load on any one processor, making the system faster and more responsive. In the example, the inference engine, data acquisition, and man-machine interface processes reside on different processors.

R\*Time contains examples of many enhancements that real-time expert systems employ to apply knowledge-based problem-solving methods to real-time problems. The key features are four:

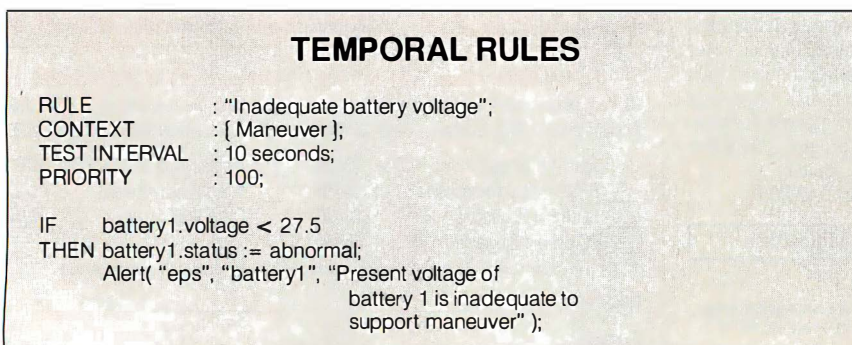
*Time-triggered rules.* In traditional expert-system shells, you encode rules in an IF-THEN syntax that you test or invoke in two ways: when the data in the antecedent (IF) clause changes (usually called forward chaining or data-driven inferencing), or when one of the consequent (THEN) clauses is needed to achieve a goal (called backward chaining or goal-driven inferencing).

In a real-time system, you also need to be able to tie the triggering of a rule to time (e.g., test this rule every 10 seconds) in order to ensure a reliable response. Figure 2 shows a time-triggered rule to detect a power-battery anomaly in an application that monitors a satellite maneuver. The test-interval slot in the rule's header causes the voltage to be tested every 10 seconds when the satellite is in the "maneuver" context. In addition to ensuring reliable response times, these time-triggered rules can increase performance, as the rule need not be tested every time data in its antecedent clause changes.

*Temporal reasoning.* Object-oriented methods are an integral part of today's expert-system shells. Typically, objects and their attributes are defined and assigned to classes (frames) that are organized into a hierarchy via different types of links. For example, you may have an object, named battery-1, belonging to the class battery, with attributes such as voltage, current, and status.

The most recent value of an attribute for an object is stored in a *slot*. Production rules interact with the frames by inserting and retrieving values from their slots. In a real-time system, you often need to reason about the behavior of data over time. R\*Time, for example, extends the traditional class representation in the temporal dimension by allowing the slots to point to ring buffers (see figure 3), where the system keeps a series of values and their associated time tags.

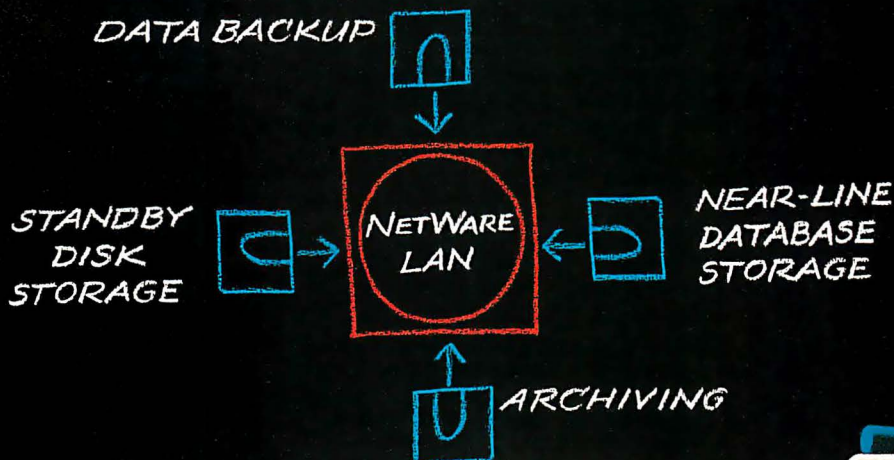
With data history available, you can create rules that can reason about past, present, and future events. Figure 4 demonstrates a rule that checks to see whether the voltage of a battery has stayed above 35 volts for at least 30 seconds. Although easily expressed in R\*Time's syntax, such a rule would be very difficult to express in a traditional expert-system framework.



**Figure 2:** Instead of being driven by goals or by data, a real-time system must be driven by time. This rule is applied every 10 seconds, regardless of the voltage or the status of the battery.

# The LANStor® Optical Solution.

## OPTICAL BACKUP STRATEGY



## Backup Your Network, Not Just Your Data.

For years, Novell® network "backup" had one dimension. It meant data backup. But now it has Storage Dimensions' LANStor Erasable Optical — and a dramatically enhanced definition.

Start with *data backup* that delivers reliability, performance and convenience tape can't touch. Random access provides instant file availability with no need to spool sequentially through tape files. And we include the top-rated ARCserve® backup software for unattended or attended, full or incremental backup.

The highest speed and capacity erasable optical on the market also delivers more backup power. It backs up your

network with *standby disk storage*, which means that should a hard disk go down, LANStor Erasable Optical can step in without missing a beat. And its *near-line database storage* capability means you get increased user productivity, allowing you to easily move cartridge-resident data on-line without increasing hard disk space. And since these cartridges have a 25-year data life, *data archiving* is secure, simple and done with unparalleled confidence.

Adopt a strategy that backs up your entire Novell network, not just your data. A strategy called LANStor Erasable Optical. Call (408) 879-0300. Storage Dimensions, 2145 Hamilton Avenue, San Jose, CA 95125.



STORAGE DIMENSIONS

© 1990 Storage Dimensions. LANStor is a registered trademark of Storage Dimensions

*Call me I'm interested: circle 302*

*Please send literature: circle 301*

**Focus of attention.** When a significant event occurs, it is important that a real-time expert system be able to focus its resources on important goals. For example, several methods for focusing attention on significant events include changing the set of sensors the system is currently monitoring; invoking a new set of rules that specializes in the current problem; changing the sampling rate or filtering scheme of the data being analyzed; and activating another inference engine to analyze the event. This ability to focus attention lets a system maintain a very large body of knowledge while applying only what is needed at any specific time.

**Continuous operation.** Many real-time systems need to operate in a continuous and reliable manner. Early expert-sys-

tem shells, often written in a symbolic language such as Lisp, have traditionally had to interrupt processing while a "stop and copy" was performed to free space that the system was no longer using. Even with ephemeral garbage collection, most systems still must stop and copy at some point. A real-time system can't take time out for garbage collection. One method is to free memory as soon as it is no longer in use, so memory allocation can be kept relatively constant.

**From Art to Discipline**

Real-time problem solving exaggerates many human limitations—tendencies to overlook relevant information, to respond inconsistently, to respond too slowly, or to panic when the rate of information flow is too great—just when the need to overcome these shortcomings is

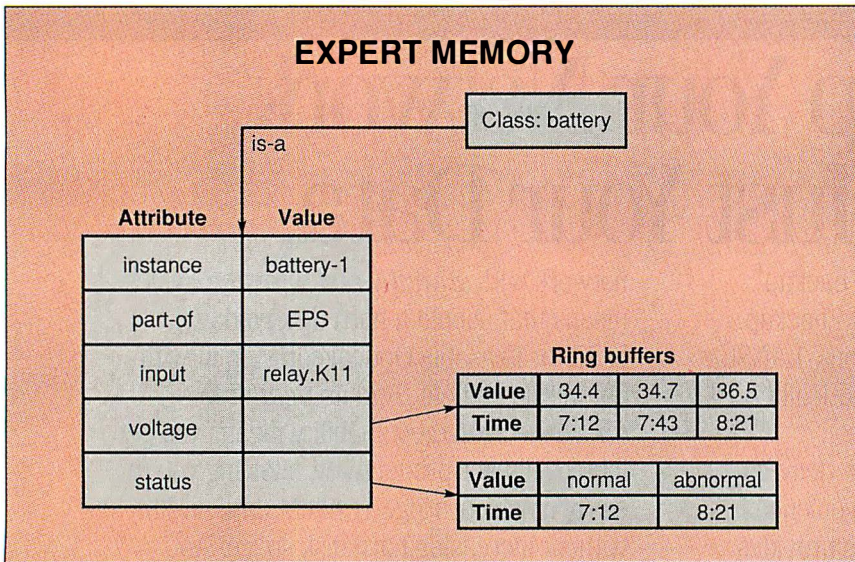
the greatest. This explains the considerable interest in intelligent real-time systems—interest that is bound to intensify as real-time systems become even more complex.

Applying knowledge-based methods to real-time systems can result in many significant benefits, including reduced staffing levels, reduced need for the continuous presence of highly skilled operators, reduced training costs, increased safety, higher quality, higher throughput, less downtime, and more consistent, higher-quality monitoring.

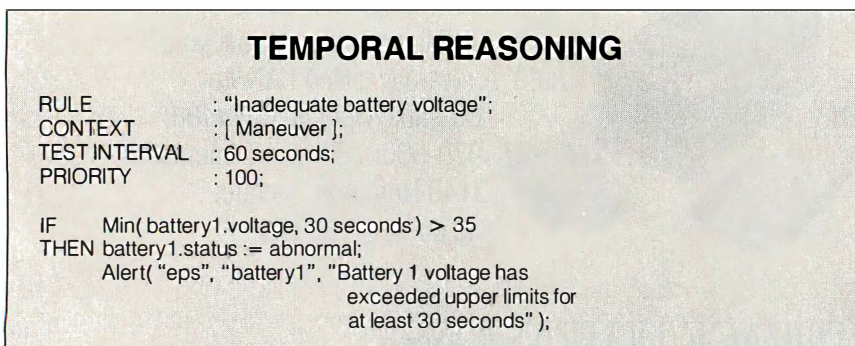
The aerospace industry was one of the first to adapt expert-system technology to real-time problems. Today, AI systems monitor such complex devices as the Hubble Space Telescope, NASA's space shuttle, the Magellan space probe, and several military satellites. In almost all situations, the expert system acts as an adviser to a human operator who has ultimate responsibility for monitoring and controlling the vehicle.

Real-time expert systems have also been installed as process controllers in manufacturing facilities. Today, expert systems are in operation at many paper, chemical, water-treatment, and other types of plants throughout the world.

As the application of knowledge-based systems evolves from an art to an engineering discipline, you can expect real-time expert systems to address ever more challenging applications. A knowledge-based system operating in a real-time situation must respond to a changing task environment with an asynchronous flow of events and dynamically changing requirements with limitations on time, hardware, and other resources. During the 1990s, you will see expert-system technology play a crucial role in the monitoring and control of a growing number of complex systems. ■



**Figure 3:** To function in a real-time environment, an expert system must be able to remember historical data. The figure shows how ring buffers let a frame-representation system remember information about battery voltage and status.



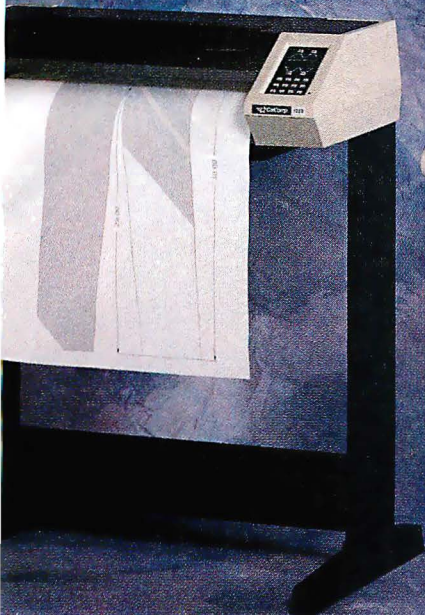
**Figure 4:** With the capacity to remember the past, a real-time expert system can then build rules that take advantage of this feature. This rule checks the recent voltage values to see if the battery is in an abnormal state.

REFERENCES

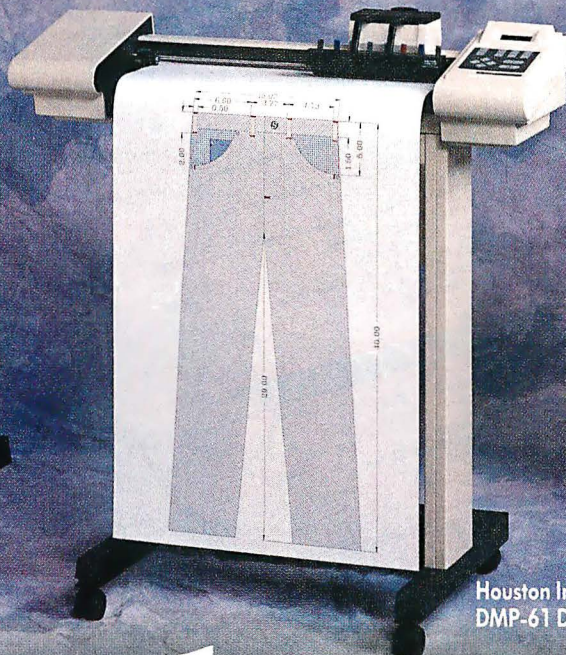
1. O'Reilly, C. A., and A. S. Cromarty. "Fast Is Not Real Time in Designing Effective Real-Time AI Systems." In *Applications of Artificial Intelligence II*, 548. Bellingham, WA: International Society of Optical Engineering, 1985.
2. Stankovic, J. A., and Ramamritham. *Hard Real-Time Systems: A Tutorial*. Washington, DC: Computer Society Press (IEEE), 1988.

*Thomas J. Laffey is president and CEO of Talarian Corp. (Mountain View, CA), where he leads a group applying AI and advanced software methods to complex real-time problems. You can reach him on BIX c/o "editors."*





CalComp® 1023



Houston Instrument  
DMP-61 DL

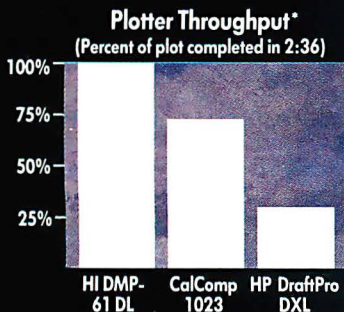


Hewlett Packard  
DraftPro® DXL

# Simply stated, we beat the pants off the competition.

O.K., let's settle this performance thing once and for all. **SPEED.** In a recent comparison of throughput for the three top selling plotters, the Houston Instrument DMP-61 DL came out on top. One-third faster than the CalComp 1023. Over three times faster than the HP DraftPro DXL. In other words, whatever you plot in one hour with us could take you all afternoon with them.

**QUALITY.** We also deliver unsurpassed quality with identical mechanical resolution to CalComp and HP,



**SCAN-CAD™ Option**

Turn your HI DMP Series plotter into a scanner with SCAN-CAD. This exclusive option attaches to your plotter to scan up to E-size drawings—all at a fraction of the cost of a stand-alone scanner.

and superior same pen repeatability.

**VERSATILITY.** Only the Houston Instrument plotters offer Quick Scale™ where any size drawing can be

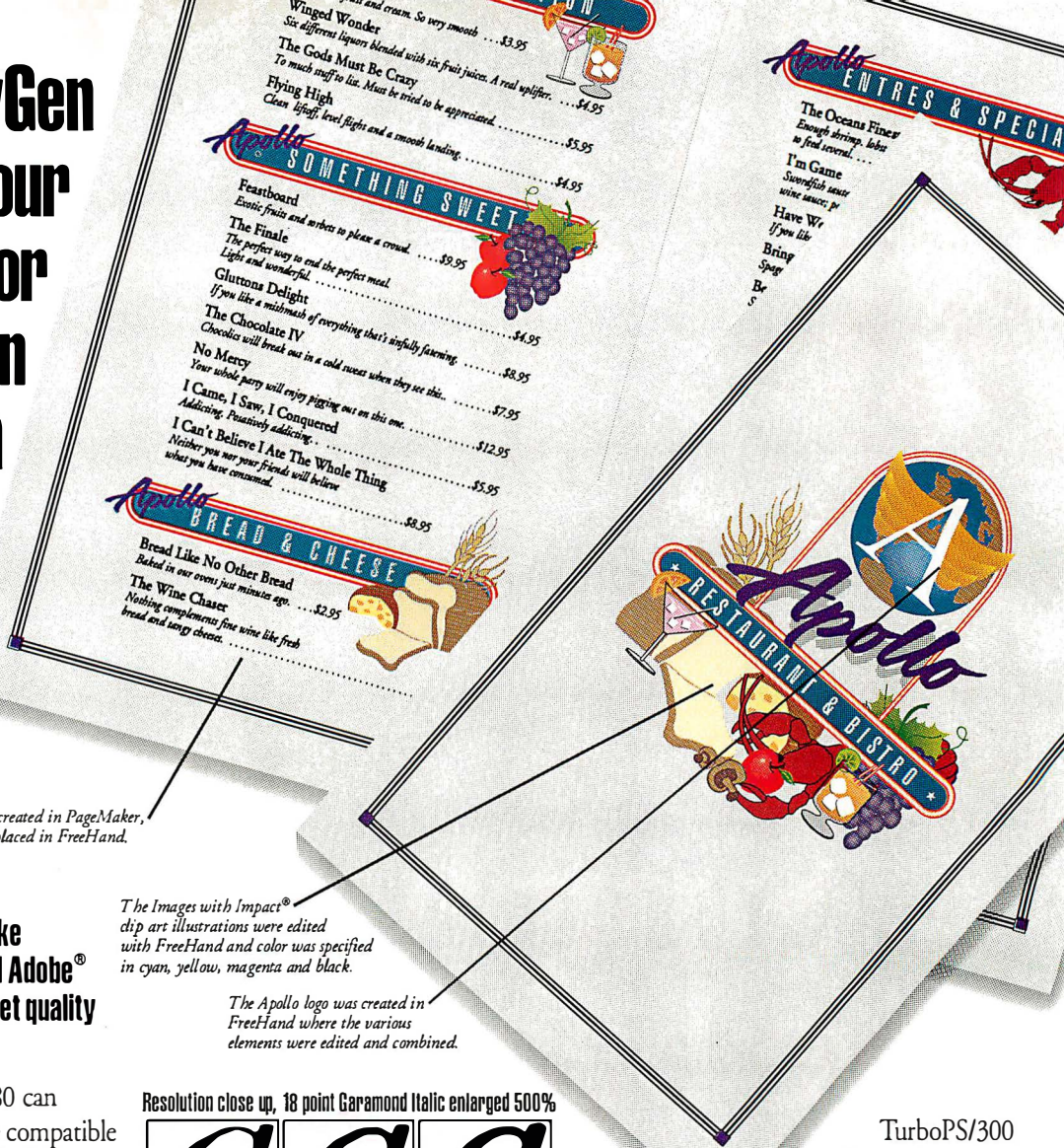
easily scaled and plotted at the current media size, plus the capability to save up to six different user configurations in memory—all standard.

**PRICE.** Best of all, the HI DMP-60 DL Series helps you beat the pants off your competition all at a very competitive price. For more information on the DMP-60 DL Series plotters call 1-800-444-3425.

**HOUSTON INSTRUMENT™**  
A Summagraphics Company

For IBM/Compatible information circle 136; For Macintosh information circle 137; For Reseller inquiries circle 138 on Reader Service Card.  
\* D-size Columbia plot using AutoCAD® Release 10 with the HP 7585 driver on a COMPAQ® 386 16 MHZ computer with math coprocessor. Plotters were set to manufacturer's recommended settings for pen and media combinations used for check plot and final plots. © 1990 Summagraphics Corporation, Seymour, CT 06483. All rights reserved.

Let NewGen satisfy your hunger for high-resolution with an affordable 800 dpi printer!



Text for the menu was created in PageMaker, saved as EPS files and placed in FreeHand.

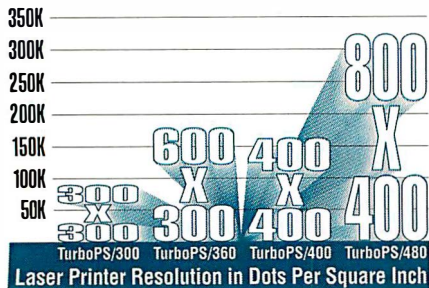
The Images with Impact® clip art illustrations were edited with FreeHand and color was specified in cyan, yellow, magenta and black.

The Apollo logo was created in FreeHand where the various elements were edited and combined.

Add powerful applications like PageMaker®, FreeHand® and Adobe® Type Fonts to produce typeset quality output at your own facility.

The NewGen TurboPS/480 can produce PostScript® language compatible output at 800 x 400 dpi, nearly four times the resolution of other laser printers. And when we say PostScript compatible, we mean it, including Type 1 fonts, special effects and EPS files from all your favorite applications and programs.

The NewGen TurboPS/480 is a complete printer with built-in AppleTalk®, parallel and serial ports. And unlike some printers, it works in mixed Mac-PC



Resolution close up, 18 point Garamond Italic enlarged 500%



300 x 300 dpi LaserWriter II    800 x 400 dpi NewGen PS/480    600 x 600 dpi Varityper VT-600

environments, and it doesn't require an internal PC processing board or dedicated server.

To show you how confident we are that you'll be impressed with 800 x 400 dpi output, we printed this page at actual size, including the menu which was output as color separations.

What does all this resolution and compatibility cost? Very little. The TurboPS/480 - with 800 x 400 dpi and RISC performance - lists for about 25% to 50% less than its competitors, while our TurboPS/400, TurboPS/360 and

TurboPS/300 laser printers cost less than slower 300 and 400 dpi PostScript language printers.

If you have an appetite for high-speed, high-resolution PostScript language printing, call 714/641-8900 today to get your TurboPS evaluation kit.

Dealer inquiries welcome.



This ad was created and separated on a TurboPS printer. For information about its production, contact NewGen Corporation.



**NewGen Systems Corporation™**

17580 Newhope Street, Fountain Valley, CA 92708  
Telephone (714) 641-8900 FAX (714) 641-2800

Circle 217 on Reader Service Card  
(RESELLERS: 218)

# AI in Practice

*Once it works, does it still qualify as AI?*

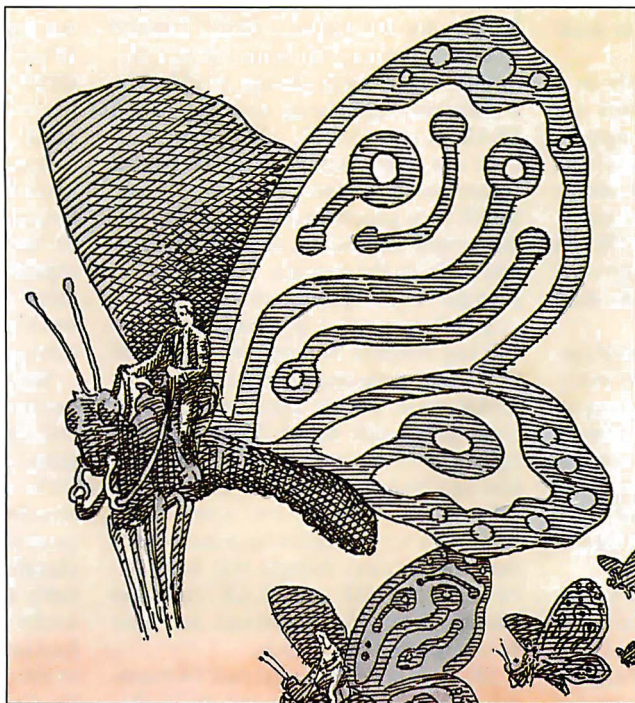
*Martin Heller*

**W**hen you think of artificial intelligence, the picture that usually comes to mind is of a hopelessly impractical academic research project that somehow survives from grant to grant, producing unreadable papers and fascinating but useless demonstrations. At some companies, however, the focus for AI has long been on practical applications.

The question is, does their practicality make the applications any less “artificially intelligent”? In other words, once it works, is it still AI? Or is AI simply a phrase used in the theoretical and planning stages of a problem that does not lend itself to traditional programming solutions? I’ll discuss these questions in the context of a real company’s real-world use of AI techniques and methods.

## Expert Systems

Expert systems have many virtues and some drawbacks. Since expert or knowledge-based systems are built using high-level, nonprocedural if-then rule structures, they are easier to understand, build, and change than conventional programming systems. But they are harder



to control, less modular, and slower than procedural systems.

In the past, the answer to the speed complaint has often been specialized hardware, such as rather expensive Lisp machines. This sort of thinking has limited the market for expert systems; now AI developers seem more willing to separate their development systems from their delivery systems.

A knowledge-based system that is developed using an expert-system shell might eventually be partially or completely translated to compiled Lisp. For even greater speed—and even less flexibility—the application might finally be translated to compiled C code.

People rarely think of C code as being AI. Lisp, sure. Expert systems, certainly. But C? C is for systems programmers, right? And programming isn’t related to AI, is it?

## System Configuration

DEC started building its first expert system back in 1978. XCON, developed in cooperation with Carnegie Mellon University and deployed in 1979, has been the system used to configure VAX and PDP-11 computers for production ever since. Over the last dozen years, XCON has undergone continual updates to handle new products and at least one major rewrite.

DEC has built this experience into an AI business that could easily stand on its own, employing about 500 people worldwide. The company currently has more than 50 mission-critical knowledge-processing systems in daily operation, sys-

tems that save it about \$200 million a year.

XCON was written in OPS5, a forward-chaining rule-based language that was developed at Carnegie Mellon; it was DEC's third try at a technical configuration system for VAX computers. The first two attempts (using conventional programming) were dismal failures. It was simply too difficult to manage the scale and complexity of all the combinations of thousands of different components in a procedural way. The OPS5 environment provided the developers with the capability to handle XCON's scale and complexity and with the flexibility inherent in the rule-based architecture.

Most expert systems start as prototypes, with fewer than 100 rules. Some grow then to more realistic systems, with up to 1000 rules. Relatively few become much bigger than that, because it's difficult to manage even expert systems when they become that complicated.

There is no magic about expert systems; they just operate at a higher level than most languages. It is important to know right at the start of building a little prototype that you will be able to scale your system up later.

OPS5 is implemented primarily as a pattern-matching engine. Variables are *named slots*, and every rule attempts to match its *if* pattern to all the objects in its world. The rule fires only if it sees a match. There is no hierarchy of class, and the named slots are not typed. When the rule does fire, it can change any variable in its world, according to its *then* clause.

Sometimes known as a *blackboard system*, this sort of framework lets every rule know about everything else going on in the system, but it is the very antithesis of modular programming, which emphasizes minimizing side effects by restricting the scope and accessibility of data. OPS5 has enormous flexibility, at the expense of modularity and speed.

In a volatile domain like XCON's (new products are introduced on a continuing basis), it makes sense to emphasize flexibility. There is little penalty for errors. The typical failure mode of an incorrect OPS5 rule is that it does nothing: It never matches anything, or it changes a variable that isn't used by any other rules. This is less demanding than in a language like C, where one uninitialized pointer can crash the system.

The OPS5 language provides a simple mechanism for focusing control on specific rule groups in a sort of procedure-call manner. A data element is labeled the *control element* by convention and

**T**here is  
no magic about expert  
systems; they just  
operate at a higher level  
than most languages.

may also be manipulated as data. However, this powerful, yet fairly low-level, feature alone does not guarantee good use of control. New OPS5 programmers can get carried away with their new tool and its control structures.

#### CASE? That's Not AI

Tom Cooper, Judy Bachant, Ken Gilbert, and their colleagues at DEC have developed a software-engineering methodology to help knowledge engineers become more disciplined in using OPS5 properly. This methodology is called RIME, for R1 Implicit Made Explicit (R1 being the original name for XCON).

The RIME methodology is aided by a software-engineering tool set called SEAR. Using SEAR, OPS5 programmers can select a template for the type of control structure they would like to use. SEAR then generates the OPS5 code for the control framework, and the programmer fills in the specific rules to go in each part of the framework.

SEAR includes a graphical problem-solving method definer with its own OPS5-like meta-language, a compiler for SEAR code, a rule checker for OPS5 code, and a rule editor. The methodology and tools help to decompose a problem into manageable pieces and to avoid side effects. Historically, some OPS5 rules were very complex because some of the programmers thought that was efficient; with RIME and SEAR, rules are "atomic," easy to understand, and have no unexpected side effects.

SEAR is not an optional tool for maintaining XCON: It is mandatory. Although knowledge engineers are free to write OPS5 code by hand, all new rules for XCON are passed through the rule checker when the knowledge engineers log onto the source code-control system; programmers whose rules fail to meet a SEAR standard receive E-mail warnings at their terminals.

But the difference between code written before RIME and after is obvious. Pre-RIME rules must often meet a dozen

or so conditions before they fire, and perhaps take half a dozen actions if they do fire. Post-RIME rules tend to have half a dozen or fewer conditions in their *if* clauses and only one action in their *then* clauses.

A typical problem-solving method implemented in SEAR is the *propose-apply* paradigm. *Propose* rules start a logical subprocess in which a number of possibilities are put forward; then, *eliminate* rules in the subprocess choose the preferred possibilities by removing less-desirable alternatives from consideration. When the subprocess reaches a goal (by elimination and iteration), control returns to the calling process with the goal defined. In this way, the programmer can control the order of evaluation of groups of rules; XCON has over 10,000 rules in some 300 groups.

RIME combines software engineering with expert systems. Does the use of software-engineering techniques mean that the resulting systems aren't AI? If a system works predictably, is it by definition no longer artificially intelligent?

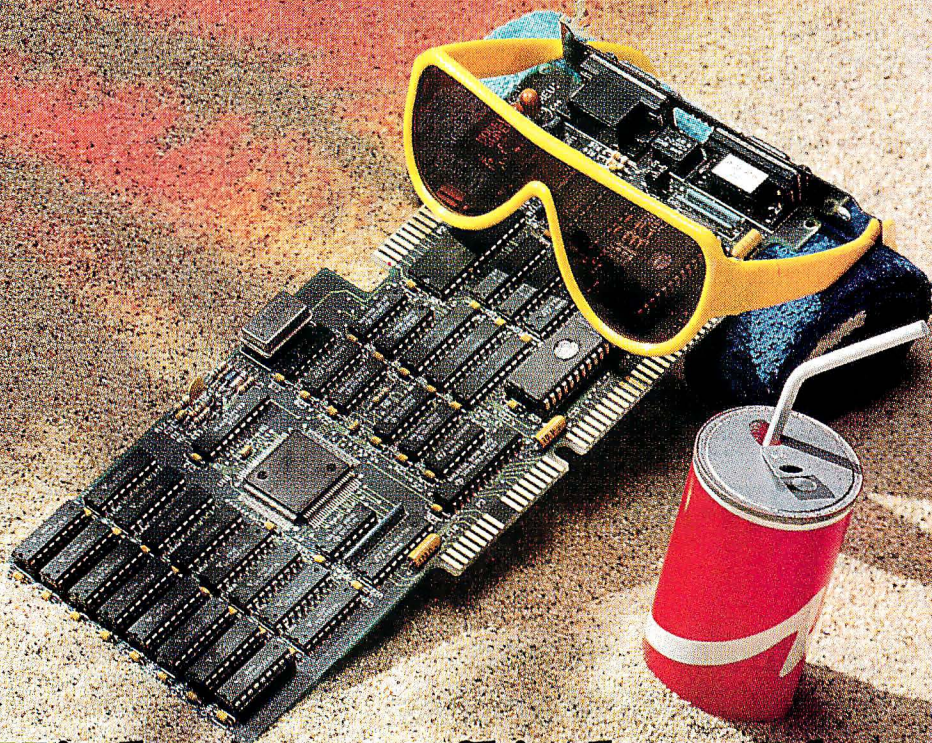
#### An Easy Solution

While RIME and SEAR are valuable for OPS5 programmers, they don't address the needs of people who want to build a small knowledge-based system only occasionally. These people are not likely to learn OPS5, or any other programming language, no matter how "English-like" or "high level" the language may be, and regardless of how good the tools are. For them, DEC's AI Research Group is now working on experimental tools and methodologies called Easy Programming.

Building on the premise that no programming language is likely to empower end users to build their own expert systems, and on the experience that many sorts of knowledge-based systems are structurally similar, Easy Programming generates knowledge-based processes by classification and description. You initially navigate a menu showing the hierarchy or tree of known applications, looking for a knowledge domain similar to your own. The system tries to quantize the "nearness" to help you recognize a similar domain.

Once you select a domain, Easy Programming draws on a template of highly parameterized meta-code for that domain and tries to extract as much information as possible from you to flesh out the application. Knowledge acquisition—so often the chore of a highly skilled knowledge engineer—becomes, at least in theory, the province of the Easy Programming system, the domain expert, an

# Give your eyes a break.



## With new flicker-free 1024 x 768 70-Hz SUPERVGA.

Our new VGA card has hi-res color made in the shade. Thanks to its refresh rate of 70Hz and higher, it helps reduce eyestrain. You get the brightest, sharpest, most stable images imaginable. So you aren't left starry-eyed.

You get up to 1024 x 768 resolution in 16 colors, both interlaced and non-interlaced, plus other 256-color modes. All made possible by our proprietary ASIC chip technology.

Genoa's SuperVGA card works with just about everything. With analog and multi-frequency monitors. With PS/2® and PC®/XT®/AT® computers. With most popular software packages. And with all standard operating systems.



To check our specs, call (408) 432-9090 today. Or write Genoa, 75 E. Trimble Road, San Jose, CA 95131, FAX (408) 434-0997, London 44-923-33737, Taiwan 886-02-776-3933.

Insist on  
Genoa Value.  
**GENOA**

ordinary programmer, and the end user.

Easy Programming allows top-down code reuse, in contrast to the bottom-up approach that object-oriented programming languages promote. It capitalizes on generic application areas like scheduling that remain essentially similar no matter what the domain. An appropriate application for Easy Programming would be, for example, a small business that wanted to automate its back-office applications. Easy Programming extends its

applicability with an open architecture: The programmer can drop down to a low level when needed, instead of running into a wall when the application is almost complete.

#### Routing Trucks—Yes, Trucks

Not all the expert systems at DEC are built with OPS5. For one thing, not all applications lend themselves to forward chaining, which is most often used for design problems where the answers can't

be enumerated ahead of time, but must be constructed by the application. Backward chaining is useful for diagnostic problems where the possible answers are known.

Hybrid methods sometimes work on problems that don't exactly fit the design or diagnosis class. Also, frame-based representation is critical in many applications. In cases like these, the company used Knowledge Craft, a product of the Carnegie Group, which allows forward-chaining rules, backward-chaining rules, object hierarchies, and Lisp code.

One such application is the National Dispatcher Router (NDR), which is a knowledge-based system that minimizes truck-transportation costs without reducing customer service. Since the company has a continuous-mileage agreement with several trucking companies, the per-mile cost of transporting goods decreases as the distance a truck travels on a single trip increases, as long as various constraints are met.

For example, trips are considered to end whenever a truck is idle for more than 24 hours, or returns to its point of origin and completely unloads. One driver can travel only 450 miles a day; a second driver can increase the daily mileage at additional cost—and those are just the simple constraints.

In 1985, Carnegie Mellon developed a prototype NDR system. While incomplete, the prototype demonstrated proof of concept, and the project was transferred to Janet Rothstein at DEC. A parallel effort to solve the problem with operations-research methods was not completed. One of the Carnegie Mellon researchers came to DEC for a month and worked directly with Rothstein.

One conclusion from the NDR project is that co-development or "apprenticeship" is a more effective approach to technology transfer than the usual drop-it-in-their-laps method. Later in the project, Rothstein and the Distribution IS Group used the same apprenticeship method to transfer NDR to the distribution group.

Rothstein originally wrote all the constraints and scheduling heuristics in NDR as rules, for flexibility. She tried depth-first and breadth-first searches, but eventually settled on a beam search for scheduling. The flexibility of rule-based programming proved useful.

All too often the experts had difficulty conveying all their knowledge at one sitting. Rothstein had the experience so common to knowledge engineers: The experts would say one thing, sign off on a specification based on what they said,



## *The software solution for network CD-ROM access*

OPTI-NET is the unique software-only solution for shared CD-ROM access for NetBIOS® and Novell®'s IPX®/SPX® based systems.

And, the new OPTI-NET VAP version allows LAN-wide access to CD-ROM drives installed directly on a Novell Advanced NetWare® file server or external bridge.

In addition, Online offers complete packaged solutions for CD-ROM networking. We're the exclusive distributor of the Grolier Electronic Encyclopedia™ network version, now with VGA images!

***"On the performance  
side, OPTI-NET flies.  
It's fast, and ...  
it operates transparently."***

M. Keith Thompson, PC Magazine  
February 27, 1990

Call Kim Mote or Cheryl McGarry at (800) 922-9204. In Maryland call (301) 428-3700. OEM, VAR, and distributor inquiries are invited.

**11 WEEK**

January 8, 1990

## **Highest Rating!**

**ONLINE Products Corporation**

*Sharing Information Through Technology™*  
*A Reed International Electronic Publishing Company*

20251 Century Boulevard Germantown, Maryland 20874 (301) 428-3700 (800) 922-9204 FAX: (301) 428-2903  
Brand names and product names are trademarks or registered trademarks of their respective companies.

# "SPEED TO BURN"

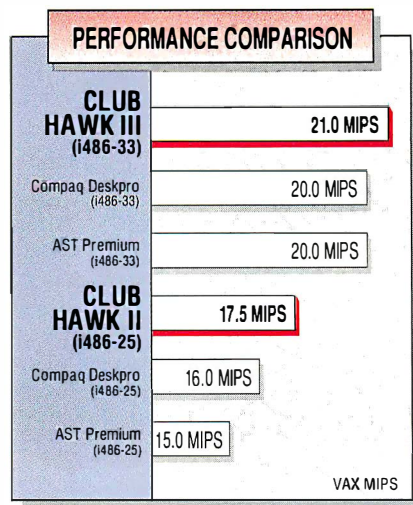
## CLUB HAWK 486 SERIES



The time of DOS mainframe has arrived! Running at a blazing speed of 21 VAX MIPS, CLUB's award winning HAWK family, based on Intel's i486 CPU, achieve the mainframe horse-power that out-performs any RISC or SPARC based systems in their class.

With such extraordinary value, price/performance, and compatibility, the HAWK line of systems break through new benchmark barriers in UNIX/XENIX, DOS, and Novell environments. Combine this with our family of 386 based computers and peripherals, you receive the widest selection of systems from a single major world class manufacturer.

It's no wonder that hundreds of thousands of these systems have



been installed in corporations world wide. That's why CLUB's systems are called the Ultimate Business Computers. Put yourself on the fast track and call today for more information.

*"CLUB AT prides itself on being an authorized Novell reseller, making the tower model a good choice for LAN server applications. ... [ CLUB ] combines field-leading performance, solid construction, and knowledgeable technical support at an exceptionally low price." PC Magazine, February, 1990*

*"When it comes to the basics - price, performance, and ... capacity - [ CLUB ] delivers outrageous value."*

*PC World, Best Buy Award 1989*

**For more information call:**  
Continental USA, Hawaii, and Alaska:  
**(415) 683-6600**  
Fax: (415) 490-2687  
CLUB Canada, Toronto: (416) 609-8121  
International Sales: (415) 683-6623  
Call for Corporate and Educational Discounts  
GSA # G500K90AGS5260

# CLUB

**American Technologies, Inc.**

The Ultimate Business Computers

Ad# v.1/4-90  
The above mentioned brands and names are trademarks of their respective companies.

Circle 58 on Reader Service Card

and then look at the resulting system and say, "That's not right. We forgot to tell you about one more thing." While the knowledge was still formulated as rules, it was easy to change. Code would have

been much more cumbersome.

On the other hand, once the scheduling mechanism was stable, Rothstein recorded the heuristics as Lisp functions, for speed. The whole development cycle

took two years; NDR is currently in place and saving the company 10 percent of its continuous-mileage shipping costs, or about \$1 million per year, after paying back its development costs in the first year of its use.

Unlike XCON, NDR has a fairly stable domain and needs little ongoing development. It works, and it saves the company money. Is it still AI? Does the translation of rules into code in any way change its intelligence?

### Shortening the Circuit

The Electronic Computer-Aided Process Planning (ECAPP) system solves a different kind of routing problem. It helps DEC to plan the manufacturing process for assembling electronic components onto printed circuit boards.

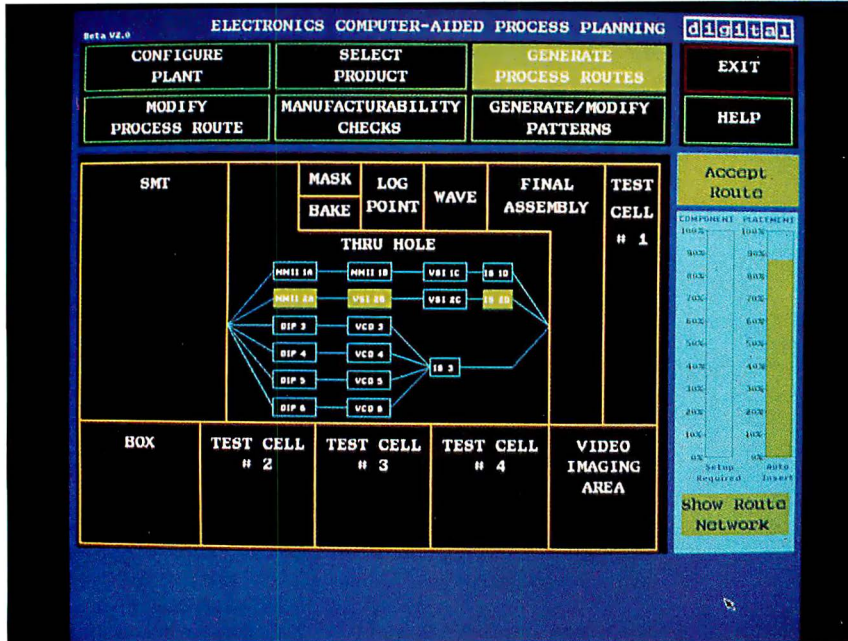
ECAPP uses the CAD information for a printed circuit board, along with its knowledge base, to generate all the feasible process routes for a product through a factory and to recommend the "best" route (see photo 1). Then it goes on to generate the numerical control code (insertion patterns) for the assembly equipment. Along the way, ECAPP checks the module for manufacturability and simulates the assembly process (see photo 2).

Like NDR, ECAPP was built with the Knowledge Craft expert-system shell, using both rules (for flexibility) and Lisp (for speed). It is currently in regular use at two assembly plants.

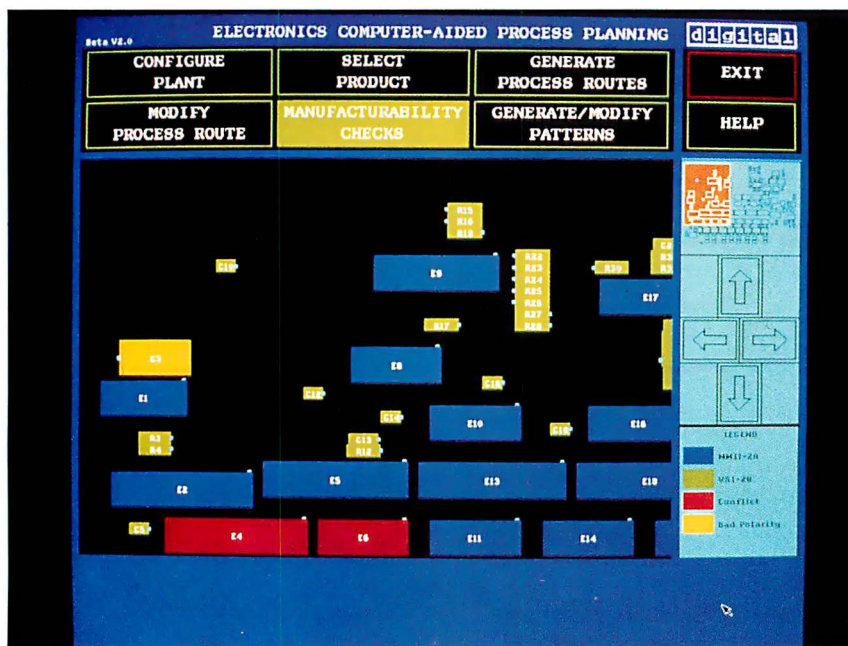
Overall, ECAPP has reduced the time it takes to introduce a new product into production from a few days to a few hours and has ensured consistent, high-quality process plans and correct insertion patterns. ECAPP led to a \$500,000-to-\$800,000-per-year cost reduction at one plant.

What makes the process planning in ECAPP different from other generative process planners for electronics assembly? All the knowledge in ECAPP is represented declaratively in the knowledge base, including process-planning and manufacturability rules. For example, if a new machine is added to a factory, all that is required for ECAPP to run correctly is that the machine and its characteristics be described in the factory's machine knowledge base. No programming needs to be changed.

The difference between ECAPP's rule-based approach to generative process planning and a brute-force approach is that the rules limit the search space for alternative routes. The process-planning rules in ECAPP consider only components, process operations, and assembly machines that are feasible alternatives



**Photo 1:** All the feasible process routes for a printed circuit board shown on a layout of the factory floor. The recommended route highlights the selected machines. Note in the "thermometers" on the right that the recommended route has an 85 percent automatic assembly with no setup required. (Photo courtesy of DEC)

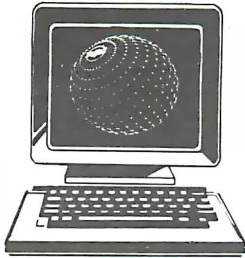


**Photo 2:** A graphical display of the printed circuit board with its components color-coded according to the machine that will be used to assemble them. Components that exceed manufacturing constraints are highlighted: spacing-rule violations are shown in red; polarity-rule violations are shown in yellow. (Photo courtesy of DEC)



# 3 books for only \$2.95

plus a 4th book of your choice FREE!



**YES!** Please accept my membership in the *Computer Professionals' Book Society* and send the 3 volumes listed below, plus my **FREE BOOK\*** billing me only \$2.95. If not satisfied, I may return the books within 10 days without obligation and have my membership cancelled. I agree to purchase 3 or more books at regular Society prices

during the next 2 years, and may resign at any time thereafter. A shipping/handling charge and sales tax will be added to all orders.  
\*Not valid for books counting as 2 selections.

			<b>FREE BOOK*</b>
--	--	--	-------------------

Name \_\_\_\_\_

Name of Firm \_\_\_\_\_  
(If you want Society Bulletins sent to your office)

Address \_\_\_\_\_

City \_\_\_\_\_ State \_\_\_\_\_ Zip \_\_\_\_\_

Valid for new members only. Foreign applicants will receive special ordering instructions. Canada must remit in U.S. currency. This order subject to acceptance by the *Computer Professionals' Book Society*.

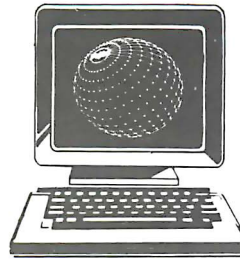
**BYP191B**



**Computer  
Professionals'  
Book Society**

# 3 books for only \$2.95

plus a 4th book of your choice FREE!



**YES!** Please accept my membership in the *Computer Professionals' Book Society* and send the 3 volumes listed below, plus my **FREE BOOK\*** billing me only \$2.95. If not satisfied, I may return the books within 10 days without obligation and have my membership cancelled. I agree to purchase 3 or more books at regular Society prices

during the next 2 years, and may resign at any time thereafter. A shipping/handling charge and sales tax will be added to all orders.  
\*Not valid for books counting as 2 selections.

			<b>FREE BOOK*</b>
--	--	--	-------------------

Name \_\_\_\_\_

Name of Firm \_\_\_\_\_  
(If you want Society Bulletins sent to your office)

Address \_\_\_\_\_

City \_\_\_\_\_ State \_\_\_\_\_ Zip \_\_\_\_\_

Valid for new members only. Foreign applicants will receive special ordering instructions. Canada must remit in U.S. currency. This order subject to acceptance by the *Computer Professionals' Book Society*.

**BYP191A**



**Computer  
Professionals'  
Book Society**

Money  
Saving Offer!

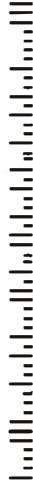
**BUSINESS REPLY MAIL**

FIRST CLASS PERMIT NO. 9 BLUE RIDGE SUMMIT, PA 17214

POSTAGE WILL BE PAID BY ADDRESSEE

***Computer Professionals'***  
***Book Society***

**Blue Ridge Summit, PA 17214-9988**



Money  
Saving Offer!

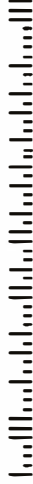
**BUSINESS REPLY MAIL**

FIRST CLASS PERMIT NO. 9 BLUE RIDGE SUMMIT, PA 17214

POSTAGE WILL BE PAID BY ADDRESSEE

***Computer Professionals'***  
***Book Society***

**Blue Ridge Summit, PA 17214-9988**



NO POSTAGE  
NECESSARY  
IF MAILED  
IN THE  
UNITED STATES



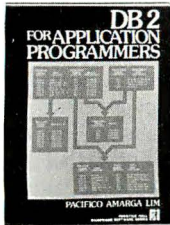
NO POSTAGE  
NECESSARY  
IF MAILED  
IN THE  
UNITED STATES



# THE COMPUTER PROFESSIONALS' BOOK SOCIETY

## 3 books for only \$2<sup>95</sup> plus a 4<sup>th</sup> book of your choice FREE!

Values to  
\$119.80



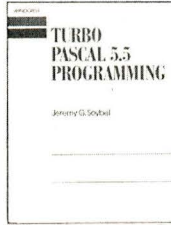
9263 \$40.00  
Counts as 2



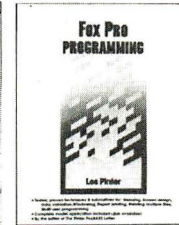
3424 \$39.95  
Counts as 2



9309P \$28.95  
Counts as 2



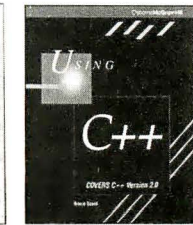
3527P \$19.95



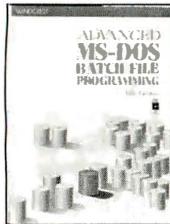
3525P \$24.95



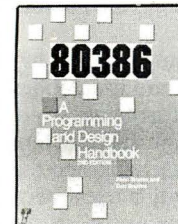
3399 \$32.95  
Counts as 2



15034P \$24.95



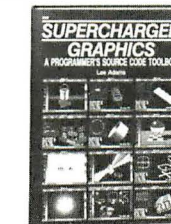
3197 \$34.95  
Counts as 2



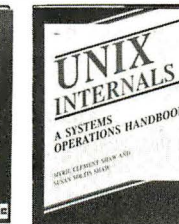
3237P \$24.95



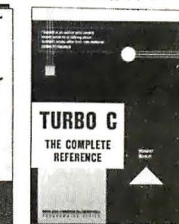
3221 \$29.95



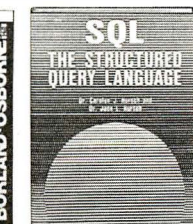
2959 \$29.95



2951P \$18.95



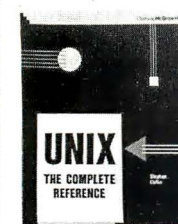
15004P \$24.95



3016P \$17.95



3290 \$39.95  
Counts as 2



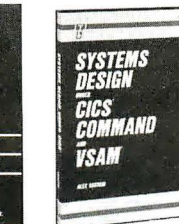
9258P \$26.95



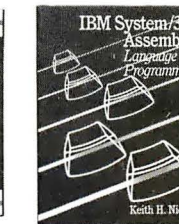
10015 \$42.95  
Counts as 2



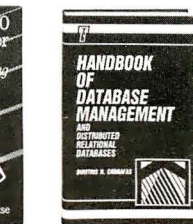
3508 \$32.95



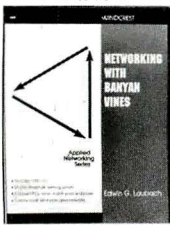
2843 \$28.95



3380 \$36.95  
Counts as 2



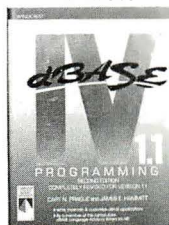
3253 \$49.95  
Counts as 2



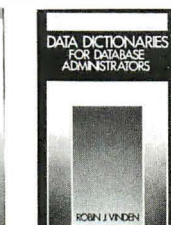
3405P \$21.95



3376 \$21.95



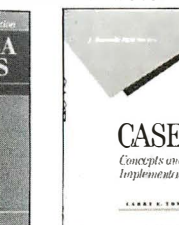
3569P \$28.95  
Counts as 2



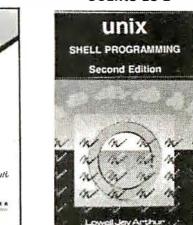
3515 \$29.95



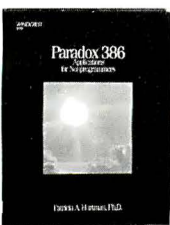
9334P \$24.95



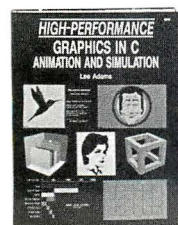
10011 \$44.95  
Counts as 2



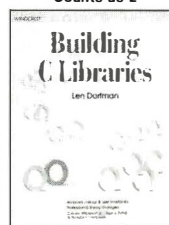
9349P \$26.95



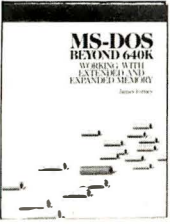
3178P \$22.95



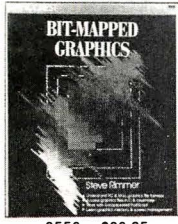
3049 \$37.95  
Counts as 2



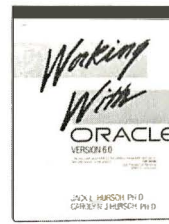
3418P \$24.95



3239 \$29.95



3558 \$38.95  
Counts as 2



3246P \$21.95

## How the Club Works

**YOUR BENEFITS:** You get 4 books for \$2.95 when you join. You keep on saving with discounts of up to 50% off as a member.

**YOUR PROFESSIONAL BOOKSTORE BY MAIL:** Every 3-4 weeks, you will receive the Computer Professionals' Book Society News describing the Main Selection and Alternates, as well as bonus offers and special sales, with scores of titles to choose from.

**AUTOMATIC ORDER:** If you want the Main Selection, do nothing and it will be sent to you automatically. If you prefer another selection, or no selection at all, simply indicate your choice on the reply form provided. You will have at least 10 days to decide. As a member, you agree to purchase at least 3 books within the next 2 years and may resign at any time thereafter.

**BONUS BOOKS:** Starting immediately, you will be eligible for our *Bonus Book Plan*, with savings of up to 80% off publishers' prices.

**IRONCLAD NO-RISK GUARANTEE:** If not satisfied with your books, return them within 10 days without obligation!

**EXCEPTIONAL QUALITY:** All books are quality publishers' editions especially selected by our Editorial Board.

BYP191

for assembling a product.

When you run ECAPP, you do not really know that you are running an expert system. You are running a program that helps you manufacture better and faster. Does the fact that it uses rules and Lisp make it AI? Does the fact that it works predictably and acts as if it were programmed prevent it from being AI?

### It's Not Just for DEC Anymore

Configuring computer systems with XCON is quite specific to DEC's product line, although the idea of doing configurations with a forward-chaining system is transferable to other enterprises. Process planning for electronic-circuit-board assembly could be applied by other printed-circuit-board manufacturers. Truck routing could be applied in some measure by any firm with a continuous-mileage program; certainly, the knowledge that a beam search works best for the routing problem is useful and transferable.

Another knowledge-based process, however, could be applied to any business: enterprise-wide modeling of business systems. Ty Chaney and his colleagues at DEC have developed a discrete

modeling methodology and software tools built on top of Knowledge Craft that address the practical processes of doing business and aid in designing major business systems.

Business systems (both the software and the procedures to go with it) can take several years to develop and often require a corporation to change its routine ways of doing business. While competent people may do their own jobs efficiently, they don't always know how their methods interact with other people in other departments.

To optimize a business system in a global sense requires the combined input of people from many departments, people with different views of the company and the process, people who may in the normal course of business never interact directly. A key element of the symbolic modeling method is to bring together representatives of the business functions involved and to generate for each one of them a diagram of the system that conforms to that person's viewpoint.

In a conventional discrete-system modeler, such as SLAM II (from Pritsker and Associates of West Lafayette, IN),

simulations can run at any level of detail that suits the analyst; there will always be some output from the simulation. The problem is that it's too easy to make assumptions that invalidate the model.

For instance, an analyst may assume in modeling a purchasing system that the buyers always understand what they are ordering or that the vendors always provide their current product specifications and price lists. Anyone who has ever written a purchase order knows that these assumptions don't always hold true. In fact, fulfilling a purchase order can be a complicated process, particularly if all the items are not found at one fulfillment site.

The symbolic modeling (SYMMOD) software has deliberately been designed *not* to generate any output unless the simulation has accounted for the actual transactions necessary to complete the activity's event network, supporting the business process being modeled.

SYMMOD uses frames to hold information—reflecting the processes modeled in enough detail to be realistic—and explicit messages between processes. SYMMOD objects have access only to

## Complete VGA Color Systems

Start At

**\$2,195**

Call NOW!

TOLL FREE!

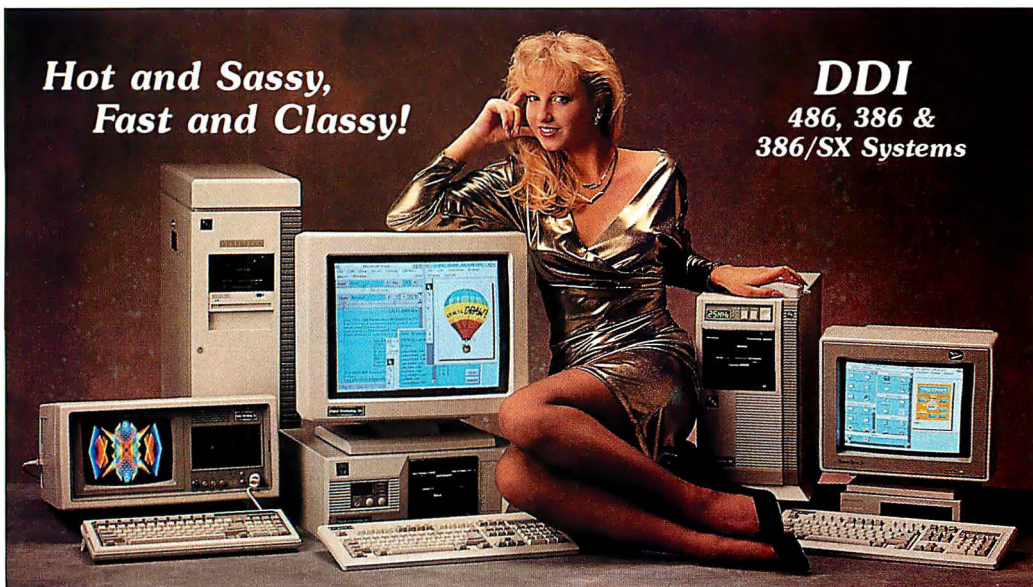
1-800-331-1090

or 213-371-7568

FAX 213-214-5483

### FULL Support!

- 30-day Money-back Guarantee
- One-year Warranty Parts & Labor
- 24-hour Parts Replacement
- Toll-free Technical Support



### Full Line of DDI Systems:

- 486™/33 & 25 MHz EISA Systems from \$4,795
- 486™/33 & 25 MHz ISA Systems from \$3,995
- 386™/33 & 25 MHz ISA Systems from \$2,995
- 386SX/20 & 16 MHz ISA Systems from \$1,995

### Case Options

- Desktop
- Mini Tower
- Super Tower
- Portable

### Also Available:

#### SCSI Hard Disks (Formatted):

45 MB, 28ms	183 MB, 18ms
65 MB, 28ms	338 MB, 16ms
85 MB, 28ms	440 MB, 16ms
110 MB, 18ms	678 MB, 16ms
137 MB, 15ms	1050 MB, 15ms
172 MB, 15ms	

#### VGA Monitors:

Size	Type	Resolution	Dot Pitch
14"	Mono	1024 x 768	N/A
14"	Color	1024 x 768	.28mm
16"	Color	1024 x 768	.28mm
20"	Color	1024 x 768	.31mm
20"	Color	1280 x 1024	.31mm

## Digital Distributing, Inc.

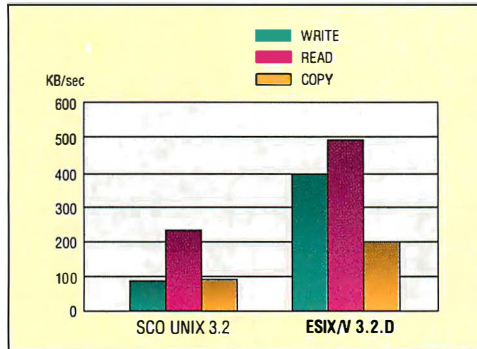
486 and 386 are trademarks of Intel Corporation. MS-DOS & XENIX are registered trademarks of Microsoft Corp. OS/2 is a registered trademark of IBM. UNIX is a registered trademark of AT&T.

### All DDI Systems Run: MS-DOS®, OS/2®, UNIX®, XENIX®

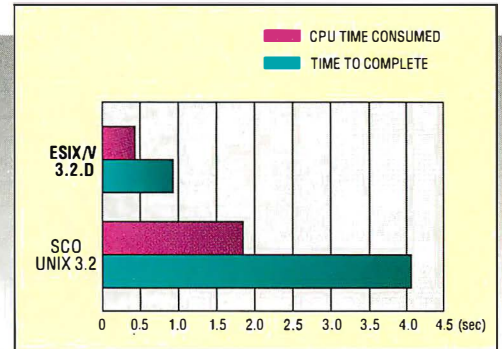
All Systems DELIVERED with MS-DOS  
Installed, Configured and READY TO RUN!

# When Selecting Your UNIX Operating System, Consider These Facts:

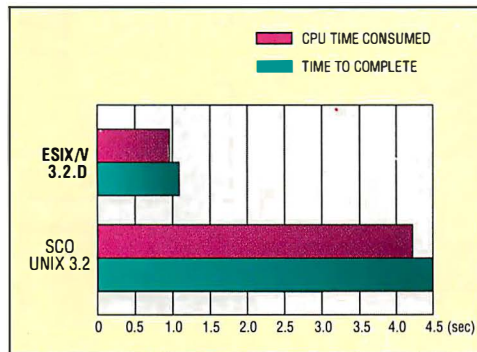
## Performance\*



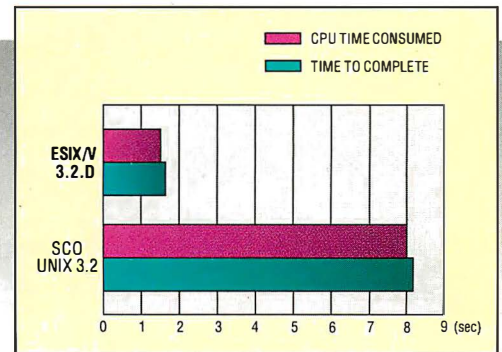
5000 BLOCKS TEST



PIPE-BASED CONTEXT SWITCHING



EXECL THROUGHPUT TEST



SYSTEM CALL OVERHEAD TEST

## Features



- R.3.2 operating system
- Unlimited user license
- Development system
- TCP/IP runtime & development system
- LAN, WAN support
- STREAMS
- X-Window client & server programs
- 100% SVVS & SVID conformance
- Free hotline technical support service



- R.3.2 operating system
- Unlimited user license
- Development system
- TCP/IP runtime & development system
- SCO X-Sight

## Price

**\$825**

**\$3575**

At ESIX, we don't rely on marketing hypes, we deliver good, solid, working products. Whether you are a value-added reseller, a system integrator, a software developer or an end-user, you will appreciate what ESIX System V has to offer -- a cost-effective, robust UNIX operating system from which you can develop your multi-user, multi-tasking computing environment. All ESIX products are available and shipping today. For more information about ESIX System V, or for the dealer nearest to you, call us at (415) 683-2068

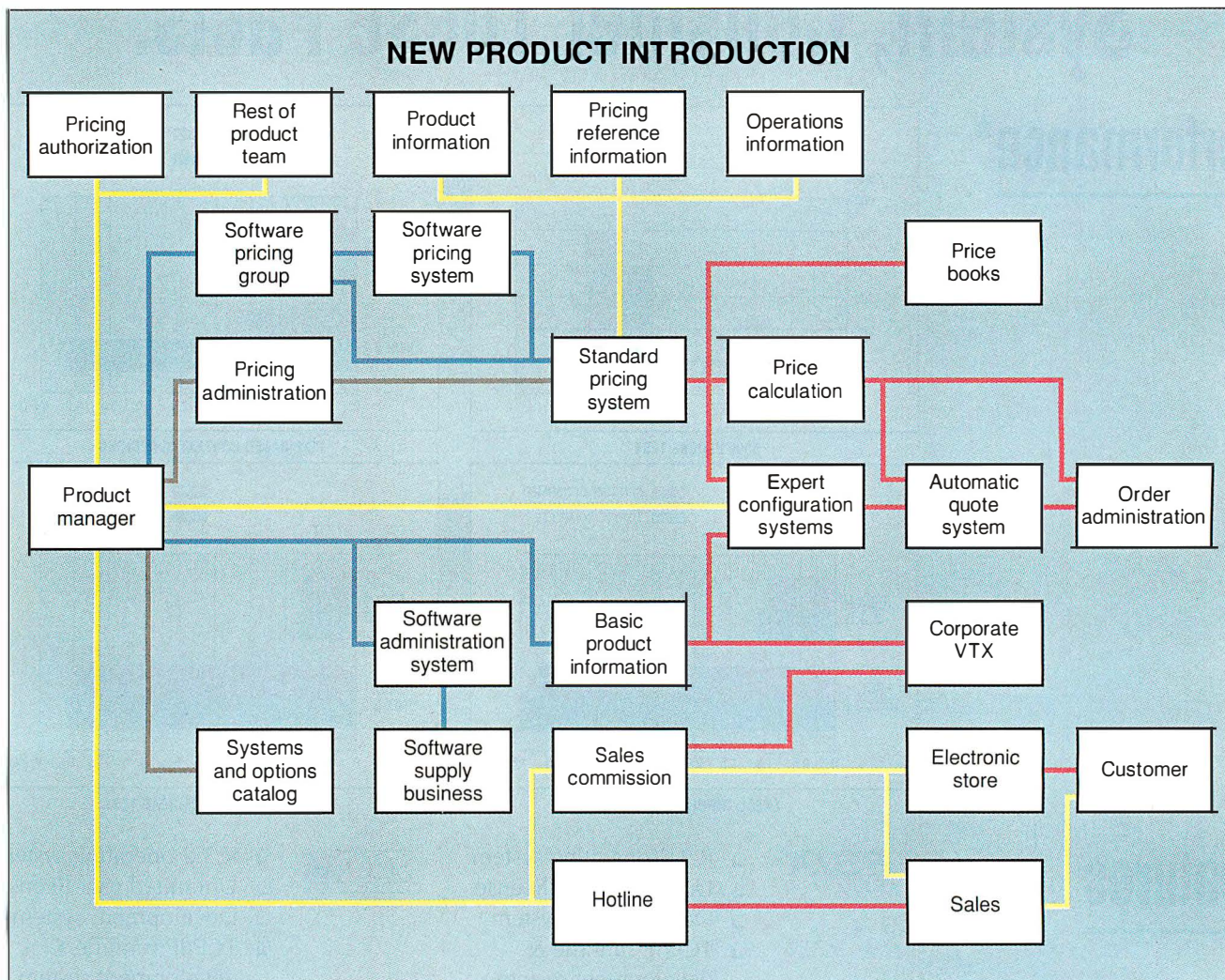


See us at UniForum  
Dallas Infomart  
January 22-24, 1991  
Booth 3253

48431 Milmont Dr.  
Fremont, CA 94538  
Fax: (415) 651-0728  
U.S.A



Prices based on UNIX System V Release 3.2, unlimited user license and compatible product offering. All other company names and products are trademarks or registered trademarks of their respective companies. ESIX Computer, Inc. is a subsidiary of Everex Systems, Inc. ESIX System V is a trademark of ESIX Computer, Inc. Above information subject to change without notice. © Copyright 1990 ESIX Computer, Inc. All rights reserved. Ad3 8/90 v.1  
\*Based on MUSBUS Benchmark Suite on STEP 386/25, 16MB memory, Default kernel configuration, standard C Compiler, NBUF=600, NHBUF=128



*Incorporating a new product into an existing system. This diagram emphasizes how complicated it is to disseminate (or obtain) information in a large company.*

their own status and to messages from other objects; they have no global knowledge at all, which reflects the real world rather well. Do you know the status of a project going on down the hall without hearing a report or receiving a memo?

### Closing the Loop

In the course of building a model of how new-product introductions work, the group modeled the process of incorporating a new product into XCON (see the figure). The model highlights the complexity involved in extracting information within a large company.

The knowledge engineer first has to find out that there is a new product in the works. In some companies, this box might be filled in by "and then a miracle happened"; in others, notification would be part of a standard product-introduction procedure.

Once new-product notification has occurred, the developer must find out the product's specifications by obtaining the information from the product managers, design engineers, and manufacturing engineers. Sometimes there is an initial lack of information or a conflict in the information received from these sources. If conflicts arise, the knowledge engineer works to reconcile the difference.

Most computer models would ignore those instances in which the information is not provided or is incorrect; they would probably be fine 80 percent to 90 percent of the time. But the added realism of symbolic modeling empowers the analyst to deal with the unusual problem cases that eat up so much valuable time. (Pareto's principle tells us that 20 percent of the fields produce 80 percent of the crops; its flip side is that 20 percent of the wagons need 80 percent of the

maintenance.)

The product specifications go into a review process, which gives the people who were unable to provide the information in the first place a chance to make corrections. Eventually, perhaps after several iterations, the information will be judged correct by all the people who know anything about it, and the approved specifications will be coded as rules. More feedback loops follow as the rules themselves are checked and corrected. Eventually, the new product is incorporated into the configuration process, and another new product comes down the line.

While this may appear a little bit chaotic, it is not atypical of business procedures that "just grew." The methods do work, though. The review process and feedback loops ensure that the result is correct. At companies where the review

# DR DOS 5.0. WE COULDN'T HAVE SAID IT BETTER.



**IBM Launches New Consulting Program**  
Specialists Will Analyze Clients' Businesses with Eye Toward Modernizing Host-Based Applications.  
See Page 145.

## DRI To Upstage Giants With Own DOS 5.0

By Gina Smith

Users hungry for the memory relief promised by DOS 5.0 will be able to buy the system software next month—but not from IBM or Microsoft Corp.

Digital Research Inc. (DRI) is poised to release DR-DOS 5.0, the latest version of its DOS-compatible operating system. Early users and company officials say it offers many of the key features planned for Microsoft's unannounced DOS 5.0.

DR-DOS 5.0 is the first commercial version of the previously OEM product. Its most noteworthy feature is a memory-management capability that allows users to free as much as 620K bytes of memory for application use, said Dick Williams, president of DRI in Monterey, Calif.

Although Microsoft officials have said that a new DOS version with similar features will be shipped by year's end, sources say that version is in the very early stages of development.

"Microsoft is only promising this, and DRI will be shipping soon. If [DR-DOS] can prove it's really compatible, and if it looks good, I'd have no problem recommending it," said Bob Hollingsworth, a computing consultant for an automobile maker in Detroit.

"I don't care whose name is on the package if it can help us with our memory problem," said Darrin McCarthy, end-user computing analyst with Porsche Cars North America Inc. in Reno, Nev.

Beta testers report that DR-DOS 5.0 includes a number of features not found in current MS-DOS and PC-DOS versions. Among them are a graphical,

See DRI Page 6

### ASK DVORAK



### A major advance in DR-DOS

graphical user interface designed to be used equally well with a keyboard or a mouse. ViewMAX allows for easy execution of DOS commands and "point and shoot" execution of any application software, eliminating the need for users to learn and correctly execute cryptic DOS commands. The user's disk layout can be viewed as icons, text or in a graphical tree format.

Users who need to transfer data from one machine to the other can do so easily with FileLINK, a file transfer utility included in DR-DOS 5.0. FileLINK provides easy, high-speed transfer of files and programs between systems over standard serial cables. The utility installs itself from one machine to the other via the serial link, so DR-DOS 5.0-based systems can communicate with machines running less functional DOS operating systems.

**Key NewWave Office Elements Due This Month**  
from Steve Higgins

**FIRST LOOK**  
Turbo C++ Delivers Power To Programmers  
By Peter Coffee

So what's all the hoopla about? MemoryMAX... for one thing. A breakthrough in memory management that can give you more than 620K so you can run today's memory-intensive applications, including, for example, dBASE IV, on Novell NetWare.

In fact, John Dvorak calls MemoryMAX nothing short of "amazing."

The Press goes on to mention that because DR DOS 5.0 is fully DOS compatible, you can run all your current DOS applications. And because it is easy to install and requires no hard disk reformat-

ting, upgrading to DR DOS is simple. Since DR DOS 5.0 also includes ViewMAX..., a graphical interface, DOS is easier than ever to use.

Now if we could just get a word in edgewise, we would simply like to add that DR DOS 5.0 is available now. Call your local dealer today.

## DR DOS 5.0

**Digital Research**®  
WE MAKE COMPUTERS WORK  
(408) 647-6675

For Laptop and Notebook manufacturers, DR DOS 5.0 is fully executable from either RAM or ROM. And, it's available with BatteryMAX..., a battery-saving feature that can increase battery life 2-3 times (dependent upon OEM implementation).

Digital Research is a registered trademark, and the Digital Research logo, DR DOS, MemoryMAX, ViewMAX, and BatteryMAX are trademarks of Digital Research Inc. Copyright © 1990, Digital Research Inc.  
Reprinted from PC Week May 14, 1990. Copyright © 1990 Ziff Communications Company.  
Reprinted with permission from The San Francisco Examiner. Copyright © 1990 The San Francisco Examiner.

process is absent, more mistakes occur. Mistakes are not self-correcting, so you don't necessarily want to eliminate all the loops, the checks and balances in the design.

One of the major benefits of symbolic modeling is that it exposes inefficient processes to scrutiny and allows them to be replaced by streamlined processes, with just enough feedback in the system to keep it self-correcting.

SYMMOD combines the techniques of business analysis and discrete modeling with knowledge-based methods. Designing a symbolic model is like any other systems analysis: You draw boxes and arrows a lot and worry about inputs and outputs at each box. Writing a SYMMOD program is much like writing Lisp code. Running a SYMMOD program is like running any other discrete-system simulator. Does that make it any less artificially intelligent?

Currently, SYMMOD is used internally at DEC; it will shortly be used to model enterprise-wide processes for other companies. Such models can have high-leverage effects and lead to global streamlining of major aspects of a busi-

## Symbolic modeling exposes inefficient processes to scrutiny.

ness operation. This is a far cry from stand-alone laboratory AI systems, but the "strange loop" that uses one knowledge-based process to model another would fit right in at any AI lab in the world.

### But Is It AI?

The question "Is it AI?" highlights a misconception. You can write ordinary programs in Lisp, supposedly an AI language. And you can write AI in C, a procedural language. Rule-based systems give you a lot of flexibility, while more traditional programming systems give you better speed. It's really a continuous spectrum. In the course of development,

a project can shift back and forth across that spectrum. What's important is incorporating feedback from experts and users into the development cycle. Expert systems have everything to do with capturing knowledge in a form the computer can use, and nothing, other than some history, to do with reproducing the actual functioning of a human brain.

Is it AI? You can argue that question based on whatever arguments you find convincing. I see the continuous spectrum of languages with AI at one end and traditional languages at the other much like a base/treble spread on a receiver. As you turn the dial, the mixture varies.

Do these practical applications qualify as AI? Yes, they do—but not 100 percent. They were born of AI techniques, but they also contain elements that qualify as more traditional programming. They lie somewhere on the spectrum—but not wholly at either end. ■

*Martin Heller is a software developer who contributes frequently to BYTE. He has a Ph.D. in physics from Brown University. You can reach him on BIX as "mheller."*

# You got the look.

a sample of fax output using Communiqué fax software



**GoldenSection**  
advertising

Carmina Cortez  
Friendly Press, inc.

Dear Carmina,

Welcome to the age of personal communication! As you can see, all PC fax software is not alike. The fax that you are now reading was created using Communiqué from Grey Matter Response. I wrote the body of this letter using Communiqué's on-board Memo Processor and then let the software take care of the rest. It automatically merged in our company logo and my personal signature as it transmitted the fax using Communiqué's exclusive proportional Fax Fonts. This professional looking document was completed in a matter of minutes, saving me time and energy.

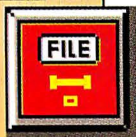
The Communiqué software has a graphic user interface based on easy-to-understand icons and buttons (everyone at the office keeps dropping by my desk just to see it!) Let's get together sometime and I'll show it to you.

Best Regards,  
*Tina Berma*  
Tina Berma n  
Golden Secti on

current fax board owners: ask about our \$179 trade-in offer!



The better your faxes look, the better you look. That's why Communiqué produces eye-catching faxes like the one on the left. Communiqué even improves the look of your PC with its easy-to-use Graphic User Interface. And right now, Communiqué software *plus* a 9600 baud PC fax board is at an introductory price of only \$249 (\$50 off the retail price.) For more information or to order, call 1-800-927-9713.



Grey Matter Response  
PO 3147 Santa Cruz, CA 95063  
(408)427-3678 / fax: (408)427-0493



**COMMUNIQUE**  
personal communication

Communiqué™ requirements: IBM PC or compatible with 640k, hard disk, graphic card (color or monochrome), MS-DOS 3.0 or higher, and a mo. sc.



# RISC FREE!

## Free i860™ Processor and i860/APX Software!

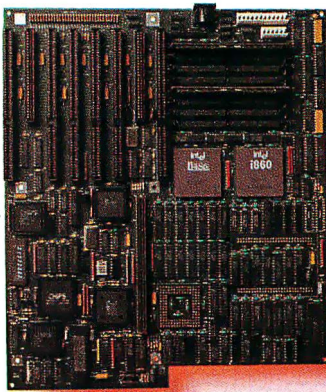
By now, you've probably heard about our industry-first 4860 MotherBoard that packs the power of the Intel 80486 CPU with the Intel 80860 RISC processor (i486™ + i860 = 4860).

What you haven't heard is that, for a limited time, when you buy a 4860 MotherBoard with 16MB of RAM, Hauppauge will give you an i860 RISC processor and the i860/APX operating system at no additional cost.

Why *give* you this capability? Because you'll enjoy a level of processor performance never seen before in a PC. Our bet is that you'll be so impressed, you'll come back for more!

**A PC Revolution:** In the PC environment, the 4860 is a 486-based MotherBoard which runs over 2 times faster than 386 computers. It delivers main-frame power for applications including CAD, LAN and desktop publishing. This board is fully compatible with DOS, IBM's OS/2, Novell Netware and SCO Xenix. What's more, Hauppauge's 4860 supports up to 64 MBytes of memory *without* a RAM expansion board.

**RISC-Y Business:** The i860 processor is ideal in complex applications, performing up to 25 million floating-point operations per second. It adds to the power of 486, so you can run rings around ordinary PCs. There's



even an optional 64-bit frame buffer for ultra high-performance workstation graphics.

By adapting Intel's APX (Attached Processor Executive) software to our 4860 MotherBoard, we've created a way to exploit the power of the i860 to give you *practical* multiprocessing. In fact, the i860/APX provides a base for entirely new applications made possible by the advent of the i860 RISC processor.

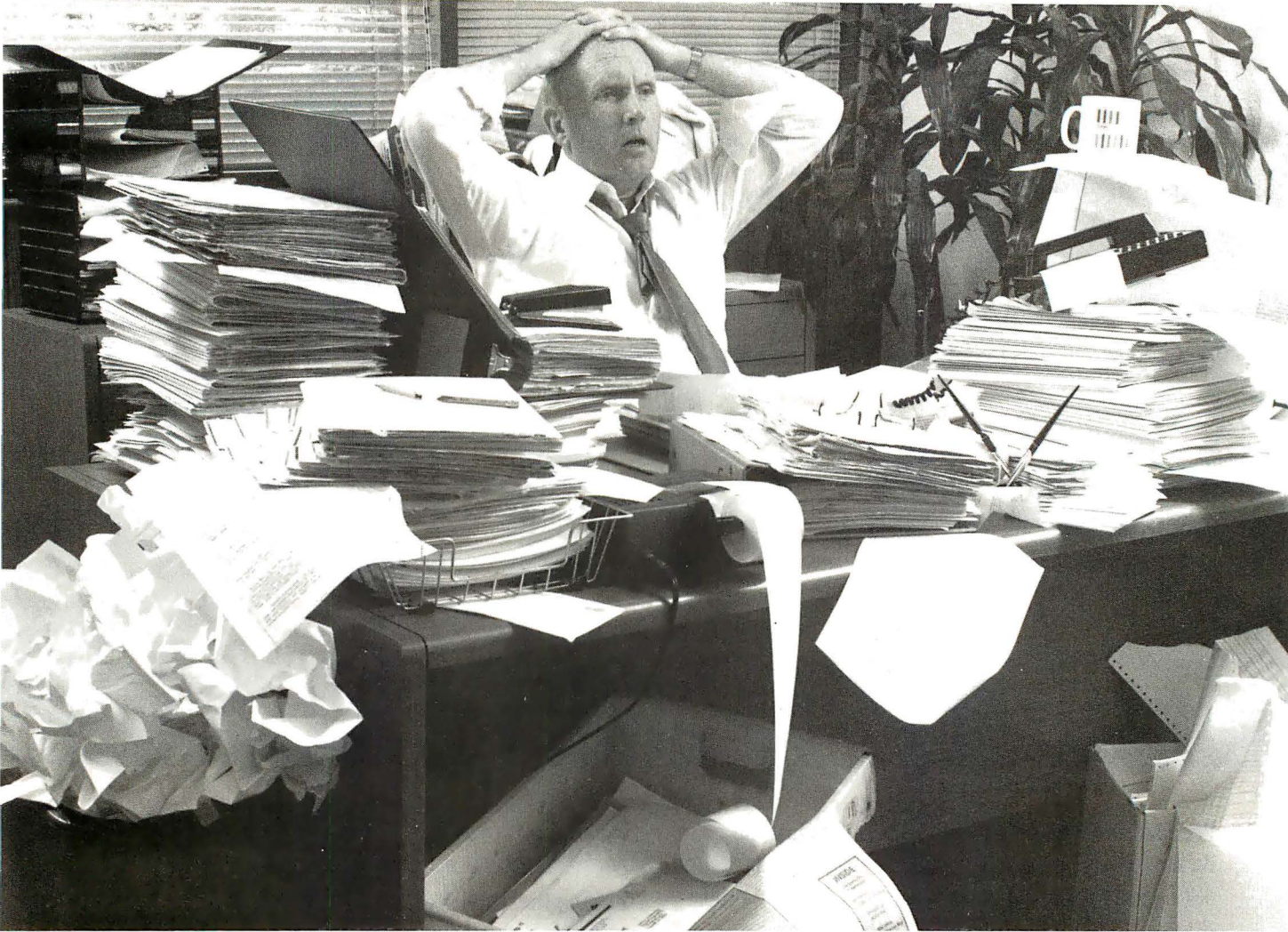
**Technical Features:** 4 Mbytes of high speed RAM expandable to 64 Mbytes shared between i486 and i860 processors  
• Socket for optional Intel 82485 Turbo Cache 486 Module  
• Full size PC/AT form factor  
• 7 EISA I/O slots  
• 64-bit expansion slot  
• 1 parallel, 2 serial ports and a built-in PS/2-style mouse port.

Get our unique 4860 MotherBoard and enjoy a RISC-free investment. Our board is designed with the world's highest performing microprocessors. So you can have the world's highest performing PCs and workstations.

For more information, call **1-800-443-6284**.

Hauppauge Computer Works, Inc.  
91 Cabot Court  
Hauppauge, New York 11788  
Telephone: 516-434-1600  
Fax: 516-434-3198  
In Europe (49) 2161-17063

**Hauppauge!**



# DESK NOT BIG ENOUGH?

*17 million business documents  
are lost or misfiled each day.*

Announcing a major breakthrough in image storage and retrieval:

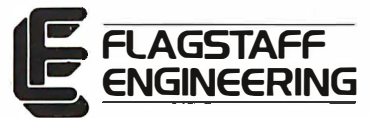
**Paper  
Tamer**

*PaperTamer* offers more power and flexibility than other existing document storage and retrieval systems—and *PaperTamer* costs 1/10th of the price.

*PaperTamer* is designed to eliminate the need to run to the file room every time you need information. *PaperTamer* provides immediate access to over a million images, documents, memos and articles.

Flagstaff Engineering offers a complete line of peripheral products to provide complete image storage and retrieval systems including scanners, optical drives and mass storage devices.

No one delivers rock solid solutions like Flagstaff Engineering, the company that continues to help people read a world of information.



**Domestic Sales and Marketing**  
1120 Kaibab Lane  
Flagstaff, AZ 86001  
(602) 779-3341 / FAX (602) 779-5998

**International Sales**  
1930 S. Alma School #C202  
Mesa, AZ 85210  
(602) 831-5100 / FAX (602) 831-0684

GSA APPROVED

Circle 113 on Reader Service Card

# Putting the Experts to Work

*Expert systems can capture and deploy the intricate thought processes of those who think for a living*

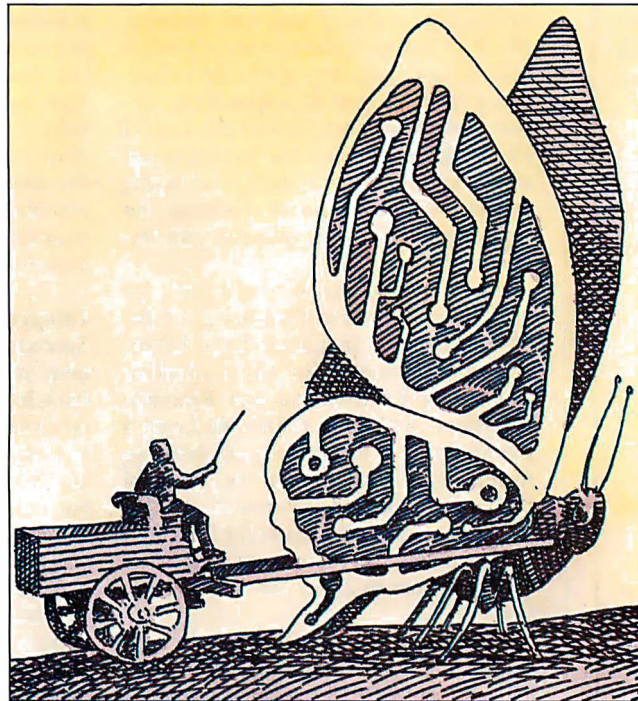
*Daniel W. Rasmus*

**A**rtificial intelligence has been a curiosity to many and a livelihood for a few. Each year, more and more people are participating in the technology, and each year more and more people are being touched by it without knowing it. But how has the technology of AI gone beyond the laboratory and extended itself into the real world?

Older computer packages, like general ledgers and payroll, were designed to work faster than people, but only when precise information was entered into their highly structured silicon calculators. Intelligent systems are designed to work on knowledge.

All knowledge workers have one thing in common: They think for a living. They may think about the strategic focus of a company, or they may think about the best way to repair a broken machine. But whatever they think about, and however they think about it, expert systems can capture and deploy the intricate thought processes of knowledge workers.

Applied knowledge usually takes the form of "assistant" programs, as intelligent guides for new employees or those



less skilled in the work force. Some of these assistant programs encompass the knowledge of various experts and put it to work solving problems, like scheduling the workers in a factory, where the incoming data may be overwhelming.

Intelligence also involves how people react to the world. When I say something to others, I expect them to react. When I write a note, I expect someone to under-

stand what I have written. This is a lower level of cognition, one most often taken for granted. It is also an area of AI research and application.

Many people think that AI is limited to expert systems, but it encompasses a broad spectrum of technologies. Robots, expert systems, natural-language systems, vision systems, speech recognition and synthesis, handwriting recognition, neural networks, and intelligent interfaces are all components of the AI equation.

## **AI in Databases**

The personal computer database is a repository of much corporate and personal data, yet individuals often forget exactly what they have. Companies have vast databases of corporate information that churn daily on their mainframes, but it's often difficult to discover the connections between disparate systems. With expert systems, the programs find the data, no matter what file it's in.

Many expert systems are stand-alone applications. Some of them can access databases and ASCII files, but few can be embedded in C programs. Most early expert systems gave expert advice only and did little to talk to the real world.

## BBS Sysops

- Are you looking for ways to improve your board? Something that will set you apart from other boards in your area?
- Are your subscribers interested in Microcomputers? Listen to this!

### Announcing the Bulletin Board EXchange

The Bulletin Board Exchange allows you to become a publisher of Micro-BYTES Daily, an on-line news service from BYTE. Bulletin Board Exchange/MicroBYTES is a custom package of news and features designed especially for local BBSes, and is available only to sysops.

Every Monday through Friday you get articles about developments in micro-computing, telecommunications and selected new product announcements. Get the latest news about MS DOS machines, Macintoshes, Unix workstations, Amigas, Atari STs, peripherals and software. All the stories are reported, written, and edited by the staff of BYTE Magazine, BYTEweek and BIX, and our world-wide network of reporters and editors.

Not only do you get a great resource for your subscribers, but you also get access to BIX which will cut your cost of exchanging information and conducting BBS network business.

### All this is just \$49 a quarter.

Your one-year subscription to the Bulletin Board Exchange (billed quarterly) may be cancelled any time without further charge; just notify us. If you prefer, you may subscribe for three months only, at just \$69.

If you call BIX direct, you pay no hourly telecommunications charge. If you call using Tymnet, the rates are only \$3/hour on evenings and weekends and \$6/hour on weekdays. You may also purchase unlimited off-peak Tymnet for just \$20 a month.

### Subscribe today.

**BIX**

One Phoenix Mill Lane  
Peterborough, NH 03458  
800-227-2983  
In NH 603-924-7681

## **S**mart *applications of expert systems are already turning up in products.*

Today, however, things are different. For example, at Southern California Edison, AICorp's KBMS is used to implement company policy. KBMS is the knowledge processor in the PC Automated Configuration Expert that lets departments configure their personal computer purchases according to corporate standards. PACE retrieves price and product data from DB2 relational databases on an IBM 3090 and provides detailed configurations for PCs and Macintoshes, including peripherals, memory boards, and cables.

One fundamental change that expert systems make in the workplace is in how knowledge is distributed and retained. Much of the knowledge worker's job is taking raw data and applying intelligence to it, producing information. Expert systems can help retain this kind of knowledge even when the expert is unavailable. Intelligent systems also supply expert-level performance potential for new employees and employees with less skill.

An example of this kind of knowledge is found in the Aid to Evaluating the Redevelopment of Industrial Sites expert system developed for the Canadian Council of Environment and Resource Ministers. AERIS is a 300-rule Level 5 knowledge base that helps guide environmental engineers through the decision process on site redevelopment. dBASE files store parameters about the sites, and retrieved database records are used in the expert system to order and select questions.

The system was designed to help less-skilled engineers run site scenarios with less help, but AERIS is turning a several-week job into a several-hour job. Several cases a day can now be run, and more what-if information is possible than with manual methods. AERIS is helping engineers choose the best use for reclaimed toxic-waste sites.

### Neural Networks

Intelligent systems are also making inroads into neural networks. To many, neural networks are even more removed

from reality than expert systems. An expert system is at least programmed, and you can see what makes it tick, but neural networks are more of a mystery.

A simple, but very useful, neural network is NeuroShell from the Ward Systems Group. NeuroShell was originally shipped as a stand-alone backward-propagation neural-network implementation. Systems designers input the characteristics of a problem, provided several case studies, and then allowed the neural network to learn from the cases. When learning was complete, previously unseen cases could be presented to the system, and they would be classified according to the generalizations gleaned during the learning process.

The current version of NeuroShell comes in several flavors; one of those is a database version. The standard version of NeuroShell uses a characteristics file that must be entered. With the database version, the characteristics file is a dBASE file. Some fields in the database are described as defining characteristics while others classify them.

NeuroShell reads in the data from the database and learns the relationships between the defining characteristics and the classifying characteristics. Once the learning process is complete, the database version of NeuroShell facilitates distributing the knowledge contained in the database. (For more information on combining neural networks with expert systems, see the text box "Solving the Unsolvable" on page 284.)

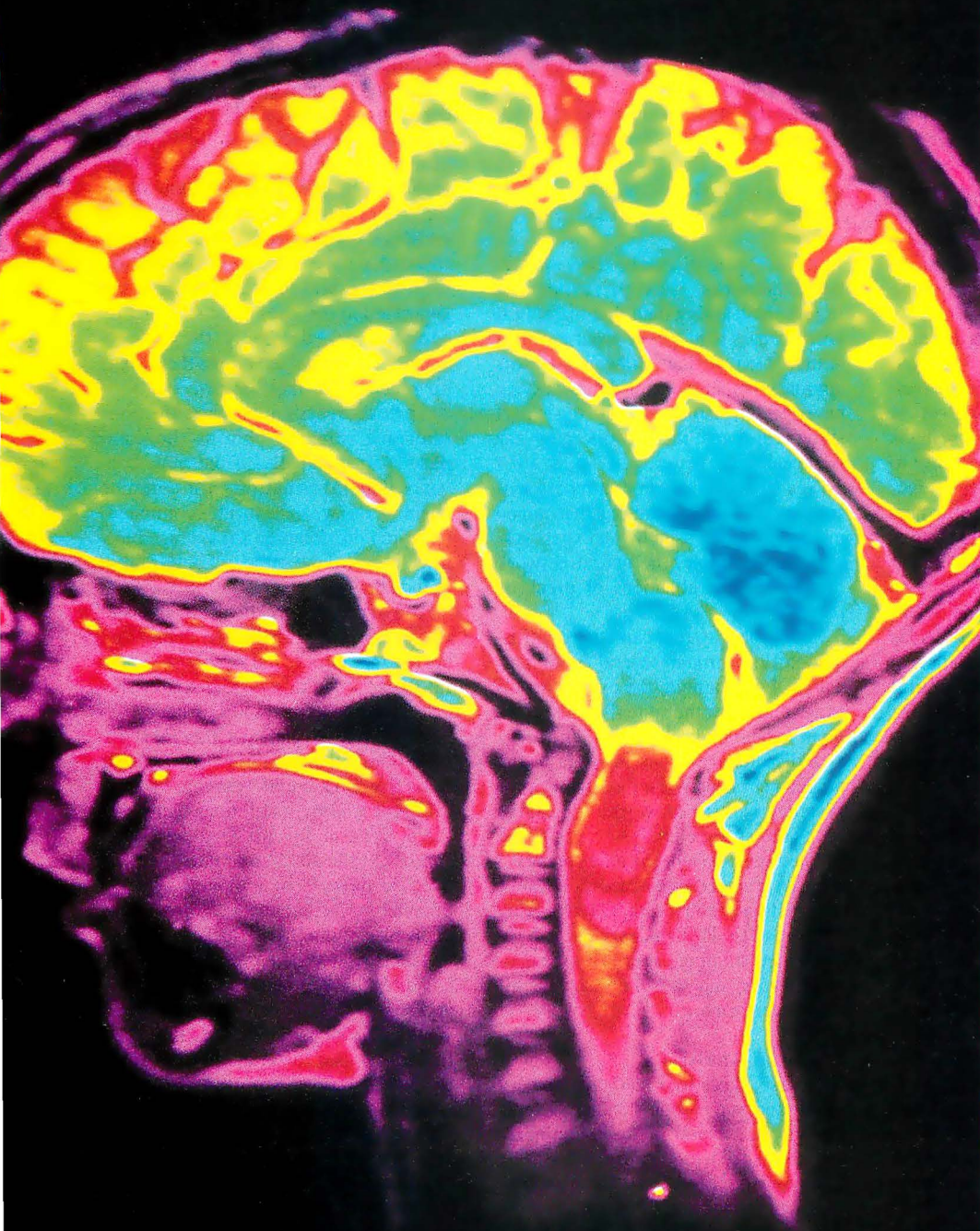
### Integration

Spreadsheets are an important component in the day-to-day lives of many knowledge workers. Recently, I had the opportunity to work with a manufacturing engineer who used a spreadsheet in his work writing shop-floor standards for new manufactured parts. He spent several hours every time a new assembly was introduced, churning through data and drawings to see how the part should be made and how long it would take to make it.

The problem was that the manufacturing engineer's information did not come in a form easily transferred to the computer. I called the CAD department and requested CAD data files for input to a "system" I was going to build. This "system" was an expert system.

While I was waiting for the data file, I went through the engineer's spreadsheet and made it more amenable to the project. I named cells and cleaned up formulas. However, I changed little of substance. The manufacturing engineer

At Mount Sinai Hospital,  
some of the best brains in the  
country rely on Sony.



Fortunately, critical patient data  
is tucked into the safest place of all.

A Sony data cartridge.

In fact, hundreds of detailed files  
can be accessed from one, single,  
solitary data cartridge.

Which is how the renowned  
doctors at Mount Sinai Hospital  
in New York City store patient  
diagnostic data.

Not one byte can be lost.

That's why Sony produces, with  
exacting care, a range of mini and  
ultra-high capacity data cartridges  
up to 525 megabytes.

And if Sony data cartridges can  
do all of this, they can also back up  
another vitally important life force  
with the utmost integrity.

Your business operations.



**SONY**

Circle 296 on Reader Service Card

## Solving the Unsolvable

Marge Sherald

Given the recent advances in artificial neural-network technology, will AI ever approach human intelligence? Government studies have used one measurement of neural-network power, the number of neural interconnects, as an indicator of intelligence. Neural networks implemented on even the largest massively parallel computers were rated at less than 100 million connections; an average cockroach eclipses that power by an order of magnitude with its neural network of a billion interconnects.

That's not very encouraging for anyone working in AI. However, when you look beyond these "intelligence ratings" and see the number of real-world applications built with expert systems and neural networks, it's not so easy to dismiss the field as a high-tech fad. Even more reassuring are several new trends that may cause the field to take some giant steps in the direction of human intelligence.

The business, academic, and scientific worlds are developing applications that combine expert systems with neural networks or combine multiple neural networks into a single application. These new hybrids can tackle problems previously unsolvable by a single expert system or neural network.

One way to appreciate the synergy of expert systems and neural networks working together is to view it as a parallel to the combined functioning of the left and right sides of the human brain. Expert systems (the left brain) excel where there are hard-and-fast rules and when precise computations are needed. Expert systems can work with symbolic representations of data and can explain why they reached a specific conclusion.

Neural networks (the right brain) excel at problem diagnosis, decision making, and other classifying problems where "fuzzy" pattern recognition of data representations and relationships is required. Neural networks surpass expert systems in making decisions where a human counterpart uses judgment and intuition based on years of experience rather than a set of rules.

The same can be said when the rules are too numerous to be practical or when a change in the problem param-

eters would require a complete rewrite of all the rules. Like expert systems, neural networks can capture knowledge from databases and learn to make decisions in the real world.

According to industry expert Patrick Simpson of General Dynamics' Intelligent Systems Group, there are four common methods of combining expert systems with neural networks:

1. Expert systems can be used to train neural networks. The expert system can supply the training data that the neural network uses to judge the accuracy of its output. One obvious drawback to this approach is that the neural network can never get any "smarter" than the expert system, although the network may very well generalize better.
2. Neural networks can preprocess sensor data into representations that can be more effectively used by an expert system. For example, the neural network can make generalizations or preclassifications.
3. The expert system can control information flow through several neural networks. For example, the expert system can explain how the system works, elicit input to help make decisions, and serve as a dispatcher for passing data to the proper neural network for further processing. Neural networks have also been used as dispatchers.
4. The expert system can analyze the responses provided by the neural network and facilitate enhanced understanding of the results. This analysis can also result in new training patterns for the neural network and thus improve overall system performance.

### Financial Analysis

Of course, these four methods are very basic, and some sophisticated systems incorporate several of the techniques. Don Barker, the coordinator of the Computer Assisted Learning Center at Gonzaga University, developed a prototype system to analyze the financial health of a business that also uses an expert system to call a neural network.

Barker chose the KnowledgePro expert system from Knowledge Garden, NeuroShell from Ward Systems Group, and dBASE III Plus from Ashton-Tate

(Torrance, CA), explaining that "these software environments require little programming experience and provide for quick and simple data exchanges."

Barker's system examines four standard business ratios. The quick ratio indicates the amount of liquid assets available to meet a firm's current obligations. The debt-to-worth ratio shows the proportion of capital contributed by creditors as compared to the funds contributed by the owners. The sales-to-receivables ratio compares the revenues generated to the level of outstanding receivables carried. Finally, the profit-to-worth ratio shows the return the owners are receiving on their investment.

The expert system provides the user-interface screens, obtains the company's financial data from you, converts that information into common business ratios, and executes commands to search the database for average business ratios for the same or similar types of industry.

The expert system then calls the neural network to estimate the company's borrowing ability. Barker chose a neural network for this system subtask because the rules for making a loan decision are not as clear as the rules for computing business ratios. The sample cases that exist are inconsistent because different lending institutions apply different criteria for making loan decisions. "In the absence of clear rules or precise data, a neural-network approach has the best chance of producing plausible results," said Barker.

The expert system creates a file that contains the computed business ratios and passes the ratios to the neural network. The neural network has been trained on case histories that are stored in the database. Each case history includes the four business ratios along with a field that states whether the loan was approved or denied. Based on its previous training, the neural network instantly predicts the probability of the business receiving a loan.

The system passes the results back to the expert system, which then uses rules to interpret a business's ratios in comparison with the industry averages. You see a summary screen that displays the firm's business ratios and the industry's

average along with an explanation of the comparisons and a display of the likelihood of the business being able to raise capital by securing a loan.

The purpose of Barker's prototype was to show that "symbolic (expert systems) and parallel distributed processing (neural networks) are not competing AI strategies but complementary. By uniting them, we can avoid many of the weaknesses inherent in each method while capitalizing on their unique strengths."

### Underwater Vehicle Control

The necessity of working in a real-time environment calls for a different approach to integrating expert systems with neural networks. General Dynamics Electronics Division (San Diego, CA) was faced with the task of building a control system for an autonomous underwater vehicle. The software had to be capable of solving problems, such as the vehicle getting caught in seaweed or fishing nets, collision with ships or buoys, sensor or other hardware failure, and poor atmospheric or water conditions. After diagnosing a problem, the system had to be able to formulate a new mission plan.

Unlike the previous application, this system has an expert system, a neural network, and a model-based system—three "knowledge sources"—all working on the same problem at the same time. When the knowledge sources finish processing, their solutions appear on a "blackboard" where they are "voted" on before the underwater vehicle takes any action. A team from the Intelligent Systems Group at General Dynamics wrote the programs rather than using commercial packages.

One knowledge source can feed information to another and thus improve the quality of the solution. For example, if the neural network finishes its diagnosis first and posts that information on the blackboard, the expert system uses it to formulate a direction for the search through its knowledge base.

The system had to be capable of determining the most critical stimuli in the underwater vehicle's environment. The team created a prioritizer that determines the importance of a detected event and derives a time allotment, in seconds, within which the vehicle must respond. For example, an overheating motor requires a 1-second response, but a loss of altitude gives the vehicle several minutes to respond.

At the end of the time period that the prioritizer allotted, all the solutions proposed by the knowledge sources that appear on the blackboard are submitted to a "voting algorithm." This algorithm considers the expected precision of each solution, as well as how many solutions appear on the blackboard. For example, the model-based system is considered to be more precise than the expert system, which is considered to be more precise than the neural network.

According to the team, the model-based system is considered to have deep reasoning capability while the expert system's rules may be superficial when faced with a novel situation. The neural network usually provides the fastest solution and a robustness not found in the other systems. "If all else fails, the neural network can provide some kind of reasonable default response," according to the team report.

The team is now focusing its efforts on the mission-replanning system, as well as determining if additional knowledge sources are needed and deciding whether to use existing blackboard-system frameworks or to design new ones.

### Solid Future

These applications detail some innovative implementations of expert-system/neural-network combinations. The synergy of the two might be just the step needed for AI to surpass the cockroach without a great advance in hardware.

When you project what is to come from the thousands of existing applications that are currently saving time and money, the future for AI appears solid.

### BIBLIOGRAPHY

- Atkins, M., and R. Deich. "A Hybrid Artificial Intelligence Diagnostic System." The Intelligent Systems Group, General Dynamics Electronics Division, San Diego, California. Paper currently in preparation.
- Barker, D. "Analyzing Financial Health: Integrating Neural Networks and Expert Systems." *PC AI*, May/June, 1990.
- Barker, D. "Neural Networks and Expert Systems." *AI Week*, vol. 7, no. 9, May, 1990.
- Sherald, M. "Neural Networks Versus Expert Systems: Is There Room for Both?" *PC AI*, July/August, 1989.

*Marge Sherald is vice president of Ward Systems Group (Frederick, MD). She can be reached on BIX c/o "editors."*

could still enter the data the same way.

But I needed to name the cells, because the expert system I was going to use, Neuron Data's Nexpert Object, writes directly to named cells. Nexpert Object has many features that make it appropriate for taking on real-world tasks. It talks to most major commercial databases and spreadsheets, uses an intelligent interface for knowledge engineering, executes C programs from within the run-time and development systems, and comes as a set of C libraries so its inference engine can be embedded in custom applications.

Writing directly to named cells avoids rewriting the spreadsheet in a database format and avoids creating new methods and systems for the users to learn. (As an information analyst, I am concerned about not changing the ways in which people work.)

Once the database file arrived, I built a basic retrieval engine with Nexpert Object that read the data into memory and created dynamic objects. I then added a few rules that helped to classify the information, which was then written directly into the spreadsheet cells. Information that I could not derive from the data, I requested from the engineer. Between the data and the questions, I could infer other needed information.

In the prototype of the system, what would have taken an hour of manual work took only a few minutes. The final document was neatly printed on a laser printer, but it told nothing of its expert-system origins.

The expert system not only classified the database data, it also asked all the nondatabase questions consistently. None of the required cells would ever arrive empty again. Spreadsheets, CAD data, and expert systems were working hand in hand. The ability for expert systems to interact comfortably with existing software will be a key factor in their survival as a technology.

### The Help Desk

Another area where expert systems are making inroads into the real world is in help-desk applications. Help desks apply simple logic to solve problems that are very visible and very costly. When I call the manufacturer of a computer peripheral, I am often dismayed at the amount of time it takes for someone to respond. The savings generated just by answering service calls faster can sometimes justify much of the development expense of an expert system.

Some companies, like Emerald Intelligence, are adding a new look to their ex-

# WATCOM C8.0/386

Optimizing C Compiler and Tools  
for 386 Extended DOS

# Unleash 386 Power on Your Microsoft C Code.

- Interactive source-level debugger
- Generates high-performance code for 32-bit protected mode
- Microsoft source and library compatible
- Fast, tight code
- Profiler
- Protected-mode version of compiler
- Graphics library
- 100% ANSI C and SAA compatible
- Run-time compatible with WATCOM FORTRAN 77/386

## Experts Agree on WATCOM C:

"When Novell went looking for a 32-bit compiler for use with the NetWare 386 developer's kit, the company selected WATCOM's...It's clear that Novell chose wisely; this product is a winner."

*Fred Hommel, BYTE, December 1989*

"WATCOM C/386 is a fantastic new ANSI C compatible compiler for 386-based PC's...If you have written your application in Microsoft C, you will love this compiler."

*J. Richard Hines, Electronic Test, December 1989*

"Microsoft library- and source- compatibility makes WATCOM C7.0/386 ideal for porting DOS applications to 32-bit native mode. This compiler enables full 386 performance without 640K limitations."

*Richard M. Smith, President, Phar Lap Software, Inc.*

"WATCOM is definitely the leader in object-level optimizations...For flat-out executable speed,... WATCOM C showed shining performance."

*Computer Language, February 1989*

## WATCOM C8.0/386 Professional

• 100% ANSI C optimizing compiler • Protected-mode version of compiler • 386 run-time library object code • Windowed source level debugger • Profiler • Editor • 386 graphics library • MAKE • Linker • Object-code librarian • Object-code disassembler • Supports Phar Lap and ERGO DOS extenders

## WATCOM F77/386

• 32-bit optimizing FORTRAN compiler based on WATCOM C technology • Full ANSI FORTRAN 77 plus extensions • Includes WATCOM C development tools: Windowed source-level debugger, Profiler, Editor, MAKE, Linker, Object-code librarian and Object-code disassembler • Protected-mode version of compiler • Run-time compatible with WATCOM C8.0/386 • Supports Phar Lap and ERGO DOS extenders



# WATCOM

# 1-800-265-4555

415 Phillip Street, Waterloo, Ontario, Canada N2L 3X2 Tel. (519) 886-3700 Fax (519) 747-4971

WATCOM C is a trademark of WATCOM Systems Inc. Trademarked names are the properties of their respective owners.  
© Copyright 1990 WATCOM Products Inc.



pert-system development environments. A new interface makes the systems more accessible to help-desk managers and technicians. Using the Mahogany Help-Desk point-and-click interface, you can describe symptoms and solutions in a tree diagram. Each node of the tree contains a custom question, explanation files, or graphics files with "hot spots" that equate to answers.

The logic engine in HelpDesk is the same as the one found in the standard Mahogany product, but developers no longer need to concern themselves with objects, inference mechanisms, rules, or data validation. HelpDesk takes the results of the simple dialog boxes that the developer fills in, and generates the user interface and the logic. Now, as with spreadsheets and word processors, it's more important to focus on the content of the problem that you are trying to solve than on the methodology you must use to solve it.

### Embedded Systems

Several applications lend themselves to the embedded approach to intelligent applications. One of the most obvious is intelligent CAD equipment. When designers place components on a PC board drawing, or a new hole in a sheet metal part, an expert system could work beneath the CAD program to verify that the design is manufacturable.

The expert system may be able to recommend how to change the design to conform to manufacturing capabilities, or what manufacturing changes would be needed to accommodate the new design. Smart applications of expert systems are already turning up in products.

One air-conditioning manufacturer used the simple logic of Millennium Software's HyperX HyperCard expert system to write the logic for controlling a new unit. In the next few years, the use of inference-engine technology will become so commonplace that you may not even know that it's hiding under your word processor, CAD program, or hypertext authoring tool.

### Inferences from the Edge

There are still many stumbling blocks to the successful implementation of intelligent-system technologies. Hardware tools like Voice Navigator and Personal-Writer require training, and expert systems require costly and time-consuming knowledge engineering to translate the knowledge of experts into executable code.

The hardware people will continue to rely on faster processors and better algo-

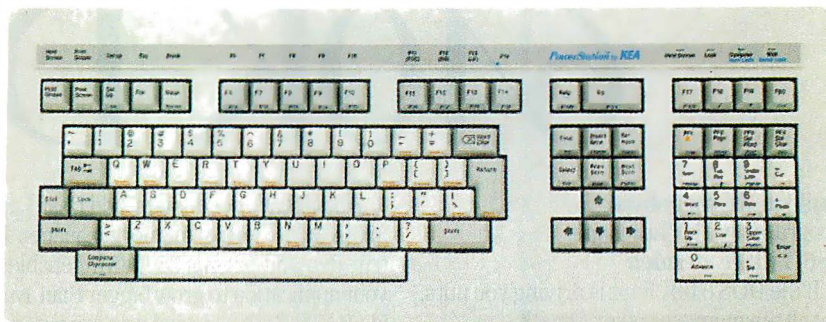
rithms to bring us instruments that respond to us more naturally. And the expert-system people will create tools that use AI techniques themselves to sort through the conflicting data that confronts knowledge engineers.

The technology will continue to evolve, and we will see the infiltration of AI technology into every place the computer goes. The 1990s will see the walls between intelligent applications and conventional applications crumble.

Systems analysts will become knowledge engineers, and knowledge engineers will become systems analysts. Perhaps it is not too soon to start referring to these professions as "information analysts," for what they do is apply knowledge to data to produce information. ■

*Daniel W. Rasmus is a freelance writer in Laguna Hills, CA, who specializes in expert systems. You can reach him on BIX c/o "editors."*

For the **Ctrl**  
you've been waiting to **Find**  
in DEC terminal emulation,  
**Select** the PowerStation keyboard.



The *PowerStation* keyboard gives you the control you need for key-by-key emulation of a DEC terminal. The *PowerStation* is an exact VT200/VT300 layout keyboard that plugs into your PC. The *PowerStation* brings VAX applications to your PC without having to hunt for re-mapped keys.

Here's the opportunity to standardize on one keyboard throughout your organization. The *PowerStation* keyboard has been designed to work on PCs, XTs, ATs, PS/2s, and the AT&T PC. You can switch effortlessly between real VTs and the *PowerStation*.

The *PowerStation* lets you run PC versions of your favorite VAX applications, including EDIT+, WPS-PC, WPS-PLUS/DOS, and nu/TPU. And the keyboard can be used with regular DOS applications.

The *PowerStation* keyboard comes with ZSTEM 240 or ZSTEM 220 terminal emulation software for connecting to

your VAX. ZSTEM 240 includes full VT241 emulation and complete VT340 16 color ReGIS & sixel graphics. If you only need text, ZSTEM 220 will give you fast, accurate and complete VT220/320 emulation. ZSTEM includes file transfer protocols, as well as extensive network capability, with support for Novell, 3COM, Ungermann-Bass, Excelan, Wollongong, FTP, Sun and DEC's CTERM and LAT. With KEA's top-notch technical support and documentation, plus a solid warranty, you can be assured of quality products backed by quality people.

KEA Systems Ltd.  
3738 North Fraser Way, Unit 101  
Burnaby, B.C., Canada V5J 5G1  
Telephone: [604] 431-0727  
Fax: [604] 431-0818  
Orders: 1-800-466-3870



Do it! Call Today!

ZSTEM and the KEA and ZSTEM logos are trademarks of KEA Systems Ltd. All other brand and product names are trademarks or registered trademarks of their respective holders. Copyright KEA Systems Ltd. 1990. All rights reserved.

# Extended-DOS

## 640K DOS



# Go Beyond 640K DOS.

### Build multi-megabyte programs with Phar Lap's 386|DOS-Extender.™

If the DOS 640K limit is driving you nuts, get all the memory you want with 386|DOS-Extender from Phar Lap.®

**Large-scale benefits.** By turning DOS into a true 32-bit operating system, 386|DOS-Extender shatters the 640K barrier. It lets you create protected mode applications that use all the memory in the machine – up to 4 gigabytes. You work within a flat, 32-bit address space. No more suffering with overlays, bank-switched EMS, or segmentation.

With full 32-bit memory and power, you can finally build workstation-class applications for the PC. Your Extended-DOS programs will run considerably faster, have room for more features, and be more responsive than those in 16-bit DOS.

And if that's not enough, add Phar Lap's 386|VMM™ virtual memory manager. With true demand-paging, 386|VMM enables your application to grow bigger than available RAM. Both code and data are automatically swapped to disk as needed.

**Total compatibility.** Because 386|DOS-Extender is embedded into your program, it is invisible to the end-user. Your program looks exactly like any other DOS application. There's no new operating environment for your end-users to buy or learn.

Every 80386 PC that can run MS-DOS or PC-DOS can run 386|DOS-Extender. It is completely compatible with all DOS-based software, including TSRs and network managers.

386|DOS-Extender is backed by a full complement of 32-bit languages. Choose your favorite from among C, Fortran, Pascal, Ada, Assembler, and others. And with

Phar Lap, you'll be using the finest, most widely used 386 software development tools in the world.

**Proven success.** AutoCAD 386, IBM Interleaf Publisher, and Paradox 386 are just a few of the hundreds of Extended-DOS applications already being shipped with 386|DOS-Extender. Utilizing this exciting new technology, industry leaders are keeping their competitive edge by delivering the speed and power that 386 users have been waiting for.

So if DOS is looking smaller than ever, call Phar Lap today.

And see what it's like beyond 640K.

### PharLap 386|DOS-Extender.

*We open a world of memory.*



Phar Lap Software, Inc.  
60 Aberdeen Avenue  
Cambridge, MA 02138  
617-661-1510  
FAX 617-876-2972

Trademark holders: 386|DOS-Extender™ and 386|VMM™ – Phar Lap Software, Inc.; Interleaf Publisher™ – Interleaf, Inc.; Paradox™ – Borland International. Registered trademark holders: Phar Lap® – Phar Lap Software, Inc.; Ada® – U.S. Dept. of Defense; MS-DOS® – Microsoft Corp.; AutoCAD® – Autodesk, Inc.; IBM® – IBM Corporation. ©1989 Phar Lap Software, Inc.

Circle 251 on Reader Service Card

# Real Artificial Life

*How do algorithmic evolutionary mechanisms and knowledge representations combine to synthesize an a-life organism?*

*Richard Marlon Stein*

One of the goals of AI research is to simulate complex biological processes, such as learning and memory. These natural functions are specialized operations, the product of millions of years of biological evolution. Mankind is now beginning to harness this evolutionary mechanism in the form of artificial life, a method for exploring complex biological processes. Through the study of a-life, investigators hope to discover how evolution synthesizes living systems.

This discussion is not so esoteric as you may think. Computerized a-life forms have already appeared. Computer viruses multiply and infect other computer systems, breeding within the host. They propagate through networks or are exchanged by concealing themselves within a file. A computer virus may be benign, or it can wreak havoc. A virus's behavior, while not necessarily indicative of intelligence, does mimic symptoms produced by naturally occurring parasitic viruses.

## Worthy of Investigation

The first conference for a-life was held at the Los Alamos National Laboratory



Center for Nonlinear Studies in 1987 (see reference 1). The conference was organized by Christopher G. Langton, who was "frustrated with the fragmented nature of the literature on biological modeling and simulation."

The conference participants realized a fundamental conclusion: "Artificial systems which exhibit life-like behaviors are worthy of investigation on their own

rights, whether or not we think that the processes that they mimic have played a role in the development or mechanics of life as we know it to be. Such systems can help us expand our understanding of life as it *could be*" (see reference 1). Thus, a-life can be broadly classified as a form of computational biology, an analytical method for studying biological systems.

Biologists have traditionally explored living organisms such as bacteria, ants, fruit flies, and flatworms from a top-down approach. By dissecting an organism into its representative parts, you learn the form and function of each of its organs and chemicals. The living entity vanishes in the search for simplicity within an organism.

A living organism is not necessarily intelligent—by human standards at least. The vast majority, 99.99 percent, of all living, organic matter is not intelligent. A tree, virus, or bacterium possesses no known intelligence, but it is alive, and it represents considerable complexity.

Living organisms reproduce and function in specialized ways. At some point, a system exhibits lifelike behavior because its complexity produces action and

### RULE-BASED SYSTEM

RULE 1 → When hit by punch, recoil  
PUNCH → A force  $\geq$  10 newtons  
RECOIL → Translate -5 feet in the z direction

**Figure 1a:** A rule-based production system, such as those created with Lisp or OPS5, can model specific aspects of behavior. The rules fire according to input conditions. Here, the recoil rule will fire if the hit is hard enough. You can also code these rules as IF...THEN constructs in C or FORTRAN.

purpose of function for the system. In some cases, some specialized behavior emerges in living organisms, as when a bee forages for pollen. But specialized behavior is not necessarily a sign of intelligence.

#### The I in AI

Intelligent behavior requires knowledge representation, a framework for evaluating information. In classical AI research, this means a collection of data structures and procedures or methods for manipulating them. AI research has produced several methods and mechanisms for approximating intelligent behavior.

Rule-based expert systems are common working examples of knowledge representations (see reference 2). An expert system responding to a specified input produces an output based on the knowledge embedded in the data structures, objects, events, and other entities with respect to an interpretation of the production rules (see figure 1a).

The data structures represent a *context*, a scope of applicability for the knowledge base. The *interpreter* controls the processing of the context during each *cycle*. Which rules are applicable at any instant? What are their priorities? An expert system mechanizes queries into a knowledge base distilled from an intelligent source, usually a person.

A person becomes an expert—that is, acquires specialized knowledge, or learns—by trial and error. Doing course homework is an example of this; it is an individualized and sequential activity. You learn from mistakes and apply the understanding to memory for later use. This is a cognitive process that affects a single individual within a population.

AI is a form of computational psychology, where cognitive processes are analytically modeled. Learning is manifest as a neurological process. It operates on the brain of an individual but does not affect a population of organisms.

However, an expert system operates with a “cooked” specification. It is constrained to execute a knowledge base in a

finite manner and does not necessarily alter its production system to accommodate knowledge outside its context.

A rule-based production system is not easily adaptable for knowledge representation. Production systems do not generally possess the structure to evolve knowledge representation; a programmer must encode knowledge by adding or modifying rules and data structures.

On the other hand, artificial neural networks *are* adaptable structures (see reference 3) and can be trained to perform specific functions (see figure 1b). They are also linear structures. A small change at the input produces a small change at the output. An expert system may generate widely different outputs for slightly different inputs, a by-product of the conditional constraints embedded within the rule structure. In addition, an artificial neural network is a tolerant computation structure. An unanticipated input will not cause it to crash.

Artificial neural networks are important mechanisms for knowledge representation in a-life systems, but they are not the only possible technique. Some researchers apply finite-state automata, such as those found in Conway's Game of Life (see reference 3), to serve as knowledge representation for an a-life creature.

A finite-state automaton uses a simple state-transition table to guide the organism. That is, it exists in some initial state, an input is applied, the state-transition table is consulted, and the organism then assumes a new state (see figure 1c).

The knowledge-representation scheme is of fundamental importance to a-life simulations. Whether it is a collection of rules, a neural network, or a finite-state automaton, it serves as the underlying agent, generating behaviors that emulate those found in natural systems. The behaviors found in living systems and those produced from some a-life simulations have one very important similarity: They change and adapt by applying an evolutionary process.

Survival of the fittest and natural se-

lection mediate evolution in the natural world. If nature can evolve living systems, why can't humanity simulate this process, and understand and dissect the most successful specialization mechanism of the natural world? A-life studies focus on evolving systems, or systems that change their behavior through the course of their simulated lifetimes.

#### Distinguished A-Life

The principles of natural selection and survival of the fittest supply the mechanism for achieving a goal in certain a-life simulations. A-life relies on a computational representation of an organism, because the simulations of these artificial organisms are carried out on a computer. How do algorithmic evolutionary mechanisms and knowledge representations combine to synthesize an a-life organism?

Some computer viruses, such as the one that disrupted the Internet, operate from a predetermined, declarative instruction set. The Internet virus demonstrated the vulnerability of a computer network. Connectivity between computer systems will increase as computers become more prevalent and powerful, and this fact raises their susceptibility to viruses.

The disruption of the telephone system in the U.S. last year provides an analogous example of computerized a-life forms. In this case, switching centers, major hubs of telephone traffic, all performed according to specification. But a problem arose when a certain untested condition emerged between some of the switching centers.

The new and devastating behavior resulted from a superimposition of complex conditional constructs. The electronic spasm originated from the collective action of distributed parts and demonstrated behavior that was logical, under the circumstances, but unacceptable.

These two examples illustrate the chaos that can arise from the uncontrolled propagation and unanticipated behaviors found in a-life forms. These instances underscore the compelling need to analyze and study the formation of a-life systems, whether they are purposefully created, unforeseen, or intentionally insidious.

The most interesting a-life forms evolve specific behaviors during their simulated lifetimes. In these advanced cases, the a-life entity will acquire a skill after several generations of breeding and attempting to solve a problem, like following a food trail. A-life simulations



1. Help Icon 2. AutoCAD Sub-Menu Icon 3. Icons Are Made In AutoCAD 4. GT Top 10™  
5. Bird's-Eye Icon 6. GT Flexicon Pops Up At Cursor 7. Hot Spots to Nested Sub-Menus 8. Reassignable Icon 9. Resize Icon

# Give Your AutoCAD® A New Interface.

If you use AutoCAD 386, here's some uplifting news. *GT Flexicon™* software does more than move your tablet from the table to the screen. As the industry's first fully automated, user-definable interface, *GT Flexicon* allows you to step through commands so naturally, you'll view AutoCAD

Suddenly, you realize how productive you are. Soon, you wonder how you could have worked any other way.



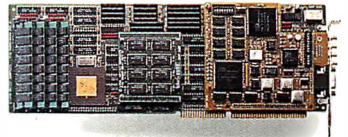
▲ Pop-up AutoCAD GT Flexicons appear instantly at your cursor.

in a whole new way.

Compatible with our popular ARTIST graphic controllers or any VGA card, *GT Flexicon* takes only seconds to appreciate. Simply scroll over your favorite GT commands, and soon you'll be panning and zooming from a bird's-eye view. To help you hold your thoughts, we've added reassignable icons that can be assigned and re-assigned to any AutoCAD command, lisp routine or macro during your drawing session, so your eyes never leave your work.



GT Flexicon runs with ARTIST XJS, XJ12, XJ10, 12MC or any VGA card.



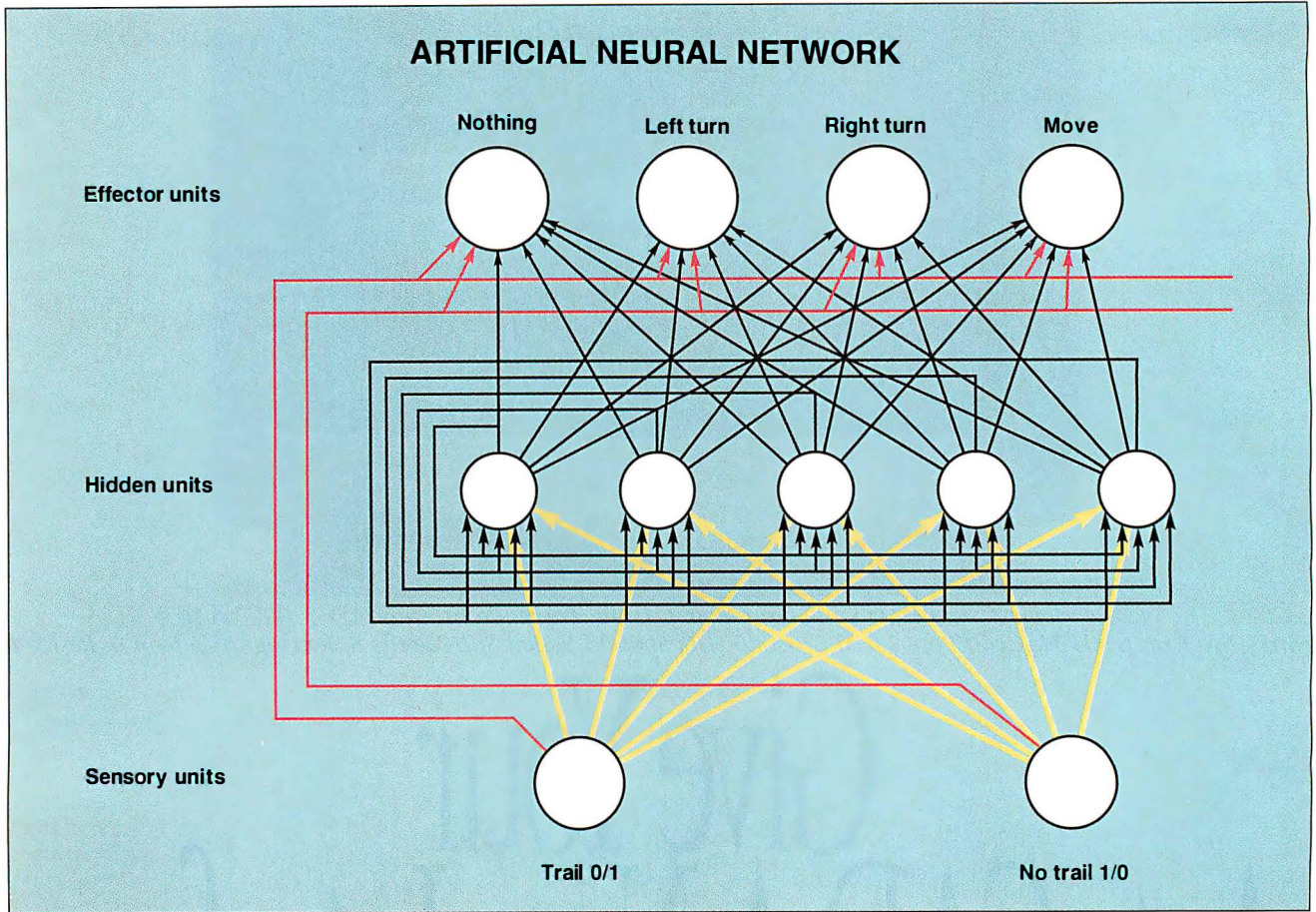
▲ ARTIST Graphics keeps pace with AutoCAD changes and upgrades.



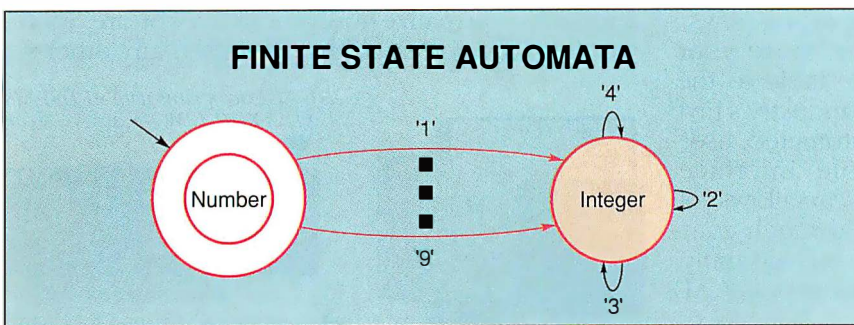
GT Flexicon. It's more than new software. It's a new point of view. For your nearest dealer, call "1-800-6-ARTIST"



A Central Systems Company  
ARTIST is a U.S. registered trademark of ARTIST Graphics. AutoCAD is a registered trademark of Autodesk, Inc. © Copyright ARTIST Graphics. All rights reserved. Specifications subject to change.



**Figure 1b:** The artificial neural network may be used as knowledge representation for certain forms of artificial life. The sensory units act as input discriminators, the hidden units provide connection and feedback, and the effector units generate output conditions. (Figure courtesy of David R. Jefferson)



**Figure 1c:** The state-transition diagram describes how finite-state automata can change. The machine starts in a known state, parses an input condition, consults the transition diagram (or table), and determines which state to engage next.

designed to explore fundamental questions about evolution use algorithmic techniques implementing survival-of-the-fittest and natural-selection formalisms.

Genetic algorithms (see reference 4)—a recent development for performing optimization—support the equivalent biological mechanisms of reproduction,

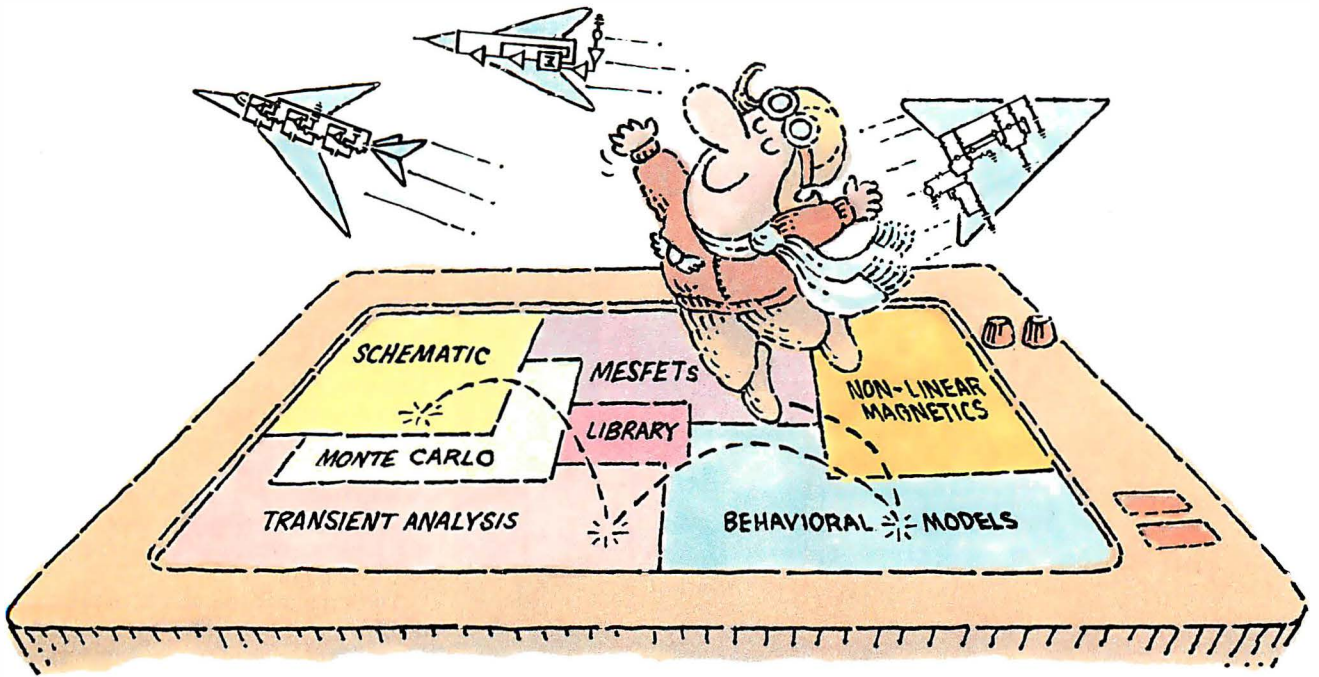
crossover, and mutation within an algorithmic structure suitable for a-life simulations. Evolving a-life systems depend on a mechanism for transcribing instinctive behavior acquired from previous generations, and genetic algorithms are a fine vehicle for expediting this process.

Biological evolution shows that chance governs an organism's function. A chee-

tah is a cheetah because evolution made it that way. But some a-life simulations are goal-directed, while biological evolution is opportunistic and tries to ensure a species' survival. This notion differentiates a-life simulations from natural biological evolution. A-life simulations reach their goals—perform limited optimization on specific functions of arbitrary complexity—by applying evolutionary operators to knowledge representation.

The a-life simulation is clearly very different from a conventional expert system. A-life depends on *selective* coding of knowledge representation, rather than declarative coding. Selective coding arises from the crossover of genetic information in the form of an electronic genome, or *genotype*, the DNA of a-life. The genotype expresses the function, purpose, and potential behavior for an a-life organism, just as the DNA in a living body expresses those notions for a living organism (see figure 2).

A-life genotypes are simply long bit



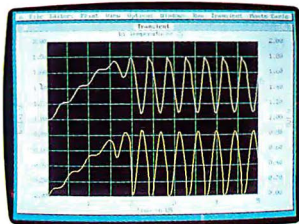
# THE NEW MICRO-CAP III.™ SO YOU CAN TEST-FLY EVEN MORE MODELS.

It wasn't easy. But we did it. Made the long-time best-selling IBM® PC-based interactive CAE tool even better.

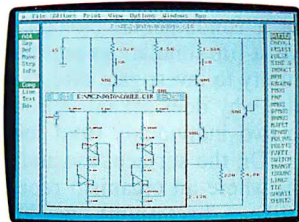
Take modeling power. We've significantly expanded math expression capabilities to permit comprehensive analog behavioral modeling. And, beyond Gummel Poon BJT and Level 3 MOS, you're now ready for nonlinear magnetics modeling. Even MESFET modeling.

Analysis and simulation is faster, too. Because the program's now in "C" and assembly language. That also means more capacity—for simulating even larger circuits.

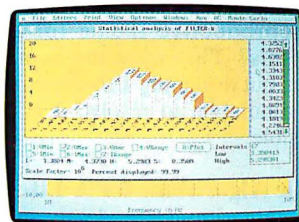
As always, count on fast circuit creation, thanks to window-based operation and a schematic editor. Rapid, right-from-schematics analysis—AC, DC, Fourier and transient—via SPICE-like routines. The ability to combine digital/analog circuit simulations using integrated switch



*Transient analysis*



*Schematic editor*



*Monte Carlo analysis*

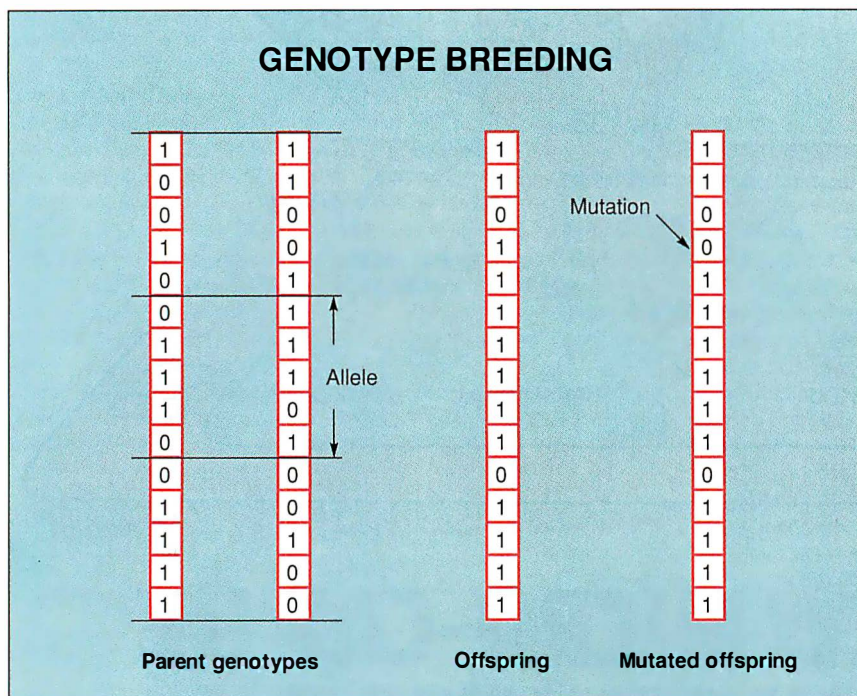
models and parameterized macros. And stepped component values that streamline multiple-plot generation.

And don't forget MICRO-CAP III's extended routine list—from impedance, Nyquist diagrams and BH plots to Monte Carlo for statistical analysis of production yield. The algebraic formula parsers for plotting virtually any function. The support for Hercules, CGA, MCGA, EGA and VGA displays. Output for plotters and laser printers.

Cost? Still only \$1495. Evaluation versions still only \$150. Brochure and demo disk still free for the asking. Call or write for yours today. And see how easily you can get ideas up and flying.

**SPECTRUM**

1021 S. Wolfe Road  
Sunnyvale, CA 94086  
(408) 738-4387



**Figure 2:** The parent genotypes are bred together, producing an offspring that inherits a random contribution of alleles from both. The offspring's genotype is then subjected to a mutation, where some bits in the genotype are "flipped" to account for this random, natural occurrence. The mutation rate is usually much rarer than depicted here (about 1 bit per thousand is typical).

strings, a sequence of concatenated 1s and 0s. Within each genotype, specific sequences of 1s and 0s represent a gene, or *allele*. The alleles direct the specific components of behavior for the a-life system. The success that a particular a-life process demonstrates during the execution of a task determines whether it will be selected for breeding in the next generation.

Evolving a-life simulations are scored with each generation. The highest scorers within an a-life population are selected to breed for the next. An a-life population consists of many separate genotypes—perhaps thousands of bit strings—each executing a unique context or process that aims at specializing performance for a specific function or goal. Each individual genotype executes a directed task, the task is scored, and the top scorers—say, the top 1 percent or the top 10 percent—breed the next generation.

The highest scorers from an a-life population are analogous to "survival of the fittest." The fitness criterion reflects the effectiveness of a genotype to specialize with respect to a given function. Those genotypes that are not high scorers eventually die off; their alleles cannot compete with their peers in the a-life population.

The successful genotype is selectively bred with its peers in the population, ensuring the partial replication of its survivability. Thus, each successive generation usually acquires more skill and more ability and becomes more specialized to achieve a particular goal or objective. Specialization of a genotype results from protracted evolution. Just as a particular plant or insect fills a niche in nature's scheme, so can an a-life genotype.

From a fundamental biological perspective, a-life simulations present a new opportunity to investigate evolution. For example, why does sexual reproduction require two individuals from the same species? On the surface, asexual reproduction, where an organism reproduces itself (like a bacterium), would seem twice as efficient. What allowed the sexual mechanism to emerge as the dominant reproductive theme for higher organisms? This question is hard to answer, but designing a *traditional* computer simulation to resolve it is nearly impossible.

#### Genetic Algorithms for A-Life

Genetic algorithms are ideally suited as the foundation for a-life investigations because they simulate the natural processes of biological evolution and pro-

duce specialized genotypes through the reproduction, crossover, and mutation operators. Genetic algorithms are an innovative alternative to traditional optimization techniques in that they have the flexibility and capability to evolve a complex system, rather than attempting to develop (and code) one from scratch.

Figure 3 uses a genetic algorithm to find a maximum for the function  $f(x) = .25 \times x^2$  over the range  $0 \leq x \leq 31$ . A 5-bit, unsigned genotype is selected at random for each of the six members in a population. The function  $f(x)$  evaluates the genotypes—those that score highest (fit best) are then selected to breed the next generation.

The crossover points, selected randomly, may be weighted by each genotype's percentage of fitness with respect to the total of all fitness scores. If  $f_i$  is the fitness of genotype  $g_i$ , "select %" is the ratio of fitness  $f_i$  to the average fitness for genotype  $g_i$ . The count column is the ratio of "select %" to the average selection percentage, an indication of the likelihood of breeding the particular genotype  $g_i$ .

The first generation in this example was created entirely at random, by flipping a coin. A heads toss produced a 1, and tails produced a 0. Random selection of mating genotypes produced the second generation. The crossover points represent the places within the bit strings where portions of one genotype are copied to the offspring. The crossover points were also determined by random draw.

The first generation shows an average fitness value of 31, while the second generation's fitness is 68, more than double the first. This indicates that the average population is evolving toward an optimum value of the goal function.

This process is continued until the maximum value is achieved. The genotype that belongs to this maximum value is the most specialized and highly evolved member. If the function were changed somehow, you could use this genotype as a seed for the new specialization activity, or it might be quicker to begin with a new, randomly selected genotype population.

A genetic algorithm achieves effectiveness through the large number of alleles sampled and compared for crossover during the reproduction process. If you consider a genotype with only 100 bits, the total number of strings that can be coded are  $2^{100}$  ( $1.26 \times 10^{30}$ ). This implies that a colony of  $10^{30}$  different (unique) individuals is possible.

A large population of genotypes has an extraordinary mix of individuals, some





**SUBJECT:**  
V.P., Engineering

**PROBLEM:**  
Your competitor has announced the product.  
Your Engineering team isn't even working on it.  
Your customers want it now.  
What's your answer?

**SOLUTION:**  
**MICRONICS**

Today, time-to-market is everything. Everyone wants the latest technology. You have to have a product when the demand is hot. And it has to work.

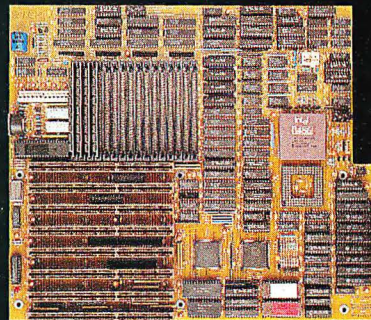
Before investing time and money now, and still miss the window, turn to Micronics for your system board needs.

Dedicated to advanced engineering, Micronics has a full line of 80386 and 80486 ISA/EISA products.

We provide excellent time-to-market and superior design without sacrificing performance or reliability. In fact, we have a proven record with hundreds of thousands of system boards in the field today.

Our own designs, FCC certification, complete compatibility testing and less than 1% field failure rates make Micronics system boards the industry leaders.

Micronics is your answer. Give us a call today.



**MICRONICS**  
COMPUTERS INC.

*The Power*

232 E. Warren Avenue  
Fremont, California 94539  
(415) 651-2300  
Fax (415) 651-5666

more fit than others. Mixing genotypes through crossover and reproduction can generate a specialized a-life organism tuned to achieve the desired goal. The huge pool of possible genotypes and their effectiveness provide the possibilities to conduct a nearly global search for the most perfect genotype.

But performing a global search for the "fittest" genomes to breed counters biological observations. Organisms of like species residing in geographically distant places do not always come together and breed. Local groups of organisms tend to breed, and this tendency creates genetic diversification. Some a-life researchers have observed signs of diversification in genome fitness during simulations using localized selection criteria.

### The Neural Connection to A-Life

The evolutionary characteristics of a-life are generally controlled with genetic algorithms, but their ability to demonstrate lifelike behavior and specialize in a dynamic, natural environment is a task for neural networks. The marriage between genetic algorithms and neural networks, the essence of a-life, is a very recent de-

velopment pioneered by David R. Jefferson and his collaborators at UCLA (see reference 5).

To demonstrate how a-life systems evolve complex behavior with neural networks, Jefferson simulated an ant colony whose sole purpose was to navigate through a trail with twists, gaps, and turns. Each generation of the ant colony, composed of 65,536 independent neural networks, was simulated on a Connection Machine as 65,536 separate processes.

In this experiment, the ant genotypes were generated entirely at random, and their bit strings were used to compute the weights and interconnections for a neural network. A recurrent artificial neural network (see figure 1b), the computational representation for the ant, directed the movement of the ant along the trail according to the genotype contents.

At first, most of the ants did not take any steps onto the trail; they either spun around or did nothing. But a few ants did take a step or two onto the trail, and they were rewarded for their random efforts. Their fitness values were scored higher than those who did not walk on the trail.

The highest-scoring ant genotypes then became the parents to breed the next generation. The neural networks were recomputed from these second-generation genotypes. More ants in the second generation moved further along the trail.

After a few hundred generations, the genetic components of the simulation, reproduction, crossover, and mutation had produced super-ants who could expertly navigate the trail. The ants had "learned" to move through the maze by evolution directed through neural computation.

Their neural-network structure had acquired a precisely tuned, specialized configuration for locomotion along a fixed trail. The neural network served as the intelligent agent of the ant, while the genetic algorithm altered its genotype over several generations.

While the highly evolved ants could navigate their training trail, they performed very poorly on a different trail. Jefferson found that it was quicker to begin from scratch, with a new random ant-genotype population. The highly evolved ants had become overspecialized for a specific trail and failed to adapt rapidly to a new environment.

This finding indicates that overspecialization can result in an evolutionary dead end. Jefferson's a-life simulations demonstrated that genetic algorithms and neural networks form an effective combination for examining how specialized behavior evolves.

The larger the a-life population, the more varied the genotypes become. A large population is modeled, with each member acting as an independent process. In Jefferson's case, he used a massively parallel computation system, a Connection Machine, to conduct the a-life simulation.

The larger the population, the more genotypes there are enhancing the gene pool. Parallel-processing systems, especially SIMD (single instruction/multiple data) style systems, are ideal platforms for serious a-life research. It is not practical to execute 65,536 simultaneous processes on a supercomputer or a workstation.

Jefferson's ant simulation is intriguing for another, potentially fortuitous application. Although Jefferson did not develop a computational representation for the neurological motor mechanism in artificial ants, real ants possess an ingenious locomotive apparatus that coordinates all six legs. The Mars Rover, an autonomous vehicle for exploring the Martian terrain, could employ this mechanism, if scaled to sufficient size.

<b>GENETIC ALGORITHM</b>					
<b>1st generation</b>					
<b>i</b>	<b><math>g_i</math></b>	<b>decimal</b>	<b>fitness</b>	<b>select %</b>	<b>count</b>
1	01100	12	36.0	0.193	1.15
2	10010	18	81.0	0.436	2.60
3	00011	3	2.3	0.012	0.071
4	01001	9	20.3	0.109	0.652
5	00100	4	4.0	0.022	0.132
6	01101	13	42.3	0.228	1.37
Sum			185.90	1.000	5.98
Average			30.98	0.167	1.00
Maximum			81.00	0.436	2.60
<b>2nd generation</b>					
<b>i</b>	<b><math>g_i</math></b>	<b>decimal</b>	<b>fitness</b>		
1	10101	21	110.25		
2	01111	15	56.25		
3	01000	8	16.00		
4	10010	18	81.00		
5	10011	19	90.25		
6	01111	13	42.25		
Sum			406.00		
Average			67.66		
Maximum			110.25		

**Figure 3:** The second generation promotes a higher average fitness value than the first. This implies that the average population is moving toward an optimum. No mutations were applied to this sample.

The Mars Rover must confront an environment with changing topography, shadows, crevices, and terrain. This is a tremendously difficult problem in real-time robotics control, machine vision, and adaptive learning.

A traditional software-engineering effort, organized to conduct an investigation with classical software techniques, would be prohibitively expensive. But a likely alternative would be to apply a life simulation to evolve a smart machine capable of performing the task.

The Mars Rover must learn how to walk over terrain under independent, autonomous control. An ant, through the course of evolution, is perfectly adapted for this task. The Rover must learn to successfully walk through the terrain as well. A life simulation techniques may be able to implement this navigation and terrain-negotiation function more easily.

### Genetic-Algorithm Applications

Genetic algorithms are not restricted to the laboratory. Recently, Axcelis (Seattle, WA) announced its Evolver software, an add-on to existing spreadsheet applications, such as Lotus 1-2-3 and Micro-

soft Excel. The Evolver product enables you to perform optimization on a set of variables through the application of a genetic-algorithm structure that is built into the product. Evolver is a truly innovative piece of software, the first commercially available genetic algorithm for small systems.

With Evolver, you can determine what is the best time to deliver packages based on traffic flow, package volume, and fuel costs (should they vary hourly, daily, or weekly). Evolver lets you simply click on a spreadsheet variable and establish whether a maximum or minimum is desired. You can use Evolver to predict stock-market averages based on news feeds or other electronic information sources. You could also add it to the Intelligent Desktop, a multimedia environment being researched at the MIT Media Lab.

While Evolver performs optimization in a mode similar to simulated annealing (see "Configuring Parallel Programs," December 1989 BYTE), the U.S. Patent Office recently granted John R. Koza of Stanford University a patent (see reference 6) for using genetic algorithms to

solve symbolic problems, such as computing where two lines intersect in space from an algebraic specification. Koza's approach with genetic algorithms is unique. He constructs populations of Lisp programs that attempt to solve a problem symbolically, as TK!Solver (Universal Technical Systems, Rockford, IL) does with analytical-function specifications.

The various Lisp programs are scored according to a fitness criterion. The highest-scoring programs produce an expression for the solution closest to the known analytical one. The programs that generate the analytical solutions are then used to breed the next generation. Rather than breeding a bit string, Koza's method breeds algebraic expressions.

This patent may prove useful for enhancing symbolic computation programs, where you need to solve more difficult algebraic systems than existing symbolic-manipulation systems can handle. Koza's method relies on the operator to discriminate between algebraic expressions and select the ones most suitable for subsequent generations. Placing the assessment responsibility on the

## Prize catch for Windows, OS/2 and DOS developers.

**Bugs take note:** MultiScope™ is the only debugger that is CodeView™ compatible and provides up to 13 views of programs.

**The only debugger to offer run-time and post-mortem debugging.** The only debugger to provide Windows, Presentation Manager and character mode user interfaces.

**The only debugger to incorporate 386 virtual machine and ICE technologies from Nu-Mega,** makers of Soft-ICE™ and MagicCV™.

**The only debugger "that lets you focus on the problem to be solved rather than the tool used to solve it."** —IEEE Software 11/89

**And the only debugger to win top industry awards from PC Magazine, Info World and BYTE.**  
DOS—\$179; DOS & Windows—\$379;  
OS/2—\$449.

**For your free trial-version,** please call 800-999-8846  
In CA (415) 968-4892, or Fax (415) 968-4622  
For European pricing, ++46-13-63189.



**MULTISCOPE™**  
DEBUGGER

The World's Best Debuggers  
**MultiScope Inc.**

a Logitech Company 

MultiScope is a trademark of MultiScope, Inc. CodeView is a trademark of Microsoft, Inc. Soft-ICE and MagicCV are trademarks of Nu-Mega.

Circle 204 on Reader Service Card

operator implies manual intervention, rather than a completely automated evolution process.

### Future A-Life

The interdisciplinary nature of a-life research serves as a rich backdrop for discovery. Molecular biologists, who study molecular evolution and immune-system responses, have a new avenue to explore their field from a less contrived and more suitable context.

Molecular computations for designing pharmaceutical products are enormously complicated and can scarcely provide meaningful information for any but the smallest systems. With a-life simulation techniques, the next 5 to 10 years should see a rapid rise in the development of new computational tools for investigating chemical and molecular systems.

Current a-life simulations produce genotypes tuned to achieve specific goals. Integrating robotic controls into an a-life simulation may produce a genotype for an autonomous roving vehicle used for future planetary exploration.

The organizations that can construct specific genotypes for solving important

problems will dominate industries by the exploitation of a-life simulations. Computer simulations are far cheaper than people, and every organization has a requirement to reduce costs. If software can be evolved independently of the engineering process, then the cost to produce a specific product will certainly drop.

The rise of a-life simulation prospects is limited only by the inventiveness of software engineers who can adapt existing algorithms to evolutionary contexts. Nature's skill and craftsmanship, when harnessed toward the creation of a-life, present a virtually unlimited reservoir of possibilities for engineering solutions. Exploiting these opportunities are roles for the most innovative among us. ■

### ACKNOWLEDGMENT

I'd like to thank Professor David R. Jefferson of UCLA's computer science department for consenting to be interviewed for this article.

### REFERENCES

1. Langton, C. G., ed. *Artificial Life: SFI Studies in the Sciences of Complexity*. Reading, MA: Addison-Wesley, 1988.

2. Barr, A., and E. A. Feigenbaum. *The Handbook of Artificial Intelligence*, vol. 1. Los Altos, CA: William Kaufman, Inc., 1981.

3. Gardner, M. "On Cellular Automata, Self-Reproduction, The Garden of Eden and the Game of 'Life.'" *Scientific American* 224(2), 1971.

4. Goldberg, David E. *Genetic Algorithms in Search, Optimization and Machine Learning*. Reading, MA: Addison-Wesley, 1989.

5. Jefferson, David R., et al. "The Genesys System: Evolution as a Theme in Artificial Life." In *Proceedings of the 2nd Artificial Life Workshop*, ed. C. Langton. Reading, MA: Addison-Wesley, 1990.

6. Koza, John R. "Non-Linear Genetic Algorithms for Solving Problems." *United States Patent Number 4935877*, U.S. Patent Office, June 19, 1990.

Richard Marlon Stein is a software consultant and freelance writer from Van Nuys, CA. He has a B.S. in physics from the University of California at Irvine. You can reach him on BIX c/o "editors."

see Resource Guide on page 300

# Mail smarter and save money on your PC using the One-Two Power Punch

**ArcList**<sup>®</sup>—your first punch—lets you professionally manage your list on your IBM or compatible PC with 640K RAM and a hard disk.

### SAVE MONEY:

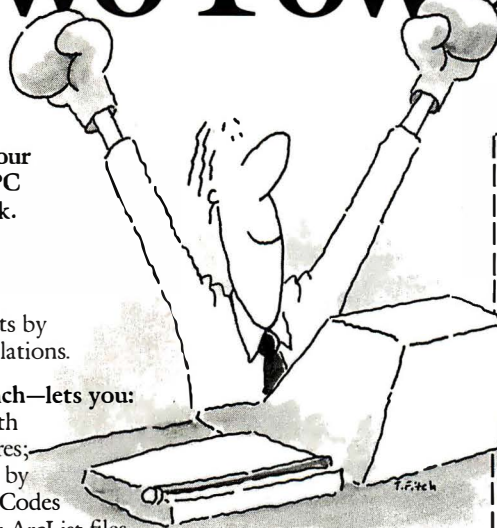
- eliminate duplicates from dBase<sup>®</sup>, ASCII or ArcList files;
- take advantage of postal discounts by presorting according to USPS regulations.

**AccuMail**<sup>™</sup>—your second punch—lets you:

- easily knockout undeliverables with automatic address correction features;
- quickly knock down postal costs by inserting carrier route and ZIP+4 Codes into your existing dBase, ASCII or ArcList files.

Find out more about *ArcList* and *AccuMail*! For a FREE copy of "How to Manage Your Mailing List" call 1-800-368-5806 or write:

Group 1 Software, Inc.  
Washington Capital Office Park  
6404 Ivy Lane, Dept. P-BR70  
Greenbelt, Maryland 20770-1400



- Please rush me a FREE copy of "How to Manage Your Mailing List."
- I'm ready to see ArcList and AccuMail in action. Please contact me at once.

Name \_\_\_\_\_

Title \_\_\_\_\_

Organization \_\_\_\_\_

Street \_\_\_\_\_

City \_\_\_\_\_

State \_\_\_\_\_ Zip \_\_\_\_\_

Telephone (\_\_\_\_\_) \_\_\_\_\_

©1989 Group 1 Software, Inc.

P-BY 1

**GROUP 1**<sup>®</sup>  
GROUP 1 SOFTWARE  
The Direct Marketing Software Company

Call for the dealer nearest you.

# Discover Parallel Processing

## Quadputer™

The Microway Quadputer is the world's most popular PC Transputer development environment. It can be purchased with two to four Transputers and one to four megabytes of RAM per processor. The Quadputer runs all the popular Transputer development software, all of which is available from Microway. It is compatible with our Monoputer™ which provides 1 to 16 megabytes of RAM and a single T800, our Videoputer™ which comes in VGA and higher resolution versions and is powered by a memory mapped pair (T800 and 34010), and our Linkputer™ whose cross bar switching network can dynamically link up to 32 Transputers. Finally, all Microway Transputer products can be used with our Number Smasher-860 to provide out-of-this-world numeric performance!

For more information, please call 508-746-7341.

# Microway

The World Leader in PC Numerics

Corporate Headquarters, Research Park, Box 79, Kingston, MA 02364  
TEL 508-746-7341 • FAX 508-746-4678  
U.K. - 32 High St., Kingston-Upon-Thames, 081-541-5466 • Italy 02-74.90.749  
Holland 40 836455 • Germany 069-75-2023 • Japan 81 3 222 0544

## Number Smasher® 860

The highest performance coprocessor card to ever run in a PC, Number Smasher-860 delivers up to 80 million single precision floating point operations per second at 40 MHz and produces over 10 Linkpack megaflops. The board comes standard with an ISA interface, two Transputer Link Adaptors that allow it to interface with a Microway Quadputer or Videoputer, your choice of our NDP Fortran, C or Pascal for the 80860, plus 8 megabytes of high speed memory.

## NDP Fortran-860, C-860 and C++-860

Microway NDP 860 Compilers make it easy to recompile your favorite mainframe, 80386 or PC application for the 80860. The resulting code runs on our XTEND-860™ environment under DOS, UNIX or XENIX.



## Resource Guide: Intelligent Software

*The commercialization of AI technology takes two primary forms: expert systems and neural-network simulators. Below are many of the companies producing products for these two areas (E = expert systems; N = neural networks).*

**AbTech Corp.<sup>N</sup>**  
700 Harris St.  
Charlottesville, VA  
22901  
(804) 977-0686  
**Inquiry 1225.**

**Advanced A.I.  
Systems, Inc.<sup>E</sup>**  
P.O. Box 39-0360  
Mountain View, CA  
94039  
(415) 948-8658  
**Inquiry 1226.**

**AICorp, Inc.<sup>E</sup>**  
138 Technology Dr.  
Waltham, MA 02254  
(617) 891-6500  
**Inquiry 1227.**

**AI Ware, Inc.<sup>N</sup>**  
11000 Cedar Ave.  
Cleveland, OH 44106  
(216) 421-2380  
**Inquiry 1228.**

**Artificial Intelligence  
Research Group<sup>E</sup>**  
921 North La Jolla Ave.  
Los Angeles, CA 90046  
(213) 656-7368  
**Inquiry 1229.**

**Artificial Intelligence  
Technologies, Inc.<sup>E</sup>**  
40 Saw Mill River Rd.  
Hawthorne, NY 10532  
(914) 347-6860  
**Inquiry 1230.**

**Beacon Expert  
Systems, Inc.<sup>E</sup>**  
35 Gardner Rd.  
Brookline, MA 02146  
(617) 738-9300  
**Inquiry 1231.**

**Bell Atlantic<sup>E</sup>**  
P.O. Box 3528  
Princeton, NJ 08543  
(609) 275-4545  
**Inquiry 1232.**

**California  
Intelligence<sup>E</sup>**  
912 Powell St.,  
Suite 8  
San Francisco, CA  
94108  
(415) 391-4846  
**Inquiry 1233.**

**California Scientific  
Software<sup>N</sup>**  
10141 Evening Star Dr.,  
Suite 6  
Grass Valley, CA 95945  
(916) 477-7481  
**Inquiry 1234.**

**Carnegie Group, Inc.<sup>E</sup>**  
5 PPG Place  
Pittsburgh, PA 15222  
(412) 642-6900  
**Inquiry 1235.**

**Cognition Technology<sup>E</sup>**  
55 Wheeler St.  
Cambridge, MA 02138  
(800) 622-2829  
(617) 492-0246  
**Inquiry 1236.**

**Comdale Technologies,  
Inc.<sup>E</sup>**  
833 The Queensway,  
Suite 202  
Toronto, Ontario,  
Canada M8Z 5Z1  
(416) 252-2424  
**Inquiry 1237.**

**COSMIC<sup>E,N</sup>**  
University of Georgia  
382 East Broad St.  
Athens, GA 30602  
(404) 542-3265  
**Inquiry 1238.**

**Digital Equipment Corp.<sup>E</sup>**  
146 Main St.  
Maynard, MA 01754  
(508) 493-5111  
**Inquiry 1239.**

**Emerald Intelligence,  
Inc.<sup>E</sup>**  
3915-1A Research  
Park Dr.  
Ann Arbor, MI 48108  
(313) 663-8757  
**Inquiry 1240.**

**Experience in Software,  
Inc.<sup>E</sup>**  
2000 Hearst Ave.  
Berkeley, CA 94709  
(415) 644-0694  
**Inquiry 1241.**

**Expertech, Inc.<sup>E</sup>**  
206 Sacramento St.,  
Suite 211  
Nevada City, CA 95959  
(916) 265-6635  
**Inquiry 1246.**

**ExperTelligence, Inc.<sup>E</sup>**  
5638 Hollister Ave.,  
Suite 302  
Goleta, CA 93117  
(805) 967-1797  
**Inquiry 1247.**

**Expert Systems Design,  
Inc.<sup>E</sup>**  
156 Tunnel Rd.  
Berkeley, CA 94705  
(415) 548-5129  
**Inquiry 1244.**

**EXSYS, Inc.<sup>E</sup>**  
P.O. Box 11247  
Albuquerque, NM 87192  
(505) 256-8356  
**Inquiry 1248.**

**Gold Hill  
Computers, Inc.<sup>E,N</sup>**  
26 Lansdowne St.  
Cambridge, MA 02139  
(617) 621-3300  
**Inquiry 1250.**

**HNC, Inc.<sup>N</sup>**  
5501 Oberlin Dr.  
San Diego, CA 92121  
(619) 546-8877  
**Inquiry 1251.**

**Hyperpress Media Lab  
Publishing Corp.<sup>E</sup>**  
P.O. Box 8243  
Foster City, CA 94404  
(415) 345-4620  
**Inquiry 1252.**

**IBM<sup>E</sup>**  
Old Orchard Rd.  
Armonk, NY 10504  
(914) 765-1900  
**Inquiry 1253.**

**ICAD<sup>E</sup>**  
201 Broadway,  
Seventh Floor  
Cambridge, MA 02139  
(617) 868-2800  
**Inquiry 1254.**

**If/then Solutions<sup>E</sup>**  
P.O. Box 52097  
Palo Alto, CA 94303  
(415) 322-3430  
**Inquiry 1255.**

**Inference Corp.<sup>E</sup>**  
550 North Continental  
Blvd.  
El Segundo, CA 90245  
(213) 322-0200  
**Inquiry 1256.**

**Inference Engine  
Technologies<sup>E</sup>**  
1430 Massachusetts Ave.,  
Suite 306-I  
Cambridge, MA 02138  
(617) 923-0998  
**Inquiry 1257.**

**Information Builders,  
Inc.<sup>E</sup>**  
1250 Broadway  
New York, NY 10001  
(212) 736-4433  
**Inquiry 1258.**

**IntelliCorp<sup>E</sup>**  
1975 El Camino Real W  
Mountain View, CA  
94040  
(415) 965-5500  
**Inquiry 1259.**

**IntelligenceWare, Inc.**<sup>E</sup>  
9800 South Sepulveda  
Blvd., Suite 730  
Los Angeles, CA 90045  
(213) 417-8896  
**Inquiry 1260.**

**Intelligent  
Environments**<sup>E</sup>  
2 Highwood Dr.  
Tewksbury, MA 01876  
(508) 640-1080  
**Inquiry 1261.**

**KDS Corp.**<sup>E,N</sup>  
934 Hunter Rd.  
Wilmette, IL 60091  
(708) 251-2621  
**Inquiry 1262.**

**Knowledge Garden,  
Inc.**<sup>E</sup>  
473A Malden  
Bridge Rd.  
Nassau, NY 12123  
(518) 766-3000  
**Inquiry 1263.**

**Lucid, Inc.**<sup>E,N</sup>  
707 Laurel St.  
Menlo Park, CA 94025  
(415) 329-8400  
**Inquiry 1264.**

**Millenium Software**<sup>E</sup>  
3275 Laguna Cyn. Rd.,  
Building 0-2  
Laguna Beach, CA 92651  
(714) 497-7439  
**Inquiry 1265.**

**Nestor, Inc.**<sup>E,N</sup>  
One Richmond Sq.  
Providence, RI 02906  
(401) 331-9640  
**Inquiry 1266.**

**Neural Systems, Inc.**<sup>N</sup>  
2827 West 43rd Ave.  
Vancouver, British  
Columbia,  
Canada V6N 3H9  
(604) 263-3667  
**Inquiry 1267.**

**NeuralWare, Inc.**<sup>N</sup>  
Penn Center W,  
Building IV, Suite 227  
Pittsburgh, PA 15276  
(412) 787-8222  
**Inquiry 1268.**

**Neurix, Inc.**<sup>N</sup>  
327 A St., Sixth Floor  
Boston, MA 02210  
(617) 426-5096  
**Inquiry 1269.**

**Neuron Data**<sup>E,N</sup>  
156 Univ. Ave,  
Third Floor  
Palo Alto, CA 94301  
(415) 321-4488  
**Inquiry 1270.**

**Norrad**<sup>EN</sup>  
114 Daniel Webster  
Hwy. S, Suite 280  
Nashua, NH 03060  
(603) 434-0047  
**Inquiry 1123.**

**Olmsted & Watkins**<sup>N</sup>  
2411 East Valley Pkwy.,  
Suite 294  
Escondido, CA 92027  
(619) 746-2765  
**Inquiry 1124.**

**Orphic Systems**<sup>E</sup>  
1700 Walnut St.  
Philadelphia, PA 19103  
(215) 735-8510  
**Inquiry 1245.**

**OXKO Corp.**<sup>E</sup>  
P.O. Box 6674  
Annapolis, MD 21401  
(301) 266-1671  
**Inquiry 1125.**

**Paperback Software  
International**<sup>E</sup>  
2830 Ninth St.  
Berkeley, CA 94710  
(415) 644-2116  
**Inquiry 1126.**

**Perceptics Corp.**<sup>E</sup>  
725 Pellissippi Pkwy.  
Knoxville, TN 37933  
(615) 966-9200  
**Inquiry 1127.**

**ROSH Intelligent  
Systems, Inc.**<sup>E</sup>  
One Needham Place  
50 Cabot St.  
Needham, MA 02194  
(617) 449-0049  
**Inquiry 1128.**

**SAIC**<sup>EN</sup>  
10260 Campus  
Point Dr.  
Mail Stop 71  
San Diego, CA 92121  
(619) 546-6290  
**Inquiry 1129.**

**Software Architecture  
and Engineering, Inc.**<sup>E</sup>  
1600 Wilson Blvd.,  
Suite 500  
Arlington, VA 22209  
(703) 276-7910  
**Inquiry 1130.**

**Software Artistry, Inc.**<sup>E</sup>  
3500 Depauw Blvd.,  
Suite 1100  
Indianapolis, IN 46268  
(317) 876-3042  
**Inquiry 1131.**

**Software Plus**<sup>E</sup>  
1315 Pleasant  
Meadow Rd.  
Crofton, MD 21114  
(301) 261-0264  
**Inquiry 1132.**

**Symbolics, Inc.**<sup>E</sup>  
8 New England Exec. Park  
Burlington, MA 01803  
(617) 221-1000  
**Inquiry 1133.**

**Symbologic Corp.**<sup>E</sup>  
15379 Northeast  
90th St.  
Redmond, WA 98052  
(206) 881-3938  
**Inquiry 1134.**

**Talarian Corp.**<sup>E</sup>  
1043 North Shoreline  
Blvd., Suite 201  
Mountain View, CA  
94043  
(415) 965-8050  
**Inquiry 1135.**

**Togai InfraLogic, Inc.**<sup>E</sup>  
30 Corporate Park,  
Suite 107  
Irvine, CA 92714  
(714) 975-8522  
**Inquiry 1136.**

**Ward Systems  
Group, Inc.**<sup>N</sup>  
245 West Patrick St.  
Frederick, MD 21701  
(301) 662-7950  
**Inquiry 1137.**

---

*Inclusion in the resource  
guide should not be taken  
as a BYTE endorsement  
or recommendation.  
Likewise, omission from  
the guide should not be  
taken negatively. The  
information here was  
believed to be accurate  
at the time of writing, but  
BYTE cannot be  
responsible for omissions,  
errors, or changes that  
occur after compilation of  
the guide.*

## CASE Trends Joins BIX

*CASE Trends*, the magazine for Computer-Aided Software Engineering, has opened a conference in BIX. Meet on line each month with the *CASE Trends* staff and special guest experts for discussions of CASE news, industry trends and CASE techniques.

### ■ Special Topics Each Month

This month Eliot Weinman, Executive Editor of *CASE Trends*, will host a month-long discussion on "CASE Technology: An Update of Recent Trends." Next month the special topic will be "CASE and Re-Engineering." And March will be the month for "Evaluating PC-Based CASE Tools."

In future months, we'll explore topics like "CASE and Object-Oriented Environments," "CASE and Information Engineering," and "Advanced Software Engineering/CASE & AI." (join case.trends)

## IBM Exchange Update

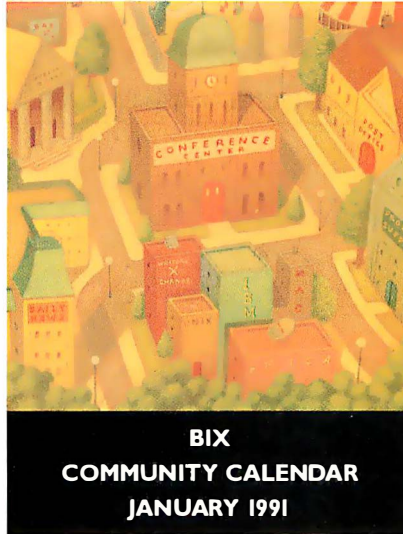
### ■ PC Insider Info

In the IBM PC conference we're tossing around opinions on keyboards, high-res video adapters/monitors, tape drives/tape software, and fast CPUs, to name a few. Find out which hardware is a good investment for you. (join ibm.pc)

Need to know anything about MFM, RLL, ESDI, IDE or SCSI disks and disk controllers? Know something the rest of us should? We discuss it all in the IBM PC drives conference. (join ibm.pc/drives)

### ■ OS/2 Conference: Speculation Abounds

How do you use Named Pipes on an



OS/2 LAN for remote control? Add your thoughts in the OS/2 LAN topic. (join ibm.os2/lan)

Also, join in on discussions of OS/2 Lite (the 1.3 version) and the upcoming version 2.0. Feel free to speculate on version 3.0 and whether it will support RISC architectures. Hypothesize on how IBM and Microsoft's new relationship will affect the future development and acceptance of OS/2. Check out the topic 'other', beginning at message 3735. (join ibm.os2/other)

### ■ Free LAN Software

LAN remote control software is available in the LANS conference. Source code for both NETBIOS and Novell IPX is located in the 'lans' conference 'long.messages' topic. (join lans/long.messages)

Find executables in the conference's listings area. (join lans/listings)

This month we'll also be discussing how to diagnose and troubleshoot Novell NetWare. (join lans/netware)

### ■ Hot Topic: Microsoft Windows

Both users and programmers are giving their points of view on Microsoft Windows these days. We're also discussing upgrades to Microsoft C 6.0. The new DOS 5.0 version is causing

quite a stir, as well. (join microsoft)

## Mac Exchange Update

### ■ New Mac Conference

Now HyperCard enthusiasts have a conference of their own. If you're one, join in and swap HyperCard codes, share experiences and discuss techniques. (join mac.hypercard)

## Talk in the Writers' Exchange

Our newest topic here centers around articles and book excerpts posted by science fiction and computer writer Michael A. Banks. Moderator Hugh Kenner hosts conversations on everything from school levies to computer store service. Drop in for entertainment in the form of provocative articles (posted before magazine publication), humorous articles and chit-chat. (join writers.talk/mike)

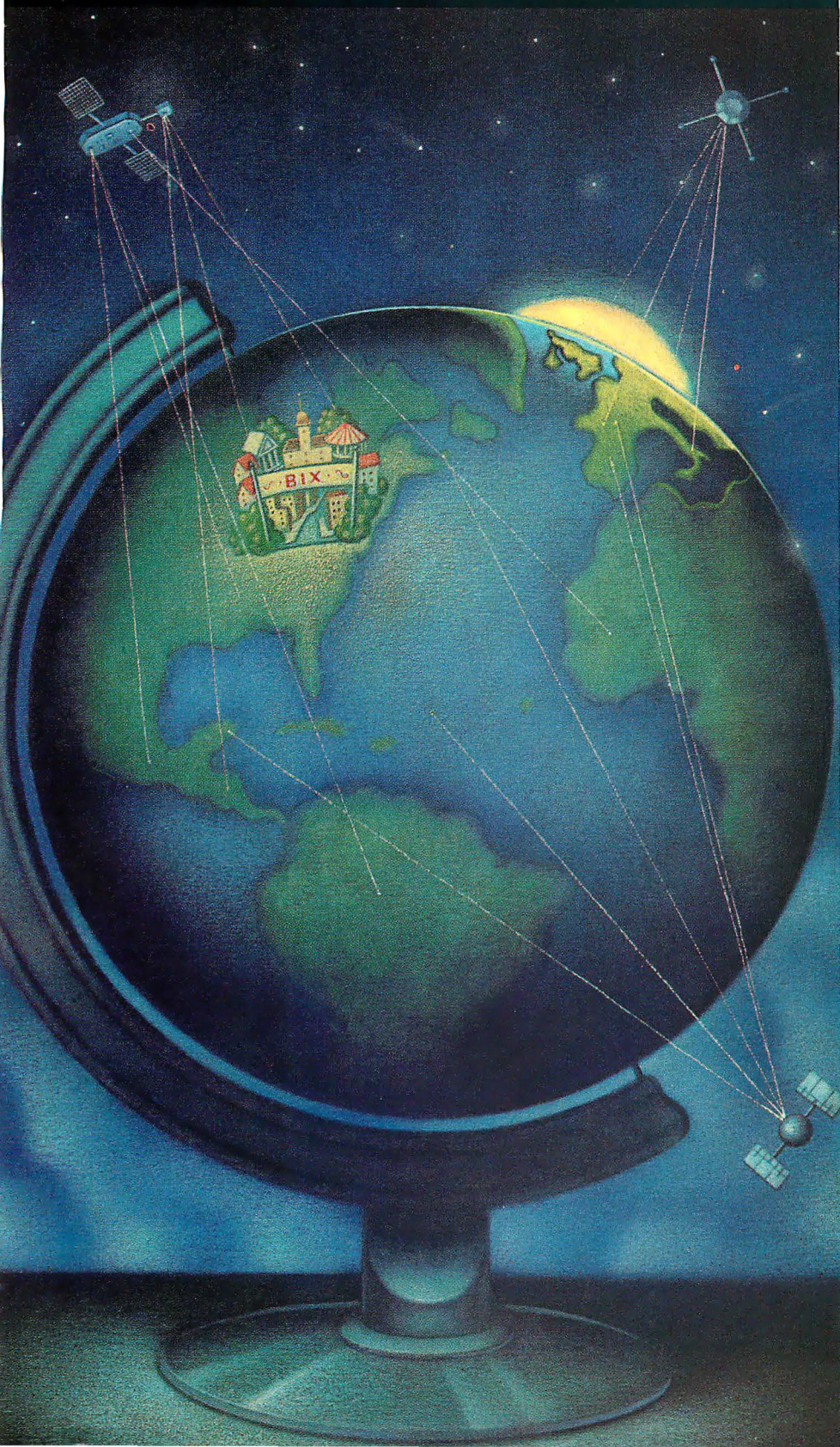
## Conference Round-Up

Exciting things are happening at BIX in these conferences:

- Aviation Find out about the supersonic airplane that rides its own shock wave. (join aviation/wave.riders)
- Gibson Research Gibson Research is now on line to answer your questions on Spinrite or hard drives. (join gibson-research)
- Tandy Discuss your Tandy Model 2000, or other models. (join tandy)
- DBMS Consider the relative merits of the Network model and the Relational model in DBMS design. (join dbms)
- Hamilton Discuss *BYTE* author Douglas Hamilton's new C Shell for OS/2. (join hamilton)



**BEAM YOURSELF  
TO A PLACE  
WHERE COMPUTER SAVVY  
ABOUNDS.**



■ Imagine a setting in which communal wisdom is on tap. A place that has the fit and feel of a small, friendly town, yet the sophistication and resources of a global community. One which you can visit electronically—to increase your knowledge of computers and their applications, hone your skills, share insights with thousands of other computer pros, and have fun. Such a community would be called BIX.

**Subscribe to BIX, the flat-fee, on-line information service.**

BIX is your access to industry news. And to many special interest Exchanges—such as our *Amiga*, *IBM*, *Mac*, *Writers'*, and *Interactive Games* Exchanges—which include thousands of free, downloadable programs. All for just \$39 per quarter.\*

**Subscribe via your computer...**

Set your program for full duplex, 7 bits, even parity, 1 stop bit. Call BIX on our registration-only number: 800-225-4129. In MA: call 617-861-9767. International: call NUI310690157800. Then hit the return key, and respond:

<b>Prompt:</b>	<b>You Enter:</b>
login	bix
Name?	bix.ville

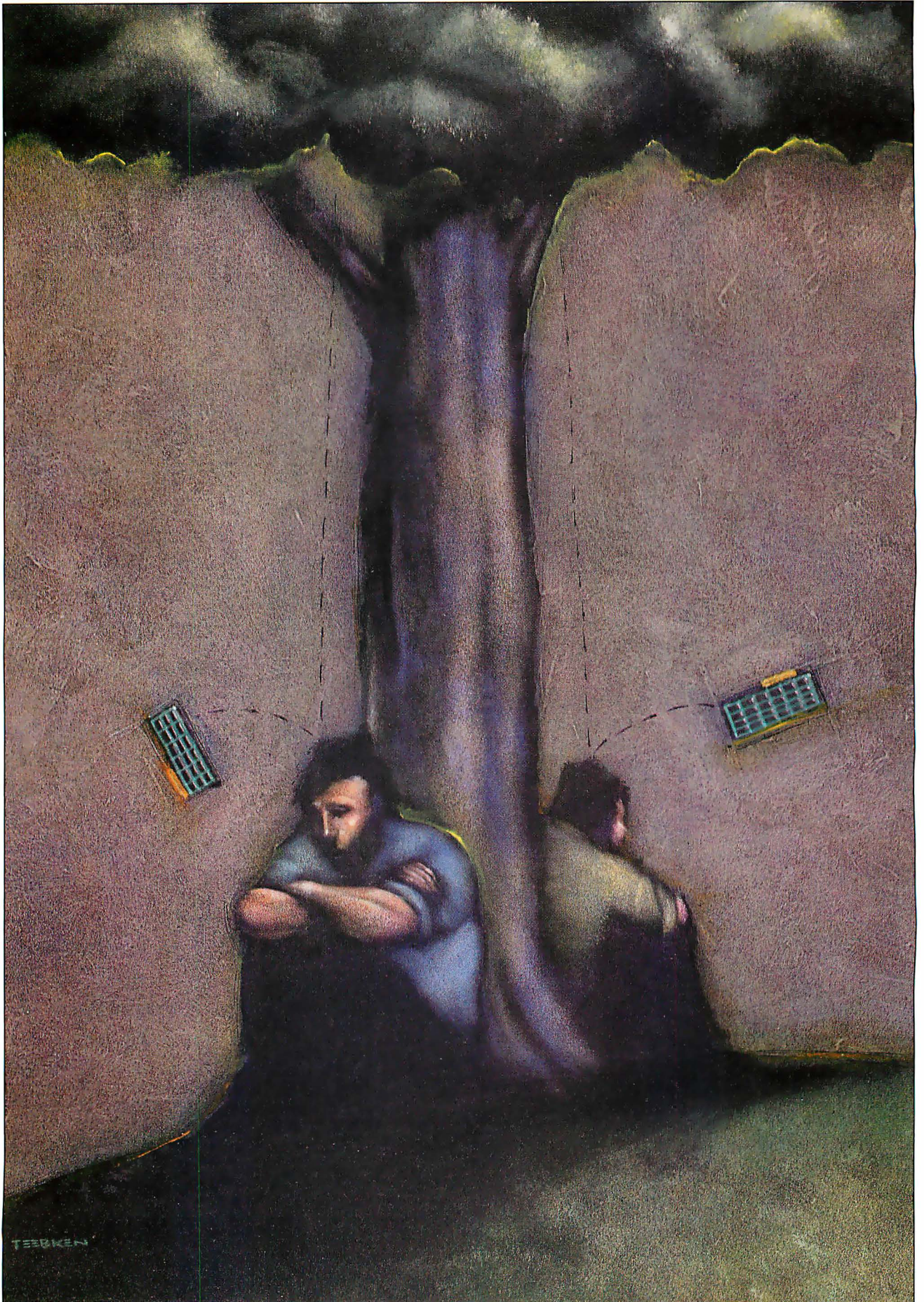
You may buy off-peak access via *Tymnet* at \$20 per month or \$3 per hour, or you may buy peak access at \$6 per hour.\*\*

\*Based on a \$156 annual fee, billed quarterly. Telecommunications charges are extra. You may cancel at any time without future charges.

\*\*Available only in contiguous 48 states. *Tymnet* rates subject to change.

800-227-2983 • In NH 603-924-7681

**BIX**



# MICRO, MICRO: WHO MADE THE MICRO?

*A lone California inventor says he did,  
but not everyone agrees*

*BYTE Staff*

**I**n the days to come, Gilbert Hyatt could become either a very rich man or just a footnote in computer history books.

Hyatt, an obscure 52-year-old systems designer, electronics engineer, and aerospace consultant, lives in La Palma, California. On July 17, 1990, after a 20-year battle with the U.S. Patent Office, Hyatt was granted patent #4,942,516 for a "Single Chip Integrated Circuit Computer Architecture." According to Hyatt, the patent establishes him as the man who invented the microprocessor—in contrast to popular belief, which credits engineers at Intel and Texas Instruments (TI) with the invention.

The announcement of Hyatt's patent grant triggered immediate and widespread controversy in the computer industry, not to mention the stock market. Although industry watchers say it's still too early to predict what effect the Hyatt patent will have on the computer industry, most agree that it could be enormous.

Hyatt's patent is sure to face challenges from the big guns in the semiconductor industry. If it can successfully survive those challenges, even minimum royalties could amount to some several hundred million dollars a year. Although Hyatt, who says he plans to set very reasonable fees for the use of his invention, will not receive retroactive royalties, he would earn proceeds from his brainchild for the next 17 years.

Currently, Hyatt is negotiating a joint-venture agreement with a "major American corporation that has an integrated circuit division." This firm, says Hyatt, proposes to take a license on the patent, to assist with financing, and, with its licensing capability, to license the patent to others. Hyatt says he won't sell the microcomputer patent. "I'm not giving it away. The joint venture is more a license for them and a little bit of technology exchange. We're negotiating with licensees now who have approached us."

While many have expressed their delight in seeing a lone-wolf industry engineer granted a patent for an invention with such all-encompassing ramifications, others look at Hyatt's pronouncements somewhat skeptically. Tyler Sperry, editor of

*Embedded Systems*, comments, "Hyatt is a media darling. He's very carefully searching for a patron—if he doesn't get a major company to sponsor him, he's dead." Bruce Koball of the *Microprocessor Report* agrees, "This guy has nothing by himself. Either the Japanese buy in and use it against America, or vice versa."

## **In the Beginning**

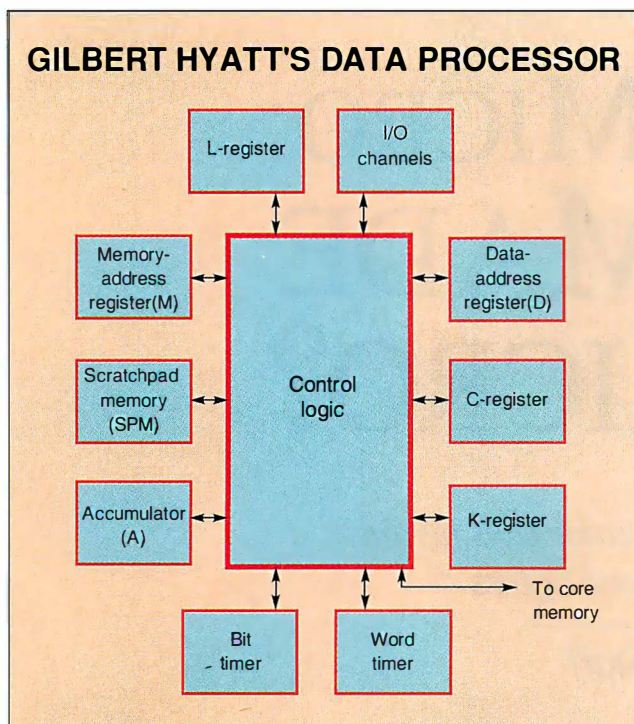
Where did Hyatt—who until recently was virtually unknown in the industry—come from? In 1955, Hyatt graduated from Long Beach Poly High School. He attended Long Beach City College for two years and finished his B.S.E.E. degree at the University of California at Berkeley. In 1963, after working in industry for a few years, Hyatt began working at Hughes Aircraft and going to school part-time. He obtained his M.S.E.E. in 1965 and later joined Teledyne as a research scientist.

In 1968, according to Hyatt, he built the first breadboard for a new type of small computer in his home. "I trademarked the name *microcomputer*, because it was a computer smaller and more efficient than the minicomputer."

Hyatt formed a company called Micro Computer and built his first working computer later that year. He obtained venture capital financing from several sources, including Robert Noyce and Gordon Moore, both of whom were to play important parts in the creation of the microprocessor. "We had brought in—or I should say, the finder for the financing brought in—Dr. Noyce and Dr. Moore, the Intel founders," says Hyatt. "Essentially, we needed access to a chip-making capability so that we could put my computer on a chip." (See the text box "Hello, Mr. Chips?" on page 308.)

The "effective date" of Hyatt's patent filing is December 28, 1970, for a computer on a chip—the microcomputer having a CPU, operand memory, and ROM on an IC chip. The figure on page 306 shows a block diagram from Hyatt's patent, showing the data processor.

In 1971, after a dispute over Hyatt's refusal to assign the financial backers rights to his patents, the firm went out of busi-



*This block diagram, from the patent granted Gilbert Hyatt, shows the components of his data processor. The basic timing functions derive from bit and word timers. Basic arithmetic happens in the A register. The C, K, and L registers handle instructions and control. The M register is used to address main memory. The SPM registers provide intermediate storage independent of the main memory. The I/O channels move data to and from registers.*

ness. Noyce and Moore went on to become founders of Intel.

As most Silicon Valley history books tell it, the development of the first commercial microprocessor in the early 1970s was the result of work done by a team of Intel engineers led by Ted Hoff and Federico Faggin. Intel named its chip, which began shipping in late 1971, the 4004. In 1971, TI and engineer Gary Boone also were working on the development of primitive microprocessors.

So what's the connection between Hyatt, Hoff, and Faggin? According to Hoff and Faggin, they never heard of Hyatt until the recent announcement of his patent grant (see the text box "... This Is Intel on the Line" on page 309). Nevertheless, the Intel connection is hard to discount completely. According to Thampy Thomas, president of NexGen Software, "There are so many factors for the microprocessor—and who invented it—that it is difficult to count them. One interesting aspect is the folklore. [Hyatt's] company had the name Micro something in it before there were such things, and Bob Noyce and Gordon Moore were investors. That's interesting."

### Slowly Grinds the Wheel

One of the biggest problems in proving the validity or nonvalidity of Hyatt's claim is the way patent applications are handled in the U.S. Patent filings are kept secret and only revealed when the patent is granted. In other countries, after a certain amount of time passes and while the application is still in process, the contents are revealed to the general public.

The granting of Hyatt's patent came as a complete shock to

almost everyone in the electronics industry. Had it been known years ago that there was a contender for a patent on the microprocessor, evidence could have been saved, gathered, and presented for claims pro or con. But it is almost impossible 20 years later to go back and prove or disprove Hyatt's claim. This fact has led many to suggest that our patent system procedures be changed to handle such difficult cases.

Why did it take the Patent Office 20 years to approve Hyatt's patent? The broad-based nature and vast implications of his invention were the reason, says Hyatt. "The Patent Office gave [the patent] quite a bit of scrutiny and was very, very careful." Part of the reason for the extremely lengthy and long-drawn-out (even for the Patent Office) process is that Hyatt experienced at least seven continuations during the procedure, and the government twice rejected his patent. Both times Hyatt appealed his case before the U.S. Court of Appeals for the Federal Circuit.

"The decision the Court of Appeals made 2½ years ago clarified the issues and pointed the way to getting them resolved," Hyatt says. "However, they did not issue the patent then. We had to refile it and resolve the issues in the new filing. But the new filing still has the benefit of the 1970 'effective' filing date."

Hyatt's original filing attempts on the recent patent were made sometime in 1969, but, according to his longtime patent attorney, Gregory Roth, the original applications may not have conformed to the Patent Office's prescribed format. Thus, the effective filing date of December 1970 is the date when Hyatt's patent application, first complying with the office's requirements, was accepted.

In the late 1970s, Hyatt was involved in some patent-related litigation with toymaker Mattel over whether its electronic games infringed some of his patents. A federal judge threw out two of Hyatt's patents, ruling that Mattel had not infringed them. This verdict was upheld on appeal.

### In Defense of a Patent

But there's a vast difference between getting a patent and enforcing it. What are Hyatt's chances of getting any money from some of America's largest corporations?

Michael Slater, editor of *Microprocessor Report*, says, "On the surface, the patent does indeed cover at least every single-chip microcomputer, and potentially a lot of systems that are not single-chip. It may be so broad as to cover anything that has a processor, ROM, and RAM. But I'm not at all convinced that if you look hard, you won't find other people that documented the same ideas at an earlier time. They may not have filed any patent claims, though."

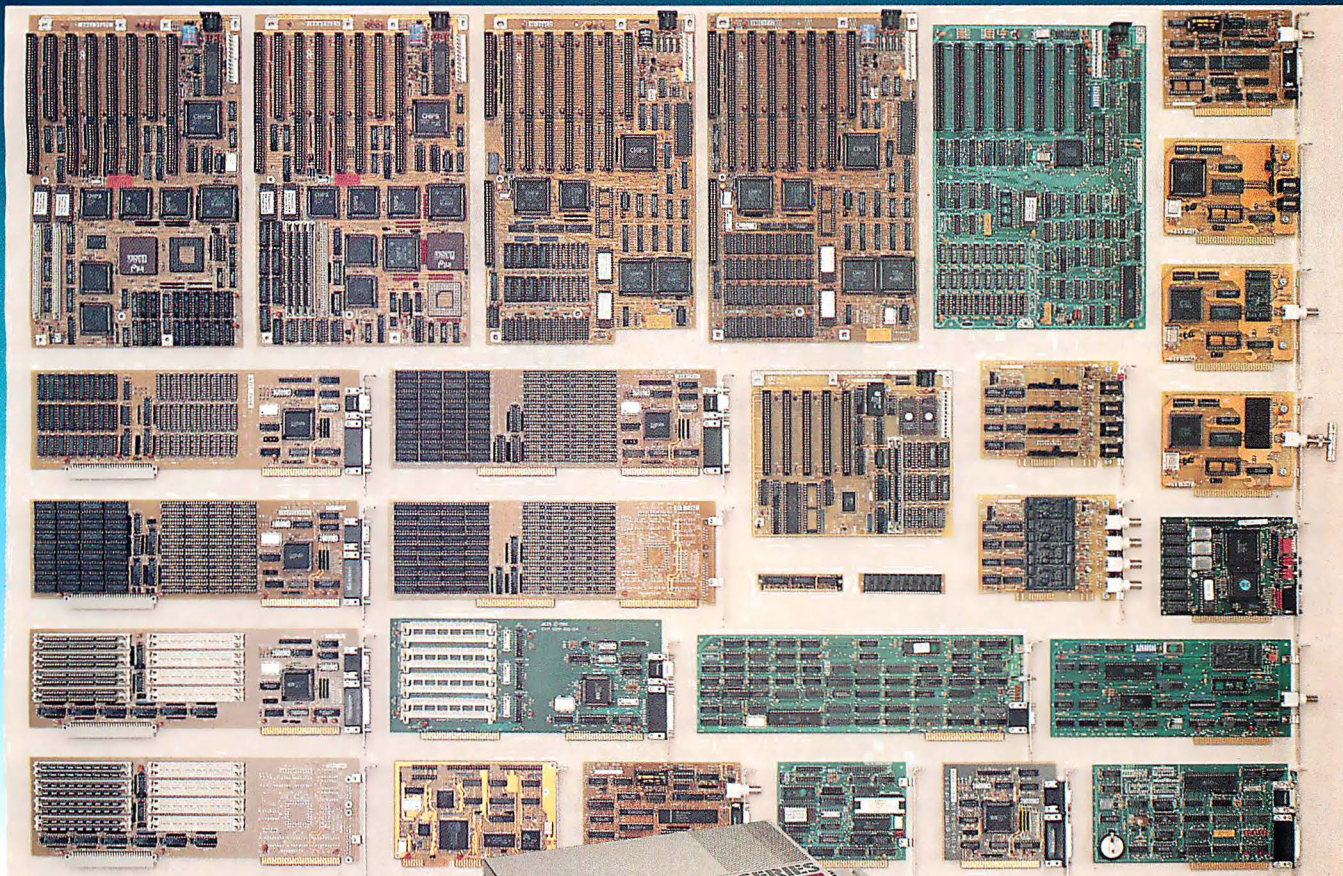
According to Slater, the biggest challenge Hyatt could face is that he's grossly outgunned. "In reality, I think he's going to have a very long, hard battle in collecting any significant royalties," Slater says. "We have an individual inventor here who's written his own patents, and he's up against many of the largest companies in the United States. They can probably keep him in court for the rest of his life. If he makes it relatively inexpensive for people to pay him, though, then maybe they'll decide just to pay him instead of incurring the expense of fighting it."

Gary Hecker, a Los Angeles attorney who wrote Quarterdeck's patent on multitasking technology, says that there are several provisos concerning the Hyatt patent. "If the patent is valid, if it was infringed upon, and if it's asserted, then Hyatt might have a strong case. But there's going to be a lot of [scrutiny] by all parties involved. The industry won't simply roll over without very careful examination of this exhaustive file history. Of course, any litigation on a case like this would cost millions of dollars and take years."

*continued on page 311*

# JC BOARDS,

## WORLD CLASS HIGH PERFORMANCE PRODUCTS



**P**ictured above is a portion of the products made by JCIS. Our factories in California have been producing boards for VARs and OEMs since 1979. These boards have been designed by JCIS for performance and reliability.

Our boards are used by OEMs worldwide as the basis for many of their own systems. More than 1/4 million end users are using JCIS designed products. More than 450 dealers offer our boards and systems to their clients.



JC Information Systems Corp.  
*High Performance Company Since 1979*  
161 Whitney Place  
Fremont, CA 94539  
Tel: (415) 659-8440  
FAX: (415) 659-8449



Our experienced engineering staff have designed-to-spec, many products using the latest technology, for OEMs that do their own manufacturing. And we can provide you as well, with a design that offers world class performance.

Call or FAX for a complete catalog of our current products. Experience the extraordinary quality, performance and engineering that goes into each JCIS product.

## Hello, Mr. Chips?

*An interview with Gilbert Hyatt, the man who currently holds the cards in the microprocessor game.*

**BYTE:** *What was the technology environment when you began work on the microprocessor? What were the technological forces that motivated you?*

**Hyatt:** There were two basic disciplines with problems that needed addressing. The microcomputer was a bridging technology that solved the problems in both of these disciplines.

The first was the integrated circuit discipline where they had just come up with LSI and were looking for ways to solve some horrendous problems that were preventing LSI from becoming widely used. The second was the computer discipline where the technology had sort of stalled at the minicomputer level. The old computer architectures did not permit them to make significant advances or take full advantage of the LSI technology.

Minicomputers used core memories that could not be miniaturized. They were working on monolithic ferrite memories that don't have the problems of core memories and were incompatible with the LSI technologies.

Literature is full of IC experts crying about all the problems with LSI—getting it to market and building systems with LSI. There was a well-known limitation on ICs that was called the gate/pin ratio. The microcomputer is quite different. A computer is an architecture that you can add a lot of memory to and not increase the pins. It is a heavily time-shared type of device with an I/O channel or bus or multiple channels so you really don't have to increase the number of pins even if you substantially increase the number of gates.

Another unsolvable problem with LSI was custom chips. When you build a logic gate, everyone can use it, because they all use gates. However, when you interconnect 100 gates, you get a very specialized device that maybe only one company can use for one product. It no longer is a general-purpose-type device. The more gates you interconnect, the more special-purpose the device gets.

I was convinced that we were on the threshold of some major technological



*Gilbert Hyatt, an obscure southern California engineer, may have changed history. He waged a 20-year process that resulted in his being granted a patent for the creation of the microprocessor.*

advances, and I knew that I could come up with a solution to the problems and help with that revolutionary change. I was more technology- and problem-driven at the time.

**BYTE:** *Exactly what does your patent cover?*

**Hyatt:** This patent application/disclosure has 30 or 40 different inventions in it. Patents have already been issued on several of them.

**BYTE:** *Does the patent recently granted cover a microprocessor or a microcontroller?*

**Hyatt:** Well, I have claims—which are legal descriptions—being interpreted by laypeople, and certainly you come up with a lot of misinterpretations. The broader claims have three features.

Claim 1 has a read-only memory, an alterable memory, and a processor. If you find a computer chip that has a ROM on it—and there are a lot of nonmicrocontroller chips that have ROMs—and if you have alterable mem-

or, like registers, and certainly a processor, then you invoke claim 1. So that goes far, far beyond microcontrollers.

Many of the claims are not limited to a single chip and therefore can cover multichip configurations. For example, claim 36 and many of the claims subsequent to that are more general microcomputer-related claims that do not require a single-chip implementation.

**BYTE:** *Did you actually produce a device or product?*

**Hyatt:** There was a whole range of computers. The first one was the breadboard—a fully operating hardware developmental model that I built in 1968. Then starting in 1969, I began building prototypes that used printed circuit wiring and continued with prototype development and pilot production through the 1971 time frame when the company went out of business.

The funder for the financing brought in Dr. Noyce and Dr. Moore, the Intel founders, in order to give us access to a chip-making capability so that we could put my computer on a chip. However, as you know from history, that never panned out. They did build micros, but not for me.

**BYTE:** *Is it true that Ted Hoff received a patent for a microprocessor?*

**Hyatt:** No, it isn't. Hoff received a patent in 1973 on a coder circuit on a RAM chip that happened to be in a microprocessor environment. That is the novelty that he addressed. That was the case that was filed in 1973 and [the patent that was] issued about a year later—a Hoff, Faggin, and Mazor patent.

**BYTE:** *What about Texas Instruments?*

**Hyatt:** TI patented a calculator chip, and now there's a challenge as to whether Gary Boone, the inventor named on the patent, really developed it, or whether TI got the design from somewhere else. There is no challenge to my patent right now.

**BYTE:** *It's been mentioned in the press that you're working on an agreement*

*continued on page 310*

## ... This Is Intel on the Line

*Ted Hoff, Federico Faggin, and Stanley Mazor, creators of the first commercial microprocessor (the Intel 4004), have been credited with fathering the microprocessor. We spoke with Hoff and Faggin to get their response to the Hyatt patent. Here's what they had to say.*

**BYTE:** *In our interview with Gilbert Hyatt, he stated that your patent—which we understood to be for the creation of a microprocessor—was for a coder circuit on a RAM chip in a microprocessor environment, and not a microprocessor per se. Comments?*

**Hoff:** That isn't quite true, but Intel did take a rather casual attitude toward filing for a patent on the microprocessor. Rather than concerning ourselves with filing for a patent, we focused our application on the techniques that made our chip feasible and devoted our efforts to actually making the first microprocessor—the 4004. It was formally proposed to a Japanese firm [in] September 1969 as an alternate to a calculator chip set that it wanted Intel to build.

My contribution was the architecture and the instruction set. Stanley Mazor also made contributions. Federico Faggin, who joined Intel in April 1970, did the detailed circuit design and layout. I believe the processor ended up containing just over 2100 transistors. Based on the number of transistors needed to produce Hyatt's processor, it wouldn't have been practical at that time.

**BYTE:** *How can you draw that conclusion?*

**Hoff:** I've seen the Hyatt patent. There were so many aspects of chip design that needed to be considered in those days, which were not addressed in the Hyatt patent. In the specifications portion of the patent application in the December 1970 filing, Hyatt made no mention of a single-chip implementation.

Hyatt used the term "monolithic" but defined it as meaning using semiconductor memory rather than core memory. That's different from today's meaning of all-on-one-chip. One claim out of 80 in that application cites a computer with RAM and ROM on one chip. In March of 1970, nine months before

Hyatt's application, I published an article stating that it was feasible to produce a central processor on one chip. Previous articles had discussed "computers on a slice" but concluded they weren't yet practical.

**BYTE:** *But does this fact preclude his having been the first one to apply for a patent, just because it was previously mentioned in a reference?*

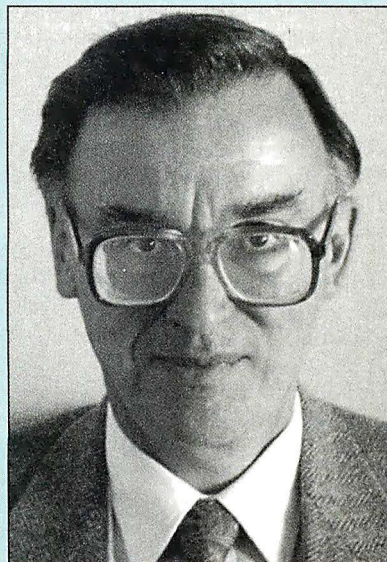
**Hoff:** Generally, you can't file for a patent on something that has been public for a year or more. Also, you aren't supposed to file on someone else's work, but it's all right to file on unique additions or refinements to prior work.

By 1970, putting a computer on a slice of silicon had been discussed for several years. One such article appeared in 1964, but the author felt process yields needed to be improved to make [the process] practical. My 1970 article noted that the process had advanced to the point where a central processor of sufficiently small size could be done as a single chip. A real issue for Hyatt's patent would be, "Was it an enabling disclosure?"

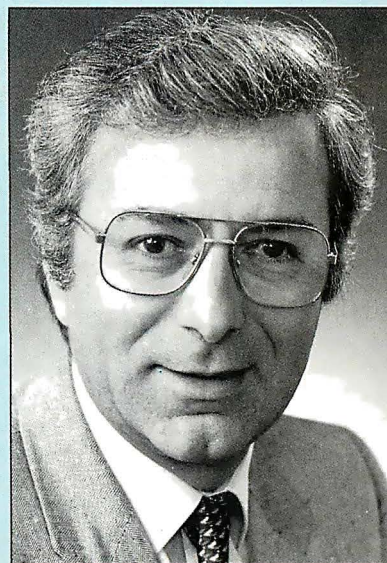
**BYTE:** *An enabling disclosure?*

**Hoff:** A patent is supposed to tell one who is of ordinary skill in the art how to duplicate the invention without undue experimentation. If the invention is a computer on a chip, the patent must tell how to do that using available technology. As recently as 1988, the U.S. Court of Appeals turned down Hyatt's application for not being enabling.

Hyatt's main argument was that he was able to build his computer on two-sided printed circuit boards and that this fact was sufficient proof that the computer could be built as a single integrated circuit. The differences between integrated circuits and printed circuit boards were totally overlooked. As examples, there is no mention of process choice, or the effects of interconnection resistances, which are higher on integrated circuits by orders of magnitude. Coupling between elements of an integrated circuit can be a much more significant problem than on printed circuit boards.



*Ted Hoff*



*Federico Faggin*

At one point, Hyatt claimed he would use discretionary wiring, a technique promoted by Texas Instruments in the late 1960s. Discretionary wiring was based on fatally flawed assumptions, which even a few authors of that era recognized. Over the years, Hyatt made changes in the specifications of his patent. The 1970 application was for something he called a "factored computer."

**BYTE:** *What was that?*

*continued on page 310*

## Hello, Mr. Chips?

*with some company, unnamed at this point, concerning licensing the rights.*

**Hyatt:** Right now, there's a joint-venture relationship with a manufacturing company. It proposes to take a license on my patent, then to assist with financing, and, with its licensing capability, to license my patent to others.

**BYTE:** *What impact do you believe the granting of your patent and its issuance will have on technology? Do you believe that as a result, technology will speed up, slow down, or keep the same pace?*

**Hyatt:** I think it will have a profound impact on the technology, because as a royalty flow is generated, I will turn those funds back into the technology for the next-generation products. Inconsequential royalty percentages won't have any significant impact on the current products but will have a significant effect on speeding up the introduction of the new-generation technologies.

As the excellent patent environment continues and patents are shown to be a good protection for intellectual properties, you will find a lot more people put-

ting a lot more money into R&D. Now they can protect their R&D better, and they may even be better able to let the R&D pay for itself by licensing it. The whole industry will benefit.

**BYTE:** *Can you explain to us briefly what your DRAM-performance-enhancement technology is all about?*

**Hyatt:** As you know, DRAMs are the backbone of the computer industry. They're dense, they're low in cost, and they support memory-intensive types of applications. However, they are slow. There are two ways that have been used to adapt to them. One is typically to slow down the microprocessor with wait states, and the other is to use cache memories to provide a higher-speed interface. Both of these are undesirable solutions. The ideal situation is to get a faster main memory.

Depending on the application, the DRAMs using my architecture can run approximately three times as fast as they would in conventional memory architectures. Most of the row addresses (the slow portion of the cycle) are unnecessary. I developed a circuit to detect when a row access cycle is redundant. Because I'm minimizing the num-

ber of row address cycles, we are not as row address insensitive and therefore can relax the design constraints on row addressing and take a little more care speeding up the chip select and the column addressing.

**BYTE:** *Tell us about the work you are doing on your "twenty-first-century computer."*

**Hyatt:** My work gets into the physio-visual aspects of the human mind, what the mind responds to, how best to communicate large amounts of information to an operator, and how to implement systems that can facilitate that type of communication.

For example, productivity of operators increases as their systems approach real time, and when you reach full real-time operation, you have significant improvements in operator productivity. That situation has to do with the operator's mind being able to concentrate better and interact better with the machine.

Vista has nothing to do with OSes and application programs. It's a hardware implementation that taps the inherent visual capabilities of the mind and implements systems that facilitate that type of communication.

## ... This Is Intel on the Line

**Hoff:** It appeared to be a form of distributed computer. There is no mention in the specifications of a single-chip implementation, and just one of 80 claims mentioned a single chip. That claim was amended in 1972, deleting the single-chip reference. His 1973 filing, however, restored that single-chip computer claim. In 1974, he amended the specifications, changing the title to "Monolithic Computer."

Even with the changes of 1974, the specifications of his application still did not say anything about a one-chip implementation. It wasn't until 1978 that Hyatt added a single-chip reference to the specifications. Even then, there was still no information about what considerations needed to be made for one-chip implementation. His writings, even to the present, give no consideration to most of the factors that went into designing a complex integrated circuit.

For example, Hyatt's patent calls for an 8-MHz clock. Our 4004 target specification called for a 1-MHz clock. Federico Faggin was an outstanding designer—if anyone could have gotten the speed up to 1 MHz, he could have. But he ended up with only about 800 kHz.

In addition, Hyatt's system needed to handle paper tape at 1000 characters per second, plus maintain a multiplexed display. It is not at all clear, especially because his was a serial processor, not parallel like the 4004, that his system would have been functional if it had had to be slowed by a factor of eight or more.

The processor that's described in his patent uses 512 bits of shift-register scratch-pad memory. Implementing that scratch-pad memory and his processor logic would have taken about 10,000 transistors. Adding the amount of main memory he specifies would require at least 35,000 more. Using favorable yield models and assuming defect densities that would have made a 4004 die cost \$5, the average cost of one of his chips would have been about \$1 million. These are some of the reasons I don't believe his chip was feasible in 1970.

**BYTE:** *Did you know him at the time? When you and Faggin were working on your microprocessor, had you ever heard of him?*

**Hoff:** No, I didn't. I had never heard of him.

**BYTE (to Federico Faggin, currently**

*president of Synaptics, Inc.): What do you think about Gilbert Hyatt's patent for the microprocessor?*

**Faggin:** A patent is supposed to teach people skilled in the art how to do something novel. Hyatt's patent is more like a prophesy. You need more than a prophesy to patent something. You have to show something that is possible to do with the existing technology—a model has to be realizable. His patent shows integration into a single chip of ROM, RAM, and CPU. The technology to do that was not around at that time.

Our patent patented certain novel aspects of the 4004 so that Intel would have something to protect. This whole thing starts with the thought that the microprocessor was an invention. The microprocessor is not an invention. It is an implementation, a realization. Like going to the moon isn't an invention—it's a realization. To speak of the inventor of the microprocessor is absolutely wrong. This whole thing seems preposterous to me. There is no way that that patent could stand up if challenged.

Nobody heard of him for 20 years and then after all the industry had been created by other people, he comes up with this patent. I never heard of him.



Hyatt, however, states unequivocally that his patent will be upheld, saying, "There is no challenge to my patent right now, just a lot of discussion in the media, to a large degree by people who are not professionals. The Patent Office and Court of Appeals have addressed every conceivable issue that could possibly arise, and we've survived them."

In fact, says Hyatt, his patent may be used to help smaller companies fend off patent suits from larger semiconductor companies. TI, which received a patent for microprocessor work done by its engineer Gary W. Boone, has been aggressively pursuing royalty payments from a number of companies, including Zenith Data Systems. "My patent is probably the best 'prior art' against the Boone patent. I recently announced that I have agreed to be a technical expert and, in fact, witness for Zenith against TI."

### Questions That Beget Questions

Many people think that Hyatt's patent has a good chance of standing up to any challenges that are levied against it. But others are posing significant questions and concerns about the validity of his claim.

To be granted a patent, you do not have to turn an idea into an actual product. However, you must describe how to build your creation accurately and clearly enough that others can do so.

Hyatt says that his company did produce some devices as a result of his early work. "There was a whole range of computers. The first one was the breadboard, a fully operating hardware developmental model. I built that in 1968." Hyatt says that starting in 1969, his company began building prototypes that used printed circuit wiring and continued with prototype development and pilot production through 1971, when the company went out of business.

Still, some are asking whether Hyatt revealed enough information in the patent for "one ordinarily skilled in the art" to be able to produce a microprocessor.

Michael Slater comments on this issue, "His patent doesn't describe how to reduce his invention to practice. Furthermore, I believe that an aggressive search will turn up extensive prior art. Hyatt had some fairly straightforward ideas that many other people were working on at the same time. He spent his time and energy writing patent applications and fighting with the Patent Office, while others made the microprocessor a commercial reality."

Another issue is that of allowable changes to the patent. According to Gregory Roth, at the time of the patent's effective filing, its title was "Factored Data Processing System for Dedicated Applications." Hyatt says the title "Data Processing System" preceded this title, but the Patent Office asked that he change it to a more specific description. The title of the granted patent is quite different: "Single Chip Integrated Circuit Computer Architecture."

How much change can you make in a patent application from beginning to end? "Only minor corrections," says Roth. A patent's title is different, however, states Hyatt. "A patent can be amended as long as there is no new matter entered. But changing the title does not make it new matter if the new title finds a basis in the rest of the application."

"The Patent Office restricts patents to a single invention and requires the filing of continuation patent applications on the different inventions. It also requires a descriptive title on each. In addition, the title and the abstract have no legal significance—they are only descriptive to generally show what the claims are directed to."

There also are requests for clarification concerning the extent of Hyatt's changes to his original patent application, to



# Reading worth writing for.

If you're looking for some good reading, you've just found it. The free Consumer Information Catalog.

The Catalog lists about 200 federal publications, many of them free. They can help you eat right, manage your money, stay healthy, plan your child's education, learn about federal benefits and more.

So sharpen your pencil. Write for the free Consumer Information Catalog. And get reading worth writing for.



**Consumer Information Center  
Department RW  
Pueblo, Colorado 81009**

A public service of this publication and the Consumer Information Center of the U.S. General Services Administration.

## MICRO, MICRO: WHO MADE THE MICRO?



Industrial Control Systems  
LAN Terminals  
Diskless Systems

# ROMDISK™

For the IBM PC, XT,  
AT PC DOS\* or MS DOS\*

## SOLID STATE DISKETTE AND DRIVE EMULATORS FOR DISKLESS SYSTEMS

- Diskless systems with local DOS and program storage for client LAN terminals, and embedded and industrial control systems.
- Single or dual disk emulation of 5¼" or 3½" diskettes.
- EPROM, Flash EEPROM and SRAM technology. Flash EEPROM models are electrically erasable. SRAM models are battery backed. EPROM models are ultraviolet erasable.
- On-board EPROM programmer—simply copy a diskette to program the EPROMs or Flash EEPROMs. Flash EEPROMs remotely programmable on LANs.
- Two Autoboot modes, a File (read) and a Programming mode—automatic disk drive designation set-up during booting.
- Utilities and Users Manual included.
- List prices from \$195. OEM prices available.

 **CURTIS, INC.** 2837 North Fairview Ave. • St. Paul, MN 55113  
612/631-9512 • Fax 612/631-9508 

\* IBM PC, XT, AT, PS/2 and PC DOS are trademarks of IBM; MS DOS is a trademark of Microsoft

# Are you looking into other peoples' Windows?

Write your own Windows™ 3.0 applications  
Quickly and Easily with Software Engineer™.

- A complete LISP programming environment including a LISP-aware program editor.
- Supports Dynamic Data Exchange (DDE) at a higher level than the SDK. Create both client and server applications.
- Supports GDI, the clipboard, dialog boxes and menus.
- Sample programs supplied include DDE sessions with Microsoft® Excel and Micrografx™ Charisma®.
- Requires 386-based or fast 286-based machine and Windows™ 3.0.

## \$249.95

To order Software Engineer  
or for more information,  
Call (214)234-2611  
or FAX (214)234-2674

  
**RAINDROP  
SOFTWARE**

845 Arapaho Road • Suite 105 • Richardson • Texas • 75081  
Some names mentioned above may be trademarks or registered trademarks of their respective holders.

cover new technology that might not have been available when he made his original filing. Hyatt says, "My objectives were to solve LSI [large-scale integration] problems, including chip customization, gate-to-pin ratio limitations, monolithic interconnections on the chip, quantity of transistors on the chip, and number of pin-outs. I also wanted to better apply LSI in computers and in systems. The solution was my microcomputer—a fully integrated circuit computer."

Trevor Marshall, owner and president of YARC Systems, notes, "The U.S. Patent Office doesn't, and can't, do due diligence on patents—only internationally do they do it. A patent in the U.S. doesn't mean anything until it has been defended in court—unless you've got the money to enforce it."

"My prediction about the outcome," says Slater, "is that if Hyatt asks for any significant royalties, the patent will be challenged and overturned."

### The Next Round

The busy southern California engineer has a number of projects under way. In fact, he is the owner of some 50 patents. Hyatt's newest patent is for a DRAM-performance-enhancement technology he has developed. According to Hyatt, his method would let DRAM chips run about three times faster than they can in conventional memory architectures.

Another of Hyatt's current projects is something he calls a "personal computer for the twenty-first century." Although he will reveal little information concerning his new type of computer, he says that it will address the issues of presenting large amounts of information to users, with technology based on current understanding of the mind and visual ability.

"It's the tip of the iceberg of some of the technologies that I've been working on," says Hyatt. "There are many disciplines, and they all have to operate in concert to give the performance and the special features that I feel are necessary for the next-generation PC."

A look at Hyatt's previous work may provide some clues to his forthcoming project. In recent years, he has been carrying out research in the area of display technology, and he has a number of patents to show for it. Some theorize that Hyatt is creating a type of new display that lets the user communicate directly with the computer in real time.

### What Does It Mean to Me?

Hyatt would not reveal details of his pending agreement with the unnamed U.S. electronics firm, which could involve licensing his patent to chip manufacturers. However, typical royalty rates range from as little as 0.5 percent to 2 percent of revenues. That could add up to several million dollars of royalties for companies like Intel, Motorola, and others, if they decide to pay rather than fight. Those costs would undoubtedly be passed on to consumers, although the bottom line for computer buyers might not be that noticeable.

Hyatt says the royalties will help the computer industry rather than harm it, since the money will finance new ventures that will expand the U.S. technology base. Only time will tell whether patent #4,942,516 will yield enough money to fund Hyatt's new projects. But after 20 years, Gilbert Hyatt has proved that he is, above all else, a very patient—and persistent—man. ■

Contributors to this article include Janet J. Barron, Jeffrey Bertolucci, Howard Eglowstein, Owen Linderholm, Kenneth M. Sheldon, and Tom Thompson. You can reach them on BIX as "neural," "bertolucci," "heglowstein," "owenl," "ksheldon," and "tom\_thompson," respectively.

# CompUSA

**Fastest Shipping  
Largest Selection  
Best Customer Service  
Guaranteed Lowest Prices!**

## COMPU DYN E 286-16



80286, 16MHz  
0 wait state  
1MB RAM  
1.2MB 5 1/4" Drive  
IDE HD controller  
8 expansion slots  
**\$489**



12" Amber 14" VGA Color  
750 x 350 .41 dp 640x480

40MB 28ms	<b>\$859</b>	<b>\$1079</b>
71MB 28ms	<b>\$949</b>	<b>\$1169</b>
89MB 19ms	<b>\$999</b>	<b>\$1239</b>
124MB 19ms	<b>\$1059</b>	<b>\$1279</b>

Video Card Included!

## Leading TECHNOLOGY 6800SX



80386SX, 16MHz  
0 wait state  
1MB RAM  
1.2MB 5 1/4" Drive  
IDE HD controller  
DOS4.01  
**\$799**



12" Amber 14" VGA Color  
750 x 350 .41 dp 640x480

40MB 28ms	<b>\$1139</b>	<b>\$1359</b>
71MB 28ms	<b>\$1259</b>	<b>\$1469</b>
89MB 19ms	<b>\$1329</b>	<b>\$1539</b>
124MB 19ms	<b>\$1429</b>	<b>\$1639</b>

Video Card Included!

## COMPU DYN E 386-25C



80386, 25MHz  
0 wait state  
1MB RAM  
1.2MB 5 1/4" Drive  
IDE HD controller  
8 expansion slots  
**\$1149**



14" VGA White 14" VGA Color  
.41 dp 640x480 .31 dp 800x600

40MB 28ms	<b>\$1599</b>	<b>\$1789</b>
89MB 19ms	<b>\$1759</b>	<b>\$1939</b>
124MB 19ms	<b>\$1799</b>	<b>\$1979</b>
211MB 19ms	<b>\$2189</b>	<b>\$2379</b>

Video Card Included!

### Laptops

#### Arima ACT 286-410



12MHz 80C286  
VGA display  
Keybd detaches  
40MB 27 ms HD  
1.44 MB floppy  
**\$1949**

Toshiba T1000SE ..... Call  
Toshiba T3100SX ..... Call  
Megahertz T224  
2400bps modem ..... \$129  
PacRim 1.2MB ext. drive .. \$159  
TI TravelMate 2000 ..... Call

### Monitors

#### COMPU DYN E 14/800V



14" VGA Color  
800x600 res.  
.31 dot pitch  
**\$295**

Leading Tech 12" Mono ..... \$69  
NEC Multisync 3D VGA ..... \$629  
LTI 400V VGA 640x480 14" \$269  
CompuDyne 14/1024V  
1024x768 ..... \$349  
Sony 1304 VGA 1024 x 768 \$649

### Storage Devices

#### Seagate ST157A



40MB 28 ms HD  
IDE  
3 1/2" drive  
**\$239**

#### Hard Drives

Seagate ST225 20MB  
w/controller ..... \$228  
Seagate ST238R 30MB  
w/controller ..... \$239  
Seagate ST1102A 89MB .. \$489  
Seagate ST1144A124MB .. \$569  
Seagate ST1239A 211MB \$889  
Micropolis 1578-15 330MB \$1439  
Plus Development  
40MB Hardcard II ..... \$379  
80MB Hardcard II ..... \$659

#### Floppy Drives

Toshiba 5 1/4" 1.2MB ..... \$62  
Sony 3 1/2" 720K ..... \$55  
Sony 3 1/2" 1.44MB ..... \$62  
Pacific Rim 5 1/4" ext ..... \$199

#### Tape Backups

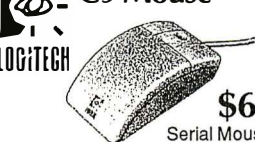
CompuDyne 60MB Int. .... \$229  
CompuDyne 120MB Int. .... \$319

### Miscellaneous

Plastic CPU Stand ..... 3.99  
I/O Boards  
Suntek I/O Extension  
AT Parallel/Serial .. \$33  
**Memory Boards**  
STB Rapidmg AT OK ..... \$159  
**Math Co-Processors**  
Intel 80287-8 ..... \$189  
Intel 80387SX ..... \$285  
Intel 80387-20 ..... \$365  
Intel 80387-25 ..... \$459  
Copy II PC Deluxe Board .. \$102

### Accessories

#### C9 Mouse



Genius Dynamouse 6000 ..... \$29  
Microsoft Serial Mouse ..... \$84  
Kraft KCIII Joysticks ..... \$14  
CH GameCard ..... \$33  
Logitech ScanMan+ ..... \$165  
CH Flightstick ..... \$39  
Complete Page Scanner .... \$689  
Niscan GS Hand Scanner .. \$199

### Software

Over 500 titles, including:  
**Windows 3.0**



Newest version of Microsoft Windows  
**\$85**

Microsoft Word/Windows .... \$279  
PFS: Professional Write 2.2  
w/Professional File ..... \$139  
WordPerfect 5.1 ..... \$244  
Lotus 1-2-3 2.2 ..... \$319  
Lotus Works 1.0 ..... \$99  
Microsoft Excel  
for Windows 2.1 d ..... \$298  
Grammatik IV ..... \$46  
Freelance + 3.01 ..... \$299  
Harvard Graphics 2.3 ..... \$269  
PageMaker 3.01 ..... \$479  
Ventura Pub. 3.0 / Windows \$499  
DAC Accounting 4.1 ..... \$76  
Quicken 4.0 ..... \$35  
Pacioli 2000 ..... \$27  
Microsoft QuickBasic ..... \$59  
Turbo C++ ..... \$125  
Check It 3.0 ..... \$78  
DesqView 386 2.3 ..... \$109  
Direct Access 5.0 ..... \$58  
Norton Utilities 5.0 ..... \$109  
PC Tools 6.0 ..... \$79  
QEMM 386 5.1 ..... \$52  
Act! 2.0 ..... \$209  
Calendar Creator Plus 3.0 .... \$35  
Carbon Copy+ 5.2 ..... \$107  
PC Anywhere IV ..... \$89  
Procomm Plus 1.1B ..... \$63  
Fastback Plus 2.1 ..... \$96  
Algeblaster Plus ..... \$27  
F-19 Stealth Fighter ..... \$37  
Battlechess ..... \$27  
Leisure Suit Larry ..... \$22  
PC Globe + ..... \$35  
Reader Rabbit ..... \$24  
SimCity ..... \$28  
Where in Time is  
Carmen Sandiego? ..... \$27  
TurboTax 1990 ..... \$39  
Sound Blaster ..... \$149

### Graphics Cards

#### ATI Basic VGA/16



16 Bit VGA  
640x480, 16 color  
Switchless install  
**\$75**

CompuDyne VGA 800  
640 x 480 ..... \$69  
CompuDyne VGA 1024  
1024 x 768 ..... \$95  
ATI VGAWonder256 Plus  
1024 x 768 ..... \$179  
Leading Tech MGP Mono .... \$24  
Leading Tech CGA Color .... \$25

### Printers

#### Star NX1001



9 Pin printer  
80 column  
180 cps draft  
75 cps NLO  
5 resident fonts  
**\$135**

Epson LX810 9-pin ..... \$169  
Epson LQ510 24-Pin ..... \$275  
Panasonic KX-P1180 80 col \$158  
Panasonic KX-P4420 laser \$789  
TI micro Laser PS17  
PostScript ..... \$1479  
Star NX1020 Rainbow ..... \$185  
Star NX2420 24-Pin 80 col \$289

### Modems

#### COMPU DYN E 2400i



2400 baud  
Internal modem  
Viscom software  
**\$59**

ATI 2400i w/MNP5 ..... \$145  
CompuDyne ext.2400 ..... \$69  
Complete Fax 4800 ..... \$139  
Cmpit Answering Machine .. \$219  
Complete Communicator ..... \$389  
Fremont Fax 96 ..... \$145  
Fremont 1 Liner ..... \$209

### Sony Diskettes

Bulk	Boxes of Ten
3 1/2" DS/DD (50) with sleeves \$25	5 1/4" DS/HD \$879
3 1/2" DS/HD (50) with sleeves \$49	3 1/2" DS/HD \$1399

### Switches, Surges

2-pos ser. switch ..... \$7.99  
6-outlet EMI/RFI  
Surge w/6'cord ..... \$6.99  
6-outlet EMI/Modem  
Surge w/6'cord ..... \$8.99  
Kensington Masterpiece ..... \$84

### Cables

**IBM Parallel Printer Cables**  
6 foot ..... \$2.29  
**Modem Cables**  
6 ft. 9-25 pin AT ..... \$1.99



CompUSA, Inc.  
1515A Surveyor  
Addison, TX 75244  
**1-800-932-COMP**  
Hours of operation (CST):  
Monday - Friday 8am - 7pm  
Saturday 9am - 4pm

**Guaranteed Satisfaction!**  
If you find a current lower advertised price in this publication, we will beat that price, guaranteed!  
No-Questions-asked 30-day money back guarantee on hardware. Money back guarantee does not include shipping.

All returns must be in "as new" condition, w/ original packaging, w/o modifications or damage. Returns require an RMA (Return Merchandise Authorization) Number.  
Defective Software exchanged for same item only. Defective hardware repaired or replaced at

CompUSA's discretion.  
Most orders placed before 2pm Central Time will be shipped same day.  
COD, Visa, Mastercard, Discover, Checks and Cashier Checks accepted. Texas residents add sales tax. Add 3% freight charges - min. \$5/order. Orders shipped UPS Ground - call for overnight freight charges.

Not responsible for typographical errors, errors in photography, or errors of omission.  
Prices and availability subject to change. Due to changing market conditions, call us toll free for current pricing and availability.

**Company Purchase Orders accepted upon credit approval.**

**NO CREDIT CARD SURCHARGE!**

**To Order Call 1-800-932-COMP or Fax (214) 702-0300**

# BREAK AWAY FROM HO-HUM MICE & SCANNERS!

Presenting DFI's CHS-4000 Color Handy Scanner<sup>®</sup> and DMS-400 Mouse



**D**epart from the humdrum of ordinary scanners and mice. Live up to the full power of communication with DFI's new CHS-4000 Color Handy Scanner and DMS-400 Mouse.

For the serious scanning enthusiast, the CHS-4000 scanner has a 400 dpi resolution, color gray scale output, PC Paintbrush IV+, among others. And the quality that you've come to expect from the company that started handheld scanning.

The DMS-400 Mouse is an opto-mechanical, three-button, 400 dpi mouse that is compatible with Microsoft and Mouse Systems mice through an easy hardware switch. Totally redesigned for maximum comfort and minimal fatigue, it's the world's most comfortable mouse.

Live up to your full creative potentials with DFI's CHS-4000 and DMS-400 Mouse. Who knows where it will lead you to?

Call or fax us today for more information.

Copyright 1990 DFI Inc. All rights reserved worldwide. All other product names mentioned are trademarks or registered trademarks of their respective owners.

## DFI<sup>®</sup>

West Sacramento, CA  
Tel: 916 373 1234  
Fax: 916 373 0221

East Brunswick, NJ  
Tel: 908 390 2815  
Fax: 908 390 2817

Miami, FL  
Tel: 305 477 1988  
Fax: 305 594 0607

West Germany  
Tel: 040 234 766  
Fax: 040 233 666

United Kingdom  
Tel: 81 462 9290  
Fax: 81 462 7538

Taiwan, ROC  
Tel: 02 543 3966  
Fax: 02 537 7458

Circle 87 on Reader Service Card

# ETHERNET: TEN YEARS AFTER

*The popular DEC/Intel/Xerox standard celebrates  
a decade of data sharing*

*Rich Seifert*



Imagine a world without networks: no Novell/3Com/TOPS, no clients, no servers. No Token Ring, Ethernet, or LocalTalk. No transceivers, wiring hubs, bridges, or routers. No TCP/IP, no Open Systems Interconnection.

That's the way it was back in 1980. Networks involved either proprietary point-to-point connections or leased lines from the telephone company, and 300-bps modems were standard. This was the environment in which DEC, Intel, and Xerox formed a partnership to develop a network standard, an effort in which I took part. We had to go where no LAN had gone before.

A blank sheet of paper is a scary proposition, but most engineers and product marketers rarely have to work with one. You're usually designing a product that is second- or third-generation—an incremental improvement on an existing concept, a logical extension of existing ideas.

Working on an established field of play can have its drawbacks, too, especially for established players. As Enzo Torresi (president of NetFrame Systems) has said, "The only reason God could create the world in six days was because He didn't have to worry about the installed base." Backward compatibility is the bane of the systems designer. You can't (or shouldn't) ship new products that don't interoperate with the products you shipped last year. It's a great way to lose customers.

We had no such problems with Ethernet in 1980. It was more than a clean sheet of paper—it was an empty book.

## **An Ethereal History**

In the early to mid-1970s, Robert Metcalfe and his group at Xerox's Palo Alto Research Center invented and implemented an early Ethernet system. The system was widely used within Xerox and became a key part of the company's Alto computer system (which was never sold commercially). The Alto was the basis for the later commercial Xerox Star and, in many ways, the Apple Macintosh. During 1979, Xerox, together with DEC and Intel, worked to transform the core Ethernet work done at PARC into a network standard, implementable in silicon and

suitable for volume use and manufacture by a wide variety of companies.

Employees from each of the three companies worked together from 1979 through to the publication of the version 1.0 specification in September 1980. Version 2.0 was published in November 1982. The major change in version 2.0 was the inclusion of standard network management capabilities. (For more details, see the text box "Ethernet Basics" on page 316.)

While the original technology was functional, it was not a complete design. The DEC/Intel/Xerox team solved the problems of building large networks, algorithm stability, electrical and system performance, installability, reliability, cost, and so on. The resulting design used the same basic principles as Metcalfe's prototype (it was still a CSMA/CD [carrier sense multiple access with collision detection] bus), but it bore few other similarities. The changes included electrical signaling, cable types, connectors, packet formats, CSMA/CD and back-off algorithm, cyclic-redundancy-check (CRC) calculation, system timing, and network management primitives. The result was a well-specified system (i.e., anyone could build a compatible product from the specifications) that could support all those applications that we thought about but that didn't yet exist.

## **It Didn't Come Easy**

It would be nice if a group of smart people could look at a problem, figure out the solution, write it down, and tell everyone about it. It would also be nice to win the lottery, but the probabilities of the two events are roughly equal.

The Ethernet *Blue Book* published in 1980 contained just the results of all the discussions, tests, mistakes, and negotiations that went on for more than a year before the release. There were more variations than you can imagine. At various stages in its development, Ethernet had preambles from 1 to 64 bits long, a variety of different collision-detection methods, 16-bit CRC, high-level data-link control (HDLC) framing (i.e., flag characters and bit stuffing), and address lengths of from 32 to 64 bits.

This last item is especially interesting. With a 48-bit address

## Ethernet Basics

Ben Smith

Is Ethernet that coaxial cable that connects the computers in a LAN, or is it what goes through the cable? Some of each: It is the *definition* of how the data is transferred, and also the definition of one of several possible physical media and connections: thick-wire Ethernet. Other variations, such as thin-wire Ethernet ("Cheapernet") and unshielded twisted-pair Ethernet (UTP—10 Base-T), are not really Ethernet. These are alternative IEEE 802.3 specifications for the physical layer.

However, networking is not so much about the wires (or fiber optics) that connect machines as it is about how the machines communicate—i.e., the protocol. The machines must be using the same set of rules to communicate.

The issue of what "the rules" are can become an intermanufacturer political and marketing issue. To solve such

issues, standards are developed by industry groups and committees such as the IEEE.

Ethernet is the former type of standard, made by industry groups. It specifies a CSMA/CD (carrier sense multiple access with collision detection) bus network. CSMA/CD is a technique of sharing a common medium (the cable) among several devices. It is based on the same etiquette that makes for a polite group conversation: "Listen before talking." Of course, even when people are trying not to interrupt each other, there are those embarrassing moments when two people accidentally start talking at the same time. That is essentially what happens in networks, where such a situation is called a *collision*.

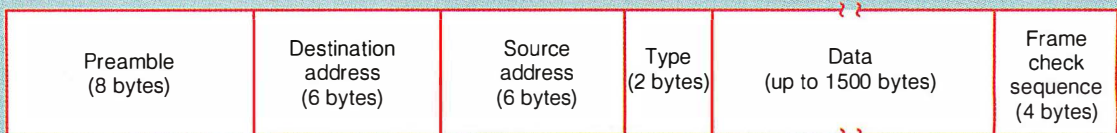
If a node on the network detects a collision (by receiving too strong a signal), it alerts the other nodes by jamming the

network. Then, after a random pause, the sending nodes try again. There is no acknowledgment of messages at this level of network communications.

The messages are technically called *frames* (see the figure). It is on the definition of a frame that IEEE 802.3 and Ethernet differ. This is also part of the MAC (media access control) layer of the network specification. A frame consists of an 8-byte preamble, a 6-byte destination address, a 6-byte source address, a 2-byte type field (used by higher-level protocols to identify a specific type of frame), a data field of up to 1500 bytes, and a 4-byte frame check sequence, which contains the CRC (cyclic redundancy check).

*Ben Smith is a technical editor for BYTE. You can reach him on BIX as "bensmith."*

### AN ETHERNET FRAME



length, you need some form of address administration to ensure that no two stations have the same address. Ethernet does this by allocating blocks of addresses to vendors, who are then individually responsible for assigning unique addresses to their products. If Ethernet had a 64-bit address space, a station could select an address at random, and the probability that two stations on the same network would have the same address would be insignificant. (We went through the mathematical analysis 10 years ago and proved it, at least to ourselves.) "But no one would have believed us," says Bob Printis, manager of systems architecture at PARC (and one of the few team members still with their original company). "We would have had to fight an endless battle on that one."

Ultimately, an Ethernet scheme of 48-bit universal addressing was accepted and adopted by the IEEE 802 and fiber-distributed data interface (FDDI) network standards. This was especially painful for Printis, who initially inherited the responsibility of assigning the vendor address blocks correctly.

#### The First Reviews

When the Ethernet technology was first exposed to the market, it drew lots of criticism. People said, "It's overkill. It costs too much. I don't understand it. It's too complicated."

Of course, all this was true. In the years 1980 through 1982, no one needed a network with a data rate of 10 megabits per second. There was hardly a computer around that could keep up with that, much less do anything useful with the information at that speed. (A common technology in use at the time was Corvus Systems' Omninet, a 1-Mbps twisted-pair bus, used primarily for disk sharing among Apple II computers.) Ethernet controller boards cost from \$1000 to \$4000, without software, transceivers, and so on. And, for the time, it was complicated.

However, we were planning for the future. We had to resist the temptation to develop merely what the market needed at the time. Ours was a vision of distributed databases, interoperability, and multivendor networks that exceeded the capabilities of simple technology. We wanted to build an infrastructure that could support the development of a wide variety of applications and have a long-enough product life to allow those applications to grow without having to tear out the underpinnings every few years. Not doing that would be like building a two-lane road to a new frontier; it will get you there now, but it will be obsolete by the time the frontier is developed. Better to build a superhighway and let it be empty for a while; there will be people to use it soon enough. (No surprise that two-thirds of the Ethernet triumvirate were in California.)

*continued*

A close-up portrait of Boone Bucher, a man with short brown hair, wearing a light blue dress shirt and a dark patterned tie. He is looking directly at the camera with a slight smile.

BOONE BUCHER  
Vice President, Sales

"Hi. I'm Boone Bucher, VP of Sales at SSDC. I'm sure you've heard all the talk about math coprocessors. If you've discovered how much you can benefit from a math coprocessor, maybe I can help. Here are the facts. The IIT Advanced Math Coprocessor from SSDC is faster (in some cases only 5-10% faster, but usually 150% or more), has more capability (4X4 instructions plus three times the registers), guaranteed compatibility, the best warranty in the industry and costs

**FACT  
IS**

less. But most important, the SSDC team is here to back you up. We were the first to give you diagnostic software. Toll free tech support is available. And if needed, we have field applications engineers all around the country to support you. All you need to do to have this team behind you is ask your dealer for the IIT Advanced Math CoProcessor from SSDC, or call 1-800-284-7732 for the dealer nearest you. Call today to get the best math coprocessor in the industry – and that's a fact."



1001 Capital of Texas Hwy. South, Bldg. I • Austin, Texas 78746  
512/327-8608 • FAX 512/327-5233

Circle 284 on Reader Service Card

## THE MOST ADVANCED CORDLESS MOUSE



### THE ZEN MOUSE

Available in cordless and corded models for  
IBM PC's, PS/2's, and compatibles.

- Dynamic Tracking
- 10-1000 dpi
- No Cleaning Required
- Rechargeable
- Compatible with Microsoft™, Logitech™, and MSC Mice
- No Mouse Pad Required
- Compatible with virtually all application software
- Made in USA



ZENY  
COMPUTER  
SYSTEMS INC.

4033 Clipper Court  
Fremont, California 94538

Tel 415/659-0386  
Fax 415/659-0468

10% OFF WITH THIS AD

It's interesting that we aren't hearing the same complaints today about FDDI—other than cost, of course. That's because we've learned the Ethernet lesson of letting the market and applications develop to use the technology as it matures.

FDDI-based systems today do not take full advantage of the technology; neither the available silicon, the protocols we commonly use today, nor the attached systems can truly exploit the full capability of the channel. But the FDDI community is thinking and planning for the future. It learned from the Ethernet experience how fast one can go from overkill to underpowered.

#### Keeping an Open Mind-Set

The original Ether-thinking wasn't designed to give a competitive advantage to its developers. From the beginning, the design

**W**e've  
learned the Ethernet lesson of  
letting the market and applications  
develop to use the technology  
as it matures.

and architecture were open. The developers thought that any disadvantage incurred by allowing competition to flourish would be offset by the increase in the size of the total market. Networking is only truly useful when everyone does it, and even a small piece of the pie is adequate if the pie is huge.

When designing Ethernet, we used a 20-year product life as our model, expecting that installations and quantities would ramp up over the first five to 10 years and then taper off as middle age set in and some new technology emerged. This was before there was even a complete system design: no silicon, no independent networking companies, no applications, nothing. We saw Ethernet as the UART of the 1990s. (UART, which stands for universal asynchronous receiver/transmitter, is the key component of a serial port.) In 1980, no reasonable manufacturer built a computer without an RS-232C port. Even if you didn't have an immediate use for it, you put one in anyway, because it gave your users flexibility. Our vision was that, in 1990, computer manufacturers would put networking into every machine, for the same reasons.

Virtually all of that vision has come true. Look at Sun workstations, DEC VAXes, and Macs. In each case, networking is an integral part of the product. Every Sun comes with an Ethernet port, and every Mac with a LocalTalk connection. The only way to connect terminals to (the larger) VAXes is through Ethernet, terminal servers, and local-area transport. The LAN business exploded during the 1980s, in parallel with PCs, to totally transform information technology. LAN hardware, LAN value-added resellers, third-party installers and support, thousands of software applications—none of these could have existed without the core technology and standards.

What may be more interesting are all the things we didn't foresee that have affected our business. For example, according to Bob Printis, no one predicted the emergence of twisted-pair

# Where Adults Come To Play!

## ODYSSEYBBS

### America's Premier Adult Online Service!

- Local Numbers Covering 850 U.S. & Canadian Cities!
- CHAT Live With Others in Group or Private!
- 1000's of Shareware Programs For IBM's & Macs...  
...With No Surcharges For Downloads!
- Exciting Multiplayer Games Played in Real Time!
- Wide Range of Business & Personal Services!
- Professional, Technical & Leisure Message Bases!
- National "For Sale" & "Wanted" Classified Listings!
- Plus Many, Many More Low-Cost Services!

**CALL NOW FOR YOUR FREE DEMO!**

FOR INFORMATION AND A LOCAL  
NUMBER NEAR YOU, CALL BY MODEM

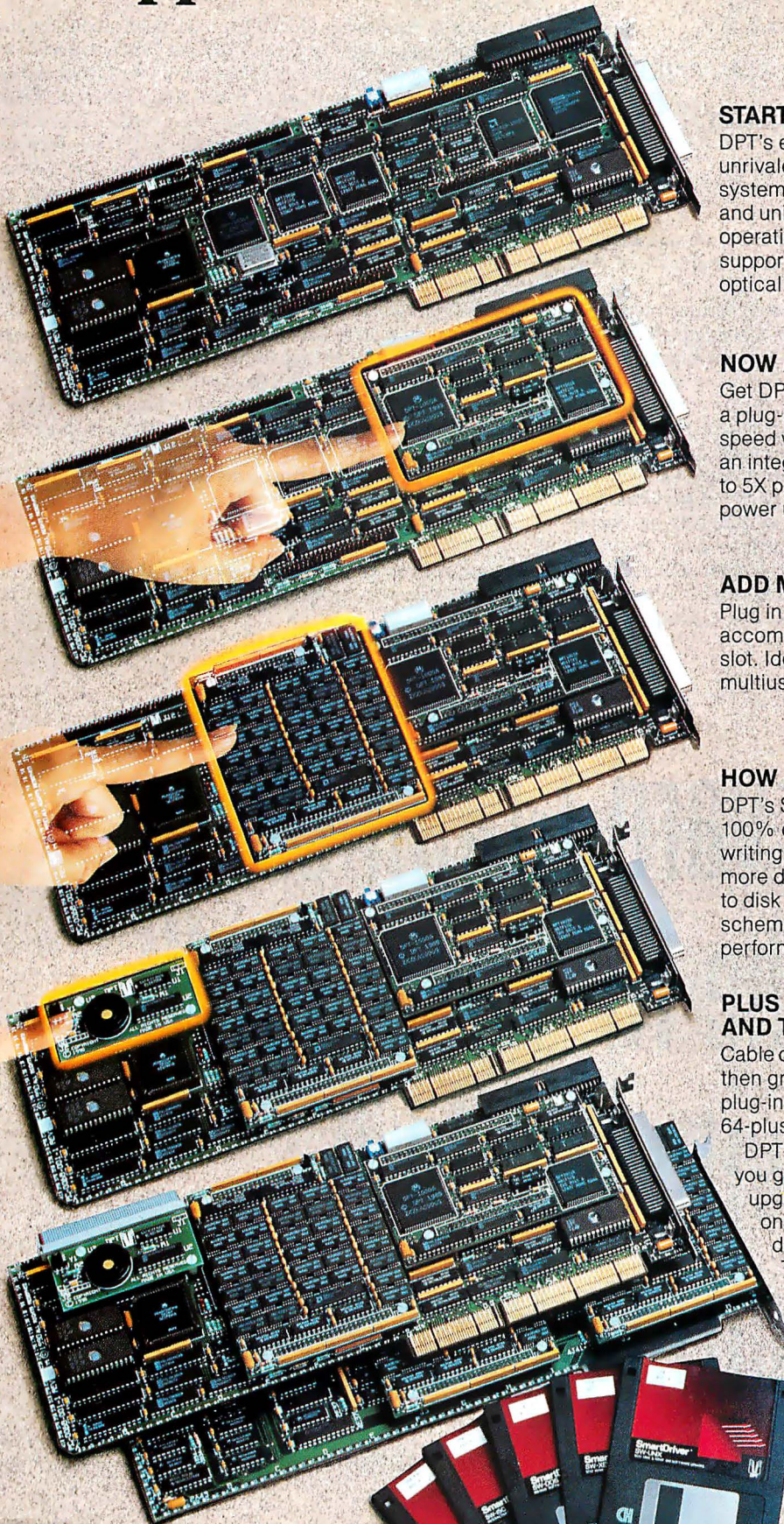
**818 358-6968**

3/12/2400 Baud 8/N/1, Must Be Over 18

Computer Productions Inc., 1307 S. Shanrock, Monrovia, CA 91016 (818) 358-0936



# SmartCache™ Plus: the grow-as-you-go approach to SCSI controllers



## START WITH THE BEST ...

DPT's entry level SmartCache Plus board offers unrivaled price/performance for single-user systems. It features ISA or EISA bus mastering, and universal SCSI disk compatibility for all PC operating systems. SmartDriver software supports SCSI-2 peripherals like tape and optical drives.

## NOW ADD CACHING!

Get DPT's award-winning caching technology in a plug-in module! Move up to disk caching speed without investing in a new controller. With an integral 512K cache, the module provides up to 5X performance gains for workstations, power users, and small multiuser systems.

## ADD MORE USERS, ADD MORE CACHE!

Plug in a 2 MB or 4 MB memory module and accommodate up to 18 users from a single card slot. Ideal for medium-sized networks or multiuser systems.

## HOW ABOUT DISK MIRRORING?

DPT's SmartCache mirroring module provides 100% disk fault tolerance by simultaneously writing all data to a second "mirrored" drive. No more data loss or costly system down-time due to disk failures. And unlike software mirroring schemes, fault tolerance is achieved with no performance penalties.

## PLUS STILL MORE CACHE, AND THEN SOME...

Cable over to DPT's 4 MB Cache Expansion Card, then grow your system to 16 MB by adding more plug-in memory modules—enough power for 64-plus users!

DPT has your solution—no matter how you grow. Performance, compatibility and upgradability make SmartCache Plus the only SCSI controller you'll ever need. For details, contact Distributed Processing Technology, 140 Candace Drive, Maitland, FL 32751. Phone (407) 830-5522; FAX (407) 260-5366. In Europe (UK) phone 44 (0) 488 4319.

 **DPT**

Circle 96 on Reader Service Card  
(RESELLERS: 97)

**A**s LANs  
became a commodity,  
people became more concerned  
with "mundane issues."

---

as the medium of choice. The original Ethernet was coaxial-cable based. This invariably required the installation of new cable to implement an Ethernet LAN.

As LANs became a commodity, people became more concerned with "mundane issues" such as wiring up one's building. Issues like these have become much more important than the communications system in use on that wire; you only get one chance to do it right. Today, twisted-pair wiring is popular, based not on data rates or electrical characteristics, but on ease of installation, reconfiguration, and cable management.

During the Ethernet design, we never realized the extent to which these issues would overshadow electrical performance. Compared to coaxial cable or fiber, twisted-pair has worse noise performance and higher bit error rates and can run at LAN data rates only over much shorter lengths. But users are willing to live with these restrictions in exchange for the admin-

istrative advantages it offers. As in many other facets of life, people are willing to give up a lot for convenience.

#### So Who Cares?

If you look at back issues of BYTE (or any publication covering the networking industry between 1980 and 1984), you will find articles touting the superiority of baseband over broadband (or broadband over baseband), or of Token Ring, Ethernet, Token Bus, Slotted Rings, and so on, over one another. There were arguments over such minutiae as preamble bits, frame formats, type and length fields, checksum algorithms, and address lengths. You don't see these anymore. The network wars are over, and everybody has won. (Well, almost everybody.)

When networking consisted solely of technology, technology was the subject of controversy. The basic building blocks of our business were just being cast, and everyone argued over the shape and color of the bricks. While all these things were ultimately decided, it turns out that it really didn't matter what the decisions were. The important thing today is that they were decided and we could get on with the business of networking.

Today, hardly anyone cares about the technology as long as it works. There are only three things users really care about:

1. What applications can I run on my network?
2. How should I wire my building?
3. How do I manage the network effectively?

Users are not concerned with the shape of the connector, the color of the cable, or the formats of the bits on the wire. It's not

Harvard Graphics®  
And The HP LaserJet III  
Invite You To A  
Very Exciting Presentation.

Token Ring versus Ethernet; it's applications that run on Token Ring versus applications that run on Ethernet.

To the extent that applications, wiring systems, and network management are technology-independent, the underlying network characteristics become invisible and unimportant. The only vestige of their presence is performance. But there is rarely a perceptible performance difference once all the layers of software, server bottlenecks, and disk latencies are inserted between the user and the wire.

### What Would We Change?

If the original Etherneters could change anything, what would they change?

Dave Redell, originally principal scientist with Xerox Business Systems and now a member of the research staff at DEC's Palo Alto Systems Research Laboratory, would have set the maximum packet size higher than the current 1500 bytes. "There was nothing magic about that number," said Dave. "It was a compromise. The main concern at the time was the cost of memory."

During the specification discussions, the packet size limit varied from around 600 bytes to as much as 10K bytes. Longer packets make for more efficient channel utilization, but they also increase the probability of an error in the packet and a collision on the next packet. However, the overriding concern at the time was that simple (read "cheap") controllers would allocate a fixed, maximum-size buffer for every received packet. With 1K-bit and 4K-bit RAMs the norm (this was 1979, remember?), that was a major concern. So, we compromised.

The 1500 bytes allows for 1K bytes of user data, plus any reasonable protocol overhead. "If it were longer, large file transfers would be faster, and we might have avoided some of the Token Ring-to-Ethernet bridging hassles," laments Redell.

Bob Printis would have included a length field and avoided the Ethernet versus IEEE 802.3 wars. [Editor's note: *IEEE 802.3, while based on Ethernet, included some differences that made the two incompatible. Despite the well-intentioned efforts of the IEEE, the de facto Ethernet standard is far more widely used than the official standard.*] The only significant difference between Ethernet and IEEE 802.3 is the IEEE standard's use of the length field versus Ethernet's use of a type field. The two can be made to at least coexist by assigning all type field values to be numerically greater than the maximum length of 1500 bytes.

Personally, I would have saved every Ethernet user a lot of grief by not specifying the dreaded slide-latch connector (used on the cable between the station and the transceiver). We really had good intentions. I was fed up with RS-232C connectors that fell off because the tiny screwdriver necessary to tighten them down was never handy. I just didn't realize that the slide latch was so flimsy and unreliable until it was too late. Ethernet installers around the world must curse me every day. ■

*Rich Seifert is president of Networks and Communications Consulting. Formerly with DEC and Industrial Networking, Inc., he is coauthor of the Ethernet specifications (versions 1.0 and 2.0) and the IEEE 802.3 and 802.4 standards. He can be reached on BIX c/o "editors" or on Usenet at seifert@asylum.sf.ca.us.*

# Yours.



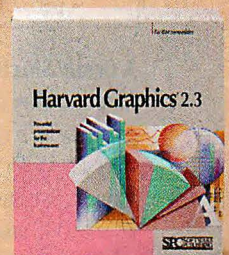
Harvard Graphics 2.3 from Software Publishing Corporation brings new dimensions to presentation graphics. The Hewlett-Packard LaserJet III printer writes a new chapter in printing history.

Put them together and your presentation becomes a major event.

Harvard Graphics is packed with easy-to-use new features that will dazzle your audience—like a gallery of pre-designed charts and DrawPartner,™ an integrated advanced drawing package.

The HP LaserJet III has raised the standard of printing excellence with HP's exclusive Resolution Enhancement technology. Your graphics will look unusually sharp—better than ever before.

With Harvard Graphics and the HP LaserJet III, your next presentation is certain to be well attended. And well received.



**SPC** SOFTWARE PUBLISHING CORPORATION

For a free demo disk and product information, call 1-800-345-2888, operator 330.

Harvard Graphics and DrawPartner are trademarks of Software Publishing Corporation. HP LaserJet III is a product of Hewlett-Packard.  
© 1990 Software Publishing Corporation, 1901 Landings Drive, Mountain View, CA 94039-7210

# All the features of HP BASIC, and more.

## For less.



HTBasic	BASIC FEATURES:	HP BASIC
YES	IEEE-488 GPIB (HP-IB), RS-232 Instrument Control	YES
YES	Integrated Environment: Mouse, Editor, Debugger, Calculator	YES
YES	Supports 16 Megabytes of Memory (breaks DOS 640K barrier)	YES
YES	Engineering Math: Matrix Math, Complex Numbers	YES
YES	High Level Graphics: Screen, Plotter, Printer	YES
YES	Structured Programming with Independent Subprograms	YES
YES	Runs on Industry Standard Personal Computers	NO*
YES	Industry Standard Graphic Printer Support: Epson, IBM, lasers, etc.	NO
YES	Industry Standard Network Support: Novell, IBM, Microsoft, NFS, etc.	NO
YES	Industry Standard IEEE-488 Support: National Instruments, Iotech, etc.	NO
YES	Exchange data files with Industry Standard PC applications	NO*
YES	No-charge Telephone Technical Support	NO
YES	Instant on-line HELP system	NO

**A Costly Situation.** Every engineer needs the power and features of a "Rocky Mountain" BASIC workstation, but not everyone can have one. They simply cost too much. Fewer workstations, less productivity. **The Best Way.** TransEra HTBasic software provides the *only* way for serious technical computer users to turn their PC into a workstation without having to add costly hardware. Powerful workstations for everyone means greater productivity. **Extraordinary Versatility.** In addition, TransEra HTBasic works with the Industry Standard Personal Computer hardware, software, and networks. It even allows you to easily exchange data between your favorite DOS programs and the files you create in the BASIC workstation environment. All at a fraction of the cost of other solutions.

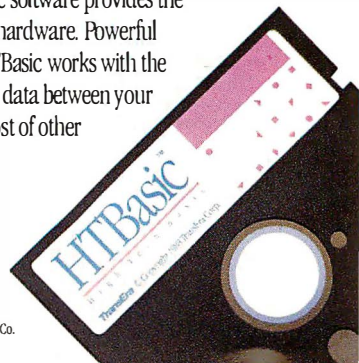
More compatibility. More versatility. More possibilities.  
Less expense. Less hassle.

To find out more, call 1-801-224-6550.

**TransEra**  
Engineering Excellence for 15 Years™

Circle 335 on Reader Service Card (RESELLERS: 336)

\* Without the addition of a costly 68000 co-processor. © Copyright 1990 TransEra Corporation. All rights reserved. HP, HP BASIC, and HP-IB are registered trademarks of Hewlett-Packard Co.



# FLEXOS'S MUSCLE

*FlexOS may look like MS-DOS,  
but that is where the similarity ends*

*Ben Smith*

**PART**  
**Six**

FlexOS, from Digital Research (remember CP/M?), is a real-time, multiuser, multitasking operating system particularly suited for point-of-sale applications. The basic utilities look and behave just like their MS-DOS counterparts (e.g., COPY, CHDIR or CD, and TREE), but

the underlying functionality of the operating system is from an alternate reality.

FlexOS is rich with features for both applications developers and users (e.g., X/GEM, the multitasking version of the GEM graphical user environment). Concurrent processes can share the same program image. Files have read, write, execute, and delete privileges for three user classes: Owner, Group, and World. The list of advanced operations is far greater than the list of elements of DOS compatibility. FlexOS with all its options is a solid, attractive, and familiar world for any real-time application.

## At the Core

Unlike MS-DOS, FlexOS is a protected-mode operating system that takes advantage of 286 and 386 processors. It uses DOS media for its files. It recognizes DOS file systems, making the exchange of DOS and FlexOS files totally transparent. The 386 version even has a DOS applications environment, allowing you to run DOS applications in protected mode under FlexOS. The core of FlexOS consists of the *supervisor* and the *resource managers*. The supervisor controls the flow of requests from application programs. It handles CPU and memory-related requests with its kernel and passes device-related requests on to the resource managers as appropriate (see the figure).

The resource managers provide the administrative glue between the supervisor and the device drivers. There are separate resource managers to control the disk drives, pipes (interprocess communications), network facilities, the console, and a collection of miscellany, including communications with serial terminals and parallel printers.

In some ways, the process management is similar to Unix:

Each process has a process ID and a family ID. Spawned processes retain the family ID of their parent. Besides spawning a new process (which runs concurrently with the parent), you can create a subroutine process (running in series with the parent). In this latter case, a new process ID is not created, and the calling process sleeps until the subroutine is finished. FlexOS also allows you to chain processes together; in other words, the calling process becomes the called process. All child processes can share memory with their parent processes.

At the heart of the supervisor kernel is the event-driven *dispatcher*, which responds to interrupts and schedules processes in the following way:

- All asynchronous service routines are run to completion, one at a time.
- Each standard process is run for its slice of time. These are run in the order of the priority levels in the process table.

Unlike Unix, FlexOS yields both system and user processes to interrupts. This way, FlexOS supports real-time asynchronous I/O in its application programming and device driver interfaces. An interrupt service routine is allowed to take control once the CPU state has been saved.

Once the time-critical operations are complete, the interrupt service routine can pass its activities on to an asynchronous service routine, which has a priority like the user processes. At this point in interrupt handling, the control returns to the dispatcher. FlexOS also provides a polling mechanism for non-interrupt-driven device drivers.

Applications for FlexOS must be polite about memory usage, because the operating system does not swap user process space out to disk. If a program isn't using some of its allocated memory, it should free it so that other processes can use it.

The FlexOS memory model treats system processes differently from user processes. System processes (e.g., supervisor, resource managers, and drivers) run without parameter-bound checking and have direct access to system hardware; memory

addressing is direct. A user process runs with full protection and is isolated from any direct access to hardware.

**For the Developer**

The primary applications development language for FlexOS is C—specifically, the MetaWare High C compilers. This is supplemented with Digital Research's RASM-86 relocatable code assembler and LINK86, its corresponding linker.

The kicker for the FlexOS development environment is the FlexView windowed symbolic/source code debugger. A good symbolic debugger can make the difference between painful applications development and fast, efficient applications development—particularly for programmers who are new to the operating system and libraries.

The basic programming interface to FlexOS is provided by supervisor calls, the counterpart to Unix system calls. (Table 1 is a summary of the SVCs.) For example, to change the priority

of a process from 200 to 100 (a higher priority), you would SET the prior field of the process table entry for a process. (When the COMMAND SVC creates a user process, the default priority is 200.) Many of the fields in a system table (see table 2) are read-only. In fact, the prior element is the only field that you can change in the process table.

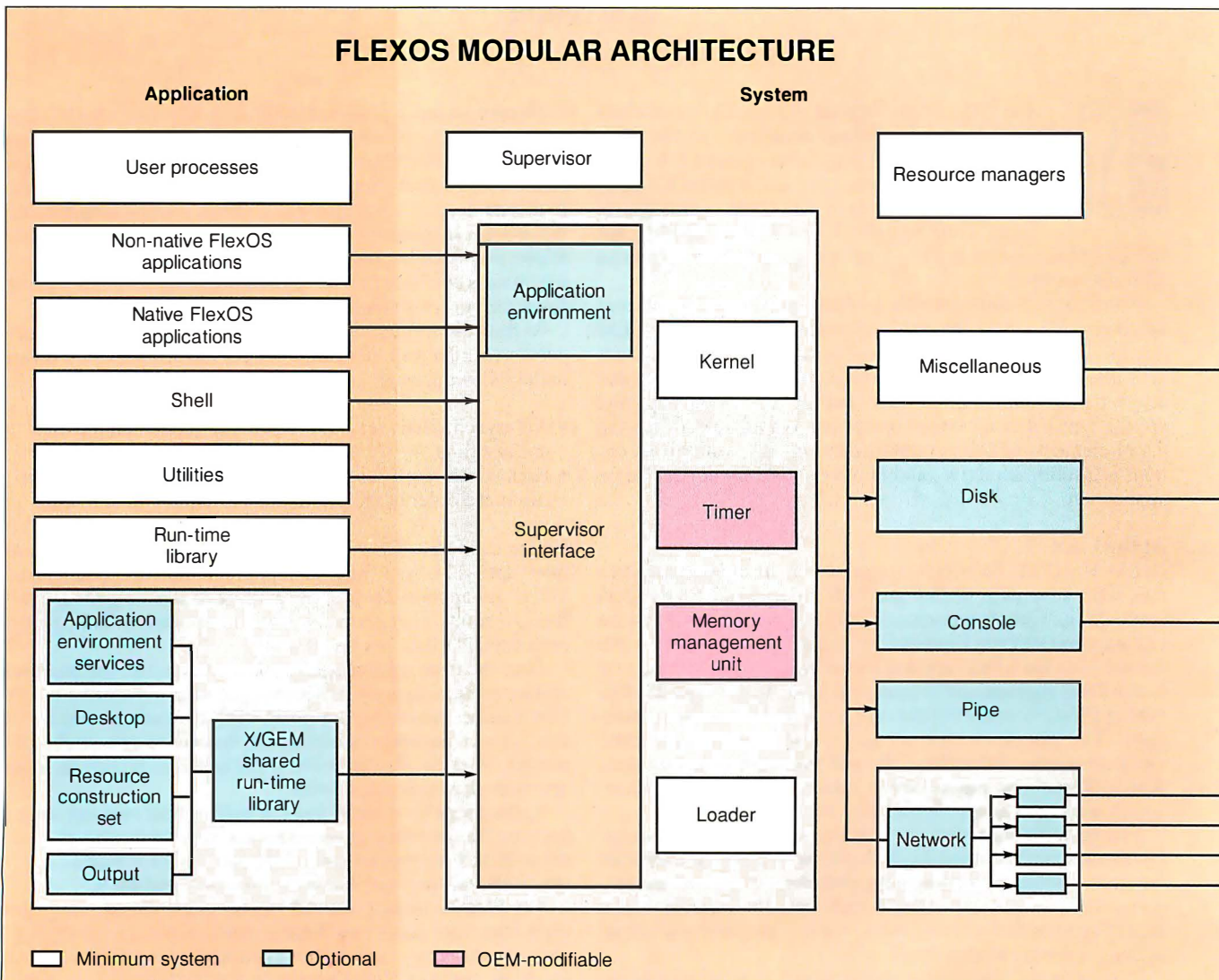
**Control from the Command Line**

Many of the facilities that are available to the programmer through SVCs are also available to the user through shell commands and utilities. For example, the information of the process table is available through the PROCESS command. Unfortunately, you can do little more than view entries in the process table and kill processes. There is no way at this level of FlexOS to change the priority of a process or to move a background process into the foreground.

Although there are far more commands available to the FlexOS user than there are for the MS-DOS user, the script language has the same flow control and syntax as DOS .BAT files, with one notable extension: BATCH. The BATCH command allows nested scripts, meaning a .BAT file can be used as a sub-routine of another .BAT file.

The interactive command interpreter has a command his-

*The system comprises application services, a supervisor, resource managers, and their associated drivers and subdrivers.*



ALTERNATIVE OPERATING SYSTEMS

tory. You cycle through the history list using a search string. As any user of the Unix Korn shell will tell you, this is a great time saver when you are doing system administrative chores. Another convenience is the ability to load device drivers without rebooting the system.

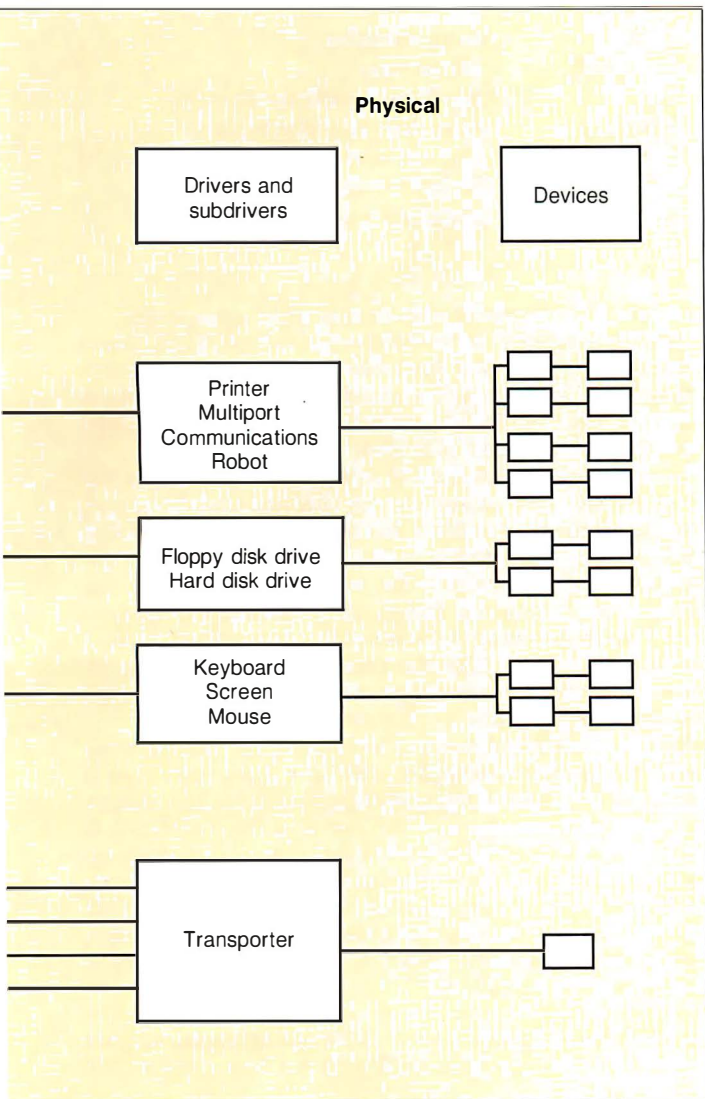
Several Unix utilities are part of FlexOS, including pr, grep, split, and paste. The impression you get at the command level is that FlexOS is MS-DOS with Unix extensions for multiuser, multitasking operation.

**Valuable Modules**

Most of the alternative operating systems that we have covered in this series have provided only functionality; they have left aesthetics as an exercise for the developer. This is not the case with FlexOS.

Digital Research has ported its valuable GEM graphical user interface (GUI) to FlexOS. This version is called X/GEM but still looks the same as the MS-DOS version, including a window manager, a file manager, and several utilities. (X/GEM requires more memory than your basic 640K-byte system.)

The value that X/GEM adds to the GEM of MS-DOS and the Atari ST comes from the use of the underlying multitasking of FlexOS and support for sophisticated intelligent graphical

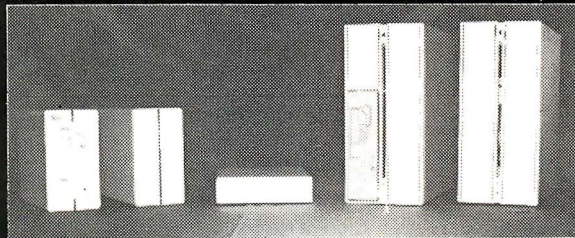


**FAST SCSI STORAGE**

Compatible with 286/386/Laptop, Apple II, Atari, Amiga, Sun, Macintosh, Silicon Graphics, Next, IBM RS6000

**A-Hive & Jr.(3.5") - Enclosure for SCSI Drives**

- Room for 2-HH or 1-FH drive 30 Watts \$119.
- Incl. all internal cables 65 Watts \$169.



**Half Shell-Compact Hard Drive (1.4"x5.5"x7.5")**

low power 40MB-120MB from \$599

**Hermit Crab-Portable Hard Drive (2.8"x5.5"x7.5")**

32MB to 200MB 28ms to 12ms from \$399

**Laptop SCSI Drive 32MB-1.5GB from \$595**

**SCSI Hard/Floppy Drive 2MB-1.5GB from \$159**

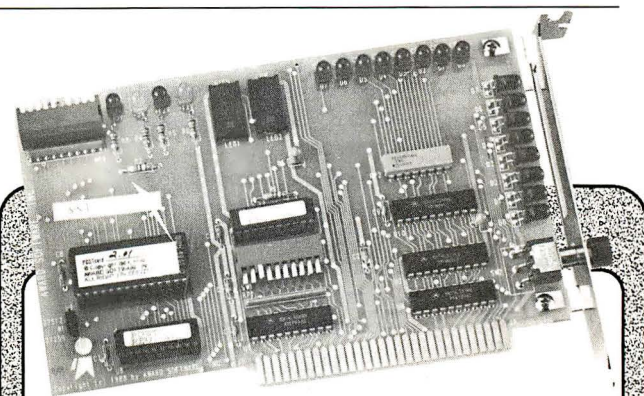
**Cartridge Hard Drive 44MB \$499**

**SCSI Tape Drive 50MB-1.3GB from \$389**

**2HD/4Floppy 286/386 Controller**

**XT/AT/286/386 SCSI/ESDI/MCA Controller**

**TULIN CORPORATION** Tel:408-432-9025  
2156H O'Toole Ave, San Jose,CA95131 Fax:408-943-0782



**AWARD POSTCARD™  
DIAGNOSTIC CARD**

- DOS not required for diagnostic functions
- POST (Power On Self Test) routine monitoring
- Supports XT/286/386 based microcomputers
- Works with most BIOS versions including AWARD, AMI, PHOENIX, QUADTEL
- Built in comprehensive diagnostic functions in ROM
- Fits into any 8/16 BIT slot
- Optional digital diagnostic diskettes for floppy disk alignment
- Serial and parallel loop back connectors included

• **New Low Price \$249.00**

**Order Now 1-800-800-2467**



599 Canal Street  
Lawrence, MA 01840

(508) 686-6468  
FAX: (508) 683-1630

**FLEXOS SUPERVISOR CALLS**

**Table 1:** The basic programming interface for FlexOS is provided by supervisor calls.

SVC	Purpose
<b>File management</b>	
CREATE	Create a file.
DELETE	Delete a file.
OPEN	Open a file.
CLOSE	Close a file.
READ	Read a file.
WRITE	Write to a file.
RENAME	Rename or move a file.
DEFINE	Define logical name for a path.
LOCK	Lock/unlock an area of a file.
SEEK	Modify or obtain current file pointer.
<b>Console file management</b>	
COPY	Copy one screen rectangle to another.
ALTER	Alter a screen rectangle.
XLAT	Specify keystroke translation.
<b>Event management</b>	
STATUS	Get status of an asynchronous event.
RETURN	Get return code of completed event.
WAIT	Wait for multiple events.
CANCEL	Cancel asynchronous event.
<b>Process management</b>	
COMMAND	Perform shell command.
CONTROL	Control a process for debugging.
OVERLAY	Load overlay from command file.
TIMER	Set and wait for timer interrupt.
ABORT	Abort specified process.
EXIT	Terminate with return code.
ENABLE	Enable software interrupts.
DISABLE	Disable software interrupts.
SWIRET	Return from software interrupts.
EXCEPTION	Set software interrupts on exceptions.
MALLOC	Allocate memory to heap.
MFREE	Free memory from heap.
<b>Device management</b>	
SPECIAL	Perform special device function.
DEVLOCK	Lock/unlock device for user/group.
INSTALL	Install, replace, and associate drivers.
<b>Table management</b>	
GET	Get table values.
SET	Set table values.
LOOKUP	Scan and retrieve tables.

**FLEXOS SYSTEM TABLES**

**Table 2:** The key to system control in FlexOS programs lies in system tables, data structures that contain information about the status of the system. To operate on system tables, you use the supervisor calls GET, SET, and LOOKUP (see table 1).

Table	Contents
PROCESS	Process information
ENVIRON	Process environment
TIMEDATE	System time of day
MEMORY	System memory use
PIPE	Pipe information
SHMEM	Shared memory information
DISKFILE	Disk file information
DISK	Disk device information
VIRCON	Virtual console information
SYSTEM	Global system information
FILNUM	File numbers table
SYSDEF	System logical name table
PROCDEF	Process logical name table
CMDENV	Command environment
DEVICE	Device information
PATHNAME	Full path name
SRTL	Shared run-time libraries information
MOUSE DT	Mouse driver table information
VDIPRN	VDI printer device information
PORT	Port device information
SPECIAL	Special device information

**ITEMS DISCUSSED**

**FlexOS** .....(Contact vendor for pricing)  
 Digital Research, Inc.  
 OEM Sales  
 4401 Great America Pkwy., Suite 200  
 Santa Clara, CA 95054  
 (408) 982-0700  
**Inquiry 1008.**

hardware. It is compatible with existing GEM applications.

There is an optional network extension to FlexOS that allows several FlexOS systems to share disks, printers, and communications pipes. The underlying transport and low-level protocol is not defined. Digital Research distributes drivers for IBM Token Ring Adapter and TCP/IP on Ethernet.

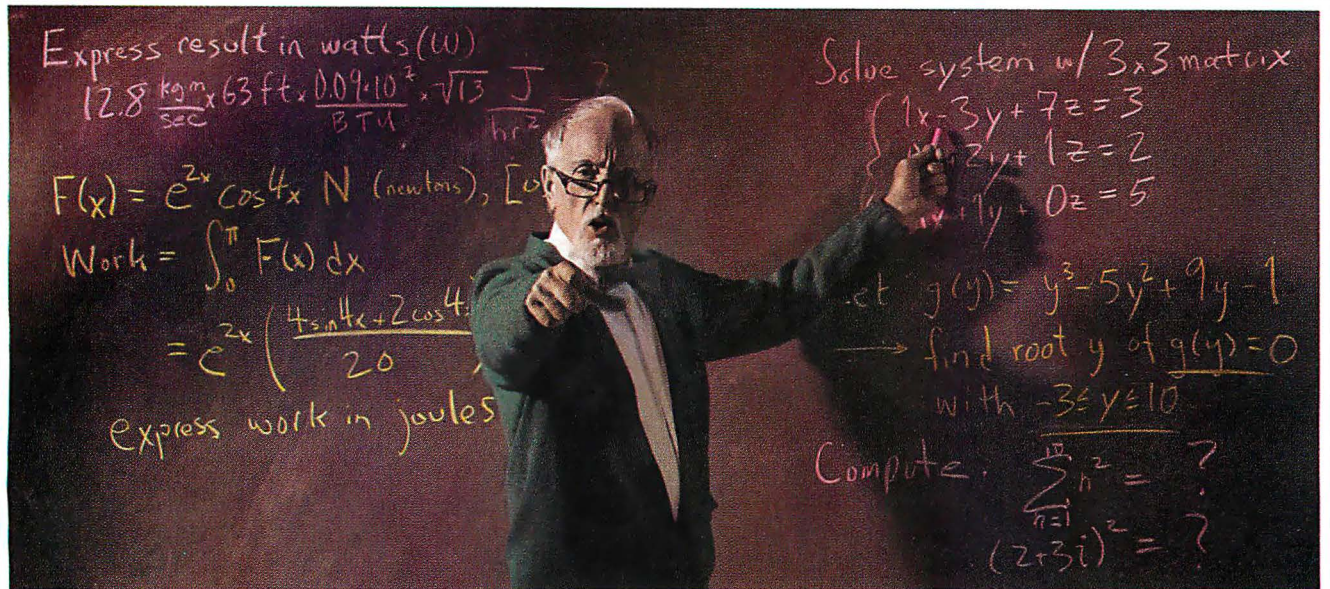
Nearly everything in FlexOS is modular. Not only are the device drivers, networking, and the GUI and application programming interface modules, but the basic system is broken into submodules that can be installed as needed. The whole system can be stripped down to the point that it can be put into ROM, a requirement for factory-floor and point-of-sale devices. FlexOS data-entry devices and "cash registers" can boot and run entirely from ROM; the transactions are sent across the network to another device that has mass storage and appropriate administrative programs.

FlexOS was not designed as a DOS clone, nor is it marketed as one; it is for multitasking and multiuser applications. Nor is it designed as a simple Unix substitute; it is a real-time operating system that necessarily lacks much of the complexity of Unix. Digital Research has been in the business of making operating systems since the beginning of the microcomputer era, and in many ways it is responsible for early acceptance of the microcomputer. It has also been making multiuser operating systems from those early days. The company's experience is quite apparent in FlexOS. ■

*Ben Smith is a technical editor at BYTE and the author of Unix Step by Step (Howard Sams, 1990). He can be reached on BIX as "bensmith."*



# In college, you would have killed for MathCAD. So why aren't you calculating with it now?



100,000 engineers and scientists already let MathCAD do their calculations for them.

Now that college is far behind you, perhaps it's time you graduated from spreadsheets, calculators and programming.

Because in today's working world of engineering and science, there's no time for anything less than MathCAD. The software that lets you perform engineering and scientific calculations in a way that's faster, more natural, and less error-prone than any calculator, spreadsheet, or program you could

write yourself.

Thanks to MathCAD's live document interface,<sup>™</sup> you can enter equations anywhere on the screen, add text to support your work, and graph the results.



March 14, 1989 issue.  
 Best of '88  
 Best of '87

It also comes complete with over 120 commonly used functions built right in. Perfect for creating complex equations and

formulas, as well as exponentials, differentials, cubic splines, FFTs and matrices.

You get three-dimensional plotting, vivid graphing, and the ability to import HPGL files from most popular CAD programs, including AutoCAD.<sup>®</sup>

Done calculating? MathCAD prints *all* your analyses in presentation-quality documents, even on PostScript<sup>®</sup> compatible printers.

All of which has made MathCAD far and away the best-selling math software in the world. In fact, it's used by over 100,000 engineers and scientists — just like you.

There's MathCAD for the PC. MathCAD for the Mac, written to

take full advantage of the Macintosh<sup>®</sup> interface. And a Unix<sup>®</sup> version that utilizes the speed and unlimited memory of your Unix workstation.

We also have Applications Packs for Advanced Math, Statistics, Mechanical, Chemical, and Electrical Engineering. Each is a collection of adaptable mathematical models, designed to let you start solving your real world problems right away.

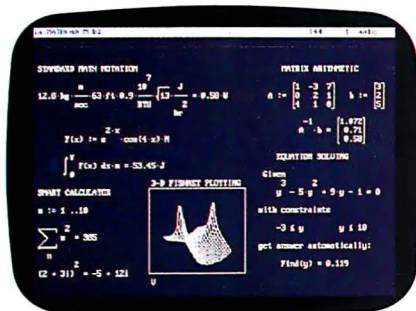
For a free MathCAD demo disk, or upgrade information, dial 1-800-MATHCAD (in MA, 617-577-1017). Or see your software dealer.

Available for IBM<sup>®</sup> compatibles, Macintosh computers, and Unix workstations. TM and © signify manufacturer's trademark or registered trademark, respectively.

**1-800-MATHCAD**

**MathCAD<sup>®</sup>**

MathSoft, Inc., 201 Broadway, Cambridge, MA 02139



 **TELCON**<sup>®</sup>

**M I C R O B A G**



Germany:  
**TELCON GmbH**  
Prinzregentenstr. 120  
8000 MÜNCHEN 80  
Tel.: 089 / 470 50 76  
Fax : 089 / 470 82 11

USA:  
**TELCON USA**  
7270 S.W. 48th Street  
MIAMI, FL 33155  
Tel.: 305 / 669 19 81  
Fax : 305 / 667 70 59

Spain:  
**TELCON Ibérica S.L.**  
Plata Castilla, 3 Piso 14-D1  
28046 MADRID  
Tel.: 1 / 733 73 67  
Fax : 1 / 733 73 67

**DEALER  
INQUIRIES  
WELCOME**

Circle 316 on Reader Service Card

# THE OBJECT-ORIENTED AMIGA EXEC

*A close look at the object-oriented core of the Amiga operating system*

*Tim Holloway*



**O**bject-oriented is the computer buzzword for the early 1990s. It's the latest Holy Grail, which will let programmers leap tall buildings in a single bound, cure world hunger, and produce 100,000 lines of fully debugged code a day.

Well, maybe not. After all, AT&T invented one of the premier object-oriented programming languages, C++, and was unable to get release 2.0 out within a year of its predicted release date. Nevertheless, there is no question that OOP is a Good Thing, and producers of operating systems have been furiously recoding their products as object-oriented systems, generally using C++.

Yet there is one object-oriented operating system that has been in widespread use since 1985. It runs Commodore's Amiga, although, ironically, it was not written in an OOP language.

## Amiga Exec—An "OOPS" Design

The Amiga's operating system is sometimes incorrectly referred to as AmigaDOS. Actually, the Amiga operating system has three major components: Exec, the multitasking kernel; AmigaDOS proper, which provides the high-level file systems and Command Line Interface; and Intuition, the basis for the graphical user interface (GUI). I'll be discussing only the Amiga Exec. Of the three, it is the most object-oriented and the most comparable to the C++ programming language.

That may seem surprising. Aren't GUI's what made OOP so famous? Well, yes, but there's more to OOP than simply dealing with data objects that correspond to graphical images. More on this later.

Although many Amiga features have a potentially unlimited number of elements, the absolute minimum RAM that the Amiga system software requires is a fraction of what many comparable systems require; even counting the ROM part of the operating system, the memory consumed is only about 512K bytes (although newer Amigas can support larger ROMs).

So what's missing from the Amiga operating system that

makes it so small? How does the Amiga manage to provide multitasking and windowing services in less than one-half to one-fourth the memory that Apple and IBM computers need? The answer lies in *minimal redundancy*.

If you examine the internal structure of many popular operating systems, you'll discover that it's "OS versus them." That is, you have this somewhat monolithic block of stuff that is the core operating system, some additional voodoo acting as device drivers and the like, and applications code—and only an uneasy truce ever lets them meet. Even though the operating system may itself be composed of many components, its appearance to the applications programmer is still essentially as a rather mysterious edifice, beyond which only selected portions of applications software may go.

The Amiga operating system is different. Relatively few parts of it are totally opaque; in fact, with later revisions of the operating system, the trend has been to further open its internals for applications use. This is even more surprising considering that, unlike the Macintosh, the Amiga runs its applications in the nonprivileged state.

## No Magic

Most present-day operating systems operate as if the operating-system code is "magic"; that is, it spends most of its time running in privileged states, inhibiting interrupts, executing arcane instructions that are incomprehensible to mere mortal applications programmers, and otherwise doing things that are completely outside the scope of applications programming. That isn't really true.

Very little operating-system code is truly magic; most of it deals with managing tables, lists, queues, and other such mundane tasks. However, since these are operating-system tables, lists, queues, and so forth, they are generally managed with special routines that run in privileged, noninterruptible, memory-managed, or otherwise arcane environments.

What tends to be overlooked is that it is often possible to take all the "magical" parts of code and separate them from the

“nonmagical” parts, resulting in a set of controlling routines to switch modes, and a lot of data-handling routines that look suspiciously similar.

This situation means that, first, there exists the possibility that general-purpose versions of some of these routines can be created to replace all these similar-but-not-identical functions; and second, since these routines are no longer magic, they can be accessible to application programs as well, reducing their overall size and complexity, to say nothing of the time saved by using pre-debugged code.

Using general-purpose code for critical operating-system functions might seem like heresy to some—after all, aren’t “general-purpose” and “efficient” mutually exclusive? The answer appears to be no, or more accurately, “If it’s general-purpose and it’s not efficient, perhaps it’s not general-purpose enough.” What usually wastes time in general-purpose code is all the testing and branching that it has to do to handle the variations of data structures it processes.

Where does OOP come into all this? The answer lies in the principle of inheritance. By arranging the system data structures much as we did for system code in traditional systems and by placing related data items in a common sequence, we gain two advantages: a reduction in the amount of special-case processing that was so offensive, and the creation of a hierarchy of data object classes. As a side effect, the system becomes easier to understand—there are fewer unique functions.

### An Inside View

Exec, as mentioned earlier, is the nucleus (or kernel) of the Amiga operating system, and it is realized in just such a manner. Exec consists of a collection of increasingly complex object classes, as can be seen in figure 1. When a new Exec object class is defined based on a simpler class, it contains all the data objects of the simpler class and also is (usually) valid for not only operations defined for that class, but for all operations pertaining to the simpler class, as well. This is known as function *inheritance*.

Exec’s heavy reliance on inheritance is what makes it so compact. It does not contain separate sets of routines to manipulate tasks, I/O devices, intertask messages, and so on; instead, it contains basic routines to handle collections of objects—be they task objects, device objects, or whatever—and adds functions only where additional support is required. In contrast,

many operating systems contain a collection of task routines (including those required to manage the task table) and a collection of device routines (including those required to manage the device table), and so forth.

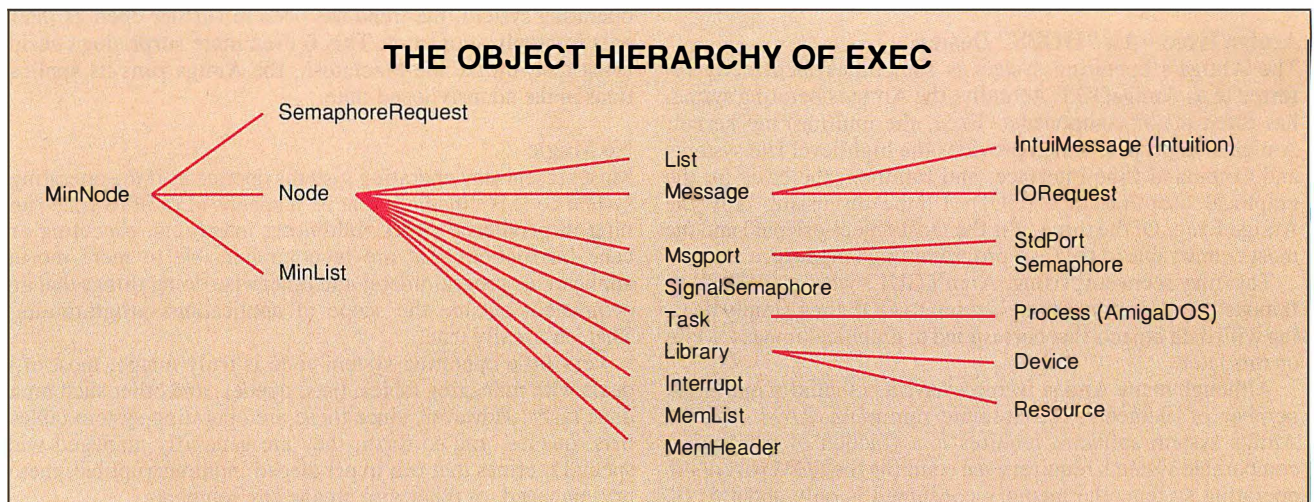
There are many ways to represent collections of data internally, each with its own advantages and disadvantages. Exec is based on the doubly linked list. The list elements are allocated dynamically from anywhere in RAM that’s convenient (see the section on memory management); therefore, there are no tables to fill up. On the other hand, access speed is highly dependent on the number of nodes in the list, but there are ways to reduce that problem, as I’ll explain later.

The Amiga operating system distinguishes itself in that the operating system itself provides support for doubly linked lists. Exec supports two levels of lists: lists and MinLists. (The Lattice C++ implementation adds two more that are similar to the standard Exec lists, but without automatic initialization.) These are used to define items that the Amiga system software initializes.

The MinList is the anchor to a doubly linked list of MinNodes. MinNodes contain next and previous MinNode pointers. The MinList structure contains a pair of dummy MinNodes to simplify processing by reducing special-case logic required to process items at the ends of the list. An empty MinList always consists of two MinNodes—the dummy nodes at the front and the end of the MinList—both of which are contained *within* the MinList data structure itself. The dummy front node’s next-node pointer points to the actual first node of the list. Its previous-node pointer is always NULL.

A similar situation exists in regard to the dummy end node. Since the dummy front node’s previous-node pointer is always NULL and the dummy end node’s next-node pointer is also always NULL, it was possible to save a small amount of memory by making them overlap by sharing the same NULL pointer. Dummy MinNodes do add one complication: The last actual item of the list is not the one with the NULL next-node pointer: That honor belongs to the dummy node.

A complete set of functions exists to support insertion and deletion of MinNodes at either end—or points in between—of a MinList. By using the proper functions, therefore, a MinList can be used as a first-in/first-out (FIFO) (also known as a queue) or as a last-in/first-out (LIFO) (also known as a stack), as well as a general-purpose list.



**Figure 1:** The nucleus of the Amiga’s operating system consists of a collection of increasingly complex object classes.

Once again, note that there is nothing magical about MinLists, MinNodes, or any of the functions that act on them. Although they are extensively used by the Amiga operating system, they can be used just as freely in any application program.

### Friends and Members

A note about C++ *friend* and *member* functions. When a class is defined in C++, its internal components are (unless otherwise specified) protected from casual access. This is a strong selling point; it makes it harder for an object's innards to be corrupted and easier to locate the responsible function. To make practical use of (and to alter) the information within a class object, therefore, some sort of access mechanism is required. C++ provides two: a friend function, which is like a traditional C function, except that by having been declared a friend of one or more classes, it is allowed to directly access the data stored within that class or classes; and a member function, which is actually owned by a specific class and therefore has an "invisible" extra parameter passed to it: "this," which is a pointer to the class object being acted on.

Exec was designed to be used by non-OOP languages; thus, the Exec functions are, in effect, friend functions. The #include files made up by MTS Associates to support C++ on the Amiga generally define them as such. However, to better support Exec in its capacity as an object-oriented system, a number of member functions were also defined. For example, virtually every object in the Amiga is in some sort of list, so most objects have a member function named `next()`. No matter what it is, no matter how it's linked, and no matter what the name or relative location of the object's next-item pointer, you are thus always guaranteed that you can get a pointer to the next one in the list by using the `next()` function.

### Lists: MinLists and Then Some

A list is an extended MinList, made up of nodes. The nodes are MinNodes plus a 1-byte type field, a 1-byte priority, and a pointer to the node's name, which is a C-format string. Figure 2 shows the structure of a node. A node incorporates the structure of a MinNode, and thus automatically inherits the properties of a MinList to form a list.

Subsequently, a list can use all the MinList functions. A list can be maintained as a FIFO or LIFO, just like a MinList. However, a list can also be maintained in priority sequence, courtesy of the list friend function `Enqueue()`. If the nodes in the list are given names, it is also possible to search the list for the first/next node of that name. This can be very useful, as it's how Exec locates a number of public objects.

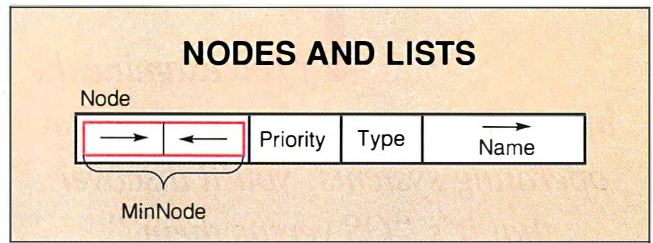
### Signals

Signals are represented by a 32-bit word containing a pattern of signal flags. There are 16 that are allocatable to the user and 16 reserved by the operating system. When a task signals another task and the other task is in a signal wait state, the receiving task's incoming signal information has the incoming signal bits logically ORed in. This is then ANDed with the recipient task's pattern of signals that it is waiting on. A nonzero result causes the task to become dispatchable.

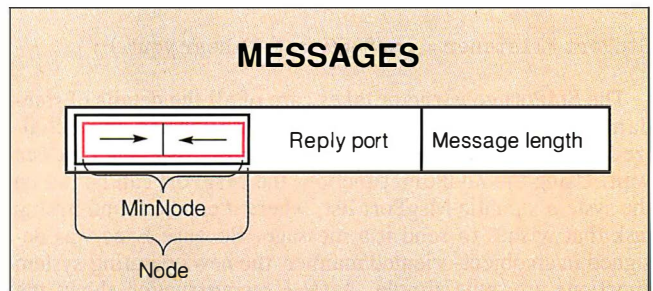
This is an extremely efficient way to activate a sleeping task, and it can be done at any system level, including in interrupt routines, which are denied many of the more sophisticated system services.

### Messages

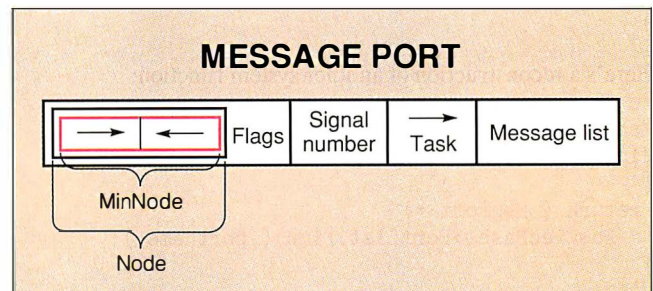
Figure 3 shows how a message is constructed from a node. Messages are extremely important in the operation of the



**Figure 2:** Nodes can be located by name and arranged in priority order. Nodes are anchored by lists. Since a node incorporates a MinNode, it inherits all the list properties and functions.



**Figure 3:** The Amiga operating system uses "messages" to pass information from task to task, as the basis for I/O requests, and as the medium of transfer for Intuition's mouse and window events. A message incorporates a node and therefore inherits all its properties and functions.



**Figure 4:** A message is transmitted to a message port, which contains a list of incoming messages to be serviced, in priority order. Like messages, message ports incorporate a node and therefore inherit all the properties and functions of a node.

Amiga. They are used to pass information from task to task, as the basis for I/O requests, and as the medium of transfer for Intuition's mouse and window events. Unlike a signal, which can merely give an "I'm here!" indication, a message can have complex information piggybacked on it.

A message is an extended node and is usually transmitted to a message port (MsgPort), another type of node that contains a list of incoming messages to be serviced, in priority order (see figure 4). MsgPorts can be private and anonymous, or they can be added to the system message port list. Frequently, they occur in pairs (one of each), since after a message is serviced, it is common to forward it to a reply MsgPort, where it is generally recycled or discarded—although it is possible to bounce a message through a whole series of ports. There are several different ways to implement a MsgPort, but the most common way is sup-

**I** *f you examine the internal structure of many popular operating systems, you'll discover that it's "OS versus them."*

ported by a special C++ class named the StdPort—or standard message port—which can be created and initialized by coding

```
StdPort *listener = new StdPort ( "I hear you" );
```

The StdPort constructor takes care of all the details of standard MsgPort initialization. Memory is allocated and initialized, and a signal is acquired on which the listening task can wait. Using the AddPort function, the MsgPort can be put on the system's public MsgPort list, where it can be found by any task that wishes to send it a message. Because Exec was designed in an object-oriented manner, the new operating-system functions are quite simple. A C++ reconstruction shows the following:

```
void AddPort ( MsgPort *mport )
{
  Forbid() ;// disable task-switching
  Enqueue ( AbsExecBase->PortList , mport ) ;
  Enable() ;// re-enable task-switching
}
```

Here's a reconstruction of another system function:

```
MsgPort *
FindPort ( const char *portname )
{
  return ( MsgPort * )
    AbsExecBase->PortList.find ( portname ) ;
}
```

FindPort illustrates another important design feature. If you searched a system list every time you wanted to access an element in that list, system performance would suffer. Instead, the convention is to search and return the object's address. Thereafter, the object's address can be used directly (the Amiga does not use Macintosh-style handles, which cause objects to shift about in memory). The downside of that is that you must never move or remove an object that other tasks may be using. Libraries and devices ensure this by maintaining a user count. For simple message ports, the application should either enforce a log-in/log-out facility or else require that all messages be sent on a one-shot basis (i.e., FindPort/ PutMsg).

Each task is limited to a maximum of 32 distinct signals but can have an unlimited number of MsgPorts. The same signal can be used by more than one MsgPort, which is what keeps Intuition tasks from being limited to a finite number of open windows.

### IORequests

IORequests are extended messages that include I/O control and transfer information sent to devices. A basic set of commands

(read, write, control, and so on) is common to all IORequests; for a given device, additional extensions can be added as needed. A number of special-purpose device IORequest classes have been derived; any device implementer is at liberty to derive his or her own extensions as needed. It's fairly common to end up with something like the following:

```
MyDeviceRequest is based on:
StdIORequest is based on:
IORequest is based on:
Message is based on:
Node is based on:
  MinNode
```

With each level of inheritance, you gain additional properties and functions. The only new code required is that which supports your own unique class of object.

### Libraries

Another important type of node is the library. It consists of a base structure, preceded by function vectors and followed by optional private storage. There is a set of basic functions (e.g., open, close, and expunge) common to all libraries. Beyond that, the designer is free to add functionality at will.

Unlike most operating systems, the Amiga operating system does not use software interrupts or illegal instruction traps to provide operating-system services. Instead, there is a master library, named exec.library, located in the ROM kernel. All the fundamental system functions—the list primitives, memory management, functions to load and open libraries (the libraries' own internal initialization and open routines are called from this)—are defined here. The only immutable part of the operating system is absolute memory location 4, which points to the Exec library structure (ExecBase). The data portion of ExecBase contains the fundamental Exec structures, including the list definitions for the system message ports, libraries, devices, and tasks.

It's interesting to compare Exec libraries with the dynamic link libraries used by OS/2 and Microsoft Windows. DLLs support sets of functions, but they provide additional services as well. The Intel 286 and subsequent chips support the concepts of different levels (rings) of security. If you don't hold the requisite minimum security level, a request will fail. DLL function dispatching can cause security-level switching. The Motorola 68000-series equivalent of this is the Module Call facility. It, however, requires at least a 68020 microprocessor unit and preferably a paged memory management unit. AmigaDOS runs on all 68000s, so the only security levels inherently available are due to the fact that AmigaDOS programs run by the default user state, whereas the operating system runs in supervisor state, as required.

There are pros and cons to both approaches. Since Exec libraries are essentially simple vector tables, the overhead of calling library functions is barely higher than when the function is resident in the calling program (much less than a software interrupt), instead of being shared system code. On the other hand, a carefully designed DLL, while incurring a small speed penalty, is more immune to damage from programs that have run amok.

Note that DLLs are extensions to the Microsoft operating systems; the basic system functions are still software-interrupt driven. Hence, there has to be logic for both kinds of library interfaces. Amiga libraries, however, not only provide a single interface, but they are immune to the problem inherent to all software interrupts—there's only a finite number of them,

# "HOLLYWOOD SQUARES"

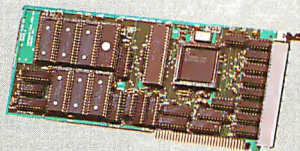
Brought to you by GTEK, Inc.



**PCSS-8I**

### Intelligent Serial Co-processor

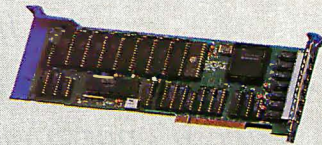
- 15 MHz On Board Processor
- 32K-128K DYNAMEMORY
- High Performance - Low Cost
- DOS, SCO™ XENIX®, SCO™ UNIX®



**PCSS-8IV**

### Intelligent Serial Co-processor

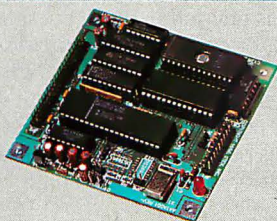
- 32K-728K Of DYNAMEMORY
- Execute Custom Protocols On The Board - 8086 Code Compatible
- Eight Ports Per Card
- DOS, SCO™ XENIX®, SCO™ UNIX®



**MCSS-9IM**

### Intelligent Co-processor

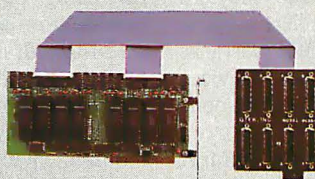
- For Micro-Channel Computers
- 32K - 1M Of DYNAMEMORY
- 9 Ports Per Card
- DOS, SCO™ XENIX®, SCO™ UNIX®



**2020 SBC**

### 2020 Single Board Computer

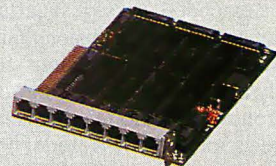
- Low Cost Controller
- 15 MHz 8082
- RS232/422/485
- Stackable Option Boards



**PCSS-8X**

### Eight Port Serial Board

- Full Modem Control Signals
- 100% COM Port Compatible
- Add Up To 32 Ports
- DOS, SCO™ XENIX



**PCSS-8TX**

### Compact Eight Port Serial Board

- 100% COM Port Compatible
- Fits In Half Slot
- Modular RJ-11 Jacks
- DOS, SCO™ XENIX®



**MODEL 9000**

### (E)(E)Prom Programmer

- QuickPulse & Intelligent Algorithms
- Programs Eproms (Up To 4Mb), EEproms and MPU's
- Up To 57K Baud
- Ultra Fast!



**ROMX-2XL**

### Eprom Emulator

- Reduces Development Time
- Emulates Thru Megabit Eproms
- Battery Backed, Autoemulate
- Communications Software Included



**MODEL 9800**

### Gang Programmer

- Programs 8 Parts At Once
- QuickPulse & Intelligent Algorithms
- Programs Eproms (Up To 4Mb), EEproms And MPU's
- Ultra Fast!

**GTEK**® INC.

Development Hardware & Software • P.O. Box 2310 • Bay St. Louis, MS 39521-2310  
MS & Technical Support 601-467-8048 • Fax 601-467-0935



All GTEK products have a full 1-year warranty • Order Toll Free 800-282-GTEK (4835) • OEM & Dealer inquiries welcomed

DYNAMEMORY is a trademark and GTEK is a registered trademark of GTEK, Inc. All other trademarks are property of their respective companies.

Circle 129 on Reader Service Card (RESELLERS: 130)

**T**he Amiga  
operating system is unusual in that  
it doesn't partition memory for  
applications.

which never seems to be enough for practical purposes. Libraries, on the other hand, are not only "infinitely" expandable, but it is a straightforward task to create new ones that are indistinguishable from the built-in ones—or even to completely override a built-in one by inserting a new library of the same name at a higher priority on the system library list.

The library concept is itself extended; it forms the basis for an I/O device by adding a few standard functions. Most devices work via extended messages, called IOREquests. There are also extensions to these extensions (such as the StdIORequest), as well as customized extensions for specific devices. Devices typically also possess one or more tasks so that I/O can be done asynchronously, although this is not mandatory.

There is another, less-understood extension to the library, called the resource. A resource essentially acts as a coordinator for shared resources (generally hardware), such as the different drives on a disk controller, or the serial and parallel I/O ports (which are implemented on the same chips).

### Tasks

The task structure is yet another node. This one contains all the definitions required to make Exec a fully functional, preemptive, priority-driven, multitasking operating system. A task is roughly equivalent to an OS/2 thread. An extended task, known as a process, provides additional information to permit use of the AmigaDOS functions defined in the library named dos.library—chiefly such things as Unix-like I/O services, program loading capabilities, and the like.

Exec's task scheduler is not as elaborate as OS/2's, which is rumored to have been lifted bodily from IBM's VM/370 mainframe operating system. The OS/2 dispatcher dynamically adjusts task priorities based on certain algorithms that are in the "magic" part of the operating system. While this is impressive, it's doubtful that a single-user operating system needs it. No matter, you're stuck with it. About the best you can do is turn it off, but it still eats up real memory.

Exec gives good performance with a simple time-slice dispatching algorithm. More complex custom algorithms can be attached in a straightforward manner, if required. This can be done safely (and in a release-independent manner) on the Amiga, because both the dispatcher functions and task lists are accessible via well-defined interfaces.

Nothing in the basic design of Exec actually requires only a single CPU to be present in the system. Exec could be implemented in a multiprocessor system if access to system lists were properly serialized. Amiga 2500 systems contain a 68000 and a 68020 (or 68030). At present, one or the other is put to sleep at boot time, but there are possibilities here.

### Semaphores

Originally, serialization in Exec was done either by the `Forbid()` function, which prevents other tasks from being dis-

patched, or `Disable()`, which switches off interrupts. However, this serializes the entire system. For serializing access to a specific resource, semaphores are better.

There are two kinds of semaphores in Exec. A `SignalSemaphore` is based on a `MinNode`. It provides high-performance serialization but has restrictions on use. A semaphore is based on the message system and can be used in more general situations. Either type of semaphore is preferable to the cruder `Forbid()/Permit()` or `Disable()/Enable()` functions, both of which reduce the amount of multitasking that can be done while serialized on the resource.

### Interrupts

An interrupt is a data structure that points to interrupt-handling code, plus any working storage it might require. To allow for more than one task to handle an interrupt event, interrupts are nodes. The exact handling of interrupts varies, depending on the type of interrupt.

### Memory Management

The Amiga operating system is unusual in that it doesn't partition memory for applications, or even the operating system itself. Instead, it maintains a free memory list where each chunk of free memory has certain attributes, and requests are matched against them. Thus, no application runs out of memory until the system itself runs out of memory, and there is no requirement to juggle segments or, as with the Macintosh, compact memory.

A set of low-level functions can be used to acquire and free memory, but Exec also provides a set of functions to manage memory within pools acquired by the application. This has several advantages: less overall memory fragmentation, lower overhead (since the entire pool can be released as a unit, instead of piecemeal), and the ability to preallocate enough memory for applications that have a lot of dynamic memory usage.

There is no system-memory-in-use list. If an application fails and doesn't have a cleanup routine, or if the programmer neglects to free all acquired memory, it's lost until the system is rebooted.

Exec memory management supports both bank-switched memory and virtual memory. Memory allocated with the `MEMF_PUBLIC` attribute is guaranteed to always be visible to all tasks, interrupt routines, and the system supervisor. Memory on the application's stack or allocated without this flag has no such guarantee. With a minimum of 8.5 megabytes of RAM, neither virtual memory nor switched memory cards are in widespread use, so it's likely that many applications will fail should this situation change.

All the other components of the Amiga's operating system—AmigaDOS, Intuition, the WorkBench, the system's unique built-in animation routines, and so on—all ultimately depend on the services of Exec. Exec is compact, efficient, flexible, reliable, and expandable. And no other system I've ever worked with has been so easy to work with. I like that. ■

### BIBLIOGRAPHY

Commodore staff. "Amiga ROM Kernel Reference Manual: Exec." Reading, MA: Addison-Wesley, 1986.  
Sassenrath, Carl. "Guru's Guide to the Commodore Amiga: Meditation #1—Interrupts." Ukiah, CA: Sassenrath Research, 1988.

*Tim Holloway is president of MTS Associates, a system software development firm in Jacksonville, Florida. He can be reached on BIX as "tholloway."*





**The Brick**  
**The fastest 386SX™...**

- ▲ 16 or 20 MHz 386SX
- ▲ 44 to 212 MB HD
- ▲ 1 to 8 MB RAM
- ▲ 1024 x 768 VGA
- ▲ 2,400 bps modem
- ▲ 3" x 8" x 11"
- ▲ 16-bit expansion slot

**...in just 8.3 lbs!**

3" x 8" x 11"



# THE BRICK™

**"A Tote-able that Outperforms the Desktops..."**

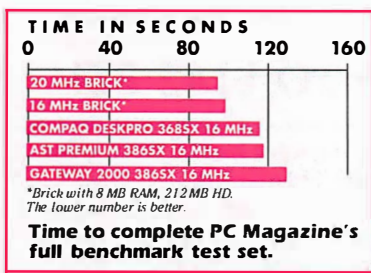
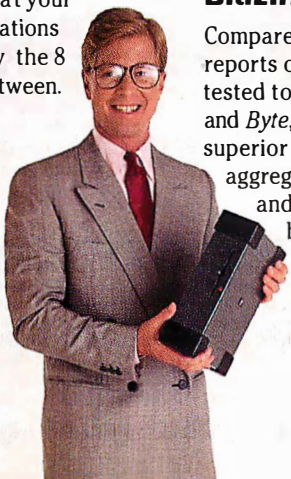
— PC MAGAZINE, Sept. 1990

*This new generation PC is remarkable for the performance and the practicality it provides. The Brick is powerful enough for the most demanding applications, while its elegance, quietness and size make traditional PC's seem downright obtrusive by comparison.*

**More Practical Than a Portable**

For multisite computing, the Brick offers an alternative to the usual trade-offs of laptops or multiple PC's. Just keep your preferred keyboard and full size monitor, plus power supply at your regular destinations and carry only the 8 lb. Brick in between.

Bricks are available with 16 or 20 MHz 386SX, 1-8 MB of RAM,



a fast 44, 104 or 212 MB Conner or Teac IDE hard disk, and a 387 coprocessor socket. A 2,400 bps Hayes compatible modem is standard.

The fast VGA graphics features up to 1024 x 768 non interlaced resolution with a full 1 MB of video memory.

**Blazingly Fast**

Compared to published reports of all 386SX machines tested to date by PC Magazine and Byte, the Brick offers superior performance on the aggregate of system, video and hard disk benchmarks.

**Surprisingly Expandable**

The Brick is only about the size of a ream of copier paper, yet you can still add up to two ISA half cards internally. A docking port allows easy connection to our Docking



Terminal, which instantly hooks up all cables and provides another 16-bit slot.

**Satisfaction Guaranteed**

All Ergo products have a 30 day, money back guarantee, a One Year Warranty, unlimited 800 toll free support, and advanced diagnostics and updates via modem. You'll find complete information on the Brick, plus a full complement of enhancement products in our 32-page free catalog.

**\$2,495**

**Includes**

- ▲ 16 MHz Intel 386SX
- ▲ 1 MB RAM, Exp. to 8 MB
- ▲ 44 MB hard disk
- ▲ 1024 x 768 VGA
- ▲ 2,400 bps modem
- ▲ 3.5" 1.44 MB floppy
- ▲ 16-bit half card exp. slot
- ▲ Freight included

**\$2,695**

with 101 Keyboard & 12" Mono VGA Monitor

**\$2,995**

with 101 Keyboard & 14" Color VGA Monitor



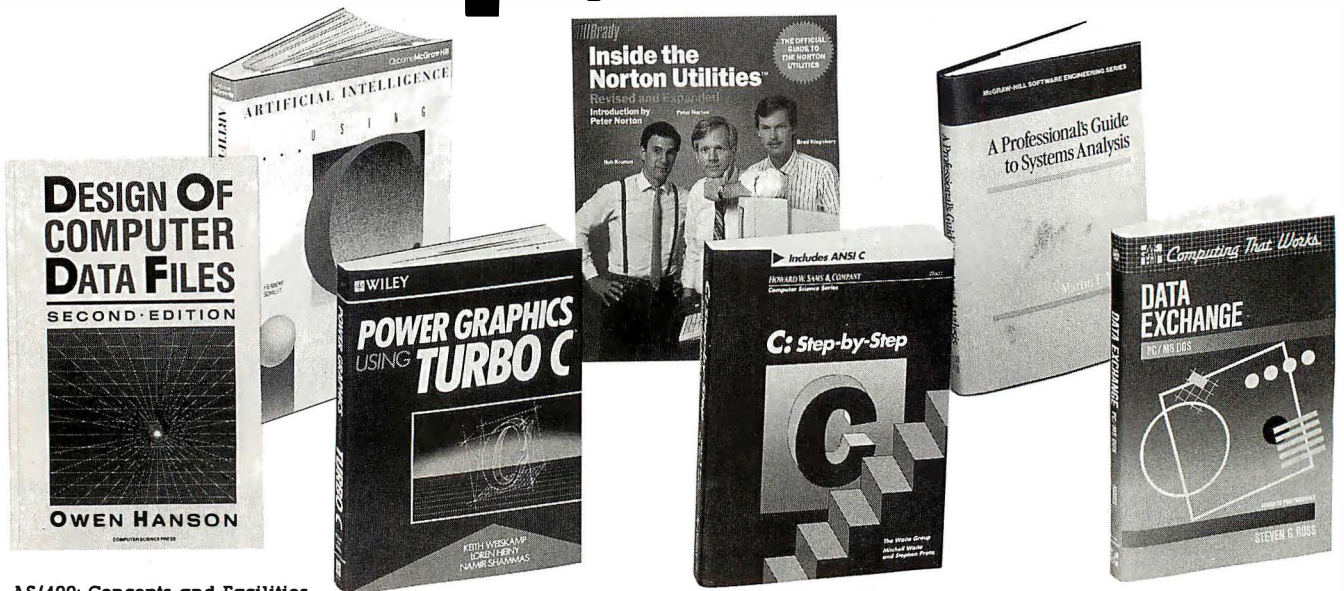
One Intercontinental Way, Peabody, MA 01960  
 Tel: (508) 535-7510 Fax: (508) 535-7512

**Order Factory Direct**  
**1-800-633-1925**  
**Free 32-Page Catalog**

Circle 106 on Reader Service Card

BY191

# Take any 3 books for only \$1<sup>00</sup> each



## when you join BYTE Book Club<sup>®</sup> VALUES UP TO \$142.85!

- Your one source for computer books from over 100 different publishers
- the latest and best information in your field
- discounts of up to 40% off publishers' list prices

**AS/400: Concepts and Facilities.** By T. Baritz and D. Dunne. 256 pp., *illus.* A unique, hands-on introduction to the machine and its capabilities, this thorough guide offers sample code for a variety of everyday business projects. Coverage includes development tools, languages, integration, and more. 183/015 Pub. Pr., \$39.95

**INTRODUCING PC-DOS & MS-DOS, Second Ed.** By T. Sheldon. 403 pp., *illus.*, *softbound*. This Second Edition covers all releases through 4.0, as well as Microsoft Windows and DOS-SHELL. Features the same hands-on tutorial format of the First Edition, with expanded coverage of batch file techniques that can dramatically increase your computing speed. 565/651 Pub. Pr., \$29.95

**LOCAL AREA NETWORKS: Architectures and Implementations.** By J. Martin, with K. K. Chapman. 353 pp., *illus.* An indispensable reference for all who buy, install, maintain, or manage LAN services. Provides complete coverage of the concepts, architectures, and implementations of LAN technology. 584900-3 Pub. Pr., \$44.00

**A PROFESSIONAL'S GUIDE TO SYSTEMS ANALYSIS.** By M.E. Modell. 307 pp., *illus.* Detailed coverage of what you need to know—what questions to ask, how to conduct a cost-benefit analysis, how to document and validate your findings—to design the best systems for your user's needs. 426/325 Pub. Pr., \$37.95

**DATA EXCHANGE: PC/MS-DOS.** By S. Ross. 426 pp., *illus.*, *softbound*. Now you can convert files quickly and painlessly from word processing programs to spreadsheets . . . from spreadsheets to databases . . . or from databases to word processing programs. Packed with simple, step-by-step instructions that will save you headaches and money. 539/235 Pub. Pr., \$24.95

**C: Step-by-Step.** By M. Waite and S. Prata. 629 pp., *illus.*, *softbound*. Mastering C has never been easier! This updated version of the classic *C Primer Plus* includes ANSI C, pointers, structures, bitwise operators, and much more . . . all in a format that makes learning it faster and easier than ever. 585146-6 Pub. Pr., \$29.50

**INSIDE THE NORTON UTILITIES: Revised and Expanded.** By R. Krumm. 559 pp., *illus.*, *softbound*. The "official guide" now covers all the latest upgrades and shows you how to get the most from the Standard and Advanced Editions, the Norton Commander, Editor, Disk Doctor, and the On-Line Guides. 585444-9 Pub. Pr., \$24.95

**MVS PERFORMANCE MANAGEMENT.** By S. L. Samson. 400 pp., *illus.* This unique work demystifies MVS and provides strategies for solving performance problems. Extensive coverage of control mechanisms ranges from measurement and modeling to application tuning and workload management. 545/286 Pub. Pr., \$42.95

**DESIGN OF COMPUTER DATA FILES, Second Ed.** By O. Hanson. 419 pp., *illus.* This comprehensive book contains lucid descriptions of the latest techniques and storage devices to help you design files for maximum performance at minimum cost. Easy to read, with scores of examples, tables, and illustrations. 585143-1 Pub. Pr., \$37.95

**HOW TO BE A SUCCESSFUL COMPUTER CONSULTANT, Second Ed.** By A. R. Simon. 280 pp., *illus.* This new edition of a best-seller is updated to steer your career toward the emerging opportunities of the '90s, including security, microcomputer networking, systems integration, and much more. 575/541 Pub. Pr., \$29.95

**POWER GRAPHICS USING TURBO C.** By K. Weiskamp, L. Heiny, and N. Shammas. 367 pp., *illus.*, *softbound*. This easy-to-follow manual is packed with practical examples of actual code, guidelines for programming 2D and 3D graphics using animation, customizing CAD/CAM, the capabilities of the Borland Graphics interface, and more. 585091-5 Pub. Pr., \$22.95

**ARTIFICIAL INTELLIGENCE USING C: The C Programmer's Guide to AI Techniques.** By H. Schildt. 412 pp., 37 *illus.*, *softbound*. This hands-on guide shows you how to create your own AI applications and systems using C. After an introductory overview it provides coverage of expert systems, logic, natural language processing, machine learning, pattern recognition, and more, with ready-to-run programs illustrating each topic. 881255-0 Pub. Pr., \$21.95

**PROGRAMMING USING THE C LANGUAGE.** By R.C. Hutchison and S.B. Just. 519 pp., *illus.* Whether you want to understand programs in C written by others, or write better C programs of your own, this practical, authoritative book gives you the tools and guidance you need. Coverage includes program organization, sorting algorithms, recursion, linked lists, and more — with many sample programs. 315/418 Pub. Pr., \$29.95

**DATA PROCESSING IN UNIX.** By R. S. Tare. 438 pp., *illus.* The only guide you'll ever need to harness the full power of UNIX for database management. It sets out system selection criteria . . . examines such applications as INFORMIX, INGRES, and UNIFY . . . and explores flat file systems in UNIX. 628/858 Pub. Pr., \$39.95

**CIARCIA'S CIRCUIT CELLAR, Vol. VII.** By S. Ciarcia. 256 pp., *illus.*, *softbound*. The latest volume in this best-selling series provides schematics, operating explanations, and step-by-step building instructions for a wide range of projects—from video digitizing to multitasking process control. 109/699 Pub. Pr., \$19.95

# BYTE BOOK CLUB®

## Membership Order Card

Please enroll me as a member and send me the three choices I have listed below. Bill me only \$3.00, plus local tax, postage and handling. I agree to purchase a minimum of two additional books during my first year as outlined under the Club plan described in this ad. Membership in the club is cancellable by me any time after the two book purchase requirement has been fulfilled. A shipping and handling charge is added to all shipments.

Indicate below by number the books you want. A few expensive books (noted in the descriptions) count as more than one choice.

<input type="text"/>	<input type="text"/>	<input type="text"/>
----------------------	----------------------	----------------------

Signature \_\_\_\_\_

Name \_\_\_\_\_

Address/Apt.# \_\_\_\_\_

City, State, Zip \_\_\_\_\_

Corporate Affiliation \_\_\_\_\_

This order subject to acceptance by McGraw-Hill. All prices subject to change without notice. Offer good only to new members. Foreign member acceptance subject to special conditions.

# BYTE BOOK CLUB®

## Membership Order Card

Please enroll me as a member and send me the three choices I have listed below. Bill me only \$3.00, plus local tax, postage and handling. I agree to purchase a minimum of two additional books during my first year as outlined under the Club plan described in this ad. Membership in the club is cancellable by me any time after the two book purchase requirement has been fulfilled. A shipping and handling charge is added to all shipments.

Indicate below by number the books you want. A few expensive books (noted in the descriptions) count as more than one choice.

<input type="text"/>	<input type="text"/>	<input type="text"/>
----------------------	----------------------	----------------------

Signature \_\_\_\_\_

Name \_\_\_\_\_

Address/Apt.# \_\_\_\_\_

City, State, Zip \_\_\_\_\_

Corporate Affiliation \_\_\_\_\_

This order subject to acceptance by McGraw-Hill. All prices subject to change without notice. Offer good only to new members. Foreign member acceptance subject to special conditions.



NO POSTAGE  
NECESSARY  
IF MAILED  
IN THE  
UNITED STATES



**BUSINESS REPLY MAIL**

FIRST CLASS MAIL PERMIT NO. 42 HIGHTSTOWN, NJ

POSTAGE WILL BE PAID BY ADDRESSEE

**McGraw-Hill Book Clubs**  
**P.O. Box 582**  
**Hightstown, NJ 08520-9452**



NO POSTAGE  
NECESSARY  
IF MAILED  
IN THE  
UNITED STATES



**BUSINESS REPLY MAIL**

FIRST CLASS MAIL PERMIT NO. 42 HIGHTSTOWN, NJ

POSTAGE WILL BE PAID BY ADDRESSEE

**McGraw-Hill Book Clubs**  
**P.O. Box 582**  
**Hightstown, NJ 08520-9452**





**TURBO PASCAL EXPRESS**, Revised Ed. By R. Jourdain. 584963-1 Pub. Pr., \$39.95

**COBOL II: Programming Techniques; Efficiency Considerations; Debugging Techniques (Includes Release 3.1).** By H. Bookman. 065/330 Pub. Pr., \$39.95

**ADVANCED MS-DOS BATCH FILE PROGRAMMING.** By D. Gookin. 585018-4 Pub. Pr., \$24.95

**ARTIFICIAL INTELLIGENCE & TURBO C.** By C. F. Chabris. 585052-4 Pub. Pr., \$24.95

**POWER GRAPHICS PROGRAMMING.** By M. Abrash. 585443-0 Pub. Pr., \$24.95

**32-BIT MICROPROCESSORS.** Edited by H. J. Mitchell. 425/85X Pub. Pr., \$49.95

**ADVANCED 80386 PROGRAMMING TECHNIQUES.** By J. L. Turley. 881342-5 Pub. Pr., \$22.95

**A DOS USER'S GUIDE TO UNIX.** By D.W. Topham. 585537-2 Pub. Pr., \$27.95

**80386: A Programming and Design Handbook, 2nd Ed.** By P. Brumm and D. Brumm. 585077-X Pub. Pr., \$24.95

**PRINCIPLES OF ARTIFICIAL INTELLIGENCE AND EXPERT SYSTEMS DEVELOPMENT.** By D.W. Rolston. 536/147 Pub. Pr., \$47.95

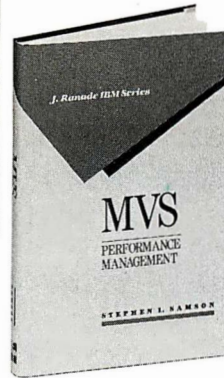
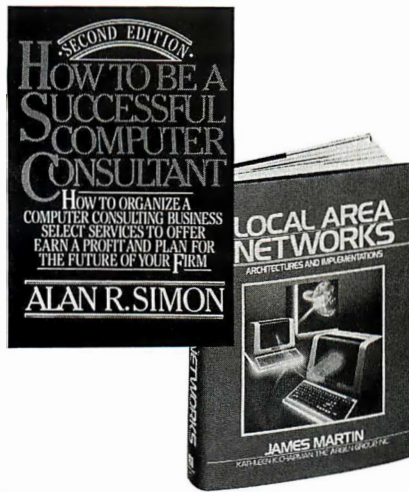
**VM PERFORMANCE MANAGEMENT.** By T. Eddolls. 189/668 Pub. Pr., \$39.95

**DB2/SQL: A Professional Programmer's Guide.** By T. Martyn and T. Hartley. 406/669 Pub. Pr., \$39.95

**DATA COMMUNICATIONS: A User's Guide, 3rd Ed.** By K. Sherman. 585384-1 Pub. Pr., \$34.00

**OPERATING SYSTEMS.** By M. Milenkovic. 419/205 Pub. Pr., \$47.95

**IBM PS/2: A Reference Guide.** By T.J. Byers. 095/272 Pub. Pr., \$39.95



**1-2-3 RELEASE 3: The Complete Reference.** By M. Campbell. 881318-2 Pub. Pr., \$28.95

**GRAPHICS DESIGN AND ANIMATION ON THE IBM MICROCOMPUTERS.** By J. Sanchez. 585375-2 Pub. Pr., \$28.00

**STRUCTURED ASSEMBLY LANGUAGE.** By L. Dorfman. 585593-3 Pub. Pr., \$34.95

**GUIDE TO ORACLE.** By T. Hoechst, N. Milander, and C. Chabris. 206/317 Pub. Pr., \$39.95

**VS COBOL II FOR COBOL PROGRAMMERS.** By P. Kavanagh. 335/710 Pub. Pr., \$39.95

**C: The Complete Reference, 2nd Ed.** By H. Schildt. 881538-X Pub. Pr., \$28.95

**INTRODUCTION TO SNA NETWORKING: A Guide for Using VTAM/NCP.** By J. Ranade and G.C. Sackett. 511/446 Pub. Pr., \$39.95

**ONLINE COMMUNICATIONS SOFTWARE.** By R. Ashley, J. Fernandez, and P. Ashley. 024/634 Pub. Pr., \$27.95

**Any 3 books for \$1.00 each... if you join now and agree to purchase two more books—at handsome discounts—during your first year of membership.**

**ADVANCED GRAPHICS IN C: Programming and Techniques.** By N. Johnson. 881257-7 Pub. Pr., \$22.95

**DEVELOPING APPLICATIONS USING DOS.** By K.W. Christopher, Jr., B.A. Feigenbaum, and S.O. Saliga. 585469-4 Pub. Pr., \$24.95

**STRUCTURED WALKTHROUGHS, 4th Ed.** By E. Yourdon. 585016-8 Pub. Pr., \$28.50

**WINDOWS PROGRAMMING: An Introduction.** By W.H. Murray III and C.H. Pappas. 881536-3 Pub. Pr., \$28.95

**SAS SYSTEM: A Programmer's Guide.** By M. Aronson and A. Aronson. 024/677 Pub. Pr., \$39.95

**FILE ORGANIZATION FOR DATABASE DESIGN.** By G. Wiederhold. 701/334 Pub. Pr., \$47.95

**STRETCHING TURBO C.** By K. Porter. 584967-4 Pub. Pr., \$24.95

Clip & Mail

**BYTE BOOK CLUB®**

P.O. Box 582

Hightstown, NJ 08520-9959

Please enroll me as a member and send me the three choices I have listed below. Bill me only \$3.00, plus local tax, postage and handling. I agree to purchase a minimum of two additional books during my first year as outlined under the Club plan described in this ad. Membership in the club is cancellable by me any time after the two book purchase requirement has been fulfilled. A shipping and handling charge is added to all shipments.

Indicate in the boxes the code numbers of the books you want.

Signature \_\_\_\_\_

Name \_\_\_\_\_

Address / Apt. # \_\_\_\_\_

City / State / Zip \_\_\_\_\_

This order subject to acceptance by McGraw-Hill. All prices subject to change without notice. Offer good only to new members. Foreign member acceptance subject to special conditions.

BYCA-032

**Here's how BYTE Book Club® works to serve you:**

- **Important information . . . we make it easy to get!** Today, professionals who perform best are those who are best informed. For reliable, hands-on information, turn to the Byte Book Club. Every 3 or 4 weeks (12-15 times a year), members receive the Club Bulletin offering more than 30 books – the best, newest, most important books from all publishers.
- **Dependable service . . . we're here to help!** Whether you want information about a book or have a question about your membership, just call us toll-free or drop us a line. To get only the books you want, make your choice on the Reply Card and return it by the date specified. If you want the Main Selection, do nothing – it will be sent to you automatically. (A small shipping and handling charge is added to each shipment.)
- **Club convenience . . . we do the work!** You get a wide choice of books that

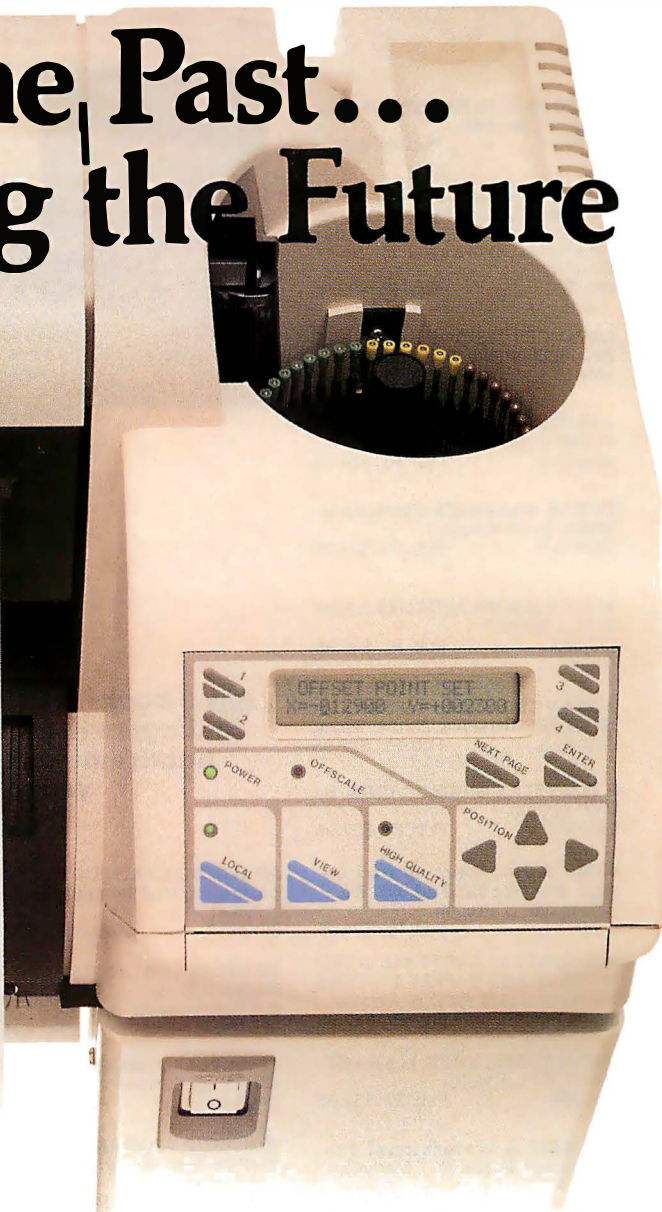
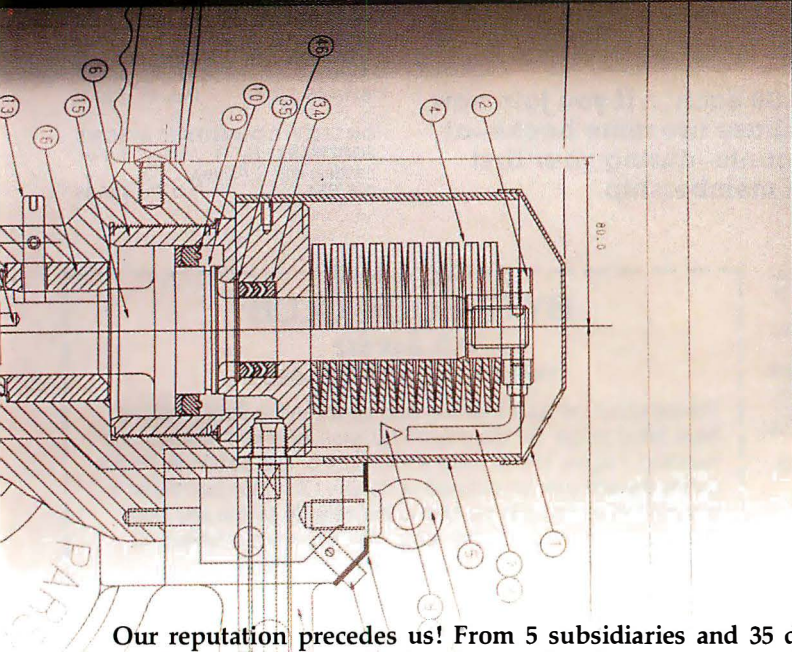
simply cannot be matched by any bookstore. And all your books are conveniently delivered right to your door. You also get 10 full days to decide whether you want the Main Selection. (If the Club Bulletin ever comes late and you receive a Main Selection you don't want, return it for credit at our expense.)

- **Substantial savings . . . and a bonus program too!** You enjoy substantial discounts—up to 40%—on every book you buy. Plus, you're automatically eligible for our Bonus Book Plan which allows you savings up to 70% on a wide selection of books.
- **Easy membership terms . . . it's worthwhile to belong!** Your only obligation is to purchase 2 more books – at handsome discounts – during the next 12 months, after which you enjoy the benefits of membership with no further obligation. You or the Club may cancel membership anytime thereafter.

Fill out the card and mail today! If the card is missing, write to:

**BYTE Book Club®, P.O. Box 582, Hightstown, New Jersey 08520-9959**

# Recording the Past... ...Plotting the Future

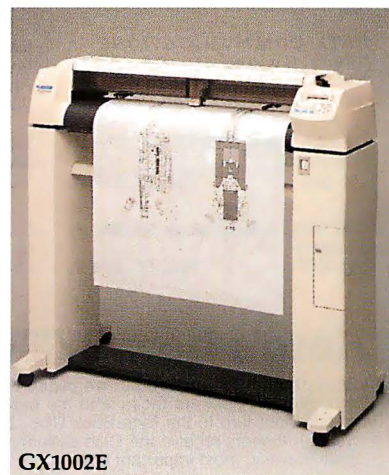


Our reputation precedes us! From 5 subsidiaries and 35 distributors in more than 40 countries worldwide, thousands of customers purchased more in 1989 than ever before. And they were able to choose new products from an ever-expanding array of plotters, penless plotters, digitizers, recorders and supplies.

The Graphtec reputation is one of building products that work well and last a long time. We earned that reputation the hard way, by delivering over 40 years of the best innovation, support, and after-sales service in the industry.

Speed and accuracy are the hallmarks of our latest flagship plotter, the A0 large-format GX1002E. Capable of accepting both pens and pencils, the GX1002E attains plotting speeds of up to 1202 mm/s at 45° or 850 mm/s in the axis direction. Throughput is further enhanced by a 32-bit CPU, 1MB buffer (expandable to 2MB), and pen/vector sorting functions.

If you are looking for a top-of-the-line plotter, you won't be disappointed by the Graphtec GX1002E. Or if you prefer, consider our pen-only GX1002 model instead. You'll receive the same benefits for a lower price.



GX1002E



**GRAPHTEC CORPORATION** Mita 43rd Mori Bldg., 13-16, Mita 3-chome, Minato-ku, Tokyo 108, Japan Tel:(03)453-0511 Fax:(03)453-7187  
U.S.A.: American Graphtec, Inc. Tel:(714)454-2800 Fax:(714)859-2800 **Australia:** Southern Graphtec Pty. Ltd. Tel:(02)748-4888 Fax:(02)748-4882  
Europe: Graphtec Europe GmbH Tel:(040)511-5059 Fax:(040)511-9155 **United Kingdom:** Graphtec (UK) Ltd. Tel:(0270)625-115 Fax:(0270)626-733

Circle 124 on Reader Service Card

# PUTTING WAVEFORMS TO PAPER

Want to capture displayed data on a Mac into a file? Here's how.

In the past decade, microcomputers have invaded engineering and scientific laboratories. What's more, with the introduction of ever-more-sophisticated interface and data acquisition cards, micros (in this case, Mac IIs) have become serious tools for controlling lab instruments and acquiring their data. A Mac II can store volumes of this data, crunch it into meaningful results, and display it.

However, a stumbling block that has arisen is the conversion of the displayed data into something that Mac graphics applications could use. What has been needed is a way to produce high-resolution hard-copy output of the data for publication.

Using Symantec's Think Pascal compiler in my laboratory research at Yale, I implemented a solution that translates digitized waveform information into standard Macintosh graphics objects. As Mac graphics objects, the information can then be either pasted into other applications via the Clipboard or saved to disk as PICT files. Although my data was mainly digitized voltage samples, the examples shown here can be just as easily applied to any data pairs displayed as a two-dimensional curve.

## A Little Nerve

Work in my laboratory centers around the study of electrical responses of nerve tissue. The nerves are stimulated with a short current pulse, and an oscilloscope digitizes the evoked responses (called *action potentials*). I use a Mac II that is equipped with an IOtech IEEE-488

general-purpose interface bus (GPIB) interface card that transfers the digitized samples from the oscilloscope. A multi-function A/D, D/A, digital I/O, and timer board from GW Instruments generates digital and analog signals that I use for precise control of experimental parameters.

I store the digitized waveforms as compressed text fields in HyperCard 1.2.5. HyperCard is assisted by a healthy assortment of XCMDs, written in Think Pascal, that handle computation-intensive tasks such as data compression/decompression, fast waveform plotting, and digital filtering.

The entire system worked extremely well until it came time to publish my results and include real waveforms on paper. A little browsing through the volumes of *Inside Macintosh* (the official Mac bible, with a detailed description of the Mac OS) revealed that it would not be difficult to write a short procedure that converts a digitized waveform into a graphics object. To explain how I accomplished this, I'll start with a brief background of how the Mac generates and handles graphics.

## QuickDraw Basics

The Mac relies heavily on graphics procedures to draw its Desktop, windows, icons, and so forth. To handle these computationally intensive operations, the Mac ROM contains a set of powerful and highly optimized graphics primitives that are collectively called QuickDraw. All graphics are constructed on a 2-D grid whose *x* and *y* coordinates are 16-bit integers with values that range from -32,768 to 32,767. Note that QuickDraw locations are defined as integral positions on this grid, unlike in PostScript, whose coordinate system uses floating-point values.

At the programmer's disposition is a set of ROM Toolbox calls that create basic geometric shapes, such as lines, rectangles, ovals, and polygons. In turn,

you can fill each of these shapes or objects with a certain pattern or draw its outline with a particular pen width or pen pattern. It quickly becomes apparent that a series of calls to different QuickDraw procedures can result in a complex image. The stunning graphics, created by QuickDraw calls, that can be displayed on Mac screens certainly attest to this.

QuickDraw further simplifies things by defining a data structure called a *picture*. A picture is nothing more than a series of recorded QuickDraw calls. Pictures are typically stored in compressed form and are accessed through a variable-length handle. These pictures can be written to disk files with a file type of PICT. A PICT file is a standard file type that's recognized by most graphics applications. You can record images by using a standard QuickDraw call (*OpenPicture*), and you can reconstruct them on the screen by "playing back" the picture with the *DrawPicture* QuickDraw procedure.

## Creating the Waveform

It really doesn't matter how digitized signals are stored. Some applications might save the *x-y* values (in my application, these correspond to time-voltage pairs from the oscilloscope) as an ASCII table or as 1-D or 2-D integer or real arrays. As I noted above, QuickDraw expects points on a grid with integer coordinates, so your data ultimately has to be converted to integers.

How you do this is important, since it influences the final resolution of your image. Here's an example: I use a setting of  $\pm 100$  millivolts full-scale on my oscilloscope when sampling my signals. If you take each sample and map these voltage readings into an integer array by rounding (e.g., -44.7 mV becomes -45 mV, +58.3 mV becomes +58 mV, etc.), the maximum resolution you can ever attain is one part in 200. However, the A/D converter in the oscilloscope

digitizes signals with a 12-bit dynamic range, equivalent to a resolution of one part in  $2^{12}$  (4096). I am better off taking the raw data from the converter and using the actual 12-bit values as the coordinates of my graphics object. This way, full resolution is maintained and no information is lost.

But there is one problem with this approach. When it's displaying graphics, QuickDraw maps each point to a pixel on the screen. At an average display resolution of 72 dots per inch, my waveform y-axis might be as large as 4096 dots, or 57 inches. Even using a 21-inch monitor, I would never be able to see more than a small part of the waveform at any one time. Printing is even worse: Nothing short of a poster-size page would hold the entire image.

As it turns out, this is not as big a hurdle as it seems; I can choose the appropriate graphics application to scale the waveform. This way, I still can use the full range of 4096 points to produce the best-looking waveforms.

You should also give careful consideration to the x-axis. In the example shown in listing 1, every point is simply mapped onto the coordinate plane. With 4000 points per waveform, it won't take many waveforms pasted into the same document to choke most existing graphics applications. Even if the application is ro-

bust enough to handle the data, screen redraws will be painfully slow, even on a Mac II.

For display purposes, showing only every tenth data point should be ade-

**W**ith 4000  
points per waveform,  
it won't take many  
waveforms pasted  
into the same  
document to choke  
most existing graphics  
applications.

quate. This depends on your signal and how many high-frequency components that it contains. (Nyquist sampling theory applies to graphics, as well—faster-changing signals require more points for faithful reproduction.) In my laboratory,

I reached a compromise that uses an adaptive approach. An algorithm analyzes the waveform, and the faster it changes, the more points are sent to the grid to better render these rapidly changing segments.

Trial-and-error tests will help you find values that yield the best results. Assuming you have an integer array of  $x$  and  $y$  values that you can deal with, examine the code in listing 1 to see how a picture structure is created and used.

### Creating a Picture

You must first allocate a handle before it can accept the QuickDraw calls that define the picture; you accomplish this by calling `OpenPicture`. A waveform is best represented as a *polygon*, a related collection of straight-line segments. In a polygon, these segments move together and can be scaled together in a graphics application—no manual grouping of hundreds of scattered lines is necessary. In addition, you can split a polygon into two or more polygons, or you can bind two polygons into a single one. Finally, you can smooth a polygon to reduce the jaggies and yield beautiful results on a laser printer.

As an aside, a limitation of the latest version of the LaserWriter driver (6.0 as of this writing) will not allow printing of polygons with more than about 400 vertices. You must either manually split a large polygon after importing it into your graphics application or initially build it as a contiguous series of smaller polygons.

In QuickDraw, you create a polygon in much the same way as you create a picture: You open it (using `OpenPoly`), record a series of straight lines (using `MoveTo` and `LineTo`), and conclude the definition (using `ClosePoly`). The lines are actually "drawn" in the current pen width and pattern by `FramePoly`. Once the vertices have been saved in the picture, the handle is finally deallocated. In my application, the y-coordinates that are passed to the `MoveTo` and `LineTo` calls must be negated, because in QuickDraw the positive y-axis points downward. Otherwise, your picture will appear upside down.

I always draw a baseline as the last line segment of the polygon, so it always moves with the rest of the waveform. In the figure it is drawn at 0 volt, but in practice you will draw it at whatever level your oscilloscope's offset happens to be set to. This gives an excellent frame of reference (to let you know if the waveform is floating on some DC voltage level).

**Listing 1:** A Pascal procedure to record data points into a QuickDraw polygon. The polygon is saved onto the Clipboard and into a file.

```
{Pascal code demonstrating how to convert an integer}
{array into a Macintosh graphics structure, which is then pasted}
{onto the Clipboard and written to a 'PICT'-type disk file.}
{'nPoints' is the number of elements in the wave, which is passed}
{in the integer array 'theWave', of type 'waveType'.}
procedure WaveToPICT (nPoints: integer; theWave: waveType);

var
  sysFlag: boolean;
  j, vRefNum, refNum: integer;
  longZero, longCount, count, scrapResult: longint;
  drawRect, picFrame: rect;
  fName, prompt, origName, nullStr: str255;
  myPic: picHandle;
  myPoly: polyHandle;
  scrapType: ResType;
  OSResult: OSErr;
  creator, fileType: OSType;
  reply: SFReply;
  where: point;
  dlHook: ProcPtr;

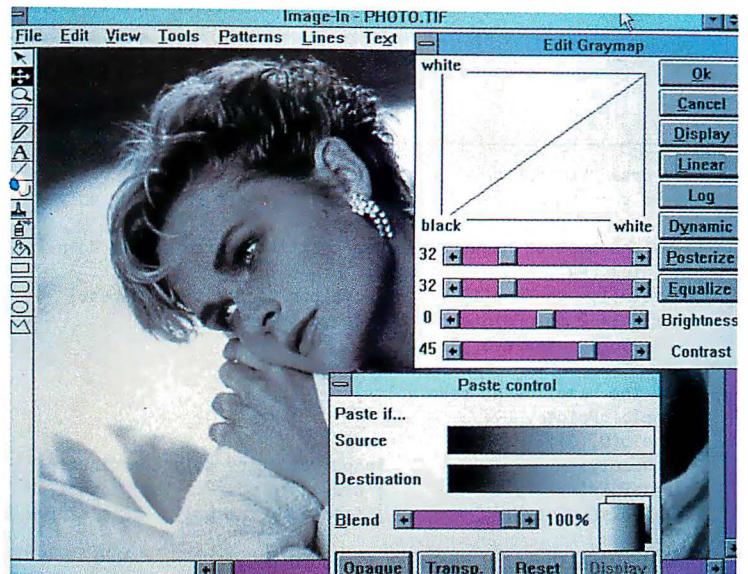
begin
  {allocate handle for picture, define big picture frame}
  setRect(picFrame, 0, -5000, 10000, 5000);
  myPic := OpenPicture(picFrame); {start recording QuickDraw calls}
```

*continued*

*continued*



# How to Make Great Gray-Scale Images!



**Image-In Scan and Paint Plus** is a powerful gray-scale editor that provides the missing link between scanning gray-scale images and editing them for final "finished art" production.

**Image-In Scan and Paint Plus** gives you the most complete graphics tool kit available for IBM PC and compatible Windows 2.0 or 3.0 environments. Scanning, painting and editing all types of images, and preparing them for printing is now easy to do, with *more power* for a true desktop publishing environment!

Adding **Image-In Scan and Paint Plus** to your desktop publisher will put an "electronic darkroom" right on your computer. Turn bad photographs into great photographs with graymap editing, paste control, filters for autosketching, edge enhancement, sharpening and softening, snow and snowplow techniques. Images can be combined and blended to make composites and posterized for special effects *right on your computer*. Imagine not having to send your photographs to a production house for processing! You simply scan or import a photo, manipulate it the way you want it to look and print the image!

Circle 142 on Reader Service Card (RESELLERS: 143)

## Image-In supports these scanners!

Canon  
The Complete PC  
Compugraphic  
Epson  
HP ScanJet  
IBM 3119  
Logitech

Marstek  
Microtek  
NISCA  
Panasonic  
Ricoh  
Xerox/Data  
Copy



Fill out the coupon below to receive information on all of Image-In's programs and get the *free booklet HOW TO MAKE GREAT GRAY-SCALE IMAGES!* The booklet provides tips on scanning, manipulating and printing gray-scale images for desktop publishing experts.

All of Image-In's programs are integrated to provide a "seamless" environment with the power of Microsoft Windows. Image-In programs include:

- Image-In Scan/Paint**  
Image input and editing
- Image-In Plus**  
Electronic darkroom
- Image-In Read**  
Automatic text reading/trainable OCR
- Image-In Vect**  
Image vectorization/autotracing
- Image-In Panorama**  
Image database manager

**Please!** Send me information on Image-In programs and a free **HOW TO MAKE GREAT GRAY-SCALE IMAGES!** booklet.

Name \_\_\_\_\_

Company \_\_\_\_\_

Title \_\_\_\_\_

Address \_\_\_\_\_



**IMAGE-IN  
INCORPORATED**

City \_\_\_\_\_

State \_\_\_\_\_ Zip \_\_\_\_\_

Telephone \_\_\_\_\_

Type of computer you have \_\_\_\_\_

Type of scanner you have \_\_\_\_\_

406 East 79th Street • Minneapolis, MN 55420 • (612) 888-3633 • FAX (612) 888-3665

**1-800-345-3540**

```

{now draw the polygon - it will be recorded in myPic}
  myPoly := OpenPoly; {allocate handle, start recording poly }
                {coordinates}
{y-values must be negated because positive y-axis points down }
{in QuickDraw}
  MoveTo(1, -theWave[1]); {move pen to first coordinate}
  for j := 2 to nPoints do {record the rest}
    LineTo(j, -theWave[j]);

{draw the baseline at zero volts}
  LineTo(nPoints, 0);
  LineTo(0, 0);
  ClosePoly; {stop recording poly coordinates}
  FramePoly(myPoly); {'draw' the poly in the picture}
  KillPoly(myPoly); {dispose of the poly - it's stored in myPic}

{now draw calibration marks as a second poly}
  myPoly := OpenPoly; {create a new poly}
  MoveTo(npoints + 100, 0); {start 100 points to the right of wave}
  LineTo(npoints + 100 + 200, 0); {make horizontal limb 200 points long}
  LineTo(npoints + 100 + 200, -150); {make vertical limb 150 points high}
  ClosePoly;
  FramePoly(myPoly);
  KillPoly(myPoly);

  ClosePicture; {stop recording picture}

{*** put the picture on the Clipboard ***}
  scrapResult := ZeroScrap; {clear/initialize the Clipboard}
  scrapType := 'PICT'; {we're putting a picture there}
  count := myPic^.picSize; {size of picture in bytes}
  if odd(count) then
    count := count + 1; {must be even}
{place the picture on the Clipboard - if scrapResult=0 then no error}
  scrapResult := PutScrap(count, scrapType, ptr(myPic^));

{alert MultiFinder to update other scraps}
  sysFlag := SystemEdit(3); {3 is a 'Copy' command}

{*** write the picture to a disk file ***}
{prompt for a filename}
  where.h := 100;
  where.v := 100;
  dlgHook := nil;
  origName := 'Wave.PICT';
  prompt := 'Save graphics to: ';
  SFPutFile(where, prompt, origName, dlgHook, reply);
{create the file}
  creator := '????';
  fileType := 'PICT';
  OSResult := Create(reply.fName, reply.vRefNum, creator, fileType);
{open the file}
  OSResult := FSOpen(reply.fName, reply.vRefNum, refNum);
{write 512-byte header first}
  longZero := 0;
  longCount := 4;
  for j := 1 to 512 div 4 do
    OSResult := FSWrite(refNum, longCount, @longZero);
{write picture to file}
  count := myPic^.picSize;
  OSResult := FSWrite(refNum, count, ptr(myPic^));
{close file}
  OSResult := FSClose(refNum);
{update volume info}
  nullStr := '';
  OSResult := FlushVol(@nullStr, reply.vRefNum);

  KillPicture(myPic); {we're done, release the picture handle}

end;

```

Finally, it is frequently necessary to convey to the reader the absolute magnitude of the waveform by printing calibration marks along with it. In the example, an arbitrary pair of marks measuring 200 (x) by 150 (y) is drawn separately as an L-shaped polygon. In reality, you would read your oscilloscope's horizontal sweep speed and vertical sensitivity (e.g.,  $\mu\text{s}/\text{sample}$  and  $\mu\text{V}/\text{count}$ , respectively) and calculate the appropriate size of the calibration marks. You now have a complete description of your waveform and can instruct QuickDraw to conclude the picture definition with a call to ClosePicture.

You then copy the picture that's now in the handle myPic to the Clipboard with a standard Toolbox call (PutScrap). An important point to note here when running under MultiFinder is the call to SystemEdit. This instructs MultiFinder to update all other scraps (a separate scrap is maintained for each application) with the new information. Otherwise, when you paste the Clipboard's contents into another application, it might not contain your most recent picture.

Finally, you save the picture to a PICT file. The calls to SFPutFile, Create, FSOpen, FSWrite, and FSClose are Mac Toolbox calls that first put up a dialog box that lets the user select a destination filename, open the file, write to the file, and close the file when the application is done. A 512-byte header must precede the picture definition. This header contains information specific to each graphics application, but it can contain all zeros in the generic case.

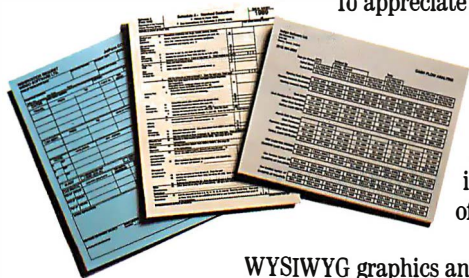
### Importing the Picture

Your picture now exists as a standard QuickDraw graphics object—albeit a giant one—residing either on the Clipboard or in a disk file. By choosing a good graphics application, you can manage this large object quite easily.

The application I use for most of my graphics work is Deneba Software's Canvas 2.1. I can paste my waveform directly into a Canvas document, and it will also recognize generic PICT files. Either way, you end up with a large waveform spanning several pages.

However, Canvas allows you to manipulate objects even though they extend well beyond the size of your drawing. As a matter of fact, you don't even have to see the entire picture in order to reduce it; you simply paste it, group all the parts (they are all selected automatically after the paste), and go to the Scale menu to reduce both x and y dimensions by any percentage (10 percent fits the example

# WE'D LIKE TO SUGGEST A FEW NEW CRITERIA FOR CHOOSING FORMS SOFTWARE.



To appreciate the benefits of JetForm™ software, we invite you to first examine the subject of business forms themselves. And why every business has so many.

It's because forms are the proven way to gather information. Communicate it. Store it, and process it. Which is precisely the point of view from which JetForm was developed.

Naturally, JetForm gives you complete WYSIWYG graphics and font control, using the industry standard Microsoft® Windows interface.

But we also give you something else. And that's a set of capabilities that turns forms software from a handy way to replace pre-printed forms into a powerful way to run a business.

Which is why you'll find JetForm prints faster on the laser printers that businesses use most.

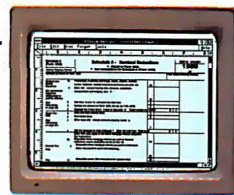
And connects more effectively to networks. So both forms and the information they contain can be better shared and communicated - across departments, or entire organizations. And not just with IBM® PCs, but with HP®3000s, HP9000s, DEC® VAXs™ and UNIX® machines.



Combined with our optional JetForm-Merge and JetForm-Server software, JetForm makes it possible to completely automate and streamline the entire information management process. From design and forms completion, to printing and integration with your existing dBASE® files.

As years pass, other software makers may discover the true purpose of business forms, and upgrade their products to the capabilities of JetForm. But JetForm has them today. And a new business day starts tomorrow.

Call 800-267-9976 for complete information on the full family of JetForm forms software.



**THEY'RE MORE THAN JUST FORMS. THEY'RE YOUR BUSINESS.**

## SPEED

*Find out how fast it prints on HP LaserJet® printers, and the new IBM LaserPrinter 4019. You'll find JetForm is three times faster than others.*

## RANGE

*How well does it work in a network? Sending forms around the office is one thing. Managing information throughout your organization, across multiple platforms, is quite another.*

## CAPACITY

*Will it handle all your forms needs? Including complex policies and contracts, as well as bar code labels? Will it handle them in the volume you'll need as your forms applications grow?*

## CONTROL

*Just because it "links" to your database doesn't mean it takes full advantage of database links. JetForm verifies data, performs calculations, and fully reads and writes dBASE files.*

## DESIGN

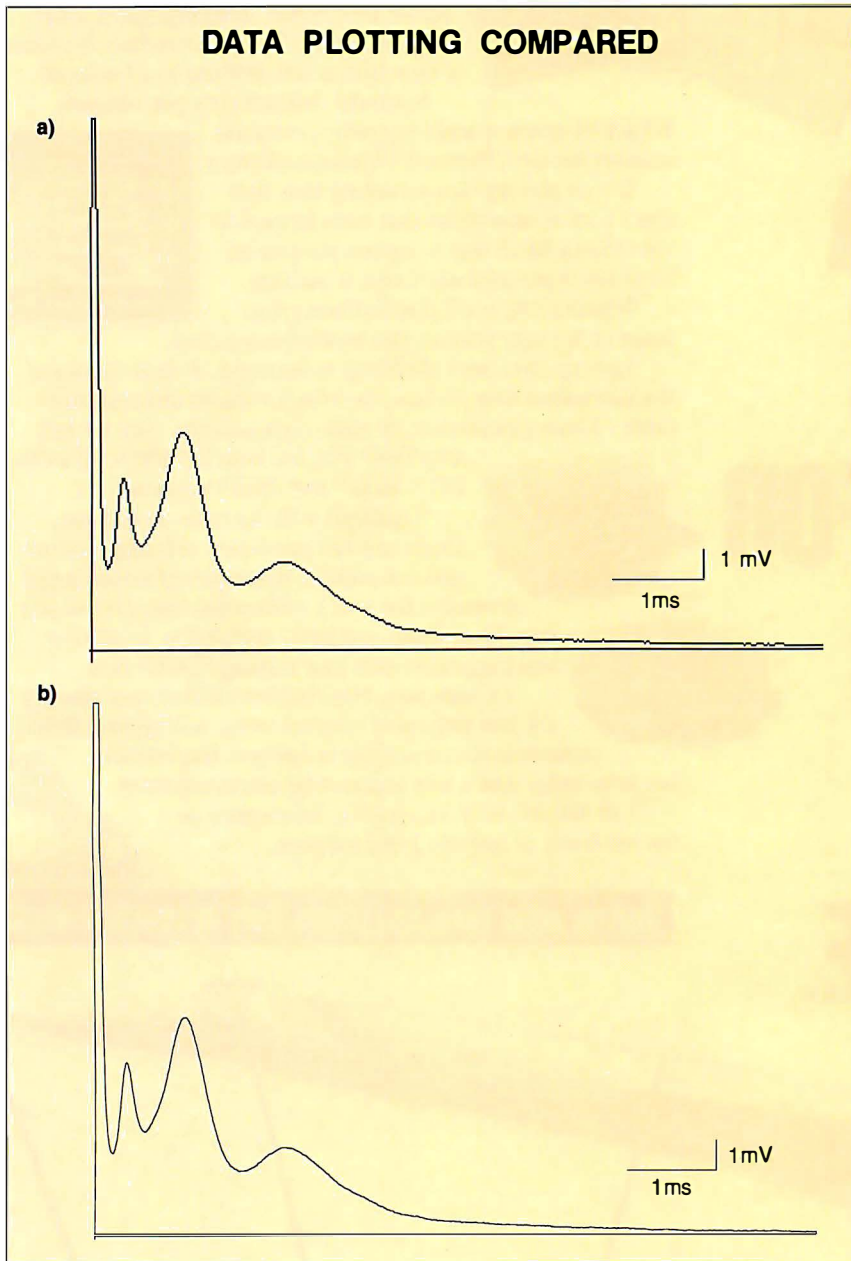
*Make sure you get a full set of flexible, easy to use, WYSIWYG design tools tailored to forms design. After all, this isn't desktop publishing. It's information management.*



MICROSOFT  
WINDOWS  
Version 3.11 Compatible Product

Call (800) 267-9976 (US only) or (613) 594-3026. Indigo Software Ltd., 560 Rochester Street, Suite 400, Ottawa, Canada K1S 5K2  
© 1990 Indigo Software Ltd. JetForm is a trademark of Indigo Software Ltd. All company and product names are trademarks or registered trademarks of their respective owners.

Circle 167 on Reader Service Card



**Digitized electrical response recorded from an optic nerve.**  
 The top tracing (a) was drawn as a bit map in HyperCard and then pasted into Canvas 2.1. The printing resolution is limited to 72 dpi, even though the waveform contains many more sampled points. In (b), the sampled data was converted into a PICT file (using the technique described in the article), pasted into Canvas, and reduced. Note the markedly improved resolution with the latter method. Calibration marks are included as a reference and will automatically scale with the waveform.

on a single page).

By scaling a large object in Canvas, you maintain full resolution because, in contrast to QuickDraw, Canvas graphics are not limited to the screen's pixel resolution. Furthermore, the calibration marks scale down precisely with the rest of the waveform, maintaining the original proportions.

**Picture Perfect**

The figure shows an example of a typical waveform recorded in my laboratory, demonstrating the superior resolution and flexibility of object-oriented graphics compared to bit-mapped images. The top part of the figure was drawn as a bit

map within HyperCard and then pasted into Canvas. My HyperCard stack contains an XCMD that automatically decompresses a previously stored waveform and places it on the Clipboard for pasting into any object-oriented graphics application.

The bottom part shows the same signal converted to a polygon object. Notice the smooth output that results, because by using a polygon to represent the waveform I can obtain a higher resolution. Scaling by different percentages in the x or y directions will always be reflected in the calibration marks as long as they are grouped along with the waveform. Ungrouping the curve and marks allows you to manipulate the two as totally separate graphics entities.

All operations pertaining to polygons (e.g., coloring, smoothing, splitting, editing individual vertices, and setting the line width) can be applied to my imported waveforms as if they were created within Canvas in the first place. You can add labels, axes, or other embellishments from within the graphics application. Alternatively, if these labels and axes are used routinely, they can be easily generated by the original translator XCMD with a few extra lines of code.

As you can see, once you understand the basic principles of Macintosh graphics, it's easy to write a short Pascal (or C, if you prefer) procedure that converts digitized waveforms (or any other 2-D data that you wish to display) into standard Macintosh QuickDraw graphics objects. As QuickDraw objects, your graphics can be pasted into any Mac application that accepts picture data: graphics, page layout, or word processing programs.

In addition, as a QuickDraw object, your graphic is not limited to screen resolution; it will reproduce properly on a high-resolution laser printer. I find this to be the best way of transferring my signals to paper for reports or publications. With your own data and a little effort, you too will be impressed by the quality of your printed results. ■

Editor's note: The source code for listing 1 is available for the Mac in electronic format. See page 5 for details.

Peter K. Stys is an associate research scientist at Yale University. In addition to lab work, he divides his time between seeing patients at Yale's Neurology Clinic and Mac programming. He also builds hardware and writes software for real-time laboratory data acquisition. You can reach him on BIX c/o "editors."

# EEF

## ELEX ELECTRONIC FILING

The ELEX Electronic Filing System (EEF) is a hardware/software system designed to reduce the frightening volumes of paperwork that burden businesses on a daily basis. As paper is eliminated, transactions are made in a fraction of the time required by traditional means, costly storage facilities are reduced, data security and integrity is enhanced, and work quality and quantity is increased. These factors all give companies and individuals the competitive advantage they need to excel in the business environment of the 90's.

### Filing vs. Archiving

Document image processing is a new technology which has just begun to evolve. The myriad of hardware devices on the market, and the lack of an industry standard protocol for communicating between them, make the integration of an electronic filing system a formidable task. And without intelligent software to control all aspects of the storage, management, and retrieval of documents, the filing system will be nothing more than a micro-fiche machine in disguise.

With these considerations in mind, EEF was designed as a turn-key solution which relieves the clients of all the intricacies involved in integrating a truly functional electronic filing system. Yet its flexible design allows continuous and smooth upgrade as the users needs grow and change.

### Open Architecture

EEF is designed as a totally open architecture system. Rather than being a closed package, EEF is composed of individual building blocks defined by their area of electronic

filing functionality. These blocks are not bound to specific hardware/software limitations. As such, they can be combined in a variety of forms on each of the following operating platforms, to achieve optimal satisfaction of an application's specific demands:

- A single user workstation under the DOS or the OS/2 operating system.
- A local area network - **Novell NetWare 286** and higher or any DOS 3.1 compatible network.
- A **host computer** under the **UNIX, VAX/VMS** or **IBM AS/400** system with a PC connection.

Input
Scanner, Fax, Word Processing, Host Computer, Etc.
Processing
Document Manager, Retrieval Engine, Hyper-Media, Database Application Generator, Turn-key Solution.
Output
Printer, Plotter, High Res. Display, Fax, Host Computer

### EEF Applications

The EEF system opens a vast new world of opportunities for you. The possible applications are limitless, and to name a few:

#### Management Systems

Any application which requires original documents and forms (e.g. verification of signatures and L/C in the banking area).

#### Scientific and Engineering Data

Any application in these fields that requires maps, charts, logs,

sketches, etc.

#### Medical Uses

The kind of visual information which is so essential for medical applications is handled by EEF in a natural, straightforward manner.

#### Art Catalogs

Making multi/media presentations of art works, for example at auctions, can provide an exciting new display method.

#### Real Estate / Travel Agency

EEF can be used to take the customers on an on-site electronic tour without ever leaving the office, thus shortening the process of selection.

### EEF Pilot System

For prospective clients wishing to enter the field, we have prepared a pilot system, enclosing in one package the full range of functions necessary for electronic filing. The system components are:

#### Hardware

386 base micro-computer at 33MHz with 64K cache, 8 MB RAM, 1.2GB with access time of 0.8MS (disk caching), proprietary scanner and printer interfaces, high resolution (1660 x 1200) CRT display, laser printer 300 dpi at 8 ppm, scanner 300 dpi with 100 page feeder.

#### Software

The EEF software package, including the document manager, the retrieval engine, the hypermedia interface, and 20 hours of customization services.

Total cost for the pilot system is 30,000 US\$.

For further details and literature, please contact:

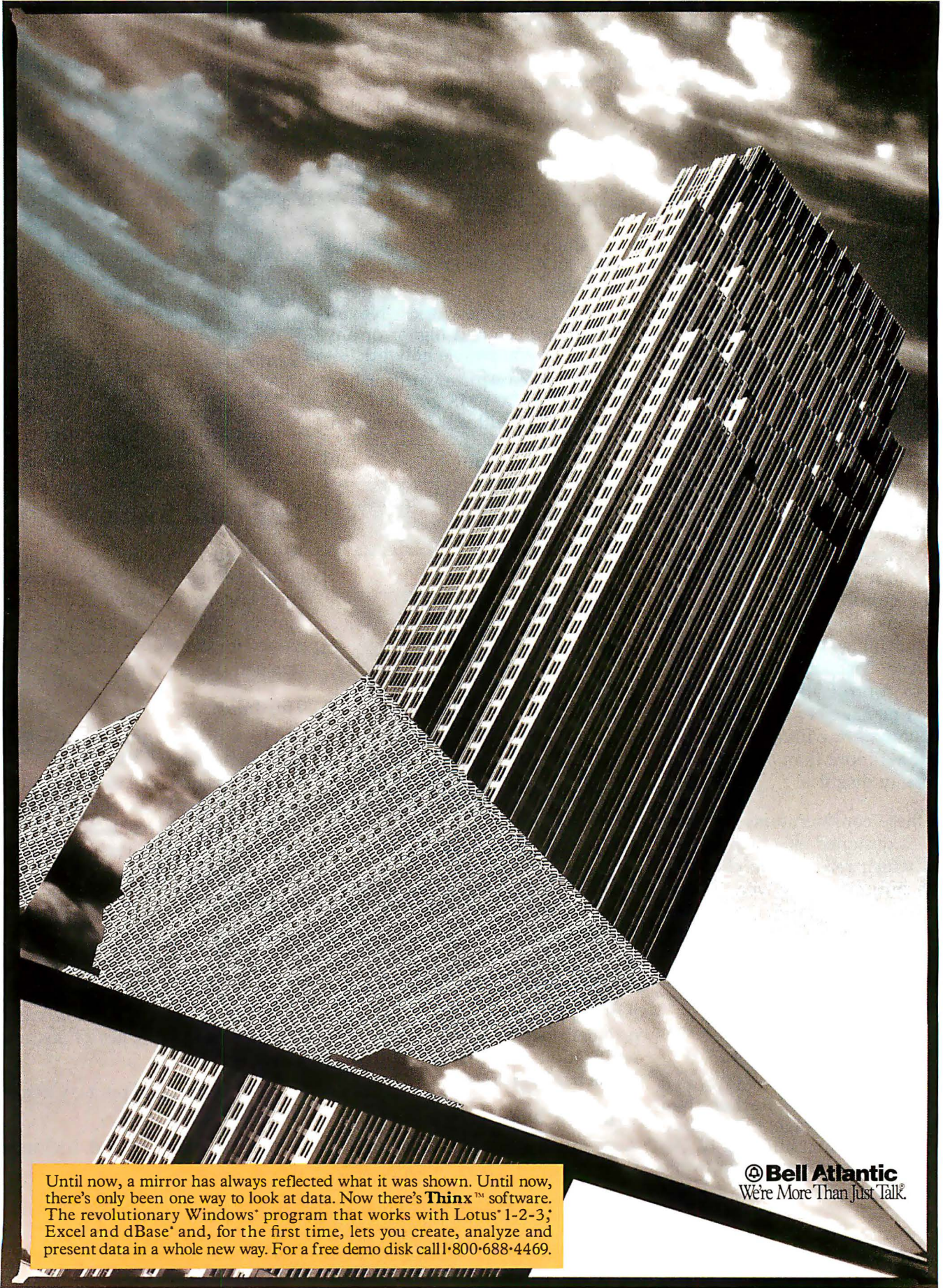
### EUROPE: ELEX INFORMATION SYSTEMS SA

65, Rue de Lausanne 1202 Geneva Switzerland Tel. + 41 22 738 11 88 Fax. + 41 22 738 11 90

### USA: ELEX INFORMATION SYSTEMS INC.

125-127 North 4th Street Philadelphia, PA 19106 USA Tel. + 1 215 627 7202 Fax. = 1 215 627 2342.

Trademarks: DOS, OS/2, Microsoft Corp; NetWare, Novell, Inc.; UNIX, SCO Corp; AS/400, IBM Corp; VAX/VMS, Digital Equip. Corp.



Until now, a mirror has always reflected what it was shown. Until now, there's only been one way to look at data. Now there's **ThinX**™ software. The revolutionary Windows® program that works with Lotus® 1-2-3, Excel and dBase® and, for the first time, lets you create, analyze and present data in a whole new way. For a free demo disk call 1-800-688-4469.

**Bell Atlantic**  
We're More Than Just Talk®

# Personal Supercomputing with the Intel i860

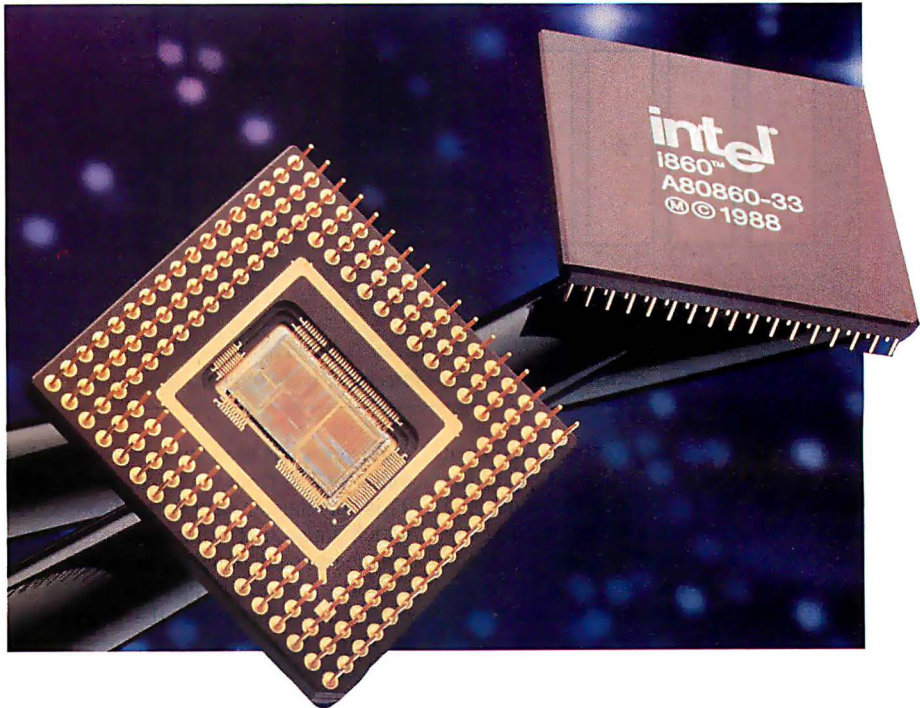
A close look at Intel's RISC-based "Cray on a chip"

**Y**ou've heard the old adage: Most people use only 15 percent of their brainpower. Geniuses, however, tap into the 85 percent reserve. Well, I don't know if that's really true for humans, but it certainly applies to computers.

The key to great performance is a CPU architecture that keeps transistors in constant and productive use. The i860 has that ability. Master its memory systems and integer and floating-point processors, then make all these pipelined units run in parallel, and you're well on the way to PC supercomputing.

Who needs personal MFLOPS (millions of floating-point operations per second)? The scientists and engineers who (like me) grew up on the IBM 7094s of the sixties and 370s of the seventies, and who today use VAXes, Crays, and IBM 3090s—that's who. In particular, anyone who studies three-dimensional physical systems develops an insatiable lust for numeric horsepower. Of course, all sorts of nontechnical professionals—bankers, architects, economists, filmmakers, brokerage firms, meteorologists—also benefit from supercomputers more than most people suspect.

Before the arrival of supercomputers, you had to use simplifying assumptions to reduce 3-D problems to two dimensions. But when it comes to analyzing something like the precise flow of air over an airplane in flight, there's no substitute for true 3-D analysis. And the payoff can be dramatic. Shaving even a fraction of a point off the drag coefficient of a new airliner will result in immense fuel savings over the lifetime of a fleet of 500 planes.



The most popular technique for studying real-world objects is called finite-element analysis. In FEA, you "mesh" an object with a polygon grid to create an armature of elements. Then you solve for some property while applying constraints to each element.

Whether the property under investigation is an electrical, thermal, fluid-flow, or stress field, the problem always boils down to the same thing: solving a linear equation that contains a matrix of coefficients. These matrices often have dimensions in excess of 10,000 by 10,000 elements and can consume hundreds of megabytes of disk storage. Of course, matrix math also plays a key role in 3-D graphics. Zooming, rotating, translating, and clipping all rely on matrix operations.

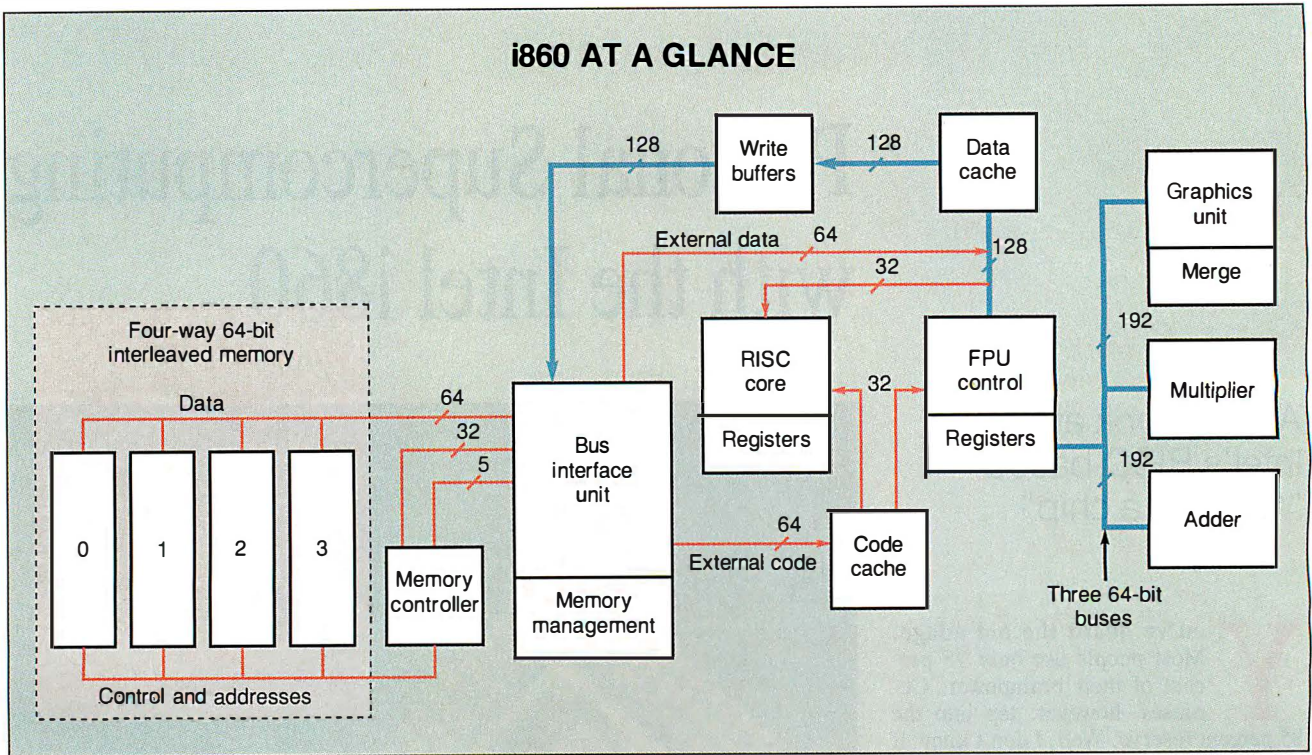
These are just the operations at which the i860 can excel. But it doesn't happen automatically. In scalar mode, as you'll see, the i860 doesn't do much better than

an i486/80487 or a Weitek WTL4167.

To attain peak performance, you have to exploit the chip's pipelining and parallel-processing capabilities. Figure 1 shows the i860 with its recommended memory subsystem. The architecture is of the Harvard type, with separate instruction and data caches. Instructions feed out of a 4K-byte, 64-bit-wide cache that can drive both the CPU ("RISC core") and FPU simultaneously through independent 32-bit instruction buses—that's one flavor of i860 parallelism.

Data feeds out of an 8K-byte, 128-bit-wide cache that can drive two long real arguments at a time at the adder, multiplier, or graphics unit. (The processor also has 32 integer registers and 32 floating-point registers, each 32 bits wide.) The adder is a three-stage pipeline, as is the multiplier, and these two units can hook together in a variety of ways. That's another form of parallelism.

To make the i860 hit full stride on a



**Figure 1:** The i860 features a Harvard architecture, wide internal data paths, pipelined arithmetic units, and a graphics unit.

numeric problem, as you'll see, you have to get the CPU and FPU working at the same time, feed and flush the adder and multiplier pipelines efficiently, and exploit the adder/multiplier synergy. Once you see how that's done, you'll understand better why the i860 has the architecture that it does. (For a more complete review of the i860 architecture, see "The Intel 80860," December 1989 BYTE.)

### The i860 in Scalar Mode

I normally use a benchmark that I call the "Whetscale" (a variation of the Whetstone) to compare scalar numeric devices. Because scalar operations aren't repetitive and can't be pipelined, the Whetscale doesn't give the i860 a chance to really stretch its legs.

The i860's raw speed is impressive. Table 1 shows the Whetscale results for a variety of numeric devices. The improvement in scalar performance over the last

eight years has been stunning—roughly a factor of 250 from the 80287 to the i860. This correlates nicely with Moore's law, which states that semiconductor performance has been doubling annually.

Notice, however, that the i860 is not dramatically faster than the Weitek 4167 at single-precision scalar operations. That shouldn't be a surprise. The state of the art in fast FPUs has been at or below the 100-nanosecond mark for the last several years.

A number of chip companies, including Weitek, Analog Devices, and Texas Instruments, have made a business of selling special floating-point data paths for minicomputers to companies such as Sun Microsystems and Alliant. The challenge now is not simply to build faster data paths (i.e., the parts of the device that carry out the arithmetic), but to organize the remainder of the system so that it is able to feed the data paths as fast

as they consume numeric data.

It brings to mind the hot-rod speedshop business. The first solution to building faster cars is bigger engines. Soon everyone has huge engines running in cars that can't make corners. The speed problem then becomes one of cornering and, after that's mastered, of reducing aerodynamic drag.

Weitek was the first of the "engine" companies. It started out building 16-bit flash multipliers and expanded into a complete line of FPUs.

Intel, recognizing that none of its OEMs was likely to take the Sun approach to incorporating Weitek support, contracted with Weitek for a chip that glued Weitek engines to a 386 using a memory-mapped interface. That worked as a stopgap measure: Intel could claim Weitek performance for its 386 line and compete with RISC machines while maintaining DOS compatibility.

### WHETSCALES

**Table 1:** These are the "Whetscales" for Intel and Weitek numeric devices, in MFLOPS. Note the 250-fold speedup from the 80287 to the i860.

	80287 10 MHz	80287 20 MHz	80387SX 20 MHz	80387DX 20 MHz	3167 20 MHz	80387 33 MHz	3167 33 MHz	1486 25 MHz	4167 25 MHz	1860 33 MHz
<b>Single-precision</b>	0.061	0.185	0.612	0.615	2.27	1.61	4.05	3.31	9.95	12.36
<b>Double-precision</b>	0.051	0.133	0.554	0.560	2.00	1.43	3.57	2.94	7.71	12.36



WHETMATS

**Table 2:** These are the "Whetmats" for Intel and Weitek numeric devices, in MFLOPS. Even in scalar mode, the i860's raw speed gives it an edge over the Weitek 4167.

	80287 10 MHz	80287 20 MHz	80387SX 20 MHz	80387DX 20 MHz	3167 20 MHz	80387 33 MHz	3167 33 MHz	i486 25 MHz	4167 25 MHz	i860 33 MHz
<b>Single-precision</b>	0.028	0.181	0.282	0.378	1.32	0.866	2.56	1.87	4.55	5.88
<b>Double-precision</b>	0.024	0.059	0.204	0.328	0.62	0.672	1.12	1.70	1.93	4.91

WHETMAT/WHETSCALE RATIO

**Table 3:** The Whetmat/Whetscale ratio describes how well a processor copes with the addressing overhead associated with vector operations. For single-precision work, the 4167 and the i860 have comparable vector efficiencies, but in double-precision the i860's 64-bit external data bus pulls it significantly ahead of the 4167.

	80287 10 MHz	80287 20 MHz	80387SX 20 MHz	80387DX 20 MHz	3167 20 MHz	80387 33 MHz	3167 33 MHz	i486 25 MHz	4167 25 MHz	i860 33 MHz
<b>Single-precision</b>	0.460	0.441	0.469	0.614	0.581	0.537	0.632	0.565	0.457	0.475
<b>Double-precision</b>	0.470	0.440	0.368	0.585	0.307	0.469	0.313	0.578	0.250	0.397

Intel got busy back in the "frame" shop building a device that could properly take advantage of today's wide numeric data paths. Think of the Whetscale as a drag race. Both the 4167 and the i860 have plenty of what it takes to post a good

mark: good compilers and brute force. But when it comes to the Le Mans of the numerics business—double-precision vector operations (as exemplified by the LINPACK benchmark)—the i860, with its 160-MB-per-second memory inter-

face, runs the course as much as 10 times faster than a 4167-equipped i486.

**Jacking into the Matrix**

I use a second benchmark, called the "Whetmat," to evaluate performance on

The DGIS™ SDK and a TI 34010-based High-Performance Graphics Board for one amazing price.

High performance, high resolution graphics are the wave of the future. With the DGIS Software Developer's Kit™ (SDK), qualified software developers can write for the future today.

The DGIS Developer's Kit provides everything needed to develop applications and drivers for DGIS-compatible 34010 graphics boards—boards from companies such as Compaq, Dell, Hewlett-Packard, NCR, NEC, TI and more than 30 others worldwide. Software developed with this kit can access the full power of the 34010, supporting the greatest number of high resolution graphics boards at the highest levels of performance, resolution and color.

DGIS, the premier and most widely-shipped interface for the TI 340X0 family of graphics coproces-

**THE POWER OF HIGH RESOLUTION GRAPHICS PROGRAMMING CAN BE REACHED WITH ONE EASY NUMBER:**



sors, provides an outstanding feature-rich programming model with 100+ graphics functions. The DGIS SDK includes documentation and language bindings for the DGIS interface, device drivers for Windows 3.0, utilities, and the GSS AT1050™ 1024X768 34010 graphics board (which normally sells for \$1295 alone).

The DGIS SDK is compatible with most C compilers and supports the XMS standard as well as DOS Extenders from Rational and PharLap.

Stepping up to the big screen has never been easier or more attractive. Call today.



Call (503) 641-2455.  
Ask for Dept. DGIS-1.

All prices subject to change without notice. GSS, DGIS, The DGIS Software Developer's Kit, GSS AT1050 are trademarks of Graphics Software Systems Inc. All other trademarks belong to their respective owners.

a typical vector operation—a matrix multiplication. The Whetmat, in conjunction with the Whetscale, gives you a way to measure the relative efficiencies of scalar and vector operations.

On scalar processors, vector operations run slower than scalars for two reasons: They have to access operands from memory instead of registers, and they have to compute the address of each operand as it is used. Table 2 shows raw Whetscale results, and table 3 displays

“vector efficiency”—that is, Whetmats divided by Whetscales, which I take as a measure of how effectively a scalar processor copes with the addressing overhead of vector problems.

I’m still restricting the i860 to scalar mode, but even without the advantages of pipelining and parallelism, notice how the i860 begins to distinguish itself from the i486 and 4167. The i860 continues to perform well on the double-precision Whetmat, while the i486 and the 4167

are hardly better than an i486 running on its internal FPU. Moreover, the i860 outdoes the Weitek devices in terms of double-precision vector efficiency.

The problem with the 4167 is that, for large matrices, it’s bound by the data bus. (You see the same thing happening with the 80387SX, which keeps up with its DX cousin on the Whetscale but falls behind on the Whetmat.) What turns out to be the biggest asset of the i860 for vector operations performed in scalar mode is its 64-bit-wide external data bus.

If the 4167 were attached to the i486 with a 64-bit-wide bus, you could drive a double-precision, memory-accessing operation with two lines of i486 code (instead of the four that it actually requires) and thereby double the 4167’s performance for certain vector operations.

Even in scalar mode, then, the i860’s raw speed and wide external data bus give it a significant edge over competing numeric devices. But 4.91 double-precision MFLOPS falls far short of the chip’s rated maximum: 66 MFLOPS (at 33 MHz). How do you get the i860 to live up to its full potential?

### Henry Ford Had the Right Idea

A pipelined processor works just like one of Ford’s assembly lines. The i860 has four of them, and you can use them or not, depending on the problem and how you decide to code it. The four pipelines are the external memory loader, the adder, the multiplier, and the graphics unit.

The adder and multiplier can load from registers, the data cache, or external memory. The ability to pipeline loads from external memory is crucial for vector operations on large matrices.

The adder and the multiplier, both of which are three-stage pipelines, are available to both scalar and pipelined instructions. In scalar mode, these units produce a result every three cycles. But pipelined instructions can control the units on a cycle-by-cycle basis, producing new results each cycle.

The amount of work you can get out of the i860 pipes is simply the speed of the pipes times the number of pipes in operation. At 33 MHz, with both the adder and multiplier yielding new results each cycle, that’s 66 MFLOPS!

Of course, the problem that is being solved must require some sequence of additions and multiplications that alternate, so the adder and multiplier can work together. But that’s not as artificial as it may seem. Vector dot products, which are the core of other vector operations, such as matrix multiplication, have

**8051 & 68HC11**  
PC-Based In-Circuit Emulators

**Nohau**  
Covers All Your Development Needs for the 8051 and 68HC11 Families!

**Free Demo**  
You can start your debugging with this **FREE** demo simulator. You can load up to 512 bytes of code, assembler, C, or PL/M and do full debugging/simulation in assembly and source level. A great way to get started for **FREE**. Fantastic for schools! Just call and we'll send it!

**Full Simulator**  
The full-blown simulator is an extension of the DEMO. You can load up to 64K of code and use 64K of XDATA space. You can program an “external environment” to interact with your code to simulate your target system. The emulator is the hardware extension of the simulator!

**In-Circuit Emulation**  
The 24MHz real-time emulator has been the industry standard for years. With its complex breakpoint logic and advanced trace, nobody can beat it for performance. Plug-in or RS-232 configuration. All 8051 derivatives are supported!

**NOHAU CORPORATION**  
51 E. Campbell Avenue, Campbell, CA 95008  
(408) 866-1820 • FAX (408) 378-7869

Call Today for your **FREE** Video and Software Demo

```

Help File Disp-Alt
P0 FF F3 FF
P1 FF IP 00
P2 FF IE 00 TLO TLO TL1
CODE WINDOW, MODULE:
.64 void moving_demo() {
0042 E4 CLR A
0043 F5 19 MOV .n,A
.69 for( p1 = arrayX, c = sizeof( array
0045 75 1A 02 MOV .p1,#02
0048 75 1B 00 MOV .1B,#00
004B 75 1C 00 MOV .1C,#00
004E 75 1B 3F MOV .c,#3F
0051 E5 18 MOV A,.c
0053 FF MOV R7,A
0054 14 DEC A

```

DATA  
0020: 25 A3 C4 56 100  
0024: 28 32 A7 FF 400  
0028: E2 A4 50 92 400

Identical User Interface for All Three Products — You Can't Go Wrong!

Australia (02) 654 1873, Austria (0222) 38 76 38, Benelux +31 1858-16133, Canada (514) 689-5889, Denmark (42) 65 81 11, Finland 90-452 1255, France (01)-69 41 2 801, Germany 08131-25083, Great Britain 0962-73 31 40, Hungary 01-137 2182, Israel (03) 48 48 32, Italy (011) 771 00 10 Korea (02) 784 784 1, New Zealand (09) 392-464, Portugal (01) 81 50 454, Sweden, Norway (040) 92 24 25, Singapore (065) 284-6077, Spain (93) 217 2340, Switzerland (01) 740 41 05, Taiwan (02) 7640215, Thailand (02) 281-9596, Yugoslavia 061-57 19 49.

exactly this sort of interleaved add/multiply behavior.

Given the right sort of problem, you've got to arrange to keep your numeric factory fed with numbers, and to get rid of the results as fast as they come out the back end. Here, the i860's Harvard architecture comes into play.

The 64-bit external data bus can shuffle 8 bytes of data to or from memory every other cycle—that's 4 bytes per cycle, or 160 MBps. To start a single-precision dot product on every cycle—and thereby keep the load and numeric pipelines fed—you will have to read one operand from memory while grabbing the second operand from a register or out of the cache.

The i860's 8K-byte data cache can hold entire rows when multiplying matrices as large as 2000 elements. As a matter of fact, the i860 is said to be operating in "Cray" mode when its cache emulates

the vector registers of a Cray. That's feasible because the i860 can move data between its cache and the FPU's register file at a whopping 640 MBps. Moreover, the two kinds of loads—pipelined loads from external memory straight into registers, and cached loads that fill the "vector register"—can proceed in parallel.

#### Wiring for Dual-Operation Mode

I've said that the i860 supports two forms of parallelism. In *dual-operation mode*, the adder and multiplier work in concert. In *dual-instruction mode*, the RISC core loads floating-point registers while the FPU runs in parallel. The two modes are complementary; I'll tackle dual-operation mode first.

Before you can understand "dual-ops," though, let me review basic pipelining. Tables 4a and b show the pipelined multiplication of two arrays of single-precision floating-point numbers. As you can see, it's a series of instructions of the form

```
pfmul.ss src1, src2, dest
```

where the *p* in *pfmul* selects pipelined mode, and the *.ss* specifies single-precision operands and a single-precision result. The special register *f0* acts as a dummy destination for the first three instructions, while the pipeline fills. Thereafter, each instruction yields a result that began its trip through the pipeline three instructions ago. At the end, register *f0* acts as a placeholder again, this time supplying dummy operands to flush the last three results out of the pipeline.

Now, a vector dot product boils down to a sequence of operations like this:

#### REGISTER SETUP

**Table 4a:** Floating-point registers *f4* to *f11* hold the first array, and registers *f12* to *f19* hold the second array. Results appear in registers *f12* to *f19* after a three-cycle delay.

src1	src2	Destination
f4	f12	f12
f5	f13	f13
f6	f14	f14
f7	f15	f15
f8	f16	f16
f9	f17	f17
f10	f18	f18
f11	f19	f19

#### PIPELINED MULTIPLICATION IN ACTION

**Table 4b:** Once you prime the multiplier, it produces a new result each cycle (*G*= garbage).

Instruction	Multiplier			Result
	Stage 1	Stage 2	Stage 3	
pfmul.ss f4,f12,f0	f4×f12	G	G	None
pfmul.ss f5,f13,f0	f5×f13	f4×f12	G	None
pfmul.ss f6,f14,f0	f6×f14	f5×f13	f4×f12	None
pfmul.ss f7,f15,f12	f7×f15	f6×f14	f5×f13	f12←f4×f12
pfmul.ss f8,f16,f13	f8×f16	f7×f15	f6×f14	f13←f5×f13
pfmul.ss f9,f17,f14	f9×f17	f8×f16	f7×f15	f14←f6×f14
pfmul.ss f10,f18,f15	f10×f18	f9×f17	f8×f16	f15←f7×f15
pfmul.ss f11,f19,f16	f11×f19	f10×f18	f9×f17	f16←f8×f16
pfmul.ss f0,f0,f17	G	f11×f19	f10×f18	f17←f9×f17
pfmul.ss f0,f0,f18	G	G	f11×f19	f18←f10×f18
pfmul.ss f0,f0,f19	G	G	G	f19←f11×f19

## Subscription Problems?



**We want to help!**

*If you have a problem with your BYTE subscription, write us with the details. We'll do our best to set it right. But we must have the name, address, and zip of the subscription (new and old address, if it's a change of address). If the problem involves a payment, be sure to include copies of the credit card statement, or front and back of cancelled checks. Include a "business hours" phone number if possible.*

**BYTE**

Subscriber Service  
P.O. Box 555  
Hightstown, NJ 08520



$$(1 \times 2) + (3 \times 4) + (5 \times 6) + \dots$$

For this job, you'd need to interleave addition and multiplication. There are 62 ways to chain together the i860's adder and multiplier. Figure 2a shows the full

set of possibilities. The adder, for example, can receive operands from floating-point registers, the special T (temporary) register, the multiplier, or itself.

To perform the dot product, combine the adder and multiplier to create a "mul-

tiple-accumulate" instruction, which, as shown in figure 2b, recirculates the adder's results back through the adder.

Take a look at the dot product example in tables 5a and b. In table 5b, the cryptic `m12apm.ss` is the multiply-accumulate instruction. It wires the FPU so that the multiplier gets two operands from registers, and so that the adder's two operands are the multiplier's result and its own prior result. During the priming phase, you fill up the multiplier with the first three product terms:  $1 \times 9$ ,  $2 \times 10$ , and  $3 \times 11$ . When terms reach stage 3, you start referring to them by their value.

By the fourth instruction, you have a problem. The third stage of the adder is about to feed back into the adder's first stage and get added to the garbage value there. Instructions 4 through 6 therefore prime the adder with 0s using pipelined additions involving the dummy register `f0`. Since `pfadd.ss` is a pipelined operation, it will take three cycles to complete. The `pfadd.ss` instructions affect only the adder; the values in the multiplier are untouched.

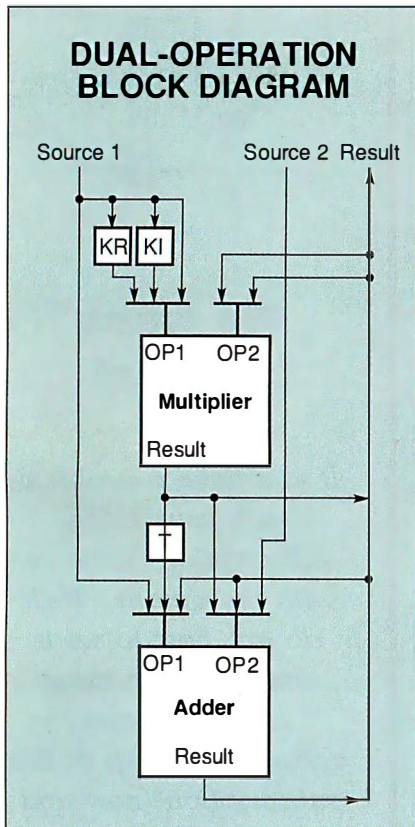
Now you can enter the steady-state part of the algorithm. After another three-cycle latency, during which the adder combines multiplier results with the 0s in its pipeline, the adder begins its real work: accumulating partial sums in each of its stages.

Figure 3 shows what's happening in a more graphical way. For the first six cycles of the journey through the pipeline's stages, all terms progress from left to right, just like on an assembly line. Then the pattern abruptly reverses, as adder results feed back to the first stage of the adder. In a real program, the steady-state part would be a loop with dozens or hundreds of operand pairs.

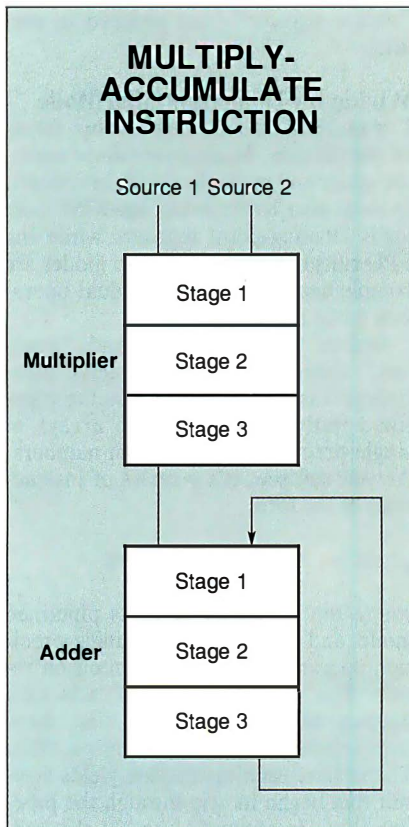
When all the product pairs have been fed in from their registers, start harvesting the sums. First, flush the multiplier with 0s. You use the same multiply-accumulate instruction, since, while you're flushing the multiplier, you want the adder to keep accumulating sums.

After three cycles, the multiplier's job is done. The adder contains partial sums in each of its stages; once you combine these, you'll have the answer. You could load them off to three registers and then use scalar operations to combine them, but this would cost at least three cycles to unload the pipes plus nine cycles to perform the three additions. Instead, use a series of pipelined additions with a single scalar addition, for a total of eight cycles.

The final code sequence in table 5b is worth a close look. Begin by taking what was in the adder pipe at the end of the last



**Figure 2a:** The multiplier and adder can receive inputs from registers, their own outputs, or each other's outputs. They can be wired 62 different ways to create special-purpose instructions, such as "multiply-accumulate."



**Figure 2b:** The multiply-accumulate instruction is formed by combining the adder and the multiplier. The multiplier feeds the adder, while the adder's results recirculate back through the adder.

STATE DIAGRAM OF DUAL-OPERATION MODE							
		Multiplier			Adder		
Stages		1	2	3	1	2	3
	Cycles						
4	↓	4 * 12	3 * 11	20	9 + 0	0	0
5		5 * 13	4 * 12	33	20 + 0	9 + 0	0
6		6 * 14	5 * 13	48	33 + 0	20 + 0	9
7		7 * 18	6 * 14	65	48 + 9	33 + 0	20
8		8 * 19	7 * 18	84	65 + 20	48 + 9	33

**Figure 3:** After seven cycles, partial sums begin to accumulate as the adder's results recirculate back through the adder.

# No other training—in school, on the job, anywhere—shows you how to troubleshoot and service computers like NRI

## DIGITAL MULTIMETER

Professional test instrument for quick and easy measurements.

## LESSONS

Clearcut, illustrated texts build your understanding of computers step by step.

## SOFTWARE

Including MS-DOS, GW BASIC, word processing, database and spreadsheet programs.

## HARD DISK

20 megabyte hard disk drive you install internally for greater data storage capacity and data access speed.

## NEW! AT-COMPATIBLE COMPUTER

High-speed 80286 CPU (12 MHz clock, 0 wait states), 1 meg RAM, 1.2 meg, 5¼" high-density floppy disk drive.

## MONITOR

High-resolution, non-glare, 12" TTL monochrome monitor with tilt and swivel base.

## TECHNICAL MANUALS

With professional programs and complete specs on your computer.

## DIGITAL LOGIC PROBE

Simplifies analyzing digital circuit operation.

## DISCOVERY LAB

Complete breadboarding system to let you design and modify circuits, diagnose and repair faults.

Only NRI walks you through the step-by-step assembly of a powerful AT-compatible computer system you keep—giving you the hands-on experience you need to work with, troubleshoot, and service all of today's most widely used computer systems. You get all it takes to start a money-making career, even a business of your own in computer service.

No doubt about it: The best way to learn to service computers is to actually *build* a state-of-the-art computer from the keyboard on up. As you put the machine together, performing key tests and demonstrations at each stage of assembly, you see for yourself how each part of it works, what can go wrong, and how you can fix it.

Only NRI—the leader in career-building, at-home electronics training for more than 75 years—gives you such practical, real-world computer servicing experience. Indeed, no other training—in school, on the job, *anywhere*—shows you how to troubleshoot and service computers like NRI.

### You get in-demand computer servicing skills as you train with your own AT-compatible system—now with 20 meg hard drive

With NRI's exclusive hands-on training, you actually build and keep the powerful new AT-compatible West Coast 1010 ES computer, complete with 1 meg RAM and 20 meg hard disk drive.

You start by assembling and testing the 101-key "intelligent" keyboard, move on to test the circuitry on the main logic board, install the power supply and 1.2 meg 5¼" floppy disk drive, then interface your high-resolution monitor. But that's not all.

### Only NRI gives you a top-rated micro with complete training built into the assembly process

Your NRI hands-on training continues as you install the powerful 20 megabyte hard disk drive—today's most wanted computer peripheral—included in your course to dramatically increase your computer's storage capacity while giving you lightning-quick data access.

Having fully assembled your West Coast 1010 ES, you take it through a complete series of diagnostic tests, mastering professional computer servicing techniques as you take command of the full power of your computer's high-speed 80286 microprocessor.

In no time at all, you have the confidence and the know-how to work with, troubleshoot, and service every computer on the market today. Indeed you have what it takes to step into a full-time, money-making career as an industry technician, even start a computer service business of your own.

### No experience needed, NRI builds it in

You need no previous experience in computers or electronics to succeed with NRI. You start with the basics, following easy-to-read instructions and diagrams, quickly

moving from the fundamentals to sophisticated computer servicing techniques. Step by easy step, you get the kind of practical hands-on experience that makes you uniquely prepared to take advantage of every opportunity in today's top-growth field of computer service.

What's more—you learn at your own pace in your own home. No classroom pressures, no night school, no need to quit your present job until you're ready to make your move. And all throughout your training, you have the full support of your personal NRI instructor and the NRI technical staff always ready to answer your questions and give you help whenever you need it.

### Your FREE NRI catalog tells more

Send today for your free full-color catalog describing every aspect of NRI's innovative computer training, as well as hands-on training in robotics, video/ audio servicing, electronic music technology, security electronics, telecommunications, and other growing high-tech career fields.

If the coupon is missing, write to NRI School of Electronics, McGraw-Hill Continuing Education Center, 4401 Connecticut Avenue, Washington, DC 20008.

AT is a registered trademark of International Business Machines Corporation

## NRI School of Electronics

McGraw-Hill Continuing Education Center  
4401 Connecticut Avenue, Washington, DC 20008



For career courses approved under GI bill  
 check for details

### Check one FREE catalog only

- |  |  |
|--|--|
| <input type="checkbox"/> Computers and Microprocessors | <input type="checkbox"/> Security Electronics        |
| <input type="checkbox"/> Robotics                      | <input type="checkbox"/> Electronic Music Technology |
| <input type="checkbox"/> TV/Video/Audio Servicing      | <input type="checkbox"/> Basic Electronics           |
| <input type="checkbox"/> Computer Programming          | <input type="checkbox"/> Telecommunications          |

Name \_\_\_\_\_ (please print) \_\_\_\_\_ Age \_\_\_\_\_

Address \_\_\_\_\_

City/State/Zip \_\_\_\_\_ Accredited Member, National Home Study Council 170 - 031

multiply-accumulate, 117, and put it in register f20. The next instruction should strike you as bizarre. It appears to place f20 and f21 into the pipeline, while putting the stage 3 adder result into f21. But this is the first use of f21. How can the result you're about to place in f21 also be the same operation's input value?

Simple: The i860 works backward. Its internal clock breaks pipelined operations into three parts. On cycle 1 of the internal clock, the last stage of the adder gets stored to the destination. On cycle 2, stages 1 and 2 advance to stages 2 and 3. On cycle 3, the inputs latch into stage 1.

This backward way of doing things actually makes a lot of sense, as it starts off the most time-consuming part of the

process (storing results) early. It's also what makes it possible for results to recirculate back through the adder with a single instruction.

**Prepare for Lift-off:  
Entering Dual-Instruction Mode**

Until now, the assumption has been that operands are simply available in registers. To load those registers without stalling the pipeline, you'll have to tackle the second form of i860 parallelism: dual-instruction mode.

In that mode you will be doing pipelined loads and pipelined computation at the same time. But, again, let's start by looking at a simple pipelined load. The memory subsystem uses a three-stage

**REGISTER SETUP**

**Table 5a:** Registers f4 to f11 contain the first array, and f12 to f14 contain the second.

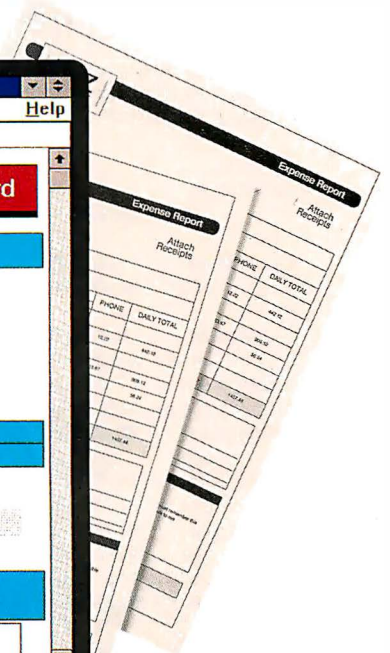
src1	Value	src2	Value
f4	1.0	f12	9.0
f5	2.0	f13	10.0
f6	3.0	f14	11.0
f7	4.0	f15	12.0
f8	5.0	f16	13.0
f9	6.0	f17	14.0
f10	7.0	f18	15.0
f11	8.0	f19	16.0

**MULTIPLY-ACCUMULATE IN ACTION**

**Table 5b:** During the steady-state part of the algorithm, each instruction drives the three stages of the multiplier and the three stages of the adder in parallel (G=garbage).

	Multiplier stages			Adder stages			Result
<b>Priming: Fill multiplier with first three products</b>							
m12apm.ss f4,f12,f0	1×9	G	G	G	G	G	Ignore
m12apm.ss f5,f13,f0	2×10	1×9	G	G	G	G	Ignore
m12apm.ss f6,f14,f0	3×11	2×10	1×9	G	G	G	Ignore
<b>Priming: Prepare adder for first product</b>							
pfadd.ss f0,f0,f0	3×11	2×10	1×9	0	G	G	Ignore
pfadd.ss f0,f0,f0	3×11	2×10	1×9	0	0	G	Ignore
pfadd.ss f0,f0,f0	3×11	2×10	1×9	0	0	0	Ignore
<b>Steady state</b>							
m12apm.ss f7,f15,f0	4×12	3×11	20	9+0	0	0	Ignore
m12apm.ss f8,f16,f0	5×13	4×12	33	20+0	9+0	0	Ignore
m12apm.ss f9,f17,f0	6×14	5×13	48	33+0	20+0	9	Ignore
<b>Now the first product term feeds back to the adder</b>							
m12apm.ss f10,f18,f0	7×18	6×14	65	48+9	33+0	20	Ignore
m12apm.ss f11,f19,f0	8×19	7×18	84	65+20	48+9	33	Ignore
<b>We've multiplied all terms, now flush the multiplier</b>							
m12apm.ss f0,f0,f0	0×0	8×18	126	84+33	65+20	57	Ignore
m12apm.ss f0,f0,f0	0×0	0×0	152	126+57	84+33	85	Ignore
m12apm.ss f0,f0,f0	0×0	0×0	0×0	152+85	126+57	117	Ignore
<b>Combine adder stages and store result</b>							
pfadd.ss f0,f0,f20	G	G	G	0+0	152+85	183	f20←117
pfadd.ss f20,f21,f21	G	G	G	183+117	0+0	237	f21←183
pfadd.ss f0,f0,f20	G	G	G	0+0	183+117	0	f20←237
pfadd.ss f0,f0,f0	G	G	G	0+0	0+0	300	f0←0
pfadd.ss f0,f0,f21	G	G	G	0+0	0+0	0+0	f21←300
fadd.ss f20,f21,f20	G	G	G	G	G	G	f20←537

# When can I have data entry for my dBASE files using Windows 3.0?



## NOW! with PerFORM PRO

Why spend time building your own custom front-end for dBASE files and Windows? PerFORM PRO Designer & Filler comes in a box, ready to use.

PerFORM PRO is your best way to set up data entry under Windows 3.0 - directly to your dBASE files! You don't even have to own or learn dBASE to use PerFORM.

With PerFORM PRO you can directly read and write dBASE files. Even create and update your own indexes. Right from Windows 3.0! Whatever DBMS you use, if it writes dBASE (.DBF) files, PerFORM PRO can be your standard WYSIWYG data entry interface.

Ensure that you get the data you need in the format you need it. For serious data entry work you need functions like mouse control, user-definable functions (UDFs), LAN support, calculated and compulsory fields, validation tables, autotabs,

customized on-line help, electronic signature security and bar code support. You get all of these and more.

PerFORM PRO comes with separate Designer and Filler software. Create a data entry form with Designer. Then, install as many copies of Filler as there are people to fill and update your dBASE files.

Where intense speed is required, PerFORM even has a character-based Fast-Fill mode for lightning-fast data entry, similar to Word for Windows draft mode.

Not only does PerFORM PRO make a great front-end, it prints and publishes great forms too.

PerFORM's custom printer drivers give you high speed on HP Laserjets. Sophisticated font control for all common laser printers including PostScript. PerFORM PRO comes with desktop publishing power. It has all the high end

graphics power you need: boxes, combs and gray scale support - even graduated scales.

If you're still waiting to use your dBASE files under Windows 3.0, wait no longer. It's here. And it's called PerFORM PRO.

"PerFORM PRO defines the state of the art in forms packages."

- Michael Miller,  
InfoWorld, September 24, 1990

"Overall, PerFORM is the forms management program to beat - not many other programs come even close."

- Paul Litwin,  
Data Based Advisor, October 1990

### PerFORM PRO

60 DAY MONEY-BACK  
GUARANTEE!

**DELIRINA**  
TECHNOLOGY INC.

Call now for a dealer near you!

**1-800-268-6082**

**Listing 1:** Note the use of both pipelined (pfl d) and scalar (fl d) load instructions. Pipelined loads are appropriate when you're going to use an operand once and then throw it away. Use scalar loads when you want operands to get stored in the cache.

```
// Multiply eight elements of row A by column B.
// Row A is contained in registers f4..f11.
// Row B is contained in registers f12..f19.

inner::
d.m12apm.ss    f4,f12,f0    //Start f4*f12 into multiply-accumulate pipe.
                fld.q     16(r29)++,f8 //Load 4 elements of A into f8..f11
                                     //from cache, and increment r29 by 16.
d.m12apm.ss    f5,f13,f0    //Start f5*f13 into multiply-accumulate pipe.
                pfl d.d   8(r24)++,f16 //Load third stage of pipe into f16,f17
                                     //and increment f24 by 8.
d.m12apm.ss    f6,f14,f0    //Continue with multiply-accumulate pipe.
                pfl d.d   8(r24)++,f18 //Load and service B pipeline.
d.m12apm.ss    f7,f15,f0    //Continue with multiply-accumulate pipe.
                fld.q     16(r29)++,f4 //Load A now for use at top of loop!
d.m12apm.ss    f8,f16,f0    //Continue with multiply-accumulate pipe.
                nop                                     //Dual-instruction mode always requires pairs.
d.m12apm.ss    f9,f17,f0    //Continue with multiply-accumulate pipe.
                pfl d.d   8(r24)++,f12 //Load B now for use at top of loop!
d.m12apm.ss    f10,f18,f0   //Continue with multiply-accumulate pipe.
                bla      r27,r28,inner //Start branching to the label now!
d.m12apm.ss    f11,f19,f0   //Last multiply-accumulate in inner loop.
                pfl d.d   8(r24)++,f14 //Load B for next loop now!
```

pipeline that is controlled by the instructions of the form:

```
pfl d.z src1(src2), freg
```

or

```
pfl d.z src1(src2)++, freg
//autoincrement
```

In both forms, src2 provides a base address to which src1 gets added. In the auto-increment mode, each instruction increments src2 by src1; that makes it possible to load arrays with constant stride factors stored in src1.

The z stands for the number of bytes to load into memory: 4 or 8. Because you're working with a three-stage pipeline, the destination register, freg, receives the data specified in the third prior pfl d instruction, not the current one. As you can imagine, it's just about impossible to write pipelined code for the i860 without drawing stage diagrams to visualize what is happening in the pipelines.

In dual-instruction mode, you execute pipelined loads and pipelined add/multiply operations simultaneously. To

## BIOS SOURCE CODE

The AT BiosKit gives you a complete Bios with source code in C you can modify for your own applications! The BiosKit includes a Bios on diskette ready for programming Eproms, and includes the utilities you need to Rom the sources Code. The Bios also has a Rom Monitor/Debug and Setup. At last you have control over the core of your system. Over 380 pages, with diskette, \$199. The XT BiosKit is only \$99. The Intel Wildcard Supplement for the XT BiosKit is \$49. Software tools: You need MS C and MASM 5.1 for modifying the Bios.

**FREE** We'll include a free copy of the pocket-sized XT-AT Handbook by Choisser and Foster with each BiosKit if you mention this ad when you order. Of course, this \$9.95 value is also available by itself. Or buy five or more for only \$5.00 each.



**800-462-1042**  
619-271-9526



### Annabooks

12145 Alta Carmel Ct., Suite 250  
San Diego, CA 92128

FAX 619-592-0061

**Money-back guarantee**

## A MESSAGE TO OUR SUBSCRIBERS

FROM TIME TO TIME WE MAKE THE BYTE subscriber list available to other companies who wish to send our subscribers material about their products. We take great care to screen these companies, choosing only those who are reputable, and whose products, services, or information we feel would be of interest to you. Direct mail is an efficient medium for presenting the latest personal computer goods and services to our subscribers.

Many BYTE subscribers appreciate this controlled use of our mailing list, and look forward to finding information of interest to them in the mail. Used are our subscribers' names and addresses only (no other information we may have is ever given).

While we believe the distribution of this information is of benefit to our subscribers, we firmly respect the wishes of any subscriber who does not want to receive such promotional literature. Should you wish to restrict the use of your name, simply send your request to the following address.

**BYTE** MAGAZINE

ATTN: SUBSCRIBER SERVICE

P.O. BOX 555

HIGHTSTOWN, NJ 08520





AMONG THE WORLD'S  
GREATEST TIME-SAVERS

Now available:  
Whitewater Resource  
Toolkit™ 3.0

## A remarkably fast route to Windows™ 3.0

Complete Windows 3.0 applications in half the time

You don't need a miracle to complete Microsoft® Windows 3.0 applications quickly and easily.

Just the latest development tools from The Whitewater Group. They help you take advantage of all the features of Windows 3.0 with unprecedented speed.

No matter what kind of application you're developing... whether it's a prototype or a complete system... we have a time-saving Windows solution for you.

**Actor**®, the complete development system named:

- *Best in its Class*, InfoWorld, 1989
- Finalist, *Technical Excellence Award*, PC Magazine, 1990

**ObjectGraphics**™, our portable graphics library...

**Whitewater Resource Toolkit**™, for creating and customizing Windows resources...

**WinTrieve**™, for indexed file management...

*"Whitewater's Actor 2.0, Resource Toolkit for Windows, and WinTrieve deliver benefits that any organization planning to use Microsoft Windows or the OS/2 Presentation Manager can ill afford to do without."*

**William F. Zachmann**

(Reprinted from PC Magazine, April 24, 1990. © 1990 Ziff Communications Company)

For more information including your copy of our detailed brochure "The Fast Route to Windows Development"

Phone 1-800-869-1144 today!

Or FAX your request for information to 708-328-9386



**The Whitewater Group**®

1800 Ridge Avenue, Evanston, IL 60201-3621 USA 708-328-3800

## “Parlez-vous Q-TEL™?”



Oui...Si...Ja...now the answer is Yes wherever you go internationally—thanks to our *new Q-TEL International* database. Domestically, you've seen how our Q-TEL databases bring you the most current and accurate rate and tariff information. Now *Q-TEL International* database brings it to you *worldwide*. It has the same superior performance packaging, and easily adapts to your applications.



If you're speaking bottom line savings, parlez with CCMi today. Call **1-800-526-5307 ext.: 290.**

*Ask for our new and expanded catalog!*

**CCMI** First-Rate Information



IT'S 11:35 p.m.  
SOMEONE TWO THOUSAND  
MILES AWAY JUST SAW  
YOUR AD...AND WANTS  
MORE INFORMATION, NOW.  
HOW DO YOU  
SATISFY THIS POTENTIAL  
CUSTOMER?

### TRY THIS DEMO

1. Pick up the phone connected to your FAX machine and dial:  
**USA: 708-924-7465 UK: (+44) 672 84242**
2. Follow the simple voice instructions, using the phone keypad to respond.
3. You will be asked to press in the code number for FaxFacts.  
**USA—Press: 889812# UK—Press: 201#**
4. Continue to follow instructions being given over the phone.
5. Once all steps are completed, you will be asked to press the “START” or “RECEIVE” button on your FAX.
6. Within seconds, after pressing this button, you will be given information on this instantaneous literature delivery system.

FaxFacts is a product of  
Copia International, Inc.

USA: (708) 682-8898  
UK: (+44) 672 84535  
USA FAX: (708) 665-9841

accomplish this feat, you exploit the i860's ability to fetch two instructions at once from the instruction cache.

Listing 1 shows the inner loop of a matrix multiplication in dual-instruction mode. The *d.* prefix that precedes each multiply-accumulate instruction tells the processor to execute this floating-point instruction and the following core instruction simultaneously.

Note the use of both pipelined (*pfld*) and scalar (*fld*) load instructions. With pipelined loads, you bypass the cache; that's appropriate for large arrays that you're going to touch just once. Scalar loads fill the cache; that's useful for small matrices that will fit entirely in the cache, or for larger matrices whose rows can be cached.

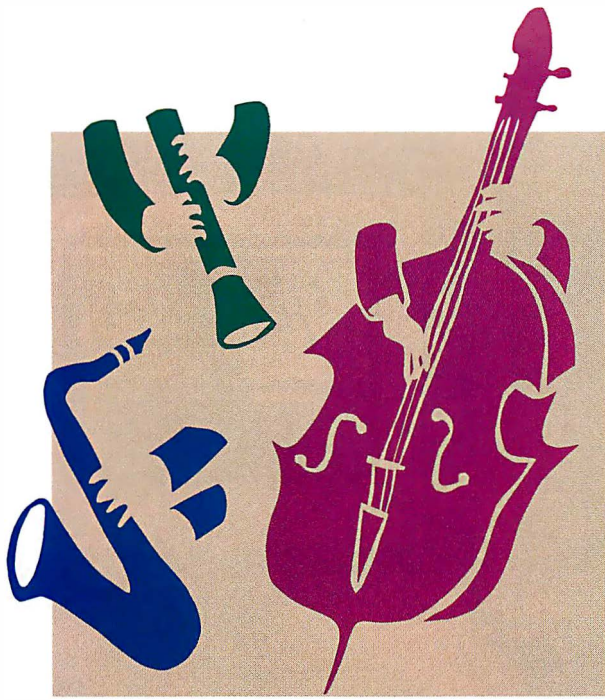
There are many points of interest in this short piece of code, which takes just eight cycles (200 ns) to execute at 40 MHz. On every cycle, the i860 schedules four or five processor activities. For example, the third and fourth lines of code start the multiplier (and adder) pipes, store the third previous pipelined load to *f16* and *f17*, and increment *r24* by a constant stride factor of 8. That means the i860 performs five tasks every 25 ns, or one every 5 ns, which is the equivalent of 200 million operations per second on a conventional system. That's what transistor productivity is all about.

The code has a unique rhythm. The pipelined loads at the head of the loop deliver their goods at the bottom half of the loop, while the loads at the bottom are arranged to feed the top of the loop. The whole loop has the feel of the antique push-pull amplifiers used to power radio transmitters back in the old days.

After rewriting the Whetmat to call a hand-coded matrix multiply like the one that is shown in listing 1, the i860 hit 62 MFLOPS. That's quite close to the theoretical limit of 66 MFLOPS (at 33 MHz), and much faster than the 4.9 MFLOPS the i860 achieves in scalar mode.

The i860 can make your dreams of personal supercomputing come true. My i860-powered Compaq 386/20 portable computer turns in over 10 LINPACK MFLOPS. How good is that? The top-of-the-line VAX 8800 produces 1.2 LINPACK MFLOPS; an IBM 3081K does only slightly better at 2.1. Of course, a Cray X cranks out over 60 LINPACK MFLOPS, but I can't carry one home. ■

*Stephen S. Fried is president of Micro-Way, Inc. (Kingston, MA), whose products include NDP Fortran-386 and an i860-based coprocessor for PCs. He can be reached on BIX c/o "editors."*



## AvCase™ 8051

# Three finely-tuned instruments for embedded-system development.

*AvCase™ 8051 C Compiler, Assembler, and Simulator from Avocet.* Play them solo, for peak performance. Or bring them together in perfect harmony as an integrated system. AvCase will manage all the steps—from editing source code, compiling, assembling, and linking, all the way to debugging.

- *High-level language in the key of C.* AvCase C Compiler is our biggest seller. It produces fast, tight, optimized code that helps speed development time.
- *Clear, concise scoring.* AvCase Assembler is the classic Avocet assembler tuned-up and ready for your most demanding applications.
- *Full dress rehearsal without leaving your desk.* AvCase Simulator lets you test code on your own PC. With the new source-level debugging feature you can work at both the C and assembly language level.
- *Let the music begin.* If you want to meet your project deadlines—come in on budget—and develop a high-quality, bug-free product—you simply can't do better than AvCase. Find out more about these finely-tuned instruments. Fax, write, or call toll-free 1-800-448-8500 for complete information, including a free AvCase Brochure and Avocet Catalog.

**AVOCET**  
SYSTEMS, INC.



# The joy of C-scape

*Elegant graphics and text*

**T**he C-scape™ Interface Management System is a flexible library of C functions for data entry and validation, menus, text editing, context-sensitive help, and windowing. C-scape's powerful Look & Feel™ Screen Designer lets you create full-featured screens and automatically generates complete C source code.

C-scape includes easily modifiable high-level functions as well as primitives to construct new functions. Its object-oriented design helps you build more functional, more flexible, more portable, and more unique applications—and you'll have more fun doing it.

**The industry standout.** Many thousands of software developers worldwide have turned to the pleasure of C-scape. The press agrees: "C-scape is by far the best. . . . A joy to use," wrote IEEE *Computer*. Major companies have selected C-scape as a standard for software development.

C-scape's open architecture lets you use it with data base, graphics, or other C and C++ libraries. C-scape runs in text or graphics mode, so you can display text and graphics simultaneously. To port from DOS or OS/2 to UNIX, AIX, QNX, or VMS, just recompile. C-scape also

**Graphics.** Run in color in text or graphics mode. Read images from PCX files.

**Object-oriented architecture.** Add custom features and create reusable code modules. C++ compatible.

**Mouse support.** Fully-integrated mouse support for menu selections, data entry fields, and to move and resize windows.

**Portability.** Hardware independent code. Supports DOS, OS/2, UNIX, AIX, VMS, others. Autodetects Hercules, CGA, EGA, VGA. Supports Phar Lap and Rational DOS extenders.

**Text editing.** Text editors with word wrap, block commands, and search and replace.

**Field flexibility.** Masked, protected, marked, required, no-echo, and named fields with complete data validation. Time, date, money, pop-up list, and many more higher-level functions; create your own.

**Windows.** Pop-up, tiled, bordered and exploding windows; size and numbers limited only by RAM.

**Menus.** Pop-up, pull-down, 123-style, or slug menus; create your own.

**Context-sensitive help.** Link help messages to individual screens or fields. Cross reference messages to create hypertext-like help.

**Code generation.** Build any type of screen or form with the Look & Feel™ Screen Designer, test it, then automatically convert it to C code.

**Screen flexibility.** Call screens from files at run time or link them in. Automatic vertical/horizontal scrolling.

**International support.** Offices in Berlin, Germany, with an international network of technical companies providing local training, support and consulting.

supports Phar Lap and Rational DOS extenders.

**Trial with a smile.** C-scape is powerful, flexible, portable, and easy to try. Test C-scape for 30 days. It offers a thorough manual and function reference, sample programs with source code, and an optional screen designer and source code generator. Oakland provides access to a 24-hour BBS, telephone services, and an international network of companies providing in-country support. No royalties, runtime licenses, runtime modules. After you register, you get complete library source code at no extra cost.



**Call 800-233-3733** (617-491-7311 in Massachusetts, 206-746-8767 in Washington; see below for International). After the joy of C-scape, programming will never be the same.

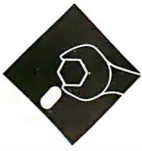
DOS, OS/2 (Borland and Microsoft support); with Look & Feel, \$499; library only, \$399; UNIX, etc. start at \$999; prices include library source. Training in Cambridge and Seattle each month. Mastercard and Visa accepted.

**OAKLAND**

BY191

**Oakland Group, Inc.** 675 Massachusetts Ave., Cambridge, MA 02139 USA. FAX: 617-868-4440. **Oakland Group, GmbH.** Alt Moabit 91-B, D-1000 Berlin 21, F.R.G. (030) 391 5045, FAX: (030) 393 4398. **Oakland International Technical Network** (training, support, consulting): **Australia** Noble Systems (02) 564-1200; **Benelux** TM Data (02159) 46814; **Denmark** Ravenholm (042) 887249; **Austria-Germany-Switzerland** ESM 07127/5244; **Norway** Ravenholm (02) 448855; **Sweden** Linsoft (013) 111588; **U.K.** Systemstar (0992) 500919. Photo by Jessica A. Boyatt; Karji by Kaji Aso. Picture shows a C-scape program combining data entry with video images loaded from PCX files. C-scape and Look & Feel are trademarks of Oakland Group, Inc.; other trademarks belong to their respective companies. Copyright © 1990, by Oakland Group, Inc. Features, prices, and terms subject to change.

Circle 226 on Reader Service Card



# GENETIC ALGORITHMS

Programming takes a valuable tip from nature

In 1618, Johannes Kepler discovered that a planet's distance from the sun was related to the length of its year. He discovered the correct equation through a certain amount of intelligent guesswork and some experimentation. How could you begin to get a computer to solve this problem intelligently? You could try equation after equation until you found one that fit the data, or you could get your computer to do the work.

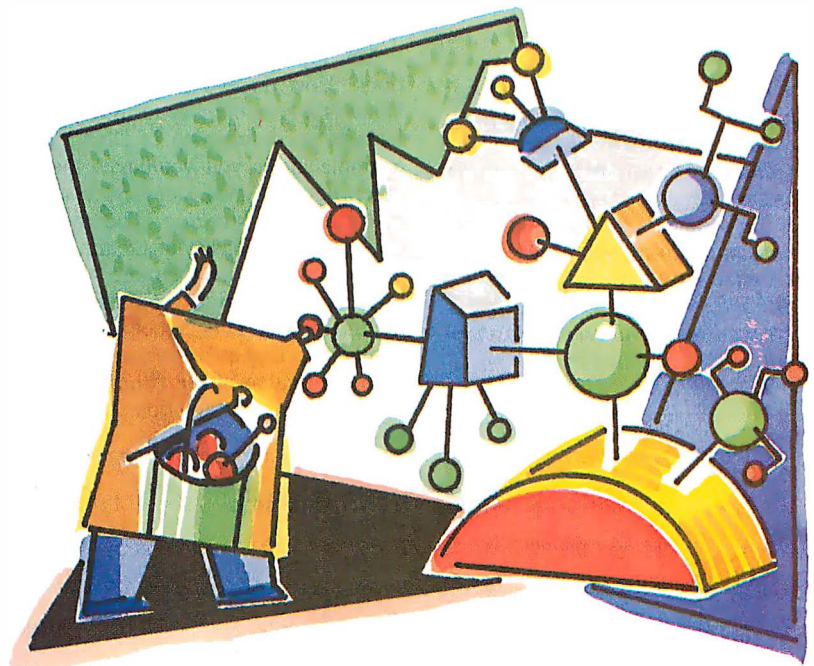
Another scenario: You are trying to program a robot to move around a complex and changing realm. The robot needs to adapt quickly to unanticipated problems without being reprogrammed. How can a computer find solutions to problems where the problems are not clearly spelled out?

Finding answers to these real-world problems is hardly easy. A solution to the first problem could be a formula composed of any number of sines, cosines, distances, and year lengths that is the best model of planetary motion. Not only are the combinations of rules that govern the movement of robots without number, but the rules themselves need to change. Rules that might work in one realm need adjustment to work in another realm.

One technique for solving these kinds of problems, called *breeding*, comes from nature. This genetic metaphor encompasses a wide range of search strategies and is proving to be a very flexible way to get computers to learn how to solve problems for themselves.

## Mean Genes

Programming a computer to maintain its own "gene pool" of solutions and search for the best one requires you to first



answer a few questions. What do potential solutions look like? How will the different solutions vary? What range of possible solutions might be in the pool? What is the difference between the good answers and the bad ones? What is a good way to quantify this? How will breeding take place? How can solutions be crossbred with each other?

The best place to begin is with an example from algebra: Find a way to solve two simultaneous equations,  $ax+by=c$  and  $dx+ey=f$ , where  $x$  and  $y$  are unknowns and  $a, b, c, d, e,$  and  $f$  are constants. You can easily show that  $x=(ec-bf)/(ae-bd)$ . To simplify the example (without reducing its generality), let's say that  $ae-bd=1$ .

You want to make the computer "learn" the solution to this problem. To do this, you must come up with a basic plan for describing what a solution for  $x$  looks like: It must be some arithmetic combination of  $a, b, c, d, e,$  and  $f$ . Why

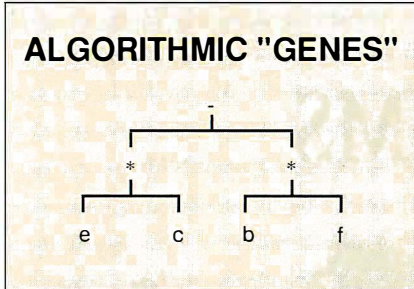
give the computer any more hints than this? Let the solution domain be the set of  $(( ))$  equations, made up of either the addition, subtraction, or multiplication of the six constants  $a, b, c, d, e,$  and  $f$ . This is represented in the computer as a binary tree with an  $a, b, c, d, e,$  or  $f$  in the leaves and an operation at each of the interior nodes joining two leaves. Figure 1 shows the tree that represents the correct solution. You can call these potential solutions *genes*.

You can easily generate genes by randomly choosing arithmetic operations or constants; if it is an operation, you recursively call the same procedure on itself to find the two subtrees below it. This will generate plenty of solutions, almost all of them incorrect. It would be possible to check them all and eventually find a correct one, but it is unnecessary to take this exhaustive approach. Surprisingly, breeding better solutions from genetic algorithms is much faster.

*continued*

**Gene Gym**

If you are going to apply some Darwinian test of fitness, you need to develop a function that quantifies "best." You can create an appropriate function for the ex-



**Figure 1:** To solve the two simultaneous equations  $ax + by = c$  and  $dx + ey = f$  (where  $x$  and  $y$  are unknowns and  $a, b, c, d, e,$  and  $f$  are constants), you can set up a binary tree with the constants as "leaves" in the tree, and mathematical operations at the branches. Solving for  $x$  gives  $x = (ec - bf) / (ae - bd)$ . If you assume that  $ae - bd = 1$ , then  $(ec - bf)$  is the correct answer. This tree shows how this "gene" is represented in the computer.

ample of two simultaneous equations from a set of 15 samples. For instance, if  $a=1, b=2, c=4, d=0.5, e=2,$  and  $f=3$ , then  $x=2$ . Why not test a random tree with these particular values of  $a$  through  $f$  and see how closely it comes to the correct answer of 2? If your program selects 15 random tests and can find the correct answer in all cases, there is a pretty good chance it is the correct answer for all possible values of  $a$  through  $f$ . So let the fitness of a solution be the sum of the squares of the differences between the correct answer and the current attempt. The best answer will have a fitness of 0, and the worst will be a large number.

You need to answer two final questions. How do two solutions "breed?" What is a sensible way to mimic the effects of recombination of DNA? In the example above, you would have the computer perform two steps: *reproduction* and *crossover breeding*. The reproduction step will consist of creating a new generation in which the more "fit" solutions are more highly represented than the unfit ones. This can be done by randomly selecting answers that are weighted by the value of the fitness equation. More of the fitter solutions tend to sur-

vive into the next generation.

The actual mixing takes place in the crossover breeding. You accomplish this by taking two potential solution trees, selecting a random interior node from each of them, and then swapping the subtrees below them. (Figure 2 shows how this can be done with two solution trees.) This is applied to random pairs in the generation. Usually the process of reproduction is followed by crossover breeding of a fraction of the genes. The two operations of reproduction and crossover breeding are interwoven until the solution is found.

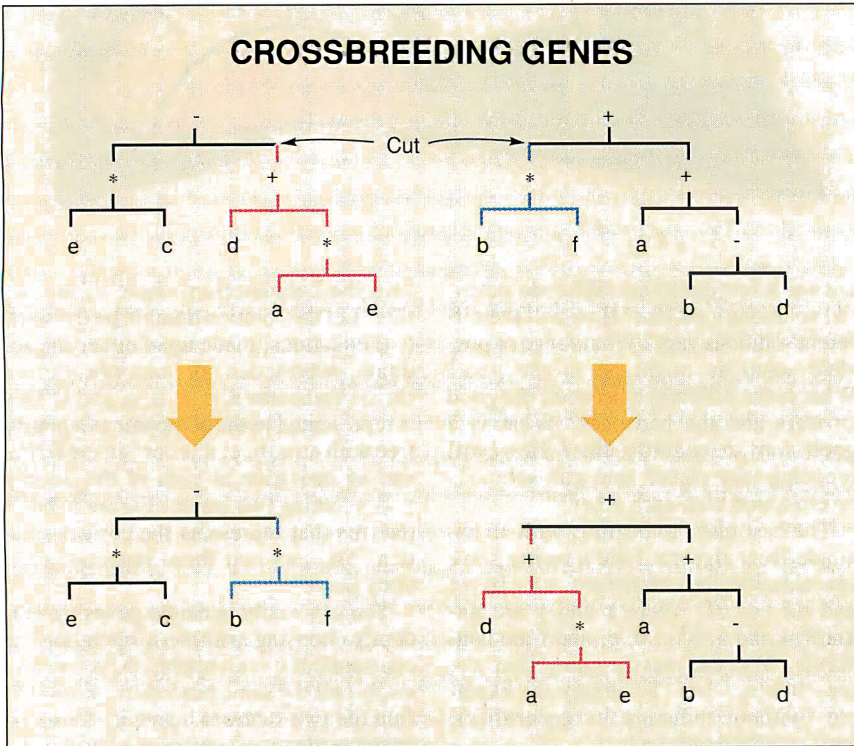
Some researchers have extended this genetic metaphor to include a form of random mutation: For each batch of reproduction and crossover breeding, a small number of random nodes are selected and changed. The genes with these small differences will often shake a population out of a static configuration.

**Actual Behavior**

A complete listing of a genetic algorithm is available as GENE.PAS in electronic format (see page 5 for details). See the text box "A Sample Genetic Algorithm" at right for the pseudocode of the software.

The program was written in Pascal, and its structure is complete enough to allow modification to any other problem. It is only necessary to rewrite EvaluateGene and the random Gene Creation code at the beginning. Most of the other code does not need to be modified to suit the individual problem. The software also includes other parameters, such as the number of potential solutions in each generation and the maximum size of the tree.

If you experiment with this example of genetic problem-solving software, you'll notice that the default parameters aren't necessarily more useful than others, but it is possible to come up with some rules of thumb. For example, more genes in each generation means that the simulation will take longer to run, but it will also maintain a wider range of diversity. The number of times that you test cases is a trade-off between speed and a vague notion of accuracy. More test cases means that the computation of the fitness function takes longer, but it also means that the computation will do a better job of screening out mistakes. If only one test case is used, then random functions that just happen to get that one case right would be selected far too often, and the fitness function would provide little guidance. On the other hand, testing 40 or 50 cases would be overkill.



**Figure 2:** To "breed" two possible solutions and come up with a still better solution, you can perform "crossover breeding." Here, two solutions (top) are cut at the points indicated, and the subtrees below those points are swapped, resulting in two new solutions (bottom). Note that one of the new genes is the correct solution shown in figure 1.

## A Sample Genetic Algorithm

The pseudocode example in listing A uses three parameters: the size of the gene pool; MaxGenes, the number of generations to simulate; and MaxGeneration, the number of genes to cross, which is some value that is less than or equal to MaxGenes and the mutation probability.

### Data Structures

**Variables.** A list of values that make up the realm that the genetic algorithm is trying to model. In the case of the two simultaneous equations, it is the set {a, b, c, d, e, f}.

#### Listing A: The main loop.

```
for i:=1 to MaxGenes do
  OldGenePool[i]:=
    CreateRandomGene
  for Generation:=
    1 to MaxGeneration do
    for i:=1 to MaxGenes do
      FitnessValue[i]:=
        EvaluateGene
          [OldGenePool[i]];
      NormalizeFitnessValues;
      Reproduce; {Creates new genes
        in NewGenePool}
      CrossOver[CrossOverNumber];
      Mutation[MutationProbability];
    end;
```

**Operations.** The set of possible operations applied to the variables. In the case of the two simultaneous equations, it would be {\*,+,-} but may include functions of one operand, such as sine, or user-defined functions of many operands.

**Gene.** A tree with operations on its interior nodes and variables on its leaves.

**OldGenePool, NewGenePool.** The old and new gene pools.

**Test Cases.** A set of values for the variables and a correct answer. For instance, if {a=8, b=5, c=2, d=3, e=2, f=1}, then  $x = -1$ . The potential Genes are checked against these Test Cases to determine their fitness.

### Functions

**CreateRandomGene.** This returns a random tree filled with operations at the interior nodes and variables on the leaves. Used at the beginning only.

**EvaluateGene[x:Gene]:Fitness Value.** EvaluateGene takes a gene, compares it against the test cases, and produces a number that measures how good the gene is in matching the correct results. One function that works well uses the sum of the squares of the difference between the value using the gene and the correct value:  $\Sigma (\text{gene-result} - \text{correct value})^2$ . This is usually inverted so that the best genes have a fitness

value approaching 1, and the worst a value approaching 0:

$$\frac{1}{1 + \Sigma (\text{gene-result} - \text{correct value})^2}$$

**NormalizeFitnessValues.** This takes the fitness values from the evaluating gene and normalizes them so the total adds up to 1. This produces a relative fitness number. The best genes have a much higher rating than the others.

**Reproduce.** This takes an old generation and creates a new generation using NormalizeFitnessValues. To create each new gene in the pool, Reproduce copies an old one selected with a randomized process weighted by the normalized fitness values (i.e., the genes with the highest fitness values are more likely to make it into the NewGenePool). The weighting ensures that the new set of genes will contain the better genes.

**CrossOver[i].** This function takes *i* different genes from NewGenePool in pairs and “breeds” them by crossover. That is, it selects a random interior node of each gene and swaps the subtrees under these nodes. This creates the different types of functions.

**Mutation[p.].** This selects nodes at random from the genes in NewGenePool and with probability *p* and mutates them into something different.

Setting the number of genes that are mated with each other through crossover (CrossOverNumber in the pseudocode) involves a more subtle trade-off. Consider the extremes: If there was no crossover, then the program would never create any new structures from the initial random population; the population would tend toward a stable selection of the best initial guesses. On the other hand, if every gene was crossed with another after reproduction, then many superior genes would quickly be crossed out of existence. Crossbreeding 90 percent of the population seems to work reasonably well, because good functions will often have a high-enough fitness value to make their way into the noncrossed 10 percent. Choosing a mutation rate involves weighing the same trade-off.

The fitness function is another important detail that needs to be tuned carefully. If the function is too steeply graduated, the moderately successful genes will still enjoy a vastly superior fitness value,

and the next population will be almost completely homogeneous. Suddenly, any hope for good combinations produced from crossover will be gone. On the other hand, if there is not enough difference in the fitness functions, then there will be little guidance to the function and the whole process will be no better than a random walk. The fitness function uses the square of the sum of the differences. (Other functions may be better for different applications.)

The entire process of developing genetic algorithms is, by nature, empirical. The best results always come if you stop the program frequently and watch the way the functions change. I’ve found that I need to tune the fitness function several times before success. When I was first running the software and trying to find a solution for two simultaneous equations, I was generating random genes with 31 nodes, while the correct function only had seven. Since the random process of crossover and mutation conserved the

number of nodes in the system, I usually encountered trees that were larger than optimum. I solved this problem by generating genes with a wide range of sizes. The important part was rolling up my sleeves and watching the gene pool change.

At first, you may be disappointed. Using genetic algorithms often does not yield a correct solution because the process has evolved itself into a “genetic corner,” or niche. The system can reach a stable state in which the remaining genes will often combine to make further instances of themselves. The result is that no amount of crossing or mixing will generate substantially different forms. To an extent, this effect is unavoidable.

The fitness function drives the system toward better solutions, and sometimes it takes a wrong turn. The system will often converge after running and rerunning the fitness function several times. A mutation process can help move the process

# WRITE US. . . SO THEY WON'T CALL YOU

Many people enjoy receiving information about products or services in their homes by telephone.

But if you want fewer phone calls from national advertisers, we can help.

Telephone Preference Service can effectively reduce phone calls from national advertisers. And, it's absolutely FREE.

Just send us your name, full address, area code and phone number. We'll tell participating national advertisers to remove your name from their calling lists.

After all, they only want to talk to people who want to listen.



## Telephone Preference Service

Direct Marketing Association

11 West 42 Street

P.O. Box 3861

New York City, NY 10163-3861

**T**here have been several programs that have learned to navigate and plan.

out of a niche, but mutations aren't as successful as just having the breeding start over with new values. If the mutation rate is too high, the system starts mutating backward because it overwhelms the force of reproduction. As an alternative to mutation, you can run several different gene pools in parallel and then occasionally cross the different pools together.

### Real-World Examples

For many years, there has been experimentation with genetic algorithms that solve real-world problems. In 1980, S. F. Smith created a poker-playing set of rules using genetic breeding for his doctoral dissertation from the University of Pittsburgh. The program was not forced to choose which cards to discard, but it did have to control the betting. In a set of runs against a fairly good poker algorithm, the software quickly learned how to exploit a bug in the algorithm and trounce it. Even when the bug was fixed, the genetic algorithm still continued to learn to win consistently.

There have been several programs that have learned to navigate and plan. For his Ph.D. dissertation from the University of Michigan, L. B. Booker created a system where a simulated animal learned how to find its way around a machine "world." John Koza and Martin Keane of Stanford University have adapted genetic techniques to keep a broom balanced, an application that is important not only to the circus but to a wide range of robots. Their technical report also contained examples from Kepler's work, as well as a way of solving two simultaneous equations.

John Koza has also written on the genetic approach to economic modeling. He has been especially interested in having genetic algorithms discover scientific equations.

At Xerox's Palo Alto Research Center (PARC), Tadd Hogg and Bernardo Huberman have been using genetic algorithms to stabilize some of the chaos in networks. They've found that if there is chaos caused by having many agents on a

■ ■ ■ ■ ■  
■ And the winner is...  
■ **INVISIBLE**  
■ **SOFTWARE**

Invisible Software actually offered \$1000 to the first dealer at COMDEX/NETWORLD who could prove their DOS-Based system was faster. Guess who came home with the \$1000? **INVISIBLE SOFTWARE!**

In a controlled test environment no network came close to Invisible Software's new NET/30 2.0. The Invisible Network performs faster, smoother data transactions without draining system memory capacity. The result is a faster LAN at an affordable price.

And now, the Undeatable Invisible Network is available to the public. If you'd like any further information or a copy of the test results, please contact Invisible Software at 415-570-5967.

## **NEW NET/30 2.0**

Invisible Software, Inc. 1142 Chess Dr.  
Foster City, CA 94404 (415) 570-5967





# JUGGLING ACTS...

## ...ARE FOR CLOWNS

● **Juggling files, documentation, people and time is no way to manage a software project. You need to know who is working on what, which files are being changed and why. And your team should be moving ahead on development, not stuck in costly collisions.**

### **MKS RCS – Your Project Manager**

MKS RCS (Revision Control System) helps keep your project from becoming a juggling act by maintaining a complete history of changes to a file and giving you access to any of the changes. MKS RCS also automatically saves crucial descriptive information about each revision.

An advanced user interface and excellent documentation make MKS RCS extremely easy to use. Or if you prefer, you can operate from the command line. MKS RCS can automate every aspect of your project, handle both binary and text files with ease, provide unlimited branching and merging capabilities and compress log files to save valuable disk space.

### **The Bigger the Better**

The more complex your project, the more you need MKS RCS. In a multi-user environment, eliminate access conflicts

with locking options. Manage and track development to deliver your project on time, on spec and on budget.

For individual projects, MKS RCS handles the headaches of recording and retrieving files. Whether you are on a LAN or an individual PC, MKS RCS will make you more productive.

### **Price and Performance Leader**

MKS RCS has all the features you will ever need in a revision control system at a price that will fit your budget.

MKS RCS for DOS is just \$249; for OS/2, SCO or 386 Unix \$349. A 5-CPU LAN license for DOS is \$995; for OS/2, SCO or 386 Unix \$1,395.

Call MKS for LAN pricing for more than 5 CPUs.

### **MKS Software Management Team**

Reduce the juggling act even more with the MKS Software Management Team (MKS RCS and MKS Make). You set up the rules stating which files must be changed when other files are altered, and MKS Make automatically keeps those files in synch.

#### **TO ORDER, CALL:**

1-800-265-2797 (continental U.S. only)  
1-519-884-2251 (outside continental U.S.)  
1-519-884-8861 (FAX)

Australia 03-419-0300

03-555-4544

Belgium 02/736.60.64

England 0763 244114

0364 53499

071 833 1022

Finland 08-5054536

France

01 47 95 01 07

Germany

055-704800

0721 886 664

06126/595-0

30 852 00 45

020 14 24 63

Netherlands

0762 704 60

Sweden

Full 30 day money back guarantee.

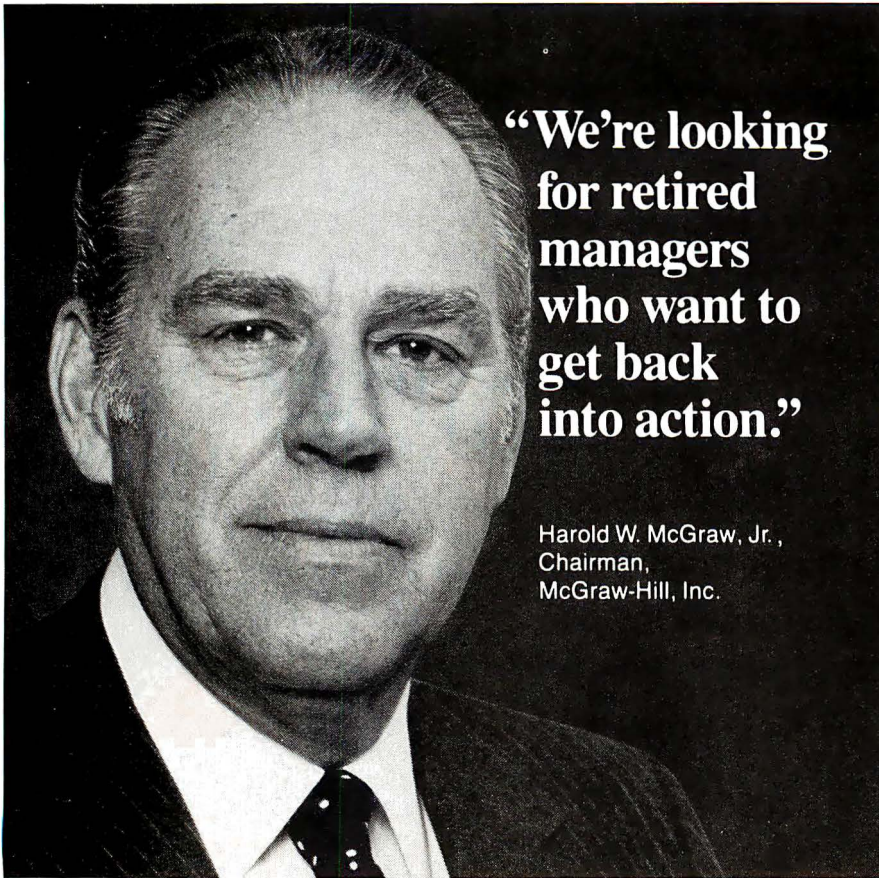


**MKS**

35 King Street North  
Waterloo, Ontario  
Canada. N2J 2W9

MKS, MKS RCS and MKS Make are trademarks of Mortice Kern Systems Inc. UNIX is a trademark of AT&T.

Circle 202 on Reader Service Card



**“We’re looking  
for retired  
managers  
who want to  
get back  
into action.”**

Harold W. McGraw, Jr.,  
Chairman,  
McGraw-Hill, Inc.

I’m a volunteer supporter of the International Executive Service Corps, a not-for-profit organization with a vital mission:

We send retired U.S. managers overseas to help businesses in developing countries, which often respond by increasing their imports of U.S. goods. In fact, developing countries consume about 40 percent of U.S. exports.

As an IESC volunteer, you would not get a salary. But you would get expenses for you and your spouse, plus a world of personal satisfaction.

IESC leads the field in this kind of work. We’ve done over 9,000 projects in 81 countries. We could have a project that’s just right for you. To find out, send this coupon to: Harold W. McGraw, Chairman, McGraw-Hill, Inc., P.O. Box 10005, Stamford, CT 06904-2005.



**International  
Executive  
Service Corps**

It's not just doing good.  
It's doing good business.



**Dear Mr. McGraw:** Tell me more about becoming an IESC volunteer. I am a recently retired manager or technician—or am about to retire—from a U.S. company. I’m free to accept an overseas assignment. I understand that volunteers receive expenses for themselves and their spouses, but no salary.

Name \_\_\_\_\_

Address \_\_\_\_\_

City \_\_\_\_\_ State \_\_\_\_\_ Zip \_\_\_\_\_

M2

network competing for a resource (e.g., a file server), then rewarding the best predictive agents will stabilize the network.

David Goldberg, now at the University of Alabama, wrote a genetic system for his Ph.D. that learned how to control a gas pipeline. The important problems are determining correct flow rates and pressures to meet demand, and detecting leaks. His program can learn how to successfully handle the changes in demand.

#### A Short Theoretical Explanation

At this point, you may be wondering what is really going on in this big primordial soup of bits. Is it just random coincidence that is mating the correct subexpressions? Even though fitness functions control the reproduction, crossover and mutation quickly destroy whatever coherence there is. Is it more luck than science? One of the founders of the field, John Holland, introduced the notion of a schema to provide an abstract way of understanding the process.

To explain this, I’ll use a simple example of a genetic algorithm from David Goldberg’s book (see the Further Reading section at the end of this article). Consider a problem where the genes are 5-bit-long binary strings of 0s or 1s and the goal is to find the largest possible string (11111). You do the crossover by taking two strings, choosing a cutting position, and then switching. For instance, if the cut comes after the first bit, 10010 and 00111 yield 00010 and 10111. The fitness function is just the value of the string when taken as a binary number. The value of 10010 is 18. It should be easy to see how a small population will eventually evolve the right answer.

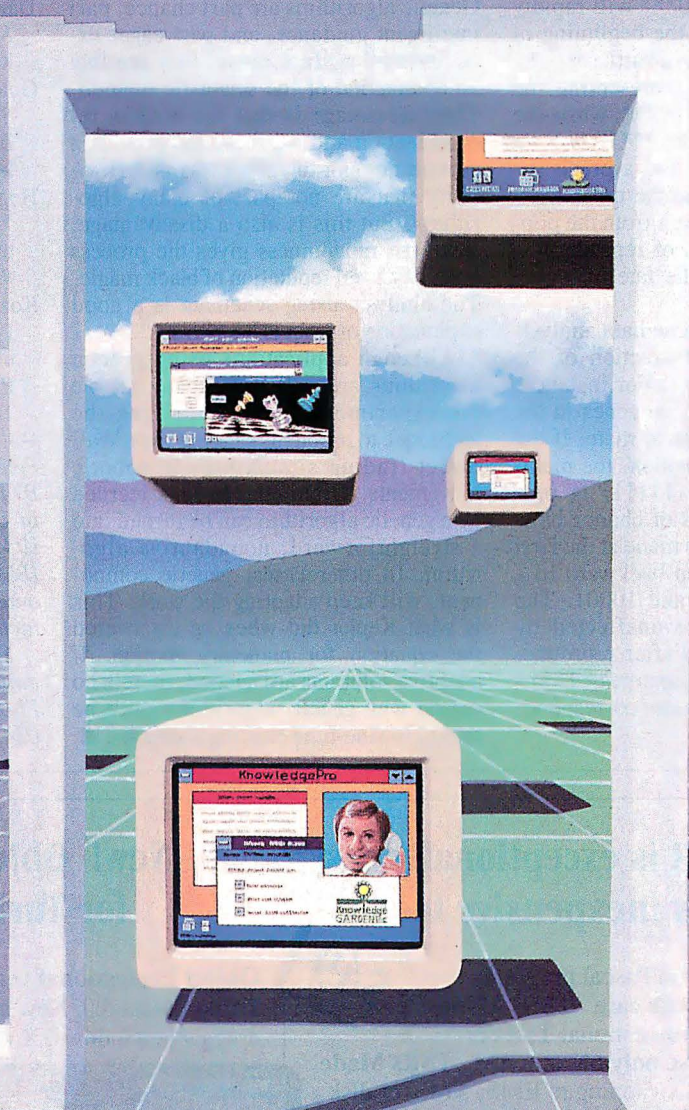
A schema in this instance is a string made up of three different characters—0, 1, or \*, where the asterisk stands for “don’t care.” Each string in the population could correspond to a number of different schemata. For instance, the gene 10010 would correspond to the schemata 1\*\*\*\*, 10\*10, and 10010, among others.

In a similar way, each schema might have several corresponding genes, which are members of the population. For instance, 10\*\*\* would correspond to both 10010 and 10111. The value of a schema is related to the fitness function, and it is easy to see that schemata like 11\*\*\* are better than ones like 00\*1\*.

When reproduction occurs in the gene pool, the results are mirrored in schemata, and the better schemata find themselves with more corresponding genes than the less-fit schemata. In this example, the schema 1\*\*\*\* will probably find

# KnowledgePro<sup>®</sup>

## ... a world beyond ToolBook?



### The press decide...

**PC WEEK July 16, 1990...** "KPWIN is more responsive than ToolBook ... fully exploits the Windows environment ... the result is extraordinary development productivity."

**PC MAGAZINE October 30, 1990...** "KnowledgePro's support for Windows objects is much richer than ToolBook's... doesn't suffer from the speed or bitmap size problems that ToolBook does..."

**INFOWORLD October 1, 1990...** "KPWIN runs faster than ToolBook ... so easy you'll think you've forgotten something. ... In the same class as Next Step and far above the clunkier competition..."

Circle 172 on Reader Service Card



### YOU decide...

If you buy KPWIN and choose to send it back within 60 days we'll refund your money.

KnowledgePro Windows (KPWIN) is fast, and it doesn't limit you to single windows with 64k boundaries. Interactive tools get you started and a rich OOP language gives you the control you need for serious applications. Hypertext and hypermedia give your applications depth and built-in expert systems technology lets you create smart programs. Links to the outside world are easy with DDE and DLL's.

KPWIN costs \$695 with no runtime fees for applications, Amex, Visa, M/C and COD accepted. Dealers welcome.

To order call **518-766-3000**  
**FAX 518-766-3003** or write to:

Knowledge Garden Inc.  
473A Malden Bridge Rd.  
Nassau, NY 12123, U.S.A.



itself with more corresponding genes in the population, while 00\*\*\* will rapidly lose representation. At the beginning of these operations, the main battles will be between the schemata representing the high-order bits, such as 1\*\*\*\*, while the fortunes of schemata like \*\*\*10 will be largely random. When the average fitness values increase and the unfit schemata like 00\*\*\* are driven from the population, then the forces of reproduction will shift to deciding the fate of lower-order schemata.

The nice part of the schemata analysis is that it allows the abstraction of the complexities of crossover. For instance, 11110 and 00001 might be genes in the population that are set up to mate. If the cut comes at the last position, the maximum fitness possible (11111) is produced. But if the winds of chance blow differently and the cut is made at the first spot, the result is a step backward to a population with 01110 and 10001. The schemata, however, are unaffected by the random choice, and after reproduction of whatever pair emerges, 1\*\*\*\* will probably still have more corresponding genes than 0\*\*\*\*.

### Problems, Caveats, and Conclusions

Genetic algorithms are part chance, part intelligent guidance, and part eager experimentation. In a sense, they are like an abstraction of the scientific method. Their advantage is that the endless recombination and reproduction provide a certain amount of robustness and flexibility that are not part of many algorithms. But this is also a disadvantage, since the randomness gives the process an undeserved reputation of black magic. The analysis using schemata is a good explanation of what is happening.

Although applications using genetic algorithms are still new, many people are experimenting with applying the technique to problems ranging from Wall Street trading simulations to robotic movements. Often, the lessons learned by a genetic algorithm can be turned into a straightforward, nonadaptive algorithm. In other cases, genetic components will keep adapting the work. This is what Kepler did when he discovered the equation for planetary motion. If adaptive solutions are needed, there's no reason why genetic algorithms can't be reused to fine-tune existing solutions. ■

### FOR FURTHER READING

Davis, Lawrence. *Genetic Algorithms and Simulated Annealing*. Los Altos, CA: Morgan Kaufmann, 1987.

Goldberg, David E. *Genetic Algorithms in Search, Optimization and Machine Learning*. Reading, MA: Addison-Wesley, 1988.

Hogg, Tadd, and Bernardo Huberman. "Controlling Chaos in Distributed Systems." Xerox PARC Technical Report #90-00133.

Koza, John. "Genetic Programming: A Paradigm for Genetically Breeding Populations of Computer Programs to Solve Problems." Stanford Computer Science Technical Report #90-1314.

*Peter Wayner is a consulting editor for BYTE. Currently reading toward a Ph.D. in computer science at Cornell University, he has been involved in research at IBM's Thomas J. Watson research lab and at the Xerox PARC. He can be contacted on BIX as "pwayner."*

*Your questions and comments are welcome. Write to: Editor, BYTE, One Phoenix Mill Lane, Peterborough, NH 03458.*

## "Writing a TSR is exceptionally easy" ... and now it's inexpensive too!

## New! Object Professional for Turbo Pascal 6.0

Now you can turn Turbo Pascal programs into rock solid TSRs with ease. **TSRs Made Easy** lets you create conventional TSRs or swapping TSRs that use only 6K of RAM. **TSRs Made Easy** provides ■ TSR swapping to EMS, XMS, or disk ■ selectable hot keys ■ keyboard macros ■ unloadable TSRs ■ 8087 TSR support ■ interface to transient programs ■ ISR handling, and more.

**TSRs Made Easy** includes full source, complete documentation, and plenty of small example and demo programs. You pay no royalties.

**Object Professional** version 1.1 is fully updated for Turbo Pascal 6.0. New are SAA/CUA style dialog boxes, draggable windows, XMS/EMS 4 support, and more.

**Object Professional** includes over 100 object types that will multiply your productivity. Included are windowing and menu systems, menu and data entry screen generators, data object types, and routines that provide swapping TSRs.

You'll get up to speed fast with clear documentation, on-line help, full source code, and hot demo programs.

"The range of objects is fantastic. **Object Professional** could save you man-years of effort."

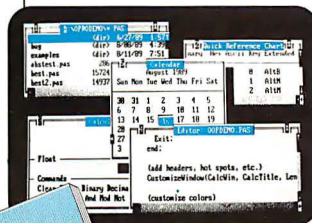
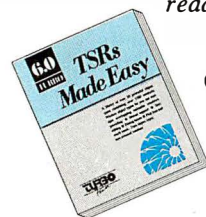
Jeff Dumtemann

"Writing a TSR... is exceptionally easy. The documentation is extremely readable and well done."

Computer Language, May 1990

One of programming's most formidable tasks is now very simple... and very affordable!

**TSRs Made Easy, only \$49.**



TSRs Made Easy has exactly the same TSR routines as OPro. TSRs Made Easy requires Turbo Pascal 6.0. 5.5 or 5.0. OPro requires Turbo 6.0 or 5.5. 5.25" and 3.5" disks included. Add \$5 per order for standard shipping in U.S./Canada. Call for other shipping charges. Registered owners of OPro may update to version 1.1 for \$20, include your serial number.



9AM-5PM PST Monday through Friday, USA & Canada.  
For more information call (408) 438-8608, fax to (408) 438-8610,  
or send mail to CompuServe ID 76004.2611

TurboPower Software P O Box 66747 Scotts Valley, CA 95067-0747

**Object Professional, only \$189.**  
**Call toll-free to order: 1-800-333-4160**

# Power

Incredible Value!



Don't take our word for it, take theirs...

46 main [var] auto unsigned int 2 -si- 2

```

38 addr->zip = 76442;
31 printf("The structure memb
32 printf("%f\n%f\n%f\n%f\n
33 addr->street, addr->ci
34 size = sizeof(struct ADDR
35 printf("The structure size
36 printf("addr->street start
37 pr
38 pr
39 pr
40 }

```

A watchpoint has matured.  
size > 0  
Old value was 0  
New value is 122  
Space bar will clear notice & watchpoint

Space for struc starting at address 5416:0000  
Assigning values to members.

The structure member values...

```

Joe Bob's Texas
1251 Cow Chip Trail
Fort Worth TX 76442

```

addr	far ptr	0:5416:0000
addr->name	array	"Joe Bob's Te
addr->street	array	"1251 Cow Chi
addr->city	array	"Fort Worth"
addr->state	array	"TX"
addr->zip	array	76442
size		122
_job[0]	pointer	0x02cb
*_job[0]	struct	00x02cb
_job[1]	pointer	0x02ed

Power Trace Debugger

"Do you know what the underground bargain C compiler of this year is? It's the Mix Power C compiler. For under \$25 with shipping, it is one heck of a good compiler."

Victor Schneider  
Dr. Dobb's Journal, June 88 (Letter to the editor)

"Overall, Power C's performance is remarkable for the price. Quite compatible with the Microsoft C and Turbo C "standards", Power C is a heavyweight contender in the educational, hobbyist, and perhaps even the professional market — at a bantamweight price."

Stephen Davis  
PC Magazine, September 13, 88 (Review)

"Power C is an unbelievable product for \$19.95, and is very competitive with Turbo C, Microsoft C, and Microsoft's new Quick C in both features and performance. It is excellent for the beginner who wants to learn C, or for the experienced programmer who wants to develop professional applications. The manual alone is worth the price of this package, and the generous library source code and assembler offer adds to the value of it. If you have any desire to program in C, or want a more powerful C compiler, get a copy of Power C!"

Michael Cortese  
Computer Shopper, August 88 (Review)

"The Ctrace debugger is where Mix really shines. It is magnificent. It's not only better than the stripped down debugger Microsoft includes with Quick C, it's better than the full debugger Microsoft provides with its high-end compiler (Codeview)."

David Weinberger  
Computer Shopper, November 88 (Review)

Circle 201 on Reader Service Card



**Technical Specifications**

Power C includes: Power C compiler with integrated Make, Power C Linker, Power C Libraries (450 functions), the Power C book (680 pages), and support for...

- ✓ ANSI standard
- ✓ IEEE floating point
- ✓ 8087/80287 coprocessor
- ✓ auto-sensing of 8087/80287
- ✓ automatic register variables
- ✓ unlimited program size
- ✓ mixed model (near & far pointers)
- ✓ graphics on CGA, EGA, VGA, & Hercules

**Optional Products:**

- ✓ Power Ctrace debugger
- ✓ Library source code
- ✓ BCD business math

Order now by calling our toll free number or mail the coupon to Mix Software, 1132 Commerce Drive, Richardson, TX 75081.

**1-800-333-0330**

For technical support call: 1-214-783-6001  
Minimum System Requirements:  
DOS 2.0 or later, 320K memory, 2 floppy drives or hard drive.  
Runs on IBM PC, XT, AT, PS/2 and compatibles.

**60 day money back guarantee**

Name \_\_\_\_\_  
Street \_\_\_\_\_  
City \_\_\_\_\_  
State \_\_\_\_\_ Zip \_\_\_\_\_  
Telephone \_\_\_\_\_  
Paying by:  Money Order  Check  
 Visa  MC  AX  Discover  
Card # \_\_\_\_\_  
Card Expiration Date \_\_\_\_\_  
Computer Name \_\_\_\_\_ Disk Size  5 1/4"  3 1/2"

Product(s) (Not Copy Protected)

<input type="checkbox"/> Power C compiler (\$19.95)	\$ _____
<input type="checkbox"/> Power Ctrace debugger (\$19.95)	\$ _____
<input type="checkbox"/> Library Source Code (\$10.00)	\$ _____
<input type="checkbox"/> (includes assembler & library manager)	
<input type="checkbox"/> BCD Business Math (\$10.00)	\$ _____
Add Shipping (\$5 USA - \$20 Foreign)	\$ _____
Texas Residents add 8% Sales Tax	\$ _____
Total amount of your order	\$ _____

**B**

## SmartLynx-MC

### Intelligent Eight Port RS 232 Micro Channel Adapter for PS/2 Systems and Compatibles.

Supports AIX, UNIX, XENIX,  
QNX PC-MOS and DOS.

Call for Special  
Introductory Offer

**1-800-553-1170**



662 Wolf Ledges Parkway  
Akron, OH 44311

Circle 240 on Reader Service Card

## Eight Serial Ports One Board

Quatech's ES-100 provides eight  
RS/232 serial ports in a single AT  
slot. RJ-11 modular connectors.  
16450 UARTS are standard. Optional  
buffered 16550 UARTS. PC-AT, ISA,  
or EISA compatible. Priced below  
\$500! Quantity Pricing Available!

Call for our PC Interface Handbook:

**1-800-553-1170**



662 Wolf Ledges Parkway  
Akron, OH 44311

PC-AT is a trademark or  
registered trademark of IBM Corp.

Circle 241 on Reader Service Card

## RS-422/RS-485 Boards for AT, Micro Channel

RS-422/RS-485 asynchronous  
serial communication boards from  
Quatech! available in 1 to 4 ports  
for PC-AT and compatibles and 1  
to 4 ports for PS/2 Micro Channel.

Call for our free  
PC Interface Handbook:

**1-800-553-1170**



662 Wolf Ledges Parkway  
Akron, OH 44311

PC-AT, Micro Channel, and PS/2 are trade-  
marks or registered trademarks of IBM Corp.

Circle 242 on Reader Service Card

## Synchronous Communication Boards for AT

Quatech synchronous/  
asynchronous serial boards for  
PC-AT and compatibles support  
RS-232, RS-422, and RS-485  
communication.

Call for our free  
PC Interface Handbook:

**1-800-553-1170**

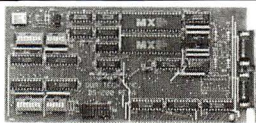


662 Wolf Ledges Parkway  
Akron, OH 44311

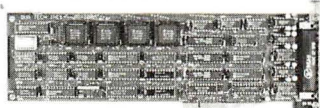
PC-AT and PC are registered  
trademarks of IBM Corp.

Circle 243 on Reader Service Card

## Communications Data Acquisition



"PC-AT (ISA) Interfaces"



"PS/2 Micro Channel Interfaces"



Phone: (216) 434-3154 • FAX: (216) 434-1409

TELEX: 510-101-2726

PC-AT, PS/2 and Micro Channel are  
registered trademarks of IBM Corporation.

Circle 244 on Reader Service Card

## Digital I/O Board

Single-slot Quatech PXB-721 for  
PC-AT has 72 digital I/O lines.  
Connect three choices of data  
acquisition modules. Supports  
Labtech Notebook™

Call for our free  
PC Interface Handbook:

**1-800-553-1170**



662 Wolf Ledges Parkway  
Akron, OH 44311

LabTech Notebook is a trademark of  
Laboratories Technologies Corp.

Circle 245 on Reader Service Card

## PXB-160 16-BIT TRUE PARALLEL DIGITAL I/O

- Two eight bit ports
- Latched I/O
- DMA and I/O Modes
- Handshakes for 16 Bit I/O Transfer
- Programmable timer for Interrupt or DMA Transfer
- External interrupt and data transfer request inputs
- List Price Below \$400.00

Call the Order Line  
**1-800-553-1170**



662 Wolf Ledges Parkway  
Akron, OH 44311

Circle 246 on Reader Service Card

## 2 parallel, 2 serial, 1 board

Quatech DSDP-402 for PC-AT  
has two parallel ports, and two  
serial ports for any combina-  
tion of RS-232, 422, and 485  
communication. DSDP-100,  
two parallel and two RS-232  
ports, available at lower cost.

For order info, call:  
**1-800-553-1170**



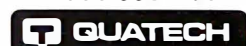
662 Wolf Ledges Parkway  
Akron, OH 44311

Circle 247 on Reader Service Card

## Wave Form 20MHz - 32K \$1290

The WSB-100 Wave Form Synthe-  
sizer Board from Quatech has the  
best set of numbers in the market.  
With speed to 20MHz and a 32K  
memory at \$1290, it's making  
waves in more ways than one. The  
WSB-100 is also a star performer  
as a digital pulse/word generator  
with the optional digital module.

Call for our free  
PC Interface Handbook  
**1-800-553-1170**



662 Wolf Ledges Parkway  
Akron, OH 44311

Circle 248 on Reader Service Card

**BYTE**

---

# PRODUCT SHOWCASE

---

- BUYER'S MART
- BYTE BITS
- PRODUCT SPOTS
- MICRO PRODUCT CENTER
- CATALOG SHOWCASE



# Catalog Showcase

## The Card Shop



The Memory Board Experts at The Card Shop would like to introduce ourselves through some of our better-known associates, for example: PARITY PLUS by MEMREL, INTEL, AST and DFI.

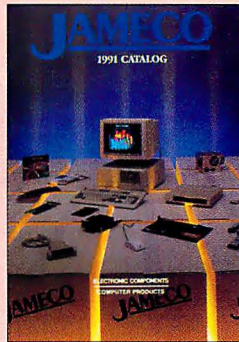
We invite you to call and talk to our knowledgeable, courteous staff about any of your memory board needs.

You'll also appreciate the Ten-Day, Money-Back Free Trial, Generous Warranties and Commitment to Excellence in all of the product lines that we carry.

1-800-346-0055 FAX 602-948-8458  
Scottsdale, AZ

Circle 320 on Reader Service Card

## Jameco Electronics



30-day Money-back Guarantee...  
Large Selection, Competitive Prices...  
High Quality Technical Assistance...

Our staff of 30 technicians is on hand eight hours a day to answer your technical questions before and after your purchase.

99.99% of all Products are in stock...

Jameco stocks over 4,000 different products. 99.99% of these products are available for off-the-shelf shipment at any time.

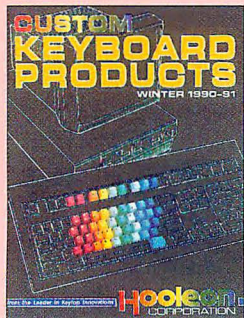
Fast Shipment...

Most orders shipped within 24 hours. Guaranteed shipment within 48 hours for all in-stock items.

1-415-592-8097

Circle 164 on Reader Service Card

## Hooleon



### CUSTOM KEYBOARD PRODUCTS

Improve productivity and reduce training time by having your software commands color-coded and imprinted on your keyboard. Custom keys, SnapCap™ Keycaps, custom imprinted keytop and keyfront labels, templates, plus new macro devices and custom keyboards. WordPerfect and 5250 Emulation KeyCaps for IBM 101-keyboard; relegendable keys for IBM®, Cherry®, Wyse® and KeyTronic®; Keytop Label kits for WordPerfect™, DisplayWrite™, Data Entry and language conversions.

Call 602-634-7515 for FREE catalog.

Order Hotline 1-800-937-1337

Circle 135 on Reader Service Card

## Zericon



### Factory Direct Savings on Large Format Plotters

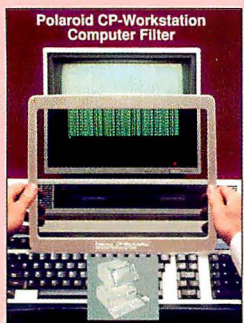
Zericon is the low-price leader, offering the following plotter lines direct from the factory. The Valuline series of "D" Size plotters offers moderate performance at 15 IPS for under \$2,000. The Designer series offers high performance at 25 IPS in Multi-Pen "A-E" sizes; prices under \$3,000. All Zericon products are sold with a no-risk satisfaction guarantee.

40491 Encyclopedia Circle, Fremont CA 94538

1-800-727-8380

Circle 372 on Reader Service Card

## Polaroid



Polaroid Corporation introduces a new product to its family of **Circular Polarizer Filters** for computer monitors. The Polaroid CP-Workstation Filter is a high quality circular polarizing glass filter which reduces glare and improves contrast. The CP-Workstation filter also features a transparent conductive coating that reduces electromagnetic interference against VLF/ELF radiation and eliminates static.

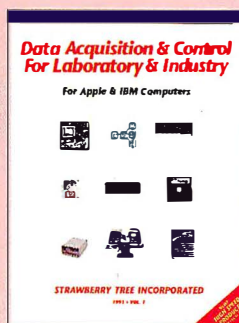
Polaroid produces a full range of anti-glare filters in glass and polyester to fit most monitors.

Polaroid Corporation, Polarizer Division N2, 1 Upland Road, Norwood, MA 02062.

1-800-225-2770 FAX 617-446-4600

Circle 255 on Reader Service Card

## Strawberry Tree



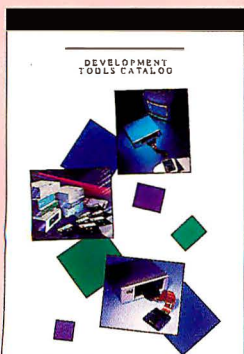
Catalog of data acquisition and control hardware and software for IBM and Macintosh computers for laboratory and factory, featuring new high-speed plug-in board products. The catalog includes WorkBenchMac™ and WorkBench PCT™ software for data acquisition and control using a revolutionary new icon-based graphical interface.

Strawberry Tree Incorporated, 160 So. Wolfe Road, Sunnyvale, CA 94086.

1-408-736-8800

Circle 303 on Reader Service Card

## Intel Corporation



Choosing the right architecture and development support are two of the most important decisions you face today. For successful microcomputer development, Intel offers you the total solution with the most up-to-date and powerful tools available.

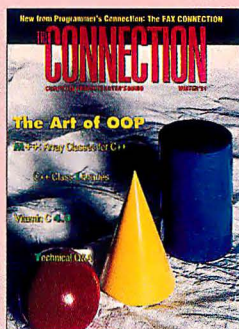
And we also offer you the easiest way to buy. Our Development Tools Catalog lists all our tools products in one guide. Call us at 1-800-874-6835, or FAX us at 503-696-4633 to get your free copy today.

Intel Corporation, Development Tools Operation, 5200 NE Elam Young Parkway, JF1-15, Hillsboro, OR 97124

1-800-874-6835 FAX 503-696-4633

Circle 155 on Reader Service Card

## Programmers Connection



### "An Indispensable reference"

THE CONNECTION is your Ultimate Buyer's Guide to the highest quality software available for your IBM PC. You'll find its easy-to-use cross references will guide you to a description of EVERY product including its system requirements, cross product compatibility, version numbers and more. THE CONNECTION is the *Only* software reference guide you'll ever need.

Call for your FREE copy!

USA 800-336-1166  
CANADA 800-225-1166  
FAX 216-494-5260

Circle 264 on Reader Service Card



# Catalog Showcase

Advertisers: For more information contact Ellen Perham at (603) 924-2598.

## National Instruments

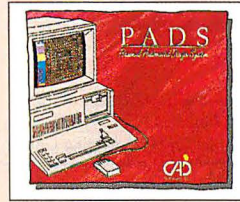


Free 488-page full-color catalog describing instrumentation hardware and software products for personal computers and workstations. Application software for data analysis and presentation and for collecting data using instruments and plug-in boards. Features GPIB interfaces, data acquisition and DSP boards, driver level software, signal conditioning and VXI controllers.

1-512-794-0100

Circle 211 on Reader Service Card

## CAD Software



### Electronic Engineering Design System

PADS design systems are the logical solution to your engineering problems. They provide workstation level features and performance at a price within the reach of any company designing circuit boards. The balance between automatic functions and interactive tools makes PADS the choice for engineers and designers. With PADS, you can get your product to the market faster with designs that work the first time.

Call CAD Software today for your authorized PADS Reseller for a product demonstration or for free PADS Evaluation Software.

1-508-486-8929 1-800-255-7814

Circle 52 on Reader Service Card

## Keithley Metrabyte



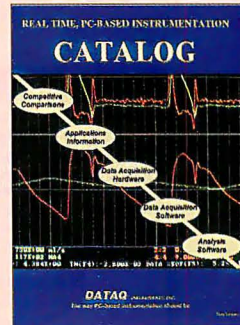
1991 DATA ACQUISITION HANDBOOK New Free 272-page full-color handbook describes our complete line of Data Acquisition products for 1991. The handbook also introduces many new products for Data Acquisition, PC Instrumentation, Communication and Industrial Control. Provides facts on all plug-in boards and data acquisition/control/analysis software for the IBM PC/XT/AT, PS/2 and Microchannel plus helpful configuration guides and application notes.

KEITHLEY METRABYTE/ASYST/DAC, 440 Myles Standish Blvd., Taunton, MA 02780

1-508-880-3000

Circle 169 on Reader Service Card

## Dataq Instruments



Free catalog describing instrumentation hardware and software products for PCs with competitive comparisons and application information. We specialize in real time 50,000 Hz sample rates to disk and display simultaneously. Our analysis software supports FFT, IFFT, Stats, X-Y, Digital Filtering, Integration, Differentiation, Arithmetic Operations and more. For a free catalog and demo disk, write or call Dataq Instruments, Inc., 825 Sweitzer Avenue, Akron, OH 44311.

1-800-553-9006

Circle 84 on Reader Service Card

# UNIVERSAL CALL 800-678-8648

MEMORY PRODUCTS FAX 714-751-2023  
1378 LOGAN AVE SUITE E COSTA MESA CA 92626

WE ACCEPT VISA/MC/AMEX  
PO'S FROM QUALIFIED FIRMS UNIVERSITIES  
AND GOVT AGENCIES WESHIP COD  
OPEN M-F 7AM-5PM SAT 8AM-2PM  
20% RESTOCK FEE NONDEFECT RETURNS

IBM PS/2 MEMORY	SIMM SIPP MODULES	DRAM CHIPS	MATH CO'S	EXPANSION-BOARDS FOR ALL PC'S	TOSHIBA LAPTOP MEMORY
<b>6450604</b> .....\$139 2MG MODULES FOR 55SX, 50Z, 70E61/121 <b>6450608</b> .....\$149 2MG MODULE FOR 70A21 <b>6450379</b> .....\$247 2MG FOR 80-111/311 <b>6450375</b> .....\$135 1MG MODULE FOR 80-041 <b>34F2933</b> .....\$419 4MG MODULES <b>30F5360</b> .....\$149 2MG KIT FOR 30-286 <b>6450605</b> .....\$460 2-8MG BOARD W/2MG MODEL 70 & 80 <b>6451060</b> .....\$550 4MG FOR 80-A21/A31 <b>34F3011</b> .....\$920 4-16MB BOARD W/4MB MODELS 70&80	4X9-80NS.....\$355 1X9-70NS.....\$59 1X9-80NS.....\$53 1X9-100NS.....\$52 1X9-120NS.....\$51 256X9-60NS.....\$29 256X9-70NS.....\$24 256X9-80NS.....\$19 256X9-100NS.....\$17 256X9-120NS.....\$15 <b>MAC/AMIGA SIMMS</b> 1X8-80NS.....\$62 1X8-100NS.....\$55	1MGX1-80NS.....\$5.50 1MGX1-100NS.....\$5.25 1MGX1-120NS.....\$5.10 <b>256K X 4</b> 256X4-80NS.....\$5.75 256X4-100NS.....\$5.50 <b>256K X 1</b> 256X1-70NS.....\$2.95 256X1-80NS.....\$1.99 256X1-100NS.....\$1.85 256X1-120NS.....\$1.95 256X1-150NS.....\$1.50 <b>64KX4</b> 64X4-120NS.....\$2.25 64X4-100NS.....\$2.50 64X4-80NS.....\$2.95 <b>64KX1</b> 64X1-150NS.....\$1.05 64X1-120NS.....\$1.50 64X1-100NS.....\$2.00 <b>STATIC COLUMN</b> 256X1-100NS.....\$2.50 256X1-80NS.....\$3.00 256X1-70NS.....\$3.95	<b>IIT</b> 2C87-8.....\$169 2C87-10.....\$199 2C87-12.....\$255 2C87-20.....\$289 <b>CYRIX</b> 83D87-16.....\$289 83D87-20.....\$329 83D87-25.....\$429 83D87-33.....\$519 <b>NEW CYRIX FOR 386SX</b> 83S87-16.....\$270 83S87-20.....\$350 <b>INTEL</b> 8087-2.....\$115 80287-8.....\$179 80287-10.....\$179 80287XL.....\$220 80387-16.....\$305 80387-20.....\$350 80387-25.....\$450 80387-33.....\$549 80387-SX.....\$299	<b>BOCA RESEARCH</b> <b>BOCARAM AT</b> ..\$119 TO 2MG EXP FOR AT'S <b>BOCARAM XT</b> ..\$119 UP TO 2MG EXP FOR XT'S <b>BOCARAM AT/IO+</b> 2-4MG W/SER & PAR \$157 <b>BOCARAM50Z</b> .....\$159 2MG FOR PS2 50&60 <b>ORCHID</b> <b>RAMQUEST 16/32</b> 2-8MG LIM 4.0 FOR PS2 W/SER & PAR PORT <b>ONLY \$299 W/2MG \$419</b> <b>AST</b> <b>RAMPAGE PLUS 286</b> UP TO 8MG LIM 4.0 FOR AT'S <b>ONLY \$289 W/2MG \$399</b> <b>AST 6PAK PLUS 286</b> \$119 W/2MG \$229	1MG FOR T1000SE/XE..\$287 2MG FOR T1000SE/XE..\$369 2MG FOR T1200XE.....\$183 2MG FOR T1600.....\$193 2MG FOR T3100SX.....\$183 4MG FOR T3100SX.....\$543 2MG FOR T3100E.....\$183 2MG FOR T3200SX.....\$183 4MB FOR T3200SX.....\$583 3MB FOR T3200.....\$274 2MB FOR T5100.....\$193 2MB FOR T8500.....\$183
<b>COMPAQ MEMORY</b> <b>DESKPRO 386 20/20E 25/25E 286E 386S</b> 1MG MOD.....\$119 4MG MOD.....\$339 1MG BRD.....\$199 4MG BRD.....\$495	<b>HP LASERJET</b> <b>SERIES II &amp; IID</b> 1MG.....\$89 2MG.....\$155 4MG.....\$254 <b>SERIES IIP &amp; 3</b> 1MG.....\$99 2MG.....\$149 4MG.....\$259 <b>AST PREMIUM 1MG MODULES ONLY \$69</b>	<b>INTERNATIONAL ORDERS ACCEPTED</b> <b>5 YEAR WARRANTY ON ALL PRODUCTS</b> <b>CALL THE PC UPGRADE SPECIALISTS !!!</b>			<b>MONTHLY SPECIALS SAVE \$\$\$</b> <b>BOCARAM AT PLUS 2-8MG LIM 4.0 ONLY \$119 W/2MG</b> <b>3.5" FDD FOR COMPAQ ONLY 1/3 HEIGHT ONLY \$129</b> <b>AST RAMVANTAGE UP TO 3MG EXTENDED MEMORY W/128K ONLY \$47</b>

Circle 351 on Reader Service Card (RESELLERS: 352)

# THE BUYER'S MART

## A Directory of Products and Services

THE BUYER'S MART is a monthly advertising section which enables readers to easily locate suppliers by product category. As a unique feature, each BUYER'S MART ad includes a Reader Service number to assist interested readers in requesting information from participating advertisers.

Effective January 1, 1991.

RATES: 1 issue—\$675 3 issues—\$625 6 issues—\$600 12 issues—\$525  
Prepayment must accompany each insertion. VISA/MC Accepted.

AD FORMAT: Each ad will be designed and typeset by BYTE. Advertisers must

furnish typewritten copy. Ads can include headline (23 characters maximum), descriptive text (250 characters is recommended, but up to 350 characters can be accommodated), plus company name, address and telephone number. Do not send logos or camera-ready artwork.

DEADLINE: Ad copy is due approximately 2 months prior to issue date. For example: November issue closes on September 8. Send your copy and payment to THE BUYER'S MART, BYTE Magazine, 1 Phoenix Mill Lane, Peterborough, NH 03458. For more information call Brian Higgins at 603-924-2656. FAX: 603-924-2683.

### ACADEMIC COMPUTING

#### 166 MHz PC

Proprietary technologies allow us to deliver our PC compatible workstation years ahead of the industry. Take advantage of inexpensive PC software (vs. UNIX), and the performance our platform offers, to execute applications previously run on minis and supers. We're offering the first 5000 of our 1993 production units at wholesale pricing. Educational and quantity discounts.

#### Eclotech, Inc.

Dept. 4142, P.O. Box 12887, Research Triangle Park, NC 27709

Inquiry 701.

### ACCESSORIES

#### RADIOACTIVE?

Plot it on your PC with The RM-60 RADIATION MONITOR Serial or printer port. Detects: ALPHA•BETA•GAMMA•X-RAY. MicroR, 1000 times the resolution of standard geiger counters. Excellent for tracking RADON GAS. Find sources.

Plot: • Background • Cosmic Rays • Clouds • Foods  
Call/Write for PC MAGAZINE review. • TSR • GM Tube  
VISA/MASTER Phone orders. Not satisfied? Full refund.

Tel: (302) 655-3800

#### Aware Electronics Corp.

P.O. Box 4299, Wilmington, DE 19807 \$149.50

Inquiry 702.

#### CUT RIBBON COSTS!

Re-ink your printer ribbons quickly and easily. Do all cartridge ribbons with just one ink! For crisp, black professional print since 1982. You can choose from 3 models:

Manual E-Zee Inker — \$39.50  
Electric E-Zee Inker — \$94.50  
Ink Master (Electric) — \$189.00

1000s of satisfied users. Money-back guarantee.

#### BORG INDUSTRIES

525 MAIN ST., JANESVILLE, IA 50647  
1-800-553-2404 In IA: 319-987-2976

Inquiry 703.

EXTENDER: Attach KB/Monitor up to 600' from CPU  
COMPANION: Add a 2nd or 3rd KB/Monitor—600' from CPU  
COMMANDER: Control 2 to 96 CPU's with a single KB/Monitor  
PHONEBOOT: Boot or reboot PC by Phone  
FREE DEALER KIT

#### CYBEX CORPORATION

2800-H Bob Wallace, Huntsville, AL 35805  
205-534-0011 International Fax 205-534-0010

Inquiry 704.

#### FOR 386, 286 & PC

Modem 2400BPI Int.	\$ 69	FaxModem 4800x9600INT	\$139/259
640K PC Memory Card	\$ 29	2M AT Memory Card	\$ 99
MGP Graphic card+P/ports	\$ 25	16 Bits 800x600 VGA Card	\$ 72
XT HD/HD FD Controller	\$ 32	AT HD/FD Card MFM/RLL	\$89/119
XT I/O (FIS/PP/GC)	\$ 29	AT I/O (S/P/G), 15/2S	\$19/25
XT-10286-12M/Board	\$65/130	386 X-16MB/Board	\$360
386-25MHz M/Board	\$695/795	386-33 64K Cache M/Board	\$890

(Call for Complete Price List!!!)

#### KOPEC INTERNATIONAL CO.

838 N. Glenville Dr., Richardson, TX 75081  
Order: 800-654-8008 Tech: 214-907-1958 Fax: 214-907-1963

Inquiry 705.

### ACCESSORIES

#### HEWLETT PACKARD

Buy — Sell — Trade

Laser Jet II/III	Color Pro (7440)
Laser 2000 2 Meg/4 Meg upgrades	HP-7550A
Desk Jet	Draft Pro DXL/EXL
Rugged Writer	Draftmaster III
Electrostatic Plotters C1600 (D Size)/C 1601 (E Size)	
Science Accessories Corporation Sonic Digitizers	
36" x 48" (2750)	60" x 72" (3175)

#### T. E. Dasher & Associates

4117 Second Ave. S., Birmingham, AL 35222  
Phone: (205) 591-4747 Fax: (205) 591-1108  
(800) 638-4833

Inquiry 706.

### ARTIFICIAL INTELLIGENCE

#### NeuralWorks Explorer

NeuralWorks Explorer is a neural net tutorial that provides the novice user with a method of learning neural net theory as well as an environment in which to build practical real time applications such as targeted marketing, stock prediction, process control and more. PC and MAC. Price \$495. VISA/MC accepted. University discounts available.

#### NeuralWare, Inc.

412-787-8222

See our ad on page 238.

Inquiry 707.

#### Software Engineer Do Your Own Windows!

At last a LISP programming environment which takes advantage of a GUI and protected mode on the PC. Software Engineer™ for Windows™ 3.0 is a complete programming environment. It includes a LISP-aware text editor, allowing quick, easy and interactive Windows development. Software Engineer supports ODE, GDI, the clipboard, dialogboxes and menus. Software Engineer is priced at \$249.95.

#### Raindrop Software Corporation

845 E. Arapaho, Suite 105, Richardson, Texas 75081  
(214) 234-2611 Fax (214) 234-2674

See our ad on page 312.

Inquiry 708.

#### muLISP® 87 for MS-DOS

Fast, compact, efficient LISP programming environment. muLISP programs run 2 to 3 times faster & take 1/2 to 1/3 the space of other LISPs. 450 Common LISP functions, multi-window editing & debugging, flavors, graphics primitives, lessons & help, demo programs, comprehensive manual.

#### Soft Warehouse, Inc.

3615 Harding Ave., Suite 505, Honolulu, HI 96816  
(808) 734-5801

Inquiry 709.

#### NEURAL NETWORKS MADE EASY!®

THE VISIBLE NEURAL NETWORK® will painlessly teach you the complete feed-forward/back-propagation algorithm. NO MATH BACKGROUND REQUIRED beyond basic arithmetic. Package includes tutorial program, illustrated manual and GWBASIC source code of a functioning neural network application. SATISFACTION GUARANTEED or your money back. \$29.95 + \$3.00 S/H to:

#### The Visible Neural Network, Inc.

4228 Weskan Court, Bridgeton, MO 63044-1317  
(314) 739-2654 MC/Visa (24 hrs)

Inquiry 710.

### BAR CODE

#### LABELING SOFTWARE

On EPSON, IBM, OKI dot matrix or LaserJet. Flexible design on one easy screen. Any format/size. Up to 120 fields/label. 18 text sizes to 3" readable at 100'. AIAG, MIL-STD, 2 of 5, 128, UPC/EAN, Code 39. File Input & Scanned logos/symbols (PCX)—\$279. Other programs from \$49. 30-day \$\$ back.

#### Worthington Data Solutions

417-A Ingalls St., Santa Cruz, CA 95060  
(408) 458-9938 (800) 345-4220

### BAR CODE READERS

For PC, XT, AT, & PS/2, Macintosh, and any RS-232 terminal. Acts like 2nd keyboard, bar codes read as keyed data. With steel wand—\$399. Top rated in independent reviews. Works with DOS, Xenix, Novell, Alloy, -ALL software. Lasers, magstripe, & slot badge readers. 30-day \$\$ back.

#### Worthington Data Solutions

417-A Ingalls St., Santa Cruz, CA 95060  
(408) 458-9938 (800) 345-4220

### PORTABLE READER

Battery-operated, handheld reader with 64K static RAM, 2x16 LCD display, 32-key keyboard, Real-Time-Clock. Wand or laser scanner. Program prompts and data checking through its own keyboard. Easy data transfer by RS-232 port or PC, PS/2 keyboard. Doubles as On-Line Reader. 30-day \$\$ back.

#### Worthington Data Solutions

417-A Ingalls St., Santa Cruz, CA 95060  
(408) 458-9938 (800) 345-4220

### PRINT BAR CODES/BIG TEXT FROM YOUR PROGRAM

Add bar codes and big graphics characters to your program. Print from ANY MS-DOS language. Bar codes: UPC, EAN, 2 of 5, MSI, Code 39, Epson, Oki, IBM dot matrix text up to 1/2". LaserJet up to 2". Font cartridges not required. \$179-\$239. 30-day \$\$ back.

#### Worthington Data Solutions

417-A Ingalls St., Santa Cruz, CA 95060  
(408) 458-9938 (800) 345-4220

### BAR CODE READERS

Keyboard emulation for PC/XT/AT & PS/2's, all clones and any RS-232 Terminal. Transparent to your operating system. Available with Steel wands, Lasers, Slot & Magstripe Readers. Same day shipping, 30-day money-back guarantee. One-year warranty. Reseller discounts available.

#### AMERICAN MICROSYSTEMS

2190 A Regal Parkway, Euless, TX 76040  
(800) 648-4452 (817) 571-9015 FAX (817) 685-6232

## BAR CODE

### BAR CODE PRINTING SOFTWARE

- MS/PC DOS SYSTEMS
- 9 & 24 PIN DOT MATRIX
- H-P LASER JET/PLUS/SERIES II
- MENU-DRIVEN or MEMORY RESIDENT
- CODE 39, I 2/5, UPC A/E, EAN 8/13
- BIG TEXT & BAR CODE SOFTFONTS

### AMERICAN MICROSYSTEMS

2190 A Regal Parkway, Euless, TX 76040  
(800) 648-4452 (817) 571-9015 FAX (817) 685-6232

Inquiry 711.

### BAR CODE PRINTING

Print bar codes from your custom program. ANSI C routines generate and print Code39, I25, Codabar, UPC A/E, EAN 8/13 and supplements. Supports LaserJet, OKI, and EPSON and custom printers. Works with UNIX/XENIX, MSDOS and others. All SOURCE CODE included. No royalties. Single pattern \$85. All patterns \$250.

### Infinity Computer Services, Inc.

P.O. Box 269, Coopersburg, PA 18036  
Voice: 215-965-7699 BBS: 215-965-8028

Inquiry 712.

### PC-Wand Bar Code Solutions

Bar codes are easy with a FULL line of readers & printers. They plug & play with your existing systems, most all makes of CPU/printer/terminal/software in your office, store, truck, factory or warehouse. Our bar code DOS programs print on matrix or laser printers. 30 day refund, 1 year warranty.

### International Technologies & Systems Corp.

655-K North Berry St., Brea, CA 92621  
TEL: (714) 990-1880 FAX: (714) 990-2503

Inquiry 713.

### PORTABLE BAR CODE READER

You can have a wedge or RS232 bar code reader and a portable reader together in one unit. The extremely light hand-held unit has a large keypad and is simple to operate.

Friendly advice given.

### PACIFIC MICROSYSTEMS

2560 9th Street, Suite 214M, Berkeley, CA 94710  
(800) 242-5271 FAX (415) 644-2731

Inquiry 714.

### 5-YR. WARRANTY AT PERCON

PERCON decoders are now covered by a five-year limited warranty. That means you won't spend one cent replacing your PERCON bar code decoder for five full years. That's reliability you can count on!

### PERCON

1710 Willow Creek Circle, Eugene, OR 97402-9153  
Phone: (800) 873-7266 FAX: (503) 344-1399  
See our ad on page 382.

Inquiry 715.

## ENV

Prints bar coded envelopes for fast delivery. E...easy to use, N...nationally listed by USPS, V...value packed. ENV bar coded envelopes are quickly sorted and delivered by the US Post Office. Postage discounted when over 200 bar coded pieces. • Use with any Word Processor or Mail Merge package • ENV Batch, Popup and Mail Merge versions on disk • Print return address, special messages and logos • for HP LaserJets and EPSON LQ series printers. No new equipment required. Great program for any type and size business, church, club or association. Order for MSDOS computers NOW \$49.95

### Pike Creek Computer Company

2 Galaxy Dr., Newark DE 19711-2920  
To Order: (302) 239-5113 Dealers call (800) SELL LOW

## BAR CODE

### PC BAR CODE SPECIALISTS

Bar code readers designed for fast, reliable, cost-effective data entry. They emulate your keyboard, so scanned data looks just like it was typed in! Choose from stainless steel wand, laser gun, card slot reader, and magnetic stripe scanner. Also, powerful Bar Code and Text printing software. Great warranty. Generous dealer discounts.

### Seagull Scientific Systems

15127 N.E. 24th, Suite 333, Redmond, WA 98052  
206-451-8966

Inquiry 716.

### DATA INPUT DEVICES

Bar Code, Magnetic Stripe Readers & SmartCard Encoder/Reader for microcomputers & terminals, including IBM PS/2 & others, DEC, Macintosh, AT&T, CT, Wyse, Wang. All readers connect on the keyboard cable & are transparent to all software. UPC & 39 print programs, magnetic encoders, & portable readers are also available.

### TPS Electronics

4047 Transport, Palo Alto, CA 94303  
415-856-6833 Telex 371-9097 TPS PLA  
1-800-526-5920 FAX: 415-856-3843

Inquiry 717.

### VARIANT MICROSYSTEMS BAR CODE READERS DELIVER

WAND/LASER/MAGNETIC CARD CONNECTIVITY

- Keyboard wedges (Internal/External) for IBM PC/XT/AT, PS/2 and portables.
- RS232 wedges for WYSE, Link, Kimtron terminals
- Bar code and label printing software
- Full two-year warranty
- 30-Day Money-Back Guarantee
- Extensive VAR/Dealer Discounts

3140 De La Cruz Blvd., Suite 200/Santa Clara, CA 95054/(408) 960-1680  
800-666-4BAR FAX: (415) 623-1372

Inquiry 718.

## CAD

### \$99 Electro-CAD \$99

- Do your own Schematics / 2xPCB's / SMT
- Rubber-Banding / Inter-trace FLOOD
- Context-sensitive Hypertext HELP
- Graphics libraries w/EDITOR
- Total control of EGA/VGA for layout

FREE DEMO DISK

### AEROUX Engineering

32 West Anapamu, Suite 228, Santa Barbara, CA 93101  
(805) 962-9695

Inquiry 719.

### AutoCAD Users!!

Increase your VGA-based AutoCAD performance up to 10 times with GT Express software.

- Instant zooms, pans and redraws
- Supports Release 11
- 1024x768 resolution
- GT Flexicon user interface
- Bird's-eye View
- Single or dual screen configuration

Call ARTIST SOFTWARE (800) 999-9678 for your FREE demo diskette.

Inquiry 720.

### CAD-DRAWING VIEWSTATION

Allows non-CAD users to view drawings on PCs, print, plot, attach personal notes, and hyper-link between files. Change views and layers. Accurate entity representation. Easy to use.

- Sirlin VIEW/DWG for AutoCAD DWG files: \$295
- Sirlin VIEW/PLUS for DWG, DXF, HPGL and dBase: \$395

Developers: ask about linkable Sirlin VIEW/LIB. Dealers welcome.

Sirlin Computer Corporation  
225 Lowell Road, Hudson, NH 03051  
(603) 595-0420 Fax (603) 595-7779

## CAD/CAM

### STEPPER MOTOR CONTROL FROM A PRINTER PORT!

NEW Indexer LPT™ software VERSION 2.0 \$249

- Controls up to six motors simultaneously
- Linear and Circular Interpolation.
- New features to accommodate machine control.
- Easy-to-use DOS device driver. Super Manual.
- CAD-CAM interface available.

Ability Systems Corporation, 1422 Arnold Ave.  
Roslyn, PA 19001 (215) 657-4338

Inquiry 721.

### CAD/CAM Developer's Kit

Save months writing AutoCAD ADS or standalone CAD/CAM applications!

(617) 628-5217

### Building Block Software

PO Box 1373 Somerville, MA 02144

Inquiry 722.

## CD-ROM

### FREE CHINON CD ROM PLAYER

Purchase \$995 worth of Alde's workhorse CD ROM software and receive a Chinon CDS-430 External or CDS-431 Internal CD ROM drive, cable, card, and DOS extensions absolutely free. Other bundled combinations also available.

### ALDE PUBLISHING INC.

Box 1190, Glen Lake, MN 55345  
800/727-9724 (Voc) 612/934-2824 (Fax)

Inquiry 723.

### Largest Selection and Best Price Microsoft Programmers Library & Drive \$949. Computer Library \$695 • Public Domain S/W \$49. NEC PC or Mac Drive Kit \$749 • Bookshelf-Best Price!

Drives from \$499. Hundreds of titles from \$29.  
MC/VISA/AMEX/COD, Money-back Guarantee.  
Call or write for free 120-page catalog.

### Bureau of Electronic Publishing

141 New Road, Parsippany, NJ 07054  
800-828-4766

### THE SOURCE FOR CD-ROM

See our ad on page 110.

Inquiry 724.

### CD ROM, Inc.

CO-ROM, WORM, MAGNETO-OPTICAL DRIVES, CO-ROM DISCS FOR IBM AND MAC, OPTICAL CONSULTING SERVICES

\* PUBLISHING \* DISTRIBUTION \* NETWORKING

QUALITY PRODUCTS AND SERVICES AT COMPETITIVE PRICES  
FREE CATALOG

TEL. 303-231-9373

1667 COLE BLVD., SUITE 400, GOLDEN, CO 80401  
FAX: 303-231-9581, CIS: 72007,544  
VISA/MC/AMEX/GOV'T. POS

Inquiry 725.

## COMMUNICATIONS

### SDLC OR X.25 SUPPORT

Use Sangoma hardware and software to provide cost effective, robust and easy-to-use SDLC or X.25 links from MS-DOS, UNIX, PC-MOS, etc.

All real time communication functions performed by intelligent co-processor card.

Full function SNA emulation packages also available.

Sangoma Technologies Inc.  
(416) 474-1990

Inquiry 726.

# THE BUYER'S MART

## COMPUTER INSURANCE

### INSURES YOUR COMPUTER

SAFEWARE Computerowners coverage provides replacement of hardware, media and purchased software. As little as \$49 a year covers accidents, theft, power surges and more. One call does it all. Call 8 am-10 pm ET. (Sat. 9 to 5)

**TOLL FREE 1-800-848-3469**

(Local 614-262-0559)

**SAFEWARE, The Insurance Agency Inc.**

Inquiry 727.

## CROSS ASSEMBLERS

### CROSS ASSEMBLERS

Universal Linker, Librarian  
Targets for 36 Microprocessors  
Hosts: PC/MS-DOS, micro VAX, VAX 8000

#### ENERTEC, Inc.

BOX 1312, 811 W. Fifth St.  
Lansdale, PA 19446

Tel: 215-362-0966 Fax: 215-362-2404

Inquiry 728.

### CROSS ASSEMBLERS/SIMULATORS

New unique full-function simulators for the 8096 and 80C196 controllers, featuring ALL MODES of interrupts, plus the HSI, HSO, and A/D functions. We also support the 8048/49, 8080/85, 8051/52, and Z80 controllers with excellent, reasonably priced Cross Assemblers and Simulators.

#### Lear Com Company

2440 Kipling St., Ste. 206, Lakewood, CO 80215  
(303) 232-2226 FAX: (303) 232-8721

Inquiry 729.

### CROSS ASSEMBLERS

Relocatable  
Macros  
PC Compatible

**GUARANTEED,  
SUPPORTED**

DEBUG SIMULATORS • DISASSEMBLERS  
EPROM PROGRAMMERS

#### MICRO COMPUTER TOOLS CO.

Phone Toll Free (800) 443-0779

In CA (415) 825-4200

912 Hastings Dr., Concord, CA 94518

Inquiry 730.

## CROSS DISASSEMBLERS

### PROFESSIONAL PC SOFTWARE

#### CROSS-DISASSEMBLERS

Analytic, Automatic Label Generation

#### CROSS-ASSEMBLERS

Relocatable, Macro, Universal Linker + Librarian

#### C CROSS COMPILERS

#### SOURCE TRANSLATION UTILITIES

Support for Intel, Motorola, Zilog, TI, RCA

Order Today: (408) 773-8465

#### LOGISOFT

PO Box 61929, Sunnyvale, CA 94086  
FAX: (408) 773-8466

Inquiry 731.

## DATA CONVERSION

### MEDIA CONVERSION/DATA TRANSLATION

More than just a straight dump or ASCII transfer!

Word Processing, DBMS, and Spreadsheet data on Disks or Tapes transferred directly into applications running on Mainframes, Minis, Micros, Dedicated Word Processors, Typesetters, and Electronic Publishing systems.

IBM PS/2 & Macintosh supported  
#1 in the translation industry!

#### CompuData Translators, Inc.

3345 Wilshire Blvd., Suite 407, Los Angeles, CA 90010  
(213) 387-4477 1-800-825-8251

Inquiry 732.

376 B Y T E • JANUARY 1991

## DATA CONVERSION

### DBMS/COPY

CONVERTS YOUR DATA INTO INFORMATION

Now your favorite stat package can access any database. DBMS/COPY can directly convert any database or spreadsheet file (ORACLE, PARADOX, dBASE, LOTUS etc.) into any stat package file (SAS, SPSS, SYSTAT, etc.) and vice versa. The PLUS version allows sorts, selections, and recalculations. \$195 30-day guarantee. VISA/MC/AMEX/PO/COD. Call for free limited version.

#### CONCEPTUAL SOFTWARE INC.

P.O. Box 56627, Houston, TX 77256

(713) 667-4222 FAX: (713) 667-3FAX  
1-800-STATWOW

Inquiry 733.

### WE'LL DO IT BETTER... FOR LESS!

Conversion, Duplication, Any Format  
FREE TEST • SATISFACTION GUARANTEED

Plus, the Personal Touch: Ask Questions and we'll explain it to you in simple English!!

#### DATACOPI SERVICE

P.O. Box 820214, Dallas, TX 75382

1-800-969-DATA 214-272-7751

Inquiry 734.

### ☆ America's Leaders in Data Conversion ☆

DISK → DISK • TAPE → DISK  
OPTICAL SCANNING

WE CONVERT MORE FORMATS THAN ANYONE ELSE!!!

IBM, DEC, VAX/VMS, APPLE, WANG, XEROX, NBI, LANIER,  
CPT, UNIX, Wordperfect...

QUICK—RELIABLE—HIGHEST QUALITY

NATIONAL DATA CONVERSION INSTITUTE

5 East 16th Str., NY, NY 10003 (212) 463-7511

Inquiry 735.

## DATA RECOVERY

### CRASHED?

Your valuable data can be recovered!

- 95% success rate • Fast turnaround
- Servicing Novell, DOS, Macintosh, Unix, Xenix, OS/2, Bernoulli and more!

#### ONTRACK DATA RECOVERY, INC.

Keeping you in business is our business.

1-800-872-2599

Inquiry 736.

### DATA RECOVERY

Data lost from 1/4" cartridges of 1/2" tape can be recovered almost every time. We have helped Banks, Insurance Companies, Telephone Companies, Commodity Dealers, Hospitals, Software Houses, Government Departments. The list is endless. We charge a small fixed fee for investigation and then on a time and materials basis.

The QICPAK Cartridge Interchange People

#### Vogon Enterprises Ltd.

94 Easthampstead Road, Wokingham, Berkshire RG11 2JD ENGLAND  
Tel 0734-784511 or 0734-890042 Fax 0734-890040

Inquiry 737.

## DATA/DISK CONVERSION

### THE #1 CHOICE

in disk & tape conversion

for many leading corporations, government agencies, law firms, and companies in every industry—world-wide.

Free test • Satisfaction guaranteed

#### Graphics Unlimited Inc.

3000 Second St. North, Minneapolis, MN 55411

(612) 588-7571 or (612) 520-2345

FAX: (612) 588-8783

Inquiry 738.

## DATA/DISK CONVERSION

### QUALITY CONVERSIONS

to or from virtually

#### ANY TAPE OR DISK FORMAT!

Horan Data Services converts over 2000 formats incl. 9-track tape, 3480 Cartridge and 8", 5 1/4" or 3 1/2" diskettes. All densities & most operating systems supported. Formats include EBODIC, ASCII, databases, spreadsheets, and dedicated or PC word processors.

**Call 1-800-677-8885**

Hours 8:00AM to 5:30PM Eastern Time

817 Main Street, Third Floor, Cincinnati OH 45202

Inquiry 739.

### IBM PC ↔ TO ↔ HP FILE COPY FASTER EASIER TO USE

Update version uses windows: Call for free demo! IBM PC <to> HP File Copy allows IBM PCs, PS/2, compatibles to interchange files with Hewlett-Packard Series 70, 80, 200, 300, 1000, 9000s.

#### Oswego Software

Box 310

708/554-3567

Oswego, IL 60543

FAX 708/554-3573

Inquiry 740.

## CONVERSION SERVICES

Convert any 9-track magnetic tape to or from over 3000 formats including 3 1/2", 5 1/4", 8" disk formats & word processors. Disk-to-disk conversions also available. Call for more info. Introducing OCR Scanning Services.

#### Pivar Computing Services, Inc.

165 Arlington Hgts. Rd., Dept. #B

Buffalo Grove, IL 60089 (800) Convert

Inquiry 741.

## DATABASE MGMT SYSTEMS

### SAVE TIME & MONEY!

OCELOT2—THE SQL! is a stand-alone database engine with a complete DB2 compatible SQL interface for developers who use BASIC, C, PASCAL, or COBOL.

- packs the full power of SQL into a 640KB PC;
- requires only 320KB RAM for program development;
- outperforms the rest!

For IBM and clones: \$195 & up. Free info.

#### OCELOT COMPUTER SERVICES INC.

#1502, 10025 - 106 Street, Edmonton, AB, Canada, T5J 1G7  
(403) 421-4187

Inquiry 741.

## DISK DRIVES

### BEST BUY!!!

HD Kits for AT: Drive, Controller, Rails & Cables

40MB - MFM - \$ 339

65MB - RLL - 459

80MB - MFM - 689

150MB - ESDI - 1099

NEW, ONE YEAR WARRANTY

#### jb TECHNOLOGIES, INC.

5105 Maureen Lane, Moorpark, CA 93021

(805) 529-0908 Fax (805) 529-7712

Inquiry 742.

## DUPLICATION

### SOFTWARE DUPLICATION

- DISKETTE & TAPE
- CUSTOM PRINTING
- CUSTOM PACKAGING
- FULFILLMENT

#### MEGASOFT, INC.

P.O. Box 710, Freehold, NJ 07728

(800) 222-0490

(908) 462-7628

Inquiry 743.

# THE BUYER'S MART

## EDUCATION

### B.S. & M.S. in COMPUTER SCIENCE

The American Institute for Computer Sciences offers an in-depth correspondence program to earn your Bachelor of Science and Master of Science degrees in Computer Science at home. B.S. subjects covered are: MS/DOS, BASIC, PASCAL, C, Data File Processing, Data Structures & Operating systems. M.S. program includes subjects in Software Engineering and Artificial Intelligence.

### AMERICAN INST. for COMPUTER SCIENCES

2101-BY Magnolia Ave. South, Ste. 200, Birmingham, AL 35205  
800-767-2427 205-323-6191

Inquiry 744.

## ENTERTAINMENT

### WHERE ADULTS COME TO PLAY! ODYSSEY BBS

• Designed for Adult modem users • Low cost local access numbers covering 850 cities! • Live online chat with other users! • Large software file library! • "Bulletin board" style Forums! • Interactive online games! • Matchmaker dating database! • And much, much more. 24 hours a day!

We also can provide your company with national BBS services. Call (818) 358-0936 for details!

Information and Signup By Modem

(818) 358-6968 (3/12/24 Baud, 8/N/1, Must be over 18)  
Voice Information (818) 357-9570

Inquiry 745.

## SHAREWARE

FOR IBM™ AND COMPATIBLES

FREE 112 PAGE CATALOG  
OVER 3000 PROGRAMS

CALL 1-800-245-BYTE (2983)

BEST BITS & BYTES

P.O. Box 8225-B, Van Nuys, CA 91409  
FOREIGN COUNTRIES SEND \$4.00 FOR SHIPPING

Inquiry 746.

### NEMESIS™ Go Master®

Go, a game of strategic elegance, has been a way of life in the Orient for over four thousand years. Many consider Go to be the secret of the Japanese businessman's success. "While chess is a game of war, Go is a game of market share" [President of Nikko Hotels].

Chaos Manor 1989 User's Choice Award  
BYTE 4/90, p.62

Toyogo, Inc. The Leader in Computer Go.  
PO Box F, Dept. Y, Kaneohe, HI 96744  
(808) 254-1166 or 1-800-TOYOGO-9

Inquiry 747.

## EXPANSION CHASSIS

### Add 8 or 16 BIT Slots to ATs

Increase the number of slots in your IBM PC/XT/AT and MAC compatible PCs with an expansion chassis. Available in 6, 8, or 12 slot versions w/8 and/or 16-bit AT (12 MHz buss speed) capability. Units come in desktop or rack mounts chassis and power supplies up to 400 watts. Interface cards and cables included.

### PERX, Inc.

200 Tamal Vista Blvd. #525, Corte Madera, CA 94925  
1-800-722-7379 or 415-927-0155 in CA  
Fax 415-927-0159

Inquiry 748.

## FINANCIAL SOFTWARE

### BrainMaker:

"The most fascinating computer software I've ever seen... learn about this stuff." John Dvorak, PC Mag. Predicts stocks, bonds, sales, inventories. Comprehensive documentation. Menus. Only \$195! Certified by Intel and Micro Devices

Free Brochure: 916/477-7481  
California Scientific Software

Inquiry 749.

## FLOW CHARTS

### WINDOWS FLOWCHARTER \$129

FFlow 2.0 is a professional drawing tool for flowcharts & org charts. Requires Microsoft Windows 3.0. 100 shapes auto adjust in size. Diagonal lines and curves. Auto line routing and re-routing. Click on a shape to bring up a sub-chart. Move charts to other apps. via the Clipboard. Call for free trial disk.

### RFF ELECTRONICS

1053 Banyan Court, Loveland, CO 80538  
Phone: (303) 663-5767 FAX: (303) 669-4889

Inquiry 750.

## FRAME GRABBER

### FRAME GRABBERS

Publishers' VGA 256 Grey scales \$655.00

Publishers' Color 256 colors \$830.00

VGA-to-Video Adapter

VGA-TV GE/O Genlock overlay \$830.00

(Overlay text and graphics on live video

and record it on a VCR)

Manufactured in the U.S.A.

3 Year Manufacturers Warranty

### THE KRUEGER COMPANY

(800) 245-2235 (602) 820-5330

Inquiry 751.

## GRAPHICS

### YOUR PHOTOS-SUPER VGA

Integrated Images can convert your photographs, slides, and VHS or 8 mm video tapes to 640 by 480 (or 320 by 200), 256 color images. Many file formats available, including PCX, GIF, CUT and others. Prices start at \$325 per picture. Discounts for quantity orders. Call or write for more information.

### Integrated Images Incorporated

P.O. Box 10021, Lansing, MI 48901

(517) 485-6636

Inquiry 752.

### EGAD Screen Print

Prints contents of VGA, EGA, CGA displays on variety of dot-matrix, inkjet, and laser printers. Prints in gray tones or color. Crop box lets you print any region of the screen. Enlarge graphics 1 to 4 times (reduction too). Setup program for picking printer colors, etc. \$35.00 Postpaid. Call or write for free catalog.

### LINDLEY SYSTEMS

4257 Berwick Place, Woodbridge, VA 22192-5119  
(703) 590-8890

Inquiry 753.

### IMAGE CAPTURE BOARD

Capture images from any VCR or Camcorder. Resolution up to 512 x 480 pixels; 65,536 colors or 256 shades of grey. Images saved in GIF, PCX, TIFF formats and more. For XT/AT/PS2. Includes user friendly software and user's guide. One year warranty. VGA required. Can capture from live video (eliminates need for expensive digital video). Ideal for desktop publishing, CAD, Animation, and Pictorial Databases.

\$749

VISA/MC/AMEX/C.O.D.

### PEGA Micrographics

P.O. Box 713, Westerville, OH 43081, (614) 885-1007  
1-800-477-PEGA

Inquiry 754.

## HARD DRIVE REPAIR

### HARD DRIVE REPAIR

ALSO

### DATA RECOVERY

FAST TURN!! CALL FOR DETAILS

### H&W micro labs, inc.

528-C Forest Parkway, Forest Park, GA 30050

404-366-1600

Inquiry 755.

## HARD DRIVE REPAIR

Beat the cost of replacement!

10% Off Discount **REPAIR** Coupon 10% Off

HARD DISC and FLOPPY DRIVES

FULL WARRANTY PROTECTION

Fast Turnaround • Data Recovery

### jb TECHNOLOGIES, INC.

5105 Maureen Lane, Moorpark, CA 93021

(805) 529-0908 Fax (805) 529-7712

Inquiry 756.

### HARD DISC DRIVES

Sales • EXCHANGE • Repair

Trade in your defective drive for NEW, with FULL WARRANTY!

TREMENDOUS SAVINGS!

TECHNICAL SUPPORT OF COURSE!

Large Inventory Hard and Floppy Drives

### jb TECHNOLOGIES, INC.

5105 Maureen Lane, Moorpark, CA 93021

(805) 529-0908 Fax (805) 529-7712

Inquiry 757.

## DATA RECOVERY

SALES of new, remanufactured and removable disk drives

FULL TECHNICAL SUPPORT

### ROTATING MEMORY SERVICE

1506 Dell Avenue, Campbell, CA 95008

(408) 370-3113

Inquiry 758.

## HARDWARE

### LATEST AWARD BIOS

User definable hard drives, 101/102 keyboard and 3.5" 1.44Mb floppy support are now available in Award BIOS Ver. 3.1 for the IBM AT, 286 and 386 compatibles.

### COMPUTERWERK, INC.

851 Parkview Blvd., Pittsburgh, PA 15215

Orders: 800-423-3400

Tech: (412) 782-0384

Inquiry 759.

### APPLE® II & MACINTOSH®

• Systems • Peripherals • Parts

Look for us at

COMDEX

LAS VEGAS

(The Sands

Convention Center)

Booth #N2591

Call for a CATALOG

USA & Canada:

800-274-5343

International: 617-891-6851

Fax: 617-891-3556

Save

up to

50%

on Mac

CPUs.

### Pre-Owned Electronics, Inc.

30 Clematis Avenue • Waltham, MA 02154

Inquiry 760.

### ROM BIOS UPGRADES

For Your IBM or Compatible • A New BIOS Upgrade Will:  
• Support Windows 3.0 • Support 360K, 720K, 1.2 MB & 1.44 MB Floppy Drives • User defined hard drive types • Supports VGA • Novell & Netware compatible • Expanded hard drive table • Enhanced 101/102 Keyboard • 100% IBM compatible • Complete documentation • Latest version • Complete set up in ROM.

Dealer/Distributor Inquiries Welcome Authorized Award Software Inc. Dist.

800-800-BIOS Fax 508-683-1630

800-800-2467

508-686-6468

### Unicore Software

599 Canal Street, Lawrence, MA 01840

See our ad on page 325

Inquiry 761.

# THE BUYER'S MART

## HARDWARE/COMPUTERS

### SC/FOX™ EMBEDDED COMPUTERS

PC Parallel Coprocessor Plug-in Boards: 15 MIPS av 50 MIPS burst using the SC32 32-bit CPU or the 16-bit Harris RTX 2000; VME Master/Slave System Controller SBC: 16 MIPS av 70 MIPS burst, uses RTX 2000 cpu, SCSI, 2 ser, 1 prt ports, to 640K bytes. Stand-Alone Single Board Computers: 18 MIPS av 60 MIPS burst, 3U or 100x100mm Eurocard-size using either SC32 or RTX 2000. Ideal for embedded real-time control, data acquisition, robotics, and signal processing. OEM software development system included.

**SILICON COMPOSERS INC** (415) 322-8763  
208 California Avenue, Palo Alto, CA 94306

Inquiry 762.

### TDS9092 Forth Embedded Computer

Priced correctly for building into products this board has small size, low power and high level language. It interfaces to LCD & keyboard and has on-board multitasking, interrupts, dual RS232 ports, RAM, non-volatile EEPROM, PC bus and 35 I/O lines. Optional precision A-D and battery-backed RAM. A data logger can run 12 months on a small battery. Use for machine control, data logging, robotics instruments and automation. Call or fax for details. Now \$179 (25 qty)

### The Saelig Company

1193 Moseley Road, Victor, NY 14564  
Phone (716) 425-3753 Fax (716) 425-3835

Inquiry 763.

## HARDWARE/CONTROLLERS

### SINGLE BOARD DATA ACQUISITION & CONTROL

Single Board Computer based on Hitachi's 64180 processor has optimum features for dedicated control tasks where System Failure cannot be tolerated. Features include: Low Power CMOS • 16 chan. 13 bit A/D • 2, 16 bit Timers • 2 RS232/485 Ports • EEPROM • 192K Memory • 32 Digital I/O lines • Watchdog Timer • Dim 5.25 x 8. Options: 2 chan. 12 bit DA • Battery backed RAM/Clock • Embedded FORTH & BASIC Languages • Networking • PC support.

E-PAC 3000 \$449.00

### EMAC INC.

P.O. Box 2042, Carbondale, IL 62901 (618) 529-4525

Inquiry 764.

## INVENTORY MANAGEMENT

### STOCK-MASTER 4.0

Commercial grade inventory management software at micro prices.

- Supports all 12 transaction types
- Trend Analysis
- Quality Control
- Multiple Locations
- Purchase Order Tracking
- Open Order Reporting
- Serial/Lot # Tracking
- Stock Status Reporting
- Activity History Analysis
- Bill of Materials
- Purchase Order Writing
- Order Entry
- Material Requirements
- On Line Inquiry

### Applied Micro Business Systems, Inc.

177-F Riverside Ave., Newport Beach, CA 92663 714-759-0582

Inquiry 765.

### dFELLER Inventory

Business inventory programs written in modifiable dBASE source code.

dFELLER Inventory \$150.00

Requires dBASE II or III, PC-DOS/CPM

dFELLER Plus \$200.00

with History and Purchase Orders

Requires dBASE III or dBASE III Plus (For Stockrooms)

### Feller Associates

550 CR PPA, Route 3, Ishpeming, MI 49849  
(906) 486-6024

Inquiry 766.

## LANS

### The \$25 Network

Try the 1st truly low-cost LAN

- Connect 2 or 3 PCs, XT's, AT's
- Uses serial ports and 5-wire cable
- Runs at 115K baud
- Runs in background, totally transparent
- Share any device, any file, any time
- Needs only 14K of RAM

Skeptical? We make believers!

### Information Modes

P.O. Drawer F, Denton, TX 76202  
817-387-3339 Orders 800-628-7992

Inquiry 767.

378 BYTE • JANUARY 1991

## LAPTOP COMPUTERS

### Laptop Savings

- Laptops: Toshiba • Zenith • NEC • Sharp
- Epson • Mitsubishi • Compaq • Leading Edge
- Hyundai • Panasonic • Packard Bell
- Texas Instruments • Fora • Tandon

### Computer Options Unlimited

12 Maiden Lane, Bound Brook, NJ 08805

Phone: 201-469-7678 To order: (800) 424-7678  
9-9 M-F 9-5 Sat. 6 days Worldwide sales

Inquiry 768.

## LAPTOP PERIPHERALS

### TOSHIBA LAPTOP ENHANCEMENTS

FAX/MODEMS: 9600/2400 bps, software, acoustic port  
MODEMS, INTERNAL: 2400 bps, acoustic or serial port  
MODEM, DEDICATED: 2400 bps (T1200, T1600, T3200SX)  
SERIAL I/O CARDS: RS232, RS422, SCSI, HPI/L, Barcode  
BATTERY PACKS: 12V external battery + vehicle adapter

Contact us for more information:

### PRODUCT R&D Corporation (Calif.)

805/546-9713, Fax: 805/546-9716

Inquiry 769.

## MEMORY CHIPS

### PRICE MEETING & BEATING!

<b>DRAMS</b>	<b>SIMMS/SIPPS</b>
64K x 1-12, 10	256K x 9-10, 80, 70, 60
64K x 4-80	1MEG x 8-10, 80, 70
256K x 1-15, 12, 10, 80, 70, 60	1MEG x 9-10, 80, 70, 60
256K x 4-80	4MEG x 8-80
1MEG x 1-10, 80, 70, 60	4MEG x 9-80
<b>INTEL/CYRIX/IT MATH CO'S</b>	<b>PS/2 TYPE SIMMS</b>
80287-810	Model 30 286
80387-SX, 16, 20, 25, 33	Model 50, 55, 60, 70, 80

**CALL DRAM COMPANY** (800) 488-DRAM  
P.O. Box 590127 • S.F., CA 94159 (415) 398-2987

Inquiry 770.

## OBJECT-ORIENTED

### Improve Your Productivity

Are your programming skills out of date? Get the facts in a compact, time-saving format. Object-Oriented vocabulary, explanations, examples, vendors & bibliography. No editorials and no exclamation points. Includes Mac or PC floppy with C & C++ examples. Send \$29.95 (+\$2.50 postage & handling) to:

### buk-worm Information Services™

Dept B1, 16776 Bernardo Ctr. Dr., Ste. 110b, San Diego, CA 92128  
24 hr FAX: (619) 489-0778 VISA & MasterCard accepted

Inquiry 771.

## PROGRAMMERS' TOOLS

### HYPERINTERFACE™ II

**Menu Creator™** — An interactive WYSIWYG editor to generate a menu-driven user interface for your software.  
**Screen Creator™** — An interactive WYSIWYG editor for quick and easy screen design and a screen database manager for your software. **Advanced Library** — Extended capability for data entry for your programs. FORTRAN, Pascal, C, BASIC supported.

### Avanpro Corp.

P.O. Box 969, Pacific Palisades, CA 90272  
(213) 454-3866

Inquiry 772.

### BUGS! BUGS! BUGS! WE EXTERMINATE!

Every program has bugs. How do you find them? DIMENSIONAL REASONER™ is a new tool for finding and eliminating bugs in FORTRAN and BASIC programs. It uses the new AI technique of Symbolic Dimensional Algebra to evaluate all of your equations to see if they make sense. Just add comments defining variable units, we do the rest. 30-day \$5 back.  
PC/DOS \$65, VAX \$250. Visa/MC. Bulk discounts available.

### DIMENSIONAL REASONER™

205 Longleaf Ct., Aiken SC 29803 803-649-7887

Inquiry 773.

## PROGRAMMERS' TOOLS

### PLOT= >SOURCE.PAS

Unique full-function viewer for HPGL files and automatic code generator (requires Turbo Pascal)  
PLOT ->PAS ver. 1.0 Lit. 80000 (about \$67) plus S&H. Visa/MasterCard Accepted  
DRAW with AutoCAD, DesignCAD3D, Corel Draw, Freelance, Orcad, etc., . . . PLOT to file; RUN PLOT ->PAS: view, zoom, pan, scale, cut. . . and ENTER: your code is ready.  
NEW: with source for custom output TPU, demo programs, 3.5" and 5.25" media, manual.

### Ing. Marco Sillano

Via Massimi 154, I00136 — ROME, ITALY

Inquiry 774.

## GW-BASIC PROGRAMMERS

Create professional programs for the IBM PC with all the bells and whistles! Contains Subroutines & Programs. The 46 source code files include:

- Bar Menu
- Shell Sort
- ANSYSYS
- Screen Manager
- Key Handlers
- "Walk" Dir Tree
- Draw Forms
- Find File
- Font Demo

1-800-345-3808 (VISAMC) Toolbox 1—\$29.00

**MIPS, Inc.** • Box 3072 • Hammond, LA 70404

Inquiry 775.

### • MULTITASK Real Time

• **SERIAL COMMUNICATION** by interrupt  
MTASK® Professional was designed for the specific requirements of Scientific Laboratories and Robotics Departments. Grátis: demonstration diskette.

Available for the present, for Turbo Pascal, Turbo C, Quick Pascal, Turbo Basic. Evaluation software for only \$49. Price \$495 + Shipping \$20. Taxes not included.

### RAMSI® International

53 rue Bernard Iske, F-92350 Plessis Robinson, FRANCE  
International FAX: 33 (1) 46.32.48.37

Inquiry 776.

## PROTOTYPING

### PC-AT Wirewrap Prototype Card

The Protosystem AT wirewrap prototype card is the first card available with the signal lines laid out as buses, large labels on both sides of the card, and power and ground planes on the card. It also has pins and bypass capacitors soldered in place. An XT prototype card is also available. Call 1-800-747-2262.

### CANA GROUP

100 Walnut St., Suite 402, Peoria, IL 61602

Inquiry 777.

## PUBLIC DOMAIN

### 325 MEGABYTES Virus Free Share Ware

Dealers/Syops/Educators. Instant IBM Shareware Library for your Customers, user group or Students. Distributed in 25 Megabyte increments on HD 1.2/1.4 diskettes. \$390 for first 25 Megabytes, then add \$40.00 for each 25 Megabyte increment.

Add \$3.00 postage for each 25 Megabyte increment.

Add \$4.00/25 Meg increment for 1.44 diskettes.

Orders Only: 1-800-876-8496

Info/Tech: 1-405-524-5233

### SHARE-NET

POB 12368, Okla City, OK 73157

No Surcharge for Visa/MasterCard

We gladly accept PO's from Educational, Fed/State Agencies

Inquiry 778.

## FREE SOFTWARE FOR IBM® PC'S

TRY US! Get our SOLID GOLD HITS—Winter 1991 edition 15/5.25" or 6/3.5" disks full of our best-selling software—FREE! Great graphics, programmers utilities, desktop publishing, finance, games, education, and catalog.

Pay only \$5.00 for shipping — VISA/MC/AMEX

### SMC SOFTWARE PUBLISHERS

CALL TODAY 619-942-9998

Inquiry 779.

# THE BUYER'S MART

## PUBLIC DOMAIN

### SOFTSHOPPE, INC.

Selected Programs, Latest Versions, As Low as \$1.50, Same Day Shipping, and No Minimum Order. For FREE CATALOG for IBM PD/Shareware, CALL 800-829-BEST (2378) or FAX 313-761-7639.

### SOFTSHOPPE, INC.

P.O. Box 3678, Ann Arbor, MI 48106-3678

Inquiry 780.

## SECURITY

### FIGHT PIRACY!

Since 1986, companies worldwide have been choosing Az-Tech security products. If you demand the strongest protection available, why not choose one of these "proven leaders":

- EVERLOCK Copy Protection
- EVERTRAK Software Security
- EVERKEY Hardware "Key" Software Security

For IBM and Compatibles. 30 day money back guarantee. Free info and demo disk available.

Az-Tech Software, Inc.

305 East Franklin, Richmond, MO 64085

(800) 227-0644 (816) 776-2700  
Fax: (816) 776-8398

Inquiry 781.

### THE ULTIMATE COPY PROTECTION

- Completely Menu Driven
- Defeats all Hardware/Software Copiers
- No Source Code Changes
- Multiple Layering
- No Damaged Media
- Full Hard Disk Support
- Unlimited Metering
- FREE Demo Disk

Quite  
Simply  
The Best  
Ways To  
Protect  
Your Valuable  
Software Investment

STOPVIEW™ STOPCOPY PLUS™

BBi COMPUTER SYSTEMS® (301) 871-1094  
14105 Heritage La., Silver Spring, MD 20906 FAX: (301) 460-7545

Inquiry 782.

### COP's Copylock II

- Protects on standard diskettes
- Cannot be copied by any device incl. Option Board
- Fully hard disk installable
- Normal back-up of protected programs
- LAN-support
- Creates safe demo version of your software

Standard Version \$975, Automatic Version \$1950

### DANCOTEC Computer

In US: 2835 Sierra Rd., San Jose, CA 95132 408-728-8162 or 1-800-344-2545  
Int'l: 2880 Bagsvard, Denmark Phone +45-44440322 Fax: -44440722

Inquiry 783.

### BIT-LOCK® SECURITY

Piracy SURVIVAL 8 YEARS proves effectiveness of powerful multilayered security. Rapid decryption algorithms. PARALLEL or SERIAL port-transparent security device. Complemented by economical KEY-LOCK™ and multifunctioned COMPU-LOCK™ including countdown, timeout, data encryption, and multiproduct protection. (Dos/Unix/Mac) Also, access control.

### MICROCOMPUTER APPLICATIONS

3167 E. Otero Circle, Littleton, CO 80122  
(303) 770-1917

Inquiry 784.

### CopyControl

#### YOUR POWER TO PROFIT

- Ultra secure • Cost effective • Choose where, when and usage rate
- Change parameters by phone • No messy dongles or special disks • Hard disk and LAN support

Choose the NEW Generation Copy Protection  
FREE Demo Disk and Info  
1-800-237-8400 ext. 212

### MICROCOSM INC.

40 Wall Street, Suite 2124, New York, NY 10005

Inquiry 785.

## SECURITY

### HANDS OFF THE BOARD® 1/2 SIZE SECURITY BOARD

Stop floppy boot — Require password to boot PC  
Real-time disk encrypt — prevent boot sector virus  
Prevent DOS FORMAT/FDISK and low-level formats  
Set hard disk READ ONLY or turn ON/OFF  
Turn floppies, printers and COM ports ON/OFF  
IBM XT, AT Bus — DOS V3.0+ — \$149.95 + \$5.00 S/H

### SYSTEMS CONSULTING INC.

P.O. Box 111209, Pittsburgh, PA 15238  
(412) 781-5280

Inquiry 786.

## SOFTWARE/ACCOUNTING

### CHECK REGISTER ANALYZER

Manage your checking account and obtain a monthly expense report, a listing of checks by "to" or "for" entries and a listing of canceled checks. Reports are displayed or printed. Up to 500 checks may be entered. Recommend a hard disk and 640K memory. For PC or AT compatibles. Price 29.95.

### Backus Computer Services

P.O. Box 830793, San Antonio, TX 78283-0793  
(512) 433-4982

Inquiry 787.

### dBASE BUSINESS TOOLS

- GENERAL LEDGER
- ORDER ENTRY
- JOB COSTING
- BILL OF MATLS
- PAYROLL
- PURCH ORD/INVENTORY
- ACCOUNTS RECEIVABLE
- JOB ESTIMATING
- SALES ANALYSIS
- ACCOUNTS PAYABLE

\$99 ea. + S&H

### dATAMAR SYSTEMS Cred. Card-Check-COD

4876-B Santa Monica Ave.  
San Diego, CA 92107 (619) 223-3344

Inquiry 788.

## SOFTWARE/BUSINESS

### DATA ENTRY SOFTWARE

Full featured, heads-down data entry with two-pass verification, edit language, operator stats, much more! Designed for the PS/2®, PC, XT, AT or compatibles.

PC's from \$395 LAN version available

FREE 30 day trial

Computer Keyes Tel: 206/776/6443  
21929 Makah Rd., Fax: 206/776-7210  
Woodway, WA 98020 USA: 800/356-0203

Inquiry 789.

### StaffMinder™

Staff Administration Software—A must for all managers!

Named for its inherent ability to "keep an eye on your staff," StaffMinder™ handles the following:

- Attendance tracking and analysis
- Salary, review, and bonus tracking
- Vacation planning and scheduling
- Compliance reporting
- Skills inventory
- Employee information

StaffMinder™ provides numerous informative reports. Free serial mouse included with each order. Simple point and click interface allows for easy implementation. Source code available.

List price \$395. Ask for details on current special pricing!

### NEXT GENERATION SOFTWARE

Suite 1445, 3340 Peachtree Road, Atlanta, GA 30326  
CALL (800) 966-0707

Inquiry 789.

## SOFTWARE/ENGINEERING

### Control System Design & Simulation for PC's CODAS - II

Time & Freq. domain & s-plane design environment \* Easy entry of trans or functions \* Open or closed loop systems \* Nyquist, Nichols or Bode plots \* Root Loci \* Discrete time/sampled data systems \* Nonlinear domain \* Non-unity feedback

Also available: PCS Process Control Simulation  
Produced by Golden & Verwer Partners (UK)  
Distributed exclusively in North America by

DYNAMICAL SYSTEMS, INC.  
P.O. Box 35241, Tucson, AZ 85740 (602) 292-1962

Inquiry 790.

## SOFTWARE/ENGINEERING

### PC BASED DATA ACQUISITION

Snap-Series Software is the best solution for Integrated Data Acquisition, Analysis, and Display without programming. Works with I/O hardware by 12 manufacturers, and allows extensive time and frequency domain analysis. Ideal for monitoring, waveform generation, and DSP.

### HEM Data Corporation

17336 12 Mile Road, Southfield, MI 48076

Voice: (313) 559-5607 Fax: (313) 559-8008

Inquiry 791.

### UNLIMITED SPICE MODELS

- Diodes, Transistors
- JFETs, MOSFETs
- Power Devices
- Any SPICE Program
- Fast, Easy To Use
- Uses Data Sheet Info

SPICEMOO, The Modeling Spreadsheet, allows SPICE models to be developed from data sheet parameters in minutes. The models are compatible with any SPICE program on any computer. SPICEMOO is available now for \$200.

### Intusoft

P.O. Box 710, San Pedro, CA 90734-0710  
(213) 833-0710 FAX (213) 833-9658 CAE tools

Inquiry 792.

### SIMULATION WITH GPSS/PC™

GPSS/PC™ is an MS-DOS compatible version of the popular mainframe simulation language GPSS. Graphics, animation and an extremely interactive environment allow a totally new view of your models. If you are contemplating the creation or modification of a complex system you need GPSS/PC to help you predict its behavior. Call now.

### MINUTEMAN Software

P.O. Box 171Y, Stow, Massachusetts, U.S.A.  
(508) 897-5662 ext. 540 (800) 223-1430 ext. 540

Inquiry 793.

### ACTIVE™

Versatile! • Fast! • Easy! • Thorough!

Menu driven Active filter design in 3 easy steps: 1) Specify characteristics, 2) Select real components, 3) Analyze performance. Butterworth, Chebyshev, Bessel Realpole, etc. Full set of reports, graphs and tables.

- IBM-PC • \$745 • Call for FREE demo

### Tatum Labs Inc.

3917 Research Park Dr. B-1, Ann Arbor, MI 48108  
313-663-8810

Inquiry 794.

## SOFTWARE/GEOLOGICAL

### GEOLOGICAL CATALOG

Geological software for logplotting, gridding/contouring, hydrology, digitizing, 3-D solid modelling, synthetic seismogram, fracture analysis, image processing, scout ticket manager, over 50 programs in catalog. Macintosh too! Please call, or write, for Free Catalog!

### RockWare, Inc.

4251 Kipling St., Suite 595, Wheat Ridge, CO 80033 USA  
(303) 423-5645 Fax (303) 423-6171

Inquiry 795.

## SOFTWARE/GRAPHICS

### CHAOS: The Software™

James Gleick's  
Explore Chaos in nature for yourself, in a hands-on, visual way. Autodesk worked with James Gleick to transform some of the most famous equations from the new science of Chaos into a series of six interactive programs that let you create stunning visual patterns in high resolution color and sound. \$59.95

For IBM PC/XT/AT, PS/2 or compatibles with 640KB RAM, MS-DOS/PC-DOS, EGA/VGA

### Autodesk, Inc.

2320 Marinship Way, San Rafael, CA 94965  
1-800-688-2344

Inquiry 795.

# THE BUYER'S MART

## SOFTWARE/GRAPHICS

### QuickGeometry Library

All the C geometry and DXF routines you expect... and more!  
(617) 628-5217

### Building Block Software

PO Box 1373, Somerville, MA 02144

Inquiry 796.

## SOFTWARE/GRAPHICS

### GRAPHIC TOOLS LIBRARY

XGLIB: Very fast. User coordinates. User defined Window & viewports. Circles, ellipses, ovals, sectors, polygons & splines. Thick lines & arcs. Fill & hatch patterns. POLYARC engine. Plots and charts. Text scale, align. Screen print and TSR utility. All drawing and mouse functions work in Super VGA modes. Draw in bitmaps. Modes up to 1024x768x16-256. \$195. Most "C", Pascal, Fortran, MS Basic 4.0-7.1.

### NOVA INC.

2500 W. Higgins Road, #1144 CALL 708-882-4173  
Hoffman Estates, IL 60195 FAX 708-882-4175

Inquiry 802.

## SOFTWARE/SCANNERS

### Optical Character Recognition

PC-OCR\* software will convert typed or printed pages into editable text files for your word processor. Works with HP ScanJet, Canon, Panasonic & most other scanners. Supplied with over 20 popular fonts. User trainable: you can teach PC-OCR\* to read virtually any typestyle, incl. foreign fonts. Proportional text, matrix printer output, Xerox copies OK. From \$99. Check/VISA/MC/AmExp/COD

### Essex Software Publishing, Inc.

P.O. Box 391, Cedar Grove, NJ 07009  
(201) 783-6940

Inquiry 808.

## SOFTWARE/LANGUAGES

### IntegrAda

Standard Air Force PC Ada Compilers & environments for MS-DOS and UNIX. Integrated programming systems include validated Ada compilers, language sensitive editors, complete libraries and other Ada programming tools. FREE demo.

### AETECH, Inc. From \$795

380 Stevens Ave., Sta. 212 Solana Beach, CA 92075  
(619) 755-1277 Fax: (619) 755-7540

Inquiry 803.

## SOFTWARE/SCIENTIFIC

## FREE CATALOG 800-942-MATH

MicroMath Scientific Software  
Salt Lake City, UT 84121-0550

Inquiry 809.

## FRACTAL GRAFICS

is a radical new drawing program for your PC. Create breathtaking images and scientific models interactively with your mouse. Add dramatic effects to any PCX image. On-line tutorial, extensive Guidebook, and 200+ hands-on examples help you use and understand fractals and Chaos. Only \$79, FREE Brochure!

### Cedar Software

R1 Box 5140, Morrisville, VT 05661  
(802) 888-5275

Inquiry 797.

## The Ultimate CAD/CAM Engine

TurboGeometry Library 3.0. The most complete tool box of 2D & 3D routines available today! Over 300 routines. Surfacing, Solids, Hidden line, Volumes, Areas, Transforms, Perspectives, Decomp, Clipping, Tangents & more. 30 day guar., \$199.95 w/source S&H Incl. Foreign \$225.00. MS/PC DOS 2.0+. Turbo Pascal, Turbo C, MSC, MIX C, Zortec C++ VISA/MC, PO, Chk, USA funds only.

### Disk Software, Inc.

2116 E. Arapaho Rd., #487, Richardson, TX 75081  
(214) 423-7288, (800) 635-7760, FAX (214) 423-7288

Inquiry 798.

## FINAL LIQUIDATION!!

IBM \* Compilers, SAVE UP TO 80%!

Title	Retail Sale
COBOL V2.0 (3 1/2" & 5 1/4")	\$900 \$100
Prof. FORTRAN V1.3 (3 1/2" & 5 1/4")	\$795 \$ 90
C Compiler (3 1/2" & 5 1/4")	\$395 \$ 50
BASIC Compiler V2.0 (3 1/2" & 5 1/4")	\$495 \$ 50
Macro Assembler V2.0 (3 1/2" & 5 1/4")	\$195 \$ 40
VISA, MC, Check accepted, S and H fee \$10 per order	

### THE COMPUTER PLACE, INC.

12105 Darnestown Rd. #9A Tel: (301) 330-6016  
Gaithersburg, MD 20878 Fax: (301) 926-3415

Inquiry 804.

## Real-Time Graphics & Measurement/Control Tools

**TurboC, Microsoft C, Turbo Pascal**  
Send for datasheets on our NEW RealTime Graphics and Measurement/Control Tools for Turbo C/C++ , Microsoft C and Turbo Pascal. Process Control Bargraphs Thermocouple Linearization Fast Scrolling Graphs Polynomial Curve fitting RealTime Meters PID Control Annunciator Panels 32,768 point FFT's RealTime Mouse Support 19,2KB RS-232 Communications

### Quinn-Curtis

21 Highland Circle, Needham, MA 02194 USA  
Tel. (617) 449-6155 Fax (617) 449-6109

Inquiry 810.

## RAINDROP™

FAST, compact PrtScr Utility for end users AND developers. Hardcopy as fast as 10 secs. Average binary size - 6 kbyte. 14 video graphic standards. Scale, rotate, colorize and more. CALL from user-written programs. Complete 9- & 24-pin dot-matrix, inkjet, and laserjet library \$44.95+\$3 s/h.

### ECLECTIC SYSTEMS

8106 St. David Ct., Springfield, VA 22153  
(703) 440-0064

Inquiry 799.

## SOFTWARE/MARKETING

The "Software Success Reference Book (1987-1988)" is a MUST READ if you want to market your software products successfully. Written by David H. Bowen, publisher of Software Success™, the monthly newsletter on successfully running a software business, the Reference Book is a 268-page guide, organized by topic. Covers Lead Generation, Promotion, Pricing, Distribution, Support, etc. Only \$25. Check or Credit Card (VISA/MC/AEX).  
100% Money Back Guarantee

### Software Success

PO Box 9006, San Jose, CA 95157  
(408) 446-2504 FAX (408) 255-1098

Inquiry 805.

## SOFTWARE/VOICE

### MULTI-VOICE® TOOLS

MultiVoice Tools is a complete development Toolkit for Pascal or "C" to access all the features for most speech processing boards available today. It helps you write MULTI-LINE VOICE APPLICATION systems in minutes. A number of programming examples are provided. All programs and libraries are delivered with source code. Dialogic, Rhetorex, Pika. \$599. Watson (Single Lin) \$99. ALSO AVAILABLE: FAX Programmer's Toolkit (\$199). Based on CAS specifications. VISA/MC accepted.

### ITI Logiciel

1705 St. Joseph E, Suite 4, Montreal, Can. H2J 1N1  
(800) 567-8765 or (514) 861-5988

Inquiry 810.

## PEN PLOTTER EMULATOR

FPL0T turns your dot matrix or laser printer into an HP pen plotter. Fast hi-res output. No jagged lines. Vary line width, color. Works with Autocad, Drafex, etc. Supports NEC P5/P6, IBM Proprietary, Epson LQ/FX, Toshiba, HP Laserjet, Okidata 29x/39x, Hercules/CGA/EGA/VGA. \$64 check/m.o./VISA/MC

### Fplot Corporation

24-16 Steinway St., Suite 605, Astoria, NY 11103  
718-545-3505

Inquiry 800.

## SOFTWARE/MATHEMATICS

### MATH EDITING FOR THE PC

$$x_j^2 = \sum_{k=0}^{\infty} [x_k^{2j+1} \binom{2j}{k}] + \left( \frac{1}{\sqrt{\alpha \pm \beta x}} \right)$$

- MathEdit constructs math equations to be inserted into WordPerfect, Word, WordStar, and others.
- WYSIWYG interface—no codes need to be learned.
- MathEdit—\$199

### K-TALK COMMUNICATIONS

30 West First Avenue, Suite 100  
Columbus, Ohio 43201  
(614) 294-3535

Inquiry 806.

## STATISTICS

### Statistical Advisor Speaks English!

Statistical Navigator Professional™ lets you describe your research goal in plain english then guides you to the appropriate statistical analysis. Natural language interface, detailed report, extensive hypertext help, & pull-down menus. \$150+\$sh.

VISA, MC, AMEX, PO #, Check.

### The Idea Works, Inc.

607 Jackson St., Columbia, MO 65203  
1-800-537-4866 FAX 1-314-875-5812  
Outside USA: 1-314-875-5827

Inquiry 811.

## GRAPHICS PRINTER SUPPORT

AT LAST! Use the PrtSc key to make quality scaled B&W or color reproductions of your display on any dot matrix, inkjet, or laser printer (incl. Postscript) in up to 64 shades of gray or 256 colors. GRAFPLUS supports all versions of DOS with IBM (incl. EGA, VGA, Super VGA), Hercules, or compatible graphics boards. Linkable/OEM versions available. \$59.95

### Jewell Technologies, Inc.

4740 - 44th Ave. SW, Seattle, WA 98116  
1 (800) 284-2574 (206) 937-1081

Inquiry 801.

## MATHEMATICIANS—ENGINEERS

Have you ever seen functions of a complex variable? Would you like to really understand differential operators like div, grad and curl? How about a peek into the fourth dimension? Call or write for information on our latest PC and Macintosh software.

### Lascaux Graphics

3220 Steuben Ave., Bronx, NY 10467  
(212) 654-7429

Inquiry 807.

## NCSS 5.x Series — \$125

Easy-to-use menus & spread sheet. Multiple regression. T-tests. ANOVA (up to 10 factors, rep. measures, covariance). Forecasting. Factor, cluster, & discriminant analysis. Nonparametrics. Cross Tabulation. Graphics: histograms, box, scatter, etc. Reads ASCII/Lotus. Many new add-on modules.

### NCSS

329 North 1000 East, Kaysville, UT 84037  
Phone: 801-546-0445 Fax: 801-546-3907

Inquiry 812.



# THE BUYER'S MART

## STATISTICS

### SCA STATISTICAL SYSTEM

The *only* statistical software encompassing  
Forecasting & Time Series Analysis  
Quality and Productivity Improvement  
General Statistical Analysis

Available on DOS, OS/2 and Mac operating systems.  
Call today for more information

**Scientific Computing Associates**

4513 Lincoln Ave., Suite 106, Lisle, IL 60532, USA  
Phone: (708) 960-1698 FAX: (708) 960-1815

Inquiry 813.

## UNISTAT

Menu/mouse driven statistical package featuring a fully-fledged spreadsheet, a wide range of statistics and powerful graphics. Version 4.0. First released in 1984. Sold thousands of copies to universities, industry and research. Export/Import Lotus, dBase 3&4, dBase 3, Syk, fixed and free format excel. String data and missing data handling. Full array of 2D and 3D plots, charts and histograms, curve and distribution fitting. More than 40 parametric and nonparametric tests, cross-tabulation, breakdown, OLS, weighted, polynomial and stepwise regressions, balanced/unbalanced ANOVA, ANCOVA, etc. Demo system and 440pp. user's guide available separately

US & Canada: \$395. ADHOC Inc., Dept BT, 28 Brunswick Woods Dr., East Brunswick, NJ 08816. Tel: 201-254-7300. Fax: 201-254-7310  
Elsewhere: £295. UNISTAT Ltd, Dept BT, PO Box 383, Highgate, London N6 5UP, England. Tel: 44-(0)81 883 7155. Fax: 44-(0)81 444 9512

Inquiry 814.

## TRANSLATORS

### 100% PASCAL → C

P2C translates Turbo Pascal 3/4/5 into C code (Turbo, Microsoft, TopSpeed, ANSI) and supports all TP features: sets, nested functions, with, variant records, strings, files, interrupts, const expressions, graphics, units, dynamic memory management, mem & port arrays, absolute variables; in short—everything except inline and object-oriented features. Comes with full TP runtime library emulation and automatically generates project, make, header, and C files. English manual (130+ pages) included. Professional Edition includes complete source code for emulation library.

Standard Ed. \$395 Professional Ed. \$595 (MC, VISA, AMEX)

**LAUER & WALLWITZ GmbH**, Erlkoenigweg 9,  
D-6200 WIESBADEN, West Germany, Phone +49 (611) 42771

Inquiry 815.

## UNINTERRUPTIBLE POWER

### PROTECT YOUR COMPUTER! BATTERY BACK UPS

MICRO UPS provides standby emergency power and voltage irregularity protection! When irregularities occur, UPS kicks in immediately with the necessary power insuring continuous operation.

200 Watt #29033 \$149.00

400 Watt #29034 \$199.00

FREE CATALOG \$5.00S/H

With your order, Call 1-800-776-3700 or send order to:

**AMERICAN DESIGN COMPONENTS**

Dept. 211-011 815 Fairview Ave., P.O. Box 220, Fairview, NJ 07022

Inquiry 816.

## HOW TO PROTECT YOUR COMPUTER

### And Make It Last Longer

FREE money-saving literature tells you how to protect your computer and make it last longer with an uninterruptible power supply. 500VA through 18KVA models from the world's largest manufacturer of single-phase UPS.

### Best Power Technology, Inc.

P.O. Box 280, Necedah, WI 54646

Toll-Free (800) 356-5794, Ext. 1819

Telephone: (608) 565-7200, Ext. 1819

Inquiry 817.

## YOUR SALES MESSAGE

about the special computer product or service that you provide belongs in print.

### THE BUYER'S MART

can help you reach computer professionals and produce valuable inquiries for your company!  
Call Brian Higgins for more information

**603-924-3754**

or

**Fax: 603-924-2683**

Inquiry 818.

## UTILITIES

### COMPRESSION, ENCRYPTION

Compress and (or) Encrypt both text and binary files. Files encrypted by passwords (0-10 characters). Easy to use, fast algorithms. Comes with manual & 1 month guarantee. DOS. \$25 + \$3 handling. Write check addressed to: Dr. Yu

**Ah Shui Neurocomputing Inc.**

5131 Sundance Drive, San Bernardino, CA 92407

(714) 887-2074

Inquiry 819.

### COPY AT TO PC—BRIDGE-IT 3.5

"COPYAT2PC" RELIABLY writes 360KB floppies on 1.2 MB drives, saving a slot for a second hard disk or tape back-up. Only \$78.00 + SH  
"BRIDGE-IT 3.5" is a DEVICE DRIVER supporting 3 1/2" 720KB/1.44MB drives for PC/XT/AT without upgrading DOS/BIOS. Only \$39.00 + SH

BRIDGE-IT 3.5 BUNDLED WITH INTERNAL 14MB DRIVE AT \$129.00 + SH

VISA/MC/COD UPS B/R

### MICROBRIDGE COMPUTERS

655 Sky Way Suite 220, San Carlos, CA 94070

1-415-593-8777(CA) 1-415-593-7675 (FAX)

1-416-855-1993 (CANADA) 1-800-523-8777

0908-260-188 (UK) 04745/1689 (FRG)

Inquiry 820.

### DOS-SHELL GENERATOR

Create customized, "Point-and-click" menus that hide in less than 9K. The Mi-Shell package includes editor and debugger for the Forth-like script language and three ready-to-run sample configuration files.

TO ORDER  
Mi-Shell  
CALL **800-542-0938**

OPENetwork, 215 Berkeley Place, Brooklyn, NY 11217

VOICE: 718-398-3838 BBS: 718-638-2239

Inquiry 821.

### Recover deleted files fast!

Disk Explorer now includes automatic file recovery. You type in the deleted file's name. Disk Explorer finds and restores it. Disk Explorer also shows what's really on disk; view, change or create formats, change a file's status, change data in any sector. MS-DOS \$75 U.S. Check/ Credit card welcome.

### QUAID SOFTWARE LIMITED

45 Charles St. E. 3rd Fl.

Toronto, Ontario, Canada M4Y 1S2

(416) 961-8243

Inquiry 822.

## COPYWRITE

CopyWrite

Removes

Copy Protection

No more diskettes,

manuals or

codewheels.

1000's of products copied.

**US \$75**

### QUAID SOFTWARE LIMITED

45 Charles St. E. 3rd Fl, Dept B.

Toronto, Ontario, Canada M4Y 1S2

(416) 961-8243 Fax (416) 961-6448

Inquiry 822.

### REMOVE HARDWARE LOCKS

Software utility allows for the removal of hardware locks. Don't wait for your lock or key device to fail or to stolen.

Guaranteed to work! The following packages are available:

PCAD \$199.00 CADKEY \$ 99.00

MICROSTATION \$99.00 PERSONAL DESIGNER \$199.00

MasterCAM \$250.00 SmartCAM \$250.00

TANGO PCB \$ 99.00 CADVANCE \$99.00

PLUS SHIPPING AND HANDLING

PHONE (204) 669-4639 FAX (204) 668-3566

VISA and MASTERCARD Welcome

### SafeSoft Systems Inc.

191 Kirtystone Way, Winnipeg, MB, Canada, R2G 3B6

Inquiry 822.

## UTILITIES

### Why You Want BATCOM!

BATCOM is a batch file compiler that transforms your .bat files to .exe files to make them faster. BATCOM extends DOS with many new commands so you can read keyboard input, use subroutines, and much more. In addition, BATCOM protects your source code. No royalties! Only \$59.95. Order today!

**Wenham Software Company**

5 Burley St., Wenham, MA 01984

(508) 774-7036

Inquiry 823.

## VOICE MAIL/AUTO ATTENDANT

### Complete PC CAM™ Users!

Upgrade to a Multiple-line Voice Express®!  
This system picks up where the CAM leaves off  
with these added features:

- All lines share the same files
- Supervised call transfer options
- Free structuring capabilities
- System messages re-recordable
- Selectable recording quality
- Automatic time-based changes
- Order entry & survey capabilities
- Expandable

To order, hear demo, or to request more information:

Call (614) 870-3838

**Versicom Communications®**

1115 Wimbeldon Blvd., Columbus, OH 43228

Inquiry 824.

## WINDOWS TOOLS

### Hermes DDE Library

The Hermes DDE Library is a powerful library of high level routines for MS-Windows™ programmers. Hermes provides support for DDE at a much higher level than that provided in the Windows SDK. Your program attains added functionality by interacting and communicating with other Windows applications. Compared to the Windows SDK, Hermes reduces the code required to implement DDE by hundreds of lines of 'C'. Hermes is priced at \$295.

### Raindrop Software Corporation

845 E. Arapaho, Suite 105, Richardson, Texas 75081

(214) 234-2611 Fax (214) 234-2674

See our ad on page 312.

Inquiry 825.

## WORD PROCESSING

### FARSI / GREEK / ARABIC / RUSSIAN

Hebrew, all European, Scandinavian, plus either Hindi, Punjabi, Bengali, Gujarati, Tamil, Thai, Korean, Viet, or IPA. Full-featured multi-language word processor supports on-screen foreign characters and NLC printing with no hardware modifications. Includes Font Editor. \$355 dot matrix; \$150 add'l for laser; \$19 demo. S/H in U.S. incl'd. Req. PC, 640K, graphics. 30-day Guarantee. MC/VISA/AMEX

### GAMMA PRODUCTIONS, INC.

710 Wilshire Blvd., Suite 609, Santa Monica, CA 90401

213/394-8622 Tlx: 5106008273 Gamma Pro SNM

Inquiry 826.

## MULTI-WRITER™

MULTI-LINGUAL Word processor, 30+ languages! English, Eastern & Western European, Russian, Hebrew, Arabic, etc. No hardware modifications necessary! Font editor allows design & print out of custom-made characters. Customize keyboard layouts. Edits from right to left. Mail merge. Supports 9 & 24 pin printers & Laser Jet II. Req: IBM/PC/XT/AT/256K. Only \$200-\$12 s/h. Demo \$10 \$4 s/h. Visa/MC/Eurocheques

### Summit Software Ltd.

PO Box 2265, Jerusalem, Israel 91022

Tel: 972-2-241003 Fax: 972-2-259239

Inquiry 827.

## YOUR SALES MESSAGE

about the special computer product or service that you provide belongs in print.

### THE BUYER'S MART

can help you reach computer professionals and produce valuable inquiries for your company!  
Call Brian Higgins for more information

**603-924-3754**

or

**Fax: 603-924-2683**

Inquiry 827.



**AutoCAD® Users**



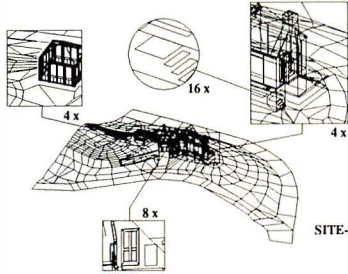
**YOU NEED THIS UTILITY!!!  
FastBreak™**

**FastBreak™** - Cookie-cut, hatch, 'break' and/or 'trim' thousands of AutoCAD® entities: 3DFACES, 3DPOLYLINES, 3DLINES, SOLIDS, TRACES, ARCS, CIRCLES, LINES, POLYLINES, exploded SURFACES, MESHES, and 3D-CONSTRUCTION... and ALL within seconds in a single 'window' or 'crossing' point and pick.

**YES! YES! YES!** - 3DFACES, SOLIDS, TRACES, surfaces, splines, 3D-meshes, and any 2D or 3D-construction can be broken and/or trimmed using FastBreak™!!!

AutoCAD® will not break or trim 3DFACES and other 3D-construction.

**FastBreak™** can do the job - quickly, accurately, and reliably in any UCS. The drawing shown is SITE-3D.DWG with four enlarged insert clips added. All four inserts were made on a 386-PC using FastBreak in less than two minutes!!!



**ClipView™** - is integrated into FastBreak and performs Automatic clipping or trimming of the above entities to create inserts. Options include: Box or Bubble boundaries, Inside or Outside (makes a hole) trim, and borders.

**FastBreak™** and **ClipView™** are integrated into DOS executable code, run interactively in AutoCAD shells from 256K, use fast block binary database, virtual memory paging, user friendly AutoLISP® interface, and perform FAST, FAST, FAST in any AutoCAD Rel. 9 through Rel 10-386.

**FastBreak™** and **ClipView™** are licensed in a single user package. Contact your dealer or buy direct (credit or money order, for UPS Next Day add \$6. shpg. fee) from:

**BZ Technical**  
P.O.Box 10, Bothell, WA 98041  
Phone: 206/258-1568 or FAX: 206/487-1357  
Retail price: \$399.<sup>95</sup> Demo: \$25.<sup>00</sup>

NOT Copy protected, NOT AutoLISP® encrypted, FULL documentation, technical support, 3.5" and 5.25" media.

"Quality software development located near the home of MICROSOFT® in Bothell's High Technology Corridor."

AutoCAD and AutoLISP are registered trademarks of Autodesk, Inc. FastBreak and ClipView are trademarks of BZ Technical.

# Santa got his wish...

## Caller ID+Plus!

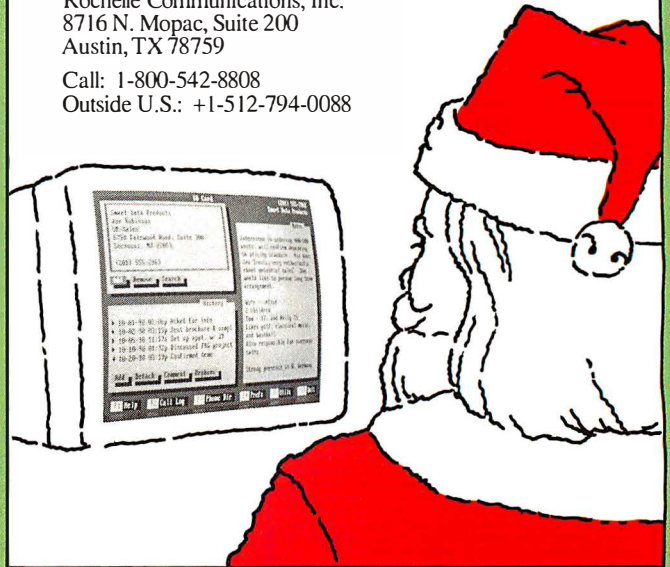
*The Complete Caller Identification and Contact Management System*

Because your business needs to be well organized but retain a personal touch, you need Caller ID+Plus. Know who is calling before you answer. Instantly display caller records. Record notes on each contact. Memory resident. Import/export data.

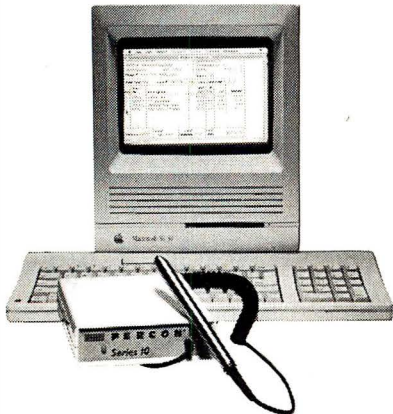
**For more information contact:**

Rochelle Communications, Inc.  
8716 N. Mopac, Suite 200  
Austin, TX 78759

Call: 1-800-542-8808  
Outside U.S.: +1-512-794-0088



# Only your imagination limits how you benefit from PERCON® keyless data collection.



Checking out books or checking in employees—input data quickly and accurately using bar codes or magnetic stripes. PERCON has proven bar code solutions for IBM®, DEC™, and Apple Macintosh®. Call 1-800-8-PERCON.

## PERCON

1710 Willow Creek Circle, Eugene, OR 97402-9153  
(503)344-1189 FAX(503)344-1399

©1989 Percon, Inc. PERCON, IBM, DEC and Apple Macintosh are trademarks.

# VOICE MASTER KEY® SYSTEM II

VOICE RECOGNITION & SPEECH RESPONSE  
FOR IBM PC/XT/AT/386, PS/2, LAPTOPS, COMPATIBLES



FOR PRODUCTIVITY, PRESENTATIONS, SOFTWARE DESIGN, ENTERTAINMENT, LANGUAGE TRAINING, EDUCATION, MORE...

**SPEECH/SOUND RECORDING and PLAYBACK.** Desktop Audio sound editing allows you to create custom sound applications. Variable sample rate (to 20 KHz) and compression levels. A four-voice music synthesizer is included also!

**VOICE RECOGNITION TSR utility** allows you to add voice command keyboard macros to your CAD, desktop publishing, word processing, spread sheet, or entertainment programs. Up to 64 voice commands in RAM at once—more from disk.

**HARDWARE SYSTEM** contains built-in speaker with separate volume and tone controls, external speaker and headphone jacks. Enclosure made of sturdy vinyl-clad steel. Attaches to parallel printer port without affecting normal printer operation (U.S. Patent 4,812,847). Headset microphone, printer cable, 9 volt AC adapter (110 volt UL/CSA listed), and comprehensive user manual included.

**QUALITY THROUGHOUT. MADE IN USA. ONLY \$219.95**

**ORDERHOTLINE:** (503) 342-1271 Mon-Fri, 8 AM to 5 PM PST

Visa/MasterCard, company checks, money orders, CODs (with prior approval) accepted. Personal checks subject to 3 week shipping delay. Specify computer type when ordering. Add \$5 shipping charge for delivery in USA and Canada. Foreign inquiries contact Covox for C&F/CIF quotes. OEM configurations available.

*30 DAY MONEY BACK GUARANTEE IF NOT COMPLETELY SATISFIED.*

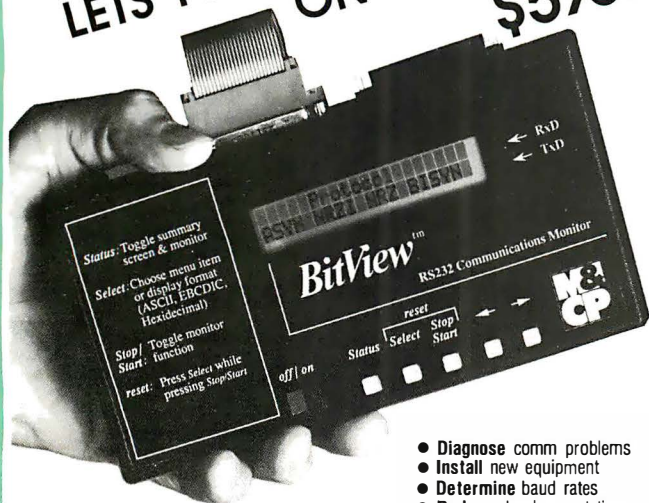
**CALL OR WRITE FOR FREE PRODUCT CATALOG**



**COVOX INC.**  
675 Conger Street  
Eugene, Oregon 97402

TEL (503) 342-1271  
FAX (503) 342-1283  
BBS (503) 342-4135

# NEW! RS-232 DATA MONITOR LETS YOU SEE WHAT'S ON THE LINE \$595!



- Diagnose comm problems
- Install new equipment
- Determine baud rates
- Reduce development time
- Troubleshoot faster
- RS-422 option available

- SDLC, HDLC, X.25, BISYNC
- Parity & CRC check
- 40 hours on 9v battery
- 8K buffer with printer dump
- 40 hours on 9v battery
- 8K buffer with printer dump
- Hex for async and sync data

BitView shows you bidirectional data in ASCII, EBCDIC, or Hex for async and sync data lines at baud rates from 64 Kbs to 38400 baud. Now find your comm problems in minutes instead of hours!

Call (212)662-6012 or Fax (212)678-6143  
MEASUREMENT & CONTROL PRODUCTS, INC.  
415 Madison Avenue, 22 Fl., New York, NY 10017



# dBASE Data Entry



The TransTerm 5 is a work station data entry/display terminal for on-line shop floor data collection into PC/AT based systems. The unit is one of a family of such terminals which feature LC displays for operator prompting and data entry via a membrane keyboard or an optional barcode wand (Code 39). A multi-terminal polling controller (up to 250 stations) and a dBASE III+ compatible software package are also available. System costs below \$300.00 per station. Call for info.

Options—backlighting for display, RS-422 I/O, 20 Ma current loop I/O, dBASE is a registered trademark of Ashton-Tate, Inc.

## COMPUTERWISE, INC.

302 N. Winchester • Olathe, KS 66062 • 913-829-0600 • Fax 913-829-0810

# UNIX®

## The Best Solution To Office Automation

Today, it's not a question of whether to automate your office, but rather how to do it. Smart small businesses rely on the proven capabilities of Unix single and multiuser systems. Unix combines multitasking, communication, and networking with mainframe power. Let **Archer Business Products, Inc.** put the power of Unix to work for you. We sell and support the following UNIX® / XENIX® products:

- Operating Systems
- Spreadsheets
- Database Management Systems
- Word Processors
- Office Automation

Call now to place an order or receive a free catalog:

**1-800-288-8996**

FAX: (918) 582-4823

8am-5pm Central, Monday thru Friday

## ARCHER BUSINESS PRODUCTS, INC.

427 South Boston Avenue, Suite 614  
Tulsa, Oklahoma 74103

UNIX is a registered trademark of AT&T.  
XENIX is a registered trademark of MICROSOFT CORP.

# LAST•BAT™

## The Only Lifetime Setup Battery System for PC/AT and Compatible Computers

**\$49<sup>95</sup>** +\$5.00 SHIPPING

- Permanent
- Easy to Install
- Replaces IBM part #8286121
- For IBM PC/AT, Compaq 286, 386 and all AT Compatibles
- Made in the U.S.A.



### LIFETIME WARRANTY

ACCUMATION, Inc. will replace a malfunctioning LAST•BAT for as long as the original purchaser uses it in the machine in which the LAST•BAT was originally installed, providing, of course, that the LAST•BAT is installed and used correctly.

## ACCUMATION™

ACCUMATION, INC.

8817 SOUTHWEST 129 TERRACE • MIAMI, FLORIDA 33176

**305-238-1034**



LAST•BAT and ACCUMATION are trademarks of Accumation, Inc. IBM is a registered trademark of International Business Machines Corporation. Compaq 286 & 386 are registered trademarks of the Compaq Corporation.

© Copyright Accumation, Inc. 1988.



## Spectacular Performance. Now Playing On 9-Track Tape.

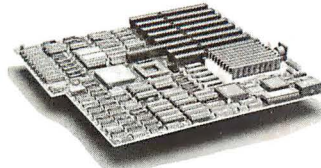
If you're looking to connect 9-track tape to your PC, Overland Data offers an all-star cast of complete subsystems. They are equally at home playing for all IBM PC compatibles or PS/2's, under DOS, UNIX, XENIX, PICK & NOVELL, 800 to 6250 bpi. They perform EBCDIC-ASCII conversions and backup brilliantly. And the supporting cast can't be beat. **Two year warranty on controllers, one year on tape drives.** Expert help by phone. 30 day, money back application guarantee. And ten years experience as founder and leader of the industry. All of which means spectacular performance play after play. To reserve your seat, call us at:

**1-800-PC9-TRAK**

**OVERLAND DATA**  
San Diego, CA

1-800-729-8725 • 1-619-571-5555 • FAX 1-619-571-0982 • TELEX 754923 OVERLAND

## THE FASTEST 80486 & 80386 15 Mips, FASTER THAN EVEREX STEP & ALR



### FEATURE

- 64/256K Write Back Cache
- Transparent Refresh/Weitek
- 32 Bit Memory Expand To 16MB
- UNIX, OS/2 & NOVELL Compatible
- 1 Yr Full Warranty
- Complete Documentation

### SYSTEM BOARD

MODEL	CACHE	MIPS	0K	4M
486/33	64K	15.0	2695	2895
486/25	64K	11.4	2159	2359
386/33	64K	8.3	989	1189
386/25	64K	6.2	889	1089

\*256K Cache Available

Complete Desktop System With  
1.2 MB Floppy, HD/Floppy Controller,  
101 Keybrd And 4MB Memory

MODEL	BASE	MONO	VGA
486/33	3195	3345	3595
486/25	2659	2809	3059
386/33	1489	1639	1889
386/25	1389	1539	1789

\* Tower Add \$200 & Hard Disk Available

### SUPER TOWER



\$335  
Qty. 5

- 5 Half Ht. Drive Bay
- 2 Full Ht. Drive Bay
- 250 Watt UL/Power Supply
- Dual Fans
- Double Security Lock
- Wheels / Caster
- Front Display Panel
- Excellence For UNIX & NOVELL Server
- UPS Optional

### MONITOR

VGA	315.00
MULTISCAN	415.00
SUPER VGA	345.00

### UNIVERSAL 3 1/2 - 5 1/4 KIT

FLOPPY	5.00
HARD DISK	5.00

### INTEL MATH-CO

80387-20	345.00
80387-25	435.00
80387-33	540.00

### DRAM

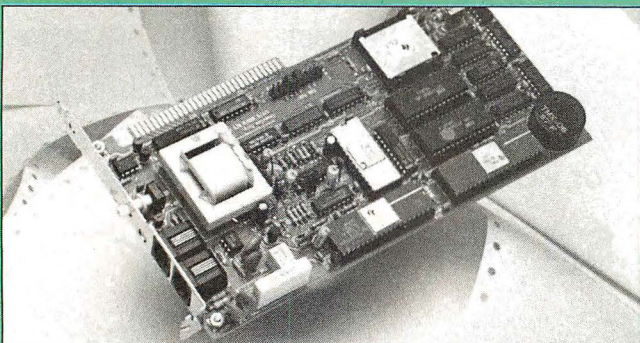
4M x 9 - 80	300.00
1M x 9 - 80	69.00
1M x 9 - 70	79.00

### HARD DISK

MAXTOR 4170E 150MB	899.00
MAXTOR 4380E 330MB	1349.00
MAXTOR 8760E 65MB	1994.00

**TP ENTERPRISE INC.**

47273 Fremont Blvd., Fremont, CA 94539  
Tel: 415-623-3818 Fax: 415-623-3840

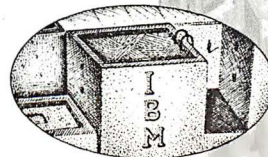


**COMPUcom**

## 9,600-38,400 bps MODEM+FAX...\$279

NOW you can afford a **SPEEDMODEM™**. Raw speed of 300 - 9600 bps and 4:1 data compression push throughput up to 38,400 bps. Dynamic Impedance Stabilization™ provides robust performance on noisy telephone circuits. A 9600 bps send/receive, full-featured FAX is included on the same card. Total communications capability—only \$279. It comes with a 30-day money back guarantee and a 5-year warranty. **BYTE** magazine said our 2400 bps modem was "a real deal"..."well we've done it again... our **COMBO™** is setting a new standard for value and performance. See for yourself... \*3/89p.102

(408)732-4500 **CALL NOW 800 ACT ON IT** (800)228-6648



**2,168  
IBM PROGRAMS  
FREE.**

■ Here in the BIX community, you can download your choice of 2,168 programs developed for IBM PCs and their compatibles. You can attend dozens of informative and provocative conferences, too. All this and more is yours in the *IBM Exchange*, with your subscription to BIX. Call our special Customer Service number for more information: 1-800-227-2983 (in NH, call 603-924-7681).

**BIX**

# EXPLORE UNIXWORLD... RISK FREE!

**YES!** Start my one-year (12 issue) subscription for only \$18.00, that's 50% off the newstand price.

NAME: (PLEASE PRINT) \_\_\_\_\_ TITLE: \_\_\_\_\_

COMPANY NAME: \_\_\_\_\_

ADDRESS: \_\_\_\_\_  HOME  OFFICE

CITY: \_\_\_\_\_ STATE: \_\_\_\_\_ ZIP: \_\_\_\_\_

BILL ME AT \$18.00\*  PAYMENT ENCLOSED. PLEASE CHARGE MY:  VISA  MASTERCARD  AmEx

CARD #: \_\_\_\_\_ EXP. DATE: \_\_\_\_\_ SIGNATURE: \_\_\_\_\_

\*U.S.A. ONLY. Canadian: 1 yr. \$24. Other Foreign: 1 yr. \$38. All Foreign orders must be prepaid in U.S. Funds.

**Please complete all questions to qualify for the rates shown above. Subscriptions at the above rates are limited to persons with active professional, functional, and managerial responsibilities in UNIX or XENIX Computing. Other subscriptions: \$36 a year in U.S., Canada: \$48, Other Foreign: \$76.**

CIRCLE ONE ONLY

**My Company's Primary Business**

- a. Mfg. of Comp./Comp. Equip.
- b. Mfg. (except Comp./Comp. Equip.)
- c. Systems Integrator/House
- d. Software Developer
- e. VAR, Dealer or Distributor
- f. Communications/Telephone
- g. Transportation/Utilities
- h. Mining or Construction
- i. Fin./Ins./Real Estate
- j. Whlse. or Retail Trade
- k. Consulting
- l. Government or Military
- m. School or University
- n. Other: \_\_\_\_\_
- o. Medical/Dental/Legal
- p. Research/Development

CIRCLE ONE ONLY

**My Primary Job Function**

- a. Corp. or Fin. Mgmt.
- b. MIS/DP Mgmt.
- c. Office Mgmt./Admin.
- d. Telecommunications
- e. Systems Integration
- f. Design or Dev. Eng.
- g. Prog./Software Dev.
- h. Research/Analysis
- i. Marketing or Sales
- j. Purchasing
- k. Mfg./Production
- l. Distribution
- m. Education/Teaching
- n. Consulting
- o. Gov./Public Admin.
- p. Other: \_\_\_\_\_
- q. Technical Staff/  
Engineering Support

CIRCLE ONE ONLY

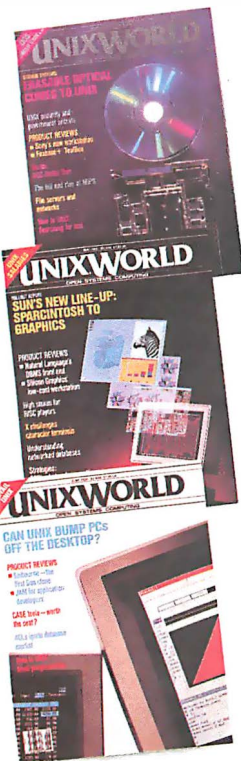
**The Number of Employees At All Locations Of My Company**

- a. Under 10
- b. 10-49
- c. 50-249
- d. 250-999
- e. 1,000-4,999
- f. 5,000 or more

CIRCLE ALL THAT APPLY  
**I Purchase/Influence The Purchase Of The Following:**

- a. Mainframe Computers
- b. Minis/Superminis
- c. Micros/Supermicros
- d. Workstations
- e. Board Level Products
- f. Terminals
- g. Printers
- h. Disk Drives
- i. Tape Drives
- j. Modems/Multiplexors
- k. LAN Equipment
- l. Software

EA1B5



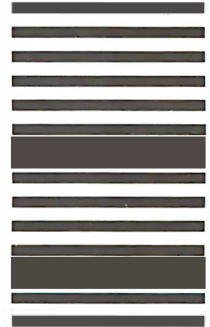
## SAVE 50%

**Your No-Risk Guarantee:** I may cancel at any time and receive a refund for the balance of my subscription. Please allow 6-8 weeks for processing.

\*TM of AT&T. UnixWorld is not affiliated with AT&T.



NO POSTAGE  
NECESSARY  
IF MAILED  
IN THE  
UNITED STATES



**BUSINESS REPLY MAIL**  
FIRST CLASS MAIL PERMIT #42 HIGHTSTOWN, NJ

POSTAGE WILL PAID BY ADDRESSEE

# UNIXWORLD

SUBSCRIPTION SERVICES  
P.O. BOX 570  
HIGHTSTOWN, NJ 08520-9328



# Up to date. Down to earth.

**Changing the world.** UNIX is changing the world of computers, the world of business—quite simply, changing the world. It's revolutionizing office automation. It's required for U.S. government computer contracts. It's the backbone of information strategies worldwide.

**The information you need.** That's why you need *UNIXWORLD*—the magazine that keeps you up to date on the rapidly changing world of open systems computing. Each issue brings you the latest product trends and technical advances that can affect your business. The inside story on some of the world's

biggest high-tech companies. Easy-to-understand programming tips and tutorials that can help you and your company use UNIX to its fullest. And unbiased hardware and software reviews to help you invest wisely when you buy.

**The whole UNIX-verse.**

*UNIXWORLD*'s in-depth features go beyond dry technical facts, to show how the pieces fit together—to tell you what's important about the advances and the strategies that are changing your world. And *UNIXWORLD* consistently offers the freshest, most down-to-earth writing you'll find in any computer publication.

**Subscribe and Save.** Subscribe today, and receive the next 12 issues of *UNIXWORLD* for just half the regular newsstand price. Save even more by ordering for two or three years. You can't lose—every subscription to *UNIXWORLD* comes with a no-risk guarantee.\*

1 year \$18.00 (save 50%)  
2 years \$32.00 (save 55%)  
3 years \$42.00 (save 60%)

**Subscribe now! Call toll-free:**

**1-800-341-1522**

**UNIXWORLD**

**If you're into UNIX, you need *UNIXWORLD* MAGAZINE.**

UNIX® is a registered trademark of AT&T. UNIX WORLD is not affiliated with AT&T.  
\*UNIXWORLD's no-risk guarantee: If not satisfied, cancel and receive a full refund for the balance of your subscription.  
A McGraw-Hill publication

# MEMORY UPGRADES Circle 111 on Reader Service Card (RESELLERS: 112)



**WE ACCEPT INTERNATIONAL ORDERS**  
 3 day International delivery available via Federal Express or DHL!  
**CALL (714) 588-9866** OR FAX **FAX (714) 588-9872**  
24-HOURS-A-DAY



TOLL FREE FROM ANYWHERE IN THE U.S. OR CANADA

**ORDER NOW 1-800-535-5892**

## LAPTOP MEMORY

### TOSHIBA

Model 1000SE/XE	1MB	\$269.00
	2MB	\$375.00
Model T1200XE	2MB	\$225.00
Model T1600	2MB	\$225.00
Model T3100E	2MB	\$225.00
Model T3100SX	2MB	\$225.00
	4MB	\$549.00
Model T3200SX	2MB	\$225.00
	4MB	\$549.00
Model T3200	3MB	\$319.00
Model T5100	2MB	\$225.00
Model T5200,T8500	2MB	\$225.00
	8MB	\$1299.00

### COMPAQ

Portable LTE 286	1MB	\$149.00
	2MB	\$249.00
SLT-286	1MB	\$219.00
	4MB	\$875.00
SLT-386	1MB	\$225.00
	2MB	\$395.00

### ZENITH

SuperSport 286 and 286e	1MB	\$189.00
	2MB	\$325.00
SuperSport SX and 286e	2MB A or B	\$325.00
TurboSport 386e	1MB	\$259.00

### NEC

ProSpeed 286 and 386SX/16	1MB	\$289.00
	4MB	\$749.00
ProSpeed 386	2MB	\$489.00
	8MB	\$1659.00

## IBM MEMORY

Model PS/1	512K	1057035	\$89.00
	2MB	IBM PN N/A	\$399.00
Models 30-286, Exp. Board 1497259	512K Kit	30F5348	\$45.00
	2MB Kit	30F5360	\$139.00
Models 70-E61/121,55SX,65SX	1MB	6450603	\$79.00
Models 70-E61/121,50Z,55SX,65SX	2MB	6450604	\$149.00
Models 55SX, 65SX, 34F3077 & 34F3011	4MB	34F2933	\$409.00
Model 70-A21	2MB	6450608	\$159.00
Models 80-A21/A31	4MB	6451060	\$549.00
All Models 70 and 80	2-8MB w/2M	6450605	\$499.00
	2-14MB w/2M	34F3077	\$539.00
Models 50, 55Z, 60 & 65SX	2-16MB w/2M	6450609	\$589.00

## LASER PRINTER MEMORY

Hewlett-Packard LaserJet IIP, III & IIID	1MB	334748	\$99.00
	2MB	334758	\$169.00
	4MB	33477B	\$299.00
Hewlett-Packard LaserJet II & IID	1MB	33443B	\$99.00
	2MB	33444B	\$169.00
	4MB	33445B	\$299.00
Panasonic4450I and 4420	1MB	KX-P443	\$179.00
	2MB	KX-P441	\$239.00
IBM Laser 4019 and 4019e	1MB	1039136	\$179.00
	2MB	1039137	\$239.00
	3.5MB	1038675	\$329.00
Canon LBP-8II, 8IIR, 8IIT	2MB	S63-1880	\$169.00

## COMPAQ MEMORY

DeskPro 286-E,386-20/20E/25	1MB	113131-001	\$139.00
	4MB	113132-001	\$339.00
DeskPro 386S/16	1MB	113646-001	\$139.00
	4MB	112534-001	\$349.00
DeskPro 286N, 386N and 386SX and 20	1MB	118688-001	\$89.00
	2MB	118689-001	\$169.00
	4MB	118690-001	\$449.00
DeskPro 386-33, 486-33 & SystemPro	2MB	115144-001	\$179.00
	8MB	116561-001	\$1199.00

## AST MEMORY

Premium 386C and 386-16	1MB Kit	500510-007	\$95.00
	4MB Kit	500510-008	\$349.00
Premium 386-20	1MB Kit	500510-003	\$129.00
	4MB Kit	500510-004	\$369.00
Premium 386-SX/16/25/33 and Cupid card	1MB	500718-002	\$95.00
Premium 486	2MB	500718-004	\$342.00
Premium II 386SX/20 and 386SX/16	1MB	500780-003	\$109.00
	4MB	500780-004	\$589.00

## HEWLETT-PACKARD MEMORY

Vectra QS/20PC, RS/25PC and 20C	1MB Kit	D1640A	\$89.00
	4MB Kit	D1642A	\$295.00
Vectra 486 PC and 386/25 PC	1MB Kit	D2150A	\$89.00
	4MB Kit	D2151A	\$449.00
	8MB Kit	D2152A	\$895.00
Vectra 386/25 PC	2MB Kit	D2381A	\$169.00

## BRAND NEW!

For IBM PS/2 Models 90 & 95	2MB	\$249.00
	4MB	\$589.00
For IBM RISC/6000 320, 530 and 550	16MB	\$CALL
	32MB	\$CALL
For SHARP NOTEBOOK 6220	1MB	\$249.00
For NEC TurboSport 386E	1MB	\$259.00
	4MB	\$589.00

This is only a sample of the hundreds of products in stock today at F.S.I.!

## SIMMS DRAM

IBM TYPE	1MX1
4Mx9-80	\$299.00
1Mx9-12	\$54.00
1Mx9-10	\$56.00
1Mx9-80	\$58.00
1Mx9-70	\$60.00
256x9-12	\$16.00
256x9-10	\$17.00
256x9-80	\$18.00
256x9-60	\$20.00
1MX1-10	\$5.50
1MX1-80	\$6.00
1MX1-70	\$6.50
256KX1	
256KX1-12	\$1.80
256KX1-10	\$1.90
256KX1-80	\$2.00
256KX1-70	\$2.50

PLEASE SEND ALL P.O.'S AND MAIL ORDERS TO:  
**First Source International, Inc.**  
 36 Argonaut, Suite 140  
 Aliso Viejo, California 92656

## TERMS AND CONDITIONS

- ✓ NO SURCHARGE ON MC OR VISA
- ✓ Terms: AmEx (+4%), Visa, MasterCard, COD, Net 30 on purchase orders from qualified firms.
- ✓ 20% Restocking fee on all non-defective returns & refused orders. RMA # required
- ✓ Manufacturers part numbers are for your convenience, all products third party, 100% compatible or full refund!
- ✓ Prices and Availability subject to change.

**100% COMPATIBLE OR YOUR MONEY BACK!**

# UNICORN - YOUR I.C. SOURCE!

## COLLIMATOR PEN (INFRA-RED)



- Output: 2.5 mW (max.)
- Current: 90-150 mA
- Operating Voltage: 2.2-2.5V
- Wavelength: 820nm
- Collimation: .18mrad (typ.)
- Size: 11mm diameter

STOCK # **SB1052** PRICE **\$39.99**

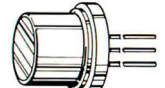
## LASER DIODE (INFRA-RED)



- Output: 10 mW (max.)
- Current: 90-150 mA
- Operating Voltage: 2.2-2.5V
- Wavelength: 820nm

STOCK # **SB1053** PRICE **\$9.99**

## LASER DIODE (VISIBLE-RED)



- Output: 5 mW (max.)
- Current: 65-100 mA
- Operating Voltage: 1.75-2.2V
- Wavelength: 780nm

STOCK # **LS022** PRICE **\$19.99**

## LASER DIODE (VISIBLE-RED)



- Output: 4 mW (max.)
- Current: 20 mA
- Operating Voltage: 2.2-3.0V
- Wavelength: 665nm

STOCK # **LS3200** PRICE **\$129.99**

## POWER SUPPLY



- Input: 115/230v
- Size 7" L x 5 1/4" W x 2 1/2 H
- Output: +5 volts @ 3.75 amps
- Output: +12 volts @ 1.5 amps
- Output: -12 volts @ .4 amps

STOCK # **PS1003** PRICE **\$19.99**

## EPROMS

STOCK #	PINS	DESCRIPTION	1-24	25-99	100+
1702	24	256 x 4 1us	3.99	3.79	3.41
2708	24	1024 x 8 45ns	6.49	6.17	5.55
2716	24	2048 x 8 450ns (25v)	3.29	3.13	2.82
2716-1	24	2048 x 8 350ns (25v)	3.79	3.60	3.24
TMS2716	24	2048 x 8 450ns	6.29	5.98	5.38
27C16	24	2048 x 8 450ns (25v-CMOS)	3.99	3.79	3.41
2732	24	4096 x 8 450ns (25v)	3.79	3.60	3.24
2732A-2	24	4096 x 8 200ns (21v)	3.79	3.60	3.24
2732A	24	4096 x 8 250ns (21v)	3.69	3.51	3.16
2732A-4	24	4096 x 8 450ns (21v)	3.19	3.03	2.73
TMS2532	24	4096 x 8 450ns (25v)	5.79	5.50	4.95
TMS2532P	24	4096 x 8 450ns (25v-One Time Programmable)	1.99	1.89	1.70
27C32	24	4096 x 8 450ns (25v-CMOS)	4.19	3.98	3.58
2764-20	28	8192 x 8 200ns (12.5v)	3.99	3.79	3.41
2764	28	8192 x 8 250ns (21v)	3.79	3.60	3.24
2764A-20	28	8192 x 8 200ns (12.5v)	3.99	3.79	3.41
2764A	28	8192 x 8 250ns (12.5v)	3.29	3.13	2.82
TMS2564	28	8192 x 8 250ns (25v)	6.79	6.45	5.81
27C64	28	8192 x 8 250ns (21v-CMOS)	4.19	3.98	3.58
27128-20	28	16,384 x 8 200ns (21v)	5.79	5.50	4.95
27128	28	16,384 x 8 250ns (21v)	5.09	4.84	4.35
27128A	28	16,384 x 8 250ns (21v)	5.79	5.50	4.95
27C128	28	16,384 x 8 250ns (21v)	5.79	5.50	4.95
27256-20	28	32,728 x 8 200ns (12.5v)	5.29	5.03	4.53
27256	28	32,768 x 8 250ns (12.5v)	4.79	4.55	4.09
27C256	28	32,768 x 8 250ns (12.5v)	5.29	5.03	4.53
27512-20	28	65,536 x 8 200ns (12.5v)	7.49	7.12	6.41
27512	28	65,536 x 8 250ns (12.5v)	6.99	6.64	5.98
27C512	28	65,536 x 8 250ns (12.5v-CMOS)	6.99	6.64	5.98
27C1024	32	131,072 x 8 200ns (12.5v-CMOS)	17.99	17.09	15.38
68764	24	8192 x 8 450ns	13.99	13.29	11.96
68766	24	8192 x 8 450ns	14.99	14.24	12.82



ORDER BY PHONE!

10010 Canoga Ave., Unit B-8 • Chatsworth, CA 91311  
 OUTSIDE CALIFORNIA: (800) 824-3432 (Orders Only)  
 IN CALIFORNIA: (818) 341-8833  
 ORDER BY FAX: (818) 998-7975  
 Minimum Order \$15.00



# A-BUS™ NEWS

## New Products

Alpha Products proudly announces two new product lines: **C-Net** serial communications devices, and **Alpha Box** interfaces. These new products are not merely A-Bus accessories, but complete sets of products for all of your interfacing needs.

All the products are used to connect different types of devices to your computer. Our communications devices help you connect devices that have computer interfaces already built in. **C-Net** provides the option of connecting many different RS-232 devices to a single serial port on your computer. We also carry converters to other standards, including RS-422, RS-485 and IEEE-488.

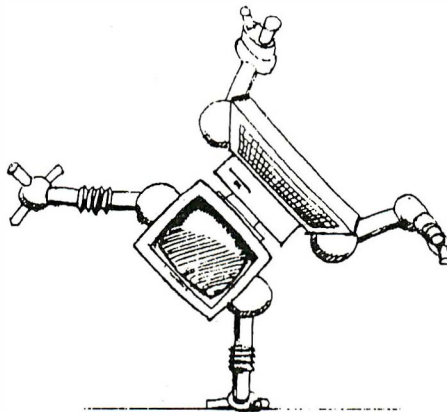
- **C-Net Adapter.** Connects the master control computer to C-Net. \$74
- **Quad C-Net Module.** Connect 4 RS-232 serial devices to C-Net. Each device is configurable (baud rate, parity, etc.) and has 4.8K byte input and output buffers. \$695
- **C-Net Device Module.** Connect any RS-232 Device to C-Net for data collection or communication, with handshaking. \$195

Alpha Boxes and A-Bus cards both provide ways to interface other types of devices to your computer. **Alpha Boxes** sense, measure, switch and govern. They feature:

- Each box is an attractively packaged self contained module that connects directly to the computer and includes power supply.
- The input boxes offer the option of logging data "off-line" and downloading it rapidly to the computer.
- Built-in intelligence provides a simple and consistent interface to your software.

### A Sampling of Alpha Box Products:

- **Digital Input:** 64 TTL/CMOS/0.5V input channels. \$495
- **Digital Output:** 64 TTL/CMOS/0.5V level outputs. \$495. 120VAC control available.
- **Digital I/O:** 32 TTL Level (0.5V) Inputs and 32 Outputs. \$495
- **Analog Input:** 16 channels. 0-5.1V, 20mV steps (8 bit). 2000 readings/sec. \$495. Expansion Option: 16 more channels. \$100
- **12 Bit Analog Input:** 16 channels, programmable gain. 10000 inputs/sec, max. \$995. Option: 16 more inputs. \$200
- **Digital Output:** 4 channel, 12 bit D/A. ±5.1V outputs. \$495. Expander Option: 12 more outputs. \$200
- **Counter:** 16 inputs, 24 bit. \$595



"We can make your PC do things you wouldn't believe."

## C<sup>3</sup> From Your PC

- **Command**
- **Control**
- **Communications**

Bring new dimensions to your computer with A-Bus, C-Net and Alpha Boxes. No longer is your computer limited to number crunching or word processing. Now you can connect to all types of equipment, sensors or machines. This offers unprecedented power from production lines to experiments to home control.

Each product is designed to fit your needs: They're **affordable**. Compare our prices; the cost of a solution is surprisingly low. They're **simple** and easy to connect to your computer and your application, and carefully designed to adapt to your software easily. They're **versatile**. An infinite number of combinations is possible; one of them is right for you. Easily expanded or changed for future projects. They're **proven** by customers around the world, including Fortune 100 companies, universities, governments and individuals.

**Call for a Catalog (800) 221-0916**

### Overseas distributors

**Asia:** Batam DA, Singapore  
Tel: 473-4518 Fax: 479-6496

**Japan:** Japan Crescent  
Tel: 03-824-7449 Fax: 03-818-8914

**Scandinavia:** A/S Con-Trade Norway  
Tel: (04) 41 83 51 Fax: (04) 41 94 72

**Spain:** Arteca S.C.P.  
Tel: (93) 423.77.05 Fax: (93) 325.70.16

## Low Cost Data Acquisition and Control

### A-Bus Sensing & Measuring:

Read switch status. Detect or measure voltage. Read pressure, temperature, weight and other sensors. For example:

- **High-Speed 12-bit A/D converter:** 8 10 $\mu$ s analog inputs. 1 mV resolution \$179
- **8 Bit A/D:** 8 inputs, 0-5.1V in 20mV steps, 7500 conversions/sec. \$142
- **12 Bit A/D:** ±4V in 1mV steps, 130mS conversion time. 1 input, expandable \$153
- **Temperature Sensor:** 0-200°F 1° Accuracy. 10mV/°F. \$12
- **Digital Input:** 8 opto-isolated. Read voltage presence, switch closure. \$65
- **Latched Input:** Each individually latched to catch switch closures or alarm loops. \$85
- **Touch Tone Decoder:** \$87
- **Counter/Timer:** 3 16-bit counters. Generate or count pulses. Time events. \$132
- **Clock with Alarm:** real time clock with calendar and battery backup. \$98

### A-Bus Switching & Governing:

Switch any type of electrical device. Adjust level or position. A sampling:

- **Relay Card:** 8 individually controlled industrial relays. 3A at 120VAC, SPST. \$142
- **Digital Output Driver:** 8 outputs: 250mA at 12V. For relays, solenoids... \$78
- **Reed Relay Card:** 8 individually controlled relays. 20mA @ 60VDC, SPST. \$109
- **Multiplexer:** Switch up to 32 channels to a single common. \$83
- **Smart Stepper Motor Control:** Microprocessor controls 4 motors. English commands for position, speed, units, limits, etc. \$299
- **Telephone Control Card:** On/off hook, generate and decode touch tones, call progress detection. \$159
- **X-10 Controller:** Control and sense standard wall outlet power modules. \$149
- **Voice Synthesizer:** Unlimited vocabulary, text to speech software built in. \$159
- **D/A:** Four 8 Bit Outputs. Adjustable full scale. \$149
- **24 line TTL I/O:** Connect 24 signal, TTL 0/5V levels or switches. (8255A) \$72

### A-Bus Adapters and Software:

Adapters connect A-Bus cards to your particular computer.

- Plug-in adapters for IBM PC/XT/AT/386 and compatibles (\$69), Micro-Channel (\$93), Apple II, Commodore, TRS-80.
- Serial adapters for Mac, PC, etc.
- Odin PC compatible software. Control relays from analog inputs or time schedules. Logging. Runs in background. \$129

# ALPHA Products

242-B West Ave, Darien, CT 06820 USA (203) 656-1806 Fax 203 656 0756

# SuperSound TurboSound

SoundFX-III, -Stereo, -Mono, -Eng, -Jr  
SoundBytes, SoundJr, SoundCard,  
Digital Audio Authoring Workstation,  
MSC/TurboC/Windows 3.0 Libraries,  
Custom Sound Hardware/Software  
**ALL WE DO IS SOUND!!**

**IBM-PC DIGITAL VOICE / SOUND**  
from only \$20 (Player module) to \$640 (Developer's Kit)

Pro Quality Software / Hardware  
- in use worldwide, even Japan!

- 30 Day Money-Back Guarantee if not Satisfied
- JUST LIKE HAVING A CASSETTE TAPE RECORDER IN A PC.
- Fastest, easiest Editors with the most features for the price.
- Quick, simple hardware / software installation.
- Use for Foreign Language training / communications.
- For Business: Training, Slide Shows - with Grasp, ShowPartner FIX ...
- For Engineering: Function Gen, Clear Voice Alarms, Storage Scope...
- For Fun: Create Your Own Sounds For Games, Alter Your Voice...

Orders: 800-969-4411 by Silicon Shack FAX: 408-374-4412

5120 Campbell Ave. # 112, San Jose, CA 95130.

Technical: 408-446-4521

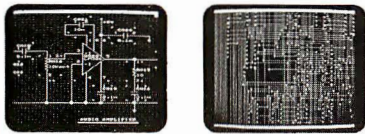
Ask for FREE PRODUCT CATALOG of IBM-PC sound products.

Developers: Add TurboSound - PC audio engine to your product.

\* SuperSound, SoundFX, SoundCard, SoundBytes, and TurboSound are trademarks of Silicon Shack Ltd. Other product names are trademarks of their manufacturers.

Circle 292 on Reader Service Card

## EZ-ROUTE VERSION II



### SCHEMATIC TO PCLAYOUT \$500 INCLUDES AUTO ROUTER

EZ-ROUTE Version II from AMS for IBM PC, PS/2 and Compatibles is an integrated CAE System which supports 256 layers, trace width from 0.001 inch to 0.255 inch, flexible grid, SMD components and outputs on Penplotters as well as Photo plotters and printers.

Schematic Capture \$100, PCB Layout \$250, Auto Router \$250.

**FREE EVALUATION PACKAGE**  
**30 DAYS MONEY BACK GUARANTEE**  
1-800-972-3733 or (305) 975-9515

**ADVANCED MICROCOMPUTER SYSTEMS, INC.**  
1321 N.W. 65 Place - Ft. Lauderdale, FL 33309

Circle 25 on Reader Service Card

the **LOGIC LAB**

the **LOGIC LAB**

is a complete logic development system

\* GAL Device Programmer and Logic Compiler

Software Complete with Sample Devices.

\* Supported Devices Include:

16V8 16Z8

20V8 22V10

20RA10 39V18

18V10 26CV12

\* Allows Prototyping of 42 Different Standard PLD's

\* Accepts All Standard JEDEC Download Files.

\* Software Updatable.

\* 30 Day Money Back Guarantee.

\* Visa and Master Card Accepted \*

CALL FOR FREE DEMO DISK

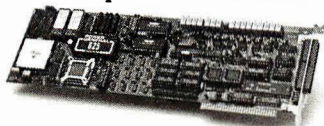
**Programmable Logic Technologies, Inc.**

P.O. Box 1567  
Langmont, CO 80501  
Ph. (303) 772-9059

MADE IN USA  
GAL is a registered trademark of  
Lattice Semiconductor Corporation

Circle 261 on Reader Service Card

## Data Acquisition Processor™



Onboard Intelligence For IBM PC/XT/AT/386

- 16 MHz 80C186 for general processing
- 20 MHz DSP56001 for digital signal processing
- Sustained digital signal processing of 10 MIPS
- FFT and FIR filtering without programming
- Acquires analog and digital inputs to 235K s/s
- Buffers and processes input data as required
- Updates analog or digital outputs to 250K s/s
- Over 100 commands without programming
- Custom commands may be written in C

Call for FREE Demo Diskette

**MICROSTAR**

**LABORATORIES**

(206) 881-4286

2863 152 Ave. N.E.

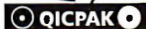
Redmond, WA 98052

FAX (206) 881-5494

Circle 199 on Reader Service Card

## QIC 'n Easy Access to all your Data Everytime

AS/400  
Sys 36/38  
Apollo  
Everex  
Sun  
Sytos  
UNIX



Lotus 123  
DBASE  
Mail Merge  
Secure Data  
Duplication  
XENIX  
UNIX

The QICPAK family provides unique facilities to access 1/4" (QIC) data cartridges created on a wide range of Micros, Minis and Mid-Range Systems using your PC. This gives you a secure, low cost, fast and high capacity alternative.

QICPAK's facilities cover all aspects of cartridge processing, including:

- Extracting data directly from the cartridge into packages such as Lotus 123 or dBASE or for use in Mail Merge applications
- Data files can be extracted by QICPAK from cartridges recorded on many systems, including: IBM System 36/38, IBM AS/400, IBM PC-RT, Apollo, Everex, Maynard, Mountain, Sun, Sytos, UNIX and XENIX systems etc.
- QICPAK's High Speed Cartridge Duplication gives complete in-house control.
- QICPAK's Backup & Restore facilities are UNIX tar compatible
- Custom applications, e.g. recorded information may be protected from unwanted access providing secure interchange of your confidential information.
- Source in Microsoft & Turbo C, Turbo Pascal and BASIC is provided. We provide both QICPAK kits for use with existing 1/4" cartridge drives and also complete internal & external solutions. Support is by the developers.

**VOGON**

VOGON ENTERPRISES LIMITED  
94 Easthampead Road, Wokingham,  
Berkshire RG11 2JD England  
Tel: (44) 734 764511/890042 Fax: (44) 734 890040



Circle 358 on Reader Service Card

## COPROCESSOR SPECIALIST

INTEL		AMD	
8087	5MHZ 78.	AM80C287-10	
8087-2	8MHZ 109.	with manual & disc	\$ 99.00 !
8087-1	10MHZ 145.		
80287-8	177.		
80287-10	197.	2C87-8	164.
80387DX-16	299.	2C87-10	178.
80387DX-20	340.	2C87-12.5	189.
80387DX-25	420.	2C87-20	239.
80387DX-33	519.	3C87-16	259.
80C287A-12	245.	3C87-20	279.
80287XL	189.	3C87-25	359.
80287XLT	189.	3C87-33	449.
80387SX-16	269.	3C87SX-16	298.
80387SX-20	289.	3C87SX-20	CALL
WEITEK			
3167-20	340.	X83D87-16	259.
3167-25	569.	X83D87-25	295.
3167-33	699.	X83D87-33	368.
4167-25	747.	X83S87-16	230.
4167-33	990.	X83S87-20	252.

ANN & ANTHONY (DAI)

2464 El Camino Real, Suite 420

Santa Clara, CA 95051

Tel: (408) 988-5083 Fax: (408) 988-3986

Circle 27 on Reader Service Card

## TWIX PC CASH REGISTERS NEW MODELS, LOW PRICES



- NEW 3011/12 "REGISTER HEADS": Receipt printer, register keyboard, cash drawer & monitor in a sleek package for hook-up to a XT/AT or PS-2.
- NEW 3041 "REGISTER TERMINAL": TV950 terminal emulation for multi-user oper. systems with built in controls for drawer, receipts, scanners & more.
- NEW 3081 "REGISTER COMPUTER": Standalone "AT" compatible with C floppy drives, 1 MB Ram.
- NEW "TWIX ADVANTAGE" RETAIL POS Software: Advanced features, network, scanner interface.

**TWIX INTERNATIONAL CORP.**

4401 S. BROADWAY, ENGLEWOOD, CO 80110

(303)789-5333 FAX (303)788-0670

Circle 343 on Reader Service Card

## Free leaflets and catalogues

Info# Topic

- 00011 Printer buffers. Perhaps the simplest way to speed up a computer system.
- 00021 The ideal interface is like a cable: Easy to install. Invisible in use.
- 00031 T-Switches and Auto-switches. Optimised for easy operation.
- 00041 Data cables. Highly flexible. Simple to install. A well thought-out system.
- 00051 Interface Cards. Carefully developed to eliminate application problems.
- 00401 ToolArt: Useful art for computer professionals.
- 00511 Brains beats money. Enhancements you can install yourself.
- 00521 UNIX-Installations. Tips&products.
- 00531 The right way to install a computer.

W&T Products Corp.  
2209 NE 54th Street  
Ft. Lauderdale, FL 33308  
Phone 1-800-628-2086  
Fax 1-305-351-9099



Circle 363 on Reader Service Card

## 9-Track Tape Subsystem for the IBM PC/XT/AT



Now you can exchange data files between your IBM PC and any mainframe or mini-computer using IBM compatible 1600 or 6250 BPI 9-Track tape. System can also be used for disk backup. Transfer rate is up to 4 megabytes per minute on PCs and compatibles. Subsystems include 7" or 10 1/2" streaming tape drive, tape coupler card and DOS compatible software. For more information, call us today!

**QUALSTAR**

9621 Irontdale Ave., Chatsworth, CA 91311

Telephone: (818) 882-5822

Circle 269 on Reader Service Card



PS/2 model 30/286-30 meg .....	1795
PS/2 model 50Z/286-60 meg .....	2395
PS/2 model 55SX/386SX-60 meg .....	2695
PS/2 model 70/386-120 meg .....	5595
PS/2 model 80/121-120 meg .....	NEW
*** Monitor Extra ***	



Compaq 286E-40 meg .....	1995
Compaq 386/20E-100 meg with 4 meg memory .....	3595
Compaq 386S-100 meg with 2 meg memory .....	2795
Other models .....	CALL
*** Monitor Extra ***	

### NOVELL SPECIALS

ELS I .....	510
ELS II .....	1150
Advance 286 V 2.15 .....	1899
Advance SFT V 2.15 .....	2999

# LOW PRICE LEADER

## SINCE 1983

### LAPTOP

Texas Instruments TM2000 .....	2595
Compaq LTE/286-40 .....	2975
Sharp 6220 .....	2595

CALL FOR OTHER BRANDS

### LAPTOP ACCESSORIES

Memory	
1 meg Toshiba 1000SE .....	190
2 meg Toshiba 3100SX .....	210
2 meg Toshiba 3200SX .....	210
2 meg Toshiba 5200 .....	220
1 meg Compaq SLT .....	280



### Everex System I 1545

Everex Step 286/12-1 meg  
40 meg VGA card and monitor

### Everex System II 2195

Everex Step 386SX-2 meg  
40 meg VGA card and monitor

### Everex System III 4850

Everex Step 386/33-4 meg  
150 meg VGA card and monitor

\* Call for models & configurations \*

### AGI COMPUTER

AGI 386SX-1 meg .....	1595
40 meg VGA card and monitor CALL FOR OTHER MODELS	



AST 386SX-2 meg .....	2195
40 meg VGA card and monitor CALL FOR OTHER MODELS	

### DISKS

DYSAN 5.25 HD/3.5 HD .....	13/26
MAXELL 5.25 HD/3.5 HD .....	12/25
Minimum 10 box order	

### WE STOCK

CITIZEN  
OKIDATA  
EVEREX  
HITACHI

GOLD STAR  
PC MOUSE  
LOGITECH  
MITSUBISHI

NEC  
WYSE  
SONY  
ACER

PRINCETON GRAPHICS  
HOUSTON INSTRUMENTS  
MICROSOFT MICE  
IRWIN & ARCHIVE

AMDEK  
HAYES  
CALCOMP  
TAXAN

TOSHIBA  
SAMSUNG  
MAGNOVOX  
TAPE BACK

### MONITORS

NEC Multisync IIA .....	499
NEC Multisync 3D .....	649
Emerson VGA .....	340
NEC Multisync 5D .....	2350
Sony 1304 .....	659
Sony 1302 .....	619

### SOFTWARE SPECIAL

dBase IV .....	455
Wordperfect 5.1 .....	260
Aldus Pagemaker .....	495
Ventura Publisher .....	525
Clipper .....	535
WordStar 5.5 .....	150
EasyExtra .....	40



## NOVELL Authorized Dealer

### SPECIALS

HP Scan Jet .....	1425
Hp Paint Jet .....	965
Lotus Ver. 3.0 .....	355
Kodak 150P .....	355
Complete Fax Board .....	399
Okidata 391 .....	625
Epson LQ1050 .....	660
Panasonic 1124 .....	319
HP-7475 Plotter .....	1595
SummaGraphic .....	365

### LASER PRINTERS

HP Laser IIID .....	2550
HP Laser 2P .....	995
HP Laser III .....	1650
Panasonic 4450 .....	1395
Brother HL-8-E .....	1895
NEC LC 890 .....	3195
Toshiba Laser 6 .....	1095

### INTEL COPROCESSORS

8087-3 .....	105
8087-2 .....	145
80287-8 .....	225
80287-10 .....	249
80387-16 .....	395
80387-20 .....	425
80387-25 .....	495
80387-33 .....	599

### PACIFIC DATA PRODUCTS

P. Page II .....	395
P. Page IIP .....	365
P. 1-2-4 Mem II .....	140
P. One Meg IIP .....	160
P. 25 in One .....	250
P. Headlines .....	245

### LAN BOARDS

8 bit Arcnet .....	110
16 bit Arcnet .....	220
8 bit Ethernet .....	190
16 bit Ethernet .....	275
8 port Active Hub .....	325
Token Ring Card .....	399
Tokenhub 4-port .....	355
Call for other LAN Accessories	

### MODEMS

Everex 2400 Int/Mnp .....	179
Hayes 2400B .....	315
Hayes 9600B .....	875
USRobotics Hst/Dual .....	1150
More in stock .....	Call

Corporate Accounts  
Welcome

Call for Volume  
Discounts

Consultants Call  
for Pricing

Exports  
Available

# Computerlane

## Outside California: 1-800-526-3482

## Inside California: 818-884-8644 • FAX: 818-884-8253

22107 Roscoe Blvd., Canoga Park, CA 91304 • 1/2 Block west of Topanga

Hours: Monday - Friday 9 - 6 Saturday 10 - 6

Compaq is a Registered Trademark of Compaq. IBM is a Registered Trademark of International Business Machines.

ALL QUOTED  
PRICES ARE CASH  
PRICES ONLY

Visa and MasterCard  
3% higher,  
American Express  
5% higher

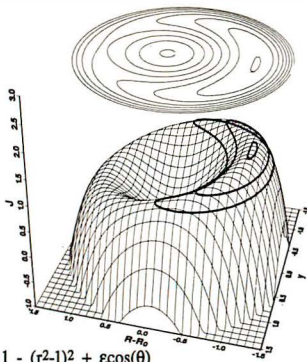
Prices subject to change  
without notice.

\*Quantities are limited

# GraphiC™

"gives you all the C language routines you need to write an impressive scientific graphing program of your own. Highly recommended.\*"  
 — PC Magazine

Orbits correspond to J = constant contours



$$J = 1 - (r^2 - 1)^2 + \epsilon \cos(\theta)$$

IBM® PC (with source code) \$395

Circle 287 on Reader Service Card

Macintosh® (no source code) \$295

Circle 288 on Reader Service Card

Licensed for personal use only

# VTEK-HP 1.0™

New!

DEC® VT220/102/52 & Tektronix® 4010/4014/4105 Terminal Emulator for IBM® PCs

Circle 289 on Reader Service Card

VTEK-HP has added full VT220 emulation to VTEK New High Performance features:

- ▶ TIFF export
- ▶ Color PostScript® and viewable EPS
- ▶ HP-GL/2™ and PaintJet XL™ support
- ▶ Full national character set support
- ▶ Telephone dialer
- ▶ faster and uses less memory
- ▶ requires '286 or '386 and VGA/EGA

VTEK-HP \$245 VTEK \$195

**Scientific Endeavors**  
 508 North Kentucky Street  
 Kingston, TN 37763 USA  
 (615) 376-4146 FAX: (615) 376-1571

## 80C51 BASIC-52 BOARD FOR DISTRIBUTED DATA ACQUISITION

**\$220 US includes:**

- Intel 80C51FA, new PWM array
- RS422/485, auto RX/TX flow
- RS232, auto override select
- 64K static RAM, battery back up
- 32K CMOS EPROM, 8K Basic-52
- Battery operated & NiCd charge
- On board power supply, 300ma
- Hitachi LMxx LCD driver port
- PC communication software

★★★ **OPTIONS** ★★★

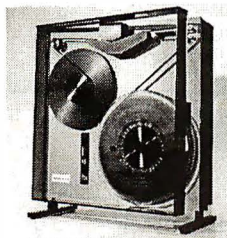
Prototyping Board (Dig.+Analog) . . \$39US  
 PC/RS232 ↔ RS422/485 . . . \$44US  
 80C51 Kit form . . . . . \$99US

**BINARY DATA ACQUISITION CORP.**  
 1735 Bayly Street, Pickering, Ontario L1W 3G7  
 Canada, Phone (416) 420-8029 Fax (416) 831-0510  
 Cashiers Cheque or Visa

Circle 36 on Reader Service Card

**MULTI-SPEED !!!**  
**9 TRACK TAPE SUBSYSTEM**  
 for IBM PC/AT/386

**1 YEAR WARRANTY**



- IBM/ANSI compatible at 800\*/1600/3200 bpi
- Controller, cables and software included
- Interfaces for PS/2\*, Xenix\* and DEC\*
- SCSI\*, AT or MCA\* Bus I/O at 25/50/100 ips.

\*OPTIONAL SHOWN/OPTIONAL DUST COVER  
**AKSystems Inc.**  
 20741 Marilla St. Chatsworth CA 91311  
 TEL: 818/709-8100 FAX: 818/407-5889

Circle 17 on Reader Service Card

# 486 \$1995

Made in U.S.A.

## JC GOLD CARD

The JCS 486, The New Performance Leader in Personal 486 Systemboards

- Intel 80486/25(B6) CPU
- 8KB Cache integrated in CPU
- Math Coprocessor integrated in CPU
- Shadow RAM for Video & System BIOS
- Second Level Cache Memory expandable to 512KB
- Waitak 4167 numeric coprocessor socket
- 30 DAY MONEY BACK GUARANTEE

**486 Complete System . . . \$3385**  
 Include 4MB Memory, 150MB ESDI HDD, ESDI Cache Controller, 12 of 1.44MB FDD, MS DOS, AT VO, 101 Keyboard

80386/20 CPU Bd, C&T chipset \$615  
 80386/25 CPU Bd, C&T chipset \$665  
 80386/25 Cache Bd, C&T chipset \$845

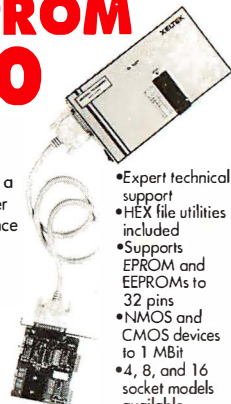
Dealer Inquiries welcome  
**Jemini Electronics** TEL (408) 727-9986  
 3400 De La Cruz Blvd, Unit T FAX  
 Santa Clara Ca, 95054 (408) 727-7687

Circle 166 on Reader Service Card

## E/EPROM \$180

Why not buy your E/EPROM programmer from a company with over 12 years experience in providing both hardware and software tools?

Order today, call **800-448-8500**



- Expert technical support
- HEX file utilities included
- Supports EPROM and EEPROMs to 32 pins
- NMOS and CMOS devices to 1 MBit
- 4, 8, and 16 socket models available
- IBM PC/XT/AT/386 compatible
- 1 year warranty

**AVOCET SYSTEMS, INC.**

120 Union St., Rockport, ME 04856  
 Outside US 207-236-9055 • FAX 207-236-6713

The source for quality embedded-system tools

Circle 35 on Reader Service Card

## FREE CATALOG

**RS-232C INTERFACE & MONITORING EQUIPMENT CATALOG**

WRITE or CALL for YOUR FREE COMPREHENSIVE B & B ELECTRONICS CATALOG TODAY!

Pages and pages of photographs and illustrated, descriptive text for B&B's complete line of RS-232C converters, RS-422 converters, current loop converters, adapters, break-out boxes, data switches, data splitters, short haul modems, surge protectors, and much, much more. Most products meet FCC Part 15J. Your RS-232 needs for quality, service and competitive prices will be more than met by B&B ELECTRONICS. Manufacturer to you, no middleman! Money-back guarantee! Same-day shipment! One-year warranty on products! Technical support is available.

Write For Your FREE Catalog Today!

**B&B electronics**  
 MANUFACTURING COMPANY

4002N Baker Road P.O. Box 1040 • Ottawa, IL 61350

Phone: 815-434-0846



Order direct from manufacturer TODAY & SAVE!

Circle 48 on Reader Service Card

### AST Upgrades

500718-001 386/25...\$65  
 500718-002 386/33...\$70  
 500510-004 386/p...\$350

### D-RAM

256x1- 150ns...\$1.59  
 256x1- 120ns...\$1.69  
 256x1- 100ns...\$1.79  
 256x1- 80ns...\$1.89  
 256x1- 70ns...\$1.99  
 256x1- 60ns...\$2.25  
 1x1-1 100ns...\$4.50  
 1x1-1 80ns...\$4.75  
 1x1-1 70ns...\$4.99  
 1x1-1 60ns...\$7.99  
 256x4 80ns...\$4.99  
 256x4 70ns...\$5.99  
 256x4 60ns...\$7.99  
 4464- 120ns...\$1.75  
 4464- 100ns...\$2.00  
 4164- 120ns...\$1.50  
 4164- 100ns...\$1.75

### COMPAQ

113131-001 386/20...\$425  
 113131-001 386/25...\$425  
 115144-001 386/33...\$325

### SIMM-SIPPS

1x9-100...\$49  
 1x9-80...\$52  
 1x9-70...\$54  
 1x9-60...\$65  
 1x8-100 MAC...\$45  
 1x8-80 MAC...\$47  
 256x9-100...\$15  
 256x9-80...\$20  
 256x9-70...\$22  
 256x9-60...\$25

### PS2 SIMMS

30F348 512K...\$55  
 30F5360 2MEG...\$160  
 6450603 1 MEG...\$85  
 6450604 2MEG...\$170  
 6450608 2MEG...\$175

**AMT International**  
 (408) 432-1790

2393 OUME Drive  
 San Jose, CA 95131  
 FAX: (408) 944-9801

Circle 26 on Reader Service Card

# Trend Systems

T R E N D S Y S T E M S I N C .

## Memory Expansion Boards



### ORCHID

**RAMQUEST 8/16** Card expandable to 32MG. for IBM PCs, XT's, AT's, PS/2 Model 30-286 and compatibles. Supports 8 and 16 bit bus. Uses 256K 1 MG or 4MG Modules. w/OK \$289

**RAMQUEST EXTRA 16/32** 0-8MG, 0 wait state card for PS/2 Mod 50, 60 & 80 fully supports 16 and 32-bit memory access. Includes 1 SER and 1 PAR port. Free serial cable. EMS 4.0 and OS/2 compatible. Uses 256K and/or 1MG SIMMS w/OK \$279.

### EVEREX

**RAM 3000 DELUXE** Up to 3MG Selectable memory addresses. Expanded Memory Specifications (EMS) 4.0/ OS/2. Can be used to backfill base memory up to 640K and the rest as expanded and/or extended memory. Uses 256K D-RAM w/OK \$ 89

**RAM 8000** Up to 8MG capacity/support to base, extended or expanded memory in any combination. Fully compatible with Lotus, Intel, Microsoft, EMS 4.0, EEMS. Supports Multi-Tasking and DMA Multi-Tasking in hardware. Software configurable (no dip switches to set). Full 16MG window for future expansion. Zero wait state. Uses 1MG D-RAM w/OK \$189

### BOCA RESEARCH

**BOCARAM/AT** Provides up to 2MG LIM EMS 4.0 and/or 4MG of extended, expanded or backfill memory. For 16 bit bus. Operates up to 16MHz. Uses 256K D-RAM w/OK \$109

**BOCARAM/AT PLUS** Provides up to 8 MG of extended, expanded or backfill memory. Operates up to 33MHz and is set thru software. Uses 1MG D-RAM w/OK \$129

**BOCARAM/AT I/O PLUS** Provides up to 4MG of extended, expanded or backfill memory for 16 bit bus. Operates up to 33 MHz and is set thru software. Has serial and parallel port. Uses 1MG D-RAM w/OK \$145

### COMPAQ MEMORY

#### ADD-ON MODULES

MODEL	1MG	2MG	4MG	8MG
386/20/20E/25/25E				
DESK PRO 286E, 386S	\$135		\$375	
386/33, 486/25 & SYSTEM PRO		\$320		\$2,495

#### MEMORY EXPANSION BOARDS

MODEL	512K	1MG	2MG	4MG	8MG
386/16		\$425	\$675	\$1375	\$2495
386/20E/25E 386S		\$250		\$725	
Portable 386					\$1250
Portable LTE	\$219	\$325			\$495
SLT/286		\$279			

#### MEMORY UPGRADE KITS

MODEL	512K	2MG	4MG
Portable III	\$70	\$178	
DESKPRO 386/16		\$250	\$795

## Fax Boards

### CALCULUS EZ-FAX

Now works with Windows 3.0! Manufactured CCITT Group III. Provides fully concurrent background operation. Allows user to transmit, receive and view documents on screen. Once in memory, the transmissions may be edited for retransmission, printed, stored for future, or discarded off your hard drive. **SOFTWARE INCLUDED.**

00FX (4800 baud)	Trend Price	\$189
002FX (9600 baud)	Trend Price	\$289

## Modems

### EVEREX

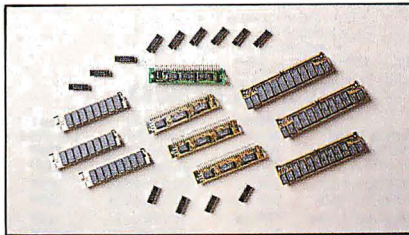
Internal 1200 BAUD	\$ 69	Internal 1200 BAUD	\$ 59
Internal 2400 BAUD	129	External 1200 BAUD	99
Internal 2400 BAUD w/MNP 5	169	Internal 2400 BAUD	69
External 2400 BAUD w/MNP 5	199	External 2400 BAUD	129

### TREND

## Laptop Memory

2MG Card-Toshiba Portable T1200e	\$435
2MG Card-Toshiba Portable T1600	259
2MG Card-Toshiba Portable T3100SX	265
4MG Card-Toshiba Portable T3100SX	615
512K Card-Toshiba Portable T3100e	149
2MG Card-Toshiba Portable T3100e	259
2MG Card-Toshiba Portable T3200SX	289
4MG Card-Toshiba Portable T3200SX	689
3MG Card-Toshiba Portable T3200	419
2MG Card-Toshiba Portable T5100	265
2MG T5200	265
2MG Module-Toshiba Portable	265
2MG Module-Toshiba Desktop T8500	345

## Memory Products



### SIMM/SIPP MODULES

	150ns	120ns	100ns	80ns	70ns	60ns
4MG X 9	—	—	—	\$415	\$385	—
1MG X 9	—	\$ 50	\$ 53	\$ 55	\$ 60	\$ 80
1MG X 8	—	\$ 62	\$ 60	\$ 69	—	—
256 X 8	\$ 16	\$ 24	\$ 39	—	—	—
256 X 9	—	\$ 13	\$ 16	\$ 20	\$ 24	—

### D-RAM

ALL PACKAGES & SPEEDS AVAILABLE

### 286 MATH CO-PROCESSORS

	6MHz	8MHz	10MHz	12MHz	12.5MHz	20MHz
IIT (2C87)	—	\$185	\$219	—	\$280	\$324
INTEL (80287)	\$120	\$183	\$208	\$280	—	—

### 8088 MATH CO-PROCESSORS

INTEL (8087)	5MHz	8MHz	10MHz
	\$88	\$115	\$165

### 386 MATH CO-PROCESSORS

	16MHz	20MHz	25MHz	33MHz	SX
CYRIX (83D87)	\$305	\$350	\$450	\$549	—
IIT (3C87)	\$305	\$350	\$450	\$549	—
INTEL (80387)	\$305	\$350	\$450	\$549	\$290

### HP MEMORY

HP II & II D	HP II P & III	
1 MB	1 MB	\$ 62
2 MB	2 MB	\$ 94
4 MB	4 MB	\$289
TONER	\$ 74	TONER \$ 70

### IBM PS-2

34F2933 - 4MG Memory Module for 55SX; 65SX	\$599
Memory Option IBM P/N 34F3077; 34F3011	149
6450375 - 1MG Memory Bd for 80-041	320
6450379 - 2MG Memory Bd for 80-111,311-121; 321	
6450603 - 1MG Module for 70-E61; -121; Adaptor Board	95
IBM P/N 6450605, 6450609, 34F3011 & 34F3077	
6450604 - 2MG Module for 70-061, E61; -121, 502, 55SX 65SX; P70	165
Adaptor Board IBM P/N 6450605, 6450609, 34F3011 & 34F3077	185
6450608 for Model 70A21	185
30F5360 (Kit-2 ea)	190
30F5348 (Kit-2 ea)	72



**WE WILL MEET OR BEAT ANY ADVERTISED PRICE**

**1-800-678-2818**

#9 Exchange Place, Suite 900

Salt Lake City, Utah 84111

Local 801-350-9180 Fax 801-350-9179

TERMS AND CONDITIONS: NO SURCHARGE FOR MC OR VISA. TERMS: MC • VISA • COD • CASH • AMEX ADD 4%. PURCHASE ORDERS FROM QUALIFIED FIRMS. 20% RESTOCKING FEE ON NON-DEFECTIVE RETURNS. PRICES SUBJECT TO CHANGE.

## Trend 386-25 MHz COMPUTER SYSTEM



- DTK Motherboard
- Intel 80386-25 MHz Microprocessor
- Intel 80387 Socket
- 8/25 MHz Clock Speed
- Page Mode
- Interleave/Shadow RAM
- 8 Expansion Slots: 2x8 bit, 5x16 bit, 1x32 bit
- 1 MB On Board Expandable to 8 MB
- 1.2 or 1.44 Disk Drive
- IDE/1:1 Hard/Floppy Controller
- Serial/Parallel
- Baby AT Desktop Case w/200 W Switch Power Supply
- 101 Enhanced Keyboard
- Speed Rating: Landmark 31.7, Norton SI 27.1, Power Meter (MIPS) 4.35
- FCC Class B Approved/UL, TUV Listed

**TREND PRICE**  
**\$1159**

## Trend 386SX/16 COMPUTER SYSTEM

### 60MG Hard Drive/14" Monitor

- 14" VGA Paper White Monitor
- VGA Board w/ 256
- Phoenix Bios.
- 1 MG On/Bd Memory
- 1.2 Floppy Drive
- 60MB RLL Hard Drive
- 2 Serial Ports
- 2 Parallel Ports
- 1 Game Port
- 101-Key Click Keyboard
- 3 Button Mouse
- 3 Year Warranty

**TREND PRICE**  
**\$1259**

## Hard Drives

KALOCK 20MB XT 20 MB, MFM, 3.5 HH, 40 ms	\$225
MITSUBISHI 40MB, 5.25HH, MFM, 28ms	319
MITSUBISHI 60MB, 5.25HH, RLL, 28ms	849
CONNER 3204 200MB, 3.5HH, RLL/IDE, 16ms	900

## Video Adapters

### TREND

EGA CARD 640 X 480, 16 color EGA/MGA/CGA/Hercules	\$ 89
VGA CARD 1024 X 768, 16 color, VGA/EGA/MGA/CGA	119
MONO CARD w/parallel port	25
CGA CARD 2/parallel port	25

## Specials

<b>DFI MOUSE</b>	\$ 35
3-Button Mouse with Selectable Sensitivity. Software - up to 400	
<b>STAR MICRONICS</b>	\$159
Dot Matrix Printer 180 cps 34cps/nlq NX1000/2	
<b>360K FLOPPY DRIVES</b>	\$45
Panasonic & Mitsumi XT Only DS/DD	
<b>MONO VGA MONITOR</b>	\$99
14" Paper White, Tilt & Swivel Base	10 or more \$89

*The Trend To Follow...*

25MHz 386 SYSTEM  
1.2 MEG FLOPPY • 1 MEG MEMORY  
101 KEYBOARD MINI CASE 200 WATT PWR SUPPLY  
1 YEAR WARRANTY YOUR PRICE 999<sup>00</sup>

# 4TH YEAR ANNIVERSARY SPECIAL

## COMPAQ (BOARDS & MODULES)

Compaq Model	Memory Added	Compaq Equiv. Part #	Your Low Price
DESKPRO 286	512K Kit	113012-001	59 <sup>00</sup>
DESKPRO 286N, 386N	1MB Module	118688-001	138 <sup>00</sup>
386S/20	2MB Module	118689-001	219 <sup>00</sup>
	4MB Module	118690-001	569 <sup>00</sup>
DESKPRO 386/16	1MB Board	108069-001	299 <sup>00</sup>
	2MB Board	108069 W/71	499 <sup>00</sup>
	1MB Kit	108071-001	199 <sup>00</sup>
	4MB Board	108070-001	699 <sup>00</sup>
	4MB Kit	108072-001	449 <sup>00</sup>
DESKPRO 386s	1MB Board	113633-001	248 <sup>00</sup>
	4MB Board	113634-001	548 <sup>00</sup>
	1MB Module	113646-001	138 <sup>00</sup>
	4MB Module	112534-001	318 <sup>00</sup>
DESKPRO 386/20, 25 286E	1MB Module	113131-001	139 <sup>00</sup>
	4MB Module	113132-001	295 <sup>00</sup>
DESKPRO 386/20e	1MB Board	113644-001	248 <sup>00</sup>
	4MB Board	113645-001	548 <sup>00</sup>
DESKPRO 386/33, 486/25	2MB Module	115144-001	218 <sup>00</sup>
SYSTEMPRO	8MB Module	116561-001	999 <sup>00</sup>
	32MB Module	116568-001	599 <sup>00</sup>
<b>PORTABLE -</b>			
PORTABLE III	512K Kit	107331-001	89 <sup>00</sup>
	INTFC BD	107808-001	99 <sup>00</sup>
	EXP BD	107811-001	249 <sup>00</sup>
	2MB Kit	107332-001	179 <sup>00</sup>
SLT/286	1MB Module	110235-001	249 <sup>00</sup>
	4MB Module	110237-001	899 <sup>00</sup>
LTE/286	512K Board	110770-001	199 <sup>00</sup>
	1MB Board	110781-001	179 <sup>00</sup>
	2MB Board	110781-002	249 <sup>00</sup>
PORTABLE 386	1MB Kit	107651-001	249 <sup>00</sup>
	INTFC BD	107707-001	99 <sup>00</sup>
	4MB Board	107653-001	799 <sup>00</sup>
	4MB Ext Board	107654-001	799 <sup>00</sup>
SLT/386S	1MB Module	108303-001	349 <sup>00</sup>
	2MB Module	108304-001	499 <sup>00</sup>

## SIMM MODULES

Description	120NS	100NS	80NS	70NS	60NS
256 x 9 IBM	19 <sup>00</sup>	24 <sup>00</sup>	29 <sup>00</sup>	26 <sup>00</sup>	39 <sup>00</sup>
1Meg x 8 Apple	58 <sup>00</sup>	61 <sup>00</sup>	64 <sup>00</sup>	71 <sup>00</sup>	79 <sup>00</sup>
1Meg x 9 IBM	55 <sup>00</sup>	57 <sup>00</sup>	59 <sup>00</sup>	69 <sup>00</sup>	74 <sup>00</sup>
4Meg x 9 IBM	—	339 <sup>00</sup>	349 <sup>00</sup>	399 <sup>00</sup>	—

## AST MEMORY

AST Model	Memory Added	AST Equiv. Part #	Your Low Price
BRAVO/286 & PREMIUM WKST 286	128K Kit	500510-011	49 <sup>00</sup>
	512K Kit	500510-010	59 <sup>00</sup>
	2MB Kit	500510-002	169 <sup>00</sup>
	4MB Kit	500510-008	359 <sup>00</sup>
BRAVO/386SX	2MB Kit	500510-002	169 <sup>00</sup>
	4MB Kit	500510-008	359 <sup>00</sup>
PREMIUM 286 ADVANCE	512K Kit	500510-010	79 <sup>00</sup>
	1MB Kit	500510-007	99 <sup>00</sup>
WKST 386SX	2MB Kit	500510-002	169 <sup>00</sup>
	4MB Kit	500510-007	359 <sup>00</sup>
386/16, C	1MB Kit	500510-008	149 <sup>00</sup>
PREMIUM	4MB Kit	500510-004	369 <sup>00</sup>
386/25, 16sx, 386/33	1-16MB	500718-001-2	79 <sup>00</sup>
PREMIUM 486/33	1-16MB	500722-004	495 <sup>00</sup>
2ST, 25T, 25, 25E & 33	1-16MB	500718-002	89 <sup>00</sup>
	2MB SIMM	500718-004	249 <sup>00</sup>
	1-16MB	500722-004	495 <sup>00</sup>

## BOCA AT PLUS MEMORY BOARD

16 BIT MEMORY BOARD FOR 286, 386 AT  
OK-BMega Board • 4.0 LIM Compatible • New 5 Hr. Warranty  
• Conventional, Expanded and Extended Memory  
• Supports DOS, OS/2, LIM/EIMS & EEMS  
• Operates with CPU Speeds to 33 MHz

OK - 129<sup>00</sup> 2 Meg - 246<sup>00</sup> 4 Meg - 353<sup>00</sup> 8 Meg - 577<sup>00</sup>

## TOSHIBA MEMORY

Toshiba Model	Memory Added	Toshiba Equiv. Part #	Your Low Price
PORTABLE T1000SE & XE	1MB BD	PC14-PA8311U	299 <sup>00</sup>
	2MB BD	PC14-PA8312U	449 <sup>00</sup>
PORTABLE T1200xe	2MB BD	PC13-PA8306U	259 <sup>00</sup>
PORTABLE T1600	2MB BD	PC8-PA8302U	259 <sup>00</sup>
PORTABLE T3100e	512K Kit	PC9-PA8340U	149 <sup>00</sup>
	2MB Kit	1PC9-PA8341U	199 <sup>00</sup>
PORTABLE T3100SX	2MB BD	PC15-PA8308U	259 <sup>00</sup>
	4MB BD	PC15-PA8310U	589 <sup>00</sup>
PORTABLE T3200	3MB BD	PC6-PA7137U	399 <sup>00</sup>
PORTABLE T3200SX	2MB Kit	PC12-PA8307U	249 <sup>00</sup>
	4MB Kit	PC12-PA8309U	589 <sup>00</sup>
PORTABLE T5100	2MB BD	PC7-PA8301U	259 <sup>00</sup>
PORTABLE T5200	2MB Kit	PC10-PA8304U	259 <sup>00</sup>
DESKTOP T8500	8MB Kit	PC10-PA8313U	1495 <sup>00</sup>

## IBM PS/2 (BOARDS & MODULES)

IBM PS/2 Model	Memory Added	IBM Equiv. Part #	Your Low Price
PS/2 25/286	512K Kit	30F5348	48 <sup>00</sup>
30-286, 50 & 60	2MB Kit	30F5360	174 <sup>00</sup>
PS/2 50Z & 55-SX, 65SX	1MB SIMM	6450603	98 <sup>00</sup>
	2MB SIMM	6450604	139 <sup>00</sup>
55SX & 65SX	4MB Module	34F2933	399 <sup>00</sup>
50, 50Z, 55 & 60, 65SX	2-BMB Board	1497259	499 <sup>00</sup>
PS/2	1MB SIMM	6450603	98 <sup>00</sup>
70-E61, 061, 121	2MB SIMM	6450604	139 <sup>00</sup>
PS/2 70-A21 AX1.BX1	2MB SIMM	6450608	159 <sup>00</sup>
PS/2 80-041	1MB Module	6450375	135 <sup>00</sup>
PS/2 80-111,121,131,321	2MB Module	6450379	199 <sup>00</sup>
80-A21, A31	4MB Module	6451060	499 <sup>00</sup>
PS/2	2-16MB Board	6456053 OR	489 <sup>00</sup>
ALL 70s & 80s	4-16MB Board	34F3077	589 <sup>00</sup>
	8-16MB Board	34F3011	989 <sup>00</sup>

## RAM CHIPS

Description	150NS	120NS	100NS	80NS	70NS
64 x 4	120	120	240	—	—
64 x 4 In Stock	180	220	240	380	—
256 x 1 Call For Qty Dis.	—	160	160	190	220
256 x 4	—	500	600	700	800
1 Meg x 1	—	400	500	590	690

## ZENITH MEMORY

Zenith Model	Memory Added	Zenith Equiv. Part #	Your Low Price
Z386/33	1MB Module	ZA3800ME	99 <sup>00</sup>
	2MB Module	ZA3800MG	199 <sup>00</sup>
Z386/25, 20	1MB Module	ZA3800ME	99 <sup>00</sup>
	2MB Module	ZA3800MG	199 <sup>00</sup>
	4MB Module	ZA3800MK	649 <sup>00</sup>
Z248, Z286LP, Z386SX	2MB Module	Z-605-1	249 <sup>00</sup>
TURBO SPRT 386,386E	1MB Kit	ZA3034ME	549 <sup>00</sup>
SUPER SPRT SX	2MB Kit	ZA180-64	449 <sup>00</sup>
	2MB Kit	ZA180-86	449 <sup>00</sup>
	2MB Kit	ZA180-87	449 <sup>00</sup>
SUPER SPRT 286 286e, SX	1MB Kit	ZA180-66	249 <sup>00</sup>
	2MB Kit	ZA180-64	399 <sup>00</sup>

## EVEREX MEMORY BOARDS

RAM 3000 DELUXE Up to 3 Meg. (EMS) 4.0 OS/2. Back up base memory and expanded and/or extended memory. Uses 256K D-RAM 99<sup>00</sup>  
RAM 8000 0-BMG capacity base, extended or expanded memory any combination. Compatible w/Lotus, Intel, Microsoft, EMS 4.0, EIMS. Supports Multi-tasking & DMA Multi-tasking in hardware. Uses IBM D-RAM 199<sup>00</sup>  
RAM 10000 0-10MB extended or expanded memory. Compatible with Lotus, Intel, Microsoft, EMS 4.0. Uses 1 MB D-RAM. 179<sup>00</sup>

## IBM HP & CANON LASER JETS

Model	Memory Added	HP Equiv. Part #	Your Low Price
LASER JET II & IID	1MB Module	33443B	99 <sup>00</sup>
	2MB Module	33444B	149 <sup>00</sup>
	4MB Module	33445B	249 <sup>00</sup>
HP, HP3 & IID	1MB Module	33474A/B	119 <sup>00</sup>
	2MB Module	33475A/B	168 <sup>00</sup>
	4MB Module	N/A	268 <sup>00</sup>
CANON LBP 811, 811R, 811T	1MB Module	N/A	199 <sup>00</sup>
	2MB Module	N/A	224 <sup>00</sup>
	4MB Module	N/A	429 <sup>00</sup>
IBM LASER MODEL 4019	1MB Board	1039136	199 <sup>00</sup>
	2MB Board	1039137	299 <sup>00</sup>

## CANON FLATBED SCANNER IX-12F

• 300 DPI • 16 Secs per page • 32 Level Gray Scale  
• 1 year warranty • Ready to go Interface card and cable included  
List 1595 Your Price 799<sup>00</sup> w/o Interior 499<sup>00</sup>  
OPTIONS: OCR 199<sup>00</sup> PC Paint by Z-Soft 1.65 79<sup>00</sup>  
Sheet Feeder (also works with HP) 299<sup>00</sup>

## 4TH ANNIVERSARY SPECIALS

80387-16MHz	279 <sup>00</sup>	80387-33MHz	499 <sup>00</sup>
80387-20MHz	319 <sup>00</sup>	80387-16SX Version	289 <sup>00</sup>
80387-25MHz	399 <sup>00</sup>	80387-20SX Version	379 <sup>00</sup>

## CYRIX CASMATH PROCESSOR

• 5 Year Warranty • Programs executed up to 3 times faster  
• Plug & object code compatible with Intel • PC Week rated it over all math chips

## WANGTEC TAPE BACKUPS

• 6.5MB per minute  
• Wangtec 5099EN24 drive  
• PC 36 Controller • Menu driven • Software  
• DC600 cartridge • Easy installation  
List 999<sup>00</sup> Your Price 379<sup>00</sup>  
Wangtec 40MB backup works off floppy controller 189<sup>00</sup>

## DAISY WHEEL PRINTER

• 14CPS Letter Quality  
• Manufactured by Silver Reed  
• IBM Centronics Parallel Interface  
• New 90 day warranty  
List 1499<sup>00</sup> Your Price 990<sup>00</sup>  
12 CPS version for 89<sup>00</sup> 6 ft. Cable 99<sup>00</sup>

## FULL PAGE SCANNER BY AT&T

• IBM Interface & Cable  
• PagePower Software.  
A complete draw; Scan, fax packages  
• 200DPI • Automatic Sheet Feeder  
OCR Software 199<sup>00</sup> List 999<sup>00</sup> Your Price 269<sup>00</sup>

## 2 YEAR WARRANTY MODEMS

• Fully Hayes Compatible • Monitor Speaker with Volume Control  
• 2400/300 Baud Transmission Rate • Addressable COM 1,2,3,4  
• Compatible with IBM PC, XT, AT and Compatibles  
• Full Duplex Operation • Complete with Software  
• Two Year Manufacturer's Warranty • Auto Dial/Auto Answer  
Internal 79<sup>00</sup> External 89<sup>00</sup>

## 1 YEAR WARRANTY POWER SUPPLIES

IBM DIRECT REPLACEMENT  
150 WATT XT Comp. • UL Appr. • 110/220V input switch • 4 drives 499<sup>00</sup>  
200 WATT AT Comp. • UL Appr. • 110/220V input switch 69<sup>00</sup>

## 1 YEAR WARRANTY SEAGATE HARDDRIVE

Model	Capacity	Access Time	AT KIT	XT KIT
ST125-0	20MB	40msec	3.5"	\$249
ST125-1	20MB	28msec	3.5"	\$319
ST138-0	30MB	40msec	3.5"	\$289
ST138-1	30MB	28msec	3.5"	\$309
ST125	20MB	65msec		\$199
ST238R (RL)	30MB	65msec		\$219
ST257-1	42MB	28msec		\$269
ST1277R-1 (RL)	65MB	28msec		\$339
ST4096	80MB	28msec		\$549
ST4144 (RL)	120MB	28msec		\$649

XT kits include cables, software (over 32MB) controller  
AT kits include cables, rails, software (over 32MB)

## 1 YEAR WARRANTY VIDEO CARDS

EGA Card 79<sup>00</sup>  
MonoGraphics (Hercules Compatible) with Par. Port 299<sup>00</sup>  
Color Graphics (Hercules Compatible) with Par. Port 399<sup>00</sup>  
Mono Card Text Only 99<sup>00</sup>  
VGA Card 1024 x 768 (256K Exp 512K) 109<sup>00</sup>  
STB mono/color card 299<sup>00</sup>

## 1 YEAR WARRANTY SAMSUNG MONITORS

12" Amber w/Tilt & Swivel Base 89<sup>00</sup>  
14" Color 640 x 200, 16 colors 209<sup>00</sup>  
14" EGA 640 x 350, 64 colors/31 369<sup>00</sup>  
VGA 1024 X 768 Multiscan (Panasonic Tube) 28 399<sup>00</sup>  
14" VGA Demo looks new, 31 Dot Pitch 284<sup>00</sup>

## RODIME & CONNER HARDDRIVES

40 Meg 18 Mil. Sec. 399<sup>00</sup> 100 Meg 18 Mil. Sec. 549<sup>00</sup>  
200 Meg 18 Mil. Sec. 849<sup>00</sup>

## 1 YEAR WARRANTY FLOPPY DRIVES

360K 1/2 Ht. 5 1/4 59<sup>00</sup>  
1.2 Meg 5 1/4 79<sup>00</sup>  
720K 3 1/2" Drive w/5 1/4" mounting 69<sup>00</sup>  
1.44 Meg 3 1/2" Drive w/5 1/4" mounting Sony 79<sup>00</sup>  
360K Tandon TM100-2 Full Ht. (The original IBM) 89<sup>00</sup>

## 5 YEAR WARRANTY INTEL COPROCESSORS

Model	Speed	Price	Model	Speed	Price
8087	5MHz or less	79 <sup>00</sup>	80387-16	16MHz	299 <sup>00</sup>
8087-2	8MHz	114 <sup>00</sup>	80387-20	20MHz	349 <sup>00</sup>
8087-1	10MHz or less	149 <sup>00</sup>	80387-25	25MHz	449 <sup>00</sup>
			80387-33	33MHz	549 <sup>00</sup>
80287	6MHz	149 <sup>00</sup>	80387-SX		298 <sup>00</sup>
80287-8	8MHz	189 <sup>00</sup>	80387-SX20		328 <sup>00</sup>
80287-10	10MHz	205 <sup>00</sup>	80287-L		359

**New, Improved!**

# 8051/8052 BASIC COMPILER!

Full floating-point numbers, integer, byte and bit extensions. Fully compatible with MCS BASIC 52. Runs on IBM-PC or compatible.

## \$295.00

Call Now! 603-469-3232



Binary Technology, Inc.  
Main Street • P.O. Box 67 • Meriden, NH 03770

## DYNAMIC RAMS

4Mx9	80ns	\$220.00
PS2	2M 604/608	\$105.00
1Mx9	80ns	\$ 44.50
1Mx8	80ns	\$ 41.00
256x4	100ns	\$ 4.75
✓ 1Mx1	100ns	<b>\$ 4.25</b>
✓ 41464	100ns	<b>\$ 2.35</b>
✓ 41256	100ns	<b>\$ 1.95</b>
51258	80ns	\$ 2.75
4164	120ns	\$ 1.70

\* For quantity discount, high-speed parts, SIPP ..... Please Call!

■ MATH COPROCESSORS	3C87	IT/CYRIX	\$ CALL		
80387-33	33mHz	\$535.00	2C87-20	20mHz	\$235.00
80387-25	25mHz	\$435.00	2C87-12	12mHz	\$194.00
80387-20	20mHz	\$350.00	2C87-10	10mHz	\$178.00
80387-16	16mHz	\$305.00	2C87-8	8mHz	\$160.00
80387SX	16mHz	\$275.00	■ V-20	8/10mHz	\$8.5/15

## I.C. EXPRESS

15140 Valley Blvd. City of Industry, CA 91744  
Customer service: (818) 333-8880 FAX: (818) 369-1236

**ORDER: (800) 877-8188** (Mon.-Fri. 8-5 PST)  
CALL FOR CURRENT PRICES & VOLUME DISCOUNTS.

Price Shown for cash. MasterCard/VISA add 3%. Prices are subject to change. Minimum order \$10.00. Shipping & Handling: UPS Ground \$5.00, Air \$7.00 (1 lb.) ALL MERCHANDISE IS 100% GUARANTEED WITH PROMPT DELIVERY.

## UNIVERSAL PROGRAMMER



\$ 585

- Programs PLD (PAL, PEEL, EPLD, EEPLD, FPLD, GAL), E(E)PROM (up to 4MBits), BIPOLAR PROM, & Microcontroller
- Tests TTL/CMOS Logic & D/S Ram
- Reliable and fast programming with Normal, Intelligent, Interactive, Quick pulse algorithms
- Accepts JEDEC, INTEL Extended HEX, Motorola S, Tektronix HEX, Binary formats
- Manages 8, 16, and 32-bit word split
- Supports most compilers in JEDEC format
- Software controlled 40-pin universal device programmer
- Interfaces with the IBM PC/XT/AT/386 or compatibles
- High speed parallel interface card


**XELTEK**  
764 San Alejo Ave., Sunnyvale, CA  
Tel (408) 745-7974 Fax (408) 745-1401

DUNCAN IN CANADA  
(416) 742-4448

COD. VISA, MC, AMEX

Circle 367 on Reader Service Card

## I/O MASTER CARD Series



### COMPLETE DATA ACQUISITION SOLUTIONS for IBM PC/XT/AT

#### MCP-550 FEATURES:

- High performance, low cost data acquisition card with multi-functions: A/D, D/A, D/I, D/O
- Maximum sampling rate of 100,000 samples/sec with option or 80,000 samples/sec (standard)
- Industry standard 12-bit resolution
- 16 single ended or 8 differential A/D channels
- Two 12-bit monolithic multiplying D/A channels
- TTL compatible 24 D/I & D/O channels
- Switch selectable analog input range: 0 -10V or +10V
- Can be used with MCE-730: a versatile 16 channel analog input multiplexing and signal conditioning card
- Complete support of vendor application S/Ws, such as Labtech Notebook, ASYST ...
- Low introductory price of \$669!!!

**XELTEK**  
764 San Alejo Ave. Sunnyvale, CA 94086  
(408) 745-7974 • FAX (408) 745-1401

Circle 368 on Reader Service Card

## VIDEO FRAME GRABBERS




MODEL	RESOLUTION	
HRT 256-4	256 x 256 x 4	495
HRT 256-8	256 x 256 x 8	795
HRT 512-8	512 x 512 x 8	995
HRT 512-24	512 x 512 x 24	1995

- IBM PC/XT/AT COMPATIBLE
- DIGITALIZE IN REAL TIME
- COMPOSITE VIDEO IN
- 24 BIT RGB OUT except model HRT 256-4
- 16 level gray scale out
- SOFTWARE LIBRARY OF IMAGE ANALYSIS ROUTINES
- FREE SOFTWARE UPGRADES TO REGISTERED OWNERS
- FULL CREDIT ON UPGRADE PURCHASE IN FIRST YEAR RETURN OLD BOARD AND JUST PAY DIFFERENCE

**HRT** HIGH RES TECHNOLOGIES  
P.O. BOX 76  
LEWISTON, N.Y. 14092  
PHONE 416-497-6493 FAX 416-497-1988

Circle 133 on Reader Service Card

## MEMORY UPGRADES


### IBM PS/2, APPLE AST, COMPAQ HEWLETT PACKARD ZENITH, SUN MICRO STANDARD SIMMS LAPTOP MEMORY (NEC, TOSHIBA, APPLE, COMPAQ) LASER PRINTER MEMORY (HP, CANON, TEC ENGINE)

**NO RISK, BEST PRICE, BEST QUALITY**

**ADD ON AMERICA**  
A DIVISION OF ROHM CORPORATION  
433 N. MATHILDA AVE. SUNNYVALE, CA 94088  
TEL (408) 746-1590 FAX (408) 746-1593

1-800-292-7771

Circle 15 on Reader Service Card



## 3M DATA CARTRIDGES

5.25" 720 kb DS	4.89	Pre-Formatted	5.69
5.25" 1.2 mb HD	8.89	Pre-Formatted	9.69
3.50" 1.0 mb DS	6.99	Pre-Formatted	7.69
3.50" 2.0 mb HD	13.79	Pre-Formatted	14.69

Price Per Box

### 3M DATA CARTRIDGES

DC-2000	13.95	DC-600A	18.99
DC-300XLP	17.39	DC-6150XTD	19.99

(Call for others and also formatted)

### TAPE AND BACKUP

700-1/2"-2400-C55	11.95	777-1/2"-2400-C55	10.95
DEC-TK-50	23.95	DEC-TK-52	35.95
IBM-3480	4.55	Opt Rewrite Disks	159.00

### 3M HIGHLAND DISKETTES

5.25" 720 Kb DS	3.79	5.25" 1.2 mb HD	6.49
3.50" 1.0 mb DS	6.79	3.50" 2mb HD	11.99



## BASF

DS-DD	Export Quantity Discounts Available	DS-HD
49 PER BOX	5.25" BASF Brand Diskettes	749 PER BOX
679 PER BOX	3.50" BASF Brand Diskettes	1199 PER BOX



## Verbatim DataLifePlus

Teflon/Preformatted

\* TEFLON / PREFORMATTED #

DS-DD	Quantity Discounts Available	DS-HD
529*# PER BOX	5.25" DataLife Plus Diskettes	899# PER BOX
719 PER BOX	3.50" DataLife Diskettes	1399 PER BOX



## maxell

5.25" DS/DD	5.25" DS/HD	3.50" DS/DD	3.50" DS/HD
4.89	8.89	7.19	13.89

## KAO COLOR BULK

DS-DD	"No-Logo"	DS-HD
.39	5.25" Color Diskettes	.69
.59	3.50" Color Diskettes	.99

## BULK DISKETTES

5.25" DS/DD	5.25" DS/HD	3.50" DS/DD	3.50" DS/HD
.28*	.42*	.39	.79

\*WITH SLEEVES, LABELS AND W/P TABS



## HEWLETT PACKARD

Laserjet Series I-II-III Laserjet Toners 74.95  
Laserjet Series II P 60.95



## DEC

Compactape for TK50 & TZ30	24.95
Compactape II for TK70 & TK52	38.95
LN03 Maintenance Kit	159.90



## EPSON Original DFX5000

18.29

**WE BEAT ANY PRICE!!**

TERMS: No surcharge on VISA, MasterCard or AMEX. Order packaging and processing = \$2.95 per order. COD orders add \$3.95. PO's accepted from recognized institutions on Net 30 days. L/C, T/T and Bank Draft acceptable. Price quoted for case (100 disks or 10 cartridges). For quantities less than 1 case add 10% SHIP PRICING surface \$1.95/5 cartridges, \$0.95/50 diskettes. (Prices subject to change without notice. Errors and omissions not accepted. All warranties are from manufacturers.)

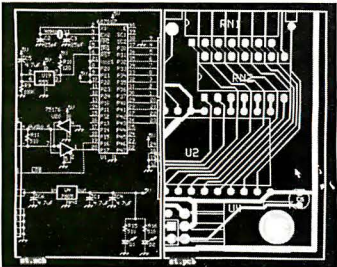
Toll Free Order Line: 1-800-523-9681  
Information Line: 1-801-255-0080  
TLX-9102404712 FAX-801-572-3327

## DISKOTECH

213 Cottage Avenue  
P.O. Box 1339 Sandy, Utah 84091





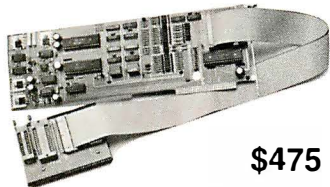


**New Schematic and PCB Software**  
 With support for extended and expanded memory, HiWIRE II can handle your most demanding schematic and PCB designs quickly and easily. The unique HiWIRE editor allows you to display and edit schematics and PCBs simultaneously, using the same commands for each. HiWIRE II is \$995, and is guaranteed.

**WINTEK Corporation**  
 1801 South Street, Lafayette, IN 47904  
 (800) 742-6809 or (317) 448-1903

Circle 364 on Reader Service Card

**UNIVERSAL PROGRAMMER**



\$475

**PAL EPROM**  
**GAL 8748/49**  
**PROM 87C51...**  
**EEPROM EXOTIC's**  
**5ns PALs**  
**4 Meg EPROMs**  
 Parts added at your request.

FREE software updates on BBS.  
 Powerful menu driven software.

Call - (201) 994-6669  
**Link Computer Graphics, Inc.**  
 4 Sparrow Dr., Livingston, NJ 07039  
 FAX: (201) 994-0730

Circle 175 on Reader Service Card



NOW — stop data loss before it strikes!  
**DriveGuard** puts you on the offensive against sudden data loss disasters by detecting marginal conditions in your 5.25 in., high-density, floppy drive before they become a problem. At last you'll know when it's safe to store your valuable data on disk.  
 Selected features:

- Fast, accurate test of your floppy drive.
- Resolves interchangeability problems.
- Easy to use, menu driven interface.
- On-line help, mono and color support.
- Printed reports with test result history.

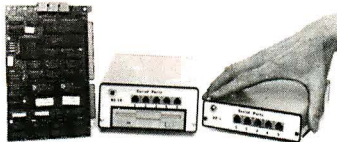
**DriveGuard** is an indispensable utility for anyone who owns or uses a PC/AT or 100% compatible computer with one or more 5.25 in., high-density, 1.2 meg floppy disk drives. 512k RAM required.

Send check or money order for \$89.95+\$4.00 S&H to Test Technology, P.O. Box 360118, Milpitas, CA 95036. California residents add sales tax. Call (408) 946-1722, 9am to 5pm PST.

"Don't boot up without it!"

Circle 318 on Reader Service Card

**GET on the PC BUS**



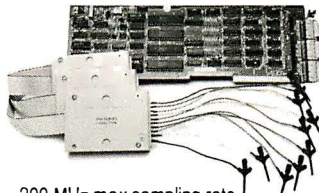
**DOS & .EXE in ROM AT Class Computers \$299**

It's easy to run stand-alone applications from ROM! Develop and download your code from a PC, then follow our simple steps to burn .exe & DOS in ROM.

**CPU** NEC V50, 10mhz, cmos, runs PC/AT code  
**1M RAM, 256K ROM, 5 serial ports**  
**Firmware** BIOS, Utilities, Monitor & Source code  
**Expansion** Standard PC/AT cards on a backplane  
 Piggyback: Flop, Printer, Keyboard, SCSI

**Kila SYSTEMS**  
 655 Hawthorn Ave., Boulder CO, 80304 Fax 303-786-9983  
**Call!**  
**(303) 444-7737**

**200 MHz Logic Analyzer**



- 200 MHz max sampling rate
- 24 Channels Timing and state
- 16K samples/channel
- 16 Levels of triggering
- 3 External Clocks and 12 Quality lines
- Variable, TTL, ECL threshold levels
- FREE software updates on 24 Hour BBS

\$ 799-LA12100 (100 MHz)  
 \$1299-LA27100 (100 MHz)  
 \$1899-LA27200 (200 MHz)

Price is complete Pads and Software included  
 Call - (201) 994-6669

**Link Computer Graphics, Inc.**  
 4 Sparrow Dr., Livingston, NJ 07039  
 FAX: (201) 994-0730

Circle 176 on Reader Service Card

**There is a Difference!**  
 Lifetime Free Updates

**CP-1128**  
**\$1295**



A programmer is not just another programmer. That is why BP Microsystems is committed to bringing our customers the highest quality programmers at an affordable price. This commitment is evident in our CP-1128 Combination PROM/EPROM/PLD Programmer supporting over 1800 devices up to 28-pins. Call today!

**BP MICROSYSTEMS**  
 1-800-225-2102  
 713/461-9430

Circle 42 on Reader Service Card

**IME COMPUTERS**

EST. 1981 Quality Products at Liquidation Prices

ASK ABOUT OUR VOLUNTARY DISCOUNTS!

**SPECIAL CLOSE-OUT PRICES!**

**MAXTOR 3.5" • HALF-HEIGHT • SCSI 100MB • 26ms 1-Year IME warranty**



**HARD DRIVES**  
 Internal \$399  
 External \$499

**PLUS SUPER VALUES ON OTHER MAXTOR DRIVES**

Model#	XT-3280	EXT-4380
CONDITION	NEW	Recertified
Formatted	244MB	319MB
Interface	SCSI	SCSI
Height	Full	Full
Ave. Seek Time	30ms	27ms
IME Warranty	90 days	90 days
Last List Price	\$2,265.00	\$2,325.00
IME Price	\$699	\$999

**LIMITED TIME OFFER ON EXT-4380 SPECIAL PRICE \$899**

**SPECIAL OFFER ON CPU-ONLY SYSTEMS**

**AMDEK 10MHz 286**

INCLUDING:

- 102-key extended keyboard
- 1 parallel and 1 serial port
- HD/FD controller
- 90-Day IME warranty
- 512KB RAM
- 1.2MB floppy drive
- 7 expansion slots
- MS-DOS 3.3

While supplies last ..... only **\$379**

**Amdek/Wyse 12.5MHz 286**

**Private Label (CPT)**

- 1MB RAM standard; 16MB addressable
- Dual-hard/dual-floppy controller (Western Digital)
- 102-key "Rexon" keyboard
- 7 expansion slots (5 avail.)
- 3 storage bays (2 available)
- 2 serial ports, 1 parallel port
- MS/DOS 3.3, GW BASIC
- 1.2MB floppy drive
- One wait state
- Small footprint

While supplies last ..... only **\$499**

**Xerox 2700-II Heavy-Duty Laser Printer**

- Equivalent to DEC LN01 laser printer
- 300dpi
- 60,000 pp/month duty cycle
- 500-sheet offsetting stacker safely stores output
- Portrait and landscape modes supported

Orig. List Price: \$27,000 • Our Price? The lowest imaginable!  
 (It's under \$10000!) **CALL US!**

**NOVELL'S NETWORKWARE 386 Software Version 3.1 Just \$4200**

**VGA COLOR AT B&W PRICES! Zenith 13" VGA Color Monitor**

- Private Label: "Data General"
- 0.31 Dot Pitch
- Graphics Mode... • 640 x 480 resolution • 16 colors out of a palette of 256,0000
- 15-pin "D" connector
- Text Mode... • 80 characters x 25 rows • 720x 400 resolution w/ 9 x 16 character cells

TILT/SWIVEL STAND AVAILABLE FREE!  
 (minimal shipping charge)  
 (Last List Price: \$695.00) **\$289**

**15" Amdek Hi-Res Monitor**

- Monochrome—paper-white
- WYSIWYG—Res. to 1280 x 800
- Automatic mode switching
- Includes drivers for all popular software, display card, 30-day IME warranty. New.

(List Price \$999.00) **IME Price: \$179**

**Call (800) 999-1911** NO SURCHARGE  
 VISA MasterCard  
 FAX (617) 254-0392 • BOSTON, MA

# **NEC and DATAWARE**

## **WORKING FOR YOUR FUTURE**

**NEC** **DESKTOP SYSTEMS** **286** **386**  
Powermate, Businessmate and Powermate Portables

**NEC** **LAPTOP SYSTEMS** **386SX** **486**  
Ultralite and Prospeed

**NEC** **GRAPHICS and OPTICAL** **2A** **3D**  
Monitors, Graphic Boards, Media and CD-ROMs **4D**

**NEC** **PRINTERS** **P32/3300** **5D**  
Dot Matrix and Laser **P62/6300**  
Colormate PS Color Thermal Transfer - **P9300**  
Multimedia and Desktop Publishing Capability  
for IBM, Apple and DEC **90/290**

### **NEC PREMIER SERVICE CENTER**

**WALK-IN and ON-SITE SERVICE**

**\$500,000 PARTS INVENTORY**

**MOST COMPLETE LINE OF NEC SUPPLIES IN STOCK**

**CALL FOR THE VERY BEST IN PRICES AND SERVICE**

Free Lotus 1-2-3™ and Windows™ with any **NEC** 386SX, 386 or 486 III  
**\$400.00 off every Colormate PS III**

**DATAWARE PRODUCTS, INC.**

**295 University Ave.**

**Westwood, Massachusetts 02090**

**1-800-242-4374 in Mass. - (617) 461-1160 FAX: (617) 461-0083**

# BLAST YOUR MESSAGE THRU!

**VOICE MAIL • TELEMARKETING CALL PROCESSING**

Let Powerline transform your PC/XT/AT/386 into a multi-line voice processing command center. Have your computer intelligently process your sales, inquiries and messages. Complete package.

**Single Line (Bignouth) . . . \$295.00**  
**Multi-Line . . . . . \$895.00**

(Developer/OEM packages available)  
 VISA • MC • AMEX • COD

**Call: (415) 522-3800**  
 FAX: (415) 522-5556

**TALKING TECHNOLOGY, INC.**   
 1125 ATLANTIC AVE., ALAMEDA, CA 94501

©1990 TALKING TECHNOLOGIES INC.

Circle 312 on Reader Service Card

# IEEE 488.2

Hardware for IBM PC/AT, Micro Channel, Sun, Macintosh, DEC, and NeXT.

Software for DOS, UNIX, VMS, menu-driven and icon-driven environments.

IEEE 488 extenders, analyzers, converters, analog I/O, and digital I/O.

**Call for your free IEEE catalog**

IOtech, Inc. • 25971 Cannon Road  
 Cleveland, Ohio 44146 • (216) 439-4091

Circle 158 on Reader Service Card

## X.25 SDLC QLLC HDLC ADCCP PAD

- C source code
- ROM-able
- Full porting provided
- No OS required

**GCOM, Inc.**  
 1776 E. Washington  
 Urbana, IL 61801  
 (217) 337-4471

Specialists in Computer Communications  
 FAX 217-337-4470

Circle 116 on Reader Service Card

# VERBATIM SONY • BASF

**100% CERTIFIED LIFETIME WARRANTY**

5 1/4" DS/DD	\$ .39 each
5 1/4" DS/HD	.59 each
3 1/2" DS/DD	.59 each
3 1/2" DS/HD	1.09 each

Price based on mix/match qty. of 300 in bulk.  
 Includes Tyvek sleeves and label kits.

**PREFORMATTED • COLORS • TAPES**

## MEGASoft

P.O. Box 710, Freehold, NJ 07728  
**800-222-0490**  
 In NJ 908-462-7628  
 FAX 908-462-5658

Circle 192 on Reader Service Card

# DATA ACQUISITION

- Systems for Lab, Factory & Field
  - PC Software Included
  - Serial, Modem, & Bus
  - Stand Alone Ability
  - Laptop & Handheld
  - PC & MAC Cards
  - Inexpensive
  - OEM & VAR
  - RTU's

**FREE CATALOG & DEMO DISK!**

Manufacturers of Measurement & Control systems for Laboratory, Industrial, & Field applications. Specialists in Battery-Powered systems.

Call for applications info: (201) 299-1615  
 P.O. Box 246; Morris Plains, NJ 07950 U.S.A.

**ELEXOR**

Circle 104 on Reader Service Card

# Terminal Emulation

## TEK 4105/4010

- Tektronix 4105
- Tektronix 4010/4014
- VT320, VT220, VT102
- Picture files
- VGA and EGA support
- High resolution hardcopy

## VT320

- VT320, VT220, VT102 emulation
- File transfer
- 132 column modes
- Color support
- Hot key
- Extensive network support

■ ■ ■ **Diversified Computer Systems, Inc.**  
 3775 Iris Avenue, Suite 1B  
 Boulder, CO 80301 (303) 447-9251  
 FAX 303-447-1406

Trademarks: VT102, VT220 — DEC; Tektronix — Tektronics Inc.

Circle 98 on Reader Service Card

# KNAPCO

MASTER DISTRIBUTORS

## TOSHIBA UPS

### TRUE ON-LINE UPS SYSTEMS

**SINE - WAVE**  
 TOTALLY SELF CONTAINED  
 LESS THAN 3% THD. GELL - CELL BATTERIES FOR UP TO 30 MIN.  
 RS232 PORT STANDARD, PROTECTS AGAINST BLACKOUTS, BROWNOUTS, SAGS, SPIKES & LINE NOISE. NOW UPS SHIPPABLE  
**\*NEW SMALLER PROFILE**

	LIST	DEALER
500 VA.	\$ 1499.	\$ 1199.
750 VA.	\$ 1799.	\$ 1399.
1K VA.	\$ 2099.	\$ 1494.
2K VA.	\$ 3999.	\$ 2999.
3K VA.	\$ 6599.	\$ 3999.
5K VA.	\$ 9379.	\$ 6499.

## TOSHIBA UPS

ORDER HOT LINE  
**800-827-4718**

**INTERNATIONAL TRANSFORMERS**  
 220v. / 110v. step up / down

100 WATT. TRANSF	\$ 28.
300 WATT. TRANSF	\$ 40.
500 WATT. TRANSF	\$ 59.
1000 WATT. TRANSF	\$ 89.
1500 WATT. TRANSF	\$ 98.
*2000 WATT. TRANSF	\$116.
*3000 WATT. TRANSF	* TAPS \$197.

**VOLTAGE REGULATORS & CONDITIONERS**

TYR 500 500 WATT 110 / 220v.	\$259. \$128.
TYR1000 1000 WATT 110 / 220v.	\$349. \$196.

\*\* Above with STEP UP or DOWN TRANSFORMERS  
 MY 2K 2000 WATT 220v. ONLY \$429. \$239.  
 YR2K 2000 WATT 110 / 220v. \$649. \$379.  
**MY5 500 WATT (110 v. REGULATOR) \$ 99.**

**NEW WE HAVE THE BEST PRICE**  
**AUTOMOBILE INVERTERS (110v. MOBILE POWER FOR YOUR VAN OR CAR) POWERS LAB EQUIPMENT, FAX MACHINES, LAPTOPS, PORTABLE TELEPHONES, NINTENDO. COPY MACHINES, TYPEWRITERS \$79.**

**AMERICAN POWER CONVERSION**  
 LOW COST OFF - LINE POWER SUPPLIES  
 NEW!!!! SINE WAVE

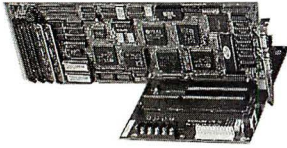
200 DL	110 or 220v. Models	\$199.	\$169.
450 AT	Retail Dealer	\$399.	\$269.
*400 SMART-UPS		\$499.	\$325.
*600 SMART-UPS		\$699.	\$479.

**813 - 449 - 0019**  
 FAX 813 - 449 - 0701 R-22

# KNAPCO

QUALITY DISTRIBUTION FOR 45 YEARS  
**1201 HAMLET AVE.**  
**CLEARWATER FL. 34616**

Industrial & Lab Automation with PCs  
**ADVANTECH**



**All-in-One 80286-12  
CPU Card**

PCA-6125 **\$395**

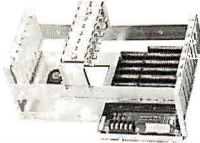
- 12MHz 80286 microprocessor
- Socket for 80287 math coprocessor
- AMI BIOS assures compatibility
- Memory configuration: 512K, 1M, 2M & 4M
- Built-in interface for 2 IDE H/D and 2 F/D
- On-board: 1 parallel/2 serial ports
- VLSI CMOS for low power consumption

**408-293-6786**

1340 Tully Rd., #314, San Jose, CA 95122 FAX 408-293-4697

Circle 22 on Reader Service Card

Industrial & Lab Automation with PCs  
**ADVANTECH**



**Industrial PC Card Cage  
with 8 Slot Backplane**

IPC-6010 **\$195**

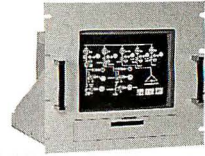
- Open-style framework for flexible installation in a custom enclosure
- 8 slot backplane with LED power indicators
- 4 layer PCB with dedicated power & ground planes
- Supports both standard PC power connection and industrial screw terminal connection
- Special hold-down clamp protects plug-in cards

**408-293-6786**

1340 Tully Rd., #314, San Jose, CA 95122 FAX 408-293-4697

Circle 22 on Reader Service Card

Industrial & Lab Automation with PCs  
**ADVANTECH**



**19" Rack Mounted  
Multi-Sync Monitor**

IPC-650/651M **\$895**

- 14" Multi-sync monitor
- Fully compatible thru Super VGA & 8514/A
- 1024 dots x 768 lines with .31mm dot pitch
- 19" EIA RS-310C standard rack
- Nickel coated aluminum housing
- Lexan overlay protects CRT screen

USA & Canada: San Jose, CA  
Tel: 408-293-6786 Fax: 408-293-4697  
Europe & Asia: Taipei, Taiwan  
Tel: 886-2-9184567 Fax: 9184566

Circle 22 on Reader Service Card



**QUARTERHORSE**  
High Capacity  
Tape Subsystems

for Disk Backup, Data Acquisition, and Archiving  
Everything you need in a single, high-quality package: Drive, SCSI Host Adapter, Enclosure, and DSI's Backup Software.

- 320/520 Mb 1/4" CT . . . . \$1,495
- 1.2 Gb 4mm DAT . . . . . \$3,195
- 2.3 Gb 8mm HS . . . . . \$3,695
- New: 450 Mb 3480 CT . . . . \$4,295

Optional Application Interface Library (in "C") available. Full Support.

Terms: U.S.-VISA, COD, pre-approval, credit.  
Other: Prepaid wire transfer, international letter of credit.

**DATA STRATEGIES  
INTERNATIONAL, INC.**

9020 Capital of TX Hwy, Ste. 420, Austin, TX 78759  
(512) 338-4745 FAX (512) 345-1328

Circle 81 on Reader Service Card

**EZ-WRITER**  
(E)EPROM MULTIPROGRAMMER™

Best Portable (E)EPROM  
Programmer Money Can Buy.



Models from  
**\$495.**  
★ Made in USA

- Stand-alone
- Remote Control
- 40-pin Micro option
- All models with 40 char. LCD
- GANG/SET (E)EPROM option
- RAM expandable to 16 Megabit
- Model KF, with Parallel Port for fast Up/Download
- Universal (E)EPROM support including 40-Pin Devices
- Model K3/C3, easy 3 key Operation

**BYTEK** Corporation  
800-523-1565  
FL: (407) 994-3520  
Fax: (407) 994-3615  
CA: (408) 437-2414  
Telex: 4998369BYTEK

Circle 46 on Reader Service Card

Advertise your  
computer products  
through  
**BYTE BITS**  
(2" x 3" ads)

For more information  
call Mark Stone at  
**603-924-2695**

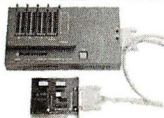
BYTE  
One Phoenix Mill Lane  
Peterborough, NH 03458

Circle 45 on Reader Service Card



**UNIVERSAL  
PROGRAMMER  
& TESTER**

**ALL-03  
IMPROVED**  
**\$695**  
(FREE UPDATE)



**SOFTWARE FEATURES:**

- (E)EPROM: NMOS, CMOS (up to 4-MB) • BPROM, PAL, CMOS PAL, GAL, PEEL, EPD, FPL • Microcomputer (8748, 51, -C51, 823 Series) • IC & MEMORY TEST • HEX to BINARY (INTEL/80/86, MOTOROLA/S1/S2, TEKTRONICS).
- 2-Way or 4-Way BINARY Filesplitter and shuffler. • Dump file to console in BINARY format. • Function include screen editing for BINARY DATA, ASCII and JEDEC FUSE MAP. • Security programming, Auto Programming and much more.

**HARDWARE FEATURES:**

- 40-Pin test socket with 40-Sets of software controlled circuit and 40-Sets of TTL I/O.
- 3 Groups of programmable D/A VOLTAGE SOURCE & 2 Groups of OSC output source.
- 60% of Digital components in high speed CMOS HCT type.
- Hardware expandable for complex device programming.
- Hardware Configuration is available for Software Designers.
- 'GO'-key & 'GOOD'-LED permit stand-alone machine operation.
- Various Adapters (1 to 4 Sockets)—Optional.

\*\*\* 1-Year Warranty & 30 Days Money-Back Guarantee \*\*\*

TEL: (408) 748-8491, FAX: (408) 748-8492

**C & J MICRONICS**

1400 Coleman Ave. Suite D-13, Santa Clara, CA 95050

Call Toll Free (for Orders Only): 1-800-633-3449

Circle 80 on Reader Service Card

**33 MHz  
Single Board Computer**

Landmark 58.7 MHz



Norton SI 45.9  
Power Meter 8.1 MIPS

- Intel 80386 25/33 MHz processor
- Intel 82395 25/33 MHz "smart" cache controller (16-64K)
- Optional 25/33 MHz co-processor
- Up to 32 MB page mode memory
- 8 MHz I/O speed
- Phoenix/AMI/Award/Quadtel BIOS
- Passive backplane with seven expansion slots



PROFESSIONAL  
COMPUTER  
SYSTEMS (408) 263-0222

550 Valley Way, Milpitas, CA 95035

Circle 260 on Reader Service Card

**16-BIT RESOLUTION  
ANALOG-TO-DIGITAL  
CONVERTER**  
**12,000 SAMPLES/SEC**  
for IBM PC, XT & AT  
**SINGLE PIECE PRICE**  
**\$475**

We manufacture a broad line of data acquisition and control hardware and software for Apple and IBM computers.

Call for quotes on custom hardware or complete systems.

**LAWSON LABS, INC.**

74 4th AVE. W.N.  
KALISPELL, MT 59901  
800 321-5355 or 406 257-5355  
FAX 406 257-5572



Circle 174 on Reader Service Card

**48 CHANNEL 25MHz LOGIC ANALYZER**



**PA480 \$1595 + POD PRICE**

\*New WINDOWS 3.0 Compatible Software

- 48 Channels @ 25 MHz x 4K word deep
- 16 Trigger Words/16 Level Trigger Sequence
- Storage and Recall of traces/setups to disk
- Disassemblers available for: 68000, 8088, 8086, 6801, 6811, Z80, 8085, 6502, 6809, 6303, 8031.

NCI □ 6438 UNIVERSITY DRIVE  
HUNTSVILLE, AL 35806 • (205) 837-6667

Circle 212 on Reader Service Card

**PLD Design Software**

Get Started with CUPL™ for only **\$149.95**



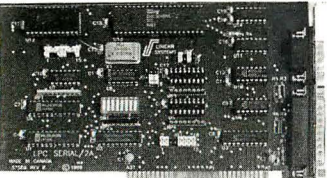
Now you can have a PLD Starter Kit that gives you all the horsepower that the CUPL PLD compiler offers, at a fraction of the cost. For more information, call 1-800-331-7766 or 305-974-0967.

**LOGICAL DEVICES, INC.**

Circle 177 on Reader Service Card  
(RESELLERS: 178)

**New**

**LPC Serial/2A HDLC/SDLC Data Communication Controller for IBM PC/AT Bus**



- Dual Channel Synchronous Controller (Z85C30)
- Runs 800K BAUD
- Full Duplex DMA
- HDLC LapB software option

**CMC Computer Modules, Inc.**  
2348C Walsh Ave.  
Santa Clara, CA 95051  
Tel: (408) 496-1881  
Fax: (408) 496-1886

IBM PC/AT is a trademark of IBM, Inc.

Circle 382 on Reader Service Card

**MARYMAC®**

14th year

of discounting Tandy® computers, Fax and Radio Shack® products

**Radio Shack® Tandy®**

We will meet or beat... **GUARANTEED LOWEST PRICES**

**MARYMAC INDUSTRIES INC.**  
22511 Katy Fwy.  
Katy (Houston), TX 77450  
1-713-392-0747 FAX (713) 574-4567  
Toll Free 800-231-3680

Circle 187 on Reader Service Card

**Program Your Chips**

In Sets of 4 for **\$495.00**



Special offer Now Includes:  
Free UV eraser, CUPL starter Kit and a \$300.00 Factory Rebate with the PDT-1 EPROM, EPLD, Micro Programmer.

**LOGICAL DEVICES, INC.**  
1-800-331-7766

Circle 179 on Reader Service Card  
(RESELLERS: 180)

**DOS IN ROM!**

ALWAYS WAITING FOR A PROMPT? SPEED UP WITH MVS ROM DRIVE!

- BOOT 0.1 SEC
- 1/2 SIZE CARD
- ANY PGMS, DOS
- LANS, CONTROL
- 64K... \$95
- 360K... 200
- 1.44M... 300

M V S  
(508) 792 9507

**8088 SINGLE BOARD COMPUTER**

- PC ON A CARD!
- 1. DEBUG ON PC
- 2. TEST SBC RAM
- 3. BURN EPROM
- BATTERY, SOLAR
- 5YR WARRANTY
- 62 PIN PC BUS
- 2PAR, 3SER, RTC
- LCO/KBD PORTS
- MVSBCL... \$95
- MVBIOS... 60
- PC CABLE... 50
- PC CARD... 85




Circle 194 on Reader Service Card

**Made in USA!**



**PC BASED UNIVERSAL DEVICE PROGRAMMER \$695/895**

- Programs EE/EPROMs, MICROS, BIPOLARS, PALS, GALS, EPLDs, PEELS. (current libraries support over 900 devices by over 35 manufacturers).
- Software driven pin drivers. D/A generated programming voltages (8 bit DACs used to generate voltages from 5-25V with 0.1V resolution for all pins).
- Fast device programming/verify/read via dedicated parallel interface.
- Upgradeable for virtually any future programmable devices up to 40 pins.
- Self-sustinent operation. No additional modules or plug-in adapters required.
- Includes user friendly MEMORY BUFFER FULL SCREEN EDITOR. Commands include: Fill, Move, Insert, Delete, Search. Data entry can be done in ASCII or HEX form. FUSEMAP EDITOR for Logic devices.
- Friendly Menu-Driven Interface. Device selection by P/N and Manufacturer.
- Supports 8/16/32 bit data word formats.
- Programming algorithms: Normal, Intelligent I & II, Quick Pulse Programming. Automatic selection of fastest algorithm for any given part.
- Verify operation performed at normal & worst case operating voltage.
- Functional test: JEDEC standard functional testing for logic devices. TTL Logic functional test for 74xx/54xx series devices and memory devices. Test library can be updated by the user. User definable test pattern generation.
- File formats accepted: JEDEC (full), JEDEC(kernel), Binary, MOS Technology, Motorola Hex, Intel Hex, Tektronix Hex.
- Base price (\$695) includes Interface card, cable, Memory + Micro + Bipolar library, TTL/CMOS/MEMORY device test capability, one year free updates.
- Complete price (\$895) includes all of the above plus LogiC Device Library.
- Library updates can be received via floppy or B&C Customer Support BBS.
- Full 1 year warranty. Customer support via voice line, Fax & dedicated BBS.

**Made in USA!**



**UNIVERSAL RS-232 PROGRAMMER \$345/495**

- Programs EE/EPROMs, ZPRams, Intel Micros, Flash EPROMs, Memory Cards.
- Stand-Alone Mode for EE/EPROM and Memory Card Duplication / Verify.
- All 24/28/32 pin EE/EPROMs to 4 Mbits (upgradeable to 32 megabits).
- Micros: 8741A, -2/A, -4, -8, -9, -51, -C51, -C51FA/B, -52, -53, -55, -C521, -C541, 9761.
- Model UP100 (\$345). Model UP200 (\$495) accepts dedicated modules.
- Memory Cards Programming Module (Seiko/Epson/Fujitsu) - \$145.
- GANG Programming Module (4 sockets) - \$145.
- Optional built-in Eraser/Timer module - \$50; Conductive foam pad.
- On-Board Programming capability; Custom interface modules available.
- User friendly, Menu-Driven Interface Program for IBM-PC and Macintosh.
- Can be operated with any computer containing an RS-232 serial port.
- OEM open board programmer configurations available (from \$245).
- One year free software updates and Customer Support.
- Customer support via voice line, dedicated BBS or fax; Full 1 year warranty.

**Made in USA!**



**INTELLIGENT ROM EMULATOR \$395**

- Emulates 2716 through 27512 EPROMs (2k to 64k bytes) with a single unit.
- Megabit parts can be emulated with multiple units (Mega adapter required).
- Connects to the standard parallel printer port. Uses standard printer cable.
- FAST data loading via parallel printer port (64k bytes in less than 10 seconds).
- Intelligent "In-Circuit-Emulator" type features include: Address Compare (with HALT output), Address Snapshot (for target addr. bus monitoring), Trigger Input (for external events monitoring), Programmable Reset Output.
- Powerful Memory buffer editor. Selectable word sizes (8,16,32).
- User friendly software. Command set includes: Load, Write, Display, Run, Type, Edit, Fill, Run-Command-File, Monitor, Port, Reset, Help, Calculator.
- Cascadable to 8 units. Includes target cable with Trigger, Halt & Reset clips.
- CMOS model with NiCad rechargeable 9V battery backup - \$495. (Can be used in stand-alone mode; Built-in battery recharging circuitry.)
- File formats accepted: Binary, Intel Hex, Motorola S.

MC / VISA / AMEX Call today for datasheets!

**B&C MICROSYSTEMS INC.**

750 N. PASTORIA AVE., SUNNYVALE, CA 94086 USA  
TEL: (408) 730-5511 FAX: (408) 730-5521 BBS: (408) 730-2317

**ARC TANGENT PROFESSIONAL MAIL** \$695

*Complete Mailing List Management Software*

The most advanced, professional-level mailing list management system available for IBM and compatible microcomputers. Save thousands of dollars on postage, printing, and processing costs.

- Unlimited number of names and addresses
- Sophisticated merge/purge duplicate detection
- Complete postal presorting and barcoding
- Custom letters, labels, reports
- Convert data from dBase, ASCII, other formats

Arc Tangent, Inc.  
121 Gray Avenue  
Santa Barbara, CA 93101-1831  
(805) 965-7277



Circle 29 on Reader Service Card

**BIG PLANS ... SMALL BUDGET ??**

Development Tools for 6805, 68HC05, 68HC11



**SPEAK WITH THE ENGINEERS**

The Engineer's Collaborative, Inc.  
Rt 3 Box 8C Barton, VT 05860  
TEL: (802) 525-3458  
FAX: (802) 525-3451  
Toll Free (800) 336-8321 ext. 101

In-Circuit Emulators      Programmers  
Simulator/Debuggers      Compiler/Assemblers  
Learning Tools              Terminal Emulators

**CALL US TO HELP YOU SELECT YOUR TOOLS**

Circle 321 on Reader Service Card

**ICs PROMPT DELIVERY!!!**  
SAME DAY SHIPPING (USUALLY)  
QUANTITY ONE PRICES SHOWN for NOV. 18, 1990

Memory For Almost ALL Computers

<b>DYNAMIC RAM</b>		
4M Board for hp LJ's w/2MB	\$165.00	
SIMM 2M IBM PS/2 Model 70	165.00	
SIMM 1M AST Prem386/33Mhz	120.00	
SIMM 1Mx9 80 ns	47.00	
SIMM 256Kx9 100 ns	18.00	
1 Mbit 1Mx1 60 ns	9.95	
1 Mbit 1Mx1 80 ns	4.90	
41256 256Kx1 80 ns	2.75	
41256 256Kx1 100 ns	1.95	
41256 256Kx1 120 ns	1.45	
4464 64Kx4 100 ns	1.95	
41264* 64Kx4 100 ns	5.95	
<b>EPROM</b>		
27C1000 128Kx8 200 ns	\$14.00	
27C512 64Kx8 120 ns	5.25	
27256 32Kx8 150 ns	6.75	
27128 16Kx8 250 ns	3.65	
<b>STATIC RAM</b>		
62256P-10 32Kx8 100 ns	\$7.50	
6264P-12 8Kx8 120 ns	4.25	

OPEN 6 DAYS, 7:30 AM-10 PM. SHIP VIA FED-EX ON SAT.

SAT DEL ON FED EX ORDERS RECEIVED BY: Th: \$2 \$824 b Fr: \$1 \$1700 1 b COD AVAILABLE

MasterCard/VISA or UPS CASH COD MICROPROCESSORS UNLIMITED, INC. 24 000 S. Peoria Ave. BEGGS OK, 74421 (918) 267-4961

No minimum order. Please note: prices subject to change! Shipping, insurance extra, up to \$1 for packing materials.

Circle 198 on Reader Service Card

**VIDEO CAPTURE BOARD**

Over 16 Million on screen colors  
512 x 512 x 24

FREE Menu Driven Software includes:

- 10 FREE hrs C development for YOUR application !
- Comp/Decompression, filters histograms, DSP, zooms, etc ..
- C Graphics Library

Digitizes at Video rate  
Composite Video In/Out  
IBM AT/386 compatible  
1 YEAR WARRANTY  
30 day Money Back Guarantee

\$1875      1753 Mass. Ave.  
**EECS**      Cambridge MA 02140  
Tel : 617-498-9838  
FAX : 617-491-6808

Circle 105 on Reader Service Card

**!!!! NEW !!!!**

32 I/O ← - → RS-232



- \* FINALLY ANY COMPUTER CAN HAVE I/O
- \* PLUGS INTO ANY STANDARD RS-232 PORT
- \* 16 DIGITAL INPUTS, 16 DIGITAL OUTPUTS
- \* ALL I/O OPTO-ISOLATED PROTECTED
- \* NO ADDITIONAL HARDWARE REQUIRED
- \* NO MORE SPECIAL PLUG-IN CARDS
- \* EASY TO PROGRAM IN ANY LANGUAGE
- \* UP TO 4 BOARDS CONNECT TO ONE RS-232
- \* IDEAL FOR REMOTE MONITOR & CONTROL
- \* USED IN INDUSTRY, SCHOOLS, LABS & HOBBY
- \* INDUSTRIAL VERSION AVAILABLE
- \* RS-422/485 VERSION AVAILABLE
- \* GRAFCET CONTROL SOFTWARE AVAILABLE
- \* COMES WITH PC BASIC PROGRAM DEMO DISK
- \* STANDARD UNIT PRICED AT ONLY \$349 QTY 1
- \* DEALER INQUIRIES ARE WELCOME

P. SHERMAN ENTERPRISES (514) 331-3712


Circle 268 on Reader Service Card

**9-Track Tape For Your IBM PC/XT/AT/PS-2™**

Read 1600 or 6250 bpi 9-track tapes from a micro, mini or mainframe in EBCDIC or ASCII as mirror image or by individual files.

Use the 2000 PC™ for disk backup, data interchange or archival storage.

PC/XT/AT/PS-2 are trademarks of IBM. 2000 PC is a trademark of Digi-Data.



DIGI-DATA CORPORATION  
8580 Dorsey Run Road  
Jessup, MD 20794-9990  
(301) 498-0200  
800-782-6395  
FAX (301) 498-0771

... First In Value

Circle 93 on Reader Service Card

**PC MAGAZINE EDITORS' CHOICE**

FROM THE PEOPLE WHO BROUGHT YOU THE WORLD-RENOWNED AMI BIOS

**AMIDIAG**  
ADVANCED DIAGNOSTIC UTILITY

"... the most comprehensive package that delivered the most accurate results in the shortest time..."  
PC Magazine, August 1990

Finally available to you, the end user, the most comprehensive diagnostic utility ever. AMIDIAG delivers to the user a software-based diagnostic tool suitable for use on IBM PC Compatible 80286, 80386 and 80486 based systems. AMIDIAG carries the same high-quality characteristics that you are used to receiving from AMI.

Features

- ◆ Extensive RAM and ROM testing, with graphic RAM error display
- ◆ Testing of video adapter and all video functions and modes, from MDA to VGA
- ◆ Hard disk diagnostic/performance tests
- ◆ Floppy disk diagnostic/performance tests
- ◆ Serial and parallel port tests
- ◆ Extensive Keyboard testing
- ◆ Pull-down menus
- ◆ Three modes of testing to choose from: Time-bound, Pass-bound and Continuous
- ◆ Repairs errors to screen, disk, or printer
- ◆ Runs individual, selected, or all tests
- ◆ 51/4" and 51/2" disks available

Available From:  
**UPGRADES ETC. INCORPORATED**

Toll Free (800) 541-1943  
15251 N.E. 90th Street  
Redmond, WA 98052  
FAX (206) 881-8294

\* We Are Your BIOS and Upgrade Source

**\$99.00**

Circle 353 on Reader Service Card

**ROM BIOS UPGRADES**

**ROM BIOS FEATURES**

THE ROM BIOS UPGRADES SUPPORT 360K, 720K, 1.2MB & 1.44MB FLOPPY DISK DRIVES; COMPLETE SET-UP IN ROM, EGA AND VGA SUPPORT; OPTIONAL BUILT-IN DIAGNOSTICS IN ROM (AMI ONLY); NOVELL AND NETWORK COMPATIBLE; SUPPORTS UP TO 48 DIFFERENT TYPES OF HARD DRIVES PLUS TWO USER DEFINED; 64, 101 & 102 KEY KEYBOARD SUPPORT; 100% IBM COMPATIBLE; SUPPORTS 0.1 OR 2 WAIT STATES; COMPLETE DOCUMENTATION; LATEST VERSIONS. WE ARE THE LARGEST STOCKING BIOS DISTRIBUTOR IN AMERICA!

**XT BIOS UPGRADES**

AMI-XT BIOS ..... 49.95      PHOENIX-XT BIOS ..... 49.95

**AT 286 BIOS UPGRADES**

AMI-286INTEL BIOS ..... 69.95      AMI-286 VLSI BIOS ..... 69.95  
AMI-286 CHIP & TECH BIOS ..... 69.95      PHOENIX-286 INTEL BIOS ..... 69.95  
AMI-286 AST BIOS ..... 69.95      PHOENIX-286 AST BIOS ..... 69.95

**AT 386 BIOS UPGRADES**

AMI-386INTEL BIOS ..... 69.95      AWARD-386 CHIP & TECH BIOS ..... 69.95  
AMI-386 VLSI BIOS ..... 69.95      PHOENIX-386 INTEL BIOS ..... 69.95  
AMI-386-SX INTEL BIOS ..... 69.95      PHOENIX-386 INTEL BIOS ..... 69.95  
AMI-386-SX CHIP & TECH BIOS ..... 69.95      PHOENIX-386 CHIP & TECH BIOS ..... 69.95  
AWARD-386 INTEL BIOS ..... 69.95      PHOENIX-386-SX INTEL BIOS ..... 69.95

**IBM BIOS UPGRADES**

PHOENIX-IBM-PC BIOS ..... 69.95      PHOENIX-IBM-AT BIOS ..... 69.95  
PHOENIX-IBM XT BIOS ..... 59.95

**KEYBOARD BIOS UPGRADES**

AMI-286/386 KEYBOARD BIOS ..... 34.95  
AWARD-286/386 KEYBOARD BIOS ..... 34.95  
PHOENIX-286/386 KEYBOARD BIOS ..... 34.95

**UPGRADES ETC. INCORPORATED**  
(800) 541-1943

15822 H.E. 165TH ST.  
WOODHULL, WA 98052  
(800) 541-1943 - ORDERS  
(206) 882-8294 - TECH SUPPORT  
(206) 881-8294 - FAX

VISA \* MC \* COD

Circle 354 on Reader Service Card

**Intelligent Solutions**

**SCSI CONTROLLERS FOR ISA & MCA**

**The Only DCBs to Consider for NetWare!**

NEW! PROCOMP F-DCB for NetWare has on-board boot & floppy support.

NEW! DRAVADD & DRANLM deliver super hard disk & erasable optical performance under NetWare.

Use with NetWare 286 & 386. (Also, drivers for OS/2, DOS and XENIX.)

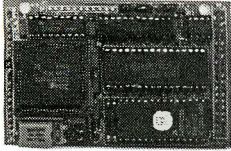
NEW! Create fully NetWare Ready compatible drives using DCBSET 5.

**PROCOMP** Phone: (216) 234-6387  
FAX: (216) 234-2233

The SCSI Professionals  
6777 ENGLE ROAD, CLEVELAND, OH 44130

Circle 259 on Reader Service Card

## Instant Microcontroller



### Instant C Programming

Don't use a microprocessor, use a SmartBlock™ microcontroller module to build your custom controller. Our low cost Dynamic C™ makes programming a snap. 3.5 x 2.5 inch module includes microprocessor, memory, time/date clock, eeprom, watchdog, serial ports and more. As low as \$59. The efficiency of a custom design without the headaches.

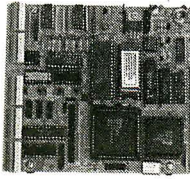
#### Z-World Engineering

1340 E. Covell Blvd., Davis, CA 95616  
Tel: (916) 753-3722  
Fax: (916) 753-5141

## Little Giant™

### C Programmable Controller

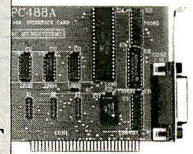
This shirt pocket sized computer interfaces directly to the outside world. Use it to control anything. Instantly programmable using your PC with Dynamic C. ROM and battery backed RAM to 1024k bytes. 8 Channel, 10/12 bit, A/D with conditioning. High voltage and current drivers. Battery backed time and date clock. Watchdog and power fail. 4 serial channels. 24 parallel I/O lines. Timers. Integral power supply. Terminations for field wiring. Expansion connector. Plastic or metal field packaging available. OEM versions from \$199.00.



#### Z-World Engineering

1340 Covell Blvd., Davis, CA 95616  
(916) 753-3722  
Fax: (916) 753-5141

## LOW COST INTERFACE AND DATA ACQUISITION / CONTROL CARDS FOR PC/XT/AT



### RS-485/422 Card [PC485] \$95/125

- Serial Async. Communication up to 4,000ft; 2 or 4 wires; NS16450 UART;
- A additional simple programs in C, Pascal & Assembly \$58.
- Can be configured as COM1-COM4; Maximum Baud Rate 56KB.
- Flexible configuration options. RTS or DTR control of transmission direction.
- Full/Half duplex operation. Supports hardware handshaking (RTS,CTS).
- Dual drivers/receivers; Handles 64 devices; Compatible with most comm. sw. (rtw).
- High speed version available (supports baud rates up to 256KB) - \$165

### Dual-Port RS-485/422 [PCL743] \$175

- Two independent channels / UARTs; 2 or 4 wire operation. Max. Baud 56KB
- Dipswitch configurable as COM1-4 (IRQ2-7). On board terminator resistor.

### IEEE-488 Card [PC488A] \$145

- Includes DOS Device Driver and sample Communication program in BASIC.
- A Additional simple programs in C, Pascal & Assembly \$58.
- IRQ (I-6), DMA channel 1 or 2. Up to 4 boards per computer.
- Compatible with most IEEE-488 Software packages for IBM-PC.
- I/O Addresses and Control Registers compatible with NI's GPIB-PCII.
- PC488C card version with Built-In Bus Analyzer hardware and software - \$445 (Allows Real Time 488 Bus Data Capture in background operation mode.)

### Digital I/O & Counter [PCL720] \$175

- 32 Digital Input and 32 Digital Output Channels, 3 channel programmable counter/timer. User configurable clock source. Bread board area.

### 144 Bit Digital I/O [PCL722] \$295

- 144 lines (24 bits x 6 ports) of TTL compatible digital I/O. Output buffers sink 24mA, source 15mA. Interrupt handling capability. Opto-22 module compatible.

### Relay & Isolated D/I [PCL725] \$240

- 8 Relay actuator outputs, 8 Opto-isolated digital inputs. Relay driver circuits.
- LED indicators for activated relays. On board signal conditioning.

### 10 Channel Counter [PCL830] \$295

- 10 Independent 16 bit up/down counters. Programmable frequency output.
- 16 bit TTL input and 16 bit TTL output ports. Selectable interrupt channel.

### 6 Channel 12 bit D/A [PCL726] \$495

- Output Ranges: 0 to +5V, 0 to +10V, ±5V, ±10V or sink +420mA.
- Settling time: 70µs. Linearity: ±1/2bit. Voltage output driving capacity: ±5mA
- Digital I/O: 16 digital inputs and 16 digital outputs; TTL compatible.

### 12 BIT A/D & D/A [PCL711s] \$295

- A/D converter: 8 single-ended channels; Device: AD574; Conversion time less than 25µsec; Input range: ±5V; Software Trigger Mode only.
- D/A converter: 2 channels; 12 bit resolution; Output Range 0-5V.
- Digital I/O: 16 Input / 16 Output channels; All I/Os TTL compatible.
- External Wiring Terminal Board with mounting accessories included.
- Utility Routines and Demo/Sample Programs for BASIC and Quick-BASIC.

### 12 Bit A/D & D/A [PCL812] \$395

- A/D converter: 16 single ended inputs; Device: AD574; Conversion time less than 25µsec; Built-in programmable pacer; Input ranges: ±10V, ±5V, ±1V.
- D/A converter: 2 channels; 12 bit resolution; Output Range 0-5V.
- Digital I/O: 16 Input / 16 Output channels; All I/Os TTL compatible.
- Counter: 1 channel programmable interval counter/timer; Uses Intel 8254.
- DMA and interrupt capability. Utility software for Basic included.

### 12 Bit w/ Prgm. Gain [PCL812pg] \$450

- A/D converter: 16 single ended inputs; Device: HAD574; Conversion time less than 25µsec; Built-in programmable pacer;
- Software Programmable Multiple Input Ranges: ±10V, ±5V, ±2.5V, ±1.25V, ±0.625V, ±0.3125V.
- D/A converter: 2 channels; 12 bit resolution; Output Range 0-5V.
- Digital I/O: 16 Input / 16 Output channels; All I/Os TTL compatible.
- Counter: 1 channel programmable interval counter/timer; Uses Intel 8254.
- DMA and interrupt capability. Utility software for Basic included.

### Fast 12 Bit A/D/A [PCL718] \$795

- A/D converter: 16 single ended or 8 differential channels; 12 bit resolution; Programmable scan rate; Built-in Interrupt and DMA control circuitry. Conversion speed 60,000 samples/sec (standard), 100,000 samples/sec (optional).
- Input ranges: Bipolar: ±10V, ±5V, ±2.5V, ±1V, ±0.5V; Unipolar: 10.5, 2.1V.
- D/A converter: 2 channels; Resolution: 12 bits res; Settling time: 5µsec, ±5V
- Digital I/O: 16 OUT, 16 IN; TTL compatible; All I/Os TTL compatible.
- Counter: 16 bit prog. interval counter/timer; Uses Intel 8254; Pacer clock;
- Software: Utility software for BASIC and QuickBASIC included. Supported by LabDAS (\$195/495), ASYST, LABTECH, UnkelScope

### Fast 12 Bit w/ Pgm Gain [818] \$845

- A/D converter: 16 single ended or 8 differential channels; 12 bit resolution; Programmable scan rate; Built-in Interrupt and DMA control circuitry. Conversion speed 100,000 samples per second.
- Software Programmable Input ranges: Bipolar: ±10V, ±5V, ±2.5V, ±1V, ±0.5V; Unipolar: 10.5, 2.1V.
- D/A converter: 2 channels; Resolution: 12 bits res; Settling time: 5µsec, ±5V
- Digital I/O: 16 OUT, 16 IN; TTL compatible; All I/Os TTL compatible.
- Counter: 16 bit prog. interval counter/timer; Uses Intel 8254; Pacer clock;
- Software: Utility software for BASIC and QuickBASIC included. Supported by LabDAS, ASYST, LABTECH, UnkelScope

### Stepper Motor Card [PCL738B] \$395

- Capable of independent and simultaneous control of up to 3 stepper motors.
- Speed: Programmable from 3.3 PPS to 3410 PPS; Built-in acceleration control.
- Output Mode: One clock (Pulse, Direction) or two clock (CW, CCW pulses)
- Step position: Red-back, Opto-isolated outputs. Crystal based timing.
- Includes 8 bit digital input/output port. Order P/N (PCL738B)

MC / VISA / AMEX

Call today for datasheets!

Circle 51 on Reader Service Card



**B&C MICROSYSTEMS INC.**

750 N. PASTORIA AVE., SUNNYVALE, CA 94086 USA  
TEL: (408)730-5511 FAX: (408)730-5521 BBS:(408)730-2317

Circle 374 on Reader Service Card

Circle 375 on Reader Service Card

# RENTALS

Our unique service provides you a short-term solution to your computer needs!

- IBM
- COMPAQ
- MACINTOSH
- LASERS
- PORTABLES
- LAPTOPS

Next Day Delivery Available

**PC Computer Rental**

CALL TOLL FREE

**800-785-4727**

Circle 237 on Reader Service Card

Circle 134 on Reader Service Card



### 3M Diskettes

	5.25"	Unformatted	Per Disk
DS/DD	#00234		\$ .57
DS/HD	#12100		\$1.00
	3.5"	Sold 10/box	
DS/DD	#12042		\$ .82
DS/HD	#12513		\$1.52
	5.25"	Formatted	Per Disk
DS/DD	#12597		\$ .63
DS/HD	#12883		\$1.06
	3.5"	Sold 10/Box	
DS/DD	#12882		\$ .86
DS/HD	#12881		\$1.61

**1-800-258-0028**

Call for free 60 page catalog!

Min. order \$25.00. S&H: FOB Grand Rapids MI. COD: add'l \$5.50. MI residents + 4% tax. Prices subject to change.

**Precision Data Products™**

P.O. Box 8367  
Grand Rapids, MI 49518  
616-698-2242 FAX: 616-698-9047

Circle 258 on Reader Service Card

## 486/25MHz 64K Cache Series \$1995



- i486/25MHz CPU w/8K Cache
- 64K External Cache Memory
- Expand 8Mb Memory On-Board
- Burst Mode for Max Throughput
- Baby-Size (8.5 by 13 in)
- AMI 486 BIOS w/Setup
- Intelligent Memory Refresh Scheme

**HOMESMART COMPUTING**

**800-627-6998**

(713)496-9110/Fax Info Line

14760 Memorial Dr. Houston, TX 77079

Prices Reflect Discount for Cash/MC/VISA  
All Prices Subject to Change Without Notice

Circle 134 on Reader Service Card

## R & R Electronics

6050-X, McDonough Drive, Norcross, GA 30093

(404) 368-1777 • Fax (404) 368-9659

We accept VISA MC Am Exp. & Discover + Fees

### D-RAMS SIMMs/SIPPS

256K-120	\$2.00	256Kx9-80	\$18
256K-80	\$2.25	1Mx8-80	\$45
64Kx4-100	\$1.90	1Mx9-80	\$50
256Kx4-80	\$5.25	1Mx9-60	\$75
1Mx1-80	\$5.00	4Nx9-80	\$350

### INTEL/WEITEK ITT/CYRIX

8087-2	\$115	2C87-8	\$170
80287-XL	\$225	2C87-10	\$188
80387-SX61	\$288	2C87-12	\$200
80387-20	\$350	3C87-20	\$310
80387-25	\$448	3C87-25	\$420
80387-33	\$545	3C87-33	\$505

PS/2-1mg	\$ 95	VGAcad 256K	\$ 99
PS/2-2mg	\$180	2400 Modem	\$ 66
HP laserjet 2mg	\$175	Dexxa Mouse	\$ 40
1.44 F/D	\$ 70	SVGA Monitor	\$375
Boca AT +	\$149	Card 2S, P,G	\$ 26

CALL FOR OTHER COMPONENTS



**1-800-736-3644**



Circle 282 on Reader Service Card

# EDITORIAL INDEX BY COMPANY

Index of companies covered in articles, columns, or news stories in this issue  
Each reference is to the first page of the article or section in which the company name appears

Company, Page #	Inquiry #				
<b>A</b>					
AbTech, 300	1225	Citrix Systems, 134	1206	General Dynamics, 281	
AC DataLink, 54	1290	Claris, 107, 147	1145	General Information, 72	1317
Adaptec, 168	1113	Cognition Technology, 300	1236	General Services Administration, 19	
Adobe Systems, 19, 147	1138	Comdale Technologies, 300	1237	Gold Hill Computers, 300	1250
Advanced A.I. Systems, 300	1226	Commodore Business Machines, 19, 329		Gonzaga University, 281	
Advanced Micro Devices, 10, 147	1139	Compaq Computer, 147, 210, 347	1009	Grey Matter Response, 58	1296
Advanced Software Automation, 62	1301		1112	Groupe Bull, 19	
AlCorp, 300	1227	CompuAdd, 19, 147, 168	1010	GSI, 46	1282
Al Ware, 300	1228		1114	GW Instruments, 339	
Aldus, 95		Computer Assisted Learning Center, 281		<b>G</b>	
Alliant, 347		Computer Technology, 19		Logitech, 147	1023
Amateur Systems, 416		ConnectWorks, 58	1294	LomasData Products, 168	1117
Ameritech, 19		COSMIC, 300	1238	Los Alamos National Laboratory Center for Nonlinear Studies, 289	
Amiga, 329		Crosstalk Communications, 19		Lotus Development, 19, 147, 230	1024 1204 1264
Analog Devices, 347		<b>D</b>		Lucid, 300	
Apple Computer, 19, 107, 147, 213, 315	1075 1140 1147 1286	D-Link Systems, 186	1083	<b>M</b>	
Appoint, 50	1286	Dariana Technology Group, 228	1109 1110	MacroMind, 19, 147	1025
Arche Technologies, 73	1151	Dataproducts, 19		Macronix, 46	1283
Ariel, 46	1281	DCA, 186	1078	Magee Enterprises, 62	1300
Artificial Intelligence Research Group, 300	1229	DCM Data Products, 19		Magic 7 Software, 73	1155
Artificial Intelligence Technologies, 300	1230	Defense Advanced Research Projects Agency, 259		Mahogany, 281	
Artisoft, 186	1076	Delta Point, 126	1167	Mars Microsystems, 19, 44	1273
Ashton-Tate, 66, 281	1302	Delta Tao, 147	1011	Marstek, 45	1275
AT&T, 19		Deneba Software, 339		Mass Optical Storage Technologies, 147	1026
Aware Electronics, 50	1289	Department of Transportation, 19		Mathsoft, 73	1157
Axcelis, 289		Digital Equipment, 19, 267, 300, 315	1239	Matrox Electronic, 46	1280
<b>B</b>					
Beacon Expert Systems, 300	1231	Digital Research, 147, 323	1008 1012	Mattel, 304	
Bell Atlantic, 300	1232	Distributed Processing Technology, 168	1115	Maxtor, 168	1121
Bellcore, 19		Dragon Systems, 147	1013	Meiko World, 19	1161
Bell Labs, 239		DTK Computer, 19		Meridian Data, 73	
Bitstream, 19, 147	1141	Dynamic Microprocessor, 186	1079	Micro Computer, 304	
Borland International, 19, 126, 147	1142 1163	<b>E</b>		Microcom Systems, 186	1081
Brightwork Development, 186	1077	Edsun Laboratories, 19, 147	1014	Microelectronics, 19	
Brown-Wagh Publishing, 73	1160	Emerald Intelligence, 281, 300	1240	Micro Express, 44	1274
Building Block Software, 62	1299	Encore Computer, 19		MicroMath Scientific Software, 70	1310
Bureau of Electronic Publishing, 73	1162	EPA, 19		MicroNet, 186	1086
<b>C</b>					
C&T, 19		Ergo Computing, 73	1154	Micropolis, 45, 168	1277 1027
C-Cube Microsystems, 147	1143	Experience In Software, 300	1241	Microrim, 147	
Calera Recognition Systems, 147	1144	Expertech, 300	1246	Microsoft, 19, 72, 95, 126, 147, 329	1028 1166 1315
California Intelligence, 300	1233	ExperTelligence, 300	1247	Microtest, 111	1105
California Scientific Software, 300	1234	Expert Systems Design, 300	1244	Millenium Software, 281, 300	1265
Canadian Council of Environment and Resource Ministers, 281		EXSYS, 300	1248	MIPS, 19	
Carnegie Group, 300	1235	<b>F</b>		Mirror Technologies, 45	1278
Carnegie Mellon University, 267		Farallon Computing, 186	1080	MIT, 289	
CCS Custom Computer Systems, 44	1271	Fast Technology, 168	1116	MIT Artificial Intelligence Laboratory, 239	
Central Point Software, 72	1314	FirstMark Technologies, 66	1306	Monolithic Systems, 201	1061
CH Products, 73	1159	Focus Systems, 19		Motorola, 19, 329	
Chicony Electronics, 19		Folio, 230	1205	MTS Associates, 329	
Chips & Technologies, 19		Fresh Technology, 186	1084	<b>N</b>	
		Future Trends Software, 70	1308	NASA, 259	
		<b>G</b>		National Design, 46, 126	1164 1279
				National Science Center for Science Information System, 19	
				National Science Foundation, 19	
				NCR, 147	1029
				Nestor, 300	1266
				NetFrame Systems, 315	
				Network General, 111	1106
				Neural Systems, 300	1267
				NeuralWare, 300	1268
				Neurix, 300	1269
				Neuron Data, 281, 300	1270
				NewTek, 147	1030
				NexGen Software, 304	
				NeXT, 147	1031
				<b>L</b>	
				LAN Systems, 186	1085
				Link Resources, 19	
				Locus Computing, 101	1004
				<b>H</b>	
				Harcourt Brace Jovanovich, 19	
				Hercules Computer Technology, 19, 147	1016
				Hewlett-Packard, 19, 147	1017
				Hewlett-Packard/Apollo, 147	1018
				HNC, 300	1251
				Houghton Mifflin Software, 147	1019
				Hub Material, 50	1288
				Hyperpress Media Lab Publishing, 300	1252
				Hyundai Electronics America, 19, 54	1290
				<b>I</b>	
				IBM, 19, 147, 300, 329	1020 1253 1254
				ICAD, 300	
				ICL, 19	
				If/then Solutions, 300	1255
				Inference, 300	1256
				Inference Engine Technologies, 300	1257
				Information Builders, 300	1258
				Informative Technologies, 73	1156
				Inner Media, 227	1111
				Insignia Solutions, 19	
				Insite Peripherals, 19	
				Institute for Learning Studies, 239	
				Integrated Inference Machines, 101	1007
				Intel, 10, 58, 147, 304, 315, 329, 347	1021 1297
				Intelecsis, 19	
				IntelliCorp, 300	1259
				IntelligenceWare, 300	1260
				Intelligent Environments, 300	1261
				Interactive Systems, 101, 147	1006 1022
				Intermap, 66	1303
				Invisible Software, 54	1292
				Iron Mtn Software, 72	1311
				<b>J</b>	
				JYACC, 19	
				<b>K</b>	
				KDS, 300	1262
				Knowledge Garden, 300	1263
				KXCom, 54	1291
				<b>L</b>	
				LAN Systems, 186	1085
				Link Resources, 19	
				Locus Computing, 101	1004



# A MESSAGE To OUR SUBSCRIBERS

FROM TIME TO TIME WE make the BYTE subscriber list available to other companies who wish to send our subscribers material about their products. We take great care to screen these companies, choosing only those who are reputable, and whose products, services, or information we feel would be of interest to you. Direct mail is an efficient medium for presenting the latest personal computer goods and services to our subscribers.

Many BYTE subscribers appreciate this controlled use of our mailing list, and look forward to finding information of interest to them in the mail. Used are our subscribers' names and addresses only (no other information we may have is ever given).

While we believe the distribution of this information is of benefit to our subscribers, we firmly respect the wishes of any subscriber who does not want to receive such promotional literature. Should you wish to restrict the use of your name, simply send your request to the following address.

**BYTE MAGAZINE**  
ATTN: SUBSCRIBER SERVICE  
P.O. Box 555  
HIGHTSTOWN, NJ 08520



Norrad, 300	1123	Sun Microsystems, 19, 147, 315, 347	1043
Northern Telecom, 19		Symantec, 107, 339	1149
Northgate Computer Systems, 19		Symbolics, 300	1133
Norton-Lambert, 186	1082	Symbologic, 300	1134
Novell, 19, 315			
<hr/>			
<b>O</b>		<b>T</b>	
Office of Personnel Management, 19		Talarian, 259, 300	1135
Olmsted & Watkins, 300	1124	Tally Systems, 72	1313
On Technology, 107	1150	Tatung, 19	
Open Software Foundation, 19		Telecommuting Solutions for America, 19	
Opus Systems, 19, 147	1032	Teledyne, 304	
Orphic Systems, 300	1245	Texas Instruments, 147, 304, 347	1044
OXKO, 300	1125	Thomas-Conrad, 111	1107
<hr/>			
<b>P</b>		Tigon, 19	
Paperback Software International, 300	1126	TMI, 66	1305
Paragon Concepts, 107, 147	1033	Togai InfraLogic, 300	1136
	1148	Toshiba America Information Systems, 19, 126	1165
Para Systems, 89	1221	Trackmate America, 72	1312
Perceptics, 300	1127	Transcomputer, 19	
Perceptive Solutions, 147, 168	1034	Traveling Software, 73	1158
	1118	TriGem, 19	
Pioneer, 73	1153	Truevision, 204	1108
Pixar, 223	1060	Twinhead, 19	
POP Computer Products, 72	1316		
Pritsker and Associates, 267		<b>U</b>	
<hr/>			
<b>Q</b>		Ultinet Development, 186	1087
Q/Cor, 147	1035	Ultrastor, 168	1119
QMS, 147	1036	Universal Technical Systems, 289	
Quarterdeck Office Systems, 147, 304	1037	University of Alabama, 361	
<hr/>			
<b>R</b>		University of California at Berkeley, 249	
Radius, 147	1038	University of Michigan, 361	
RDI, 19		University of Pittsburgh, 361	
Reference Software, 147	1039	US Sage, 58	1295
Research Development and Innovations, 19		U.S. Sprint, 19	
ROSH Intelligent Systems, 300	1128		
<hr/>			
<b>S</b>		<b>V</b>	
SAIC, 300	1129	Valtell, 45	1276
Samna, 19, 147	1040	Videologic, 19	
Sampo, 19		Visix Software, 147	1045
The Santa Cruz Operation, 101	1005	Viteq, 89	1222
SecureWare, 19		VPL Research, 19	
Sharp Electronics, 19, 147	1041		
Shiva, 147	1042	<b>W</b>	
Signal Analytics, 70	1309	Ward Systems Group, 281, 300	1137
Softsync/BLOC, 66	1304	Weitek, 347	
Software Architecture and Engineering, 300	1130	Western Digital, 147, 168	1046
Software Artistry, 300	1131		1120
Software Plus, 300	1132	Workhorses, 73	1152
Solarix Systems, 19, 44	1272		
Solbourne, 19		<b>X</b>	
Spiral Software, 70	1307	Xerox Business Systems, 361	
Stanford University, 239, 289, 361			
StereoGraphics, 50	1287	<b>Y</b>	
<hr/>			
		YARC Systems, 304	
		<b>Z</b>	
		Zenith Data Systems, 19, 304	
		Zinc Software, 218	1223
		Zola Technologies, 62	1298

# READER SERVICE

To get further information on the products advertised in BYTE, fill out the reader service card by circling the numbers on the card that correspond to the inquiry number listed with the advertiser. This index is provided as an additional service by the publisher, who assumes no liability for errors or omissions.

## Alphabetical Index to Advertisers

Inquiry No.	Page No.	Inquiry No.	Page No.	Inquiry No.	Page No.	Inquiry No.	Page No.	
8	3M	111	99	DTK	200	202	MKS	365
9	ABACUS SOFTWARE, INC.	261	100	DTK	200	203	MONOLITHIC SYSTEMS CORP.	92
10	ABACUS SOFTWARE, INC.	261	105	ECCS	400	204	MULTISCOPE, INC.	297
11	ABTECH, INC.	244	101	ELCEE COMPUTEK, INC.	192	205	MYLEX CORP.	175
12	ABTECH, INC.	244	102	ELCEE COMPUTEK, INC.	192	206	MYLEX CORP.	175
13	ACCUMATION, INC.	383	103	ELEX INTERNATIONAL	345	207	NANAO	226
14	ACCUMATION, INC.	383	104	ELEXOR, INC.	397	208	NANAO	226
15	ADD ON AMERICA	393		ERSON	22,23	209	NANTUCKET	243
16	ADVANCED MICRO DEVICES	245	106	ERGO COMPUTERS	335	210	NATIONAL INSTRUMENTS	C111
17	AK SYSTEMS	390	107	ESIX SYSTEMS	275	211	NATIONAL INSTRUMENTS	373
18	ALPHA PRODUCTS	387	108	EXREX SYSTEMS	184, 185	212	NCI	399
19	ALR	2,3	109	FAIRCOP CORP.	217	213	NEC - MONITORS	12, 13
20	ALR	2,3	110	FALCO DATA PROD.	94	214	NEC - SYSTEMS	56, 57
21	ALTEC TECHNOLOGY CORP.	153	111	FIRST SOURCE INTERNATIONAL	386	215	NEURALWARE	238
22	AMERICAN ADVANTECH	398	112	FIRST SOURCE INTERNATIONAL	386	216	NEVADA COMPUTER	392
22	AMERICAN ADVANTECH	398	113	FLAGSTAFF ENGINEERING	280	217	NEWGEN SYSTEMS	266
22	AMERICAN ADVANTECH	398	114	FLYTECH TECHNOLOGY	157	218	NEWGEN SYSTEMS	266
24	AMERICAN SMALL BUS. COMP.	203	115	GALACTICOMM	82, 83	219	NO NOISE CORP.	177
25	AMS	388		GATEWAY 2000	32A-D	220	NO NOISE CORP.	177
26	AMT INT'L	390	116	GCOM, INC.	397	221	NOHAW CORP.	350
27	ANN & ANTHONY (DAI)	388	117	GENERIC SOFTWARE, INC.	173	222	NORTHGATE COMPUTER	140, 141
28	ANNABOOKS	356	118	GENESIS DEVELOPMENT CORP.	256	223	NORTHGATE COMPUTER	142, 143
29	ARC TANGENT, INC.	400	119	GENESIS DEVELOPMENT CORP.	256	224	NORTHGATE COMPUTER	144, 145
30	ARCHER BUSINESS PRODUCTS	383	120	GENOA	259		NRI/MCGRAW-HILL	352A-B
31	ARTISOFT	212	121	GENCO ENGINEERING	258		NRI/MCGRAW-HILL	352B
32	ARTIST GRAPHICS	291	122	GRAPHIC SOFTWARE SYSTEMS	349	225	NU-MEGA TECHNOLOGIES	76
33	ASHTON-TATE	146	123	GRAPHIC SOFTWARE SYSTEMS	349	226	OAKLAND GROUP, INC.	360
34	ASHTON-TATE	146	124	GRAPHTEC	338	228	OMNITEC, INC. U.S.A.	84
379	AVOCET SYSTEMS, INC.	359	125	GREENVIEW	78	229	ONLINE PRODUCTS CORP.	270
35	AVOCET SYSTEMS, INC.	390	127	GROUP 1 SOFTWARE	298	230	ONLINE PRODUCTS CORP.	270
380	BELL ATLANTIC	346	128	GROUP 1 SOFTWARE	298	231	OVERLAND DATA	384
36	BINARY DATA ACQUISITION CORP.	390	129	GTEK, INC.	333	232	PANASONIC DOT MATRIX PRINTER	63-65
	BINARY TECHNOLOGY	393	130	GTEK, INC.	333	233	PANASONIC - LASER PRINTER	38-40
	BIX	205, 282	131	HAUPPAUGE COMPUTER WORKS	279	234	PANASONIC - MONITORS	253
	BIX	384	132	HERCULES	98	235	PARA SYSTEMS	79
450	BIX	302, 303		HEWLETT-PACKARD PERIP. GRP.	132, 133	236	PATTON & PATTON	80
37	BLACK & WHITE INT'L	178		HEWLETT-PACKARD PERIP. GRP.	166, 167	237	PC COMPUTER RENTAL	401
38	BLACK & WHITE INT'L	178	133	HIGH RES TECHNOLOGIES	393		PC CONNECTION	112, 113
39	BLAISE COMPUTING	6	134	HOME SMART COMPUTING	401		PC CONNECTION	114, 115
40	BORLAND INTERNATIONAL	11	135	HOCON	372		PC CONNECTION	116, 117
41	BORLAND INTERNATIONAL	11	136	HOUSTON INSTRUMENT	265	238	PERCEPTIVE SOLUTIONS, INC.	91
42	B MICROSYSTEMS	395	137	HOUSTON INSTRUMENT	265	239	PERCEPTIVE SOLUTIONS, INC.	91
43	BUREAU OF ELECTRONIC PUB.	110	138	HOUSTON INSTRUMENT	265	240	PERCON	382
	BUYERS MART	374-381	139	IBM - PS-2 MULTI MEDIA	25	250	PERSONAL TEX	96
45	BYTE BITS	398	140	ICL/INFORMATION & CTRL LABS	220	251	PHAR LAP	288
	BYTEBOOK CLUB	336, 337	141	IYAMA ELECTRIC	7	252	PINNACLE MICRO	85
	BYTEBOOK CLUB	336A-B	142	IMAGE-IN	341	253	PINNACLE MICRO	85
	BYTE CARD DECK	122	143	IMAGE-IN	341	254	PLUS DEVELOPMENT CORP.	93
	BYTE SUB MESSAGE	358, 403	144	IME COMPUTERS	395	255	POLAROID	372
	BYTE SUB SERVICE	351	145	IME COMPUTERS	395	256	POPKIN SOFTWARE	248
46	BYTTE COMPUTER CORP.	398	146	INTEGRAND RESEARCH CORP.	196	257	PRACTICAL PERIPHERALS, INC.	99
	BYTTEWEEK/NEWSLETTER	246, 283	147	INTEL CORP.	26, 27	258	PRECISION DATA PRODUCTS	401
47	BZ TECHNICAL	362	148	INTEL CORP.	26, 27	259	PROCOMP, USA	400
48	B&B ELECTRONICS	380	149	INTEL CORP.	67-69	260	PROFESSIONAL COMPUTER SYS.	388
49	B&C MICROSYSTEMS	399	150	INTEL CORP.	67-69	261	PROGRAMMABLE LOGIC TECH	388
50	B&C MICROSYSTEMS	401	151	INTEL CORP.	155	262	PROGRAMMERS SHOP	232, 233
51	B&C MICROSYSTEMS	401	154	INTEL CORP.	155	263	PROGRAMMERS SHOP	234, 235
52	CAD SOFTWARE	373	155	INTEL CORP.	372	264	PROGRAMMER'S CONNECTION	372
53	CADRE TECHNOLOGIES, INC.	21	156	INVISIBLE SOFTWARE	364		PROGRAMMER'S PARADISE	59
54	CALERA RECOGNITION SYS.	183	157	IN-FOCUS SYSTEMS	71	265	PROGRAMMER'S PARADISE	60, 61
55	CAPITAL EQUIPMENT CORP.	88	158	IO TECH	397	266	PROTECH MARKETING	129
56	CAPITAL EQUIPMENT CORP.	87	160	I.C. EXPRESS	393	267	PROTECH MARKETING	129
57	CDA COMPUTER SALES	106	162	JAMECO	198, 199	268	P. SHERMAN ENTERPRISES	400
	CLEO COMMUNICATIONS, INC.	118	164	JAMECO ELECTRONICS	372	240	QUATECH	370
58	CLUB AMERICAN TECHNOLOGY	271	165	JC INFORMATION SYSTEMS	307	241	QUATECH	370
59	CNS, INC.	219		JDR MICRODEVICES	409-411	242	QUATECH	370
126	COMMUNIQUE FAX 9600	278		JDR MICRODEVICES	409-411	243	QUATECH	370
	COMP PROFESSIONAL BK STY 272	A-B	166	JENNEL ELECTRONICS	390	244	QUATECH	370
	COMP PROFESSIONAL BK STY 273	A-B	167	JETFORM CORPORATION	343	245	QUATECH	370
61	COMP USA	313	168	KEA SYSTEMS LTD.	287	246	QUATECH	370
	COMPAQ COMPUTER	30, 31	169	KEITHLEY METRABYTE	373	247	QUATECH	370
63	COMPUADD	123-125		KILA SYSTEMS	395	248	QUA TECH	370
64	COMPUCOM	384	170	KNAPCO	397	269	QUALSTAR	388
65	COMPUTER FRIENDS, INC.	240	171	KNAPCO	397	270	QUANTUM SOFTWARE SYS. LTD.	131
382	COMPUTER MODULES, INC.	399	172	KNOWLEDGE GARDEN	367	271	QUARTERDECK	197
66	COMPUTER PERIPHERALS, INC.	202	173	LAHEY	120	272	RADIO SHACK	CIV
227	COMPUTER PRODUCTIONS, INC.	318	174	LAWSON LABS	398	273	RAIMA	47
67	COMPUTERLANE	389	175	LINK COMPUTER GRAPHICS	395	274	RAINBOW	97
68	COMPUTERWISE, INC.	383	176	LINK COMPUTER GRAPHICS	395	275	RAINBOW	97
	CONTROL CORP.	102, 103	177	LOGICAL DEVICES	399	276	RAINBOW SOFTWARE	312
	COPIA INTERNATIONAL LTD.	358	178	LOGICAL DEVICES	399	277	RECOGNITA CORP.	138
70	CORTEL SYSTEMS	37	179	LOGICAL DEVICES	399	278	ROCHELLE COMMUNICATIONS	382
71	COVOX, INC.	382	180	LOGICAL DEVICES	399	279	ROCHELLE COMMUNICATIONS	382
72	COVOX, INC.	382	181	LOGITECH	51	280	ROSE ELECTRONICS	121
73	CSS LABS	224, 225	182	LOGITECH	51	281	ROYKORE	90
74	CSS LABS	224, 225	183	LOTUS	105	282	R&R ELECTRONICS	401
77	CURTIS, INC.	312	184	MAGEE ENTERPRISES	104	283	S <sup>2</sup> DEVELOPMENT CORP.	179
78	CYRIX	161	185	MAGEE ENTERPRISES	104	284	S <sup>2</sup> DEVELOPMENT CORP.	317
79	CYRIX	161	186	MAP INFO	108	285	SANTA CRUZ OPERATION	55
80	C&J MICRONICS	398		MARK WILLIAMS CO.	75	286	SAS INSTITUTE	109
430	D-LINK	343	187	MARYMAC INDUSTRIES	399	287	SCIENTIFIC ENDEAVORS	390
81	DATA STRATEGIES INT'L	398	188	MATHSOFT	327	288	SCIENTIFIC ENDEAVORS	390
82	DATALUX CORPORATION	229	190	MEASUREMENT & CONTROL	383	289	SCIENTIFIC ENDEAVORS	390
83	DATALUX CORPORATION	229	191	MEASUREMENT & CONTROL	383	290	SEQUISTER SOFTWARE, INC.	221
84	DATA INSTRUMENTS	373	192	MICROSOFT, INC.	397	291	SHRUB TECHNOLOGY	192
81	DATWARE	396	193	MEGATEL COMPUTER CORP.	397	278	SERBER TECHNOLOGY	192
85	DELL COMPUTER CORP.	C11, 1	194	MERRIMACK VALLEY SYSTEMS	399	292	SILICON SHACK LTD.	388
383	DELFINA TECHNOLOGIES	355	195	MERRITT COMPUTER PROD.	244		SMALL COMPUTER BK CLUB 240A-B	
87	DFI	314	196	MICRO SOLUTIONS COMP. PROD.	256		SMALL COMPUTER BOOK CLUB 241	
88	DIGITAL DISTRIBUTING	274	197	MICRONICS	295	293	SN'W	120
89	DIGITAL DISTRIBUTING	274	198	MICROPROCESSORS UNLTD.	400		SOFTWARE PUBLISHING	320, 321
90	DIGITAL RESEARCH	277		MICROSOFT	8, 9	296	SONY	283
91	DIGITAL VISION	220		MICROSOFT	18	297	SPECTRUM SOFTWARE	293
92	DIGITAL VISION	220		MICROSOFT	29	298	SPSS	207
93	DIGI-DATA CORP.	400		MICROSOFT	37	299	STANDARD COMPUTER	52, 53
94	DISKOTECH	393	199	MICROSTAR LABORATORIES	138	300	STATSOFT	81
95	DISKOTECH	393		MICROWAY	181	301	STORAGE DIMENSIONS	263
96	DISTRIBUTED PROCESSING TECH	319		MICROWAY - C+ +	222	302	STORAGE DIMENSIONS	263
97	DISTRIBUTED PROCESSING TECH	319		MICROWAY	229	303	STRAWBERRY TREE	372
98	DIVERSIFIED COMPUTER SYS.	397	201	MIX SOFTWARE	369	304	SUMMAGRAPHS	247
305	SUMMAGRAPHS	247	202	MKS	365	305	SUMMAGRAPHS	247
306	SUMMAGRAPHS	247	203	MONOLITHIC SYSTEMS CORP.	92	306	SUMMAGRAPHS	247
307	SUN MICROSYSTEMS	42, 43	204	MULTISCOPE, INC.	297	307	SUN MICROSYSTEMS	42, 43
309	SUPERSOFT	165	205	MYLEX CORP.	175	309	SUPERSOFT	165
310	SYSTAT	193	206	MYLEX CORP.	175	310	SYSTAT	193
311	SYSTAT	193	207	NANAO	226	311	SYSTAT	193
312	TALKING TECHNOLOGY	397	208	NANAO	226	312	TALKING TECHNOLOGY	397
313	TANGENT COMPUTER	151	209	NANTUCKET	243	313	TANGENT COMPUTER	151
315	TECHNOLOGY POWER ENTER	384	210	NATIONAL INSTRUMENTS	C111	315	TECHNOLOGY POWER ENTER	384
316	TELECON	328	211	NATIONAL INSTRUMENTS	373	316	TELECON	328
317	TELEPHONE PRODUCT CENTER	394	212	NCI	399	317	TELEPHONE PRODUCT CENTER	394
318	TEST TECHNOLOGY	395	213	NEC - MONITORS	12, 13	318	TEST TECHNOLOGY	395
	TEXAS INSTRUMENTS	16, 17	214	NEC - SYSTEMS	56, 57		TEXAS INSTRUMENTS	16, 17
319	TEXAS MICROSYSTEMS	208, 209	215	NEURALWARE	238	319	TEXAS MICROSYSTEMS	208, 209
	TEXAS MICROSYSTEMS	208A-B	216	NEVADA COMPUTER	392		TEXAS MICROSYSTEMS	208A-B
320	THE CARD SHOP	372	217	NEWGEN SYSTEMS	266	320	THE CARD SHOP	372
321	THE ENGINEERS COLLABORATIVE	400	218	NEWGEN SYSTEMS	266	321	THE ENGINEERS COLLABORATIVE	400
322	THE PERISCOPE CO.	206	219	NO NOISE CORP.	177	322	THE PERISCOPE CO.	206
323	THE PERISCOPE CO.	206	220	NO NOISE CORP.	177	323	THE PERISCOPE CO.	206
324	THE SOFTWARE LINK	194	221	NOHAW CORP.	350	324	THE SOFTWARE LINK	194
325	THE SOFTWARE LINK	194	222	NORTHGATE COMPUTER	140, 141	325	THE SOFTWARE LINK	194
326	THE SOFTWARE LINK	195	223	NORTHGATE COMPUTER	142, 143	326	THE SOFTWARE LINK	195
32								

# READER SERVICE

\* Correspond directly with company.

Inquiry No.	Page No.	Inquiry No.	Page No.	Inquiry No.	Page No.	Inquiry No.	Page No.
493	FLAGSTAFF ENGINEERING . . . IS-72	485	UNIVERSAL DATA SYSTEMS . . . IS-9	569	MYODA, INC . . . MW-9	616	CAD WAREHOUSE . . . PC-16
438	GALAXY MICROGRAFX SYSTEMS-88	486	UNIVERSAL DATA SYSTEMS . . . IS-9	570	NOGA/NAT.COMP.GRAPH.ASSOC MW-7	612	CHUN YUN ELECTRONICS . . . PC-13
439	GAMMA PRODUCTIONS . . . IS-18	487	USA SOFTWARE . . . IS-17			613	DERBYTECH COMPUTERS, INC PC-20
440	GLOCKENSPIEL . . . IS-39	486	VIZIFLEX SEELS, INC . . . IS-48			614	DERBYTECH COMPUTERS, INC PC-20
441	GREY MATTER . . . IS-64	489	V.D.S. SPA . . . IS-6			617	H.CO COMPUTER PRODUCTS PC-17
437	IGEL . . . IS-32					618	H.CO COMPUTER PRODUCTS PC-17
444	IMS/FINATOR . . . IS-68					619	IRIS SOFTWARE PRODUCTS . . . PC-1
445	INEX TECHNOLOGY INT'L . . . IS-6					620	IRIS SOFTWARE PRODUCTS . . . PC-1
446	INTERQUAD LTD . . . IS-58					621	METAWARE, INC . . . PC-19
447	IN WIN DEVELOPMENT . . . IS-54					622	MICROCOM COMPUTERS . . . PC-5
448	IQ ENGINEERING . . . IS-35					623	MYODA, INC . . . PC-11
449	IQ ENGINEERING . . . IS-35					624	MYODA, INC . . . PC-11
451	ISLAND SYSTEMS . . . IS-30					625	THE PRINTER WORKS . . . PC-2,3
452	ISLAND SYSTEMS . . . IS-30					626	THE PRINTER WORKS . . . PC-2,3
453	IXIL LTD . . . IS-30					627	TRANS PC SYSTEMS . . . PC-16
454	IGC . . . IS-72					626	TRANS PC SYSTEMS . . . PC-16
455	IGC . . . IS-72					629	VERIDATA RESEARCH, INC . . . PC-7
457	LOGIC PROGRAMMING ASSOC . . . IS-48					630	VERIDATA RESEARCH, INC . . . PC-7
458	MAYFAIR MICROS . . . IS-28						
459	MEGADATA . . . IS-60						
460	MEGADATA . . . IS-60						
461	MICROCOSM . . . IS-66						
462	MICROGRAFX . . . IS-19						
463	MICROPRESS, INC . . . IS-62						
464	MICROPRESS, INC . . . IS-62						
465	MINOLTA GMBH . . . IS-11						
466	PHILIPS . . . IS-21						
467	PROGRAMMERS ODYSSEY . . . IS-22						
468	PROLOG DEVELOPMENT CTR . . . IS-26						
469	PROLOG DEVELOPMENT CTR . . . IS-26						
470	SCOTTS DALE SYSTEMS . . . IS-31						
471	SHENG LABS . . . IS-40						
472	SHENG LABS . . . IS-40						
473	SIMPLE TECHNOLOGY, INC . . . IS-56						
474	SOFTWARE CONSTRUCTION CO., LTD . . . IS-41						
475	SOFTWAREHOUSE EUROPE . . . IS-38						
494	SOLO UNIBIT . . . IS-61						
476	SOLUTION SYSTEMS . . . IS-47						
477	SURAH, INC . . . IS-72						
478	TEAC . . . IS-2						
481	TOLTRAN/GREENTREE ASSOC . . . IS-62						
482	TOLTRAN/GREENTREE ASSOC . . . IS-62						
492	TP ENTERPRISE LTD . . . IS-66						
463	TRIANGLE DIGITAL SERV.LTD . . . IS-72						
484	TWINHEAD . . . IS-12,13						

**INT'L DIRECT RESPONSE POSTCARDS**

- \* BEST POWER TECHNOLOGY . . . IS
- \* BYTEWEEK . . . IS
- \* C USFS JOURNAL . . . IS
- \* COMPUTER SOLUTIONS, N.W. . . IS
- \* GATEWAY 2000 . . . IS
- \* JOURNELOBJECT ORIENTED PROG . . IS
- \* MICROSOFT SYSTEMS JOURNAL . . IS
- \* PROGRAMMERS JOURNAL . . . IS
- \* REASONABLE SOLUTIONS . . . IS
- \* SOFTWARE BLACKSMITHS, INC . . IS
- \* TOUCHBASE SYSTEMS, INC . . . IS
- \* TRANSERA, INC . . . IS

**REGIONAL SECTIONS**

**Midwest 72MW1-20**

- \* BIX . . . MW-14
- 551 BSI . . . MW-5
- 552 BSI . . . MW-5
- 558 CAD WAREHOUSE . . . MW-16
- 559 CAD WAREHOUSE . . . MW-16
- 553 CHUN YUN ELECTRONICS . . . MW-19
- 554 COMPUTER PERIP.DIRECT,INC . . MW-11
- 555 COMPUTER PERIP.DIRECT,INC . . MW-11
- 556 DERBYTECH COMP., INC . . . MW-20
- 557 DERBYTECH COMP., INC . . . MW-20
- 560 H.CO COMPUTER PRODUCTS MW-15
- 561 H.CO COMPUTER PRODUCTS MW-15
- 562 IRIS SOFTWARE PRODUCTS . . . MW-1
- 563 IRIS SOFTWARE PRODUCTS . . . MW-1
- 564 KANDU, INC . . . MW-17
- 565 KANDU, INC . . . MW-17
- 566 MICON COMPUTERS . . . MW-13
- 567 MICROCOM COMPUTERS . . . MW-3
- 568 MYODA, INC . . . MW-9

**Northeast 72 NE1-26**

- 576 ADI CORP . . . NE-21
- 577 ADTECH . . . NE-17
- 578 ADTECH . . . NE-17
- 579 BITWISE DESIGNS, INC . . . NE-14
- 580 BRIGHTBILL-ROBERTS . . . NE-2
- 561 BSI . . . NE-13
- 562 BSI . . . NE-13
- 569 CAD WAREHOUSE . . . NE-22
- 590 CAD WAREHOUSE . . . NE-22
- 583 CCS-CUSTOM COMPUTER SYS . . NE-9
- 584 CHUN YUN ELECTRONICS . . . NE-18
- \* COMPUTER SALES PROF . . . NE-5
- \* COMPUTER SALES PROF . . . NE-11
- 565 CPT DIRECT . . . NE-23
- 586 DEERFIELD DATA SYSTEMS . . . NE-20
- 587 DERBYTECH COMPUTERS, INC . . NE-28
- 588 DERBYTECH COMPUTERS, INC . . NE-28
- 591 FD MICROSYSTEMS . . . NE-25
- 592 FD MICROSYSTEMS . . . NE-25
- 593 GLASGAL COMMUNICATIONS . . . NE-7
- 594 H.CO COMPUTER PRODUCTS . . . NE-10
- 595 H.CO COMPUTER PRODUCTS . . . NE-10
- 596 MANCHESTER EQUIPMENT . . . NE-1
- \* MANCHESTER EQUIP . . . NE-72A-B
- 597 MICROCOM COMPUTERS . . . NE-3
- 598 MYODA, INC . . . NE-15
- 599 MYODA, INC . . . NE-15
- 600 SAINT CROIX CORP . . . NE-27
- 601 SAINT CROIX CORP . . . NE-27
- 602 SIMPLE TECHNOLOGY . . . NE-24
- 603 STRATEGIC MAPPING . . . NE-26
- 604 UNITED INNOVATIONS . . . NE-19

**Pacific Coast 72 PC1-20**

- 609 BRIGHTBILL-ROBERTS . . . PC-9
- 610 BSI . . . PC-15
- 611 BSI . . . PC-15
- \* BYTE CARD DECK . . . PC-14
- 615 CAD WAREHOUSE . . . PC-18

**South 72SO1-20**

- 635 ARIEL DESIGN, INC . . . SO-3
- \* BIX . . . SO-5
- 636 BSI . . . SO-5
- 637 BSI . . . SO-5
- 644 CAD WAREHOUSE . . . SO-14
- 645 CAD WAREHOUSE . . . SO-14
- 638 CHAUMONT & ASSOCIATES . . . SO-9
- 639 CHUN YUN ELECTRONICS . . . SO-18
- 642 DERBYTECH COMPUTERS, INC . . SO-20
- 643 DERBYTECH COMPUTERS, INC . . SO-20
- 646 FD MICROSYSTEMS . . . SO-13
- 647 FD MICROSYSTEMS . . . SO-13
- 646 FIRST COMPUTER SYS., INC . . . SO-17
- 649 FIRST COMPUTER SYS., INC . . . SO-17
- 650 H.CO COMPUTER PRODUCTS . . . SO-8
- 651 H.CO COMPUTER PRODUCTS . . . SO-8
- 652 INTECC CORPORATION . . . SO-11
- 653 INTECC CORPORATION . . . SO-11
- 654 MICROCOM COMPUTERS . . . SO-1
- \* MICROCOM JOURNAL MGT GNCNL . . SO-19
- 655 MYODA, INC . . . SO-7
- 656 MYODA, INC . . . SO-7
- 657 SOFTWARE COMPOSERS . . . SO-16
- 658 SOFTWARE COMPOSERS . . . SO-16

## BYTE ADVERTISING SALES STAFF:

Steven M. Vito, Associate Publisher/V.P. of Marketing, One Phoenix Mill Lane, Peterborough, NH 03458, tel. (603) 924-9281  
 Arthur Kossack, Eastern Advertising Director, Two Prudential Plaza, 180 North Stetson Ave., Chicago, IL 60601, tel. (312) 616-3341  
 Jennifer L. Bartel, Western Advertising Director, 14850 Quorum Drive, Suite 380, Dallas, TX 75240, tel. (214) 701-8496  
 Liz Coyman, Inside Advertising Sales Director, One Phoenix Mill Lane, Peterborough, NH 03458, tel. (603) 924-2518

**NEW ENGLAND**  
 ME, NH, VT, MA, RI, CT, ONTARIO  
 CANADA & EASTERN CANADA  
 Dan Savage (617) 860-6344  
 Scott Gagnon (603) 924-2651  
 McGraw-Hill Publications  
 29 Hartwell Avenue  
 Lexington, MA 02173  
 FAX: (617) 860-6999

**EAST COAST**  
 NY, NYC, NJ, DE, PA  
 Kim Norris (212) 512-2645  
 Ariane Casey (212) 512-2368  
 Patricia Payne (603) 924-2654  
 McGraw-Hill Publications  
 1221 Avenue of the Americas—  
 28th Floor  
 New York, NY 10020  
 FAX: (212) 512-2075

**SOUTHEAST**  
 NC, SC, GA, FL, AL, TN, VA,  
 MS, AR, LA, DC, MD, WV, KY  
 John Y. Schilin (404) 843-4782  
 Patricia Payne (603) 924-2654  
 McGraw-Hill Publications  
 4170 Ashford-Dunwoody Road  
 Suite 520  
 Atlanta, GA 30319  
 FAX: (404) 252-4056

**MIDWEST**  
 IL, MO, KS, IA, ND, SD, MN,  
 WI, NE, IN, MI, OH  
 Kurt Kelley (312) 616-3328  
 MaryAnn Goulding (603) 924-2664  
 McGraw-Hill Publications  
 Two Prudential Plaza  
 180 North Stetson Ave.  
 Chicago, IL 60601  
 FAX: (312) 616-3370

**SOUTHWEST,  
 ROCKY MOUNTAIN  
 CO, OK, TX,**  
 Alison Keenan (214) 701-8496  
 Patricia Payne (603) 924-2654  
 McGraw-Hill Publications  
 14850 Quorum Drive  
 Suite 380  
 Dallas, TX 75240  
 FAX: (214) 991-6208

**NORTH PACIFIC:** San Francisco, CA  
**NORTHERN CA, OR, ID, MT,  
 WY, NORTHERN NV**  
 Roy J. Kops (415) 954-9728  
 McGraw-Hill Publications  
 425 Battery Street  
 San Francisco, CA 94111  
 FAX: (415) 954-9786

**NORTH PACIFIC:** Campbell, CA  
 SILICON VALLEY, HI, WA, AK,  
 W. CANADA  
 Bill McAfee (408) 879-0381  
 Leslie Hupp (408) 879-0381  
 McGraw-Hill Publications  
 1999 South Bascom Ave.  
 Suite #210  
 Campbell, CA 95008  
 FAX: (408) 879-9067

**SOUTH PACIFIC:** Los Angeles, CA  
 LOS ANGELES COUNTY, AZ,  
 NM, SOUTHERN NEVADA  
 Alan El Faye (213) 480-5243  
 Jonathan Sawyer (603) 924-2665  
 McGraw-Hill Publications  
 3333 Wilshire Boulevard #407  
 Los Angeles, CA 90010  
 FAX: (213) 480-5249

**SOUTH PACIFIC:** Costa Mesa, CA  
 ORANGE COUNTY,  
 SAN DIEGO COUNTY, UT  
 Ron Cordek (714) 557-6292  
 Jonathan Sawyer (603) 924-2665  
 McGraw-Hill Publications  
 3001 Red Hill Ave.  
 Building #1—Suite 222  
 Costa Mesa, CA 92626  
 FAX: (714) 557-2219

**BYTE BITS (2x3)**  
 Mark Stone (603) 924-6830  
 BYTE Publications  
 One Phoenix Mill Lane  
 Peterborough, NH 03458

**The Buyer's Mart (1x2)**  
 Brian Higgins (603) 924-3754  
 BYTE Publications  
 One Phoenix Mill Lane  
 Peterborough, NH 03458

**Regional Advertising**  
 James Bail (603) 924-2533  
 Barry Echavarría (603) 924-2574  
 Larry Levine (603) 924-2637  
 BYTE Publications  
 One Phoenix Mill Lane  
 Peterborough, NH 03458

**BYTE Deck**  
 Ed Ware (603) 924-2596  
 BYTE Publications  
 One Phoenix Mill Lane  
 Peterborough, NH 03458

**Catalog Showcase**  
**BYTE International Direct  
 Response Postcards**  
 Ellen Perham (603) 924-2598  
 BYTE Publications  
 One Phoenix Mill Lane  
 Peterborough, NH 03458

**Peterborough, NH Office**  
 Inside Sales FAX: 603-924-2683  
 Advertising FAX: 603-924-7507

## International Advertising Sales Staff:

Uwe Kretzschmar, European Advertising and Marketing Manager, BYTE Publications,  
 McGraw-Hill Publishing Co., Wimbledon Bridge House, One Hartfield Road, Wimbledon, London, SW19 3RU, England, Tel: 44 81 543 1234, Fax: 44 81 540 3833

**GERMANY, SWITZERLAND,  
 AUSTRIA**  
 Uwe Kretzschmar (44-81-545-6268)  
**UNITED KINGDOM**  
 Roz Weyman (44-81-545-6269)  
 McGraw-Hill Publishing Co.  
 Wimbledon Bridge House  
 One Hartfield Road  
 Wimbledon, London SW19 3RU  
 England  
 Tel: 44 81 543 1234  
 FAX: 44 81 540 3833  
 TELEX: 892191

**FRANCE, ITALY**  
 Zena Coupé, Amanda Blaskett  
 A-Z International Sales Ltd.  
 4 Ashmount Road, Hornsey Lane  
 Highgate, London N19 3BH  
 England  
 Tel: 44 71 281 4116  
 FAX: 44 71 281 8224

**ISRAEL**  
 Dan Ehrlich  
 Ehrlich Communication International  
 P.O. Box 11297  
 Tel Aviv 61112  
 Israel  
 Tel: (972) 3 449823  
 FAX: (972) 3 5468168

**JAPAN**  
 Masaki Mori  
 McGraw-Hill Publishing Co.  
 Overseas Corp.  
 Room 1528  
 Kasumigaseki Bldg.  
 3-2-5 Kasumigaseki,  
 Chiyoda-Ku  
 Tokyo 100, Japan  
 Tel: 81 3 581 9811  
 FAX: 81 3 581 4018

**SWEDEN**  
 Media Marketing AB  
 Karlbergsvagen 89A  
 S-10031 Stockholm  
 Sweden  
 Tel: 46 8 301280

**HONG KONG**  
 Stephen Marcopoto  
 Seavex Ltd.  
 503 Wilson House  
 19-27 Wyndham St.  
 Central, Hong Kong  
 Tel: 852-868-2010  
 Telex: 60904 SEVEX HX  
 FAX: 852 810 1283

**SINGAPORE**  
 Jocelyn Domingo  
 Seavex Ltd.  
 400 Orchard Road, #10-01  
 Singapore 0923  
 Republic of Singapore  
 Tel: 65 734 9790  
 Telex: RS35539 SEAVEX  
 FAX: 65 732 5129

**TAIWAN**  
 Summer Chien  
 Tina Lai  
 Acer TWP  
 977 Min Shen E. Road, 1-4 Flr.  
 Taipei 10581, Taiwan ROC  
 Tel: 886 2 763 0052  
 Fax: 886 2 765 6874

**BENELUX**  
 Ellen Pardede  
 Batenburg 103  
 3437 AB Nieuwegein  
 The Netherlands  
 Tel: 31 34 02 49496  
 FAX: 31 34 02 37944

# READER SERVICE

To get further information on the products advertised in BYTE, fill out the reader service card by circling the numbers on the card that correspond to the inquiry number listed with the advertiser. This index is provided as an additional service by the publisher, who assumes no liability for errors or omissions.

\* Correspond directly with company.

## Index to Advertisers by Product Category

Inquiry No.	Page No.	Inquiry No.	Page No.	Inquiry No.	Page No.	Inquiry No.	Page No.
<b>HARDWARE</b>							
926	ADD INS	175	LINK COMPUTER GRAPHICS . . . 395	145	IME COMPUTERS . . . . . 395	83	COMPUADD . . . . . 123-125
16	ADVANCED MICRO DEVICES . . . 245	221	NOHAU CORP . . . . . 350	448	INTERQUAD LTD . . . . . IS-5	554	COMPUTER PERIP.DIRECT,INC. 11
22	AMERICAN ADVANTECH . . . . . 398	261	PROGRAMMABLE LOGIC TECH 388	207	NANAO . . . . . 228	555	COMPUTER PERIP.DIRECT,INC. 11
25	AMT INT'L . . . . . 390	367	XELTEK . . . . . 393	208	NANAO . . . . . 226		* COMPUTER SALES PROF. . . . . NE-5
27	ANN & ANTHONY (DAI) . . . . . 388	375	Z-WORLD . . . . . 401	213	NEC - MONITORS . . . . . 12,13		* COMPUTER SALES PROF. . . . . NE-11
36	BINARY DATA ACQUISITION CORP 390	<b>931 INSTRUMENTATION</b>		214	NEC - SYSTEMS . . . . . 56,57	585	CPT DIRECT . . . . . NE-23
409	BLUE CHIP TECHNOLOGY . . . . . IS-72	104	ELEXOR, INC. . . . . 397	234	PANASONIC - MONITORS . . . . . 253	85	DELL COMPUTER CORP . . . . . CII,1
55	CAPITAL EQUIPMENT CORP . . . . . 86	174	LAWSON LABS . . . . . 398	466	PHILIPS . . . . . IS-21	556	DERBYTECH COMPUTERS,INC MW-20
56	CAPITAL EQUIPMENT CORP . . . . . 87	176	LINK COMPUTER GRAPHICS . . . . . 395	517	BIT WIRE DESIGNS,INC . . . . . NE-14	557	DERBYTECH COMPUTERS,INC MW-20
382	COMPUTER MODULES, INC . . . . . 399	210	NATIONAL INSTRUMENTS . . . . . CII,1	551	BSI . . . . . MW-5	587	DERBYTECH COMPUTERS,INC NE-28
69	COMTROL CORP . . . . . 102,103	212	NCI . . . . . 399	552	BSI . . . . . MW-5	588	DERBYTECH COMPUTERS,INC NE-28
78	CYRIX . . . . . 161	388	XELTEK . . . . . 393	581	BSI . . . . . MW-5	613	DERBYTECH COMPUTERS,INC PC-20
79	CYRIX . . . . . 161	<b>932 KEYBOARDS/MICE</b>		582	BSI . . . . . MW-5	814	DERBYTECH COMPUTERS,INC PC-20
96	DISTRIBUTED PROCESSING TECH 319	82	DATALUX CORPORATION . . . . . 229	583	BSI . . . . . MW-5	842	DERBYTECH COMPUTERS,INC SO-20
97	DISTRIBUTED PROCESSING TECH 319	83	DATALUX CORPORATION . . . . . 229	69	COMTROL CORP . . . . . 102,103	843	DERBYTECH COMPUTERS,INC SO-20
438	GALAXY MICROCRRAFT SYS . . . . . IS-66	91	DIGITAL VISION . . . . . 229	73	CSSLABS . . . . . 224,225	88	DIGITAL DISTRIBUTING . . . . . 274
120	GENOA . . . . . 269	92	DIGITAL VISION . . . . . 220	74	CSSLABS . . . . . 224,225	89	DIGITAL DISTRIBUTING . . . . . 274
122	GRAPHIC SOFTWARE SYSTEMS 348	168	KEA SYSTEMS LTD . . . . . 287	430	DALINK . . . . . 343	99	DTK . . . . . 200
123	GRAPHIC SOFTWARE SYSTEMS 348	181	LOGITECH . . . . . 51	432	EASY NETWORK . . . . . IS-67	100	DTK . . . . . 200
131	HAUPFADIGE COMPUTER WORKS 278	182	LOGITECH . . . . . 51	433	EASY NETWORK . . . . . IS-67		* ELONEX . . . . . IS-43
132	HERCULES . . . . . 98	224	NORTHGATE COMPUTER . . . . . 144,145		* ELONEX . . . . . IS-43	106	ERGO COMPUTERS . . . . . 335
133	HIGH RES TECHNOLOGIES . . . . . 393	249	PERCON . . . . . 382	114	FLYTECH TECHNOLOGY . . . . . 157	108	EVEREX SYSTEMS . . . . . 184,185
134	HOME SMART COMPUTING . . . . . 401	371	ZENY COMPUTER . . . . . 318	114	IYAMA ELECTRIC . . . . . 7	110	FALCO DATA PROD . . . . . 94
150	H.C.COMPUTERPRODUCTS . MW-15	<b>933 MASS STORAGE</b>		190	MEASUREMENT & CONTROL . . . . . 383	591	FD MICROSYSTEMS . . . . . NE-25
561	H.CO COMPUTER PRODUCTS . MW-15	8	3M . . . . . 111	191	MEASUREMENT & CONTROL . . . . . 383	592	FD MICROSYSTEMS . . . . . NE-25
594	H.CO COMPUTER PRODUCTS NE-10	17	A K SYSTEMS . . . . . 390	274	RAINBOW . . . . . 97	848	FD MICROSYSTEMS . . . . . SO-13
595	H.CO COMPUTER PRODUCTS NE-10	81	DATA STRATEGIES INT'L . . . . . 398	275	RAINBOW . . . . . 97	847	FD MICROSYSTEMS . . . . . SO-13
617	H.CO COMPUTER PRODUCTS PC-17	93	DIGI-DATA CORP . . . . . 400	278	ROCHELLE COMMUNICATIONS 382	648	FIRST COMPUTER SYS.,INC SO-17
618	H.CO COMPUTER PRODUCTS PC-17	113	FLAGSTAFF ENGINEERING . . . . . 280	279	ROCHELLE COMMUNICATIONS 382	649	FIRST COMPUTER SYS.,INC SO-17
650	H.CO COMPUTER PRODUCTS SO-8	493	FLAGSTAFF ENGINEERING . . . . . IS-72	324	THE SOFTWARE LINK . . . . . 194	114	FLYTECH TECHNOLOGY . . . . . 157
851	H.CO COMPUTER PRODUCTS SO-8	998	MICRO SOLUTIONS COMP.PROD. 258	325	THE SOFTWARE LINK . . . . . 194		* GATEWAY 2000 . . . . . 32A-D
151	INTEL CORP . . . . . 67-89	229	ONLINE PRODUCTS CORP . . . . . 270	328	THE SOFTWARE LINK . . . . . 195	560	H.CO COMPUTER PRODUCTS MW-15
152	INTEL CORP . . . . . 67-89	230	ONLINE PRODUCTS CORP . . . . . 270	327	THE SOFTWARE LINK . . . . . 195	561	H.CO COMPUTER PRODUCTS MW-15
158	IO TECH . . . . . 397	231	OVERLAND DATA . . . . . 384	369	XIRCOM . . . . . 257	594	H.CO COMPUTER PRODUCTS NE-10
165	JC INFORMATION SYSTEMS . . . . . 307	238	PERCEPTIVE SOLUTIONS,INC . . . . . 91	<b>938 PRINTERS/PLOTTERS</b>			
193	MEGATEL COMPUTER CORP . . . . . 178	239	PERCEPTIVE SOLUTIONS,INC . . . . . 91	586	DEERFIELD DATA SYSTEMS . . . . . NE-20	818	H.CO COMPUTER PRODUCTS PC-17
194	MERRIMACK VALLEY SYSTEMS 389	252	PINNACLE MICRO . . . . . 85		* EPSON . . . . . 22,23	850	H.CO COMPUTER PRODUCTS SO-8
197	MICRONICS . . . . . 295	253	PINNACLE MICRO . . . . . 85	124	GRAPHTEC . . . . . 338	851	H.CO COMPUTER PRODUCTS SO-8
198	MICROPROCESSORS UNLTD . . . . . 400	254	PLUS DEVELOPMENT CORP . . . . . 93		* HEWLETT-PACKARD PERIP.GRP. 132,133	144	IBM - PS/2 MULTI MEDIA . . . . . 25
199	MICROSTAR LABORATORIES . . . . . 388	259	PROCOMP,USA . . . . . 400	138	HOUSTON INSTRUMENT . . . . . 285	145	IBM COMPUTERS . . . . . 395
	* MICROWAY . . . . . 181	269	QUALSTAR . . . . . 388	138	HOUSTON INSTRUMENT . . . . . 285	147	INTEL CORP . . . . . 26,27
	* MICROWAY - C + + . . . . . 222	298	SONY . . . . . 283	448	IO ENGINEERING . . . . . IS-35	148	INTEL CORP . . . . . 26,27
	* MICROWAY . . . . . 299	301	STORAGE DIMENSIONS . . . . . 283	449	IO ENGINEERING . . . . . IS-35	852	INTELEC CORPORATION . . . . . SO-11
203	MICROLITHIC SYSTEMS CORP . . . . . 92	302	STORAGE DIMENSIONS . . . . . 283	465	MINOLTA GMBH . . . . . IS-11	653	INTELEC CORPORATION . . . . . SO-11
205	MYLEX CORP . . . . . 175	478	TEAC . . . . . IS-2	217	NEWGEN SYSTEMS . . . . . 266	162	JAMECO . . . . . 198,199
206	MYLEX CORP . . . . . 175	341	TULIN CORP . . . . . 325	218	NEWGEN SYSTEMS . . . . . 266	166	JEMINI ELECTRONICS . . . . . 390
228	OMNITEL, INC. U.S.A . . . . . 84	<b>934 MISCELLANEOUS</b>		232	PANASONIC DOT MATRIX PRTER 63-65	584	KANDU,INC . . . . . MW-17
268	P.SHERMAN ENTERPRISES . . . . . 400	18	ALPHA PRODUCTS . . . . . 387	233	PANASONIC - LASER PRINTER38-40	585	KANDU,INC . . . . . MW-17
240	QUA TECH . . . . . 370	22	AMERICAN ADVANTECH . . . . . 398		* SOFTWARE PUBLISHING . . . . . 320,321	171	KNAPCO . . . . . 397
241	QUA TECH . . . . . 370	65	COMPUTER FRIENDS,INC . . . . . 240	477	SURAH,INC . . . . . IS-72	596	MANCHESTER EQUIP . . . . . NE-1
242	QUA TECH . . . . . 370	71	COVOX, INC. . . . . 382	825	THE PRINTER WORKS . . . . . PC-2,3	596	MANCHESTER EQUIP . . . . . NE-72A-B
243	QUA TECH . . . . . 370	72	COVOX, INC. . . . . 382	828	THE PRINTER WORKS . . . . . PC-2,3	567	MICROCOM COMPUTERS . . . . . MW-3
244	QUA TECH . . . . . 370	429	CYBEX CORP . . . . . IS-42	804	UNITED INNOVATIONS . . . . . NE-19	597	MICROCOM COMPUTERS . . . . . NE-3
245	QUA TECH . . . . . 370	431	DIETRICH POS EQUIPMENT . . . . . IS-72	<b>939 SCANNERS/IMAGE PROCESSORS</b>			
248	QUA TECH . . . . . 370	105	EECS . . . . . 400	408	BEHAVIOR TECH COMP CORP IS-59	654	MICROCOM COMPUTERS . . . . . SO-1
247	QUA TECH . . . . . 370	437	IGEL . . . . . IS-32	87	DFI . . . . . 314	658	MYODA,INC . . . . . MW-9
248	QUA TECH . . . . . 370	144	IME COMPUTERS . . . . . 395	<b>940 SOFTWARE SECURITY</b>			
272	RADIO SHACK . . . . . CIV	145	IME COMPUTERS . . . . . 395	496	ALADDIN . . . . . IS-51	569	MYODA,INC . . . . . MW-9
282	R&R ELECTRONICS . . . . . 401	447	IN WIN DEVELOPMENT . . . . . IS-54	426	CONTROL TELEMETRY . . . . . IS-52	598	MYODA,INC . . . . . NE-15
292	SILICON SHACK LTD . . . . . 388	146	INTEGRAND RESEARCH CORP . . . . . 198	438	FAST ELECTRONIC GMBH . . . . . IS-57	599	MYODA,INC . . . . . NE-15
602	SIMPLE TECHNOLOGY . . . . . NE-24	157	IN-FOCUS SYSTEMS . . . . . 71	121	GLENCO ENGINEERING . . . . . 258	623	MYODA,INC . . . . . PC-11
322	THE PERISCOPE CO . . . . . 206	192	MEGASOFT, INC . . . . . 397	288	PROTECH MARKETING . . . . . 129	624	MYODA,INC . . . . . PC-11
323	THE PERISCOPE CO . . . . . 206	195	MERRITT COMPUTER PROD . . . . . 244	287	PROTECH MARKETING . . . . . 129	655	MYODA,INC . . . . . SO-7
392	TOUCHBASE SYSTEMS,INC . . . . . 74	219	NO NOISE CORP . . . . . 177	<b>941 SYSTEMS</b>			
432	TP ENTERPRISE LTD . . . . . IS-66	220	NO NOISE CORP . . . . . 177	11	ABTECH,INC . . . . . 244	627	TRANS PC SYSTEMS . . . . . PC-16
483	TRIANGLE DIGITAL SERV.LTD IS-72	283	S <sup>2</sup> DEVELOPMENT CORP . . . . . 179	12	ABTECH,INC . . . . . 244	628	TRANS PC SYSTEMS . . . . . PC-16
339	TRUEVISION . . . . . 215	312	TALKING TECHNOLOGY . . . . . 397	577	ADTECH . . . . . NE-17	338	TRI-STAR COMPUTER . . . . . 15
340	TRUEVISION . . . . . 215	343	TWIX INTERNATIONAL CORP . . . . . 388	578	ADTECH . . . . . NE-17	484	TWINHEAD . . . . . IS-12,13
345	UNICORE SOFTWARE . . . . . 325	346	UNICORN ELECTRONICS . . . . . 386	402	AGC . . . . . IS-63	629	VERIDATA RESEARCH,INC . . . . . PC-7
489	V.D.S. SPA . . . . . IS-6	488	VIZIFLEX SEELS,INC . . . . . IS-48	19	ALR . . . . . 2,3	365	XEC PRODUCTS . . . . . 163
<b>927 DRIVES</b>		374	Z-WORLD . . . . . 401	20	ALR . . . . . 2,3	366	XEC PRODUCTS . . . . . 163
77	CURTIS, INC . . . . . 312	<b>935 MODEMS/MULTIPLEXORS</b>		21	ALTEC TECHNOLOGY CORP . . . . . 153	370	ZENITH DATA SYSTEMS . . . . . 155
179	LOGICAL DEVICES . . . . . 399	406	BAY TECHNICAL ASSOCIATES IS-69	835	ARIEL DESIGN,INC . . . . . SO-3	<b>942 TERMINALS</b>	
180	LOGICAL DEVICES . . . . . 399	407	BAY TECHNICAL ASSOCIATES IS-69	579	BIT WIRE DESIGNS,INC . . . . . NE-14	68	COMPUTERWISE,INC . . . . . 383
196	MICRO SOLUTIONS COMP.PROD. 256	64	COMPUCOM . . . . . 384	551	BSI . . . . . MW-5	<b>943 UPS</b>	
<b>928 FACSIMILE</b>		66	COMPUTER PERIPHERALS,INC 202	552	BSI . . . . . MW-5	13	ACCUMATION,INC . . . . . 383
491	404 TECHNOLOGIES,INC . . . . . IS-42	115	GALACTICOMM . . . . . 82,83	581	BSI . . . . . MW-5	14	ACCUMATION,INC . . . . . 383
490	DATATRONICS TECHNOLOGY,INC IS-71	459	MEGADATA . . . . . IS-80	582	BSI . . . . . MW-5	413	CIC DISTRIBUTORS . . . . . IS-66
170	KNAPCO . . . . . 397	480	MEGADATA . . . . . IS-80	610	BSI . . . . . PC-15	414	CIC DISTRIBUTORS . . . . . IS-66
171	KNAPCO . . . . . 397	257	PRACTICAL PERIPHERALS,INC . . . . . 99	611	BSI . . . . . PC-15	171	KNAPCO . . . . . 397
<b>929 GRAPHICS TABLETS</b>		485	UNIVERSAL DATA SYSTEMS . . . . . IS-9	836	BSI . . . . . SO-5	171	KNAPCO . . . . . 397
304	SUMMAGRAPHICS . . . . . 247	486	UNIVERSAL DATA SYSTEMS . . . . . IS-9	837	BSI . . . . . SO-5	235	PARA SYSTEMS . . . . . 79
305	SUMMAGRAPHICS . . . . . 247	<b>938 MONITORS</b>		558	CAD WAREHOUSE . . . . . MW-16		
306	SUMMAGRAPHICS . . . . . 247	576	ADI CORP . . . . . NE-21	559	CAD WAREHOUSE . . . . . MW-16		
<b>930 HARDWARE PROGRAMMERS</b>		22	AMERICAN ADVANTECH . . . . . 398	589	CAD WAREHOUSE . . . . . NE-22		
35	AVOCET SYSTEMS, INC . . . . . 390	553	CHUN YUN ELECTRONICS . . . . . MW-19	590	CAD WAREHOUSE . . . . . NE-22		
	* BINARY TECHNOLOGY . . . . . 393	584	CHUN YUN ELECTRONICS . . . . . NE-18	815	CAD WAREHOUSE . . . . . PC-18		
42	BP MICROSYSTEMS . . . . . 395	612	CHUN YUN ELECTRONICS . . . . . PC-13	616	CAD WAREHOUSE . . . . . PC-18		
80	C&J MICRONICS . . . . . 398	839	CHUN YUN ELECTRONICS . . . . . SO-18	644	CAD WAREHOUSE . . . . . SO-14		
129	GTEK, INC . . . . . 393	427	CTX INTERNATIONAL . . . . . IS-14	645	CAD WAREHOUSE . . . . . SO-14		
130	GTEK, INC . . . . . 393	428	CTX INTERNATIONAL . . . . . IS-14	638	CHAUMONT & ASSOCIATES . . . . . SO-38		
	* KILA SYSTEMS . . . . . 395	435	ETAP . . . . . IS-53	58	CLUB AMERICAN TECHNOLOGY 271		
		144	IME COMPUTERS . . . . . 395		* COMPAQ COMPUTER . . . . . 30,31		

# READER SERVICE

\* Correspond directly with company.

Inquiry No.	Page No.
<b>SOFTWARE</b>	
<b>944 APPLE/MAC APPLICATIONS Business/Office</b>	
603 STRATEGIC MAPPING	NE-26
<b>945 APPLE/MAC APPLICATIONS Scientific/Technical</b>	
286 SAS INSTITUTE	109
310 SYSTAT	193
311 SYSTAT	193
<b>946 APPLE/MAC APPLICATIONS Miscellaneous</b>	
603 STRATEGIC MAPPING	NE-26
<b>947 APPLE/MAC GRAPHICS</b>	
118 GENESIS DEVELOPMENT CORP 256	
119 GENESIS DEVELOPMENT CORP 256	
570 NCGAINAT.COMP.GRAPH.ASSOC	MW-7
<b>948 APPLE/MAC LAN</b>	
156 INVISIBLE SOFTWARE	364
<b>949 APPLE/MAC LANGUAGES</b>	
417 COBALT BLUE	IS-66
<b>950 IBM/MSDOS APPLICATIONS Business Office</b>	
29 ARC TANGENT, INC.	400
33 ASHTON-TATE	146
34 ASHTON-TATE	146
380 BELL ATLANTIC	346
* COPIA INTERNATIONAL LTD.	358
383 DELFINA TECHNOLOGIES	355
103 ELEX INTERNATIONAL	345
439 GAMMA PRODUCTIONS	IS-18
167 JETFCRM CORPORATION	343
186 LOTUS	105
* MICROSOFT	137
236 PATTON & PATTON	80
273 RAIMA	47
277 RECOGNITA CORP	138
657 SOFTWARE COMPOSERS	SO-16
658 SOFTWARE COMPOSERS	SO-16
<b>951 IBM/MSDOS APPLICATIONS Scientific/Technical</b>	
28 ANNABOOKS	356
53 CADRE TECHNOLOGIES, INC.	21
153 INTEL CORP	139
154 INTEL CORP	139
457 LOGIC PROGRAMMING ASSOCIATES	48
177 LOGICAL DEVICES	399
178 LOGICAL DEVICES	399
184 MAGEE ENTERPRISES	104
185 MAGEE ENTERPRISES	104
463 MICROPRESS, INC.	IS-62
464 MICROPRESS, INC.	IS-62
204 MULTISCOPE, INC.	297
215 NEURALWARE	238
256 POPKIN SOFTWARE	248
297 SPECTRUM SOFTWARE	293
298 SPSS	207
300 STATSOFT	81
310 SYSTAT	193
311 SYSTAT	193
321 THE ENGINEERS COLLABORATIVE	400
333 TOUCHSTONE	77
334 TOUCHSTONE	77
359 WARD SYSTEMS GROUP	242
360 WARD SYSTEMS GROUP	242
364 WINTEK	395
<b>952 IBM/MSDOS APPLICATIONS Miscellaneous</b>	
580 BRIGHTBILL-ROBERTS	NE-2
609 BRIGHTBILL-ROBERTS	PC-9
* MICROSOFT	29
481 TOLTRAN/GREENTREE ASSOC	IS-62
482 TOLTRAN/GREENTREE ASSOC	IS-62
<b>953 IBM/MSDOS APPLICATIONS Word Processing</b>	
* MICROSOFT	8,9
<b>954 IBM/MSDOS — CAD</b>	
24 AMERICAN SMALL BUSI.COMP	203
25 AMS	388
32 ARTIST GRAPHICS	291
101 ELCEE COMPUTEK, INC.	192
102 ELCEE COMPUTEK, INC.	192
117 GENERIC SOFTWARE, INC.	173

Inquiry No.	Page No.
<b>955 IBM/MSDOS COMMUNICATIONS</b>	
126 COMMUNIQUE FAX 9600	278
420 COMPEX, INC.	IS-45
421 COMPEX, INC.	IS-45
98 DIVERSIFIED COMPUTER SYS	397
<b>956 IBM/MSDOS GRAPHICS</b>	
32 ARTIST GRAPHICS	291
54 CALEPA RECOGNITION SYS	183
70 COREL SYSTEMS	37
101 ELCEE COMPUTEK, INC.	192
102 ELCEE COMPUTEK, INC.	192
118 GENESIS DEVELOPMENT CORP 256	
119 GENESIS DEVELOPMENT CORP 256	
140 ICL/INFORMATION & CTRL LABS 250	
142 IMAGE-IN	341
143 IMAGE-IN	341
462 MICROGRAFX	IS-19
570 NCGAINAT.COMP.GRAPH.ASSOC	MW-7
281 ROYKORE	90
287 SCIENTIFIC ENDEAVORS	390
288 SCIENTIFIC ENDEAVORS	390
289 SCIENTIFIC ENDEAVORS	390
* SOFTWARE PUBLISHING	320,321
339 TRUEVISION	215
340 TRUEVISION	215
<b>957 IBM/MSDOS — LAN</b>	
103 ELEX INTERNATIONAL	345
377 SERVER TECHNOLOGY	192
378 SERVER TECHNOLOGY	192
<b>958 IBM/MSDOS LANGUAGES</b>	
379 AVOCET SYSTEMS, INC.	359
40 BORLAND INTERNATIONAL	11
41 BORLAND INTERNATIONAL	11
109 FAIRCOM CORP	217
440 GLOCKENSPIEL	IS-39
173 LAHEY	120
* MICROSOFT	18
201 MIX SOFTWARE	369
202 MKS	365
209 NANTUCKET	243
468 PROLOG DEVELOPMENT CTR	IS-26
469 PROLOG DEVELOPMENT CTR	IS-26
290 SEQUITER SOFTWARE, INC.	221
476 SOLUTION SYSTEMS	IS-47
* WATCOM	286
362 WHITEWATER GROUP, THE	357
373 ZORTECH	48,49
<b>959 IBM/MSDOS UTILITIES</b>	
37 BLACK & WHITE INT'L	178
38 BLACK & WHITE INT'L	178
39 BLAISE COMPUTING	6
412 C SOURCE	IS-65
415 CLARION SOFTWARE	IS-37
416 CLARION SOFTWARE	IS-37
59 CNS, INC.	219
125 GREENVIEW	78
562 IRIS SOFTWARE PRODUCTS	MW-1
563 IRIS SOFTWARE PRODUCTS	MW-1
619 IRIS SOFTWARE PRODUCTS	PC-1
620 IRIS SOFTWARE PRODUCTS	PC-1
451 ISLAND SYSTEMS	IS-30
452 ISLAND SYSTEMS	IS-30
172 KNOWLEDGE GARDEN	367
184 MAGEE ENTERPRISES	104
185 MAGEE ENTERPRISES	104
481 MICROCOSM	IS-66
225 NU-MEGA TECHNOLOGIES	76
226 OAKLAND GROUP, INC.	360
251 PHAR LAP	288
271 QUARTERDECK	197
476 SOLUTION SYSTEMS	IS-47
318 TEST TECHNOLOGY	395
335 TRANSERA	322
336 TRANSERA	322
342 TURBO POWER	368
353 UPGRADES.ETC	400
354 UPGRADES.ETC	400
357 VERMONT CREATIVE SOFTWARE 35	
358 VOGON ENTERPRISES LTD	388
<b>960 UNIX/OTHER APPLICATIONS Business Office</b>	
30 ARCHER BUSINESS PRODUCTS	383
127 GROUP 1 SOFTWARE	298
128 GROUP 1 SOFTWARE	298
365 XEC PRODUCTS	163
366 XEC PRODUCTS	163
<b>961 UNIX/OTHER APPLICATIONS Miscellaneous</b>	
413 CIC DISTRIBUTORS	IS-66
414 CIC DISTRIBUTORS	IS-66
467 PROGRAMMERS ODYSSEY	IS-22
471 SHENG LABS	IS-40
472 SHENG LABS	IS-40

Inquiry No.	Page No.
<b>962 UNIX/OTHER — CAD</b>	
188 MATHSOFT	327
<b>963 UNIX/OTHER — CROSS DEVELOPMENT</b>	
116 GCOM, INC.	397
* TEXAS INSTRUMENTS	16,17
<b>964 UNIX/OTHER — LANGUAGES</b>	
* BINARY TECHNOLOGY	393
109 FAIRCOM CORP	217
621 METAWARE, INC.	PC-19
276 RAINDROP SOFTWARE	312
362 WHITEWATER GROUP, THE	357
<b>965 UNIX/OTHER — UTILITIES</b>	
125 GREENVIEW	78
453 IXI LTD	IS-46
276 RAINDROP SOFTWARE	312
355 VENTURCOM	216
356 VENTURCOM	216
<b>966 DESKTOP PUBLISHING</b>	
101 ELCEE COMPUTEK, INC.	192
102 ELCEE COMPUTEK, INC.	192
250 PERSONAL TEX	98
280 ROSE ELECTRONICS	121
<b>967 EDUCATIONAL/ INSTRUCTIONAL</b>	
9 ABACUS SOFTWARE, INC.	261
10 ABACUS SOFTWARE, INC.	261
* BYTEBACK ISSUES	IS-58
45 BYTEBITS	398
* BYTE BOOK CLUB	336,337
* BYTE BOOK CLUB	336A-B
* BYTE CARD DECK	122
* BYTE CARD DECK	PC-14
* BYTE CARD DECK	MW-18
* BYTE SUB SERVICE	351
* BYTE SUB MESSAGE	356,403
46 BYTEK COMPUTER CORP	398
* BYTEWEEK/NEWSLETTER	246,283
* COMP PROFESSIONAL BK STY 272A-B	
* COMP PROFESSIONAL BK STY	273
* NRI/MCGRAW-HILL	352A-B
* NRI/MCGRAW-HILL	353
* SMALL COMPUTER BK CLUB	240A-B
* SMALL COMPUTER BOOK CLUB	241
* UNIXWORLD	384A-B
* UNIXWORLD	385
363 WIESEMANN & THEIS GMBH	388
<b>968 MAIL ORDER/ RETAIL</b>	
401 3EST-USA	IS-66
15 ADD ON AMERICA	393
403 AMDS LTD.	IS-16
405 ATICO	IS-24,25
43 BUREAU OF ELECTRONIC PUB	110
47 B Z TECHNICAL	382
48 B&B ELECTRONICS	390
49 B&C MICROSYSTEMS	399
50 B&C MICROSYSTEMS	401
51 B&C MICROSYSTEMS	401
52 CAD SOFTWARE	373
558 CAD WAREHOUSE	MW-16
559 CAD WAREHOUSE	MW-16
589 CAD WAREHOUSE	NE-22
590 CAD WAREHOUSE	NE-22
615 CAD WAREHOUSE	PC-18
616 CAD WAREHOUSE	PC-18
844 CAD WAREHOUSE	SO-14
645 CAD WAREHOUSE	SO-14
638 CHAUMONT & ASSOCIATES	SO-9
61 COMP USA	313
422 COMPEX INTERNATIONAL, INC.	IS-66
423 COMPUCLASSICS	IS-23
424 COMPUVAE INT'L	IS-49
554 COMPUTER PERIP DIRECT, INC.	11
555 COMPUTER PERIP DIRECT, INC.	11
425 COMPUTER QUICK	IS-50
* COMPUTER SALES PROF	NE-5
* COMPUTER SALES PROF	NE-11
67 COMPUTERLANE	389
84 DATAQ INSTRUMENTS	373
381 DATAWARE	396
556 DERBYTECH COMPUTERS, INC.	MW-20
557 DERBYTECH COMPUTERS, INC.	MW-20
587 DERBYTECH COMPUTERS, INC.	NE-28
588 DERBYTECH COMPUTERS, INC.	NE-28
613 DERBYTECH COMPUTERS, INC.	PC-20
614 DERBYTECH COMPUTERS, INC.	PC-20
642 DERBYTECH COMPUTERS, INC.	SO-20

Inquiry No.	Page No.
<b>643 DERBYTECH COMPUTERS, INC.</b>	
94 DISKOTECH	393
95 DISKOTECH	393
434 ELEX INTERNATIONAL	IS-29
591 FD MICROSYSTEMS	NE-25
592 FD MICROSYSTEMS	NE-25
646 FD MICROSYSTEMS	SO-13
647 FD MICROSYSTEMS	SO-13
111 FIRST SOURCE INTERNATIONAL 386	
112 FIRST SOURCE INTERNATIONAL 386	
441 GREY MATTER	IS-64
135 HOOLEON	372
444 IMS/FINATOR	IS-68
445 INEX TECHNOLOGY INT'L	IS-68
155 INTEL CORP	372
160 I.C. EXPRESS	393
164 JAMECO ELECTRONICS	372
6 JDR MICRODEVICES	409-411
7 JDR MICRODEVICES	409-411
564 KANDU, INC.	MW-17
565 KANDU, INC.	MW-17
169 KEITHLEY METRABYTE	373
* MARK WILLIAMS CO	75
187 MARYMAC INDUSTRIES	399
458 MAYFAIR MICROS	IS-28
* MICROCOMPUTER MKTG CNCL	SO-19
568 MYODA, INC.	MW-9
569 MYODA, INC.	MW-9
598 MYODA, INC.	NE-15
599 MYODA, INC.	NE-15
623 MYODA, INC.	PC-11
624 MYODA, INC.	PC-11
655 MYODA, INC.	SO-7
656 MYODA, INC.	SO-7
211 NATIONAL INSTRUMENTS	373
216 NEVADA COMPUTER	392
219 NO NOISE CORP	177
220 NO NOISE CORP	177
222 NORTHGATE COMPUTER	140,141
223 NORTHGATE COMPUTER	142,143
224 NORTHGATE COMPUTER	144,145
* PC CONNECTION	112,113
* PC CONNECTION	114,115
* PC CONNECTION	116,117
255 POLAROID	372
258 PRECISION DATA PRODUCTS	401
262 PROGRAMMERS SHOP	232,233
263 PROGRAMMERS SHOP	234,235
264 PROGRAMMER'S CONNECTION	372
* PROGRAMMER'S PARADISE	59
265 PROGRAMMER'S PARADISE	60,61
282 R&R ELECTRONICS	401
600 SAINT CROIX CORP	NE-27
601 SAINT CROIX CORP	NE-27
470 SCOTSDALE SYSTEMS	IS-31
473 SIMPLE TECHNOLOGY, INC.	IS-56
602 SIMPLE TECHNOLOGY	NE-24
293 SN'W	120
* SOFTLINE	IS-55
474 SOFTWARE CONSTRUCTION CO. LTD	IS-41
475 SOFTWAREHOUSE EUROPE	IS-38
303 STRAWBERRY TREE	372
315 TECHNOLOGY POWER ENTER	384
317 TELEPHONE PRODUCT CENTER	384
320 THE CARD SHOP	372
337 TREND SYSTEMS	391
351 UNIVERSAL MEMORY PROD	373
352 UNIVERSAL MEMORY PROD	373
487 USA SOFTWARE	IS-17
372 ZERICON	372
<b>969 MISCELLANEOUS</b>	
418 COMPEX, INC.	IS-44
419 COMPEX, INC.	IS-44
495 ESC	IS-52
593 GLASGAL COMMUNICATIONS	NE-7
454 IGC	IS-72
455 IGC	IS-72
219 NO NOISE CORP	177
220 NO NOISE CORP	177
237 PC COMPUTER RENTAL	401
316 TELCON	328
<b>970 ON-LINE SERVICES</b>	
* BIX	205
* BIX	282
450 BIX	302,303
* BIX	384
* BIX	MW-14
* BIX	SO-15
227 COMPUTER PRODUCTIONS, INC	318
<b>971 OPERATING SYSTEMS</b>	
90 DIGITAL RESEARCH	277
107 ESIX SYSTEMS	275
* MARK WILLIAMS CO	75
270 QUANTUM SOFTWARE SYS., LTD	131
285 SANTA CRUZ OPERATION	55
344 UHC	100
355 VENTURCOM	216
356 VENTURCOM	216

# REQUEST FREE PRODUCT INFORMATION BY FAX

Just fax this page to 1-413-637-4343. Save time because your request for information will be processed *immediately*.

- 1** Circle the numbers below which correspond to the numbers assigned to advertisers and products that interest you.
- 2** Check off the answers to questions "A" through "E".
- 3** Print your name, address, and fax number clearly on the form.
- 4** Remove this page or copy this page clearly and fax it to the number above.

Fill out this coupon carefully. PLEASE PRINT.

Name \_\_\_\_\_  
 Title \_\_\_\_\_  
 Company \_\_\_\_\_  
 Address \_\_\_\_\_  
 City \_\_\_\_\_  
 State/Province \_\_\_\_\_ Zip \_\_\_\_\_  
 Country ( ) \_\_\_\_\_  
 Phone Number \_\_\_\_\_ Fax Number \_\_\_\_\_

**A. What is your primary job function/principal area of responsibility? (Check one.)**

- 1 MIS/DP
- 2 Programmer/Systems Analyst
- 3 Administration/Management
- 4 Sales/Marketing
- 5 Engineer/Scientist
- 6 Other

**B. What is your level of management responsibility?**

- 7 Senior-level
- 8 Middle-level
- 9 Professional

**C. Are you a reseller (VAR, VAD, Dealer, Consultant)?**

- 10 Yes
- 11 No

**D. What operating systems are you currently using? (Check all that apply.)**

- 12 PC/MS-DOS
- 13 DOS + Windows
- 14 OS/2
- 15 UNIX
- 16 MacOS
- 17 VAX/VMS

**E. For how many people do you influence the purchase of hardware or software?**

- 18 1-25
- 19 26-50
- 20 51-99
- 21 100 or more

Inquiry Numbers 1-495

Inquiry Numbers 496-990

Inquiry Numbers 991-1479

1	2	3	4	5	6	7	8	9	10	11	496	497	498	499	500	501	502	503	504	505	506	991	992	993	994	995	996	997	998	999	1000	1001
12	13	14	15	16	17	18	19	20	21	22	507	508	509	510	511	512	513	514	515	516	517	1002	1003	1004	1005	1006	1007	1008	1009	1010	1011	1012
23	24	25	26	27	28	29	30	31	32	33	518	519	520	521	522	523	524	525	526	527	528	1013	1014	1015	1016	1017	1018	1019	1020	1021	1022	1023
34	35	36	37	38	39	40	41	42	43	44	529	530	531	532	533	534	535	536	537	538	539	1024	1025	1026	1027	1028	1029	1030	1031	1032	1033	1034
45	46	47	48	49	50	51	52	53	54	55	540	541	542	543	544	545	546	547	548	549	550	1035	1036	1037	1038	1039	1040	1041	1042	1043	1044	1045
56	57	58	59	60	61	62	63	64	65	66	551	552	553	554	555	556	557	558	559	560	561	1046	1047	1048	1049	1050	1061	1052	1053	1054	1055	1056
67	68	69	70	71	72	73	74	75	76	77	562	563	564	565	566	567	568	569	570	571	572	1057	1058	1059	1060	1061	1062	1063	1064	1065	1066	1067
78	79	80	81	82	83	84	85	86	87	88	573	574	575	576	577	578	579	580	581	582	583	1068	1069	1070	1071	1072	1073	1074	1075	1076	1077	1078
89	90	91	92	93	94	95	96	97	98	99	584	585	586	587	588	589	590	591	592	593	594	1079	1080	1081	1082	1083	1084	1085	1086	1087	1088	1089
100	101	102	103	104	105	106	107	108	109	110	595	596	597	598	599	600	601	602	603	604	605	1090	1091	1092	1093	1094	1095	1096	1097	1098	1099	1100
111	112	113	114	115	116	117	118	119	120	121	606	607	608	609	610	611	612	613	614	615	616	1101	1102	1103	1104	1105	1106	1107	1108	1109	1110	1111
122	123	124	125	126	127	128	129	130	131	132	617	618	619	620	621	622	623	624	625	626	627	1112	1113	1114	1115	1116	1117	1118	1119	1120	1121	1122
133	134	135	136	137	138	139	140	141	142	143	628	629	630	631	632	633	634	635	636	637	638	1123	1124	1125	1126	1127	1128	1129	1130	1131	1132	1133
144	145	146	147	148	149	150	151	152	153	154	639	640	641	642	643	644	645	646	647	648	649	1134	1135	1136	1137	1138	1139	1140	1141	1142	1143	1144
155	156	157	158	159	160	161	162	163	164	165	650	651	652	653	654	655	656	657	658	659	660	1145	1146	1147	1148	1149	1150	1151	1152	1153	1154	1155
166	167	168	169	170	171	172	173	174	175	176	661	662	663	664	665	666	667	668	669	670	671	1156	1157	1158	1159	1160	1161	1162	1163	1164	1165	1166
177	178	179	180	181	182	183	184	185	186	187	672	673	674	675	676	677	678	679	680	681	682	1167	1168	1169	1170	1171	1172	1173	1174	1175	1176	1177
188	189	190	191	192	193	194	195	196	197	198	683	684	685	686	687	688	689	690	691	692	693	1178	1179	1180	1181	1182	1183	1184	1185	1186	1187	1188
199	200	201	202	203	204	205	206	207	208	209	694	695	696	697	698	699	700	701	702	703	704	1189	1190	1191	1192	1193	1194	1195	1196	1197	1198	1199
210	211	212	213	214	215	216	217	218	219	220	705	706	707	708	709	710	711	712	713	714	715	1200	1201	1202	1203	1204	1205	1206	1207	1208	1209	1210
221	222	223	224	225	226	227	228	229	230	231	716	717	718	719	720	721	722	723	724	725	726	1211	1212	1213	1214	1215	1216	1217	1218	1219	1220	1221
232	233	234	235	236	237	238	239	240	241	242	727	728	729	730	731	732	733	734	735	736	737	1222	1223	1224	1225	1226	1227	1228	1229	1230	1231	1232
243	244	245	246	247	248	249	250	251	252	253	738	739	740	741	742	743	744	745	746	747	748	1233	1234	1235	1236	1237	1238	1239	1240	1241	1242	1243
254	255	256	257	258	259	260	261	262	263	264	749	750	751	752	753	754	755	756	757	758	759	1244	1245	1246	1247	1248	1249	1250	1251	1252	1253	1254
265	266	267	268	269	270	271	272	273	274	275	760	761	762	763	764	765	766	767	768	769	770	1255	1256	1257	1258	1259	1260	1261	1262	1263	1264	1265
276	277	278	279	280	281	282	283	284	285	286	771	772	773	774	775	776	777	778	779	780	781	1266	1267	1268	1269	1270	1271	1272	1273	1274	1275	1276
287	288	289	290	291	292	293	294	295	296	297	782	783	784	785	786	787	788	789	790	791	792	1277	1278	1279	1280	1281	1282	1283	1284	1285	1286	1287
298	299	300	301	302	303	304	305	306	307	308	793	794	795	796	797	798	799	800	801	802	803	1288	1289	1290	1291	1292	1293	1294	1295	1296	1297	1298
309	310	311	312	313	314	315	316	317	318	319	804	805	806	807	808	809	810	811	812	813	814	1299	1300	1301	1302	1303	1304	1305	1306	1307	1308	1309
320	321	322	323	324	325	326	327	328	329	330	815	816	817	818	819	820	821	822	823	824	825	1310	1311	1312	1313	1314	1315	1316	1317	1318	1319	1320
331	332	333	334	335	336	337	338	339	340	341	826	827	828	829	830	831	832	833	834	835	836	1321	1322	1323	1324	1325	1326	1327	1328	1329	1330	1331
342	343	344	345	346	347	348	349	350	351	352	837	838	839	840	841	842	843	844	845	846	847	1332	1333	1334	1335	1336	1337	1338	1339	1340	1341	1342
353	354	355	356	357	358	359	360	361	362	363	848	849	850	851	852	853	854	855	856	857	858	1343	1344	1345	1346	1347	1348	1349	1350	1351	1352	1353
364	365	366	367	368	369	370	371	372	373	374	859	860	861	862	863	864	865	866	867	868	869	1354	1355	1356	1357	1358	1359	1360	1361	1362	1363	1364
375	376	377	378	379	380	381	382	383	384	385	870	871	872	873	874	875	876	877	878	879	880	1365	1366	1367	1368	1369	1370	1371	1372	1373	1374	1375
386	387	388	389	390	391	392	393	394	395	396	881	882	883	884	885	886	887	888	889	890	891	1376	1377	1378	1379	1380	1381	1382	1383	1384	1385	1386
397	398	399	400	401	402	403	404	405	406	407	892	893	894	895	896	897	898	899	900	901	902	1387	1388	1389	1390	1391	1392	1393	1394	1395	1396	1397
408	409	410	411	412	413	414	415	416	417	418	903	904	905	906	907	908	909	910	911	912	913	1398	1399	1400	1401	1402	1403	1404	1405	1406	1407	1408
419	420	421	422	423	424	425	426	427	428	429	914	915	916	917	918	919	920	921	922	923	924	1409	1410	1411	1412	1413	1414	1415	1416	1417	1418	1419
430	431	432	433	434	435	436	437	438	439	440	925	926	927	928	929																	

# FREE PRODUCT INFORMATION

Want More Information About the Products and Advertisers Featured in this Issue?

**1** Circle numbers on reply card which correspond to numbers assigned to items of interest to you.

**2** Check all the appropriate answers to questions "A" through "E".

**3** Print your name and address and mail.

Fill out this coupon carefully. PLEASE PRINT.

Name \_\_\_\_\_  
 Title \_\_\_\_\_  
 Phone \_\_\_\_\_ Fax \_\_\_\_\_  
 Company \_\_\_\_\_  
 Address \_\_\_\_\_  
 City \_\_\_\_\_ State \_\_\_\_\_ Zip \_\_\_\_\_

**A. What is your primary job function/principal area of responsibility? (Check one.)**

- 1 MIS/DP
- 2 Programmer/Systems Analyst
- 3 Administration/Management
- 4 Sales/Marketing
- 5 Engineer/Scientist
- 6 Other

**B. What is your level of management responsibility?**

- 7 Senior-level
- 8 Middle-level
- 9 Professional

**C. Are you a reseller (VAR, VAD, Dealer, Consultant)?**

- 10 Yes
- 11 No

**D. What operating systems are you currently using? (Check all that apply.)**

- 12 PC/MS-DOS
- 13 DOS + Windows
- 14 OS/2
- 15 UNIX
- 16 MacOS
- 17 VAX/VMS

**E. For how many people do you influence the purchase of hardware or software?**

- 18 1-25
- 19 26-50
- 20 51-99
- 21 100 or more

Please send me one year of BYTE Magazine for \$24.95 and bill me. Offer valid in U.S. and possessions only.

JANUARY  
IRSD002

Inquiry Numbers 1-493																	Inquiry Numbers 494-986																	Inquiry Numbers 987-1479																																																																																																																																																																																																																																																																																																																																																																																																																																																																																																																																																																																																																																																																																																																																																																																																																																																																																																																																																																																																																																																																																																																																																																																																																																																																																																																																																
18	19	20	21	22	23	24	25	26	27	28	29	30	31	32	33	34	35	36	37	38	39	40	41	42	43	44	45	46	47	48	49	50	51	52	53	54	55	56	57	58	59	60	61	62	63	64	65	66	67	68	69	70	71	72	73	74	75	76	77	78	79	80	81	82	83	84	85	86	87	88	89	90	91	92	93	94	95	96	97	98	99	100	101	102	103	104	105	106	107	108	109	110	111	112	113	114	115	116	117	118	119	120	121	122	123	124	125	126	127	128	129	130	131	132	133	134	135	136	137	138	139	140	141	142	143	144	145	146	147	148	149	150	151	152	153	154	155	156	157	158	159	160	161	162	163	164	165	166	167	168	169	170	171	172	173	174	175	176	177	178	179	180	181	182	183	184	185	186	187	188	189	190	191	192	193	194	195	196	197	198	199	200	201	202	203	204	205	206	207	208	209	210	211	212	213	214	215	216	217	218	219	220	221	222	223	224	225	226	227	228	229	230	231	232	233	234	235	236	237	238	239	240	241	242	243	244	245	246	247	248	249	250	251	252	253	254	255	256	257	258	259	260	261	262	263	264	265	266	267	268	269	270	271	272	273	274	275	276	277	278	279	280	281	282	283	284	285	286	287	288	289	290	291	292	293	294	295	296	297	298	299	300	301	302	303	304	305	306	307	308	309	310	311	312	313	314	315	316	317	318	319	320	321	322	323	324	325	326	327	328	329	330	331	332	333	334	335	336	337	338	339	340	341	342	343	344	345	346	347	348	349	350	351	352	353	354	355	356	357	358	359	360	361	362	363	364	365	366	367	368	369	370	371	372	373	374	375	376	377	378	379	380	381	382	383	384	385	386	387	388	389	390	391	392	393	394	395	396	397	398	399	400	401	402	403	404	405	406	407	408	409	410	411	412	413	414	415	416	417	418	419	420	421	422	423	424	425	426	427	428	429	430	431	432	433	434	435	436	437	438	439	440	441	442	443	444	445	446	447	448	449	450	451	452	453	454	455	456	457	458	459	460	461	462	463	464	465	466	467	468	469	470	471	472	473	474	475	476	477	478	479	480	481	482	483	484	485	486	487	488	489	490	491	492	493	494	495	496	497	498	499	500	501	502	503	504	505	506	507	508	509	510	511	512	513	514	515	516	517	518	519	520	521	522	523	524	525	526	527	528	529	530	531	532	533	534	535	536	537	538	539	540	541	542	543	544	545	546	547	548	549	550	551	552	553	554	555	556	557	558	559	560	561	562	563	564	565	566	567	568	569	570	571	572	573	574	575	576	577	578	579	580	581	582	583	584	585	586	587	588	589	590	591	592	593	594	595	596	597	598	599	600	601	602	603	604	605	606	607	608	609	610	611	612	613	614	615	616	617	618	619	620	621	622	623	624	625	626	627	628	629	630	631	632	633	634	635	636	637	638	639	640	641	642	643	644	645	646	647	648	649	650	651	652	653	654	655	656	657	658	659	660	661	662	663	664	665	666	667	668	669	670	671	672	673	674	675	676	677	678	679	680	681	682	683	684	685	686	687	688	689	690	691	692	693	694	695	696	697	698	699	700	701	702	703	704	705	706	707	708	709	710	711	712	713	714	715	716	717	718	719	720	721	722	723	724	725	726	727	728	729	730	731	732	733	734	735	736	737	738	739	740	741	742	743	744	745	746	747	748	749	750	751	752	753	754	755	756	757	758	759	760	761	762	763	764	765	766	767	768	769	770	771	772	773	774	775	776	777	778	779	780	781	782	783	784	785	786	787	788	789	790	791	792	793	794	795	796	797	798	799	800	801	802	803	804	805	806	807	808	809	810	811	812	813	814	815	816	817	818	819	820	821	822	823	824	825	826	827	828	829	830	831	832	833	834	835	836	837	838	839	840	841	842	843	844	845	846	847	848	849	850	851	852	853	854	855	856	857	858	859	860	861	862	863	864	865	866	867	868	869	870	871	872	873	874	875	876	877	878	879	880	881	882	883	884	885	886	887	888	889	890	891	892	893	894	895	896	897	898	899	900	901	902	903	904	905	906	907	908	909	910	911	912	913	914	915	916	917	918	919	920	921	922	923	924	925	926	927	928	929	930	931	932	933	934	935	936	937	938	939	940	941	942	943	944	945	946	947	948	949	950	951	952	953	954	955	956	957	958	959	960	961	962	963	964	965	966	967	968	969	970	971	972	973	974	975	976	977	978	979	980	981	982	983	984	985	986	987	988	989	990	991	992	993	994	995	996	997	998	999	1000	1001	1002	1003	1004	1005	1006	1007	1008	1009	1010	1011	1012	1013	1014	1015	1016	1017	1018	1019	1020	1021	1022	1023	1024	1025	1026	1027	1028	1029	1030	1031	1032	1033	1034	1035	1036	1037	1038	1039	1040	1041	1042	1043	1044	1045	1046	1047	1048	1049	1050	1051	1052	1053	1054	1055	1056	1057	1058	1059	1060	1061	1062	1063	1064	1065	1066	1067	1068	1069	1070	1071	1072	1073	1074	1075	1076	1077	1078	1079	1080	1081	1082	1083	1084	1085	1086	1087	1088	1089	1090	1091	1092	1093	1094	1095	1096	1097	1098	1099	1100	1101	1102	1103	1104	1105	1106	1107	1108	1109	1110	1111	1112	1113	1114	1115	1116	1117	1118	1119	1120	1121	1122	1123	1124	1125	1126	1127	1128	1129	1130	1131	1132	1133	1134	1135	1136	1137	1138	1139	1140	1141	1142	1143	1144	1145	1146	1147	1148	1149	1150	1151	1152	1153	1154	1155	1156	1157	1158	1159	1160	1161	1162	1163	1164	1165	1166	1167	1168	1169	1170	1171	1172	1173	1174	1175	1176	1177	1178	1179	1180	1181	1182	1183	1184	1185	1186	1187	1188	1189	1190	1191	1192	1193	1194	1195	1196	1197	1198	1199	1200	1201	1202	1203	1204	1205	1206	1207	1208	1209	1210	1211	1212	1213	1214	1215	1216	1217	1218	1219	1220	1221	1222	1223	1224	1225	1226	1227	1228	1229	1230	1231	1232	1233	1234	1235	1236	1237	1238	1239	1240	1241	1242	1243	1244	1245	1246	1247	1248	1249	1250	1251	1252	1253	1254	1255	1256	1257	1258	1259	1260	1261	1262	1263	1264	1265	1266	1267	1268	1269	1270	1271	1272	1273	1274	1275	1276	1277	1278	1279	1280	1281	1282	1283	1284	1285	1286	1287	1288	1289	1290	1291	1292	1293	1294	1295	1296	1297	1298	1299	1300	1301	1302	1303	1304	1305	1306	1307	1308	1309	1310	1311	1312	1313	1314	1315	1316	1317	1318	1319	1320	1321	1322	1323	1324	1325	1326	1327	1328	1329	1330	1331	1332	1333	1334	1335	1336	1337	1338	1339	1340	1341	1342	1343	1344	1345	1346	1347	1348</

# FREE PRODUCT INFORMATION

Want More Information About the Products and Advertisers Featured in this Issue?

**1** Circle numbers on reply card which correspond to numbers assigned to items of interest to you.

**2** Check all the appropriate answers to questions "A" through "E".

**3** Print your name and address and mail.



NO POSTAGE  
NECESSARY  
IF MAILED  
IN THE  
UNITED STATES

## BUSINESS REPLY MAIL

FIRST CLASS MAIL PERMIT NO. 176 PITTSFIELD, MA

POSTAGE WILL BE PAID BY ADDRESSEE

# BYTE

READER SERVICE  
PO Box 5110  
Pittsfield, MA 01203-9926  
USA



Fill out this coupon carefully. PLEASE PRINT.

Name \_\_\_\_\_  
 Title \_\_\_\_\_  
 ( ) \_\_\_\_\_ ( ) \_\_\_\_\_  
 Phone \_\_\_\_\_ Fax \_\_\_\_\_  
 Company \_\_\_\_\_  
 Address \_\_\_\_\_  
 City \_\_\_\_\_ State \_\_\_\_\_ Zip \_\_\_\_\_

**A. What is your primary job function/principal area of responsibility? (Check one.)**

- 1 MIS/DP
- 2 Programmer/Systems Analyst
- 3 Administration/Management
- 4 Sales/Marketing
- 5 Engineer/Scientist
- 6 Other

**B. What is your level of management responsibility?**

- 7 Senior-level
- 8 Middle-level
- 9 Professional

**C. Are you a reseller (VAR, VAD, Dealer, Consultant)?**

- 10 Yes
- 11 No

**D. What operating systems are you currently using? (Check all that apply.)**

- 12 PC/MS-DOS
- 13 DOS + Windows
- 14 OS/2
- 15 UNIX
- 16 MacOS
- 17 VAX/VMS

**E. For how many people do you influence the purchase of hardware or software?**

- 18 1-25
- 19 26-50
- 20 51-99
- 21 100 or more

Please send me one year of BYTE Magazine for \$2495 and bill me. Offer valid in U.S. and possessions only.

JANUARY  
IRSD002

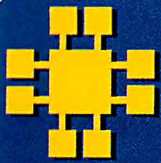
Inquiry Numbers 1-493

Inquiry Numbers 494-986

Inquiry Numbers 987-1479

1	2	3	4	5	6	7	8	9	10	11	12	13	14	15	16	17	494	495	496	497	498	499	500	501	502	503	504	505	506	507	508	509	510	987	988	989	990	991	992	993	994	995	996	997	998	999	1000	1001	1002	1003
18	19	20	21	22	23	24	25	26	27	28	29	30	31	32	33	34	511	512	513	514	515	516	517	518	519	520	521	522	523	524	525	526	527	1004	1005	1006	1007	1008	1009	1010	1011	1012	1013	1014	1015	1016	1017	1018	1019	1020
35	36	37	38	39	40	41	42	43	44	45	46	47	48	49	50	51	528	529	530	531	532	533	534	535	536	537	538	539	540	541	542	543	544	1021	1022	1023	1024	1025	1026	1027	1028	1029	1030	1031	1032	1033	1034	1035	1036	1037
52	53	54	55	56	57	58	59	60	61	62	63	64	65	66	67	68	545	546	547	548	549	550	551	552	553	554	555	556	557	558	559	560	561	1038	1039	1040	1041	1042	1043	1044	1045	1046	1047	1048	1049	1050	1051	1052	1053	1054
69	70	71	72	73	74	75	76	77	78	79	80	81	82	83	84	85	562	563	564	565	566	567	568	569	570	571	572	573	574	575	576	577	578	1055	1056	1057	1058	1059	1060	1061	1062	1063	1064	1065	1066	1067	1068	1069	1070	1071
86	87	88	89	90	91	92	93	94	95	96	97	98	99	100	101	102	579	580	581	582	583	584	585	586	587	588	589	590	591	592	593	594	595	1072	1073	1074	1075	1076	1077	1078	1079	1080	1081	1082	1083	1084	1085	1086	1087	1088
103	104	105	106	107	108	109	110	111	112	113	114	115	116	117	118	119	596	597	598	599	600	601	602	603	604	605	606	607	608	609	610	611	612	1089	1090	1091	1092	1093	1094	1095	1096	1097	1098	1099	1100	1101	1102	1103	1104	1105
120	121	122	123	124	125	126	127	128	129	130	131	132	133	134	135	136	613	614	615	616	617	618	619	620	621	622	623	624	625	626	627	628	629	1106	1107	1108	1109	1110	1111	1112	1113	1114	1115	1116	1117	1118	1119	1120	1121	1122
137	138	139	140	141	142	143	144	145	146	147	148	149	150	151	152	153	630	631	632	633	634	635	636	637	638	639	640	641	642	643	644	645	646	1123	1124	1125	1126	1127	1128	1129	1130	1131	1132	1133	1134	1135	1136	1137	1138	1139
154	155	156	157	158	159	160	161	162	163	164	165	166	167	168	169	170	647	648	649	650	651	652	653	654	655	656	657	658	659	660	661	662	663	1140	1141	1142	1143	1144	1145	1146	1147	1148	1149	1150	1151	1152	1153	1154	1155	1156
171	172	173	174	175	176	177	178	179	180	181	182	183	184	185	186	187	664	665	666	667	668	669	670	671	672	673	674	675	676	677	678	679	680	1157	1158	1159	1160	1161	1162	1163	1164	1165	1166	1167	1168	1169	1170	1171	1172	1173
188	189	190	191	192	193	194	195	196	197	198	199	200	201	202	203	204	681	682	683	684	685	686	687	688	689	690	691	692	693	694	695	696	697	1174	1175	1176	1177	1178	1179	1180	1181	1182	1183	1184	1185	1186	1187	1188	1189	1190
205	206	207	208	209	210	211	212	213	214	215	216	217	218	219	220	221	698	699	700	701	702	703	704	705	706	707	708	709	710	711	712	713	714	1191	1192	1193	1194	1195	1196	1197	1198	1199	1200	1201	1202	1203	1204	1205	1206	1207
222	223	224	225	226	227	228	229	230	231	232	233	234	235	236	237	238	715	716	717	718	719	720	721	722	723	724	725	726	727	728	729	730	731	1208	1209	1210	1211	1212	1213	1214	1215	1216	1217	1218	1219	1220	1221	1222	1223	1224
239	240	241	242	243	244	245	246	247	248	249	250	251	252	253	254	255	732	733	734	735	736	737	738	739	740	741	742	743	744	745	746	747	748	1225	1226	1227	1228	1229	1230	1231	1232	1233	1234	1235	1236	1237	1238	1239	1240	1241
256	257	258	259	260	261	262	263	264	265	266	267	268	269	270	271	272	749	750	751	752	753	754	755	756	757	758	759	760	761	762	763	764	765	1242	1243	1244	1245	1246	1247	1248	1249	1250	1251	1252	1253	1254	1255	1256	1257	1258
273	274	275	276	277	278	279	280	281	282	283	284	285	286	287	288	289	766	767	768	769	770	771	772	773	774	775	776	777	778	779	780	781	782	1259	1260	1261	1262	1263	1264	1265	1266	1267	1268	1269	1270	1271	1272	1273	1274	1275
290	291	292	293	294	295	296	297	298	299	300	301	302	303	304	305	306	783	784	785	786	787	788	789	790	791	792	793	794	795	796	797	798	799	1276	1277	1278	1279	1280	1281	1282	1283	1284	1285	1286	1287	1288	1289	1290	1291	1292
307	308	309	310	311	312	313	314	315	316	317	318	319	320	321	322	323	800	801	802	803	804	805	806	807	808	809	810	811	812	813	814	815	816	1293	1294	1295	1296	1297	1298	1299	1300	1301	1302	1303	1304	1305	1306	1307	1308	1309
324	325	326	327	328	329	330	331	332	333	334	335	336	337	338	339	340	817	818	819	820	821	822	823	824	825	826	827	828	829	830	831	832	833	1310	1311	1312	1313	1314	1315	1316	1317	1318	1319	1320	1321	1322	1323	1324	1325	1326
341	342	343	344	345	346	347	348	349	350	351	352	353	354	355	356	357	834	835	836	837	838	839	840	841	842	843	844	845	846	847	848	849	850	1327	1328	1329	1330	1331	1332	1333	1334	1335	1336	1337	1338	1339	1340	1341	1342	1343
358	359	360	361	362	363	364	365	366	367	368	369	370	371	372	373	374	851	852	853	854	855	856	857	858	859	860	861	862	863	864	865	866	867	1344	1345	1346	1347	1348	1349	1350	1351	1352	1353	1354	1355	1356	1357	1358	1359	1360
375	376	377	378	379	380	381	382	383	384	385	386	387	388	389	390	391	868	869	870	871	872	873	874	875	876	877	878	879	880	881	882	883	884	1361	1362	1363	1364	1365	1366	1367	1368	1369	1370	1371	1372	1373	1374	1375	1376	1377
392	393	394	395	396	397	398	399	400	401	402	403	404	405	406	407	408	885	886	887	888	889	890	891	892	893	894	895	896	897	898	899	900	901	1378	1379	1380	1381	1382	1383	1384	1385	1386	1387	1388	1389	1390	1391	1392	1393	1394
409	410	411	412	413	414	415	416	417	418	419	420	421	422	423	424	425	902	903	904	905	906	907	908	909	910	911	912	913	914	915																				





# JDR Microdevices®

2233 BRANHAM LANE, SAN JOSE CA 95124

- BUY WITH CONFIDENCE FROM JDR!
- 30-DAY MONEY BACK GUARANTEE
- 1 YEAR WARRANTY
- TOLL-FREE TECH SUPPORT

## DYNAMIC RAMS

PART#	SIZE	SPEED	PINS	PRICE
4116-150	16384x1	150ns	16	1.49
4164-150	65536x1	150ns	16	2.49
4164-120	65536x1	120ns	16	2.89
4164-100	65536x1	100ns	16	3.39
TMS4464-12	65536x4	120ns	16	3.95
41256-150	262144x1	150ns	16	1.95
41256-120	262144x1	120ns	16	2.15
41256-100	262144x1	100ns	16	2.25
41256-80	262144x1	80ns	16	2.75
414256-100	262144x4	100ns	20	8.95
414256-80	262144x4	80ns	20	9.95
1MB-120	1048576x1	120ns	18	7.95
1MB-100	1048576x1	100ns	18	8.95
1MB-80	1048576x1	80ns	18	9.95
1MB-70	1048576x1	70ns	18	10.75

## SIMM/SIP MODULES

PART#	SIZE	SPEED	FORM	PRICE
41256A9B-80	256K x 9	80ns	SIMM/PC	33.95
421000A9B-10	1MB x 8	100ns	SIMM/MAC	79.95
421000A9B-10	1MB x 9	100ns	SIMM/PC	79.95
421000A9B-80	1MB x 9	80ns	SIMM/PC	89.95
421000A9B-60	1MB x 9	60ns	SIMM/PC	99.95
256K9SIP-80	256K X 9	80ns	SIP/PC	33.95
256K9SIP-60	256K X 9	60ns	SIP/PC	39.95
1MBx9SIP-10	1MB x 9	100ns	SIP/PC	79.95
1MBx9SIP-80	1MB x 9	80ns	SIP/PC	89.95

## MATH CO-PROCESSORS

8087	5 MHz	89.95
8087-2	8 MHz	129.95
8087-1	10 MHz	169.95
80287-XLT	12MHz	247.95
80287-XL	6/8/10/12 MHz	247.95
80387-16	16 MHz	359.95
80387-SX	16 MHz	319.95
80387-SX20	20 MHz	399.95
80387-16	16 MHz	359.95
80387-20	20 MHz	399.95
80387-25	25 MHz	499.95
80387-33	33MHz	649.00



**5 YEAR WARRANTY**  
WITH MANUAL & SOFTWARE GUIDE



## CYRIX CO-PROCESSORS

STATE-OF-THE-ART TO SAVE YOU LONGEVITY WORRIES! MANUAL & SOFTWARE GUIDE, FULL 5-YEAR GUARANTEE!

83D87-16	16 MHz	\$299.95	83D87-33	33MHz	\$549.00
83D87-20	20 MHz	\$349.95	83S87-16 (SX)	16MHz	\$269.95
83D87-25	25MHz	\$439.95	83S87-20 (SX)	20MHz	\$329.95



## Derick's HIGH-TECH SPOTLIGHT

When a computer system spends much of its time waiting for peripherals like the hard disk or video display, it is said to be "I/O bound."

First we wait for the disk drive to become ready, then seek, rotate to a position under the head, and finally read in or write out the data. If the program happens to be performing a "sort" operation on disk data, the disk could be tied up for several minutes.

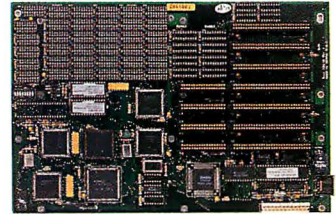
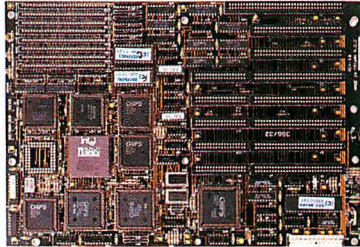
In this situation, a faster processor will make little difference. The fastest 386 computer might only improve performance by 15%. If your hard drive seems slow, consider this: drives purchased a few years ago took 85 milliseconds to seek the heads, and required 4-5 revolutions of the disk to read 8.5K of data. Many current drives average 28ms or less to get on track, and with a 1:1 interleave controller can read a full track in one revolution.

By the way, your old drive can be used as a second drive, with a new 1:1 interleave. It won't seek any faster, but at least it won't require 4-5 revolutions to read one track!

Derick Moore, Director of Engineering

For more TECHNICAL INFORMATION, be sure to order our new 1991 CATALOG. It's free!

## YOUR MOTHERBOARD CONNECTION!



### MINI 25MHz 386 \$799

- NORTON SI 26.6 • LANDMARK AT SPEED 30.1
- "THE FASTEST NON-CACHING MOTHERBOARD THAT WE TESTED." —BYTE MAGAZINE, APRIL 1990.
- MEMORY INTERLEAVING FOR NEAR ZERO WAIT STATES
- SOCKETED FOR 80387 COPROCESSOR
- USES 80NS 256K OR 1MB SIMM/DIP RAMS
- 16MB RAM CAPACITY: 8MB ON BOARD, 8MB USING OPTIONAL RAM CARD (OKB INSTALLED)
- ON-BOARD RAM: 1/2MB USING 4/8 256K SIMMS OR 4/8MB USING 4/8 1MB SIMMS • FIVE 16-BIT SLOTS, TWO 8-BIT SLOTS, ONE 32-BIT SLOT FOR PROPRIETARY RAM CARD
- AMI BIOS • SIZE: 8.5" X 13"

MCT-M386-25 ..... \$799.00

MCT-M386-M25 PROPRIETARY RAM CARD ..... \$99.95

1/2MB USING 36/72 256KX1 DRAMS OR 4/8MB USING 36/72 1MBX1 DRAMS

### 33MHz CACHE 386 \$1495

- NORTON SI 45.9 • LANDMARK AT SPEED 50.8
- 33MHz 80386 CPU • 64K ZERO WAIT STATIC RAM CACHE
- 1/2/4/8MB ON-BOARD RAM USING 80NS SIMMS (OKB INSTALLED)
- 1/2MB USING 4/8 256K SIMMS OR 4/8MB USING 4/8 1MB SIMMS • SOCKETED FOR 80387-33 MATH CO-PROCESSOR
- 8 EXPANSION SLOTS (ONE 32-BIT, SIX 16-BIT, ONE 8-BIT)
- AMI BIOS ASSURES IBM COMPATIBILITY
- 8/33MHz KEYBOARD ADJUSTABLE SPEEDS

MCT-386MBC-33 ..... \$1495.00

MCT-386MBC-25 25MHz VERSION ..... \$999.00

### MINI 25MHz CACHE 386 \$1299

- NORTON SI 30.5 • LANDMARK AT SPEED 40.7
- 25MHz 80386 • REQUIRES 1 OF THE RAM CARDS BELOW
- SHADOW RAM FOR ROM BIOS
- MEMORY CACHING FOR SUPERIOR PERFORMANCE
- MEMORY INTERLEAVING FOR NEAR 0 WAIT STATE OPERATION (8 BANKS OF MEMORY REQUIRED)
- SOCKETED FOR 80387 OR WEITEK 3167 COPROCESSORS

MCT-C386-25 ..... \$1199.00

RAM CARD (REQUIRED FOR OPERATION):

1/2/4/8/16 MB USING 256K OR 1MB SIMMS (OK INSTALLED)

MCT-C386-M16 ..... \$99.95

## LOCAL & INTERNATIONAL ORDERS WELCOME!

CALL: 408-559-1200  
OR FAX: 408-559-0250

### NEW CACHE 486 \$2495

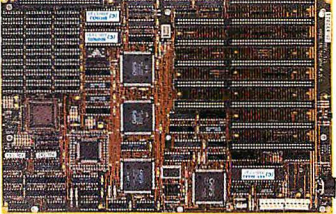
- LANDMARK AT SPEED 114.5
- THIS HIGH-PERFORMANCE STANDARD SIZE MOTHERBOARD IS WELL-SUITED TO CAD/CAM/CAE WORKSTATION TASKS AS WELL AS LAN SERVER APPLICATION. IF YOU RUN MULTITASKING, MULTI-USER OR UNIX APPLICATION, THIS MOTHERBOARD IS FOR YOU.
- INTEL 80486-25 CPU FEATURING AN INTERNAL 80387 FPU AND 8K CACHE • 128K CACHE MEMORY ON BOARD • EXPANDABLE TO 16MB ON BOARD USING 1MBX9 SIMMS OR 256KX9SIMMS (OK INSTALLED) • SOCKETED FOR A WEITEK 4167 MATH CO-PROCESSOR • EIGHT 16-BIT BUS SLOTS • AMI BIOS
- SOFTWARE SELECTABLE SPEEDS • FULLY COMPATIBLE WITH OS/2, NOVELL, DESQVIEW, UNIX, WINDOWS AND WINDOWS 3.0

MCT-486MB25 ..... \$2,495.00

### 12MHz 286 \$199.95

- NORTON SI 14.0 • LANDMARK AT SPEED 15.9
- 12/6MHz KEYBOARD SELECTABLE SPEEDS
- CHOICE OF FAST 0 WAIT STATE OR 1 WAIT STATE FOR ECONOMICAL SLOWER RAM
- AMI BIOS ASSURES IBM COMPATIBILITY
- FIVE 16-BIT AND THREE 8-BIT SLOTS
- EXPANDABLE TO 4MB ON BOARD (OKB INSTALLED)

MCT-M286-12 ..... \$199.95



### 16MHz MINI 386-SX \$399.95

- NORTON SI 15.3 • LANDMARK AT SPEED 20.8
- USES 16MHz INTEL 80386SX CPU
- EXPANDABLE TO 8MB ON BOARD
- 512K/1MB USING 18/36 256KX1 DRAMS OR 2/4 256K SIPS OR 4/8 256KX4 AND 2/4 256KX1 DRAMS; 2/4MB USING 18/36 1MBX1 DRAMS OR 2/4 1MB SIPS; 6/8MB USING 36 1MBX1 DRAMS AND 2/4 1MB SIPS
- AMI BIOS
- CHOOSE FAST 0 WAIT STATE OR 1 WAIT STATE FOR ECONOMICAL USE OF SLOWER RAM
- FIVE 16-BIT & THREE 8-BIT EXPANSION SLOTS
- CHIPS & TECHNOLOGY NEW ENHANCED ADVANCED TECHNOLOGY (NEAT) CHIPSET
- SOCKET FOR 80387SX-16 COPROCESSOR
- 8.5" X 13" SIZE FITS IN MINI-286 AND FULL-SIZE 286 CASES

MCT-386SX ..... \$399.95

### 20MHz 286 \$389.95

- NORTON SI 20.3 • LANDMARK AT SPEED 26.3
- NEAT CHIPSET HAS POWER TO COMPETE WITH 386 SYSTEMS
- EXPANDABLE FROM 512K TO 8MB; 512K/1MB USING 18/36 256KX1 DRAMS OR 2/4 256K SIPS; 2/4MB USING 18/36 1MBX1 DRAMS OR 2/4 1MB SIPS; 6/8MB USING 36 1MBX1 DRAMS AND 2/4 1MB SIPS
- 20/10MHz KEYBOARD SELECTABLE SPEEDS • AMI BIOS
- SHADOW RAM AND PAGE INTERLEAVED MEMORY
- FAST 0 WAIT STATE OR 1 WAIT STATE FOR SLOWER RAM
- 8.5" X 13" FITS MOST 8088, MINI-286 & FULL-SIZE 286 CASES
- FIVE 16-BIT & THREE 8-BIT SLOTS
- SOCKET FOR 80287-12 MATH CO-PROCESSOR

MCT-M286-20N ..... \$389.95

### 16MHz 286 W/NEAT CHIPSET \$289.95

MCT-M286-16N NORTON SI 16.2 / LANDMARK AT 21.1

### 12MHz 286 W/NEAT CHIPSET \$269.95

MCT-M286-12N NORTON SI 12.0 / LANDMARK AT 15.5

### 10MHz 8088 NORTON SI 2.1 \$99.95

- 8088-COMPATIBLE; OPERATES AT 4.77/10MHz
- KEYBOARD SELECTABLE CLOCK SPEEDS • SOCKET FOR 8087-1 COPROCESSOR • 8 SLOTS • MCT BIOS • 640K RAM CAPACITY (OKB INSTALLED)

MCT-TURBO-10 ..... \$99.95

VISA CUSTOMER SERVICE 800-538-5001  
MasterCard TECHNICAL SUPPORT 800-538-5002

MON.-FRI. 7 A.M. TO 5 P.M., SATURDAY, 9 A.M. TO 3 P.M. (PST)  
**ORDER TOLL-FREE 800-538-5000**

KEY CODE #1013



# JDR Microdevices®

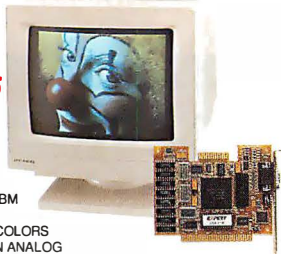
ORDER TOLL-FREE 800-538-5000

- BUY WITH CONFIDENCE FROM JDR!
- 30-DAY MONEY BACK GUARANTEE
- 1 YEAR WARRANTY
- TOLL-FREE TECH SUPPORT

## MONITORS

VGA PACKAGE  
**\$499.95**

VGA COLOR AND CLARITY AT AN EGA PRICE! • 8/16 BIT VGA CARD IS FULLY COMPATIBLE WITH IBM VGA • 640 X 480 RESOLUTION IN 16 COLORS • HIGH RESOLUTION ANALOG MONITOR • EGA/CGA/MONO AND HERCULES COMPATIBLE • DRIVERS FOR WINDOWS, GEM, LOTUS 1-2-3, SYMPHONY, AUTOCAD & VENTURA  
VGA-PKG ..... \$499.95



LOCAL & INTERNATIONAL

CALL: 408-559-1200/FAX: 408-559-0250

**MULTISYNCH MONITOR \$429.95**  
• 14" NON-GLARE SCREEN • 800 X 600 MAX RESOLUTION  
• CGA/EGA/VGA COMPATIBLE • TTL OR ANALOG MODE  
JDR-MULTI

**VGA MONITOR \$379.95**  
• 14" ANALOG VGA MONITOR • GLARE RESISTANT SCREEN  
• 720 X 480 MAXIMUM RESOLUTION • TILT/SWIVEL BASE  
VGA-MONITOR

**EGA MONITOR \$339.95**  
• 14" NON-GLARE SCREEN WITH 640 X 350 MAXIMUM RESOLUTION • DISPLAY 16 COLORS SIMULTANEOUSLY  
EGA-MONITOR

**14" SCREEN MONO \$139.95**  
• GLARE-RESISTANT 14" SCREEN WITH AMBER DISPLAY  
• 720 X 350 RESOLUTION • TILT/SWIVEL BASE  
GM-1489

MONO-SAMSUNG SAMSUNG 12" FLAT SCREEN \$129.95  
MONO-VGA PAPERWHITE VGA MONITOR ..... \$139.95  
NEC-MULTI-3D NEC MULTI-3D MULTISYNCH ..... \$649.00  
CM-1440 SEIKO DUAL FIXED FREQUENCY ..... \$599.00  
CM-1450 SEIKO 15" DUAL FIXED FREQ. .... \$749.00

## Littlefoot™ CASE \$249.95

- MOUNTS FOR STANDARD FULL SIZE AND MINI-MOTHERBOARDS
  - INCLUDES 250WATT POWER SUPPLY
  - MOUNTS FOR 3 FLOPPY AND 4 HARD DRIVES
  - TURBO AND RESET SWITCHES
  - SPEED DISPLAY, POWER, DISK LEDS
  - MOUNTING HARDWARE, FACEPLATES AND SPEAKER INCL.
- CASE-100 ..... \$249.95  
CASE-200 "SUPERFOOT"—HOLDS 11 DRIVES ..... \$499.95  
CASE-120 "MINIFOOT" W/200 WATT PS ..... \$199.95  
NOTE: CASES DO NOT INCLUDE DRIVES.



## STANDARD CASES

- FULL SIZE SLIDE CASE  
CASE-70 ..... \$89.95  
CASE-50 FOR 8088 OR MINI-86 MOTHERBOARDS ..... \$59.95  
CASE-FLIP FLIP-TOP XT-STYLE CASE ..... \$39.95  
CASE-SLIDE SLIDE TYPE XT-STYLE CASE ..... \$39.95  
CASE-JR ..... \$149.95  
WITH 150W POWER SUPPLY. FOR 8088 OR MINI-286 BOARDS.  
CASE-JR-200 ..... \$189.95  
WITH 200W POWER SUPPLY. FOR 8088 OR MINI-286 BOARDS.  
NOTE: CASES DO NOT INCLUDE DRIVES.



## PC POWER SUPPLIES

- PS-135 135 WATT FOR 8088 - U.L. APPROVED ..... \$59.95  
PS-150 150 WATT FOR 8088 - U.L. APPROVED ..... \$69.95  
PS-200X 200 WATT FOR 8088 - U.L. APPROVED ..... \$89.95  
PS-200 200 WATT FOR 286/386 - U.L. APPROVED ..... \$89.95  
PS-250 250 WATT FOR 286/386 ..... \$129.95

## UNINTERRUPTIBLE POWER SUPPLIES

- CONDITIONED CRITICAL LOAD/BACK-UP DURING BLACKOUT.  
PART NO. VA FREQ. CURRENT BATTERY PRICE  
EMERSON-20 300 60hz 2.50A 10min. \$299.95  
EMERSON-30 500 60hz 4.20A 10min. \$499.95  
EMERSON-40 800 60hz 6.70A 10min. \$699.00

## POST CODE DIAGNOSES SYSTEM PROBLEMS!

TO DIAGNOSE, PLUG IT INTO A CARD SLOT. READ THE INDICATOR DISPLAY & CHECK THE MANUAL FOR THE CORRESPONDING POWER-ON SELF-TEST CODE. SWITCH-LESS AND JUMPERLESS DESIGN. COMPATIBLE W/80286 & 80386-BASED SYSTEMS.  
PCODE ..... \$49.95



## DISPLAY CARDS

**8/16-BIT VGA \$169.95**  
• 8088 OR 286/386/486 PC COMPATIBLE • 800 X 600 IN 16 COLORS • 256K VIDEO RAM • SUPPORTS ANALOG AND TTL  
MCT-VGA-16  
MCT-VGA-8 8-BIT VERSION ..... \$149.95  
MCT-VGA-1024 1024 X 768 VGA ..... \$189.95  
MCT-VGA-1024+ 1024 X 768 IN 256 COLORS ..... \$249.95  
MCT-VGA 1024+ VGA WITH TTL SUPPORT ..... \$189.95

**MONO GRAPHICS/PRINTER \$49.95**  
8088/286 COMPATIBLE • HERCULES COMPATIBLE MONOGRAPHICS • SUPPORTS LOTUS 1-2-3 • 720 X 348 DISPLAY • ADDRESS PARALLEL PRINTER PORT AS LPT1 OR 2  
MCT-MGP

## MORE DISPLAY CARDS

MCT-CGP CGA GRAPHICS FOR RGB MONITOR ..... \$49.95  
MCT-EGA EGA CARD WITH 256K RAM ..... \$149.95

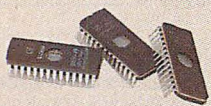
## CABLES AND GENDER CHANGERS

MOLDED, GOLD-PLATED CONTACTS; 100% SHIELDED

CBL-PRNTR-25 25 FT. PC PRINTER CABLE 15.95  
CBL-PRNTR-RA RIGHT ANGLE PRINTER CABLE 15.95  
CBL-DB25-MM DB25 MALE-DB25 MALE 6 FT. 9.95  
CBL-DB25-MF DB25 MALE-DB25 FEMALE 6 FT. 9.95  
CBL-9-SERIAL DB9 FEMALE-DB25 MALE 6 FT. 6.95  
CBL-CNT-MM 36-PIN CENTRONICS -MM 14.95  
GENDER-VGA DB9-DB15 ADAPTOR 4.95  
HUNDREDS MORE AVAILABLE—CALL FOR MORE INFO

## DEVELOPERS' WORLD

JDR caters to the developer with a full line of prototyping and programming products. Here are just a few examples. Request our catalog for our complete line!

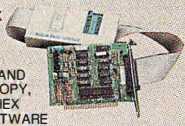


## EPROMS

PART#	SIZE	SPEED	Vpp	PINS	PRICE
2716-1	2048x8	350ns	25V	24	4.95
2732A	4096x8	250ns	21V	24	3.95
2764	8192x8	450ns	12.5V	28	3.95
2764-250	8192x8	250ns	12.5V	28	3.95
2764-200	8192x8	200ns	12.5V	28	4.49
27128	16384x8	250ns	12.5V	28	3.95
27128A-200	16384x8	200ns	12.5V	28	4.95
27276	32768x8	250ns	12.5V	28	4.95
27C256	32768x8	250ns	12.5V	28	5.95
27512	65536x8	250ns	12.5V	28	5.95
27C101-20	131072x8	200ns	12.5V	32	17.95

## EPROM PROGRAMMER

• PROGRAMS 27XX AND 27XXX EPROMS UP TO 27512 • SPLIT OR COMBINE CONTENTS OF SEVERAL DIFFERENT SIZED EPROMS (VARIOUS FORMATS AND VOLTAGES) • READ, WRITE, COPY, BLANK CHECK AND VERIFY • HEX AND INTEL HEX FORMATS SOFTWARE  
MOD-EPROM



## DATARASE II EPROM ERASER \$39.95

• SMALL SIZE! • ERASES ALL SIZE EPROMS UP TO 4 AT A TIME—MOST IN 3 MINUTES  
• WALL PLUG POWER SUPPLY  
DATARASE II



## JDR'S OWN MODULAR PROGRAMMING SYSTEM

EACH MODULE USES A COMMON HOST ADAPTOR CARD—USE JUST 1 SLOT TO PROGRAM EPROMS, PROMS, PALS & MORE!

## COMMON HOST ADAPTOR CARD

• UNIVERSAL INTERFACE FOR THE PROGRAMMING MODULES • SELECTABLE ADDRESSES PREVENTS CONFLICTS  
MOD-MAC ..... \$29.95

## UNIVERSAL MODULE \$499.95

• PROGRAMS EPROMS, EEPROMS, PALS, BI-POLAR PROMS, 8748 & 8751 SERIES DEVICES; 16V8 AND 20V8 GALs (GENERIC ARRAY LOGIC) FROM LATTICE, NS, SGS  
• TESTS TTL, CMOS, DYNAMIC & STATIC RAMS  
• LOAD DISK, SAVE DISK, EDIT, BLANK CHECK, PROGRAM, AUTO, READ MASTER, VERIFY AND COMPARE  
• TEXT TOOL SOCKET FOR 3" TO 6" WIDE ICs (8-40 PINS)  
MOD-MUP ..... \$499.95  
MOD-MUP-EA 4-UNIT ADAPTOR ..... \$99.95

## EPROM MODULE \$119.95

• PROGRAMS 24-32 PIN EPROMS, CMOS EPROMS & 16K TO 1024K EEPROMS • HEX TO OBJ CONVERTER • AUTO, BLANK CHECK/PROGRAM/VERIFY • VPP 5, 12.5, 12.75, 13, 21 & 25 VOLTS • NORMAL, INTELLIGENT, INTERACTIVE & QUICK PULSE PROGRAMMING ALGORITHMS  
MOD-MEP ..... \$119.95  
MOD-MEP-4 4-EPROM PROGRAMMER ..... \$169.95  
MOD-MEP-8 8-EPROM PROGRAMMER ..... \$259.95  
MOD-MEP-16 16-EPROM PROGRAMMER ..... \$499.95

## PAL MODULE \$249.95

• PROGRAMS MMI, NS, TI 20 & TI24 PIN DEVICES • BLANK CHECK, PROGRAM, AUTO, READ MASTER, VERIFY & SECURITY FUSE BLOW  
MOD-MPL



new!

PDS-601

## 8-BIT SOLDERLESS 8088 BREADBOARD WITH DECODE \$79.95

• INCLUDES ADDRESS DECODING LOGIC, DATA BUFFERING, 2 LSI CIRCUITS FOR PROGRAMMABLE DIGITAL I/O AND COUNTER-TIMER FUNCTIONS • LOGICALLY GROUPED  
• ACCESSES ALL 62 I/O SIGNAL CONNECTIONS • CLEARLY LABELLED BUS LINES • ACCEPTS UP TO 24 FOURTEEN-PIN ICs • ACCEPTS 9, 15, 19, 25 OR 37-PIN D-SUBS  
PDS-601 ..... \$79.95  
PDS-600 ABOVE CARD WITHOUT DECODE ..... \$49.95

## 286 BUS BREADBOARD WITH DECODE \$89.95

• ADDRESS DECODING LOGIC, DATA BUFFERING, 2 LSI CIRCUITS FOR PROGRAMMABLE DIGITAL I/O AND COUNTER-TIMER FUNCTIONS • ACCESSES ALL 96 I/O SIGNAL CONNECTIONS • LOGICALLY GROUPED • OVER 2,000 PINS  
• ACCEPTS 9, 15, 19, 25 OR 37-PIN D-SUB CONNECTORS  
PDS-611 ..... \$89.95  
PDS-610 ABOVE CARD WITHOUT DECODE ..... \$59.95

## MORE PROTOTYPE CARDS...

JDR-PR1 8-BIT WITH +5V AND GROUND PLANE 27.95  
JDR-PR2 ABOVE WITH I/O DECODING LAYOUT 29.95  
JDR-PR2-PK PARTS KIT FOR JDR-PR2 ABOVE 8.95  
JDR-PR10 16-BIT WITH I/O DECODING LAYOUT 34.95  
JDR-PR10-PK PARTS KIT FOR JDR-PR10 ABOVE 12.95

## MORE PROGRAMMING MODULES...

MOD-MMP MICROPROCESSOR PROGRAMMER ..... \$179.95  
MOD-MIC DIGITAL IC & MEMORY TESTER ..... \$129.95  
MOD-MBP BI-POLAR PROM PROGRAMMER ..... \$299.95

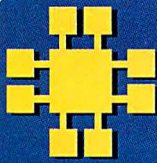
## PAL DEVELOPMENT SOFTWARE

ENTRY-LEVEL PAL DEVELOPMENT FROM CUPL. FULL SUPPORT FOR 16L8, 16R4, 16R6, 16R8, 20L8, 20R4, 20R8 & 20X8.  
MOD-MPL-SOFT ..... \$99.95



TERMS: Minimum order \$10.00. For shipping & handling include \$4.00 for ground and \$5.50 for air. Orders over 1 lb. and foreign orders may require additional shipping charges—contact our Sales Dept. for the amount. CA residents must include applicable sales tax. Prices subject to change without notice. We are not responsible for typographical errors. We reserve the right to limit quantities and to substitute manufacturer. All merchandise subject to prior sales. A full copy of our terms is available upon request. Items pictured may only be representative. JDR, the JDR logo, JDR Microdevices, and the MCT logo are registered trademarks of JDR MICRODEVICES, INC. Modular Circuit Technology, Littlefoot, Minifoot and Superfoot are trademarks of JDR MICRODEVICES, INC. Copyright 1990 JDR MICRODEVICES.

KEY CODE #1013



# JDR Microdevices®

2233 BRANHAM LANE, SAN JOSE CA 95124

- BUY WITH CONFIDENCE FROM JDR!**
- 30-DAY MONEY BACK GUARANTEE
  - 1 YEAR WARRANTY
  - TOLL-FREE TECH SUPPORT

## MICROPOLIS DRIVES

KITS INCLUDE FLOPPY/HARD CONTROLLER AND CABLE.

1654 161 MB ESDI, 16MS ..... KIT: \$1099 ... DRIVE: \$ 899  
 1674 158 MB SCSI, 16MS ..... KIT: \$1199 ... DRIVE: \$949  
 1664 345 MB ESDI, 14MS ..... KIT: \$1699 ... DRIVE: \$1449  
 1694 338.1MB SCSI, 14MS ..... KIT: \$1749 ... DRIVE: \$1449  
 1568 676 MB ESDI, 16MS ..... DRIVE: \$2195  
 1588 676 MB SCSI, 16MS ..... DRIVE: \$2195  
 1598 1034MB SCSI, 14MS ..... DRIVE: \$3995

**NEW! REMOVABLE HARD DISK RACK \$69.95 new!**

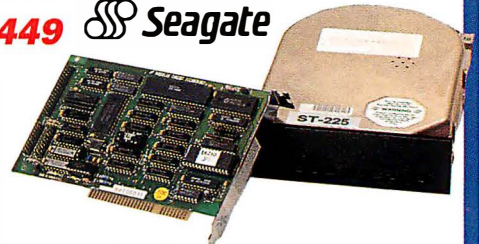
- FIXED RACK MOUNTS IN STANDARD 5.25" DRIVE SLOT
  - REMOVABLE TRAY FITS STANDARD 3.5" DRIVE FOR STANDARD ST-506 INTERFACE HARD DISK DRIVES
  - INCLUDES ALL CABLES & CONNECTORS
- MOBRK-3.5 ..... \$69.95

## Seagate HARD DISKS

**21.4MB \$199 65.5MB \$349**  
**32.7MB \$219 80.2MB \$569**  
**42.8MB \$299 84.9MB \$449**

## DRIVE KITS

**21.4MB \$249**  
**32.7MB \$279**



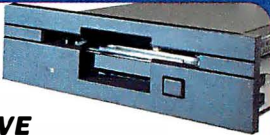
KITS INCLUDE HARD DRIVE, DRIVE CONTROLLER, CABLES AND JDR'S DETAILED INSTRUCTION MANUAL

SIZE	MODEL	AVG. SPEED	FORM FACTOR	DRIVE ONLY
21.4MB	ST-225	65MS	5-1/4"	\$199
32.7MB RLL	ST-238	65MS	5-1/4"	\$219
42.8MB	ST-251-1	28MS	5-1/4"	\$299
43.1MB SCSI	ST-251N	40MS	5-1/4"	\$419
65.5MB RLL	ST-277-1	28MS	5-1/4"	\$349
80.2MB	ST-4096	28MS	5-1/4"	\$569
84.9MB SCSI	ST-296N	28MS	5-1/4"	\$449
122.7MB RLL	ST-4144R	28MS	5-1/4"	\$699
21.4MB	ST-125	40MS	3-1/2"	\$259
32.1MB RLL	ST-138R	40MS	3-1/2"	\$289

**\$99.95**

## 1.44MB 3-1/2" DRIVE

- 80 TRACKS • 135 TPI • HIGH DENSITY
  - READ/WRITE 720K DISKS, TOO
  - INCLUDES ALL NECESSARY MOUNTING HARDWARE
- FDD-1.44X BLACK FACEPLATE ..... \$99.95  
 FDD-1.44A BEIGE FACEPLATE ..... \$99.95  
 FDD-1.44SOFT SOFTWARE DRIVER ..... \$19.95  
 MF355A 3-1/2" MITSUBISHI 1.44MB, BEIGE ..... \$129.95  
 MF355X 3-1/2" MITSUBISHI 1.44MB, BLACK ..... \$129.95  
 FDD-360 5-1/4" DOUBLE-SIDED DD 360K ..... \$69.95  
 FD-55B 5-1/4" TEAC DOUBLE-SIDED DD 360K ..... \$89.95  
 FDD-1.2 5-1/4" DOUBLE-SIDED HD 1.2M ..... \$89.95  
 FD-55GFV 5-1/4" TEAC DOUBLE-SIDED HD 1.2M ..... \$99.95



## ENHANCED KEYBOARDS

- FC-3001 101-KEY, 12 F-KEYS & CALCULATOR ..... \$74.95  
 BTC-5339 101-KEY WITH 12 FUNCTION KEYS ..... \$69.95  
 BTC-5339R COMPACT 101-KEY, 30% SMALLER ..... \$79.95  
 MAX-5339 101-KEY MAXI-SWITCH (286 ONLY) ..... \$84.95  
 K103-A AUDIBLE "CLICK" 101-KEY KEYBOARD ..... \$84.95

## STANDARD KEYBOARDS

- BTC-5060 84-KEY WITH 10 FUNCTION KEYS ..... \$59.95  
 MAX-5060 MAXI-SWITCH 84-KEY (286 ONLY) ..... \$64.95

## PC-TRAC \$89.95

- HIGH RES. (200 PULSE/INCH)
  - 2-AXIS POINTING DEVICE (X & Y)
  - INCLUDES MAP DEVICE DRIVE WITH BALLISTIC GAIN
- PC-TRAC W/RS-232C SERIAL INTERFACE ..... \$109.95  
 FAST-TRAP THE 3-AXIS MOUSE ALTERNATIVE!



## LOGITECH TRACKMAN

- TO 300 DPI RES. • MOUSEWARE UTILITIES, MENUS, MOUSE-2-3 • REQ. 256K MIN. MEMORY
- TRACKMAN SERIAL VERSION —NO CARD REQ. .... \$99.95  
 TRACKMAN-B BUS VERSION ..... \$99.95  
 W/SHORT CARD FOR 8088, 286, 386 OR PS/2 MODELS 25 & 30



## LOGITECH MICE

- 3-BUTTON SERIES 9 • 320 DPI RES. • SERIAL PS/2 COMPAT.
- LOGC9 SERIAL MOUSE ..... \$98.95  
 LOGC9-C SERIAL MOUSE (NOT PS/2 COMPATIBLE) ..... \$79.95  
 LOGC9-P SERIAL MOUSE WITH PAINTSHOW ..... \$109.95  
 LOGB9 BUS MOUSE ..... \$89.95  
 LOGB9-P BUS MOUSE WITH PAINTSHOW ..... \$104.95

## GENISCAN SCANNER

- \$199.95**
- UP TO 400 DPI • 32 LEVELS OF GRAY SCALE
  - W/INTERFACE CARD, SCAN-EDIT II AND DR.GENIUS
- GS-4500 ..... \$199.95



## MODULAR CIRCUIT TECHNOLOGY INTERFACE CARDS

### DRIVE CONTROLLERS

**1.44MB FLOPPY \$49.95**



- 8088 OR 286 COMPATIBLE • SUPPORTS 2 FLOPPY DRIVES (360K, 720K, 1.2MB & 1.44MB) • USER SELECTABLE AS A PRIMARY OR SECONDARY (3RD OR 4TH) FLOPPY DRIVE
- MCT-FDC-HD ..... \$49.95

### HIGH DENSITY 4-FLOPPY CARD \$59.95

- INTERFACES UP TO 4 FLOPPY DRIVES • CABLES FOR 4 INTERNAL DRIVES • BIOS FOR ANY COMBO OF DRIVES
- MCT-FDC-HD4

### FLOPPY DISK CONTROLLER \$29.95

- INTERFACES UP TO 4 360K/720K FLOPPY DRIVES
  - DB37 CONNECTOR FOR EXTERNAL DRIVES
- MCT-FDC

### HARD DISK CONTROLLER \$79.95

- SUPPORTS 16 DRIVE SIZES INCLUDING 10, 20, 30 AND 40MB • CAN DIVIDE 1 LARGE DRIVE INTO 2 LOGICAL DRIVES
- MCT-HDC

### 286/386 FLOPPY/HARD \$149.95

- 1:1 INTERLEAVE FOR IMPROVED PERFORMANCE
  - CONTROLS 2 HARD & 2 FLOPPY DRIVES (360K/720K/1.2MB/1.44MB) • CONCURRENTLY USE HARD & FLOPPY DRIVES
- MCT-FAFH

### IDE MULTI-IO FLOPPY/HARD \$89.95

- SUPPORTS 2 IDE HARD DRIVES & 2 FLOPPIES • 2 SERIAL & 1 PARALLEL PORT • SUPPORTS COM 1 & 2, LPT 1, 2 OR 3
- MCT-IDEIO

### MULTIFUNCTION I/O CARDS

#### MULTI I/O CARD \$59.95

- SERIAL PORT • CLOCK/CALENDAR WITH BATTERY
  - PARALLEL PORT IS ADDRESSABLE AS LPT1 OR LPT2
- MCT-IO

#### MULTI I/O FLOPPY \$79.95

- SUPPORTS UP TO 2 360K FLOPPIES
  - SERIAL, PARALLEL, GAME PORT AND CLOCK/CALENDAR
- MCT-MIO

#### 286/386 MULTI I/O CARD \$59.95

- SERIAL, PARALLEL AND GAME PORTS • USES 16450 SERIAL SUPPORT CHIPS FOR HIGH SPEED OPERATION
- MCT-AIO

#### NEW! ALL-IN-ONE-CONTROLLER \$129.95

- MONOCHROME GRAPHICS • SUPPORTS 2 IDE HARD DRIVES AND 2 FLOPPIES • 2 SERIAL AND 1 PARALLEL PORT
- MCT-MGEIO

### MEMORY CARDS

#### 576K RAM CARD \$49.95

- USER SELECTABLE CONFIGURATION TO 576K • USES 64K AND 256K DRAMS (0K INSTALLED)
- MCT-RAM

#### EMS CARD \$129.95

- USER EXPANDABLE TO 2MB USING 1MB DRAMS • CONFORMS FULLY TO LIM EMS 3.2 • RAM DISK SOFTWARE
- MCT-AEMS

#### MCT-AEMS-256 EMS 41256 DRAMS \$129.95

#### MCT-EMS 8088 EMS CARD 2MB CAPACITY \$129.95

#### EEMS CARD \$149.95

- EXPANDABLE TO 4MB USING 256K X 4 DRAMS IN INCREMENTS OF 512K • CONFORMS TO LIM 4.0
- MCT-EEMS

## 4800/2400 BPS FAX MODEM

**\$119.95**

- 4800 BAUD GROUP III FAX TRANSMISSION ONLY • 2400 BPS DATA MODEM • W/MENU DRIVEN PROFXAX SOFTWARE
  - SENDS DOS TEXT, PCX & TIFF FILES TO FAX TRANS.
- MCT-FAXM ..... \$119.95  
 MCT-24I INTERNAL 2400 BAUD DATA MODEM ..... \$89.95  
 MCT-12I INTERNAL 1200 BAUD DATA MODEM ..... \$59.95

## VIVA 2400 BAUD MODEM \$119.95

- 2400/1200/300 BAUD OPERATION • HAYES AT COMMAND SET COMPAT. • EXTENDED S-REGISTER PROGRAMMING • SPEAKER
  - 2ND PHONE JACK • AUTO DIAL TONE/REDIAL • STD. RS-232C INTERFACE
- VIVA-24E ..... \$119.95  
 VIVA-24MNP ..... \$149.95  
 ERROR CORRECTING VERSION



## FAX/PHONE SWITCHER

- ROUTES CALLS FROM 1 PHONE LINE TO YOUR FAX, MODEM AND ANSWERING MACHINE! • OPERATES ON SINGLE OR MULTI-LINE SYSTEMS • AUXILIARY PORT
- FAXM-SWITCH ..... \$109.95

## CALL FOR OUR FREE CATALOG!

### BARGAIN HUNTER'S CORNER



**INTEL'S 9600 BAUD INTERNAL MODEM**

- DELIVERS UP TO 16 TIMES THE SPEED OF A 2400BPS MODEM
  - SUPPORTS 300, 1200, 2400, 4800, 9600 BPS
  - V.42BIS, V.42, V.32, AND MNP LEVELS 1 THROUGH 5
  - UP TO 38.4K BPS UNDER V.42BIS
  - INTEL 5-YEAR WARRANTY
- PCEM7296 EXPIRES 1/31/91

**CUSTOMER SERVICE 800-538-5001**  
**TECHNICAL SUPPORT 800-538-5002**

MON.-FRI. 7 A.M. TO 5 P.M., SATURDAY, 9 A.M. TO 3 P.M. (PST)

**ORDER TOLL-FREE 800-538-5000**

KEY CODE #1013

# CHAOS MANOR MAIL

*Jerry Pournelle answers questions about his column  
and related computer topics*

## Zenith Orphan

Dear Jerry,

I would be grateful if I could enlist your help in looking after an orphan computer for which I am the guardian.

The computer in question is a four-year-old Zenith ZP-151, which was an early diskless laptop with Microsoft Word, Multiplan, and Project stored in ROM in an early version of Microsoft Works. It is sturdy and reliable.

The machine came with a cable and a software package (called ZPXFER) that allows you to upload and download programs via the RS-232C ports of Zenith computers, such as the Z-150 series. Unfortunately, the program doesn't seem to let you do the same through the ports of non-Zenith computers, which seems strangely arbitrary and is now frustrating, because I would love to use it with my AT and 386 clones.

Would you or your readers have any suggestions as to how I can use ZPXFER with my AT and 386 clones? Quite a few Zenith Z-150 series machines were sold, so the question may have some general interest. Zenith and the Zenith community that I have tried to contact have not been able to help.

The same machine had a port for a cassette recorder interface, but no specifications for this are provided. I would be interested to know if anyone has ever successfully interfaced this machine with any storage device.

I use the AT and 386 clones mainly for word processing and data analysis. For the latter task, I use SPSS-PC and a nice new logistic regression/survival analysis package called Egret, developed at the University of Washington in Seattle. I also use a package called NCSS, which has nice graphics, including Chernoff's faces. I would love to see implementations of sophisticated statistical graphics programs at affordable prices on MS-DOS machines (I am totally naive about Unix).

I really enjoyed your recent comments on the decisions about whether to update, change, or stick with old versions of software. I don't have any uninterruptible

power supplies, and I dread the time when my equipment gets zapped!

I am a pediatrician working in developmental pediatrics, with an emphasis on epidemiology. My first degree and first love was psychology, so we share some interests. I am mainly interested in whether epidemiology can help us understand the causes of conditions such as cerebral palsy and undiagnosed mental handicaps.

Have you ever read any of the novels of Nigel Balchin? He was a distinguished British psychologist who also wrote successfully. His novel *Mine Own Executioner* introduced me to psychology. Balchin also wrote some good novels that often examined responses to fear in astronauts (*Kings of Infinite Space*) and bomb disposal experts (*The Small Back Room*).

Andrew J. Brunskill  
Iowa City, IA

*I had a Z-150, but I fear we gave it away. I don't know how to port things from it; apparently Zenith did a few things in a nonstandard way in those days. I recall, vaguely, that we had to get a new programmable array logic chip for the Z-150 to make it work properly.*

*I did my undergraduate work at the University of Iowa. Do the students still stand at the bottom of the hill to push tourists' cars at first snowfall?*

*I haven't read the novel in question, but if I see it in a bookstore, I'll grab it.*

—Jerry

## Changing Configurations

Dear Jerry,

I am writing in response to the letter from Norm C. Peterson (March 1990).

Peterson seems to want to be able to install certain device drivers that are furnished only in the .SYS form from the command line. I am unaware of any way of translating a .SYS file to a .COM file, but I have automated the change from one configuration to another. A quick and easy way to change configuration seems to be Peterson's fundamental, underlying need.

I keep all the various configurations that I would like to use in a series of files (e.g., CONFIG.001, CONFIG.002, and CONFIG.003). Then when I want to change configuration, I type COPY CONFIG.003 CONFIG.SYS and reboot. (I also keep a set of AUTOEXEC.BAT files in a similar format and change them at will.) While I don't do it, you can automate the COPY process with a batch file to shorten the typing and help prevent errors. For example, C.BAT would be a single line—COPY CONFIG.%1 CONFIG.SYS—or you could get fancier, with a menu to remind you what the individual configurations are.

At a second level of sophistication, I keep all the CONFIG.nnn files listed sequentially in a single ASCII file, CONFIG.DOC, so I can create a new CONFIG file by selecting portions of the old ones as needed. I don't have to look up the syntax of something I am already using; it is there in the .DOC file. When I have the new CONFIG.nnn ready in the CONFIG.DOC file, I mark it with a block and use the block-write-to-disk file function of my word processor (Control-K-W in WordStar nondocument mode) to create the actual CONFIG.nnn file. A similar process is used to keep an AUTOEXEC.DOC file.

This procedure also has the advantage of letting me return immediately to the original/desired configuration after an installation program has decided to change CONFIG.SYS or AUTOEXEC.BAT for me. This is an annoyance that you have written about from time to time.

Frederick S. Holmes Jr.  
Annandale, VA

*Please see my column in the July 1990 issue for a review of BOOTCON, which solves this problem once and for all.*

—Jerry

## College on Tape

Dear Jerry,

I liked the idea of having the entire Library of Congress on CD-ROM (Computing at Chaos Manor, June 1990), and I wonder just how to go about doing

that—write another letter to my congressperson?

I see ads for boards that allow you to back up a hard disk onto VHS videotape. That should mean that a VHS videotape with an entire hard disk's load of stuff on it could load about as much information on just about any subject as a person could want. It's a little change in the idea of how to use a hard disk drive—not as a permanent file, but as a big temporary file.

A college course—including a textbook, exams, lectures, and library materials—could fit on about 10 VHS tapes. A videotaped lecture could be available at the library; you could rent it, borrow it, or buy it.

A four-year program would cost about \$1000 for the PC, a color monitor, and two small hard disk drives; \$500 for the VCR and interface board; \$1000 for the tapes, and another \$500 or so for registration and administrative overhead. A B.A. for \$3000 seems quite likely. That's cheap enough for the third world to do.

Doc Stanley  
Calexico, CA

*Good idea. The information gap is getting wider, I fear, and we need innovative ways to close it.*—Jerry

### Affordable CD-ROMs

Dear Jerry,

The proliferation of CD-ROM libraries greatly disturbs me. CD-ROM publishers who insist on developing proprietary retrieval software are very quickly becoming their own worst enemy. A music compact disc costs anywhere from \$10 to \$15 and can be played in any CD player and quite a few laser disc players. An inexpensive CD-ROM package usually starts at \$100 and quickly goes up from there. I do not wish to pay several hundred dollars for a CD-ROM package that is difficult to use.

I firmly believe that the high cost of CD-ROM drives is a direct result of the price of the ROM libraries. Why should a CD-ROM drive cost more than a CD

player? CD-ROM starts digital and stays digital. There is no need for the circuitry necessary to convert digital to analog, as in the CD player.

Consumers need to say no to CD-ROM publishers' high prices until the quality is reflected in the price tag. If these publishers want to carve a niche for themselves, then they need to offer affordable packages. This should not hurt their profits, but enhance them. (Seen any poor rock stars lately?)

A certain degree of standardization is also necessary. Maybe what I need is a form of compressed ASCII in combination with a widely transportable graphics format. I know the drawbacks of ASCII, but can you think of a more transportable medium? (I can pass ASCII files among my AT clone, my 512K-byte Macintosh, and my Commodore 64 without difficulty.) Publishers could develop their own presentation formats, but the basic retrieval scheme should work on any CD-ROM that I drop into my machine. This is asking for miracles, but perhaps there is a way yet.

The Library of Congress is undoubtedly the greatest repository of printed information in the world, and it has certain standards for the submission of printed text (I'm sure that you, as a writer, are aware of this). Since the Library of Congress is in the process of saving all its documents on CD-ROM, might not it enforce a standard for retrieval?

For true multimedia capabilities, we also need standardized, multipurpose drives. What we need is a CD player with a SCSI port as well as the standard stereo connections.

Wouldn't multidisk CD-ROM capabilities be nice, especially if they could all be read by the same software? It's about time the CD-ROM industry looked at what the consumers need, rather than running around with a "me first and me exclusively" attitude.

George Avent Jr.  
Columbia, SC

*Two things: the electronics really are more complex in a CD-ROM drive than in*

*a CD player; and I understand that CD-ROM drives are finally going below \$500 and will soon be half that. By "soon," though, I mean probably a year or so, alas.*

*CD-ROM technology grows slower than I like, but progress is being made. Thanks.*—Jerry

### Adaptive Technology

Dear Jerry,

I read with interest the letter from Arni Fredrickson concerning large-print computer displays (Chaos Manor Mail, June 1990). As a visually impaired person employed in the computer field, I know of several products that may be of interest.

PC Lens, from ARTS Computer Products in Boston, is a TSR program. It takes characters that application programs write into monochrome adapter memory and maps them into large-print characters on a color graphics display. Using this approach, you're not limited to specific application packages; you can run virtually all IBM PC-compatible programs.

Vista is a hardware device manufactured by Telesensory Systems in California. Like PC Lens, it provides a wide array of character sizes up to several inches high on a 19-inch monitor. This package has the ability to enlarge graphics images as well as text-based material.

I suggest that Fredrickson contact the Technology Center of the American Foundation for the Blind in New York City. The people there may be able to provide additional information.

Douglass M. Fitzsimmons  
Sewickley, PA

*Thanks. They sound like good programs.*  
—Jerry ■

---

*Jerry Pournelle holds a doctorate in psychology and is a science fiction writer who also earns a comfortable living writing about computers present and future. He can be reached c/o BYTE, One Phoenix Mill Lane, Peterborough, NH 03458, or on BIX as "jerrypp."*

# PRINT QUEUE

Hugh Kenner

## Math Reconstructed

*A worthy volume rediscovers the golden mean for readers in the postgeometry generation*

The French architect Le Corbusier imagined gods at play: “They play with numbers, of which the universe is made.” He added that this play goes on behind a wall. Over that wall, for millennia, humans have been stealing glimpses.

At the New Jersey Institute of Technology, where Jay Kappraff teaches mathematics of design, his students draw on a harvest of such glimpses. They learn—and we can, too, from his *Connections: The Geometric Bridge Between Art and Science* (McGraw-Hill, 1991, \$19.50)—how Renaissance architects derived room dimensions from the musical scale; what Béla Bartók’s music owes to the Fibonacci series (each term the sum of its two predecessors, and the ratio of successive terms approaching the golden mean, 1.618 . . . , as a limit); and what graph theory has to do with traffic patterns in a house, and also with reducing the count of the diagonal braces that keep houses from collapsing.

“It was only at the conclusion of my work on this book,” Kappraff confesses, “that I discovered what it was about.” Be assured, this is no crank book. Its theme is geometry as mediator between “the unity and harmony of the natural world and the capability of humans to perceive this order.”

By page 8, the Greeks have discovered that golden mean, 1.618 . . . ; in our notation, “half of 1-plus-the-square-root-of-5.” Make one side of a rectangle that long; make the other side 1. Now, down at one end, fence off a 1-by-1 square; the part that’s left over will have exactly the same proportions as the rectangle you started with. That is true of no other ratio.

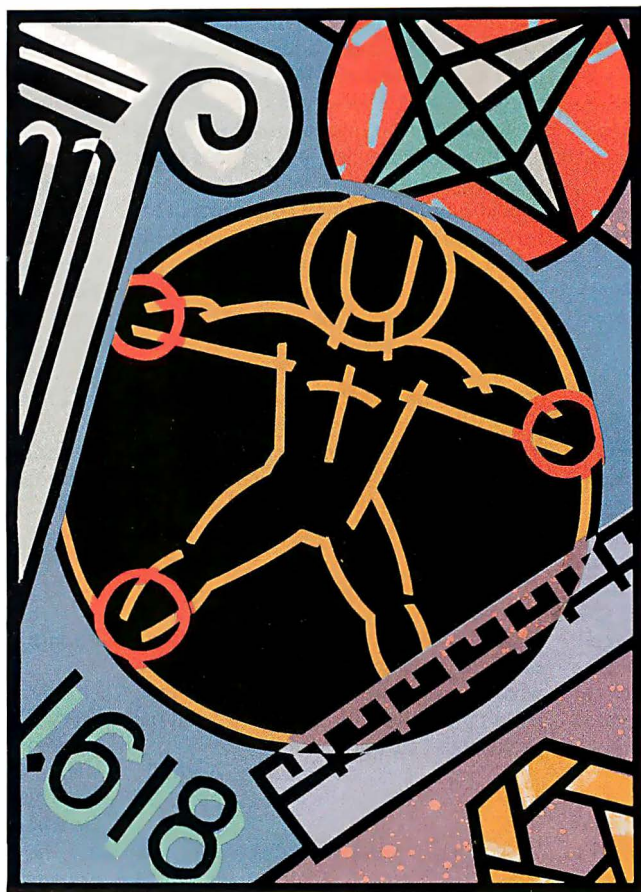
Being a magic number, the golden mean turns up everywhere. By page 26, Botticelli’s Venus is being analyzed into golden-mean modules; therefore, the ratio, navel-to-sole/navel-to-crown, is exactly 1.618 . . . Now: Did the golden ratio pulsate at Botticelli’s fingertips? Very likely. It was part of a quattrocento painter’s education. But it’s also “close to the average value for this ratio in the adult population at large.” So the picture does accord with normal experience of what a fine body would look like.

Is that anticlimactic? It shouldn’t be. For behold a golden principle. Some proportions seem natural because they’re in nature. Having formed our sense of fitness on perceived order, we’ve learned to cherish formulas that describe it.

Also: Natural forms, one way or another, came into being amid forces in tension, a theme D’Arcy W. Thompson’s classic *On Growth and Form* explored decades ago. That those tensions are mathematically describable is one assumption on which the whole edifice of Western science relies. The descriptions, too, are famously economical; *elegant* is a word we often hear. (Equations even get rejected by hunch: “Inelegant!”) So

do not be surprised when elegant numbers recur and recur to describe (1) what’s just “there”; (2) how it came about; and (3) what we select as most elegant from all that we ourselves have brought about with paintbrush, chisel, welder’s torch, and CAD program.

However, there’s more to 1.618 . . . than just visual experience. Once isolated by math, it acquires a life of its own. You want its reciprocal? Just subtract 1. Its square? Just add 1. A handy embodiment? Just draw a regular pentagon; the line from any corner to the corner after the next is longer than any side by, yes, 1.618 . . . Oh: If you have sudden need for a regular pentagon, a perfect one inheres in a mere knot; tie the simplest kind neatly in a paper tape and flatten it. Then, lo, a pentagon! Knots, pentagons, golden mean: This does all get uncanny. Is it preordained that numbers to describe our bodily experience will also be numbers interesting on paper? It does seem so.



It nearly verges on the mystical.

Thus, if geometry describes, it also instigates, since you never know what may pop out of an unlikely abstraction. Graph theory leads to the old Tower of Hanoi puzzle (i.e., three pegs, the first with a tapering pile of rings; shift the rings one by one from peg 1 to peg 3, using peg 2 for interim storage, but *never* place a larger ring on a smaller).

Next, it turns out that an  $n$ -dimensional cube models the best strategy for transferring  $n$  rings. Kappraff presents a diagram to clarify that for  $n = 3$ . So, four rings? Constructing a four-dimensional cube would be a sticky problem; as a mental model, though, it does guide us as we move those rings. Finally, we learn that such merely discussable cubes are used to model “optimal networks for the flow of information in parallel processing computers.” Whew. The music goes down and around and around, and parallel processors are one place it comes out.

It’s fair to add that piecing glimpses together has led workers less scrupulous than Kappraff into wild places. Here’s something he reports without telling us to buy it. The diameter of the earth divided by that of the moon gives us 11-to-3. To get English statute miles, multiply both numbers by 720: Lo, 7920-to-2160, earth-to-moon, just about right! But look, 720 is  $(3 + 4 + 5)$  multiplied by  $(3 + 4 + 5)$ , and geometry buffs will recognize 3, 4, 5 as the sides of a right-angled triangle, because  $3^2 + 4^2 = 5^2$ , a fact Egyptian builders are known to have implemented in a 3-to-4-to-5 loop of knotted rope. (And how many knots around that rope? Why, 12, the number of months! Gee whillikers!)

Whereupon a man named J. Michell, in a 1988 book called *Dimensions of Paradise*, bade us ponder the “New Jerusalem Diagram,” a plan he says was subscribed to by Plato and the builders of Stonehenge, not to mention St. John in Revelation 21. The plan is generated by a 3, 4, 5 triangle, from which (I haven’t space to show you a diagram) it’s easy to derive a large 11-unit square surrounded by 3-unit outriders. And lo, 11-to-3! Lo, earth-to-moon! Lo, finally, from its  $(3 + 4 + 5)$  factors, that 720 multiplier! And, yes, the moon *is* just  $3 \times 720$  miles thick! (Official figure: 2159.9.) Ah, what lore our ancestors must have shared with gods!

But that neatness presupposes builders of Stonehenge—Bronze Age folk chipping at chalk with deer-horn picks—who knew the relative diameters of earth and moon, a ratio, so far as we can tell, first approximated by Alexandrian Greeks some 2000 years post-Stonehenge. Yes, and they’d have had to know the absolute diameters, too.

Finally, our pleasure in a neat multiplier to convert 3 and 11 into just-right miles: Alas, that requires yet one more unlikely assumption. For it needs chalk-chippers foresighted enough to have enshrined today’s English statute mile, 5280 exactly of 12-inch feet, something that got defined only as late as the sixteenth century. (That number,  $8 \times 220 \times 3$ , was used to obtain a match with 8 furlongs of 220 yards. English miles had previously come in several flavors, all loosely related to the Roman *milia*, “thousand.” At 1000 two-step “paces,” what the stocky legionaries stepped out would have been some 10 percent shorter.)

Balderdash, in short, of the kind that’s given Kappraff’s subject a bad name. “The reader must judge,” he intones as he reports it. That comes, it’s fair to add, as early as page 4, where he’s feeling his way toward the sort of book he’s writing. No-where else do his expositions assume ancients to whom gods had spoken. They assume either natural forces, or else people

## Piecing glimpses together leads workers less scrupulous than Jay Kappraff into wild places.

doing what seemed natural at the time, and draw our attention to congruences.

Thus, in chapter 6—and by then he’s on a roll—he moves rapidly but cleanly from soap films, minimizing area, to road networks, minimizing length, to “inner tissue from the shaft of a bird-feather and the fruit of a crab-apple,” in which we find nigh-identical patterns thanks to constraints that keep nudging the edge/face ratio toward 6.

Such constraints supply a social metaphor whenever “closer interaction with some neighbors makes cooperation with others less easy”—for instance, when market towns are getting located. (Fifty years ago that seemed a toy for two German theoreticians; it’s since been “quite well” validated by footwork in Szechwan.)

Nor are we done. Turn the page, and we’ve a map of Cambridge, Massachusetts, school districts (place the school where it’s closer to its children than its neighbors are); turn another, and we’re back with soap-bubble patterns; later in the chapter we’re examining the placement of hexagons on a pineapple, to encounter, without surprise, 1.618... yet once more. And That’s Not All, Folks: It’s just a skim of three-fourths of one chapter.

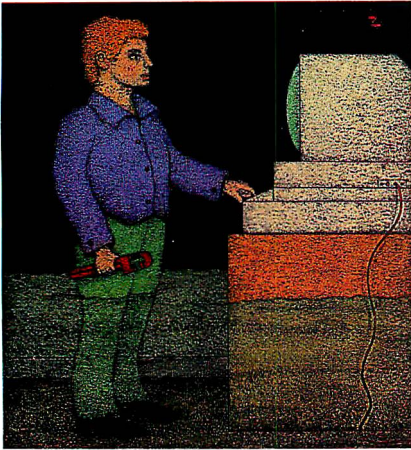
Kappraff’s epilogue deserves a moment’s pondering. “Although two- and three-dimensional Euclidean geometry has traditionally nourished the roots of mathematical thought, today it is a much neglected subject studied only by a few specialists.” That is true. Math got deconstructed a generation or more before literature. The greatest geometrician of our time, Toronto’s H. S. M. Coxeter, I’ve heard described as a crank. At Harvard, Arthur Loeb hangs in there. They are two major geometrical generalists I happen to know of. I know of them out of my (and their) interest in Buckminster Fuller, yet another “crank,” to get associated with whom will do you no good in academe. (It never harmed me, but I don’t claim expertise in math.)

Well, “It is out of the need to rediscover geometry as the language of the arts and sciences that design science had its origins.” And design science is what Jay Kappraff professes, albeit not at a place congruent with Harvard. “To help recreate the linkages that bind us to the work of the centuries that have preceded us”: Those are his book’s last words. It’s certainly heartening that a major publisher has issued it in both paperback and hardback. ■

---

*Hugh Kenner is a professor of English at Johns Hopkins University. He writes for publications ranging from the New York Times to Art & Antiques. His recent books include Mazes and Historical Fictions. He can be contacted on BIX as “hkenner.”*

*Your questions and comments are welcome. Write to: Editor, BYTE, One Phoenix Mill Lane, Peterborough, NH 03458.*



## A new breed of software for people who don't need all the answers

A day doesn't pass at BYTE without our receiving a press release telling us about some new product or company that is at the "forefront of technology" in its particular area. It must be getting pretty crowded at the forefront. I recently heard of a guy who had bought a small piece of the forefront—with barely a hundred feet of frontage—back when it was cheap. Today, he's making millions renting it to venture capitalists by the week.

One area of the forefront to which companies periodically claim they have muscled their way is artificial intelligence, which means making computers think the way humans do. In my case, this would mean devising a system that could remember all the words to the "Flintstones" theme song but forget that the car registration ran out last week.

Of course, researchers love to spend time arguing about just what constitutes AI. These are the people who, when they were in college, spent a lot of time sitting around dorm rooms and arguing about trees falling in the forest, rather than engaging in useful activities like streaking and playing Grateful Dead records loud enough to be heard in the next state. After graduation, these people went into research and industry, where they're still

*Stop Bit is an open forum for informed opinion on topics related to personal computing. The opinions expressed are those of the author and not necessarily those of BYTE or its staff. Your contributions and comments are welcome. Write to: Editor, BYTE, One Phoenix Mill Lane, Peterborough, NH 03458.*

arguing. (See this month's State of the Art section.)

The most common place to find AI is in expert systems—computer programs that distill the knowledge of human experts for use by nonexperts. The idea is that, when the human expert isn't available, you consult the computer. Expert systems have been around for a while now, and they're the most tangible result of the boom in AI that was predicted a few years back by consultants who make a living predicting booms in industries.

However, expert systems have never caught on as a major applications category, like word processing or spreadsheet programs. There are a few reasons for this. First, expert systems can be expensive. It costs money to extract information from experts, most of whom react to the idea that they could be replaced by a machine with as much enthusiasm as if they were going for a lobotomy.

Another reason expert systems haven't caught on is that nobody likes a know-it-all. Think about it. If you've got a problem, what do you do? First, you probably call a friend, someone who knows a little bit about the subject and won't charge you anything to offer an opinion—someone named Carl or Walter. What we need is software that can put the Carls and Walters of the world on a disk. What we need are "amateur systems."

Here's an example, something I call the Amateur Auto Mechanic. For authenticity, it would come in a jacket with greasy fingerprints and oil smudges. When you boot the disk, it would make a noise like a '67 Chevy revving its engine. A sample session might go like this:

- Q: What's up?  
 A: My car keeps stalling.  
 Q: Is there smoke coming out of the exhaust pipe?  
 A: Yes.  
 Q: What color is the smoke?  
 A: Blue.  
 Q: Really? Wow, you had better have

someone look at that.

How much would you pay for a program like that? Not much, huh? Well, that's the point—you wouldn't *have* to pay much. And you'd get what you paid for.

Then there's the Amateur Plumber:

- Q: What's the matter?  
 A: There's a puddle under my kitchen sink.  
 Q: Where's the water coming from?  
 A: From the trap.  
 Q: Maybe you should try tightening the little silver thingamajig around the neck of the trap. Does that help?  
 A: Now there's water everywhere.  
 Q: How much water? (Choose one):  
 a. a lot  
 b. a whole lot  
 c. get out the mop  
 d. get out of the house

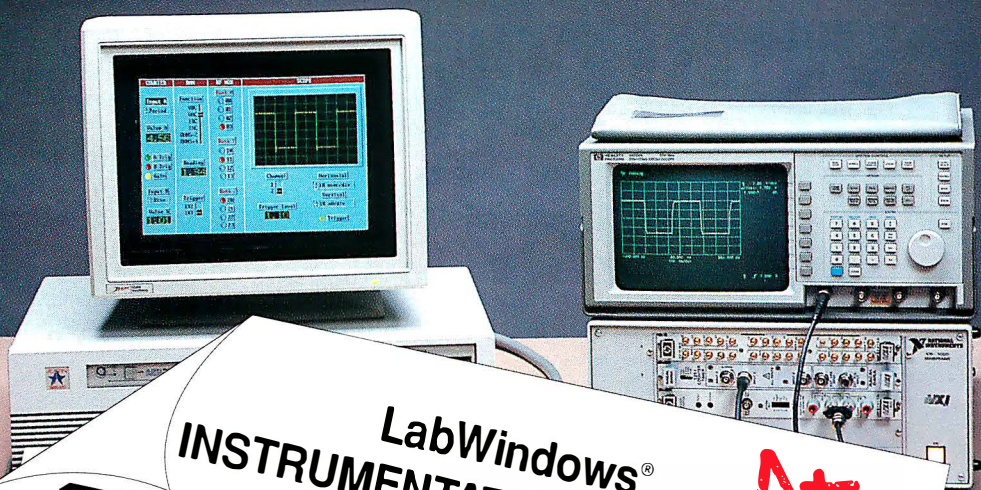
Here is another idea. Everybody knows that the cost of health care is skyrocketing. This is largely because people have gotten used to running off to see the doctor for every little complaint. To cut down on these types of visits, I've been collecting the knowledge base for a program called the Amateur Physician. I was a premed in college and worked in several hospitals, so I already know most of the basic terminology, phrases like, "There's a lot of that going around," or "My cousin had that, but now she's: a) much better; b) much worse; c) dead; d) in Pittsburgh."

As you can see, I've already done a lot of the preliminary work on this concept, and all I need is some backing to make it a success. Interested venture capitalists should give me a call at Amateur Systems, Inc. I plan to locate the company far from the forefront of technology, where there's lots of room for growth. ■

*Kenneth M. Sheldon is a senior editor for BYTE. He can be reached on BIX as "ksheldon."*



# Put LabWindows to Your Test



## LabWindows® INSTRUMENTATION SOFTWARE **A+**

### Data Acquisition

GPIB  
 Plug-in Boards  
 VXI  
 RS-232

True  False

Industry standard Microsoft C, QuickC, and QuickBASIC development tools for data acquisition and instrument control.  
 Instrument drivers for over 100 GPIB, VXI, and RS-232 instruments.

Integrated support for plug-in data acquisition boards.  
 Powerful analysis library for real-time data processing.

Extensive graphics library for creating full-color displays on printers and plotters.  
 Code generation and debugging tools for faster program development.

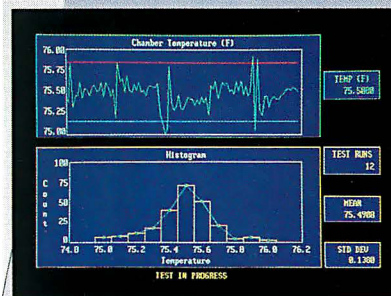
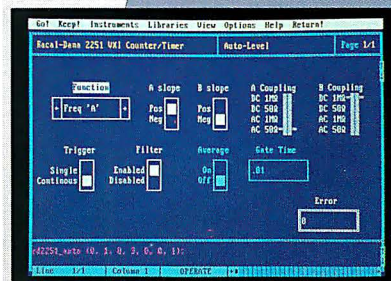
Software development tools for production test and ATE systems.

### Data Analysis

Digital Signal Processing  
 Statistics  
 Curve Fitting  
 Array Operations

### Data Presentation

File I/O  
 2D Plots  
 Real Time Strip Charts  
 Printer and Plotter Output



**LabWindows...making industry standard programming languages work for you in data acquisition and instrument control.**


**NATIONAL INSTRUMENTS®**  
*The Software is the Instrument®*  
 6504 Bridge Point Parkway  
 Austin, TX 78730-5039

Circle 210 on Reader Service Card

National Instruments Italy (02) 4830 1892  
 National Instruments France (1) 48 65 33 70  
 National Instruments Switzerland (056) 82 18 27  
 National Instruments United Kingdom (06) 35 523 545  
 Nihon National Instruments K.K. (Japan) (03) 788 1921

**Call for a FREE Demo Disk and Catalog**  
**(512) 794-0100 • (800) 433-3488 (U.S. and Canada)**

# "A STUNNING ACHIEVEMENT IN VALUE."

—PC Laptop  
Magazine,  
October '90 Issue

"...the Tandy® 1500 HD might be one of the most important laptops of the early 1990s."  
—PC Laptop

A 10MHz clock speed and 640K memory (expandable to 1.64MB) deliver power. DeskMate® productivity software comes pre-installed and ready to use.

"The swift (25ms) hard disk loads your favorite programs with no waiting..."  
—Portable Computing, Oct. '90

Portable Computing's reviewer also said "it's the slimmest I've seen that supplies what laptop users want: real disks. The Tandy gives you a genuine 1.44MB floppy and 20MB hard drive."

"The Tandy 1500 HD is the best XT®-class notebook yet."  
—Portable Computing

Tandy Power View LEDs give you a constant readout of your battery status. 640 x 200 graphics, a full-size keyboard, and a removable, rechargeable 3 1/2-hour battery round out the package nicely.

"...a near-ideal machine to take on the road."  
—PC Laptop

It's less than six pounds—and just 1.7" thin. At just 8 ounces, even the AC adapter/charger is travel-size.



"...a terrific value at its low \$1999 price."  
—PC Laptop

Portable Computing concluded: "The Tandy 1500 HD is an outstanding value, and an outstanding notebook computer. Tandy is always a solid contender, but this time it's a winner."

## CREATING NEW STANDARDS

### PROVEN LEADERSHIP

Over 7,000 USA locations, 39,000 employees, seven research and development centers, 31 USA and overseas manufacturing plants—NOBODY COMPARES!

### GUARANTEED SATISFACTION

Over 35 million customers benefit annually from our satisfaction guarantee. Putting you first has made us #1 in PC compatibles—NOBODY COMPARES!

**Radio Shack**  
**AMERICA'S**  
**TECHNOLOGY**  
**STORE**™

Prices apply at participating Radio Shack stores, Computer Centers and dealers. Quotations reprinted with the permission of PC Laptop and Portable Computing. XT/Reg. TM IBM Corp. Radio Shack is a division of Tandy Corporation.

Circle 272 on Reader Service Card