

BYTE

DECEMBER 1990

A MCGRAW-HILL PUBLICATION

New SPARCstations



from Sun,
Solbourne,
and
CompuAdd
PAGE 140

STATE OF THE ART IN

COMPUTER GRAPHICS

How 3-D Techniques, Advanced Color Technology, and HDTV Will Put Workstation-Quality Graphics on Your Desktop

"Laptop on a Chip" designs

Understanding X.400

"Real" Relational Databases vs. the Pretenders

Sony NeWS vs. MIPS Magnum

TI's New TravelMate 3000

Norton Utilities for Unix, Mac

DR DOS 5.0

Dell Station 425E

Unix for the Amiga



\$3.50 U.S.A./\$4.50 IN CANADA
0360-5280



THE NEW DELL SYSTEM 433TE
33 MHz EISA i486™

• Intel 80486 microprocessor running at 33 MHz with 128 KB external cache.
****Commercial Lease Plan. Lease for as low as \$377/month.**
330 MB Super VGA Color System (800 x 600) \$10,499
Price listed includes 4 MB of RAM.*
80, 100, 190, 330 and 650 MB hard drive configurations available.



THE NEW DELL SYSTEM 425TE
25 MHz EISA i486.

• Intel 80486 microprocessor running at 25 MHz.
Commercial Lease Plan. Lease for as low as \$278/month.
190 MB Super VGA Color System (800 x 600) \$7,499
Price listed includes 4 MB of RAM.*
80, 100, 190, 330 and 650 MB hard drive configurations available.



THE DELL SYSTEM 433E
33 MHz EISA i486.

• i486 microprocessor running at 33 MHz.
Commercial Lease Plan. Lease for as low as \$307/month.
100 MB Super VGA Color System (800 x 600) \$8,499
Price listed includes 4 MB of RAM.*
80, 100, 190, 330 and 650 MB hard drive configurations available.



THE DELL SYSTEM 425E™
25 MHz EISA i486.

• i486 microprocessor running at 25 MHz.
Commercial Lease Plan. Lease for as low as \$235/month.
100 MB Super VGA Color System (800 x 600) \$6,499
Price listed includes 4 MB of RAM.*
80, 100, 190, 330 and 650 MB hard drive configurations available.



THE NEW DELL SYSTEM 325D
25 MHz 386.™

• Intel 80386 microprocessor running at 25 MHz with 32 KB external cache.
Commercial Lease Plan. Lease for as low as \$112/month.
40 MB VGA Color Plus System \$2,999
Price listed includes 1 MB of RAM.*
40, 80, 100, 190, 330 and 650 MB hard drive configurations available.

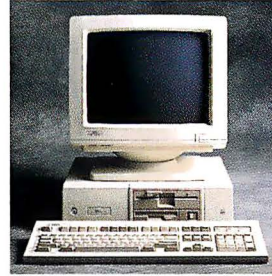

THE DELL SYSTEM 316SX
16 MHz 386SX.

• Intel 80386SX microprocessor running at 16 MHz.
Commercial Lease Plan. Lease for as low as \$79/month.
40 MB VGA Color Plus System \$2,099
Price listed includes 1 MB of RAM.*
20, 40, 80, 100 and 190 MB hard drive configurations available.



THE DELL SYSTEM 320LX
20 MHz 386SX.

• Intel 80386SX microprocessor running at 20 MHz.
Commercial Lease Plan. Lease for as low as \$104/month.
40 MB VGA Color Plus System \$2,799
Price listed includes 1 MB of RAM.*
40, 80, 100, 190, 330 and 650 MB hard drive configurations available.



THE DELL SYSTEM 210
12.5 MHz 286.

• Intel 80286 microprocessor running at 12.5 MHz.
Commercial Lease Plan. Lease for as low as \$59/month.
20 MB VGA Monochrome System \$1,549
Price listed includes 1 MB of RAM.*
20, 40, 80 and 100 MB hard drive configurations available.



THE NEW DELL SYSTEM 320LT
20 MHz 386SX.

• Intel 80386SX microprocessor running at 20 MHz.
Commercial Lease Plan. Lease for as low as \$141/month.
40 MB, 2 MB RAM* \$3,899
20 MB hard drive configurations also available.

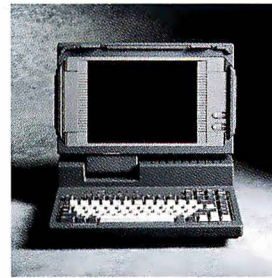

THE DELL SYSTEM 316LT
16 MHz 386SX.

• Intel 80386SX microprocessor running at 16 MHz.
Commercial Lease Plan. Lease for as low as \$112/month.
20 MB, 1 MB RAM* \$2,999
40 MB hard drive configurations also available.

The Dell System 433TE and 425TE are class A devices sold for use in commercial environments only. *Performance Enhancements. Within the first megabyte of memory. 128 KB (316SX, 320LT, 316LT and 210), 96 KB (333D and 325D) or 384 KB (320LX, 425E, 433E, 425TE and 433TE) of memory is reserved for use by the system to enhance performance. Can be optionally disabled on 333D, 325D, 316SX and 210. All systems are photographed with optional extras. All prices and specifications are subject to change without notice. Dell cannot be responsible for errors in typography or photography. †Source: From Compaq September 11, 1990 press release. ††Source: From Compaq July 23, 1990 press release. **Payment based on 36-month open-end lease. Leasing arranged by Leasing Group, Inc. In Canada, configurations and prices may vary. DELL SYSTEM is a registered trademark. Dell, 425E and SmartVu are trademarks of Dell Computer Corporation. Intel is a registered trademark and 386, 486, and i486 are trademarks of Intel Corporation. Other trademarks and trade names are used to identify the entities claiming the marks and names of their products. Dell Computer Corporation disclaims any proprietary interest in trademarks and trade names other than its own. On-site service may not be available in certain remote locations. Shipping, handling and applicable sales tax not included in the price. For information on and a copy of Dell's 30-day Total Satisfaction Guarantee, limited warranty, and Xerox's Service Contract, please write to Dell USA Corporation, 9505 Arboretum Boulevard, Austin, Texas 78759-7299. ATTN: Warranty. © 1990 Dell Computer Corporation. All rights reserved.

TOP OF THE MARK.

So what do you get by paying the extra mark-up for a Compaq?

Not a better computer. Dell's new 386™ systems are as fast, expandable and compatible as Compaq's.

Not better service. In 8 straight *PC Week* polls of corporate cutsumers, Dell's service rated much higher than everyone else's.

Not better personal attention. From the



The new Dell 33 MHz and 25 MHz 386 computers.

moment you first call us, and for as long as you own your computer, we'll work

with you custom configuring your computer and answering any questions—no matter how small—whether it be technical, sales or service related.

In fact, the only thing extra you get from Compaq is, well, mark-up.

Our new 386's pull a fast one on pricier computers. Both the 33 MHz Dell System® 333D and 25 MHz Dell System 325D are faster and more expandable than most higher priced systems.

The new Dell™ 325D is a fast, reliable machine with up to 16 MB of RAM on the

system board and a 32 KB cache designed into a compact footprint.

The new Dell 333D is as good as a 386 PC can get. Not only is it 33% faster than the Dell 325D, it has a 64 KB cache for an extra kick in performance.

We design every machine to our specs, then build it to yours. We design our computers; we know them inside out. So when you call us, we can talk to you about what you need a computer

THE NEW DELL SYSTEM 333D 33 MHz 386 AND THE NEW DELL SYSTEM 325D 25 MHz 386.

STANDARD FEATURES:

- Intel® 80386 microprocessor running at 33 MHz (333D) or 25 MHz (325D).
- Page mode interleaved memory architecture.
- Standard 1 MB of RAM,* optional 2 MB or 4 MB of RAM expandable to 16 MB on system board.
- Integrated VGA controller with 1024 x 768 support.
- Integrated hard drive and diskette drive interface.
- 64 KB (333D) or 32 KB (325D) SRAM cache.
- SmartVu-Advanced System Diagnostic Display.
- Socket for Intel 80387 or WEITEK 3167 math coprocessor.
- 5.25" 1.2 MB or 3.5" 1.44 MB diskette drive.

- 6 industry standard expansion slots (five 16-bit, one 8-bit).
- High-performance IDE (40 MB, 80 MB, 100 MB, 190 MB) and ESDI (330 MB, 650 MB) hard disk drives.
- 1 parallel port, 2 serial ports, PS/2 compatible mouse port, all integrated.
- 177 watt power supply.
- 12-month Xerox® On-Site Service Contract.

	<u>333D</u>	<u>325D</u>
40 MB VGA Color Plus System	\$3,599	\$2,999
Prices listed include 1 MB of RAM.* 80, 100, 190, 330, 650 MB hard drive configurations available.		

AD CODE 11EM0

TO ORDER, CALL

800-388-3355

HOURS: 6 AM-9 PM CT M-F 8 AM-4 PM CT SAT.

In Canada 800-387-5752. In the U.K. 0800 414535. In France (1) 30.60.68.00. In Germany 06103/701-0. In Sweden 0760-713 50.

TOP OF THE MARK-UPS.



Compaq's 33 MHz and 25 MHz 386 computers.

But, for the sake of argument, let's suppose something does go wrong with your Dell computer. Both the Dell 333D and 325D come with our SmartVu,[™] the built-in diagnostic display that ingeniously identifies problems even if the monitor goes down.

for, and then put together the most efficient, economical package for you. We take you through all the choices you have in memory sizes, monitors, storage devices, high performance controllers and accessories. Once you agree about exactly what you need, we immediately begin custom configuring your computer, perform a completed system test, then send it off.

Then you get 30 days to use it. If you aren't satisfied, send it back. We'll return your money, no questions asked.

Even if something goes wrong, it won't wreck your day. Actually, one of the nice things about our service is that you'll rarely need it. Another *PC Week* poll category we dominate is the one called "reliability"—due in no small measure to our extensive burn-in testing on each computer before it goes out the door.

If you still need help, our Dell toll-free technical support hotline solves 90% of all problems over the phone, often within 4 or 5 minutes. Or, if you use our new Dell TechFax line at 1-800-950-1329, we'll fax back technical information immediately.

If we still haven't solved the problem, we'll send trained technicians from the Xerox Corporation[^] to your desk the next business day with the solution in hand.

For sale, for lease,^o for less. Call us. Talk to a computer expert whose only job is to give you exactly what you want in computers, service, software, printers and financing.

You'll get solid information that could save you time and money on computers with high marks, not high mark-ups.

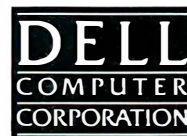

HERE'S OUR NEW STORE, SO YOU'LL NEVER HAVE TO GO TO THEIR STORE AGAIN.

When you buy from a traditional computer store, here's what you get:

A beefy retail mark-up.

Pressure to buy something you don't want.

That crummy feeling of not knowing what you're getting, because the salesman isn't sure what he's selling.

And, when there's a problem, some guy with a screwdriver taking your computer apart.

When you call Dell, on the other hand, here's what you get:

A frank talk with experts about what you need, and a recommendation about the best overall package for you.

Custom configuration, with options including monitors, memory sizes,

accessories,
software and
peripherals.

Service—often voted the best in the industry—by computer experts who know our computers inside and out.

A variety of financing and leasing^o options.

A firm promise to build your computers, a configured systems test, and shipment by two-day



THE NEW DELL SYSTEM® 333D 33 MHz 386.

STANDARD FEATURES:

• Intel® 80386 micro-processor running at 33 MHz. • Page mode interleaved memory architecture. • Standard 1 MB of RAM*, optional 2 MB or 4 MB of RAM expandable to 16 MB on system board. • Integrated VGA controller with 1024 x 768 support. • 64 KB high-speed SRAM. • Socket for Intel 80387 or W/INTEL 3167 math coprocessor. • 5.25" 1.2 MB or 3.5" 1.44 MB diskette drive. • 6 industry standard expansion slots (five 16-bit, one 8-bit). • High-performance IDE (40 MB, 80 MB, 100 MB, 190 MB) and ESDI (330 MB, 650 MB) hard disk drives. • 1 parallel port, 2 serial ports, PS/2 compatible mouse port, all integrated. • SmartVu™ - Advanced System Diagnostic Display. • 12-month On-Site Service Contract provided by Xerox.†

40 MB VGA Color Plus System \$3,599

Price listed includes 1 MB of RAM*. 40, 80, 100, 190, 330, and 650 hard drive configurations available.

AD CODE 11EM0

TO ORDER, CALL

800-388-3355

HOURS: 6 AM-9 PM CT M-F 8 AM-4 PM CT SAT.

In Canada 800-387-5752. In the U.K. 0800 414535. In France (1) 30.60.68.00. In Germany 06103/701-0. In Sweden 0760-713 50.

air standard.

A 30-day, no questions asked, money back guarantee.

A one-year limited warranty.

And a great price, with no retail mark-up.

Call us now. Why waste a trip when everything you need is right in front of you?

**Rip Your Competition
to Shreds...**



photo: Ron Taylor/ Tom Stack & Assoc.

33-MHz 386DX™, EISA..\$1995

**INTRODUCTORY
SPECIAL!**
Rebates of up to
\$650
on great
BusinessVEISA
Peripherals till
December 31, 1990.
Contact ALR for details!

The ALR BusinessVEISA

**It's What You Need
to Thrive in Today's
Hostile Business World**

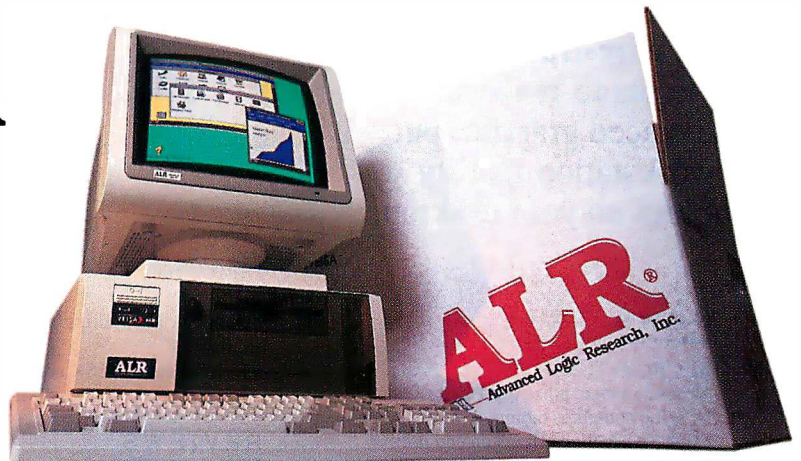

It's a sink or swim world out there, and if you don't take advantage of the latest in today's technology, *your competition will*. To survive in a sea of reduced budgets and accelerated time schedules, you need a computer that's both inexpensive and fast. You need a system that will exploit the best of today's and tomorrow's technology without exploiting your budget. You need the ALR BusinessVEISA.

One of the easiest ways for your company to remain competitive is to reduce its spending; that's why we've priced the BusinessVEISA Model 101 at just \$1995. With its 33-MHz 386-processor and its advanced 32-bit EISA bus, the BusinessVEISA gives you all the power you'll need to devour today's most advanced business applications.

Designed to survive the changing tides of your business environment, the BusinessVEISA can take advantage of both standard 8- and 16-bit add-on boards and advanced 32-bit EISA enhancement products. This powerful system can feast on the latest in today's and tomorrow's high-speed I/O and multimastering technology.

As you conquer new territories, your BusinessVEISA can expand its jaws to accommodate i486 power. *Just Upgrade the CPU!*™ Simply plug in an ALR VEISA 25 or 33-MHz i486 CPU module to boost your performance up to 270%. Then watch your competition scatter.

Don't ignore your killer instinct. Call ALR today.

1-800-444-4ALR

Hunt for the Real 32-bit System		
	ALR BusinessVEISA	AST* Premium™
Architecture	386/33-101 VEISA	386SX/16-5V CUPID-32?
CPU Speed	33-MHz✓	16-MHz
CPU	386DX✓	386SX
Data Path	32-Bit✓	16-Bit
Memory	1-MB	1-MB
Bus	32-Bit EISA✓	16-Bit ISA
List Price	\$1995	\$2495
Price of 25-MHz i486 Upgrade	\$1995	\$4895

Just Upgrade the CPU!™

ALR VEISA 25-MHz i486 CPU Module
ALR VEISA 33-MHz 386 CPU Module 33-MHz i486 CPU Module

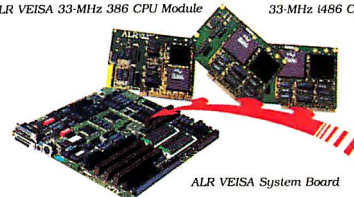

ALR VEISA System Board

ALR 9401 Jeronimo, Irvine, CA 92718
(714) 581-6770 FAX: (714) 581-9240

Available at these selected resellers:

Connecting Point **ENTRE** **TCBC**

Prices and configurations subject to change without notice. Prices based on U.S. dollars. System shown with optional monitor/graphics adapter and 3.5" floppy. VEISA, BusinessVEISA, and Just Upgrade the CPU! are trademarks and ALR is a registered trademark of Advanced Logic Research, Inc. All other brand and product names are trademarks or registered trademarks of their respective owners. Shark photo: Ron Taylor/ Tom Stack & Assoc. ©1990 by Advanced Logic Research. AST, we saw your mailer. Would you like some of our product literature so you can get your information right next time?

CONTENTS

December 1990
Volume 15, Number 13

COVER STORY

STATE OF THE ART Advanced Graphics

PAGE 250

From wire-frame models to photo-realism: Advanced graphics put workstation-quality graphics on your desktop.

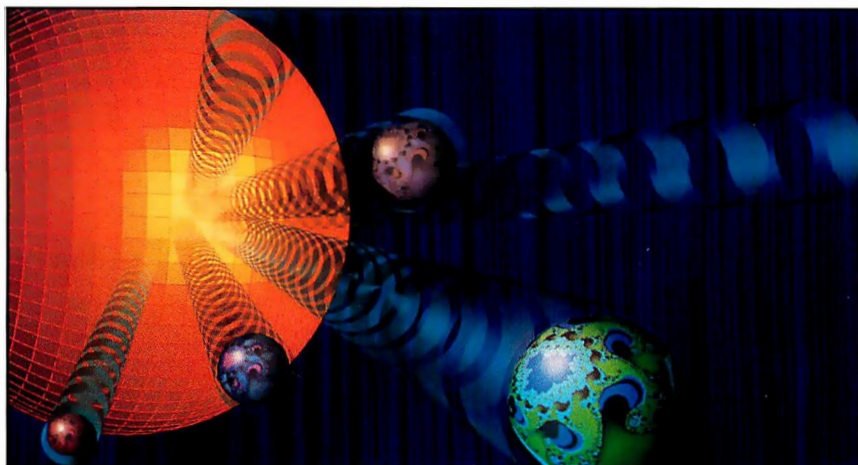

NEWS

- 19 **MICROBYTES**
Near-ultrasonic noise produced by some computer monitors can have negative effects on end users.
- 44 **WHAT'S NEW**
HP launches the latest LaserJet, the Mac II gets a 386 processor, AutoCAD goes to release 11, and more.

FIRST IMPRESSIONS

- 132 **SHORT TAKES**
Step 486/50, a technological showpiece from Everex and Velox
Muse, Occam's natural-language interface program
ProLine Backup System, Tecmar's tape backup solution for a NetWare LAN
- Amiga 3000UX, a Unix graphics workstation from Commodore*
- Hardcard IIXL, Plus Development provides easy storage*
- 140 **Son of SPARCstation**
Sun Microsystems ups the midrange workstation ante.
- 142 **CompuAdd Delivers a Low-Cost SPARCstation**
The SS1 is a faithful clone.
- 144 **Solbourne S4000 Outguns SPARCstation 1+**
The S4000 uses Solbourne's own integrated, 64-bit CPU.

- 151 **Suddenly, Everything's Smaller in Texas**
TI's 5.7-pound 386SX notebook.

REVIEWS

- 156 **When Laser Printers Can't Cut It**
A look at 27 alternatives to the popular laser printer.
- 172 **Sony NeWS and MIPS Magnum: A Double Shot of RISC**
Two RISC workstations join the low-end Unix market.
- 178 **The Norton Utilities for System V**
- 179 **The Norton Utilities for the Mac**
More than just warmed-over versions of the Norton Utilities for DOS.
- 182 **CAD and NetWare 386 Join Forces**
IsiCAD's CADVance 4.0 makes good on the promise of multiuser CAD applications.
- 191 **NCR's S486/MC33 Has Unique Approach to Reliability**
NCR's new 33-MHz 486 Micro Channel system is among the fastest.
- 197 **DR DOS Offers Hope for the RAM-Crammed**
Digital Research's new MS-DOS competitor promises to make more memory available for applications.
- 201 **On Becoming a Clock Wise Scheduler**
Phase II Software's ClockWise helps manage your time.
- 206 **Battle for the Best Unix V/386**
New releases from Interactive Systems and The Santa Cruz Operation.
- 209 **Microsoft Word Brings PC-Style Word Processing to Unix**
Unix word processing takes a turn for the better.
- 213 **Plug-and-Play Unix Machine**
Dell's Intel-based Unix workstation.
- 221 **LAN Manager 2.0: A Force to Be Reckoned With**
Microsoft's network flagship proves it is a viable alternative to NetWare.
- 229 **A Digital "Quill" for Mac Video Displays**
Data Translation's VideoQuill combines text, graphics, and video.
- 233 **Unix and 1-2-3**
Now you can run Lotus 1-2-3 under Unix.
- 237 **A "More Filling" Generation of Tape Backup**
Tape drives from Colorado Memory Systems and Core International.
- 246 **Reviewer's Notebook**
Dolch adds a color screen to an impressive luggable, and Ashton-Tate addresses dBASE IV problems.

STATE OF THE ART

- 250 **ADVANCED GRAPHICS Introduction**
- 253 **Graphics Go 3-D**
Creating photo-realistic 3-D images is a real challenge.
- 263 **Ray Tracing for Realism**
Simulating light rays in a 3-D scene.

Portable Chips/312

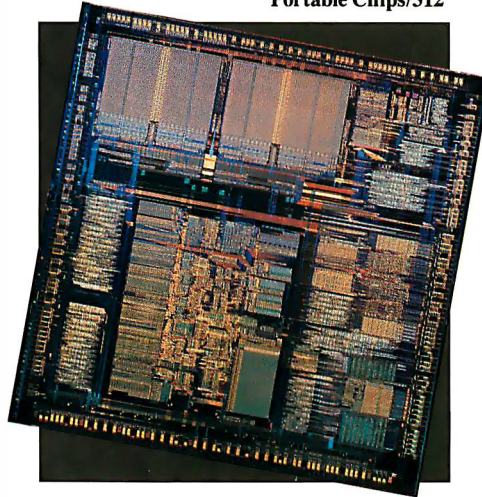

- 275 **Color WYSIWYG Comes of Age**
Matching the colors you see on-screen with your printed output.
- 281 **True Color for Windows**
Windows 3.0 makes 24-bit color a realistic option.
- 289 **Putting the Squeeze on Graphics**
Compression technologies for full-color graphics and full-motion video.
- 297 **HDTV Sparks a Digital Revolution**
In the 1990s, the shift will be to high-definition and digital pictures.
- 307 **Graphics Engines**
A manufacturers roundup.

FEATURES

- 312 **Portable Chips**
When it comes to chips, small can mean powerful.
- 321 **Relational Databases: The Real Story**
Is that a relational database manager or not?
- 327 **Concurrent C**
An AT&T language for programming multiprocessor systems.
- 337 **Strength (and Safety) in Numbers**
RAID systems may boost PC performance and reliability.
- 341 **X.400: Standardizing E-Mail**
E-mail is ready to live up to its promise.
- 345 **Alternative Operating Systems, Part 5:**
Unix with a Microscope
Minix, a low-cost Unix, runs on ordinary personal computers.
- 349 **Easier Strings for the Mac**
C++ routines simplify Macintosh string-handling.

HANDS ON

- 355 **UNDER THE HOOD**
VGA to the Max
A new set of extensions breathes life into Super VGA hardware.
- 361 **SOME ASSEMBLY REQUIRED**
More Than Just Fast
A look at programming SCSI devices on Macs and MS-DOS machines.

DEPARTMENTS

- 6 **Spotlight**
Our Print Queue columnist has a long history with BYTE and computers.
- 10 **Editorial:**
A Laptop on a Chip... Almost
- 33 **Letters, Ask BYTE, and Fixes**
BYTE readers join in the 15th anniversary commemoration.

PERSPECTIVES

- 417 **CHAOS MANOR MAIL**
- 418 **PRINT QUEUE**
A Fairy-Tale Future
High-tech prophet Raymond Kurzweil's latest work is a masterful look at the present and future of intelligent machines.
- 420 **STOP BIT**
A Plea for Software That Works
It's time developers started concentrating on software integrity.

READER SERVICE

- 406 Editorial Index by Company
- 408 Alphabetical Index to Advertisers
- 410 Index to Advertisers by Product Category
- Inquiry Reply Cards: after 412

PROGRAM LISTINGS

- From BIX: Call (800) 227-2985
- From BYTEnet: Call (617) 861-9764
- On disk: See card after 344

EXPERT ADVICE

73
COMPUTING
AT CHAOS MANOR
Working Smart
by Jerry Pournelle
Jerry looks at portable computers and an outlining program.

93
DOWN TO BUSINESS
Getting Bigger Groupware
by Wayne Rash Jr.
With groupware, you can communicate with almost anyone, almost anywhere.

101
BEYOND DOS:
WINDOWS AND OS/2
I've Got DIBs
by Martin Heller
Martin presents an overview of Windows and OS/2 color capabilities.

105
MACINATIONS
Inspiration at the Year's End
by Don Crabb
A look at what Apple has accomplished over the year, and an inspirational new product.

119
THE UNIX /bin
Back to the Workstations II
by David Fiedler
Unix workstations and personal computers completely merge.

125
NETWORKS
Kicking and Screaming into the Present
by Mark L. Van Name and Bill Catchings
DEC slowly embraces PC networking standards.

BYTE (ISSN 0360-5280/90) is published monthly with an additional issue in October by McGraw-Hill, Inc. U.S. subscriber rate \$29.95 per year. In Canada and Mexico, \$34.95 per year. Single copies \$3.50 in the U.S., \$4.50 in Canada. Executive, Editorial, Circulation, and Advertising Offices: One Phoenix Mill Lane, Peterborough, NH 03458. Second-class postage paid at Peterborough, NH, and additional mailing offices. Postage paid at Winnipeg, Manitoba. Registration number 9321. Printed in the United States of America. **Postmaster:** Send address changes. USPS Form 3579, and fulfillment questions to BYTE Subscriptions, P.O. Box 551, Hightstown, NJ 08520.

6.0 AND COUNTING!

Integrate sophisticated features into your Microsoft C and QuickC applications with

C TOOLS PLUS/6.0™

C TOOLS PLUS version 6.0 is filled with many advanced routines for developing high-powered C applications, including: virtual, stackable menus and windows with full mouse support and optional "drop shadows"; multiple virtual pop-up help screens; a miniature multi-line editor for gathering user responses in a robust fashion; a single function call which can move, resize, and promote a window or menu on top of all others; the ability to update covered windows automatically when they are written to; support for EGA, VGA, and MCGA text modes including 30-, 43-, and 50-line modes; support for the enhanced (101/102 key) keyboard.



All this and more for only \$149!

C TOOLS PLUS/6.0 also contains functions for writing interrupt service routines; creating pop-up memory resident applications; general memory "peeks" and "pokes"; access to the DOS PRINT utility; as well as many other general utility functions and macros.

COMPLETE PROFESSIONAL PACKAGE.

Blaise Computing's function libraries offer easy to use solutions to your programming needs. You get source code, complete sample programs, and a comprehensive reference manual with extensive examples. Supports QuickC and Microsoft C 5.0 and later.

30 DAY GUARANTEE.

If during the first 30 days you are not completely satisfied, we'll refund your money.

Other powerful products from Blaise Computing

C ASYNCH MANAGER™	\$189
ASYNCH PLUS™	\$189
VIEW232™	\$189
POWER SCREEN™	\$149
Turbo C TOOLS™	\$149
POWER TOOLS PLUS™	\$149

Call today for more information

(800) 333-8087

BLAISE COMPUTING INC.

2560 Ninth Street, Suite 316
Berkeley, CA 94710
(415) 540-5441
FAX (415) 540-1938

Trademarks are property of their respective holders.

S P O T L I G H T

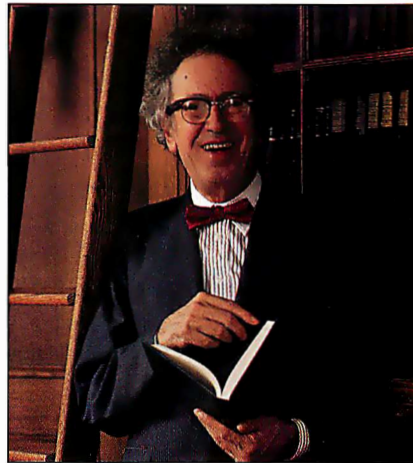

HUGH KNOWS BOOKS (AND COMPUTERS)

Our Print Queue author has a distinguished career outside the computer world

BYTE readers know Print Queue columnist Hugh Kenner as our thought-provoking reviewer of books. But some of you may also know him as a noted literary critic and James Joyce scholar. His interest in computers dates back to 1973 and was sparked by a long-standing interest in math.

"I got one of the very first HP-35 units, having written a book about Bucky Fuller and being interested in the math behind his geodesic domes. The HP-35 was followed by the programmable HP-65, then by the HP-41C. By the late 1970s, I was well into programming; my book *Geodesic Math* [University of California Press, 1976] exhibits examples," says Kenner.

In fact, Kenner had to choose between mathematics and physics or English language and literature when he started at the University of Toronto in 1941. "I have never regretted the latter decision—I'd have been a merely competent mathematician, but I'm better than that at what I elected instead—but the former has always stayed available," Kenner explains.

Built His First PC

A charter BYTE subscriber, Kenner did not immediately jump onto the personal computer bandwagon. "The HP [calculator] I could hold in my hand could do as much [as the early personal computers] more simply. I got interested, though, about the time disk drives were announced. What I wanted was a way to revise my writing without retyping.

"A longtime Heathkit builder, I got an H-89 kit, which my 11-year-old daughter helped me assemble. (No connection Lisa soldered has ever failed. Same aptitude as 11-year-olds once displayed with needlepoint.) When the 16-bit Z-100 was announced, someone at Brady Books thought to ask me to write a user's guide. The Z-100 has since been joined by a Zenith SupersPort and a Kaypro 386. All four machines are still in use."

First BYTE Article a Travesty

Kenner's first BYTE article was a collaborative effort with computer scientist Joseph O'Rourke—a language statistics program called Travesty. "It drew as much reader response as any program BYTE had ever run," he recalls. That led to Kenner writing reviews of computer books, which led to Print Queue.

Although Print Queue resides in the back of BYTE, it generates more mail each month than any other column, except for Jerry Pournelle's Computing at Chaos Manor. Pro or con, Kenner makes his readers think and respond. ■

Ventura Publisher introduces the Gold Series. It simply does more, any way you look at it.

And now there are several new ways to look at it. Because the desktop publisher that does more for you now does it all in the three leading PC environments.

The Gold Series introduces new Ventura Publisher® editions for DOS/GEM, Windows 3.0, and OS/2 Presentation Manager. That means new ease of use and learning as well as compatibility with hundreds more software applications. All three new editions can use documents from Ventura Publisher 1.1 and 2.0.

It does even more than before.

The Gold Series gives you much more than a choice of environments. At no extra cost, each edition includes our Professional

Extension and Network Server. So you also get such advanced DTP features as interactive table creation and scientific equation editing, cross referencing, and vertical justification.

And you get networking. So several users can edit and proofread simultaneously as well as share stylesheets and network resources. On Novell, IBM, 3COM, and other Windows- and OS/2 Presentation Manager-compatible networks.

Whether you're designing a newsletter or publishing a directory, you'll do it faster and more effectively with Ventura Publisher. Unique features give you more flexible and precise type control, and automate many

steps other programs make you repeat over and over. Ventura Publisher is the one DTP program that can handle all your publishing and design projects.

If you want to do more in desktop publishing, doesn't it make sense to use the program that does the most? Call today for more information about the new Ventura Publisher Gold Series. (800) 822-8221 in USA; (800) 228-8579 in Canada. For training information, call (800) 445-5554. Ventura Software Inc., a Xerox company.

Ventura Publisher Gold Series
It simply does more.



Ventura Publisher® is a trademark of Ventura Software Inc., a Xerox company. XEROX® is a trademark of XEROX CORPORATION. All other product names or trademarks are property of their respective owners. ©1990, Ventura Software Inc.

Circle 338 on Reader Service Card



The only point on Windows

As the people responsible for the Microsoft® Windows™ environment, we believe we're in a good position to offer some very sound advice on Windows Computing. And that,

as you've probably guessed by now, is the Microsoft Mouse.

You see, the Mouse allows you to navigate the Windows environment and applications with untold ease.

ter you'll need s Computing.



As well as unparalleled accuracy.

Furthermore, we've made the decision to buy a Mouse even easier. Now it's available either with software, or on its own for the purist.

Visit a dealer and check it out for yourself. We think you'll see our point.

Microsoft
Making it all make sense

Microsoft logo are registered trademarks and Windows and Making it all make sense are trademarks of Microsoft Corporation. The Microsoft Mouse design is patented. (Design Patent #302, 426.)

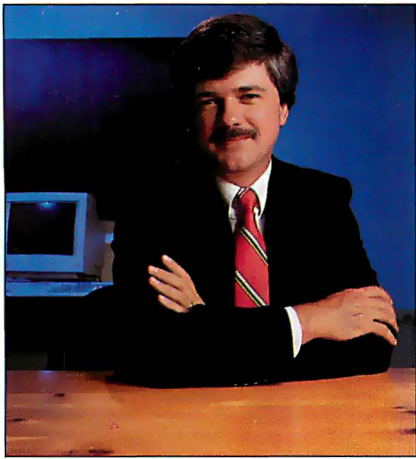

A LAPTOP ON A CHIP . . . ALMOST

When they're not duking it out in the courtroom, companies like AMD and Intel are redefining laptop technology

Last month, I wrote about the current crop of laptops—and they are indeed spectacular. But the game's not over yet, by a long shot. The best of current technology offers you a full spectrum of choices, from i486-based lunchbox luggables, to 386-based portables and notebooks, to fabulously lightweight and fast 286 notebooks, to tiny hand-held 8086-based units.

Soon, very soon, you can expect hand-held 286 machines—an AT in the palm of your hand—and a plethora of 386-based notebooks.

The Hand-Helds

In October, AMD (Austin, TX) announced its “AT on a chip,” a single chip that contains an AMD 286 microprocessor and all the ancillary chips required to build a basic IBM AT. More accurately described as “most of an AT on a chip,” the 286ZX and its low-power sibling, the 286LX, need only a DRAM chip, a keyboard controller, and a system bus to make a working computer. (This contrasts with the 10 to 100+ chips some other designs use.)

The 286ZX chip is designed for desktop machines, and the 286LX is designed for laptop and notebook computers. The 286LX adds some battery-saving features to improve laptop performance, such as a CPU shutdown mode that turns off the 80C286 section of the chip. A standby mode shuts down all system

clocks except those that are needed for DRAM refreshing. It barely sips power, which should stretch out battery life to the max.

This compacting of elements reduces many of the engineering headaches that arise when cramming a 286-based VGA computer into a notebook form factor, so you can expect to see many more of these laptops and notebooks on the market. That, in turn, should help keep prices reasonable.

It also augurs well for 286-based hand-helds. Now that's a machine I want to use—a full-blown go-anywhere AT that fits in a pocket. Don't laugh; they're being developed right now.

The Notebooks

Longtime readers may recall that I'm no big fan of the 386SX for desktop computers because it has a narrow bus that needlessly cripples I/O. (*Needless* is the key word. The SX was not designed to fill a consumer need, but purely for marketing reasons. By promoting the SX, which it alone manufactured, Intel hoped to kill off the perfectly adequate 286, which other companies—such as AMD, Harris, and Fujitsu—also sold.)

In portables, bus width isn't much of an issue. For one thing, you tend not to stuff a portable full of plug-in cards. For another, now that there's a reasonable body of 386-specific software, a portable SX gives you increased compatibility with your desktop system's software, albeit with the performance hit of the SX's CPU-to-memory bottleneck.

SX chips have been used in laptops for quite a while, and they are starting to show up in notebook computers in some numbers.

From SX to SL

Enter the 386SL. Intel describes it as a “386 processor expressly designed for the emerging notebook-size personal computer market.”

The 386SL is a 20-MHz 386 core com-

bined with a main-memory subsystem controller with a 32-megabyte address space, an EMS 4.0 memory controller, an AT/Industry Standard Architecture bus controller, a cache controller, and support for the 80387SX math coprocessor. A companion chip, the 82360SL ISA peripheral and power management chip, supports CPU, memory, and peripheral functions, as well as providing programmable features to manage power to prolong battery life.

Intel also provides a family of low-power support logic chips for modems, keyboards, memory, network adapters, and the like. Intel is setting itself up as a virtual one-stop source for laptop silicon.

We can't meaningfully test these new chips until they're installed in a real-life system, but Intel believes that the compact, highly integrated 386SL is about 20 percent faster than an ordinary 20-MHz 386SX. This means that the SL line can deliver “true” 386 performance levels even in low-power, compact systems. The SL may be the chip the SX should have been all along.

How compact will SL systems be? The SL chips themselves come in several configurations, the smallest being an amazingly dense 227-lead land grid array. The two main chips contain a total of 1.1 million transistors, and they are fabricated using 1-micron technology. Intel says that a complete 386 AT can be built on a board measuring just 4 by 6 inches (about 10 by 15 centimeters). Incidentally, that's about the size of a Sharp Wizard. . . .

West Coast news editor Owen Linderholm has been following these developments all along. His report on the AMD ZX and LX chips appeared in October's *Microbytes*, and his excellent feature on what's new in laptop chip sets appears in this issue on page 312. Check it out.

—Fred Langa
Editor in Chief
(BIX name “flanga”)

New Version Now Available



Borland's Turbo Pascal 6.0 is the Fastest Way from Inspiration to Application

Jump-Start Your Application

When you're inspired to write a program, you want to spend your time developing code that solves your problems. Not hours and hours writing common routines for event handling, data management or user interface.

Now, you can jump-start your applications development by programming with the latest release of the World's #1 Pascal Compiler, Turbo Pascal® 6.0 with Turbo Vision.™

Now with Turbo Vision

With Turbo Vision, the first object-oriented application framework for DOS, you get a giant head start on creating better applications in far less time. Use a Turbo Vision object and your program automatically inherits a hot program architecture that includes overlapping windows, pull-down menus and mouse support. Turbo Vision makes it fast and easy—setting you free to develop the parts of your applications that solve your problem.

And Turbo Pascal 6.0 comes loaded with Turbo Vision applications including a calendar, a calculator, an editor, a clock, a directory browser and forms.

New Turbo-Charged Environment

The new Turbo Integrated Development Environment (IDE) features a multi-file editor, overlapping windows and mouse support.

And Turbo Help lets you copy, compile and run an example program for every standard Pascal library routine so you can use it in your code.

Pro Version with Turbo Drive™

Turbo Pascal® Professional 6.0 also includes: a professional version of the compiler with Turbo Drive,† for compiling big applications in extended memory; Turbo Debugger® 2.0, for killing the toughest bugs; Turbo Profiler™ 1.0, for eliminating bottlenecks; and Turbo Assembler® 2.0, the world's fastest, 100% MASM-compatible assembler.

An Inspiring Offer

The suggested retail price for Turbo Pascal 6.0 is \$149⁹⁵, and \$299⁹⁵ for Turbo Pascal Professional 6.0.

REGISTERED TURBO PASCAL OWNERS. You can upgrade to Turbo Pascal 6.0 for only \$69⁹⁵* or to Turbo Pascal Professional 6.0 for only \$99⁹⁵* direct from Borland.



**To order, see your dealer
To upgrade, call now: 1-800-331-0877**

Circle 51 on Reader Service Card
(RESELLERS: 52)

B O R L A N D
The Leader in Object-Oriented Programming

CODE: MA89

*Add \$10.00 for shipping and handling. Offer expires February 28, 1991. Offer good in U.S. and Canada only. Mail orders to Borland International, Inc., P.O. Box 660001, Scotts Valley, CA 95067-0001. Residents in CA, CT, GA, IL, MA, MI, NY, OH, PA, TX, VA and WA please add appropriate sales tax. For orders outside the U.S., call (408) 438-5300. Turbo Drive compiler requires 1Mb extended memory. Hard disk recommended. Copyright ©1990 Borland. All Borland products are trademarks of Borland International, Inc. Corporate Headquarters: 1800 Green Hill Road, P.O. Box 660001, Scotts Valley, CA 95067-0001, (408) 438-5300. Offices in: Australia, Denmark, France, Germany, Italy, Japan, Sweden and the United Kingdom. Porsche is a registered trademark of Porsche. B1 1386

The IBM RISC System/ Designing on any other workstation



Whatever you're creating, you'll sail into a whole new age with any of the four POWERstations in the RISC System/6000 family. Because POWER (Performance Optimization With Enhanced RISC) processing can give you performance you've probably only dreamed about:

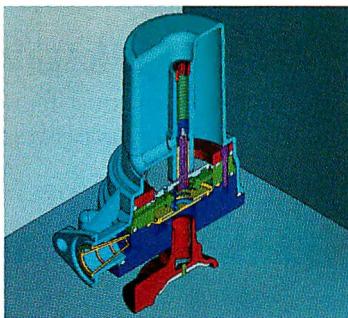

up to four instructions per machine cycle, 42 MIPS and 13 MFLOPS. Suddenly, complex designs don't take eons anymore.

The four RISC System/6000 POWERstations feature a range of graphics processors from grayscale to Supergraphics to satisfy any graphics demand. Great news for Power Seekers working on animation, scientific visualization, medical imaging and engineering solutions like CADAM™, CAEDS™ and CATIA™. And for electrical design automation, there's IBM's all new CBDS™ and an arsenal of over 60 EDA appli-

6000™ family. will seem downright primitive.

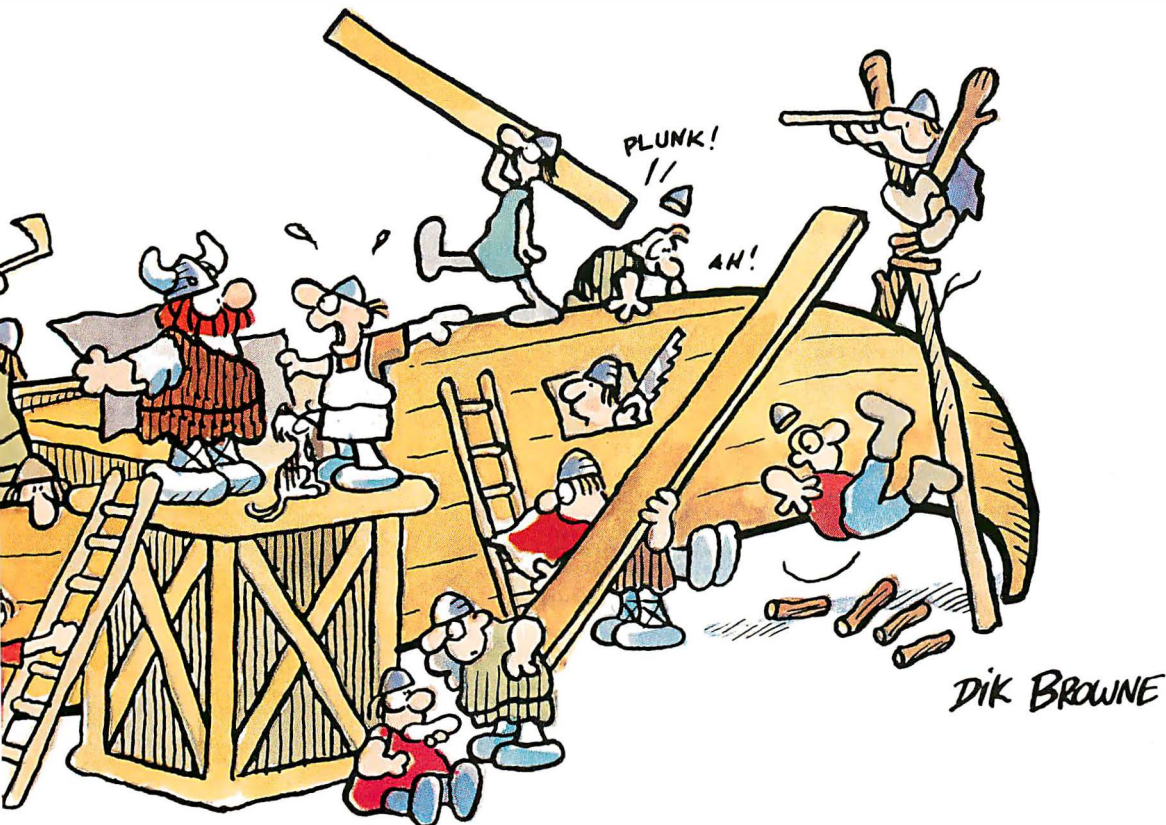

cations from more than a dozen vendors.

With every POWERstation, you can get an almost unimaginable palette of 16 million colors, which gives you 3D images so realistic, they fairly leap off the screen, with super sharp resolution of 1,280x1,024 pixels. And when it's time to call in the heavy artillery, the POWERstation 730 draws nearly one million 3D vectors per second. Like all POWERstations, it can come complete with its own graphics processor, freeing the POWER processor to rapidly create and analyze your designs. All at prices that won't sink anybody's budget.

So if you're tired of paddling upstream with yesterday's performance, call your IBM marketing representative or Business Partner to find out more about the RISC System/6000 family. For literature, call 1 800 IBM-6676, ext. 991.

Civilization never looked so good.

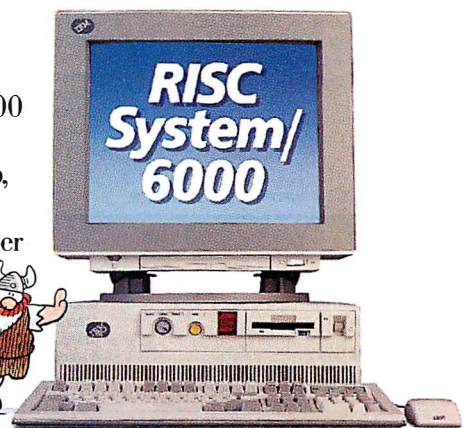

For the Power Seeker.

Circle 139 on Reader Service Card

BYTE

EDITOR IN CHIEF
Frederic S. Langa

MANAGING EDITOR
Anne Fischer Lent

NEWS
New York: Managing Editor: Rich Malloy
Associate News Editor: Andrew Reinhardt
Peterborough: Senior Editor, Microbytes:
D. Barker, Senior Editor, New Products:
Stan Miastkowski
Associate News Editors, What's New: David
Andrews, Martha Hicks
Editorial Assistant: Amanda Waterfield
San Francisco: News Editor: Owen
Linderholm
Associate News Editor: Jeffrey Bertolucci
London: Senior Editor: Colin Barker

BYTELAB
Managing Editor: Michael Nadeau
Technical Director: Rick Grehan
Senior Editor: Dennis Allen
Technical Editors: Alan Joch, Robert
Mitchell, Tom Yager
Testing Editors/Engineers: Stephen Apiki,
Stanford Diehl, Howard Eglowstein,
Stanley Wszola

STATE OF THE ART
Senior Editor: Jane Morrill Tazelaar
Technical Editor: Robert M. Ryan

FEATURES
Senior Editor: Kenneth M. Sheldon
Technical Editors: Janet J. Barron,
Ben Smith

SENIOR EDITORS, AT LARGE
Tom Thompson, Jon Udell

SPECIAL PROJECTS
Senior Editor: Gene Smarte

SENIOR CONTRIBUTING EDITOR
Jerry Pournelle

CONTRIBUTING EDITORS
Bill Catchings, Don Crabb, David Fiedler,
Hugh Kenner, Mark J. Minasi, Wayne
Rash Jr., Mark L. Van Name

CONSULTING EDITORS
Jonathan Amsterdam, Nick Baran,
Laurence H. Loeb, Trevor Marshall, Stan
Miastkowski, Dick Pountain, Phillip
Robinson, Peter Wayner

COPYEDITING
Chief Copy Editor: Lauren A. Stickler
Copy Administrator: Cathy Kingery
Copy Editors: Susan Colwell, Jeff
Edmonds, Judy Grehan, Nancy Hayes
Margaret A. Richard, Warren Williamson

EDITORIAL ASSISTANTS
Office Manager: Peggy Dunham
Assistants: Linda C. Ryan, June Sheldon

ART
Director: Nancy Rice
Assistant Director: Joseph A. Gallagher
Art Assistant: Jan Muller
Technical Artist: Alan Easton

BIX BYTE INFORMATION EXCHANGE

DIRECTOR
Stephen M. Laliberte

MANAGING EDITOR
Tony Lockwood

MICROBYTES DAILY
Coordinator: D. Barker Peterborough,
Rich Malloy New York, Nicholas Baran
Sandpoint, ID, Jeffrey Bertolucci
San Francisco, Laurence H. Loeb
Wallingford, CT, Stan Miastkowski
Peterborough, Wayne Rash Jr.
Washington, DC, David Reed Lexington,
KY, Andrew Reinhardt New York,
Jan Ziff Washington, DC

PRODUCTION
Director: David R. Anderson
Senior Editorial Production Coordinator:
Virginia Reardon
Editorial Production Coordinators:
Barbara Busenbark, Denise Chartrand

TYPOGRAPHY
Systems Manager: Sherry Fiske
Applications Manager: Donna Sweeney
Typesetter: Christa Patterson

ADVERTISING SERVICES (603) 924-6448
Director of Advertising: Lisa Wozmak
Assistant: Christine W. Tourgee
Customer Service Supervisor: Linda Fluhr
Senior Account Coordinator: Lyda Clark
Account Coordinator: Dale J. Christensen
Materials Coordinator: Karen Cilley
Advertising Assistant: Roxanne Hollenbeck
Creative Services Manager:
Susan Kingsbury
Production Artist: Lillian J. Wise
Quality Control Manager: Wai Chiu Li
Production Coordinator: Rod Holden

ADMINISTRATION
Publisher's Assistant: Donna Nordlund

MARKETING AND PLANNING
Director: L. Bradley Browne
Marketing Communications Manager:
Pamela Petrakos-Wilson
Public Relations Manager: Dawn Matthews
Assistant Promotion Manager: Lisa
Jo Steiner
Marketing Art Director: Stephanie
Warnesky
Associate Art Director: Sharon Price
Senior Market Research Analyst: Julie
Perron
Copyrights Coordinator: Faith Kluntz
Reader Service Coordinator: Cynthia
Damato Sands
Marketing Assistant: Carol Pitman

FINANCIAL SERVICES
Director of Finance and Services:
Phillip L. Penny
Business Manager: Kenneth A. King
Assistants: Marilyn Parker, Diane Henry,
JoAnn Walter, Jeanne Gatcombe, Jaime
Huber, Agnes Perry

CIRCULATION
Director: Glyn Standen
Subscriptions Manager: Paul Ruess
Assistant Manager, Subscriptions:
Margaret Liszka
Subscriptions Assistant: Holly Zilling
Newsstand Manager: Vicki Weston
Distribution Coordinator: Karen Desroches
Back Issues: Louise Menegus
Direct Accounts Coordinator: Ellen Dunbar
Direct Accounts Telephone Sales
Representative: Karen Carpenter

BUILDING SERVICES
Cliff Monkton, Gary Graham,
Ed Codman

PERSONNEL
Human Resources Administrator: Patricia
Burke, Human Resources Assistant: Fran
Wozniak, Receptionist: Beverly Goss

EXCHANGE EDITORS
Macintosh Exchange: Laurence H. Loeb,
IBM Exchange: Barry Nance, User Group
Exchange: David Reed, Interactive Game
Exchange: Richard Taylor, Amiga
Exchange: Joanne Dow, Writers Exchange:
Wayne Rash Jr., Tojerry Exchange: Jerry
Pournelle, Telecommunications Exchange:
Stephen Satchell

PUBLISHER
Ronald W. Evans

ADVERTISING SALES
Associate Publisher, Vice President
of Marketing: Steven M. Vito

Administrative Assistant: Carol Cochran

Eastern Advertising Director:
Arthur H. Kossack (312) 616-3341
Sales Assistant: Julie Watson
Western Advertising Director:
Jennifer L. Bartel (214) 701-8496
Sales Assistant: Mary Lynn Heinritz

NEW ENGLAND
ME, NH, VT, MA, RI, CT, ONTARIO,
CANADA, & EASTERN CANADA
Daniel D. Savage (617) 860-6344

EAST COAST
NY, NYC, NJ, DE, PA
Kim Norris (212) 512-2645
Ariane Cassey (212) 512-2368

SOUTHEAST
NC, SC, GA, FL, AL, TN, VA, MS, AR, LA,
DC, MD, WV, KY
John Schilin (404) 643-4762

MIDWEST
IL, MO, KS, IA, ND, SD, MN, WI, NE,
IN, MI, OH
Kurt Kelley (312) 616-3326

SOUTHWEST, ROCKYMOUNTAIN
CO, OK, TX
Alison Keenan (214) 701-8496

SOUTH PACIFIC
SOUTHERN CA, AZ, NM,
LAS VEGAS, UT
Ron Cordek (714) 557-6292
Alan El Faye (213) 460-5243

NORTH PACIFIC
HI, WA, OR, ID, MT, NORTHERN CA, WY,
NORTHERN NV, WESTERN CANADA
Bill McAfee (406) 879-0381
Roy J. Kops (415) 954-9766
Leslie Hupp (408) 679-0381

INSIDE ADVERTISING SALES
Director: Liz Coyman
Administrative Assistant: Susan Boyd
Sales Secretary: Vivian Bernier

NATIONAL ADVERTISING SALES
Mary Ann Goulding (603) 924-2864
Patricia Payne (603) 924-2654
Jon Sawyer (603) 924-2665
Scott Gagnon (603) 924-2651

BYTEBITS (2x3)
Mark Stone (603) 924-6630

THE BUYER'S MART (1x2)
Brian Higgins (603) 924-3754

CATALOG SHOWCASE/INT'L CARDS
Ellen Perham (603) 924-2598

REGIONAL ADVERTISING SECTIONS
James Bail (803) 924-2533
Barry Echavarría (603) 924-2574
Larry Levine (603) 924-2637

BYTE DECK
Ed Ware (603) 924-6166

INTERNATIONAL ADVERTISING SALES STAFF
See listing on page 409.

BUSINESS AND MARKETING
Secretary: Patricia Bausum, Marketing
Services Coordinator: Denise A. Greene,
Billing Services Coordinators: Tammy
Burgess, Donna Healy, Editorial Assistant:
Brian Warnock

TECHNOLOGY
Programmer/Analyst: John Spadafora,
Programmer: Peter Mancini, Systems
Consultant: Gary Kendall

EDITORIAL AND BUSINESS OFFICE:
One Phoenix Mill Lane, Peterborough, NH
03458, (603) 924-9281.

West Coast Branch Offices: 425 Battery St.,
San Francisco, CA 94111, (415) 954-9718;
3001 Red Hill Ave., Building #1, Suite 222,
Costa Mesa, CA 92626, (714) 557-6292.

New York Branch Editorial Office: 1221 Avenue
of the Americas, New York, NY 10020, (212)
512-3175.

BYTEnet: (617) 861-9764 (setmodem at 8-1-
N or 7-1-E: 300 or 1200 baud).
Editorial Fax: (603) 924-2550. **Advertising Fax:**
(603) 924-7507.

SUBSCRIPTION CUSTOMER SERVICE: Outside
U.S. (609) 426-7676; inside U.S. (800) 252-
BYTE. For a new subscription—(800) 252-
9402 U.S. only, or write to BYTE Subscrip-
tion Dept., P.O. Box 555, Hightstown, NJ
08520. Subscriptions are \$29.95 for one
year, \$54.95 for two years, and \$74.95 for
three years in the U.S. and its possessions.
In Canada and Mexico, \$34.95 for one year,
\$64.95 for two years, \$87.95 for three years.
In Europe, £29 (U.S. \$50) for fast surface
delivery, £41 (U.S. \$70) for air delivery. All
other countries, U.S. \$150 for fast surface
delivery. Air delivery to selected areas at
additional rates upon request. Single copy
price is \$3.50 in the U.S. and its posses-
sions, \$4.50 in Canada. Foreign subscrip-
tions and sales should be remitted in U.S.
funds drawn on a U.S. bank. Please allow
six to eight weeks for delivery of first issue.

EDITORIAL CORRESPONDENCE:
Address editorial correspondence to:
Editor, BYTE, One Phoenix Mill Lane,
Peterborough, NH 03458. Unacceptable
manuscripts will be returned if accom-
panied by sufficient postage. Not res-
ponsible for lost manuscripts or photos.
Opinions expressed by the authors are not
necessarily those of BYTE.

PHOTOCOPY PERMISSION:
Where necessary, permission is granted by
the copyright owner for those registered
with the Copyright Clearance Center (CCC),
27 Congress St., Salem, MA 01970, to
photocopy any article herein for personal or
internal reference use only for the flat fee of
\$1.50 per copy of the article or any part
thereof. Correspondence and payment
should be sent directly to the CCC, 27
Congress St., Salem, MA 01970. Specify
ISSN 0360-5280/90, \$1.50. Copying done
for other than personal or internal refer-
ence use without the permission of McGraw-Hill,
Inc., is prohibited. Requests for special
permission or bulk orders should be
addressed to the publisher. BYTE is avail-
able in microform from University Microfilms
International, 300 North Zeeb Rd., Dept.
PR, Ann Arbor, MI 48106 or 18 Bedford
Row, Dept. PR, London WC1R 4EJ,
England.

OFFICERS OF MCGRAW-HILL, INC.:
Joseph L. Dionne, Chairman, President and
Chief Executive Officer; Robert N. Landes,
Executive Vice President, General Counsel
and Secretary; Walter D. Serwatka,
Executive Vice President; Frank D.
Penglase, Senior Vice President, Treasury
Operations; Robert J. Bahash, Executive
Vice President and Chief Financial Officer;
Thomas J. Sullivan, Executive Vice
President, Administration; Mary A. Cooper,
Senior Vice President, Corporate Affairs,
and Executive Assistant to the Chairman;
Ralph R. Schulz, Senior Vice President,
Editorial.

Founder: James H. McGraw (1860-1948).

Copyright © 1990 by McGraw-Hill,
Inc. All rights reserved. BYTE and
BIX are registered trademarks of
McGraw-Hill, Inc. Trademark registered in
the United States Patent and Trademark
Office.

 Member
Audit Bureau of Circulation

Chinese characters translate as "Great Wall".

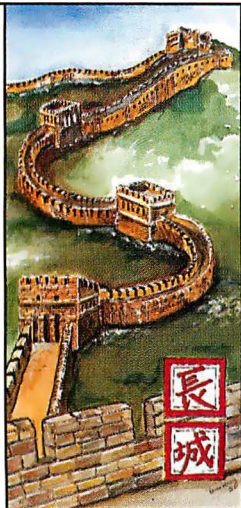

S O F T W A R E D E V E L O P E R S

How To Manage Your LAN Site Licenses. Every Day. Every Time.

Times Change.
The Need To Protect Doesn't.

Licensing software for use on a LAN used to mean "give-away." No matter what site license limits were set, there was really no way to manage actual usage of the software once it was installed on the network.

Now, with the NetSentinel™ security/license management system from Rainbow Technologies, developers can specify how many concurrent users will be permitted—with confidence that the limits will be observed.

Simply. Effectively. Economically.

Based on proven technology from the worldwide leader in PC software protection, the NetSentinel from Rainbow Technologies can be used on most popular PC LANs.

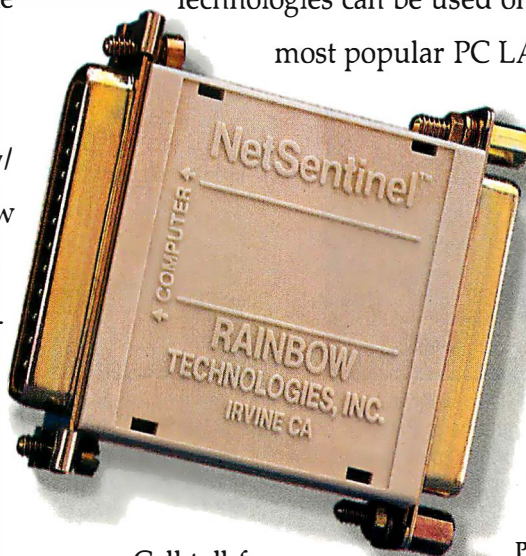

Site License Revenue Protection For LAN Applications.

Call toll-free today for more details.

With Rainbow's NetSentinel, your software need never again be a part of the "free distribution network."



RAINBOW TECHNOLOGIES

9292 Jeronimo Road, Irvine, CA 92718
TEL: (714) 454-2100 • (800) 852-8569
FAX: (714) 454-8557 • Apple Link: D3058
Rainbow Technologies, Ltd., Shirley Lodge, 470 London Rd.
Slough, Berkshire SL3 8QY, U.K. TEL: 0753-41512 • FAX: 0753-43610

NetSentinel is a trademark of Rainbow Technologies, Inc.
Copyright ©1990 Rainbow Technologies, Inc.

The IEF™ can help you develop unprecedented quality, production



"The IEF is a superior tool for implementing Information Engineering because it integrates the entire process from planning through code generation. We're deploying the IEF throughout the corporation."

David V. Evans
Vice President
Director, Information Systems
J.C. Penney

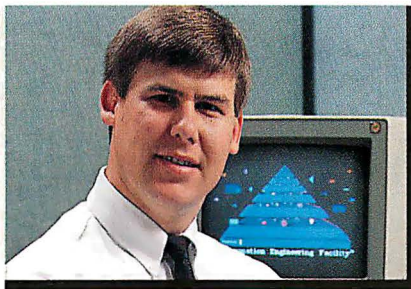

"Our On-line Banking system has been in production for more than 12 months—500,000 transactions a day—without a single code failure. And we had very few enhancements to do. Our users got what they needed the first time out."

Mark Quinlan
Senior Programmer/Analyst
Huntington National Bank

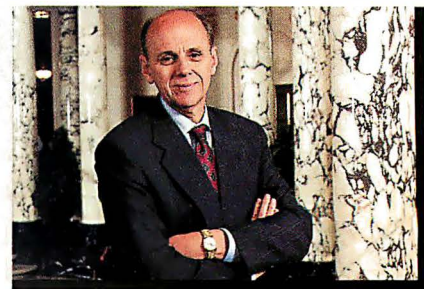

"To meet the dramatically reduced time-to-market requirements for our products, we need high-quality systems that can be changed fast. That's why we've chosen the IEF as the CASE solution for our entire organization."

John Pajak
Executive Vice President
Mass Mutual Life Insurance

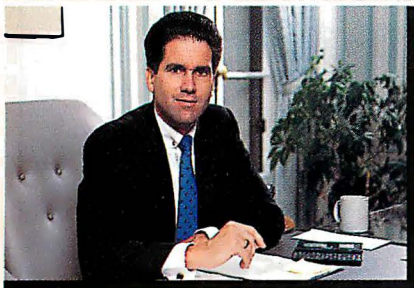

"The strengths of the IEF are clear-cut. One obvious quality advantage is that application changes are made to diagrams, not code. This ensures ongoing integrity—the specification always matches the executing system."

Paul R. Hessinger
Chief Technology Officer
Computer Task Group

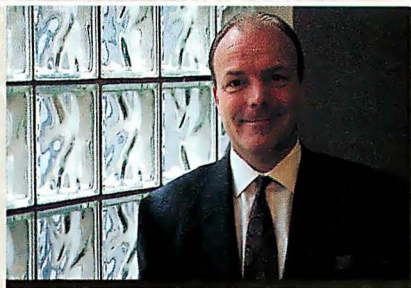

"I've seen other CASE tools fail, so I raised the bar high when we evaluated the IEF. It passed with flying colors. I could not be happier with my decision to adopt the IEF company-wide."

John F. Mott
President
AMR Travel Services



"Our users were extremely pleased when we finished our first project—a 60-transaction system—in one-half the budgeted time. We had tried interfaced CASE tools without success. IEF integration makes the difference."

Giorgio Sorani
Division Head – MIS
Lubrizol

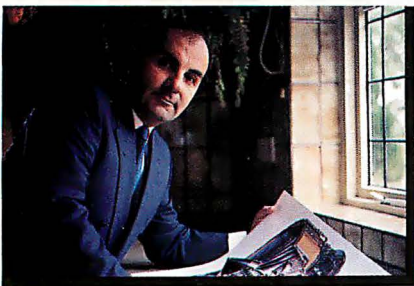

"We are using the IEF to develop a new generation of manufacturing systems replacing over 300 existing systems. We estimate that IEF will increase our productivity by between 2-to-1 and 3-to-1 for new systems development.."

Wal Budzynski
Head of Operations, Systems/Computing
Rolls-Royce



"We used the IEF to rebuild our aging Frequent Flight Bonus system. With DB2 tables of up to 52 million rows, we needed high performance. And we got it...98% of our transactions complete in less than 3 seconds."

Cloene Goldsborough
Director of Data Resource Management
TWA

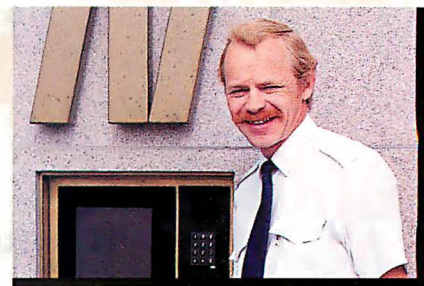

"Our first IEF system was completed faster, and with fewer errors, than any system I've ever seen. If I had to go back to the old ways, I'd find another job...outside the DP world. It means that much to me."

Mogens Sorensen
Chief Consultant
Nykredit (Denmark)

Top information systems with productivity and maintainability.

The success of Texas Instruments CASE product is proven—in the field.

Major companies have used TI's CASE product, the Information Engineering Facility™ (IEF™), for everything from rebuilding aging high-maintenance-cost systems to development of new enterprise-wide strategic systems.

Study shows zero code defects.

The quality of IEF-developed systems is remarkable. In recent CASE research by The Gartner Group, application developers were asked to report the number of abends they had experienced. (An "abend" is a system failure or "lock-up" caused by code defects.) *IEF developers reported zero defects—not one abend had occurred in IEF-generated code.*

Maintenance productivity gains of up to 10-to-1.

In this same study, developers were asked to compare IEF maintenance productivity with their former methods. Of those responding, *more than 80 percent had experienced gains of from 2-to-1 to 10-to-1.* (See chart.)

Specifications always match the executing application.

With the IEF, application changes are made to diagrams, not code. So, for the life of your system, specifications will always match the executing application. The Gartner Group research showed that *all* IEF users who reported making application changes made *all* changes at the diagram level.

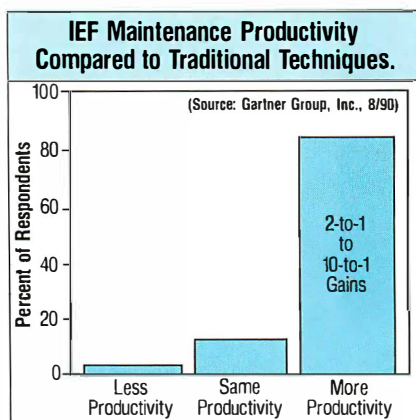

Developers were asked to compare IEF maintenance to former methods. Of those responding, more than 80% reported productivity gains of from 2-to-1 to 10-to-1.

Mainframe applications can be developed and tested on a PC.

With our new OS/2 toolset, you can develop mainframe applications, from analysis through automatic code generation, on your PC. Then, using the IEF's TP monitor simulator and the diagram-level testing feature, you can also test these mainframe applications without ever leaving the PC.

More environmental independence coming soon—develop on PC, generate for DEC/VMS, TANDEM, UNIX.

The IEF has generated applications for IBM mainframe environments (MVS/DB2 under TSO, IMS/DC, and CICS) since early 1988. Soon you'll be able to develop systems in OS/2 and then automatically generate for other platforms. DEC/VMS, TANDEM and UNIX are scheduled for availability in 1991. More will

follow. We are committed to increased environmental independence in support of the Open Systems concept.

We are committed to standards.

IEF tools and IEF-generated code will comply with standards as they emerge. We will adhere to CUA standards and to the principles of IBM's AD/Cycle and DEC's Cohesion—and we will support Open Systems environments centering around UNIX. In any environment, the COBOL, C and SQL we generate adhere closely to ANSI standards. Our presence on standards committees helps us keep abreast of ANSI and ISO developments affecting the CASE world.

Full-service support.

Of course, our technical support, consultancy, training courses, satellite seminars, and other informational assistance will continue apace. We also offer re-engineering and template services. This full-service support will remain an integral part of the IEF product.

For more information, including a VHS video demo, call 800-527-3500 or 214-575-4404.

Or write Texas Instruments, 6550 Chase Oaks Blvd., Plano, Texas 75023.

TEXAS INSTRUMENTS

THE RIGHT DECISION



The 486 Champ

"...THIS COMPUTER DESERVES YOUR ATTENTION."

PC MAGAZINE - SEPTEMBER 11, 1990



On the September 11, 1990, 24 of the industry's hottest 486 powerhouses went head to head for the honor of winning *PC Magazine's* coveted *Editor's Choice Award*. Tri-Star delivered knock-out punches in speed, price and virtually every other important category.

Once again the choice is clear. If you or your company demands the most performance for the money, the highest quality components and unrivaled 486 power, Tri-Star is more than the right decision - *it's the only decision.*

"...probably has the best mix of support, service, and customer satisfaction policies of all the computers in this review."

PC MAGAZINE - July, 1990

"Support Policies - Excellent."
INFOWORLD - MAY 7, 1990

FLASH CACHE 486/25 \$4995

Complete with Intel's 80486 CPU, 64K RAM Cache, 4MB RAM, 1.2MB Floppy, 1.44MB Floppy, 200MB Hard Drive, 1024 x 768 SVGA Color Combo, Parallel & Serial Ports, and 101 Keyboard.

FLASH CACHE 386/33 \$3495

Complete with Intel's 80386 CPU, 64K RAM Cache, 4MB RAM, 1.2MB Floppy, 1.44MB Floppy, 200MB Hard Drive, 1024 x 768 SVGA Color Combo, Parallel & Serial Ports, and 101 Keyboard.

FLASH CACHE 386/25 \$2795

Complete with Intel's 80386 CPU, 64K RAM Cache, 4MB RAM, 1.2MB Floppy, 1.44MB Floppy, 104MB Hard Drive, 1024 x 768 SVGA Color Combo, Parallel & Serial Ports, and 101 Keyboard.

CAD WORKSTATIONS

All Tri-Cad Systems include the Flash Cache 386/486 complete with Math Co-processor, Nanao 16" non-interlaced display and a 12 x 12 Digitizer.

TRI-CAD PROFESSIONAL
325
\$4695

TRI-CAD ADVANCED
333
\$5495

TRI-CAD EXPERT
425
\$6495

UPGRADES:

RENDITION II/256 V
\$695

20" HITACHI MONITOR
\$995

"...THOSE OF YOU WHO WORK IN THE CAD ENVIRONMENT SHOULD INQUIRE ABOUT ITS (TRI-STAR'S) BUNDLED SYSTEMS."
PC MAGAZINE



ALL FLASH CACHE COMPUTER SYSTEMS INCLUDE:

- ◆ 60 Day Money Back Guarantee ◆ 2 Year Warranty
 - Parts & Labor ◆ 12 Month TRW On- Site Service
 - ◆ Lifetime Toll-Free Technical Support
 - ◆ Air Express Parts Replacement
- Circle 325 on Reader Service Card

All prices and specifications subject to change without notice. Money Back guarantee does not include shipping charges. All systems have been verified or certified to comply with part 15 of the FCC rules for a Class A or Class B computing device.



1.800.678-2799

707 West Geneva, Tempe, Arizona 85282

Tech Support 1.800.688-TECH
Telephone 602.829-0584
Fax 602.345-0110

Monday - Friday 7:00am-7:00pm MST
Saturday 9:00am-4:00pm MST

MICROBYTES

Research news and industry developments shaping the world of desktop computing

Edited by D. Barker

Monitor Noise Causes Stress, Researchers Say

The near-ultrasonic noise produced by some computer monitors and VDTs can actually lower worker efficiency and might even cause health problems in women who use them, according to a new study. Researchers Caroline Dow and Douglas Covert, professors at the University of Evansville (Indiana), say they found that a 16-kHz pure-tone sound caused significant amounts of stress in the college-age women participating in the study. They say this tone is similar to sounds made by most of the commonly used computer monitors.

"In these experiments we have made the link between stress and a specific attribute of the VDT," Dow says. In their controlled experiments, Dow and Covert demonstrated that the 16-kHz tone, which is at the top of the range of most human hearing, can cause a significant reduction in a worker's accuracy of intellectual performance and also spur short-term increases in speed. The two researchers say that lowered productivity and a brief increase in the speed of work are symptoms of high stress.

Women appear most susceptible to the problem because they tend to hear better than men in higher-frequency ranges. As a result, the professors say, women can be aware of the tone while men aren't. Dow and Covert also say that women are especially affected by the sound at the peaks of their estrogen levels. High estrogen levels are typical of the first trimester of pregnancy. Even whisper-quiet sources of the tone appear

to cause stress among women, they say. Dow says the tone could be a factor in some of the cases of gynecological problems, including miscarriages, that some people have associated with computerized workplaces.

Industrial-environment researchers have generally discounted gender in considering the effects of the 16-kHz tone. Some previous studies, however, have shown that the sound could cause psychological distress in some men and a greater number of women when the sound was at high-volume levels.

The two professors offer three suggestions. Try to use a high-definition monitor; they have scanning rates that are well above the range of human hearing. (Dow won't speculate on which resolution is best; the higher, the better, she says. She also points out that some monitor cases are designed so well that they muffle any sounds.) Ear plugs offer temporary relief, especially ones designed to reduce the intensity of high-pitched sounds. Another suggestion is to install an electronic circuit that produces the same 16-kHz pure tone but operates 180 degrees out of phase; the two sounds will cancel each other out. The two professors admit that some engineers are skeptical about this process, and there is no evidence yet that not hearing the sound actually eliminates the effects.

Is your monitor stressing you out? Dow suggests turning your tube off for 15 minutes and then seeing if you feel more relaxed.

— David Reed

New Hardware, Software Squeezing Graphics

Graphics, especially color images, can strain the CPU capacity, bus bandwidth, and storage space of most personal computers. But new developments in data compression will help facilitate the use of images on not-that-exotic desktop systems.

C-Cube Microsystems (San Jose, CA) is putting its CL550 image processor chip, based on the Joint Photographic Experts Group (JPEG) compression algorithm, onto \$995 add-in boards for

Macs and IBM PC compatibles. These boards will be able to compress images by as much as 75 to 1, the company says. The new Compression Master boards can squeeze image files to one-twenty-fourth their original size with no visible loss of quality, C-Cube says.

A 300-dpi 24-bit color scan of an 8½-by 11-inch page can take 28 MB of disk space—which means that it takes only a few such scans to fill an 80-MB disk—but after being fed through the Com-

NANOBYTES

Users apparently pushed the right buttons when **protesting Apple's decision** to disable the scripting capabilities in the standard HyperCard 2 package. Apple and **Claris**, now proprietor of the hypertext program, announced that the new HyperCard would be delivered to users in a run-time-only version; in other words, you couldn't develop your own stacks (programs). Those hyperscripting tools were going to come in an optional package. After a furor on several on-line services, including BIX's Macintosh Exchange, the decision was nixed. HyperCard product manager Mike Holm says now that a full version of HyperCard will indeed be bundled with new Macs; however, it will not enter scripting or programming mode without the user making a minor change: removing an opaque button over the scripting choices on the Home stack. Claris plans to have a shrink-wrapped HyperCard 2.0 upgrade available in the near future for a retail price of \$49.95.

Microsoft (Redmond, WA) has collected a set of **device drivers** for printers, displays, pointing devices, and other peripherals that work with **Windows 3.0**. The drivers were written by hardware developers and then certified by Microsoft. The Windows Supplemental Driver Library includes drivers for HP's LaserJet Series II and III printers that Microsoft says improve printing performance from within Windows. This first version of SDL also includes printer drivers from AMT, Bitstream, Brother, Canon, IBM, Kodak, Okidata, Olivetti, Seiko, and Star. The "enhanced" display drivers, including ones for Super VGA systems, come from ATI, Chips & Technologies, Compaq, Graphic Software Systems, Video Seven, and Western Digital. Novell has provided a network driver. You can order the SDL from Microsoft by calling (800) 426-9400; the cost is \$20.

NANOBYTES

Interleaf (Cambridge, MA) says it will soon bring to market some desktop publishing products that implement its “**active document**” technology. Announced last March, active documents are electronic documents that can “access, evaluate, and act on information,” Interleaf says. The first incarnation is in the new Interleaf 5 series, a set of six programs for specific job categories (e.g., writer, engineer, and illustrator). Active electronic documents can evaluate and act on information they receive. For example, Interleaf and **Lotus** have created an “intelligent link” that lets Interleaf documents display information from Lotus 1-2-3 files as Interleaf automated tables or charts. You activate the link by copying an icon representing the spreadsheet and pasting the icon into an Interleaf document. Interleaf plans to offer a Lotus toolkit for creating intelligent links in a spreadsheet. The Interleaf 5 products for Unix workstations are scheduled to begin shipping in limited numbers this month. Versions for DOS and VMS are scheduled to ship next spring; Mac versions will ship next summer.

Motorola (Austin, TX) has packaged a new version of its 68030 for use as an **embedded controller**. The new 68EC030 performs comparably to the regular 68030, the heart of high-end Macs and workstations, and it’s object code-compatible with its ancestors, the 68000 and the 68020. The 40-MHz chips cost \$75 each in quantities of 1000.

Quark (Denver) is taking **XPress**, one of the leading Macintosh desktop publishing programs, to OS/2. As part of its development agreement with IBM, Quark also is developing software to “enhance integration and connectivity of multiple vendor systems,” the company said. These efforts include groupware and data-exchange software. Quark recently demonstrated a prototype of XPress running under Windows 3.0. However, company founder Tim Gill says that Windows lacks the connectivity and networking features needed for large-scale workgroup publishing, and hence the focus on OS/2.

pression Master, the page would take up just a little more than 1 MB. This sort of file compression is especially important if images will be traveling across a network.

C-Cube has also developed a programming interface, called the Image Compression Interface. ICI is a set of calls that can be written into Mac or PC applications to let them access transparently a Compression Master board installed in the system or any other compression board that adheres to the ICI standard. If no board is present, the compression is done in software, through JPEG version 8.2 algorithms supplied with C-Cube’s Compression Workshop software. Because both the JPEG and ICI specifications are open, any software or hardware vendor can build to the standard.

Several software companies have announced support for ICI, and some on the Macintosh side said ICI support has already been written into their applications, including Adobe Photoshop, Quark XPress 3.0, Aladdin Systems’ Stuffit DeLuxe, Studio/32 from Electronic Arts, and Salient DiskDoublerPlus. Autodesk said it intends to support ICI in Animator.

An early adopter of the C-Cube squeezing technology is Macintosh peripherals maker SuperMac Technology (Sunnyvale, CA), which announced at the recent Seybold Conference that, starting in January, it will include still-

image compression software with all its color graphics cards and storage systems. The new SuperSqueeze software is based on JPEG algorithms obtained from C-Cube and will comply with C-Cube’s Image Compression Interface. People who purchase SuperMac products now will be eligible to receive the SuperSqueeze software for free. Others can buy it for \$49.

Radius (San Jose, CA) is also putting the squeeze on graphics. The company announced at Seybold a software implementation of the JPEG standard. The Radius software, for the Mac II platform, will compress still images only. The new software can compress a 0.75-MB, 24-bit full-color image to 25K bytes in less than 6 seconds on a Mac IIcx and in less than 3 seconds on a Mac IIfx, the company says.

The Radius software will be priced at “around \$300.” The company’s software approach is more flexible than hardware JPEG implementations like the C-Cube chip, Radius claims. The firm points out that an image-compression board takes up a Mac II slot and costs \$1000 or more. Furthermore, revisions to the JPEG standard will be less painful for users of software-based compression products, Radius says; it is cheaper to buy a software upgrade than it is to buy a new add-in board. However, the hardware solution is still the faster method of image compression.

— Andy Reinhardt and Jeff Bertolucci

AT&T Promises Multiprocessing Unix Next Year

AT&T’s Unix System Laboratories (USL) plans to start enhancing Unix System V release 4 next year, with the most significant change involving multiprocessing. AT&T is working with Sequent and other companies to develop a symmetrical multiprocessing version of Unix System V release 4 that can handle up to 10 processors. This release, called SVR4 MP, is slated for the first half of 1991, AT&T said.

Although it will be developed on Intel processors (the i486 and the i860), versions also will be available for MIPS, SPARC, and Motorola (88000) CPUs. A later version (SVR4 ES/MP) will be able to handle up to 30 processors. One of the companies that plan to use the multiprocessing Unix is NCR, which announced several multiprocessing computer systems recently.

A new version called SVR4 ES will be more secure, USL said, and will conform to the B2 level of security as

outlined by the U.S. National Computer Security Center. This level is designed to be more resistant to computer viruses and to make it more difficult for operators to create security loopholes either accidentally or intentionally. This version is scheduled for the first half of 1991.

The new SVR4 will be better at disk management, AT&T says. USL developers are working to increase performance by storing parts of files on different physical hard disk drives.

AT&T would not disclose pricing for these new versions of Unix, saying that price information usually precedes product availability by about 60 days. AT&T representatives would not commit to a single graphical user interface for the new Unix, and they offered only muted support for Open Look, the GUI that AT&T had originally proposed for System V. Some people had expected AT&T to



NOW YOUR SOFTWARE CAN TEST ITSELF.

Your customers expect software that works. All the time. The key to software quality is exhaustive testing. It's also an engineer's worst nightmare. But it doesn't have to be. Because now you can automate your software testing.

Introducing the Atron Evaluator. The first and only non-intrusive automated PC-based software testing tool.

The Atron Evaluator automatically runs your software regression testing programs. All of them. All day. All night. Giving you thoroughly tested, higher quality software.

The Atron Evaluator is hardware-based. And since it's non-intrusive, software behavior is tested without the risk of alteration. Once your tests have run, you can refer to automatically generated test reports to double-check test results.

The Atron Evaluator saves time. And time makes you money. Development cycles are shortened, so your software gets to market sooner. And while your test programs are running, you can be more productive. Start a new project. Or go home.

For more information about the Atron Evaluator, call us at 1-800-733-6036. And put an end to your worst nightmares. Automatically.

CADRE

Cadre Technologies, Inc.
19545 N.W. Von Neumann Drive
Beaverton, Oregon 97006

In Europe, contact:

Elverex Limited, Enterprise House
Plassey Technology Park, Limerick, Ireland
Phone: 353-61-338177

QA Training Limited, Cecily Hill Castle
Cirencester, Gloucestershire, GL7 2EF, England
Phone: (0285) 655888

NOW AVAILABLE IN
VGA & PS/2[®]

MAX
LTR

A4

B5

When we sat down to all the lights c

Accurate color scanning seems a simple enough goal. Yet in a flash of engineering brilliance, Epson® designers have raised the standard by creating the ES-300C color scanner.

Using three separate light bars, Epson's innovative TruePass™ scanning system, does in one pass what most other

color scanners require three passes to accomplish.

The result is more precise images in less time. Gone are registration difficulties, poor fidelity and color dropout.

*The new EPSON ES-300C
is both MS-DOS and
MACINTOSH compatible.*

The ES-300C is as impressive in black and white or grayscale as it is in color. 256 shades of gray complement 16.8 million colors. Resolution settings can be



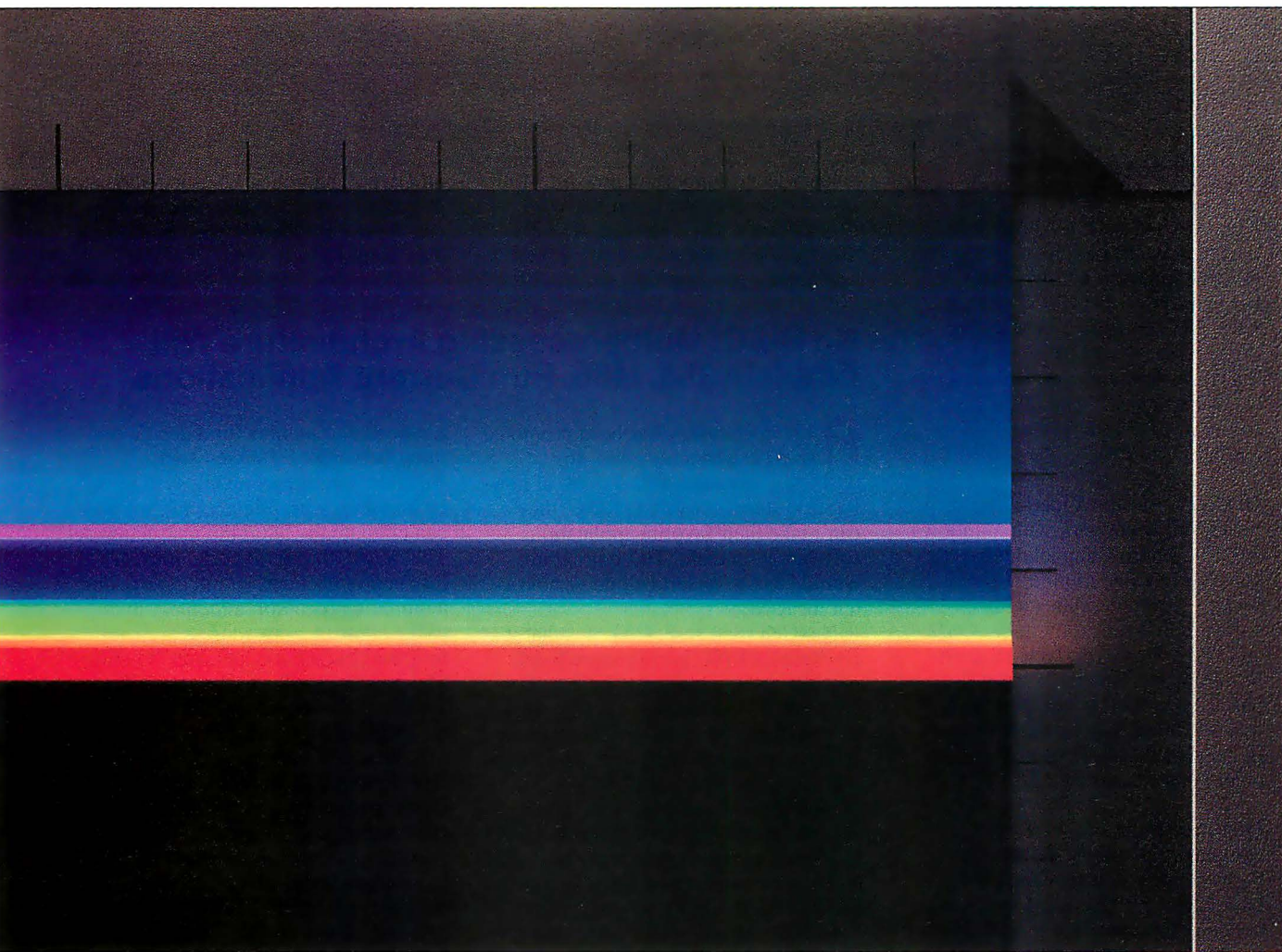

design a better scanner, come on at once.

adjusted between 50 and 600 DPI to optimize output from any printer, or to any monitor. Compatibility is assured with a choice of easily installed MS-DOS® or Macintosh® interface kits, featuring the latest industry-leading scanning and editing software.

With a price as attractive as its image would suggest, the full color ES-300C costs about the same as most black and white scanners.

A demonstration of the Epson ES-300C will be an illuminating experience. Other scanners simply pale by comparison.

Engineered For The Way You Work.™

EPSON

NANOBYTES

Maxtor (San Jose, CA) has developed a new 3½-inch hard disk drive that the company claims is **the biggest** in the business. The new LXT-535 can store 535 MB. The drive comes with a SCSI or an AT interface. Average seek time is 12 ms, Maxtor says. The OEM price for the LXT-535 is \$1450; for the LXT-437, \$1250.

IBM's M-Motion Video Adapter/A board will soon work with Windows 3.0. The Micro Channel device for converting video input to VGA images currently comes with software that runs only under OS/2 and DOS. However, IBM recently introduced in Japan a Windows-based M-Motion board, and the U.S. market should see a similar product in the near future, IBM multimedia chief Peter Blakeney told BYTE.

Qualitas (Bethesda, MD), the company that makes the 386Max high-memory manager for 386-based systems, has developed a new version of the product specifically for 386-based PS/2s. The new BlueMax (\$155) addresses a particular problem experienced by PS/2 users: Because IBM uses 64K bytes of high memory for the BIOS to support OS/2 and other future capabilities, there's not enough high memory to hold network adapters, TSR programs, and an expanded-memory page frame. BlueMax removes those portions of the IBM BIOS that are used only by OS/2 and reloads the BIOS to use only 64K bytes of high memory instead of 128K. The result is that network interfaces and EMS drivers can be loaded into high memory, with room left over for a few TSR programs.

Graphic Software Systems (Beaverton, OR) has come out with a kit for writing 34010-based applications drivers to the Direct Graphics Interface Standard. The DGIS 3.0 Software Development Kit comes with the DGIS firmware, C subroutine calls, sample programs, documentation, program utilities, and a 34010 board for testing the drivers. The kit costs \$695. GSS also has the first graphical interface for 34010-based products working with OS/2 Presentation Manager.

acknowledge support by now for Motif, the GUI used by the Open Software Foundation's Unix. Instead, AT&T is talking about establishing a common application programming interface for

all GUIs. Theoretically, users who buy programs written to this generic API can choose for themselves which GUI they would like to use.

— Rich Malloy

No RISC: Multiprocessing Architecture Will Emulate 386, i486, Run Current Applications

RISC technology has been promoted as a performance savior for desktop computing. But if users of non-RISC systems convert to RISC, they can't take their favorite applications software with them. Those programs would have to be left behind or rewritten for RISC.

NexGen (San Jose, CA) says that it can surpass RISC performance levels without making current software obsolete. The company is designing a new complex-instruction-set computer architecture that will be able to run most software now working on IBM PC-compatible computers. NexGen says the multichip processor at the heart of its multiprocessing architecture will be binary-compatible with DOS, OS/2, and The Santa Cruz Operation Unix.

NexGen says that its systems architecture is the first to support "true symmetric, scalable multiprocessing in a personal computer environment." A machine built around the NexGen design will be able to have four CPUs. These machines will perform at speeds "greater than twice that of a 486, SPARC, or MIPS" system and comparable to that of an IBM RISC System/6000, said Peter Janssen, vice president of NexGen.

Although the company has been "thrown in the basket with" chip makers trying to clone Intel's 386, "we're doing

a superscalar architectural design of a microprocessor," Janssen said. NexGen's multiprocessing system will be based on a proprietary chip set that can emulate the 386/i486 instruction set. That VLSI chip set incorporates an instruction decoder, an integer executor, a numeric processor, a memory and cache controller, an address preparation unit, and instruction and data tag chips. The processor talks to the rest of the system with a 64-bit multiprocessor bus; the designers say that the bus can operate at 267 MBps. Integer and floating-point instructions can execute concurrently. Most integer instructions are handled in a single cycle, Janssen said. The memory system can feed the processor 8 bytes of instructions or data during every cycle. The instruction and data caches use ordinary static RAM.

NexGen hopes to sell its design initially to OEMs. Resultant multiprocessing server systems could show up early in 1991, Janssen said. Workstations and servers built around the NexGen processor will be able to "swap disks and I/O boards with PS/2s and EISA machines," he said. Although computer makers Compaq and Olivetti have made equity investments in NexGen, there's no contractual obligation to use the company's new technology, Janssen said.

— D. Barker

NCR's New Environment Built on Cooperation

NCR has concocted a "general-purpose information processing environment" that's a model of cooperation. In fact, that's what NCR calls its ensemble of client/server-based workgroup software: Cooperation.

Cooperation provides not only a graphical desktop interface, network support, and E-mail, but also sophisticated network file management, wide-area-network support, terminal emulation and host links, database engines and front ends, document conversion, work-flow automation, an executive information system (EIS) shell, and network management functions. Many

of these things are available in competing "office environments," but Cooperation, based on open standards and software from other companies, also includes open application programming interfaces, development tools, and a library of reusable objects to simplify custom programming.

NCR's system, designed to run on 386-based PCs, starts with DOS and then adds Windows 3.0 and Hewlett-Packard's New Wave 3.0, for an iconic workspace that can treat data files as objects and invoke "agents" to automate complex or repetitive tasks. The servers will be running OS/2 LAN Manager (or,

In a world that
changes economic
systems overnight,
can we really
afford personal
computer systems
that take weeks
to set up, months
to learn, and
years to deliver
on their promises?

No. But, fortunately, afford a

In the 1980s, American companies invested nearly \$90 billion in PCs, yet office productivity has shown disappointing gains.

Not everybody was disappointed, however. According to a new independent study by Diagnostic Research, Inc.*, companies that invested in Macintosh® computers are enjoying dramatic results. Managers gave Macintosh productivity ratings that were 37% higher than for MS-DOS systems and 32% higher than for PCs running Windows. Which is like getting back 17 extra weeks a year.

In a global economy of snowballing competition, the story behind those figures may be of interest.

In 1984, Apple introduced Macintosh on the simple premise that computers should work the way people do.

Now, as others rush to market with Macintosh look-alikes, Apple turns out to have been the practical, dependable, results-oriented computer company all along.

Introducing a new series of Macintosh computers from \$999†

Our three new personal computers were designed to rectify the one flaw that still exists in Macintosh. Namely, some people still don't have one.

So now, starting at \$999†, there is a Macintosh at a price that almost everyone can afford.

The Macintosh Classic.®

This one has everything that makes a Macintosh a Macintosh. Built-in networking. A SuperDrive™ disk drive, which reads both Macintosh and MS-DOS files. And a \$999† price that includes the built-in monitor, 1MB of

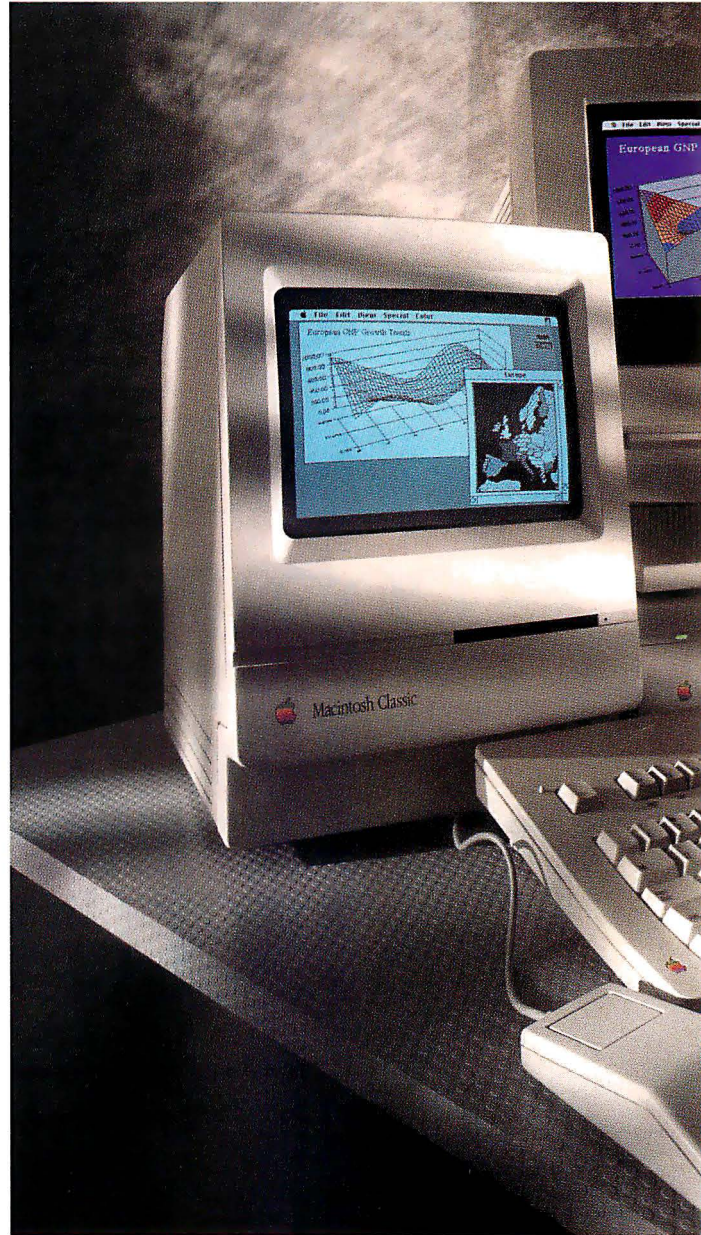

The new Macintosh Classic, Macintosh IIx, and

RAM, keyboard, mouse, and system software. A 40MB hard disk is optional. Its processor is an 8 MHz 68000 chip. And it outperforms the popular Macintosh SE.

The Macintosh LC.

The new, low-cost Macintosh LC introduces exquisite

* The figures are included in a 1990 study conducted by Diagnostic Research, Inc., among Fortune 1000 managers and business computer users familiar with Macintosh and MS-DOS or Windows systems. Call and we'll send you Macintosh, and "The power to be your best" are registered trademarks, and SuperDrive is a trademark of Apple Computer, Inc. MS-DOS and Windows are registered trademarks of Microsoft.

now everybody can Macintosh.



Macintosh LC on stage together for the very first time.

Macintosh color and graphics to a wider world.

With its 16 MHz 68020 processor, it runs all the thousands of Macintosh programs at impressive speed.

And, with the optional Apple® IIe Card, it will run thousands more Apple II applications as well.

The Macintosh LC expands by adding a card to its slot. A 40MB internal hard drive is standard. A built-in video chip runs an Apple monochrome or low-cost color monitor — without adding a video card. And the Macintosh LC, like the Mac® IIsi, lets you record your voice and other sounds into the computer. Which will make voice-annotated software a standard Macintosh feature.

The Macintosh IIsi.

Running a 20 MHz 68030 microprocessor, the new Macintosh IIsi delivers serious number-crunching at the most attractive possible price.

Into its sleek package are compressed the powerful essentials of the Mac II line. Including an optional 32-bit NuBus™ slot for high-performance graphics and accelerator cards. Along with advanced networking systems like Ethernet and Token-Ring. Plus a 40 or 80MB hard drive. Built-in video chips drive four different Apple monitors.

Why the least
expensive Macintosh is more
powerful than the
most expensive anything else.

Every Macintosh, from the original to the latest, shares a compelling quality unavailable in any other PC at any cost: People really like using it. What they like to do, they do. And so they get more done.

Call us at 800-538-9696, ext. 350, for the name of your nearest authorized Apple reseller.

You'll find an amazing thing happens when you give people the power to be their best. They'll be it.

The power to be your best. 

NANOBYTES

New subsidiaries of **Nakamichi Peripherals Corp.** of Japan are gearing up to deliver their new 3½-inch rewritable optical disk drives to OEMs and end users. **Mass Optical Storage Technologies** (Cypress, CA) is the developer and manufacturer of the 3½-inch optical disk drive and will sell it on an OEM basis. **Ocean Microsystems** (Campbell, CA) will sell the drive to end users. **MOST's** RMD-5100 drive offers a capacity of 128 MB on single-sided disk cartridges that are roughly the same size as familiar 3½-inch magnetic media. **MOST** says that the drives have an average access time of 35 ms, comparable to many hard disk drives. The **Ocean Vista 130** drive, slated to be available to users by the end of this year in limited stock, will cost \$3395 for XT/ATs and compatibles, \$3595 for PS/2s, \$3195 for Macs, and \$3990 for AT-bus systems running Unix or Xenix.

Trying to encourage software development for its i860 RISC microprocessor, **Intel** and five of its i860 customers have formed a support group for the 64-bit chip. The **Mass860** group will offer software developers porting assistance as well as technical and marketing help. In addition to Intel's Microcomputer Components Group, founding members are **Alliant Computer Systems**, **IBM**, **Oki**, **Olivetti**, and **Samsung**. **Mass860's** new multilayer application binary interface (ABI) will enable third-party software to run unchanged across a variety of hardware platforms that support the i860, **Intel** said; for example, a program that runs on an i860 auxiliary processor on a PC will run in identical binary format on workstations from **Oki**, **Olivetti**, and **Samsung**, and will run under **PAX** on "supercomputer-class systems" from **Alliant**, **Intel** said.

An old name in typewriters, **Smith-Corona** (New Canaan, CT), plans to introduce a line of personal computers aimed at home and small business users. The new PCs will be developed by Taiwan-based **Acer** to specifications from **Smith-Corona**, and manufactured by **Smith-Corona** in Cortland, New York.

someday, Unix System V release 4) and the Mezzanine network file management software from **Saros**. Cooperation comes with a set of applications from other companies: **Gupta's** **SQLBase Server**, **FutureSoft's** **DynaComm** terminal emulator, **Mastersoft's** **Word** for **Word** file-conversion utilities, **Channel Computing's** **Forest & Trees** EIS system, and **Software Products International's** **Access SQL**.

The secret to Cooperation is that it is an amalgam of third-party applications. **NCR** has integrated them into a tightly coupled environment that can be installed on any IBM-compatible computer—both a technical and a political accomplishment.

One drawback to Cooperation, compared with typical PC network configurations, is its cost; the software modules (which provide user and network services and applications) are expensive by PC standards and require expensive computers. But **NCR** officials maintain

that the per-user cost is still less than that of minicomputer and mainframe software or the cost of hiring consultants to integrate complex PC applications.

Cooperation client machines must be 286- or 386-based PCs with at least 6 MB of RAM. Clients run **DOS**, **Windows**, **NewWave**, and whatever other client modules have been purchased. Servers have to be 386 or 486 machines with 12 MB of RAM and at least 200 MB of disk storage. **NCR** said the servers have to be **Micro Channel** systems because they require the bus bandwidth, but the company couldn't explain why an **EISA**-bus machine wouldn't suffice. Servers run **OS/2** and **LAN Manager 2.0**, in addition to the chosen modules of Cooperation. The cost ranges from \$23,000 (for a 12-user system) to \$58,000 (for 24 users). **NCR** expects Cooperation to be generally available in March.

— Andy Reinhardt

Motorola to Go Superscalar with Future Chip

At the recent Microprocessor Forum, **Motorola** disclosed not a new product so much as its ambitious plans for a new product. This non-announcement concerned the **Motorola 88110**, which is a future member of the 88000 family of RISC processors; if **Motorola** is right, the 88110 chip will be one of the performance leaders of the decade.

The 88110 will be a superscalar design, meaning it will be able to execute more than one instruction per clock cycle. **Motorola** will put the CPU, FPU, graphics execution units, memory manager, and instruction and data cache all on the same chip. The 88110 will use 80-bit-wide data paths internally throughout the chip. The design will incorporate speculative execution techniques to anticipate the tasks that it will be given to run. **Motorola** says it

can produce this chip sometime in 1991 and that it will be between three and five times faster than the 88100.

The chip maker has made what some microprocessor experts consider bold predictions. **Motorola** said it can retain object-code compatibility while adding a highly parallel superscalar design and dynamic instruction scheduling, and implementing this at 100-MHz clock rates with extremely wide data buses. **Motorola** designers say that by the end of the 1990s, the company will be producing multiprocessor chips that contain 100 million transistors and are capable of operating at 300 MHz.

Motorola officials say that the 88000 architecture will provide a broad range of processors that can control anything from a toaster to a supercomputer, all with the same basic instruction set.

— Owen Linderholm

Mixed-Media Magazines on Disc Are on the Way

With some help from hypertext tools and multimedia development programs, four companies are readying or have released new interactive magazines on CD-ROM. The platters will provide everything from software demos to music videos to ads with electronic buttons you can press for more information.

These kinds of publications, which

tend to make heavy use of graphics, sound, and hypertext links, are easier to design now than a year or so ago because of sophisticated programs for manipulating images and linking information. **Verbum**, for example, has constructed its **Verbum Interactive** disk entirely with off-the-shelf software. "A couple of years ago," says **Michael Gosney**, president and publisher, "it

POCKET FRIENDLY

and very Practical



Meet the new Practical Pocket Modem™...a tiny 2400 bps modem that delivers big modem performance and features. A giant value at \$159!

Despite its credit card size the PM2400PPM gives you Hayes 2400 compatibility and all the advantages of 2400 bps data transmission. And thanks to a remarkable design approach, **no-fail power** comes from the RS232 port and the telephone line...you never have to find a wall outlet or change batteries! Our new Software Speaker™ enables the modem to send detailed call progress information to the computer's terminal.

Now, if you're a Mac-user, you'll need a separate 9V battery adaptor which is included in the special Macintosh Package. The PM2400PPM couldn't be more portable or Practical.

Quality and reliability is backed by the Practical Peripherals warranty: the modem performs for 5 full years or we'll repair or replace it FREE. Simple.

It doesn't get more Practical than that.

PRACTICAL PERIPHERALS®

Circle 235 on Reader Service Card

31245 La Baya Drive, Westlake Village, CA 91362. Sales Office: 1-800-442-4774
Corporate Headquarters: 1-818-706-0333, Technical Support: 1-818-991-8200, FAX: 1-818-706-2474

All products and names trademarked are properties of their respective manufacturers.

© 1990 Practical Peripherals, Inc. All rights reserved.

On the left, the best-selling VGA monitor. On

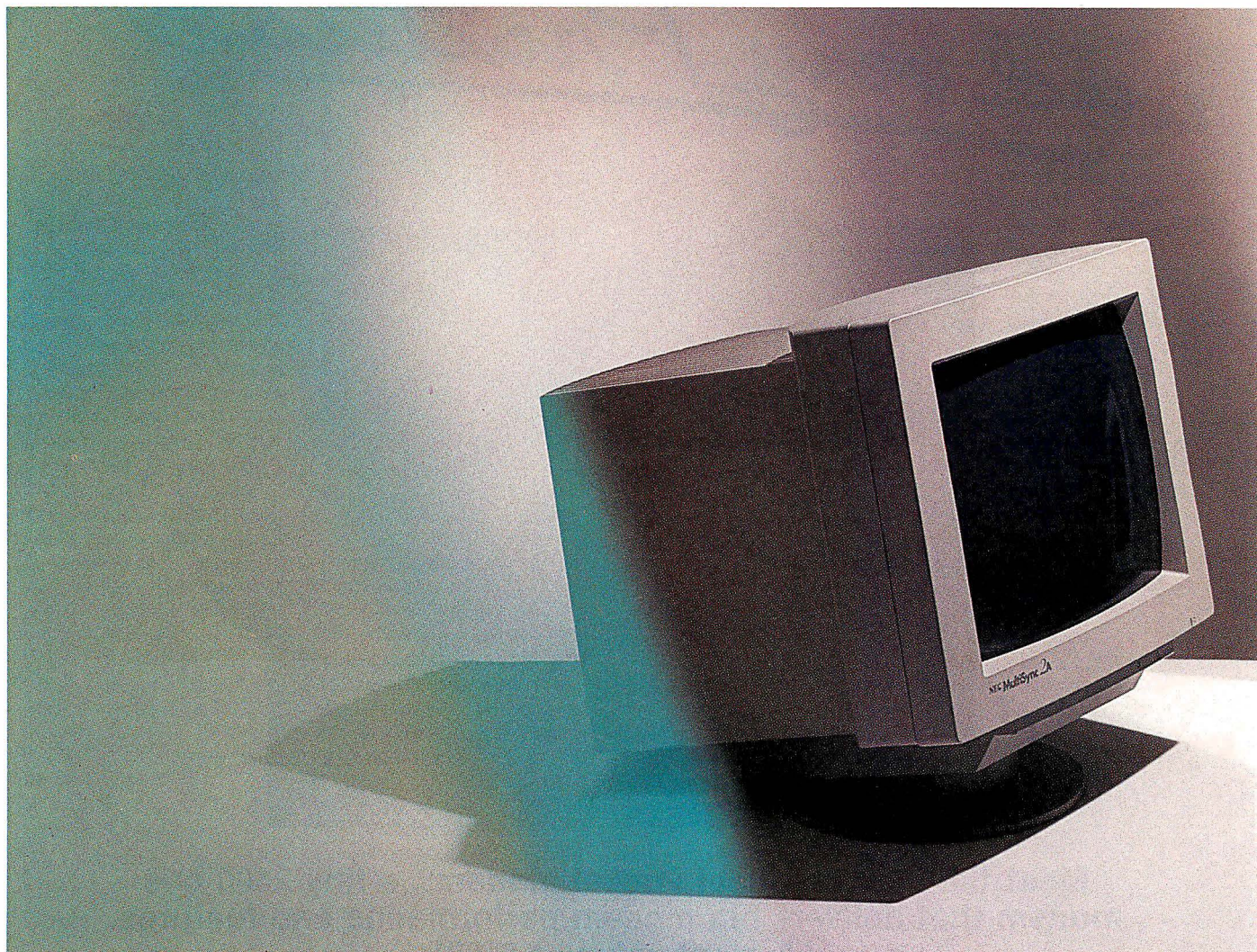

The MultiSync® 2A is one monitor that performs like two. On one hand, it's an uncompromised VGA monitor that works so well, VGA users have made it the best-selling 14" VGA color monitor in America.

On the other hand, the MultiSync 2A is also an equally uncompromised SuperVGA monitor, providing the perfect upgrade path to a standard that, at 800 x 600, gives you 56% more resolution than VGA.

the right, the best-selling SuperVGA monitor.

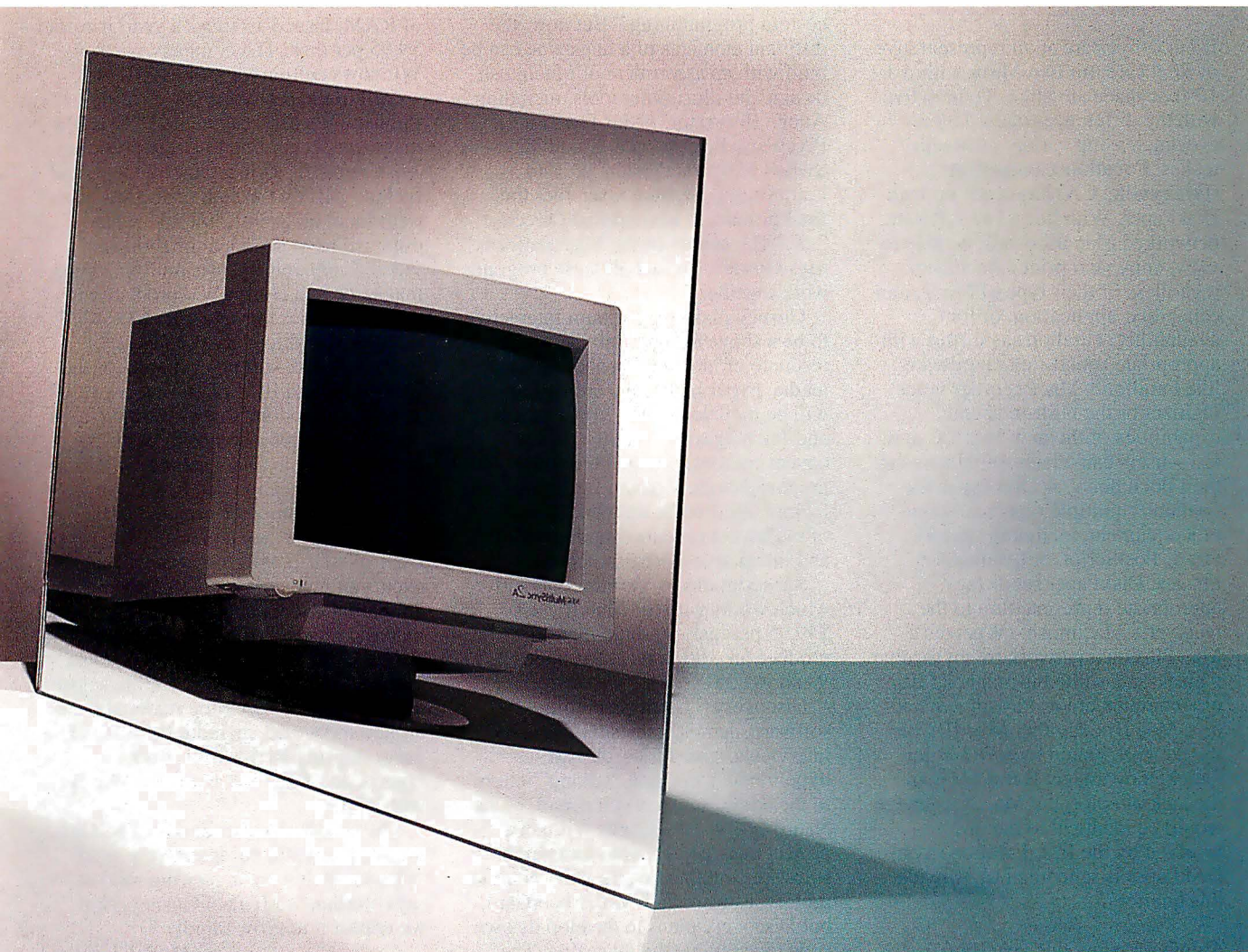

It's even available in a gray-scale version—the MultiSync GS2A—
which delivers everything the 2A does, in glorious shades of gray.

The MultiSync 2A. It's two of the best monitors you've ever seen.

For technical information or for the location of the dealer nearest
you, call 1-800-FONE-NEC. For product literature, call 1-800-826-2255.

In Canada, call 1-800-268-3997.

MultiSync is a registered trademark of NEC Technologies, Inc. © 1990 NEC Technologies, Inc.

Circle 203 on Reader Service Card

NEC

NANOBYTES

If our offices are at all representative of Real Life, **no two Macs** within a 10-foot space are alike. To help live with the differences caused by an ever-increasing variety of Macintoshes, **Farallon Computing** (Emeryville, CA) has come up with DiskPaper. With this \$149 software, networked Mac users will be able to view, copy, and print a document regardless of their type of Mac, color capability, application, or font availability, Farallon says. And with appropriate sound-input hardware—like Farallon's MacRecorder voice digitizer or the built-in sound capabilities of the new Mac LC and IIsi—users can attach sound notes to their documents. A DiskPaper file contains "multiple representations" of a document, including QuickDraw, PostScript, or bit-mapped images. DiskPaper sends the appropriate representation to the receiver's Macintosh. (Whereas a Mac Plus on a network might receive a black-and-white bit-mapped image of a complex color drawing created on a Mac IIfx, another Mac IIfx on the network would receive a color QuickDraw image. But other than the lack of color, the Mac Plus image would be identical to the one received by the IIfx, Farallon says.) DiskPaper is scheduled to be ready this quarter.

Things are slow this year, but **semiconductor companies** can expect a healthy increase in sales during the next two years, according to one forecast. Sales in 1991 to 1993 will perk up due to the "continuing pervasiveness" of semiconductors in the electronics industry, according to the **Semiconductor Industry Association**. The group predicts more than \$75 billion in semiconductor sales in 1993. As for predictions of a gloomy economic situation, SIA statistical programs director Doug Andrey said that the semiconductor growth rate doesn't necessarily follow that of the economy as a whole. The industry experienced double-digit growth rates in the late 1970s, when the economy was in a recession, Andrey said. But then the chip industry had its worst years in 1984 and 1985, when the general economy was doing well, he said.

would have taken hundreds of hours of custom programming." But now, the different elements of a magazine can be built with an assortment of Macintosh design and illustration tools, including Adobe Illustrator, Aldus FreeHand, PixelPaint Professional, Studio 8, Swivel 3D, StrataVision 3D, and LetraStudio. Verbum assembles the final product in MacroMind Director 2.0. "The beauty of the Mac platform," says Gosney, "is that all these programs work together."

Gosney plans for Verbum Interactive to be a showcase of creativity and a resource of information about multimedia, hypermedia, and animation. It will be modeled on the firm's paper-and-ink magazine, *Verbum*, which covers computer-based publishing and graphic design. Verbum Interactive will feature multimedia art work, a database of multimedia products and services, and interactive advertisements.

Subscriptions to Verbum Interactive, which works with the Mac II, cost \$49.95 per disk. Verbum plans to produce an edition that runs under Windows 3.0.

Discovery Systems is putting software, demos, games, multimedia interviews, sound files, clip art, hypermedia tools, and "talking" letters to the editor, sent via voice mail, on its Nautilus CD, says Marsh Williams, project manager. Readers can purchase software contained on the disk. Nautilus prototypes were built with SuperCard, but Discovery plans to develop its own code to assemble the magazine. The

magazine "runs" on a Mac with 2 MB of RAM. Issued 13 times a year, it costs \$9.95 per disk. The company plans a Windows edition for early 1991.

Still in the prototype stage, Antic Publishing's as-yet-unnamed CD-ROM magazine, according to Antic president Jim Capparell, will capture the look and feel of "riffing through the pages" of a traditional magazine, but with added dimensions of sound, animation, and video. Capparell likens a multimedia magazine to a Hollywood production; Antic is even referring to the CD-ROM magazine's editors as "producers."

Antic's disk will be available for the Macintosh and IBM platforms, as well as for Commodore's new CD TV, which combines a compact disk drive and computer in one machine. Subscriptions will cost in the \$10 to \$25 range.

The least computer-oriented of the new CD-ROM magazines, underControl's Grip, will focus on current events and music. Grip will incorporate animation, video, news, editorials, and material gleaned from 8mm decks, VCRs, cameras, videodisks, and frame grabbers. Cofounder Nick Cuttillo says underControl is receiving material from around the world, including a video of the collapsing Berlin wall. Built in HyperCard, Grip will require a Mac II with 2 MB.

The potential audience for CD-ROM magazines is still comparatively small. "Obviously it's not a very big market," says Verbum's Michael Gosney, "but we expect it to grow rapidly."

— Mark Clarkson

LAN Leaders Call for Network Benchmarks

Officials from companies prominent in computer networking have called for some industry standards for testing LANs. The new Performance Testing Alliance met during NetWorld '90 to discuss developing LAN benchmarks. The PTA includes Novell, AT&T, IBM, 3Com, and Banyan.

"The thing about LANs is that they're so complicated," said Drew Major, Novell systems architect. "It's a lot easier in many ways to test a minicom-

puter. It's all centralized in one box."

While all the companies at the PTA meeting supported the idea of standard benchmarks, the development of those benchmarks might create considerably more friction. The PTA will have to find a way to test every layer of a network. Its benchmarks will have to be portable. And the benchmarks will need to isolate specific components, testing different configurations and loads.

— Jeffrey Bertolucci

ARE YOU AN INNOVATOR? *If you, your company, or your research group is working on a new technology or developing products that will significantly affect the world of microcomputing, we'd like to write about it. Phone the BYTE news department at (603) 924-9281. Or send a fax to (603) 924-2550. Or write to us at One Phoenix Mill Lane, Peterborough, NH 03458. Or send E-mail to "microbytes" on BIX or to "BYTE" on MCI Mail. An electronic version of Microbytes, offering a wider variety of computer-related news on a daily basis, is available on BIX.*

IN ATLANTA, GEORGIA...



AT THE GRAND CANYON IN ARIZONA...



AND IN ZURICH, SWITZERLAND...



 **GATEWAY2000**

"You've got a friend in the business."

People the World Over

Everywhere you look these days you'll find Gateway 2000 computers. That's because people everywhere know a good value when they see one. In all 50 states and in over 70 foreign countries, thousands of people are comparing price, quality and service – and choosing Gateway 2000.



In Atlanta...

ZSoft, the well-known graphics software company, often demonstrates its software at trade shows on Gateway 2000 computers. Dave Steier, ZSoft code librarian and software demonstrator, said he prefers showing products on Gateway systems. "They're terrific," Dave remarked. "I just got back from a show where I was using Gateway 33's and they're screamers." Don Womick, Jr., a programmer for ZSoft, bought a Gateway 2000 20 MHz 386 for his personal use because he liked the Gateway systems at work. "With Gateway," said Don, "I was able to get the performance I need at a price I could afford."

Don and Dave both commented on the excellent service they received from Gateway. "Everyone is uniformly polite, friendly and helpful," Dave said.



ZSoft employees Dave Steier, left, and Don Womick, Jr., with Don's Gateway 2000 20 MHz 386 system.

At the Grand Canyon...

Papillon Grand Canyon Helicopters uses Gateway 2000 computers in its operation. Rick Carrick, chief pilot, started using PC's a few years ago to run point-of-sale software and to perform weight and balance calculations on aircraft, a critical safety and efficiency procedure. Initially he experimented with several computer firms. "I called Gateway because I liked their ads," Rick admitted. "But I've become a loyal customer because their machines are indestructible and they have excellent customer service."

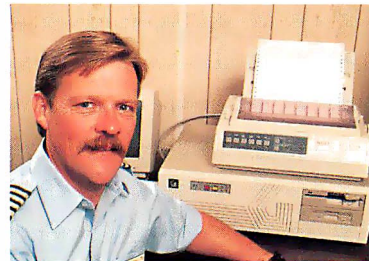

Rick Carrick, Papillon Grand Canyon Helicopters, and his indestructible Gateway 2000 286.

Papillon Helicopters has another Gateway 2000 computer now – a 25 MHz 386 – and Rick said he's in the process of replacing all of the company's PC's with Gateway 2000 systems.

In Zurich...

Michael Paravicini runs a Gateway 2000 33 MHz 386 system. Michael is a management consultant for Price Waterhouse in Zurich. "I was impressed by Gateway's price-features comparison," he remembered. "My system cost far less than you'd expect to pay for a comparable computer."

Michael Paravicini, Price Waterhouse, and his Gateway 2000 33 MHz 386 system.

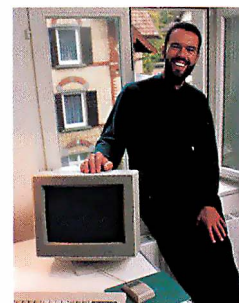

Continuing, he said, "It was also the responsiveness they showed when I sent a fax request for a quotation. Out of ten U. S. companies

Choose Gateway 2000!

I contacted, Gateway was the most prompt and efficient in responding. I still haven't heard from some of the others."

PC Magazine's survey about service and reliability confirms what these customers are saying:

"Gateway shared top billing with such heavy-weights as Compaq, IBM, and HP for those who would buy their products again...Overall, Gateway's high marks bode well for the company's future, as does its commitment to customer service."

PC Magazine
September 25, 1990

From the Heartland

The combination of price, quality and service makes Gateway 2000 the best value in the industry. But value alone doesn't explain how a little company in the Midwest, just celebrating its fifth anniversary, managed to outdistance hundreds of other companies, selling more systems through the direct market channel than any other PC manufacturer in the

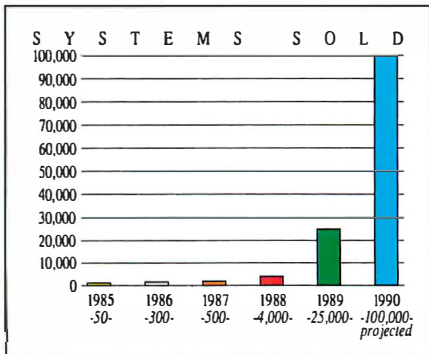

Gateway 2000 sells more computers through the direct market channel than any other PC manufacturer in the country.

Computer magazine readers will remember the company's early ads featured a picture of the Waitt cattle farm with the headline, "Computers from Iowa?"

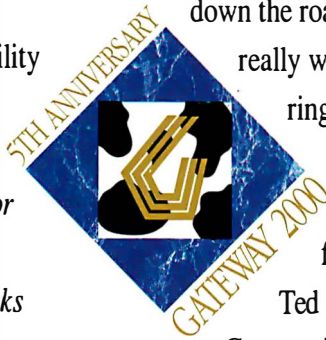

"In the computer industry, longevity should be measured in dog years."

"We can't run that ad anymore," continued Ted, grinning, "because we built a new plant 14 miles down the road in South Dakota. But the cows really worked for us. They made the phones ring. From then on, though, we built our business on value – good prices on quality systems with old-fashioned, personal service."

Ted mentioned another reason for Gateway's success. "We take a long-term approach to customer service," he said.

"When you buy a computer from Gateway 2000, you become part of our family and we're going to be there for you as long as you own that machine."

As Ted talked about the company's fifth anniversary, he laughed again. "In the computer industry, longevity should be measured in dog years," he chuckled, "because everything's moving so fast. That makes Gateway 35 years old! But seriously, we've come a long way in five years. And I owe it all to the great people at



Gateway and to our customers." *Gateway 2000 will be there for you 'til the cows come home.*

When you add it all up, you'll understand why you've got a friend in the business at Gateway 2000.



8 0 0 - 5 2 3 - 2 0 0 0
610 Gateway Drive • N. Sioux City, SD 57049 • 605-232-2000 • Fax 605-232-2023

GATEWAY 2000 SYSTEMS

12MHZ 286VGA

- 80286-12 Processor
- 1 MB RAM
- 1.2 MB 5.25" Drive
- 1.44 MB 3.5" Drive
- 40 MB 17ms IDE Drive
- 16 Bit VGA with 512K
- 14" 1024 x 768 Color Monitor
- 1 Parallel & 2 Serial Ports
- 101 Key Keyboard
- MS DOS 3.3 or 4.01

\$1495.00

GATEWAY 386SX

- 4 MB RAM
- 1.2 MB 5.25" Drive
- 1.44 MB 3.5" Drive
- 40 MB 17ms IDE Drive
- 16 Bit VGA with 512K
- 14" 1024 x 768 Color Monitor
- 1 Parallel & 2 Serial Ports
- 101 Key Keyboard
- MS DOS 3.3 or 4.01
- MS WINDOWS 3.0



\$1995.00

25MHZ 386VGA

- 4 MB RAM
- 1.2 MB 5.25" Drive
- 1.44 MB 3.5" Drive
- 80 MB 17ms IDE Drive
- 16 Bit VGA with 512K
- 14" 1024 x 768 Color Monitor
- 1 Parallel & 2 Serial Ports
- 101 Key Keyboard
- MS DOS 3.3 or 4.01
- MS WINDOWS 3.0

\$2495.00

25MHZ 386CACHE

- 64K Cache RAM
- 4 MB RAM
- 1.2 MB 5.25" Drive
- 1.44 MB 3.5" Drive
- 110 MB 17ms ESDI Drive
- ESDI Cache Controller
- 16 Bit VGA with 512K
- 14" 1024 x 768 Color Monitor
- 1 Parallel & 2 Serial Ports
- 101 Key Keyboard
- MS DOS 3.3 or 4.01
- MS WINDOWS 3.0



\$3195.00

33MHZ 386VGA

- 64K Cache RAM
- 4 MB RAM
- 1.2 MB 5.25" Drive
- 1.44 MB 3.5" Drive
- 200 MB 17ms IDE Drive
- 16 Bit VGA with 512K
- 14" 1024 x 768 Color Monitor
- 1 Parallel & 2 Serial Ports
- 101 Key Keyboard
- MS DOS 3.3 or 4.01
- MS WINDOWS 3.0



\$3495.00

25MHZ 486VGA

- 64K Cache RAM
- 8 MB RAM
- 1.2 MB 5.25" Drive
- 1.44 MB 3.5" Drive
- 200 MB 17ms IDE Drive
- 16 Bit VGA with 512K
- 14" 1024 x 768 Color Monitor
- 1 Parallel & 2 Serial Ports
- 101 Key Keyboard
- MS DOS 3.3 or 4.01
- MS WINDOWS 3.0

\$4395.00

CACHE SPECIAL

- Same features as our PC Mag Editor's Choice 25 MHz 386 Cache system except this machine has an 80 MB 17ms Drive instead of the 110 MB 17ms EDSI Drive.

\$2895.00

STANDARD FEATURES AND SERVICES

- Microsoft® WINDOWS™ with all 386 and 486 systems
- 30-day money-back guarantee
- One-year warranty on parts and labor
- New leasing options now available
- Toll-free technical support for the life of the machine
- Free on-site service to most locations in the nation
- Free overnight shipment of replacement parts
- Free bulletin board technical support

*If our standard configurations don't fit your needs, we'll be happy to custom configure a system just for you.
Due to the volatility of the DRAM market, all prices are subject to change.*



8 0 0 - 5 2 3 - 2 0 0 0
610 Gateway Drive • N. Sioux City, SD 57049 • 605-232-2000 • Fax 605-232-2023

LETTERS

and Ask BYTE

Fifteen Years and Counting

I found the September issue bittersweet. I read it thinking that it was one of the most enjoyable issues of any computer periodical I've ever read. (I subscribe to many magazines, so that's quite an impression.) However, I was astonished to find that the principal man behind the Apple II, Macintosh, and NeXT computers—who is, of course, Steven P. Jobs—was not on your list of influential people in personal computing. This omission was particularly hard for me to bear in light of the many people on the list whom I would not even consider in Jobs's class. In my opinion, Jobs should be considered the most important force in bringing personal computers to the masses.

I believe a gross injustice has been done.

Kevin Weidner
Pleasantville, NY

Steve Jobs consented to participate in the BYTE Summit but was unable to do so due to last-minute scheduling conflicts.

—Bob Ryan

I thank you for the excellent September issue. The coverage all around is superb, and I thoroughly enjoyed the 63 [experts] writing about the PC's present and future. I have learned a lot.

F. A. Mulla
Nakuru, Kenya

One would hardly expect Don Crabb's Macinations column to minimize graphics-based computing, but his enthusiasm seems to have carried him over the brink in his September column. I thought back, as he suggested, to the time when I read what I thought was a really good book and found it was not the graphics that drew me into it (in fact, it had no pictures at all!). Rather, it was the skill of the writer.

Can it be that Crabb has fallen into the very trap that he so eloquently warns of in the very same article? As Alan Kay points out in your Summit, "technology is just an amplifier." Contrary to Marshall McLuhan, the message is really the message. Even so, I read Crabb's column every month and appreciate it.

I want to congratulate you on your 15th anniversary. I agree with Esther Dyson's

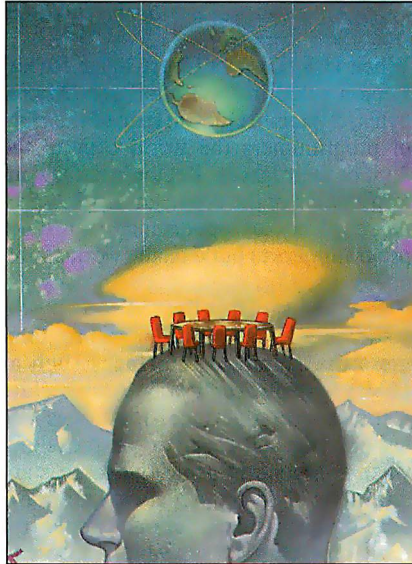

comment ("I don't want to babysit this computer. I want it to act *for* me, not *with* me"). That's the future of computing: not a more servile or fun servant, but a more able one. Graphical user interfaces (GUIs), networks, fancy input and output, and all the rest must work toward this goal. If I want a video game, I'll look to Nintendo, not Apple or IBM or Microsoft.

Gary Fisher
Allendale, MI

Congratulations on your 15th anniversary. I enjoyed the anniversary issue a great deal.

I came away from reading Alan Kay's comments ("The BYTE Summit") feeling that Kay is brilliant and innovative but that his revolution is not for me (nor, I think, is it for many of my colleagues).

I found it very telling that Kay said, "The PARC stuff we did was originally designed for children." Now the icons

WE WANT TO HEAR FROM YOU. Please double-space your letter on one side of the page and include your name and address. Letters two pages in length or under have a better chance of being published in their entirety. Address correspondence to Letters Editor, BYTE, One Phoenix Mill Lane, Peterborough, NH 03458. You can also send letters via BIXmail c/o "editors."

Your letter will be read, but because of the large volume of mail we receive, we cannot guarantee publication. We also reserve the right to edit letters. It takes about four months from the time we receive a letter until we publish it.

make much more sense to me. I can admire Alan Kay without wanting to think like him or work like him.

I think that there are many people in computing who have very good reasons for not using GUIs. When we make our choices, we opt for speed, flexibility, and compactness. I know many people who choose DOS (delphic as it is) because it is a fast "shorthand" interface.

Like everyone else, I am impatient for improvements to DOS; I want to be able to give directions and files longer, more descriptive names and to be able to work with files that are associated with the programs used to create them. I also want to be able to switch from one program to another and then back again instantaneously. Occasionally, I would also like to be able to work in true WYSIWYG mode. I know, however, that I do not need a GUI to achieve these goals, and I will always opt for a solution that is economical and agile and that doesn't make me wait.

Richard Zakin
Oswego, NY

Your September issue completely overwhelmed me. I couldn't read it all. But I admire you for the risk you took with your prognostications. I am looking forward to your 25th anniversary issue in 2000 to see how embarrassed you are. Predicting the future is seldom accurate. But keep it up.

Robert LaFara
Indianapolis, IN

Alvy Ray Smith's suggestion ("The BYTE Summit") that people would prefer to communicate with pictures instead of words was a thought-provoking one, and it is certainly a logical extrapolation of the direction in which our nonliterate, TV-oriented culture is moving.

To take Smith's idea a bit further, when we get a sufficient number of these new icons (including, I assume, pictures that represent "justice," "sadness," "truth," etc.), we will certainly need standards so that we can all use the same pictures for identical concepts. I am curious, however, as to how we will organize the manuals to quickly find the appropriate icon to represent a specific thought—a dictionary, if you will.

I am sure that the problem is soluble.

After all, the Chinese have been using pictures to represent concepts for a long time now.

Sydney B. Self Jr.
Sudbury, MA

Copyright Controversies

The opportunity for full protection of intellectual rights must be available to all, contrary to what Mitch Kapur has learned from his "very, very good" experiences with software ("Litigation vs. Innovation," Stop Bit, September).

Innovation is not ethereal and does not just appear to the most enthusiastic of the bunch. It is the result of hard work and of dedication to R&D, all of which deserve to profit from success in the marketplace. But that success does not have much chance in an environment where the results of effort can be stolen by any thief or ring of thieves who declare themselves innovators.

The only way that developers can be protected is by the courts. The glut of intellectual-property litigation that scares Kapur is perhaps a result of innovation thieves being brought to justice.

Brian Livingston
Norman Wells, Northwest Territories,
Canada

I agree with Mitch Kapur's remarks on software copyright, but I think that he does not sufficiently address the issue of visual copyright, per se.

When you attempt to copyright or patent the user interface of your program, that is an act of theft. How is it that the user interface belongs to the users? Surely I hear a multitude of enraged cries from programmers: "It's our interface; we designed it."

It is a common delusion of the more arrogant sort of software developer that the value of the user interface consists in its inherent excellence, that his or her user interface is somehow easier to use, and all that. Nonsense! The value of a user interface consists almost entirely in the fact that users have learned to use it, all too often with unnecessary difficulty.

When user interfaces are "user friendly," that generally means that they have borrowed the conventions of street signs, Coke machines, and the like. So the principle holds—the value of a user interface is the value of the skill of the users.

In proof of this, there are any number of minor user interfaces whose few users will proclaim their excellence at the top of their lungs. Yet these interfaces have little or no cash value, because so few people know them.

I might add that the less arrogant de-

velopers are positively compulsive about allowing the user to redesign the interface at will, via elaborate customization programs.

Andrew D. Todd
Springfield, OR

When U.S. District Court Judge Robert Keeton ruled in the Lotus case (Microbytes, September), he affirmed the right of programmers the world over to the fruit of their labors. Keeton's narrow interpretation of the copyright law has provided plenty of opportunity for other programmers to build on the work of predecessors.

But the test of this limited concept will come only as more and more programmers use standard interfaces such as IBM's Systems Application Architecture common user interface. How does one not infringe on creative "expression" when everyone is using the same standard style? I do not pretend to know law, but I do know that I, for one, would like some protection for my work if I were to use such a standard, as I desire to do. Please let us know, IBM and Microsoft.

Bill Hartzell
Garland, TX

Monitor Fallout

I'm glad to see BYTE publishing articles on electromagnetic emissions from video displays ("Of Monitors and Emissions," September). Bill McGinnis's article is good; it takes the reader right inside the CRT.

Still, as a Ph.D. physicist, I was disappointed to notice McGinnis's failure to distinguish between electromagnetic fields that are radiated away from the source and those that are not. All ionizing radiation (e.g., visible and infrared light) and all broadcast nonionizing radiation (e.g., microwaves and radio-frequency radiation) radiate energy away from the source, thereby producing radiation emissions. But extremely low-frequency (ELF) fields (which include frequencies from 50 Hz to 100 Hz) do not radiate energy through the air away from the source.

Emissions that are radiated through space can affect creatures far from the source. These effects do not occur for nonradiated fields such as ELF.

I have never encountered the distinction between *radiation* and *emission* that McGinnis points out. Those who make this distinction must be scientists or engineers in a specialized discipline with which I am not familiar.

Marjorie Lundquist
Milwaukee, WI

I agree that very few far-field emissions exist in the 30-Hz (wavelength 10 million meters) to 300-Hz (wavelength 1 million meters) region. But the point of the article was not to limit shielding considerations to the far-field condition. There are fields coming from most video terminals that are identifiable as either electric or magnetic.

The interest in emissions in this frequency range centers on two main considerations: How large is the field, and how can it be reduced? The first question can be answered by qualified personnel using measurement equipment. The second question can be addressed by identifying emissions sources and applying appropriate shielding techniques to them. My article was intended as a guide to sources of emissions and possible remedies.

The distinction between radiation and emissions is very common among members of the Electromagnetic Compatibility Society and is gaining acceptance from some in the IEEE. The main reason for promoting these terms is the misunderstanding of the term radiation by many people. Too often, the first thought is of some nuclear event, which is incorrect. It is something like the "flammable/inflammable" problem. Now, tanker trucks are marked "flammable," since the other term was so misunderstood.

I invite all to use the word emissions where it is appropriate to help reduce the misunderstanding of radiation.

—Bill McGinnis

Wrestling with Resolutions

I read with some astonishment a statement that the resolution of images dropped to 72 dots per inch or 75 dpi when they were imported using the Clipboard ("Word Processors That Build Character," September). I cannot say that this is not true in the DOS world, but I can definitely say that it is not true in my experiences with the Macintosh.

My regular word processor is Full-Write Professional 1.1. I also use Write-Now 2.2, Microsoft Word 4.0B, and MacWrite II 1.0. I use a Hewlett-Packard Deskwriter for most of my printing. I have used several of these applications to compose a departmental newsletter for a university. The masthead of the newsletter contains a 300-dpi scanned image of the university's logo, which is pasted into the newsletter from the Clipboard.

I could not remember any difficulty printing the newsletter at full resolution. After I read your article, I conducted a test to make sure that I was not mistaken. Each of the word processing programs

We slash interface development time. (and we can prove it!)

C-PROGRAMMERS: See for yourself how Vermont Views™ can help you create user interfaces the easy way.

If you want to start saving a *tremendous* amount of time and effort, call for your free Vermont Views demo kit and put us to the test. Vermont Views is a powerful, menu-driven screen designer that comes with a C library of over 550 functions. Which means you can create user interfaces in just a fraction of the time it takes to write the code yourself!

Why try to reinvent the wheel when Vermont Views lets you interactively create pull-down menus, window-based data-entry forms (with tickertape and memo fields), scrollable form regions, choice lists, context sensitive help, and a host of other interface objects.

Vermont Views combines the convenience of a fourth generation language with the power, flexibility, and blinding execution speed of native C code.

Turn your prototype into the application.

Let's face it. With most systems, you have to throw away your prototype when coding begins. Which means you waste precious time

and effort. With Vermont Views, things are a lot different. In fact, the prototype actually *becomes the application*. So menus and data-entry forms are usable in the final application without change. Names of functions for retrieving, processing, and storing data can all be specified as the prototype is created. And that's just for starters.

Here's a truly universal solution. When you create an interface with Vermont Views, you can port it among PC-DOS, OS/2, UNIX, XENIX, and VMS.

Vermont Views can be used with any database that has a C-language interface (most do), and will create interfaces for any roman-based language. Our form-locking version lets you develop quickly and safely on networks and multi-user operating systems, too.

If you need DOS graphics in your applications, we also have the answer. Vermont Views™ GraphEx allows all Vermont Views' windows, menus, and forms to work in CGA, EGA, VGA, and Hercules graphics modes. So you can use your favorite graphics package to create charts, graphs, and other images to enhance text displays.



Vermont
Creative
Software

Pinnacle Meadows,
Richford, VT 05476
Phone: (802) 848-7731
FAX: (802) 848-3502

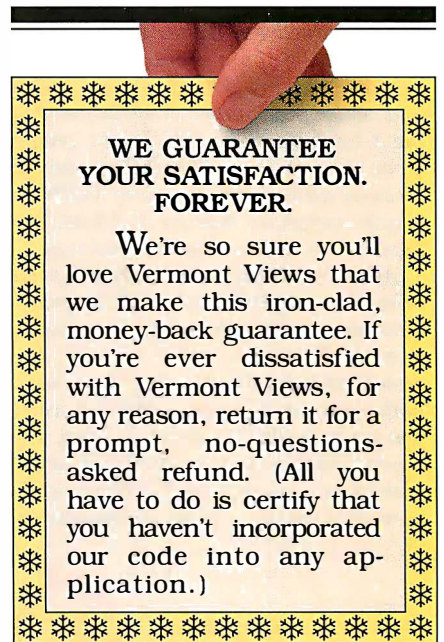

Call for your FREE demo kit!

800-848-1248

(Please mention "Offer 078")

Don't take our word for it. Put Vermont Views to the test by calling for your personal, free demonstration kit. Or fax us at (802) 848-3502.



© Copyright 1990
Vermont Creative Software

printed a 300-dpi bit map pasted from Canvas 2.1 at full resolution. In fact, the only problem that I have with resolution occurs with drawings created in FullWrite's drawing environment. For those drawings, the resolution is limited to 72/75 dpi.

Matthew F. Ware
Greensboro, NC

When I tested FullWrite, I used AppleScan 1.0.2 (Apple's 300-dpi scanner software) as my 300-dpi image source and copied the scanned images directly to the Clipboard. The 72-/75-dpi images came through fine. The 300-dpi images retained all their information; FullWrite simply interpreted them as 75 dpi and displayed them at four times normal size.

After receiving your letter, I tried bringing some 300-dpi AppleScan images into Adobe's Photoshop and then placing them in FullWrite. Oddly enough, that seemed to work fine. In this case, we're both right—it apparently matters where you get your 300-dpi graphics from. I've made a note to take another look at this with future releases of FullWrite or the scanner software.—Howard Eglowstein

ASK BYTE



Direct to Disk

I have a Western Digital WD-1006V-MM2 hard disk drive controller card and a Seagate ST255 hard disk drive. I'd like to program the hard disk drive operations directly, without the help of DOS or the ROM BIOS. Where can I get detailed information about my hard disk drive controller?

Igor Bujanovic
Zagreb, Yugoslavia

You can get technical literature about Western Digital controllers by contacting

*Western Digital
Literature Department
15345 Barranca Pkwy.
Irvine, CA 92718
(800) 832-4778
BBS (714) 756-8176 (protocol 8N1)*

In Europe, the nearest office to you is Western Digital Germany (Zamdorfer Strasse 26, D-8000 Munich 80, Germany.

—S. W.

PC or Not PC?

I am writing to get your advice before shopping for my next computer system.

My primary decision involves which type of computer I should choose: an Apple Macintosh or an IBM PS/2 or compatible. After I have decided on one, shopping for the right model to suit my needs (and all my desires, if I can afford them) should be relatively easy.

On the IBM AT, my weekly computing environment includes MultiMate Advantage II, Lotus 1-2-3, FoxPro, Microsoft Paintbrush, PC Tools, Turbo Pascal, NewsMaster, and Print Shop.

On the Macintosh II, my environment includes Microsoft Word, Microsoft Excel, FoxBase+/Mac, Mac Paint, Turbo Pascal, Think C, and Aldus PageMaker.

I have more expertise on the IBM; I have an AT, a Microsoft Mouse, and an Epson LQ printer. Nevertheless, I prefer the Macintosh interface, and the Mac has grown up; it's not just a desktop publishing machine anymore.

However, both my paid summer internships thus far have required IBM experience (e.g., Lotus 1-2-3 and WordPerfect), and the job market stresses the IBM machines, too.

Ideally, I would like the best of both worlds in my next computer—a Mac with an add-in card for IBM compatibility, for example. But have all the bugs been worked out of this technology? Would you recommend the use of such technology?

At the high end, I can afford a PS/2 Model 80 or a Macintosh IIci, with just enough money left over for a 24-pin printer.

Should I go with Apple or IBM?

Oscar Rozario
Leysin, Switzerland

There's no clear answer to your question; if there were, one or the other type of computer probably wouldn't exist. I'll give you a couple of guidelines to help you decide.

When you're trying to decide on either architecture or capacity, don't start by picking the machine; first pick the applications you want to run. Some types of applications are best represented on Apple architectures, while others have more support on the PC. You have a specific applications list in mind; that's an excellent start. Remember that your list will change with time, but you'll probably lean toward similar applications in the future.

On the PC, you've got MultiMate Advantage II, certainly an industry-standard word processor with no parallel on the Mac. There are good reasons to stay with MultiMate, and each one might seem

to vote for the PC. PC Tools has many uses, but the primary one is to make life on the PC easier. For that reason, I would tend to discount that package when making the decision. Similarly, you would overlook Symantec's SUM or similar Mac products. Lotus 1-2-3 is another product with no exact parallel on the Mac, except that spreadsheets are more alike than word processors, and you could switch. The Mac has several good ones. Then there are cross-platform products. You've named FoxPro, Microsoft Word, Excel, and PageMaker. All of them are available on the Mac and on the PC under Windows. Even your paint programs are a good cross. Several Windows paint programs have capabilities similar to Macintosh paint programs.

Second, after you go through your applications list, look for products that you could replace with something on another platform. Do you have to exchange files or disks with someone else using that product? Will you be networking the machine? Factor that in, and start adding up the score. Remember that you rarely spend any actual time working with DOS, so don't let that scare you away from the PC. As for the user interface, you say you prefer the Mac; lots of people do—so many that Mac-like shells have become very popular on other environments. Windows 3.0 is a strong product in its own right, yet it feels enough like a Mac to encourage many products to be supported on both platforms.

I suggest that you take a look at Windows 3.0 and play around with it for a while. You have two products on your PC applications list that require a PC. All your Mac products have exact or close PC parallels. In your case, a PC running Windows might be the way to go, particularly since your job field seems to favor using PCs.

That said, make sure you have enough computer. Windows and Windows applications tend to be resource hogs, so don't be stingy. A big hard disk drive (80 megabytes or bigger) is a definite must—the bigger and faster, the better. I further suggest a minimum of a 25-MHz 386-based machine with 4 MB of RAM if you plan on using Windows as a multitasker. If you go for the Mac, the IIci would serve you well—again, with lots of RAM. Ideally, you would own both types of machines. (I own both Macs and PCs and wouldn't give up either.) Add-in cards with Intel coprocessors for the Mac simply haven't been as big a win as everyone hoped. They're generally slower than folks would like and fairly expensive, and the compatibility is good, but not perfect.

To become
the hottest name
in dot matrix printers
you simply build
one terrific
printer

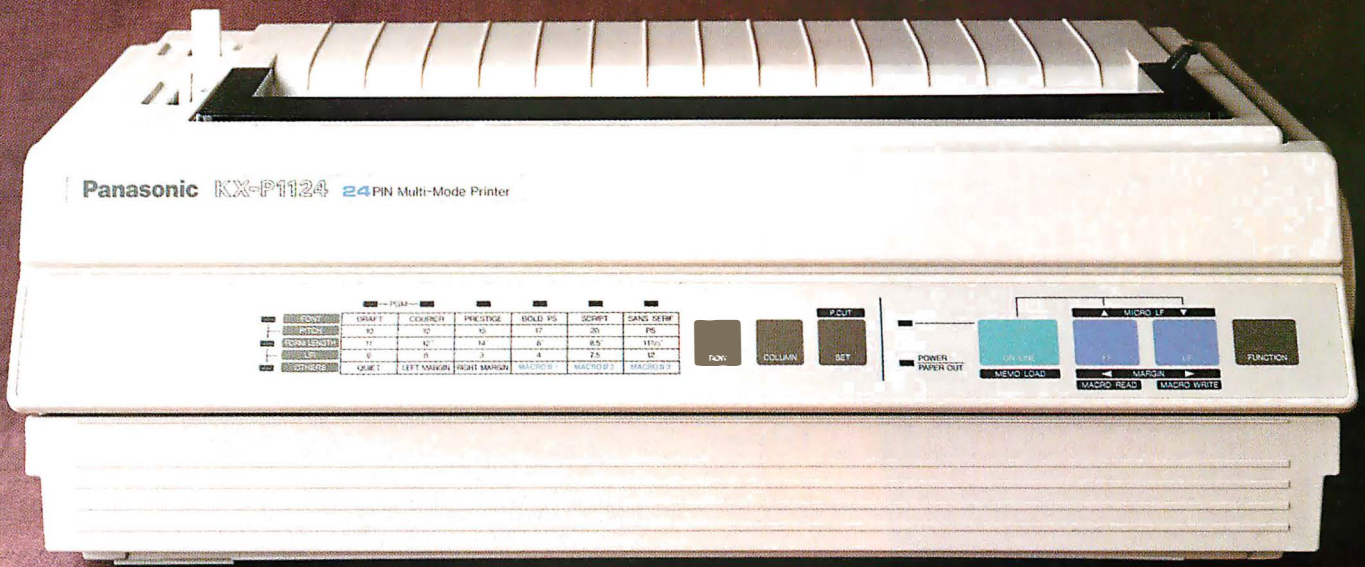

The award-winning KX-P1124.

after another,

after another,

after another,

after another,

after another.

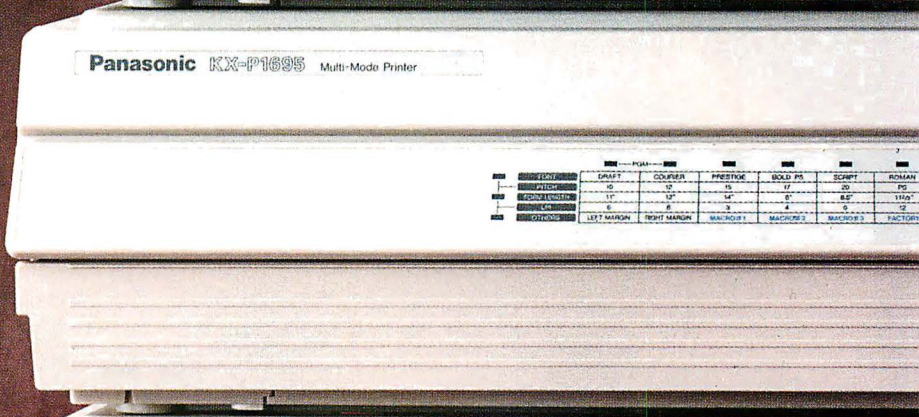
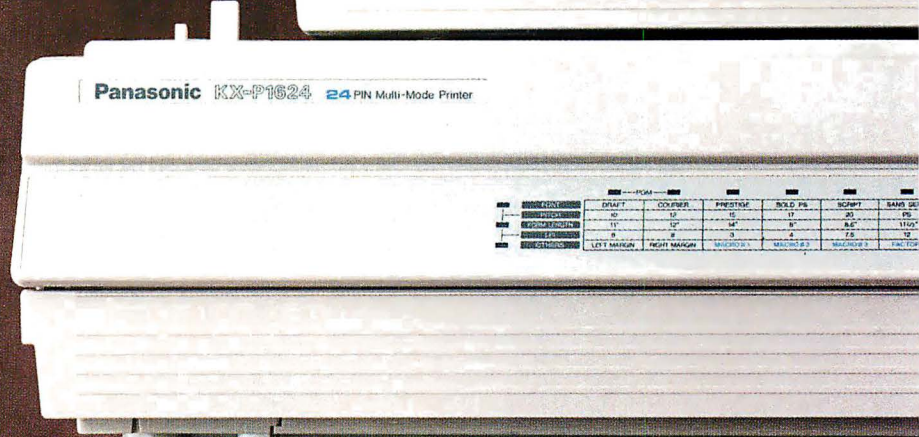

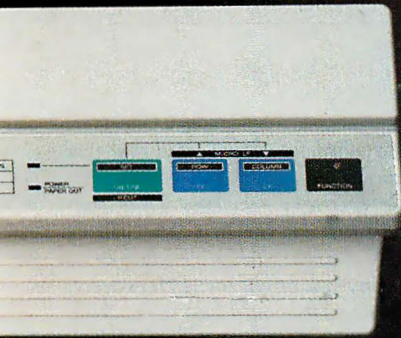

*If you want
the perfect
printer for
the home.*

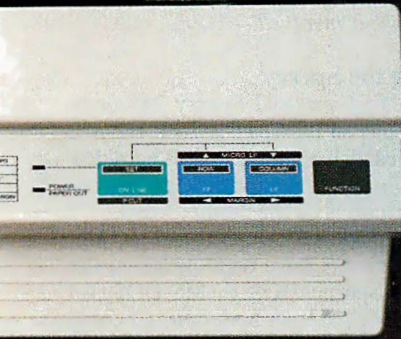

*If you want
a little more
speed for your
home office
printing.*

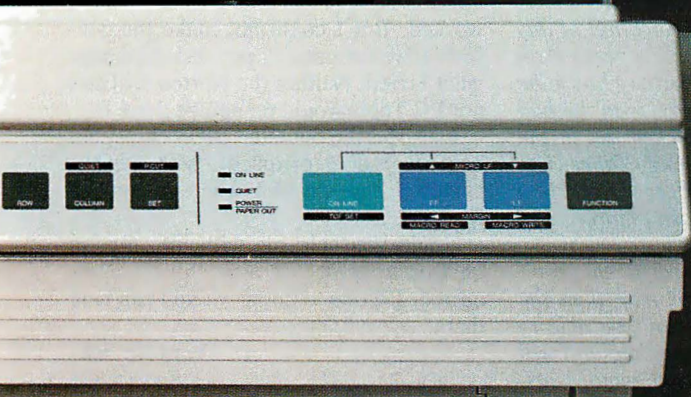

*If you want
the same
features as
the 1124, but
with a wide
carriage.*

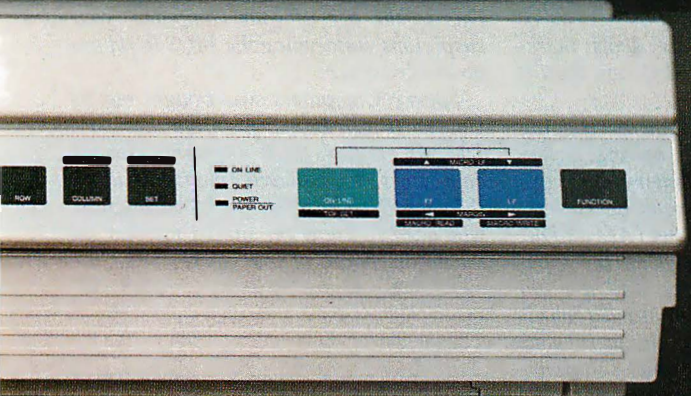

*If you want
high speed,
high volume
for spread-
sheets and
financials.*

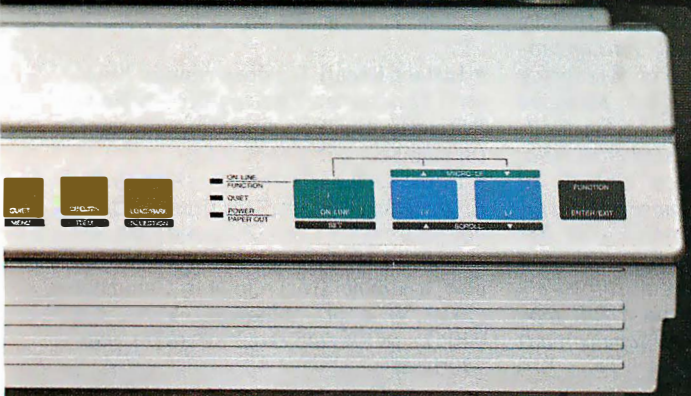

*If you want
near laser
quality at
dot matrix
prices.*

A few years ago, we redefined what people expect from a dot matrix printer. By creating a 24-pin as sophisticated as it is simple. And as affordable to buy as it is economical to own.

The KX-P1124 has won its share of awards. But it's not the only Panasonic® Dot Matrix to receive rave reviews. Now there's



a whole family to choose from. All with EZ Set™ operator panel, multiple paper paths, a variety of fonts, 2-year limited parts and labor warranty (see your dealer for details), and other features that typify our approach to price/performance for today's office environment.

There are feature-rich 9-pin models for every-day drafts. And superb 24-pins for important correspondence. In both regular and wide-carriage versions.

And we've just introduced what may well be the quintessential office printer for the 90's, the KX-P1654. A wide-carriage 24-pin that rockets along at up to 375 characters per second. With print quality approaching that of lasers.

Chances are, your first Panasonic printer will lead to another, and another, and another.

For further information on Panasonic Dot Matrix Printers, see your Panasonic dealer, or telephone toll-free 1-800-742-8086.

*Printers, Computers, Peripherals,
Copiers, Typewriters and Facsimiles*

Panasonic
Office Automation 

Engineered for the office. Designed for people.

For running the occasional PC package on your Mac, SoftPC is an interesting hack. Using the Mac's 680xx, it emulates the 80x6 and PC BIOS to run DOS applications. It works amazingly well, but it, too, is slower than the real thing.

To sum up, the choice between architectures is a hard one, one that should be driven by the applications you want to run and the environment you need to run in. Pick the software first, and then fit the hardware to it. Once you get your new computer, start saving up for one of the other kind. It's getting more and more obvious that anyone serious about computing needs access to both a Macintosh and an MS-DOS machine these days.

—H. E.

What Good Is a Backup?

I have an IBM PS/2 Model 80 with two ESDI hard disk drives (one is 100 megabytes, the other 300 MB), an external 5¼-inch 1.2-MB floppy disk drive, a mouse, and a 60-MB MaynStream (from Maynard Systems) tape backup system with version 2.2 of the tape backup software.

My trouble is related to the tape backup system and the 100-MB hard disk drive. At the beginning of the month, I made an image backup of my C drive, and when I tried to restore the data after a disk crash, the software returned an Unable to find partition error message. I called the technical-support group of the company that sold me the MaynStream.

The people I spoke with told me that I should perform a low-level format on the hard disk drive, repartition it into its original configuration, and try again. I'm using DOS 4.01, and the drive had only one partition, so that was easy. After reformatting, I reinstalled DOS and tried again. I still got the same error message.

I then brought the tapes to the technical-support people. They tried the same thing on one of their machines with the same result. Desperately—it is very precious data—I contacted some people who also use MaynStream tapes, but they had never encountered such problems.

Is the data on the tape lost, or is there a way to restore it? I never had any problems before with the MaynStream, and it still works when I use the normal backup and restore utilities. What is the purpose of a backup system when you can't restore the data on it?

Verecken Luc
Leuven, Belgium

The good news is that your tape is probably recoverable. Unfortunately, it's go-

ing to cost you gobs of money. Maybe I should explain why.

There are two ways a tape backup system can work. The file-by-file backup will walk through the file system and sequentially copy each file that it encounters onto a contiguous piece of tape. The file structure on the tape is created and maintained by the tape software and has nothing whatsoever to do with the computer's file system. The advantage here is that if the original disk is lost, any machine, regardless of operating system, should be able to recover the data as long as its hard disk drive is big enough. Image backups work by scanning through the hard disk, sector by sector, and copying an exact image of each sector without regard to its contents. On a DOS machine, this will include the boot sectors, file allocation tables (FATs), directories, and files, as well as the location of any locked-out bad sectors. To restore an image tape, the hard disk drive has to be formatted in the same way, with the bad sectors identified and locked out in the same way they were before. Otherwise, the tape software may try to restore data onto a bad sector that wasn't marked bad when the backup was made.

If the restore disk has a different geometry or a different sector map than the original, the software won't be able to figure out where to put the data and will report the kind of error you found. I suspect that by reformatting the drive, you either marked additional bad sectors or freed up previously bad disk spots, thereby making the disk look different than it was.

To recover your tape, someone is going to have to restore all the sectors, determine what your drive geometry must have looked like, and reconstruct an entirely new disk based solely on the FATs and directory information stored on the tape. It's an elaborate process, and it's not cheap. I spoke with Maynard technicians, who, while sympathetic to your plight, couldn't offer any quick solutions.

To answer your last question next, it's never been remotely obvious to me why anyone would offer an image backup program when the chances of recovering data were so minimal. In fact, Maynard no longer provides an image backup facility with the MaynStream, and most other vendors have dropped them, as well. In the future, don't use the image backup facility—erase that software from your disk and stick with the file-by-file stuff. And to be doubly safe, use your software's verification feature, or run a full tape verify to make sure that the tape is readable.

The Maynard folks suggested that you might want to send your tape to one of the many file recovery services. They suggested X-Late (P. O. Box 161, Lake Elmo, MN 55042, (612) 770-8087) as one company you might try. Prices vary, but recovery costs could run up to \$100 per megabyte of data, depending on how much work is involved.—H. E.

Sparing the Sperry

I have a five-year-old Sperry 286 computer. It has an EGA, a 5¼-inch 1.2-MB floppy disk drive, and a 30-MB hard disk drive. The hard/floppy disk drive controller circuit is on the motherboard.

I want to add a 3½-inch 1.44-MB floppy disk drive. I have tried updating the installed Sperry DOS to MS-DOS 3.3 and PC-DOS 3.3. In both cases, I could address drive B and do a DIR that sort of worked. But I could not make the 3½-inch drive format a floppy disk no matter what I tried. Neither the Norton Utilities nor PC Tools would recognize drive B.

I suspect the outdated BIOS chips, but because I deal primarily with generic clones, I have no idea where to look to find out.

Could you help me with information on this upgrade? If new chips are required, I'd like to know where I can find them.

Vern De Fehr
Fresno, CA

Due to the age of your computer, your suspicions concerning the BIOS ROM are probably correct.

Sperry Computers was bought out by Unisys (P. O. Box 500, Blue Bell, PA 19424). Unisys still supports Sperry computers. You can order parts by calling (800) 448-1424. The parts technicians will need to know the model number on the motherboard of your Sperry 286.

—S. W.

FIXES

- Instant Recall 1.2 does contain "tickle" functions. The features table in "Strictly for Personal Information" (September) failed to note that.

- In the October article "A Knowledge Engineering Toolkit," we listed the London address for Logic Programming Associates. LPA Prolog and MacProlog are also available from Quintus Computer (1310 Villa St., Mountain View, CA 94041, (800) 245-6442 or (415) 965-7700). ■

Multi-Platform C++

MS-DOS • WINDOWS • OS/2 • DOS 386 • UNIX 386

MS-DOS

Zortech's industrial strength compiler provides all the benefits of C++, but with the speed and code size you would expect from the best C compilers.

The quality of the original Zortech C++ implementation together with the continuous improvement achieved since its launch in June 1988 produces fabulous benchmarks. Just look how far it's ahead of the nearest competitor.

Zortech C++ provides state of the art, USEFUL features, most of which are added in direct response to customer requests.

You can effortlessly cruise through the DOS 640K barrier using Zortech's Virtual Code Manager (VCM™). This allows you to develop applications up to 4MB in size whilst in real mode, without changing your C/C++ source code. Zortech's much acclaimed 'handle pointers' provide an elegant solution to processing EMS memory.

Zortech C++ also uses the Rational Systems™ DOS Extenders allowing you to easily compile and debug really large programs, even large MS-Windows 3.0 applications. If you want to purchase a Rational Systems license for your own applications, your Zortech code is Plug & Go.

Zortech's new C++ Workbench provides a cross platform development environment for C++. It has really useful features including powerful source and

grep browsers, to look at your handiwork.

In response to hundreds of requests, MS-Windows 2.1 support was added into the base DOS C++ Compiler in version 2.0. Now with Zortech C++ V2.1 development of C++ applications for Windows 3.0 is a reality not a promise.

Along with the C++ compiler comes a top quality ANSI C compiler. In fact, after reviewing 14 C/C++ compilers in its May

1990 issue, Computer Language Editor J. D. Hilderbrand said:

"The pressure to name an overall winner in

the compiler sweepstakes is nearly overwhelming... it's an easy choice. We pick Zortech!"

Thousands of our customers had existing C code they wanted to recompile, so we made it simple. In the words of BYTE Magazine:

"I fed a Microsoft C specific version of the Micro-EMACS editor source to Zortech's compiler, and less than one hour later, I had a new (and smaller) program."

Our C++ Debugger, which understands C and Assembler too, is CodeView™ compatible, but that's where the similarities end. This feature packed tool can examine your program from 19 viewpoints and uses overlapping windows with full mouse support, icons and dialog boxes.

Debugging large programs is no problem with our DOS Extender, Virtual and Remote debugger versions. Quite simply, there's

no better C++ debugger to use and no better C++ to debug.

Our C++ Tools package is the most comprehensive set available. All 25 class libraries are extensively documented and come with the full source code.

The Zortech C++ Developer's Edition V2.1 includes C and C++ Compilers, C++ Debugger, C++ Tools and the FULL Library Source Code (excluding Flash Graphics). That's right, you don't have to pay hundreds of dollars extra for source code - it's in the box!

MS-WINDOWS

Improved support for MS-Windows (including new Windows 3.0 support) is provided in the base C++ DOS compiler, at no extra cost. With Zortech, you can now even compile from within Windows!

Support for new extended keywords `_loads` and `_export` as well as the ability to create DLL's make programming in Windows with C++ practical. We provide extensive documentation and 50K of sample code to illustrate development of applications in this exciting new environment.

Do you need MS-Windows class libraries? Call for details of third party Zortech Validated Products.

OS/2 NEW

The OS/2 Developer's Edition option now provides a C++ Compiler and source level Debugger designed for C++. In the words of OS/2 Magazine:

"Zortech C++ serves as a direct replacement for the Microsoft C Compiler in developing applications, allowing programmers to use object-oriented techniques in OS/2 development."

DOS 386 NEW

Now MS-DOS developers can build true 32 bit C and C++ applications for 386 processors using Zortech's powerful development system. The Zortech C++ V2.1 Developer's Edition for DOS 386, contains 32 bit versions of the C and C++ Compiler, Flash Graphics library, C++ Debugger and full standard library source code together with all the familiar features provided with the standard DOS Developer's Edition.

Using Phar Lapp's much acclaimed 386/DOS Extender Technology, you can build applications which access 4 Gigabytes of linearly addressable memory. Your applications will also be Plug & Go for use with Phar Lapp's 386 DOS Extender which may be purchased separately.

UNIX 386 NEW

Not a day passes at Zortech HQ without numerous requests for a UNIX version of Zortech C++. Now, DOS and OS/2 developers can reach new markets by easily moving their code to SCO UNIX 386 and binary compatibles.

The Zortech C++ V2.1 UNIX 386 Compiler generates the same tight, fast code that Zortech's DOS and OS/2 users have come to expect. UNIX specific versions of Flash Graphics and the C++ Workbench are also provided.

In line with the traditional Zortech Policy, owners of the Zortech C++ V2.1 UNIX 386 Compiler will be able to inexpensively upgrade to the forthcoming Zortech C++ V2.1 UNIX 386 Developer's Edition.



Freedom of Choice.

At Jameco, you have the freedom to choose from a complete line of starter, mid-range, and full powered computer kits. You also have the freedom to build and expand these kits by choosing the major components that best suit your individual needs. From memory, monitors, and disk drives; to scanners, mice, and trackballs; to cables, power protectors, and more.

Take a look at our high-end 80386 and 80386SX expandable computer kits:

Jameco 33MHz 32KB Cache, 80386 Computer Kit

Includes:

- 80386 33MHz Motherboard with 32KB cache, 4MB RAM (expandable to 16MB)
- 101-key enhanced keyboard
- Multi I/O Card
- Toshiba 1.44MB, 3.5" DSHD floppy disk drive
- Vertical enclosure with 6 half-height drive bays
- 300 Watt power supply
- DR DOS 5.0 by Digital Research and Diagsoft's QAPLus diagnostic software

\$2599.95 monitor extra
JE3833

Jameco 20MHz 32KB Cache, 80386SX Computer Kit

Includes:

- AMI 80386SX 20MHz Motherboard with 32KB cache, 4MB RAM (expandable to 16MB)
- 101-key enhanced keyboard
- Multi I/O Card
- Toshiba 1.44MB, 3.5" DSHD floppy disk drive
- Mini-vertical computer case
- 200 Watt power supply
- DR DOS 5.0 by Digital Research and Diagsoft's QAPLus diagnostic software

\$1899.95 monitor extra
JE3820

Call Jameco for our new 1991 catalog. In it you'll find an extensive offering of quality computer and electronic components. You have the freedom to order 24 hours a day and if you need assistance, expert technicians are available from 7 am to 4 pm (PST) to help you with all your computing needs. Enjoy the freedom of choice. Call Jameco today at (415) 592-8097.

To place an order, call our
24-hour order hotline
(415) 592-8097.
Or FAX us at (415) 592-2503,
or (415) 595-2664.

JAMECO
COMPUTER PRODUCTS

1355 Shoreway Rd., Belmont, CA 94002

FAX: (415) 592-2503

Terms: Prices are subject to change without notice. Items subject to availability and prior sale. Complete list of terms/warranties is available upon request.

All trade names are registered trademarks of their respective companies.

© 12/90 Jameco Computer Products



Please refer to **Mail Key 1** when ordering

Circle 155 on Reader Service Card

24 Hours a Day.



JAMECO

JAMECO

JA

WHAT'S NEW

HARDWARE • SYSTEMS

Light Portables Take Flight

NEC Technologies has launched the UltraLite 286V, a 6½-pound 12-MHz notebook computer. The system comes with 1 MB of RAM (expandable to 2 or 5 MB), a 3½-inch 1.44-MB external floppy disk drive, and a 20-MB hard disk drive.

The system also features a 10-inch backlit screen with 640- by 480-pixel VGA resolution. The removable battery cartridge system provides up to 2½ hours of power; the system also comes with an auto-sensing/auto-switching AC power supply that works with both U.S. and international power systems.

The system measures 9½ by 12½ by 1⅞ inches. Options include a 2400-bps modem, a send/receive fax modem, and a SCSI adapter.

Price: \$3999.

Contact: NEC Technologies, Inc., 1255 Michael Dr., Wood Dale, IL 60191, (708) 860-9500.

Inquiry 1271.



The Samsung S3600 is a 12-MHz laptop with a 40-MB hard disk drive and a VGA-compatible screen.

The Samsung S3600, like the NEC UltraLite 286V, comes with a 286 processor, 1 MB of RAM, a 3½-inch 1.44-MB floppy disk drive, and a VGA screen. But the Samsung weighs in at a hefty 16 pounds, including its battery.

The S3600 comes with a rechargeable nickel-cadmium battery that provides 3 hours of power, a battery charger, and a power management feature similar to the UltraLite's.

Options include LapLink

III software, a 2400-bps modem, and a carrying case.

Price: With 40-MB hard disk drive, \$3499.

Contact: Samsung Information Systems America, Inc., 3655 North First St., San Jose, CA 95134, (800) 624-8999 ext. 851.

Inquiry 1272.

386SX Systems with Windows on the Side

The Mitac MPC2386E is a basic 20-MHz 386SX system with an option for Super VGA graphics. The system comes with Windows 3.0, a mouse, and 1 MB of RAM (expandable to 4 or 8 MB).

The system is sold without any disk drives but has room for both 5¼- and 3½-inch floppy disk drives.

SPREAD THE WORD

Your new product is important to us. Please address information to New Products Editors, BYTE, One Phoenix Mill Lane, Peterborough, NH 03458. Better yet, use your modem and mail new product information to the microbytes.hw or microbytes.sw conferences on BIX. Please send the product description, price, ship date, and an address and telephone number where readers can get more information.

Price: \$2395.

Contact: American Mitac Corp., 410 East Plumeria Dr., San Jose, CA 95134, (800) 648-2287 or (408) 432-1160.
Inquiry 1273.

The Eltech 2200 is another 20-MHz 386SX system that comes with Windows 3.0 installed. It includes 2 MB of RAM (expandable to 8 MB), 5¼- and 3½-inch floppy disk drives, a 40-MB hard disk drive, a VGA card and monitor, a mouse, and DOS 4.01.

Price: \$2199.

Contact: Eltech Research, Inc., 47266 Benicia St., Fremont, CA 94538, (800) 234-4331 or (415) 438-0990.
Inquiry 1274.

Going for the GoldStar

GoldStar Technology's GT212 is a 12-MHz 286-based system with 1 MB of RAM and 16-bit VGA capability for under \$1000. The base system has an Intelligent Drive Electronics interface and VGA capability built into the motherboard. It also includes a dual floppy disk drive controller; serial, parallel, and mouse ports; and DOS 4.01. The system measures 4 by 15 by 15½ inches.

Price: \$995.

Contact: GoldStar Technology, Inc., 3003 North First St., San Jose, CA 95134, (408) 432-1331.

Inquiry 1275.



Mitac's 20-MHz 386SX comes with Windows 3.0 installed along with a mouse and more.

HP Does It Again for Less

Hewlett-Packard's LaserJet IIID is its second printer with the HP PCL 5 printer language and HP Resolution Enhancement technology. This 300-dpi, 8-ppm LaserJet is compatible with the III and IID and replaces the IID, according to HP.

Like the IID, the IIID offers double-sided printing and the same internal bit-mapped typefaces as the IIP (i.e., Courier and Line Printer). Two font-cartridge slots give you the option of plugging in fonts, typefaces, and PostScript cartridges.

Also like the IID, the IIID comes with two letter-size paper trays for an input capacity of 400 sheets. An automatic envelope feeder is available for the IIID. In addition, the IIID comes with 1 MB of memory and two slots for memory upgrade boards.

HP's Resolution Enhancement technology adjusts the position and size of dots to smooth the jaggies of 300-dpi



The HP LaserJet IIID laser printer offers low-cost printing for high-volume users.

printing. The PCL 5 printer language uses Intellifont font-scaling technology from Agfa, which allows the printer to scale typefaces on the fly.

Price: \$3595.
Contact: Hewlett-Packard Co. Inquiries, 19310 Pruneridge Ave., Cupertino, CA 95014, (800) 752-0900.
Inquiry 1276.

Hard Disk Drive Gives RAM to the Amiga

The SupraDrive 500XP for the Amiga 500 combines a 20-MB hard disk drive and installed RAM. The drive consumes less than 4 W of power and does not require fans or external power, according to Supra.

The RAM is installed on the 500XP board in DRAM chips in configurations of 0.5, 1, or 2 MB of RAM with 256K- by 4-bit DIP DRAM chips, or in configurations of 2, 4, or 8 MB with an add-on RAM board using 1-megabit by 4-bit DRAM chips. The drive plugs into the Amiga's expansion port.

Price: \$679 for a minimum configuration (20-MB hard

disk drive with 0.5 MB of RAM).

Contact: Supra Corp., 1133 Commercial Way, Albany, OR 97321, (800) 727-8772 or (503) 967-9075.
Inquiry 1277.

Low-Cost Video Printer from Sony

The UP-3000 prints with 256 levels of color from a palette of over 16 million colors per pixel at more than 500 TV lines of horizontal resolution in a 4- by 3-inch format.

The printer has a one-frame memory and uses RGB 8-bit digital signal processing and advanced color-dye-transfer thermal printing technology. In normal scanning mode, the printer produces a

picture about the size of a 35mm photo on an A6 page. It has an RS-232C interface and accepts and outputs RGB analog, composite video, and S-video signals.

Price: \$3999.
Contact: Sony Corp. of America, 9 West 57th St., New York, NY 10019, (212) 418-9427.
Inquiry 1278.

An 8514/A VGA Monitor

The ViewSonic 4 is a multiple-frequency VGA monitor that has a multiscanning frequency of from 20 to 38 kHz and a presetting function. The monitor features



auto-sizing controls and a nonglare 14-inch screen on a tilt-and-swivel base.

Price: \$599.
Contact: ViewSonic, 12130 Mora Dr., Santa Fe Springs, CA 90670, (213) 944-3041.
Inquiry 1279.

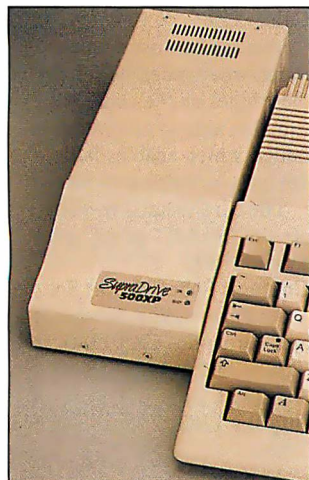

SupraDrive 500XP for the Amiga.

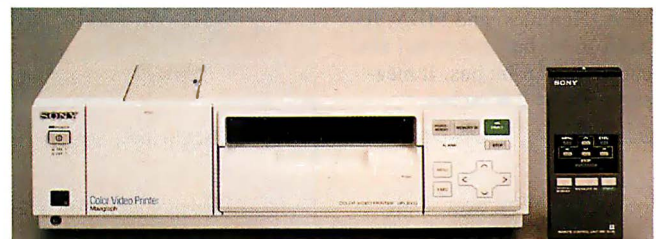

Sony's UP-3000 turns video to color hard copy.

Orange Micro Lets You Mix Apples with DOS and OS/2

The Orange386, a single-slot coprocessor card that works in any Mac II, features an on-board 16-MHz Intel 386SX. With the card in place, you can run OS/2 and DOS applications in a Mac window as if they were Mac applications, according to Orange Micro.

The Orange386 has two AT slots so you can install any IBM add-on card on it; you can also add an 80387 math coprocessor. Other features of the Orange386 card include PC interface hardware for serial, parallel, 1.2-MB floppy disk drive, and Intelligent Drive Electronics ports. This lets you connect almost any PC-type peripheral to the card.

Price: \$2295.

Contact: Orange Micro, Inc., 1400 North Lakeview Ave., Anaheim, CA 92807, (714) 779-2772.

Inquiry 1280.

Basic VGA for Less Than \$99

A full 16 bits on a compact VGA card is what you get for \$99 with ATI's VGABASIC-16. The card uses a proprietary application-specific IC that makes it over three times faster than competitors' cards, ATI says.

The VGABASIC-16 is compatible with CGA, EGA, VGA, Hercules, and MDA. It has a 16-bit bus design but also supports an 8-bit bus. It measures 6¼ by 2¾ inches,

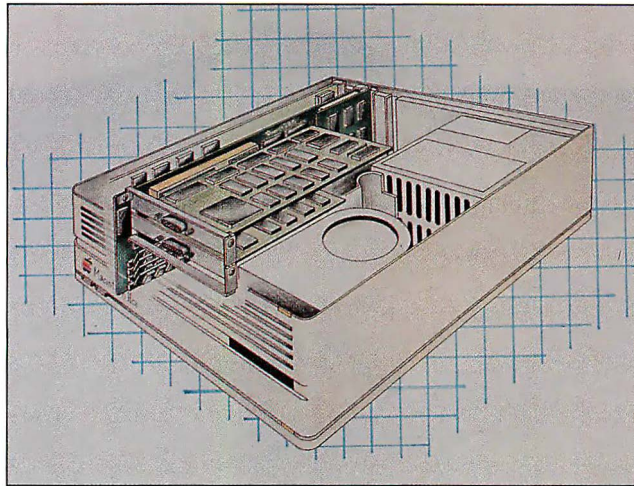

The Orange386 puts a powerful PC in your Mac.

which, ATI says, makes it the smallest VGA card in the world.

Price: \$99.

Contact: ATI Technologies, Inc., 3761 Victoria Park Ave., Scarborough, Ontario, Canada M1W 3S2, (416) 756-0718.

Inquiry 1281.

Mac DSP Boards Meet Your Floating-Point Needs

Spectral Innovations is offering floating-point digital signal processing (DSP) boards for the Mac II and SE/30.

The boards provide a peak performance of 32 MFLOPS and feature NuBus and processor direct slot (PDS) compatibility. The bus interface

for the board includes a 5-MBps DMA mode that lets you transfer programs and data between Mac and MacDSP local memory without interrupting MacDSP program execution.

The boards, based on AT&T's DSP32C DSP, have an integrated DMA controller that performs IEEE-compatible 32-bit floating-point arithmetic. The higher-end board, the MacDSPAP, is designed for memory-intensive array-processing applications such as image processing, 3-D modeling, graphics animation, and PostScript acceleration. It provides from 64K bytes to 1 MB of zero-wait-state RAM.

The lower-cost board, the MacDSPXI, is designed for signal-processing applications where cost is a factor. This board features built-in

16-bit A/D and D/A converters with a sample rate of 128 kHz, and it performs at up to 24 MFLOPS.

Both boards are available with C development environments, which include a compiler, an assembler, a simulator, and a linker. The boards are also compatible with Spectral Innovations' signal analysis program.

Price: MacDSPAP, \$4994; MacDSPXI, \$2895; C development environment, \$1500.

Contact: Spectral Innovations, 4633 Old Ironsides Dr., Suite 450, Santa Clara, CA 95054, (408) 727-1314.

Inquiry 1282.

Oscilloscope Card with a 256K-byte Storage Buffer

Soltec says that its SCC-1220 digital storage oscilloscope card is the first integrated scope with a 256K-byte storage buffer.

The card has a sampling frequency of from 40 MHz to 1 Hz. It is capable of simultaneous sampling on two channels at up to 20 MHz per channel. All features, functions, and setup parameters are selectable from menu-driven software called PC-Calc.

You can capture single events unattended by setting the trigger on the card. You can also zero in on prototype faults, which enables fault analysis, according to Soltec.

The card installs in a single slot in an XT or AT.

Price: \$1300.

Contact: Soltec Corp., Sol Vista Park, 12977 Arroyo St., San Fernando, CA 91340, (800) 423-2344 or (818) 365-0800.

Inquiry 1283.

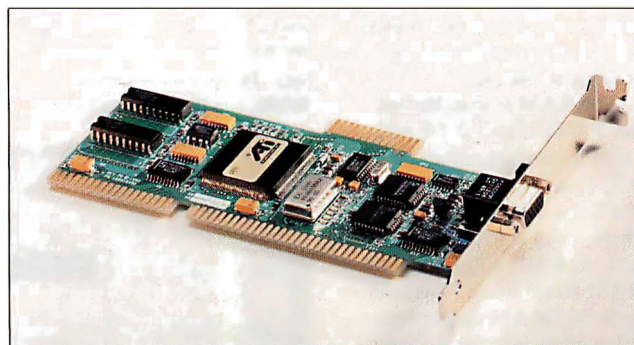

The VGABASIC-16 delivers 16 bits on a card that measures 6¼ by 2¾ inches.



The DBMS That Opens Windows™

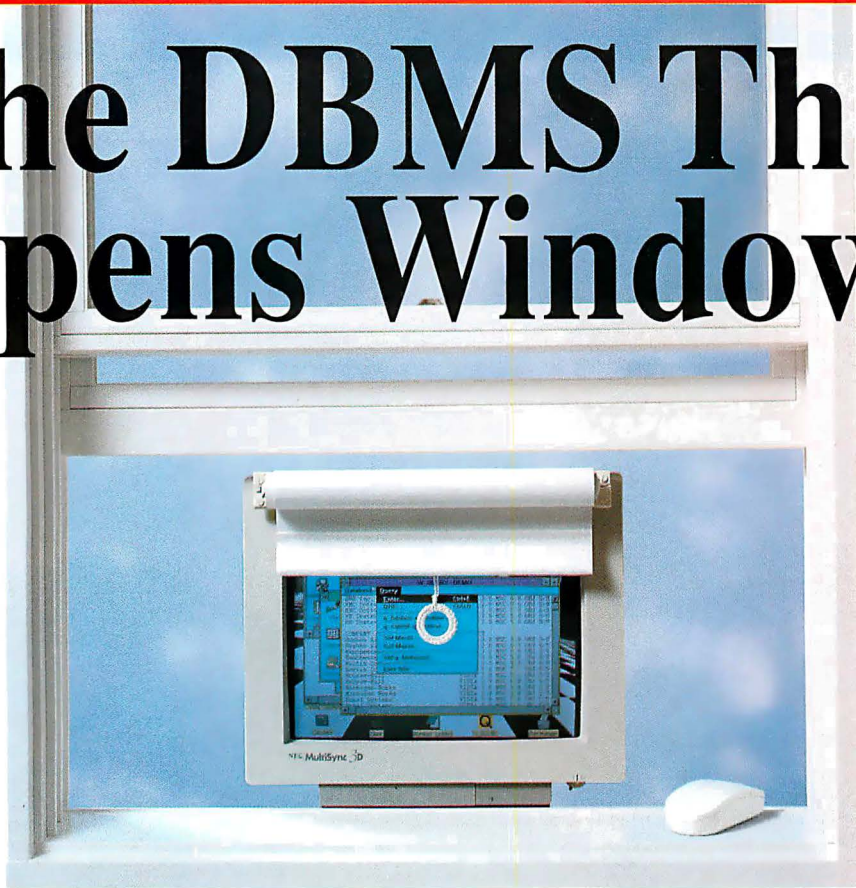

Get High Performance Under Microsoft Windows 3.0™ With db_VISTA III DBMS.

Develop Windows applications that are better, faster, and more profitable. db_VISTA III combines speed, flexibility, and productivity into one DBMS tool for C and Windows programmers. Add db_VISTA III's high-speed SQL retrieval to your application and watch your users enjoy power they've never experienced before.

Built For Windows.

db_VISTA III for Windows 3.0 follows all of the Microsoft

guidelines for memory use. Dynamic linked libraries (DLL), multi-tasking, and multi-user environments are all supported. For even faster development, use db_VISTA III with products like ToolBook®, Windowcraft®, or Actor®.

No Other DBMS Opens Windows Like db_VISTA III!

- **Speed.** Benchmarks show db_VISTA III significantly outperforms any DBMS under Windows.
- **No Royalties.** Increase your profits; decrease your overhead.
- **C Source Code Available.** For total programming flexibility.
- **Portability.** db_VISTA III supports most environments.

Special \$195 Developer's Edition

For a limited time only, you can get your hands on db_VISTA for Windows for only \$195. Call today and ask about our Developer's Edition and experience how db_VISTA III can open Windows for you.

Developer license only; not for distribution.

Call 1-800-db-RAIMA

(1-800-327-2462)

In Washington state call: (206) 747-5570

Full Raima Support Services - Including Training. Develop your applications even faster with Raima Training Classes:

- Dec. 3-5, 1990 - Germany
- Dec. 3-5, 1990 - Australia
- Dec. 10-14, 1990 - San Diego, CA
- Dec. 17-18, 1990 - Taiwan
- Jan. 28-Feb. 2, 1991 - Dallas, TX
- Feb. 4-8, 1991 - Switzerland

db_VISTA™ III Database Management System

Specifications: Single & multi-user. Automatic recovery. Automatic referential integrity. Relational and network data models supported. Relational SQL query and report writer. Complete revision capability. C source code is available. No royalties. **Supports:** MS Windows, MS-DOS, OS/2, VMS, UNIX, BSD, QNX, SunOS, Macintosh.



Raima Corporation 3245 146th Place S.E., Bellevue, WA 98007 USA (206)747-5570 Fax: (206)747-1991 Telex: 6503018237 MCI UW
International Distributors: Australia: 61 2 419 7177 Austria: 43 022 43 81861 Brazil: 55 11 829 1687 Central America: 506 28 07 64 Denmark: 45 42 887249 France: 33 1 46092784
Italy: 39 045 584711 Japan: 81 03 865 2140 Mexico: 52 83 49 53 00 The Netherlands: 31 2503 26312 Norway: 47 244 8855 Sweden: 46 013 124780 Switzerland: 41 064 517475
Taiwan: 886 02 552 3277 Turkey: 90 1 152 0516 United Kingdom: 44 0992 500919 Uruguay: 598 292 0959 USSR: 01 32 35 99 07; 812 292 7210; 0142 437952 West Germany: 49 07022 34077
Copyright ©1990 Raima Corporation. All rights reserved. db_ is registered in the U.S. Patent and Trademark Office. Windows 3.0, ToolBook, Windowcraft, and Actor are trademarks of their respective companies.

Circle 259 on Reader Service Card

THE ONLY COMPETITION FOR OUR NEW HANDHE



New ScanMan® Model 256 puts professional gray scale scanning within everyone's grasp. It does almost everything a big, expensive scanner can do, for a fraction of the price. **N**ew ScanMan Model 256 lets you capture the subtlest details in your originals, in 256 shades of gray. Special retouching software tools let you enhance difficult originals and preview the results. You can dramatically improve the contrast and brightness of any image. So you always give your monitor and printer the best possible image to work with. **W**hat really sets ScanMan Model 256 apart is its ingenious Ansel™ software (Windows™ 3.0 compatible). Ansel lets you scan



LD SCANNER REQUIRES A MUCH BIGGER HAND.



SCANMAN MODEL 256 GRAY SCALE

and print 8" x 11" images by effortlessly stitching two 4" x 11" images together. You can instantly re-align, resize, flip or rotate images to create special effects. **T**he possibilities are endless. You can scan photos, line art, illustrations or logos and create magazine quality layouts. With optional CatchWord™ Intelligent OCR software you can scan text in most any typeface. **N**ew ScanMan Model 256 comes with Logitech's™ legendary quality and lifetime warranty. All for only \$499 (Micro Channel version, \$599). For more information call Logitech Customer Sales: in California (800)552-8885; in Canada (800)283-7717; in Europe ++41-21-869-9656.

Outside CA call:
800-231-7717 ext. 348



LOGITECH

Tools That Power The Desktop.

®/TM: Trademarks of registered owners.

Circle 174 on Reader Service Card (RESELLERS: 175)



Click and Play from the MacJukebox

The MacJukebox, which consists of an infrared interface box, a Macintosh Plus, software, and cables, lets you remotely control your infrared peripherals (e.g., TVs and compact disk players). The interface box includes an infrared receiver, a transmitter, and the connections to hook it up to the serial port of the Mac Plus.

Using the software provided, you can control infrared peripherals with the click of a button after you've converted command sequences to macros, and you can link the macros to a set time or event. The software also gives you extensive organizing capabilities, such as listing all your CDs by artist or song title. Then when you click on a song or series of songs, your selections will play in sequence just as on a jukebox.

Price: \$1599; without the Mac Plus, \$599.

Contact: DanCraft Enterprises, 5520 West 118th Place, Inglewood, CA 90304, (213) 643-8782.

Inquiry 1284.

DSP on the NeXT

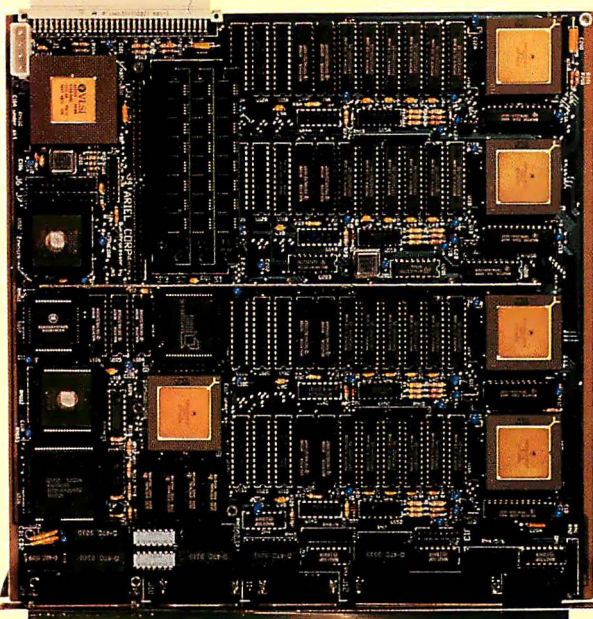

The QuintProcessor board can add up to 67.5 MIPS performance to the NeXT machine, according to Ariel. The board features five 27-MHz digital signal processors. The DSP chips are the same as those installed on the NeXT system's processor. Four are used as slave processors for computation, while the fifth is an I/O processor that manages DRAM, SCSI storage, and interprocessor commu-

nications.

The QuintProcessor is compatible with Ariel's BUG-56, a debugger bundled with the NeXT.

The QuintProcessor has five DSP ports and can be connected to Ariel's digital microphone for recording and signal analysis.

Price: \$6995.

Contact: Ariel Corp., 433 River Rd., Highland Park, NJ 08904, (201) 249-2900.

Inquiry 1287.

adds four SE slots to the Mac SE; and the SE/30 chassis, which adds four NuBus slots to the Mac SE/30. Other chassis are available for the Mac II family.

All the chassis connect to the Macs through an interface card and cable assembly. Each chassis has a power supply, a cooling fan, and the slots. The NuBus chassis can accommodate internal disk drives, according to Second Wave.

Price: Home Base, \$995; SE Plus, \$795; SE, \$995; SE/30, \$1295.

Contact: Second Wave, Inc., 9430 Research Blvd., Echelon II, Suite 260, Austin, TX 78759, (512) 343-9661.

Inquiry 1285.

Speak into the Microphone

Micro IntroVoice is a modular speech-processing system that comes with a microprocessor and has the ability to recognize up to 1000 words. The manufacturer reports a recognition accuracy of more than 98 percent.

Micro IntroVoice listens to command or data input. It then responds by sending keystrokes via the serial port and text to the on-board synthesizer for audio prompting.

The voice system works with any IBM PC or compatible, according to the manufacturer. It comes with software, sample vocabularies, a battery charger, and a serial cable.

The NEC V-25 microprocessor operates at 8 MHz and comes with 128K bytes of RAM.

Price: \$1295.

Contact: Voice Connexion, 8258 Kingslee Rd., Bloomington, MN 55438, (612) 944-1334.

Inquiry 1286.

Expansion Chassis Systems for Macs

Second Wave's line of Expanse expansion chassis systems lets you add to your Macintosh. The Home Base, the chassis for the Mac Portable, fits under the machine and contains two slots for standard SE option cards, enabling you to get more out of your Portable when it's parked on your desk at home or in the office.

Other Expanse chassis systems include the Plus, which adds four SE slots to the Mac Plus; the SE chassis, which



Second Wave's line of expansion chassis systems gives you the ability to expand your Mac Portable, Plus, SE, or II. With the Home Base, for example, you are able to add two slots to your Mac Portable.

WHAT IS THIS SMALL BOX ?

A UNIX HOST!

A LAN SERVER!

A WORKSTATION

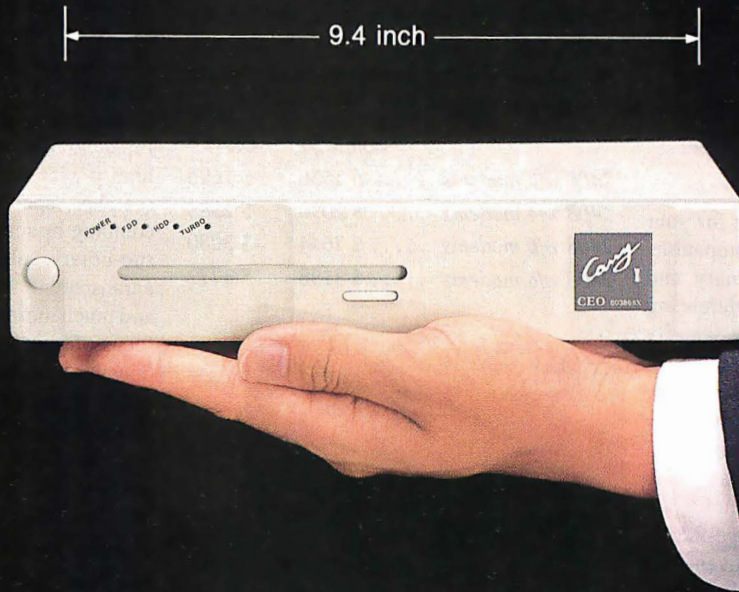

The Carry-I 9300 80386SX, 4M-byte RAM, 80M-byte Harddisk,
One Expansion Slot, VGA...

Carry-I -the World's First & Original Book-Size Desktop Computer

The Carry-I 9000 series comes complete with 80386SX/80286-16/80286-12 microprocessor (Co-Processor optional), 1024 x 768 VGA/MGA & CGA display interface, 1/2/4 MB RAM, one 3.5" 1.44 MB FDD or one FDD plus one 40/80 MB HDD, one 8 bit expansion SLOT, one parallel and two serial I/O ports, and one 30W auto range switching power adapter, all in the traditional 240mm x 185mm x 45mm (9.4" x 7.3" x 1.8") casing of Carry-I. Each package includes two mini-tower stands and a carry bag. The 82 key mini keyboard and 9 inch color or monochrome VGA monitor are optional.

Other Carry-I products include the 8000 series XT & AT book-size personal computers and the 6000 series XT and AT book-size LANstations, ETHERnet pocket LAN adapter and Carry Mouse.

CARRY-I

A Refreshing Idea....
A New Standard....
Computing Goes Better With CARRY-I



FLYTECH TECHNOLOGY CO., LTD.
HEAD OFFICE:
2FL. NO. 8 LANE 50, SEC. 3, NAN-KANG
RD. TAIPEI, TAIWAN, R.O.C.
TEL# 886-2-7852556 FAX# 886-2-7852371, 7837970
W.G.:
TEL# .39-69-746081 FAX# 49-69-749375

U.S.A.:
TEL# 1-408-7277373,4
FAX# 1-408-7277375
H.K.:
TEL# 852-3051268
FAX# 852-7968427

DISTRIBUTOR:

• CANADA: BUDGETRON INC. TEL# 416-564-7800 FAX# 416-564-2679 • FRANCE: M3C L'INFORMATIQUE DU SUCCES TEL# 1-48271976 FAX# 1-42355916 • HONG KONG: PARKLY TECHNOLOGY LTD. TEL# 852-3051268 FAX# 852-7968427 • ISRAEL: MLL COMPUTERS SYSTEMS LTD. TEL# 3-7515511 FAX# 3-7516615 • ITALY: PRIMA COMPUTER TRADING ITALIA TEL# 522-518599 FAX# 522-518599
• MALAYSIA: COMMUNICATION TECHNOLOGY SDN. BHD. TEL# 03-2748888 FAX# 03-2749988 • NETHERLAND: KOPIERSYSTEMEN NEDERLAND B.V. TEL# 2968-84141 FAX# 2968-97436 • NORWAY: SECUS DATA A/S TEL# 2-722510 FAX# 2-722515 • SINGAPORE: TRANSNIKO PTE LTD. TEL# 4758408 FAX# 4713803 • SOUTH AFRICA: PC MART COMPUTER GROUP TEL# 11-8043355 FAX# 11-8024153
• SPAIN: AT ELECTRONIC S.A. TEL# 1-5645434 FAX# 1-4110869 • SWITZERLAND: ESS SOFTWARE TRADING SA TEL# 022-622020 FAX# 022-615650 • UNITED KINGDOM: CENTERPRISE INTERNATIONAL LTD. TEL# 256-463754 FAX# 256-843174 • WEST GERMANY: MACROTRON AG TEL# 89-4208233 FAX# 89-423745 • BELGIUM: CELEM S.A. TEL# 41-676434 FAX# 41-676515

Circle 113 on Reader Service Card

Operate your own BBS

with the world's most popular, expandable, flexible

Multi-User Online Bulletin Board System

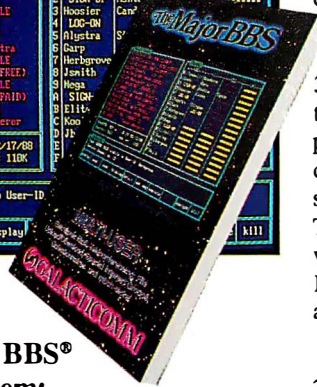

The Major BBS® starter system:

A complete BBS software package for your PC, PS/2, XT, AT, 386, 486, or compatible. Includes electronic mail with binary and ASCII file "attachments", SIG conferencing or "forum" areas with configurable security level access control, file upload/download, message keyword searching, "quickscans" for fast access to new messages, message and file "threading", real-time multi-user "chat" and teleconferencing, "classified ad" and "user registry" databases, etc. Also includes accounting, Audit Trail, and timed usage-metering features, and hundreds of convenience features for the Sysop (System Operator), such as a full-screen configuration editor, the ability to import/export files to/from floppy without system shutdown, "SIG-Op" privilege delegation, and much more. Supports up to 2 simultaneous users (from a database of thousands) on a single CPU. Works with standard Hayes-compatible COM1/2/3/4 internal or external modems, or with serial ports up to 38,400 bps. Minimum RAM requirement 512K. Minimum disk requirement 20MB. Requires PC-DOS or MS-DOS 3.1 or later.

The Major BBS Standard Edition \$ 59

When you're ready to expand:

No LAN or multi-tasking OS necessary! Double the number of simultaneous users that your system can support, from 2 to 4, or 4 to 8, or any number up to 64 simultaneous users on a single CPU, for a flat \$300 software license fee per doubling. The upgrade process is quick, automatic, and fully upward-compatible — i.e. you can install an update or upgrade onto your existing system without disrupting any of your user account files, E-Mail messages, configuration variables, or any other aspect of your system. For up to 16 users, 640K RAM is sufficient; above 16 users, more than 640K may be necessary. Prerequisite: The Major BBS (any edition).

Users, per doubling (up to 64) \$ 300

If you need multi-modem hardware:

Our Model 2408 consists of up to 8 Hayes-compatible modems on a single circuit card, for the PC/XT/AT/386/486 family. Each modem operates independently at 300/1200/2400 bps (automatically switching to match the caller's bps rate). Built-in serial ports are not COM-port based, so this card can co-exist with other COM port hardware in the same machine (drivers for software other than The Major BBS are not included but may be written). RJ-11 telephone cables are included. MNP Class 4 (error correction) modems are available as an option.

	MNP Class 4	non-MNP
2408 w/2 modems	\$ 1696	\$ 1536
2408 w/4 modems	\$ 2388	\$ 2090
2408 w/6 modems	\$ 3080	\$ 2644
2408 w/8 modems	\$ 3772	\$ 3198

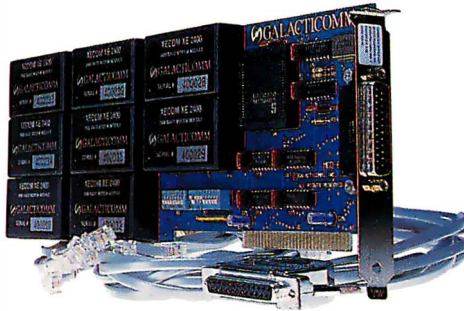

When you're ready for source code:

With the C source code to The Major BBS, you can add 3rd-party software, such as The Major Database (a general-purpose, configurable database manager), various multi-player real-time adventure games, dial-out utilities, global command utilities, accounting enhancements, and much more. Also, you can maintain your own copy of the BBS, or you can modify it to suit your own unique requirements. The Major BBS C source code package is fully documented, and it includes the Galaticomm Software Breakthrough Library, plus all of the



utility object libraries, linker control files, and DOS "batch" files you will need, along with a detailed Programmer's Guide. Works with Turbo C 1.5, 2.0, or 2.01, Turbo C++, or Microsoft C 4.0, 5.1, or 6.0. Prerequisite: The Major BBS Standard Edition.

Standard Edition C source code \$ 285

For the ultimate in file transfer flexibility:

The File Library Edition of The Major BBS has everything that the starter system does, plus built-in ZMODEM, KERMIT, SuperKERMIT, YMODEM-g, and YMODEM (batch) file transfer protocols. Also, it offers super-fast pre-indexed keyword file searches, library-wide searches as well as constrained searches, special file upload/download accounting options, alternate DOS "paths" per sub-library, split paths for CD-ROM support, a transparent "DOS-only" sub-library option, and much more. This package is for you if the focus of your system will be the upload and download of large amounts of files. You can easily upgrade from the starter system to the File Library Edition, without losing any of your data files or configuration work you have already done. Prerequisite: The Major BBS Standard Edition.

File Library extensions \$ 199

File Library C source extensions* . . . \$ 159

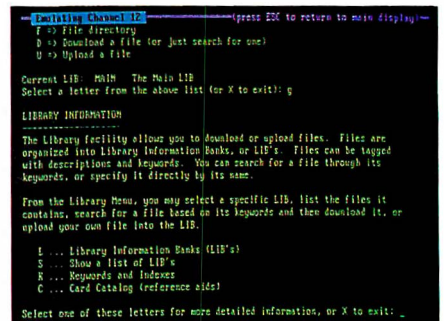

If you decide to offer online games and amusements:

The Entertainment Edition of The Major BBS has everything that the starter system does, plus Quest for Magic (a multi-player interactive text adventure game), Androids! (a multi-player arcade-style ANSI-graphics game), Flash Attack (a futuristic tank and laser battle for multiple players with IBM PC's), and the Action Teleconference Link-Up, which includes private "chambers", action verbs (grin, wink, nudge, etc.), the ability to link to other systems for huge multi-system teleconferences, custom entry/exit strings, user-configurable profiles, and much more. This Edition supports the Flash™ Protocol (where most of the game functionality is on the user's

end of the phone line), for which dozens of incredible new multi-user games are now being developed. Upgrading from the starter system to the Entertainment Edition is quick



and easy and involves no loss of data or function. Prerequisite: The Major BBS Standard Edition.

Entertainment extensions \$ 149
Entertainment C source extensions* . . \$ 129

If your requirements include order entry and catalog sales:

The Shopping Mall Edition of The Major BBS has everything that the starter system does, plus online shopping. Your online mall can have multiple "stores", each run by its own separate "merchant", if desired. Each merchant has control over his or her own product line, pricing, discount structure, store welcome message, sales tax handling, etc. Also, each merchant may create up to 6 different payment methods (e.g. VISA, MC, AMEX, C.O.D., "bill me", etc.), and up to 6 different shipping methods (e.g. UPS, FedEx, US Mail, etc.), each with its own rates (flat rate, percent of sale, 1st-ounce/add'l-ounce, or 1st-pound/add'l-pound). Users may browse product catalogs at no obligation, or order products and services directly online! Orders generate invoices that are posted to the individual merchant as attachments to E-Mail. To upgrade from the starter system to the Shopping Mall Edition takes only a few minutes. Prerequisite: The Major BBS Standard Edition.

Shopping Mall extensions \$ 249
Shopping Mall C source extensions*. . \$ 189

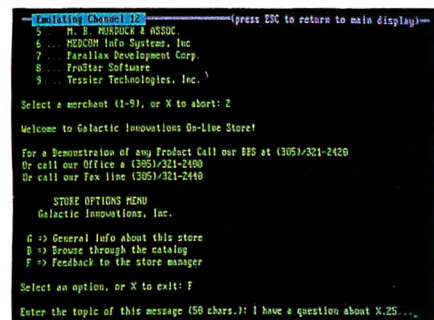

For super-flexibility of menu trees and ANSI screens:

The MenuMan Edition of The Major BBS can do everything that the starter system does, and in addition you as Sysop can create your own menu trees, with menus leading to menus leading to menus, as deeply "nested" as you like. The "leaves" of your menu trees can be ordinary ASCII or ANSI files, which are simply dumped to the user's display (with or without automatic screen breaks), or they can be any of the built-in functions of the BBS such as scanning the user's incoming E-Mail or firing up a SIG quickscan. Includes commands like GO <pagename>, FIND <topic>, USERS, and for the Sysop, the equivalent of the DOS commands DIR, RENAME, COPY, DEL, MKDIR, and RMDIR, as well as a set of privileged commands for editing and extending the menu trees, remotely, while the BBS remains fully online. Upgrading from the starter system to the MenuMan Edition takes only minutes. Prerequisite: The Major BBS Standard Edition.

MenuMan extensions \$ 149
MenuMan C source extensions* \$ 129

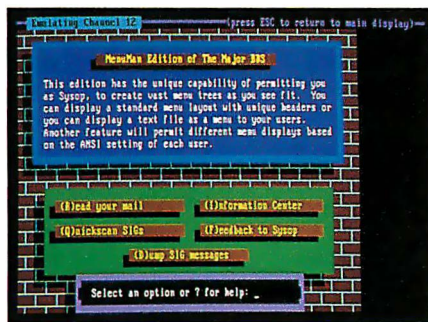

As your system grows larger...

The GalactiBox™ is our 16-slot "expansion chassis", for large-scale systems. It has the unique ability to address individual modems by slot number rather than just COM port address, so you can use up to 16 standard internal modems in it, side by side, without conflict. Includes built-in 150W power supply, interface card for your XT/AT/386/486, cables, and full documentation. Up to 4 boxes may be attached to one CPU, for a total of up to 64-channel expansion capacity. Prices shown below are for standard 300/1200/2400 bps Hayes-compatible internal modems. We also have 9600 bps V.32/V.42 MNP Class 5 modems available, call for prices.

GalactiBox (unpopulated) \$ 1992
GalactiBox w/4 modems \$ 2416
GalactiBox w/8 modems \$ 2840
GalactiBox w/16 modems \$ 3688

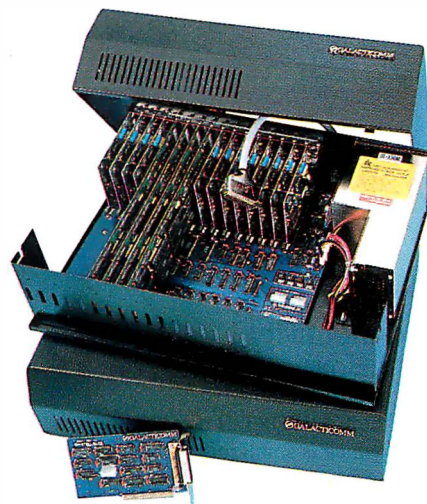

...and that's not all! For advanced applications, we also offer an X.25 direct-connect software option, a protected-mode development toolkit, and special licensing arrangements for up to 256 simultaneous users! And don't forget the smorgasbord of 3rd-party add-ons available, such as The Major Database from Galactic Innovations. Custom programming and integration services are also available. Your system can grow in power and sophistication, far into the future, with The Major BBS.

Here's How To Order:

Just dial (305) 583-5990 and say, "I'd like to place an order!" We can generally ship your order within 48 hours. We accept major credit cards, or we can ship C.O.D. Prices shown do not include shipping or insurance.

For more information, you may either call the main order number and ask for a sales engineer, or dial (305) 583-7808 with your modem (8-N-1) for a free demo of most of our products. This demo system also contains an online Shopping Mall with many of the 3rd-party add-ons available for The Major BBS, operated by the 3rd-party vendors themselves.

Give us a call today!



The Major BBS, Flash Protocol, and GalactiBox are trademarks of Galacticom, Inc. PC, PS/2, XT, AT, and PC-DOS are trademarks of International Business Machines Corp. Hayes is a trademark of Hayes Microcomputer Products, Inc. The Major Database is a trademark of Galactic Innovations, Inc. Turbo C and Turbo C++ are trademarks of Borland International, Inc. MS-DOS and Microsoft C are trademarks of Microsoft Corp. UPS is a trademark of United Parcel Service. FedEx is a trademark of Federal Express Corp. MNP is a trademark of Microcom, Inc.

*The C source code extensions are necessary, if you wish to combine multiple extended Editions together, or add 3rd-party software, or develop your own modifications. Prerequisites, in each case, are the Standard Edition C source code, and the corresponding extended Edition.

GALACTICOMM

Galacticomm, Inc. 4101 S.W. 47 Ave.
Suite 101, Fort Lauderdale, FL 33314

Modem: (305) 583-7808
Fax: (305) 583-7846
Voice: (305) 583-5990

Circle 116 on Reader Service Card

Connectivity in a Box

The LANPORT-II box, which is smaller than most external modems, lets you dial in to your Novell network from remote sites. You can hook LANPORT-II anywhere along your network cabling, according to Microtest.

The LANPORT-II box (which measures 4 by 7½ by 1 inch) includes a built-in network interface, RAM, ROM, asynchronous communications firmware, two serial ports, and software. It's compatible with terminal emulation programs such as Procomm and Crosstalk, and it works with PCs, Macs, mainframes, and other ASCII terminals.

Three levels of security are included in LANPORT-II. When you call in to the network, LANPORT-II answers the call, prompts you to log on, and requests your password. Once you're logged onto the file server, you're presented with a menu of options, and LANPORT-II becomes transparent.

LANPORT's two serial ports operate at up to 19,200 bps, allowing multiple users to share modems. With LANPORT's network interface, you don't need a dedicated communications server on the network, as you do with other remote communications devices. With the optional On-Link feature, you don't need a computer up and running on the network to use LANPORT-II—you can power up remotely.

Price: \$495 to \$695.

Contact: Microtest, 3519 East Shea Blvd., Suite 134, Phoenix, AZ 85028, (602) 971-6464.

Inquiry 1288.

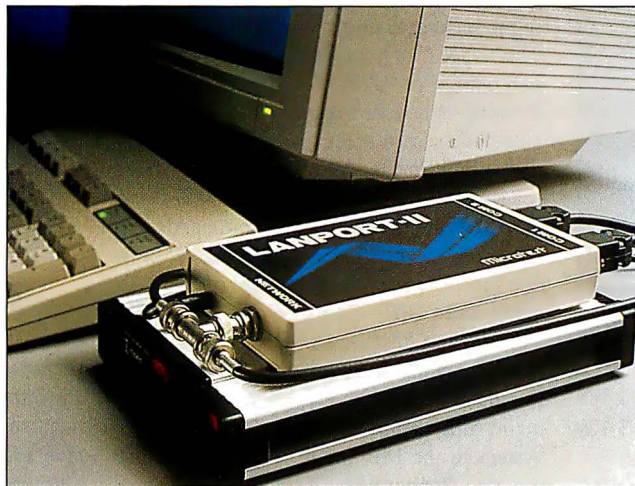

LANPORT-II lets you dial into your LAN without the need for a PC communications server.

Putting Windows on the Network

Windows Workstation 3 bridges the Windows 3.0 user interface and your Novell NetWare LAN. The software consists of seven utilities that enhance the network features of Windows 3.0.

The Workstation Print Manager brings network printing capabilities to Windows applications. Secure Station provides transparent security for network workstations and offers file encryption/decryption capabilities. The Workstation Intercom lets you

receive and send messages to users and groups of users across multiple file servers. You use the Workstation Clock to set multiple alarm messages and events to occur at user-specified times and intervals.

Windows Workstation 3 is compatible with Novell NetWare 286 2.1 and higher. To run the utilities you need Windows 3.0 and at least 1 MB of RAM on each workstation.

Price: \$695 for a 10-user license.

Contact: Automated Design Systems, Inc., 375 Northridge Rd., Suite 270, Atlanta, GA 30350, (404) 394-2552.

Inquiry 1289.

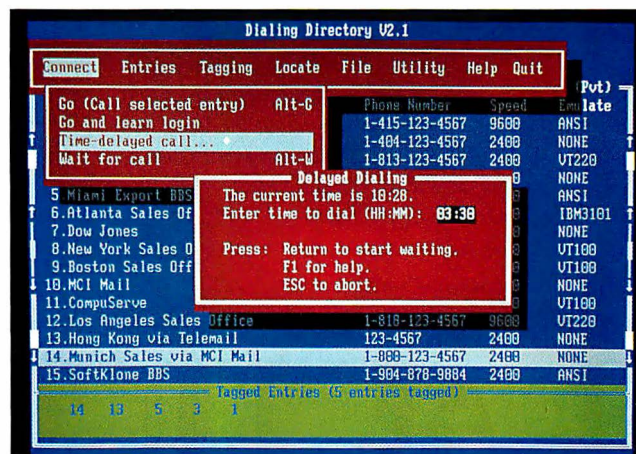

The Mirror III dialing directory features pull-down menus and can be operated with a keyboard or mouse.

Getting the Most from Your Fax

Ricoh's DX-1 Fax Adapter and communication software, compatible with PCs, Macs, and laptops, lets you use your Group 3 fax as a printer, scanner, copier, or just a fax. DX-1 software is available for controlling the fax, scanning, printing, and copying capabilities.

Price: \$799; DX-1 software, \$275.

Contact: Ricoh Corp., 5 Dedrick Place, West Caldwell, NJ 07006, (800) 637-4264 or (201) 882-2000.

Inquiry 1290.

Mirror III Gets a Boost

The communications program for PCs called Mirror III is now enhanced with several new features, including a dialing directory interface and mouse support, according to SoftKlone. Also new are scripts for several on-line services, including BIX. Version 2.0 also offers ZMODEM and XMODEM file transfer protocols and support for MNP 5.

To take advantage of the MNP session/data compression protocol, you must have an MNP modem. However, users without MNP modems can still use Mirror III software.

Additions and extensions to the Prism communications programming language include mouse support for Prism scripts, parameter passing, drawing enhancements, and several new commands.

Price: \$149.

Contact: SoftKlone, 327 Office Plaza Dr., Suite 100, Tallahassee, FL 32301, (904) 878-8564.

Inquiry 1291.



INSTANT MAINFRAME. JUST ADD SCO.

Not too long ago, a few dozen people sharing the same programs, resources, and information on a single computer at the same time meant only one thing—a mainframe.

Powerful, big, expensive, and proprietary.

More recently, the same people could be found doing exactly the same things—simultaneously sharing programs, resources, and information—on a minicomputer.

A lot cheaper, a lot smaller, yet powerful enough to do the same jobs. And just as proprietary.

Then along came the latest generation of personal computers. And now, the same people are more and more likely to be found doing exactly the same things—simultaneously sharing programs, resources, and information—on a PC.

And not a whole officeful of PCs networked together, either, but *a single PC powering the whole office at once.*

A lot cheaper, a lot smaller, yet still easily powerful enough to do the same jobs. Built to non-proprietary, open system standards that allow complete freedom of choice in hardware and software.

And running the industry-choice multiuser, multitasking UNIX® System V platform that gives millions of 286- and 386-based PC users mainframe power every business day.

The UNIX System standard for PCs—SCO.™

The SCO family of UNIX System software solutions is available for all 80286-, 80386-, and 80486-based industry-standard and Micro Channel™ computers.

Today, SCO UNIX System solutions are installed on more than one in ten of all leading 386 computers in operation worldwide.

Running thousands of off-the-shelf XENIX® and UNIX System-based applications on powerful standard business systems supporting 32 or even more workstations—at an unbelievably low cost per user. And with such blazing performance that individual users believe they have the whole system to themselves.

Running electronic mail across the office—or around the world—in seconds.

Running multiuser PC communications to minis and mainframes through TCP/IP and SNA networks.

And doing some things that no mainframe—or even DOS- or AOS/2™-based PC—ever thought about, such as running multiple DOS applications. Or networking DOS, OS/2, XENIX and UNIX Systems together. Or running UNIX System versions and workalikes of popular DOS applications such as Microsoft® Word, 1-2-3®, and dBASE III PLUS.®

Or even letting users integrate full-featured multiuser productivity packages of *their choice* under a standard, friendly menu interface.

Today's personal computer isn't just a "PC" anymore, and you can unleash its incredible mainframe-plus power for yourself—today.

Just add SCO.

For more information, call SCO today and ask for ext. 8562.



(800) SCO-UNIX (726-8649)

(408) 425-7222

FAX: (408) 458-4227

E-MAIL: ...lunet@SCO info@SCO.COM

UNIX is a registered trademark of AT&T. SCO and the SCO logo are trademarks of The Santa Cruz Operation, Inc. Microsoft and XENIX are registered trademarks of Microsoft Corporation. OS/2 and Micro Channel are trademarks of International Business Machines Corporation. 1-2-3 is a registered trademark of Lotus Development Corporation. dBASE III PLUS is a registered trademark of Ashton-Tate.
©1989 The Santa Cruz Operation, Inc., 400 Encinal Street, P. O. Box 1900, Santa Cruz, California 95061 USA
The Santa Cruz Operation, Ltd., Crossley Centre, Hatters Lane, Walford WD1 8YN, United Kingdom. +44 (0)923 816344. FAX: +44 (0)923 817781.
TELEX: 917372 SZCOWC

Circle 273 on Reader Service Card

TWO REASONS WHY TOSHIBA SELLS

At Toshiba, we think that designing a portable computer to fit real live human beings can make the difference between a computer you

love and a computer you merely tolerate.

So that's exactly what we think about when we design our portable PCs.



Chances are, you're already used to our comfortable, full-function keyboard. That's because the keys are the exact size and shape you expect them to be.

And the public has told us we were right in our thinking. In fact, according to PC Magazine, Toshiba portables rank number one in customer satisfaction.

Take our T1200XE notebook PC, for example. You'll notice how our unique screen technology makes it easy to read under virtually all lighting conditions, no matter where you decide to get your work done.

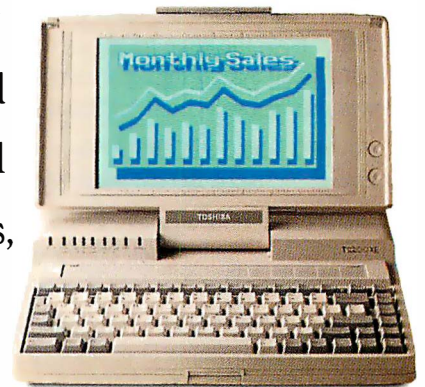

The T1200XE takes up about one square foot of desk space (or lap space) so there's always room to work.

For a free brochure or the name of your nearest Toshiba dealer, call 1-800-457-7777.

MORE PORTABLES THAN ANYONE ELSE.

Next, you'll find the keyboard to be immediately familiar, since it's what you're already used to. All of the key spacing and sizes are standard.

You'll also discover plenty of processing power packed into the 286-based T1200XE. And the 20MB hard drive means you can keep all your programs and files right where you need them. With you.

Plus, you'll undoubtedly appreciate the T1200XE's other humane features like a slim line battery pack and AutoResume™, which lets you pick up exactly where you left off. No grand reopening of the system, program and file every time you want to start work again.

The only thing you'll notice we've skimped on is size and weight. After all, what good is a portable if you can't take it with you?

With notebooks like the T1200XE it should come as no surprise that Toshiba sells more portable PCs than any other company in the world. After all, you're not the only one who recognizes a good thing when they see it.

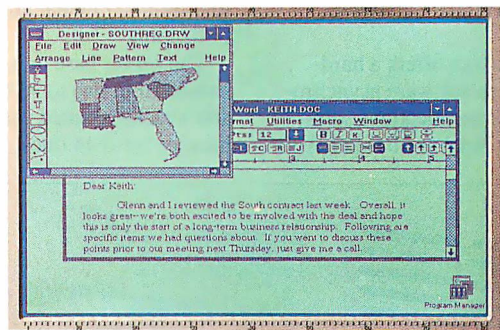
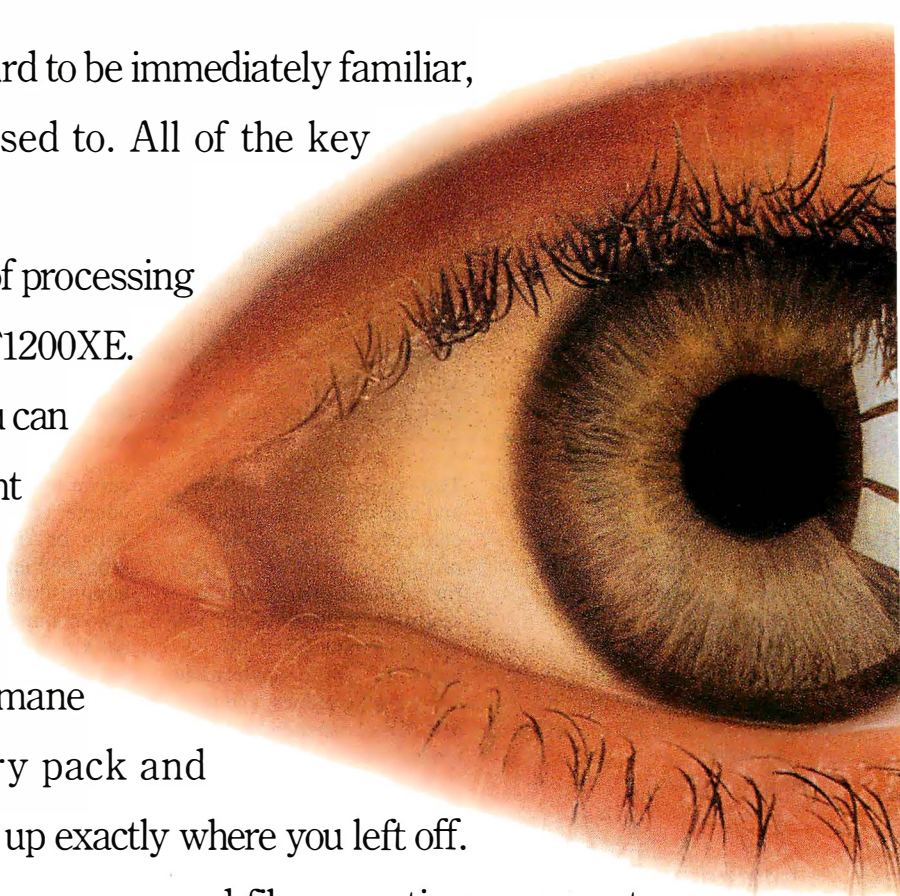

Toshiba designed the large, easy-to-read display with real, live humans in mind. So now you can work without a lot of eyestrain, neckstrain or backstrain.

In Touch with Tomorrow
TOSHIBA

Circle 314 on Reader Service Card (RESELLERS: 315)

Mac DAT Runs Alone

Mirror Technologies has introduced the T1200 DAT Drive, an external 1.3-gigabyte digital audiotape drive for Macs. The T1200 supports unattended backup and network backup and conforms to the digital data storage (DDS) recording format standard.

With the included Soft-BackUp software, you can program the T1200 for 2 hours of unattended operation. This means that it can perform backup for up to 2 hours and then shut down, freeing the system or network for other activities.

Price: \$2997.

Contact: Mirror Technologies, Inc., 2644 Patton Rd., Roseville, MN 55113, (612) 633-4450.

Inquiry 1292.

Integrated System for NetWare Communications

FlexCom offers a hardware/software asynchronous communications solution for NetWare-based LANs.



Mirror's T1200 DAT drive offers Mac users unattended backups, 1.3 gigabytes of storage, and high-speed access to data.

The system supports dial-in and dial-out access on each communications line and provides a separate processor for each dial-in or remote-access user. With FlexCom, you also get as much as 550K bytes of RAM for applications, EGA-level graphics, and up to 1 MB of expanded or extended memory.

Version 1.1 of the software features reduced memory overhead for dial-in users, extended management capability for dial-out lines, user-extendable activity logging, and line-by-line modem initialization.

The server base units can handle from two to 36 lines, and a rack-mounted version handles up to 44 lines. Each

server includes a network adapter (Ethernet, Token Ring, or ARCnet) and comes with the FlexCom/Manager administration software.

Two communications processor kits are available for the server base unit. The kits come with FlexCom/CPX software and pcAnywhere III remote-access software programs.

Price: \$3000 and up, including all hardware and software. **Contact:** Evergreen Systems, Inc., 120 Landing Court, Suite A, Novato, CA 94945, (415) 897-8888.

Inquiry 1293.

Pocket-Size LAN Adapter

You can convert your portable computer into an Ethernet workstation with a pocket-size LAN adapter from Accton Technology.

The EtherPocket adapter, which measures $3\frac{3}{8}$ by $\frac{7}{8}$ by $2\frac{1}{4}$ inches, is used in place of a network interface card. It comes with its own power adapter and attaches to the portable's parallel port.

Price: \$499. **Contact:** Accton Technology Corp., 46750 Fremont Blvd., Suite 104, Fremont, CA 94538, (415) 226-9800.

Inquiry 1294.

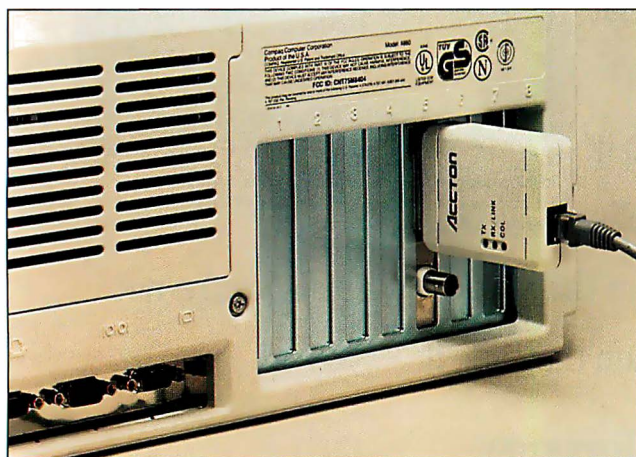

Accton's pocket-size adapter plugs into your portable's parallel port and turns it into an Ethernet workstation.

Low-Cost and Practical

The PM 9600 SA modem (a 9600-bps stand-alone modem) features automatic correct connection with remote mode, V.42 and MNP 4 error correction, V.42bis and MNP 5 data compression, and command and data rates of from 75 to 38,400 bps. It is also Hayes compatible.

Price: \$699.

Contact: Practical Peripherals, Inc., 31245 La Baya Dr., Westlake Village, CA 91362, (818) 706-0333.

Inquiry 1295.

1-2-3/G Ships Server and Node Editions

Lotus 1-2-3/G, the graphical version of the 1-2-3 spreadsheet program, is now available in standard, server, and node editions.

Lotus 1-2-3/G retains the familiar 1-2-3 commands but runs under OS/2 and adds a goal-seeking technology called Solver. Solver automates the what-if process and shows you how to achieve desired results.

The server edition supplies administrators with tools for easier network management, according to Lotus. The node edition lets you have an additional concurrent 1-2-3/G user on the network. It includes a single license for network use.

1-2-3/G runs on a PC with at least 5 MB of RAM for network versions. It runs under OS/2 1.1 or higher and is compatible with IBM, 3Com, and Novell networks.

Price: Server edition, \$895; node edition, \$595. **Contact:** Lotus Development Corp., 55 Cambridge Pkwy., Cambridge, MA 02142, (617) 577-8500. **Inquiry 1296.**

Buy one quick.

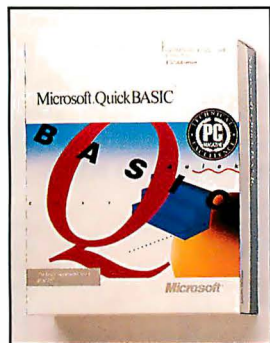

List: \$ 99
Ours: \$ 69

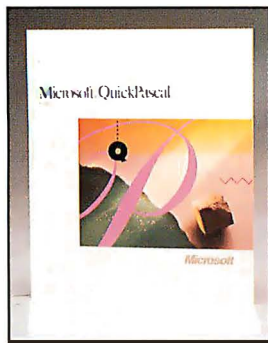

List: \$ 99
Ours: \$ 69

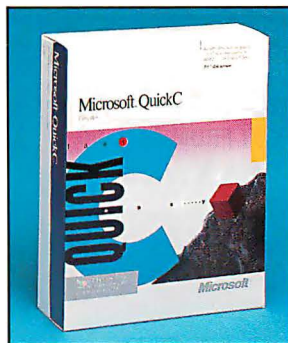

List: \$ 99
Ours: \$ 69

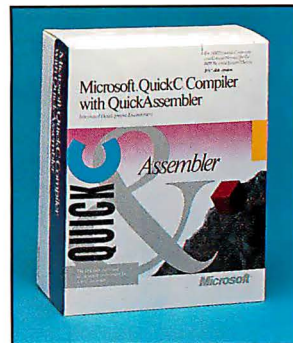

List: \$ 199
Ours: \$ 139

Get one free...

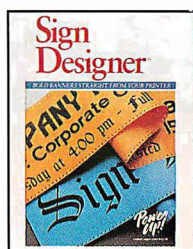
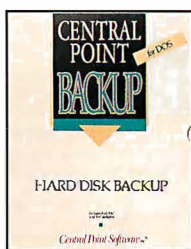
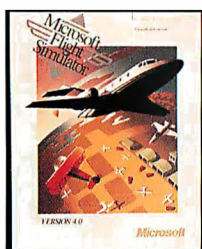

from *Programmer's Paradise*

(800)

445-7899

An unbelievable limited-time offer! Buy Microsoft® QuickBASIC™, the easiest way to learn how to program. Or QuickPascal™, the fastest way to learn and program in Pascal. Or QuickC™, the easiest way to master C and write powerful C programs. Or QuickC Compiler with Quick Assembler™, the only integrated C and Assembly development environment for MS-DOS.®

And get one of the great software products shown, worth up to \$90 (SRP), free!*

Choose from Microsoft Flight Simulator®, the closest thing to flying short of flying. Central Point Backup™, an incredibly easy way to back up documents. Or Sign Designer™, great for creating professional quality signs on your dot matrix printer.

Call *Programmer's Paradise*. Today.



Programmer's Paradise

A Division of Voyager Software Corp
1163 Shrewsbury Avenue
Shrewsbury, NJ 07702

Microsoft®
CALL TODAY!

*While supplies last. Coupon offer redeemable through Microsoft.

Circle 237 on Reader Service Card

Programmer's Paradise® ...

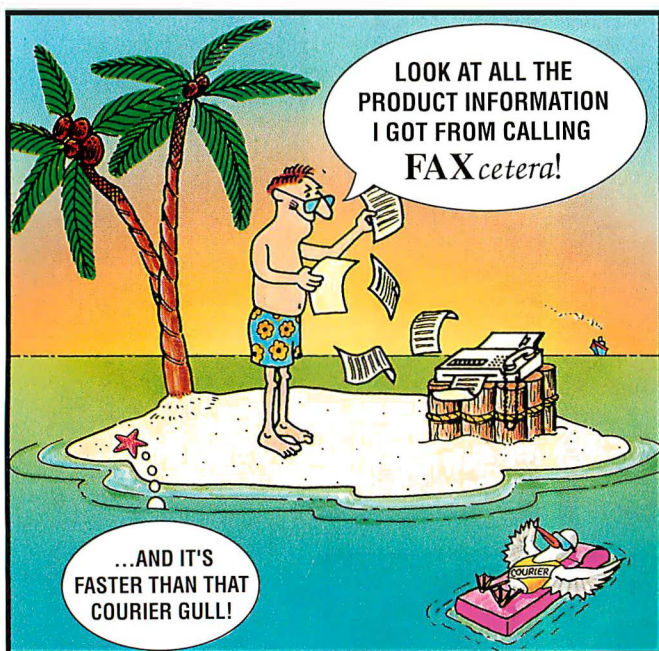

We'll Beat The Competition's Advertised Prices!

	LIST OURS		LIST OURS
386 CONTROL PROGRAMS			
DESQview 386 w/ QEMM	220 169	C++	
Microsoft Windows 3.0	150 99	C++/Views	495 419
VM/386	245 209	Intek C++	495 CALL
VM/386 MultiUser	895 839	NDP C++	495 479
VM/386 MultiUser Starter	395 339	Rogue Wave Math.h++	200 179
		Rogue Wave Tools.h++	200 179
		Turbo C++	200 139
		Turbo C++ Professional	300 205
		Competitive Upgrade	150 139
		Zinc Library	200 179
		Zortech C++ Database	299 255
		Zortech C++ Debugger	150 129
		Zortech C++	200 165
		Zortech C++ Developer's Edition	450 399
		Bundled w/ C++/Views	945 595
		Zortech C++ Tools	150 129
		Zortech C++ Video Course	500 449
		C-COMMUNICATIONS	
		Breakout II	249 189
		C Asynch Manager 3.0	189 139
		Essential Communications	329 259
		Greenleaf CommLib	359 287
		Greenleaf ViewComm	399 319
		SilverComm "C" Async Library	249 209
		View-232	189 149
		C-FILE MANAGEMENT	
		AccSys for dBASE or Paradox	395 349
		Btrieve Devel. System	595 449
		Codebase IV	295 219
		c-tree Plus	595 475
		dl3C III Plus	500 439
		db_FILE Bundle	295 249
		Essential B-Tree w/ source	198 149
		Paradox Engine	495 349
		The Toolbox - Prof. Edition	1295 1035
		The Toolbox - Special	795 635
		C-GENERAL LIBRARIES	
		Blackstar C Function Library	99 79
		C TOOLS PLUS/6.0	149 109
		C Utility Library	249 199
		Greenleaf Functions	229 179
		Greenleaf SuperFunctions	299 239
		Turbo C TOOLS/2.0	149 109
		C SCREENS	
		C-Worthy	399 CALL
		Greenleaf DataWindows	395 315
		QuickWindows Advanced (C)	169 149
		Vermont Views	495 395
		Vitamin C	225 165
		VC Screen	149 125
		C-UTILITIES/OTHER	
		Bar Code Library	389 319
		Clear for C	200 169
		C Shroud	198 149
		Heap Expander	80 70
		MKS LEX & YACC	249 197
		Objective-C	249 225
		PC-lint	139 105
		PCYACC Professional	495 459
		TimeSlicer	295 279

LIST OURS

CASE TOOLS	
EasyCASE Plus	295 265
Professional Pack	395 355
Personal CASE	199 179

COBOL LANGUAGE

Micro Focus:	
COBOL/2 w/Toolset	1800 1499
Personal COBOL	149 129
MS COBOL	900 629
Realia COBOL	995 849

CODE GENERATORS

Logic Gem	99 69
Matrix Layout 2.0	200 159
PRO-C	399 339

DATABASE DEVELOPMENT

Clarion 2.1	CALL	CALL
Clipper 5.0	795 519	
Data Junction Advanced	299 269	
dBASE IV	795 489	
dBFAST/PLUS	345 295	
dGE	295 249	
Dr. Switch-ASE	180 149	
Facelt	99 90	
FlashTools!	89 79	
Flipper	195 169	
Force 2.1	695 589	
FoxPro	795 489	
FUNCKY Library	195 179	
R&R Report Writer	150 129	
R&R Code Generator	150 129	
Say What!?	50 39	
SilverComm "C" Interface	99 89	
SilverComm Library 2.0	249 209	
The Documentor	295 245	
Tom Rettig's Library	100 80	
UI2 Version 2	595 479	

DEBUGGERS (DOS)

MultiScope	179 135
Periscope I	595 475
Periscope II w/ switch	225 179
Periscope IV/16, 25 MHz	CALL 225
Trapper	200 179
w/ optional cable	240 219
Turbo Debugger & Tools	150 105

DOCUMENTING/ FLOWCHARTING

allCLEAR	300 229
Clear for C or dBASE	200 169
C-Clearly	130 115
Flow Charting 3	250 199
Interactive Easyflow	150 125
Paginate	100 79
Source Print	99 74
Tree Diagrammer	99 74

EDITORS

BRIEF 3.0	249 CALL
EDT+	295 269
EMACS	325 265
Epsilon	195 159
KEDIT 4.0	150 125
MKS Vi	149 129
PI Editor	195 175
Sage Professional Editor	295 249
SLICK Editor	195 154
Speed Edit	295 275
SPF/PC	245 199
SYNDIE	495 399
VEDIT PLUS	185 CALL

EMBEDDED SYSTEMS

C6 to PROM	149 119
Link & Locate ++	395 349
Link & Locate ++ Extended	479 395

FORTRAN LANGUAGE

Grafmatic	135 119
Lahey F77L	595 535
Lahey Personal FORTRAN 77	99 89
MS FORTRAN	450 299
Plomatic	135 119
RM/FORTRAN	595 499

GRAPHICS LIBRARIES

Baby Driver	250 199
Essential Graphics	399 319
Font-Tools	150 119
Graf/Drive Plus Developer's	299 269
GraphiC 5.0	395 319
GSS Graphics Devel. Toolkit	795 685
GX Graphics	149 135
HALO	395 279
HALO Professional	595 419
HALO Window Toolkit	595 419
Icon-Tools/Plus	150 119
Menuet	325 279
MetaWindow	250 209
MetaWindow Plus	325 289
PCX Effects	99 89
PCX Programmer's Toolkit	195 175
PCX Text	149 135
SilverPaint	129 109
Slate w/graphics	448 415
Turbo Geometry Library	200 179

LIST OURS

LINKERS/LIBRARIANS

Overlay Toolkit	395 369
Plink86+	395 335
Plink/LTO	495 419
PolyLibrarian	249 209
.RTLink	295 265
.RTLink/Plus	495 419

OBJECT-ORIENTED TOOLS

Objective-C	249 225
Smalltalk/V	100 85
Smalltalk/V 286	200 169

OS/2 TOOLS

Brief	249 CALL
CASEPM for C	1495 1420
Epsilon	195 159
MKS LEX & YACC	349 279
MS OS/2 Pres. Manager Toolkit	500 349
MultiScope for OS/2	449 345
PCYACC	695 625
PI Editor	249 225
Smalltalk/V PM	495 369
Vitamin C (OS/2)	345 279

PASCAL LANGUAGE

Asynch PLUS	149 115
B-tree Filer	125 109
MS QuickPASCAL	99 69
Object Professional	150 109
Power Tools PLUS/5.0	149 109
Topaz	99 89
Topaz Multi-user	149 135
Turbo Analyst	99 89
TurboMAGIC	199 179
Turbo Pascal 5.5	150 105
Turbo Pascal 5.5 Professional	250 175
Turbo-Plus 5.5	199 159
Turbo Professional 5.0	125 109

SOURCE MAINTENANCE

Codan	395 345
Code Check	495 469
MKS Make	149 119
MKS RCS	189 149
MKS Software Mgmt. Team	299 239
PolyMake	179 149
PVCS Professional	495 419
SMS	495 399
TLib	139 109
5 Station LAN	419 339

WINDOWS (MS) TOOLS

Actor 3.0	895 719
Asymetrix Toolkit	395 CALL
Bridge Toolkit	695 659
Case/W	995 CALL
C-Talk/Views	450 375
dBFast/Windows	395 335
DialogCoder	499 435
Graphics Server SDK	495 419
MS Windows Development Kit	500 349
MultiScope for Windows	379 289
ObjectGraphics	445 365
ProtoView	695 625
Resource Workshop	300 269
WindowsMAKER	795 635
WinTrieve	395 339
WINDX GUI Toolbox	499 449

NEW RELEASES

Resource Workshop

The Workshop, from EdenSoft, is a fundamental tool for Windows development. It provides an integrated resource compiler and editor. Access resources instantly from the project view, edit resources graphically or as text, compile incrementally. Unmatched in features and capabilities.

List: \$300 Ours: \$269

Dr. Switch-ASE

Make any dBASE language program RAM resident, occupying only 16-20K of RAM. Advanced cut and paste for transferring of data to and from dBASE. Full network compatibility.

List: \$180 Ours: \$149

TimeSlicer 6.0

Multitasking linkable library of C functions for Microsoft C 6.0. Develop applications that will run an unlimited number of tasks concurrently. Multitasking at the application level rather than by interfacing with the operating system.

List: \$295 Ours: \$279

Guaranteed Best Prices!

(800)
445-7899

FAXcetera

Want more product information on the items in the gold box to the right? Try **FAXcetera**!! Just pick up your FAX phone and dial **201-389-8173**. Enter the **FAXcetera** product code listed below each product description—information will be faxed back to you instantly!

XENIX/UNIX	
BLAST UNIX/XENIX	495 395
Epsilon	195 169
Interactive Products	CALL
LPI-COBOL	1495 1199
LPI-FORTRAN	995 799
MetaWare High C	895 849
Microport Products	CALL
MKS RCS	395 335
MKS Trilogy	119 105
PI Editor	349 319
SCO Products	CALL
VEDIT PLUS	285 249
ADDITIONAL PRODUCTS	
APL+PLUS	695 549
Dan Bricklin's Demo II	199 159
dBx/DBPort	600 459
Guido	249 189
Lattice RPG	1600 1285
MKS AWK	99 79
Opt-Tech Sort/Merge	149 119
PC Scheme	95 79
Personal Rexx	150 139

APPLICATION SOFTWARE

COMMUNICATIONS	
BLAST II	250 225
Carbon Copy Plus	199 129
Laplink III	150 99
PC Anywhere III	145 99
Procomm Plus	99 63
SideTalk	120 99
DESKTOP PUBLISHING	
Adobe Products	CALL
Corel Draw!	595 399
HALO DPE	195 139
PageMaker	795 509
Ventura Publisher	895 549
MATHEMATICS	
Derive	200 179
MathCAD	495 315
Mathematica 386	695 625

SCIENCE & ENGINEERING	
AutoCAD Release 10	3000 CALL
AutoSketch	150 95
ChiWriter	150 129
CSS	495 469
DADISP	895 759
Design CAD 3-D	400 292
Drafix Windows CAD	695 CALL
EXACT	475 380
Generic CADD Level 3	350 289
LABTECH Acquire	195 179
LABTECH Notebook	995 799
MICRO-CAP III	1495 1269

SCIENCE & ENGINEERING (continued)

Orcad PCB	1495 CALL
PC-MATLAB	695 659
PC TEX	249 229
SCHEMA III	495 449
Systat w/ Sygraph	895 759
Tango PCB Series II	595 559
TECH*GRAPH*PAD	395 319
T ¹	595 479

SPREADSHEETS

Lotus 1-2-3 3.1	595 389
Microsoft Excel	495 319
Quattro Professional	495 329
SuperCalc 5	495 319

UTILITIES

386MAX5.0	130 114
above DISC	119 64
AboveMEM	80 75
Bootcon	60 55
Cache 86	50 39
FASTBACK Plus	189 119
HeadRoom 2.0	130 89
Hijaak Plus	199 149
Hold Everything	199 159
InfoSpotter	80 69
MACE 1990	149 105
Magellan	195 CALL
MKS Toolkit	249 199
MOVE*EM	89 79
Norton Commander	149 99
Norton Utilities 5.0	179 129
PC Tools Deluxe 6.0	149 95
Pizazz Plus	149 79
PreCursor	96 79
SitBack	99 90
Software Carousel	90 72
SpinRite II	89 75
Squish Plus	100 75
Switch-It	100 89
Tree 86	90 69
Turbo EMS 5.0	100 89
UpShot	95 89
XTreePro Gold	129 89
ZENO	269 239

WORD PROCESSING

Ami	199 129
Microsoft Word for Windows	495 349
WordPerfect 5.1	495 CALL

SOFTWARE FOR SUN WORKSTATIONS

Basmark QuickBASIC	CALL
C Programmer's Toolbox/ Sun	495 449
Edix	425 339
EMACS for Sun	395 369
Informix	CALL
Lotus 1-2-3 for Sun	CALL
Mathematica for Sun	CALL
MetaWare High C	895 849
NeuralWorks Professional II	4095 CALL
Panel Plus (Sun 3)	1595 1355
WordPerfect for Sun	495 CALL

Programmer's Policies

Phone Orders
Hours 8:30 AM-7 PM EST. We accept MC, Visa, AMEX. Domestic shipments, please add \$5 per item for shipping/handling by UPS ground. For domestic COD shipments, please add \$3. Rush service available.

Mail or FAX Orders
POs are welcome. Please include phone number.

International Service
Phone number required with order. Call or FAX for additional information.

Dealers and Corporate Accounts
Call for information.

Unbeatable Prices
We'll beat the competition's advertised prices. Prices subject to change without notice.

Return Policy
30 days. Due to copyright laws, we cannot take back software with the disk seal broken unless authorized by the manufacturer. Returned product must include R.A. number.

GUIDO 1.0

GUIDO is a powerful library of C functions which enables you to easily add graphical user interface objects to your graphics application, including menus, windows, data entry, text boxes, list boxes, radio buttons, percent bars and more—used independently or combined. Both mouse and keyboard are supported. Also contains an event-driven, object-oriented environment called the GUE, based on the high-level objects included. Requires no other graphics library. Includes manual with demos and examples. No royalties. Supports Microsoft C/Quick C and Turbo C/C++.



List: \$249 Ours: \$189 FAXcetera #2089-0004
w/ source List: \$499 Ours: \$329

Objective-C

Objective-C offers proven *true* object-oriented technology consisting of language, compiler and libraries. State-of-the-art development tool suitable for building object-oriented commercial applications in DOS, OS/2 and many other popular environments. The Objective-C language is specifically designed for reusability and flexibility, while retaining the performance and character of the industry standard C language. ICpak 101 Foundation Class Library, a basic library consisting of over twenty basic data types and I/O handlers, is included.

List: \$249 Ours: \$225 FAXcetera #1688-0001



WindowsMAKER

WindowsMAKER is a code generator that builds complete Microsoft Windows 3.0 applications. Prototype the entire user interface (menus, icons, dialog boxes, child windows, controls, etc.) in a WYSIWYG screen designer. Animate and test on users without a lengthy compile. Then generate Microsoft C code for high performance Windows applications. No runtime fees. C++ compatible. Custom code is preserved during regeneration. WindowsMAKER handles message processing, memory, debugging, compiling, MIDI and more. Port DOS or Mac programs to Windows in record time. A power tool for professional C programmers. WYSIWYG point and click programming at its best. 30 day money-back guarantee.

List: \$795 Ours: \$635 FAXcetera #2602-0002



Candlelight Software

WATCOM C8.0/386



WATCOM C8.0/386 is a 100% ANSI C optimizing compiler and run-time library for the Intel 80386 architecture generating applications for 32-bit protected mode. With C8.0/386, you can go beyond the 640K DOS limit. Library and source code compatibility with Microsoft C simplifies many porting projects. Significant features include: protected mode version of the compiler; VIDEO full-screen source-level debugger; Microsoft library and source compatibility; execution profiler; high-performance linker; graphics library.

Standard List: \$895 Ours: \$719
Professional List: \$1295 Ours: \$1099
FAXcetera #1683-0001

WATCOM

International: 201-389-9228
Customer Service: 201-389-9229
Fax: 201-389-9227

Corporate: 800-422-6507
Canada: 800-445-7899
FAXcetera: 201-389-8173

Call or Write for Latest Free Catalog!

1-800-445-7899

Programmer's Paradise



A Division of Voyager Software Corp
1163 Shrewsbury Ave., Shrewsbury, NJ 07702

Circle 238 on Reader Service Card

Our Guarantee...

Products listed here are backed by the following guarantee*:

Should you see one of these products listed at a lower price in another ad in this magazine, CALL US! We'll beat the price, and still offer our same quality service and support.

Terms of Offer:

- Offer good through December 31, 1990
- Applicable to pricing on current versions of software listed; Dec. issue prices only.
- Offer does not apply towards obvious errors in competitors' ads.

* Subject to same terms and conditions.

CASE Tools Ease OS/2 Cooperative Development

SQL/Workbench, a Presentation Manager application for OS/2 Extended Edition, lets a team that's developing cooperative processing applications benefit from the expertise of one Structured Query Language programmer.

SQL/Workbench can generate and compile Static SQL directly instead of requiring you to program it in C. One programmer keys in the SQL and puts the compiled SQL into the IBM Database Manager for use by all. This way, other programmers can do procedure calls instead of having to embed complex SQL strings into an application.

With the repository, a database administrator can check and validate the best callable procedures from a single source and not have to worry about code spread out among several programmers.

CP/Workbench helps a communications expert define transactions, conversations, buffers, and data types outside the program.

Both work on PC-to-mainframe applications.

Price: SQL/Workbench, \$7200; CP/Workbench, \$4200.

Contact: Intelligent Environments, 2 Highwood Dr., Tewksbury, MA 01876, (508) 640-1080.
Inquiry 1297.

Build Your Own Data Bridge

DBMS/Program lets you build applications that can directly read and write data simultaneously in multiple formats, including most

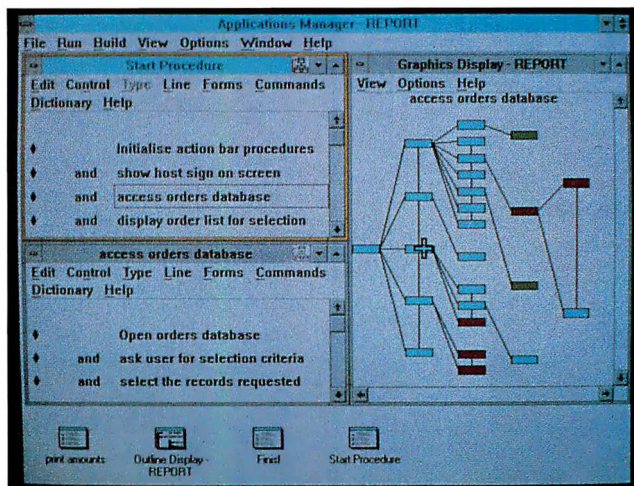

SQL/Workbench and CP/Workbench, two additions to the Applications Manager family of OS/2 development tools, help ease the creation of cooperative processing applications.

major DOS databases, spreadsheets, statistical packages, and Structured Query Language databases. Created applications can directly process more than 15 Macintosh applications supported by the company's DBMS/Copy Mac program.

Conceptual Software says that an application created with DBMS/Program can merge a database with another database, create new variables in the merged database, assign computed variables for each record in the database for the new variables, and output the result to another package for further analysis.

DBMS/Program supports Excel, Lotus 1-2-3, Quattro Pro, ACT!, dBASE, DataEase, Paradox, PFS:File, Clarion, and Oracle, Ingres, and Informix SQL databases. Over 22 statistical packages are supported, including SAS, SPSS, StatGraphics, and BMDP.

Price: \$595.

Contact: Conceptual Software, Inc., P.O. Box 56627, Houston, TX 77256, (713) 667-4222.

Inquiry 1298.

Create Foreign-Language Versions of Your Software

Performance Technology developed PowerTranslate for software companies that want to create, without recompiling, foreign-language versions of their programs or English versions of an application originally written in another language.

PowerTranslate creates a database of all the text that appears to the end user of the program, which you then translate. When you update a program, you need to translate only the modifications that will result in display changes.

PowerTranslate maintains the integrity of program text containing embedded or special codes that shouldn't be altered. Also, it will not modify text that contains a copyright banner.

The program works with C, Pascal, and similar languages.

Price: \$595; corporate license, \$4995.

Contact: Performance Technology, 800 Lincoln Center, San Antonio, TX 78230, (800) 825-5267 or (512) 524-0500.

Inquiry 1299.

Borland's Pascal Interface Library in a Box

Libraries of reusable objects are one of the touted benefits of object-oriented programming. They do, however, require substantial effort to develop and (when the libraries come from several sources) maintain. In its new version of Turbo Pascal, Borland is jump-starting that process by including Turbo Vision, a library of objects, including windows, pull-down menus, dialog boxes, and scroll bars, all with built-in mouse support. Turbo Pascal 6.0 also supports *object persistence*, the ability to map in-memory structures to disk directly.

A new compiler in Turbo Pascal 6.0 works in protected mode, letting you free up more memory for the compilation of large real-mode applications. The integrated development environment features a multifile editor with macros, overlapping windows, and built-in support for expanded memory. For bug squashing, version 6.0 offers integrated source code debugging, conditional breakpoints, a CPU window, and a hypertext help system.

With object persistence, objects know how to store themselves on disk, freeing memory and saving time by reducing instantiation. The new version also lets you integrate assembly code with its own in-line assembler.

Price: \$149.95; with Turbo Debugger & Tools, \$249.95.

Contact: Borland International, 1800 Green Hills Rd., P.O. Box 660001, Scotts Valley, CA 95066, (408) 438-8400.

Inquiry 1300.



MATH CO PROCESSORS

You know what you need
to speed up your
power applications.
There's just one more thing
you should know.



Only one math coprocessor is a chip off the old block.

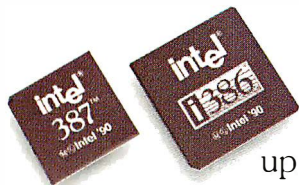

That's Intel's. And our new family of Math CoProcessors is faster—up to 50% for the 287XL.

In fact, working side by side with the Intel microprocessor already inside your computer, an Intel Math CoProcessor can increase the speed of your spreadsheet, graphics, CAD and

database programs by as much as 500%. That's good to know.

And the fact that it's made by Intel is also good to know.

Because Intel developed the first Math CoProcessor in 1982, and we've shipped millions since then. Each one is manufactured by Intel in the world's most advanced logic



facility, and then tested and retested against an exacting set of criteria.

And we can guarantee that every Intel Math CoProcessor lives up to the industry hardware standards we helped develop, delivering the same results regardless of what type of computer you're doing calculations on.

So call Intel at (800) 538-3373. Ask for

Literature Packet #F6 on Intel's new and improved Math CoProcessors. And put an Intel Math CoProcessor inside your computer. It's the only one with the Intel name to live up to.

intel[®]

The Computer Inside.[™]

©1990 Intel Corporation. 386 and 387 are trademarks of Intel Corporation.

Circle 146 on Reader Service Card (RESELLERS: 147)

Abacus's Ripple Effect Eliminates Data Duplication

Comsoft's Abacus II program for DOS integrates all accounting functions from the ground up with a real-time, single-point entry system designed for networks. You can extract information at any time from the dBASE III Plus-compatible system without closing accounts.

Once you enter information in data screens, the program ripples the entry through the entire system, automatically distributing information where needed.

Abacus II comes in single-user and multiuser versions. Both include a spreadsheet, business graphics capability, several modules, and a db.Detective program that searches nonindexed fields at up to 1000 records per second. **Price:** \$1695; with Job Estimating/Costing and Inventory/Order Entry, \$3395. **Contact:** Comsoft, Inc., 10335 172 St., Suite 208, Edmonton, Alberta, Canada T5S 1K9, (403) 489-5994. **Inquiry 1301.**

Hassle-Free Overseas Transfers

When you have to send employees overseas, Ernst & Young's two programs for the IBM PC can help you plan and manage these potentially costly assignments.

E & Y Expatriate helps you calculate and plan the costs of overseas assignments. To minimize costs, you can, for example, do what-if analyses and compare alternative tax-reduction strategies. The program has current U.S. and foreign tax information for more than 25 countries.

Expatriate Tracking Sys-

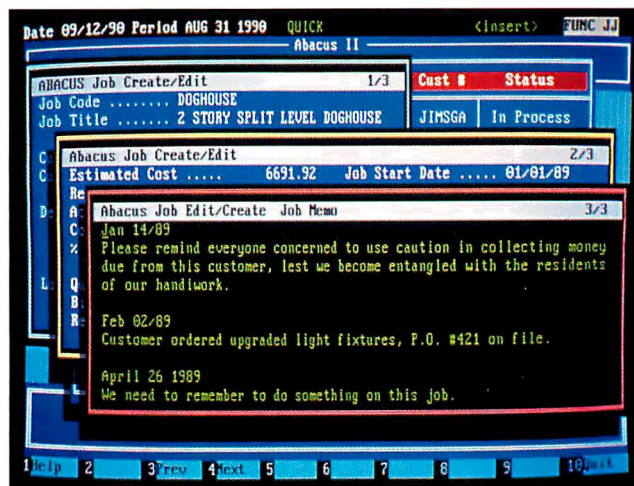

The word processor included with Comsoft's Abacus II accounting program lets you tag reminder notes onto a master file so you can easily access information on accounts.

Improve Negotiating Skills with Negotiator Pro

Beacon Expert Systems' hypertext-based program for the Mac and IBM PC can help individuals and teams improve their negotiating skills. Negotiator Pro offers advice on making better deals, developing options, and dealing with difficult opponents. The program includes a communications feature that acts as a referee, suggesting to both

sides of a negotiation alternative methods of dialogue when two teams must strike an accord but opposing strategies block this. This referee feature helps teams get on with the job when things have bogged down.

The program asks negotiators questions and, based on their answers, creates a profile of their negotiating style. It then provides a proposed negotiating strategy. It also generates reports at different levels of detail for various team members. Negotiators can use the program to prepare strategic and tactical ways to circumvent objections.

Price: \$299 for the first copy; \$99 for each additional user.

Contact: Beacon Expert Systems, Inc., 35 Gardner Rd., Brookline, MA 02146, (617) 738-9300.

Inquiry 1302.

Sagacity Helps Managers Assign Resources

Erudite's Sagacity program helps resource managers juggle the assignment of people or equipment for var-

ious tasks, considering skills, availability, costs, and other factors. Once you've entered information about tasks and resources—including available dates, billing rates, skill levels, and average time to complete the work—the program determines an optimal schedule.

Sagacity also lets you accommodate factors that are beyond your control. For example, if a client demands that a task be done by a certain individual, Sagacity lets you modify the schedule.

Price: \$1595 each for one to four users; \$1395 each for five or more users.

Contact: Erudite Corp., 533 Airport Blvd., Suite 400, Burlingame, CA 94010, (415) 348-7714.

Inquiry 1303.

Integrated Sales Prospecting

Integrated Sales Manager (ISM) is designed to help qualify prospects, letting you access one of up to 1500 prospect records within seconds. The program does this by keeping all client files stored in RAM. Once you pick a name, you can copy it to a group for even faster access.

ISM provides numerous reports and can store in RAM up to two screens of information per client. It can also store a third page on your hard disk. Other features include a week at a glance, calendar functions, and alert messages.

Price: \$498.

Contact: Aselco, Ltd., P.O. Box 251, Station S, Toronto, Ontario, Canada M5M 4L7, (416) 391-2277.

Inquiry 1304.

BIG IS OUT.



SMALL IS IN.

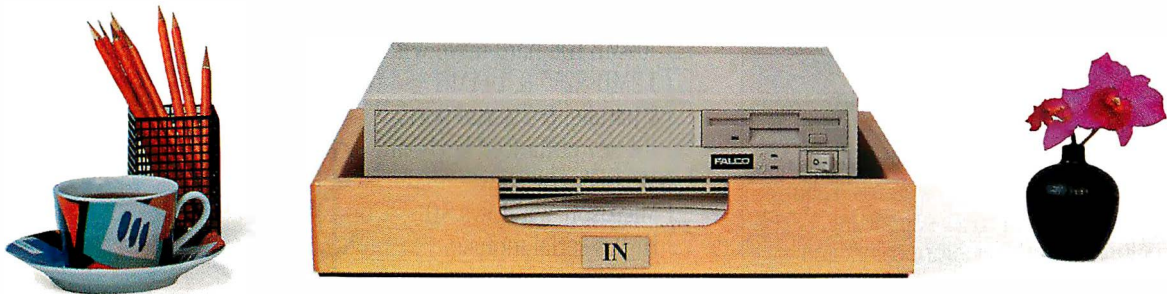

Introducing the Falco Infinity Desktop Computer. The Smallest 386SX Desktop.

If you're sizing up desktop computers, you'll immediately see the advantage of the Falco Infinity™ Desktop. It gives you 386™SX power and performance without dominating your desk space.

Half the size of a standard PC, the Infinity Desktop has everything you need on-board: Peripheral interfaces like disk controllers. Memory expansion. Communication ports. And VGA® level graphics up to 1024 x 768 resolution. Plus, two AT® compatible, 16-bit expansion slots.

It runs DOS™ 4.0, UNIX™, OS/2™ and Microsoft®

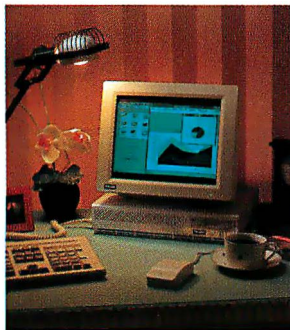

Windows 3.0. What's more, you can choose from four configurations, including a diskless network node and a full-featured model with 1.44MB floppy and the option of 40, 100 or 200 MB hard drive.

The only thing we left out is the noise. The Infinity Desktop runs so quietly, you'll hardly know it's on.

Whether you work in close quarters or spacious surroundings, the Falco Infinity Desktop covers all your needs. Without covering your desk. And that's about the size of it. To get one for your desk, call us today.

1-800-FALCO4U



If You Want In A 386 System, Do

Selecting a new computer system can be a real challenge. That's where we come in. We have the knowledge and experience to make your job easy. So, just do the Standard thing. Pick up the phone and check us out. Test us. Talk to us about our quality. Our service. And especially our prices. You'll like what you hear.

Introducing Features, Flexibility and Fantastic Color.

Then ask us about our new 386/25 and 386/33 systems. The list of standard features includes the latest that high technology has to offer. Features like a 64 KB memory cache for the 386/25, and 128 KB for the 386/33, both expandable to 256 KB, providing the fastest possible memory access. Then there's the integrated VGA controller supporting 1024 x 768 resolution, with 256 vibrant colors and a 50% performance increase all made possible by 1 MB of 32-bit video memory. Plus support for interlaced and non-interlaced monitors. When it comes to features, we set the standard.

No one can beat our flexibility either. An integrated floppy controller and hard disk interface that support up to three floppy drives and two hard drives. Up to 16 MB of RAM on board using the new industry standard 32-bit memory modules leave all six expansion slots available. Our small footprint chassis includes both 5.25" and 3.5" floppy drives and 1 parallel and 2 serial ports. And consider this feature, our new 386/25 and 386/33 systems come standard with 5 drive bays to hold up to one

Introducing Our New High Speed 386 25 System.

- 4MB of 32-bit high speed memory (Expandable to 16MB on board)
- 64K Cache memory (Expandable to 256K)
- High performance 1024 x 768 VGA with 256 colors including 1MB of video memory
- Super Hi-Res 14" VGA color monitor with tilt/swivel base
- 100MB IDE hard drive with Cache buffer
- 1.2MB 5.25" & 1.44MB 3.5" floppy drives
- 1 parallel & 2 serial ports
- 101-key enhanced keyboard
- MS DOS 4.01
- Microsoft Windows 3.0
- Hi-Res serial mouse

\$2,695.00

386 33 This powerful system has Cache memory upgraded to 128K in addition to the features listed above for only \$2995.00.

Visit us at Comdex booth # N2193

additional floppy drive or tape backup and 2 hard drives. So, we can help you add on and update to your heart's content.

Our research and development center is always striving for excellence. Since 1984 we've been designing our own products, and all of our system boards are manufactured right here in the U.S. When building our computers we utilize the latest surface mount and VLSI technology for the ultimate in product reliability and space saving design. Our performance and quality are simply the standard for our competitors to beat.

We are committed to providing you with a complete system that is ready to use the minute you open the carton. Everything is loaded, tested, burned in, and ready to go. And, in order to help you easily handle the new multi-tasking

Look At Our Other Value-Packed Systems

All of these fully-loaded systems include:

- 2MB RAM (Expandable to 8MB on board)
- High performance 1024 x 768 VGA with 256 colors including 1MB of video memory
- Super Hi-Res 14" VGA color monitor with tilt/swivel base
- 1:1 interleave Floppy/Hard Disk Controller
- 40MB 28ms Hard Disk Drive
- 1.2MB 5.25" & 1.44MB 3.5" floppy drives
- 1 parallel, 2 serial and 1 game port
- 101-key enhanced keyboard
- MS DOS 4.01
- 386SX includes Windows 3.0 and mouse

386 25 at \$1895.00 286 16 at \$1595.00 286 20 at \$1695.00

The Best Value The Standard Thing.



286 systems. And we back them with our total customer satisfaction program beginning with a 30 day money-back guarantee. If you are dissatisfied, simply return your system within 30 days for a full refund. No questions asked.

You can buy from Standard Computer with total confidence because all systems are also covered by our complete one-year parts and labor warranty. If you need help, we'll see that you get it. If you need a part, we'll express ship it to you.

When you have a question, just call our customer service hotline. Our technicians are available to you toll-free for as long as you own your system. If that isn't enough protection, how about this? We'll even include one year of on-site service at no extra charge.

Value That's Easy to Afford.

We work hard to make it easy for you to own and use our products. That also includes offering many convenient ways to purchase or lease a Standard system. Our corporate leasing programs are designed to fit your business needs.

Qualified company purchase orders, personal checks and most major credit cards are also accepted.

So, go ahead. Pick up

the phone and call us. Right now. Find out why we take so much pride in the exceptional products and services that we provide. Why our repeat customer rate is one of the highest in our industry. And why our product reliability is so famous. For us, it's just the Standard thing.

Standard Computer Corporation, 12803 Schabarum Avenue, Irwindale, CA 91706, phone 818/337-7711, FAX 818/337-2626.

and multi-screen programs, we preload MS DOS 4.01 and Microsoft Windows 3.0 then throw in a high resolution mouse to boot. How's that for commitment!

800/662-6111



We're also a Novell Gold Authorized Dealer, so you have total compatibility with all levels of the Novell operating system.

We Stand Behind Our Systems and Our Customers.

At Standard Computer, we manufacture everything from high performance 486 and 386 systems to low cost 386SX and

STANDARD
C O M P U T E R

Optimize Mechanical Designs on the Sun

Appplied Motion, a 3-D program for mechanical engineers who work on Sun-3 and Sun-4 workstations, includes an automatic design feature that lets them evaluate several alternatives. The program provides static, kinematic, dynamic, and inverse dynamic analyses in a 3-D environment. An engineer who needs to know the reaction loads of joints in a mechanism, for example, can use Applied Motion to compute the loads and, using the design sensitivity feature, minimize them.

Price: \$12,000.

Contact: Rasna Corp., 2590 North First St., Suite 200, San Jose, CA 95131, (408) 922-6833.

Inquiry 1306.

Racal-Redac and Minc Meld All-in-One Circuit Designer

Racal-Redac has integrated its CADAT program for simulating and testing programmable logic devices with Minc's tools for designing them. The program lets you design and test all kinds of digital logic circuit boards in one package.

With Minc's PLDesigner and PGADesigner device-independent tools, you describe how you want the device to work, including constraints such as maximum wattage or board size. The program's rule-driven technology mapping then automatically generates a device-specific design. These designs can incorporate devices ranging from a single field programmable gate array (FPGA) up to 20

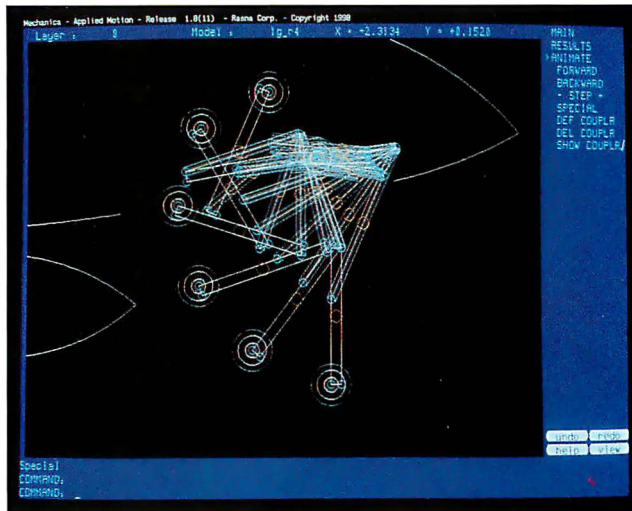

Rasna's Applied Motion recommends several alternatives to your mechanical design.

programmable logic devices (PLDs) or a combination of them.

CADAT then simulates the design, letting you verify the functionality of systems that incorporate standard logic, application-specific ICs, processors, and PLD/FPGAs without having to build a prototype board. CADAT runs on Sun workstations. Versions are planned for DEC and IBM RISC workstations.

Price: \$20,000 and up.

Contact: Racal-Redac, 1000 Wyckoff Ave., Mahwah, NJ 07430, (201) 848-8000.

Inquiry 1307.

Three from Dynacomp

Dynacomp adds three new programs—The Equator, Matrix Laboratory, and Molecular Modeling—to its line of math and science software for the IBM PC.

With The Equator, you can save equations on disk and plot them later with a range of values that you choose. The program supports trigonometric and hyperbolic functions and their inverses, square roots, and many other

types of functions. The Equator lets you store definitions of variables with their constants. Optional packages (\$19.95 each) for The Equator include equations for electrical engineering, statistics, and electromagnetics.

Matrix Laboratory lets you perform operations on moderate (20 by 20) matrices. The program supports such functions as inverse, condition, and square root.

The Molecular Modeling program lets you select elements from a periodic table and bond them. Once you have created the chemical model, you can view and animate it in 3-D.

Price: The Equator, \$59.95; Matrix Laboratory, \$19.95; Molecular Modeling, \$29.95.

Contact: Dynacomp, Inc., 178 Phillips Rd., Webster, NY 14580, (716) 265-4040.

Inquiry 1308.

How to Find the Best Equation to Fit Your Data

The TableCurve curve-fitting program takes your x,y data set and fits 221 candidate equations to it, ranking each equation in order of best fit. The program's equation set includes 60 first-order equations, 66 second-order equations, 55 third-order equations, rational polynomials, and polynomials.

TableCurve ranks each equation by the r-squared "goodness of fit" value, but it also ranks equations by floating-point efficiency. This means that you can choose the more efficient of two equations that are closely ranked in r-squared value.

Price: \$395.

Contact: Jandel Scientific, 65 Koch Rd., Corte Madera, CA 94925, (415) 924-8640.

Inquiry 1309.

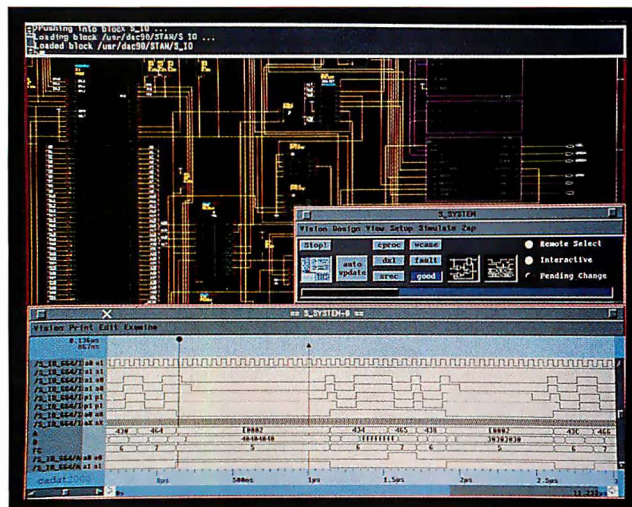

The PLD and PGA tool sets let you design, simulate, and verify your logical device and gate array plans in one package.

Hayes
ESP™

When your high-speed error-control modem outruns your PC system, you stand to lose more than a few characters. You could lose valuable time, not to mention your company's money.

The problem is that today's error-control modems often send data at speeds faster than even the best PC systems can handle.

This problem can be easily solved, however, with the new dual serial port from Hayes. When used with such high-performance software as Smartcom Exec™ or Smartcom III,* this remarkable communications coprocessor ensures data integrity at the highest speeds.

In fact, Hayes ESP is the only coprocessing serial card that can be used with standard communications software to prevent serial port

errors and provide error-free data transfer at speeds up to 57.6k bps. Even with such advanced operating systems as OS/2® and Windows.®

Of course, Hayes ESP also provides all the basic functions you want from a serial card, including two serial port connections for your printers, modems, or other equipment. And it works with all IBM® and fully compatible PCs.

What's more, Hayes ESP is backed not only by one of the best customer service staffs in the industry, but by a two-year performance warranty as well.

For more information about Hayes ESP, call us at 1-800-635-1225.

There's just no way you can go wrong with it.

Hayes. Our technology has
the computer world talking. More than ever.

Circle 132 on Reader Service Card

If you're not using Hayes ESP, you could be making a big mistake.

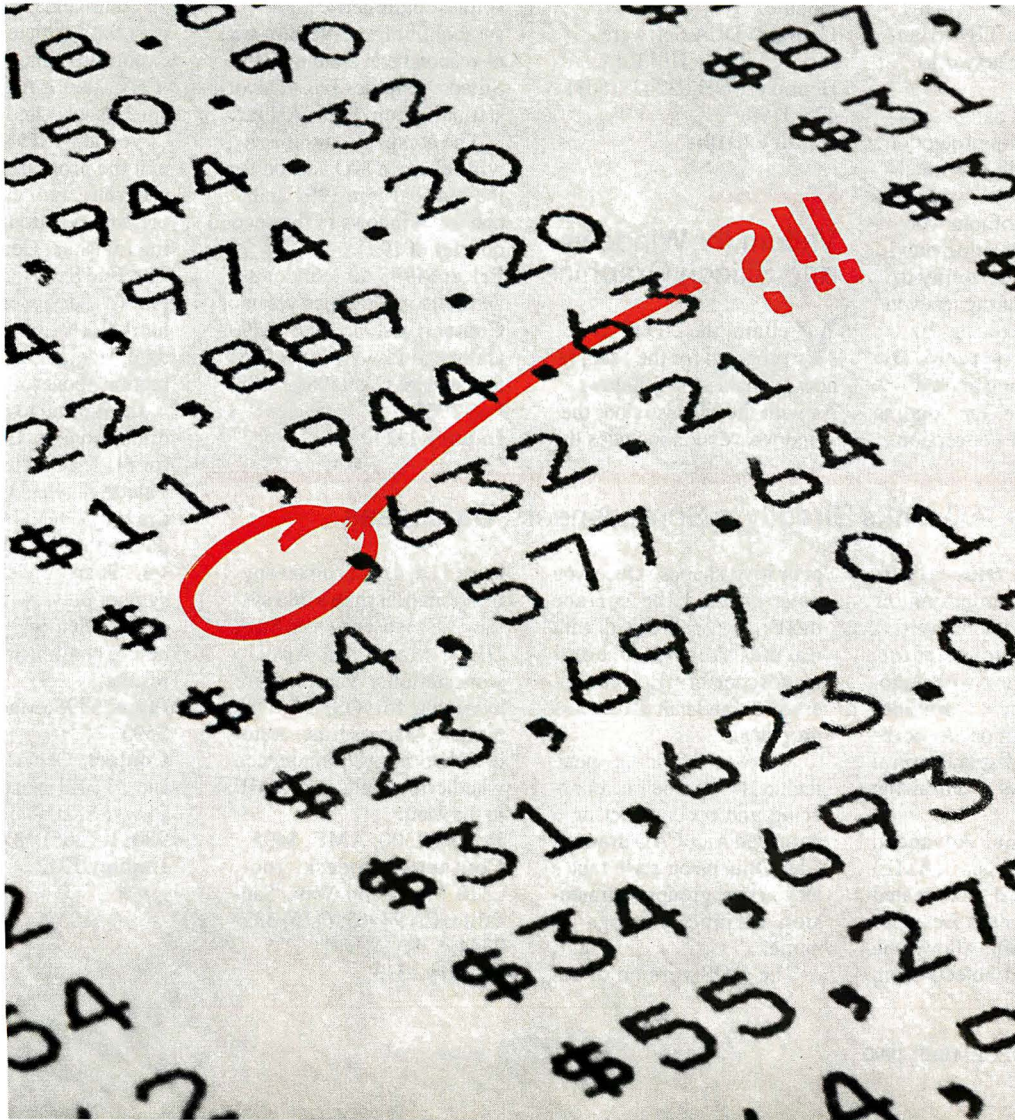

All trade names referenced are the trademarks or registered trademarks of their respective manufacturers.
© 1990 Hayes Microcomputer Products, Inc., P.O. Box 105203, Atlanta, GA 30348

Civil Engineering and Surveying for AutoCAD 11

DCA Software's civil engineering and surveying programs now support AutoCAD release 11. The company offers Survey Collection, Data Input and Reduction, Digital Terrain, Highways, Earthworks, and Landscape modules for AutoCAD, along with Coordinate Geometry, Design, and Advanced Design programs. New features of the programs include a project management system that lets you work with, store, and access information from any drive or directory, a new point database, negative stationing, right-to-left profiling, and dynamic TIN (triangulated irregular network) viewing.

The new point database offers complete point protection, sorting, and editing. With full point protection, you can add new points without worrying about overwriting previous point data. The ability to do negative stationing lets you add to existing drawings by extending from point zero. Dynamic TIN viewing and editing eliminates the step of going through DXF file conversion.

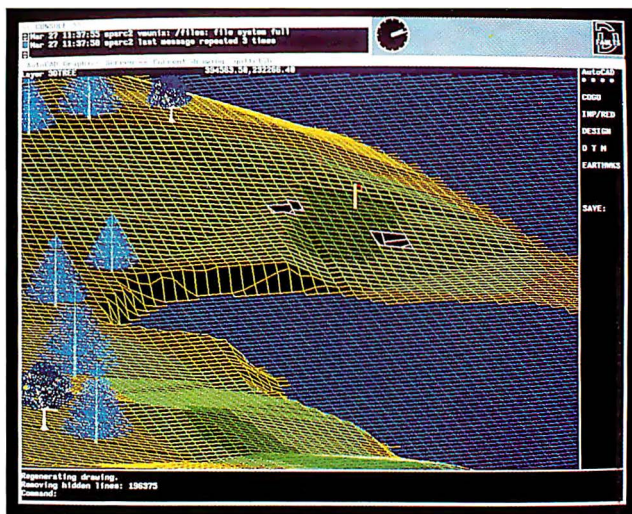

DCA Software offers a host of programs for AutoCAD 11.

The programs also add real-time cross sectioning and profiling and on-line TIN and contour generation.

Price: \$495 to \$1995 per module.

Contact: DCA Software, Inc., 7 Liberty Hill Rd., Henniker, NH 03242, (603) 428-3199.

Inquiry 1310.

Vellum for Windows and Silicon Graphics

Vellum, the 2-D CAD program for the Mac, is now available for Windows. As with the Mac version, the Windows version includes the

Drafting Assistant, Vellum's drawing aid that lets you accurately place objects in relation to one another. Other features include NURB splines, parametrics, and symbol libraries. Vellum will also soon be available on the Silicon Graphics Iris 4D workstation, according to Ashlar.

The company says that it will release a 3-D add-on for the Mac early in 1991 and one for Windows in the second quarter of 1991.

Price: \$1995 for Windows and Silicon Graphics versions. **Contact:** Ashlar, Inc., 1290 Oakmead Pkwy., Suite 218, Sunnyvale, CA 94086, (408) 746-3900.

Inquiry 1311.

New AutoCAD Links Directly to Spreadsheets, Databases

AutoCAD release 11 includes a programming language environment that lets you create programs in C that directly link with AutoCAD. Release 11 provides record locking on networks and lets you display several different views of a drawing at one time.

The optional Advanced Modeling Extension (AME) is an integrated tool created with the Autodesk Development System that allows you to create solid objects from

primitive shapes. Once you have created the surface model, you can edit it with normal AutoCAD commands, perform Boolean operations, and calculate mass properties.

Release 11's main menu includes a routine for recovering and reconstructing a damaged AutoCAD drawing file. Dimension style tables let you save groups of dimension variable settings by name.

The DOS version of re-

lease 11 will not run on anything smaller than a 286 system; it also runs on Sun, DEC, Mac, and Apollo workstations. Versions are available for OS/2 1.1 or higher. At press time, Autodesk had not yet announced whether it would port AME to the Mac.

Price: \$3500; AME, \$495. **Contact:** Autodesk, Inc., 2320 Marinship Way, San Ramon, CA 94583, (415) 332-2344.

Inquiry 1313.

Two 2-D CAD Programs for the Mac and IBM PC

Generic Software has released version 5.0 of its 2-D CAD program for the IBM PC and version 1 of its 2-D program for the Mac, both of which support automated associative dimensioning. With associative dimensioning, when you modify an object, the data associated with that object changes as well.

Other new features of Generic CADD 5.0 include the ability to zoom, pan, and execute other commands while in the middle of a drawing or editing command. It also lets you undo and redo your last 25 commands and offers support for attributes. You can export attributes in .WK1 and .CSV file formats for use in spreadsheets and databases.

Version 5.0's shell lets you exit the program, start another program, and return to your original position without having to restart Generic CADD. The File Selector utility displays a video memory of your hard disk's directory with date, size, and other information about the files.

In addition to associative dimensioning, Generic CADD for the Mac includes an Info Palette that lets you modify a drawing object by editing data rather than the object itself. Snap previewing and symbol previewing let you change elements of a design before committing to the results.

Price: \$395; Mac version, \$595.

Contact: Generic Software, Inc., 11911 North Creek Pkwy. S, Bothell, WA 98011, (206) 487-2233.

Inquiry 1312.

Introducing a Revolutionary Concept



HEALTHY COMPUTING

- *Flicker free... less eyestrain and stress.*
- *Flat screen... less fatigue and headaches.*
- *Low electromagnetic radiation... healthier work environment.*

Low Radiation Monitors

The Difference Is What You Can't See.

Do you experience eyestrain, headaches, fatigue and stress? Scientific studies show that many of these symptoms are caused by computer monitor radiation — even with occasional use.

We Care About Your Computing Safety.

Our customers demand quality, and expect long life from monitors. We expect the same from our customers. As a concerned manufacturer, ADI announces a new line of low radiation monitors to innovate a next to radiation-free computing environment.

ADI Is More Than a Monitor Manufacturer.

We also offer personal computers ranging from desktop and diskless PCs to workstations, and the complete spectrum of IBM plug-compatible and ASCII/ANSI terminals.

For more information, please contact:

HEADQUARTERS
ADI Corporation
14/F, 1, Nan-King E. Road,
Sec. 4, Taipei, Taiwan,
R.O.C.
Tel: 886-2-713-3337
Fax: 886-2-713-6555
Tlx: 21790 ADICORP

U.S.A. HEAD OFFICE
ADI Systems, Inc.
2121 Ringwood Avenue
San Jose, CA 95131
Tel: (408) 944-0100
Fax: (408) 944-0300
CA: (800) 232-8282
US: (800) 228-0530

U.S.A. EAST COAST
ADI Systems, Inc.
1259 Rt. 46E., Bldg #4
Parsippany, NJ 07054
Tel: (201) 334-0019
Fax: (201) 334-0076

The logo for ADI Corporation, featuring the letters 'ADI' in a stylized, red, outlined font, followed by 'CORP.' in a smaller, solid red font.

Make DOS Friendly in a Foreign Land

To a novice DOS user, unraveling the mysteries of DOS is difficult enough. Imagine how hard it must be if you can't speak English. A program called StarCOM consists of four programs that let you rename DOS commands to names and abbreviations that make sense in another language.

Developer OurSoft says you can also use the program to rename the DOS command and substitute a more powerful third-party command. StarCOM is not an interpreter, and thus both the command line and a batch file recognize the same command set. StarCOM does its work by renam-

ing the internal command table of COMMAND.COM. The program code of DOS remains untouched.

Price: \$59.95.

Contact: OurSoft, P.O. Box 6396, Bellevue, WA 98008, (206) 643-0204.

Inquiry 1190.

Stay in Touch on the Mac

Intouch 1.0, Advanced Software's desk accessory for the Mac, lets you store names and addresses with up

to 14 pages of notes attached to each address.

You can use the program for envelope printing and previewing, and it lets you design label and envelope layouts. The program's dial function lets you locate and dial numbers in the database,

Add Context-Sensitive Help to Your Applications

Zaron Software's Help! utility lets you add context-sensitive help and menus for your programs and DOS operations without requiring any changes or re-compiling of the application.

When used with standard text files, you can use Help! to create a flat-file help system. When used with HyperWord, Zaron's hypertext

word processor, you can create multidimensional help. You can use the TSR program to create a menu system to return text strings and commands to any application, as well as to the DOS command processor. The program is also capable of running a series of programs from script.

Help! includes sample

help files and programs, plus a help system for commonly used DOS commands, the company reports.

Price: \$49.95.

Contact: Zaron Software, 13100 Dulaney Valley Rd., Glen Arm, MD 21057, (800) 669-3348 or (301) 592-3334.

Inquiry 1191.

Prospero: the Pascal experts

The Language Definition

Prospero Pascal is a full ISO standard Pascal, with a whole range of extensions including dynamic length strings, longreals, random access file handling, bit level manipulation, type breaking, include files and separate compilation. Prospero also produced the first ever microcomputer Pascal compiler to be validated as conforming to the ISO standard (for the Z80 under CP/M) in 1983, as well as the first validated Pascal compiler for the IBM PC in 1985.

The Package

As well as a compiler, you get a linker, librarian, cross-reference generator, source level symbolic debugger (except for Z80 systems) and a free technical support hot-line.

Prospero Pascal is available for the following environments.

OS/2	\$390	Full support for OS/2 and DOS. Full ISO level 1, with Prospero Workbench, the power programmer's choice.
MS-DOS	\$290	As above, but without OS/2 support.
PC clones	\$99	Personal version.
DOS/GEM	\$99	Full GEM support, integrated development environment.
DOS→CP/M	\$768	MS-DOS hosted Z80 cross compiler.

Now with 30 day money back guarantee. Prices include UPS shipping. Federal Express next day delivery is available for an additional charge. For information on any of these products, or any of our other development tools, contact us at the address below.

Call us for further details on **1-800-327-6730**.

Prospero Software

LANGUAGES FOR MICROCOMPUTER PROFESSIONALS

100 Commercial Street, Suite 306, Portland, ME 04101 Tel: (207) 874 0382 Fax: (207) 874 0942

You Don't Have to be a Programmer to Develop Database Applications . . .

```
ZP:CODE = LD:ZIP
SET(ZP_KEY,ZP_KEY)
LOOP UNTIL BOF(ZIP)

PREVIOUS(ZIP)
IF ZP:CODE <= LD:ZIP
  SL:CODE = ZP:SLSMN

GET(SLSMN,SL:SL_KEY)
LD:SLSMN = SL:CODE
DISPLAY(?LD:SLSMN)
BREAK
```

FIRST NAME	LAST NAME	TITLE	COMP C/P
1. Jim	Brown	President	C
2. Judy	Smith	U.P. Operations	
3. John	Jones	U.P. Sales/Marketing	
4.			
5.			
6.			
7.		Material Contact	

When You Use Nutshell Plus II!

Programmers, dealers and end-users alike love the power of Nutshell Plus II. Imagine setting up a relational database ready to go in a matter of minutes! Don't worry if you change your mind; the database is modifiable instantly! Whether you wish to create

a simple mailing list or sophisticated invoicing system that joins a master client file, the capability is all there—thanks to Nutshell's simplicity of setting up custom input screens, custom reports, form letters, labels. The list is endless!

Features:

- Quick & easy design
- Fast execution
- Custom screen layouts
- Sophisticated reports, form letters, labels, etc.
- Relational lookups and information capturing
- Modifiable at any time

New Features with Nutshell Plus II:

- More import/export formats: dBASE II, III and IV, FileMaker along with ASCII and DIF.
- More search/find capabilities
- International symbol support
- Runs up to 10 times faster than Ver.I.
- Special upgrade pricing available to existing Nutshell users

And also Nutshell Plus II Professional:

- Nutshell Plus II full development version
- 4 run-time disks to distribute your applications
- Designed specifically for corporate users, VARs, consultants and resellers

Don't Create Another Database Without Trying Nutshell Plus II.

IRIS Software Products™

Visit your nearest retail dealer or call 1-800-582-IRIS to get the name of the dealer nearest you who sells Nutshell and Nutshell Plus II.

P.O. Box 57, Stoughton, MA 02072

Phone: **617-341-1990** FAX: **617-344-4640**

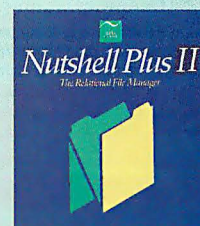

the company reports.

You can search for names and addresses using any text string, and Intouch lets you import and export addresses from other applications. As you add notes about each name in the address, the program time- and date-stamps them. **Price:** \$69.95.

Contact: Advanced Software, Inc., 1095 East Duane Ave., Suite 103, Sunnyvale, CA 94086, (800) 346-5392 or (408) 733-0745.

Inquiry 1189.

A Program to Watch Over You

Although most people prefer not to work while someone watches over their shoulder, Micro Logic's

newest program may change this attitude.

Key Watch lies in wait in your system, watching your keystroke patterns as you work in your word processor, spreadsheet, or database application. Once it detects a repetitive pattern (e.g., reformatting a document or deleting a series of cells in a worksheet), Key Watch sounds a beep to offer its assistance. At this point, you can perform the repetitive motion with a single keystroke. Other actions in which the program can save keystrokes include modifying a series of fields in a database or commenting lines of code in a program.

Micro Logic says the first implementation of the program can't look for repetitions over several different sessions in an application, although that

ability will be added in a later version. The purpose of Key Watch for now is to keep you from typing the same thing twice, saving time and effort in the process.

Key Watch runs on the IBM PC with 256K bytes of RAM. It is RAM-resident and requires 3K bytes.

Price: \$69.95.

Contact: Micro Logic Corp., P.O. Box 70, Dept. P, Hackensack, NJ 07602, (800) 342-5930 or (201) 342-6518.

Inquiry 1192.

Lightning Strikes Again

The newest version of Lightning, DacEasy's caching program for the IBM PC, lets you specify the size of

its buffer, up to 8 MB of conventional, extended, or expanded memory.

In addition to its claim that Lightning 5.5 is the fastest cache on the block, DacEasy says the program lets you choose which drives will be affected and lets you specify full track read.

The program supports DOS 4.0 and drives larger than 32 MB. It also works with Windows 3.0.

The program's Disk Watch feature, a color-coded screen indicator that appears in a corner of your screen, shows the number of disk accesses as they occur.

Price: \$29.95.

Contact: DacEasy, Inc., 17950 Preston Rd., Suite 800, Dallas, TX 75252, (800) 877-8088 or (214) 248-0205.

Inquiry 1193.

Leasing
Now Available

Digitizers

Calcomp
All Models,
CALL for Savings

Summagraphics

Sketch II 12 x 12, 4-But	345
Sketch II 12 x 12, 16-But	427
Sketch Pro II 12 x 18, 16-But	666
Large Formats	Call

Kurta

12 x 12, 4 Puck Stylus	345
12 x 12, 12-But Corded	435
12 x 17, Corded Puck	585
30 x 36, 16-But	2015
36 x 48, 16-But	2394

GTCO

Sketch Master 12 x 12	319
SL 24 x 36	Super Pricing
SL 36 x 48	Super Pricing

Hitachi

Puma 12x12, 4 or 12-But	375
Tiger 12x12, 12-But	648

Complete CAD Workstations

Each system fully configured including 2 Serial Ports, 1 Parallel Port, corresponding Math CoProcessor, Enhanced "AT" 101 Keyboard, 1.2MB Floppy, DOS 3.3, GW-Basic, SUMMAGRAPHS SUMMASKETCH PLUS, EVEREX VGA GRAPHICS CARD and EVEREX MODEL 300-01 (15-35KHz) MULTISCAN COLOR MONITOR. Each system thoroughly tested prior to shipment and supplied with a Full One Year On-Site Warranty!!!

System Configuration	Cache Memory	44MB MFM	80MB MFM	92MB ESDI	150MB ESDI
Everex Step 486/33 w/8MB	128Kb	\$8495	\$8595	\$8895	\$9095
Everex Step 486/25 w/8MB	128Kb	7595	7695	7895	8095
Everex Step 386/33 w/4MB	64Kb	6295	6395	6895	7095
Everex Step 386/25 w/4MB	64Kb	5295	5495	5995	6195
Everex Step 386/20 w/4MB	64Kb	4879	5028	5495	5795

Monitor & Card Combos

Graphics Card	Only	w/ Hitau 19"	Hitachi 21"	Hitachi 20"	Nanao 16"	Nanao
		HL6905	4320-21 AP	CM2085M	9070S	9070U
Artist XJ 10/16	Call	\$3515	\$4105	\$3415	\$2480	\$2594
Artist XJ 12/16	Call	3985	4575	3885	-----	-----
Methus 1124	\$1250	3270	3860	3170	2235	2350
Methus 1224	1260	3280	3870	3180	-----	-----
#9 Pro 1280	2110	4130	4720	4030	-----	-----
#9 Pro 1024	1299	3319	3909	3219	2284	2398
VMI Cobra 16HS	1350	3370	3960	3105	2335	2449
Video 7 VRAM 512	380	2400	3039	2300	1384	1479
Monitor Only		2020	2610	1920	985	1099

The above is a partial listing of our product line. Please inquire if you're interested in a product not listed. All names are trademarks and registered trademarks of their respective companies.

• Quoted prices reflect a 2% cash discount.
• Prices subject to change without notice.
• All manufacturers' warranties apply.

• Rated companies call for terms.
• C.O.D., VISA, Mastercard & Amex.
• Member Better Business Bureau.

We Carry a Complete Line of Modems, Network Boards & Accessories, Math & Memory Chips, Surge Protection

Renaissance GRX Graphic Boards

"Speed & Compatibility"

Plotters-All Models

Calcomp
HP
Houston Instruments
Ioline
Roland

CAD Buster \$13,500.00

EVEREXSTEP 386/33 w/8MB* SIMM, 150MB ESDI Hard Drive

Includes Renaissance Rendition II 16" Color with VGA Module, Hitachi CM-2085M or Mitsubishi HL-6905 19" Color Monitor, A thru D 8-Pen Plotter, 12 x 12 Digitizer your choice of three. *5MB minimum requirement for AutoCAD/386. Delivery limited to continental U.S.A.

1-800-289-1650
6760 Miller Road • Brecksville, Ohio 44141

CAD WAREHOUSE

True 386 LAPTOP

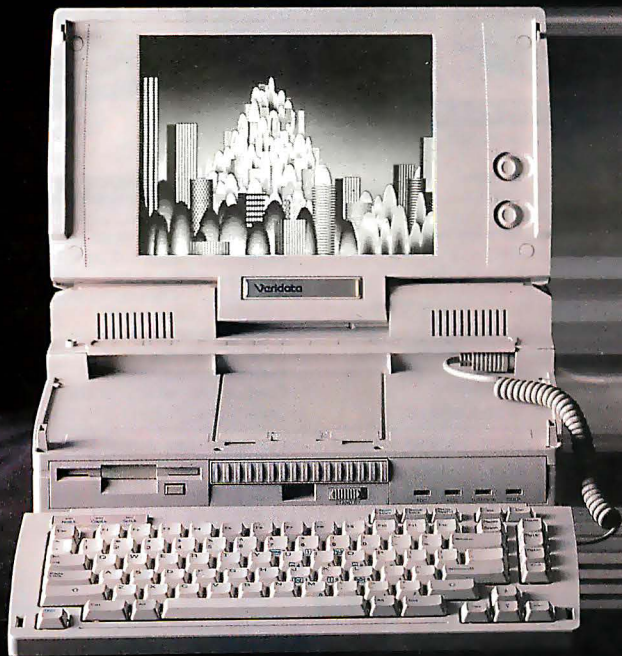

386 DX (not SX), true 32 bit, upto 100MB HDD

LAPPOWER™ 386 SPECIFICATIONS CPU AND MEMORY

Processor

- CMOS 80C386 DX (not SX) 32-bit processor 20/8 MHz, switchable. Socket for 80C387 numeric coprocessors.

Memory

- 2MB RAM standard expandable to 8MB support EMS 4.0.

DRIVES

- The internal 3.5" 1.44MB floppy disk drive, and one 40MB or one 100MB HDD with average access time less than 29ms.

VIDEO

Display

- A Double-STN Black and White display with VGA resolution. Adjustable contrast and brightness. Backlight timeout feature.

Display Graphics

- 640*480 high-resolution text and graphic; 16 levels of gray scale.

Video

- VGA/EGA/CGA/MDA utilizing the laptop LCD video controller, higher resolution possible through Desktop Expansion Chassis.

POWER

AC

- 90/250 VA (50/60 Hz) autosensing with charging indicator.

Battery

- 40.6 Watt-Hr NiCad battery pack; easy changeable recharge, orange low power LED indicator plus audible warning beeps, overcharge protection.

Intelligent Power Management

- Power control of backlight, mass storage, internal modem and process speed.

PHYSICAL

Size

- 13.7"W*8.5"D*4.3"H (349mm*316mm*107mm)

Weight

- 14 lbs (6.4 Kg).

DESKTOP EXPANSION CHASSIS (OPTIONAL)

VERIDATA RESEARCH INC.

Unit A&B, 11901 Goldring Road, Arcadia, CA91006.

Tel: (818)303-0613 Fax: (818)303-0626

DISTRIBUTORS:

in CA Tech Power 714-979-1330 Matrix Digital. Products, Inc. 800-227-5723

in GA Computer & Control Solutions, Inc. 404-491-1131 818-566-8567

Veridata
Where creativity thrives with ingenuity

VGA PORTABLE

5 YEARS PORTABLE EXPERIENCE

Color

ALL SYSTEMS RUN UNIX, XENIX,
LAN OS DOS AND OS/2.

LIGHTEST &
SMALLEST
CRT PORTABLE
1024x768 RES, 256 COLOR



VGA LCD



VGA PLASMA



The BSI 386SX was the
Fastest Machine
in PC Magazine Review

See Aug. 1990 P. 109, 120

386SX 40MB SYSTEM (Desk Top)

- 386SX-16 MHz CPU, 1MB Memory (To 4MB)
- 200W P/S, 110/220V
- 101 Enhanced Keyboard
- 1:1 Interleave Cont. Card
- 1.2 MB or 1.44MB FDD
- 40MB, 23ms, SCSI IDE Hard Drive
- 2 Serial/1 Parallel/1 Game Port
- Mono Graphic Card w/Printer Port
- 12" Amber Monitor (720x348 Res.)

\$1,089
On Sale

386-33 200MB SYSTEM (Desk Top)

- 386-33 MHz CPU, w/64K Cache Memory
- 1MB Memory on board (To 8MB)
- 200MB, 19ms, IDE Hard Drive
- Other features the same as 386SX

\$2,279

HDD	286-12	386SX	386/25	386/33	486/25
40MB	799	1089	1359	1639	2759
65MB	859	1149	1419	1699	2819
80MB	1139	1449	1719	1999	3119
100MB	1139	1449	1719	1999	3119
150MB	1409	1689	1959	2239	3359
200MB	1459	1729	1999	2279	3399
345MB	2229	2489	2759	3039	4759

- Upgrade to VGA (640 x 480 Res) + \$330
- Upgrade to VGA (1024 x 768 Res) + \$560
- Mini Vertical Case + \$50
- Regular Vertical Case + \$100

PORTABLE SKD KITS AND BAREBONE SYSTEMS AVAILABLE CALL FOR PRICING	MOTHER BOARD ON SALE
	286-12 MB \$105
	386SX MB \$355
	386-25 MB \$570
	386-33 MB \$850
	486-25 MB \$2,000

•386SX VGA 40MB LAPTOP LT54CC \$2400

•386SX VGA 40MB LAPTOP LT5600 \$2450

Prices subject to change without notice.
Call for return policy.



9440 Teistar Ave., #4, El Monte, CA 91731

For Order Only Call Toll Free

1-800-872-4547

1-818-442-0020 Information

Customer Support: (818) 442-7038

Fax: (818) 442-4527

All order will be shipped by UPS COD cashier's check. Company check on approval IBM PC XT/AT are registered trade marks of IBM Inc.

386-33 200MB COLOR VGA PORTABLE

- Built-in SONY 8.5" Color VGA Monitor
- 0.26mm Dot Pitch,
- Speed Digital Display, 3 Drive Bays
- 220W P/S 110/220V, 4 Exp. Slots
- 86-Key Detachable Keyboard
- 386-33 MHz CPU, w/64 K Cache Memory
- 1MB Memory on Board (To 8MB)
- VGA Graphic Card (512K, 1024x768 Res.)
- External Monitor Adaptor
- 1.2MB or 1.44MB FDD
- 200MB 19ms HDD (To 500MB)
- Serial/Parallel/Game Ports
- Carrying Bag, Weight 27 Lbs.
- Dimensions: 17.5(W) x 14.1(D) x 6.8(H)
- Bigger Case with 7 Exp. Slots Optional

\$3,779
(Special)

HDD	286-12	386SX	386/25	386/33	486/25
40MB	2189	2469	2779	3049	4109
100MB	2519	2799	3109	3379	4439
150MB	2879	3159	3469	3739	4799
200MB	2919	3199	3509	3779	4839
345MB	3809	4089	4399	4669	5729

VGA AMBER CRT PORTABLE 100MB AT

- Built-in 9" Amber VGA Monitor
- Speed Digital Display, 3 Drive Bays
- 205W P/S 110/220V, 4 Exp. Slots
- 86 Keyboard, Detachable Keyboard + \$30
- AT 12 MHz System, 1MB Memory (To 4MB)
- VGA Graphic Card (256K, 800x600 Res.)
- Run 48 Grey Scales VGA Internally
- Run Color VGA Externally
- 1.2MB or 1.44MB FDD
- 100MB 25ms HDD (To 500MB)
- Serial/Parallel/Game Ports
- Carrying Bag, Weight 26 Lbs
- Dimensions: 17.5 (W) x 14.1 (D) x 6.8 (H)

\$1,779

HDD	286-12	386SX	386/25	386/33	486/25
40MB	1449	1729	2039	2309	3369
65MB	1569	1849	2159	2429	3489
100MB	1779	2059	2369	2639	3699
150MB	2139	2419	2729	2999	4059
200MB	2179	2459	2769	3039	4099
345MB	3069	3349	3659	3929	4989

AMBER CRT PORTABLE 100MB AT

- Built-in 9" Amber Monitor
- Speed Digital Display, 3 Drive Bays
- 205W P/S 110/220V, 4 Exp. Slots
- 86 Keyboard, Detachable Keyboard + \$30
- AT 12 MHz System, 1MB Memory (To 4MB)
- Mono or Color Graphic Card
- Amber EGA Display (option) + \$100
- 1.2 MB or 1.44 MB Floppy Drive
- 100MB 25ms Hard Drive
- Carrying Bag Weight 26 lbs.
- Dimensions 17.5(W) x 14.1(D) x 6.8(H)

\$1,499

HDD	286-12	386SX	386/25	386/33	486/25
40MB	1169	1449	1759	2029	3089
65MB	1289	1569	1879	2149	3209
100MB	1499	1779	2089	2359	3419
150MB	1859	2139	2449	2719	3779
200MB	1899	2179	2489	2759	3819
345MB	2789	3069	3379	3649	4709

COLOR EGA CRT Portable Available

386-33 200MB VGA PLASMA PORTABLE

- 640x480 VGA Plasma Display
- Detachable 101-key Keyboard
- 200W P/S, 110/220V, 3 Drive Bays
- 386-33 MHz CPU, w/64 K Cache Memory
- 1MB Memory on Board (To 8MB)
- 1.2MB or 1.44MB FDD
- 200MB 19ms HDD (To 500MB)
- Serial and Parallel Ports
- External Monitor Adaptor
- Carrying Bag, Weight: 26 Lbs.
- Dimensions: 16 "(W) x 9.75"(H) x 8.5"(D)

\$3,269
On Sale

HDD	286-12	386SX	386/25	386/33	486/25
40MB	1729	2009	2319	2589	3649
65MB	1859	2139	2449	2719	3779
100MB	2039	2319	2629	2899	3959
150MB	2319	2599	2909	3179	4239
200MB	2409	2689	2999	3269	4329
345MB	3199	3479	3789	4059	5119

CGA PLASMA PORTABLE 100MB AT

- 640x400 CGA Plasma Display
- Detachable 86-Key Keyboard
- External RGB Monitor Adaptor

\$1,719

HDD	286-12	386SX	386/25	386/33	486/25
40MB	1409	1689	1999	2269	3329
65MB	1539	1819	2129	2399	3459
100MB	1719	1999	2309	2579	3639
150MB	1999	2279	2589	2859	3919
200MB	2089	2369	2679	2949	4009
345MB	2879	3159	3469	3739	4799

386-33 100MB VGA LCD PORTABLE

- 640x480 Res. Backlit LCD VGA Display with External Color Monitor Adaptor
- 200W 110/220V P/S, 5 Exp. Slots
- Detachable 89-Key Keyboard
- 386-33 MHz CPU with 64K Cache Memory
- 1.2MB or 1.44MB FDD
- 100MB 25ms HDD (To 500MB)
- Serial/Parallel/Game Ports
- 9.45"(H) x 7.9"(D) x 15.7"(W), 23LBS

\$2,539
Best Buy

HDD	286-12	386SX	386/25	386/33	486/25
40MB	1369	1649	1959	2229	3289
65MB	1489	1769	2079	2349	3409
100MB	1679	1959	2269	2539	3599
150MB	1999	2279	2589	2859	3919
200MB	2059	2339	2649	2919	3979
345MB	2839	3119	3429	3699	4759

•LCD CGA 640X400 Res. Portable Less \$120

•LCD EGA Model Available Call

All Merchandise FOB El Monte

ACT NOW
Limited-time
Offer

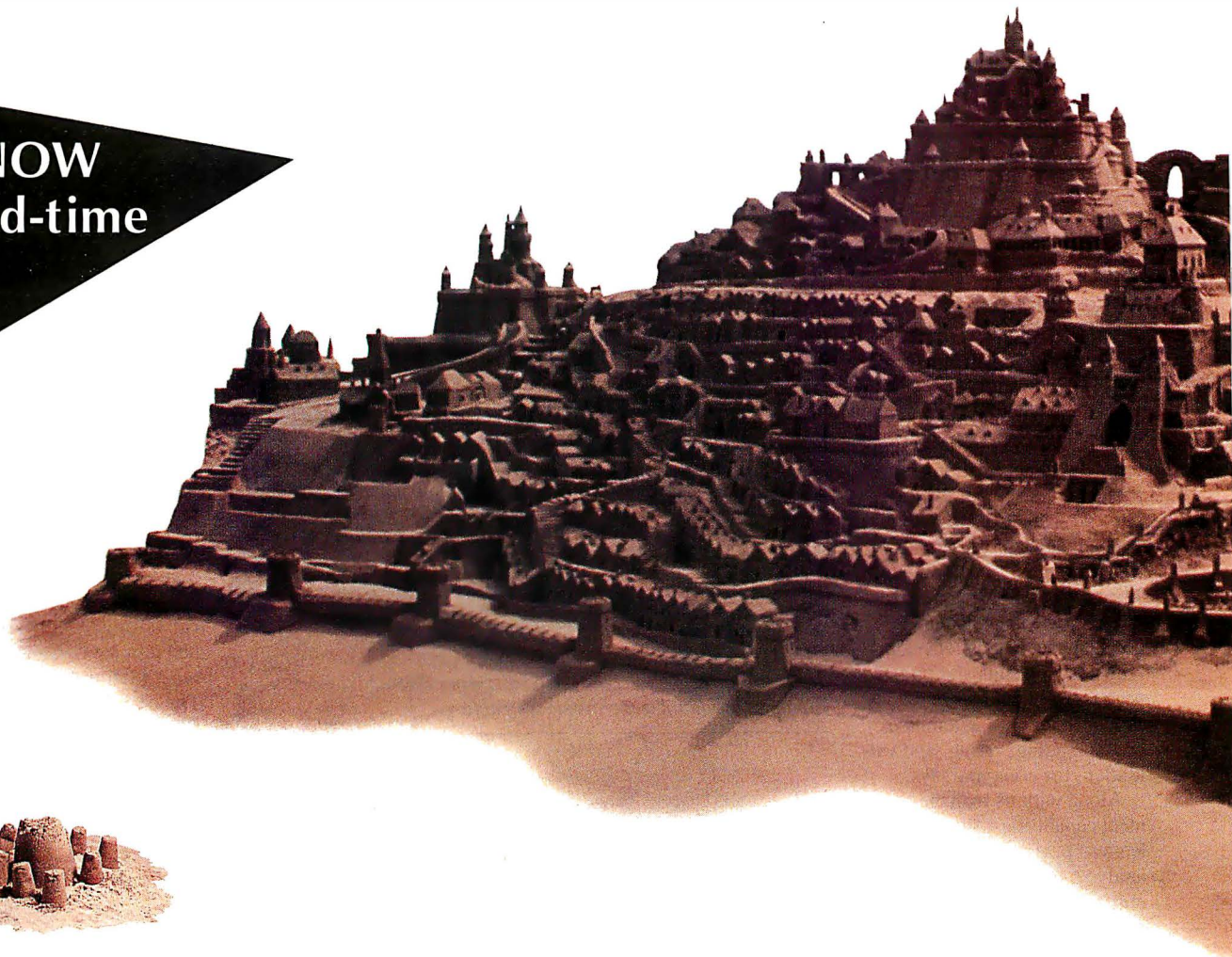

Now you can build more in a day.

HyperPAD® 2.0, a powerful software construction set for MS-DOS® systems, dramatically increases your productivity. Applications that might take months to build with tools like Pascal, C, or BASIC now take only minutes.

PC Week calls HyperPAD "the first PC program that can compare with HyperCard®." HyperPAD 2.0, now updated with over 100 new features and improvements, has almost limitless potential for creating and customizing tutorials, help systems, software prototypes, front ends to databases, networks, or CD-ROM devices, executive information systems, and dozens of other applications.

It's easy. HyperPAD's object-oriented environment gives you all the building blocks you need for maximum productivity. Its English-like scripting language is easy to use and learn, with dozens of samples to get you started.

It's flexible. HyperPAD will take you into the 90's with a full set of development tools. Its open architecture lets you easily use data stored in dBASE and ASCII files. If you need to, you can even write C or assembly language extensions.



It works on your PC. HyperPAD 2.0 is compatible with almost all PCs. You don't need a high-performance processor, multiple megabytes of memory, a graphics card, or a mouse. You get the benefits of a graphical user interface without investing in Microsoft® Windows™ or OS/2.

Order before December 31, 1990, to get HyperPAD 2.0 for only \$59.95 directly from Brightbill-Roberts (suggested list \$149.95). Mention this ad and receive a royalty-free runtime module. 60-day money-back guarantee. VISA, MasterCard, American Express, or C.O.D.

Call 1-800-444-3490 today.

Try HyperPAD 2.0 on your next project. No one will ever know how much time you didn't spend.



120 E. Washington St., Syracuse, N.Y. 13202

Take Control of Project Contracts with Artemis Cost

Metier Management Systems, a company that offers several applications for project management, developed Artemis Cost to help you manage a project's contract throughout its life cycle. The program helps you maintain consistency between costs and schedules, develop realistic proposals and budget baselines, and increase productivity with automated cost spreading, rating, and validation, the company says.

Along with its management capabilities, the program lets you perform what-if analyses to assess the potential cost of a change in rate or another factor. The program provides more than 200 standard reports, including Department of Defense formats.

As with other programs for large projects, Artemis Cost lets you define a project according to work breakdown structure, organization breakdown structure, and cost element structure.

The program works with Metier's other programs for the 386: Artemis Project 7.1.6 and Artemis Team, for allocating human resources. Artemis Cost requires either the Artemis 7000/386 command language for customizing the program to fit your company's specific needs or the run-time version. It requires a 386 with at least 1 MB of extended memory. **Price:** Artemis Cost, \$3830; 7000/386 command language, \$6090; run-time version, \$1830.

Contact: Metier Management Systems, Inc., 12701 Fair Lakes Cir., Suite 350, Fairfax, VA 22033, (703) 222-1111.

Inquiry 1166.

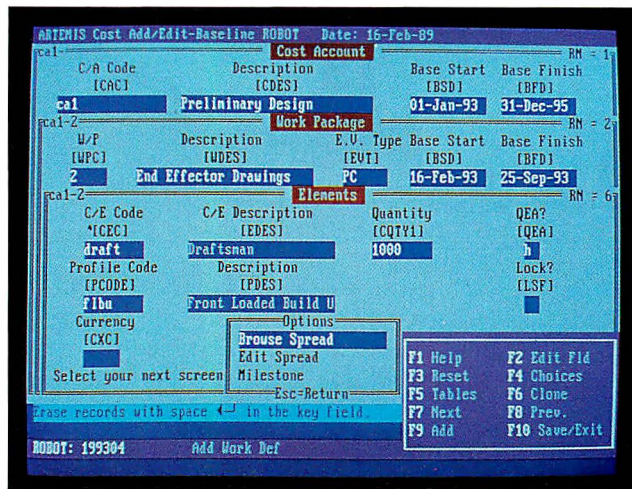

The screen layouts of Artemis Cost complement the underlying data structures, so that Cost Account, Work Package, and Elements maintain a hierarchical structure.

Take Care of Your Business

Takin' Care of Business, a program for small- to medium-size businesses, lets people without accounting experience monitor assets, liabilities, net worth, capital, and other areas of business finances.

The General Ledger is the foundation of the program. It records your transactions into the appropriate account and lets you generate a variety of financial statements.

The Account Reconciliation module balances your

checking accounts, finding the exact amount of any discrepancy. Financial Utilities helps you calculate financial risk by calculating future values, payments, terms, interest rates, and amortization schedules.

The Accounts Payable module automates the payment of invoices, preventing you from missing a discount or payment. Other modules include Accounts Receivable and Payroll, which can handle up to 1000 employees.

Price: Module prices range from \$14.95 to \$49.95.

Contact: Hooper International, Inc., P.O. Box 50200, Colorado Springs, CO

80949, (800) 245-7789 or (719) 528-8990.
Inquiry 1167.

Act! Now Works on Networks

Contact Software International says it wrote the new version of its contact management program Act! in C++ to provide the hooks to run on any DOS-based LAN and provide portability to other platforms in the future. The company added a TSR critical alarm that pops up while you're in an application such as Lotus 1-2-3.

Act! 2.0 has all the normal features of contact management programs: tracking calls, scheduling meetings, keeping to-do lists, setting alarms, and resolving conflicts. It deals with these in multiples: You can schedule tasks with reminders.

The program's word processor supports automatic mail merge.

Price: \$395; LAN version, \$995 for five.

Contact: Contact Software International, 1625 West Crosby Rd., Suite 132, Carrollton, TX 75006, (214) 418-1866.

Inquiry 1169.

Financial Planning Without Software Manuals

Granville Publications Software has released a new version of its program for managers who need to plan finances but don't want to buy an expensive spreadsheet and plow through a thick manual.

Up Your Cash Flow 2.0 has seven spreadsheet formats that automatically link related items.

Menus guide you through a financial forecast in minutes, providing a profit and loss forecast/budget, cash

flow forecast/budget, projected balance sheet, term loan amortization schedule, payroll analysis, sales by product/product line, and cost of goods sold by product/product line.

Up Your Cash Flow 2.0 lets you forecast and consolidate up to 99 branch operations and separate entities. You can complete a multiple-year forecast, use fixed and variable costs of goods sold, and have different fixed and variable costs for each month

of the forecast. The program has 28 predefined expense categories. It also provides for up to 30 user-defined categories.

Up Your Cash Flow 2.0 runs on the IBM PC with 512K bytes of RAM.

Price: \$129.95.

Contact: Granville Publications Software, 10960 Wilshire Blvd., Suite 826, Los Angeles, CA 90024, (800) 873-7789 or (213) 477-3924.

Inquiry 1168.

When MACWORLD Expo comes to San Francisco, it's big news.

125 pages
25 cents

35 cents at newsstands beyond
30 miles from San Francisco

SAN FRANCISCO

THURSDAY, JANUARY 10, 1991



POST STAFF ILLUSTRATION/KAREN SAMATIS

Fanatical and fledgling MacHeads mingle at MACWORLD Expo/San Francisco

50,000 MacHeads invade San Francisco

Register now for MACWORLD Expo/San Francisco, January 10-13,
and save \$10-\$15

For details, please turn the page . . .

EXTRA! EXTRA! The original Macintosh computer show returns to San Francisco

Mark your calendar and make your reservations. The world's biggest Macintosh event is returning to San Francisco, January 10-13, 1991. In four action-packed days, you'll pick up all the latest Macintosh news — and discover new ways to put your Mac to work — in the office, lab, studio, classroom, or in your home.

Whether you're interested in networking, spreadsheet analysis, databases, multimedia, education, accounting, law, engineering, design, publishing, illustration, animation, music, programming, or fun and games, you'll find it at MACWORLD Expo/San Francisco.

Visit over 500 exhibiting companies, attend dynamic seminars and workshops run by industry experts and sharpen your Mac skills on the spot. And more.

Here's a quick look at what you can expect in San Francisco in January:

Start off Thursday, January 10 with **State-of-the-Art Show Starters** designed to provide you with an overview of the latest and greatest developments in each conference track (and a few surprise areas). Friday and Saturday begin with exciting **Keynote Sessions** featuring luminaries from the world of Macintosh, insights from industry leaders, and a classic example of just how much fun the Mac can be!

Following the Keynote Sessions you can choose from sessions in nine different conference tracks, including:

- **The Multimedia Mac**, the integration of video, sound, and animation by the Mac
- **Designer Solutions** for architects, graphic artists, engineers and advertising professionals
- **The Mac in Entertainment**, ranging from Desktop Video to the Mac in Hollywood
- **User Workshops**, for those just getting started with the Mac
- **The Mac in Big Business** for users in large organizations
- **Programmer/Developer Forums** for veteran and novice techies
- **Special Interest Group Meetings** for users in education, healthcare and more
- **The Lighter Side** because the Mac was designed to be fun!
- **Late-Breaking/Popular Demand Topics** for those who want to get the scoop on the latest Mac developments

And finally, on Sunday, January 13 attend **Application Workshops**, a series of two-hour, intensive, application specific learning sessions.

Register for MACWORLD Expo/San Francisco by December 10th — save \$10-\$15

This is your chance to preregister for MACWORLD Expo/San Francisco, Thursday through Sunday, January 10-13, 1991, at Moscone Center and Brooks Hall/Civic Auditorium. Due to popular demand, plastic badges are back which may cause long registration lines at the show. To avoid the hassle, preregister and save!

Please choose your package and fill out this form completely. Incomplete forms will be returned. Use one form per person. (Make photocopies to register additional people.) Then send the completed form(s) along with payment to: MACWORLD Expo, P.O. Box 4010, Dedham, MA 02026.

Special Instructions for International Attendees.

If you're preregistering from outside the U.S. and prefer to have your badge sent to you instead of picking it up at Moscone Center, be sure to check the appropriate box on the preregistration form. Also, please add an additional \$45 to your preregistration cost. We will Federal Express your badge directly to you. Please fill in the exact street address and be sure to include your telephone number. Do not use a Post Office Box.

Hotel & Show Hotline:
617-361-3941



MACWORLD Expo/San Francisco announces show hours

■ CONFERENCE & EXHIBITS

Thursday, January 10	3 p.m. - 9 p.m.
Friday, January 11	10 a.m. - 6 p.m.
Saturday, January 12	10 a.m. - 6 p.m.
Sunday, January 13	10 a.m. - 3 p.m.

■ REGISTRATION

Mon.-Wed, Jan. 7, 8, 9	10 a.m. - 5 p.m.
Thursday, January 10	10 a.m. - 9 p.m.
Friday, January 11	8 a.m. - 6 p.m.
Saturday, January 12	8 a.m. - 6 p.m.
Sunday, January 13	8 a.m. - 3 p.m.

Land big savings on American Airlines AA

MACWORLD PRESS

AMERICAN Airlines is the official sponsor of MACWORLD Expo. And you can save 5% to 45% if you fly to San Francisco on American. To take advantage of this offer, just call 800-433-1790 for Star File number S-0111AL. You will automatically receive your

...Americans can find rea...
...satisfaction - and hope - i...
...alization of Eastern E...
...Americans are bedding...

...freedom, while his...
...in the West are ignored...
...use they continue to ad...
...ome old, tired prescrip...
...ism-Leninism in the...
...us empirical evidence...
...Hayek and William F. Bu...
...among others. The influen...
...lectuals is not in decline; th...
...sive power of the left is...

Americans will once ag...
to academic (read: liberal) U...

Register for MACWORLD Expo/San Francisco by Dec. 10th and save \$10-\$15

came on

This is your chance to preregister for MACWORLD Expo/San Francisco, Thursday, Friday, Saturday and Sunday, January 10, 11, 12, and 13, 1991, at Moscone Center and Brooks Hall/Civic Auditorium.

Please choose your package and fill out this form completely. Incomplete forms will be returned. Use one form per person. (Make photocopies to register additional people.) Then send the completed form(s), along with payment to: MACWORLD Expo, P.O. Box 4010, Dedham, MA 02026. **Please do not staple check to form.**

Registration cards must be received by December 10. Cards received after December 10 will be returned. Purchase orders cannot be accepted. Registration fees are non-refundable. For further information call the MACWORLD Expo/San Francisco Hotline at 617-361-3941. U.S. attendees should receive their badges no later than December 28. (Be sure to check box indicating where badge should be sent.) All other badges will be held at the Non-U.S. Preregistration Counter at Moscone Center for pick up beginning Thursday, January 10.

MACWORLD Expo Attendee Bonus:

All registration fees to MACWORLD Expo/San Francisco include a six month, \$7.50 paid subscription to *MACWORLD Magazine*. (*MACWORLD*'s basic subscription rate is \$30.00 for 12 issues.) When you preregister, we'll include your *MACWORLD Magazine* subscription request form in the preregistration package.

Please register me for:

Package One \$65

Conference sessions* and exhibits.
Preregister by December 10.
(\$80 cash only at the door)

Package Two \$15

Admission to exhibits only.
Preregister by December 10.
(\$25 cash only at the door)

I am an International attendee and would like my badge shipped by Federal Express. I have enclosed an additional \$45.00.

Please send my badge and further information to:

Please check one: Home Address Company Address

Last Name _____ First Name _____
 Street Address _____
 City, State, Zip _____
 Country _____
 Telephone _____

If mailing to company address:

Title _____
 Company _____

Check enclosed (make payable to MACWORLD Exposition) Amount: \$ _____

Master Card VISA American Express Amount: \$ _____

Account Number _____ Expiration Date _____
(Include all numbers)

Card holder signature _____
(Signature necessary to be valid.)

If card holder is other than registrant, please print name below:

Last Name _____ First Name _____

Cash only at the door. After December 10, you must register at the show.

Please check the appropriate boxes:

- Your industry or profession
 01 Manufacturer (non-computer)
 02 Manufacturer (computer industry)
 03 Distributor/dealer/retailer/service
 04 Finance/insurance/real estate
 05 Business services
 06 Professional (law/medicine)
 07 Health services
 08 Communications/publishing
 09 Education
 10 Government
 11 Consultant
 12 Other (specify) _____

Your title

- 13 CEO/president/vice president
 14 Comptroller/treasurer/accountant
 15 DP/MIS manager
 16 Owner/partner
 17 Engineer
 18 Doctor/lawyer/dentist
 19 Educator
 20 Art director/writer/editor
 21 Consultant
 22 Marketing
 23 Sales
 24 Other (specify) _____

Which personal computer(s) do you own/or use?

- 25 Macintosh
 26 Macintosh Plus
 27 Macintosh SE
 28 Macintosh II
 29 Apple II Series
 30 IBM PC (or compatible)
 31 None
 32 Other (specify) _____

Please fill out this form completely and send it, along with your check or money order to: MACWORLD Expo, P.O. Box 4010, Dedham, MA 02026.

* All conference sessions are on a first-come, first-served basis with no guaranteed seating. ALL REGISTRATION FEES ARE NON-REFUNDABLE.



PLEASE DO NOT STAPLE CHECK TO FORM.

Circle 637 on Reader Service Card (RESELLERS: 638)

Byte

Qume Releases New Version of Mailing Database

The Qumatic Instant Mailing Lists and Labels program for the IBM PC now offers a menu-driven method for easily importing an established mail list compiled in another application, Qume reports. A new feature of version 2.0 automatically enters the city and state when you type in a ZIP code.

You can sort a database by many different categories, and the program prints out a report itemizing the number of pieces sent to each ZIP code to qualify for the lowest bulk mail rates.

Price: \$59.95.

Contact: Qume Corp., 500 Yosemite Dr., Milpitas, CA 95035, (408) 942-4000.

Inquiry 1170.

Add Bar Codes to Your Mailing Labels

ComputaLabel now has an alternative to the film-master method of incorporating bar codes into your mailing label. Its Label Designer lets you combine text and art from a variety of sources and manipulate them with a bar code to make your label appear exactly as you want it. The program relies on PostScript printing technology to support printing at the high resolution (better than 300 dpi) required by some bar code families.

Label Designer lets you design your label so that it's aesthetically pleasing, yet still complies with bar code specifications. You can rotate



Qume's mailing database program lets you identify fields that you won't use and automatically skip them.

text, graphics, and bar codes at 90-degree intervals.

The program lets you adjust the code size between 80 percent and 200 percent of the nominal size, as recommended by the Uniform Code Council. Code height is adjustable in up to 0.0004-inch increments. To adjust for print gain when you print the code, you can manipulate bar width by 0.0002 inch, the company reports, for maximum accuracy.

Label Designer works on the Mac with any PostScript output device. It supports a variety of code symbology families, such as UPC, Code 39, and many others.

Price: \$395; bar code formats, \$250 each.

Contact: ComputaLabel, Inc., The Carriage House, 28 Green St., Newbury, MA 01951, (800) 289-0993 or (508) 462-0993.

Inquiry 1172.

Reduce Postal Costs on Mass Mailings

PostWare PrintForm is for hospitals, utilities, and financial institutions that want to take advantage of postage discounts without sorting thousands of letters by hand.

The program works by capturing a print image form of each letter's address. It assigns ZIP codes, ZIP+4 codes, and carrier routes. The program presorts the letters in first-, second-, or third-class mailstream order and prints them in the new order.

PostWare PrintForm runs on a 386 with 1 MB of RAM.

Price: \$15,000 to \$30,000.

Contact: Postalsoft, Inc., 4439 Mormon Coulee Rd., La Crosse, WI 54601, (608) 788-8700.

Inquiry 1171.

Share Your Opinion

With Solicit Your Editor, a database for the IBM PC that has the names and addresses of hundreds of newspaper and magazine editors, you can let your opinion be known across the U.S. The program includes an editor and fields for keeping track of what you've sent

to each editor.

Price: \$49.95; LAN version, \$129.95; yearly updates, \$24.95 and \$74.95, respectively.

Contact: T-Lan Systems, RR 2, Box 1290, Norridgewock, ME 04957, (207) 397-5511.

Inquiry 1174.

Find That ZIP

With ZIP*Phone, telemarketers can key in a phone number's area code and prefix and instantly determine the number's city, state, time zone, and local time. You can use it in TSR mode while writing a document to do things like verifying a ZIP code. You can also use it by entering a partial ZIP code or city name, and the program fills in the rest.

Price: \$95.

Contact: Melissa Data Co., 32118-8A Paseo Adelanto, San Juan Capistrano, CA 92675, (714) 661-5885.

Inquiry 1173.

Label Publishing for the Mac

MacLabelPro acts as a companion to your database or word processor, letting you directly merge existing addresses and combine them with graphics and other text elements to produce eye-pleasing mailing labels.

The program is designed to work as a back end to such applications as Works, Excel, Word, FileMaker, Multiplan, and MacWrite. You select the type of label, and MacLabelPro displays a template window inside which you design the label. Once you design the label using the program's layout and drawing tools, each address will print according to that format. MacLabelPro is also available in an IBM PC version.

Price: \$99.95.

Contact: Avery Commercial Products Division, 818 Oak Park Rd., Covina, CA 91724, (800) 541-5507 or (818) 915-3851.

Inquiry 1175.

H. Co. Computer Products

Your #1 Source For All P.C. Memory Upgrades
Call Toll Free 1-800-RAM-CHPS Ext. 200

FULL TECHNICAL SUPPORT ★ LIFETIME WARRANTY ON ALL MODULES
BUY DIRECT ★ BEST PRICES ★ BEST SERVICE

Part # EQ	Works With	PRICE
30F5348 (512K)	30-286	\$ 49.00
30F5360 (2MB)	30-286	\$ 165.00
6450375 (1MB)	80-041	\$ 149.00
6450379 (2MB)	80-111, 311	\$ 239.00
6451060 (4MB)	80-A21, A31, 111, 311	\$ 559.00
6450603 (1MB)	502, 55SX, 70-E61, 70-121, P-70	\$ 85.00
6450604 (2MB)	502, 55SX, 70-E61, 70-121, P-70	\$ 160.00
6450608 (2MB)	70-A21, A61, B-21, B61	\$ 165.00
78X895.5 (128K)	25	\$ 26.00
34F2933 (4MB)	55SX, 65SX	\$ 525.00
6450605 (2-8MB)	All 70's and 80's (Board)	\$ 525.00
6450609 (2-16MB)	50, 502, 55SX, 60, 65SX (Board)	\$ 599.00
1039136 (1MB)	Laser Printer 4019, 4019e	\$ 199.00
1039137 (2MB)	Laser Printer 4019, 4019e	\$ 325.00
1038675 (3.5MB)	Laser Printer 4019, 4019e	\$ 499.00

Call for Other IBM Upgrades

We Accept Purchase Orders from Qualified Firms, Universities and Government Agencies.

Trademarks are registered with their respective companies.

We will match or beat any advertised price.



NO SURCHARGE

Model	Memory Added	Part # EQ	PRICE
DESKPRO 386/33-486/25	2MB MODULE	115144-001	\$ 229.00
DESKPRO 386/20-25	1MB MODULE	113131-001	\$ 139.00
286e	4MB MODULE	113132-001	\$ 339.00
DESKPRO 386/20e-25e	1MB BOARD	113644-001	\$ 189.00
	4MB BOARD	113645-001	\$ 479.00
	1MB MODULE	113131-001	\$ 139.00
	4MB MODULE	113132-001	\$ 339.00
DESKPRO 386s	1MB BOARD	113633-001	\$ 189.00
	4MB BOARD	113634-001	\$ 479.00
	1MB MODULE	113646-001	\$ 139.00
	4MB MODULE	112534-001	\$ 339.00
PORTABLE III	512K KIT	107331-001	\$ 70.00
	2MB KIT	107332-001	\$ 165.00
DESKPRO 386/16	1MB BOARD	108069-001	\$ 355.00
	2MB BOARD	108069-W/71	\$ 525.00
	4MB BOARD	108070-001	\$ 850.00
	8MB BOARD	108072-001	\$1350.00
DESKPRO 386 PORTABLE	1MB KIT	107651-001	\$ 245.00
	4MB BOARD	107653-001	\$ 799.00
SLT/286	1MB MODULE	110235-001	\$ 209.00
LTE/286	1MB BOARD	117081-001	\$ 159.00
	2MB BOARD	117081-002	\$ 249.00

Ask About Other Compaq Upgrades

Model	Memory Added	Part # EQ	PRICE
MACII, Iix, Ilicx	1MB KIT	MO218	\$ 80.00
	2MB KIT	MO219	\$ 115.00
	4MB KIT	MO2707	\$ 225.00
	16MB KIT		\$1500.00
MACIici	4MB KIT	MO292LL-A	\$ 225.00
	16MB KIT		\$1500.00
MAC SE & PLUS	1MB KIT	MO218	\$ 80.00
	2MB KIT	MO219	\$ 115.00
	4MB KIT	MO2707	\$ 225.00
MAC PORTABLE	1MB KIT	MO248	\$ 279.00
	2MB KIT	N/A	\$ 899.00
	3MB KIT	N/A	\$1299.00
	4MB KIT	N/A	\$1695.00
MACIifx	4MB KIT	MO292LL-A	\$ 369.00
	16MB KIT	N/A	\$1695.00
LASER WRITER III/NTX	1MB KIT	M6005	\$ 179.00
	4MB KIT	M6006	\$ 369.00

Model	Memory Added	Part # EQ	PRICE
BRAVO/286	128K KIT	500510-011	\$ 40.00
	512K KIT	500510-010	\$ 60.00
	2MB KIT	500510-002	\$ 150.00
	4MB KIT	500510-008	\$ 300.00
PREMIUM/286 ADVANCED	512K KIT	500510-001	\$ 60.00
	1MB KIT	500510-007	\$ 120.00
	2MB KIT	500510-002	\$ 150.00
	4MB KIT	500510-008	\$ 300.00
FASTBOARD /386	1MB KIT	500510-007	\$ 120.00
	4MB KIT	500510-008	\$ 300.00
PREMIUM WKST/286	512K KIT	500510-010	\$ 60.00
	2MB KIT	500510-002	\$ 150.00
PREMIUM WKST 386/SX	512K KIT	500510-010	\$ 60.00
	1MB KIT	500510-007	\$ 120.00
	2MB KIT	500510-002	\$ 150.00
	4MB KIT	500510-008	\$ 300.00
PREMIUM 386/16	1MB KIT	500510-007	\$ 120.00
	4MB KIT	500510-008	\$ 300.00
PREMIUM 386s	1MB KIT	500510-003	\$ 160.00
	4MB KIT	500510-008	\$ 380.00
PREMIUM 386/25/16sx	1MB SIMM	500718-001	\$ 80.00
PREMIUM 386/33	1MB SIMM	500718-002	\$ 85.00

Model	Memory Added	Part # EQ	PRICE
Portable T1000SE & XE	1MB KIT	PC14-PA8311U	\$ 319.00
	2MB KIT	PC14-PA8312U	\$ 444.00
Portable T1200XE	2MB KIT	PC13-PA8306U	\$ 214.00
Portable T1600	2MB KIT	PC-PA8302U	\$ 214.00
Portable T3100c	512K KIT	PC-PA8340U	\$ 135.00
	2MB KIT	PC-PA8341U	\$ 214.00
Portable T3100SX	2MB KIT	PC15-PA8308U	\$ 214.00
	4MB KIT	PC15-PA8310U	\$ 649.00
Portable T3200sx	2MB KIT	PC-PA8307U	\$ 214.00
Portable T3200	3MB KIT	PC-PA7137U	\$ 359.00
Portable T5100	2MB KIT	PC-PA8301U	\$ 214.00
Portable T5200	2MB KIT	PC-PA8304U	\$ 214.00
DESKTOP T8500	2MB KIT	PC-PA8301U	\$ 214.00

Ask About Other Toshiba Upgrades

Cyrix Math Co-Processor
 Up to 200% Faster Than Intel Math Co-Processor
 100% Compatible — 5 Year Warranty

Part#	PRICE	Part #	PRICE
83D87-16	Call	83D87-33	\$ 485.00
83D87-20	\$ 325.00	83D87SX-16	\$ 275.00
83D87-25	\$ 385.00	83D87SX-20	Call

STANDARD SIMMS		DRAM	
Part#	PRICE	Part#	PRICE
256 X 8-12	\$ 17.00	1 X 1-100	\$ 5.50
256 X 8-10	\$ 18.00	1 X 1-80	\$ 5.75
256 X 8-80	\$ 19.00	1 X 1-70	\$ 6.25
256 X 9-12	\$ 17.00	256-150	\$ 1.75
256 X 9-10	\$ 18.00	256-120	\$ 2.00
256 X 9-80	\$ 19.00	256-100	\$ 2.15
256 X 9-70	\$ 24.00	256-80	\$ 2.35
256 X 9-60	\$ 26.00	256-70	\$ 2.55
1 X 8-10	\$ 60.00	256-60	\$ 3.35
1 X 8-80	\$ 51.00	256 X 4-10	\$ 5.75
1 X 8-70	\$ 60.00	256 X 4-80	\$ 6.00
1 X 9-10	\$ 55.00	4484-10	\$ 2.50
1 X 9-80	\$ 55.00	4484-80	\$ 3.00
1 X 9-70	\$ 61.00	4164-15	\$ 1.40
4 X 8-80	\$ 320.00	4164-12	\$ 1.85
4 X 9-80	\$ 350.00	4164-10	\$ 2.00

EPROM/CPU/SRAM/VRAM Also Available

Model	Memory Added	Part # EQ	PRICE
Power Mate SX Plus	1MB Board	APC-H850E	\$ 295.00
	2MB Board	N/A	\$ 495.00
	4MB Board	APC-852E	\$ 725.00
	8MB Board	N/A	\$1375.00

Model	Memory Added	Part # EQ	PRICE
LASER JET II & IID	1MB MODULE	H33443B	\$ 109.00
	2MB MODULE	H33444B	\$ 145.00
	4MB MODULE	H33445B	\$ 249.00
IIP & III	1MB MODULE	H33474A	\$ 119.00
	2MB MODULE	H33475A	\$ 155.00
	3MB MODULE	N/A	\$ 215.00
	4MB MODULE	N/A	\$ 259.00

intel		IIT Math Co-processors	
Part#	PRICE	Part # EQ	PRICE
8087-3	\$ 80.00	2C87-8	\$ 175.00
8087-2	\$ 117.00	2C87-10	\$ 185.00
8087-1	\$ 155.00	2C87-12	\$ 215.00
80287-6	Call	2C87-20	\$ 255.00
80287-8	Call	3C87-16	Call
80287-10	Call	3C87SX-16	Call
80287XL (12.5 MHz)	\$ 229.00	3C87-20	\$ 325.00
80287XLT (12.5 MHz)	Call	3C87-25	\$ 385.00
80387-16	\$ 305.00	3C87-33	\$ 485.00
80387SX-16	\$ 290.00		
80387SX-20	\$ 315.00		
80387-20	\$ 350.00		
80387-25	\$ 450.00		
80387-33	\$ 550.00		

We also carry memory upgrades for
ACER • AT&T • DELL • DTK • EPSON • ZENITH
• EVEREX • HP Vectra • SAMSUNG • SUN • Canon Printer
• SILICON GRAPHICS • WYSE • and other AT & XT clones

1228 Village Way, Unit D • Santa Ana, CA 92714 • (714) 542-8292 • FAX (714) 542-8648 • Hours 8:00 AM-5:00 PM PST

DEALER'S INQUIRIES WELCOME

Prices are subject to change

Circle 623 on Reader Service Card (RESELLERS: 624)

Import Math Equations into Your Word Processor

K-Talk Communications' MathEdit 2.0 lets you create typeset-quality math equations that you can import into WordPerfect, Microsoft Word, WordStar, MultiMate, PageMaker, and any other program that supports TIFF, PIX, or EPS files.

The program has more than 250 math and Greek symbols. MathEdit's macro facility lets you assign a symbol or entire equation to one keystroke.

Square roots, parentheses, division signs, and other delimiters automatically adjust to the size that's needed for each equation, according to the company.

MathEdit 2.0 requires 400K bytes of RAM and a graphics card to run on your IBM PC.

Price: \$199.

Contact: K-Talk Communications, Inc., 30 West First Ave., Suite 100, Columbus, OH 43201, (614) 294-3535.

Inquiry 1176.

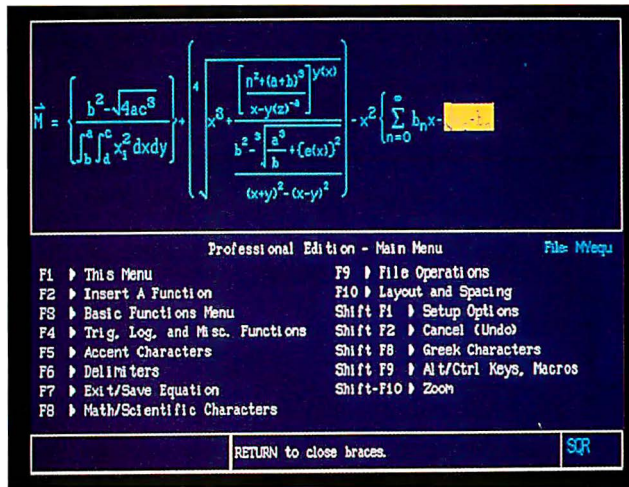

MathEdit lets you create complex arithmetic equations and export them to a variety of applications.

Avalon Publisher for SPARCstations

Elan Computer Group says its new desktop publishing system for the Sun SPARCstation, Hewlett-Packard 9000, and DECstation provides pagination, graphics, page/document layout, and word processing under a Mac-like interface.

Avalon Publisher supports PostScript printers and other typesetters, plus the HP LaserJet family of laser

printers. Features supported for page makeup include multiple threads for newspapers; text flow around graphics; text templates; and the ability to name and manipulate objects, paragraphs, and graphics as groups.

The drawing package supports Bézier curves, several types of fill patterns, and the ability to scale various bit-map formats (e.g., raster, raw bit-map, MacPaint, PCX, and TIFF). Graphics can flow with text or remain stationary.

Elan is offering Avalon Publisher with a floating license, which makes it available to everyone on your network but requires you to purchase only enough licenses for concurrent use. The system requires 18 MB of disk space, 8 MB of main memory, and the X11 Windowing System.

Price: \$1295; \$995 for each additional concurrent license.

Contact: Elan Computer Group, Inc., 888 Villa St., Third Floor, Mountain View, CA 94041, (415) 964-2200.

Inquiry 1178.

Wave4 Bridges Desktop and Dedicated Systems

Bestinfo says its Wave4 publishing system for OS/2 Presentation Manager bridges the gap between low-cost, low-powered desktop applications and high-end technologies like Penta and AteX. With Wave4 and the multitasking capabilities of OS/2, several people can work on the same document, pages, and articles without file corruption or work-flow conflicts.

The program integrates proprietary Hell and Scitex color imaging and PostScript color imaging. For production people, the program supports masking, automatic head fitting and sizing, rotation of images and frames at any orientation, and image zooming independent of the frame or page.

Price: \$12,000 to \$95,000.

Contact: Bestinfo, Inc., 1400 North Providence Rd., Media, PA 19063, (800) 346-7920 or (215) 891-6500.

Inquiry 1177.

Island's Desktop Publishing for Open Desktop

Island Graphics' Productivity Series 2.0 combines the company's word processing, painting, and drawing programs under one package for desktop publishing under SCO Open Desktop. The program is available for the IBM PC, Open Look on Sun workstations, and OSF/Motif on Apollo and Hewlett-Packard workstations.

Price: \$995.

Contact: Island Graphics Corp., 4000 Civic Center Dr., San Rafael, CA 94903, (800) 255-4499 or (415) 491-1000.

Inquiry 1179.

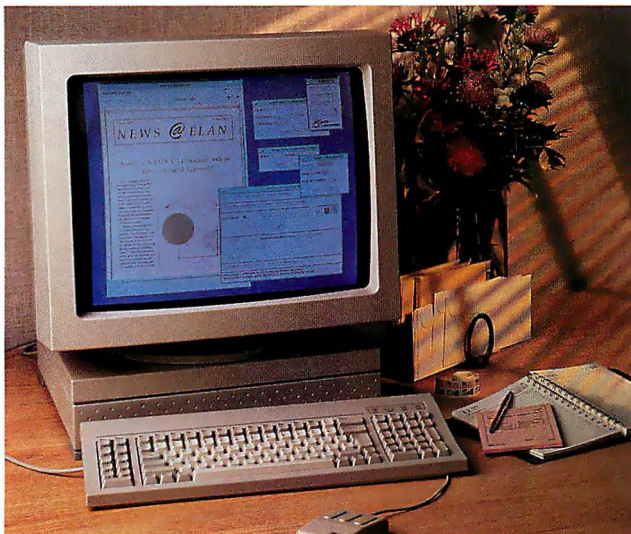

Avalon Publisher brings desktop publishing under the X11 windowing system to the SPARCstation, DECstation, and Hewlett-Packard 9000.

Easy to use desktop mapping for companies on the move.

Ryder Truck Rental, Inc. uses ATLAS mapping software to define and optimize sales territories, track and report revenues, and add impact to board room presentations. And they're on the move.

Desktop mapping and the road to success.

Whether your business is big or small, ATLAS software moves you ahead of the crowd. Now it's simple to analyze market potential, locate prospects by inputting addresses, site new retail stores, and perform scores of other useful applications. What's more, you can add punch to your next meeting by printing quality maps on almost any output device.

Mapping the easy way.

A built-in, dBASE compatible database manager allows you to select geographic regions and associated data—then pop-up useful summary statistics. Create pin and thematic maps by street, block, ZIP, county, or any set of custom territories.

Call for a free demo diskette.

Strategic Mapping, Inc. offers desktop mapping solutions for the PC and MAC—ranging from ATLAS*GRAPHICS and ATLAS*MapMaker for presentations to ATLAS*GIS, a full-featured geographic information system. See how thousands of businesses put themselves on the map with ATLAS software. Call today for your free demo diskette: (408) 985-7400, FAX (408) 985-0859.

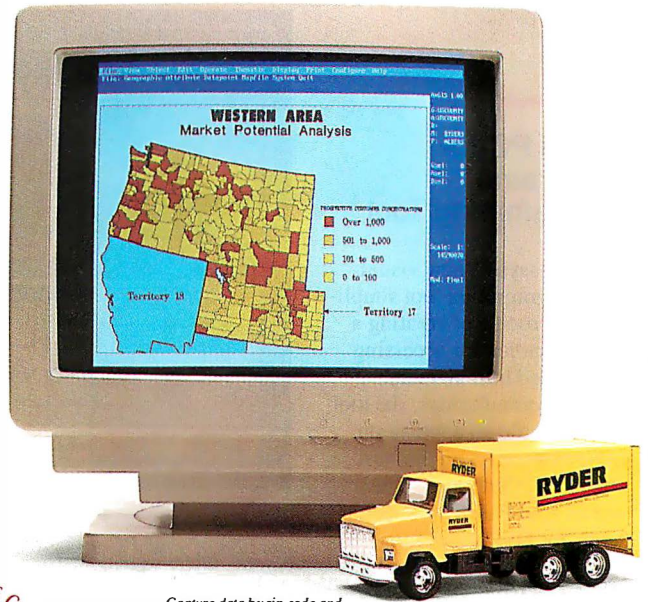

Leaders in Desktop Mapping since 1983.

STRATEGIC MAPPING, INC. 4030 Moorpark Avenue, Suite 250, San Jose, CA 95117 (408) 985-7400 FAX: (408) 985-0859

Capture data by zip code and summarize by county to highlight areas of opportunity.

Resellers inquiries invited.



MacUser
Jan 90

FUJITSU RX7300 Model A Super-Fast Desktop Laser Printer

- Emulates Epson FX-80, Diablo 630 & LaserJet Plus
- 18 pages/min ■ 300 dpi ■ 2.5MB RAM
- Choice of Serial or Centronics-Parallel Interface
- Includes installation

COMPARE! \$1999

LARGE CAPACITY PAPER HOPPER ALSO AVAILABLE

Number Nine Computer's PEPPER PRO 1024 Hi-Res Interface Boards

- REDRAWS SCREEN 20 TIMES FASTER! Great for CAD, engineers, and other heavy-duty graphics users
- On-board TI-TMS3410 graphics processor
- Up to 1024 x 768 pixels, non-interlaced
- 2-year manufacturer's warranty
- Works with popular software

\$799

Ricoh Flatbed Grayscale Scanner

- INDISPENSABLE FOR DESKTOP PUBLISHERS!
- Flatbed—bound books/sheets up to 8.5 x 11.7
- Private Label: "Wang"—equiv. to Ricoh RS-312
- Scans full page 300 dpi in 14 sec, 150 dpi in 7 sec
- Scans in 64 gray levels as well as b&w line art
- Software compatible w/Windows 2.01 or newer
- Software generates PCX or TIF files

\$599

15" Amdek Hi-Res Monitor

- Monochrome—paper-white
- WYSIWYG—Res. to 1280 x 800
- Automatic mode switching
- Includes drivers for all popular software, display card. 30-day IME warranty. New.

(List Price \$999.00) **IME Price: \$179**

Microsoft Bookshelf

CO-ROM 10-VOL REFERENCE LIBRARY **\$79**

LIST: \$295.00 **IME PRICE:**

IME COMPUTERS

EST. 1981 Quality Products at Liquidation Prices

ASK ABOUT OUR VOLUME DISCOUNTS!

COMPLETE AMDEK 286 PC SYSTEMS

Including: CPU, Hard Drive, Monitor and Keyboard

INSTALLED & TESTED BY IME

- Amdek 1280 15" High-Resolution Monitor
- 1 Parallel Port & 1 Serial Port
- 7 Expansion Slots
- MS-DOS 3.3
- 1.2MB Floppy Drive
- 102-key Keyboard
- 90-day IME Warranty



HI-RES AT LOW COST FOR THE POWER USER

12.5MHz-1MB-96MB \$1149

- All New! Includes:
- Private Label (CPT) 12.5MHz 80286
 - 1MB RAM (16MB addressable)
 - Rexon-Labelled Keyboard
 - 96MB Maxtor Drive
 - DTC 3280 Controller
 - One Wait State
 - 3 Storage Bays

OTHER AVAILABLE OPTIONS

- 19" Xerox 2-Page Display.... add \$170
- 13" EGA Color Monitor.....add \$59
- 13" Zenith (Private Label) VGA Color Monitor..... add \$189

ECONOMY SPECIAL: 12.5MHZ CPU ONLY — \$499

SPECIAL CLOSE-OUT PRICES!

MAXTOR 3.5" • HALF-HEIGHT • SCSI 100MB • 26ms

1-Year IME warranty

LXT-100 HARD DRIVES

Internal **\$399**

External **\$499**

Disk Manager software included!

PLUS SUPER VALUES ON OTHER MAXTOR DRIVES

Model#	XT-3280	EXT-4380
CONDITION	NEW OR USED	Recertified
Formatted	244MB	319MB
Unformatted	280MB	380MB
Interface	SCSI	ESDI
Height	Full	Full
Ave. Seek Time	30ms	27ms
IME Warranty	90 days (90 if used)	90 days
Last List Price	\$2,265.00	\$2,325.00
IME Price	\$699 or \$599	\$999

LIMITED TIME OFFER ON EXT-4380 SPECIAL PRICE \$899

SPECIAL OFFER ON 10MHz CPU SYSTEMS

Amdek 10MHz 286

- INCLUDING:
- 102-key extended keyboard
 - 1 parallel and 1 serial port
 - HD/FD controller
 - 90-Day IME warranty
 - 512KB RAM
 - 1.2MB floppy drive
 - 7 expansion slots
 - MS-DOS 3.3

While supplies last only **\$379**

14" FLAT SCREEN DATA TERMINALS

- "WY-150"—MADE FOR AMDEK BY WYSE, LARGEST MANUFACTURER OF TERMINALS
- These terminals will substitute for:
- (ASCII) WY-50 or 50+, TeleVideo TVI-925 or 910+, ADDS Viewpoint A2; or (ANSI) DEC VT-52 or 100.
 - Resolution to 1188 x 416
 - ASCII 101-key keyboard
 - 24K high-speed static CMOS RAM
 - Overscanned video for full-screen image
 - RS-232C, from 50 to 38.4Kbps
 - 78Hz flicker-free amber display
 - Tilt/swivel base

\$239

VGA COLOR AT B&W PRICES! Zenith 13" VGA Color Monitor

- Private Label: "Data General"
- 0.31 Dot Pitch
- Graphics Mode...
- 640 x 480 resolution
- 16 colors out of a palette of 256,0000
- 80 characters x 25 rows
- 720x 400 resolution w/ 9 x 16 character cells
- 15-pin "D" connector
- Text Mode...

TILT/SWIVEL STAND AVAILABLE FREE! (minimal shipping charge)

(Last List Price: \$695.00) **\$289**

SPECIAL VOLUME PRICE: Order 10 — only \$279 each!

Call (800) 999-1911

INTERNATIONAL CALLERS: (617) 254-1700

FAX (617) 254-0392 BOSTON, MA



NO SURCHARGE

Visual PC-to-Mainframe Programming Tool

Easel says its new visual programming tool simplifies the process of creating a PC application for accessing 3270-based host systems. Called CommBuilder, the tool lets you build an application as you interact with the host computer. Generated code works with Easel/DOS or Easel/2 (for OS/2), the company's graphical application development system.

As you access and interact with a 3270-based system, CommBuilder presents the host screen in a window. After the session is over, CommBuilder automatically generates the communications portion of the Easel code required by the application. You can use CommBuilder on-line or capture host screen images for later coding.

As CommBuilder presents the host screen to you, it uses color coding to identify protected fields, assigned fields, watch characters, and unprotected fields. The tool can interface with Layout/CUA for DOS, Easel's tool that lets you design and generate a graphical user interface for Easel (the company hasn't yet released Layout/CUA for OS/2). You can use CommBuilder to assign links between host screens for programming an Easel application that navigates through several host screens.

CommBuilder runs under DOS and generates code for use with Easel/DOS or Easel/2. It requires DOS 3.0 and 1 MB of RAM.

Price: \$1900; Easel/DOS and Easel/2, \$7500 each.
Contact: Easel Corp., 600 West Cummings Park, Woburn, MA 01801, (617) 938-8440.
Inquiry 1181.

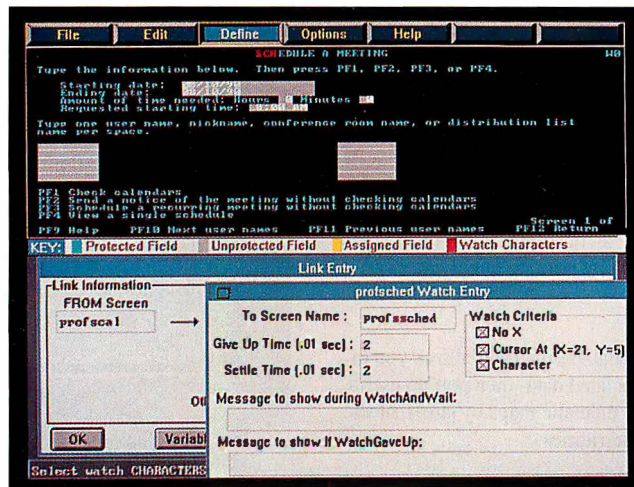

Working with CommBuilder, you create the communications portion of your PC-to-3270 application by interacting directly with the host screens.

ParcPlace Opens Up Objectworks C++

ParcPlace Systems has opened up Objectworks, the set of tools that helps you find, understand, and reuse existing C++ code. No longer are you required to use default tools like the Sun C compiler. Objectworks\C++ 2.0 supports traditional Unix tools for C preprocessing, C compiling, and linking, the company says.

Objectworks helps you analyze C++ code, even if it's not your own. The Objectworks\C++ inheritance browser draws class inheritance trees and supports multiple inheritance, so that you can view existing class relationships in graphical form. Also included is an error browser, a C++ Translator using AT&T's Language System 2.1, and a source-level debugger.

The optional Object-Kit\C++ includes AT&T's Standard Library and Standard Library Extension, a collection of 15 general-purpose C++ libraries. It also has the NIH C++ libraries.

Objectworks\C++ 2.0 requires 12 MB for the Sun-3 and SPARCstation.

Price: \$3000; Object-Kit\C++, \$500.

Contact: ParcPlace Systems, Inc., 1550 Plymouth St., Mountain View, CA 94043, (415) 691-6700.

Inquiry 1182.

STSC Plans APL for IBM's System/6000

STSC, developer of APL, known for its ability to perform complex and ad hoc analyses on large quantities of data, says it will release a version of the language for the IBM RISC System/6000 by the end of this year or early 1991. Currently available for the 386, DEC workstations, and the SPARCstation, APL is used for actuarial work, currency trading, customer tracking, and other applications, the company says.

APL interfaces with languages like assembly and C. STSC says APL excels at matrix manipulation and supports nested arrays within a single element of other arrays.

Price: \$3000 and up.
Contact: STSC, Inc., 2115 East Jefferson St., Rockville, MD 20852, (301) 984-5000.
Inquiry 1184.

Spinner Adds to Plus

Spinner Software developed the Plus Software Slot Developer's Kit for creating new object classes and customized extensions for the Plus programming language. You can use the kit to create applications that can run unmodified on the Mac and IBM PC with Windows or OS/2 Presentation Manager.

Four categories of extensions are possible with the kit. Software Slot Objects add a new object class to Plus, with all properties of the new object defined by you. Once you create and compile the new object, it goes in the same folder as Plus, and you access it like any other object. Another category, External Draw Objects, already have some properties defined in advance, since they are designed to display information on-screen. However, you determine the source and form of the displayed information, whether it be a bar graph, chart, or other data representation.

Two other categories, Software Slot Commands and Software Slot Functions, let you extend Plus. When you use these extensions to add new commands and functions, you can define an unlimited number of arguments and customized syntax, giving you greater flexibility than with external commands and external functions, according to the company.

Price: \$695.
Contact: Spinner Software Corp., 201 Broadway, Cambridge, MA 02139, (617) 494-1200.
Inquiry 1183.

MetaWare Delivers The Essential Tool For C

Way back in 1986, MetaWare delivered the first 32-bit protected-mode DOS compiler for the 386. Our High C compiler set the standard for professional software developers. High C DOS 386/486, **Version 2.3**, brings important features to extended DOS that our UNIX C customers have come to rely on for creating lightning-fast executable code:

True Globally Optimizing Technology

Global Optimizations that increase speed of code execution include: constant and copy propagation, constant expression folding, local *and* global common subexpression elimination, removal of invariant expressions from loops, live/dead analysis, dead code elimination, global register allocation, and tail merging. We've also included faster libraries with ANSI conformance and greater Microsoft compatibility. These optimizations make Version 2.3 generate 46% better Whetstone code and 15% better Dhrystone code than our previous version. But one piece was still missing:

True 32-Bit Source-Level Debugging

Our customers really needed a MetaWare-quality 32-bit, source-level debugger. It had to offer a friendly user interface with color or monochrome windows, featuring pull-down and pop-up menus. They needed to watch or edit data, registers, and breakpoints through windows that displayed: flags, memory in any format, variables, stack data, 387 registers, locals, globals, structs, pointers, modules, and more! **We've delivered!** MetaWare's 386 protected-mode debugger features source-level symbolic debug capabilities. High C users can tackle even the largest DOS C programs and debug code on the host or a remote DOS machine, via a standard serial port.

In an ever-changing, puzzling, multi-platform world, it's reassuring to know that:

Your Code is Portable to Other Platforms

Many professional programmers are delighted to discover that their existing High C programs may be easily ported to many other popular platforms, including MS-DOS, FlexOS, OS/2, UNIX System V 386/486, Sun 386i, Sun-3, Sun-4, SPARC, and IBM AIX on PS/2, RT, i860, and 370, IBM AOS 4.3 on RT and 370, Am29K, Motorola 680x0, and Intel i860. And we're already talking with several of our OEMs about porting the debugger to these and other new platforms.

Our customers who are already using the combination of High C and the new debugger all agree that the new, 32-bit source-level debugger is *the essential tool* for the only compiler you need.

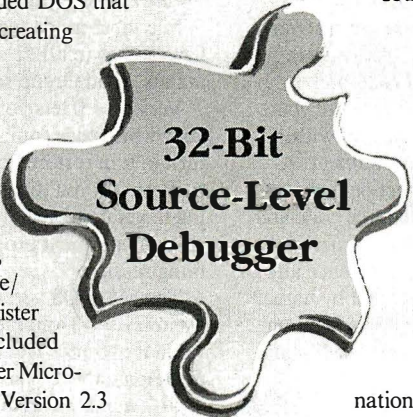

**32-Bit
Source-Level
Debugger**

MetaWare[®]
INCORPORATED

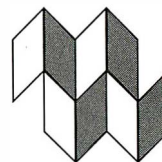

*Compiler Products for
Professional Software Developers
High C[®] • Professional Pascal[®]*

2161 Delaware Ave. • Santa Cruz, CA • 95060-5706 • 408/429-6382 • Fax 408/429-9273

MetaWare, High C, and Professional Pascal are registered trademarks of MetaWare Incorporated. Other names are trademarks of their respective companies.
© Copyright 1990 MetaWare Incorporated

Spreadsheet Functions in Your Database

Raima, developer of C products for the design of databases that combine relational- and network-model technologies, now has a library of linkable functions for embedding spreadsheet capability in your application.

Applications created with the PowerCell Spreadsheet Library let you analyze and otherwise manipulate data without having to export to a spreadsheet, perform the analysis, and reimport the changed data to the database.

The library can function as a stand-alone library, letting you add its capability to other applications. Built-in file access functions let you import and export data from WKS, WK1, DBF, and ASCII formats. The PowerCell Spreadsheet Library supports a variety of operating systems, including DOS, Windows, OS/2, Unix, Xenix and SunOS. **Price:** \$695 and up. **Contact:** Raima Corp., 3245 146th Place SE, Suite 230, Bellevue, WA 98007, (206) 747-5570. **Inquiry 1185.**

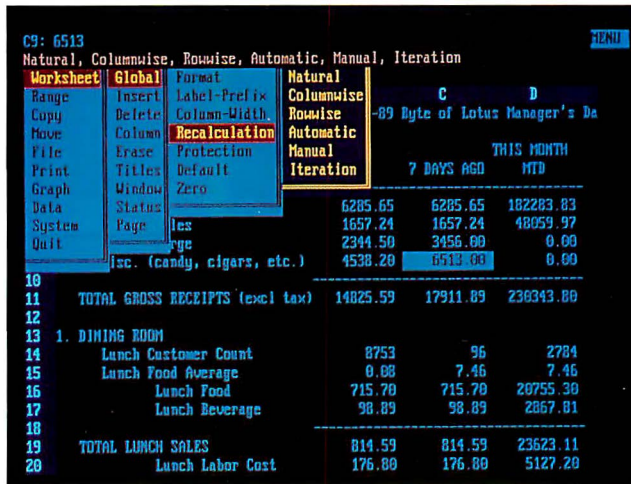

The screenshot shows a spreadsheet application interface. At the top, there's a menu bar with 'Worksheet', 'Global', 'Format', and 'Natural'. Below the menu, a data table is displayed with columns labeled 'C' and 'D'. The table contains numerical values and some text like '7 DAYS AGO' and 'THIS MONTH'. A status bar at the bottom indicates '123456'.

With the PowerCell Spreadsheet Library, you can develop database applications with built-in spreadsheets.

TAGS Function for C, C++ Added to PI Edit

PI Edit 4.0, a software development system for DOS, OS/2, and several versions of Unix, lets you use third-party tools to make, link, debug, or execute your application, all from within the PI Edit environment. A new TAGS function goes through your source code and creates a database from which you can reference any function or element by name, without knowing its location. Initially available for C and

C++, the TAGS function should support dBASE and Pascal by the end of the year.

For programmers with a Unix background, the new version has a vi keyboard interface, which lets you toggle between vi and PI modes. While in vi mode, you still have access to all PI's commands, Iliad Group says.

Version 4.0 lets you save your workspace, quit, and return to it in restored condition, saving you time from having to get up to speed at the start of your next programming session.

The MS-DOS version can remove itself from memory when it executes another application, storing itself in EMS or disk memory. Supported versions of Unix include SCO Unix and Xenix, Interactive Unix 386/ix, and AT&T systems. **Price:** MS-DOS version, \$195; PI for OS/2, \$249; PI for Unix, \$349 and up. **Contact:** The Iliad Group, Inc., 77 Geary St., Fifth Floor, San Francisco, CA 94108, (800) 473-2053 or (415) 563-2053. **Inquiry 1186.**

Develop for Windows Without a Low-Level Plunge

KnowledgePro for Windows lets you create sophisticated applications that can directly run other DOS and Windows applications without requiring you to delve into a low-level language.

KnowledgePro handles the difficult memory management problems of Windows, letting you concentrate on the application, Knowledge Garden says. Windows screen objects, fonts, icons, and bit-mapped images can be handled using one-line commands. Topics, the basic building blocks of the program, lie in wait for a particular event to occur.

Knowledge Garden says experienced Windows programmers can use KnowledgePro to quickly prototype applications. **Price:** Windows version, \$695; DOS version, \$495. **Contact:** Knowledge Garden, Inc., 473A Malden Bridge Rd., Nassau, NY 12123, (518) 766-3000. **Inquiry 1187.**

Viewpoint Systems' graphical-user-interface development tool lets you create applications for seamlessly linking Windows 3.0 applications with IBM mainframe data through Dynamic Data Exchange. I/F Builder 2.1 also lets you cut and paste 3270 mainframe data with an application for further analysis or graphing. The program supports Microsoft Word and Excel for now.

Price: \$17,500; run-time component, I/F Manager, \$395 per workstation. **Contact:** Viewpoint Systems, Inc., 1900 South Norfolk St., Suite 310, San Mateo, CA 94403, (415) 578-1591. **Inquiry 1188.**

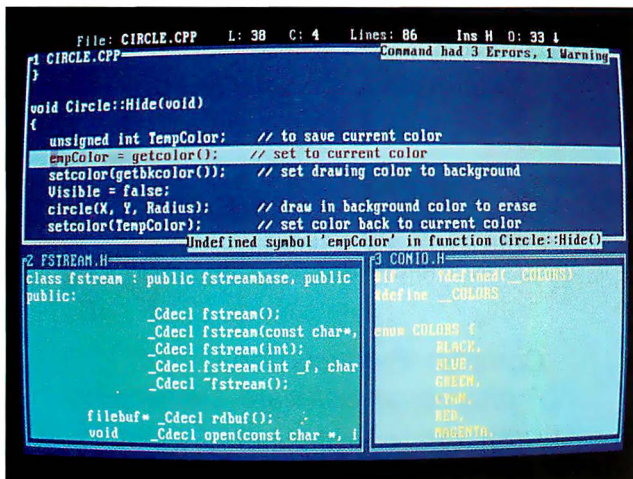

The screenshot shows a code editor window with the title bar 'File: CIRCLE.CPP L: 38 C: 4 Lines: 86 Ins H 0: 33'. The code is written in C++ and includes comments. A status bar at the bottom indicates 'Command had 3 Errors, 1 Warning' and 'Undefined symbol 'empColor' in function Circle::Hide()'. The code includes a function definition for 'Circle::Hide' and a class definition for 'fstream'.

PI Edit 4.0, a software development system, lets you do all your programming in one environment.





Microcom Computers



A HRW Technologies Company

All Systems with Free 4 Month On-Site Warranty

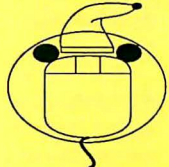
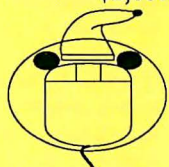
Custom Configuration Computer Systems						Pre-Configured Computer Systems	
Standard System Features: * 1MB RAM Standard * Teac 5.25" 1.2 MB or 3.5" 1.44 MB Diskette Drive * 1:1 Interleaved Hard/Floppy Drive Controller * Enhanced 101-key Keyboard * 2 Serial & 1 Parallel Port & Real Time Clock/Calendar w/Battery * Small Footprint Casew/200 Watt Power Supply(14.9" W x 16.3" D x 6.8" H) * Tower Case w/230 Watt Power Supply (Standard for 386/25C & 386/33C)						Our Commitment to Service & Quality * Free 4 Month On-Site Servicing Nationwide * 1 Year Warranty on Parts & Labor * Toll-free Technical Service & Support * No Surcharge on Credit Card Purchases * Comprehensive 72 Hour Burn-in Testing on All Systems * All Systems Made with pride in the USA * Guaranteed 100% IBM Compatible	
MICROCOM 286/12 286/12 System Features, Hard Drive, Monitor & Video Card						286/12 Xmas Special \$1,299	
Hard Drives:	IDE	IDE	IDE	IDE	ESDI		
MB/Ms	42/28	80/18	105/18	205/18	340/18		
No Video	\$799	\$1,049	\$1,099	\$1,499	\$2,099		
Mono	\$899	\$1,149	\$1,199	\$1,599	\$2,199		
VGA-Mono	\$1,024	\$1,274	\$1,324	\$1,724	\$2,324		
Hires	\$1,349	\$1,599	\$1,649	\$2,049	\$2,649	* 286/12 Standard System * 42 MB Hard Disk w/28 ms Access Time * 16-bit Hires 1024 x 768 Graphics Card * 14" Color Hires Monitor (1024 x 768) * Microsoft MS-DOS 3.30 or 4.01 * Free Mouse with This Special	
MICROCOM 386SX/16 386SX/16 System Features, Hard Drive, Monitor & Video Card						386SX/16 Xmas Special \$1,599	
Hard Drives:	IDE	IDE	IDE	IDE	ESDI		
MB/Ms	42/28	80/18	105/18	205/18	340/18		
No Video	\$999	\$1,249	\$1,299	\$1,699	\$2,299		
Mono	\$1,099	\$1,349	\$1,399	\$1,799	\$2,399		
VGA-Mono	\$1,224	\$1,474	\$1,524	\$1,924	\$2,524		
Hires	\$1,549	\$1,799	\$1,849	\$2,249	\$2,849	* 386SX/16 Standard System * 42 MB Hard Disk w/28 ms Access Time * 16-bit Hires 1024 x 768 Graphics Card * 14" Color Hires Monitor (1024 x 768) * Microsoft MS-DOS 3.30 or 4.01 * Free Mouse with This Special	
MICROCOM 386/25 for 64 KB Cache, add \$300 386/25 System Features, Hard Drive, Monitor & Video Card						386/25 Xmas Special w/42 MB Hard Disk \$1,999 386/25 Xmas Special w/105 MB Hard Disk \$2,299	
Hard Drives:	IDE	IDE	IDE	IDE	ESDI		
MB/Ms	42/28	80/18	105/18	205/18	340/18		
No Video	\$1,399	\$1,649	\$1,699	\$2,099	\$2,699		
Mono	\$1,499	\$1,749	\$1,799	\$2,199	\$2,799		
VGA-Mono	\$1,624	\$1,874	\$1,924	\$2,324	\$2,924		
Hires	\$1,949	\$2,199	\$2,249	\$2,649	\$3,249	* 386/25 Standard System * 42 MB or 105 MB Hard Disk * 16-bit Hires 1024 x 768 Graphics Card * 14" Color Hires Monitor (1024 x 768) * Microsoft MS-DOS 3.30 or 4.01 * Free Mouse with This Special * With 64 KB Cache - Add \$300	
MICROCOM 386/33C 386/33C System Features, Tower Case, Hard Drive, Monitor & Video Card						386/33C Xmas Special \$2,699	
Hard Drives:	IDE	IDE	IDE	IDE	ESDI		
MB/Ms	42/28	80/18	105/18	205/18	340/18		
No Video	\$1,799	\$2,049	\$2,099	\$2,499	\$3,099		
Mono	\$1,899	\$2,149	\$2,199	\$2,599	\$3,199		
VGA-Mono	\$2,024	\$2,274	\$2,324	\$2,724	\$3,324		
Hires	\$2,349	\$2,599	\$2,649	\$3,049	\$3,649	* 386/33C Standard System w/Tower Case * 105 MB Hard Disk w/Quick 18 ms Access Time * 16-bit Hires 1024 x 768 Graphics Card * 14" Color Hires Monitor (1024 x 768) * Microsoft MS-DOS 3.30 or 4.01 * Free Mouse with This Special	
Options/Upgrades: Mini-size Desktop Tower Case Add \$50 Full-size Tower Case (Standard for 386/25C & 33C) Add \$150						Microcom Xmas Mouse \$29.99 Hi-Resolution 3-Button Microsoft-compatible Mouse Up to 432 dot per inch Resolution (Great for VGA)	
Microcom Computers' Customers Include: Xerox, GTE, Motorola, Raychem, General Electric, Eastman Kodak, Pacific Bell, SEGA of America, Toshiba, Genetech, Holiday Inn, U.S. Court of Appeals, NASA, U.S. Food & Drug Administration, U.S. Dept. of Energy, U.S. Dept. of Agriculture, Lawrence Livermore National Laboratory, U.C. Berkeley, U.C. San Francisco, Stanford University, Princeton University, University of Pittsburg, University of Vermont, Pacific Gas & Electric, Wells Fargo Bank, and many more.							

To Order - Call Toll Free 1-800-248-3398

Open from 9:00 A.M. to 6:00 P.M. PST, Monday-Friday

Microcom Computers

48890 Milmont Drive, Fremont, CA 94537 - Tel: (415)623-3628 - Fax: (415)623-3620

3650-18th Street, San Francisco, CA 94110 - Tel: (415)255-2288 - Fax: (415) 255-8873

Prices are subject to change without notice. Not responsible for typographical errors. CA residents please add 7.25% sales tax. No surcharge on credit card purchases. Personal and company checks require 2 weeks clearance. All trademarks acknowledged. Tower is a registered trademark of NCR Corporation. Microcom Computers reserves the right to substitute any and all items with equivalent or better parts. All benchmarks and specifications are for your information only and may vary from system to system. Prices do not include shipping and handling.

Sculpting and Texturing Made Simple for the Mac

The new version of Sculpt 3D with Textures, Byte by Byte's three-dimensional rendering program, lets you develop textures and position image maps by means of an interface approach. Sculpt uses a Tri-View windows system to let you scale, rotate, and freely position textures accurately onto a 3-D model.

With Sculpt, you can import TIMM, PICT, and PRIM files to use as textures. You can also create solid textures from algorithmic or 3-D textures and use them to completely cover any object or space. Sculpt 3D lets you alter turbulence, irregularity, and inter-ring distance to create an unlimited number of textures. A reference cursor interacts in all three dimensions simultaneously, the company reports.

Sculpt 3D also features animation capabilities, including key frame and global animation, motion paths, splined motion paths, and object metamorphosis. Sculpt's capabilities are all provided within the Tri-View interface.

Sculpt 3D runs on the Mac with at least 4 MB of RAM, a 40-MB hard disk drive, an Apple or compatible 8-bit video card, System 6.0.5 or higher, and 32-Bit Color QuickDraw.

Price: \$2500.

Contact: Byte by Byte, Arboretum Plaza II, 9442 Capital of Texas Hwy. N, Suite 150, Austin, TX 78759, (512) 343-4357.

Inquiry 1194.

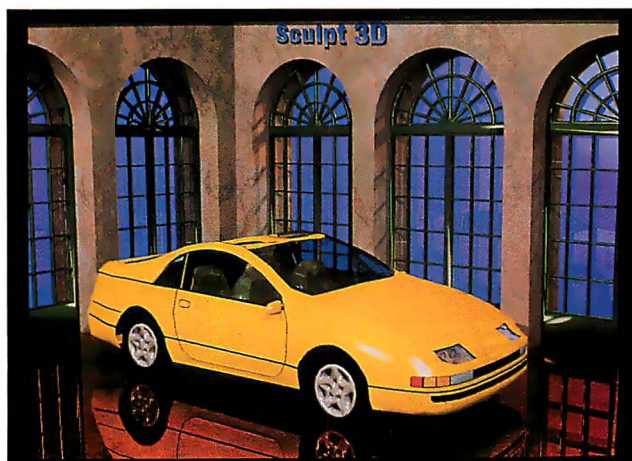

Sculpt 3D lets you animate objects once you've modeled and rendered them.

AT&T Takes You to RIO for Graphics

The new version of AT&T's RIO graphics software, version 4.0, improves upon its predecessor by offering enhanced two-dimensional layout and slide-preparation capabilities. The company has also developed RIO Animator, an add-on module for RIO that provides vector-based 2-D animation with antialiased objects, text, gradients, and transparencies.

RIO 4.0's multicolor gradient maps let you specify up to eight colors for coloring objects, text gradient maps, or backgrounds. You can also use hot keys for more efficient text editing, and you can import and output TIFF files. RIO 4.0 supports Color PostScript as an output option.

Other features of RIO 4.0 include variable page format and added rulers and tick marks, for increased accuracy in the placement of objects within the page.

The AT&T RIO package runs in Truevision TARGA and ATVista graphics environments and requires 2 MB of RAM.

Price: TARGA version,

\$1795; ATVista version, \$2495; RIO Animator, \$3000.

Contact: AT&T Graphics Software Labs, 3520 Commerce Crossing, Suite 300, Indianapolis, IN 46240, (317) 844-4364.

Inquiry 1196.

Color Image Editing Comes to Windows

Astral Development brings its color image editing program for the Mac to the PC with the release of Picture Publisher Plus for Microsoft Windows. The program allows for interactive editing and image placement. You can change the hue, saturation, and lightness of images. For page composition, you can crop, size, scale, rotate, and mirror using registration marks. You can edit pictures of any size and resolution, regardless of your system's memory capacity, Astral says.

Offered as a stand-alone program, it includes a utility for scanner calibration.

Picture Publisher Plus runs on any VGA-based system with Windows 3.0.

Price: \$695.

Contact: Astral Development Corp., Londonderry Sq., Suite 112, Londonderry, NH 03053, (603) 432-6800.

Inquiry 1195.

Render Me on the Mac

Digital Arts brings its three-dimensional modeling, animation, and rendering software for the PC to the Mac with the Digital Artist Series for the Mac II family. Model, MacRenderMan, and Animate are designed for use by virtually any professional graphics user.

Model supports spline-based modeling, object sculpting, and advanced deformation with gravity. Both 2-D and 3-D commands are available from a set of pop-up, pull-down menus, and you can alternate between environments of different dimensions.

MacRenderMan is a customized version of the Pixar MacRenderMan program. The Digital Arts software features Render Manager, which lets you interactively compose images by setting object placement, lights, and various shading and texturing parameters. You can save the images you create as TIFF, PostScript, or PICT files.

Once you've modeled and rendered the images, you can use Animate, which contains all the advanced animation capabilities provided by Digital Arts' DGS products.

These three programs from Digital Arts require 4 MB of RAM and an 8-bit display card.

Price: Model, \$2250; MacRenderMan, \$1995; Animate, \$2250.

Contact: Digital Arts, 7050 Convoy Court, San Diego, CA 92111, (619) 541-2055.

Inquiry 1197.



MYODA LT5200 SERIES

FREE: 3 BUTTON MOUSE
WITH EVERY LT5200 ORDER

Flexibility of a Laptop with the true power and expandability of a high-performance Desktop computer. MYODA has designed & built these machines with the needs of today's demanding users in mind. Just look at our features & then compare them with other machines costing twice as much and you will see why we are the clear choice for professional users. We offer true expandability with **TWO FULL SIXTEEN BIT SLOTS**, MEMORY IS EXPANDABLE TO 8MB ON THE BOARD, VGA SCREEN, EXTERNAL VGA MONITOR PORT, EXTERNAL FLOPPY DRIVE PORT. There's even a true 386-25 running at 0 WAIT STATE available with 32 KB CACHE MEMORY, & they all come with a CONNER, 40 MB HDD & a 3.5/1.44MB FDD AMI or Award BIOS.



Laptop Accessories

- External 5.25/1.2MB floppy drive
- Expansion chassis 2x8 bit, 2x16 bit (For LT-3500 only)
- Power inverter
- External battery pack with 12V inverter
- Numeric keypad
- Fax-modem card
- 12V inverter



MYODA LT-3500 \$1499

Here is your chance to pick up on the biggest bargain in Laptops anywhere. The LT-3500 is packed with features. The 80286-12 MHz CPU runs at 0 wait state, ready to blaze through those tough applications. There is also a 40 MB fast HDD & an internal 3.5/1.44MB diskette drive

- Intel 80286 CPU 0 wait state
- 6/12 MHz clock speed
- EGA GAS plasma display
- 1MB installed 4MB max
- 3.5/1.44MB floppy drive
- 40MB(28ms) hard drive
- 2 serial/1 parallel/CRT port
- Free carrying case



Model	cpu	Internal Slots	Screen	FD	HD	EXT. FD Port	Max Memory	Price
5200CD	386-25	2x16 Bit	VGA, GAS plasma	3.5/1.44	40MB IDE	YES	8MB	\$3699
5200SX	386ex-16	2x16 Bit	VGA GAS plasma	3.5/1.44	40MB IDE	YES	8MB	\$2799
5200NV	286-16	2x16 Bit	VGA GAS plasma	3.5/1.44	40MB IDE	YES	8MB	\$2299



MYODA MD3410

- Intel 80286-12 microprocessor
- Baby AT case
- Up to 4 MB RAM
- AMI BIOS



12" MONO	14" MONO	14" VGA	14" SVGA
\$539	\$579	\$895	\$969



MYODA MD5030

- Intel 80386SX-16 Microprocessor
- Baby AT case
- Up to 8 MB RAM
- Fully compatible: EMS, LIM 4.0, DOS, OS/2, UNIX, XENIX and NOVELL

12" MONO	14" MONO	14" VGA	14" SVGA
\$839	\$865	\$1169	\$1249

All Units Include:

- True intel CPUs
- 1MB RAM
- 1 year warranty
- 101 enhanced keyboard
- 2 serial, 1 parallel, & 1 game port
- Quality desktop cases & power supplies
- Dual FDD/ HDD AT BUS controllers

Installed Hard Drives:

Installation with system purchase	
40 Meg.	\$249
65 Meg.	\$339
100 Meg.	\$599

Case Upgrades

Mini tower, Mid tower and Large tower
Call for special pricing



MYODA MD7240

- Intel 80386-25 microprocessor
- 64KB cache memory
- 4MB RAM
- Full size case
- AMI designed motherboard up to 16MB RAM
- AMI BIOS
- Fully compatible: EMS, LIM 4.0, DOS, OS/2, UNIX, XENIX and NOVELL



12" MONO	14" MONO	14" VGA	14" SVGA
\$1599	\$1629	\$1969	\$2049



MYODA MD7280

- Intel 80386-33 microprocessor
- 32KB cache memory
- 4MB RAM
- up to 16MB RAM
- Fully compatible: EMS, LIM 4.0, DOS, OS/2, UNIX, XENIX and NOVELL
- CALL FOR PRICE

Circle 639 on Reader Service Card (RESELLERS: 640)

MYODA INC.

1053 Shore Road, Naperville Illinois 60563
Tel: (708) 369-5199 Fax: (708) 369-6068

Dealers/Vars Inquires:

1053 Shore Road Naperville Illinois 60563
TEL: (708) 369-5199 FAX: (708) 369-6068

OEM Inquire:

Alex Chen Taipei Office 3F No. 191 Sec. 3 Roosevelt Rd
Taipei, Taiwan TEL: 886-2-3628445 FAX: 886-2-3626283

Mail Order Sales **1-800-562-1071**

15 days money back guarantee. RMA requires on all return. No surcharge on VISA and MASTER CARD. We accept AMERICAN EXPRESS and DISCOVER CARD.

The Good, the Bad, and the Ugly of HyperCard 2.0

The recent reversals and stopgap measures in the continuing saga of the HyperCard distribution strategy are leading users to ask, "What does Claris want?"

Apple's announcement that HyperCard will be bundled with the new Macs in a run-time-only version sparked an outpouring of protest, causing Apple and Claris to rethink their strategy. Apple's announcement that the version of HyperCard 2.0 to be bundled with new Macs would not have scripting capabilities has been the object of lively discussion in the Mac community. The ensuing protest from users caused Apple and Claris, which has taken over proprietorship of HyperCard, to reverse the earlier announcement and bundle a full version with the new Macs.

At the regular Thursday night meeting of BMUG, Inc., the impending release of HyperCard 2.0 was the most discussed topic of the meeting. Amid all the rumors and speculation, one person's comment illustrated just how personally users take HyperCard, which was designed to bring hypertext authoring to anyone who owns a Mac. As users wondered how much the scripting version of Hyper-

Card might cost, someone from the audience suggested, "Let's just not buy it. [Apple] will get the idea we don't like them messing with our program."

Claris apparently heard, and listened to, the protests of stack developers and users. The company later said a full version will be shipped, but to enter scripting mode, you'll have to make a minor change to the home stack. However, it's not clear if this last-minute change in strategy will mollify HyperCard developers.

At least one HyperCard expert is calling the latest turn in this drama "pathetic."

David Drucker, a HyperCard consultant since 1987 and a member of the Boston Computer Society's MacStack-Group, says the decision by Claris to put an opaque button over the scripting choices on the home stack connotes "a despicable attitude." Drucker said the company is "still putting it out with the attitude that what you don't know is good for you." He also said the opaque button represents "the exact opposite of empowerment."

The official Claris line is that the opaque button scheme will prevent new users from destroying or altering stacks. But Drucker says that if a person is that concerned about data integrity, it's up to the developer to protect the stack, which is easily done with a one-line command.

Despite the waffling of Claris on this issue, Drucker sees the company's acquisition of the upgrade and development responsibilities of HyperCard as good news, in general. "If HyperCard had to end up in a place, this [Claris] is the best place."

According to Drucker, now that Claris has taken over HyperCard, users can look for network support, spreadsheet capabilities, and the incorporation of the XTND file-format conversion technology into future versions of HyperCard.

But Drucker says the opaque button announcement left him "amused and irritated at the same time."

"Apple's giving it over to Claris is still a good sign," he said. "As long as they [Claris] don't pull any more boneheaded things like this."

—Dave Andrews and
Kandy Arnold

BBS for Vietnam Vets

A Vietnam veteran named Larry Horn has started a new project for Vietnam veterans to contact each other. According to Horn, there isn't an easy way for veterans to contact other veterans. He is organizing a computerized project to list and refer veterans through a national BBS. The primary goal is a national veterans' reunion center that will serve veterans of all eras.

If you want to help in the financing of the project or register as a vet, you should write to the project. If you want to register, you need to include a self-addressed, stamped envelope.

Contact: Vietnam Veterans Registry, Inc., P.O. Box 430, Bridgton, ME 04009, (207) 647-8608.

Nanobytes

At a Berkeley Macintosh Users Group meeting, Esther Dyson, editor and publisher of the newsletter *Release 1.0*, spoke in hushed tones about General Magic, the Apple spin-off that is supposedly developing a new class of communications products.

Presumably because of nondisclosure, Dyson said she couldn't comment if she'd heard anything about the new company's product, which could be a new class of personal intelligent communicators. However, she did say, "When I'm alone at night, I think about General Magic."

At the same meeting, Dyson also said, "There are a lot of women industry observers, but not a lot of women industry managers. You can't legislate it. Legislation helps, but the old guys have to die off."

Jeff Cherniss, president of Advanced Software, said before he demonstrated his document-comparison program for the Mac, "Our office was burgled over the weekend. The thief took Pluses over the 386s."

A report in *Microscope*, the Mile High Computer Resource Organization's newsletter, says Windows 3.0 is causing some users to lose more than their patience. Users with exceptionally large hard disk drives (more than 1024 cylinders), drives formatted by non-FDISK programs, or systems with mismatched components might encounter problems, including the destruction of hard disk systems. If you're concerned about your system's safety, call technical support at (206) 637-7098.

What's Going On in Your Users Group?

Any visitors lately? What happened at your last general meeting? BYTE magazine is interested in hearing about the products you see and what their developers are saying. Phone the BYTE news department at (603)

924-2630 or send a fax to (603) 924-2550. You can also send a copy of your news story to One Phoenix Mill Lane, Peterborough, NH 03458, or send E-mail to "dave.news" on BIX or to "BYTE" on MCI Mail.

Buy with

Confidence

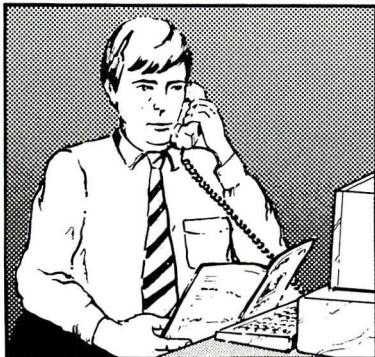

In an effort to make your telephone purchasing a more successful and pleasurable activity, The Microcomputer Marketing Council of the Direct Marketing Association, Inc. offers this advice, "A knowledgeable buyer will be a successful buyer." These are specific facts you should know about the prospective seller before placing an order:

Ask These Important Questions

- How long has the company been in business?
- Does the company offer technical assistance?
- Is there a service facility?
- Are manufacturer's warranties handled through the company?
- Does the seller have formal return and refund policies?
- Is there an additional charge for use of credit cards?
- Are credit card charges held until time of shipment?
- What are shipping costs for items ordered?

Reputable computer dealers will answer all these questions to your satisfaction. Don't settle for less when buying your computer hardware, software, peripherals and supplies.

Purchasing Guidelines

- State as completely and accurately as you can what merchandise you want including brand name, model number, catalog number.
- Establish that the item is in stock and confirm shipping date.
- Confirm that the price is as advertised.
- Obtain an order number and identification of the sales representative.
- Make a record of your order, noting exact price including shipping, date of order, promised shipping date and order number.

If you ever have a problem, remember to deal first with the seller. If you cannot resolve the problem, write to MAIL ORDER ACTION LINE, c/o DMA, 6 E. 43rd St., New York, NY 10017.

This message is brought to you by:

the MICROCOMPUTER
MARKETING COUNCIL
of the Direct Marketing
Association, Inc.
6 E. 43rd St.,
New York, NY 10017

MMCG
MICROCOMPUTER
MARKETING COUNCIL
of the Direct Marketing Association, Inc.

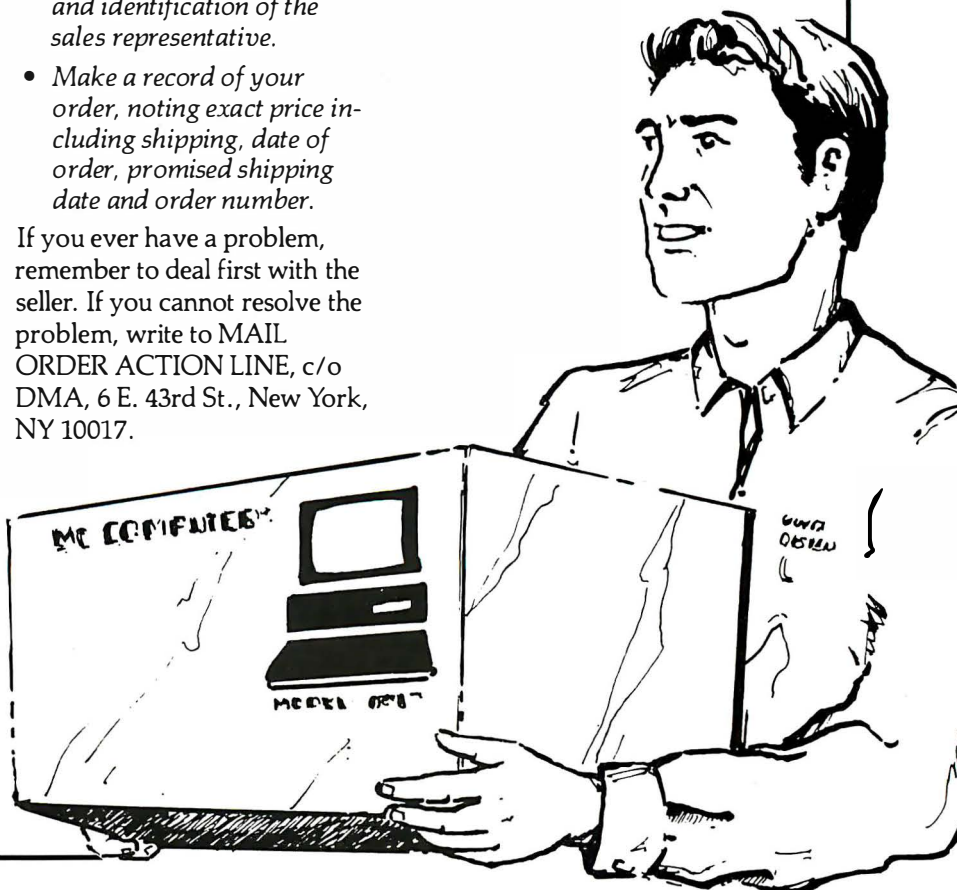

BET ON A DERBY WINNER...

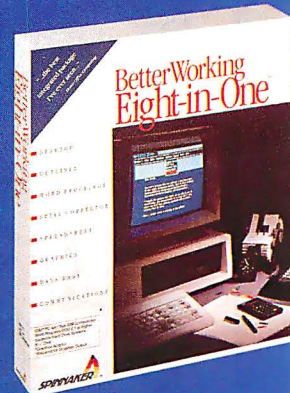

386/33C-200 PRO

- Intel 80386-33, 32-bit
- 4 M RAM 64K Cache
- 200M Hard Drive 15ms

New System
\$3,395.00

286/12-40 KEY

- Intel 80286-12, 1M RAM
- 40M Hard Drive 28ms
- Eight-In-One by Spinnaker
- Dexxa Mouse w/ Paint

\$1,495.00

386SX-40 PRO

- Intel 80386SX
- 2M RAM
- 40M Hard Drive 28ms

\$1,895.00

386/25C-65PRO

- Intel 80386-25, 32-bit
- 4M RAM 64K Cache
- 65M Hard Drive 25ms

\$2,695.00

386SX-100 PRO

- Intel 80386SX
- 2M RAM
- 100M Hard Drive, 25ms

New System
\$2,195.00

286/12-65 KEY

- Intel 80286-12, 1M RAM
- 65M Hard Drive, 33ms
- Eight-In-One by Spinnaker
- Dexxa Mouse w/ Paint

\$1,595.00

386SX-65 PRO

- Intel 80386SX
- 2M RAM
- 65M Hard Drive 25ms

\$1,995.00

386/25C-100 PRO

- Intel 80386-25, 32-bit
- 4 M RAM 64K Cache
- 100M Hard Drive 25ms

\$2,895.00

ALL DERBY COMPUTERS FEATURE

- 1.2M 5.25" and 1.44M 3.5"
- 2 Serial/Parallel/Game Ports
- MS-DOS v4.01/GW BASIC
- KEYS feature desktop cases
- 16-bit VGA 1024X768 w/512K
- VGA 1024X768 Color Monitor
- 101 Key Tronics Keyboard
- PROS feature mid-size towers

386SX-40 KEY

- Intel 80386SX, 2M RAM
- 40 M Hard Drive, 28ms
- Eight-In-One by Spinnaker
- Dexxa Mouse w/ Paint

\$1,795.00

386/25-65 PRO

- Intel 80386-25, 32-bit
- 4M RAM
- 65M Hard Drive 25ms

\$2,495.00

386/33C-65 PRO

- Intel 80386-33, 32-bit
- 4M RAM 64K Cache
- 65M Hard Drive 25ms

\$2,795.00

386SX-65 KEY

- Intel 80386SX, 2M RAM
- 65M Hard Drive, 33ms
- Eight-In-One by Spinnaker
- Dexxa Mouse w/ Paint

1,895.00

386/25-100 PRO

- Intel 80386-25, 32-bit
- 4M RAM
- 100M Hard Drive 25ms

\$2,695.00

386/33C-100 PRO

- Intel 80386-33, 32-bit
- 4 M RAM 64K Cache
- 100M Hard Drive 25ms

\$2,995.00

- 30 Day Money Back Guarantee
- 72 Hour Burn-in Testing
- All systems built in the USA
- Hours: 9:00 to 6:00 M-Sat Cen
- Shipping Charge: Keys: \$35.00
Pros: \$45.00
- 100% IBM Compatible
- Toll Free Tech Support
- One Year Warranty
- We Accept (no surcharge)



Circle 617 on Reader Service Card
(RESELLERS: 618)

DerbyTech
Computers
Inc.

1-800-24-DERBY

718 - 15th Avenue / East Moline / Illinois / 61244 / (309) 755-2662

DerbyTech
Computers
Inc.

1 YEAR FOR ~~\$42.00!~~

Special Offer! \$24.95!

Save over 40% off the single copy price by subscribing now to BYTE! Your paid subscription will include BYTE'S annual IBM PC Special Issue.

Payment Enclosed

Bill Me Later

Name _____

Company _____

Address _____

City _____ State _____ Zip _____

No-Risk Guarantee: If dissatisfied, cancel anytime for a full 100% refund.
Your subscription will start in 6-8 weeks.

BYTE

IW0D018



NO POSTAGE
NECESSARY
IF MAILED
IN THE
UNITED STATES

BUSINESS REPLY MAIL
FIRST CLASS MAIL PERMIT NO. 42 HIGHTSTOWN, NJ

POSTAGE WILL BE PAID BY ADDRESSEE:

BYTE

Subscription Department
P.O. Box 558
Hightstown, N.J. 08520-9409

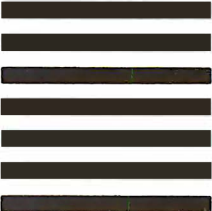



Diagnostic equipment, portable computers, and better ways of working on the road

This month we had the oddest pair of computer failures I ever heard of. They're also instructive. First, the Cheetah 486: Alex was working with QEMM-386 and Desqview, trying to get the largest possible working memory space—what in CP/M days we called a transient program area—by packing mouse drivers, buffers, and other such stuff up into the area between 640K bytes and 1 megabyte, what we're learning to call high memory; the more you can stuff up there, the larger the TPA you'll have. Alas, sometimes this can be tedious work.

It's tedious because most video board manufacturers do not tell you what areas of high memory they are going to usurp, nor indeed how large their BIOS is. You can learn only by trial and error. In general, the faster the video board, the more likely it is to be a memory hog; and if it uses the Tseng Laboratories' chips and has five crystals on-board, it's likely to be not only very fast and very reliable, but also capricious in its memory wants.

For example, the Micro Labs video board in the Cheetah 486 is extremely fast, has five crystals, uses Tseng chips, and is wonderful for those who want a high-end board for graphics or CAD; but it also grabs high-memory areas without warning, which can crash systems using QEMM-386, as I found out when the Railroad Tycoon game locked up tighter than a drum.

The only remedy is to exclude the right memory areas from QEMM-386 in the CONFIG.SYS, reset, and see if the system crashes. If it does, do a hardware reset, change the CONFIG.SYS, and do a

software reset; test for crash; and so forth. Now, of course, you can just exclude vast areas of memory, but that defeats the purpose of using QEMM-386. It's better to do the trial and error.

Failure Modes

Doing this makes you reset the machine often, which shouldn't be a problem; but suddenly the Cheetah 486 wouldn't come up. It reported a memory error on startup; and it did that every time. Very consistent.

I called Gene Sumrall of Cheetah. Incidentally, Cheetah was recently bought by Northgate Computer Systems. They also hired key Cheetah people, including Gene and Ron Sartore. Northgate's Art Lazare says he'll keep Cheetah intact as a high-end product line, which means that buyers will get Cheetah engineering backed by Northgate technical support and financial resources; that's going to be one formidable high-end system.

Gene was understandably upset. My Cheetah 486 was an early production model, and it had been tested nine ways to Sunday before being sent to me.

"Video board," Gene said. "When something like that happens, it's generally the video board."

"Right," I said, and got out my trusty Video Seven board, which, if not as fast as the Micro Labs board, is about as reliable as they come. It took about 2 minutes to put in the Video Seven board and turn on the machine.

I got the same error reading. Call Gene again.

The Cheetah 486 is built up with a motherboard capable of going up to some incredible speed and a board that carries the i486 chip and its associated glue chips. This lets you swap for a faster system when faster i486 chips become available. Cheetah sent a new CPU board by Federal Express. I swapped. Same error.

By now, Gene was ready to tear out his hair. "Can you take all the boards out," he said.

That was no problem, although I kept wondering what the machine would do with no CPU. However, the Cheetah motherboard has a small LCD that tells precisely what is going on in the boot-up process. We were hung at stage 26 (it should go to FF), and apparently that's well before the system ever gets to the i486 chip. I pulled all the boards.

"Same error," I reported. "Stops at 26."

Long silence. "I'll call you back."

The next step sounded a little weird. "Take the machine, take the boards out of it, turn it upside down, and beat on it," I was told. "Ron [Cheetah guru Ron Sartore] says there may be a little bit of metal shorting the address lines."

Well, OK, I thought. I turned the machine over and tapped it. Then I tried the vacuum cleaner, used canned air from the cleanup kit, and looked at every board slot with a strong light. I thought I found a bit of metal. Gloat. Turn on the machine. "Same problem."

The next step was a new motherboard, and to be sure it was installed right, they sent in Larry Aldridge, the local Cheetah distributor. Incidentally, Larry is also going to work for Northgate, as a director of product development. He delivered the motherboard. Installed it, and turned on the machine.

Same error.

"Power supply," Larry said. "Except that I never heard of this kind failing." He borrowed my voltmeter and fooled around a bit. "Something's pulling down the regulated voltage," he decided. But we couldn't figure what. It looked like there was nothing for it but to replace the power supply, too. Then Larry had an inspiration.

"Keyboard."

"Keyboard?" I shook my head. "OK." We disconnected the keyboard and got out another. Turn on the machine. The LCD went past 26, on up. The hard disk clicked over. The machine booted fine. Clearly, some kind of short

in the keyboard was pulling the power low, which made the machine believe it had a memory error.

There was only one problem: that keyboard is a Northgate OmniKey/Plus in the "Pournelle configuration," with the Backspace key next to the P, where God intended it to be. There aren't many of those in the world, and I sure hated the idea that one of mine (I have four) didn't work properly.

Inspection showed that the keyboard is held together with six screws. I opened it up. Everything is modular, and nothing falls apart; no problem. As I removed the keyboard from the case, something fell out. A scrap of metal, I think; it vanished behind the cushion of the couch. Meanwhile, other stuff fell out, nutshells, crumbs, bits of popcorn. I shook everything out, vacuumed it, and put it back together, said a quiet prayer, and plugged it back into the Cheetah.

No problem. Everything works fine and has for a couple of weeks now.

Meanwhile, we solved a second problem: the old Zenith Z-248, one of the early 286 machines, still does service in education, but it recently began having

The major moral of the story is clear: if you have a problem, it could be anything. We knew that back in CP/M days.

problems on boot-up. If it ever got past the boot problems it was all right, but as Bill Godbout says, "If the error rate is high enough to measure, it's too high."

Zenith has built-in diagnostics in their ROM monitor, but running that all night didn't find anything. I didn't have time to do much more with the machine, so I sent it to the local Heath/Zenith store. Alas, they couldn't find anything wrong with it at all; but when I got it back here and put it on the bench, the same problem

developed. Then, by accident, I moved the 110-volt power cord—and the machine rebooted.

Turns out there's something wrong inside the power cord. You can't see anything wrong by inspection; and, naturally, we didn't send that power cord out to Heath/Zenith with the machine. Sigh.

There are two morals to the story, one major and one minor. The minor one is, go clean your keyboards out. If you're not sure that you can get them back together, it's probably best not to take them apart. But Northgate keyboards are no problem, and you can at least vacuum the others. I've also found that washing keyboards out with warm water (I just take mine into the shower) and drying with low heat from a hair dryer will fix sticky keys and generally spruce up their appearance, as well as remove foreign objects.

The major moral of the story is clear: if you have a problem, it could be anything. We knew that back in CP/M days.

Diagnostics

All this got me looking at diagnostics. Alex and Barry Workman recommend

Compact Desk.



This pocket-sized box instantly turns a portable computer into a laptop office. Introducing the WorldPort 2496™ portable fax and data modem.

If your business is like most, fax is a way of life. The WorldPort 2496 is the fax of life on the road.

Weighing less than 8 ounces, with battery, it also runs on AC power and connects to RJ11s or optional acoustic couplers for public phone

use anywhere. Via Bell or CCITT standards. It even sends and receives fax and data messages unattended or while you run other applications.

Suddenly, a laptop in the field is a full communications center. With up-to-the-minute incoming from your host. Overnight outgoing to the branches. And on-the-run faxes to any client. Over pay phones, hotel phones and PBXs worldwide.

Get the WorldPort 2496. It adds the power of your office to the portability of your laptop. And the advantages of a fax to the convenience of your desktop.

Call us today at 800-541-0345 (in New York, 516-261-0423) for more on the WorldPort line and the dealer nearest you.



Touchbase Systems, Inc.
160 Laurel Avenue
Northport, NY 11768
(516) 261-0423
Fax (516) 754-3491

WorldPort 2496 is a trademark of Touchbase Systems, Inc. © 1989 Touchbase Systems, Inc.

Everything You Ever Wanted In UNIX. And Less. \$99.95*

OK. We know it's hard to believe. So just consider this. Coherent™ is a virtual clone of UNIX. But it was developed independently by Mark Williams Company. Which means we don't pay hundreds of dollars per copy in licensing fees.

What's more, Coherent embodies the original tenet of UNIX: small is beautiful. This simple fact leads to a whole host of both cost and performance advantages for Coherent. So read on, because there's a lot more to Coherent than its price.

SMALLER, FASTER...BETTER.

Everybody appreciates a good deal. But what is it that makes small so great?

For one thing, Coherent gives you UNIX capabilities on a machine you can actually afford. Requiring only 10 megabytes of disk space,

LESS IS MORE!	Coherent For the IBM-PC/AT and compatible 286 or 386 based machines.	Santa Cruz Operation's XENIX 286, Version 2.3.2
No. of Manuals	1	8
No. of Disks	4	21
Kernel Size	64K	198K
Install Time	20-30 min.	3-4 hours
Suggested Disk Space	10 meg	30 meg
Min. Memory Required	640K	1-2 meg
Performance*	38.7 sec	100.3 sec
Price	\$99.95	\$1495.00

*Byte Exec benchmark, 1000 iterations on 20 MHz 386. Hardware requirements: 1.2 meg 5¼" or 1.4 meg 3½" floppy, and hard disk. SCSI device driver available soon. Does not run on Microchannel machines.

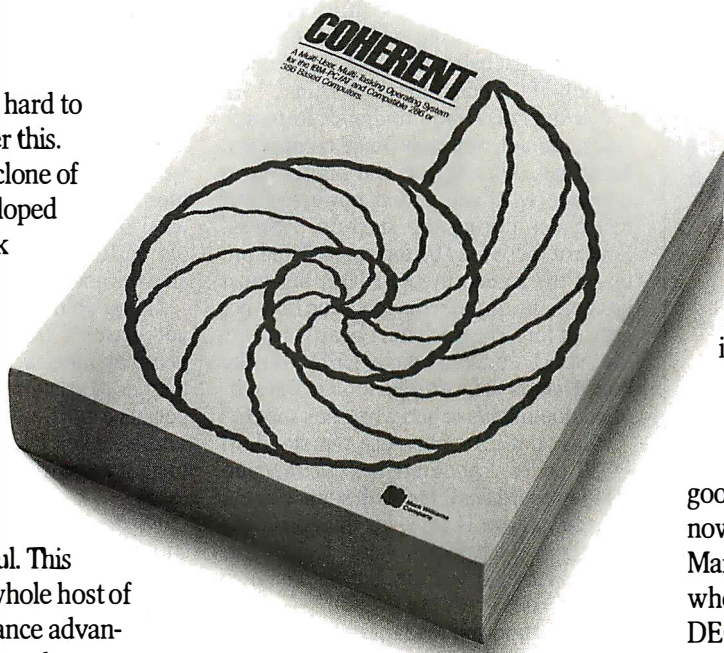

Coherent can reside with DOS. So you can keep all your DOS applications and move up to Coherent. You can also have it running faster, learn it faster and get faster overall performance. All because Coherent is small. Sounds beautiful, doesn't it?

But small wouldn't be so great if it didn't do the job it was meant to do.

EVERYTHING UNIX WAS MEANT TO DO.

Like the original UNIX, Coherent is a powerful multi-user, multi-tasking development system. With a complete UNIX-compatible kernel which makes a vast world of UNIX software available including over a gigabyte of public domain software.

Coherent also comes with Lex and Yacc, a complete C compiler and a full set of nearly 200 UNIX commands including text processing, program development, administrative and maintenance commands.

And with UUCP, the UNIX to

UNIX Communication Program that connects you to a world-wide network of free software, news and millions of users. All for the cost of a phone call.

We could go on, but stop we must to get in a few more very important points.

EXPERIENCE, SUPPORT AND GUARANTEES.

Wondering how something as good as Coherent could come from nowhere? Well it didn't. It came from Mark Williams Company, people who've developed C compilers for DEC, Intel, Wang and thousands of professional programmers.

We make all this experience available to users through complete technical support via telephone. And from the original system developers, too!

Yes, we know \$99.95 may still be hard to believe. But we've made it fool-proof to find out for yourself. With a 60-day money-back no-hassles guarantee.

You have to be more than just a little curious about Coherent by now. So why not just do it? Pick up that phone and order today.

You'll be on your way to having everything you ever wanted in UNIX. And for a lot less than you ever expected.

1-800-MARK WMS

(1-800-627-5967 or 1-708-291-6700)
60-DAY MONEY BACK GUARANTEE!



Mark Williams Company

60 Revere Drive
Northbrook, IL 60062

*Plus shipping and handling. Coherent is a trademark of Mark Williams Company. UNIX is a trademark of AT&T. XENIX is a trademark of Microsoft.

Finally, a fast, powerful text editor that integrates your favorite programming tools and uses no memory!

VEDIT PLUS

favorite programming tools and uses no memory!

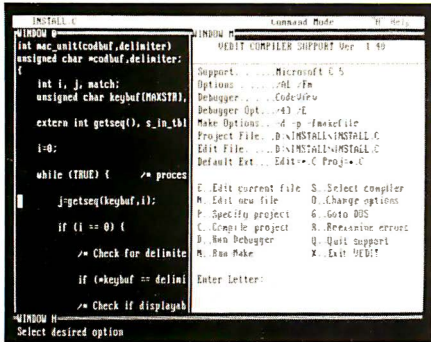

```

WINDOW #
int mac_unit(codbuf,delimter)
assigned char *codbuf,delimter:
{
int i,j,match;
assigned char keybuf(MAXSTB);
extern int getch(i),s_in_tkl;
i=0;
while (TRUE) {
    /* process
j=getch(keybuf,i);
if (i == 0) {
    /* Check for delimit
if (*keybuf == delimi
    /* Check if display
}
}
}

```

- Mouse support
- Pull-down menus
- Columnar blocks
- 1000 Level Undo
- Regular Expressions
- Small 70K, super fast
- DOS, UNIX/XENIX, FlexOS
- Also VEDIT \$69, VEDIT Jr. \$29



FREE Evaluation Copy Call 1-800-45-VEDIT

The new VEDIT PLUS is the productivity breakthrough programmers have been looking for. Run not only popular compilers, but all of your favorite tools from within the editor. When shelling to DOS, VEDIT swaps itself and any desired TSRs out of memory to give you more memory than when you entered VEDIT.

Only VEDIT gives you the advantages of a powerful and flexible editor without giving up the convenience of an integrated environment.

VEDIT offers stunning performance, versatility and ease of use. Completely written in assembly language, it's small and lightning fast. Edit text and binary files of any size, even 100+ megabytes. Installation is trivial; VEDIT.EXE and an optional help file are all you need - no overlays, no configuration files.

Other features include multiple file editing, windows, unlimited keystroke macros, "hot keys", context sensitive help, word processing, automatic indenting and total configurability. VEDIT has been the choice of 100,000 programmers, writers and engineers since 1980.

VEDIT PLUS adds a powerful "off the cuff" macro programming language, complete with source level debugging.

VEDIT PLUS - \$185 for DOS, \$285 for UNIX/XENIX. Call for a free demo today.

Greenview

P.O. Box 1586, Ann Arbor, MI 48106
(313) 996-1299 * Fax (313) 996-1308

76 B Y T E • DECEMBER 1990

two products: a software diagnostics package called CheckIt, and a hardware card called Kickstart.

CheckIt, from Touchstone Software, produces detailed reports, does exhaustive memory tests, and generally does about all a software diagnostics package can do. It's the kind of thing that you don't need often, but when you do need it, you need it bad. Of course, it can operate only if the computer is working.

Kickstart I, from Landmark Research International, works on dead computers. Machines that use 286 and higher chips generate what are called power-on self test codes during the start-up process. Some of these may be interpreted and put up on the screen by the BIOS, but most are not, and anyway the machine may not get that far. The Kickstart board displays the POST codes through LEDs on the board itself. You can then look in the supplied documents to see what they mean.

Alas, not all clones use the standard POST codes. Landmark has documented all they could find, but with some clones, all you can do is look up the standards and guess. That will probably be helpful, but it's better if you are getting standard information.

By the time you read this, there will be a Kickstart II, which will check that power is within 5 percent of standard (Kickstart I just looks to see that there is power) and will use an LCD rather than LEDs. Barry Workman says the current one is plenty good: he has to maintain systems for many clients and would hate to live without Kickstart.

The company also makes diagnostic disks to test the alignment of floppy disk drives; if you get a lot of retry errors, you might give that a try. Of course, nowadays the remedy for floppy disk drive problems is to use a head cleaning kit, and if that doesn't work, just replace the drive. They're cheap enough.

Organizing Your Thoughts

It was already plenty good, but Symantec has improved GrandView a lot. New features of version 2.0 include the ability to import and export Q&A Write files—that helps me a lot—and new screen organization. One problem with an outline program is that as you indent farther and farther, you eventually get all the way over to the right, with no room for further work. GrandView has always had a hoist command, which fills the screen with what you're working on, but that's not always optimum either; sometimes you *want* to see some of the other sub-heads in relation to what you're entering now. Anyway, the new version solves

that problem nicely.

In fact, GrandView is good enough that I could use it to write this column. Most of the word processing commands work as you'd expect, and there's mouse support. Like Q&A Write, GrandView incorporates many of the old WordStar Control-key commands, meaning that touch-typists don't have to bother with cursor keys and PageDown and Control-cursor keys, and the other stuff that tries to get your fingers off the home keys.

I only installed GrandView 2.0 last week, but I find that I'm using it a lot more than I did the old one; mind you, I used the old version quite a bit. All my old outlines read right into the new version without problems.

If you do much expository writing and you haven't tried an outline program, you may have the wrong idea about what they do. I certainly did: my previous experience with outlines came from high school, when I was required to write and turn in an outline before I could write an essay.

No doubt the exercise was good for my soul and helped me organize my thoughts in later years, but at the time I hated outlines passionately; consequently, when outline programs first appeared, I dismissed them with my most cynical sneer. I'd probably still be doing that if Jim Baen, my once and future editor and publisher, hadn't persuaded me to give them a try. Jim was right: outline programs really are useful.

You don't use them as my high school teachers demanded, as a kind of preliminary draft when you already know what you're going to say. That may work for some people, but I find it's about as easy in that case simply to tear into the subject, write everything I know, and, with the magic of word processors, edit the resulting mess into coherence. No: an outline program comes into its own when you haven't the foggiest notion of what you're going to say.

As an example, in addition to the report on the U.S.S.R. I did for BYTE, I'm working up a much longer version that I intend to integrate with another essay on the strategy of technology in this new age. That means I have to include first-hand impressions I got in Moscow, information I was given by people while I was there, reports from books and periodicals, and strategic stuff from my earlier works. The result is a haphazard jumble of thoughts in no discernible order.

Item: pictures of young provincial conscripts paying a ruble—10 percent of their monthly salary—to have their picture taken on Red Square in front of

See Us At
COMDEX
Booth #151

MINUTEMAN[®]

UNINTERRUPTIBLE POWER SUPPLIES

TOTAL POWER PROTECTION

- ★ BLACKOUTS
- ★ BROWNOUTS
- ★ OVERVOLTAGE
- ★ UNDERVOLTAGE
- ★ SURGES
- ★ SPIKES
- ★ EMI/RFI

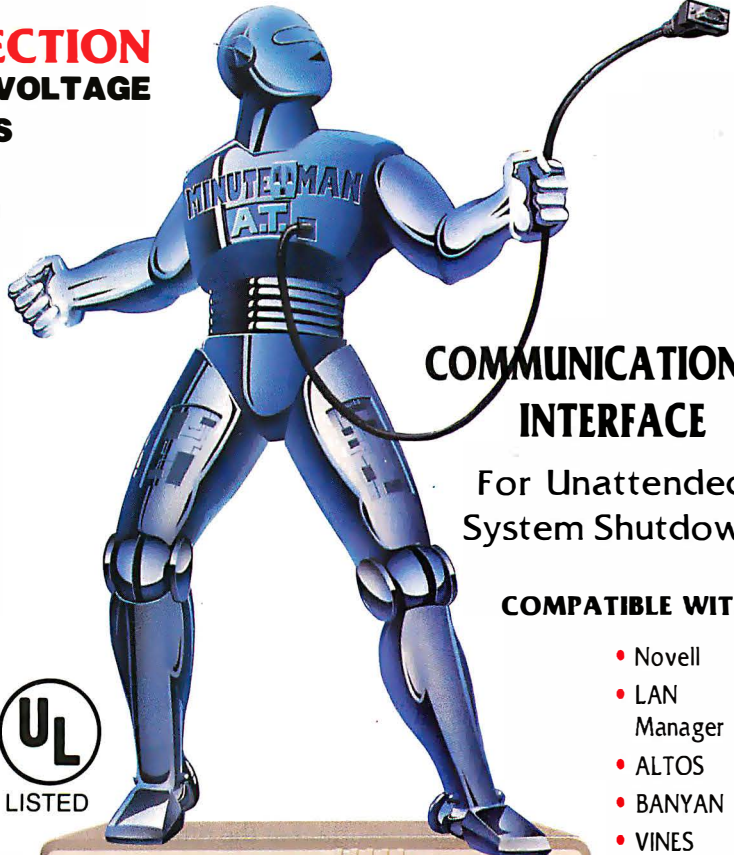

STANDBY UPS MODELS

- 250 VA To 2300 VA
- Sinewave output - 1 millisecond transfer time
- Communications interface and external battery packs available for extended run times

ON-LINE UPS MODELS

- 500 VA To 5,000 VA
- Static By-pass Standard
- True On-Line - Sinewave outputs
- Communications Interface and external battery packs available for extended run time



NETWORK MANAGER

- Shutdown software for unattended operation
- Only software to communicate with LANs and WANs
- Novell 286 VAP and 386 NLM
- SCO Xenix

SLIMLINE & UPRIGHT MODELS

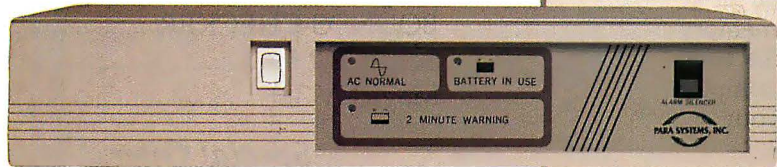

COMMUNICATIONS INTERFACE

For Unattended System Shutdown

COMPATIBLE WITH:

- Novell
- LAN Manager
- ALTOS
- BANYAN
- VINES
- System V UNIX
- Custom Configuration Any System

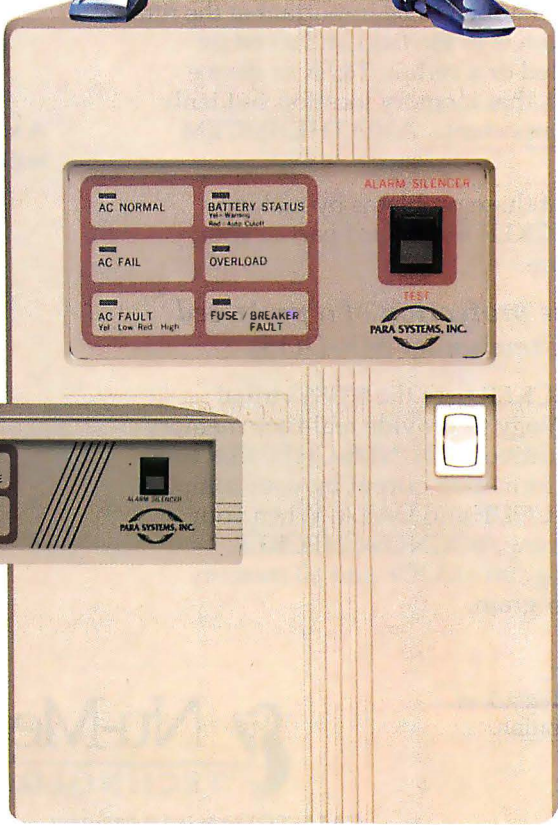

NOVELL
Monitor Boards Available

FOR L.A.N.
NOVELL LABS
TESTED AND APPROVED
NetWare Compatible



1455 LeMay Drive
Carrollton, TX 75007

Telephone:
(214) 446-7363

FAX: (214) 446-9011 TELEX: 140275 OMEGA

1-800-238-7272

"Distributed in over eighty countries"

POWER DEBUGGING

BOUNDS-CHECKER

*Finds out-of-bounds memory accesses —
AUTOMATICALLY.*

Flush out those Nasty pointer problems and other out-of-bounds memory accesses — AUTOMATICALLY.

Each time you make a change to a program, run BOUNDS-CHECKER while testing the new code. If you accidentally access out-of-bounds memory, BOUNDS-CHECKER will pop up displaying the offending SOURCE LINE. And your program runs at full speed.

Ship Bug-Free Products

You can run BOUNDS-CHECKER while testing your program. There are no additional steps to your testing cycle, but you can feel secure when the program has passed through BOUNDS-CHECKER with no reported problems.

Many over-write problems and other out-of-bounds memory accesses do NOT show up during normal testing. An out-of-bounds memory location may be modified, but that particular location doesn't happen to be important at the time. Once the program is in the field and a certain network is loaded or a certain T&SR or device driver is loaded, that memory location suddenly becomes very important... AND THE SYSTEM CRASHES.

You can prevent these problems by making BOUNDS-CHECKER a standard part of your testing procedure.

Gives you the protection of a protected operating system under MS-DOS.

BOUNDS-CHECKER uses the 80386 virtual machine technology to provide real-time memory protection. In addition BOUNDS-CHECKER uses the symbolic information output by your compiler to differentiate CODE and DATA. When your program is running, BOUNDS-CHECKER protects the program's CODE and all memory outside your program.

Requires 80386 PC.
MS-DOS is a trademark of
Microsoft Corporation.



"BOUNDS-CHECKER and Soft-ICE make sophisticated use of the most powerful versions of Intel's processor family to track down some of DOS programming's most insidious bugs. If you're developing programs for DOS, these are essential tools."

PC Magazine
July, 1990 pg. 48

Soft-ICE 2.5 New Version, New Features

The only debugger specifically designed to solve those problems unique to MS-DOS that we call the DOS Nasties.

- Memory over-writes
- Hung programs
- Program too big to debug
- Debugging T&SRs and Loadable Drivers
- Multiple Symbol Tables
- Supports Microsoft C 6.0 & Turbo C++

MagicCV 3.0 (with LOAD-BIG)

A set of tools designed to ease the memory crunch with Microsoft C 6.0.

- Run CodeView in *Less than 8k*
- Run CodeView with EMM & VCPI
- Increase heap space when compiling
- Increase memory with make
- Load high T&SR's and device drivers
- VCPI support

BOUNDS-CHECKER	\$249
Soft-ICE 2.5	\$386
MagicCV 3.0	\$199

Special Offer...

Buy BC & S-ICE	Save \$100
Buy S-ICE & MCV	Save \$86
Buy all three	Save \$186

30 Day Money-Back Guarantee



CALL TODAY (603) 888-2386 or FAX (603) 888-2465

P.O. BOX 7780 ■ NASHUA, NH ■ 03060-7780 ■ U.S.A.

Lenin's tomb. These kids are proud and walk tall, and that has implications.

Item: when we were in a working-class-district grocery store, we noted that there wasn't much for sale: plenty of potatoes and wheat flour and kasha, some butter, no vegetables at all. While we were there, two military trucks pulled up, and the officers bought several cases of milk and several gross of eggs, paying for the goods with loose cash from their pockets. The troops loaded the stuff onto the trucks and drove away. These weren't commissary officers: it was the company commander, a decorated airborne soldier of the Moscow garrison unit. An odd way to feed an elite military unit, and that too has implications.

And so forth. The neat part about GrandView is that I can write about disconnected items as I think of them. I can take my pile of photographs, leaf through them, and write whatever they remind me of; if during that process I remember something totally unconnected, it's no great trick at all to put that note in an appropriate place. Later, all this gets organized into something that is meaningful—and when it does, I'm more than

If you
*have to write anything
 at all complex and
 you haven't tried
 GrandView, you're in
 for a pleasant surprise.*

halfway through the final essay.

Outline programs aren't quite as useful for fiction, but I find I do use GrandView for character notes.

If you have to write anything at all complex and you haven't tried GrandView, I think you're in for a pleasant surprise. Recommended.

Organizing Your Life

When you reach my age, you forget things. Actually, I suspect my memory

never was as good as I like to think it was, but lately it's best described as wretched. The result is piles of little notes, scribbled on all sizes of paper. The important ones invariably get lost, and they surface only after it's just too late to call whomever I was supposed to call or do whatever job the note reminded me of.

I have, to some extent, alleviated the problem by carrying a hardbound logbook and training myself to make most of my notes in that. I also use Scotch tape to glue into the logbook business cards, photos, and the scraps of paper that still turn up. In addition, I have computerized some permanent telephone, address, and memo files I add to from time to time; I print them and paste those pages in the front of each new logbook. The result is a fairly good chronological file of what I've done and who I've seen, as well as my telephone list.

This system has its problems. One is that I go through two or three of those logbooks a year, and on trips I generally must carry at least the current book and its immediate predecessor; they weigh about as much as Sir Zed, the Sinclair

**SAVE 30 MINUTES
 EVERY TIME YOU
 HAVE A PC PROBLEM!**

**NEW VERSION 3.0
 Now Available!**

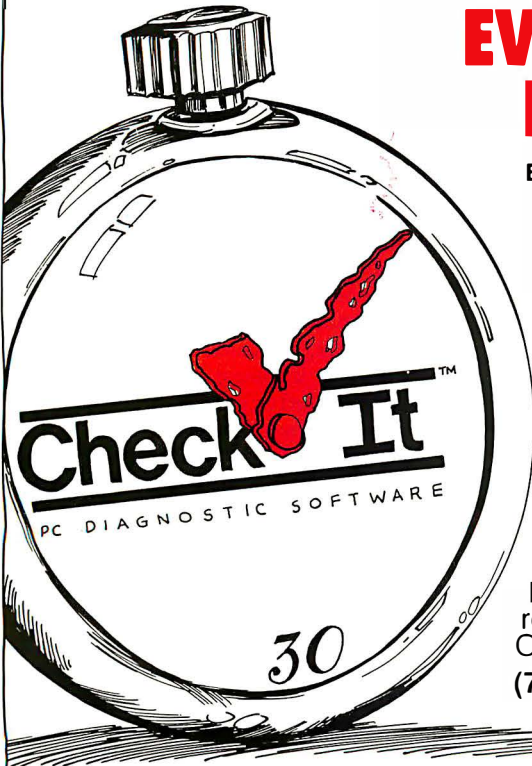

By using Check✓It® to find out if the problem is Hardware or Software

The second you suspect a problem with your PC, you should reach for Check✓It, the world's most popular PC diagnostic software. Running Check✓It should be the first thing you do -- because confirming or eliminating your PC's hardware as the source of the problem can save you time, money, and unnecessary repair calls.

Check✓It will test your PC's main system board, memory, hard disk drive and floppy disk drives, video subsystem, communication ports, printer, keyboard, mouse, or joystick. Check✓It will also display key software and setup data, including your PC's exact equipment configuration, current IRQ assignments, memory allocation, device drivers, and CMOS table.

Take a minute to run Check✓It the next time you have a PC problem. Then you'll know the answer to these key questions: Should you back it up, pack it up, and send it out for repair? Should you fix a hardware problem yourself? Or, should you concentrate on the software and configuration problems that you can correct?

The moment you suspect a PC problem, run Check✓It. It's about time!

Look for Check✓It at leading retail stores everywhere,
 Or call TouchStone TODAY!
 (714) 969-7746 or (800) 531-0450

TouchStone
 Software Corporation

2130 Main Street, Suite 250, Huntington Beach, CA 92648

Check✓It is a registered trademark of TouchStone Software Corporation. Copyright ©1990 TouchStone Software Corporation. ALL RIGHTS RESERVED.



**NEW
 "Basic
 PC Maintenance"
 Hands-On Video
 Ask for it
 TODAY!**

Z88. Second, although I try to make a sort of combination index and table of contents of my logbooks, I don't get around to that very often, so I can spend quite a bit of time hunting for a business card if I can't remember exactly when I got it.

Still in all, my system does work, because it's built around the way I normally do things: it's free-form, doesn't make me design forms and stick to them, and has access by browsing; and despite all

my computers and dozens of attempts to computerize my life, I find I always come back to my hardbound logbooks and Scotch tape.

Still, hope springs eternal, and I keep hoping to find electronic ways that will take over at least part of the job; which brings us to Tornado.

This isn't a new product. It was recommended to me when it first came out, but that version didn't work with either SideKick or Desqview, so I didn't see

how it would do me any good.

The latest version of Tornado works with both products, although there are a number of cautions about using it with SideKick (not to mention that if you have both Tornado and SideKick resident, you're going to have a pretty small TPA; no great matter, for I seldom use SideKick any longer, and then only in its own Desqview window).

As for Desqview, Tornado will work either as a TSR program beneath some other program in a window or in a window by itself. Micro Logic recommends the latter arrangement, and it seems reasonable to me. It's also possible to have multiple copies of Tornado running at the same time.

Tornado is a character-based free-form memo database. Once it's installed, you can make any text notes you please in any format you like. The result will be a number of little windows, each with some text in them. Their sizes will be appropriate to how much information you have put in them. The arrangement is controlled by you: think of the various note windows as a pile of scraps of paper of different sizes. If you pull a very large one out and put it on top, it will probably be the only one you see. On the other hand, if you put the big one on the bottom, you can lay out quite a few on top of it and then put more on top of them, until you have a jumble of notes, some visible and some partly so.

One note will be on top, and that's the one you can write on. You can also create a note on a new scrap of paper and then leave it on top or bury it into the pile.

Retrieval is simple enough. You can either browse through the notes or have the program search intelligently for some keyword or name. If it finds one, it will bring it to the top; if it finds several, it will bring all of them up and give you the chance to do another search, or, alternatively, to search for all those with your first keyword but *without* some other keyword or phrase.

You can also cause the program to date your notes from the system clock (it will insert the time, too, if you like). Alas, there's no setting to make it date notes "automagically"; you have to remember to press Escape-D when you edit the note. It will also add sequence numbers, although again not automatically.

You can group your piles of notes, so that when you call up one of the group, you use the arrow keys to flip back and forth through the others (as if you'd paper-clipped a bunch of paper scraps together). You can incorporate the contents of one note into another. There's a paste

C compiler
software simulator
source level debugger
macro assembler—development board
IBM-PC MSDOS—Sun, Apollo,
Dec UNIX—VAX VMS—Apple Macintosh

AVOCET

68000
68010
68020
68030
68040

AVOCET
SYSTEMS, INC.

The Source For Quality Embedded-System Tools

Avocet Systems, Inc., 120 Union St., P.O. Box 490, Rockport, ME 04856
In Maine, or outside U.S., call (207) 236-9055
TLX: 467210 Avocet C1 / FAX: (207) 236-6713
Call today for free catalog 1-800-448-8500

One Word About Your Hard Disk Controller

SLOW

One Word About the PSI hyperSTORE Controllers

FAST

Intelligent Mass Storage Controllers

Virtually all applications are disk bound. Today's PCs have over 60 times the power of their ancestors of just ten years ago, while hard disk performance has only just tripled. This makes mass storage the PC's worst bottleneck. PSI has eliminated this bottleneck with the hyperSTORE Caching Disk Controller, a sort of mass storage co-processor. The hyperSTORE

does for disk-intensive programs what a math co-processor does for number-crunching software. Databases, file servers, multiuser systems, and other disk-hungry applications start screaming . . . frustrated users stop screaming! Call (800)486-FAST now to find out more about PSI's line of intelligent controllers. All you have to gain is time.

hyperSTORE FEATURE HIGHLIGHTS

- Data access in 0.28ms or less at 3-4MB/sec
- Works in any 286, 386, or i486 system
- Simultaneously control any drive interface: *MFM, RLL, ESDI, SCSI, or AT/IDE*
- Controls up to 28 physical disk drives
- 0KB to 20MB of SIMM-based cache memory
- Supports all PC-based operating systems: *DOS, Windows, UNIX/Xenix, Netware, etc.*
- Data mirroring option for fault tolerance
- **NO DEVICE DRIVERS REQUIRED**

PSI

Perceptive Solutions, Inc.

2700 Flora Street · Dallas, Texas 75201
800-486-FAST · 214-954-1774 · Fax: 953-1774

European Inquiries: 415-284-9505

"Normally, it's a bit hard to pick the most impressive item at Comdex [Spring 1990], . . . This time it was easy, . . . the hyperSTORE/1600."

-Jerry Pournelle, Byte Magazine, September 1990

"PSI has created the power user's ultimate Lego set for disk controllers: the hyperSTORE/1600"

-Alfred Poor, PC Magazine, June 12, 1990

"The real-world result will be blazing record handling from within a data file as well as unstoppably fast program loads."

-Bill O'Brien, PC Magazine, February 13, 1990

To get a V.32
9600 modem with
V.42bis data compression,
you can pay their
standard price.



The price of our new 9600EX makes the price of other 9600bps modems look, well, rather inflated. Especially when you consider the quality and features the 9600EX offers.

Features like V.42bis, which compresses data up to 400% and speeds throughput up to 38.4Kbps (it's also downward compatible with MNP5). And V.42 LAP-M and MNP Level 1-4 error control that detects when data is being garbled and automatically retransmits—so you get error-free

communication. Or full-compliance with V.32, the industry standard 9600 modem protocol, as well as downward-compatibility with 4800, 2400, 1200 and 300bps modems. The 9600EX also gives you the option to operate on standard phone lines or two-wire leased lines and offers both synchronous and asynchronous transmission.

Fact is, at \$799, the 9600EX rivals the price of high-end 2400 modems. Yet, it offers 16 times the performance. Or in other words, more modem for the money.

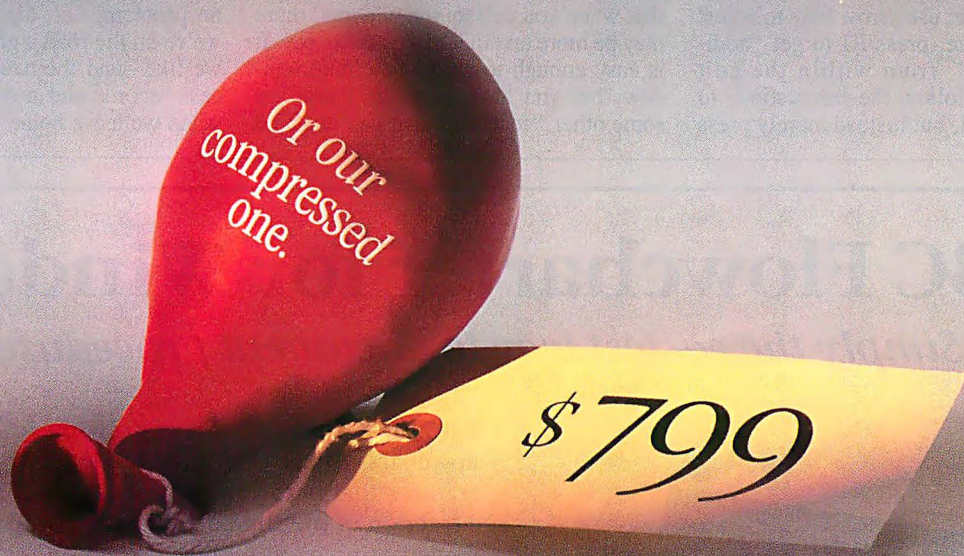

And that added performance saves you money, too. With the increase in throughput speed, the 9600EX spends less time on the phone so you spend less money on your phone bill. You'll also spend less time waiting for it to finish transmitting—and if time is money—you'll save a bundle.

Plus, like our entire family of 2400 modems, the 9600EX comes with a full, five-year warranty. The new 9600EX modem: another example of Intel's commitment to affordable quality. For

more information or a dealer near you, call: 800-538-3373. To have information faxed directly to you, call: 800-525-3019 and request Doc.#9989. And don't be swayed by those over-priced modems, because with everything the 9600EX offers for the money, you might say it just burst their bubbles.

intel[®]

Circle 350 on Reader Service Card (RESELLERS: 351)

feature that's useful if you use Tornado inside a word processor; with Desqview, you're better off using Desqview's mark and transfer features.

The broad features of Tornado are easy enough to learn; it took me about half an hour to go through the tutorial program and experiment until I was comfortable with it. The text editor has the WordStar control commands, as well as the more obvious ones involving arrow keys; it's reasonably intuitive. There are a few surprises, but no real problems.

The Tornado manual is adequate and generally well organized. Alas, there's a strong "Clear Only If Known" component to some of the instructions: for instance, they keep telling you that changing the default window (notepad) size is "easily accomplished," but they don't tell you how to do it, and it's not in either the index or the table of contents. It took no end of fooling around before I realized that you call up any window; press E for edit; Escape; use arrow keys to adjust the window size; press F1 to get "additional menus" from within the edit menu; *do not* follow the instructions to press Escape-E, but instead merely press

Quite
a few associates, both
beginners and
power users, swear by
Tornado, and some find
it indispensable.

E; and then press Escape, and when it asks if you're sure (it doesn't say sure of what), tell it Yes.

Even then, your windows will still collapse vertically if there's blank space at the end of them. This is, I suppose, to save space on-screen, but the result is that when you call up the window, there may be more text in it than you can see. It is easy enough to expand the note window, but you have to do it. There are some other "features" that you can find

only by poking about.

Still, these are nits. Tornado isn't perfect, but it's pretty good. If you're looking for a way to keep your computer near the phone and make files of the stuff that now finds its way onto little scraps of paper, this program will do the job. Tornado has a big-brother program, Info Select, that works in a similar fashion but has increased capabilities and features. Quite a few associates and colleagues, both beginners and power users, swear by Tornado, and some find it indispensable; in fact, the raves of several friends persuaded me to try it.

So far, I like it fine. I'll let you know in a few months if I'm still using it. It's quite possible I will be.

The Portable Problem

The most obvious difficulty with using Tornado or any other software for organizing your life is that you can't take it with you. If you don't travel much this is no problem, but, alas, many of us find we're on the road a great deal more than we like—and the need to make and access records and notes doesn't go away when we leave home. If anything it gets

ABC Flowcharter for Windows

"Simply the easiest way to document procedures."



ABC Flowcharter™ makes drawing and editing flowcharts easier than ever. It's loaded with features that help you make and edit charts in a fraction of the time needed with other flowcharting or drawing programs.

ABC Flowcharter's advanced link feature lets you break complicated procedures into smaller, more manageable steps. Just click on a shape to display a sub-chart or procedure. It's that easy.

Ask your dealer for a demonstration or call 1-800-227-0847 for more information. See for yourself why ABC Flowcharter is quickly becoming the standard flowcharting tool for the Fortune 1000. Retail price \$295.

Roykore™

2215 Filbert St.
San Francisco, CA 94123
415-563-9175

CSS: STATISTICA

CSS/3™ Complete Statistical System with over 1,000 presentation-quality graphs fully integrated with all procedures and on-screen graph customization ■ The largest selection of statistics in a single system; in-depth, comprehensive implementations of: *Exploratory techniques; multi-way tables with banners; nonparametrics; distribution fitting; multiple regression; general nonlinear estimation; logit/probit analysis; general ANCOVA/MANCOVA; stepwise discriminant analysis; log-linear analysis; factor analysis; cluster analysis; multidimensional scaling; canonical correlation; item analysis/reliability; survival analysis; time series modeling; forecasting; lags analysis; quality control; process analysis; experimental design (with Taguchi);* and much more ■ Manuals with comprehensive introductions to each procedure and examples ■ Integrated Stats Advisor expert system ■ Extensive data management facilities (powerful spreadsheet with formulas; relational merge; data verification; flexible programming language) ■ Optimized (plain English menus/mouse) user interface: even complex analyses require just few self-explanatory selections (CSS can be run without manual; Quick Start booklet explains all basic conventions) ■ Macros, batch/commands also supported ■ All output displayed in Scrollsheets™ (dynamic tables with pop-up windows and instant graphs) ■ Extremely large analysis designs (e.g., correlation matrices up to 32,000x32,000) ■ Unlimited size of files; extended precision; unmatched speed (Assembler, C) ■ Exchanges data (and graphics) with many applications (incl. Excel®, Lotus 3®, dBASE IV®, SPSS®) ■ Highest resolution output on practically all printers (incl. HP, Postscript), plotters, recorders, typesetters ■ IBM compatibles, 640k or more ■ Price: **\$595.**

Quick CSS™ Subset of CSS/3: all basic statistical modules (incl. data management) and the full, presentation-quality graphics capabilities of CSS/3 ■ Price: **\$295.**

CSS:GRAPHICS™ A comprehensive graphics/charting system with data management ■ All graphics capabilities of CSS/3 and, in addition, extended on-screen drawing, 19 scalable fonts, special effects, icons, maps, multi-graphics management ■ Hundreds of types of graphs ■ Interactive rotation and interactive cross-sections of 3D graphs ■ Extensive selection of tools for graphical exploration of data; fitting; smoothing; spectral planes; overlaying; layered compressions; marked subsets ■ Unique multivariate (e.g., 4D) graphs ■ Facilities to custom-design new graphs and add them permanently to menu ■ Import/export of graphs and data, 15 formats ■ Optimized (menu/mouse) user interface: even complex graphs require few keystrokes: all graphs on this page can be produced from raw data in less than 20 minutes ■ Macros, batch/commands also supported ■ Unlimited size of files ■ Highest resolution output on all hardware (see CSS/3) ■ IBM compatibles, 640k or more ■ CSS:GRAPHICS is included in CSS:STATISTICA (available separately for **\$495**).

Megafile Manager™ Comprehensive analytic data base management system ■ Unlimited size of files (up to 32,000 fields or 8 MB per record) ■ Megafile Manager is included in CSS/3 and CSS:STATISTICA (separately: **\$295**).

CSS:STATISTICA™ A fully integrated system that combines all the capabilities of CSS/3 and CSS:GRAPHICS into a single extremely comprehensive data analysis system ■ Price: **\$795.**

Domestic sh/h \$7 per product; 14-day money back guarantee.

Circle 291 on Reader Service Card



StatSoft™

2325 E. 13th St. • Tulsa, OK 74104 • (918) 583-4149
 Fax: (918) 583-4376

Overseas Offices: StatSoft of Europe (Hamburg, FRG), ph: 040/4200347; fax: 040/4911310, StatSoft UK (London, UK), ph: 0462/482822; fax: 0462/482855, StatSoft Pacific (Melbourne, Australia), ph: 613-497-4755, fax: 613-499-7410, StatSoft Canada-CCO (Ontario), ph: 416-849-0737, fax: 416-849-0918 Available From: CORPORATE SOFTWARE and other Authorized Representatives Worldwide: Holland: Lemax BV 02968-94210; France: Concept 1) 45669700; Sweden: AkademiData 018-240035; Spain: ADDLINK, SRL: ph: 34-3-459-0722

CSS, CSS.3, CSS:GRAPHICS, Megafile Manager, Quick CSS, STATISTICA, StatSoft, dBase IV, Excel, Lotus, MacDraw, Macintosh, Postscript are trademarks of their respective companies; SPSS is a registered trademark of SPSS, Inc.

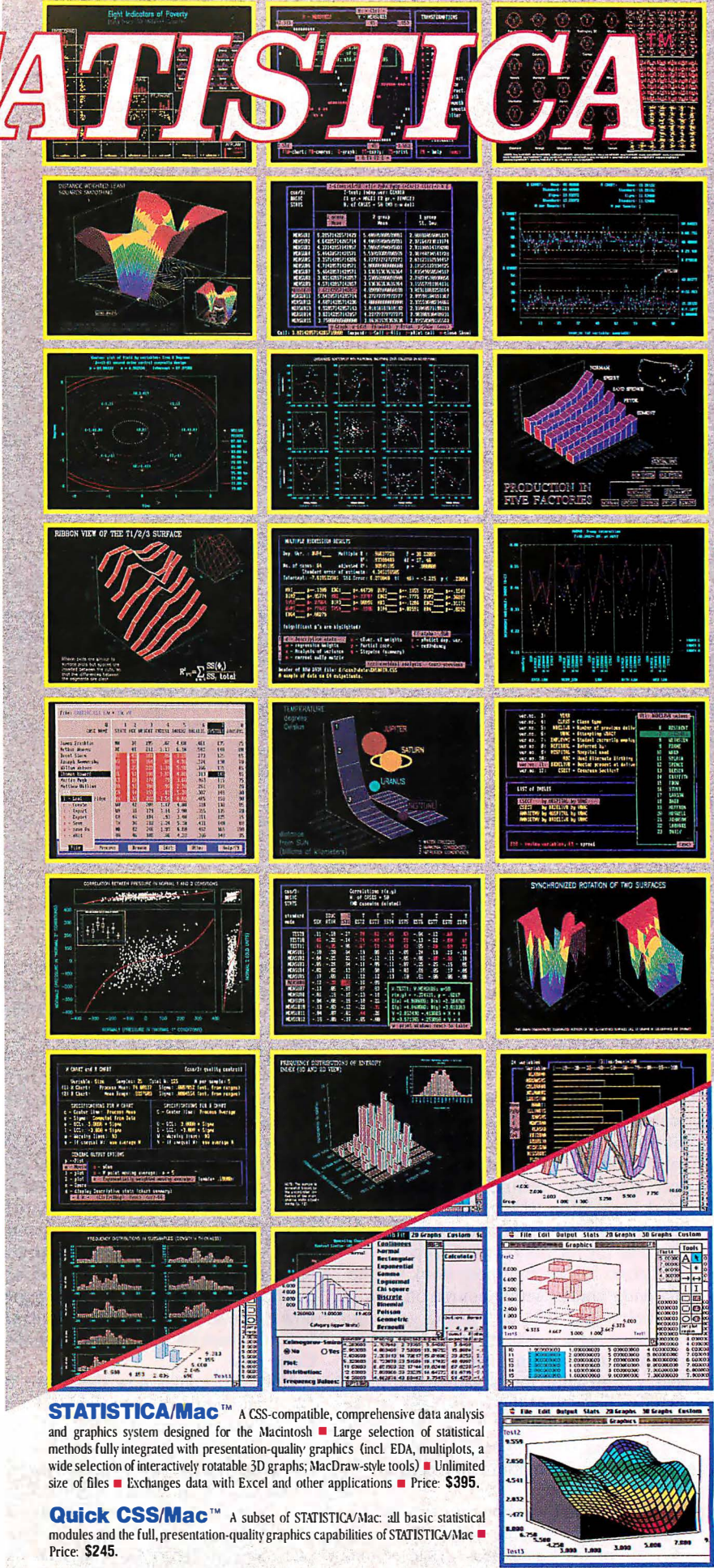

STATISTICA/Mac™ A CSS-compatible, comprehensive data analysis and graphics system designed for the Macintosh ■ Large selection of statistical methods fully integrated with presentation-quality graphics (incl. EDA, multiplots, a wide selection of interactively rotatable 3D graphs; MacDraw-style tools) ■ Unlimited size of files ■ Exchanges data with Excel and other applications ■ Price: **\$395.**

Quick CSS/Mac™ A subset of STATISTICA/Mac: all basic statistical modules and the full, presentation-quality graphics capabilities of STATISTICA/Mac ■ Price: **\$245.**

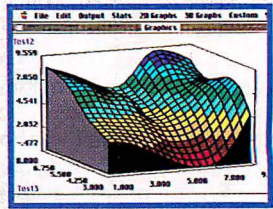

ITEMS DISCUSSED

American Heritage Dictionary \$89.95
 Houghton Mifflin Software
 One Memorial Dr.
 Cambridge, MA 02142
 (800) 633-4514
Inquiry 1149.

CheckIt\$149
 Touchstone Software Corp.
 909 Electric Ave.
 Seal Beach, CA 90740
 (800) 531-0450
 (213) 598-7746
Inquiry 1150.

Cheetah 486
 (call for price)
 Northgate Computer Systems
 7075 Flying Cloud Dr.
 Eden Prairie, MN 55344
 (800) 548-1993
Inquiry 1151.

GrandView 2.0\$295
 Symantec Corp.
 10201 Torre Ave.
 Cupertino, CA 95014
 (800) 441-7234
 (408) 253-9600
Inquiry 1152.

Info Select..... \$99.95
Tornado \$79.95
 Micro Logic Corp.
 P.O. Box 70
 Hackensack, NJ 07602
 (800) 342-5930
 (201) 342-6518
Inquiry 1153.

Kickstart I.....\$199
Kickstart II..... \$599
 Landmark Research International
 703 Grand Central St.
 Clearwater, FL 34616
 (800) 683-6696
 (813) 443-1331
Inquiry 1154.

LapLink\$149.95
Wizard Link for the Mac.....\$149.95
 Traveling Software, Inc.
 18702 North Creek Pkwy.
 Bothell, WA 98011
 (800) 343-8080
 (206) 483-8088
Inquiry 1155.

MusicEase\$295
 Grandmaster, Inc.
 P.O. Box 2567
 Spokane, WA 99220
 (509) 747-6773
Inquiry 1156.

TravelMate 2000 LT286
 with 20-MB hard disk drive ... \$3999
 Texas Instruments, Inc.
 P.O. Box 2022230
 Austin, TX 78720
 (800) 527-3500
Inquiry 1157.

Zenith SupersPort SX
 with 40-MB hard disk drive ... \$5499
 with 120-MB hard disk drive... \$6499
 Zenith Data Systems
 1501 Feehanville Dr.
 Mt. Prospect, IL 60056
 (800) 553-0331
 (708) 699-4800
Inquiry 1158.

ZQ-5200\$239.99
 Sharp Electronics Corp.
 Sharp Plaza
 P.O. Box 650
 Mahwah, NJ 07430
 (201) 529-8200
Inquiry 1159.

worse. That's when my hardbound logbook, carried with a roll of Scotch tape in a shoulder bag, comes into its own.

Clearly, there are other methods. Some use the Day-Timer system, in which they make notes in a pocket-size diary for later hand transfer to a matching desk calendar/logbook. This works very well if you do it. But after investing considerable money in Day-Timers, I found I'd get hopelessly behind in updating the desk copy, after which there wouldn't be any master schedule and I was thrown back on my memory. I gather that those who've developed the proper habits like that system a lot; but I don't have the right habits, and I'm unlikely to acquire them, or for that matter to take the course that tells me how.

Others use an enormous book that apparently comes with a course on how to organize your life: everything goes into the book, and you don't have to transfer from it to anything else because you carry it all with you. I gather that those who've developed the proper habits like that system a lot; but I don't have the right habits, and I'm unlikely to acquire them, or for that matter to take the course that tells me how.

For a while I was hoping I'd found the solution with gadgets: either the Sharp Wizard or the Casio Boss. Alas, neither really did the job. The Wizard was just a

tad too large to slip into a pocket, but that's not fatal: people, including BYTE editor in chief Fred Langa, do manage to carry it. What was fatal for me was the ABCDE keyboard located off to the side of the screen. No matter how hard I tried, I simply could not write real notes with that keyboard.

I worked at using that Wizard. I kept thinking one day something would click, and I'd really love it. Alas, it never happened, and after a while the Wizard began gathering dust. It's on a prominent shelf, so I can't forget to carry it on trips; but somehow I don't carry it, and when out of guilt I do take it, I've forgotten how to use it. I had much the same problem, although for other reasons, with the Casio Boss.

However: comes now the Sharp ZQ-5200; and while it's not all I'd like it to be, it does look to be good enough.

The ZQ-5200 is in a clamshell case about the depth of a 3½-inch floppy disk (twice that when opened, of course) and 6 inches wide. The closed thickness is about that of a cigarette case. It has an LCD screen visible in any reasonable ambient light and a QWERTY keyboard

below it. The whole thing is smaller and lighter and a heck of a lot easier to use than the old Wizard.

The ZQ-5200 comes with Traveling Software's Do List and Expense programs, which you could get as an add-on card with the Sharp Wizard. Other built-in functions are the calendar/schedule, world times, telephone directory, memo pad, and the like. The keys are grouped sensibly, with those directly controlling things up on the half with the screen, and text and calculator functions down on the keyboard half. There's no attempt at a numeric keypad: I use the numbers above the QWERTY keyboard. This isn't a problem for me, and I doubt it will be for anyone else.

In general, the ZQ-5200 operates like the Wizard did, but the QWERTY keyboard makes that a lot easier. Moreover, the Traveling Software link system that worked with Wizard works here: it's fairly easy to move data back and forth between the ZQ-5200 and your PC. Never having become a Wizard addict, I can't say for sure, but I'd bet that if you liked Wizard you'll love this.

I certainly intend to carry the ZQ-

DBMS Case Study:

Security for the Goodwill Games™*

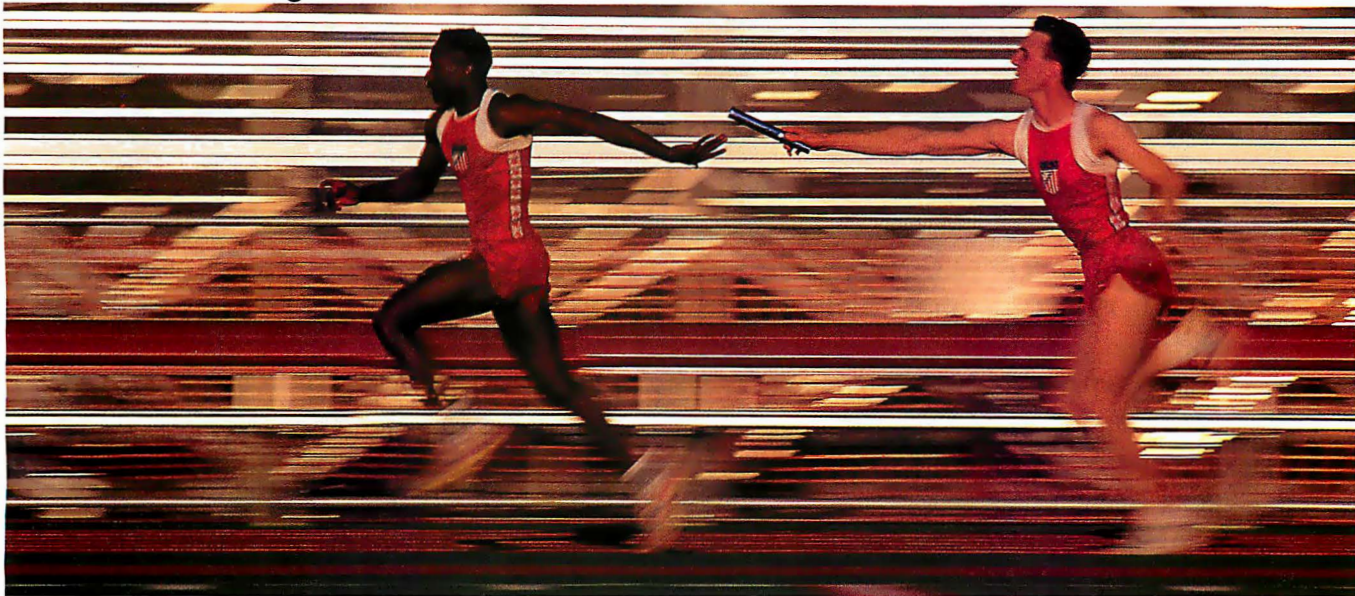

The Problem

The 1990 Goodwill Games: 2500 athletes in 22 events at 15 locations, drawing hundreds of thousands to watch them perform. A show-place for international goodwill. A potential target for terrorists. A challenge for security agencies.

With only 3,000 off-duty officers to fill 30,000 assignments, there's no room for confusion in scheduling. And scheduling must respond to last minute changes, as event times slip, as dignitaries arrive on short notice, or as threats arise. Hand-scheduling can't meet the challenge. But the Games' Integrated Police Planning Group (IPPG) found that no automated system had ever been developed for securing such events.

The Application

Automated Manpower On-line Scheduling

(AMOS) matches personnel to scheduling requirements, taking into account special training, language skills, and other factors. AMOS prepares an assignment sheet for each individual, explaining the assignment, when and where to report, how to get there – even where to park.

AMOS responds to changes quickly. The database is large and complex, yet thanks to the innovative

combined technology of the underlying db_VISTA database engine, search, match, and update times are negligible. Data integrity is assured by avoiding data redundancy. That means the information is reliable.

The Solution

AMOS was created by Raima's services subsidiary, Vista Development Corp., using the db_VISTA III DBMS. "We looked for months for a database that

was fast, flexible, and could handle a huge volume of data while still maintaining speed," said Sgt. Alan Bernstein of the IPPG. "We also wanted to find a company that could not only furnish the product, but provide the development services." They discovered Raima and db_VISTA III.

Your end users may not be fighting terrorists, but they still need fast, reliable information to get their jobs done. If you develop applications for MS-DOS, MS Windows, UNIX, QNX, OS/2, VMS, Macintosh, and other environments, db_VISTA III is the solution.



Command center personnel can adjust schedules without delay or confusion, thanks to db_VISTA III's ability to handle large volumes of data with speed and accuracy.

db_VISTA III™ Database Management System

Specifications High performance. C language portability. Complete C source code available. No royalties.

Network data model. Relational B-tree indexing. Relational SQL query and report writer. Single & multi-user. Automatic recovery. Built-in referential integrity. Complete schema revision capability. Supports: VMS, UNIX, QNX, SunOS, XENIX, Macintosh, MS-DOS, MS Windows. OS/2 compatible. Most C Compilers and LANs supported.

Raima Corporation 3245 146th Place S.E., Bellevue, WA 98007 USA (206)747-5570 Telex: 6503018237 MCI UW FAX: (206)747-1991
International Distributors: Australia: 61 2 4197177 Austria: 4 30224381861 Brazil: 55 11 829 1687 Central America: 506 2807 64 Denmark: 4 542 887249 France: 33 1 46092784
Italy: 39 045 584711 Japan: 81 03 865 2140 Mexico: 52 83 49 53 00 The Netherlands: 31 2503 26312 Norway: 47 244 8855 Sweden: 46 013 124780 Switzerland: 41 064 517475
Taiwan: 886 02 552 3277 Turkey: 90 1 152 0516 United Kingdom: 44 0992 500919 Uruguay: 598 292 0959 USSR: 01 32 35 99 07; 812 292 7210; 0142 437952 West Germany: 49 07022 34077
Copyright ©1990 Raima Corporation. All rights reserved. * "Goodwill Games" is a trademark of the Turner Broadcasting Company. db_ is registered in the U.S. Patent and Trademark Office.

Call 1-800-db-RAIMA (1-800-327-2462)

Circle 260 on Reader Service Card

RAIMA™
CORPORATION BY120

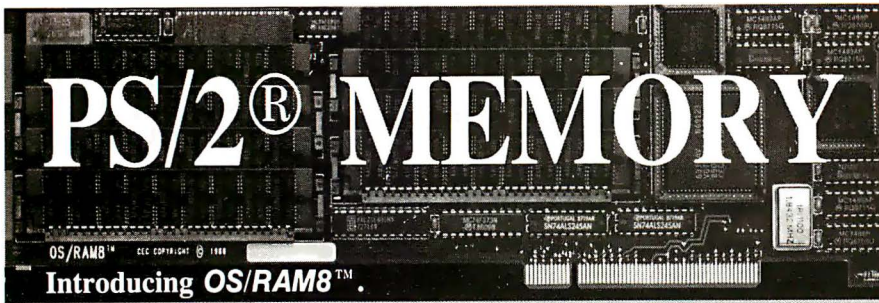

- ✓ 8 Mbytes of memory + 2 serial ports.
- ✓ Extended and expanded memory. LIM 4.0.
- ✓ Works with all of your programs.
- ✓ Run DOS or OS/2 effortlessly.
- ✓ Fast and simple switchless installation.
- ✓ Auto-configuration for all operating systems.
- ✓ Works in all Micro Channel™ computers.
- ✓ Expanded memory 10 times faster than Intel.
- ✓ Risk free guarantee. Two year warranty.
- ✓ IBM approved ID. Best price. Fast delivery.

Call today 1-800-234-4232 or 617-273-1818



Capital Equipment Corp.
Burlington, MA. 01803

PS/2 and Micro Channel are trademarks of IBM

5200 and use it, and I expect to like it. However, I do have one request: I want Traveling Software to get together with Micro Logic and develop software that lets the ZQ-5200 transfer Tornado files simply and quickly. When that happens, I may actually get my life organized and keep it that way.

TravelMate 2000, Part One

We just got it, so I don't know how it will hold up; but Texas Instruments' TravelMate 2000 LT286 makes a terrific first impression. To begin with, it's light. The detachable battery gives it about 3 hours of life; without it, the internal battery can run it for an hour. You must charge the internal battery without attaching the external, though. There's a 20-MB hard disk drive and a bright backlit screen.

What there isn't is a floppy disk drive. You can buy an external 3½-inch floppy disk drive, or you can use the built-in Traveling Software LapLink system to connect to a desktop (or another laptop with floppy disks, which is what I've had to do).

Zenith SupersPort SX

We're in San Diego for the weekend, so I brought both the TravelMate 2000 and the Zenith SupersPort SX. I'm writing this on the SupersPort SX, because given

the availability of both at your destination, I think anyone would use it every time. Its screen is brighter, and the keyboard is better. There's a built-in 3½-inch floppy disk drive, the 386SX chip with 2 MB of memory handles Desqview just fine, and the SupersPort SX is just an all-around better machine. Moreover, the battery lasts an honest 3½ hours, and you may get more. I find the SupersPort SX the closest thing yet to my home environment.

What the SupersPort SX isn't is light. By the time you get it into a case—and it's heavy enough that you'll need a case with a shoulder strap—it's a good 17 pounds, and if you put anything else in the case, such as the power converter, that's even more. For all its versatility, it's no heavier than its 286 predecessor—but it's no lighter, either.

On the other hand, I carry it, because much as I curse it while walking 3 miles in the Dallas Airport—I'm sure they use a linear program to maximize the distances you have to walk—as soon as I get to my destination, or for that matter to the Admiral's Club if there's much of a layover, I'm glad I have it. The TravelMate 2000's screen is reasonably bright, but it's nothing compared to the SupersPort SX's; that screen is not merely visible, but easy to read in *any* lighting conditions I've ever encountered.

In fact, the SupersPort SX would be good enough to be your only computer, a proposition I'm about to test: we have acquired part-time use of a beach house here in San Diego, a place I can go to get away from telephones and modems and UPS deliveries so I can write fiction. The SupersPort SX accepts an external monitor and keyboard, and next time we come down that's what I'm going to bring: either a Zenith Flat Technology Monitor or a Princeton Graphic Systems Ultra-14 high-resolution monitor (excellent: more on that one next month) and one of the "Pournelle configuration" keyboards. I'll leave monitor and keyboard here and carry the SupersPort SX back and forth.

After all, I have good reason to know that Zenith laptops are rugged: you may recall that a porter dropped my previous one on the tarmac just before I boarded an airplane for Europe, and it not only survived despite a cracked case but performed flawlessly. Cracked case and all, that machine is still in use. The SupersPort SX, meanwhile, has been carried through three western states, down here to the beach, out into the Mojave, up to Mars Hill (8000 feet) in Flagstaff, and over many a bumpy road; and it works just fine.

The bottom line is that of all the laptops I've tried, I like this SupersPort SX the best, despite its weight; enough so that I put up with the weight.

Meanwhile, Roberta has dibs on the TravelMate 2000, which weighs a bit more than her Toshiba T1000 but is immensely more powerful; and she *isn't* willing to carry a SupersPort. In a few months, I'll have a detailed report on how the TravelMate 2000 stands up to life at Chaos Manor.

American Heritage Dictionary

I'm about out of space, so this will have to be brief: it works fine. I've installed the American Heritage Dictionary program on the SupersPort SX, set up a 512K-byte Desqview window for it, and opened the program. It's memory-resident, invoked with Control-left shift plus a letter (e.g., *D* for dictionary or *T* for thesaurus), and it comes up instantly in its window. I then loaded Q&A Write in the same window and brought up AHED inside that. No problem.

Unlike Word Finder, which can be specially configured to work with Q&A Write so that it looks up the word the cursor is on when you invoke Word Finder, AHED simply asks what word you want to work on; but when you tell it, AHED is fast and efficient.

The definitions are right out of the

CHAOS MANOR

actual *American Heritage Dictionary*. Alas, there's little about word origins. However, the AHED program will look up anagrams or search with wild cards (if, for instance, you aren't sure how to spell the word); and it really is fast, much faster than you'd be able to look up the word in the printed volume.

AHED comes with an adequate but not fancy word processing program, Writer; it's a very vanilla little thing with simple commands intended for people who bought the dictionary and didn't have any editor; a lot better than nothing, but under those circumstances, I'd recommend getting PC-Write and paying the shareware fee.

AHED has a Search feature: tell it "fire AND burn" and it will, quickly, find and list all words whose definitions contain both those words. It doesn't take long for a writer to think of a lot of uses for that.

I have a few minor quibbles on interface, and I do wish they'd left in the full etymologies instead of cutting them to the bone, but otherwise AHED is the *American Heritage Dictionary* on-line in all its glory, and it works just fine. If you want a dictionary program, this is as good as any I've seen. Recommended.

MusicEase

I'm no music expert, but I know that printing and publishing music is slow and expensive. I recall one friend who composed for films; he had to hand-draw his scores using the Ozalid process. A good music program would have been a god-send.

Grandmaster's MusicEase lets you enter notes from the keyboard, or, if you have a MIDI, you can play notes that it will record. The samples I have seen, and a couple I have produced, are sure in the same league as hand-engraved.

Writing the program took Gary Rader, the program's music professor author, quite a while, since it involves scanning in dozens of symbols for the weird and wonderful notations musicians need. The program works, and it produces acceptable drafts; the laser printer output looks as good as the stuff in my wife's opera books. I claim no musical expertise, so all I can say is that it looks great; meanwhile, here's my condensation of the description Professor Rader gives of the capabilities:

An unlimited number of connected staves; one or two voices per staff; unlimited number of notes (of unlimited range) per chord; dotted and doubly dotted notes/rests; treble, bass, alto, and tenor clefs; slanted beams; tied slurs;

phrase marks; cue notes; grace notes; accidental signs; alternating stems; brackets and braces; and a partridge in a pear tree.

It looks to me as if this program goes a long way toward doing for music composers what word processors did for writers.

Winding Down

There's so much to write about that I can't possibly get to it all, but first things first: John Eklund, curator of the History of Computers and Information Technology exhibit at the Smithsonian, just sent me a picture of Zeke II, my old friend who happens to be a CompuPro Z80, on display in their newest wing. Zeke looks happy enough, but I expect he gets lonesome. If you haven't been to the Smithsonian lately, get over and say hello. I'm trying to get to Washington for a conference on diamond film technology next month, and I'll certainly drop by.

I wanted to write a mini essay on why you should never buy a dedicated word processor because you get so much more bang for the buck from a computer: as for example the Gold Star XT clone, which sells for less than any dedicated word processor I know of, and yet is just as fast and a great deal more versatile. Better yet, get a good 386SX and you can have Desqview too.

We're still working with the new DR DOS; they've about solved the problems of incompatibility with LANtastic. More on that when I learn more.

The new Desqview and QEMM-386 work fine with Windows 3.0; more on that next month.

The book of the month is *Arab and Jew: Wounded Spirits in a Promised Land* by David Shipler (Penguin, 1987); really excellent. The CD-ROM of the month is Ludwig van Beethoven's Symphony Number 9, for the Macintosh, from The Voyager Company, 1351 Pacific Coast Hwy., Santa Monica, CA 90401; magnificently done.

The game of the month is *still* Microprose's Railroad Tycoon; every time I think I've had enough, I find myself playing it again. ■

Jerry Pournelle holds a doctorate in psychology and is a science fiction writer who also earns a comfortable living writing about computers present and future. Jerry welcomes readers' comments and opinions. Send a self-addressed, stamped envelope to Jerry Pournelle, c/o BYTE, One Phoenix Mill Lane, Peterborough, NH 03458. Please put your address on the letter as well as on the envelope. Due to the high volume of letters, Jerry cannot guarantee a personal reply. You can also contact him on BIX as "jerry."

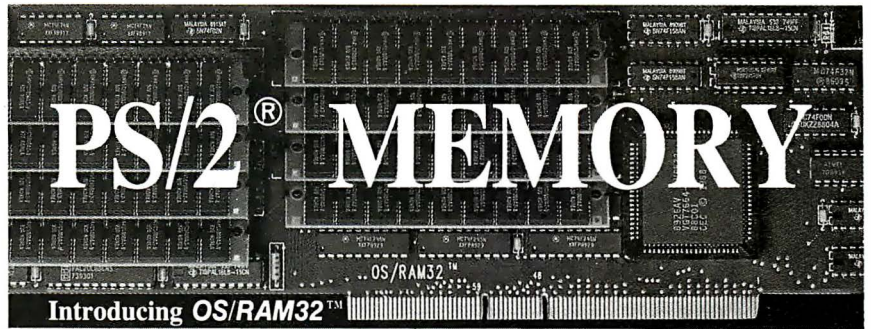

- ✓ 8 Mbytes of fast 32 bit memory.
- ✓ Works in all Micro Channel™ computers.
- ✓ Fast LIM 4.0 driver included.
- ✓ Provides extended and expanded memory.
- ✓ Easy switchless installation.
- ✓ Automatic configuration for DOS, OS/2 or UNIX.
- ✓ Risk free guarantee. Two year warranty.
- ✓ Accepted under IBM service contracts.
- ✓ From \$299 to \$998 with 8 Megabytes.
- ✓ "Best price performance", says PC Week .

Call today 617-273-1818 or 1-800-234-4CEC



Capital Equipment Corp.
Burlington, MA. 01803

PS/2 and Micro Channel are trademarks of IBM

There are
three ways
to get
everything
you expect
from a laser
printer.

*Printers, Computers, Peripherals,
Copiers, Typewriters and Facsimiles*

Panasonic
Office Automation 

When you want corporate-size features in a desk top package.

Speed, fonts, flexibility. Everything you want in a personal laser printer, in a package that fits comfortably in your office or home. The KX-P4420 prints at a fast 8 letter-sized originals per minute — up to twice the speed of some personal laser printers. And its standard features include a large-capacity paper cassette, 22 internal fonts available in 25 symbol sets (including legal), plus 512K of memory, expandable to a full 4.5MB. The 4420 personal laser printer. Corporate-size features. Personal price.

The Panasonic®
Personal Laser.



When you have several people in your department, you need a printer that can handle them all.

Lots of speed, lots of capacity, lots of emulations. The KX-P4450i is meant for the whole department. It has dual-bin, high-capacity paper cassettes. And does a full 11 pages per minute even if every page is different. Each page will be crisp and clear, no matter which of the 28 internal fonts you're using. And the 4450i emulates LaserJet Series II, as well as popular dot matrix and daisy wheel printers.* This is one laser everyone will be happy to share.

The Panasonic Shared Laser.

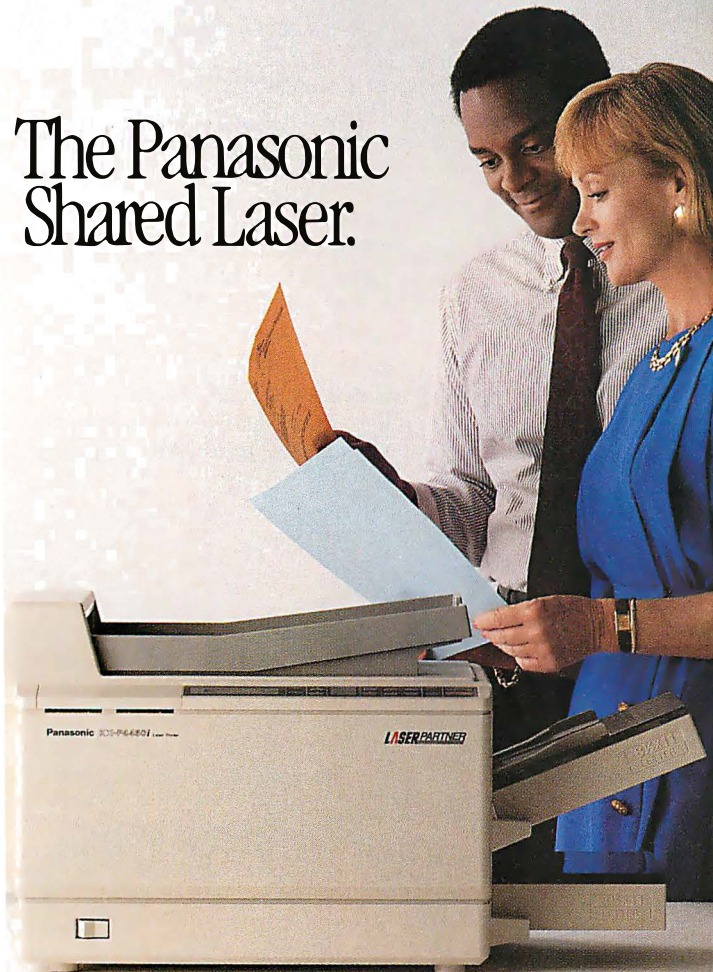

What makes the company look good makes you look good.

When appearance is all, choose the KX-P4455 with Adobe PostScript. With it, you can dramatically enhance every document with multiple fonts, varied type sizes, even images rotated and scaled to fit. At 11 pages per minute, and with superb print quality. The features you want most are standard. From 39 Adobe fonts, to dual-bin, high-capacity paper cassettes. Plus a wealth of optional typefaces. And its interfaces work beautifully with MS-DOS, UNIX or Apple environments.* With the 4455, you don't just print your documents, you publish them.

The Panasonic PostScript* Laser.

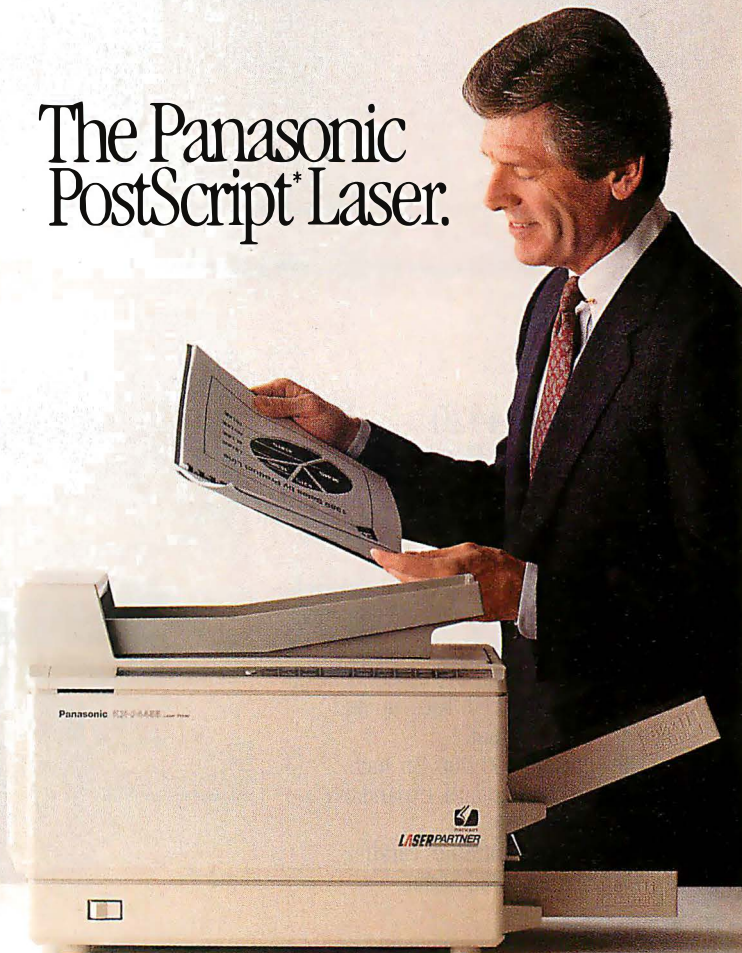

Three great laser printers. Designed specifically for the ways people do business.

The KX-P4455 Panasonic PostScript Laser.

Printing Speed: 11 pages per minute.**

Compatibility: Adobe PostScript, HP LaserJet Series II and Diablo 630 emulations.*

Fonts: 39 Adobe Fonts.*

Paper Handling: Two 250-Sheet Cassettes.

Resolution: 300 Dots Per Inch.

RAM: 2MB Standard, expandable to 4MB.

Interfaces: RS-232C/422A Serial, Centronics Parallel and Appletalk.*



The KX-P4450i Panasonic Shared Laser.

Printing Speed: 11 pages per minute.**

Compatibility: HP LaserJet Series II, Panasonic, Epson, IBM and Diablo emulations.*

Fonts: 28 Internal Fonts-14 available in both portrait and landscape. Two slots for optional font cards.

Paper Handling: Two 250-Sheet Cassettes with Manual Feed.

Resolution: 300 Dots Per Inch.

RAM: 512K Standard, expandable to 4.5MB.

Interfaces: Centronics Parallel and RS-232C Serial.

The KX-P4420 Panasonic Personal Laser.

Printing Speed: 8 pages per minute.**

Compatibility: HP LaserJet Series II emulation.*

Fonts: 22 Internal Fonts-11 available in both portrait and landscape. Two slots for optional font cards.

Paper Handling: 250-Sheet Cassette with Manual Feed. Face-up and face-down output.

Resolution: 300 Dots Per Inch.

RAM: 512K Standard, expandable to 4.5MB.

Interfaces: Centronics Parallel; Optional RS-232C Serial.

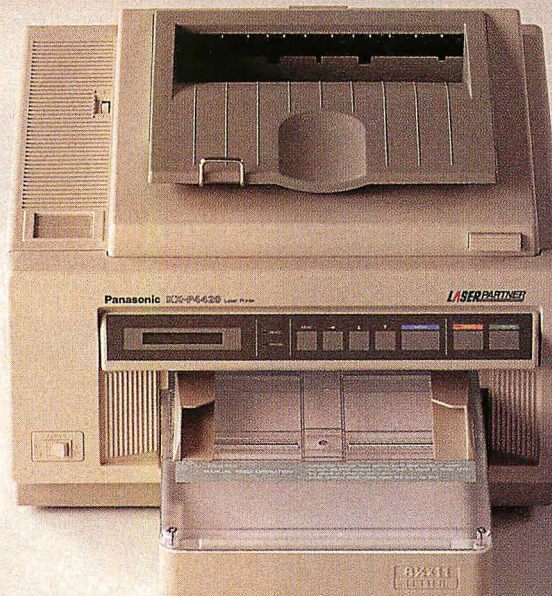

*Printers, Computers, Peripherals,
Copiers, Typewriters and Facsimiles*

Panasonic
Office Automation 

* HP and LaserJet Series II, Epson, IBM, Diablo, Adobe and PostScript, MS-DOS, UNIX and Appletalk are registered trademarks or trademarks of Hewlett-Packard Co., Seiko Epson Corp., International Business Machines Inc., Xerox Corp., Adobe Systems Inc., Microsoft Corp., AT&T, and Apple Computer Inc., respectively. ** Letter size, text mode, 5.5% image area, all originals. [Specifications are subject to change without notice.]



GETTING BIGGER GROUPWARE

High-end companies make groupware solutions into a fine art. But at what price?

Last month I looked at group productivity and the newer groupware vendors, as well as a way to create your own groupware solution. This month, I'll look at packages from vendors that created the field of groupware. One of these firms, Wang, has made groupware into a fine art.

In April 1989, I discussed earlier incarnations of WordPerfect Office and Higgins. Both packages have been updated since then. I'm mentioning Wang's solution to group productivity for the first time, but it's a direction you may find worth investigating.

Group productivity is a major reason that businesses use LANs. For routine uses, such as word processing, stand-alone computers work fine. But when several people have to work together, you need to find ways to support the interaction of the group as a whole. Where once you were satisfied when a document was generated, now you find that an entire workgroup must have access to it. This group access and the interaction that goes with it is one reason for the growth in group productivity software.

The primary activity in a workgroup is communication. When several people are assigned to a task, they are expected to communicate with each other so that it will be a communal effort. If a workgroup is set up so that the members are in close physical proximity, then communication can be accomplished by talking. When they are physically separated, they need other means of communicating, such as E-mail. Useful groupware supports this natural communication, while

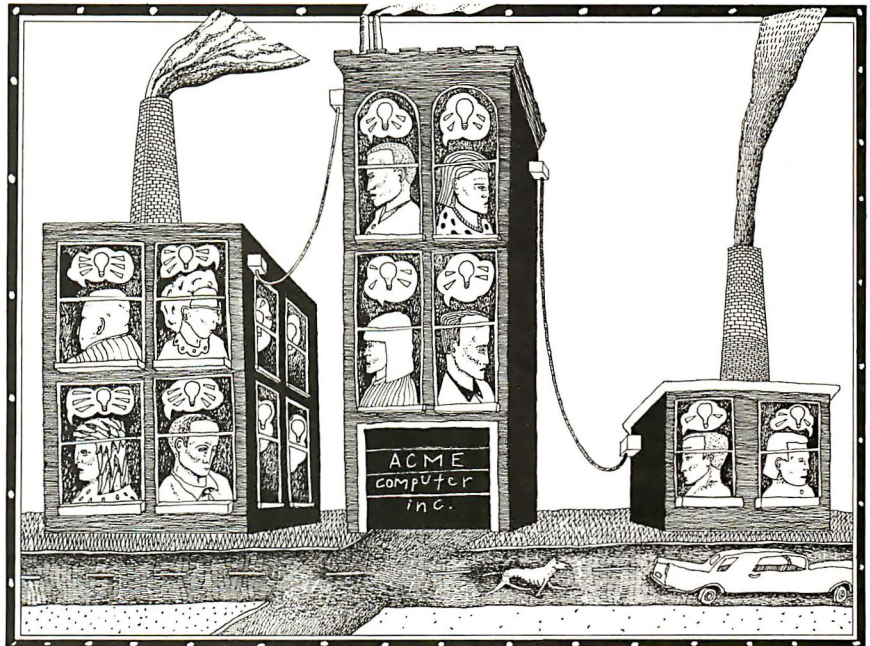

enhancing it with such functions as file transfer and automated scheduling.

In the Beginning and Now

WordPerfect Office and Higgins helped start the trend toward groupware. Although initially they were rather limited in functionality, they did support excellent E-mail services, and their scheduling packages automated what was otherwise a tiresome process. Unfortunately, at that time, neither was a total solution.

WordPerfect Office chained you to a single file server and wouldn't let you attach binary files to its E-mail. Higgins had the same single server limit, and it didn't let you incorporate specific external software into the menu system. Both packages have now been updated and are as full of features as groupware could be.

Then there's Wang, a company long known for being ubiquitous in office automation. Wang looked at group productivity with a fresh slate. It analyzed

the work people did and how they did it; it also looked at ways to get those people usually left out of the group productivity solution, such as managers, into the automated group. Looking at the results of their studies, Wang engineers decided a couple of important things:

- Managers can't type.
- Managers are used to dealing with paper forms.

Knowing how to type is usually necessary for successful computer use. But managers are used to pencils. So Wang invented a way to let people use a pencil to run their computers, at least with Wang Office and Wang Freestyle applications. You're still on your own with third-party applications, though; if you go the pencil route, you can't take advantage of non-Wang-compatible software.

Wang Office and Wang Freestyle are complementary office automation appli-

CD-ROM



NEW!

Guaranteed
Lowest Prices!

U.S. History on CD-ROM

107 U.S. History books with 1,000 images, tables & maps on one disc!
U.S. History on CD-ROM disc \$395
Complete drive kit bundled with U.S. History 895

6 Disc CD-ROM Jukebox

Pioneer DRM-600 Minichanger
Complete CD-ROM drive kit, latest in CD-ROM technology, holds 6 CD-ROM discs for instant access. **\$1299**

Buy the Minichanger, and SAVE \$\$\$ on these best selling CD-ROM titles

	regular	w/drive
MS Bookshelf all time best selling title	\$229	\$149
Grolier's Encyclopedia 21 volumes, VGA pics	\$345	\$299
MS Programmer's Library 20,000 pages	\$369	\$289
Birds of America includes pictures and sounds	\$99	\$79
Between Heaven & Hell II even stranger	\$99	\$79
U.S. History on CD-ROM 100 books, 1,000 pics	\$395	\$349

CD-ROM Drives (ready to run)

Hitachi Drives- all models, PC and Mac	\$Call
NEC CDR-72 or 82 CD-ROM Drive ext. int., PC & Mac	Call
NEC CDR-35 CD-ROM Drive external, smallest, lightest	\$499
Sun Moon Star CD-ROM Drive Bundle with 7 discs	Call
Philips CM221 CD-ROM Drive w/locking disc cartridge	\$649
800 MEGABYTE WORM less than \$0.18 per MB!	3,695
Portable computer w/ CD-ROM drive data/logo	2,995
Erasable Optical Drives	Call

Also: Denon, Chicon, & Sony drives, Best Price - Call!

MIS / DP & Programmers

C Library or Ada or Shoreware Grab Bag	89
PC-Sig Library new edition, version 8	465
Computer Library essential for MIS & PC managers	760

Libraries and Education

Consumer, Economic or Agricultural Stats (913-87)	\$99
Food Analyst's entire USDA database w/analysis software	99
McGraw-Hill Ref. Set 100,000 terms, 7,300 articles	245
Learn to Speak French with sound, study aid, Mac	249
Wordcruncher Disc: entire works of 8 authors	249
Countries of the World over 100 reference books	295
Oxford English Dictionary over 250,000 headwords!	889

Medicine & Science

Medical Year Book on Disc full text of 1988 Year Books	\$125
Pediatrics on Disc 5 years of Journal Pediatrics, 1983-89	395
Oxford Textbook of Medicine general medical reference	595
Compton's Multi-Media Encyclopedia rave reviews!	895

Miscellaneous

Shareware Express a real bargain disc	\$49
Movie Directory Database/Software Potpourri	69
Sherlock Holmes or Shakespeare on Disc "complete"	99
CIA World Fact Book perfect for international "business"	99
Microsoft Start Pack or Small Business Consultant	120
World Atlas color maps and statistics throughout world	149
Variety Home Video Directory Over 30,000 films	189
Sporting News Baseball CD a sports fans dream	234
Guinness Book of World Records Multi-media	Call
NEC Desktop Pub discs Type, Image, Photo etc... from	\$279
Telephone Directory Call for details	999

MORE! Over 200 different titles available

Free CD-ROM Product Guide with every order

Money back guarantee Free tech support
Call - Bureau On-Line CD-ROM Library,
Free access to 12 different CD-ROM discs



Overnite
Delivery

**Bureau of
Electronic Publishing, Inc.**

Dept. P, 141 New Road, Parsippany, NJ 07054
Fax # 201-808-2676

Call: 1-800-828-4766 orders only
(201) 808-2700 information

DOWN TO BUSINESS

ITEMS DISCUSSED

Freestyle system\$995
(includes tablet and interface, stylus and cables, tablet software, video software, voice option software, and local printer software for one workstation)
Freestyle Fax Option\$595
Freestyle/LAN Office Interface software\$100 per workstation
Freestyle/Light software\$249
Freestyle Scanner software \$200
Freestyle Voice Option\$795
(includes handset and board)
LAN Office server software ..\$795
Wang SC300 Scanner \$1400
Wang Laboratories, Inc.
1 Industrial Ave.
Lowell, MA 01851
(508) 459-5000
Inquiry 1221.

Higgins
eight users\$695
four-user expansion\$349
12-user expansion\$995
20-user expansion\$1495
Enable Software, Higgins Group
1150 Marina Village Pkwy.,
Suite 101
Alameda, CA 94501
(415) 865-9805
Inquiry 1222.

WordPerfect Office LAN 3.0
five users\$495
20 users \$1595
Office Connection Server\$695
MHS Gateway\$695
WordPerfect Corp.
1555 North Technology Way
Orem, UT 84057
(801) 222-4455
Inquiry 1223.

cations that allow nearly all office work, from voice mail to routing, to be done on the computer. They support digital imaging, so you can scan in your favorite forms and process them electronically. They also support digitized voice, so you can make comments while you write. They handle voice input in real time, so recipients of your message can hear you explain what's going on and see your annotations appear on the screen as if you were writing them right then.

Use Tools You're Familiar With

Unlike the other groupware packages, the Wang solution includes hardware as well as software. Freestyle requires the use of the attached electronic pencil and tablet, and you can add a scanner, a fax server, and a telephone. A version of Freestyle, called Freestyle/Light, does not require specialized hardware. Wang Office provides the more traditional groupware functions, such as E-mail, but it also supports Freestyle.

Let's say, for example, that I send BYTE editor Ken Sheldon my Comdex travel expense voucher over the BYTE LAN, so that he can approve it and I can get paid for my services. Ken would receive the digitized image of my completed and signed voucher in his E-mail. When he looked at the image and noted the expenses I'd recorded, he could also hear my voice over a Wang telephone attached to the computer, giving all the reasons why I might have exceeded the per diem. Ken could then sign his ap-

proval on the voucher using the electronic pencil attached to the tablet. His signature would show up on the screen and would be added to the digitized image.

Once the voucher was signed, Ken could forward it to the proper department for payment, or somewhere else for further action. With Wang Office, you can also use an electronic pencil and tablet to make menu selections. Thus, if he chose to, Ken could complete the whole transaction using those tools rather than having to type anything. Of course, the people on both ends must use the Wang system. As you might imagine, this process isn't simple to implement.

An Alternative GUI

While other groupware packages are built around menus, Wang uses a graphical desktop metaphor. Documents are placed in file folders where they stay on your virtual desktop in the same types of piles that you have on your real desktop. If you're using groupware, though, this may be the only graphical user interface you have.

I was not able to get WordPerfect Office to work with Microsoft Windows. Higgins is supposed to work with Windows and Desqview, but I haven't yet proven this for myself.

Commitment

To be an effective productivity solution, Wang Freestyle and Wang Office require an organizational commitment. While you don't have to buy every part of the

Take Our Course In C And The First Lesson You'll Learn Is In Economics.

NTSC
or
PAL
Formats



"I heartily
recommend...
...an excellent
bargain."

GARY RAY
PC WEEK

C's power, and portability make it the language of choice for software developers. Unfortunately, learning C can be a very costly proposition. Classroom instruction is, in a word, expensive. And many C video courses carry hefty price tags.

Learn C in as little as two weeks

Speaking of speedy, with The Complete C Video Course you can learn C in only two weeks.

Compare that with the up to four months it can take to learn C in class.

Each lesson averages 17 minutes of clear, concise instructions. Used in conjunction with our workbook you'll find they provide everything you need to know to become proficient in programming in C.

```
#include <stdio.h>
#define NAMLEN 15
#define NUMMARK 4
struct person
{
    char name[NAMLEN];
    int mark[NUMMARK];
};
```

The top C video course at the lowest possible price

But now, there's The Complete C Video Course from Zortech. It's the ultimate C training tool for home or work. And all it costs is \$295.

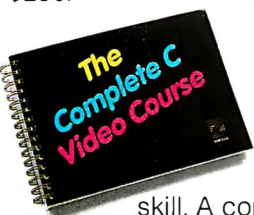

You get ten videos with 36 lessons covering all levels of programming skill. A comprehensive, easy-to-follow 365 page workbook. And even a free C compiler.

Free C compiler included

Yes, that's right. The Complete C Video Course includes our famous C compiler (it runs on any MS-DOS machine) with linker, library manager, full graphics library and on-line help. It's the choice of professional programmers everywhere for fast code, fast development and fast debugging.

Save your company thousands

If you think The Complete C Video Course is a great way for you to save money learning C, think about how much it could save your company. Use it instead of sending programmers to school and you'll save thousands. What's more, The Complete C Video Course is even tax deductible. C is unquestionably the most valuable programming language you can master. And now you can get everything you need to become productive in it from course to compiler to tools for an economical \$295. Mail the coupon or call our hotline to receive it ASAP.

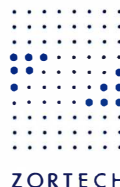

Look at all these C video pluses

- ★ Only \$295 complete.
- ★ Ten videos with 36 lessons.
- ★ Comprehensive 365-page workbook.
- ★ Free C compiler with linker, library manager, full graphics library and on-line help.
- ★ Compiler and hardware independent.
- ★ Designed to help you learn C in as little as two weeks.
- ★ Tax deductible.



Zortech Inc.
4-C Gill Street
Woburn, MA 01801
Voice: 617-937-0696
Fax: 617-937-0793

- ★ Yes, rush me The Complete C Video Course including free C compiler for \$295.00 (VHS only)
- ★ Please include (No.) extra workbooks at \$29.95 each.
- ★ I'd like to order (No.) extra C compilers with this course at the special price of \$49.95.

Name/Company

Address

Phone

City

State Zip

Here's my check for

VISA/MC #

Exp. Date

Prices do not include shipping



The Complete C Video Course \$295

Order Hotline (800)848-8408

Wang system, each user must have certain necessities, such as a special telephone to receive voice messages. But once you make the commitment, FreeStyle and Office allow groups, even those scattered around the globe, to work together as if they were in the same room.

Of course, you have to make an organizational commitment to WordPerfect Office and Higgins, too. Both packages reside on the file server, and because they are software, they can be run from any IBM PC-compatible computer. Higgins sells its licenses for groups of five; WordPerfect offers individual licenses. You'll need to license every user you plan to have using these packages. If you only automate part of the group, the rest will be hard pressed to work.

WordPerfect Office continues to be the program to beat for ease of integration into the office. Since it works just like WordPerfect, nearly everyone already knows how to use it. In addition, it installs easily, is intuitive, and has clear documentation. Your coworkers will not waste time puzzling over confusing screens or obscure commands.

Higgins is greatly improved over its

earlier version. The menu structure is more carefully thought out, and its user interface is much improved. Unfortunately, I couldn't get the software to work with NetWare 386, and the documentation was so weak that I couldn't figure out why. However, I was able to install it on an earlier version.

WordPerfect Office's installation does not work flawlessly with NetWare 386. You have to enter the user names manually because of differences between versions 2.15 and 3.0. At least there is an alternative method, however, to perform the installation.

Finding Groupware

There's no question that a well-designed groupware package can enhance the productivity of your business. If you can get people to use the package, they will find that it makes their communications easier and faster. And if your personnel are physically separated from each other, the benefits of groupware are even greater.

Because all three of these packages can communicate over long distances using wide-area networks, fax gateways, or public E-mail networks, you can form

workgroups in places where not too long ago you couldn't. This kind of software really does let groups work better together. Since it prevents the familiar time killers of telephone tag and synchronizing meeting schedules, groupware can make the work more productive as well.

While Wang has given us a total solution to group productivity, not all companies need something so comprehensive. Some can work just as well with a nice E-mail package that provides a way to set up meetings and share information. All three of these packages offer those capabilities. ■

Wayne Rash Jr. is a contributing editor for BYTE and technical director of the Network Integration Group of American Management Systems, Inc. (Arlington, VA). He consults with the federal government on microcomputers and communications. You can contact him on BIX as "waynerash," or in the to.wayne conference.

Your questions and comments are welcome. Write to: Editor, BYTE, One Phoenix Mill Lane, Peterborough, NH 03458.

You got the look.

a sample of fax output using *Communique* fax software



GoldenSection
advertising

Carmina Cortez,
Friendly Press, Inc.

Dear Carmina,

Welcome to the age of personal communication! As you can see, all PC fax software is not alike. The fax that you are now reading was created using *Communique* from Grey Matter Response. I wrote the body of this letter using *Communique's* on-board Memo Processor and then let the software take care of the rest. It automatically merged in our company logo and my personal signature as it transmitted the fax using *Communique's* exclusive proportional Fax Fonts. This professional looking document was completed in a matter of minutes, saving me time and energy.

The *Communique* software has a graphic user interface based on easy-to-understand icons and buttons (everyone at the office keeps dropping by my desk just to see it!) Let's get together sometime and I'll show it to you.

Best Regards,

Tina Berman

Tina Berman
Golden Section

current fax board owners: ask about our \$179 trade-in offer!

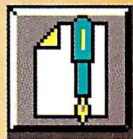

Welcome to the age of personal communication.



The better your faxes look, the better you look. That's why *Communique* produces eye-catching faxes like the one on the left. *Communique* even improves the look of your PC with its easy-to-use Graphic User Interface. And right now, *Communique* software *plus* a 9600 baud PC fax board is at an introductory price of only \$249 (\$50 off the retail price.) For more information or to order, call 1-800-927-9713.



Grey Matter Response
PO 3147 Santa Cruz, CA 95063
(408)427-3678/fax: (408)427-0493



Communique™ requirements: IBM PC or compatible with 640k, hard disk, graphic card (color or monochrome), MS-DOS 3.0 or higher, and a mouse.

After everything
you've heard
about Windows
Computing,
there are only
two things you
should believe.

Windows™

Free Working Model

Your

See for yourself. With Windows™ Computing, using your PC becomes easier, faster, and more productive than you ever imagined possible. But you don't



Windows Computing is the Windows version 3.0 environment combined with any of the hundreds of Windows applications already available.

have to take our word for it. Because, right now, we're making fully functional Working Models of Microsoft® Windows version 3.0, Microsoft Excel, Project, Word and PowerPoint® presentation graphics program as easy to get a hold of as they are to use.

Just pick up the phone and call (800) 323-3577, Dept. N62, and we'll

*The first Working Model you select is free during our Windows Computing Promotion, September 15 through December 31, 1990. One free Working Model per person. Each additional Working Model is \$9.95, applicable sales tax not included. Offer good while supplies last.

Computing

Microsoft[®]

eyes.

send you a free copy of the Working Model* you're most interested in.

Or, if you would prefer, just ask for the date, time and location of a Windows Computing seminar being held near you. Either way, the experience is sure to impress you.



The truth is, we believe there could be only one reason why people might not see just how much Windows Computing means to the future of the personal computer.

They haven't looked.

Microsoft[®]
Making it all make sense[™]

Same Day Shipping!

ALTEC TOWERS ABOVE THE REST

Now you can have the power and performance of Altec's fully loaded 486 EISA Tower delivered to your door! Check out these outstanding features:

486 EISA TOWER \$5,995

Intel 486-25 CPU □ 4 Meg RAM □ 1.2 MB 5.25" drive □ 1.44 MB 3.5" drive □ 150 MB 18ms ESDI hard drive □ ESDI controller w/32K cache □ 16-bit VGA card □ 14" VGA monitor (1024 x 768) □ 2 serial, 1 parallel & 1 game ports □ 101-key Keyboard □ Genius Mouse □ MS-DOS 3.3 or 4.01 □ Six 32-bits EISA slots & two 16-bit slots



"AltecZip 386s are solid machines featuring brand-name parts. A good buy, they are clearly affordable"

PC Magazine, May 30, 1989

"Computer users should find Altec machine an excellent value with good performance."

PC Magazine, July 1990

Altec sets the standard for the highest quality design and manufacturing of all our products. We're fast, friendly, and ready to help you select the right features for your needs. Take a look at some of our other great systems:

386/33 VGA

\$3,295

Intel 386-33 CPU □ 32K Cache □ 4 Meg RAM □ 1.2 MB 5.25" drive □ 1.44 MB 3.5" drive □ 150 MB 18ms ESDI hard drive □ ESDI controller w/32K cache □ 16-bit VGA card □ 14" VGA monitor (1024 x 768) □ 2 serial, 1 parallel & 1 game ports □ 101-key Keyboard □ Genius Mouse □ MS-DOS 3.3 or 4.01
(25 MHz Cache System deduct \$100)

386/25 VGA

\$2,595

Intel 386-25 CPU □ 4 Meg RAM □ 1.2 MB 5.25" drive □ 1.44 MB 3.5" drive □ 105 MB 18ms IDE hard drive □ 16-bit VGA card □ 14" VGA monitor (1024 x 768) □ 2 serial, 1 parallel & 1 game ports □ 101-key Keyboard □ Genius Mouse □ MS-DOS 3.3 or 4.01

386/SX VGA

\$1,850

Intel 386SX-16 CPU □ 2 Meg RAM □ 1.2 MB 5.25" drive □ 1.44 MB 3.5" drive □ 66 MB 25ms hard drive □ 16-bit VGA card □ 14" VGA monitor (640 x 480) □ 2 serial, 1 parallel & 1 game ports □ 101-key Keyboard □ Genius Mouse □ MS-DOS 3.3 or 4.01
(20 Mhz 386/SX version add \$150)

286/12/66 MB VGA COMBO

\$1,695

1 Meg RAM □ 1.2 MB 5.25" drive □ 1.44 MB 3.5" drive □ 66 MB hard drive □ 16-bit VGA card □ 14" VGA monitor (640 x 480) □ 2 serial, 1 parallel & 1 game ports □ 101-key Keyboard □ Genius Mouse □ MS DOS 3.3 or 4.01 □ Panasonic 1180 printer w/cable □ Surge Protector

286/12 VGA STAR

\$1,295 NEW

□ 1 Meg RAM □ 1.2 M or 1.44 M drive □ 40 MB hard drive □ 16-bit VGA card □ 14" VGA monitor (640 x 480, .41 mm) □ 2 serial/1 parallel & 1 game ports □ 101-key Keyboard □ MS-DOS 3.3

Various hard drive capacity available.



Technology Corp.

1-800-255-9971

Altec's Guarantee:

- 30 day money-back guarantee
- 1 year warranty for parts and labor
- Free 4 months on-site service
- Lifetime toll-free technical support



Policy: Same day shipping with standard configurations for orders before 3 PM EST. Shipping and handling extra. Personal and company checks require 10 days to clear. Prices are subject to change, and all items are subject to availability. All returns must be shipped prepaid, insured, in original condition and complete with documentation. All returns must have RMA number. 30-day money back guarantee does not include shipping. No surcharge for Visa & MasterCard, 2% for American Express.

Altec Technology Corporation • 18555 East Gale Avenue • Industry, CA 91748 • 818/912-8688 • FAX: 818/912-8046

Circle 21 on Reader Service Card

I'VE GOT DIBS

Device-independent bit maps and palette management make the PC a serious color platform

Time was, you could count the number of display options for the PC on the fingers of one hand, without letting go of your teacup. Now, a PC can be equipped with any of hundreds of displays, from portable low-resolution gray-scale LCDs to colossal high-resolution 24-bit color monitors.

Now consider its documentation's view of the Windows bit map: "a matrix of memory bits that, when copied to a device, defines the color and pattern of a corresponding matrix of pixels on the device's display surface." In other words, it's a memory image compatible with a specific display. The Windows 3.0 documentation dryly says: "Each device has its own unique color format. In order to transfer a bit map from one device to another, use `GetDIBits` and `SetDIBits`."

DIBs: Device-Independent Bit Maps

The DI in `GetDIBits` stands for device-independent. Instead of mimicking the planar structure of a given display, the DIB format contains a `Bitmapinfo` data structure that describes the bit map, plus the actual array of bytes that defines the pixels of the bit map. All well and good, but that is not the end of the story.

DIBs first surfaced in OS/2 1.1 as the Graphics Programming Interface bit map. The designers of Presentation Manager understood the problems of the Windows 2.0 bit map and wanted to avoid them. The OS/2 1.1 `Bitmapinfo` structure specifies the width and height of the bit map in pels (i.e., picture ele-

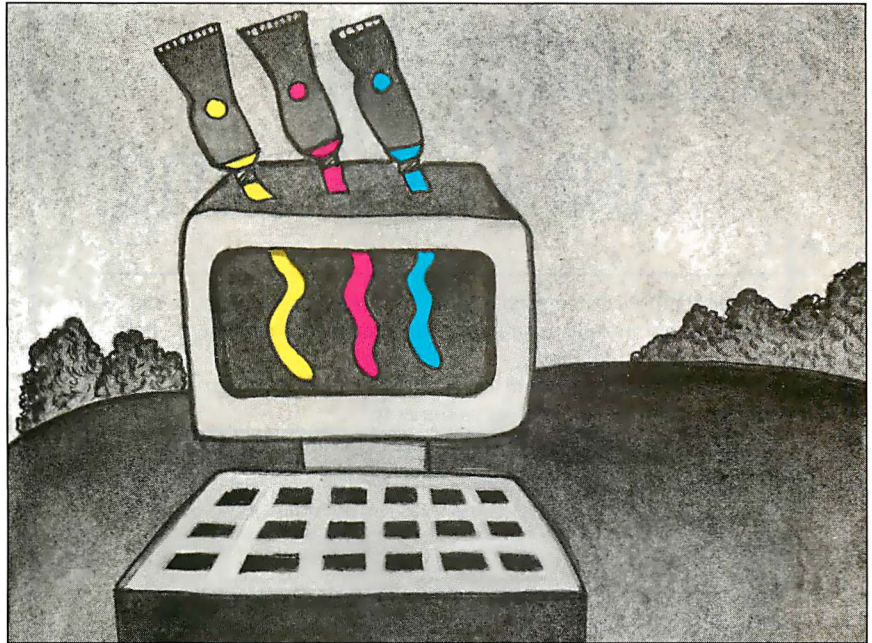

ments—called pixels in the Windows documentation and pels in the OS/2 documentation), the number of bit planes, and the number of bits per pel within a plane. It can also contain a color table to accommodate devices like the VGA that can display a certain number of colors from a larger palette—in the case of VGA, 256 colors out of 256,000.

The OS/2 1.1 `Bitmapinfo` structure is fine as far as it goes, but it doesn't go far enough. Bit maps can be very large: A 256-color bit map at 640 by 480 pels is about 300K bytes. That number is independent of the image. Without compression, even an all-black bit map will be that big.

The Windows 3.0 `Bitmapinfo` structure, which carries over into OS/2 2.0 as the `Bitmapinfo2` structure, allows for run-length-encoded images with 4 or 8 bits per pixel. While not as effective as the Ziv-Lempel compression that Graphics Interchange Format (GIF) images

use, RLE compression will reduce large areas of a single color to a few bytes.

The new structure also specifies the resolution for which the DIB was created, the number of color indexes actually used by the bit map, and the number of colors considered important for displaying the bit map. Windows 3.0 allows images with 1, 4, 8, or 24 bits per pixel and restricts the number of planes to 1.

OS/2 2.0 adds some extra fields to the DIB format. These govern, among other things, recording order (i.e., direction of scan when a bit map paints), color encoding, and halftoning. Windows 3.0 does not use these fields. Even OS/2 2.0 does not use them all yet. Although it does support halftoning, it has only one option for recording order (bottom-to-top) and one for color encoding (RGB structures).

Getting DIBs

Assuming you have installed Windows 3.0, you can find a small collection of

DIB images in your Windows directory. They have the .BMP extension and serve as wallpaper for the Windows desktop. You can find more DIB images on BIX in the microsoft conference, generally in ZIP files. You can also convert GIF images to OS/2 1.1 bit maps (which are also readable from Windows) using Graham Welland's GIF2BMP, which you can download from the "ibm.os2 listings" area on BIX.

Don't panic if you don't have OS/2:

GIF2BMP is supplied as a bound executable file that will run on DOS 3.3 and higher and on any version of OS/2. Many GIF images are in the "photo listings" area on BIX, as well as the "ibm.os2" area and the microsoft conference; you can find thousands of GIF images in CompuServe's PICS forum areas, although downloading them can be costly.

If you have access to clip art in PCX format, you can convert it to BMP format using PC Paintbrush for Windows 3.0.

To convert other formats (e.g., IFF, TIFF, and TARGA), you may have to resort to a utility program, such as HiJaak or TGL+. If you are converting TIFF files, be aware that there are several levels and types of TIFF format, and that not every TIFF reader supports every variety of file. For instance, HiJaak is unable to read level 5 color TIFF files.

Palette Management

I mentioned palettes briefly when I was describing the Bitmapinfo structure, but I didn't go into all the implications of supporting a selectable palette. For starters, I'll consider a 256-color VGA display, such as a Video Seven video RAM card with 512K bytes of memory.

Windows 2.x and OS/2 1.x load such a display with a default palette. To paint a bit map without palette management, you have a choice of getting best-match solid colors or best-match dithered colors. The solid-color image will look posterized because of the false colors and loss of shading, and the dithered image will look very grainy. Such restrictions are quite obvious in Windows 2.x and OS/2 1.x GIF viewers and in other programs that try to display 256-color images.

Under Windows 3.0 and OS/2 2.0, programs can control the palette using the system's palette manager. The system reserves 20 colors for its own use so that menus and icons will always be visible; on a 256-color display, the remaining 236 colors are available. If you have the Windows 3.0 Software Development Kit (SDK), you can see the palette change if you run the SHOWDIB and MYPAL sample programs and display some 256-color images; otherwise, you can display images with Windows PBRUSH.

Suppose two windows want different palettes. The palette manager gives priority to the active (foreground) window; background windows can take the leavings. You can see this happen by putting up two images with different palettes and bringing them to the front alternately. You'll see the active image snap into its correct colors, the background image become posterized as the palette changes, and the background image adjust itself to the new palette as well as possible.

On a 24-bit "true-color" display, the palette manager does very little. And on a 4-bit (16-color) display, there aren't any colors left over from the system palette. Applications have to be aware of what sort of display they're running on and what sort of DIB they're displaying to do the right thing—but it isn't all that complicated if you start from the SDK examples.

"Compiler Ads Are Confusing."

They all claim that their products are the fastest and most powerful. Buzz words like optimized, integrated, and modular are everywhere—never meaning quite the same thing.

We'd like to be more direct. We'll tell you what you can do with our compiler—then you make the comparisons.

■ **DUAL PERFORMANCE** You have two compilers in one integrated package—Quick for speed applications development and optimizing for the best code generation—with a simple menu option to move between the two. ■ **FLEXIBILITY** You can interface directly with C or any other language. Write only one set of sources for DOS and OS/2, run the most complex applications with no change. ■ **COMPATIBILITY** You can generate code compatible with Microsoft Windows, using all window facilities. And develop Presentation Manager applications with no additional software. ■ **OPTIMIZATION** You get true global optimization, using data flow analysis and proprietary techniques, not just the standard peephole optimization and automatic assignment of variables to registers. ■ **ENVIRONMENT** You have many features you won't find in any other environment—like the ability to organize your code into separate libraries and set compiler options both globally and on a per-module basis. And a make facility that is so well integrated, you don't even know it's there. ■ **TOOLS** You get a debugger, profiler, object librarian and overlay linker with unique capabilities. And a runtime library with surprises like interrupt driven serial communications, true multitasking, graphics, and mouse interface modules.

Stony Brook Professional Modula-2 (both the Quick and optimizing compilers for DOS and OS/2) for \$295. Stony Brook QuickMod (for DOS or OS/2) for \$95.

Stony Brook—we eliminate the confusion.

■ The fine print version of this information with all the details, including our benchmark performances, will be mailed to you within 24 hours if you call our 800 number.

800/624-7487

805/496-5837

California
and International

805/496-7429 Fax

187 East Wilbur Road, Suite 9
Thousand Oaks, CA 91360

Stony Brook
SOFTWARE

Your Partner
in Software Development

©1989 Gogesch Micro Systems, Inc.

Mylex has the best EISA solution. At least that's what people tell us.

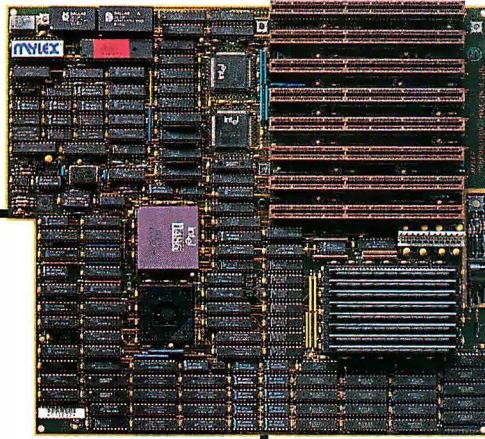

486™ 33MHz System Board



SCSI Caching Host Adapter

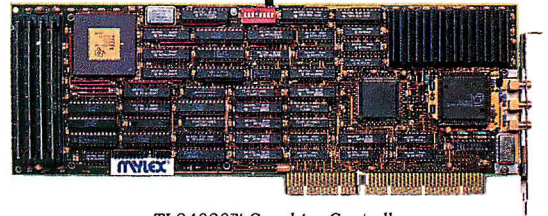

TI 34020™ Graphics Controller

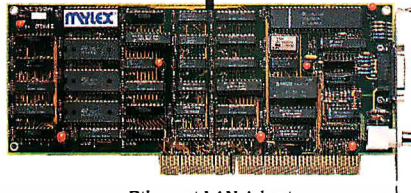

Ethernet LAN Adapter

“The Mylex MAE486 with its 32-bit EISA SCSI controller kills the competition for reading large sequential files in the IOBench 2 tests under UNIX.” *Personal Workstation*, June 1990

“The GXE020A TIGA board ...scored as much as 45 percent higher on our low-level benchmark tests than any other TIGA board evaluated.” *BYTE*, April 1990

“If I wanted to replace my entire system for optimum all-around performance, I’d build it from Mylex EISA-based boards.”

Personal Workstation, June 1990

“Mylex has done a lot of work with EISA, and we plan to use its motherboard and adapters in a LAN Labs ‘super-AT’ server.”

PC Magazine, May 1990

Of course, we've tested our EISA peripherals for compatibility with major EISA systems. To see what our high-performance EISA solutions can do for your system, call us at 1-800-446-9539, or fax us at 1-415-683-4662.

The Mylex logo, consisting of the word "MYLEX" in a bold, blue, sans-serif font.

Getting Up to Speed

I recently added DIB display and printing to EnPlot and Room Planner, two Windows 3.0 applications I've written. (EnPlot is a data-visualization and data-analysis program for scientists and engineers; Room Planner is a room-layout package for the hospitality industry.) To do that, I copied the SDK examples, modified the code somewhat to preserve my applications' mapping and background modes, and wrote a few "glue routines." It took me about two days to add DIB support to Room Planner, and another day to add it to EnPlot.

A big issue I had to address was what size the bit map should be on the screen. The natural size of a bit map is its dimension in pixels. But I wanted my applications to be WYSIWYG, and the resolution of a laser printer is about four times the resolution of a screen, so that a bit-map image that is full-screen covers about 1/16-page when it is printed.

Rather than explicitly scale the image to each resolution, I took advantage of Windows mapping modes. Room Planner uses MM_ISOTROPIC mode, with the window extent set big enough to show

the room dimensions in units of tenths of a foot; with this system, a bit map that is 100 by 200 pixels will be drawn the same size as a platform that measures 10 by 20 feet, no matter what the device resolution.

There are about half a dozen ways of getting the device-independent bit map from disk to screen. I chose to read in the file (being careful of the 64K-byte limit on far pointers), keep it in memory in DIB format, create a palette for it, and then send it to the screen or printer with StretchDIBits, since this is the only Graphics Device Interface function that correctly converts colors (i.e., to shades of gray) and scales the bit map as needed.

When drawing to the screen, I set the background mode to transparent, select and realize the palette, call StretchDIBits, and then restore the old palette and background mode. When drawing to the printer, I skip the palette manager calls. After I've drawn the bit map, I release its memory.

If I were drawing the same bit map over and over, I would probably convert the DIB to a screen-compatible memory bit map of the correct size once with Set-

DIBits, and then I would BitBlt the converted bit map to the screen as needed, avoiding multiple conversions and gaining a little speed. As it is, my application may be drawing multiple bit maps that could not all reside in memory simultaneously, so the StretchDIBits method is as good as anything.

What Does It All Mean?

Now that Windows 3.0 (and OS/2 2.0) support device-independent bit maps and palette management, the PC is ready to become a serious color platform.

Not everyone can afford a 24-bit color display, but an 8-bit Super VGA with palette management behind it can do a more than acceptable job of image display. Color separation, animation, and image-processing software aren't far behind. ■

Martin Heller develops software and writes about technical computer applications. He holds a Ph.D. in physics. He can be reached on BIX as "mheller."

Your questions and comments are welcome. Write to: Editor, BYTE, One Phoenix Mill Lane, Peterborough, NH 03458.

Run with the Fox



Fox Software is committed to excellence, and with products like FoxPro and FoxBASE+/Mac, we prove it.

We've been producing superb database management software since 1983. And our products continue to win awards worldwide.

For a FREE demo disk of any of our products, call (419) 874-0162 and see why "Nothing Runs Like The Fox!"

Fox Software

134 W. South Boundary, Perrysburg, OH 43551
USA (419) 874-0162 / UK (44) 462-421-999

NEW COMPUTERIZED POP-UP CALCULATOR

DESIGNED FOR THE CONSTRUCTION INDUSTRY

MATH PLUS

Once in a lifetime someone, somewhere will come up with a marvelous idea or product whose time has come. Well, WE HAVE DONE IT!

- A Computerized Construction Calculator that "POPS-UP" over any Accounting, Estimating, or Spread sheet, programs or even Word Processing.
- Does BASIC MATH functions, HIGH LEVEL MATH, Converts Construction units of measure OVER 100 WAYS (SF to CY, LBS to TONS, LF to BF or MBF, SF to ACRES, etc. (In Imperial or Metric Measure).
- PRINTS EVERY TRANSACTION ON AN AUDIT TRAIL.
- ALLOWS YOU TO STORE UP TO 50 DIFFERENT TRANSACTIONS IN MEMORY and lets you select and total any group of Units of measure. (SF—\$—CY—LF ONLY, Etc.).
- The program will AUTOMATICALLY deposit the answer into the program that you were working on and then CALCULATOR WILL DISAPPEAR until you need it again!
- Works on any I.B.M. PC or compatible

AMAZING! UNBELIEVABLE? BUT TRUE!

AND LISTEN TO THE BOTTOM LINE... ONLY **\$6950**

Dealer Inquiries Invited

\$7.50 for DEMO disk

Send \$69.50 to order. (Add Sales tax in California)

Racine Technologies • PO BOX 477 • Alpine, CA 92001 • (619) 445-3692
A Subsidiary of LOGICAL PROGRESSION CORP.

Their 20MHz 386 System Alone: \$6,354.
CompuAdd's NEW DX Success Kit: \$1995.
And The Deal Gets Better...



- CompuAdd 320 system and monitor
- 40MB hard drive
- *FREE* Panasonic printer \$299.95 value
- *FREE* mouse \$34.95 value
- *FREE* Windows 3.0 \$149 value
- *FREE* Microsoft Working Models
- *FREE* MS-DOS 4.01 \$89 value

We Give You A **FREE** Printer And More!

CompuAdd's NEW DX Success Kit \$1995

Lower Priced Than Other Competitor's System Alone — Get the Printer, Software and Mouse FREE! A \$573 Additional Value

CompuAdd answers your demands for affordable 386-powered systems — and goes one better with the NEW CompuAdd DX Success Kit.

The 320 system *alone* was \$2259. Now you *save* \$264 and get a *FREE* Panasonic KX-P1180 printer — a \$299.95 value! Add to that, a *FREE* CompuAdd mouse *plus* *FREE* software worth over \$230, and you have a deal that appeals to the shrewdest executive.

The NEW DX Success Kit gives you the power of our 20MHz 386 system with the convenience of our popular "plug-and-go" kits. *FREE* CompuAdd Windows 3.0, *FREE* Microsoft Working Models and *FREE* CompuAdd MS-DOS 4.01 come preloaded on your hard drive, so your system is ready to go right out of the box!

With the 320 at the heart of your kit, you have power for the most demanding tasks — detailed spreadsheets, complex databases, desktop publishing and even CAD/CAM. Compatible with OS/2 and Novell operating systems as well as MS-DOS and SCO XENIX, the 320 also makes an excellent network file server or powerful workstation.

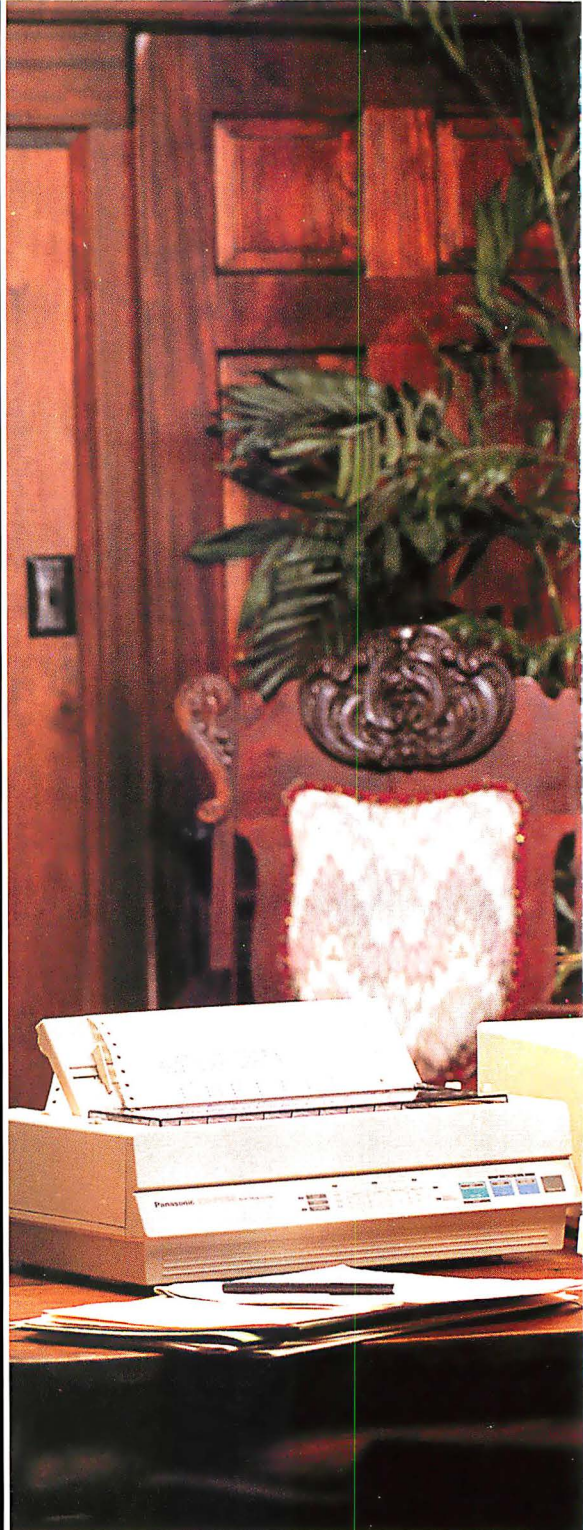

CompuAdd's NEW DX Success Kit Features:

- ▲ 80386 microprocessor running at 20MHz
- ▲ 1 MB DRAM expandable to 16MB
- ▲ 0 wait-state cache memory
- ▲ 40MB (28ms) hard drive
- ▲ 5.25" 1.2MB or 3.5" 1.44MB diskette drive
- ▲ Dual diskette controller
- ▲ Dual IDE hard drive interface
- ▲ Six 16-bit and two 8-bit expansion slots
- ▲ Five 5.25" half-height drive bays
- ▲ Built-in parallel and two serial ports
- ▲ High-performance MGA monitor and graphics adapter
- ▲ *FREE* Panasonic KX-P1180 printer \$299.95 value
- ▲ *FREE* CompuAdd mouse \$34.95 value
- ▲ *FREE* CompuAdd Windows 3.0 preloaded \$149 value
- ▲ *FREE* Microsoft Working Models preloaded
- ▲ *FREE* CompuAdd MS-DOS 4.01 preloaded \$89 value

Part Number 66674

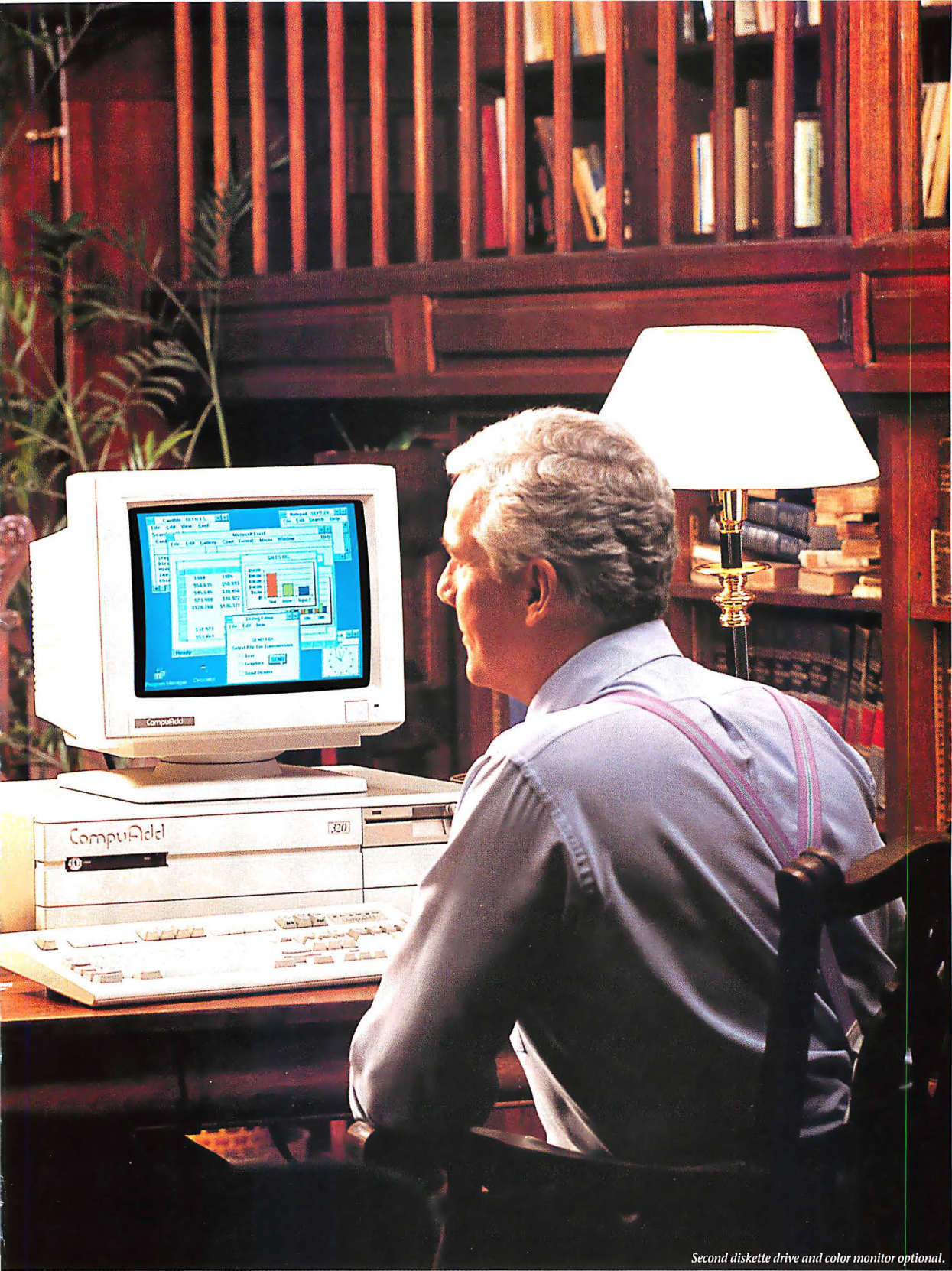

Second diskette drive and color monitor optional.

The Panasonic KX-P1180 printer that comes with your NEW DX Success Kit is a 9-pin near-letter-quality printer. Chosen as a *PC Magazine* Editor's Choice in November 1989, the Panasonic printer is a \$299.95 value — yours *FREE* when you buy CompuAdd's NEW DX Success Kit.

*Get 386 Power, Kit
Convenience and CompuAdd Value!*

Call 800-456-6008

CompuAdd[®]

Customer driven, by design.[™]

CompuAdd's Top-of-the-Line Technology at Bottom-Line Prices

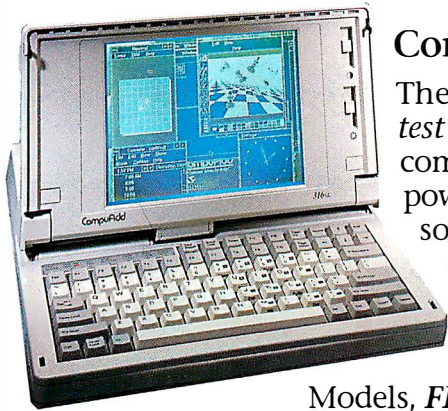

CompuAdd 316SL Laptop

The CompuAdd 316SL — *our hottest seller* — is the perfect on-the-go computing solution! It packs the power of the 386SX microprocessor into a convenient laptop —

at a price far below competitive models! Plus you get **FREE** CompuAdd Windows 3.0, **FREE** Microsoft Working

Models, **FREE** CompuAdd MS-DOS 4.01,

FREE LapLink II communications software and a **FREE** CompuAdd mouse.

You'll find the crisp, clear VGA display and spacious keyboard a pleasure to use. And if you want to use your desktop color monitor and expanded 101-key keyboard when you're not on the road, simply plug them into the built-in external ports.

CompuAdd also offers portable printers, projectors and data displays to make your 316SL a complete office on the road! Check out the savings when you buy CompuAdd's 316SL Kit with Diconix printer and modem/send-only fax.

CompuAdd 425

The technology of tomorrow is here! Based on the revolutionary Intel 486 microprocessor — the "mainframe on a chip" — the CompuAdd 425 delivers astonishing performance in a low profile system. Power for the most demanding spreadsheet, database, network or CAD/CAM applications. And it's compatible with all your favorite 286 and 386 applications.

Step up to the next generation of computing with the CompuAdd 425!

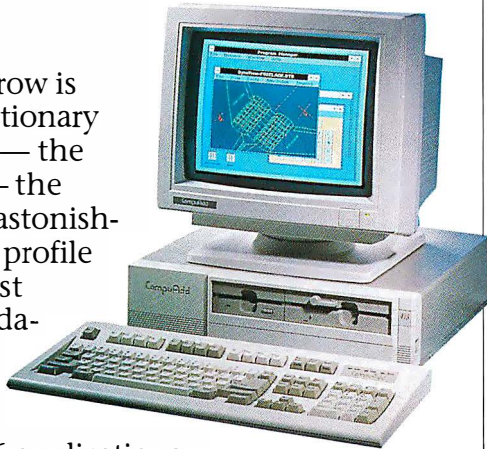

CompuAdd 316SL Laptop Features:

- 386SX microprocessor rated at 16MHz
- 2MB high-speed DRAM expandable to 6MB
- 0 wait-state page-mode memory architecture
- 40MB (28ms) hard drive
- 3.5" 1.44MB high-density diskette drive
- Dedicated internal modem/send-only fax expansion slot
- Dedicated 80387SX math coprocessor socket
- Built-in serial, parallel printer, external VGA, keyboard and 5.25" diskette drive ports
- High-resolution (640x480) VGA display
- 7" x 5.25" supertwist LCD screen (sidelit)
- 85-key keyboard with 101-key emulation
- **FREE** CompuAdd serial mouse \$34.95 value
- **FREE** CompuAdd Windows 3.0 \$149 value
- **FREE** CompuAdd MS-DOS 4.01 \$89 value
- **FREE** LapLink II software with serial cable \$89 value
- **FREE** Microsoft Working Models
- Carrying case
- Dimensions: 12.7" x 12.4" x 2.4"
- Weight: 11.5 pounds
- **System Price: \$2895 (62202)**
- **Kit Price: \$3195 (62203)**
(Kit includes Diconix 150 Plus printer and 2400 baud modem/send-only fax.)

CompuAdd 425 Features:

- 80486 microprocessor rated at 25MHz with internal 8KB cache and floating point processor
- 4MB DRAM, expandable to 16MB
- 5.25" 1.2MB or 3.5" 1.44MB diskette drive
- 80MB hard drive
- Three 16-bit and two 8-bit expansion slots
- 16-bit video graphics adapter
- CVGA monitor
- **FREE** CompuAdd mouse \$34.95 value
- **FREE** CompuAdd Windows 3.0 \$149 value
- **FREE** Microsoft Working Models
- **FREE** CompuAdd MS-DOS 4.01 \$89 value
- **System Price: \$4995 (66652)**

CompuAdd[®]

Customer driven, by design.[™]

12303 Technology, Austin, Texas 78727

Telex: 763543 COMPUADD AUS
 Fax: 512-335-6236
 Technical Support: 800-999-9901
 Outside US: 512-258-5575
 Canada: 800-387-3266
 Mexico: 95-800-010-0401
 United Kingdom: 0800-373535
 Germany: 0130-6009

Think Technology, Think CompuAdd!

CALL TODAY! or
visit a CompuAdd
Superstore for these
savings.

800-456-6008

Hours: Monday - Friday 7:00am to 9:00pm CST; Saturday 9:00am to 5:00pm CST

We accept MasterCard, VISA, money orders, certified checks and personal checks (please allow ten days for processing), C.O.D.s (\$50 minimum order), company and institutional purchase orders (minimum initial purchase \$50; thereafter \$50), and wire transfers. Please add 2% to all purchases for shipping and handling (minimum \$5; shipping outside the continental United States will increase cost). Add 8% for shipping and handling to APO/FPO addresses (minimum \$10). Please add appropriate local sales tax. Thirty-day money-back guarantee does not include return freight or shipping and handling. Opened software, videotapes, other consumables and shipping costs are nonrefundable. All return items must be accompanied by a return merchandise authorization (RMA) number. Prices and product descriptions are subject to change without notice. CompuAdd is not liable for damage due to omissions or typographical errors. Call 800-666-1872 for a copy of CompuAdd's complete warranty.



INSPIRATION AT THE YEAR'S END

The Mac markets changed during 1990, and new markets are developing

How time flies. The first year of the new decade whipped by as fast as a screen update on a Mac IIfx. It's time to evaluate what's happened to the computing community, including the Mac's position within it. In the IBM-compatible world, the Rest of Them have been cranking out 486 systems at higher clock speeds, and Windows 3.0 is a major improvement as far as DOS-based graphical user interfaces (GUIs) go.

Apple, after some dithering about, took muster and waged the battle of the market share on two fronts. It took the high ground in March with its introduction of the Mac IIfx, the first-ever Mac clocked at 40 MHz. In October, Apple began the blitzkrieg on the low end with three new low-cost Macs. Just as important, the company slashed prices on the existing models.

Apple's attack plan so far has been impressive, but it's not without flaws. The Mac IIfx's much-touted SCSI DMA will not work with anything but A/UX. System 7.0 still hasn't seen the light of day. The features on the low-cost Macs are so-so, including their pricing. If Apple is indeed in the market-share battle for the long haul, I wonder whether it will have the nerve to reduce prices further if the situation warrants it. In other words, we've gone through another year of some improvements to the Mac and its software, but we're still waiting for the next Mac revolution. I'm getting pretty itchy waiting for it to come.

The one place I see a difference is not in the volleys from the big guns over-

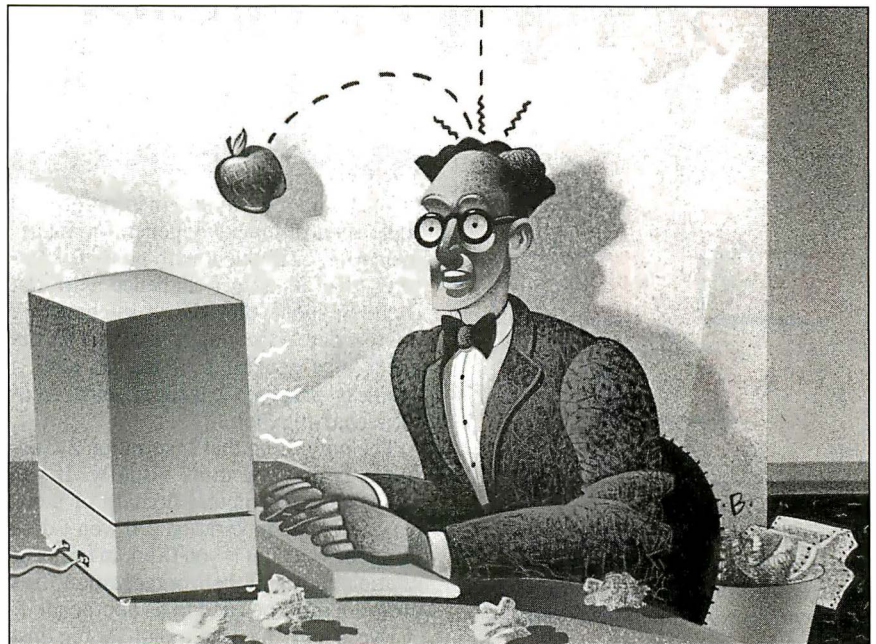

head, but when I look in the trenches where the small Mac developers hunker down. Try as we might, we just can't kill these little guys. We entice them with promises of greater profits (Windows 3.0), hotter development systems (Next-Step), and other baubles, but they stick to the Mac like glue.

Whatever the reason, it's these folks who make the most interesting Mac software today, and who typically define new software categories. These developers think about more than just adding more features to a word processor or better kerning to a page-layout system. They think about what might be possible with a Mac.

The Mac Gets Inspired

Not surprisingly, one of the newer Mac products I've found is called Inspiration 2.0. It's from a tiny family-owned company called Ceres Software in Portland, Oregon, and it's been around for a year

now, largely ignored. I spent a pleasant time conversing with its creator, Don Helfgott. He calls his program a thought processor, but that doesn't do it justice.

Inspiration 2.0 takes the Mac's ability to give you a consistent and meaningful GUI and lets you brainstorm, cranking out ideas by the bushel basket. It then organizes the ideas in a way that helps you realize what, if anything, you've really invented. Inspiration 2.0 is sort of a visual diagramming and outlining tool interweaved with a simple word processor. It's the first computer aid to creative thinking I've tried that actually works—and I've tried them all.

The theory behind Inspiration 2.0 goes something like this. Databases, word processors, and spreadsheets store and access information in ways that don't help us relate information more clearly, because they fail to distinguish between right-brain thinking (i.e., creativity, images, comprehension, imagination,

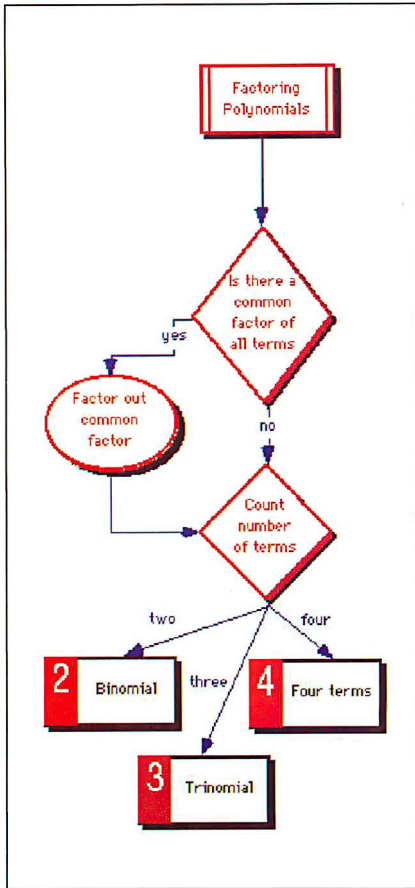

Inspiration 2.0 combines visual diagramming and outlining with a simple word processor. This Inspiration flowchart outlines the general algorithm for factoring a polynomial, as shown in listing 1.

Listing 1: This listing was derived from the Inspiration flowchart shown in the figure.

```

Factoring polynomials
  Is there a common factor of all terms?
    Count number of terms
      Binomial
        Difference of two squares
          a2 - b2 =
(a + b) (a - b)
        Sum of two cubes
          a3 + b3 =
(a + b) (a2 - ab + b2)
        Difference of two cubes
          a3 - b3 =
(a - b) (a2 + ab + b2)
      Trinomial
        Trial and error or AC method
      Four terms
        Factor by grouping
        Factor out common factor
    
```

visualization, music, and daydreaming) and left-brain thinking (i.e., logic, sequence, reasoning, and analysis). Inspiration 2.0 works by filling the gap between these two kinds of thinking.

Other programs have promised to accentuate the synergy between the right and left brains. Neil Larson's Maxthink, early versions of Dave Winer's Think-Tank outliner, ODS's Consultant, and a myriad of other shareware have all skipped through this software minefield before. None of them really pulled it off, however, because they just didn't have a good model to implement.

Inspiration 2.0 has a good model, and that's why it succeeds. Rather than trying to be all things to all thinkers, the Helfgotts have pinned down their customers—writers, entrepreneurs, creative directors, analysts, planners, educators, and consultants.

They did not make Inspiration 2.0 some kind of unwieldy general management tool, or imbue it with powerful features that its target audience will not need. In short, they didn't kitchen-sink this product by trying to make it fit the needs of a general presentation tool, a business graphics package, or a free-form charting tool.

The only thing that Inspiration 2.0 assumes is that you think visually. If you never leave the mental domain of numbers and text, Inspiration 2.0 won't do a thing for you. But if you think in terms of relationships and their organization, this program must be tried to be appreciated.

I've spent the last month doing just that. In fact, I've fallen into its organiza-

tional metaphors so easily that it's sometimes hard to go back to a more traditional outliner like More or Acta. I'm now using Inspiration 2.0 in my introductory programming class (in which I teach HyperCard 2.0 and HyperTalk) to help my students invent and categorize algorithms and get them into a form that will suggest code to them.

One way Inspiration 2.0 does that is by letting them come at both ends of a programming problem at the same time. My students learn about top-down design and bottom-up testing right from the start, but one thing they often miss is the interaction between the two. Because Inspiration 2.0 can present your information either as a free-form chart or as an outline, you can use the chart to plan your global program segments (top-down design) and the outliner to punch out the code necessary for each segment (bottom-up testing).

In a flowchart created with Inspiration 2.0 (shown at left), the general algorithm for factoring a polynomial has been outlined. To code individual segments of this algorithm, you switch to Inspiration's outline view, where you can bang out and reorganize all the code statements (see listing 1). This sort of view change doesn't really scream to be noticed, but it's exactly the kind of subtle capability that makes Inspiration 2.0 so useful.

Inspiration 2.0 isn't flashy, it isn't full of multimedia bells and whistles, it doesn't fit any traditional business computing category, and it's not expensive. Yet it's exactly the kind of software that made the Mac a ground-breaking machine and keeps me hoping for better things. It's one more reason why the Mac can easily play the power, performance, and usable facility game with any desktop computer.

Tip of the Month: Software Bridge

If you have to work between a Mac and the rest of the world—whether that world includes other Macs or PCs, whether on a network or running stand-alone—you need some good file filters or format converters. And if most of your work is with text on vastly different word processors, you need world-class translators. The only company I know that provides such high-class translators is Systems Compatibility. It makes the Software Bridge for the PC and the Mac.

The Software Bridge costs \$129, packing together a set of Apple File Exchange translators that cover 24 different word processor formats in one of 380 possible translator pairings. You can choose from

THE OPTICAL ZONE



You're traveling through another dimension — a dimension of increasing storage demands and rewritable optical technology.

Submitted for your approval, storage solutions from the #1 source of optical storage systems in the world. Systems designed for Macintosh, SUN, DEC, HP, IBM and compatibles. Support for advanced applications running Unix, Xenix, A/UX, Novell, and more.

Pinnacle Micro, the leader in this new storage revolution, provides expanded storage for multimedia, digital video, pre-press, desktop publishing, CAD/CAM, and other data-intensive applications.



In the Optical Zone, these storage requirements are met with the latest optical technology available. From the world's first 3.5 inch optical drive to the largest selling 5.25 inch optical drives and disk changers. On line, network, backup and archiving storage solutions from 128 Megabytes to 36 Gigabytes.

With optical storage, your data's life is prolonged and protected. Expansion is as easy as inserting another optical disc. With Pinnacle's

ASCENT™ program, systems can be upgraded from 650 Megabytes to 1 Terabyte.

*See the future ... Store the future ... Recall the future ... The future is Optical.
For further reference, check under "S" for storage, from Pinnacle in ... The Optical Zone.*

☎ (800) 553-7070

PINNACLE MICRO

THE OPTICAL STORAGE COMPANY™

Trademark Owners: Pinnacle Micro of Pinnacle Micro, Inc. Sun of Sun Microsystems. DEC of Digital Equipment Corp. IBM of International Business Machines Corporation. Macintosh of Apple Computer, Inc.

15265 Alton Parkway • Irvine, CA 92718 • In CA (714) 727-3300 • FAX (714) 727-1913

Circle 234 on Reader Service Card

24-bit Color is Just One of Our Strengths.



The Hercules Graphics Station Card gives you the real picture and power to spare. Power to run Windows 3.0 and beyond.

With 1024K of VRAM for 16- and 24-bit color, up to 16.7 million colors are within your grasp. Pictures will appear more lifelike than ever. And with its TI 34010 processor, the Hercules Graphics Station Card frees your CPU from time-consuming graphics functions. You can run programs like PageMaker, Excel and Corel Draw up to five times faster than the fastest super VGA card, even at 1024 x 768 resolution.

Only the Hercules Graphics Station Card combines VGA for today's applications, the TI 34010 for more power and future applications, and 16- and 24-bit color high quality photo realism. All at a surprisingly low price. Call 800 532-0600, ext. 722 for more information.



After all, 24-bit color is just one of our strengths.



© Copyright 1990, Hercules Computer Technology, Inc., 971 Parker Street, Berkeley, CA 94710. Hercules and Hercules Graphics Station Card are trademarks of Hercules Computer Technology, Inc. All other product names are trademarks of their respective owners, who are affiliated with Hercules.

Circle 133 on Reader Service Card

ITEMS DISCUSSED

Inspiration 2.0\$199
Ceres Software
2520 Southwest Hamilton St.
Portland, OR 97201
(503) 245-9011
Inquiry 1146.

Software Bridge.....\$129
Systems Compatibility Corp.
401 North Wabash Ave.,
Suite 600
Chicago, IL 60611
(800) 333-1395
(312) 329-0700
Inquiry 1147.

Word 3.0x and 4.0, MacWrite II, Microsoft RTF, WordPerfect, ASCII, and DCA/RFT on the Mac, with dozens more PC formats supported. You can translate your files between Mac and PC formats or across platforms. The Software Bridge AFE translators all work like the ones from Apple, DataViz, or Claris that you might already be using on your Mac.

Unlike the Apple and DataViz translators, the Software Bridge doesn't leave anything untranslated when it's done with your file. You'll retain the exact same formatting (e.g., boldface, underlined text, indents, tabs, headers, footers, fonts, and styles) in your translated copy as you had in the original. Graphics incorporated into the original Mac documents are also translated exactly into other Mac formats.

The Software Bridge translators automatically identify the file format before making the change, and they never limit you to one-way conversions. I've used the Software Bridge to convert files back and forth many times without any translation artifacts.

I've never been very happy with the file translators that I've used from Apple and DataViz, since they always seem to leave untranslated residue. The Software Bridge for the Mac seems to fix these problems for just about any combination of file formats you might encounter. ■

Don Crabb is the director of laboratories and a senior lecturer for the computer science department at the University of Chicago. He is also a contributing editor for BYTE. He can be reached on BIX as "decrabb."

Your questions and comments are welcome. Write to: Editor, BYTE, One Phoenix Mill Lane, Peterborough, NH 03458.

Lease a Macintosh System for as little as \$43.⁴³/month.

Why You Should Buy Your Mac from CDA.

Over the last ten years CDA has worked hard to create something unique in the field of computer mail order—a company that could provide customers with the support they would expect from a local computer dealer, along with the convenience and economy of direct-order, by mail, fax or phone. Thus CDA has grown with the computer industry and, in the process, has earned a rock-solid reputation for providing superior-quality service and support. To insure you're 100% satisfied with your purchase, CDA offers a 30 Day Money-Back Guarantee as well as a full One Year Performance Guarantee on all orders.



IBM/Macintosh Hardware

Orange 386	\$1699
DaynaFile Dual 5.25/1.2Mb	\$699
Dayna Translation Software	\$89
AccessPC by Dayna	\$85
Soft PC by Insignia	\$129

Printers (cables included)

Apple LaserWriter IINT	\$3395
Personal LaserWriter NT	\$2475
QMS PS 410	\$2199

Scanners

Microtek MSF 300GS w/SCSI ..	\$1559
------------------------------	--------

Modems

DoveFax Desktop	\$279
DataLink Mac Internal (Mac II)	\$199

Monitors

Mega Graphics 19" Rival	\$1199
Magnavox 14" Color RGB	\$459
E-Machines T-16 w/card	\$2149
Ikegami 20" Trinitron w/card	\$2799
RasterOps 19" Trin w/card ..	\$4569

Please call for our complete list of Macintosh hardware & software.

Purchase Orders Welcome.

Fax: (908) 832-9740 Ad#50-12
In NJ/Outside US (908) 832-9004

Macintosh Classic System

- Macintosh Classic w/40 Mb Apple Hard Drive, Apple SuperDrive, Keyboard, Mouse, & 2 Megabytes of RAM
- HyperCard and MultiFinder
- Virex (anti-virus) Software
- Adobe Type Manager
- 6 Outlet Surge Protector
- 10 Diskettes
- Diskette Storage Box
- Mouse Pad

Ask for Package #9101

CDA Price \$1,539

Only \$43.⁴³/month*

*Based on 48 month FMV lease

Macintosh IIsi System

- Macintosh IIsi CPU w/40 Mb Apple HD, Apple SuperDrive, and 2 Megabytes of RAM
- Microphone
- DataDesk Switchboard
- Magnavox 14" RGB Monitor
- HyperCard and MultiFinder
- Virex (anti-virus) Software
- Adobe Type Manager
- 6 Outlet Surge Protector
- Mouse Pad
- 10 Diskettes
- Disk Storage Box

Ask for Package #9110

CDA Price \$3,769

Only \$90.²⁵/month*

*Based on 60 month FMV lease

Macintosh IICI System

- Macintosh IICI CPU w/built in Video Card, Microtech Nova 105 Mb HD Apple SuperDrive, & 4 Megabytes of RAM
- Magnavox 14" Color Monitor
- DataDesk SwitchBoard
- HyperCard & MultiFinder
- Virex (anti-virus) Software
- Adobe Type Manager Software
- Norton Utilities Software
- Total Recall Software
- Demo of Microsoft Excel
- 10 Diskettes
- Disk Storage Box
- Mouse Pad
- 6 Outlet Surge Protector

Ask for Package #9107

CDA Price \$5,969

Only \$142.⁴¹/month*

*Based on 60 month FMV lease

US/Canada 800-526-5313

CDA Computer Sales

1 CDA Plaza, P.O. Box 533 Califon, NJ 07830
Apple Macintosh & LaserWriter are registered trademarks of Apple Computer Inc.

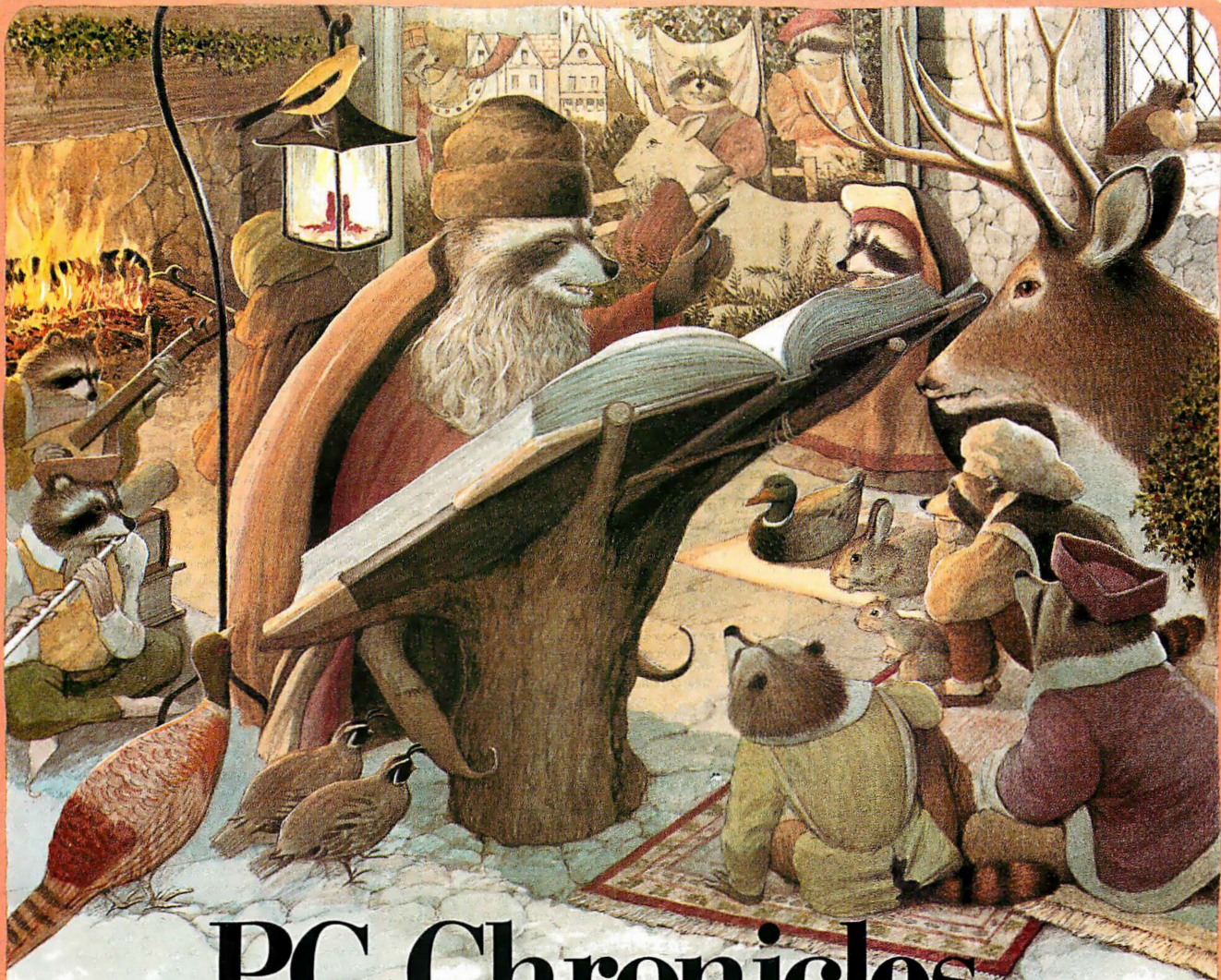

PC Chronicles.

Call me a lyre.

(Or, how we wrote the book on PC mail order.)

Truth tends to be stranger than fiction in the telltail town of Marlow, NH (pop. 564). That's why you'll often find the local color gathered 'round the ancient sage as he recounts in vivid detail how our forest glade was transformed into a PC paradise.

For, in days of yore, buying software and peripherals by mail was a perilous task, fraught with danger and uncertainty. Only those well versed in the black arts dared risk such unpredictable delivery and uncertain compatibility.

Then one day the enlightened Order of the Connection appeared majestically on the scene, bringing

the classic virtues of toll-free tech support, prompt shipping, and way-under-retail prices to the brave new world of the IBM PC. Since that glorious day our humble home has served as a beacon of light to noble users in cottages, condos, and corporations throughout America. **That'll be the day.**

It's not every day of the week you get offered your very own 1991 PC Connection Calendar. This very timely offer includes 13 classic illustrations of our legendary mascots, all your favorite holidays, and fascinating historical facts about the fiefdom of Marlow, NH. This wondrous wall calendar is free to everyone who places an order of \$750 or more between now and February 28.



Mark time with the PC Connection Calendar featuring our very own day-tripping mascots. Offer not available to accounts on net terms. One per customer.

PC CONNECTION®

Trying to find the

1990 World Class Award for Best Mail-Order Company



- 3 1/2" format available from us. Specify when ordering.
 - package includes both 5 1/4" and 3 1/2" disks.
 - 3 1/2" format available from manufacturer by request. Call us for details.
- CP—copy-protected; NCP—not copy-protected.

The four-digit number next to each product is the product's ITEM NUMBER. Please refer to this number when ordering. Thank you.

SOFTWARE

We only carry the latest versions of products. Version numbers in our ads are current at press time.

Products listed here in red are Microsoft Windows Applications.

Adobe Systems ... NCP

- 6591 Illustrator Windows 1.0 \$279.
 - 7547 Adobe Type Manager for Windows 59.
 - 7902 Adobe Type Manager for Windows and Microsoft Windows 3.0 149.
 - 6590 Streamline Windows 1.0 229.
 - 7392 Adobe PostScript Cartridge 249.
- (Entire Adobe Type Library, from 1 to 133 is available. Call for more information.)
- ### Aldus ... NCP
- 1332 PageMaker 3.01 499.

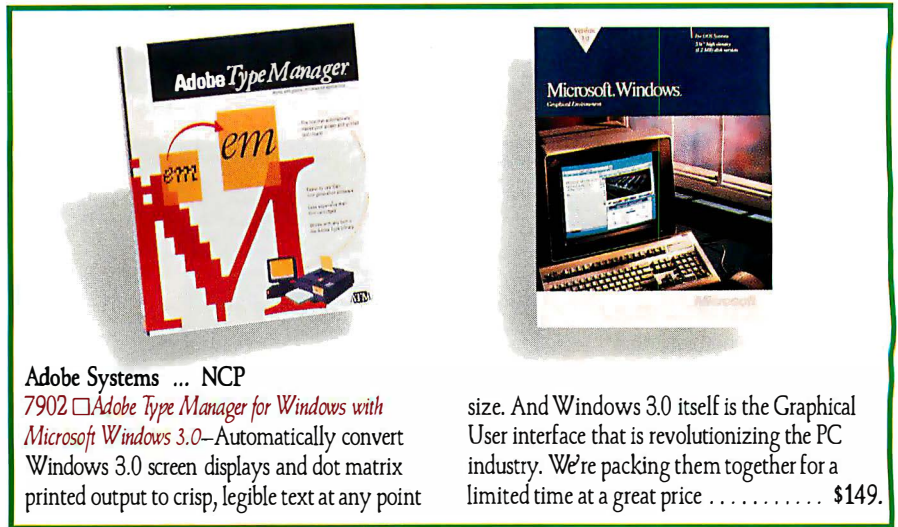

Adobe Systems ... NCP
7902 Adobe Type Manager for Windows with Microsoft Windows 3.0—Automatically convert Windows 3.0 screen displays and dot matrix printed output to crisp, legible text at any point

size. And Windows 3.0 itself is the Graphical User interface that is revolutionizing the PC industry. We're packing them together for a limited time at a great price \$149.

- 5104 Alpha Software ... NCP
- Alpha Four 1.1 319.
- Application Techniques ... NCP**
- 1214 Pizazz Plus 2.0 69.
- ASD Software ... NCP**
- 7847 Planisoft 1.0 145.
- Ashton-Tate ... NCP**
- 6580 MultiMate 4.0 299.
- 4450 dBASE IV 1.1 499.
- Asymetrix ... NCP**
- 7384 Toolbook 1.0 for Windows 309.
- Avery ... NCP**
- 6006 Label Pro 1.0 (Laser) 49.
- 7336 Label Pro 1.0 for Dot Matrix 49.
- Bastech ... CP (5 copies)**
- 4665 Bastech Utilities 2.07 25.
- Bitstream ... NCP**
- 7568 FaceLift 1.0 for Windows 2.x/3.0 59.
- 8040 FaceLift for WordPerfect 5.0/5.1 59.
- 7569 Companion Value Pack for FaceLift 1.0 (includes 25 typefaces) 125.
- Collections: Newsletters, Flyers, Books & Manuals, Reports and Proposals, Presentations or Spreadsheets each 129.
- Fontware each 89.
- Bloc Publishing ... NCP**
- 1447 FormTool Gold 3.0 55.
- 8086 Personal Law Firm 1.1 59.
- 6245 Pop Drop Plus 1.0 59.
- 8087 Ram Pack (Pop Drop Plus and Above Disk) 85.
- 4594 FormFiller 3.0 89.
- Borland International ... NCP**
- Turbo C++ 1.0 145.
- 7357 Turbo C++ 1.0 Professional 219.
- 7356 Turbo Pascal Professional 2nd Ed. 179.
- 5335 Turbo Pascal 5.5 109.
- 6242 Quattro Pro 1.0 325.
- 1514 Paradox 3.5 569.
- Broderbund ... NCP**
- 1434 New Print Shop 39.
- 1416 New Print Shop Companion 33.
- ButtonWare ... NCP**
- 6419 PC-File 5.0 89.

- Caere ... NCP**
- 6004 Omnipage 386 2.1 599.
- Central Point ... NCP**
- 5039 PC Tools Deluxe 6.0 95.
- 5038 Copy II PC 5.0 29.
- 8114 Backup 6.0 65.
- Checkfree**
- 6360 CheckFree (electronic checking srv.) 25.
- Chipsoft ... NCP**
- 1663 TurboTax 8.0 for 1990 Taxes 45.
- CompuServe**
- 7546 DOS Membership Kit 23.
- Concentric Data Systems ... NCP**
- 6575 R & R Relational Report Writer 3B 109.
- Corel Systems ... NCP**
- 5506 CorelDRAW! 1.2 329.
- Custom Applications ... NCP**
- 7474 Freedom of Press 2.2 255.
- DAC Easy ... NCP**
- 1748 Accounting 4.0 89.
- 1751 Bonus Pak 4.1 129.



Avery ... NCP
Fast & easy label printing. Design labels using special fonts, designs & clip-art. Includes pre-set layouts for Avery brand labels.

- 6006 Label Pro 1.0 (Laser) \$49.
- 7336 Label Pro 1.0 for Dot Matrix 49.

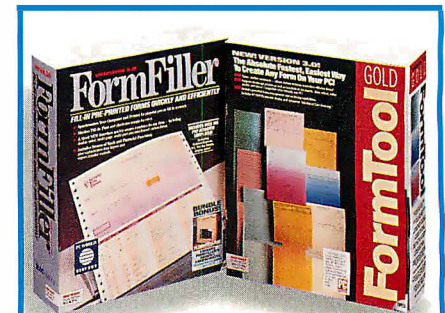

Bloc Publishing ... NCP
With Form Tool Gold, design any form in minutes. With FormFiller 3.0, accurately plug in your data. It's a perfect forms team.

- 1447 Form Tool Gold 3.0 \$55.
- 4594 FormFiller 3.0 89.

best upgrade path?

- Data Storm ... NCP**
 4798 PROCOMM PLUS 1.1 \$65.
DCA ... NCP
 7936 Crosstalk Communicator 1.0 59.
 2908 Crosstalk XVI 3.71 119.
 5611 Crosstalk for Windows 1.1 129.
Delrina Technology ... NCP
 7351 PerFORMPRO 1.0 for Windows. 299.
Dow Jones ... NCP
 5494 News/Retrieval. 24.
Fifth Generation Systems ... NCP
 7725 Direct Access 5.0. 59.
 8804 Brooklyn Bridge 3.0. 89.
 8729 MaceVaccine 1.0. 89.
 2762 Mace Utilities 1990. 99.
 7795 Disklock 1.0. 109.
 3950 Fastback Plus 2.1. 119.
FNN Data Broadcasting ... NCP
 7005 NewsReal 1.0 99.
FormWorx ... NCP
 5810 FormWorx with Fill & File 2.5 85.
 7311 Form Publisher for Windows 1.2. 145.
Fox Software ... NCP
 2233 Foxbase Plus 2.1 199.
 6188 FoxPro 1.02. 489.
Franklin Software ... NCP
 7071 Language Master 2.0 59.
 7416 Language Master 3.0 for Windows 59.
Funk Software ... NCP
 2228 Sideways 3.3 52.
 7380 P.D. Queue 1.0 (print spooler) ... 55.
 4479 Always 1.2 (for 1-2-3 or Symphony) 115.
Generic Software ... NCP
 2265 Generic CADD Level 3 5.0 225.
Great American Software ... NCP
 4880 One Write Plus Acct. Sys. 2.06 .. 179.
 5825 Money Matters 1.0. 55.
 4879 Payroll for Accounting System 2.0 89.
 7378 Financial Manager. 479.
Harvard Associates ... NCP
 2324 PC Logo 3.0 59.
hDC Computer Corp. ... NCP
 7389 Windows Express 3.0 55.
 7383 First Apps 1.0 55.

- Hilgraeve ... NCP**
 2323 HyperACCESS/5 1.1 (DOS & OS/2) \$115.
IBM ... NCP
 6599 Current 1.1 239.
Individual Software ... NCP
 2415 Typing Instructor Encore 3.0 19.
 6222 Resume Maker 1.1 29.
Inset Systems ... NCP
 7298 Hijaak 2.0 99.
 7300 Inset Plus Hijaak 125.
Intuit ... NCP
 2426 Quicken 4.0. 39.
Isogon ... NCP
 7478 FontSpace 2.0 59.
Laser Go ... NCP
 7635 Go Script Plus 3.0 189.
LaserTools ... NCP
 6882 PrintCache 2.3 99.
Lord Publishing ... NCP
 5191 Ronstadt's Financials 1.02. 75.



Great American Software ... NCP
 4880 One Write Plus Accounting System 2.06—
 Complete small business accounting that
 provides easy set-up and operation. Includes 3
 best-selling programs—Master (GL), Accounts
 Receivable, and Accounts Payable ... \$179.

- Lotus ... NCP**
 5417 1-2-3 3.1 429.
 5653 1-2-3 2.2 349.
 5134 Magellan 2.0 119.
MECA ... NCP
 4529 Checkwrite Plus 1.1 29.
 4603 Andrew Tobias' Tax Cut-1990 Taxes 49.
 7002 Home Lawyer 1.0 69.
 2798 Managing Your Money 6.0 135.
Microcom ... NCP
 7649 Virex 1.1 79.
 6234 CarbonCopy Plus 5.2. 119.
Micrografx ... NCP
 7683 Charisma 1.0. 349.
Micro Logic ... NCP
 6787 Info Select 1.1 55.

1-800/776-7777

MMC **PC Connection** 790B
 6 Mill Street
 Marlow, NH 03456
SALES 603/446-7721 FAX 603/446-7791

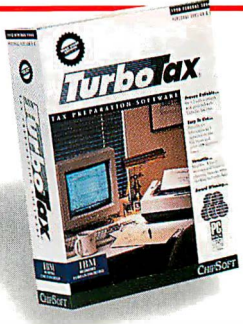

Chipsoft ... NCP
 1663 TurboTax 8.0 for 1990 Taxes—The best-
 selling, easy-to-use and complete software for
 preparing individual tax returns. TurboTax
 provides on-line help, IRS instructions and
 comprehensive tax assistance. \$45.

- Microlytics ... NCP**
 2731 GOfar 2.0 45.
Microsoft ... NCP
 7882 Productivity Pack for Windows. ... 45.
 7010 Windows 3.0 99.
 7388 Project for Windows 1.0 469.
 7387 PowerPoint for Windows 1.0. ... 329.
 2904 Works 2.0 99.
 2901 Word 5.0 209.
 6195 Word for Windows 1.1 329.
 2856 Excel 2.1 329.
 2894 QuickBASIC 4.5. 69.
 2853 C Compiler 6.0 339.
Multisoft ... NCP
 4925 PC-Kwik Power Pak 1.5 79.
Nolo Press ... NCP
 5122 For the Record 2.0. 35.
 2982 WillMaker 4.0. 39.
 Norton-Lambert ... NCP
 4928 Close-Up Customer/Terminal 3.0 135.
 4929 Close-Up Support/ACS 3.0 165.



Corel Systems ... NCP
 5506 CorelDRAW! 1.2—The world's leading
 PC illustration software now comes with
 even more value: CorelTRACE, over 100
 typefaces, over 300 clip-art images, a Pantone
 license—all bundled in for free. \$329.

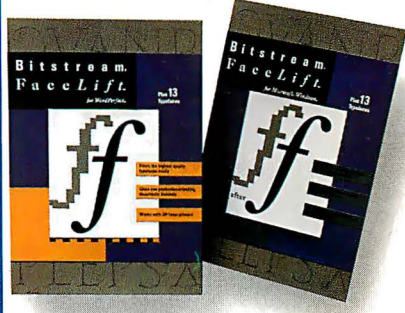

Bitstream ... NCP
 Fast & easy-to-use, FaceLift scales screen &
 printer fonts to any size. Includes 13 typefaces
 to give you professional documents instantly.
 7568 FaceLift 1.0 for Windows 2.x/3.0 . \$59.
 8040 FaceLift 1.0 for WordPerfect 5.0/5.1 . 59.

Or a faster way

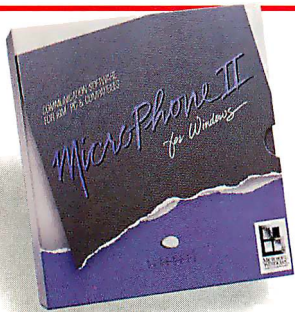

Software Ventures ... NCP
 6889 **MicroPhone II for Windows**—Telecom software that's "a joy to use," says PC Computing. With Watch Me mode to automate script creation, and portability with MicroPhone scripts on the Mac. \$215.

- PC Globe ... NCP**
 5902 PC Globe 4.0 39.
 5900 PC USA 2.0 39.
- Personics ... NCP**
 4384 Ultravision 2.0 79.
 7475 Macro Editor/Debugger 1.0 135.
 7048 Monarch 1.0 (Data Mgmt. Tool) . . 319.
- PowerUp ... NCP**
 7860 Calendar Creator Plus 3.0 45.
 7858 Express Publisher 2.0 89.
- Precision Software ... NCP**
 8102 Superbase 2 1.2 219.
 6600 Superbase 4 for Windows 1.2 469.
- Qualitas ... NCP**
 7539 386MAX 5.0 75.
 7967 BlueMAX 1.0 (386 PS/2) (3 1/2" only) . 85.
- Quarterdeck ... NCP**
 6422 QRAM 1.0 49.
 3221 Expanded Memory Mgr. 386 5.1 . . 59.
 3220 DESQView 2.3 79.
 4586 DESQView 386 5.1 129.

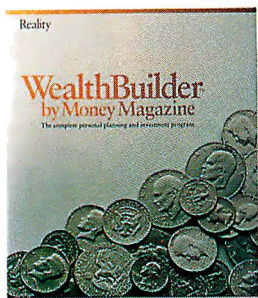

Reality Technologies ... NCP
 6572 **WealthBuilder by Money Magazine 1.1**—Save & invest wisely. Set financial goals & achieve them. Plan for retirement, a child's education, a home. Optimize your portfolio & track all of your investments \$145.

- Reality Technologies ... NCP**
 7891 WealthStarter 1.0 \$49.
 6572 WealthBuilder 1.1 145.
- Reference Software ... NCP**
 4396 Grammatik IV 1.0 52.
 7483 Grammatik for Windows 1.0 52.
- Revolution Software ... NCP**
 4480 VGA Dimmer 2.01 (screen saver) . . 29.
- RightSoft ... NCP**
 4155 RightWriter 4.0 55.
- Samna ... NCP**
 5799 Ami Professional 1.2 309.
- Sitka/TOPS ... NCP**
 6675 TOPS Network Bundle 3.0 159.
 3720 Flashcard 2.1 (AppleTalk network card; 1 year warranty) 155.
 6649 Inbox (20 user) (electronic mail) . . 219.
- Softlogic Solutions ... NCP**
 3542 Software Carousel 4.0 55.
- Software Publishing ... NCP**
 7769 PFS:Preface 1.0 (with Viruscan) . . . 49.
 3499 PFS:First Publisher 3.0 (with Deluxe Paint II) 99.
 3478 PFS:First Choice 3.02 (with Prodigy) 105.
 3496 Professional Write 2.2 (with Professional File) 179.
 3495 Professional Plan 1.01 69.
 3482 Harvard Graphics 2.3 359.
 4766 First Choice Network 299.
 7507 Professional Writer Network 2.0 . . 349.
 7513 Professional File Network 2.0 . . . 379.
 3483 Harvard Graphics Network 2.0 . . 599.
 4342 First Graphics 1.0 99.
- Software Ventures ... NCP**
 6889 **MicroPhone II for Windows** 215.
- Solution Systems ... NCP**
 7977 Brief 3.0 (Programmer's Editor) . . 155.
- Spinnaker ... NCP**
 7604 PLUS for Windows 1.0 289.
 4441 Resume Kit 1.32 25.
 4446 Eight In One 2.0 39.
- Systat ... NCP**
 7415 Systat/SyGraph 5.0 649.
- Symantec ... NCP**
 3152 Norton Commander 3.0 105.
 6397 The Norton Backup 1.1 105.
 3146 The Norton Utilities 5.0 125.
 3425 Q&A 3.0 229.
 3431 Timeline 4.0 469.
- Systems Compatibility ... NCP**
 6564 Software Bridge 4.1 79.
 6570 Software Bridge LAN 4.1 155.
- TIMESLIPS ... NCP**
 2987 Timeslips III 4.0 195.
 4277 Timeslips III Network 399.
 6994 PercentEdge 1.0 69.
- Timeworks ... NCP**
 6253 Publish-It! 1.1 115.
- Touchstone Software ... NCP**
 7420 Check It 3.0 89.
- Traveling Software ... NCP**
 5179 LapLink III 3.0 95.
- True BASIC ... NCP**
 3561 True BASIC 2.1 52.
- Vericomp ... NCP**
 6771 Memory Master 1.1 45.

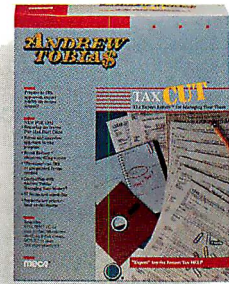

MECA ... NCP
 4603 **Andrew Tobias' Tax Cut**—New power for handling your 1990 taxes. Import data from Quicken and/or Turbo Tax, read last year's Tax Cut data, and print your return—all with new versatility \$49.

- Volkswriter ... NCP**
 6246 Volkswriter 4 1.02 109.
- West Lake Data Corp. ... NCP**
 7577 PC-FullBak+ 1.12 52.
 7574 PathMinder+ 1.0 79.
 7575 ValuePak (includes 4 programs) . . 69.
- WordPerfect Corp. ... NCP**
 7781 LetterPerfect 1.0 135.
 3804 WordPerfect 5.1 265.
 6685 DrawPerfect 1.1 279.
- WordStar International ... NCP**
 6791 WordStar Prof. 6.0 279.
 7605 WordStar 6.0 Network 345.
- Xerox ... NCP**
 7796 Ventura Publisher for Windows 3.0 569.
- XTREE ... NCP**
 6161 XTreePro Gold 1.4 85.
- ZSoft ... NCP**
 7016 PC Paintbrush IV Plus 1.0 119.
 7014 PC Paintbrush Plus for Windows 1.12 89.

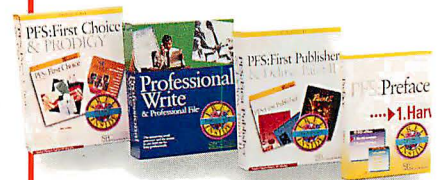

Software Publishing ... NCP
 Holiday Bundles—"Free for all promotion!"
 7769 **Preface (with Viruscan)** \$49.
 3499 **First Publisher (with Deluxe Paint II)** . 99.
 3478 **First Choice (with Prodigy)** 105.
 3496 **Professional Write (w/Professional File)** 179.

to do complex math?

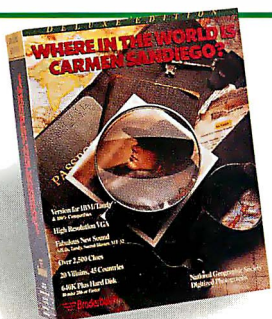

Broderbund ... CP

8068 *Where in the World is Carmen Sandiego Deluxe Edition*—Chase Carmen & her band of thieves through 45 countries. Video & audio enhanced with location graphics provided by the National Geographic Society .. \$52.

RECREATIONAL/EDUCATIONAL

Accolade ... CP

- 6030 Test Drive II: The Duel 32.
- 8081 Jack Nicklaus' Unlimited Golf & Course Design 39.
- 8079 Search for the King 39.

Bible Research Systems ... NCP

- 1464 The Word 4.3 (KJ or NIV) 159.

Broderbund ... CP

- 5701 Where/Time Carmen Sandiego? . . . 32.
- 8068 Where in the World is Carmen Sandiego Deluxe Edition 52.
- 5851 SimCity 33.

Electronic Arts ... NCP

- 5698 Abrams Battletank 11.
- 8112 TV Sports Basketball 39.
- 6881 Populous 39.
- 8109 Harpoon 45.
- 5804 Deluxe Paint II (Enhanced) 89.

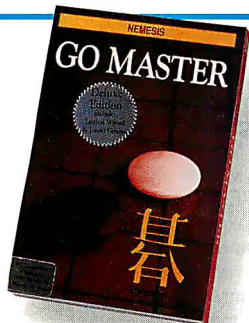

Toyogo ... NCP

7676 *Go Master Deluxe*—Chaos Manor Users Choice Award 1990 (Byte 4/90). Unites the Go playing abilities of Go Master, the corner-opening tutorial Joseki's Genius, and the life and death consultant, Tactical Wizard. \$88.

- 7849 HyperGlott ... NCP
- 7853 Word Torture - French \$29.
- 7853 Word Torture - Spanish 29.

- 8113 Lucas Film ... CP
- 7583 Pipe Dream 19.
- 7583 Indiana Jones & L.C. 35.
- 5803 Their Finest Hour (Battle of Britain) 42.

- Microsoft ... NCP
- 7881 Entertainment Pk for Windows 1.0 29.
- 2858 Flight Simulator 4.0 39.

- Microsoft Press (Books)
- 8127 *Working with Word for Windows* . . . 20.
- 8126 *Running with DOS 4th Edition* 20.
- 8129 *Running Windows (2nd Edition)* . . . 22.
- 8136 *Running Microsoft Excel* 22.

- Parlor Software ... CP
- 3159 Bridge Parlor 2.3 49.

- Penton Overseas ... NCP
- VocabuLearn/ce Levels I & II (French, Italian, German, Spanish, Russian, Hebrew and Japanese) each 39.

- Sierra On-Line ... CP
- 6023 Leisure Suit Larry III 39.
- 6796 Codename: Iceman 39.
- 6972 Conquests of Camelot 39.
- 5106 Space Quest III 39.
- 7972 King's Quest V 45.

- Spectrum Holobyte ... NCP
- Tetris 22.
- 5993 Welltris 22.
- 5817 Vette 25.
- 7602 Faces 32.

- Spinnaker ... NCP
- 5580 Sargon IV (Chess Game) 32.

- Software Toolworks ... NCP
- 6436 Hunt for Red October 20.
- 4659 Chessmaster 2100 (CP) 35.
- 4534 Mavis Beacon Typing 35.
- 7372 World Atlas 42.
- 7879 U.S.A. Atlas 42.

- Stone & Assoc. ... NCP
- Young Math (ages 5 to 8) 22.
- 3434 Kids Stuff (ages 2 to 6) 22.
- 3435 Letters, Numbers, Words (ages 2-6) 22.
- 3436 Memory Lane (ages 2 to 6) 22.
- 5231 Phonics Plus 22.
- 3439 2nd Math (ages 7 to 16) 27.
- 3433 Algebra Plus Vol 1 (ages 13+) 27.

- Toyogo ... NCP
- 7676 Nemesis Go Master Deluxe 88.
- True BASIC, Inc. ... NCP
- Kemeny/Kurtz Math Series. each 45.

HARDWARE

Manufacturer's standard limited warranty period for items shown is listed after each company name. Some products in their line may have different warranty periods.

1-800/776-7777

MMC PC Connection 790B
6 Mill Street
Marlow, NH 03456
SALES 603/446-7721 FAX 603/446-7791

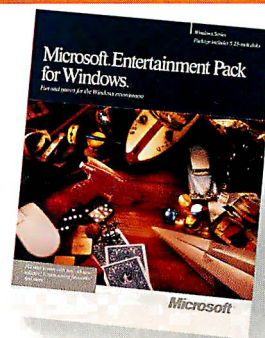

Microsoft ... NCP

7881 *Entertainment Pack for Windows 1.0*—A collection of games and a screen saver made especially for Microsoft Windows 3.0. The perfect gift for any Windows user! . . . \$29.

- American Power ... 2 years
- 7108 APC Smart-UPS 400 339.
- 6811 360SX (stand-by power source) . . . 219.
- 7107 450AT (stand-by power source) . . . 279.
- 7106 520ES (stand-by power source) . . . 329.

- AST Research ... 2 years
- 1299 SixPakPlus 384k C/S/P 179.
- 8041 SixPak 286 0k 105.
- 4107 RAMPage Plus 286 512k 419.
- 4105 RAMPage Plus MC 512k 419.
- 6979 VGA Plus Video Card (256K expandable to 512K) 199.

- Boca Research ... 5 years
- 7001 BOCARAM/AT PLUS (0-8 Meg) (LIM 4.0 extended) 125.
- 7061 BOCARAMXT OK (0-2 Meg, LIM 4.0) 99.
- 7135 TophAT (16-bit backfill 512K to 640K) 99.
- 6998 I/O Board for AT 59.
- 6999 I/O Board for Microchannel S/S/P . 109.
- 6995 SuperVGA (800x 600, 16/8 bit) . . . 115.
- 7026 1024 VGA (16 bit non-interlaced) . 149.



CH Products ... 1 year

Pick the stick the pros use, & the thrills are on us. FlightStick w/FREE Falcon! New two-port, automatic gamecards complete the package. 8119 FlightStick w/Falcon & GameCard III \$79. 8120 FlightStick w/Falcon & GameCard MCA 95.

Or what odd glitch

Intel ... 5 years
80287XL & 80287XLT Math CoProcessors—Runs up to 50% faster than other 80287 math chips. The 80287XL works in virtually every 80286-based PC, and the 80287XLT is made especially for Compaq LTE/286.. each \$199.

- Bravo Communications ... 2 years**
7400 2 Pos. Laser Compatible Switch Box 109.
- Brother International ... 1 year**
5787 HL-8e Laser Printer (HP2 comp.) 1399.
- Canon ... 1 year**
7894 BJ-10e BubbleJet Printer (4.6 lb.) 349.
7896 Sheet feeder for BJ-10e 75.
- CH Products ... 1 year**
7341 Gamecard III Plus (for Microchannel) 49.
7935 Gamecard III - Automatic 33.
8119 FlightStick w/Falcon & GameCard III 79.
8120 FlightStick w/Falcon & GameCard MCA 95.
7345 Rollermouse (Trackball) serial 85. bus 99.
- CompuCase ... 2 years**
1604 2-Position switch box 25.
1605 3-Position switch box 35.
- Cuesta Systems ... 1 year**
1608 400 Watt DataSaver 429.
5130 600 Watt DataSaver 599.
- Curtis ... lifetime**
1704 Universal Printer Stand PS-1 18.

Intel ... 5 years
2346 Inboard 386/PC with Free Samna Ami—Gives you 80386 processing power, 1 Mb RAM, and Samna's powerful Windows-based word processor (regularly at \$129). 30 Day Money Back Guarantee. \$519.

- 1694 Emerald SP-2 36.
1708 Ruby-Plus SPF-2 Plus 65.
7358 Command Center 93.
Glass Filter Plus (specify size) ea. 65.
- Data Technology ... 1 year**
6249 5280 (AT Floppy/Hard Controller) 119.
6248 7280 (AT Floppy/Hard Controller) 129.
- Datadesk ... 3 years**
6901 Switchboard 175.
- Epson ... 1 year**
We are an authorized Epson Service Center.
1906 FX-850 (80 col., 264 cps, 9 pin) call
1904 FX-1050 (136 col., 264 cps, 9 pin) call
5183 LQ-510 (80 col., 180 cps, 24 pin) call
1930 LQ-850 (80 col., 264 cps, 24 pin) call
1917 LQ-1050 (136 col., 264 cps, 24 pin) call
5184 LX-810 (80 col., 180 cps, 9 pin) call
1052 Printer-to-IBM cable (6 feet) 15.
7775 Equity LT-286e Laptop 1995.
7774 Equity LT-386SX Laptop 3069.
Removable Hard Drives for Epson Laptops
20 Meg 499. 7777 40 Meg 699.

Intel ... 5 years
Above Boards—FREE Quarterdeck QRAM and Manifest with any Above Board or piggyback, now through December 31, 1990! see Intel listing for prices.

- 5th Generation ... 1 year**
7157 Logical Connection Plus 512k 599.
- Hayes ... 2 years**
2307 Smartmodem 2400 349.
8049 JT-FAX 9600B 499.
7391 Ultra 9600 Modem 899.
- Hewlett-Packard ... 1 year**
7976 DeskJet 500 (w/ink cartridge) 599.
6754 LaserJet III (w/toner) 1699.
6582 LaserJet IIP (w/toner) 1069.
- Intel ... 5 years**
6421 2400B MNP Internal Modem 199.
4696 2400B Internal Modem 159.
2352 2400B Internal Modem 2 (for PS/2) 249.
5119 2400 Baud External Modem 179.
6420 2400EX MNP Modem 229.
7880 9600EX Modem 549.
2346 Inboard 386/PC w/1 Meg (w/free Ami) 519.
2348 Inboard 386/PC w/1 Meg Piggyback 349.
4646 Inboard 386/PC w/4 Meg Piggyback 669.
4266 Above Board Plus 512k 369.
4267 Above Board Plus I/O 512k 399.

Intel ... 5 years
7880 9600EX Modem—Provides ultra-fast data communications without sacrificing compatibility. Supports V.32 & V.42 9600 bps operation, as well as MNP Level/5 and Hayes compatible 2400/1200/300 bps modes . \$549.

- 5336 Above Board Plus 8 2 Meg 599.
5342 Above Board Plus 8 I/O 2 Meg 629.
4272 Above Board 2 Plus 512k 469.
5396 Above Board MC 32 0k 359.
7782 SatisFAXtion (fax board) 399.
7552 NetPort (3 year warranty) 489.
- MATH COPROCESSORS**
7385 80287XL (16 MHz 80286 CPU's) 199.
4750 80387SX (16 MHz 80386SX CPU's) 309.
2371 80387 (16 MHz 80386 CPU's) 349.
2372 80387-20 (20 MHz 80386 CPU's) 399.
4121 80387-25 (25 MHz 80386 CPU's) 429.
2375 8087 (4.77 MHz 8088 CPU's) 89.
2374 8087-2 (8 MHz 8088 CPU's) 129.
- Kensington Microwave ... 1 year**
2582 Master Piece Plus 109.
7899 Expert Mouse serial 119. bus 129.
- Key Tronic ... 3 years**
4518 101 Plus Keyboard 99.
- Kraft ... 5 years**
5800 3 button Thunder Joystick 29.
5802 Trackball 59.
7912 G/S+ (microchannel game card) 79.
5831 Game Card/Thunderstick Bundle 55.
7581 K130 Joystick 29.
7862 TopTrack (Laptop Trackball) 79.
- Logitech ... limited lifetime**
5464 C9 Mouse for PS/2's 69.
7768 C9 Mouse with Windows 149.
5151 HiREZ Mouse (C9) 85.
6029 Trackman (Trackball) serial 85. bus 89.
4297 ScanMan Plus (hand scanner) 185.
4794 ScanMan Plus (MicroChannel) 219.
7975 ScanMan 256 319.
- Magnavox ... 1 year**
5990 CM9032 (13" VGA Monitor, .42 dot pitch) 299.
4762 9CM082 (13" VGA Monitor, .31 dot pitch) 349.
- Micron Technology ... 2 years**
7595 Intensify 2 Meg Expansion for HP LaserJet IIP or III 175.
6668 Intensify 2 Meg Expansion for HP LaserJet II or IID 219.

your hard disk hath?

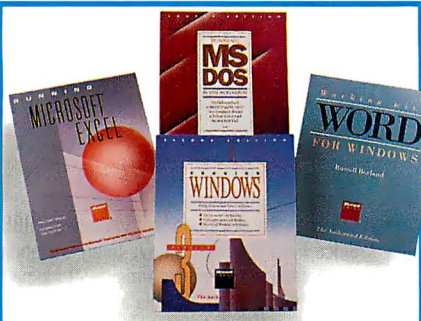

Microsoft Press

Best MS-DOS & Windows computing books.

- 8127 *Working with Word for Windows* . . . \$20.
- 8126 *Running with DOS (4th Edition)* . . . 20.
- 8129 *Running Windows (2nd Edition)* . . . 22.
- 8136 *Running Microsoft Excel* . . . 22.

- 6831 Plotter in a Cartridge (LJ IIP, IID, III) \$249.
- 6832 Plotter in a Cartridge (for LJ II) 249.
- 6835 Headlines in a Cartridge (LJ II, IIP, IID) 209.
- 7324 Pacific Print (for Novell LANS) 235.

Practical Peripherals ... 5 years

- 3101 1200 Baud Internal Modem 65.
- 3100 1200 Baud External Modem (mini) . . . 77.
- 3103 2400 Baud Internal Modem 135.
- 3102 2400 Baud External Modem 179.
- 5286 2400 Baud Int. MNP Modem (Lev. 5) 175.
- 5285 2400 Baud Ext. MNP Modem (Lev. 5) 209.
- 4542 2400 Baud Internal Modem for PS/2. 229.
- 8132 PM2400 Pocket Modem 99.
- 7934 PM9600SA 489.

PSION .. 1 year

- 7086 MC600 Mobile Computer 2149.
- 7090 512K Flash EPROM 309.
- 7962 3 1/2" External Drive 299.

Reflection Technology .. 1 year

- 7127 Private Eye (virtual display) 499.

SAFE Power Systems ... 2 years

- 4561 Safe 250W 199.
- 6747 Safe 400S (Slimline) 399.



Borland International ... NCP

1514 ☐ Paradox 3.5—This powerful database manager is even stronger. It provides faster performance using less memory while managing any available expandable or extended memory (up to 16 Mb) . . . \$569.

- 6670 Intensify 4 Meg Expansion for HP LaserJet II or IID 357.
- 7012 Beyond Memory Board for PS/2 Model 70 (2 Meg) 265.

Microsoft ... lifetime

- 7597 Microsoft Mouse 89.
- 2897 Mouse with Paintbrush 109.
- 2898 Mouse with Windows 3.0 149.

MicroSpeed ... 1 year

- PC-TRAC Trackball (incl. copy of *Welltris*) serial 75. 6008 bus 85.
- 7271 Inport 79. 6330 PS/2 79.

Mouse Systems ... lifetime

- 5997 Trackball (1 yr. wrnty.) serial 75. bus 85.
- 7878 PC Mouse III 99.

NEC ... 2 years

- 4799 Multisync 2A (VGA Monitor) 499.
- 5085 Multisync 3D Monitor 689.

Orchid Technologies ... 4 years

- 7064 Peanut VGA (256k) 129.
- 7512 ProDesigner VGA II (1024 x 768) 299.
- 7888 ProDesigner/e (256k) 209.
- 7097 1/16 Memory Card (1 Meg) 349.

PC Power & Cooling ... 1 year

- REPLACEMENT POWER SUPPLIES
- 3202 Turbo Cool 150 (25° - 40° cooler) . 129.
- 7915 Turbo Cool 300 165.
- 3200 Silencer 150 (84% noise reduction) 115.
- 7053 Innersource 2210 (internal UPS) . . 399.

Pacific Data Products ... 1 year

- 6779 25 Cartridges in One! (for LJ II, IIP, IID) 275.
- 7072 25 Cartridges in One! (for LJ III) . . . 349.
- Memory upgrade for LaserJet IIP/III
- 7054 1 Meg 149. 7055 2 Meg 199.
- 7758 3 Meg 279. 7759 4 Meg 339.
- Memory upgrade for LaserJet II
- 6839 1 Meg 179. 6838 2 Meg 249.
- Memory for Tec Engine Laser Printers
- 7634 2 Meg 219. 7633 4 Meg 369.
- 7158 Pacific Page (PostScript Cartridge for LaserJet IIP/III) 379.
- 6834 Pacific Page with free 2 Meg Memory Board (for LaserJet II) . . . 379.
- 7632 Outlines I. 209. 7631 Outlines II. 209.



MicroSpeed ... 1 year

PC-TRAC Trackball—The PC Magazine Editor's Choice (8/90)! Ergonomically designed, it requires a desk space less than 4 inches wide.

- 6007 Serial \$75. 6008 Bus \$85.
- 7271 Inport 79. 6330 PS/2 79.

- 4562 Safe 425W 329.
- 7913 Safe 650W 459.
- 7914 Safe 800W 599.
- 4560 Safe 1200W 739.

Targus ... lifetime

- 4899 Nylon Laptop Carrying Case 55.
- 7028 Foliopac 79.
- 6037 Premier Leather Carrying Case . . 199.

TheComplete PC ... 2 years

- 5140 TheComplete Page Scanner 549.
- 8082 TheComplete Half Page Scanner/400 w/ReadRight Personal OCR Software 289.
- 6797 TheComplete Fax Portable 319.

1-800/776-7777



PC Connection

790B

6 Mill Street
Marlow, NH 03456

SALES 603/446-7721 FAX 603/446-7791

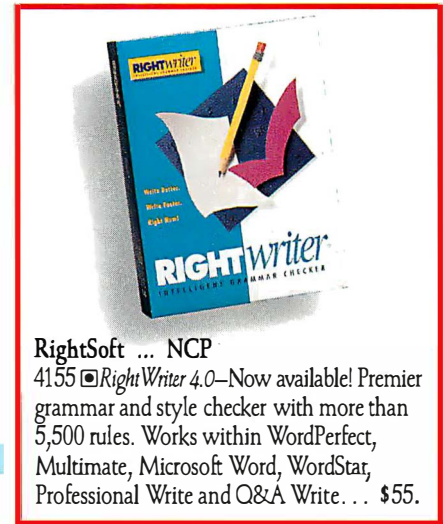

RightSoft ... NCP

4155 ☐ RightWriter 4.0—Now available! Premier grammar and style checker with more than 5,500 rules. Works within WordPerfect, Multimate, Microsoft Word, WordStar, Professional Write and Q&A Write . . . \$55.

We've got the story.

Video 7 ... 7 years

3778	Vega VGA	\$155.
5883	1024i VGA (includes 512k)	219.
4931	VRAM VGA 512k	379.

DRIVES

IOmega ... 1 year

5116	Bernoulli II Single 44 Meg Internal	995.
5117	Bernoulli II Dual 44 Meg External	1969.
5113	44 Meg Cartridge Tripak (5 1/4")	249.
2500	PC2B Controller	229.
2503	PC4B Controller (Microchannel)	299.
7551	Bernoulli II Transportable 44 Meg	997.

Mountain Computer ... 2 years

2917	40-60 Meg Internal Tape Drive	259.
2916	40-60M Ext. Tape Drive (w/power supply)	489.
5500	80-152M Int. Tape Drive	629.
5502	83-152M Ext. Tape Drive	799.
5190	DC2000 Pre-formatted Cartridges ea.	35.
6153	DC2120 Tape Cartridge (5 pack)	135.

TEAC ... 1 year

4950	360k Drive (for PC)	\$79.
4951	720k Drive (specify XT or AT, 3 1/2")	75.
4670	1.44 Meg Drive for PC/XT (3 1/2")	89.
4326	1.44 Meg Drive for AT	109.
6951	1.2 Meg Drive for AT	99.
6952	1.2 Meg Drive for PC/XT	99.

MEMORY

6556	256k DRAMs (100 ns, set of 9)	29.
5510	1 Meg x 9 SIMMs (80 nanosecond)	79.
5746	1 Meg Chips (80 ns, set of 9)	69.

OUR POLICY

- We accept VISA and MASTERCARD only.
- No surcharge added for credit card orders.
- Your card is not charged until we ship.
- If we must ship a partial order, we never charge freight on the shipment(s) that complete the order (in the U.S.).
- No sales tax.
- All U.S. shipments insured; no additional charge.
- APO/FPO orders shipped 1st Class Mail.
- International orders U.S. \$250 minimum.
- Upon receipt and approval, personal and company checks clear the same day for immediate shipment of your order.
- COD max. \$1000. Cash, cashier's check, or money order.
- 120 day limited warranty on all products.*
- To order, call us Monday through Friday 8:00 AM to 1:00 AM, or Saturday 9:00 AM to 5:30 PM. You can call our business offices at 603/446-3383 Monday through Friday 9:00 AM to 5:30 PM.

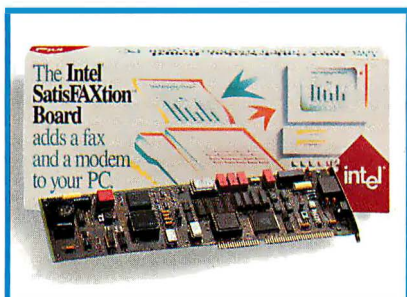

Intel ... 5 years
 7782 Satisfaxion—Send and receive faxes from within most applications using the print command. Built-in 2400 bps MNP modem standard. Includes coupons for free PC Tools and Fax-It software. \$399.

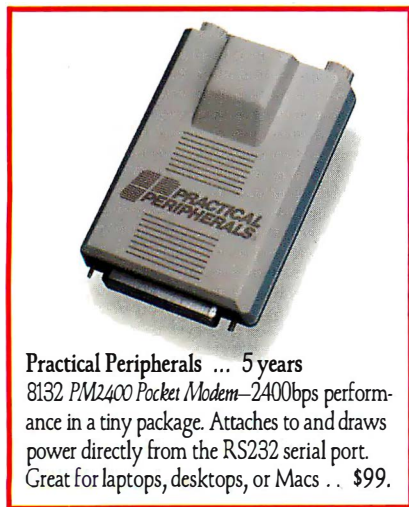

Practical Peripherals ... 5 years
 8132 PM2400 Pocket Modem—2400bps performance in a tiny package. Attaches to and draws power directly from the RS232 serial port. Great for laptops, desktops, or Macs .. \$99.



Pacific Data Products ... lifetime
 7158 PacificPage Personal Edition 4.0—New and improved PostScript emulation for your HP LaserJet IIP, IID or III. Faster, superb font quality. Minimum 1.5M printer memory required. \$379.

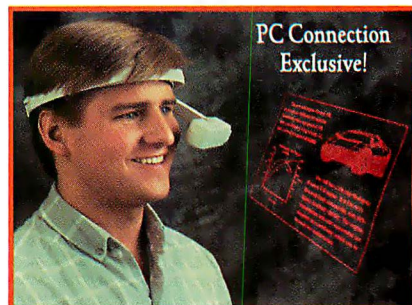

Reflection Technology ... 1 year
 7127 Private Eye—A large screen in a small box. A tiny virtual display which offers a full-size, 12" IBM CGA auxiliary screen to PCs & laptops. View privately in planes or meetings. Brighter than LCDs. \$499.

Pacific Rim ... 1 year

5011	360k External	179.
7727	360k External for PS/2	189.
5009	1.2 Meg External	209.
5010	1.2 Meg External (for PS/2's)	215.
6602	1.44 External (for PC/XT/AT)	239.

Plus Development ... 2 years

6425	Hardcard II 40 Meg (19 ms)	399.
6424	Hardcard II 80 Meg (19 ms)	699.

Seagate ... 1 year

2285	20 Meg Int. Hard Drive ST225 (w/controller and cables, 65 ms)	255.
2286	30 Meg int. Hard Drive ST238R (w/controller and cables, 65 ms)	269.
4554	40 Meg Int. HD ST251-1 (28 ms)	329.
7102	ST251-1 Model 25 (w/controller)	339.
7103	ST251-1 Model 30 (w/controller)	339.
7099	ST251-1 PC/XT (w/controller)	329.
7154	ST138R-1 Model 25 (w/controller)	359.
7155	ST138R-1 Model 30 (w/controller)	359.
7153	ST138R-1 PC/XT (w/controller)	359.

DISKS

Maxell ... lifetime

2789	5 1/4" MD2-D 360k Disks (Qty. 10)	12.
2790	5 1/4" MD2-HD 1.2Mb Disks (Qty. 10)	19.
2792	3 1/2" DS/DD 720k Diskettes (Qty. 10)	14.
2793	3 1/2" DS/HD 1.44Mb Diskettes (Qty. 10)	27.

Sony ... lifetime

3291	5 1/4" DS/DD 360k Disks (Qty. 10)	10.
3292	5 1/4" DS/HD 1.2Mb Disks (Qty. 10)	19.
3297	3 1/2" DS/DD 720k Diskettes (Qty. 10)	13.
3298	3 1/2" DS/HD 1.44Mb Diskettes (Qty. 10)	22.
6659	QD 2000 Tape Cartridge	19.

SHIPPING

- Note:** Accounts on net terms pay actual shipping.
- Continental US:**
- For heavy hardware items such as printers, monitors, Bernoulli Boxes, etc. pay actual charges. Call for UPS 2nd-Day & Next-Day-Air.
 - For all other items, add \$3 per order to cover UPS Shipping. For such items, we automatically use Airborne Express at no extra charge if you are more than 2 days from us by UPS ground.
- Hawaii:**
- For monitors, printers, Bernoulli Boxes, computers, hard drives, and power backups, actual UPS Blue charge will be added. For all other items, add \$3 per order.
- Alaska and outside Continental US:**
- Call 603/446-7721 for information.



The FairCom® Servers The developer's client/server technology

Faircom Server

Faircom Server

FairCom Server & SQL Server

■ Designed with developers in mind — you can incorporate the FairCom Servers directly into your applications. Something Oracle and MS/SQL Server won't let you do!

■ No other server can match the speed, flexibility or concurrency of FairCom Servers.

■ Multi-threaded design increases performance — the server utilizes all the previously unused time spent waiting for locks or I/O operations.

■ Industrial-quality transaction processing, including full commit and roll-back, intermediate save points and complete logging.

■ Compatible with c-tree plus, ANSI-standard SQL, QBE, our natural language query tool, and other interfaces.

■ Two configurations (FairCom Server or FairCom SQL Server) — each comes with a complete c-tree plus file handler; FairCom SQL Server also includes an ANSI-standard SQL engine.

FairCom introduced the first portable server to the developer community in 1988. Since then developers have been demanding increased user response time, faster server performance, more flexible interface options and industrial-quality transaction processing.

The kind of server technology that developers can incorporate into their applications to create more sophisticated, flexible and dependable DBMS products.

FairCom Servers. The server technology developers have been waiting for.

The FairCom Servers utilize high performance design features:

■ **Multi-threaded design**

■ **I/O minimization.** Sophisticated proprietary caching and compression algorithms reduces I/O functions

■ **Key locks.** Minimizes interference between users while maintaining maximum data availability.

Transaction Processing — The heart of the FairCom Servers.

FairCom provides industrial quality on-line transaction processing (OLTP) and fully automatic recovery, including full commit and roll back intermediate, save points and complete logging. No other server can match the speed flexibility or concurrency of FairCom Servers.

Complete interface flexibility.

FairCom Servers offer developers two configurations. The **FairCom Server** is an ultra-high performance server utilizing the widely accepted c-tree™ and c-tree plus™ Application Programmers Interface (API). The **FairCom SQL Server** includes c-tree plus and a full ANSI-standard SQL, serving both SQL and non-SQL clients simultaneously.

The FairCom Server can also be used in a stand-alone (vs. a network) configuration — it can be tightly coupled with a developer's application.

FairCom — A decade of performance and quality.

This new client/server technology breakthrough will come as no surprise to the U.S. and international software developers who have been utilizing FairCom products during the past decade. Our file handling technology is incorporated in the products of many leading companies including 3Com, Hewlett Packard, NCR, Cray, Informix, Sharp, Digital Research, IBM and others.

Call (800) 234-8180 to get a complete technical overview of the latest generation c servers — FairCom Servers.

The developer's client/server.



FAIRCOM
corporation

4006 WEST BROADWAY • COLUMBIA, MO 65203 • PHONE 314.445.6833 • 800.234.8180 • FAX 314.445.9698

Circle 107 on Reader Service Card (RESELLERS: 108)



BACK TO THE WORKSTATIONS II

An overview of personal computers, workstations, and how they are colliding in the marketplace

What with all the new high-resolution Unix workstations and the move toward open systems, some people are already proclaiming the death of the personal computer. They have a point, but it's not that Unix will be taking over the world or that you'll be forced to give up DOS after New Year's Day. And PCs as you have come to know them (and in some cases love them) are not going away. They're just going to get better.

No Computer Is an Island

The point is that the world of computers has been changed forever by the introduction of networking. Whether you're using Novell or Network File System (NFS) in your office and BIX or a BBS at home, almost all machines these days can be hooked up to others. It's almost essential for obtaining and sharing the information resources that people are finding necessary.

People generally think of LANs when they're talking about networks. However, today's computers must be able to hook up to wide-area networks, such as Usenet or Internet, as well as general-purpose information networks such as BIX or CompuServe. These allow you not only to retrieve information stored in value-added databases, but also to interact with hundreds of thousands of other users. In many cases, you can ask a question in the morning in a conference (also called newsgroup or forum) dedicated to a particular subject and have answers from knowledgeable users later

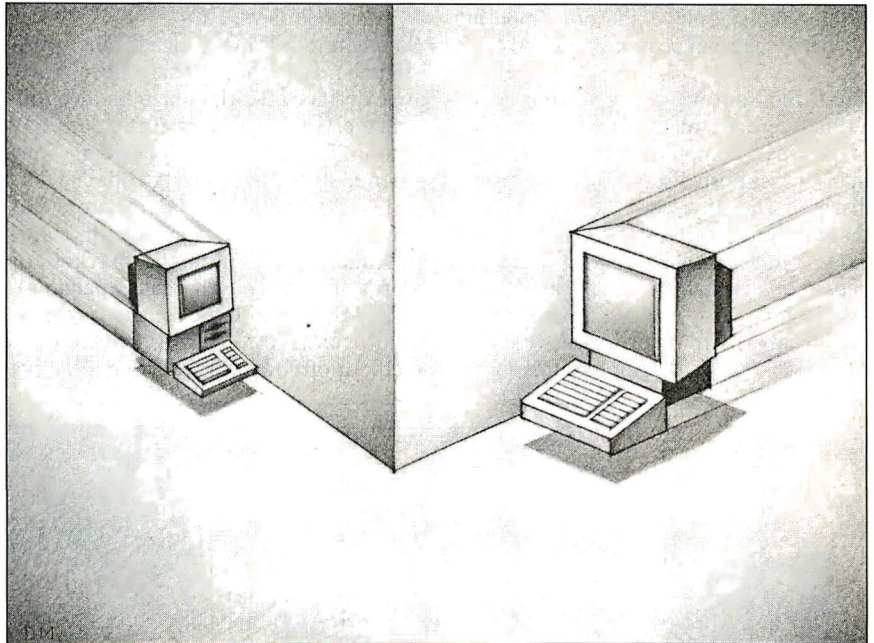

on that same day.

This capability is often underestimated by people who have never seen it in action. Imagine having the power to access industry experts (and get written responses) without paying any more than normal communications charges!

The future will bring even more intensity into this area, because—at least in North America—everyone is getting wired with fiber optics and coaxial cable (right now, it's just carrying cable TV). This will eventually allow companies to offer high-speed digital data communications to homes and offices, so that you'll be able to just plug your computer onto the network (without a modem) and connect to anybody, anywhere. Sounds futuristic, but it's coming.

The 1-Minute LANager

Despite this movement in the world of dial-up databases, the really exciting things for the office are happening in

LANs. As I mentioned in this column a year ago, Sun's version of Unix introduced local-area networking in the form of NFS, which was quickly brought to Berkeley Unix. In a LAN, you hook up machines via Ethernet cable, using industry-standard protocols such as TCP/IP, so they can communicate with each other at a speed approaching that of a hard disk. NFS allows you to access a file from anywhere on a LAN, without having to know which machine the file is located on.

Networking wasn't limited to just one vendor, since other manufacturers (notably Digital Equipment Corp.) also based their products on Berkeley Unix. Even more important, NFS was ported to other operating systems, so PCs and mainframes could also hook up to the LAN. AT&T countered with its Remote File System, which didn't catch on well. But its new version of Unix, System V release 4, will have both NFS and RFS,

which neatly wraps things up for everybody.

Of course, the power of LANs isn't just in the ability to share databases and print resources, although that's been about the limit of many PC LAN installations. Networks also give you the option of configuring powerful servers that can be accessed by workstations without expensive disks of their own. Thus, these diskless workstations can be made relatively powerful (say, with high-resolution graphics and good CPU performance) while still being economical enough to put one on everyone's desk. This gives people a lot of computing power so they can be more productive.

The Mac Factor

While there are many people who think of PCs as "computers that run DOS," many Macintosh users out there would disagree. In many ways, the Mac has a lot more going for it than PCs and their clones—at least when you're discussing networks, workstations, PCs, and Unix.

The Mac can be a real workstation, even by my rigorous definition, when it's running A/UX 2.0, Apple's latest ver-

sion of Unix. By all accounts (I haven't had the chance to work with it yet), A/UX 2.0 is the environment that Apple was promising when it first released A/UX: an operating system that runs real Unix, the X Window System, and virtually any Macintosh application.

It does all this, remarkably, without giving up that user interface that has made the Macintosh so popular. Not only that, but an optional software emulator allows you to run DOS applications from A/UX as well. For a great many people, this can be the best of all worlds.

Workstations vs. PCs

So where does this all lead? The workstation market has already been fairly well defined. It's that huge list of products typified by offerings from Sun, HP/Apollo, DEC, IBM, Data General, Sony Microsystems, and a host of others. This group of formidable competitors has been chasing after basically the same customers (although the market for workstations has itself been expanding). Factor that in with the return of reasonable pricing for RAM chips and the plethora of powerful CPUs, and the net

result is that workstation prices have dropped dramatically.

In the PC market, you have the same price drop for memory, and certainly more powerful CPUs are common. The i486 and 68040 are probably the leaders in the high-end PC market, while less expensive 386SX chips and 386 clones are rapidly bringing down prices for that level of power. High-resolution VGA boards are already fairly standard in the PC arena. Again, Macs have enjoyed this advantage from the beginning.

Microsoft Windows 3.0 is introducing large numbers of PC users to the elegance and ease of a graphical user interface (GUI), even if it isn't quite as elegant as some users might like. PCs of all types are networked these days, so everyone is familiar with the concepts of LANs, Ethernet, and file servers. And the Unix operating system is becoming so mainstream that everyone from PC users to MIS managers seems to have at least a nodding familiarity with it.

It's the Best of Times

Clearly, it's time for the revolution. With workstation prices starting below \$5000

THE MOST ADVANCED CORDLESS MOUSE

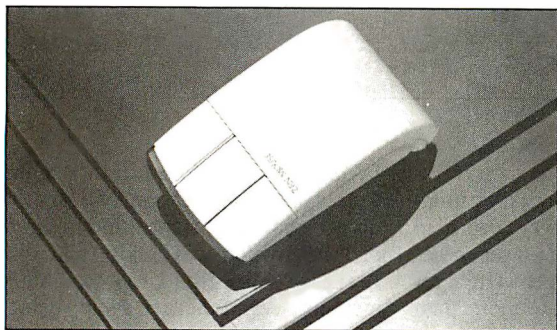

THE ZEN MOUSE

Available in cordless and corded models for
IBM PC's, PS/2's, and compatibles.

- Dynamic Tracking
- 10-1000 dpi
- No Cleaning Required
- Rechargeable
- Compatible with Microsoft™, Logitech™, and MSC Mice
- No Mouse Pad Required
- Compatible with virtually all application software
- Made in USA



**ZENY
COMPUTER
SYSTEMS INC.**

4033 Clipper Court
Fremont, California 94538

Tel 415/659-0386
Fax 415/659-0468

10% OFF WITH THIS AD

AT BUS DESIGN

At last, here is the **timing book** for the XT and AT Bus. Detailed text, tables and diagrams tell you what each signal line is for, what it does and when it does it. All the information is compatible with the IEEE P996 Specification for the ISA (AT) Bus. In addition, the 8 and 16 bit parts of the EISA Bus are included. **AT Bus Design**, by Ed Solari, has over 200 pages, with more than 100 figures and tables. Handy 7" x 9" format, soft cover, \$69.95.

FREE We'll include a free copy of the pocket-sized **XT-AT Handbook by Choisser and Foster** with each AT Bus Design book if you tell us where you saw this ad. Of course, this \$9.95 value is also available by itself. Or buy five or more for only \$5.00 each.



800-462-1042
619-271-9526



Annabooks
12145 Alta Carmel Ct., Suite 250
San Diego, CA 92128

FAX 619-592-0061
Money-back guarantee

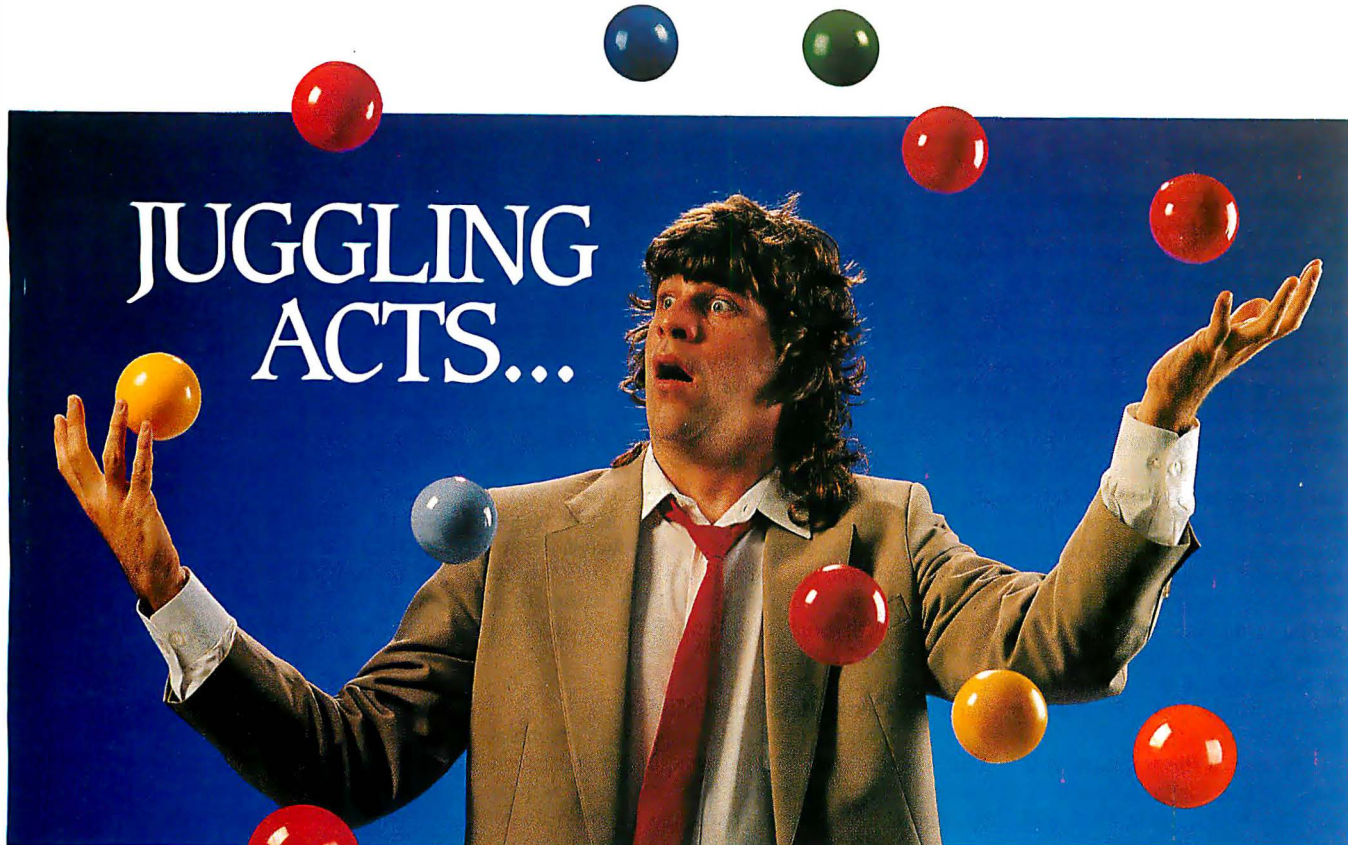

JUGGLING
ACTS...

...ARE FOR CLOWNS

● **Juggling files, documentation, people and time is no way to manage a software project. You need to know who is working on what, which files are being changed and why. And your team should be moving ahead on development, not stuck in costly collisions.**

MKS RCS – Your Project Manager

MKS RCS (Revision Control System) helps keep your project from becoming a juggling act by maintaining a complete history of changes to a file and giving you access to any of the changes. MKS RCS also automatically saves crucial descriptive information about each revision.

An advanced user interface and excellent documentation make MKS RCS extremely easy to use. Or if you prefer, you can operate from the command line. MKS RCS can automate every aspect of your project, handle both binary and text files with ease, provide unlimited branching and merging capabilities and compress log files to save valuable disk space.

The Bigger the Better

The more complex your project, the more you need MKS RCS. In a multi-user environment, eliminate access conflicts

with locking options. Manage and track development to deliver your project on time, on spec and on budget.

For individual projects, MKS RCS handles the headaches of recording and retrieving files. Whether you are on a LAN or an individual PC, MKS RCS will make you more productive.

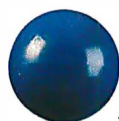

Price and Performance Leader

MKS RCS has all the features you will ever need in a revision control system at a price that will fit your budget.

MKS RCS for DOS is just \$249; for OS/2, SCO or 386 Unix \$349. A 5-CPU LAN license for DOS is \$995; for OS/2, SCO or 386 Unix \$1,395.

Call MKS for LAN pricing for more than 5 CPUs.

MKS Software Management Team

Reduce the juggling act even more with the MKS Software Management Team (MKS RCS and MKS Make). You set up the rules stating which files must be changed when other files are altered, and MKS Make automatically keeps those files in synch.

TO ORDER, CALL:
1-800-265-2797 (continental U.S. only)
1-519-884-2251 (outside continental U.S.)
1-519-884-8861 (FAX)

Full 30 day money back guarantee.

Australia 03-419-0300
03-555-4544
England 0763 244114
0364 53499
071 833 1022
Finland 08-5054536

France 01 47 95 01 07
Netherlands 020 14 24 63
Sweden 0762 704 60
West Germany 0551-704800
0721 886 664
06126/595-0



35 King Street North
Waterloo, Ontario
Canada. N2J 2W9

and plenty of PCs priced over that, cost is no longer the issue. You're about to see PCs turn into workstations, and workstations turn into PCs. The only things holding back the inevitable tide are old habits and operating-system religion. As I write this column, Sun is starting an advertising campaign aimed at PC owners, based on exactly the points I mentioned in my October column.

In the next few months, I expect to finally see some *real* diskless workstations based on PC technology: They'll be inexpensive (under \$2500), single-box computers based around a 386 or i486 CPU, with built-in Ethernet, mouse, serial, and parallel ports. They will come with a certain amount of software in ROM, which will drive the ports and display, running X Window or perhaps a higher-level GUI.

The rest of the software will be delivered on disk for installation on the server. This will include DOS and Unix, as well as software that will connect them transparently. I hope and expect to see Apple introduce the same types of products, perhaps by making a lower-cost Macintosh with enough of A/UX built in

that the cost and complexity doesn't go too high.

Next, you'll have to go the other way around. That would be something like this: a RISC-based workstation (possibly built around SPARC and SCSI architecture) that has the usual Unix workstation capabilities, plus a separate 386 processor with its own memory and AT expansion slots, and a VGA display that could be just another window on the screen. The 386 would run DOS on its own so it wouldn't slow down Unix (or vice versa), but you could share files between the two operating systems the way VP/ix does now. The price would be competitive with both high-end PCs and current workstations.

Computers from Mars

Think I've finally inhaled too much solder smoke? The workstation I just mentioned is already a reality. I will skip the most obvious jokes and simply tell you that the machine is called the Mariner 4i and it's from Mars Microsystems. You can buy the color version for less than \$9000 including a disk drive. The DOS module is an extra \$2000.

Yes, I know it sounds almost too good to be true. No, I haven't personally tried or seen one yet, although the folks at Mars swear that I'm going to be one of the first to receive an evaluation unit. You can communicate with Mars (I couldn't resist that one) at P.O. Box 1080, Mars, PA 16046, (412) 934-1040, fax (412) 934-1060, or E-mail at unet!marsmcro!br.

This is one of those occasions where "if it didn't exist, I would have had to invent it," since the Mariner really does exactly fit the scenario as I outlined it. Things are starting to happen almost as fast as they can be predicted, which means we're in for an interesting decade for sure. ■

David Fiedler is executive producer of Unix Video Quarterly and coauthor of the book Unix System Administration. He has helped start several Unix-related publications. You can reach him on BIX as "fiedler."

Your questions and comments are welcome. Write to: Editor, BYTE, One Phoenix Mill Lane, Peterborough, NH 03458.

Multiple-Choice

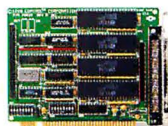

4-8

Our Hostess multiuser serial controllers are an excellent choice for up to eight occasional users. The Hostess 550 provides buffering for even higher performance. And for truly high performance, choose the Ultra 8.

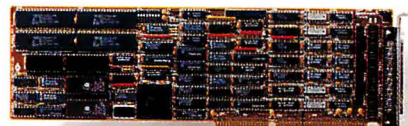

16

Expand up to 16 users with the Ultra 16 high performance intelligent serial controller. But if your multiuser requirements are more modest a 16 port Hostess 550 controller makes an equally intelligent choice.

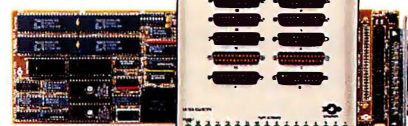

64+

Our Ultra Cluster gives you the flexibility and power for virtually limitless growth. Starting with an Ultra 8 base board, you can expand 16 users at a time, while maintaining current levels of performance every step of the way.

MULTIPLY YOUR CHOICES

At Control we pioneered multiuser technology. And we know that there are no single solutions to multiuser environments. That's why we offer more choices than any other company...from text to graphics...for modest users to over 64 users supported by a single PC. And we've not only multiplied your choices, we've multiplied performance, allowing you to expand without the high cost of adding computers.

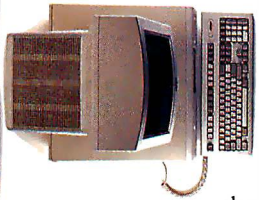

MULTIVISION. FOR CHOICES BEYOND WORDS

When graphics enter the equation, MultiVision enters the picture. A fully functional multiuser system for up to 16 users, MultiVision speeds images to the screen at a blistering 100 megabits per second. As a result, you'll experience near instantaneous transmission of your graphics.

With software that enhances standard operating system graphics drivers, MultiVision is compatible with virtually any monitor, keyboard, mouse or VGA controller supported by the operating system. MultiVision can also run applications designed for the "X" environment. But unlike a LAN-based "X" terminal, MultiVision is a multiuser system that transfers data up to 100 times faster. When you compare that performance with the cost of an "X" terminal... MultiVision's advantages really compute.



MULTIPLIED PERFORMANCE

No company offers you more performance than Control. In fact, our new DT Express driver transforms our Ultra Series into the highest performing controllers available today. DT Express dramatically

reduces host utilization and significantly increases throughput by managing all data transmission and data transform functions on the controller. So now as you add users, no one gets caught in a wait state.

■ Performance remains high as you add users.

■ Host utilization decreases.

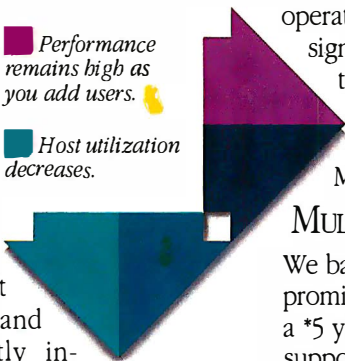

MULTIPLIED PROTECTION

We back our products with an uncompromising 30-day satisfaction guarantee, a *5 year warranty, complete technical support, and most importantly...a company that's easy to do business with. It all adds up to the best protection plan available. And if you're a VAR, call us about our Reseller Program that provides you with options designed exclusively for your needs.



*1 yr. MultiVision

for Multi-Users.

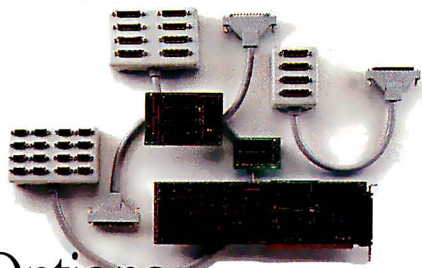

Options

Our products offer serial port and memory options that are field upgradable; compatibility with ISA (AT), MicroChannel and EISA buses; RS232, 422, 485 and Current Loop interfaces and DB 9, DB 25 and RJ 45 connectors.



Graphics

When you need to move beyond text, MultiVision moves into view—a high speed (100 megabits per second) communications controller that offers near instantaneous multiuser graphics like you've never seen before.



Control

A Control Systems Company

Multiply your choices. Call Control today.

1-800-926-6876

Control Corp., 2675 Patton Road, P.O. Box 64750 St. Paul, MN 55164

©1990 CONTROL CORPORATION. All rights reserved. All other brand names and product names are trademarks or registered trademarks of their respective holders.

Circle 74 on Reader Service Card

Up to 32 Simultaneous PC-to-Mainframe Connections with *No Impact* on Your DOS or UNIX Applications!

Your applications shouldn't have to compete with 3270 communications for your PC's scarce resources.

That's why we deliver our

Supports NetView, HLLAPI 3.0, and CLEO'S own API.

DataTalker 3270 high-performance PC-to-mainframe connectivity software on powerful

co-processor boards with on-board memory.

With DataTalker 3270, you can offload all communications processing and screen storage to the co-processor, freeing your DOS or UNIX system for applications processing. As a result, users can perform up to 32 simultaneous mainframe sessions

without affecting performance.

DataTalker 3270 provides full emulation of IBM 3278 terminals and 3274 controllers, along with 32 LUs, 512K RAM, file transfer (IND\$FILE), BSC or SNA support, and IBM 3287 printer emulation. Line speeds of up to 56K baud are supported.

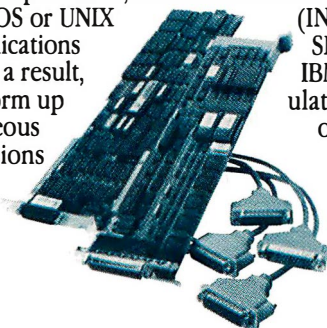

Adds only 1K to DOS applications, 40K to UNIX

To learn more, call us today at 1-800-233-2536. Or write to us at 3796 Plaza Drive, Ann Arbor, Michigan 48108. FAX: 313/662-1965.

CLEO 
CLEO Communications
A Division of Interface Systems, Inc.

AVAILABLE WORLDWIDE!

In Europe, call Sintec Peripherals Ltd. in Slough, England, at 0753-811888 (FAX: 0753-811666).



KICKING AND SCREAMING INTO THE PRESENT

DEC's LANworks for OS/2 is the latest of the firm's grudging steps to embrace PC networking standards

Once upon a time, standards for using and linking computers came blasting from corporate MIS departments like missives from above. Those days are gone. Today's standards arise from the microcomputers that sit on our desktops. Mini-computer vendors have been slow to recognize this change, and they've paid for their slowness with decreased sales.

Networking was one area where many minicomputer vendors thought they were safe. After all, Digital Equipment Corp. and others have long had their own proprietary networking products. No need to make VAXes adhere to microcomputer LAN standards; just move the VAX standards to the microcomputers, and all will be well.

This strategy led to DEC's first PC networking products, PCSA (Personal Computer System Architecture) and DEPCA, DEC's proprietary Ethernet PC Adapter. PCSA was basically DECnet, the VAX networking standard, for the PC. To run PCSA on a PC, you needed a DEPCA or a 3Com Ethernet board. With those products, PC users could work with files stored on a VAX, print on VAX printers, and log onto the VAX.

DEC provided these file and print services by using DECnet in conjunction with two PC standards: the NetBIOS and SMB (Server Message Block) protocols. Those two protocols are at the base of PC LAN operating systems like 3Com's 3+Open. By following them, DEC was able to use a standard PC file-service re-director on top of its own DECnet proto-

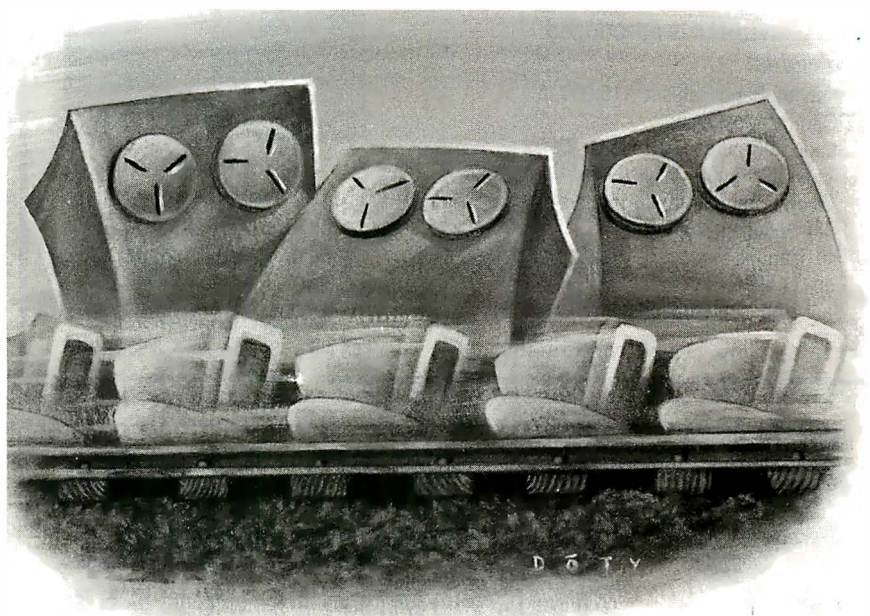

col stack. Unfortunately, PCSA can't escape its DECnet origins: Client PCs must run a DECnet protocol stack. Few, if any, PC LAN users run DECnet as their main transport protocol, so their normal LAN software won't work with the VAX; when they run DECnet, they can't use their standard LAN servers.

PCSA's requirement of either a DEC or a 3Com Ethernet board is also a problem for PC users accustomed to being able to shop around for the cheapest or fastest Ethernet card available. PCSA could have avoided this by following the Microsoft/3Com Network Driver Interface Specification, but it didn't. NDIS defines an interface with which Ethernet board device drivers can communicate with higher-level protocol stacks. By supporting NDIS, PCSA would have been able to work with any NDIS-compatible board.

DEC also didn't look too closely at typical PC LAN operating-system prac-

ing schemes when it wrote the PCSA price book. While most PC LAN operating-system vendors, such as Novell, charge per server license, DEC charges for PCSA per client license. DEC actually bundles the VAX server software license with every VAX. You then pay \$215 for each PC that you want to attach. A fee of \$215 per PC license is cheap as long as you don't hook up too many PCs, but the story changes when you connect a lot of systems. PC buyers who expect to spend \$3000 to \$5000 per server for software and then hook as many clients as possible to that server will not be happy when PCSA's cost for 50 PCs comes in at over \$10,000.

The problem with PCSA was that DEC ignored a simple fact: Microcomputer users outnumber minicomputer users by a substantial margin, and that margin is growing. Therefore, the right way to link a minicomputer to a microcomputer is to bring the microcomputer networking

EasyLAN II™

The Care Free Resource Sharing Network - For 2 PCs

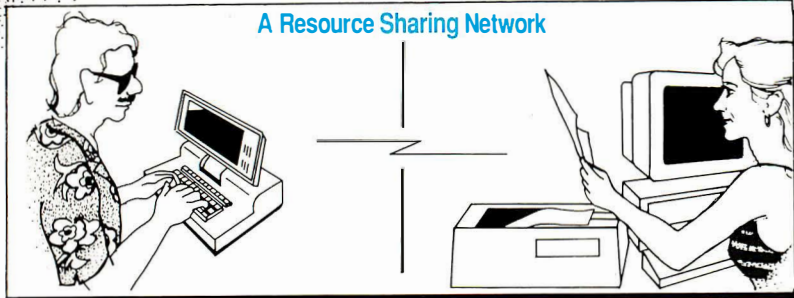

The original EasyLAN has over 100,000 happily installed users. **Now EasyLAN II is introduced.**

Highlights:

- Supports Baud Rates to 115,000
- PC-to-PC Messaging
- Supports Remote Operations
 - Operate remote applications
 - Operate remote fax or modem
- Print Spooling/Sharing
- File Transfer
- Pop-up Menu
- Background Operations



PC Magazine ...Cast Iron Reliable...

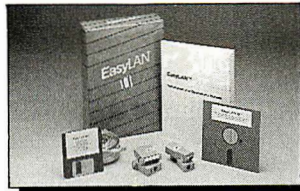

Call Toll Free - Today
To Order, or Free Information

800/835-1515 USA or Canada

EasyLAN II - \$149.95

Server Technology 2332-A Walsh Ave
Santa Clara, California 95051

Fax 408/738-0247 Tel 408/988-0142

REAL PROGRAMMERS DON'T USE SHELLS, THEY WRITE THEM.



\$89

If you or your clients require a custom menu system, Mi-Shell is the ideal tool . . . generate the perfect DOS shell with Mi-Shell's Forth-like script language.

- Uses less than 10K
- Built in debugger
- Fast browser & multi window editor
- Includes several pre-defined scripts

WHY BUY SOMEONE ELSE'S SHELL?

To order call

800•542•0938

VISA and MasterCard accepted

OPENnetwork
POWER TOOLS FOR POWER USERS

215 Berkeley Pl. • Brooklyn, NY 11217 • Voice: 718-398-3838 • BBS: 718-638-2239

standard to the minicomputer, not the other way around.

Another Perspective

Novell figured this out well before DEC, and the result was NetWare VMS. NetWare VMS lets a VAX act as just another server on a NetWare LAN. With it, PCs running client NetWare software can read and write VAX files, print to VAX printers, and even manage VAX servers just as they would any standard NetWare PC server. NetWare VMS even adds a terminal service, which is not available on regular NetWare servers, for those who need to use their PCs as VAX terminals.

Unfortunately, NetWare VMS has a few serious problems. We noted one of the biggest ones in an earlier column: The product is based on older NetWare technology that is now out of date. Newer NetWare features, such as the ability to store Macintosh files on the server, are not present under NetWare VMS. The product's performance is also not great; on our simple file transfer tests, for example, NetWare VMS ran significantly slower than PCSA.

The most potentially devastating problem, however, is that NetWare VMS and normal PC NetWare use slightly different implementations of Ethernet. Consequently, if you have an existing NetWare LAN and you decide to add a VAX to it, you can't use the same client driver software on your PCs to talk to both the VAX and your standard NetWare servers. You can work around this problem by converting all your current NetWare client PCs to DEC's type of Ethernet, but that means running different software on all the client and server PCs. You can also use a NetWare bridge to handle the translation, but that, too, is a hassle.

Little Steps Forward

We expect Novell to fix these problems someday, but right now they're major ones for existing NetWare sites. Meanwhile, DEC is not standing still: It is slowly migrating its products toward PC standards.

One of the first such steps was purely cosmetic: DEC renamed PCSA to LANworks for DOS and replaced DEPCA with its EtherWorks boards. The next step was far more significant: DEC announced a VAX-Macintosh networking product, LANworks for Macintosh, that adheres closely to Apple's current networking standards (see our October Networks column). With LANworks for Macintosh, DEC took a giant step toward the microcomputer-dominated future by

SmartCache™ Plus: the grow-as-you-go approach to SCSI controllers

START WITH THE BEST...

DPT's entry level SmartCache Plus board offers unrivaled price/performance for single-user systems. It features ISA or EISA bus mastering, and universal SCSI disk compatibility for all PC operating systems. SmartDriver software supports SCSI-2 peripherals like tape and optical drives.

NOW ADD CACHING!

Get DPT's award-winning caching technology in a plug-in module! Move up to disk caching speed without investing in a new controller. With an integral 512K cache, the module provides up to 5X performance gains for workstations, power users, and small multiuser systems.

ADD MORE USERS, ADD MORE CACHE!

Plug in a 2 MB or 4 MB memory module and accommodate up to 18 users from a single card slot. Ideal for medium-sized networks or multiuser systems.

HOW ABOUT DISK MIRRORING?

DPT's SmartCache mirroring module provides 100% disk fault tolerance by simultaneously writing all data to a second "mirrored" drive. No more data loss or costly system down-time due to disk failures. And unlike software mirroring schemes, fault tolerance is achieved with no performance penalties.

PLUS STILL MORE CACHE, AND THEN SOME...

Cable over to DPT's 4 MB Cache Expansion Card, then grow your system to 16 MB by adding more plug-in memory modules—enough power for 64-plus users!

DPT has your solution—no matter how you grow. Performance, compatibility and upgradability make SmartCache Plus the only SCSI controller you'll ever need. For details, contact Distributed Processing Technology, 140 Candace Drive, Maitland, FL 32751. Phone (407) 830-5522; FAX (407) 260-5366. In Europe (UK) phone 44 (0) 488 4319.

The logo for DPT (Distributed Processing Technology) features a stylized blue and white graphic of vertical bars of varying heights to the left of the letters "DPT" in a bold, black, sans-serif font.

Circle 98 on Reader Service Card
(RESELLERS: 99)

SEE YOUR DATA!



New MapInfo for Windows™ and MapInfo for Macintosh™ can find, display, and analyze your data geographically. Overlay data directly from spreadsheets, databases and ASCII files onto maps—from worldwide to street level. We can even supply maps and data for the entire U.S. Street maps, ZIP codes, counties, demographics, and more.



Work with your data in three ways: on maps, graphs, and in traditional rows and columns. Use the built-in SQL querying tools to perform powerful analyses. And now, you can share data across platforms. MapInfo looks and acts the same on Windows and Macintosh.

Now, there are more ways than ever to see your data with MapInfo. Whatever your platform—DOS, Windows™ or Macintosh®—MapInfo can help you see patterns, trends, and opportunities you may have otherwise missed.

MapInfo® Corp.

Changing The Way The World Looks At Information®

200 Broadway Troy, NY 12180
Call 1-518-274-8673 or 1-800-FAST-MAP
for a reseller near you.

MapInfo and Changing The Way The World Looks At Information are registered trademarks of MapInfo Corp. Others are trademarks of their respective owners.

NETWORKS

embracing the existing Mac software networking standards.

As we write this column, DEC is about to announce its first new PC networking product in some time: version 1.1 of LANworks for OS/2. Unfortunately, this new release, while more in tune with PC standards than DEC's previous PC

As hard
as it might be for a
minicomputer company
to believe, PC servers
will often contain data
that VAX users
might want to access.

networking offerings, still has a long way to go.

From the PC perspective, the major positive feature of LANworks for OS/2 is that it now conforms to the NDIS standard. It should, therefore, work with any NDIS-compatible Ethernet adapter. The biggest drawback is that LANworks for OS/2 still uses DECnet. At first glance, DECnet's presence seems to mean that, yet again, you must choose between talking to a VAX server and talking to a standard PC server.

Fortunately, that's not necessarily the case. First, it's at least theoretically possible for a client LANworks for OS/2 PC to run two different protocol stacks at the same time and thereby work with both VAX and PC servers at once. For example, by running both DECnet and NetBEUI (NetBIOS Extended User Interface), a client PC could work with both a VAX server and a standard OS/2 LAN Manager server. We don't know of any software that currently provides this ability for OS/2 clients, but it is possible.

LANworks for OS/2 does include a second way for client OS/2 PCs to talk to both VAX and OS/2 LAN Manager servers: Put DECnet on the OS/2 server. This feature is available because you can buy both client and server LANworks for OS/2 1.1 software. (The server package is based on Microsoft's LAN Manager 2.0.) In this approach, the PC server, not the clients, runs both DECnet and Net-

BEUI. Those clients that are content to ignore the VAX can continue to use their normal NetBEUI software, while those that want to see both the VAX and the PC server run DECnet. The server can handle both types of requests.

This solution is obviously not perfect, but it indicates DEC's grudging acceptance that client PCs might want to talk with both VAXes and other servers. To embrace the PC standards entirely would mean abandoning DECnet on PCs in favor of NetBEUI and/or Novell's SPX/IPX, a move that we don't think DEC is anywhere near ready to make.

Even without that step, however, there's room for improvement in LANworks for OS/2. For one thing, the VAX should be able to be both a client and a server. As hard as it might be for a minicomputer company to believe, PC servers will often contain data that VAX users might want to access.

LANworks for OS/2 also follows the same client-based pricing scheme as DEC's DOS and Mac products. The client software runs \$215 per system, while the OS/2 server software is \$325 per system. If you want to run a single OS/2 PC as both client and server, you have to buy both licenses.

Still Not Far Enough

LANworks for OS/2 is a small step forward, but it's not enough. DEC seems aware of this, because the firm is working on alternatives to the DECnet protocol stack. We have heard about only one for sure—TCP/IP, which is due early in 1991—but we hope that NetBEUI support is in the works as well. DEC is also developing a LANworks product for its VAX Unix operating system, Ultrix, and the firm plans to bring LANworks for DOS in sync with its OS/2 offering by adding NDIS support to the DOS product.

Clearly, the people at DEC are slowly coming to recognize the importance of adhering to microcomputer networking standards. We hope that they, as well as the other large-system vendors, continue to do so, and do so fast enough to survive the ongoing blitz of the little systems. ■

Mark L. Van Name and Bill Catchings are BYTE contributing editors. Both are also independent computer consultants and freelance writers based in Raleigh, North Carolina. You can reach them on BIX as "mvannname" and "wbc3," respectively.

Your questions and comments are welcome. Write to: Editor, BYTE, One Phoenix Mill Lane, Peterborough, NH 03458.



Our Printer Sharing Unit Does Networking!

An Integrated Solution

Take our **Master Switch™**, a sophisticated sharing device, combine it with **MasterNet™** networking software for PCs, and you've got an integrated solution for printer and plotter sharing, file transfer, electronic mail, and a lot more. Of course you can also share modems, minis, and mainframes or access the network remotely. Installation and operation is very simple.

Versatile

Or you can use the Master Switch to link any computer or peripheral with a serial or parallel interface. The switch accepts over 20 commands for controlling the flow of data. It may be operated automatically, by command, or with interactive menus. Its buffer is expandable to one megabyte and holds up to 64 simultaneous jobs. The

MasterLink™ utility diskette for PCs comes with every unit and unleashes the power of the switch with its memory-resident access to the commands and menus.

Other Products

We have a full line of connectivity solutions. If you just want printer sharing, we've got

it. We also have automatic switches, code-activated switches, buffers, converters, cables, protocol converters, multiplexers, line drivers, and other products.

Commitment to Excellence

At Rose Electronics, we're not satisfied until you're satisfied. That's why we have thousands of customers around the world including large, medium, and small businesses, factories, stores, educational institutions, and Federal, state, and local governments. We back our products with full technical support, a one-year warranty, and a thirty-day money-back guarantee.



**ROSE
ELECTRONICS**

**Call now for literature or more information.
(800) 333-9343**

Give a Rose to your computer

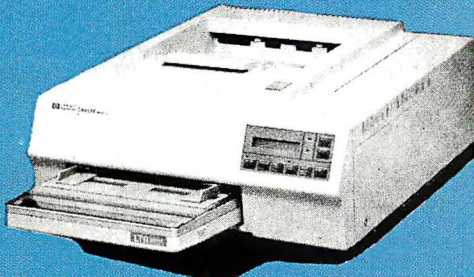

PRINTERS

HEWLETT PACKARD

Laser Jet III	PRICE MATCH!
Laser Jet II P	PRICE MATCH!
Laser Jet II D	\$CALL
Desk Jet/Desk Jet Plus	\$CALL
Laser Jet Toners	\$ 79.
250 Sheet Paper/Letter Tray	\$ 59.

KENSINGTON

100% HP Compatible Memory Boards

1 MG Upgrade	CALL
2 MG Upgrade	CALL
4 MG Upgrade	CALL

PANASONIC

KXP 1180 192 cps, 80 col, 9-pin	\$ 164.
KXP 1124 192 cps, 24-pin	\$ 275.
KXP 1624 192 cps, 132 col, 24-pin	\$CALL
KXP 1695 330 cps, 132 col, 9-pin	\$CALL
KXP 4420 Laser, 8 page per minute	\$CALL

EPSON

LX810 180/30, 9-pin	\$ 175.
FX850 330/88, 9-pin	\$ 325.
LQ850 330/88, 24-pin	\$ 515.
LQ950 264/88, 24-pin	\$CALL
LQ510 180/60, 24-pin	\$ 314.
FX1050 264/54, 9-pin	\$ 429.
LQ1050 330/88, 9-pin	\$ 699.
LQ2550 400/108, 24-pin	\$CALL

LAPTOPS

TOSHIBA

Toshiba T1000	\$ 575.
T1000 SE	\$CALL
T1000 XE	\$CALL
T1200 XE	\$CALL
T 1600 286 20MB	\$2350.
T 1600 286 40MB	\$2650.
T3100 E 286 40MB	\$2550.
T3100 SX 40MB	\$3550.
T3200 SX 40MB	\$3700.
T5100 386 100MB	\$4250.
T5200 386 40MB	\$4500.
T5200 386 100MB	\$4900.

COMPAQ

Deskpro 286E 20mb/40MB	\$ 2050/2350.
Deskpro 386S	\$CALL
Deskpro 386/20E 40MB	\$4225.
Deskpro 386/20E 110MB	\$4750.
Deskpro 386/25E 84MB	\$5450.
Deskpro 386/25E 110MB	\$6150.
Deskpro 386/25E 300MB	\$8450.
Deskpro 386/33 84MB	\$7200.

MODEL 486/25N

120MB/320MB/650MB	\$CALL
Portable III 20MB/40MB	\$ 3350/3950.
Portable 386 40MB/100MB	\$ 4750/5550.

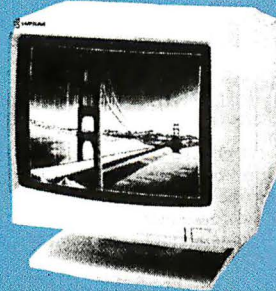

MONITORS

SAMSUNG

1257 Amber (12" 720x350)	\$ 74.
1464 RGB (14" 640x200)	\$ 205.
1453 EGA (14" 690x350)	\$ 319.
VGA (14" 720x580)	\$ 349.

NEC

Multisync 2A 14" (800x600) VGA	\$ 460.
Multisync GS 14" Mono	\$CALL
Multisync 3D 14" (1024x768) EGA/VGA	\$ 580.
Multisync 4D 16" (1024x768) 28DP	\$CALL
Multisync 5D 20" (1280x1024) .31DP	\$CALL

PACKARD BELL/PGS/SONY

Mono 12" Amber 720x350	\$ 74.
PGS Ultrasync 14" VGA	\$CALL
Sony 1302 / 1304	\$CALL

VIDEO CARDS

PARADISE

VGA 1024x768 with 512K	\$CALL
------------------------	--------

PC BRAND

Mono Graphics w/Printer Port	\$ 34.
Color Graphics w/Printer Port	\$ 34.
EGA (640x480) Autoswitch	\$ 85.
VGA 16 Bit	\$ 149.

HARDWARE

AT 12 MHZ (exp. 4 meg 0 wait)	\$ 165.
XT 10 MHZ Turbo (exp. 0 wait)	\$ 69.
Power Supply 200 Watt	\$ 49.
Power Supply 150 Watt	\$ 39.
XT Case (w/hardware)	\$ 34.
Baby AT Case (w/hardware)	\$ 52.
AT Case (Full Size)	\$ 59.
Keyboard 84 Key (tactile touch)	\$ 40.
Keyboard 101 key (tactile touch)	\$ 54.
Multi I/O Card	\$ 34.
Floppy Controller Card	\$ 21.
FHDC (1.44/1.2/720K/360K)	\$ 45.
AT I/O	\$ 32.
Serial Card	\$ 20.
Parallel Card	\$ 20.
Game Card	\$ 20.

LAPTOPS - continued

ZENITH LAPTOPS

Minisport 2MB RAM NOTE BOOK	\$CALL
Supersport 184	\$1150.
Supersport 184-2	\$1650.
Supersport 286 20MB	\$2450.
Supersport 286 40MB	\$2650.
386SX 40MB	\$3850.

NEC LAPTOPS

Prospeed 286 20MB	\$1650
Prospeed 286 40MB	\$2425.
Prospeed 386SX	\$2650.
Prospeed 386 40MB	\$3550.

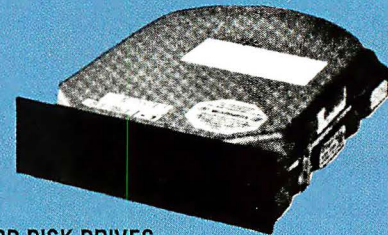

HARD DISK DRIVES

SEAGATE

20MB 65MS ST225 w/XT Controller	\$ 229.
20MB 35MS ST125 w/XT Controller	\$ 239.
30MB 65MS ST238 w/XT Controller	\$ 239.
30MB 35MS ST138 w/XT Controller	\$ 345.
40MB 28MS ST251-1	\$ 339.
80MB 28MS ST4096 Full Height	\$ 535.

HARD DRIVE CARDS

XT MFM (20mg Controller)	\$ 55.
XT RLL 27x(30mg Controller)	\$ 59.
AT MFM 2:1 Controller	\$ 79.
AT MFM 1:1 Controller	\$ 105.
AT RLL 1:1 Controller	\$ 110.

FLOPPY DISK DRIVES

TOSHIBA

360K 5.25" HH Black	\$ 59.
720K 3.5" HH w/5.25" Mount	\$ 64.
1.2MB 5.25" HH Grey	\$ 69.
1.44MB 3.5" HH Grey w/5.25" Mount	\$ 75.

TEAC

360K 5.25" HH Black	\$ 59.
720K 3.5" HH w/5.25" Mount	\$ 64.
1.2MB 5.25" HH Grey	\$ 69.
1.44MB 3.5" HH Grey w/5.25" Mount	\$ 75.

FUJITSU

360K 5.25	\$ 59.
1.2, 5.25	\$ 69.

SONY

720K 3.5	\$ 64.
1.44, 3.5	\$ 75.

MODEMS

Mastercom - 1200B (internal)	\$ 44.
Mastercom - 2400B (internal)	\$ 75.
US Robotics, Courier HST/9600B	\$ 615.

SOFTWARE

Wordperfect 5.1	\$CALL
Lotus 1-2-3 2.2/3.0	\$CALL
Microsoft ALL	\$CALL

MOUSE

Genius Mouse, GM6X	\$ 35.
Genius Mouse F301	\$ 50.
Logitech Mouse C9	\$CALL

INTEL

ALL CO-PROCESSORS	\$CALL
-------------------	--------



Day After Day More Corporations, Businesses and People just like you . . .

Choose I.S.C. for Outstanding Service, Quality & Pricing!



286 Power System	386SX Power System	386 Power System	386 Power System	486 Power System
<p>6/12 MHz Motherboard</p> <ul style="list-style-type: none"> 80286 CPU Norton Si Rating 15.3 0 Wait State 1.2MB High Capacity Floppy 1 Meg RAM Expandable to 4 MB Serial Port/Parallel Port 1.2MB Floppy Controller 8 Expansion Slots 6-16 Bit, 2-8 Bit Slots 200 Watt Power Supply AT Style Keyboard Mono Card/Parallel Port Monochrome Amber Monitor <p>\$ 675.</p>	<p>•16 MHz Motherboard</p> <ul style="list-style-type: none"> 80386SX CPU 1 Meg RAM (80 nsec.) Installed 1.2MB or 1.44MB Floppy Drive 2 Serial Ports 1 Parallel Port 80387SX Co-processor Socket Floppy Drive Controller Hard Drive Controller 8 Expansion Slots 5-16 Bit, 3-8 Bit RAM Upgradable to 8 Meg 200 Watt Power Supply 101 Key Enhanced Keyboard Clock/Calendar w/ Battery Backup Mono Card/Parallel Port Monochrome Amber Monitor AC Power Pad <p>\$ 849.</p>	<p>•20/25 MHz Motherboard</p> <ul style="list-style-type: none"> 80386 CPU AMI Bios 1 Meg RAM/Upgrade to 8 Meg 1.2MB/1.44 High Capacity Drives 2 Serial Ports/1 Parallel Port 80387 Co-processor Socket Floppy/Hard Drive Controller 8 Expansion Slots 2-32 Bit, 5-16 Bit, 1-8 Bit 230 Watt Power Supply 101 Key Enhanced Keyboard Clock/Calendar w/ Battery Backup Mono Card/Parallel Port Monochrome Amber Monitor AC Power Pad <p>\$ 1,275. 20MHz</p> <p>\$ 1,375. 25MHz</p>	<p>•33 MHz Motherboard</p> <ul style="list-style-type: none"> 64K Cache Memory 80386 CPU AMI Bios 1 Meg RAM (80 nsec) Installed 1.2MB/1.44 High Capacity Drives 2 Serial Ports / 1 Parallel Port 80387 Co-processor Socket Floppy/Hard Drive Controller 8 Expansion Slots 2-32 Bit, 5-16 Bit, 1-8 Bit RAM Upgradable to 8 Meg 230 Watt Power Supply 101 Key Enhanced Keyboard Clock/Calendar w/ Battery Backup Mono Card/Parallel Port Monochrome Amber Monitor AC Power Pad <p>\$ 1,749.</p>	<p>•25 MHz Motherboard</p> <ul style="list-style-type: none"> 80486 CPU AMI Bios 4 Meg RAM 1.2MB/1.44 High Capacity Drives 2 Serial Ports 1 Parallel Port 80487 Co-processor Socket Floppy/Hard Drive Controller 8 Expansion Slots 2-32 Bit, 5-16 Bit, 1-8 Bit RAM Upgradable to 16 Meg 230 Watt Power Supply 101 Key Enhanced Keyboard Reset Button / Keyboard Lock LED Power & Turbo Indicators Clock/Calendar w/ Battery Backup AC Power Pad <p>\$ 3,900.</p>
<p>XT Power System</p> <p>4.77/10 MHz Motherboard</p> <p>8088-10 CPU</p> <p>(1) 360K Floppy Drive</p> <p>640K RAM/Floppy Controller</p> <p>8 Expansion Slots</p> <p>150 Watt P.S./AT Style Keyboard</p> <p>Serial/Parallel/Clock & Game Port</p> <p>Mono Card/Parallel Port</p> <p>Monochrome Amber Monitor</p> <p>\$ 459.</p>	<p>HARD DRIVE OPTIONS</p> <ul style="list-style-type: none"> 20MB Seagate Hard Drive \$175. 30MB Seagate Hard Drive \$185. 40MB Seagate Hard Drive \$339. 80MB Seagate Hard Drive \$525. 		<p>MONITOR OPTIONS</p> <ul style="list-style-type: none"> Monochrome Amber Monitor Mono Card/Parallel Port \$108. EGA Monitor EGA Card \$419. VGA Monitor VGA+16 Card +512K \$436. <p>All System Parts can be purchased separately. We also carry HP, Epson, Panasonic, Samsung, NEC, Software and MORE. . .</p>	

90 DAY MONEY BACK GUARANTEE - 3 YEARS PARTS & LABOR

QUICK SHIPMENTS TO US/OVERSEAS
 C.O.D. AVAILABLE
 HOURS: MON - FRI 8AM to 5PM
 CUSTOMER/TECH SUPPORT: 9:30AM to 4:30PM
 Prices subject to change without notice



Orders: 800-955-4858 Customer Service: 800-933-5161
 Overseas Sales and Support: 213-379-4866
 Technical Support: 213-379-9209 - FAX: 213-318-0555
 2629 Manhattan Avenue #235 - Hermosa Beach, CA 90254

Circle 151 on Reader Service Card

SHORT TAKES

BYTE editors' hands-on views of new and developing products

Step 486/50

Muse

ProLine Backup System

Amiga 3000UX

Hardcard IIXL

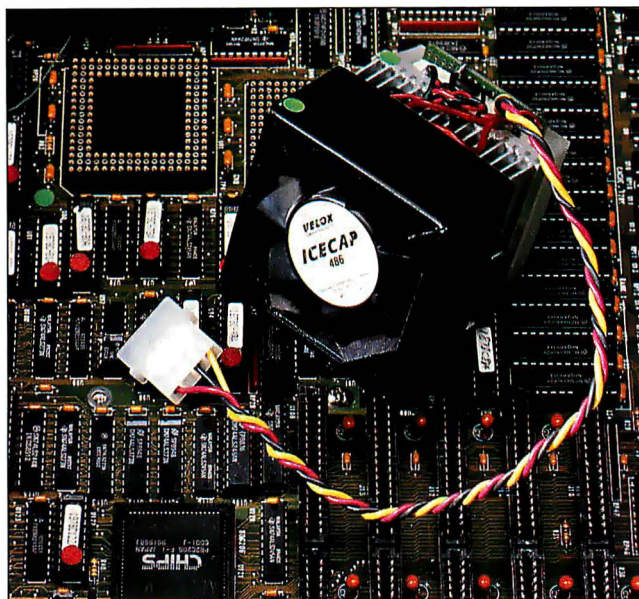

The Experimental Step 486/50 Redefines Cool

Everex has joined the racing circuit with its **Step 486/50**. Although the company won't actually bring this product to market, it is a technological showpiece with a supercooled engine that pushes Intel's i486 CPU to a scorching 50 MHz.

At the heart of the new machine is Velox Computer Technology's ICECap, which is a sophisticated temperature and voltage control system that lets Everex boost CPU clock speed to 50 MHz without overheating the CPU. The ICECap IC module, which encases the i486, plugs directly into the CPU socket and maintains the i486 at a chilly 0°C.

The Step 486/50 isn't exactly a true 50-MHz system. The ICECap sits on a modified Step 486/25 motherboard that clocks the CPU at 50 MHz and the rest of the motherboard at 25 MHz. Everex also had to add extra wait states between the external 128K-byte processor cache and the CPU. Even with these handicaps, however, the Step 486/50 gave an impressive performance. The Step 486/50 held a 28

percent edge over the Step 486/33 on the CPU tests, and it posted roughly 50 percent higher results on the floating-point tests. The FPU tests benefited because more of the tests run within the i486's on-board cache. Had Everex tuned its external processor cache for 50 MHz, both numbers would have been higher.

Remove the Step system's cover and you can't miss the ICECap. The module rises from the CPU socket like a high-rise office building, towering 3 inches above the motherboard. The system is made up of three stacked components—a thermoelectric cooler, a heat sink, and a fan—and on-board control circuitry that keeps voltage up and temperature down.

For Velox, merely preventing the i486 from overheating isn't enough. The company claims that cooling the CPU to the bottom of its operating temperature range increases reliability and lets the chip run 35 percent faster. Since it doesn't have to worry about overheating the CPU, Velox also maximizes power input at the i486's peak of 5.2 volts. This reduces propagation delay and, Velox claims, improves performance by another 15 percent.

Heat sinks and fans are common, but Velox is the first microcomputer company to use a Peltier effect device—a thermoelectric cooling system based on the principle that passing a current between two physically connected, dissimi-

lar materials produces cooling on one side and heat on the other.

The Velox device has four components. At the top and bottom of the Peltier device, an aluminum oxide "cold plate" and "hot plate" transfer heat from the i486 to the heat sink.

Sandwiched between the plates are two semiconductors that do the work. These semiconductors have opposite electrical properties, and they are arranged in such a way that, when you apply voltage to the system, electrons in both materials flow from the cold plate to the hot plate. This carries heat away from the CPU and into the heat sink. The fan then blows air down into the cooling fins, dissipating the heat inside the system unit case. Velox claims that the ICECap raises the temperature inside an AT case by 1 to 3 degrees.

To keep the CPU temperature constant, a thermal sensor generates a control signal when the chip temperature rises above freezing. The system also includes a dual clock speed generator that ramps up clock cycles as the CPU temperature drops and lets the CPU operate at normal speeds if the ICECap fails.

After running for several days, the ICECap remained surprisingly cool. The motherboard, hacked to accommodate a 50-MHz CPU, wasn't pretty. And the system had trouble running several applications, including PageMaker and Lotus 1-2-3.

In the future, you'll probably see the ICECap in systems from other vendors. In a market full of clone vendors desperate to differentiate their products, the ICECap is sure to attract attention. And for the extra \$600 it's likely to add to the price of a 486 system, users may bite.

—Rob Mitchell

THE FACTS

Step 486/50

Everex Systems, Inc.
48431 Milmont Dr.
Fremont, CA 94538
(800) 356-4283
Inquiry 1160.

Velox Computer
Technology, Inc.
2334 Walsh Ave.
Santa Clara, CA 95051
(408) 727-6100
Inquiry 1161.

Finally There's Muse for the Mac

Muse calls itself a natural-language interface program, but a more accurate description might be "query by English-like commands." You load your data by creating *databooks*, which represent a collection of up to 64,000 homogeneous or heterogeneous data structures, each of which can be tables of information that range into megabytes (with available hard disk storage). You can reference 15 of these databooks at once. One way of thinking of databooks in conventional terms would be as a relational database. Databooks are how Muse stores things.

You import or create data in *workbooks*, which look like spreadsheets with labeled axes. You can manually place information or import it in WKS, WK1, WK3, DIF, SYLK, or DBF formats. It's also possible to import it in comma, space, or tab-delimited formats. You can import fixed-field ASCII. Workbooks may have definitions and relations that apply only to the data within that workbook attached to them.

Muse can create charts from numeric data. It's also possible to create two-dimensional or

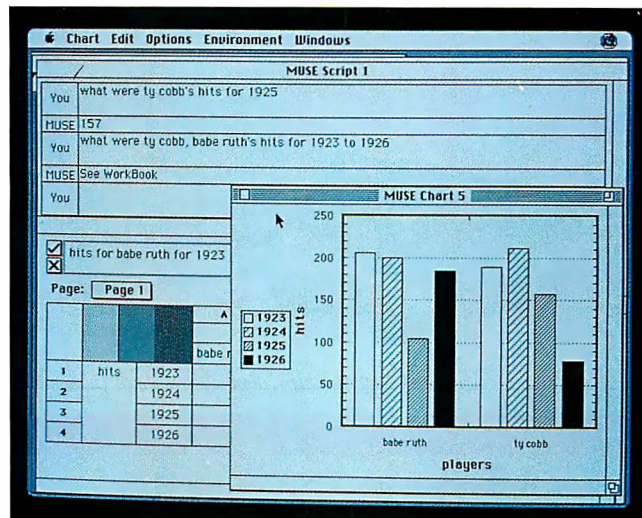

THE FACTS

Muse
\$695

Requirements:

A Mac with System 6.0.3 or higher and 2 MB of RAM. A hard disk drive is recommended.

Occam Research Corp.
85 Main St.
Watertown, MA 02172
(617) 923-3545
Inquiry 1162.

3-D (or animated series of both) charts. Other chart possibilities are bar, column, x,y, scatter, line, 3-D surface, percentage, pie, 3-D spline, 3-D ribbon, log-log, log-linear, stacked bar, stacked column, high-low-close, contour map, dual-y-axis, and combinations. Automatic axis labeling is performed with auto-sizing of the legends. While graphs are displayed on the Mac screen in color, printing them on a LaserWriter substitutes pat-

terns for colors. The resulting charts were as good as anything I have seen from WingZ, DeltaGraph, or Excel.

Scripts are the records of questions and answers posed to Muse. It's basically a collection of boxes (with one box for your questions and another box for Muse's answers) stacked on top of each other. You can save or modify them just like plain text.

I looked at an early beta copy of Muse. It would run

only on a Mac II with an FPU and 4 MB of RAM, although Occam said that the release version should be able to run on a Mac SE or Plus with 2 MB as a minimum (if slow) configuration. While the beta version I saw is certain to change, the basic functionality of the program came through rather well. The illustration shows how a simple single-variable query produced a single answer in the script window. When multiple-variable queries are made, a workbook window containing the results is produced. I tried different forms of queries, and all produced well-formatted and useful answers.

However, I thought the current system of error checking left something to be desired. If you pose a query with less than the needed number of variables, for instance, Muse simply shoots back "underdefined." It would be far more useful to have some idea of what it was that Muse actually needed for the query to be defined, perhaps with a scrolling list of available choices. I expect to see this resolved in further beta testing.

Muse is the first attempt on the Mac to make data useful by being easily obtainable. Occam seems to be on the right track thus far, and I look forward to seeing a final copy of the product.

—**Laurence H. Loeb**

DAT's a Classy Backup System

The ProLine DATAVault, a toaster-shaped SCSI digital audiotape-recording system (DAT) drive, packs 1.3 gigabytes of data onto a tiny 4-mm cartridge. Pop in Tecmar's new Proserve software, an innovative client-server program suite, and you've got the

ProLine Backup System, a comprehensive—but pricey—tape backup solution for a NetWare LAN.

Installing the DATAVault on a NetWare 286 server was a mixture of ups and downs. Could I piggyback the drive onto the server's existing Fu-

ture Domain SCSI host bus adapter? No, I had to use the Tecmar-supplied Adaptec controller—somewhat redundantly, in this case. (It's a standard Adaptec device, though, so if you're already using one of those, you won't have to add a second.) That, in turn, meant

I'd have to add a new driver to NetWare. Like its NetWare 386 cousin, the driver links dynamically with NetWare.

The driver's installation program scans the NetWare executable file; reports the IRQ, I/O, and RAM settings that are consumed by Net-

Ware-controlled boards; and recommends compatible settings for the Tecmar/Adaptec controller. So I figured I wouldn't have to run NETGEN and reinstall NetWare.

But, alas, it was not to be. Industry Standard Architecture board conflict resolution remains an uncertain science. The server's TCP/IP gateway, for reasons apparent neither to Tecmar's installation program nor to me, fought with Tecmar's adapter. I tossed out the TCP/IP board (it wasn't a permanent fixture anyway) and ran NETGEN to tell NetWare I had done that.

In spite of the conflict, I applaud Tecmar's clever scheme. In many cases, it should save busy LAN administrators a lot of time and trouble, and it offers a ray of hope to the many NetWare 286 users not in a position to upgrade to NetWare 386.

Once loaded, TAPEDRV.VAP provides an assortment of NetWare console commands. With these commands, you can reset the DATAVault and erase, format, test, or list the contents of a 4-mm cartridge. A second value-added process, PROSERVE.VAP, supplies the server (or back-end) component of the backup application. Multitasking with NetWare, PROSERVE.VAP accepts connections from client workstations, queues backup requests, and performs backups.

Client software also comes in two parts. With PROSERVE.EXE, you administer users and queues, schedule attended or unattended jobs, and monitor tape-drive status,

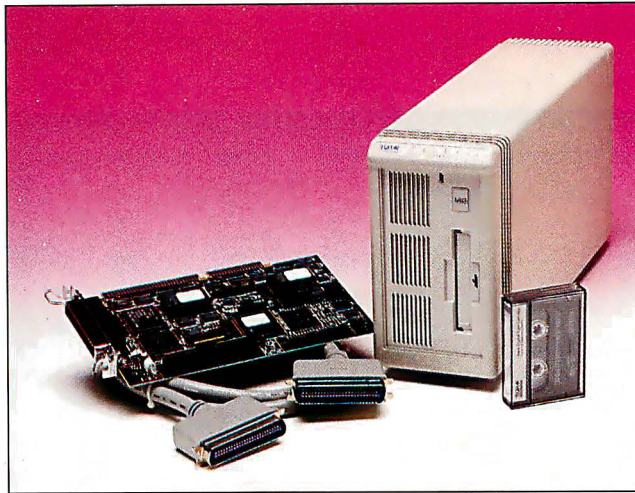

THE FACTS

ProLine Backup System

(includes drive, adapter, cable, server and client software, and documentation)

for NetWare 286, \$5995;
for NetWare 386, \$6295

Requirements:

File server: AT, PS/2, or compatible running NetWare 286 (2.1x) or

NetWare 386 (3.1).

Client: AT, PS/2, or compatible running DOS 3.0 or higher with 640K bytes of RAM.

Tecmar, Inc.
6225 Cochran Rd.
Solon, Ohio 44139
(216) 349-4030

Inquiry 1163.

tape contents, and a history of backup transactions. A Novell/C-Worthy point-and-shoot interface neatly manages a formidable array of options. You can specify the target file set to be all files, new files, or dormant files.

You can save NetWare bindery, trustee, and file attributes; in the case of a NetWare 2.15 server with Macintosh clients, you can save Mac-related directory information and resource forks as well. There is, however, no client

software for the Mac; you'll have to schedule the backup of Mac directories on the server from a PC, and you can't back up a Mac client directly to tape.

You can move files from a PC straight to tape, thanks to the client-server architecture of the Proserve software. PSCLIENT.EXE, a small (15K bytes) DOS TSR program, communicates with PROSERVE.VAP.

Once it's loaded, a backup job scheduled by means of

PROSERVE.EXE can draw files directly from the client PC. Because direct client-to-tape backup obviates the need for a large intermediate transfer area on the file server, it's a feature I prize highly.

Tecmar's deluxe Proserve software is clearly a class act. It does more than I have room to describe, and does it well. In fact, Proserve works with several species of Tecmar tape drive: DC600 (250 and 525 megabytes), DAT (1.3 gigabytes), and 8-mm analog helical-scan (2.2 gigabytes). Given this range of choices, and considering that the current highest-capacity Tecmar tape drive is 8-mm, not 4-mm DAT, why choose the DATAVault? Frankly, I'm not sure. Proponents point out that DAT—compared to 8-mm technology—offers superior error correction, requires fewer moving parts, and can find random files much more quickly.

While I've no reason to doubt those claims, I am obliged to report that the first 4-mm DAT tape I used in the DATAVault developed problems—*after* I formatted it, tested it, and performed two apparently successful backups. Tecmar agrees that it ought to provide a rigorous verification utility; the existing format and test utilities don't touch most of the tape. Although I've since had no further problems with other 4-mm tapes, I'm left wondering whether there's a percentage in being the first one on the block to use one of those newfangled DAT systems.

—Jon Udell

A Unix Graphics Workstation for the Rest of the World

Amiga enthusiasts keep telling me that the Amiga is a serious computer, that it is for the business and professional user. But old beliefs are hard to shake—at least they were until I saw the **Amiga 3000UX**. This workstation is the most complete implemen-

tation of the new AT&T Unix System V release 4.

The base Amiga 3000UX machine includes a 25-MHz MC68030, a math coprocessor, 8 megabytes of RAM, a 100-MB SCSI drive (optional 200 MB), and either a high-resolution monochrome display

or the standard Amiga color display. All the hardware parts are already integrated with the system, including a port for additional SCSI devices, a port for an additional floppy disk drive, a port for a parallel printer, and a serial connection for an external ter-

terminal, modem, or printer. Although Ethernet (thick- or thin-wire) is an option, the network software is already in place.

Most important, the system includes Unix System V release 4 and the X Window System, including Level 1

Here's How We Protect Your Software And Profits Better.

SOFTWARE PROTECTION

Windows 3.0 Support Available

We'll Never Tell...

... the world how we protect your hard work. But then, why should we? It's not that we're hard to get along with. On the contrary. We'll show you how our unworried approach to software protection can actually work better for you. We'll deliver the best balance of guaranteed copy control and cost-effective installation.

Unlike other manufacturers, our hardware is *uniquely custom-wired for each developer* and supplied with a specific *encrypted interrogation routine* for maximum security.

The precise routines assume responsibility for all hardware, software and timing issues so your time and money isn't wasted engineering protection schemes.

The Products That Protect Your Revenues

- ▶ **PROTECH KEY**
Identically reproduced packages.
- ▶ **MEMORY KEY**
MACINTOSH MEMORY KEY
NEC MEMORY KEY
Active protection, modular packages, customized packages, serialization, demo control, access control.
- ▶ **MEMORY-ONE KEY**
Customized packages, modular packages
- ▶ **MICROPROCESSOR KEY**
Non-operating system specific protection based on RS232C communications for minicomputers, workstations, etc.



MICROPHAR

In EUROPE:
MICROPHAR, 122 Ave. Ch. De Gaulle 92200,
Neuilly Sur-Seine FRANCE Tel: 33-1-47-38-21-21 Fax: 33-1-46-24-76-91

For distributors in:

- BELGIUM/NETHERLANDS. E2S (091 21 11 17) • SPAIN, (343 237 31 05)
- IRELAND, TMC (021 87 37 11) • GERMANY, Microphar Deutschland (06223 737 30)
- PORTUGAL, HCR (1 56 18 65) • UNITED KINGDOM, Clearsoft (091-3789393)
- SWITZERLAND, SAFE (024 21 53 86) • ITALY, Siosistemi (030 24 21 074)

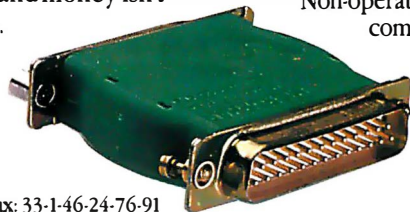

PROTECH
MARKETING, INC.

1-800-843-0413

In the U.S., the AMERICAS & the PACIFIC:
PROTECH, 9600-J Southern Pine Blvd.,
Charlotte, NC 28217 *Se Habla Español*
Tel: 704-523-9500 Fax: 704-523-7651
Hours: Mon-Thurs: 8:30-7:00 ET, Fri: 8:30-5:30 ET

FOR A DEMONSTRATION PACKAGE OR ADDITIONAL INFORMATION, PLEASE WRITE OR CALL.

*Macintosh is a registered trademark of Apple Computer, Inc.
*NEC is a registered trademark of NEC Information Systems, Inc.

For Europe, circle 249 on Reader Service Card

For Americas & Pacific, circle 250 on Reader Service Card

implementation of Open Look. The Unix manual pages are on-line. Bundled with the operating system are two C compilers (the AT&T standard compiler and the GNU optimizing compiler), the popular screen-oriented mail manager `e1m`, and several Amiga-specific utilities.

The Amiga 3000UX with release 4 is not a clone, nor a work-alike, nor a toy. It is a no-nonsense workstation that is impressive and compact. I am not saying that if you put the Amiga beside a full-size SPARCstation or a Silicon Graphics workstation you won't be able to see obvious differences that favor these automobile-priced machines. But when you put it beside a NeXT or a Macintosh or a 386 workstation, the differences are in favor of the Amiga. Consider the work (and money) that is required to build a workstation out of a 386-based Industry Standard Architecture or Extended Industry Standard Architecture bus machine; you have to get one part here and another part



there. All the parts have to be configured to work together without conflicts in interrupts and memory addresses. The Amiga 3000UX is a plug-and-play operation.

The newest release of Unix System V is significant because it incorporates the BSD features that make it so well suited for workstation comput-

ing, including mechanisms for mounting remote file systems and distributed processing. Since AT&T sells only source coderights to Unix (unless you are buying an AT&T computer), users have had to wait until the hardware vendors finished their work on porting the new source codes to their machines. Although many

THE FACTS

Amiga 3000UX
Approximately \$4000

Commodore Business
Machines, Inc.
Computer Systems
Division
Brandywine Industrial
Park
1200 Wilson Dr.
West Chester, PA 19380
(215) 431-9100
Inquiry 1164.

Unix licensees are well along in completing this task, it appears that Commodore will be the first to complete it.

The Amiga 3000UX greatly outperforms the equivalent NeXT and Mac with A/UX. In raw Unix performance, it is roughly equivalent to a 20-MHz 386 system, but it is much more suited to handling the graphics requirements of a graphical user interface like Open Look. At roughly \$4000, it is an obvious choice as a low-end workstation.

—Ben Smith

Caching In on the Hardcard

The Hardcard is a popular way to augment storage capacity because you just open your computer and drop a full-length card into a free bus slot, and you've got another drive.

The new **Hardcard IIXL**, available in 52- and 105-mega-

byte capacities, includes a built-in 64K-byte read-ahead disk cache that gives the drive a rated average access time of only 9 milliseconds.

I installed the Hardcard IIXL in less than 10 minutes. Once the drive was installed, I loaded it with software and noticed how quiet and fast it was. File copies and directory listings zoomed along at twice the speed of my old, fragmented, 65-ms Seagate, and my applications loaded more quickly. However, a two-level database indexing and a test suite of assorted Windows accessories were only slightly faster on the Hardcard.

On the low-level BYTE benchmarks, running on a slow 286 machine, the drive turned in a rating of 1.97, or about twice as fast as a standard 40-MB hard disk drive in

an IBM AT. Running in a Compaq Deskpro 386/33, its rating was 2.90. These numbers compare with a score of 2.20 for the hard disk drive supplied with the Compaq Deskpro 386/25e.

Data throughput for the Hardcard ranged from 465K bytes per second on the 286 up to 930K bytes per second on the Deskpro 386/33, versus a speed of 700K bytes per second for the Compaq 386/25e. Measured seek times averaged between 16 and 19 ms; the Hardcard performed near its hardware access speed of 17 ms rather than the cache-assisted rate of 9 ms, because the BYTE benchmark test defeated the read-ahead cache with random sector seeks. In a real application that uses more typical contiguous sector seeks, the performance would

certainly be better.

My only disappointment with the Hardcard IIXL was that its built-in cache and the SmartDrive caching software supplied with Microsoft Windows 3.0 didn't seem to complement each other.

Plus has typically charged more for the Hardcard than the price of equivalently sized hard disk drives. The 52- and 105-MB Hardcard IIXLs break that tradition with suggested list prices of \$579 and \$999, respectively. Those prices are expected to fall to \$399 and \$699 on the street, which will make the Hardcard IIXL not only convenient but also cost-competitive. If you are running out of disk space and you have slots to spare, I recommend you take the Hardcard IIXL for a spin. ■

—Andrew Reinhardt

THE FACTS

Hardcard IIXL 50
\$579; Hardcard IIXL 105,
\$999

Requirements:

A 16-bit ISA-bus slot in an IBM PC-compatible 286 or a non-PS/2 386.

Plus Development Corp.
1778 McCarthy Blvd.
Milpitas, CA 95035
(408) 434-6900
Inquiry 1165.

DR DOS 5.0. WE COULDN'T HAVE SAID IT BETTER.

THE NATIONAL NEWSPAPER OF CORPORATE MICROCOMPUTING

PC WEEK

D-14 Sunday, May 20, 1990 ★ ★ SPECTRA

JOHN C. DVORAK
ASK DVORAK



A major
advance
in DR-DOS

HIS LAST Monday
Digital Research Inc.

San Francisco Examiner
BUSINESS

graphical user interface designed to be used equally well with a keyboard or a mouse. ViewMAX allows for easy execution of DOS commands and "point and shoot" running of any application software, eliminating the need for users to learn and correctly execute cryptic DOS commands. The user's disk layout can be viewed as icons, text or in a graphical tree format.

Users who need to transfer data from one machine to the other can do so easily with FileLINK, a file transfer utility included in DR-DOS 5.0. FileLINK provides easy, high-speed transfer of files and programs between systems over standard serial cables. The utility installs itself from one machine to the other via the serial link, so DR-DOS 5.0-based systems can communicate with machines running less functional DOS operating systems.

IBM Launches New Consulting Program

Specialists Will Analyze Clients' Businesses with Eye Toward Modernizing Host-Based Applications.
See Page 145.



DRI To Upstage Giants With Own DOS 5.0

By Gina Smith

Users hungry for the memory relief promised by DOS 5.0 will be able to buy the system software next month—but not from IBM or Microsoft Corp.

Digital Research Inc. (DRI) is poised to release DR-DOS 5.0, the latest version of its DOS-compatible operating system. Early users and company officials say it offers many of the key features planned for Microsoft's unannounced DOS 5.0.

DR-DOS 5.0 is the first commercial version of the previously OEM product. Its most noteworthy feature is a memory-management capability that allows users to free as much as 620K bytes of memory for application use, said Dick Williams, president of DRI in Monterey, Calif.

Although Microsoft officials have said that a new DOS version

with similar features will be shipped by year's end, sources say that version is in the very early stages of development.

"Microsoft is only promising this, and DRI will be shipping it soon. If [DR-DOS] can prove it's really compatible, and if it looks really good, I'd have no problem recommending it," said Bob Hollingsworth, a computing consultant for an automobile maker in Detroit.

"I don't care whose name is on the package if it can help us with our memory problem," said Darrin McCarthy, end-user computing analyst with Porsche Cars North America Inc. in Reno, Nev.

Beta testers report that DR-DOS 5.0 includes a number of features not found in current MS-DOS and PC-DOS versions. Among them are a graphical,

See DRI Page 6

Key NewWave Office Elements Available This Month

from Steve Higgins

FIRST LOOK

Turbo C++ Delivers Power To Programmers

By Peter Coffee

So what's all the hoopla about? MemoryMAX™, for one thing. A breakthrough in memory management that can give you more than 620K so you can run today's memory-intensive applications, including, for example, dBASE IV, on Novell NetWare™.

In fact, John Dvorak calls MemoryMAX nothing short of "amazing."

The Press goes on to mention that because DR DOS 5.0 is fully DOS compatible, you can run all your current DOS applications. And because it is easy to install and requires no hard disk reformat-

ting, upgrading to DR DOS is simple. Since DR DOS 5.0 also includes ViewMAX™, a graphical interface, DOS is easier than ever to use.

Now if we could just get a word in edgewise, we would simply like to add that DR DOS 5.0 is available now. Call your local dealer today.

DR DOS 5.0

 Digital Research®
WE MAKE COMPUTERS WORK

For Laptop and Notebook manufacturers, DR DOS 5.0 is fully executable from either RAM or ROM. And, it's available with BatteryMAX™, a battery-saving feature that can increase battery life 2-3 times (dependent upon OEM implementation).

Digital Research is a registered trademark, and the Digital Research logo, DR DOS, MemoryMAX, ViewMAX, and BatteryMAX are trademarks of Digital Research Inc. Copyright © 1990, Digital Research Inc.

Reprinted from PC Week May 14, 1990. Copyright © 1990 Ziff Communications Company. Reprinted with permission from The San Francisco Examiner. Copyright © 1990 The San Francisco Examiner.

Circle 92 on Reader Service Card

The affordable HP Laser

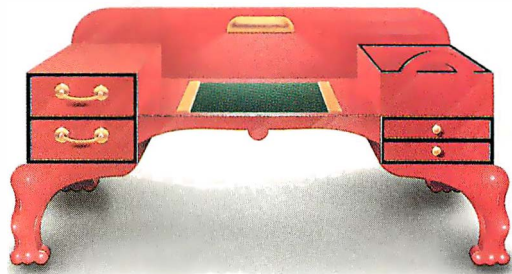
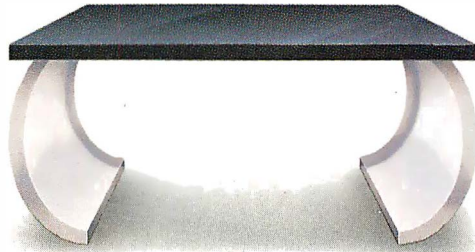

Put an HP LaserJet printer on everyone's desk.

With a list price of \$1,495*, we're now delivering the legendary Hewlett-Packard LaserJet IIP printer at a very personal size and price. Without sacrificing any of the qualities people love in a LaserJet.

You get crisp 300 dpi text and

graphics. Software and hardware compatibility. And a wide selection of HP typefaces and accessory products.



NOW GET AN EXTRA \$195* PAPER CASSETTE FREE!**

Jet IIP can top anyone's hardware.



Plus, there's room to grow, without taking up any more desk space. From our Great Start font cartridge up through scalable type, you can dramatically expand the way people express themselves. You can even add an optional 250-page paper cassette for people who have a lot to say. Or need the flexibility of two paper trays.

What's more, with HP quality built into every printer, you can look forward to smooth operation.

It's no wonder *PC Magazine* gave the HP LaserJet IIP its coveted 1989 and 1990 Editors' Choice awards. Or that *InfoWorld* selected the LaserJet IIP as the 1989 Hardware Product of The Year.

Call 1-800-752-0900, Ext. 1587 for the name of your nearest authorized HP dealer.

You'll find that when it comes to affordable laser printers, nobody can top HP.



Sun's newest progeny couples performance
with innovative software

Son of SPARCstation

The low-end workstation market is in full swing. You now have more choices for under \$15,000 than ever before (see the text boxes "CompuAdd Delivers a Low-Cost SPARCstation" and "Solbourne S400 Outguns SPARCstation 1+"). So why is Sun Microsystems introducing its new SPARCstation 2 series, starting at roughly \$20,000? As with everything, when you cut costs, you also cut corners. Graphics, performance, expandability, ease of use: One or more of these important aspects typically disappears from low-end workstations.

Sun's SPARCstation 2 series shows the

■
Tom Yager
and Ben Smith

company's commitment to the power user. Even at the bottom of the new line, Sun doesn't scrimp on features. Sixteen megabytes of memory is standard (a trend that we hope catches on—you can't do diddly in 8 MB anymore), as are a 40-MHz SPARC CPU, a 200-MB SCSI hard disk drive, three SBus connectors, two serial ports, audio I/O, thick-wire Ethernet, and a SCSI port. The SPARCstation

2GX system we received is the low-end model (see photo 1); nonetheless, it has accelerated color graphics.

A Look Inside

The inside of the SPARCstation 2GX is a study in effective computer design (see photo 2). The motherboard is smaller even than most "baby" AT clone types, with most of the space taken up by single in-line memory module sockets. Four 4-MB modules make up the 2GX's 16 MB of memory. The motherboard has room for 16 such modules for a total of 64 MB; an optional daughterboard can hold another 32 MB for a system total of 96 MB. The motherboard is small by necessity. It has to fit in a pizza box-size case along with up to two 3½-inch SCSI hard disk drives, one 3½-inch floppy disk drive, and a power supply.

The hard disk drives are mounted on plastic brackets that allow easy snap-out removal. The entire case comes apart by removing two screws. There wasn't even enough room in the case for a 50-pin SCSI cable between the two hard disk drives; Sun mounted dual connectors on the motherboard, so both hard disk drives have their own short cables going right to the board.

The 2GX's display controller is mounted on a daughtercard, overlapping another of the expansion slots. Sun claims there are three SBus "slots," which are really just sockets on the motherboard, but our 2GX had only one such socket free—the other two were occupied by the display controller. Outside the case are connectors for two serial devices, SCSI devices, monitor, keyboard/mouse, and audio. The audio connector is a DIN socket, which is where you plug in the microphone/speaker.

In Living Color

The 2GX's display controller accelerates wire-frame operations to what Sun calls "the fastest in the industry" (for the price, we tend to agree), but it also ap-

Photo 1: The Sun SPARCstation 2GX.

This tiny case holds up to 96 MB of memory, two SCSI hard disk drives, and three SBus expansion cards. Access to the 3½-inch floppy disk drive is on the right side. The window system is Sun's OpenWindows, a mix of the X Window System and Sun's NeWS PostScript-compatible extensions.



parently extends its might to the windowing system. It displays 256 colors (from a palette of 16.7 million) at a resolution of 1152 by 900 pixels. Our 2GX came equipped with a 19-inch (76-Hz refresh rate) Sony Trinitron monitor. Images are sharp, corner to corner, an important consideration if you are selling workstations into the contentious advanced graphics market. The SPARCstation 2 line reaches into that very market, with a set of options geared to match the user's level of need. The 2GS offers accelerated three-dimensional solids operations, with a 24-bit main display buffer depth and a 16-bit z-buffer. (Sun claims the 2GS will calculate and display a minimum of 150K-byte 3-D vectors, and 20K-byte solid Gouraud-shaded polygons per second.)

The 2GT, Sun's top of the SPARCstation 2 line, adds hardware antialiasing, a 24-bit z-buffer, double-buffered 24-bit display (for animation), alpha transparency, 8-bit overlay, and a resolution of 1280 by 1024 pixels. Sun claims the 2GT will calculate and display 500K-byte 3-D vectors (or 100K-byte antialiased 3-D vectors) and 100 z-buffered Gouraud-shaded polygons per second, a fivefold increase over the 2GS. (For an explanation of graphics buffering, see "3-D Graphics, from Alpha to Z-Buffer," July BYTE.)

The 2GS and 2GT are targeted at the mid- to high-end graphics market dominated by the likes of Silicon Graphics and Hewlett-Packard. These two companies pack more hardware features into their workstations (e.g., hardware texture mapping and specularity), but Sun's performance numbers are impressive. For the mainstream CAD, CAM, and other design applications users, the 2GS and the 2GT speed up essential operations enough to make complex modeling a snap. In the area of "virtual reality," however, more capable workstations still make a better choice.

From an ordinary user's standpoint, the 2GX's graphics price/performance ratio is excellent. You rarely spend time waiting for windows to draw—they just appear. Moving, resizing, and other window manipulations are similarly speedy. The graphics performance makes the 2GX's operating environment a pleasure, but there's a lot more to Sun systems than just fast hardware.

Gunning for the Mac

Steve Jobs, among other luminaries, has proclaimed the X Window System everything from poorly done to outright "brain damaged." And true enough, on

its own, it lacks functions needed to support modern applications.

But OpenWindows 2.0 is impressive. It is an excellent demonstration of the strengths of Open Look. It is complete, well integrated, and easy to use. Months ago, we had seen beta versions of OpenWindows 2.0 on much smaller machines and were impressed with the speed with which it worked then. It sings on the SPARCstation 2 series.

OpenWindows has, as its root, Sun's X11/NeWS (Network-Extensible Windowing System). NeWS adds PostScript compatibility (Sun's own, not Adobe's) to X Window. X11/NeWS uses a single server to handle both the PostScript and the X11 requests. The compatibility is complete. In our tests, every X application we ran across the network worked perfectly, with the exception of one that tried to take control of the color map. The Open Look Window Manager (olwm) did give up the color OpenWindows' designers, because the Mac is an obvious influence. There is a marvelous

File Manager, and a bundle of other applications called the DeskSet. Out of the box, OpenWindows might not be as easy to use for new users as a Macintosh, but with a bit of effort, system administrators can build a collection of menus and icons that can call out every function of the system without resorting to the shell.

The rest of the operating system is the familiar SunOS, a BSD Unix derivative with some System V libraries and utilities thrown in. SunOS is both a software developer's and a user's playground, not only because it has so much third-party support, but also because Sun provides libraries for all its added layers. As a result, there are tens of thousands of commercial applications for SunOS, a point that has not been missed by Solbourne and CompuAdd.

X Window, NeWS, and Open Look combine to make a powerful graphics application environment, and Sun even includes X Graphics Library (XGL), an X11-based immediate-mode 2-D and 3-D graphics library. This makes the

Photo 2: The inside of the 2GX.

Everything is designed to conserve space, without sacrificing expandability.

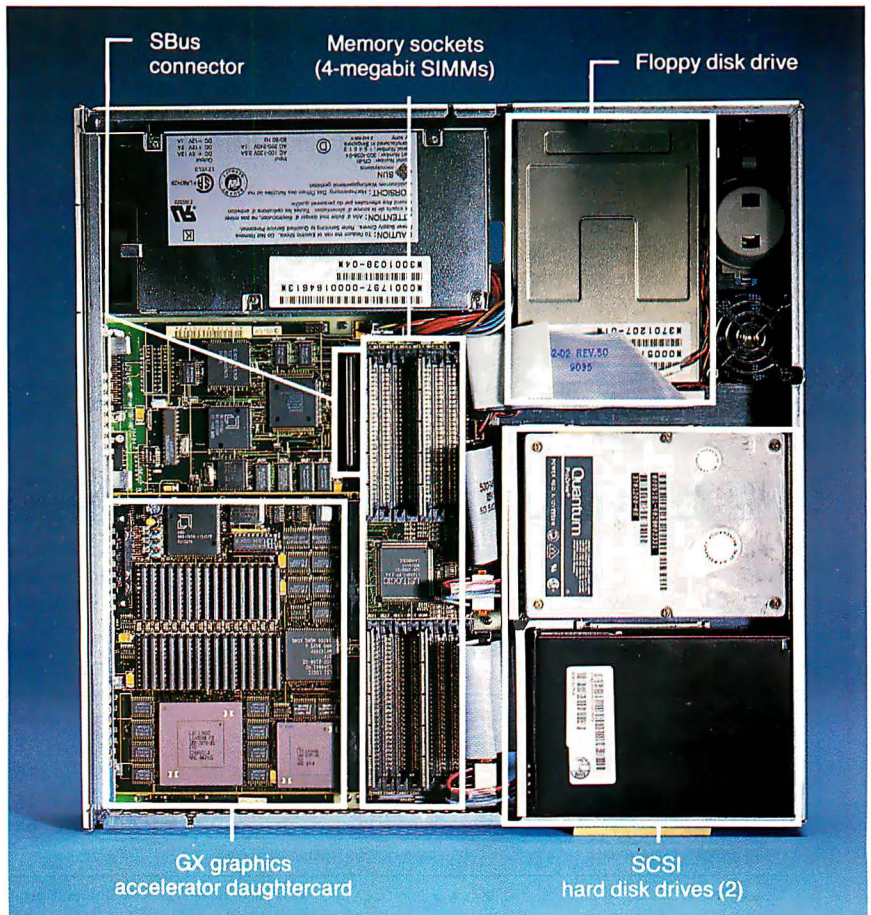

CompuAdd Delivers a Low-Cost SPARCstation

Jon Udell

The SPARCstation 1 lives in the guise of the CompuAdd SS1. CompuAdd uses a metal case, as it hopes to get an FCC class B rating. The SS1 can also accept 5¼-inch storage devices and sports a 100-watt power supply.



A SPARCstation from CompuAdd, the mail-order PC-compatible folks? Yes. CompuAdd's SS1 looks, feels, and, for all intents and purposes, is the original 12.5-million-instruction-per-second SPARCstation 1 that Sun Microsystems discontinued this summer. Differentiation was not the goal here. The SS1 has the same SPARCstation "pizza-box" case. Pop the top, and you'll find the same compact 8½-by-11-inch motherboard. With the same three SBus slots. And the same SPARC chip set: LSI Logic's 20-MHz L64801 integer unit, along with a supporting cast of LSI Logic application-specific ICs handling floating-point, caching, memory management, and DMA chores. Clearly, we've entered the era of the commodity workstation.

Don't feel sheepish if you can't tell the SS1 and the SPARCstation 1 apart. Neither can SunOS 4.1. The SS1 comes bundled with the current release of Sun's hybrid BSD/System V Unix, which boots and runs flawlessly. Any lingering doubts about the SS1's com-

patibility dispel when you run `sundiag`, Sun's low-level diagnostic utility. It probes every hardware nook and cranny: physical and virtual memory, disks, CPU and FPU, and Ethernet. No smoke and mirrors here; the SS1 aces all the tests.

Our prototype system came with 8 megabytes of memory, the standard connectors (SCSI, thick Ethernet, two serial, keyboard, and audio I/O), a 19-inch Moniterm monitor (monochrome, 1152 by 900 pixels), a 3½-inch floppy disk drive, a pair of internal SCSI hard disk drives (105-MB Quantums), and an external 200-MB SCSI drive. Sub-

THE FACTS

CompuAdd SS1
\$5995 and up

CompuAdd
12303 Technology Blvd.
Austin, TX 78727
(800) 531-5475
Inquiry 1067.

tract the disks, and you've got CompuAdd's entry-level system, priced at \$5995. A diskless unit with a 16-inch color monitor and an 8-bit frame buffer will run \$7495, or, with 200-MB of disk storage, \$8695.

How does the CompuAdd stack up against the low end of Sun's SPARC product line? If you're comparing entry-level systems, the SS1 looks like a more expensive (but expandable) version of Sun's \$4995 SLC (see table A). But what about real-world systems with adequate storage and color capabilities? An SS1 with a 200-MB drive and 8-bit color will cost \$1300 less than Sun's comparably equipped IPC, and a whopping \$5800 less than a comparably equipped SPARCstation 1+ (see table B). Of course, both the IPC and the 1+ are 25-MHz machines rated at 15.8 MIPS, so the SS1 does give away some speed. Note also that the CompuAdd prices don't include Sun's OpenWindows, which Sun now bundles with all its SPARC products.

Beyond that, Sun's seemingly anomalous pricing clouds the issue somewhat. Does the 1+'s extra RAM capacity (40 MB versus 24 MB) and third SBus slot make it \$4500 better than the IPC? Sun thinks so, and, following that logic, CompuAdd's three-slot, 64-MB-maximum SS1 looks like a real deal. However, relative to the IPC—assuming you don't plan to grow out of it—CompuAdd's price advantage is less compelling. Either way, though, there's clearly a niche for the SS1.

There are a few minor differences between the SS1 and the 1+. The SS1's entry-level system comes with a larger monitor—19 inches as opposed to 17 inches. The SS1's case is metal, not plastic, and leaves room inside to re-

LOW-END PRICE/FEATURE COMPARISON

Table A: Weighing your performance needs against your budget will determine whether the CompuAdd SS1 is a viable SPARC system choice. Sun provides superior performance, but the SS1 offers three SBus slots and up to 64 MB of RAM. The entry-level systems are diskless and have 8 MB of RAM and a 1152-by-900-pixel display.

	Price	Color?	Monitor	Slots	MIPS	Maximum RAM	GX graphics option?
Sun SLC	\$4995	No	17"	0	12.5	16 MB	No
CompuAdd SS1	\$5995	No	19"	3	12.5	64 MB	Yes
Sun IPC	\$8995	Yes	16"	2	15.8	24 MB	No*
Sun SPARCstation 1+	\$8995	No	17"	3	15.8	40 MB	Yes
Solbourne S4000	\$8995	No	19"	3	25.5	104 MB	Yes

*The IPC has two SBus slots and can theoretically support a GX accelerator. Sun "doesn't support" that configuration.

HIGH-END PRICE/FEATURE COMPARISON

Table B: The high-end systems are configured with a 200-MB hard disk drive, a 16-inch color monitor, and a 1152-by-900-pixel by 256-color graphics display.

	Price	SunOS?	ONC/NFS?	OpenWindows?
CompuAdd SS1	\$8695	Yes	Yes	No
Sun IPC	\$9995	Yes	Yes	Yes
Sun SPARCstation 1+	\$14,599	Yes	Yes	Yes
Solbourne S4000	\$22,495	No	Yes	No

place the 3½-inch floppy disk drive with a 5¼-inch device—for example, a CD-ROM. It has a beefier power supply (100 watts). It also comes with a mechanical mouse instead of Sun's standard optical mouse. Who cares? I do. Last year, a software vendor hauled a Sun system up to BYTE for a demonstration and then found he'd forgotten the optical mouse pad. An hour of hand-waving ensued. Since then, I've viewed optical mice with suspicion.

For demonstration purposes, CompuAdd provided a healthy assortment of applications, including Lotus 1-2-3, AutoCAD, Interleaf's TPS, FrameMaker, and Island Graphics' iWrite, iPaint, and iDraw. The arrival of 1-2-3 and AutoCAD legitimized the SPARCstation in the eyes of many people. The availability of popular PC spreadsheet and CAD software makes SPARC machines seem less exotic. Meanwhile, programs like TPS and FrameMaker—designed, built, and targeted to run on high-performance workstations—make SPARC more desirable. That's the push-pull dynamic that Sun hopes will carry its latest low-end machines beyond the technical arena and into the much larger commercial realm. CompuAdd, gambling on the success of that strategy, plans to ride along in Sun's slipstream.

A Basketful of GUIs

Unix is a real face-dancer these days, and on the CompuAdd I had a chance to try out several of its current manifestations. The SS1 will ship with SunView, the original Sun graphical user interface. It's awkward and dated, but more SPARC programs today support SunView than support any other GUI. Although CompuAdd won't be bundling OpenWindows, the X11/NeWS/Open Look amalgam that is Sun's new standard, our prototype SS1 came with OpenWindows 2.0. (OpenWindows

will be available separately from CompuAdd, but the company hadn't yet decided on a price. You can get it directly from Sun for \$295.) OpenWindows runs a pair of networkable window servers—X Window and NeWS—under the control of the Open Look window manager. The servers can cooperate so that, for example, X applications can use NeWS's scalable fonts. Too bad that only Sun and Silicon Graphics seem to take NeWS seriously. Its PostScript imaging model adds a lot of spice to a window system.

OpenWindows tolerates SunView applications, albeit grumpily. I was able to run Interleaf in a SunView window, alongside X11 and NeWS windows. The SunView windows kept getting stuck in the foreground, though, and things never seemed quite right. Clearly there's some distance to go yet before SPARC machines will be able to lay claim to the seamless support of a large software base that characterizes the Macintosh and, to a lesser extent, Microsoft Windows.

On the other hand, I'm more and more impressed by the ease with which Unix machines communicate—over both LANs and wide-area networks. This, more than cosmetics, will be what drives commercial acceptance of Unix. CompuAdd, a vendor of PC and Mac equipment, understands that its customers increasingly want to build heterogeneous networks, and that Unix can help glue such networks together. You want Macs in the art department and PCs everywhere else, all hooked up to a couple of SPARCstations acting as file servers and typesetting workstations? No problem. It will be one-stop shopping from CompuAdd.

Jon Udell is a BYTE senior editor at large. You can reach him on BIX as "judell."

power of the graphics hardware available to the developer, and it smooths over the differences between SPARCstation 2 models, but the developer needs to compile with different versions of the library for different graphics levels of the SPARCstation 2 series.

Over the Line

As we mentioned, Sun's selection of X Window as its graphics environment base makes connectivity across platforms almost automatic, but only in one direction. Ordinary X applications run without difficulty under OpenWindows, either locally or across network connections, but running OpenWindows applications that use NeWS, Open Look, or other extensions require those extensions on the displaying system. It is possible to write OpenWindows applications that don't require fancy software on the display server, but that would mean stripping out some of the things that make OpenWindows special. Developers should not resort to this, because Sun's low-end monochrome and color workstations also run OpenWindows.

When you can attach a fully compatible diskless node for under \$5000 (the Sun SLC), the lack of ability to exploit the window system's full potential on an X terminal or PC X server becomes unimportant. Sun has even rolled its GX graphics accelerator into its SPARCstation IPC, making that (according to Sun) the lowest-cost high-speed color workstation.

Being a Sun system, the SPARCstation 2 series systems come loaded with TCP/IP, NFS, and NIS (the Network Information Service, previously known as Yellow Pages). We had no trouble at all getting the 2GX talking to all the systems in the BYTE Unix Lab. X applications like xterm and ico, which didn't use Open Look fonts or services, ran fine across the wire, and remote log-ins and NFS activities proceeded without a hitch.

The Whole Enchilada

Sun is still the top dog in workstations. Systems like the SPARCstation 2 series offer proof that the number one spot is likely to be Sun's domain for some time. The SPARCstation 2 series' design is remarkable throughout, from its downsized desktop case to Sun's imaginative approach to operating environments. It seems perfectly suited to both demanding graphics applications and typical business fare.

Sun provided demonstration versions of many applications, including FrameMaker, WingZ, and iPaint, iDraw, and

Solbourne S4000 Outguns SPARCstation 1 +

Owen Linderholm

The quiet-running Solbourne S4000 offers an estimated 20 percent performance increase over the Sun SPARCstation 1 +.



Solbourne Computer, one of the first companies to license and build SPARC-compatible systems, has mostly concentrated on the high end with high-powered server systems. However, the company, along with its Japanese partner, Matsushita, has had the goal of building a desktop SPARC system based around a highly integrated SPARC processor of its own design. The Solbourne S4000 is that system (see the photo).

The S4000 is based around a custom SPARC chip codeveloped by Matsushita and Solbourne. The MN10501 chip uses 64-bit data paths throughout, making it the first fully 64-bit SPARC processor. It incorporates a floating-point unit (FPU), memory management unit, cache controller, and memory, making it one of the most highly integrated SPARC processors available. The on-chip cache is 8K bytes of direct-mapped physical instruction and data cache. The memory bus used by the chip is 64 bits wide and transfers data at a rate of 60 megabytes per second. Solbourne and Matsushita have been working on this processor since Solbourne first announced its intentions to make SPARC-compatible systems.

The 33-MHz processor achieves a MIPS rating of 25.5 and a SPECmark of 12. This makes it about 20 percent faster than the SUN SPARCstation 1+. The FPU and integer units within the chip operate asynchronously, and each has separate registers. Separate instruction and data caches, 64-bit data paths to the caches, and the ability to do load and store operations in a single clock cycle make the chip operate fast.

The base system (\$8995) includes 8 MB of RAM and can be expanded up to 104 MB in 8- or 32-MB increments using 1-MB single in-line memory modules. The S4000 comes with three SBus slots operating at 25 MHz. It includes an Ethernet port, two RS-423A serial ports, 8-kHz audio with an internal speaker, and various SCSI mass storage options. Supplied with the system is a 107-key PC-style keyboard, which seemed lightweight compared to Sun's keyboard, and an optical three-button mouse. During the boot process, an LED on the front of the unit changes color at each phase. Should the boot fail, the color of the LED will tell you at what point the problem occurred.

The S4000 can hold either one or two 3½-inch full-height, SCSI hard disk drives, each with 200 MB of storage space. The system can also optionally have a single 3½-inch floppy disk drive. The system box measures 17 by 17 inches and is a little over 3 inches tall.

The system board is only 9 by 11 inches, which leaves room for considerable expansion inside the system. The size was achieved by the integration of the processor and using four custom

ASICs for glue logic, peripheral, and memory control. Installing the full complement of RAM, however, limits mass storage expansion options to a single 200-MB hard disk drive. The result is that users must make a trade-off between memory storage available and mass storage available, a trade-off that may be difficult to make in some cases.

The design of the system is very clean. It consists of six field replaceable modules, so that if problems occur, modules can be rapidly removed and replaced with repaired or new parts in the field. All that you need to do is unscrew seven screws to strip the machine.

The Solbourne's operating system is OS/MP 4.0D, a SunOS 4.0.3 derivative that includes NFS, ONC, TCP/IP, Sun-View, X Window, the Solbourne Window Manager and options for GKS graphics, PEX (Phigs Extensions to X Window), Solbourne Phigs, and a DOS emulator. The Window Manager has a "virtual desktop" feature that effectively expands your work area beyond the screen's boundaries. A box in the lower right corner shows available OpenWindows. This box is live; move the cursor into it, and you can select what you need. A "hammer and nail" feature lets you tack a window in place, so no matter where you move on the virtual desktop, that window remains in view.

There are many graphics options for accelerated two-dimensional and three-dimensional graphics. Standard graphics are monochrome on a 19-inch monitor with 1152 by 900 pixels and a 1-bit-per-pixel frame buffer.

Standard color options include a 16- or 19-inch monitor displaying 1152 by 900 pixels with an 8-bit color storage frame buffer and a 2-bit overlay frame buffer. This allows up to 256 colors from a palette of over 16 million. A high-resolution color option is also available with a 19-inch monitor and a display of 1280 by 1024 pixels with two color maps, each providing 256 colors from a palette of over 16 million.

An advanced color option includes an accelerated color frame buffer known as SBus Graphics Accelerator (SGA), which can have an optional piggyback z-buffer daughtercard to accelerate hidden pixel removal. An eight-plane version, the SGA40, uses two SBus slots.

THE FACTS

Solbourne S4000
\$8995 and up

Solbourne Computer, Inc.
1900 Pike Rd.
Longmont, CO 80501
(303) 772-3400
Inquiry 1068.

Database Users Respond To Queries

Users vote ORACLE number one in five important user polls.

In a series of recent polls, Oracle's products were ranked number one by five magazines representing over four hundred thousand readers. Leading to only one conclusion: Oracle's database and networking products are the best solutions for the widest variety of PC and Mac users.

The readers of both DATA BASED ADVISOR and DBMS Magazine named Professional ORACLE Tools and Database the best SQL-based database. The readers of VARBUSINESS,

who should know something about developing applications, named it the best applications software. And Government Computer News cited reliability, compatibility and speed as some of the reasons they awarded Professional ORACLE Tools and Database the number one data manager for local area networks.

ORACLE for Macintosh received its share of acclaim from InfoWorld readers, who named it Macintosh Product of the Year.

Info World readers also

named Oracle's newest desktop product, ORACLE Server for OS/2, product of the year. As did subscribers of DBMS Magazine, who rated ORACLE Server for OS/2 the best database server.

Call 1-800-633-0498 Ext. 4905 to order or sign up for the free Oracle Client-Server Forum in your area. And see what kind of software generates this kind of hardware.

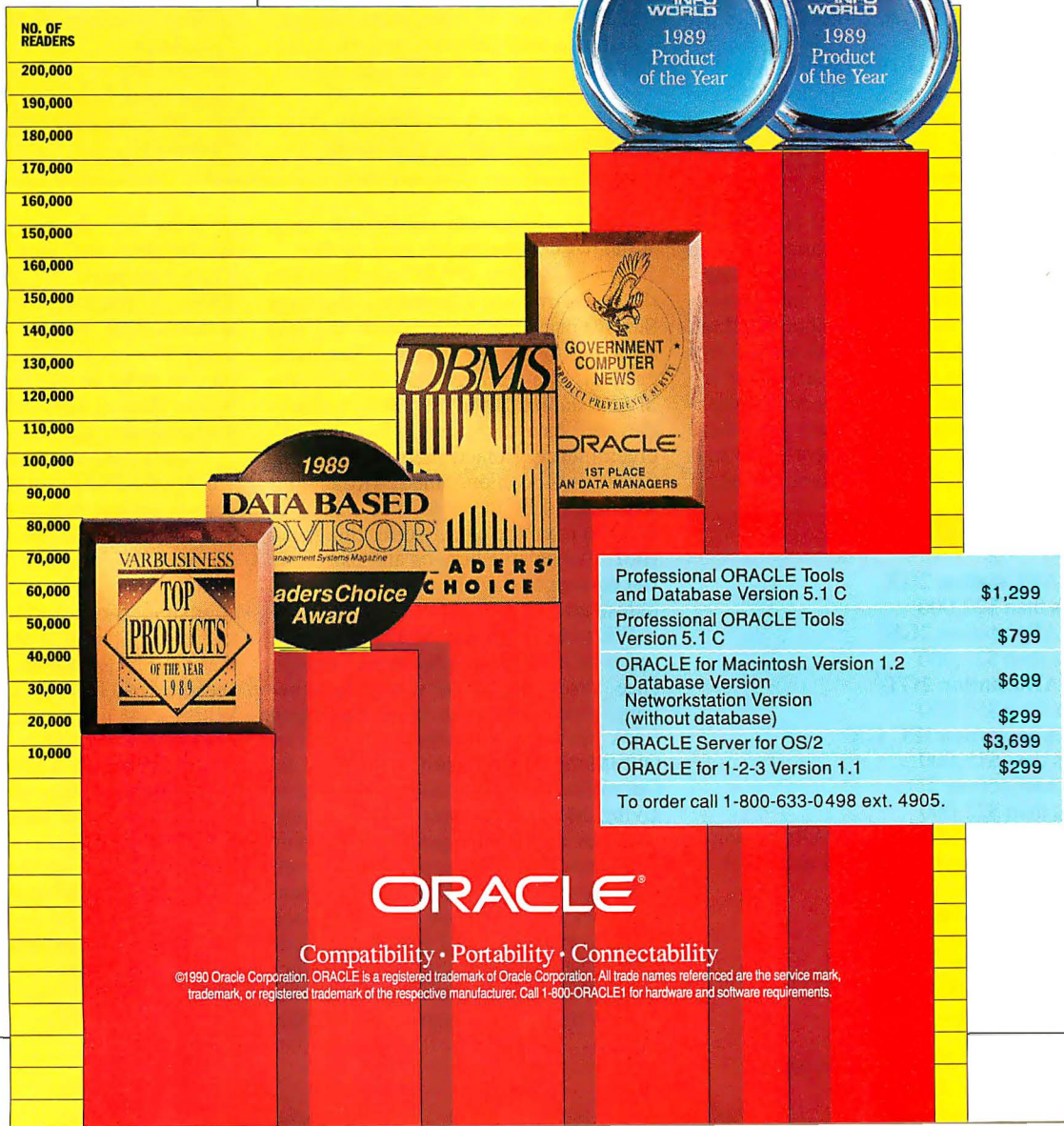

Professional ORACLE Tools and Database Version 5.1 C	\$1,299
Professional ORACLE Tools Version 5.1 C	\$799
ORACLE for Macintosh Version 1.2 Database Version	\$699
Networkstation Version (without database)	\$299
ORACLE Server for OS/2	\$3,699
ORACLE for 1-2-3 Version 1.1	\$299
To order call 1-800-633-0498 ext. 4905.	

ORACLE®

Compatibility • Portability • Connectability

©1990 Oracle Corporation. ORACLE is a registered trademark of Oracle Corporation. All trade names referenced are the service mark, trademark, or registered trademark of the respective manufacturer. Call 1-800-ORACLE1 for hardware and software requirements.

Solbourne S4000 *(continued)*

Solbourne expects a 24-plane version to be available in early 1991.

Many hardware graphics accelerators for Unix systems put X Window primitives in hardware to speed them up. Solbourne goes beyond this by putting both X Window and PEX graphics primitives in microcode on these boards to dramatically improve the system's 2-D and 3-D performance in these environments. Graphics information is stored in main memory and is pageable. The SGA accelerator board has direct memory access across the SBus to this information, so there is no work for the CPU to do in supplying the graphics information to the SGA, resulting in improved performance. The SGA board also uses two digital signal processing chips to implement a graphics transform engine that runs at a peak of 50 million floating-point operations per second. One part of the board implements a fast rectangle area fill at 240,000 pixels per second.

Some of the functions handled in microcode on the SGA include 2-D and 3-D line drawing with line styles and perspective and depth cues; 2-D poly-

gon pattern fills; 3-D polygons with strips, meshes, Bézier patches, Gouraud shading and hidden surface removal; an illumination model with eight light sources; BitBlit and dithering; and multiple color maps.

Solbourne claims that the SGA40 accelerator can draw 450,000 lines per second in 2-D operations, 200,000 lines per second in 3-D operations, and can draw 10,000 Gouraud shaded polygons per second. The SGA has direct memory access to graphics information that is stored in main memory, so that the CPU and the SGA can operate in parallel.

The S4000 with a 16-inch color monitor, 8 MB of RAM, and no disk drives costs \$11,495; it costs \$13,995 with the SGA40. A 19-inch color system with 16 MB of RAM, a 200-MB hard disk drive, a floppy disk drive, and the SGA40 with the z-buffer option costs \$22,495. (See the tables in the text box "CompuAdd Delivers a Low-Cost SPARCstation" for price and feature comparisons.)

The basic Solbourne S4000 is an \$8995 monochrome SPARCstation 1+

clone that runs faster. It can also be expanded far more than other SPARC systems in this price range. In fact, internal memory expansion can go beyond that of the SPARCstation 2 series. The operating software is not pure SunOS. It is, however, derived from SunOS and should be highly compatible with it. At the high end, the S4000 with full graphics options costs a little more than a Sun SPARCstation 1+ or IPC with GX graphics, but it also outperforms them considerably. In fact, some of its graphics features can be compared to those in the new SPARCstation 2 line.

All in all, the S4000 line is a very flexible and expandable one that makes a great deal of sense. It starts relatively cheap but with good performance. It expands easily to a very respectable level of performance, still with a good price. This level of flexibility should help Solbourne in the years ahead, where there is likely to be an explosion of SPARCstation clones.

Owen Linderholm is a BYTE news editor. You can contact him on BIX as "owenl."

iWrite. These programs all take advantage of the unique environment created by OpenWindows, and the system's performance makes them fast and glamorous. Any PC user enamored of Windows 3.0 or X Window on a VGA should feel like the horse-and-buggy driver at the dawn of the automobile. There are graphics environments that just get you where you're going, and then there's the real thing. Workstations still have that sewn

THE FACTS

SPARCstation 2GX

less than \$22,000

SPARCstation 2GS

less than \$27,000

SPARCstation 2GT

less than \$52,000

SPARCstation IPC GX

less than \$15,000

SPARCserver 2

less than \$22,000

(Upgrades available for SPARCstation and SPARCserver system 1 and 1+.)

Sun Microsystems, Inc.

2550 Garcia Ave.

Mountain View, CA 94043

(415) 960-1300

Inquiry 1066.

up, along with the Macintosh, and OpenWindows widens the gap even farther.

Although other SPARC machines like the Solbourne and CompuAdd challenge Sun for price and performance and take advantage of the abundance of Sun applications, they are attacking only the SPARCstation 1 and 1+. It is unlikely they will have a negative effect on Sun's preeminence. In fact, their presence fortifies Sun's position. Sun SPARCstations will not suffer the same fate that IBM PCs did from the clone world. Sun is not IBM; Sun is still hungry and can move fast enough to stay ahead of the spawned industries.

Working with the SPARCstation 2 series is almost an educational experience, disproving some widely held beliefs. First, those who insist that Open Look has been murdered in its sleep by OSF/Motif should feast their eyes on OpenWindows. OSF has been quicker in giving Motif more press coverage and (perhaps as a result) getting it on more machines, but more applications developers have gone with Open Look. OpenWindows 2 is X Window and Open Look taken to their best and most logical potential. Second, even though the line between PCs and workstations is getting blurrier by the day, systems like the 2GX

(and the IPC, for that matter) prove that workstations still have an edge over even Unix-equipped personal computers. Third, X Window is *not* unsuitable as an environment for demanding applications. If a vendor takes the time, as Sun has, to build on the base that MIT provides, then X applications can be fast, feature-laden, and easy to use.

Some systems are trendsetters. Just as the Apollo 2500 gave the low-end workstation market reason to exist, the Sun SPARCstation 2 series redefines the mid-range. And since Sun is the unquestionable leader of the workstation world, responsible for introducing workstation technology that sets standards, we hope that the SPARCstation 2 series signals a veering away from the cutting of corners. While some users may want the world's cheapest workstation on their desks, others can afford, and demand, the traditional performance, effortless networking, and software leadership that make the term *workstation* mean something. Two thumbs up for the SPARCstation 2 series and OpenWindows 2.0. ■

Tom Yager and Ben Smith are BYTE technical editors. You can contact them on BIX as "tyager" and "bensmith," respectively.



Captain Midnight's
SECRET SQUADRON
 NEW OFFICIAL CODE
 AND MANUAL
 for 1948

Still writing code with the same old tools?

You're only as good as the tools you use. An excellent reason to acquire the new Microsoft® Windows™ Software Development Kit. Tools tailor-made to build applications for the huge new Windows market.



Including a specially made CodeView® debugger for Windows that easily debugs even the largest applications.

And all the "how to" help you'll ever need—from the extensive hard copy and online documentation to the sample source code to the comprehensive IBM® CUA style guide.

Plus some sophisticated analysis tools and improved resource editors.

All of which suggests that if you're not

using our SDK, then you're trying to write tomorrow's programs with yesterday's tools.

But that's a situation you can easily fix with the following official code numbers:

(800) 323-3577, Dept. M24.

Call now to update your old kit with the Windows version 3.0 SDK at \$150 per kit. Or call us just to answer your questions.

The sooner you dial, the sooner you can really go to work on Windows apps.

Instead of just toying around with them.

(800) 323-3577

Microsoft®
 Making it all make sense™

Offer good only in the 50 United States. Payment in U.S. funds (plus a \$7.50 shipping and handling fee and applicable sales tax). Please allow two to four weeks for delivery. ©1990 Microsoft Corporation. All rights reserved. Microsoft, CodeView and the Microsoft logo are registered trademarks and Making it all make sense and Windows are trademarks of Microsoft Corporation. IBM is a registered trademark of International Business Machines Corporation. CAPTAIN MIDNIGHT is the registered trademark of Sandoz Nutrition Corporation which does not endorse the Windows SDK and is not affiliated with Microsoft.

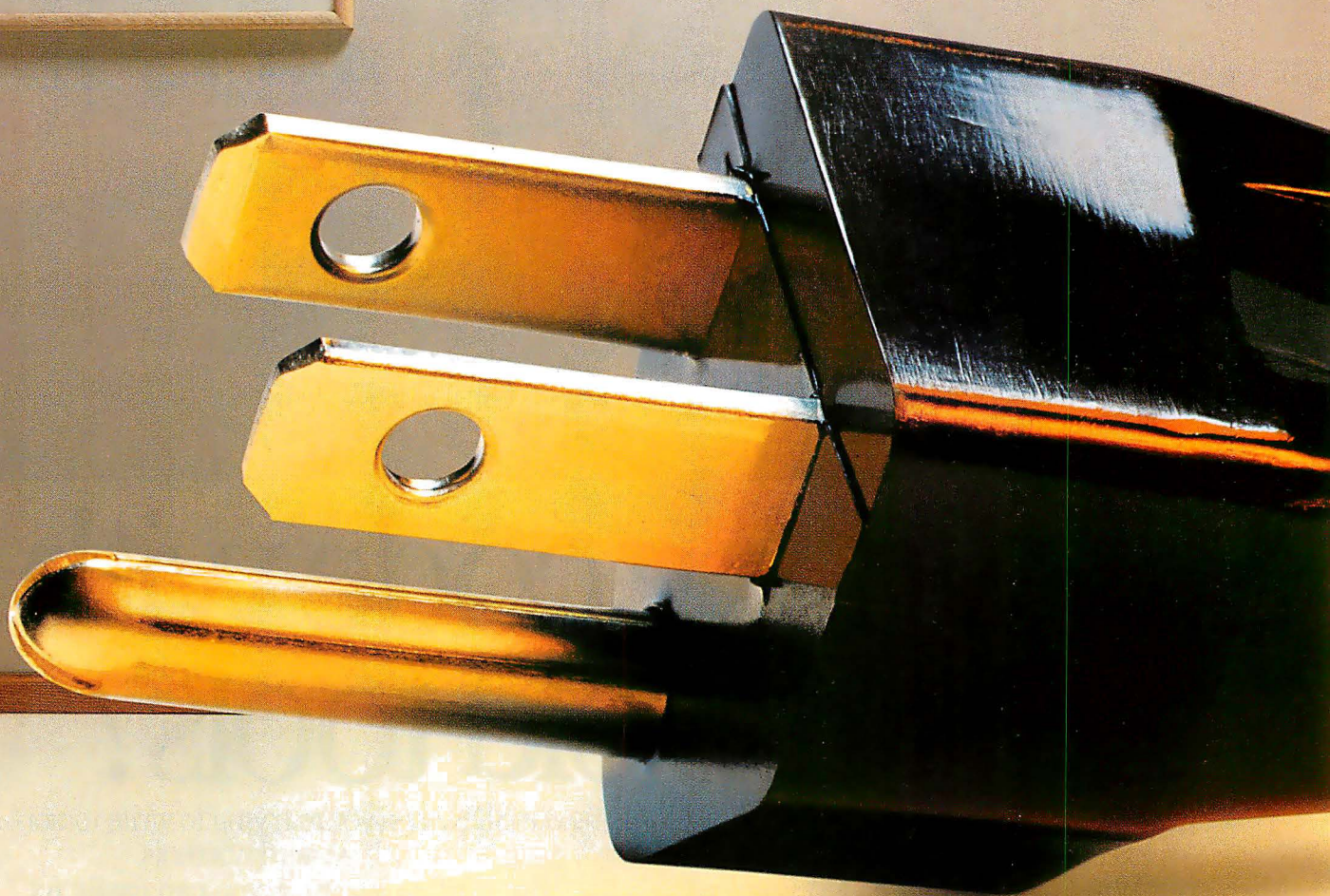

The 486™ PC. It may be a little

486™ Never before has this much power been plugged into a business PC.

Presenting the Intel 486 microprocessor—a veritable powerhouse that's been harnessed for business.

A 486 microprocessor-based PC has everything it takes to run today's high-powered applications. And run them the way you need to—simultaneously and at lightning speed.

Plus, it's compatible with the hard-

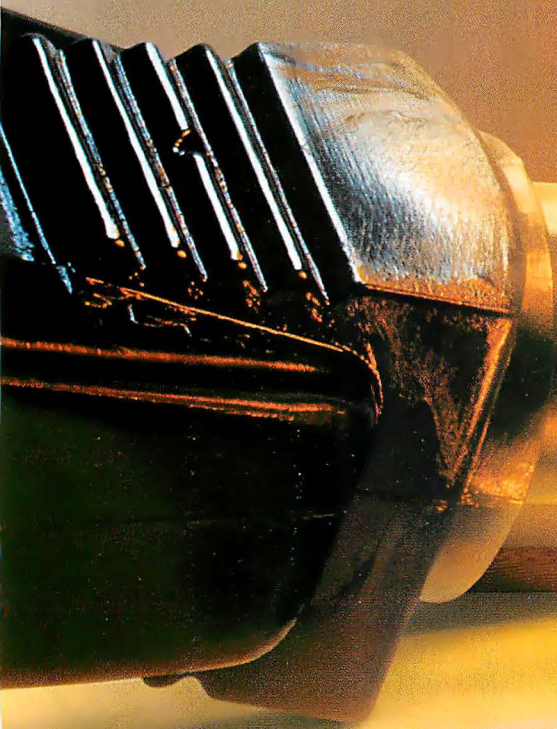
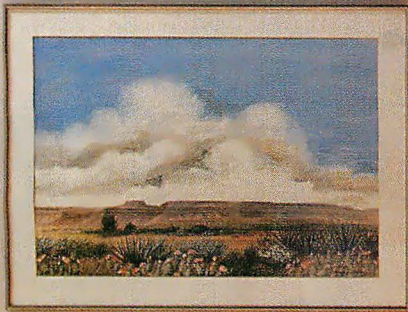

more power than you're used to.

ware and business applications you already own, so you won't spend any extra time or money on training.

The 486 PC. Plug it in and start shocking the corporate world.

For additional information, call

1-800-548-4725 and ask for "The 486 Micro-processor Means Business" brochure.

intel[®]

The Computer Inside.™

486 is a trademark of Intel Corporation.

Circle 356 on Reader Service Card (RESELLERS: 357)

Applause.

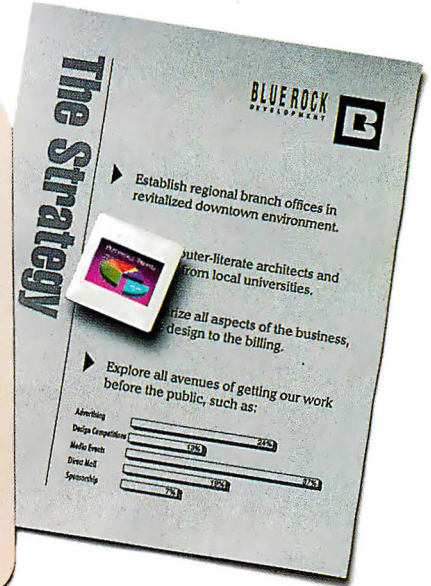
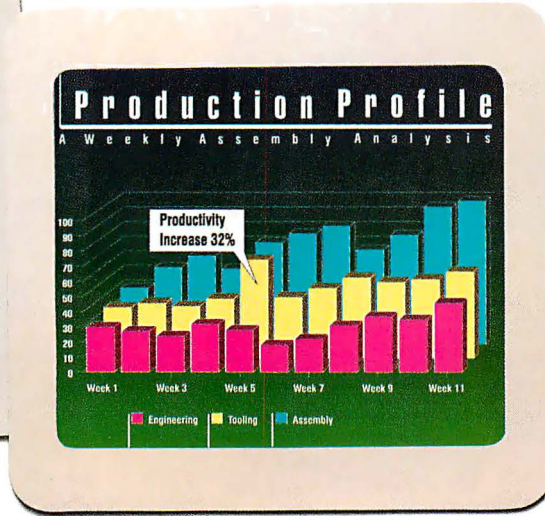

Bravos. Cheers. Hurrahs.

We found APPLAUSE II to be easier to work with than either Harvard Graphics or Freelance Plus, and faster than the Windows-based products.

INFOWORLD
JUNE 11, 1990

APPLAUSE II handles charting, drawing, and on-screen presentations with a fluidity and ease-of-use not found in either Harvard Graphics or Freelance Plus—and it does all this in a mere 512K.

PC MAGAZINE MARCH 13, 1990

PC/COMPUTING APRIL 1, 1990

It's graphical. It's interactive. It makes excellent use of the mouse. Best of all, it abandons the stodgy fill-in-the-form approach to creating charts that is used by Freelance, Harvard and 35mm Express.

The critics are raving about its ease-of-use and intuitive "Windows"-like interface. And how APPLAUSE II™ turns data into 37 different chart types automatically. In black and white or 3.6 million colors. Creating everything from dazzling overheads, slides and on-screen presentations to

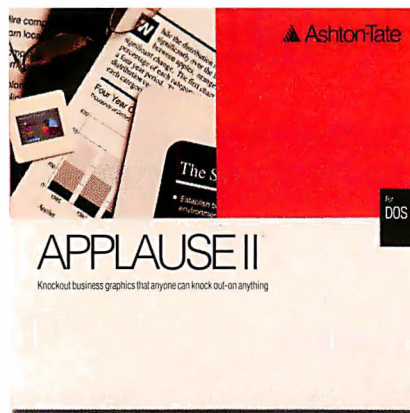

high-impact hard copy.

To find out more, call 1-800-437-4329 ext. 1308 for a free video and eye-opening demonstration disk.*

And see why the critics are giving APPLAUSE II a standing ovation.

Ashton-Tate®

*Requires either EGA or VGA card and monitor. Trademark/owners: APPLAUSE II, Ashton-Tate, Ashton-Tate Logo/Ashton-Tate Corp. Other product and publication names used herein are for identification purposes only and may be trademarks of their respective companies. ©1990 Ashton-Tate Corporation. All rights reserved.

Suddenly, Everything's Smaller in Texas

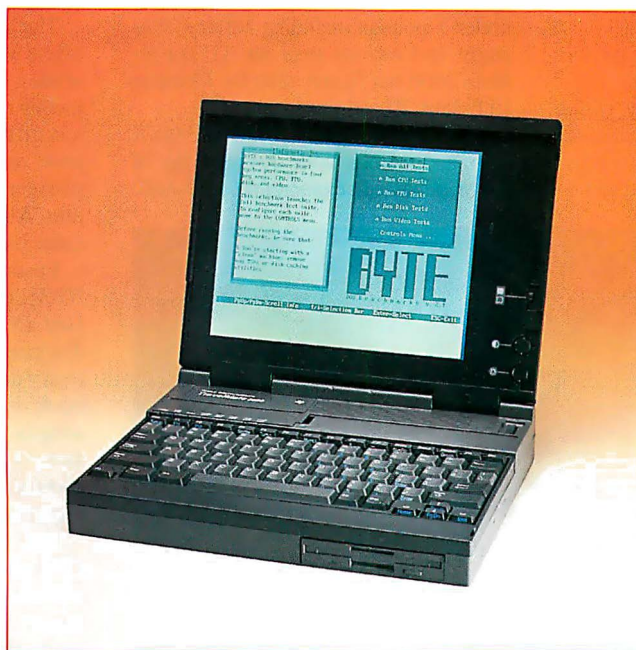

In Texas, where everything is larger than life, they suddenly seem to have a knack for designing computers that are especially small. Hard on the heels of the Compaq LTE 386s/20 comes a new 386SX notebook from Texas Instruments (TI) called the TravelMate (TM) 3000. This petite powerhouse from Dallas undercuts its rival from Houston: The overall performance is somewhat lower, but the TI notebook is almost 2 pounds lighter and has a list price that's \$1000 less.

The compact size and weight of the new TI notebook system are not surprising, since it follows in the wake of the company's impressive TravelMate 2000. This lightweight notebook, codeveloped with Sharp and also sold by CompuAdd, includes a 286 processor and a hard disk drive, yet it weighs under 4½ pounds.

The TM 3000, along with similar notebooks from Compaq, Epson, and Toshiba (see the text box "Toshiba and

TI's new 386SX
notebook weighs
less than 6 pounds

■
Andrew Reinhardt

The Texas Instruments TravelMate 3000 packs a 20-MHz 386SX, floppy and hard disk drives, and a VGA screen into a box three-quarters the size of the Manhattan yellow pages.

Epson Join SX Notebook Club" on page 152), is part of a new wave of computers that combine compact size with 386 performance and compatibility. The jump to the 386 has brought other improvements as well. In the LTE 386s/20, Compaq erased a drawback of its earlier 8086 and 286 LTEs, the lack of VGA graphics. TI has likewise solved the problems of the TM 2000 by adding to the TM 3000 a floppy disk drive, better screen contrast, conventional I/O ports (instead of the miniature ports used before), and 50 percent longer battery life, the company says.

The TM 3000 uses the 20-MHz version of the 386SX, boasts a VGA-resolution display, and includes both a floppy disk drive and a hard disk drive. All this power is packed into an 8½- by 11-inch case less than 2 inches high and weighing a comfortable 5¾ pounds, including the battery. To top it off, TI tosses in some snazzy software utilities and offers a

Toshiba and Epson Join SX Notebook Club

Designers from Texas are not the only ones shrinking 386SX computers into notebooks. Toshiba, whose T1000 practically defined the early notebook, and Epson, a quiet but long-time player in the laptop market, have both announced plans to produce SX machines in svelte form factors.

Both machines were announced too late for a hands-on evaluation, but their specifications indicate that they could be contenders in the market, assuming that pricing (which was unannounced at press time) is in line with their some-

what lower performance.

The Toshiba T2000SX, scheduled to be available in January 1991, looks like a cross between the company's existing 286-based T1200XE notebook and its T3100SX laptop. Measuring 10 by 12 by 2 inches and weighing in at just under 7 pounds including battery, it is larger and heavier than the TI TravelMate 3000 but lighter than the Compaq LTE 386s/20.

The T2000SX uses a 16-MHz 386SX chip and comes with 1 megabyte of RAM standard, expandable to 9 MB.

An 80387SX coprocessor is optional. Both a 3½-inch 1.44-MB floppy disk drive and a hard disk drive are built into the system; initially, only a 20-MB hard disk drive will be available, but Toshiba eventually plans to offer a 40-MB drive as standard.

The edge-lit supertwist nematic LCD offers VGA-resolution graphics with 16 shades of gray but measures only 8½ inches diagonally. Serial, parallel, external monitor, and numeric keypad ports are included, and there is an expansion bus for a desktop docking station. A slot for an optional modem is located under the machine.

Epson announced its machine, the NB3s, cautiously: Although it was the first SX notebook to be unveiled, Epson disclosed neither prices nor a firm delivery date. However, on paper the notebook looks impressive. It reportedly weighs just under 6 pounds and measures 8½ by 11¾ by 1¾ inches, or about a tenth of a pound and 1 cubic inch more than the TI TravelMate 3000.

The NB3s uses a 16-MHz 386SX CPU and can hold up to 5 MB of internal RAM and an optional math coprocessor. The base memory configuration has not been announced, but it will likely be 1 or 2 MB of RAM. For mass storage, both a 3½-inch floppy disk drive and a 20- or 40-MB hard disk drive are included. The backlit, black-on-white LCD offers VGA resolution with 16 levels of gray. Standard I/O ports include serial, parallel, external CRT, and numeric keypad.

One of the most distinctive aspects of the Epson notebook is its desktop docking station, which, in addition to two full-size AT-bus slots, offers bays for up to 120 MB of mass storage and support for a 101-key keyboard. The docking station itself is only 3⅓ pounds, so the notebook and base combined weigh less than 10 pounds. The NB3s is slated to ship before the end of this year.



The Toshiba T2000SX is a little larger than the Texas Instruments TravelMate 3000 and uses a 16-MHz 386SX. It has the same keyboard as the Toshiba T3100SX.

keyboard that I believe is superior to that of the LTE.

Power to Go

The TM 3000's 20-MHz 386SX CPU has enough horsepower to run demand-

ing applications while on the road, including software written specifically for the 386 instruction set. An 80387SX math coprocessor is an option, although it was not installed in the unit I evaluated. Preliminary BYTE benchmarks

rate the CPU performance at 2.75 times the speed of an IBM AT, which is a tad faster than the Compaq LTE 386s/20 and most of the deskbound 20-MHz SX machines that BYTE has reviewed so far.

The system is supplied with 2 MB of

RAM, expandable on the motherboard in 2-MB increments up to 6 MB. For mass storage, one of two 2½-inch Conner Peripherals hard disk drives is available: a 20-MB drive with a 23-millisecond average access time or a 19-ms 40-MB drive. A 3½-inch 1.44-MB floppy disk drive is located on the front of the system.

On the BYTE benchmarks, the 20-MB drive turned in a disk I/O rating of 1.60, or about 70 percent as fast as the LTE's drive. But TI supplies a disk-caching utility that boosts performance and saves battery life; with a 64K-byte cache installed in extended memory, the benchmark index rose to 1.80. It should be noted that the drives for the Compaq notebook are available in 30- and 60-MB capacities; TI plans to offer a 60-MB version in the second quarter of 1991.

The TM 3000's display is a triple supertwist nematic LCD measuring 10 inches diagonally. It is switchable between black on white or white on black via a toggle. While it is essentially the same screen used in the TM 2000, TI says that engineering refinements have produced blacker blacks and better contrast.

The screen offers 640- by 480-pixel VGA resolution with a 32-gray-shade palette (16 shades visible at a time) using the Chips & Technologies VGA chip and Quadtel VGA BIOS. It is lit from the side by a single cold-cathode fluorescent tube, yet I found it very crisp and legible in a variety of lighting conditions. The only drawback is performance: The video subsystem posted a rating of 5.31 in the BYTE benchmarks, versus 8.00 for the LTE 386s/20.

What the display and hard disk drive lack in zip, the keyboard makes up for in comfort. The TM 3000 has a 79-key keyboard with 10 function keys on the top row (F11 and F12 are accessed with an Fn key) and an embedded numeric pad superimposed on the alpha keys. Separate cursor-movement keys are arranged in an inverted T on the lower right side of the keyboard. I found typing on the TM 3000 much easier than on an LTE: the keys have a good "clicky" feel and adequate travel, and I greatly prefer the arrangement of the arrow keys to the awkward reclined-L pattern on the LTE.

To connect the TM 3000 to the outside world, TI provides standard I/O ports (i.e., parallel, serial, PS/2 mouse, and external VGA monitor), grouped behind a hinged door on the left side of the computer. Also on the left is a proprietary slot for an optional 2400-bps internal modem. On the right side is a mini-connector for an optional numeric key-

BENCHMARK RESULTS			
<i>Preliminary BYTE Lab benchmark results indicate that the new TI notebook computer has a fast CPU index compared to other 20-MHz 386SX systems, but disk and video performance are mediocre. All benchmark indexes show performance relative to an 8-MHz IBM AT; higher numbers are better.</i>			
System	CPU	Disk I/O	Video
TI TravelMate 3000	2.75	1.60	5.31
Compaq LTE 386s/20	2.58	2.32	8.00
Dell 320LX	2.19	1.86	7.10
NEC ProSpeed SX/20	2.05	1.11	5.33

pad, and on the back is another miniport for connecting to a desktop base station.

The base station is the same one offered for the TM 2000 except for a different adapter to accommodate the greater height of the TM 3000. It contains 1½ AT-bus slots for add-in cards, a 3½-inch storage bay, and a power supply to drive both the notebook and the expansion chassis. The base station is scheduled to be available in December, but TI hasn't yet announced a price.

A Power Boost

Notebook computers push the envelope in power management, because designers have to squeeze the maximum operating time out of the smallest possible battery. Although the TM 3000 uses about twice as much power as the TM 2000, TI has managed through improved power engineering and a variety of software utilities to boost run time by 50 percent, from 2 hours to 3. I wasn't able to verify this claim because my evaluation unit had some power glitches.

The TM 3000 uses removable, rechargeable nickel-cadmium batteries that together weigh about 1 pound. (Without the batteries, the system weighs only 4⅓ pounds, or about one-third of a pound more than the NEC UltraLite.) TI says that the batteries can be recharged inside the computer in 3 to 4 hours when it is not in use. An external charger will also be available.

THE FACTS

TravelMate 3000

with 20-MB hard disk drive, \$5499
with 40-MB hard disk drive, \$5999

Texas Instruments, Inc.
Information Technology Group
P.O. Box 202230, ITG-065
Austin, TX 78720
(800) 527-3500
Inquiry 1076.

To prolong operating time, TI integrated many of the TM 3000's functions into low-power application-specific ICs. CPU speed drops automatically from 20 MHz to 8 MHz when the system is idle, and a software utility called BatteryPro induces processor wait cycles when the CPU is holding for keyboard entry or I/O. These techniques alone can save 20 percent to 25 percent of battery life, TI says. Other utilities included with the TM 3000 let the user specify time intervals for blanking the screen and powering down the hard disk drive. The system also includes BatteryWatch from Traveling Software.

Swimming with Sharps

TI produced the TM 2000 in conjunction with Sharp, which sells the same machine under the name PC 6220, but Sharp did most of the engineering work. With the TM 3000, that situation is reversed: TI did the design near Dallas, and the machine will likely be relabeled and sold by Sharp as well. This alone is a clear indication of TI's engineering prowess. That TI was also able to match and even beat Compaq at a game the latter has made a specialty bodes well for TI's future in notebooks.

Then there is the price. For a starting configuration with 2 MB of RAM and a 20-MB hard disk drive, the TM 3000's suggested list price is \$5499. This includes DOS 4.01, LapLink, BatteryWatch, and other bundled software for controlling the display, disk cache, and power management. A configuration with a 40-MB drive will list for \$5999, or \$500 less than the 30-MB Compaq LTE 386s/20. This is still a lot of money, but if you need a 386 on the road or you just can't resist the latest breakthrough in portable power, the TM 3000 may be just the ticket. ■

Andrew Reinhardt is an associate news editor for BYTE in New York. He can be reached on BIX as "areinhardt."

The Okidata OK.TM
It's why we had
to re-invent
the laser printer.



What's the Okidata OK? It's a badge of honor that every Okidata product has to earn—a symbol of our commitment to design and deliver products that offer outstanding value and performance. Products that will not only satisfy you, but impress you.

The Laserless Printhead: Warranted for 5 Years.

The performance promise behind the Okidata OK is the reason we had to re-invent the conventional laser printer. Our engineers frankly rejected the industry-standard page printer technology of laser beams, lenses and rotating mirrors. Instead, they designed and built a proprietary, solid-state LED printhead with no moving parts. It's a printing system so trouble-free, we guarantee our LED print element for 5 full years—making it by far the longest warranty in the industry.

But reliability isn't the only advantage our unique printhead offers. It also means a simpler design, resulting in a straight-line paper path that's far less likely to jam—even when feeding heavy stock, envelopes, or labels. And, since we build it ourselves, it means something else—a lower cost.

The OL400: The Only \$999 Page Printer.

Our 4 ppm OL400, for example, has the lowest list price of any page printer on the market: only \$999.* Yet that price gets you a printer that earned a PC Magazine Editor's Choice Award, with standard features—extra fonts, a full 200-sheet paper tray—that you won't find on a LaserJet® IIP selling for hundreds of dollars more. Plus a slim, low-profile design that's less bulky on a desktop.

The OL800: Twice the Output, with Room to Grow.

And the OL400 isn't the only Okidata LED page printer to offer outstanding value. For applications where greater speed is needed, the OL800 delivers 8 ppm with all the advantages of the Okidata LED printhead: straight-line paper path, 5-year

printhead warranty, and a low \$1499 list price.

Like all our LED page printers, the OL800 emulates HP® Series II for compatibility with most popular software; with its speed and selection of resident type fonts, it can handle the printing needs of a whole work group. What's more, as your applications change and your needs grow, a simple upgrade kit turns the OL800 into either a font-scaling OL820 or a PostScript®-compatible OL840.

The OL820: Smarter Than a LaserJet III.

The OL820 earned the Okidata OK by learning how to do font-scaling on the fly. Thanks to a special chip our engineers designed into the 820, it can solve complex type-sizing and positioning problems instantly—problems the LaserJet III needs to talk to its software to work out. That means the OL820 can deliver up to three pages of sophisticated text while the LaserJet III is still working on its first page.

And all at a price that's hundreds of dollars less than the LaserJet III.

The OL840: PostScript and Beyond.

And for applications that require full Adobe PostScript® compatibility, our OL840 delivers it in spades. It's ready to connect to any PC or Macintosh® system, or to both at the same time—then switch between systems with the push of a button.

The Okidata OK. It's a promise that makes our job—to design and manufacture a line of page printers offering both outstanding value and performance—a hard one.

But it makes your job—choosing the right brand of page printer for your application—easier than ever before.

For additional information, call us at 1-800-800-7333.



We don't just design it to work. We design it to work wonders.™

Pictured with optional second paper tray, available on OL800, OL820 and OL840 models.
HP, LaserJet, Adobe PostScript, Macintosh are trademarks of their respective corporations.

*Manufacturers suggested retail price. Dealer prices may vary.
OKIDATA is a registered trademark of Oki America, Inc. Marque déposée de Oki America Inc.

When Laser Printers Can't Cut It

The BYTE Lab tests 27 dot-matrix and page printers that pick up where laser printers leave off

Stanford Diehl and Howard Eglowstein

Are you planning to run out and buy a laser printer? If so, stop, take a deep breath, and consider what you are buying a printer for. You might want to consider a laser printer alternative.

Sure, laser printers are fast and getting less expensive by the day. But maybe you need to print multipart forms; laser printers can't do that. Or perhaps you will be printing long program or database listings. A large stack of cut sheets is definitely not the way to print long listings. And at 5 cents per page, they're five times the cost of dot-matrix output. A long piece of perforated pin-feed paper is much more convenient and fits easily in a special binder. If you've ever pasted together multiple letter-size spreadsheets, you're sure to appreciate the ability to print on 13-inch-wide paper.

There are alternatives to the laser printer, and this month, the BYTE Lab looks at 27 printers that might suit your needs. You be the judge.

Quality is a big consideration when buying a printer, so all the reviewed printers have 24-pin print heads (or the equivalent) and produce letter-quality output. For the dot-matrix printers, we chose wide-carriage models and further required that they all handle graphics in

either IBM Proprinter or Epson LQ emulation. This narrowed the field to 21 dot-matrix and two ink-jet printers. Another alternative to a laser printer is a page printer with a nonlaser print engine. The text box "You're Being Paged" on page 158 introduces two LED, one LCS (liquid-crystal shutter), and one ink-jet page printer, each with print quality to rival the laser printers and full Hewlett-Packard PCL emulation.

If You Can't Fight 'Em, Emulate 'Em

All printers evolved from the simple typewriter. Teletypewriter machines provided feedback to the earliest hackers before CRTs became popular. Even after monitors became the preferred interface, modified teletypewriters hung around as simple hard-copy output devices. From the teletypewriter evolved the daisy wheel, whose loud and clumsy operation drove users to dot-matrix printers as soon as the machines produced acceptable quality. Now, of course, ink-jet printers and cheap laser printers threaten the dot-matrix models for mainstream applications.

Centronics marketed the first successful line of dot-matrix printers and, for a time, had the market mostly to itself. Then the Japanese printers poured in. Seiko was the first Japanese company to manufacture dot-matrix print heads. Then Seiko turned them over to its Epson subsidiary, which began selling printers of a quality and price that Centronics couldn't match.

In 1981, when IBM needed a printer for its new Personal Computer, it chose an Epson. Although the name tag said "IBM," the printer and its underlying command set were pure Epson. IBM's choice of an Epson solidified the Epson standard. Even the so-called Centronics parallel port is actually an Epson modification of the original Centronics design.

In today's dot-matrix market, most

manufacturers emulate the Epson printer command set. Printer companies emulate the Epson so that their printers will be compatible with leading software packages. To communicate with a printer, every software package must include a driver that the specific printer can understand. A printer vendor must either write its own driver for every major piece of software or create a printer that can talk to the most popular drivers around. While having a wide range of emulations will increase a printer's chances of being compatible with software products, all a printer really needs these days are IBM and Epson emulations. To be successful, most software must include drivers for the Epson and the IBM Proprinter. If your printer emulates these two (see photo 1), you won't have to worry about software compatibility.

Still, emulating the commands is not enough. The command sets, after all, continue to evolve, sprouting new features and capabilities each time Epson or IBM releases a new printer. Luckily, the enhanced commands are backward-compatible. If you have a newer Epson printer, you can still use software that supports the old models; you just won't be taking full advantage of the printer. For instance, in table 1, we list two Epson emulations—Epson 1050 and Epson 2550. Any printer that emulates the 2550 will also work with a 1050 driver and, indeed, with drivers dating back to the original MX series. The printers that do not support 2550 emulation do not include the latest enhancements to the Epson printer command set. Likewise, IBM's latest printer, the Proprinter XL24E, has an enhanced command set (that's what the *E* stands for). You should always use the most recent driver that your printer will support to ensure that you're getting the most out of your investment.

Fujitsu takes an interesting approach to the emulation issue. The DL4600 uses the Fujitsu DPL24C Plus command set,

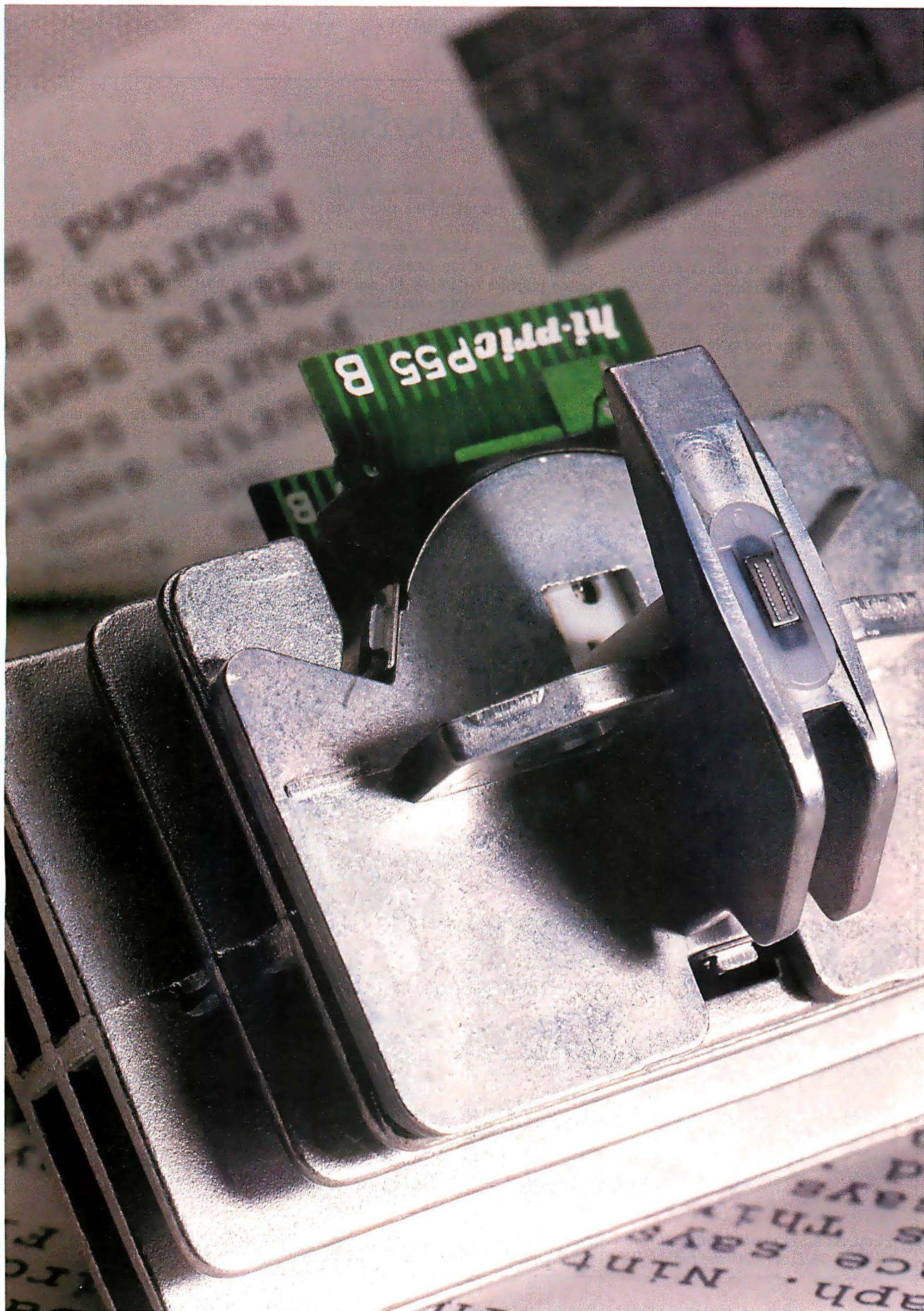

You're Being Paged

Perhaps you want a page printer but you have specific needs that a laser printer cannot address—larger paper, say. While they're not in the same category as the dot-matrix and ink-jet character printers, the four page printers that we examined (see photo A) have specific design advantages over their laser counterparts (see table A).

The first thing we wondered when we started to test these LED, LCS (liquid-crystal shutter), and ink-jet page printers was: What's the point? They aren't really cheaper, they're not always faster

(see figure A), and the LED/LCS technology uses essentially the same supplies as a laser printer.

The Epson EPI-4000 ink-jet printer is unique in that it can handle PCL or Epson graphics on 11- by 17-inch paper. It's probably not a good choice as a general-purpose printer; it's slower than the Hewlett-Packard Series II, and the water-based ink makes the paper wrinkle if you print a large black area. Still, the print quality is good, and if you need to print on large paper, the EPI-4000 is your only option.

LED and LCS technologies are similar in that they use a photosensitive drum to attract toner, much the way a laser printer does. The difference is that a laser printer uses a scanning laser beam to charge the drum. LED and LCS printers use an array of 2550 individual elements—one for each pixel on an 8½-inch line. On an LED printer, there is one LED for each pixel, and as a given line is printed, the printer activates the required LEDs.

The LCS printer uses a similar technique, but it places an array of liquid-



Photo A: Laser quality without the laser: Page printers reviewed are (clockwise from top left) the Epson EPI-4000, the Okidata OkiLaser 820, the Fujitsu RX7100 S/2, and the Qume CrystalPrint Publisher II.

crystal elements between the drum and an incandescent light source. According to Qume, this configuration allows for more even light distribution, preventing a streaky appearance in large black areas. Compared to laser printers, LED and LCS printers have fewer moving parts to break, which suggests that they may be more reliable. Without the scanning mirror, the LED/LCS technologies print a more even black without any trace of scan lines. As for performance, the Okidata OkiLaser 820 (LED) was the fastest in our long-document and text-and-graphics tests, thanks to its fast paper handling. The Fujitsu RX7100 S/2's exposed paper bin (see photo A) made it easy to load. Qume's CrystalPrint Publisher II has a fast RISC processor, which gave it an edge on the short-memo test. CrystalPrint Publisher II has both PostScript and Apple LocalTalk interfaces, making it a fine addition to any Mac network.

Overall, we couldn't detect any substantial difference in print quality between the CrystalPrint Publisher II's LCS engine and the LED printers, although all three had much blacker blacks than the Hewlett-Packard LaserJet Series II. As for reliability, the claims seem reasonable; time will tell.

COMPARING PAGE PRINTER FEATURES

Table A: Ink-jet, LED, and LCS printers offer a range of interface and emulation choices. (○=yes; ●=no; (O)=optional.)

Model	Epson EPI-4000	Fujitsu RX7100 S/2	Okidata OkiLaser 820	Qume CrystalPrint Publisher II
Price	\$1999	\$1395	\$2295	\$3995
Dimensions in inches (D,W,H)	19.6 x 12 x 28.2	6.7 x 16 x 15.7	8.5 x 17.7 x 17.7	9.1 x 15.7 x 13.4
Weight (pounds)	39½	39	37	35½
Memory—standard	512K	640K	512K	3 MB
Memory—expansion	2 MB	4 MB	4 MB	6 MB
Interface				
AppleTalk	○	○	○	●
Parallel	●	●	○	○
Print sharing	○	○	Optional	○
Serial	●	●	●	●
Twinax	●	○	○	○
Technology	Ink jet	LED	LED	LCS
Maximum print speed	Depends on page	5 ppm	8 ppm	6 ppm
Pages/refill	1000 LQ pages	6000 pages	2500 pages	7500 pages
Duty	5000 hours @ 25% duty	3000 pages/month	5000 pages/month	6000 pages/month
Paper capacity	100 sheets	150 sheets	200 sheets	100 sheets
Maximum paper size (inches)	11 x 17	8½ x 14	8½ x 14	8½ x 14
Emulation				
Diablo 630	○	●	●	○
Epson LQand FX	○	●	○	○
HP LaserJet II	●	●	●	●
IBM Proprinter	○	●	●	○
PostScript	○	(O)	○	●
Resident fonts	3	7	5 (HP), 13 (Scalable Oki)	8 (HP), 39 (PostScript)
Options	Push tractor	Font cards, second paper bin	Font cards	Font cards

PAGE PRINTER SPEED INDEX

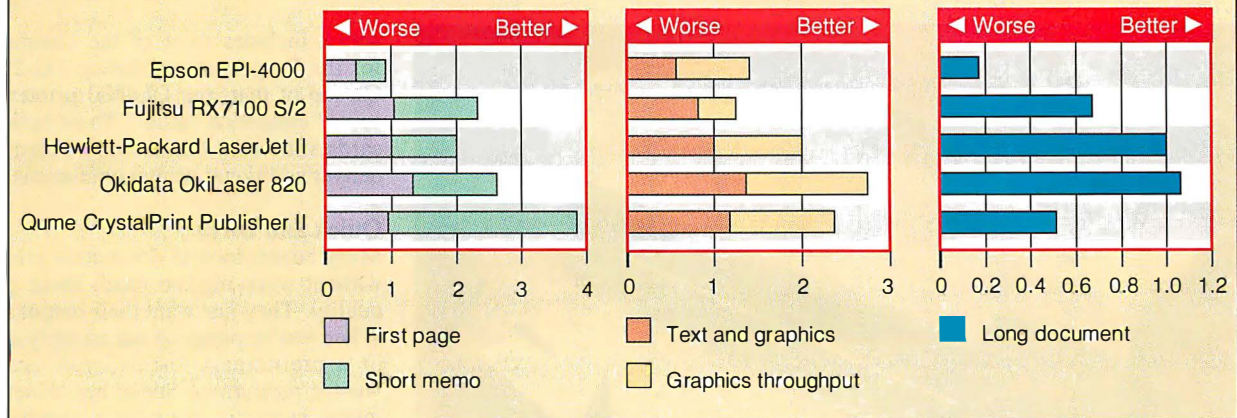

Figure A: Since these printers work like Hewlett-Packard LaserJets, we ran the tests used for our July Product Focus, "Laser Printers Get Personal." The first-page and short-memo tests are heavily influenced by warm-up time and the speed at which fonts can be downloaded. The text-and-graphics and graphics-throughput tests reflect the speed of a lengthy binary-image transfer. Finally, the long-document test rates the printers on their ability to churn out long listings. In all cases, the tests are normalized to the Hewlett-Packard Series II (its index rating is 1).

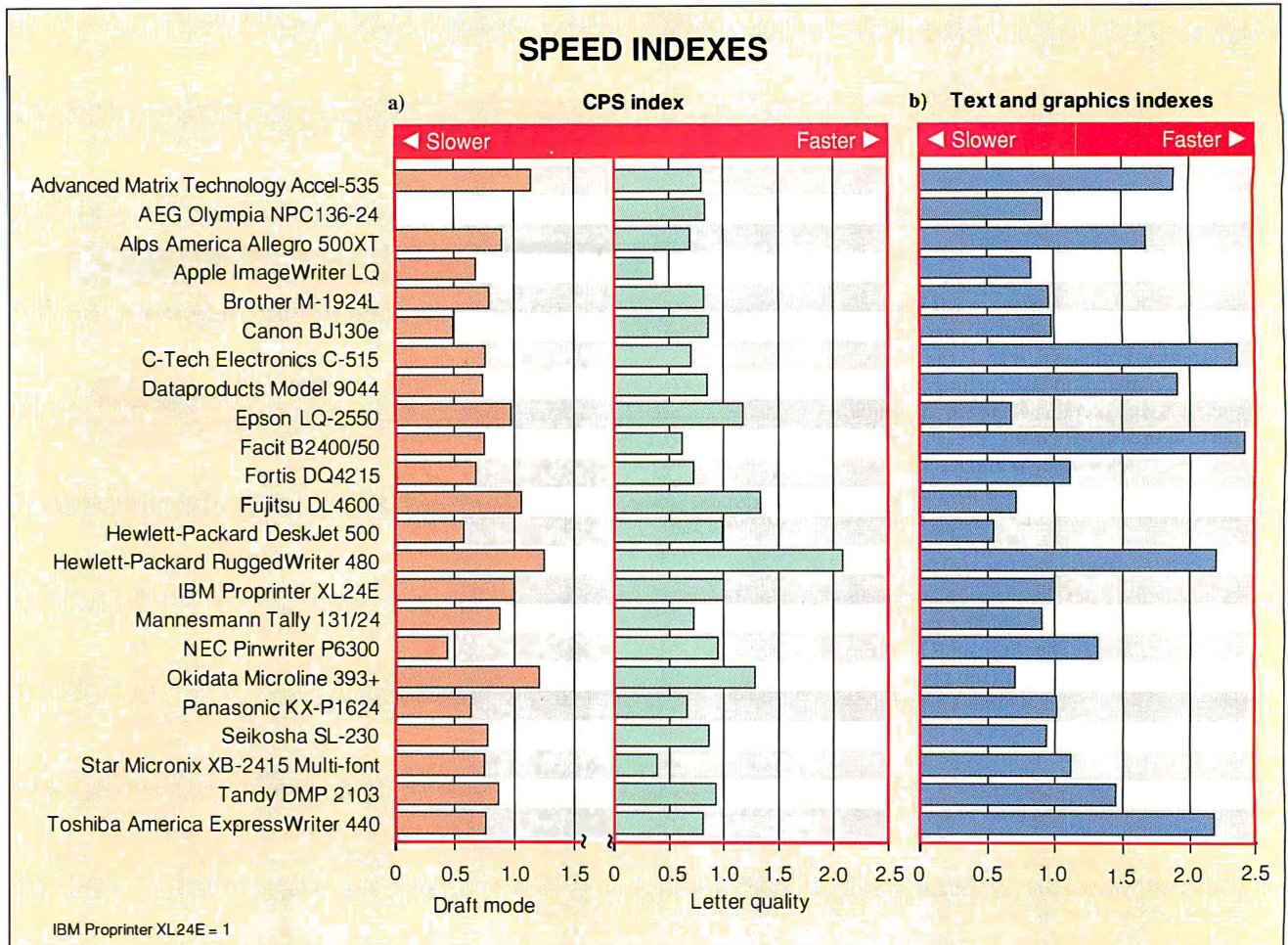

Figure 1: (a) Vendors' cps (characters per second) ratings do not always reflect real-world results. Our tests use a typical formatted document. The results are normalized on the IBM Proprinter XL24E (its index rating is 1, so a printer with a rating of 2 runs twice as fast as the Proprinter). The Hewlett-Packard RuggedWriter 480 had far and away the fastest letter-quality printing. The RuggedWriter 480 and the Okidata Microline 393+ turned in the fastest draft performance. **(b)** Our text-and-graphics test included text, line art, a gray-scale test pattern, and a gray-scale TIFF image scanned at 300 dots per inch. The results are normalized on the IBM Proprinter XL24E (its index rating is 1). The Facit B2400/50 and the C-Tech C-515 led the field. All printers were tested with the Windows 3.0 Proprinter driver unless only an Epson driver was supported. The Hewlett-Packard DeskJet 500 required its own driver.



which includes most of the commands for the Proprinter and Epson LQ-2550. On top of that, the DL4600 printer accepts "emulation cards." These optional cards slide onto the memory board and deliver additional printer emulations.

Quick and Dirty

Many buyers look to dot-matrix printers without worrying too much about print quality. They just want their output fast. When you're pumping out an early draft or a preliminary listing, you usually want it right away. Speed has become a major factor in dot-matrix purchasing decisions.

Note that the results of our testing (see

Photo 1: Setting the standards. Most dot-matrix printers emulate one or both of these two printers: the IBM Proprinter XL24E (top) and the Epson LQ-2550 (bottom).

figure 1a) conflict with the characters-per-second (cps) ratings as listed in table 1. Don't be alarmed. We have not uncovered a conspiracy. When printer vendors publish speed ratings, they are literally referring to the time it takes to print a burst of *characters*. This time does not include movement of the print head, line-feeds, and carriage returns. Our test generates a long document with numerous elements not included in vendor tests (see the text box "Lab Tests: Connect the Dots" at right). Keep this in mind when reviewing cps ratings. You can use these ratings to compare the speed of various printers, but don't expect a printer rated at 300 cps to print a 10,000-character document in 33 seconds. The BYTE Lab tests reflect real-world results that you can expect to duplicate (see also figure 1b). Table 1 includes draft and letter-quality cps ratings at 10 cpi, the accepted standard, as supplied by the vendors.

When you opt for letter-quality printing, you will, of course, forfeit some speed. Many dot-matrix printers enhance quality by printing a second identical character on top of (or slightly offset from) the first. As you would expect, this technique will at the very least halve the print speed.

Luckily, you don't have to wait for the entire printout before getting back to work. This is where printer *buffers* come in. The bigger the buffer, the more output your computer can pass to the printer and the sooner you get control of your keyboard. On the other hand, printer memory is not as vital to a dot-matrix printer as it is to a page printer. Because a page printer must first build an image in its memory, it requires a minimum amount of RAM to do its job. Dot-matrix printers use memory only as buffer space and to download fonts. So, if you're planning to use downloadable fonts with your dot-matrix printer or if you just want a healthy buffer, make sure that you have adequate memory. Table 1 lists each printer's maximum memory configuration.

Please Turn That Thing Down

The new breed of dot-matrix printer is worlds quieter than its ancestors, although after testing over 20 of them, we still went to bed at night with that annoying hum in our ears.

Some models with special "quiet" modes dampen noise by printing more slowly and by printing one-half of the line in each of two passes. Our tests revealed that most printers produce copy at roughly half-speed when printing in quiet mode. Some of the printers were

pleasantly muted even without a quiet mode. And, of course, if you really cherish your peace and quiet, the ink-jet printers barely break out of a whisper. We took sound readings for each printer and graphed the results in figure 2. We used the most common unit of sound measurement, decibels, in our testing. Doubling the volume means a 10-dB increase. A difference of 5 or 6 dB is significant, and even a 2-dB difference is noticeable.

It helps to listen to the printer before you buy it. Try to carry on a normal con-

Lab Tests: Connect the Dots

We started our tests by hooking each printer (except the Apple ImageWriter LQ) to our base system, a Compaq Deskpro 386/20. We fiddled around with the printer before consulting the manual, just to see how intuitive the interface was. We loaded razor-cut fanfold paper and fed it into the printer as specified in the manual. Usually, pushing a formfeed button or pulling back on the paper bail lever caused the paper to load automatically. We then tried the tear-off function and parked the paper for single-sheet feeding. Numerous formfeeds helped test the feeding mechanism. We usually developed a strong impression of a printer before the first real test even started.

For one test (see figure 1a), we printed a fairly long (55K-byte) document from the DOS prompt. We timed the test from the first strike of the print head to the formfeed at the end of the document. This was designed to test speed in characters per second on a formatted document. We ran the full-speed test twice, once in high-speed draft quality and once in letter-quality mode. For the Apple ImageWriter LQ, we printed from Microsoft Word 4.0 on a Mac Portable. To test the Canon BJ130e for Canon mode compatibility, we connected to a Canon Cat, one of Canon's dedicated word processors (it ran fine).

As the cps test ran, we took a sound reading of each printer. A sound meter recorded the decibel reading 3 feet in front of the printer. We recorded the highest dB rating consistently registered on the meter (see figure 2). We took a second reading for those printers with special quiet modes.

We ran our text-and-graphics speed

test from PageMaker 3.01 under Windows 3.0. With the Windows print spooler disabled, we started timing as soon as the printer began receiving data, and we stopped timing when the printout was complete (see figure 1b). Our graphics file included line art, a scanned TIFF image, a gray-scale test pattern, and text in various fonts. We tested both Epson and IBM Proprinter emulation for those printers supporting both; otherwise, we used whatever driver the printer could handle. Some printers, such as the NEC Pinwriter P6300 and the Fujitsu DL4600, have custom Windows 3.0 drivers. For these printers, we tested the available emulations as well as the native drivers. We timed the Hewlett-Packard DeskJet 500 using the standard DeskJet driver. We also tested the DeskJet 500-specific driver with scalable font technology. The scalable fonts looked terrific, and we had no problems running PageMaker with them. The PageMaker file ported directly to Mac PageMaker 3.02 for printing from the Mac Portable.

Next, we parked the fanfold paper and loaded a seven-part McGraw-Hill requisition form (if you can get one of those through, you can get anything through—these monsters have seven sheets of heavy paper and six separate carbons). We set the gap adjustment until the highest-quality printout was achieved. If a printer would not accept the seven-part form, we removed pages from the form one by one until the form fed properly. Although not all printers accepted the seven-part form, they all met or exceeded the vendor specification for multiple copies. Ink-jet printers will not generate multipart copies.

versation with the printer running. We found that the dB rating of a printer was not always as important as the quality of the sound that it made. Some emit an obtrusive sound that may register a higher dB rating, while a "quieter" model may make you cringe with its high-pitched squeal. Two of the quietest printers, the Brother M-1924L and the Seikosha SL-230, registered 65 dB in fast draft mode; in quiet mode, they both registered 62 dB. Compare that to the Panasonic KX-P1624, which prints at 77 dB in fast draft, 68 dB in quiet mode. Then

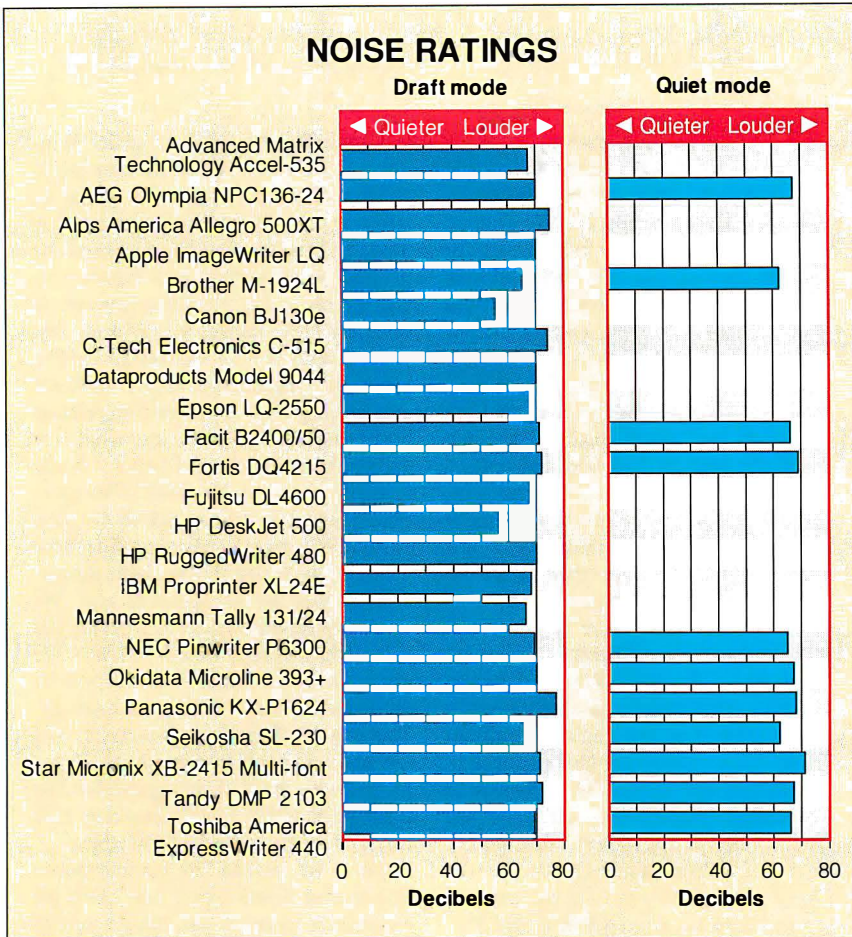

Figure 2: Sound readings taken 3 feet away from the printer. On a dB scale, an increase of 10 equates to sound twice as loud, but even a 2-dB difference is noticeable. A typical conversation registers 60 dB, while a passing truck registers about 90 dB. It was no surprise that the two ink-jet printers (the Canon BJ130e and the Hewlett-Packard DeskJet 500) were the quietest. For those printers that include a quiet mode, we measured that separately.

there are the Alps Allegro 500XT and the C-Tech C-515, buzzing in at 75 dB and 74 dB, respectively, without a quiet mode to tone down the chattering when the phone rings.

One solution to the noise problem is a printer muffler—a cabinet with foam insulation and cooling that you place over the printer. Depending on the size and quality of the enclosure, we found printer mufflers listed in several mail-order catalogs for between \$70 and \$250. Or you could hook your printer to a long serial cable and put it in your closet.

DIP Switches, R.I.P.

As simple as the technology seems at first glance, dot-matrix printers are notoriously aggravating to work with. Vendors of the latest breed have bucked this trend by improving paper-handling features and the user interface. For the most part, DIP switches—those tiny, cryptic switches used to configure printers in the past—have gone the way of the daisy wheel. Among the 24-pin printers that we looked at, only the Hewlett-Packard RuggedWriter still uses the old-time interface. In fact, the RuggedWriter uses DIP switches only for configuration settings that you won't normally deal with on a day-to-day basis. The RuggedWriter handles font and pitch changes by front-panel controls.

Some vendors still use a variation of the DIP switch theme. The Seikosha America SL-230 keeps its configuration switches on a credit-card-style function card (see photo 2). You set the switches (kind of like rotary DIP switches) and then slide the card into the front of the printer. The twist here is obvious: You can have different cards configured for each printer application. This feature is especially handy when different applications need to share one printer. Instead of fumbling through a new configuration each time a different user requires hard copy, each user simply plugs in a customized card.

Among the printers we reviewed, most offer a true menuing interface. You view menu options from an LCD or from a printed list. Either way, your current selections and possible choices are clearly displayed so you don't have to refer to a manual each time. Some of the printed menus—such as the ones from C-Tech,

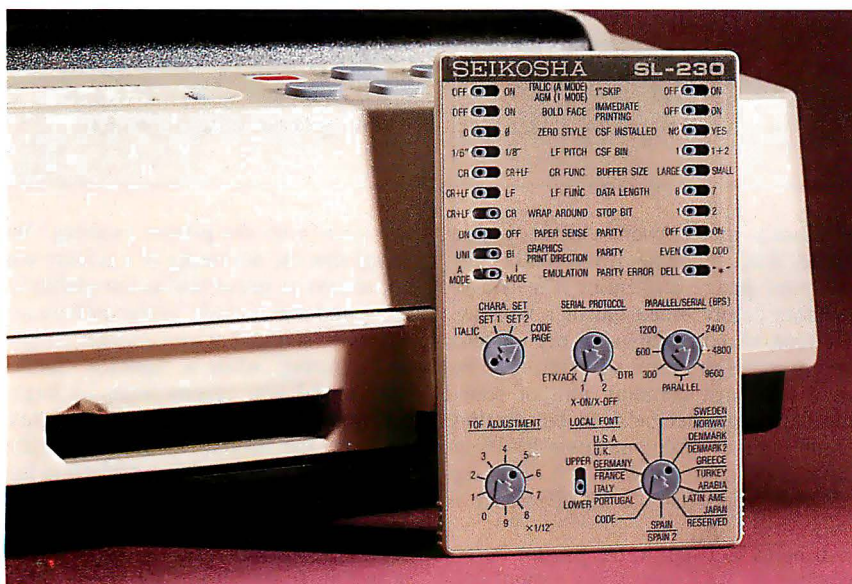
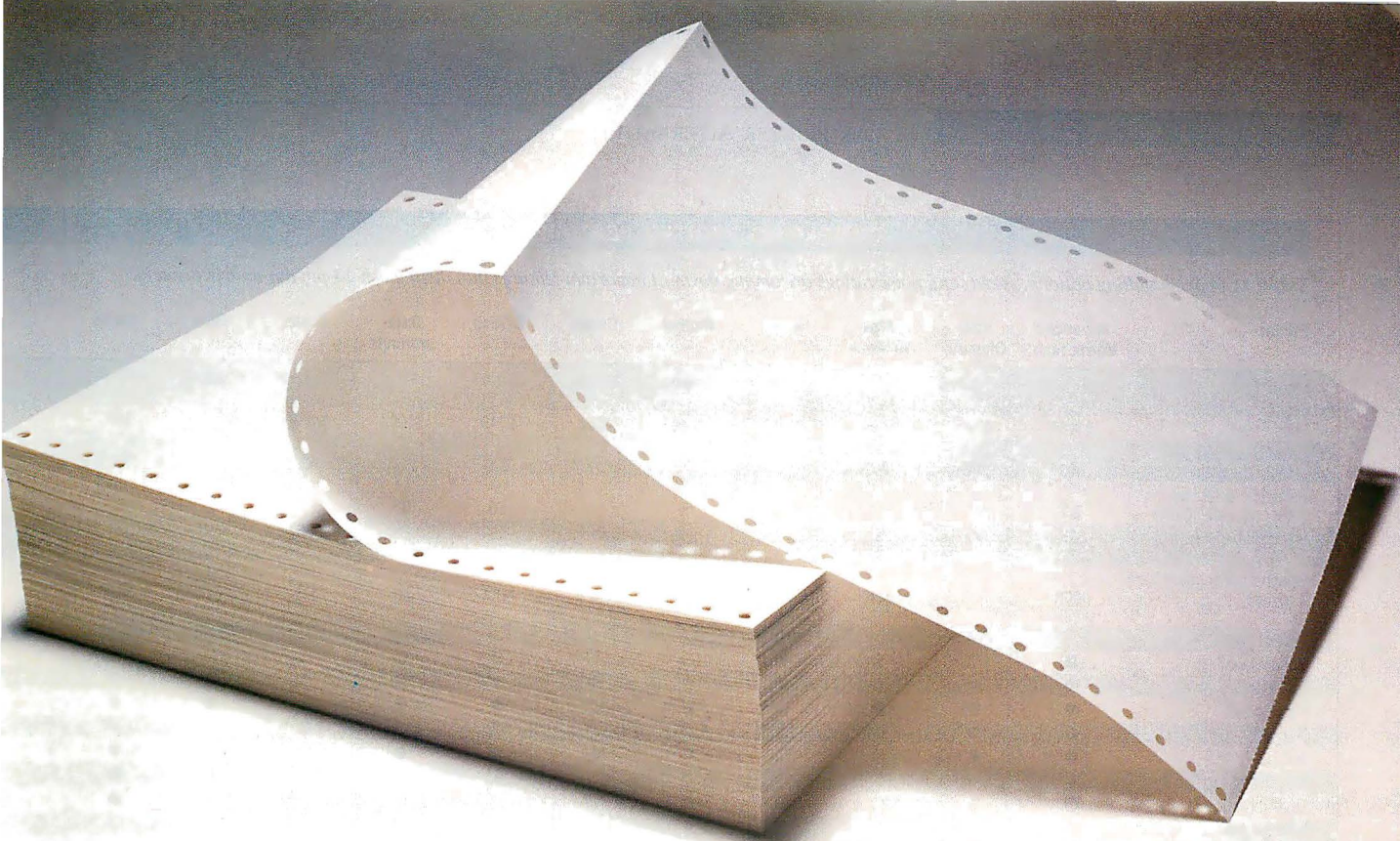

Photo 2: The Seikosha SL-230's credit-card-style function card serves the same purpose as old-fashioned DIP switches. You can keep multiple function cards, each configured for a different application.



The argument for buying our new laser line printer is full of holes.

Consider the facts and you'll agree. The

Laserfold is the logical conclusion for departmental computing environments. Particularly where high-speed printing of high-quality text is an everyday requirement.

That's because the Laserfold ends the trade-offs between high-speed line printers and high-end page printers. It simply gives you the best of both ... at a lower cost than either.

It combines laser-quality character resolution, a fast 16-pages-per-minute output,

extremely quiet operation and desktop size.

So when you're printing high-quality text on fanfold

paper for business, technical or accounting applications, there's simply no argument against choosing the Laserfold.

Pentax Technologies,
100 Technology Drive,
Broomfield, CO 80021.
Phone 303-460-1600.
FAX 303-460-1628.



PENTAX®
TECHNOLOGIES

**Advanced
Microsource**
Hopkinton, MA
(508) 435-5800
(800) 232-9920

Computer Source
Hauppauge, NY
(516) 348-7474
(800) 222-5022

**Technology
Marketing Group**
Minneapolis, MN
(800) 688-7000

**Technology
Marketing Group**
Bensenville, IL
(708) 595-4600

**Technology
Marketing Group**
Phoenix, AZ
(602) 340-9000

Nimax
San Diego, CA
(619) 566-4800

Nimax
St. Louis, MO
(314) 427-1919

Nimax
Livonia, MI
(313) 427-1010

Proven Solutions
Olympia, WA
(206) 352-4512
(800) 541-0183

Q/Cor
Norcross, GA
(404) 923-6666
(800) 548-3420

Chess
Denver, CO
(303) 573-5133

© 1990 Pentax Technologies

Circle 230 on Reader Service Card

COMPARING PRINTER FEATURES

Table 1: Paper-handling options, speed, and noise ratings are among the most important features that distinguish 24-pin dot-matrix printers.

Printer	Advanced Matrix Tech.	AEG Olympia	Alps America	Apple	Brother	Canon	C-Tech	Data-products	Epson	Facit	Fortis
Model	Accel-535	NPC 136-24	Allegro 500XT	ImageWriter LQ	M-1924L	BJ130e	C-515	9044	LQ-2550	B2400/50	DQ4215
Price	\$1485	\$799	\$799	\$1399	\$849	\$995	\$749	\$1099	\$1499	\$849	\$899
Rated characters per second—draft (10 cpi)	400	200	250	250	225	240	200	250	333	200	200
Rated characters per second—LQ (10 cpi)	80	67	83	115	75	110	66	83	111	65	67
Standard buffer (bytes)	32K	24K	23K	5K	64K	64K	28K	2K	8K	26K	24K
Optional buffer (maximum) (bytes)	400K	56K	55K	None	32K	None	None	32K	32K	None	None
Type of tractor	Push	Push	Push	Push or pull	Push	Pull(O)	Push	Push	Push	Push	Push
Bottom feed?	●	○	●	●	○	○	○	○	○	○	●
Autoload?	●	●	●	●	●	●	●	●	●	●	●
Paper park?	●	●	●	○	●	N/A	●	●	●	●	●
Tear-off?	●	●	●	○	●	N/A	●	○	●	●	●
Autobail?	●	●	○	○	●	N/A	●	●	●	○	●
Plug-in font cartridge?	●	●	○	○	●	○	●	●	○	●	●
Quiet mode?	○	●	○	○	●	N/A	○	○	○	●	●
Number of multiple copies	6	3	4	5	4	N/A	4	3	6	4	3
Resident fonts	4	6	7	N/A	9	3	9	2	7	2	4
Ribbon life (characters)	5 million	2 million	2 million	4 million	3½ million	1 million (cartridge)	3½ million	2 million	3 million	3 million	Not available
Print-head life ¹	Not available	100 million characters	200 million dots/pin	400 million dots/pin	200 million dots/pin	Not available	200 million dots/pin	200 million dots/pin	200 million dots/pin	150 million characters	100 million characters
Mean time between failures	15,000 hours (50% duty)	6000 hours (20% duty)	6000 hours (25% duty)	6000 hours (25% duty)	6000 hours (25% duty)	Not available	6000 hours (25% duty)	5000 hours (10% duty)	6000 hours (25% duty)	>4000 hours (20% duty)	6000 hours (20% duty)
Number of stored configurations	5	2	3	1	1	1	1	1	4	1	2
Dimensions in inches (D,W,H)	24 x 7.35 x 16.9	24.4 x 5.1 x 13.8	23 x 8.4 x 13.6	23.2 x 5.12 x 15	24.6 x 15.3 x 6.1	24 x 5.4 x 14.3	22.5 x 4.6 x 12.4	23 x 5.3 x 14.3	26.6 x 7.7 x 20.4	23.25 x 5.12 x 13	25 x 6.5 x 16
Weight (pounds)	48	22	17.7	38	26.5	26.5	19.84	26.5	44	24.2	27
Tested decibel level (high-speed draft)	67	70	75	70	65	55	74	70	67	71	70
Emulations											
IBM Proprinter XL24	●	●	○	N/A	●	●	●	○	○	●	●
Epson LQ-1050	●	●	●	N/A	●	○	●	●	●	○	●
Epson LQ-2550	●	●	●	N/A	●	○	○	○	●	○	●
Others	Diablo 630, Xerox 4020				Diablo 630, Brother HR			Diablo 630		Epson LQ-850	
Graphics resolution (maximum) in dpi	240 x 480	360 x 180	360 x 360	216 x 216	360 x 360	360 x 360	360 x 180	360 x 180	360 x 360	360 x 180	360 x 180
User interface	LCD, select-dial	LCD	Printed menu	DIP switches	LCD	DIP switches	Printed menu	Printed menu	LCD	Printed menu, move print head	LCD
Auto thickness sensor	○	○	○	○	○	○	○	○	●	○	○
Heat sensor	○	○	●	○	○	○	○	○	●	○	○
Micro feed (increment)	1/120 inch	1/180 inch	1/180 inch	1/216 inch	○	○	1/216 inch	1/180 inch	1/180 inch	1/180 inch	1/180 inch
Color	●	○	○	●	(O)	○	○	(O)	●	○	(O)
Warranty (years)	1	1	1	1	1	1	1	1	1	1	1
Hardware interface	P, RS-232C	P, RS-232C	P, RS-232C(O)	RS-232C, RS-422, LocalTalk(O)	P, RS-232C	P, RS-232C(O)	P, RS-232C	P, RS-232C(O)	P, RS-232C	P, RS-232C	P, RS-232C

●=Yes. ○=No. (O)=Optional. N/A=Not applicable. LQ=Letter quality.

¹ Vendors measure print-head life in characters or in dots per pin. The number of pins fired per character depends on various factors. A draft character equals roughly two dots.

Dataproducts, Okidata, and Tandy—print a line for each option you cycle through. For instance, to change the setting for characters per inch, you cycle through each option (e.g., 15 cpi, 12 cpi, 10 cpi), and each option is printed on a line as you move through them. You then press a second button when the proper option is printed out. The method is sim-

ple and clear, but it's also slow, and it wastes paper. To save time and paper, the Facit B2400/50, the Mannesmann Tally 131/24, and the Star Micronics XB-2415 Multi-font vary the technique somewhat. These models also print out menu options, but to select those options, you press directional keys to use the print head as a cursor to make your selection.

For true clarity and ease of use, you can't beat the LCD interface. With the best ones, clear options are displayed on the panel and selected simply, without reference cards or wasted paper. So if you crave an elegant cure for the printer installation blues, take a close look at the models with LCDs: the AEG Olympia NPC 136-24, the Brother M-1924L, the

COMPARING PRINTER FEATURES

COMPARING PRINTER FEATURES											
Fujitsu	Hewlett-Packard	Hewlett-Packard	IBM	Mannesmann Tally	NEC	Okidata	Panasonic	Selkosh America	Star Micronics	Tandy	Toshiba America
DL4600	DeskJet 500	RuggedWriter 480	Proprinter XL24E	131/24	Pinwriter P6300	Microline 393+	KX-P1624	SL-230	XB-2415 Multi-font	DMP 2103	ExpressWriter 440
\$1199	\$729	\$1695	\$1199	\$999	\$999	\$1499	\$650	\$998	\$899	\$899	\$699
333	240	400	240	250	250	345	160	230	200	225	200
111	120	200	80	83	125	115	53	77	67	75	66
24K	16K	2K	14K	17K	80K	23K	12K	5K	41K	16K	Not available
None	272K	16K	None	49K	None	17K	32K	64K	201K	None	Not available
Push	None	Push	Push	Push	Push	Push	Push	Push	Push	Push	Push
○	N/A	●	○	○	●	●	●	○	○	●	○
●	●	●	●	●	●	●	●	●	●	●	●
●	N/A	○	●	●	●	●	●	●	●	●	●
●	N/A	●	○	●	●	●	●	●	●	●	●
●	N/A	○	○	○	○	●	○	●	●	○	○
●	●	●	●	●	●	●	○	○	●	○	○
○	N/A	○	○	○	●	●	●	○	●	●	●
5	N/A	6	4	3	4	4	4	4	4	4	4
7	9	3	4	7	8	4	7	9	16	6	5
5 million	1000 pages (cartridges)	5 million	Not available	2.5 million	3 million	5 million	3 million	5 million	4 million	2 million	3 million
400 million dots/pin	(Part of cartridge)	Life of printer	Not available	150 million characters	200 million dots/pin	400 million dots/pin	200 million dots/pin	300 million dots/pin	200 million dots/pin	200 million characters	200 million dots/pin
8000 hours (25% duty)	20,000 hours (25% duty)	20,000 (10% duty)	Not available	7800 hours (25% duty)	6000 hours (25% duty)	4000 hours (25% duty)	5000 hours (25% duty)	5000 hours (30% duty)	4000 hours (25% duty)	5000 hours (25% duty)	Not available
2	1	1	1	2	1	1	4	1	1	1	1
22.9 x 7.5 x 15.2	17.3 x 8 x 14.8	23.6 x 8.2 x 13.7	22.7 x 4.8 x 13.5	23.5 x 6.3 x 12.5	23.6 x 8.25 x 15	16.4 x 7.1 x 22.4	23.2 x 5.6 x 15.7	23.9 x 5 x 13.8	23.3 x 5.5 x 13.4	21.7 x 4.6 x 13.6	22.5 x 5.1 x 12.4
39.7	14.3	35	27	25.7	29	37	32	26.5	23.1	22.3	19.84
68	56	70	68	66	69	70	77	65	72	72	69
●	(○)	○	●	●	○	●	●	●	●	●	●
●	○	○	○	●	●	●	●	○	○	○	○
●	○	○	○	●	●	●	●	○	○	○	○
Fujitsu DPL24C	HP PCL, Epson FX-80(O)	HP 2930, HP LaserJet		NEC Pinwriter	NEC P5200/5300						
360 x 360	300 x 300	180 x 180	Not available	360 x 360	360 x 360	360 x 360	360 x 360	360 x 360	360 x 360	360 x 360	360 x 360
LCD	DIP switches	DIP switches	Buttons, musical tones	Printed menu	Printed menu	Printed menu	LED matrix	Function card, move print head	Printed menu, move print head	Printed menu	Printed menu
●	○	○	○	○	○	○	○	○	○	○	○
○	○	○	●	○	●	○	●	●	●	●	○
1/60 inch	○	1/180 inch	1/180 inch	1/180 inch	1/180 inch	1/180 inch	1/180 inch	○	1/360 inch	1/80 inch	1/80 inch
(○)	○	○	○	(○)	(○)	(○)	○	○	(○)	○	○
1	3	1	1	1	1	1	2	1	2	1	1
P, RS-232C	P, RS-232C	P, RS-232C, HPIB(O)	P, RS-232C(O)	P, RS-232C(O)	P, RS-232C(O)	P, RS-232C	P, RS-232C(O)	P, RS-232C	P, RS-232C(O)	P	P, RS-232C

Epson LQ-2550, the Fortis DQ4215, and the Fujitsu DL4600.

Perhaps the slickest interface of all (the most fun, anyway) belongs to the Advanced Matrix Technology Accel-535. In addition to a detailed 16-character LCD, the control panel has a select dial (see photo 3). The dial serves a few purposes. With the printer off-line, the

dial acts as a platen knob, properly positioning your paper. If you turn the dial while pressing the Alt button, the print head moves left or right. This provides an easy way to set margins and print forms. You just position the head where you want to print and go to it. And finally, the dial aids the user interface. You turn the dial to scroll through vari-

ous menu options. Making setup changes on the Accel-535 is as easy as picking songs on a jukebox.

Another way to prevent configuration headaches is to use stored configurations. If you have two or three different applications for the printer, you can store the proper configuration for each one of them. When it comes time to change

How to Tell One Dot-Matrix Printer from Another

Armed with a good knowledge of printer basics, how do you go about selecting a 24-pin dot-matrix printer? As we pointed out in the main article, first decide if you really need one. If you're planning to spend many hours a day printing, you might be better served by an LED, LCS (liquid-crystal shutter), or laser printer. If quality is more important than multipart capability, or if noise is likely to be a problem, perhaps you'd be better off with an ink-jet printer.

On the other hand, if your applications require high-quality output, don't buy a dot-matrix printer just to save a few bucks. Down the road, you will probably regret not purchasing a page printer. Laser-quality output is quickly becoming the standard for business correspondence. Dot-matrix print, even at 24-pin resolution, just won't look pro-

fessional enough. For basic correspondence needs (even simple letters and memos), you should spring for the extra cash for a low-cost page printer.

If, after you have carefully weighed all these points, you're committed to buying a dot-matrix printer, consider the following issues. Do you plan to alternate between tractor-fed and single-sheet paper on a regular basis? If so, parking and autoloading features are essential. If you're going to share the printer on a network and load it down with long print jobs, a heavy-duty print mechanism and high-speed output would be wise. If you need the multipart capability but have to work in close quarters with the printer, pay attention to the quiet mode or the machine's overall noise ratings.

Labelstock has improved significantly over the years. It used to be that the

labels would come off the backing paper and jam up under the print platen, causing all sorts of serious, sometimes fatal, jams. Getting adhesive labels out from under the platen can be almost impossible. Things are better now, but we suggest that you stick with straight paper paths for printing labels. A front-to-back or bottom-to-top path will serve you well.

Finally, when you start scouting out printers, don't be content to print on a preconfigured display model. That's a good way to narrow down your choices, but once you're close to a decision, ask if you can take it through the configuration process yourself. You'll learn a lot about the printer's operation and ease of use. We found out as much about these printers by setting them up and configuring them as we did testing and analyzing them.

parameters, you can do it in one easy step; just activate the custom configuration. Table 1 reports the number of stored configurations available with each printer.

Choosing the Right Path

Despite advances, most dot-matrix printers still require some babysitting. A major problem is back-feeding. Many models still feed paper from the rear and send output to the rear. All too often, the output will curl around to the feeding mechanism, wrap around the platen, and cause a crippling paper jam. You can always direct the paper over the front of the printer to avoid the problem, but there are better solutions.

Some vendors devise paper separators. A rack or tray separates the output from

the ingoing paper, with varying degrees of success. A better way is to feed your paper in from one direction and out another. With bottom-feed printers, you can place the paper below the printer and never have to worry about back-feeding again. The paper flows in the bottom and out the rear, which also frees up a little desk space. Some bottom-feed printers require an optional pull tractor, and you will need a special stand with an opening on the surface to accommodate bottom feeding. The Alps Allegro 500XT and HP RuggedWriter 480 feed from the front and send printed copy out the rear. This prevents back-feeding and makes printing labels easier. With a straight paper path, the labels do not wrap around the platen where they often peel off or

jam the printer. You'll need to clear some extra space in front of your printer, but that's far easier than clearing a nasty jam.

Desk Snakes

Another aggravating paper problem involves the placement of a printer's cables. The parallel cable and the AC cord join the traffic at the rear of the unit, often causing messy tangles and an obstructed paper path. Some vendors, such as Brother, put the cable port on the side of the printer. This solves one problem but may cause others. The cable and port are more exposed to possible abuse, and you will need to clear out additional space beside your printer to make room for the cable. Epson opted for a simple solution: A clear plastic cover lies over the cables, keeping them out of your way.

Tractors that pull paper from above the print head are the most efficient way to move paper, but getting the last page of



Photo 3: The Advanced Matrix Technology Accel-535 has the slickest interface of the 27 dot-matrix and page printers we reviewed this month. By spinning the dial, you can scroll through the options in the menu display. When not setting options, the dial can move the paper or set margins.

Programming Books...

...for learning more Computing Know How
and all of these books include diskettes to get you there faster

BASIC Programming Inside & Out

In depth coverage for all BASIC, QuickBASIC, GW-BASIC, and Turbo BASIC programmers. Explains sound and graphics, creating help screens, pulldown menus, managing windows in BASIC, using ML with BASIC, business presentation graphics, printing multiple columns and sideways for professional results, programming serial and parallel interfaces. Dozens of demo programs and routines you can easily adapt to your own programs. 600 pages w/companion disk.

#B084 ISBN 1-55755-084-0 \$34.95

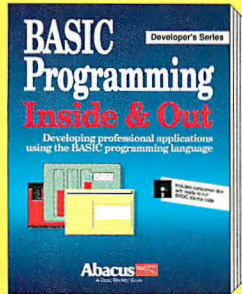

Batch File Powertools

Boost your computing productivity with this package for making truly powerful batch files. Includes dozens of new batch commands for writing time-saving, easy-to-use "power" batch files. Book with companion disk containing powerful "Batch BASIC" commands for writing even more useful batch programs. With companion disk. Available January.

#B102 ISBN 1-55755-102-2 \$39.95

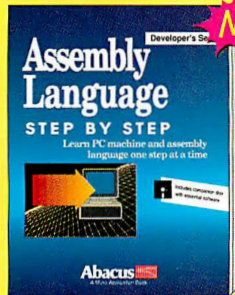

NEW!

Assembly Language Step by Step

Teaches you PC assembly and machine language from the ground up. You'll learn at your own pace using the unique simulator which show you how each instruction works as the PC executes it. 360 pages with companion disk.

#B096 ISBN 1-55755-096-4 \$34.95

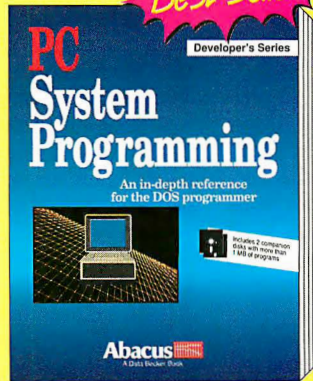

Best Seller

PC System Programming

An encyclopedia of PC technical and programming knowledge. Features parallel working examples written in Pascal, C, assembly and BASIC. Explains memory layout, DOS operations, using extended, expanded memory writing device drivers, hard disks, PC ports, mouse drivers, fundamentals of BIOS, graphics and sound, TSR programs, complete appendices. 920 page book with 2 companion disks with over 1 meg. of programs.

#B036 ISBN 1-55755-036-0 \$59.95

Programming VGA Graphics

VGA is becoming the standard display mode for PC applications. Learn the techniques for writing using the flexible and powerful VGA hardware and software. Includes new, unique DOS commands to perform dozens of VGA functions. Turbo Pascal and BASIC extensions for VGA display modes. 670 pages with 2 companion disks.

#B099 ISBN 1-55755-099-9 \$49.95

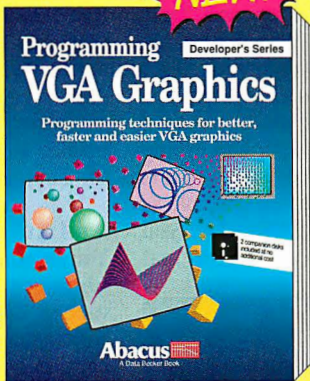

NEW!

Turbo Pascal Internals

Gives you "know how" to program faster, easier, tighter and better. Find out how to use Turbo for system programming tasks-writing TSRs, performing multi-tasking, using SAA windowing, implementing expanded and extended memory. Learn how Turbo generates machine code, handles the mouse, scans the keyboard, uses UNITES and OOPS, performs fast screen display and more. 750 pages with 2 disks of more than 800K of source code

#B080 ISBN 1-55755-080-8 \$49.95

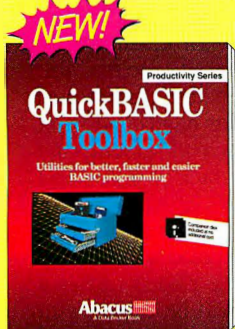
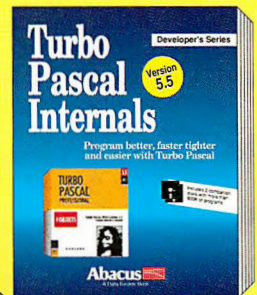

NEW!

QuickBASIC Toolbox

Packed with powerful, ready-to-use programs and routines for your own programs to get your programs written faster and better. Topics include: complete routines for SAA interfacing mouse support, pull-down menus, windows, dialog boxes and file requestors; descriptions of QuickBASIC routines and a BASIC Scanner program for printing completed project listings, more. Includes companion disk. Available January.

#B104 ISBN 1-55755-104-9 \$49.95

Available at B Dalton Booksellers, Waldensoftware, and Software Etc. and at other bookstores nationwide. In the UK contact Computer Bookshops 021-706-1188. In Canada contact Addison Wesley 416-447-5101.

Abacus

Dept. B12, 5370 52nd Street SE, Grand Rapids MI, 49512

Orders: 1-800-541-4319 • Phone: (616) 698-0330 • Fax: (616) 698-0325

In US and Canada add \$4.00 Postage and Handling. Foreign orders add \$12.00 postage per book. We accept Visa, Master Card or American Express. Call or Write for your free catalog of PC Books.

Circle 8 on Reader Service Card (RESELLERS: 9)

In US & Canada Order Toll Free 1-800-451-4319 EXT.212

For fast delivery Order Toll Free 1-800-451-4319 ext.212 or FAX (616) 698-0325

Yes, please rush the following items Yes, please rush your PC catalog
Apply to me: Visa Master Card Am.Express / I have enclosed a check / M.O.

___ Assembly Language Step by Step \$34.95	___ Programming VGA Graphics \$49.95
___ BASIC Programming Inside & Out \$34.95	___ Turbo Pascal Internals \$49.95
___ Batch File Powertools \$39.95	___ Quick BASIC Toolbox \$49.95
___ PC System Programming \$59.95	

In US and Canada add \$4.00 Postage and Handling. Foreign orders add \$12.00 postage per book.

Card# _____ Expires _____

Signature _____

Name _____

Address _____

City _____ State _____ Zip _____

a printout requires the waste of a whole sheet. To avoid this, each printer that we tested has a *push tractor* below the printing mechanism. Some vendors offer pull tractors as an option, usually to accommodate thick forms and labels. We had no problem with tractor feeding from any of the printers we tested.

The only difficulty we encountered came from the paper itself. Perforated sheets come in two major forms—regular and razor-cut. The regular paper has thick, meaty perforations that require some effort to tear. Razor-cut paper has more precise perforations that tear cleanly and leave clean edges. Sometimes in our tests the sheets tore too easily, separating the paper from the pin-feed strips and causing a paper jam. Reloading the paper usually was enough to get the job printed.

A few important features have significantly improved paper handling. Most dot-matrix printers now load automatically. You just place the paper in the tractor and push a button, and the paper loads to the correct position. The print head senses the position of the paper so that it feeds consistently each time.

What a Rip-off!

The “tear-off” feature saves tractor-fed paper. After you’ve printed a page, you can press a button to make the paper feed enough so that you can tear it off. When you return to printing, the paper is rolled back to the top of the form. Anyone who has wasted sheets of paper just to tear off a printout should appreciate this feature. Some printers automatically advance paper to the tear-off position whenever

the buffer is clear of data. When more data pours in, the printer pulls the paper back to its previous spot and begins printing again. Pretty slick. With the Alps Allegro 500XT, the paper advances to a tear-off position whenever 1 second passes without data coming into the printer. When we printed graphics from PageMaker under Windows 3.0, the data came out in spurts spaced more than 1 second apart. The Allegro would print a line of graphics, feed to the tear-off position, retreat, print another line, and feed to the tear-off position again. It’s easy enough to turn off the tear-off feature, but you should be able to configure the interval, as well.

For loading single sheets, you’ll really appreciate a *parking* feature. Simply push a button, and the fanfold paper retreats as far back as the tractor and stops. You can then switch to friction feed and load your single sheet. Another push of a button automatically loads the fanfold paper again. If you do a lot of switching between fanfold paper and single sheets, you really need parking.

Lift That Bail

Another clever feature is the automatic bail. While the paper is loading, the paper bail automatically retracts from the platen. Then, as the paper passes beneath it, the bail snaps into position. This feature is especially useful when you have a single sheet that does not feed quite far enough for the paper bail to trap it. If you leave the bail down and start printing, the paper will often crumple as it encounters the bail. Otherwise, you have to watch the paper as it ejects and

close the bail at the right time. Automatic bails stay open when the page is loaded and snap down as soon as the paper is beneath them.

One clear application still belonging solely to the dot-matrix crowd is printed forms. To test the printers, we loaded them with a seven-part, friction-feed form and filled it out, checking each copy for legibility. Although a couple of printers were unable to print all seven copies, they all easily lived up to the vendor specifications. Table 1 reports how many copies the printer can safely handle (the number on the table includes the original). We recommend that you stay within the vendor specifications for multiple copies. You can damage your print head if you don’t. The printer usually has a “paper gap” adjustment. You set the lever to reflect the number of pages being loaded. The Epson LQ-2550 and the Fujitsu DL4600 can automatically sense the paper thickness and adjust the print head accordingly, so you need not worry about manual adjustments each time.

Cut-sheet feeders hold a stack of single sheets, loading them to the printer one at a time. At least, that’s the theory. Friction feed and gravity are not the most reliable loading method. If you plan on using cut sheets most of the time, an inexpensive laser printer would better serve your needs. Paper cassettes smoothly feed single sheets, and a laser printer’s output is usually more suitable for a cut-sheet application.

And Another Thing . . .

You should always consider upgrade possibilities. Will you want color? The Advanced Matrix Technology Accel-535, Apple ImageWriter LQ, and Epson LQ-2550 can give you that right out of the box. Other models, as listed in table 1, offer a color option. This usually involves installing a small device that will raise and lower the ribbon so that the pins strike one of four color bands. To print secondary colors (such as green), the head lays down first a track of yellow and then a track of cyan. While it may form a pretty shade of green, printing a light color over any darker color will pick up stray color, ruining the ribbon. After a while, your yellows will be tinged with green, your reds with purple. Expect your color ribbons to have a much shorter life. Color-capable printers often treat an

Photo 4: Two rugged machines: the Hewlett-Packard RuggedWriter 480 (bottom) and the Okidata Microline 393+ should stand up to hard use.

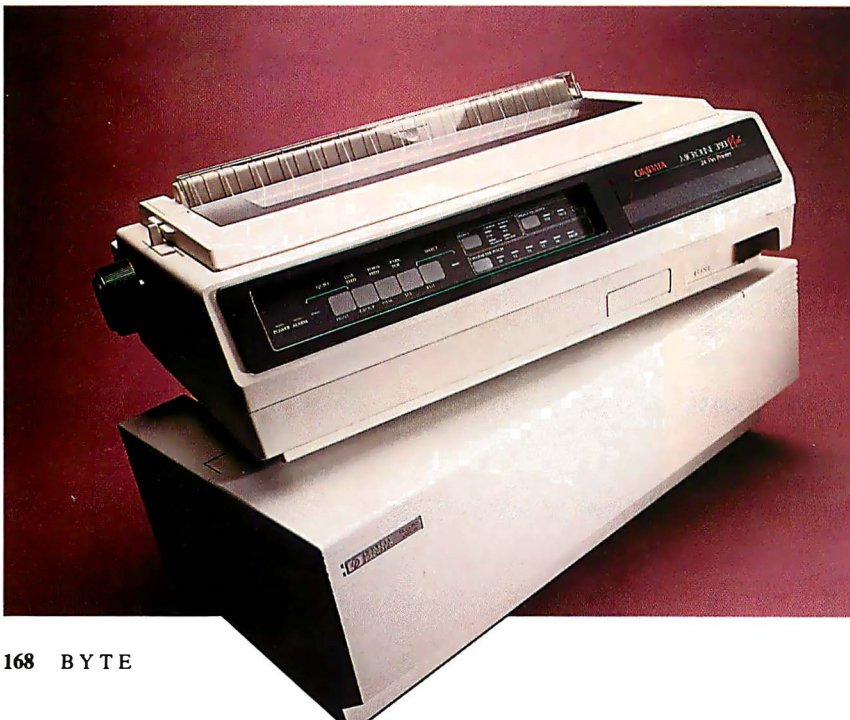

IDEK



FLAT is Beautiful and this monitor proves it!

IDEK's MULTIFLAT Series of 21-Inch Color Monitors

IDEK's MULTIFLAT Series of 21-inch Color Monitors take full advantage of the remarkable properties of their Flat Square Tubes (FST) to deliver superior resolution and a sharper image that is easier on your eyes. A glimpse at our 21" Color Monitors reveals their matchless over-scanning capability that delivers a crisp, distortion-free display across the entire screen.

In addition, Automatic Frequency Scanning realizes outstanding performance for business graphics, CAD/CAM applications as well as desk top publishing on your Mac or IBM compatible system.

As you can see below, whether your requirements are simple or complex, IDEK has the Flat Screen Color Monitor that's just right for you. And priced right, too! See for yourself what a difference a Flat Screen Monitor from IDEK can make.

MULTIFLAT Series (21" Flat CRT Monitors)

Model	H. Frequency	Dot	Resolution
MF-5021	15 to 38kHz	0.31	1024 x 768
MF-5121	21 to 50kHz	0.31	1024 x 768
MF-5221	30 to 80kHz	0.31	1280 x 1280
MF-5321 (A.R.Panel)	30 to 80kHz	0.31	1280 x 1280
MF-5421 (A.R.Panel)	30 to 80kHz	0.26	1600 x 1280

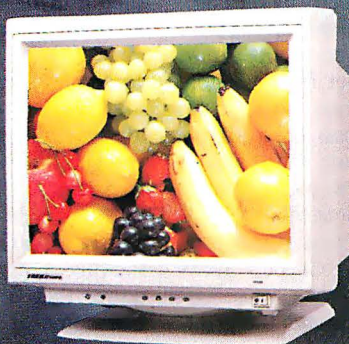

IDEK also offers its new Model MF-5117 17" Flat Screen Color Monitor that delivers the same superior resolution and performance as the other members of the IDEK lineup.

IDEK Iiyama

IIYAMA ELECTRIC CO., LTD.

Overseas Division

7th Fl., US Hanzomon Bldg., 2-13, Hayabusa-cho, Chiyoda-ku
Tokyo 102, Japan

Phone: (81) 03-265-6081 Fax: (81) 03-265-6083

IDEK Europe (W. Germany)

Neumannstrasse 38, 6000 Frankfurt a.M. 50, West Germany

Phone: (49) 69-521 922 Fax: (49) 69-521 927

IDEK North America

144 Centre Mountain View, CA 94041 U.S.A.
Phone: (1) 415-962-9410 Fax: (1) 415-962-9474

Circle 141 on Reader Service Card

COMPANY INFORMATION

Advanced Matrix Technology
(Accel-535)
765 Flynn Rd.
Camarillo, CA 93012
(805) 992-2264
Inquiry 1111.

AEG Olympia, Inc.
(NPC 136-24)
3140 Route 22
P.O. Box 22
Somerville, NJ 08876
(800) 999-7808
Inquiry 1112.

Alps America
(Allegro 500XT)
3553 North First St.
San Jose, CA 95134
(408) 432-6000
Inquiry 1113.

Apple Computer, Inc.
(ImageWriter LQ)
20525 Mariani Ave.
Cupertino, CA 95014
(408) 996-1010
Inquiry 1114.

Brother International Corp.
(M-1924L)
200 Cottontail Lane
Somerset, NJ 08875
(201) 981-0300
Inquiry 1115.

Canon USA, Inc.
(BJ130e)
One Canon Plaza
Lake Success, NY 11042
(800) 848-4123
Inquiry 1117.

C-Tech Electronics, Inc.
(C-515)
2515 McCabe Way
P.O. Box 19673
Irvine, CA 92713
(800) 347-4017
Inquiry 1116.

Dataproducts Corp.
(Model 9044)
6200 Canoga Ave.
Woodland Hills, CA 91367
(800) 624-8999
Inquiry 1118.

Epson America, Inc.
(LQ-2550 and EPI-4000)
20770 Madrona Ave.
Torrance, CA 90509
(800) 289-3776
Inquiry 1119.

Facit, Inc.
(B2400/50)
P.O. Box 9540
Manchester, NH 03108
(603) 647-2700
Inquiry 1120.

Fortis Direct Connect Systems
(DQ4215)
1820 West 220th St.,
Suite 220
Torrance, CA 90501
(213) 782-6090
Inquiry 1121.

Fujitsu America, Inc.
(DL4600 and RX7100 S/2)
3055 Orchard Dr.
San Jose, CA 95134
(800) 626-4686
Inquiry 1122.

Hewlett-Packard Co.
(DeskJet 500 and RuggedWriter 480)
18110 Southeast 34th St.
Camas, WA 98607
(800) 538-8787
Inquiry 1123.

IBM
(Proprinter XL24E)
Contact your local IBM dealer.
Inquiry 1124.

Mannesmann Tally Corp.
(131/24)
8301 South 180th St.
Kent, WA 98032
(800) 843-1347
Inquiry 1125.

NEC Technologies, Inc.
(Pinwriter P6300)
1414 Massachusetts Ave.
Boxborough, MA 01719
(800) 632-4636
Inquiry 1126.

Okidata
(Microline 393 + and OkiLaser 820)
532 Fellowship Rd.
Mount Laurel, NJ 08054
(800) 654-3282
Inquiry 1127.

Panasonic Communications and Systems Co.
(KX-P1624)
Two Panasonic Way
Secaucus, NJ 07094
(800) 346-4768
Inquiry 1128.

Qume Corp.
(CrystalPrint Publisher II)
500 Yosemite Dr.
Milpitas, CA 95035
(408) 942-4000
Inquiry 1129.

Seikosha America, Inc.
(SL-230)
10 Industrial Ave.
Mahwah, NJ 07430
(800) 338-2609
Inquiry 1130.

Star Micronics America, Inc.
(XB-2415 Multi-font)
420 Lexington Ave.,
Suite 2702
New York, NY 10170
(800) 447-4700
Inquiry 1057.

Tandy Corp.
(DMP 2103)
1800 One Tandy Center
Fort Worth, TX 76102
(817) 390-3011
Inquiry 1058.

Toshiba America Information Systems, Inc.
(ExpressWriter 440)
Computer Systems Div.
9740 Irvine Blvd.
Irvine, CA 92718
(800) 334-3445
Inquiry 1059.

all-black ribbon as a color ribbon, spreading out the printing chore over the four black "bands." A black ribbon will last at least four times as long as a color ribbon for black printing jobs. Because of the extra color bands, a color ribbon is more expensive, and printing black text will use only one-fourth of the ribbon.

You may also want a wider variety of type styles as your needs develop. Most of these printers accept some kind of font card to generate additional fonts. However, there is no standard equivalent to the HP LaserJet cartridge. In general,

dot-matrix font cartridges are proprietary beasts, offered directly by the company that sold you the printer. Some have a rich selection of fonts to choose from; others have only a select few. Vendors add new ones all the time, so find out how many and which fonts are available for your model. Be aware that because the fonts are nonstandard, your software probably won't know about them. You'll have to add the font functionality to your applications or select your new fonts from the control panel.

By all means, skim through the print-

er's documentation. At the very least, it should include clear step-by-step installation and operation instructions, expository illustrations, a complete listing of command sequences (in ASCII, decimal, and hexadecimal notation), and—as always—a sufficient index. You may not need it all now, but it may come in handy sometime.

Put It in Writing

Picking a printer from this group requires that you weigh all the evidence. For some applications, high speed is

Now 4 can share HP's LaserJet III printer...



...with BayTech's LaserShare® — expansion is made easy!

LaserShare is an expansion card that allows four users to connect simultaneously to one laser printer. Just check out our outstanding features:

- ✓ **HP LASERJET III COMPATIBILITY**
Also works with HP LaserJet II, IID, Canon LPB8II, LPB8III, Brother HL8e, and Wang LDP8 laser printers.
- ✓ **256KB, 1MB OR 4MB BUFFER**
- ✓ **SIMPLE INSTALLATION**
- ✓ **AVAILABLE MODELS**
 - 4A - 4 parallel ports
 - 4C - 4 serial ports
 - 4E - 2 parallel/2 serial ports
 - 4CB - 4 serial (256KB, Brother)
- ✓ **SAVES MONEY AND TIME**
- ✓ **UNMATCHED PRODUCT SUPPORT**

With several users having access to one laser printer, the per-user cost of your laser printer is dramatically reduced. And there's no more waiting for the printer. With LaserShare, everyone's printing needs are accommodated. BayTech's LaserShare — it's worth checking out! Call now for details!



Because Resources Should Be Shared.



Data Communications Products Division
200 N. 2nd St., P.O. Box 387 Bay St. Louis, MS 39520
Fax 601-467-4551 Phone 601-467-8231 or toll-free

800-523-2702

*All product or company names are trademarks of their respective holders.

INTERNATIONAL DISTRIBUTORS

Australia
Melbourne
Shuttle Technologies, Ltd.
(03) 587 4920

Melbourne
Goya Tech, Pty., Ltd.
(03) 747-8455

Belgium
Multiway Data Belgium
016-29 22 78

The Netherlands
Multiway Data Netherlands
079-424 111

Denmark
Trend Communications
53 65 23 45

Finland
Genine Oy Impdata
(921) 335700

France
Suresenes
Koindex International
(1) 47 72 63 11

Paris
Gradco France
(1) 42 94 99 69

Germany
Munich
AMS Computech GmbH
(089) 126806-0

Dusseldorf
Multiway Data Germany
0211-25 18 75

Italy
Torino
BRM Italiana
(011) 771 00 10

Milano
I.T.D.
(02) 749.0749

Norway
A/S Kjell Bakke
47-6-832000

Singapore
Mark Systems (FE) Pte., Ltd.
65-2261877

Spain
Vidmar Control
(93) 2454803

Sweden
Solna
Microcom/Maldata
(08) 7344100

Sollentuna
Beon Data
08-626 92 26

Switzerland
Sengstag Computers AG
00411.950.54.44

United Kingdom
Leicester & London
A-Line Dataspeed Devices, Ltd.
0533-778699

Buckinghamshire
Trend Datalink, Ltd.
(06285) 30611

Circle 43 on Reader Service Card (RESELLERS: 44)

Space-Saver Keyboard

PRODUCT FOCUS

important. For others, quality or the ability to handle multipart forms is the deciding factor. The text box "How to Tell One Dot-Matrix Printer from Another" on page 166 explains how you might choose between them and how we selected the five printers below.

It turns out that there's a good reason for the market leaders being market leaders. Epson may not be known for its other hardware offerings, but the people there sure know how to build a printer. The LQ-2550 (\$1499) is a beautiful machine. It has a simple LCD interface and all the amenities, including an automatic bail and a thickness sensor. Color is standard, and you certainly won't have to worry about compatibility. Likewise with the IBM Proprinter. Its interface is a bit cryptic, relying in part on musical tones, but its output is beautiful and its construction solid. The Okidata Microline 393+ (see photo 4) printed well, has all the amenities, and is built like a tank. For heavy-duty use and high-quality output, you probably can't do better than the Okidata.

Like the LQ-2550, the Advanced Matrix Technology Accel-535 (\$1485) is expensive, but, again, with good reason. This printer is fast and full-featured. The LCD interface is as elegant as it gets. Color is standard, as is a 32K-byte buffer (upgradable to over 400K). You'll also get four resident fonts and an excellent manual.

If speed is not a major concern but price is, the Panasonic KX-P1624 offers all the major features, seven resident fonts, and a 12K-byte buffer for \$650. For \$149 more, the AEG Olympia NPC 136-24 adds an automatic bail, a 24K-byte buffer, and an LCD interface.

Dot-matrix printers still have a broad market that page printers can't touch. And even if you already have your fancy page printer, you may want a dot-matrix printer to churn out your drafts and listings. That strategy will save time and money, not to mention wear and tear on your laser printer engine. Don't discount the lowly dot-matrix printer. It could be just the workhorse you need. Prices should continue to fall as laser printers put a squeeze on the low end of the market. You should be able to find some real steals out there. Dot-matrix technology may not be sexy, but it's still alive and well. "Old Man Ribbon," he just keeps printing along. ■

Stanford Diehl and Howard Eglowstein are BYTE Lab testing editor/engineers. They can be reached on BIX as "sdiehl" and "heglowstein," respectively.



Save an amazing 60% of the desk or counter space now taken by a standard keyboard and enjoy improved functionality at the same time. Actual size is 10.75" x 6.0" (273 x 152mm). The new MICROTYPED keyboard is rapidly gaining acceptance as a truly advanced alternative to the original IBM layout for many applications. Reliability of the MICROTYPED has been amply proven through extensive use in trading areas of the NYSE, The New York and Chicago Mercantile Exchanges as well as in many banks, brokerages, stores and at factory work stations.

Space is saved by compressing rows (not columns) and eliminating wide borders. Re-arranging and elevating the auxiliary key clusters also saves space while improving accessibility with reduced eyescan and head movement. Keys have full travel with a light tactually responsive touch. All standard features such as auto-repeat, caps, num and scroll lock are included on the MICROTYPED.

PC XT/AT, PS/2 IBM and clone compatibility. Available in US and most European language versions. Made in USA with 1 year warranty.

... beautifully sensitive and handles both typists with light touch and those who really bang away...

COMPUTER BUYERS GUIDE

... This could be the perfect layout for an enhanced keyboard that must fit into a small area...

COMPUMAG

Order direct from stock with 15 day full return privileges. VISA, MasterCard, Eurocard charges accepted.

USA	1-800-DATALUX	Fax 703-662-1682	\$124.50 + 6.00 s/h	Extra charges for PS/2 adapters,
CANADA	514-694-0870	Fax 514-694-0871	\$189.00Cdn + s/h	air shipments. OEM and reseller
EUROPE	44 + 306-76718	Fax 44 + 306-76742	£99.00 + VAT + P&P	volume discounts available.

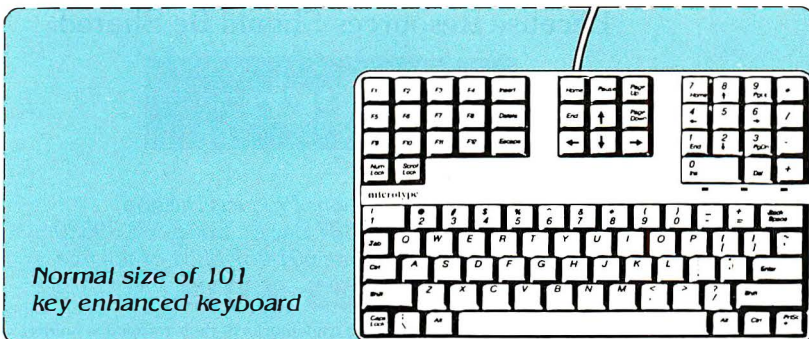

When it comes to saving space, there's no comparison.

DATALUX

DATALUX CORPORATION 2836 Cessna Drive, Winchester, Virginia 22601

Discover Parallel Processing

Quadputer™

The Microway Quadputer is the world's most popular PC Transputer development environment. It can be purchased with two to four Transputers and one to four megabytes of RAM per processor. The Quadputer runs all the popular Transputer development software, all of which is available from Microway. It is compatible with our Monoputer™ which provides 1 to 16 megabytes of RAM and a single T800, our Videoputer™ which comes in VGA and higher resolution versions and is powered by a memory mapped pair (T800 and 34010), and our Linkputer™ whose cross bar switching network can dynamically link up to 32 Transputers. Finally, all Microway Transputer products can be used with our Number Smasher-860 to provide out-of-this-world numeric performance!

For more information, please call 508-746-7341.

Microway

The World Leader in PC Numerics

Corporate Headquarters, Research Park, Box 79, Kingston, MA 02364
TEL 508-746-7341 • FAX 508-746-4678
U.K. - 32 High St., Kingston-Upon-Thames, 081-541-5466 • Italy 02-74.90.749
Holland 40 836455 • Germany 069-75-2023 • Japan 81 3 222 0544

Number Smasher® 860

The highest performance coprocessor card to ever run in a PC, Number Smasher-860 delivers up to 80 million single precision floating point operations per second at 40 MHz and produces over 10 Linkpack megaflops. The board comes standard with an ISA interface, two Transputer Link Adaptors that allow it to interface with a Microway Quadputer or Videoputer, your choice of our NDP Fortran, C or Pascal for the 80860, plus 8 megabytes of high speed memory.

NDP Fortran-860, C-860 and C++-860

Microway NDP 860 Compilers make it easy to recompile your favorite mainframe, 80386 or PC application for the 80860. The resulting code runs on our XTEND-860™ environment under DOS, UNIX or XENIX.





Buy our IBM-compatible color printer and get this Mac-compatible color printer free.

The new Phaser PX Color Printer from Tektronix.

Only \$7995

The price is as much of a breakthrough as anything else. The Phaser PX offers PostScript-language compatibility and 300 dpi thermal-wax color that's brighter and bolder than that of pricey competitors. And not only can you hook it up to an office full of PCs via serial or parallel, but it will also accommodate any

Macs that might come along. Automatically switching from port to port to keep everybody happy.

Add to that certified PANTONE** Color that can be printed on paper or transparencies, and you've got a color printer that will do more for less money than ever before.

So call 1-800-835-6100, Dept. 11J to find out how to get your hands on the new Tektronix Phaser PX. Then you can kill two birds with one color printer.

The New Tektronix Phaser PX®

**Pantone, Inc.'s check-standard trademark for color reproduction and color reproduction materials. Copyright © 1990 Tektronix, Inc.



Buy our Mac-compatible color printer and get this IBM-compatible color printer free.

The new Phaser PX Color Printer from Tektronix.

Only \$7995

The price is as much of a breakthrough as anything else. The Phaser PX offers PostScript-language compatibility and 300 dpi thermal-wax color that's brighter and bolder than that of pricey competitors. And not only can you hook it up to an office full of Macs via AppleTalk, but it will also accommodate the PCs and

workstations that might come along. Automatically switching from port to port to keep everybody happy.

Add to that certified PANTONE** Color that can be printed on paper or transparencies, and you've got a color printer that will do more for less money than ever before.

So call 1-800-835-6100, Dept. 11J to find out how to get your hands on the new Tektronix Phaser PX. Then you can kill two birds with one color printer.

The New **Tektronix Phaser PX**®

All rights reserved. Phaser is a trademark of Tektronix, Inc. All other trademarks mentioned herein belong to other companies.

Circle 302 on Reader Service Card (RESELLERS: 303)

Sony NeWS and MIPS Magnum: A Double Shot of RISC

With such a crowd of Unix workstations in the low-end market, how can you tell them apart? In a word, software. Consider, for example, the Sony NeWS 3710 and the MIPS Magnum 3000. Both machines are based on the MIPS R3000 RISC CPU chip set. Both have floating-point acceleration and fast color graphics.

Physically, these machines have much in common. They are compact, the Magnum 3000 slightly more so (see the photos). They come equipped with quarter-inch cartridge tape drives. At the rear, the machines have connections for the keyboard, serial devices, a thick-wire Ethernet port, and external SCSI devices. While both workstations use the same CPU and floating-point chips, the NeWS 3710 runs at 20 MHz, while the Magnum 3000 runs at 25 MHz.

From there, the hardware differences are almost insignificant, with a couple of exceptions. The NeWS 3710 holds a front-facing, high-density 3½-inch floppy disk drive next to the tape drive. It's a bit more expandable than the Magnum 3000, holding two 25-pin serial ports and three internal expansion slots. On the review system, two of the three slots were available; one was occupied by the color display controller. The NeWS 3710 also boasts digital stereo audio and the ability to power itself down.

The Magnum 3000 has one Industry Standard Architecture-compatible internal slot, but the color display adapter fills it (leaving it free only on the monochrome system). The machine also has

two serial ports, but one of them is devoted to the mouse through an odd cable arrangement. For convenience, the mouse plugs into the keyboard (as with the Sony), but the Magnum 3000's keyboard cable splits to connect to both the keyboard and serial port number 1 sockets. A round "don't touch me" sticker bound one edge of the case, indicating that the unit is not field-expandable.

How It Feels

If you sit in front of a workstation all day, as I do, how well the system interacts with you is important. In the case of these two machines, the display is no problem—both use the gorgeous Sony Trinitron monitor. Sony shipped a 19-inch display; MIPS sent a 16-inch monitor. The colors are true, and the pixels are small and sharply defined, making the display easy on your eyes.

The Magnum 3000's keyboard is springy, and it looks very Mac-like. It sports a network activity light (which, incidentally, never came on). The key placements are just where you'd expect them to be. The feel was a little stiffer than I like. The Magnum 3000 uses the likable, old-style Logitech Mouse (the boxy one). You can rest your entire hand on it, and the buttons have a short travel and a positive click that lets you know that you've pressed them.

On the other hand, the NeWS 3710's keyboard and mouse were so unpleasant to use that they might as well have been wrapped in barbed wire. Special keys, such as a Vertical Line key, are placed so

that a touch-typist has to stop dead and hunt for them. The Delete key is next to the Return key, inviting disaster from unsuspecting operators who terminate their programs when they try to get to the next line. The right-hand Shift key is adjacent to a dead key (it doesn't travel—I call it a "finger breaker"), and the Alt key appears on only one side of the keyboard. The mouse is also awkward to use. It's hard to wrap your hand around it, and the button travel is too long. My mouse squeaked, appropriately, when I pressed the buttons.

One redeeming feature of the NeWS 3710's interface is its software-operated power switch. I first encountered such a switch on the AT&T 3B2 and thought it was a great idea. If you're working at home and a nasty thunderstorm starts moving in, you can dial up your Sony workstation at your office and tell it to shut itself off. A special argument to the shutdown command, `-x`, does an orderly shutdown and dumps power.

The front-mounted power switch will not power down the machine (it only works to power it up), which is good, since the placement makes it a prime target for accidental contact. Remote power-down capability also adds extra teeth to any power-monitoring scheme you might set up. When your uninterruptible power supply kicks in, you can have the system automatically power off. This is such a simple, worthwhile idea and is so easy to implement that I can't understand why it isn't standard on every computer.

Software: The Real Difference

Don't let anyone fool you—the most important piece of equipment in a workstation is the software. In this regard, the systems are as different as they can be and yet still be similar; let me explain.

The NeWS 3710 that I received was running the same operating system as other Sony workstations: BSD 4.3. The Magnum 3000 runs its own RISC/OS,

which is a mix of System V and BSD. The operating-system question may be moot by the time you read this; Sony is switching over to System V release 4. Much of what that operating system promises is already in RISC/OS. MIPS stacked the BSD file system, libraries, and commands atop a System V kernel. The folks at MIPS insist that the Magnum 3000 can compile and run any BSD or System V application without modification. Add to that job control, TCP/IP networking, line-printer handling, and other BSD-isms, and you have an operating system that should please even the staunchest BSD fanatic. I prefer System V as an application environment: It's easier to maintain and use, and all the benefits of System V are apparent in RISC/

The MIPS Magnum 3000 has a smaller case than the Sony NeWS 3710 and performs noticeably better.

The Sony NeWS 3710. The floppy disk and tape drives are concealed behind a door on the right front of the case.

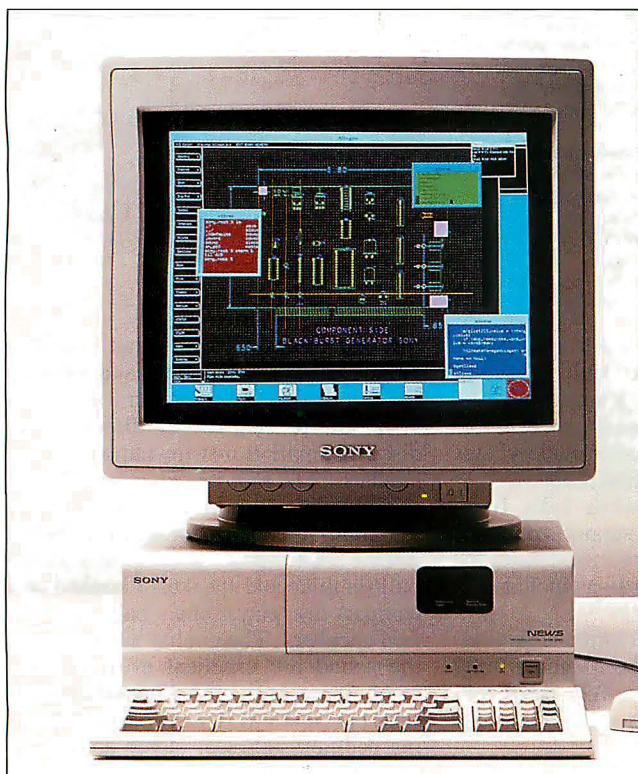
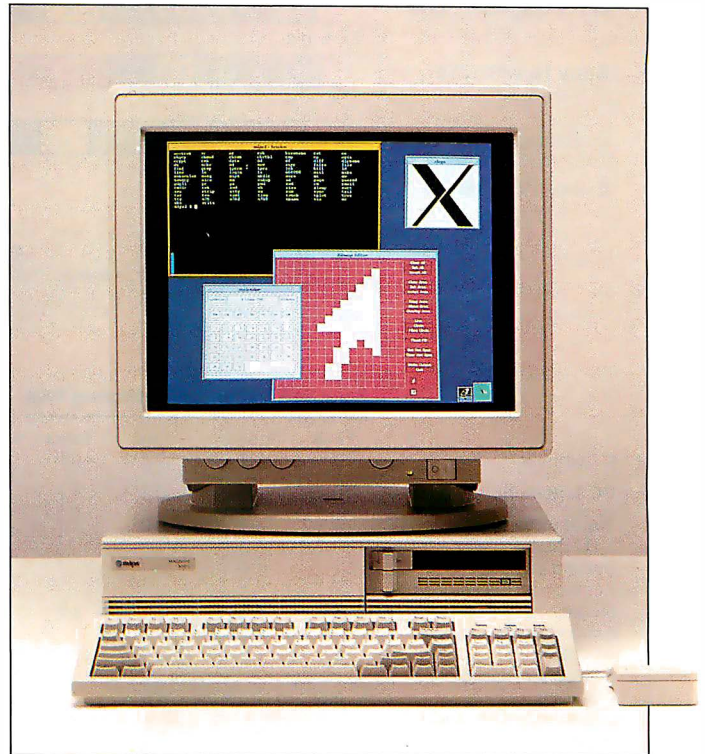

Sony NeWS 3710

Company

Sony Microsystems Co.
645 River Oaks Pkwy.
San Jose, CA 65134
(408) 434-6644

Components (as reviewed)

Processor: 20-MHz MIPS R3000
Memory: 8 MB of RAM; 64K-byte instruction cache; 64K-byte data cache
Mass storage: 3½-inch 1.44-MB floppy disk drive; 640-MB hard disk drive
Display: 19-inch Sony Trinitron color monitor; 1280- by 1024-pixel 256-color display
I/O interfaces: Two serial ports; thick-wire Ethernet interface; SCSI port; three Sony expansion slots

Price

\$18,200
With 16-inch monitor; \$16,900

Inquiry 1110.

MIPS Magnum 3000

Company

MIPS Computer Systems, Inc.
950 De Guigne
Sunnyvale, CA 94086
(408) 720-1700

Components (as reviewed)

Processor: 25-MHz MIPS R3000; R3010 math coprocessor; 32K-byte instruction cache; 32K-byte data cache
Memory: 16 MB of RAM
Mass storage: Two 200-MB internal SCSI hard disk drives; 150-MB cartridge tape drive
Display: 16-inch Sony Trinitron color monitor; 1280- by 1024-pixel 256-color display
I/O interfaces: Two serial ports; thick-wire Ethernet interface; SCSI port

Price

\$17,990

Inquiry 1109.



UNIX BENCHMARKS

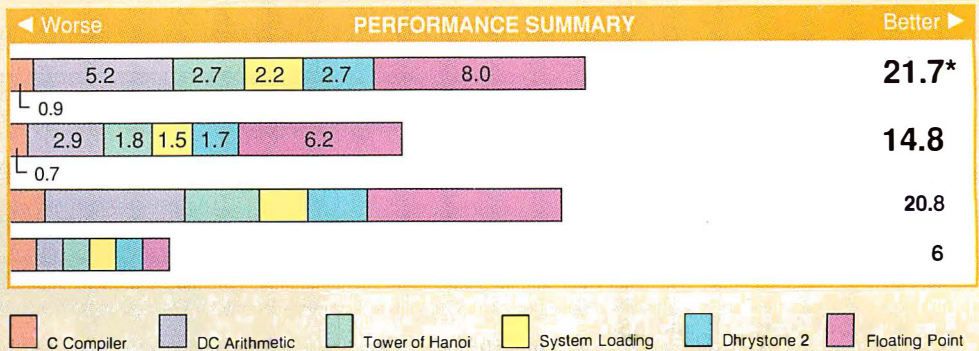

HIGH-LEVEL PERFORMANCE

	Sony NeWS 3710		MIPS Magnum 3000	
	Time	Index	Time	Index
* C Compiler	3.1	0.7	2.3	0.9
* DC Arithmetic	0.2	2.9	0.1	5.2
* Tower of Hanoi (17-disk problem)	0.3	1.8	0.2	2.7
* System Loading ¹				
1 concurrent background process	3.0	1.3	2.1	1.9
2 concurrent background processes	3.9	1.5	2.8	2.1
4 concurrent background processes	6.5	1.5	4.5	2.2
* 8 concurrent background processes	11.6	1.5	7.8	2.2

LOW-LEVEL PERFORMANCE

	Sony NeWS 3710		MIPS Magnum 3000	
	Time	Index	Time	Index
* Dhrystone 2 (without registers; Dhry./sec.)	24000	1.7	37271	2.7
* Arithmetic (10,000 iterations)				
Arithmetic overhead	0.7	1.1	1.0	0.7
Register	2.8	1.0	2.3	1.3
Short	2.7	1.3	2.4	1.5
Integer	2.8	1.1	2.3	1.3
Long	2.8	1.1	2.3	1.3
* Floating Point	1.9	6.2	1.5	8.0
Double	1.2	10.8	0.9	14.4
* Throughput				
System call overhead (5 x 4000 calls)	0.5	2.1	0.5	2.2
Pipe throughput (read and write 2048- x 512-byte blocks)	0.9	1.0	0.3	3.0
Pipe-based context switching (2 x 500 switches)	0.2	3.2	0.1	4.8
Process creation (100 forks)	0.4	2.9	0.4	3.1
Exec throughput (100 execs)	0.5	6.6	0.8	4.1
* Filesystem throughput (1600 1024-byte blocks in Kbytes/sec.)				
Read	988	N/A	884	N/A
Write	1458	N/A	859	N/A
Copy	485	N/A	327	N/A

* Cumulative index is formed by summing the indexed performance results for C Compiler, DC Arithmetic, Tower of Hanoi, System Loading (with 8 concurrent background processes), Dhrystone 2, and Floating Point tests.

¹ System loading was performed using Bourne shell scripts and Unix utilities.

Note: All times are in seconds unless otherwise specified. Figures were generated using the BYTE Unix benchmarks version 2.6. Indexes show relative performance; for all indexes, an Everex Step 386/33 running Xenix 2.3.1 = 1.
N/A = Not applicable.

OS. Soon, Sony will have them, too.

Both systems provide X Window System services, as well. Sony's X server includes the Shape (for handling nonrectangular objects) and Bézier (representing complex curves with few data points) extensions. These provide fertile ground for involved graphical applications.

The `xdpinfo` program, which reports information about the configuration of the X server, told me that both displays measured 1280 by 1024 pixels, with a depth of 8 bits (256 colors). Sony's port of X Window is apparently the more complete, as it supports all the available X color models.

Managing colors in a portable way is probably the most difficult aspect of writing X applications. It's also the thing most programmers mess up. An X server that supports multiple color models helps smooth over these differences.

MIPS's X server, while fully functional, is less robust; it supports only one color model (PseudoColor) and lacks the Shape and Bézier extensions included in Sony's server.

In simple tests, X performance was almost identical, with the Magnum 3000 showing a negligible edge. Both machines do common text and window operations in a snap.

The NeWS 3710's differentiating fea-

ture is an unusual one: sound. The machine includes the circuitry and software for digitizing high-resolution stereo audio and playing it back directly from disk. A small transistor-radio-size box handles sound I/O; it holds a monophonic microphone and a tinny speaker. If you are going to experiment with the NeWS 3710's sound, don't waste time with the built-in mike and speaker. I hooked up a compact disc player and a pair of amplified speakers. The quality and clarity of the sound are excellent even at lower resolutions. At the top 37.5-kHz resolution, the NeWS 3710 had no trouble playing back crystal-clear stereo audio captured from a CD. There was no dis-

cernible noise or hum from having the machine's workstation guts churning so nearby.

Is this fluff? Today, it probably is. Someday, however, quality audio will likely become standard fare on all systems. Macintosh users have long been aware of the value of having a variety of expressive sounds under program control. Sony's X-based sound editor is primitive and has a demo feel to it, but there's great potential there.

Complex programs could benefit from vocal prompts and varied audio warnings whose tones indicate the severity of the condition. Aids for the handicapped suggest themselves, as do educational applications. It will take some time before audio capabilities like those in the NeWS 3710 are exploited to their full potential, but getting the hardware in there is a good start.

Pedal-to-the-Metal Performance

All this fancy hardware and operating-system software would be for naught if they didn't perform. Both systems do well, running more than twice as fast as the Everex Step 386/33 baseline system.

This is worth considering if you're trying to choose among platforms. Something else worth considering is that not all implementations of the same hardware yield the same results. As the benchmark results show, the Magnum 3000 takes an early lead in integer performance and holds onto it right through the floating-point benchmark, outgunning both the NeWS 3710 and the MIPS R3000-based DECstation 5000/200CX. MIPS writes its own compilers, and the performance figures prove that the company *knows* RISC. The company uses this knowledge to full advantage, and it knows its audience, as well.

Network and X performance are respectable, and I had no trouble hooking either system into BYTE's Unix Lab network. Either machine would make an excellent X Window client server (a machine that runs X programs faster than you can and displays them at your workstation/X terminal).

As is typical of systems for which SCSI is integrated onto the motherboard, disk performance is marvelous on both machines, with the NeWS 3710 coming out slightly ahead. There is enough juice

there to hang a bevy of external SCSI drives off either of these machines and leave them on-line as compute *and* Network File System file servers.

Shutdown

I liked both systems, but I'm afraid that there isn't much to recommend the NeWS 3710 as a general-purpose workstation. It doesn't measure up to the Magnum 3000 in performance or multi-environment compatibility. I've been told to expect more "Sonyisms," of which the digital audio is the first, and Sony may well be able to make a name for itself in multimedia and other niches.

I'm loath to call any system perfect, but the Magnum 3000 seems to have all the bases covered: price, performance, and software. I would have traded the squat case for more internal expansion, but that's a minor gripe. The MIPS machine is an excellent value—evidence that sometimes it's worth going straight to the source. ■

Tom Yager is a technical editor for the BYTE Lab. You can reach him on BIX as "tyager."

Windows 3.0 Made Even Easier

BeckerTools is a deep toolbox of file and data management utilities for every Windows 3.0 user. It's multitasking is always there, waiting to help you with your file management chores. And since you already know how to point and click, you already know how to use BeckerTools.

BeckerTools adds these and more capabilities to Windows 3.0:

- Undelete - lets you recover deleted files
- Delete files - single or groups of files or directories, including read-only files
- Backup (pack files) hard disk - to multiple diskettes with password protection
- Duplicate diskettes - read in diskette once, make multiple copies
- Edit text - built-in editor with search and replace
- Copy diskettes - in single pass
- Compare diskettes - in single pass
- Wipe diskette - for maximum security
- Verify diskettes - handy security check
- Format diskettes - in any capacity supported by your drive and disk type while multitasking
- Displays - neatly formatted tree structure, with memory allocations of each directory
- Screen saver included-at no extra cost

Suggested retail price: \$79.95

Available through Radio Shack's Express Order Service, Waldensoftware, Software Etc. and other retailers nationwide. Or order direct from:

Abacus

Dept. B12, 5370 52nd Street SE, Grand Rapids, MI 49512
Orders: 1-800-451-4319 • Phone: (616) 698-0330 • Fax: (616) 698-0325

In US and Canada add \$4.00 postage & handling. Foreign orders add \$12.00 postage per item. We accept Visa, Mastercard or American Express. Call or write for your free catalog.

Circle 10 on Reader Service Card (RESELLERS: 11)

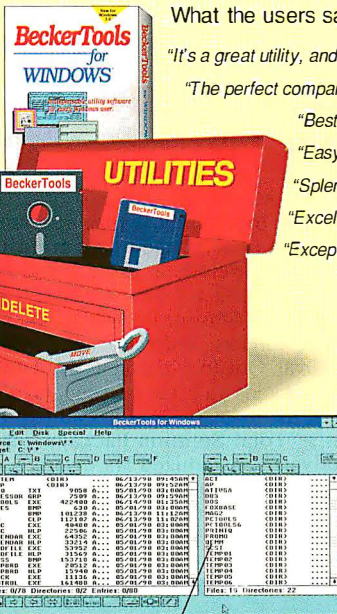

Select both the source and target file or directory from convenient single screen

What the users say about BeckerTools —

- "It's a great utility, and ...It's easy to learn!" M.B., Canada
- "The perfect companion utility for Windows 3.0" J.A., CA
- "Best file manager utility for Windows!" T.J.D., CA
- "Easy to install and use... Screen saver is a nice extra!" K.R., GA.
- "Splendid program. Will be bundled in each system." K.S., CA
- "Excellent product! Just what I've been looking for! ..." B.K., FL
- "Exceptional, well done. A solid product." J.R., FL

Perform these operations by just clicking on an icon

- Convenient one button command menu.
- Easily switch source/target directories.
- Sort by your filenames or extensions.
- Select all files in your source directory.
- Deselect just as easily.
- Select files and directories.
- See only the files you want to see.
- Select multiple files using your patterns.

System Requirements: IBM AT, 386 or compatible, and Windows 3.0. Includes both 3.5" and 5.25" diskettes Windows not included.

Order Toll Free 1-800-451-4319 Ext. 212

HIGHEST QUALITY PCs FROM

IVERSON SUPPORT WITH

TURNKEY LANS

Design studies, site survey, factory checkout, total installation, training.

CUSTOM SOFTWARE

Develop menus, drivers, application code, and documentation.

CUSTOM HARDWARE

Customization of most types of PCs and file servers.

FACTORY VISITS

Customers may visit factory and work with hardware/software engineers.

MAINTENANCE/TRAINING

Company owned district offices in major U.S. and European Cities.

COMPLETE R&D

Design, drafting, computerized sheet metal presses, PCB department.

FCC LAB

Company owned and operated full service lab.

TOTAL QC

Incoming, in line, test and burn in, cosmetic, packaging, and shipping.

LOAD SOFTWARE

Will load and test any software on mass storage device at factory.

COMPUTER PROS

Six Co. Officers began careers at IBM, average 23 years computer experience.

DESIGNER LABEL

Label showing individual or company name as system designer.

BEST NAME BRAND COMPONENTS USED

Maxtor, Seagate, Fujitsu, and Connor disk drives. Tatung and Acer displays. Western Digital floppy, SCSI, IDE, ESDI, & video controllers. Custom system boards with genuine Intel CPUs and math coprocessors. Oversized Senstron power supplies. Fujitsu keyboards.

Knowledgeable Iverson Users

Arthur D. Little, Inc.
AT&T
Australia, Government of
Boeing
Booz-Allen & Hamilton
Computer Sciences Corp.
Digital Equipment Corp.
Dow Chemical
Electronic Data Systems
Equitable Life
Ford
General Dynamics
Goodyear
Grumman Aerospace Corp.
Harris Corporation
Hewlett-Packard Co.
Hughes Aircraft
IBM Corp.
Kodak
Litton
Lockheed Missiles & Space Co.
Massachusetts Institute of Technology
McDonnell Douglas Aerospace
Motorola
NATO
Nigeria, Government of
Norway, Government of
Texas Instruments
TRW, Inc.
United Technology Corp.
plus 350 Government agencies
in the free world.

We're best at all the rest, too.

24-hour delivery on most orders. A 24-hour toll-free technical support hotline. On-site technical support and training. All purchases include a 30-day, money-back guarantee and a 1-year limited warranty. Payment by Mastercard, VISA, and personal check. Purchase orders accepted with credit approval. Quantity discounts available.

It all adds up to the best support and service in the industry. And it's all part of Iverson's "Total Solution Package" of Needs Analysis, Customized Hardware and Software, Systems Integration, Training, Installation, and Maintenance.

386/25MHz SYSTEM



BEST POWER BUY!

COMPLETE 386/25 SYSTEM WITH 179MB DRIVE \$2490

- Intel® 80386-25MHz CPU
- 1 MB RAM Memory (optional 4 or 8) on motherboard; optional 2 or 8 MB on 32-bit memory card, for up to 16 MB total
- 179 MB hard drive, 3.5" form factor; 20ms
- 5.25" 1.2 MB or 3.5" 1.44 MB floppy drive
- 16-bit VGA adapter w/512K
- 14" VGA 1024 x 768 color monitor 0.28 DP
- Enhanced 101 keyboard
- 8 industry standard expansion slots (1 32-bit); 5 available
- 1 Parallel, 2 Serial ports
- 80387-25 Coprocessor socket
- FCC A approved
- Full size AT case; 200 Watt power supply
- Flash-lite disk cache software
- Virus-Safe, virus protection software by EliaShim
- One year on-site warranty
- 24 hour technical support line
- Not offered on GSA schedule

ORDER
NOW!
CALL

1-800-444-PC90

8AM-
MIDNIGHT
EST
MONDAY-
FRIDAY

U.S. GOV'T SECURITY INTEGRATOR

BEST PRICE/PERFORMANCE

\$770 386SX/16MHz



- Intel® 80386SX-16 MHz CPU
- 1 MB RAM Memory (optional 2, 4, or 8 MB) on motherboard expandable to 16 MB via expansion board
- 5.25" 1.2 MB or 3.5" 1.44 MB floppy drive
- Enhanced 101 keyboard
- 8 industry standard expansion slots; 6 available
- 1 Parallel, 2 Serial ports
- Integrated high performance hard disk interface and disk controller (IDE)
- 80387SX Coprocessor socket
- Baby AT case
- FCC A approved
- Also available in FCC B approved Slimline case; call for prices
- Available with 80386SX-20 MHz CPU; call for prices
- Free Virus-Safe virus protection software
- Free Flash-lite disk cache software

\$1,789 386/33MHz



- Intel® 80386-33 MHz CPU
- 2 MB RAM Memory optional 4, 8, 12, or 16 MB on motherboard
- 64 KB cache S RAM Memory expandable to 256 KB cache
- 5.25" 1.2 MB or 3.5" 1.44 MB floppy drive
- Enhanced 101 keyboard
- 1 Parallel and 2 Serial ports
- 8 industry standard expansion slots (six available)
- Integrated high performance hard disk interface and disk controller (IDE)
- 80387-33 Coprocessor socket
- Add \$60 for optional Mini-Tower case
- Add \$120 for optional Full Tower case
- FCC A approved
- Free Virus-Safe virus protection software
- Free Flash-lite disk cache software

\$3,395 486/25MHz



- Intel® 80486-25 MHz CPU with built-in floating point coprocessor and 8k cache
- 4 MB RAM Memory expandable to 64 MB
- 5.25" 1.2 MB or 3.5" 1.44 MB floppy drive
- Enhanced 101 keyboard
- 1 Parallel and 2 Serial ports
- 1 32-bit memory slot
- 7 industry standard expansion slots (five available)
- Integrated high performance hard disk interface and disk controller (IDE)
- Add \$60 for optional Mini-Tower case
- Add \$120 for optional Full Tower case
- FCC A approved
- Free Virus-Safe virus protection software
- Free Flash-lite disk cache software

HARD DRIVE OPTIONS

IDE	ESDI
20 MB \$ 304	150 MB \$1,283
40 MB 339	330 MB 1,854
80 MB 556	650 MB 2,711
100 MB 699	
200 MB 1,136	SCSI
	1 GB \$5,580
	Erasable cartridge

GSA LOW PRICES FOR FEDERAL EMPLOYEES

Federal/Military/Active/Retired employees, with proper ID, are invited to purchase computers at Iverson's GSA prices...the government's own special prices. GSA price offer limited to GSA schedule products that are below mail order prices. (Contract prices established by subsidiary, International Technology Corporation with GSA Contract Number: GSOOK90AGS5276. Some configurations not available on GSA contract.) Call toll-free to receive GSA schedule or to place an order: 1-800-388-GSA1.

IVERSON IS A REAL OLD PRO

For the past 12 years, Iverson Technology Corporation has manufactured computers for the biggest and toughest customer in the world—the U.S. Government—meeting their stringent security and military standards with the industry's most exacting quality control.

In that time, our dedicated staff of mechanical, electrical and software engineers have also provided total systems support for large integration projects for over 700 government contractors and agencies from Australia to Norway—including one project with 8,000 PCs in 450 city LANs, all gatewayed into a national WAN.

Now we're bringing the industry's highest quality personal computers—and the broadest range of support and service—to the commercial market.

Discover why *Forbes*, *Fortune*, *Business Week*, *INC.*, and *The Washington Post* have used words like "Best" "Top" and "Number 1" to describe our financial performance.

1989 *Forbes* #26 of Best 200 Small Companies
 1988/87 *Business Week* #11 of Top 100 Growth Companies

DISPLAY OPTIONS

(Price includes monitor & adapter)

12" Mono TTL 720 x 350	\$174
14" Mono VGA 640 x 480	263
14" Color VGA 640 x 480	564
14" Color VGA 1024 x 768	588
16" Color VGA 1024 x 768	970

IVERSON PARENT FOUNDED IN 1978

COMPUTER CORPORATION Parent Company (IVT) Traded On AMEX

1356 BEVERLY ROAD . MCLEAN, VA 22101

TEL: (703) 749-1200 FAX: (703) 893-2396 TELEX: 289 127ITC UR

Circle 353 on Reader Service Card

REVIEW

The Norton Utilities for System V

Getting involved with Unix can be like stepping into another dimension. So much of what Unix does happens quietly and invisibly, and the operating system's complexity can make it difficult to maintain. Unfortunately, with the growth of PC Unix, virtually every user must be prepared to perform some system administration.

Interactive Systems, one of the leading vendors of 386 Unix, and Segue Software have come to the rescue with a version of the Norton Utilities for 386 Unix System V. While the Norton Utilities for System V shares some utilities (e.g., UnErase, Disk Test, and Disk Explorer) with its DOS namesake, it is not a generic DOS package simply ported to Unix. Rather, it's a new package that Segue and Interactive wrote from the ground up to be Unix-specific.

I installed and tested the Norton Utilities for System V on an Advanced Logic Research PowerVEISA 486-25 running Interactive Unix System V/386 version 2.2. The first release of the software runs only on Interactive and AT&T 386 Unix. The disks are installed using AT&T's procedures, not Interactive's. That's a pity—Interactive's install programs are faster and more informative.

After the installation, a script sets up your system to run Norton. The bulk of the script is the rebuilding of the kernel to

The Norton Utilities for System V's UnErase utility provides a list of erased files for restoration.

include support for the UnErase utility. Once installation is complete, you must reboot your machine to activate UnErase.

The documentation is stylish and appropriate. It assumes no prior knowledge of Unix and even provides a brief tutorial on common operations. A new Unix user should have no trouble installing and running the Norton Utilities.

Jumping Through Hoops

As DOS users of the Norton Utilities will attest, the package includes an odd assortment of utilities, ranging from the playfully benign to the genuinely dangerous. Where appropriate, each utility interacts with the user through a full-screen color interface. Even though it is text-based, the interface is attractive, sporting pull-down menus, windows, and drop shadows. Wherever it is better to use the sparser Unix command-line interface, Norton uses it.

UnErase, the single most important feature of the Norton Utilities for System V, lets you recover deleted files or directories. As with the DOS version, recovery is easier if you attempt it immediately after deletion. But because Norton builds UnErase into the Unix kernel, the Unix UnErase is a bit more flexible than the DOS version.

You can optimize UnErase for either maximum protection or most efficient use of disk space. The utility retains disk blocks normally freed by file deletion and returns them to the system according to user-defined age and disk free-space limits. This utility works entirely as advertised; I can't think of anything that I would have added.

Two other utilities, Disk Test and Disk Explorer, combine to give administrators

easier access to verification and repair of both floppy and hard disk drives. Disk Test verifies the integrity of a disk and lets you remap bad sectors when possible. The Disk Test and Editor programs both understand the structure of the Unix file system. The Editor, for example, has the power to browse, randomly or sequentially, through i-nodes and free-list entries. It also has the power to modify those entries, and that's where the trouble comes in.

The drawback to the Norton Utilities for System V is that it puts in the hands of *all* users a set of utilities that paint friendly, almost harmless faces on potentially destructive operations. A single slip with the Editor, for example, could render an entire system helpless. Since Unix systems are often used by several people (many of whom likely possess the all-powerful root password), it might be appropriate to offer a "safe" (and, possibly, less expensive) version.

All Things Considered

There's much more to the Norton Utilities than I can comment on here. Worth brief note, however, is a set of commands that enhance Unix shell scripts with sound (even music), color, and boxes done in line-drawing characters.

Norton for Unix is well worth having around. System administrators should routinely install UnErase on every 386 Unix system in the house. The package is well done and deserves widespread use. In the sparse domain of shrink-wrapped Unix software, the Norton Utilities for System V is bound to be a star. ■

Tom Yager is a technical editor for the BYTE Lab. You can reach him on BIX as "tyager."

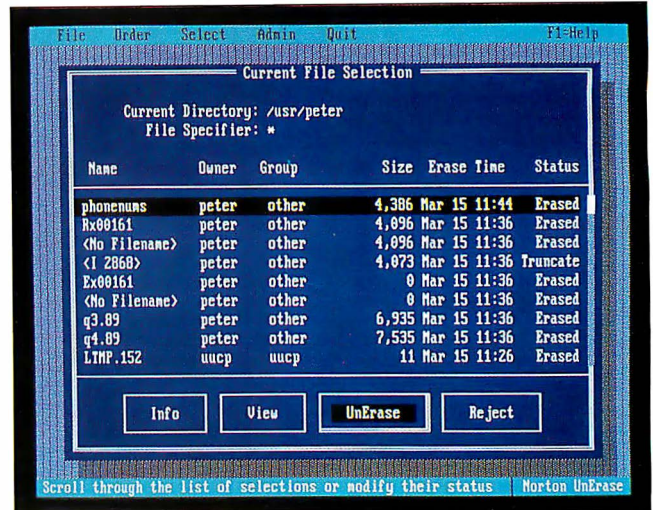

The Norton Utilities for System V

Company

Interactive Systems Corp.
2401 Colorado Ave.
Santa Monica, CA 90404
(213) 453-8649

Hardware Needed

386 or 486 PC, PS/2, or compatible
and at least 2.5 MB of free hard
disk space

Software Needed

Interactive or AT&T Unix System V/386
release 3.2

Price

\$295

Inquiry 1055.

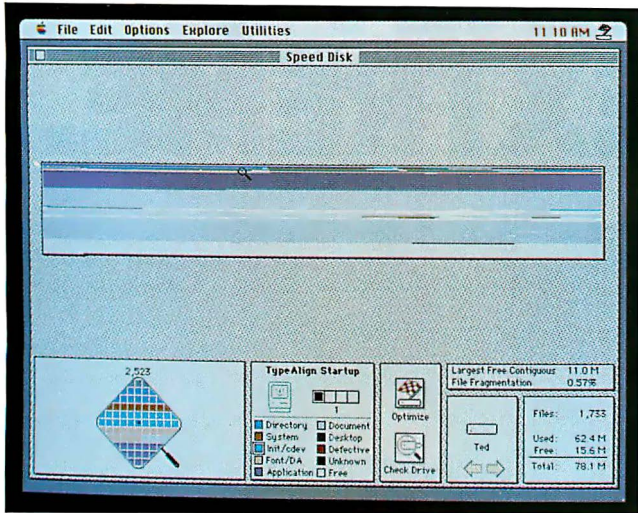

The disk optimizer for the Norton Utilities for the Macintosh uses colors to represent different file types and their location on the target disk drive. The magnifying glass lets you pinpoint a file by block.

The Norton Utilities for the Mac

Peter Norton Computing may be well known for its PC disk utilities, but I felt some apprehension when I learned that the company had written a version for the Mac. Mac applications written by PC software companies typically have serious interface flaws. After looking at the Norton Utilities for the Macintosh, however, I have to say that my fears were unfounded.

The \$129 package includes a manual and several disks that contain a disk repair/recovery application and several helpful utilities. The disk repair application resides on a red, self-booting "crash disk" that lets you boot your Mac and start recovery procedures when your Mac's hard disk drive conks out. This application contains a disk editor, with modules that diagnose and repair problems with the disk's directories or recover an accidentally formatted disk.

Exploration

The disk editor lets you examine disk data block by block. You can inspect and change data in a file's data or resource forks, or you can examine and modify the disk's boot blocks (information that the Mac needs to boot) to, say, increase the number of files the Mac can have open at any time. You cannot, however, edit the boot blocks from within the window that describes the boot block's contents, as you can with Symantec's SUM II Tools application. Instead, you make changes from a window that displays data in hexadecimal, and that makes changes tricky.

The repair utility checks and detects

problems with the disk's media and volume directory structure. It also checks for problems with files and makes repairs. For example, it can fix a file's bundle bits, which tells the Finder if the file has an icon that it must copy to the Desktop file. A bad bit usually gives you the generic document icon.

On the other two disks are useful utilities: a disk optimizer or defragger application, a file undelete cdev, a desktop layout application (used to change how the Finder displays and organizes file icons), a disk activity INIT, and help files. The disk optimizer is one of the best I've seen. It first presents a map of the hard disk's allocated and free blocks. On a color Mac, it uses different colors to flag file types such as directories, system files, applications, and data. Optimization is rapid, and the program performs integrity checks before optimization begins. You can cancel the operation at any time. The optimizer reorganizes the least-altered files (e.g., system files and applications) on one part of the disk, and it places files that change often (documents and the Desktop file) adjacent to the disk's free space. This improves performance and slows fragmentation. I optimized the hard disk drives on a Mac SE, SE/30, II, IIX, IICi, and IIFx without problems.

The FileSaver cdev functions in a way that's similar to SUM II's Shield cdev and 1st Aid Software's Complete Undelete: It creates and updates a hidden file that contains a snapshot of the volume directory and keeps a record of the most recently deleted files. FileSaver, like Com-

plete Undelete, shows which of the deleted file's blocks have been reallocated to give you an idea of the file's recoverability. You can also search for deleted files by type from a scrolling list of document types, such as MacWrite and Word. If your file is not on this list, however (say you're looking for a Photoshop file), there's no way to specify a different file creator or type.

Best Choice for Beginners

The Norton Utilities for the Mac clears the design hurdle of providing an easy-to-use interface while letting you probe volume directories, boot blocks, and data and resource forks on a Mac disk drive. The program has some minor rough edges, such as the FileSaver problem I mentioned, but overall, it's a good first showing in the Mac market.

Symantec, which offers the competing SUM II product, now owns Peter Norton Computing. Symantec says it will continue to sell both the Norton Utilities for the Mac and SUM II.

If you are familiar with the Mac's workings, SUM II Tools or Central Point Software's Mac Tools lets you get to your system's innards in more detail than does the Norton Utilities. But the Norton Utilities gives you easy-to-use tools and a bootable crash disk, while with SUM II you have to make this disk yourself—something you don't want to do in a panic situation. Mac novices should pick the Norton Utilities as their first line of defense against disk disaster. ■



The Norton Utilities for the Macintosh

Company

Symantec Corp.
10201 Torre Ave.
Cupertino, CA 95014
(408) 253-9600

Hardware Needed

Mac Plus or higher

Software Needed

System 6.0.4 or higher

Price

\$129

Inquiry 1056.

Tom Thompson is a BYTE senior editor at large with a B.S.E.E. degree from Memphis State University. You can reach him on BIX as "tom_thompson."

WE'VE TAKEN THE INDUSTRIAL PC TO EVERY EXTREME.

Companies don't make the Fortune 100 list by accident. It takes hard work and the wise investment of capital. Which is why when they buy industrial PCs, seven out of every ten Fortune 100 companies invest in Texas Microsystems.

UNBEATABLE PERFORMANCE IN ANY ENVIRONMENT.

Most people assume that an industrial PC will give the reliability needed to run critical applications in harsh environments, but the trade off can be a lack of performance and high cost of entry. With Texas Microsystems the reverse is true.

Benchmark studies show that in harsh environments Texas Microsystems 25/33 MHz 386 & 25MHz 486 PCs perform as well as powerful desktop PCs do in office environments. Yet the cost of our systems can be a pleasant surprise.

DESKTOP PERFORMANCE UNDER EXTREME CONDITIONS.

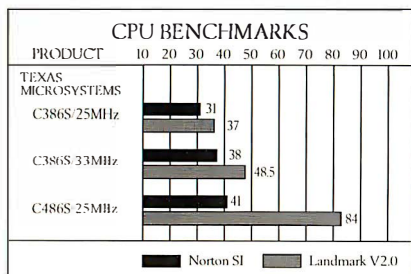

BUILT IN RELIABILITY FROM THE BOARD UP.

We build our systems from scratch, and take nothing for granted. We've been designing with Intel microprocessors since 1974. Design and manufacture most of our cards. And by using VLSI and PAL technology reduce component counts by 60% and drive MTBF numbers up to 100,000 hours.

Texas Microsystems innovations include passive backplane architecture to improve component reliability and reduce MTTR to less than 10 minutes. Our 16 point shock-



mounting techniques keep disk drives functioning at up to 25G velocities. And our 48 hour pre-test burn-in at over 130°F guarantees reliability.

NO ONE HAS MORE INDUSTRIAL EXPERIENCE.

We've been in business for 16 years. And you'll find Texas Microsystems operating in harsh environments at 70 of the Fortune 100 companies, as well as delivering mission critical solutions to the US Government and Armed Services.

MORE SYSTEMS MEAN MORE OPTIONS.

Two of our most popular systems are shown here. They can be configured with a vast choice of options

from CPUs, hard disks and drives, CMOS RAM, video cards and displays, and if none of these match your requirements we'll custom configure and test whatever system you need.

TO US "INDUSTRIAL" IS MORE THAN A DESIGN PHILOSOPHY.

You can buy cheaper industrial PCs than ours, but they may be camouflaged desktops that do not perform in extreme environments.

At Texas Microsystems, that isn't the way we build systems. Industrial PCs and Mission Critical Micros™ are all we make. Repackaging office computers is not our business. We design and manufacture all our products from scratch, we don't adapt the designs of others. And

we're always here when you need us.

**NATION-WIDE SERVICE,
FULL-TIME SUPPORT.**

We believe in offering exceptional support, including consultation during system design. After sales technical support 12 hours a day via an 800 number. On-site service from General Electric for a full year, including free parts and labor. A 30-day, no-questions-asked, money-back guarantee. And a way of ordering a Texas Microsystem that's most convenient and cost effective to you.

Opposite are two Texas Microsystems that offer an unsurpassed combination of price/performance. Order them direct or ask for a complete literature and information kit on all our systems by calling 1-800-627-8700 now.

**TWO EXTREMELY
UNBEATABLE SYSTEMS.**

Here are two of our top selling systems for business environments that demand mission critical computing, regardless of operating conditions. Like all our systems they enjoy the same engineering pedigree that ensures a unique combination of performance, reliability and value. Which is, after all, what you should expect from America's leading industrial micro systems company.

And to put a little icing on the cake, each will include a one year, on-site, warranty.

To order, call the 800 number below and one of our representatives will discuss your needs with you, give you an instant quote on the configuration of your choice. Then the system will be built to your order, tested, and shipped.

Mission Critical Micros is a trademark of Texas Microsystems Inc., all other trademarks mentioned are registered, trademarked or servicemarked by their respected manufacturers.



Texas Microsystems, Inc.
10618 Rockley Rd., Houston, Texas 77099
Tel: 713-933-8050. Fax: 713-933-1029

EXCEPT PRICE.



TEXAS MICROSYSTEM 4108
MISSION CRITICAL OFFICE PC

Features

- Choice of 80286, 80386, 80486 processors.
- Perfect for data acquisition, communications and networking applications.
- 8 full length ISA slots for industry standard cards.
- Up to 16MB of RAM on CPU, three half-height 5.25" bays for floppy/hard drives and one 3.5" hard drive.
- Super VGA graphics (1024 x 768 pixels) Also supports CGA, EGA.
- 1 parallel and 2 serial ports.
- 101-key enhanced keyboard with DIN connector on rear panel.
- 220 watt power supply.
- One year, on site warranty included.

Specifications

- Dimensions: 6.5" x 17" x 16.5"; 30 lbs.
- Power 220 Watt, 110 V.
- Operating environment.
Temperature: 0°C to 55°C. (32°F to 131°F)
Altitude: 15,000 feet equivalent

System Prices

Model	CPU/ MHz-RAM	Storage	Price
4216	286/16-1	40MB HD, 1.2 or 1.44MB floppy	\$2,900
4320	386/20-1	40MB HD, 1.2 or 1.44MB floppy	\$3,755
4325	386/25-1	104MB HD, 1.2 or 1.44MB floppy	\$4,530
4333	386/33-2	104MB HD, 1.2 or 1.44MB floppy	\$5,135
4425	486/25-4	104MB HD, 1.2 or 1.44MB floppy	\$5,995

*From \$2,900. Monitor not included.



TEXAS MICROSYSTEM 3014
RUGGEDIZED RACK-MOUNT PC

Features

- Choice of 80286, 80386, 80486 processors.
- 18-gauge nickel plated, steel chassis.
- 14 full length ISA slots for industry standard cards.
- Boards bracketed and braced on all four edges.
- Two 110 CFM fans.
- Up to 16MB of RAM on CPU, and five half-height storage bays for hard drives, floppy and/or tape backup.
- Super VGA graphics (1024 x 768 pixels) Also supports CGA, EGA.
- 1 parallel and 2 serial ports.
- Built in speaker, door lock, power and CPU reset switch.
- 101-key enhanced keyboard with DIN connector on front panel.
- 225 watt power supply.
- One year, on site warranty included.

Specifications

- Dimensions: 19" x 22.18" x 6.96" Wt. 45 lbs.
- Power 95-132/180-264 VAC, 47 to 63Hz.
- Operating environment.
Temperature: 0°C to 55°C. (32°F to 131°F)
Humidity: To 95% at 40°C non-condensing
Altitude: 15,000 feet equivalent
Vibration: .25G, 5-100Hz operating
5G, 5-100Hz non-operating
Shock: 1.0G operating at 10 Msec duration

System Prices

Model	CPU/ MHz-RAM	Storage	Price
3216	286/16-1	40MB HD, 1.2 or 1.44MB floppy	\$3,825
3320	386/20-1	40MB HD, 1.2 or 1.44MB floppy	\$4,650
3325	386/25-1	104MB HD, 1.2 or 1.44MB floppy	\$5,430
3333	386/33-2	104MB HD, 1.2 or 1.44MB floppy	\$6,040
3425	486/25-4	104MB HD, 1.2 or 1.44MB floppy	\$6,895

*From \$3,825. Rackmount monitor not included.

EVEN ORDERING IS EXTREMELY EASY. CALL

1-800-627-8700

Circle 306 on Reader Service Card

REVIEW

CAD and NetWare 386 Join Forces

It used to be that people complained they couldn't get at mainframe data. Now the data they can't get at lives on a PC. Networks abound, and the pendulum is swinging in the direction of central storage again. But few PC programs share data effectively on LANs. True, most databases can support concurrent users. But other categories of software—CAD, for example, as well as spreadsheets and word processors—typically cannot. All too often the network ends up as a speedy file transfer link, not as a foundation for collaborative work. CADvance 4.0 from IsiCAD aims to change that.

The latest release of this popular architecture, engineering, and construction (AEC) package makes good on the promise of multiuser CAD. On a NetWare 386 LAN, CADvance 4.0 goes further: NetWare loadable modules (NLMs) running on the server handle some of the database and rendering chores.

To install the program, you'll need

some of the latest weapons in the arsenal of DOS computing. CADvance now requires over 500K bytes of conventional memory after you've loaded your network driver and shell. This means that, under NetWare, it requires one of the new high-loading (EMS or XMS) NetWare shells. Unfortunately, it also requires at least one 64K-byte bank of expanded memory. So, on a 386 machine with extended memory, you can't get away with just the XMS shell. You will also require QEMM, EMM386, or an equivalent "limulator" to turn some of the extended memory into expanded memory.

CADvance also requires a security device—a parallel-port "dongle." Thankfully, you only need one. The dongled workstation acts as a license server. In addition to CADvance, it runs a TSR program that monitors the number of active CADvance users. You can install this program on more machines than you have licensed it for, because the license applies to concurrent users, not to machines.

The Sociology of CAD

IsiCAD has always used CADvance to target the AEC realm, where CAD drawings coordinate the efforts of a variety of trades. For example, an architect's floor plan typically governs the design and specification of electrical, communications, plumbing, heating, and ventilation systems. With single-user CAD software, even on a network, the designers of these various systems can't refer to a live copy of the floor plan.

Under DOS, single-user (or non-network-aware) software can only offer the limited protection that is afforded by the file system's read-only attribute. If you don't turn the attribute on, anyone can overwrite the floor plan. If you do set the read-only bit (by means of the ATTRIB command), no one can write to the file—not even its author, the architect. Even worse, there's no advance warning of an unauthorized attempt to write to a protected document. There is nothing to prevent you from reading the document and modifying it in memory; only when you try to store the file does DOS complain.

What's the answer? Everyone should be able to view the floor plan, even as the architect modifies it (see the figure). The networking extensions introduced

with DOS 3.0—and implemented in all DOS and non-DOS PC network operating systems—lay the foundation for this sort of sharing. The architect's program opens the floor-plan document in deny-write mode, thereby asserting an exclusive right to modify the document. Another program can then open the document in deny-none (or shared) mode and view it. Should the second program also try to open the document in deny-write mode—that is, for write access—it will fail. In that case, the program can deliver a timely warning, and the user won't waste any time trying to edit the file.

In CADvance 4.0, the architect opens the floor plan by means of the File/Load command, which (if successful) confers the exclusive write privilege. Other draftspersons on the network can then open the same document by means of the File/Ref command, which opens it for read access as a *reference file*. Reference files work like underlays. If you're designing the plumbing, for example, you can use a live copy of the floor plan as a guide. You can see, and even snap to, the outlines of the offices, but you can't select or modify them. There can be reciprocity as well. For example, it might be useful to cross-reference the electrical and plumbing diagrams while each of them also refers to the floor plan. That way, subsystem designers can monitor how the evolution of other subsystems affects their own.

Network Consciousness-Raising

Unlike CADvance 4.0, which is actively network-aware, most PC CAD programs are passively network-tolerant. Still, file sharing isn't that tough to implement, and I expect that the competition will soon follow suit. But there is more to the story.

Although the reference-file scheme relies only on properties of the networked file system (and therefore will work on any PC LAN), CADvance 4.0 puts the NetWare application programming interface to good use. Generally, with any NetBIOS LAN or NetWare, a program that fails to open a file in deny-write mode can report only that it failed, not why. In other words, it can report "file in use," but not "Joe's using the file." Of course, the latter message is the one that you really want, and when you are running CADvance under NetWare that's



CADvance 4.0

Company

IsiCAD, Inc.
1920 West Corporate Way
Anaheim, CA 92803
(714) 533-8910

Hardware Needed

Server: Sufficient hardware to run NetWare 286 or 386 or another PC LAN operating system; math coprocessor recommended for hidden-line-removal NLM

Client: AT or compatible with 640K bytes of RAM, at least 500K bytes of conventional RAM available after loading network drivers, and at least 64K bytes of expanded memory; math coprocessor recommended for 3-D work

Software Needed

Server: NetWare 286 or 386 3.1 (recommended) or other PC LAN operating system
Client: MS-DOS 3.1 or higher; network shell

Price

Single-user configuration: \$3495
Five-user license (as reviewed): \$12,000
10-user license: \$20,000

Inquiry 1061.

the one you get. Once you know that Joe's holding up the show, you don't have to start yelling or charge over to his cubicle. With the built-in message utility, you can contact Joe directly or broadcast a message to all CADvance users on the network.

Anyone who's tried to print graphics on a networked printer or plotter knows the attendant frustrations. Although you can redirect LPT or COM ports across the network, the results aren't always what you'd expect. With CADvance 4.0, you can send plot jobs straight into Net-

Ware queues, bypassing the troublesome middleman. You can attach a descriptive name to the plot job and queue each job on automatic hold. That way, a queue operator can identify each job's priority and paper requirements and manage the queue accordingly.

continued

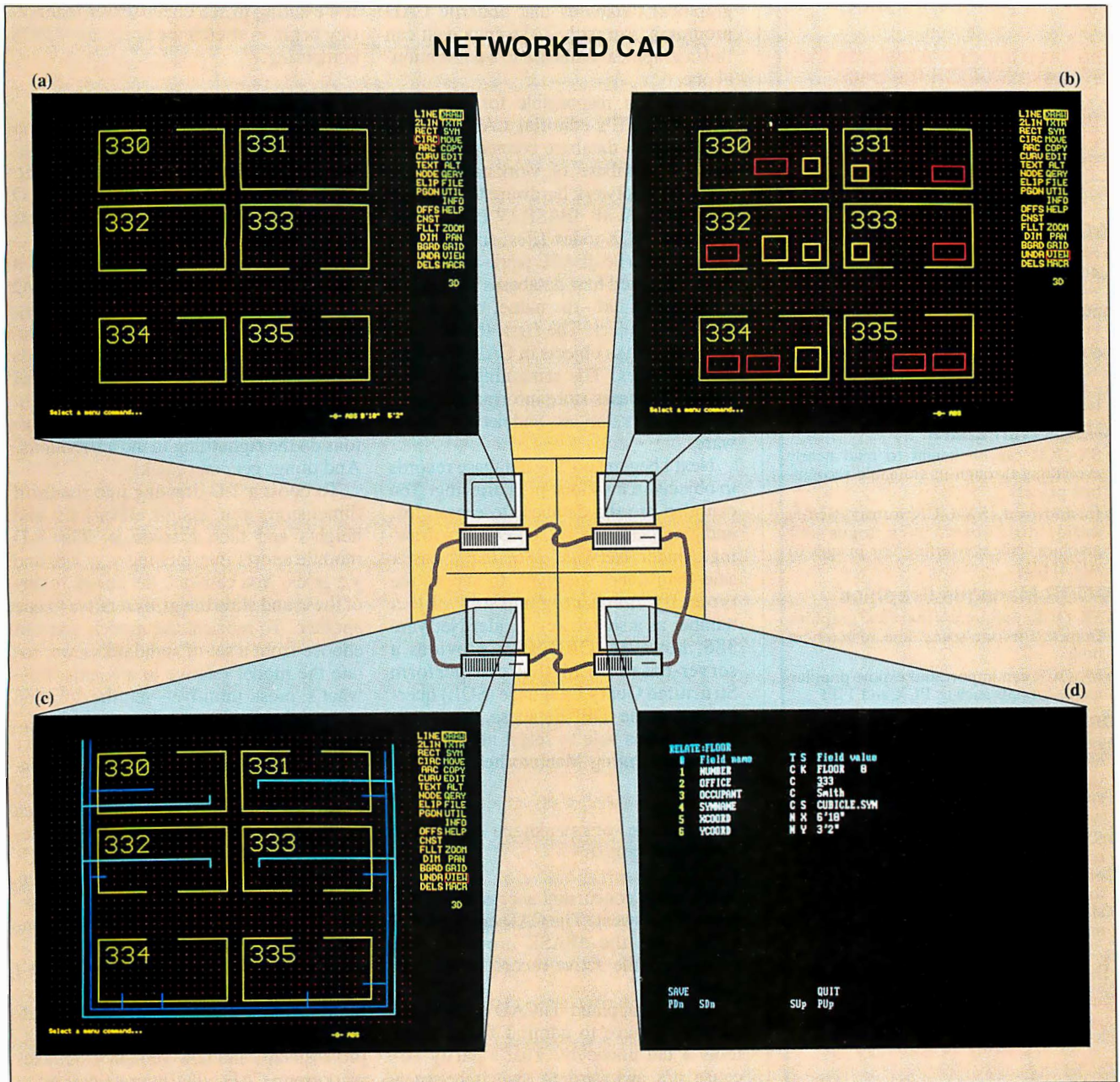

(a) CADvance 4.0 lets architects create and revise floor plans while **(b)** computer-systems designers note the location of PCs in an overlay above the "live" floor plan in read-only mode;

(c) communications engineers add a second overlay of network cabling drawings on the live floor plan, and **(d)** a Facilities Manager links objects in the plan to an external database.

Good Labor Ain't Cheap!



SX-OCR

Optical Character Recognition

Software for your scanner that really works! SX-OCR is fast, accurate and easy to use. Why type when you can just scan and convert?

The three important features that make SX-OCR the Best:

- 99+ % accuracy
- Fast, easy training module
- Excellent user interface

SX-OCR Reads Text

- SX-OCR will automatically "re-type" your documents, producing text files that work with your word processor
- SX-OCR handles English and foreign text, footnotes and headlines, typeset and typewritten material
- SX-OCR will automate the typing process - from simple business letters to illustrated product catalogs

SX-OCR Can Learn

- SX-OCR can be taught to read nearly everything through its trainable recognition process
- In addition, SX-OCR automatically avoids dirt, boxes, lines, logos and graphics while converting text images to ASCII files

SX-OCR Manages Graphics

- SX-OCR uniquely separates graphics from text in one scan... and remembers both
- SX-OCR can import and export popular image formats such as PCX and TIFF

Compatibility

- PC-AT with 640K RAM and 2mb available on hard disk - EMS memory can be used in place of the hard disk space to speed up the OCR process - works with most pc display adapters
- SX-OCR works directly with the following scanners: Cannon, HP, Microtek, Panasonic, Ricoh, Umax, Chinon, Zsoft, Princeton, Abaton, AST, Mitsubishi and others; also will work with any scanner that will make a .PCX file or a bilevel .TIF file

Suggested Retail Price \$395.00

Call toll free for special, discount prices on SX-OCR and selected Scanners
1-800-759-4001

Desktop Technology Corporation



986 mangrove, suite b
sunnyvale, ca 94086
(408) 738-4001
fax 408-739-3109

REVIEW

CAD AND NETWARE 386 JOIN FORCES

The Visual Database

Networking aside, what sets CADvance apart from most PC CAD programs is its ability to link objects in a CAD drawing with an external .DBF (dBASE-style) database. According to IsiCAD, a number of CADvance users describe themselves as facilities managers—that is, people who must track equipment inventories by location. For these users, CAD drawings are both pictures and databases. Of course, you can't use standard database tools to query the specialized graphical databases that underlie CAD programs. But with CADvance, you can link a graphical database to a conventional one.

Since I'm responsible for managing part of BYTE's editorial LAN, I tested CADvance's database connection by relating a database of workstations, cabling, and network hardware to an office floor plan. With dBASE IV (CADvance requires .NDX index files, so I couldn't use my favorite dBASE work-alike, Fox-Pro), I defined four databases indexed on a common field—the name, or number, of a CAD object. The first, the Relation database, links objects in CAD drawings to .DBF files. The remaining three Instance databases store information about offices, workstations, and network hardware.

Next I began hooking database records to objects in my floor-plan drawing. You can also use the database to search for, and graphically select, objects in a drawing. Under NetWare 286, that's easier said than done. You have to supply the typically machine-generated object number as a search key. Under NetWare 386, however, CADvance provides a server-based NLM that can perform Structured Query Language (SQL) queries against the .DBF database. So, for example, I was able to select all the symbols representing Macintoshes with this query:

```
select from workstn where workstn
.vendor = "apple"
```

What about concurrent access to the database? No sweat. The CADvance record editor, like the dBASE browser, will either lock the active record or tell you that it can't.

While I applaud IsiCAD's database support, I have to admit I found these tools a tad unwieldy. That's partly because it's awkward to switch between CADvance and dBASE. You can shell to DOS, and CADvance 4.0 relinquishes all but a 10K-byte stub of itself when you do, but effective use of dBASE with CAD-

vance really demands 386 DOS multi-tasking à la Desqview or Windows. Even then, keeping the drawings and databases in sync takes perseverance. And the SQL dialect is fairly weak: no LIKE clauses, no joins, and no subselects that return more than one value.

On the other hand, although the CAD/database interaction may not be pretty, it does work. If you need to mix the two disciplines, CADvance may be the only game in town. And the SQL NLM represents a genuine innovation for PC CAD. It's exciting to see client/server technology begin to stretch the horizons of DOS computing.

Other Dimensions

The core CAD program in CADvance remains essentially what it was in previous versions: a solid two-dimensional drafting tool with limited, though useful, 3-D extensions. You won't be designing next year's Ferrari coupe with CADvance—complex surfaces aren't its forte. But it has all the tools you need to design and document a commercial office building, and they're geared for efficient production drafting. Almost all the commands "nest," so you can always interrupt what you're doing to zoom, pan, place a symbol, or run a macro program. Mouse buttons do the right thing in most situations. And things get done quickly.

To boost a 2-D drawing into the third dimension, you assign elevations and heights and then extrude it. The 3-D module sports interlocking x,y , x,z , and y,z grids. You can lock the cursor to any of these and slide the grids relative to one another. To reorient the model, you can choose from a set of standard views, rotate the model relative to any axis, or—what's most intuitive—set the location and height of a "camera" and a "target." You can easily look around and through a 3-D model, capturing views for a presentation. Under NetWare 386, you can even queue up a series of snapshots on which the server will perform hidden-line removal.

A number of PC CAD programs outstrip CADvance's 3-D modeling prowess. But in the final analysis, the spinning teapots that shimmer on screens at computer graphics trade shows don't matter much to people who design office buildings for a living. CADvance has always been a practical tool for the AEC professional, and now version 4.0 makes workgroup CAD equally practical. ■

Jon Udell is a BYTE senior editor at large. You can contact him on BIX as "judell."

"SPEED TO BURN"

CLUB HAWK 486 SERIES



The time of DOS mainframe has arrived! Running at a blazing speed of 21 VAX MIPS, CLUB's award winning HAWK family, based on Intel's i486 CPU, achieve the mainframe horse-power that out-performs any RISC or SPARC based systems in their class.

With such extraordinary value, price/performance, and compatibility, the HAWK line of systems break through new benchmark barriers in UNIX/XENIX, DOS, and Novell environments.

Combine this with our family of 386 based computers and peripherals, you receive the widest selection of systems from a single major world class manufacturer.

It's no wonder that hundreds of thousands of these systems have

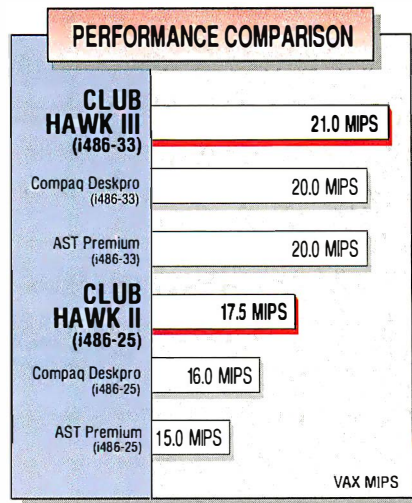

been installed in corporations world wide. That's why CLUB's systems are called the Ultimate Business Computers. Put yourself on the fast track and call today for more information.

Circle 66 on Reader Service Card

"CLUB AT prides itself on being an authorized Novell reseller, making the tower model a good choice for LAN server applications. ... [CLUB] combines field-leading performance, solid construction, and knowledgeable technical support at an exceptionally low price." PC Magazine, February, 1990

"When it comes to the basics - price, performance, and ... capacity - [CLUB] delivers outrageous value."

PC World, Best Buy Award 1989

For more information call:
Continental USA, Hawaii, and Alaska:
(415) 683-6600

Fax: (415) 490-2687

CLUB Canada, Toronto: (416) 609-8121
International Sales: (415) 683-6623

Call for Corporate and Educational Discounts
GSA # GS00K90AGS5260

CLUB

American Technologies, Inc.

The Ultimate Business Computers

The above mentioned brands and names are trademarks of their respective companies.

Ad 9 v.1/9-90

Professional developers require

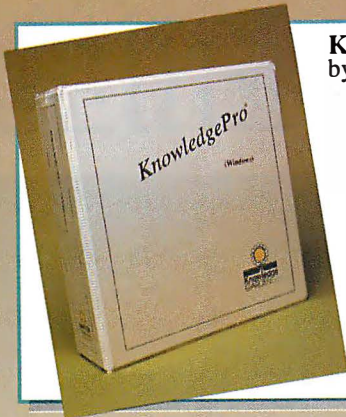

KnowledgePro
by Knowledge Garden
Introducing the **DOOR** into **WINDOWS**. KnowledgePro is a high level object-oriented language for Microsoft Windows or DOS. Integration of OOP, Hypermedia and Expert Systems technology lets you create applications and intelligent documents quickly. Supports DDE & DLL. No runtime fees for applications.

LIST: \$695 (Windows) **PS Price: \$589**
LIST: \$495 (DOS) **PS Price: \$419**
Graphics and Database Toolkits \$119 each.
FastFacts 1419-003

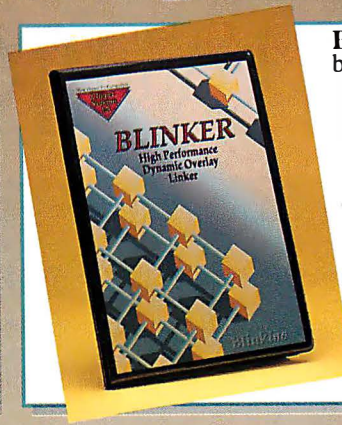

BLINKER
by Blinkinc
"Fastest dynamic overlay linker for Clipper Summer '87 and 5.0. Automatically structures overlays and reduces program memory requirement by up to 50%. Features incremental linking in fractions of a second, dynamic overlaying of C & ASM, source code of Clipper profiler for performance analysis, memory defragmentation, "burning in" of Clipper environment variables/serial numbers and creation of demo versions."
LIST: \$189 **PS Price: \$179**
FastFacts 937-001

386 DEVELOPMENT

	Price
386 Max 5.0	\$109
386DOS Extender by Pharlap	495
DESVIEW 386	189
F77-EM32 + Lahey Ergo	1055
FoxBASE+/386	479
Metaware High C 386/486	919
MetaWare Pascal 386/486	839
NDP Fortran w/VM	829
NDP C - 386	829
QEMM 386	95
VM-386	229
WATCOM C8.0 386 Prof.	1155
WATCOM C8.0 386 Stand.	795
Zortech C++ 386 Dev.	865

Visible Analyst	585
COBOL	
MS COBOL V3.0	639
Realia COBOL	859

COMMUNICATIONS ADD-ONS

C Async Manager 3.0	139
Essential COMM by S. Mtn.	259
Greenleaf Comm Library	329
QuickComm	129

DBASE

Clipper 5.0	550
dBASE IV	499
dBFAST/PLUS	315
dBMAN V	275
dBXL	209
FoxPro	495
FoxBASE + - V2.1	279
QuickSilver	399

DBMS

Cause Professional	499
CLARION Prof. Dev. V2.1	549
D the data language	359
Magic PC	379
Paradox V3.0	479
R:BASE 3.1	499

DBMS TOOLS & LIBRARIES

AdComm for Clipper	279
Artful.Lib	200
BALER Spreadsheet Compiler	399
CLEAR + for dBASE	179
Comet Multiport	119
dBASE BlackBox	65
dBASE Online	129
BRIEF w/dBRIEF	Call
dBX dBport	549
dGE 4.0	279
dQUERY MU	179
dSalvage Professional	195
FLIPPER Graphics Library	179
FUNCKY.LIB	179
Genifer - code generator	269
Net Lib	229
Pro Clip	149
R&R Relational Reportwriter	139
R&R Code Generator	129
Scrimage	139
SilverComm Library	229
SilverPaint	100

ALL-LANGUAGES

ARITY Combination Package	989
LISPC	269
PC Scheme LISP	85
TransLISP PLUS w/source	99
PDC Prolog Compiler	239

ASSEMBLERS

MS MASM	105
Turbo Debugger & Tools	119
Visible Computer:80286	85

BASIC & ADD-ONS

BAS-C Commercial	439
dB/LIB Professional	179
MS QuickBASIC V4.5	69
QBase	139
QuickPak Prof. V3.16	189

C LANGUAGE COMPILERS

Instant C	769
Lattice C - 6.0 Compiler	189
Microsoft C 6.0	349
Microsoft QuickC	69
WATCOM C8.0 Prof.	429
WATCOM C8.0 Stand.	359

CASE & PROTOTYPERS

Dan Bricklin Demo II	185
EasyCase Plus	275
EasyCase Plus Prof. Pack	365
EasyFlow	135
Instant Replay III	119
Matr x Layout	179
MetaDesign by Meta Software	295
Pro-C 2.0w/Workbench Combo	735
ProtoFinish by Genesis	279
Show Partner F/X	279



HALO Professional
by Media Cybernetics
HALO Professional is the new graphics tool for developers of large, complex applications. No other graphics library offers you as many ways to break the 640K barrier.
• 200 powerful graphics subroutines
• DOS Extender support
• Support for today's most powerful language compilers
• International character support
• Efficient memory usage
• Support for popular graphics adapters, printers, image scanners, and plotters
• Supporting Programmer's Guide and documentation
LIST: \$595 **PS Price: \$519**
FastFacts 86-044



AUTOMATE/ANYTIME
by Complementary Solutions, Inc.
AUTOMATE/ANYTIME, the Invisible Operator for your PC, is a new job-scheduling utility that automatically runs just about any software program you use, including Procomm, Fastback, dBASE, Norton Utilities, plus many other DOS programs. It executes batch file and Keyboard Macro jobs and includes a built-in backup utility. An easy to use, menu-drive program, AUTOMATE/ANYTIME runs on single and networked PCs.
LIST: \$149 **PS Price: \$139**
FastFacts 3183-001

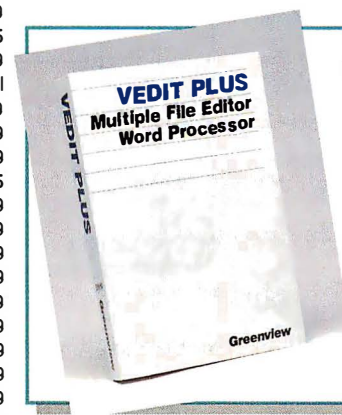

VEDIT PLUS 3.40
by Greenview Data, Inc.
The new VEDIT PLUS programmer's editor integrates your favorite compilers, assemblers, linkers, debuggers and Make programs to really speed development. Its unique memory manager swaps out TSRs and network drivers during compilation. Features multi-file editing, windows, pull-down menus, mouse support, undo, regular expressions, a powerful macro language, and complete configurability. Exceptional speed for editing even multi-megabyte text and binary files.
LIST: \$185 **PS Price: \$159**
FastFacts 25-007

more than just products...

Sourcer 486 Commenting Disassembler

by V Communications, Inc.
Generate detailed commented source code and listings from EXE, COM, device drivers and memory! Built in data analyzer and simulator separates code from data. Provides detailed comments on interrupts, I/O ports and much more. Supports code written for 8088 through 80486 processors and math co-processors. With the BIOS Pre-Processor, obtain detailed commented listings on each BIOS ROM in your system.

LIST: \$170 **PS** Price: \$149
FastFaxes 924-018

The Forval SA14400

by R.L. Couch & Company
The Forval SA14400 is one of the fastest dial-up modems available. With V.32bis/14,400bps base speed and V.42bis/MNP5 standard datacompression, this modem provides the maximum data-transfer rate. V.42/MNP2-4 error correction ensures data integrity. Compatible with all dial up standards including V.32 and V.22bis, the SA 14400 is upgraded over the phone giving you the Modem with a Future™. An internal PC version is also available. A communications package is included.
LIST: \$1245 **PS** Price: \$995
FastFaxes 2945-002

Greenleaf Comm Library

by Greenleaf Software
The Greenleaf Comm Library is an asynchronous communications library w/ interrupt-driven, circular buffered service for up to thirty-five ports. Features include: Modem control functions, XMODEM, YMODEM, & KERMIT protocol support; XON/XOFF & RTS/CTS flow control & security against data loss. Commlib™ offers support up to 115Kbaud. Included free; source and PDQPlus Online Help System. Supports all major compilers.
LIST: \$359 **PS** Price: \$329
FastFaxes 55-007

ArcList

by Group 1 Software
Mailing List Management— Discover how you can professionally manage your mailing list on your IBM compatible PC and save money with ArcList and AccuMail, two powerful, easy-to-use programs that offer you: address correction and standardization * duplicate recognition * list merge/purge * postal presorts * file maintenance * label design and printing * and more. Boost your mailing list's deliverability, and performance!
LIST Price: \$695 **PS** Price \$635
FastFaxes 1566-001

Tom Rettig's Library 85
UI2 Developer's Release 479

DEBUGGERS/ DISASSEMBLERS

DASM 225
Dis Doc Pro 229
Periscope for DOS 149
Periscope IV Varies
RE:Source by Genesoft 119
SoftPro 86/TX 345
Sourcer 486 w/BIOS pre-proc. 149
Trapper 189

DEVELOPMENT TOOLS

ASMFLOW 89
C-DOC 139
CLEAR+ for C 169
Codan 349
Buzzwords dANALYST 269
The Documentor 245
Hyperinterface II Combo 239
INSIDE! 119
MKS Lex & Yacc 199
MKS RCS 175
PC-Lint 120
PlinkLTO 439
PolyMake 159
PVCS Professional 439
ROM-Link 339
.RTLINK - by Pocket Soft 279
.RTLINK Plus 419
Source Print 97
TLIB 5.0 Version Control 125
Zortech C++ Tools Call

EDITORS

BRIEF Call
Cheetah 195
Epsilon 119
KEDIT 139
QEdit TSR 89
Sage Professional Editor 249
SPF/PC - V2.1 129
Vedit + 139

EXPERT SYSTEMS

Eclipse 386 560
Exsys Professional 695
Logic Gem by Sterling Castle 89
Personal Consultant Plus 1999

FILE ADD-ONS

Accsys for Paradox w/source 739
CBTREE 179
C-Data Manager 279
CodeBASE 4 279
CQL - w/ source 359
c-tree by Faircom - source 329
C-TRIEVE 229
db_FILE/RETRIEVE - SU 199
Faircom Toolbox Prof. 889
Faircom Toolbox Special 539
WKS Library 149
XQL 649

FORTTRAN

FOR_C w/source 789
Lahey FORTRAN F7L 549
Lahey Personal FORTRAN Call
MS Fortran Opt. Compiler 309
RMFORTRAN 499

GENERAL ADD-ONS

C Tools Plus - V6.01 98
C Utility Library 189
Greenleaf SuperFunctions 239
Opt-Tech Sort 119
Turbo C Tools by Blaise 109

GRAPHICS

Bar Code Library w/Source 369
Essential Graphics v3.0 349
GraphiC 319
graphics-Menu 165
GSS Graphics Dev't Toolkit 699
HALO 279
HSC Sunscan 289
LaserControl 139
MetaWINDOWS 209
MetaWINDOW/PLUS 289
PCX Programmer's Toolkit 229

HARDWARE

Aegis 55
ALL Chargecard 399
Capital Equipment Corp.
OS/RAM32 0M 225
OS/RAM8 0M 299
OS/RAM4 0M 179
DigiCHANNEL COM/8i 875
DigiCHANNEL MC/8i 949
DPT
SmartCache ST506 1099
SmartCache RLL 1099
SmartCache ESDI 1099
Disk Mirroring Module 685
Emerson UPS
Model 10 UPS 169
Model 20 UPS 319
Model 40 UPS 699
AccuCard 209
AccuSaver 69
EtherCard Plus 239
EtherCard Plus/A 349
Erasable Optical Drive Call
Hardlock Kit by Glenco 369
IIT Adv. Math Coprocessors
3C87-25 450
3C87-33 559
2C87-20 329
2C87-12 279
Intel Math Coprocessors
80387-25 555
80387-33 675
J T Fax 9600 595
KickStart I 179
KickStart II 399
KickStart III 689
LANstor LAN150S 1599
LaserStor WORM Drive 3295
Personal Modem 2400 179
QX/12K Modem 699
QX/V.32c Modem 1349
Seagate ST-125-1 20M 299
Seagate ST-4096-1 80M 639
Seagate ST-251-1 40M 339
SentinelScout (kit of 10 keys) 265
SpeedStor AT 320S 1999
Smartmodem 2400 (Ext.) 359
The Shadow SVGA1024K 319
VGA WONDER 512K 359

THE PROGRAMMER'S SHOP 1-800-421-8006

The Programmer's Shop is

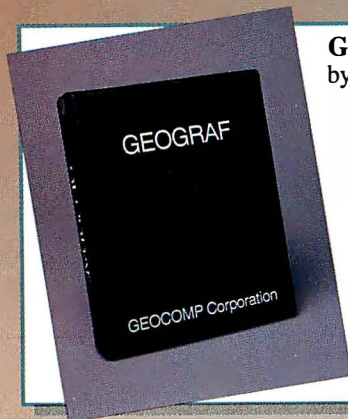

GEOGRAF Professional
by GEOCOMP Corporation
GEOGRAF is a graphics library of subroutines which allow you to create customized graphics from within your own code. GEOGRAF is available for most C, BASIC, and FORTRAN compilers. Includes: 13 fonts, four line types, unlimited data points, real-time graphs and batch processing. Device independent routines and over 250 printers, plotters and video screens are supported!
LIST: \$325 **PS Price: \$319**
FastFaxes 1037-001

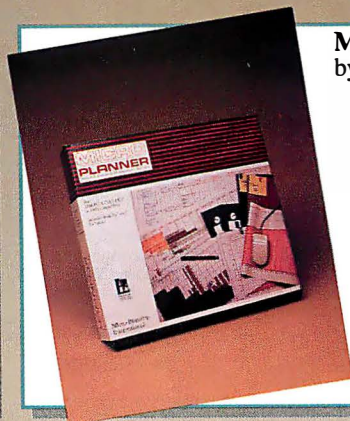

MICRO PLANNER
by Micro Planning International
MICRO PLANNER with its unique graphic interface will have you building a step-by-step model of your project in less than a day, allowing you to create impressive reports-including PERT charts and bar charts-that look as powerful on paper as on the screen. From there, Critical Path Method will calculate start dates and deadlines, forecast bottlenecks, and optimize crucial resources. MICRO PLANNER is available for PC's & Mac's with interchangeable files between machines.
LIST: \$595 **PS Price: \$449**
FastFaxes 1387-003

NETWORKS

dBXL/LAN	519
Btrieve Dev. Kit	479
Netware SQL	519
Netware C Interface	239

OBJECT-ORIENTED/C++

Intek C++ 80386	469
Smalltalk/V	85
Smalltalk/V-286	185
Turbo C ++	159
Turbo C ++ Prof.	259
Zinc Interface Library	179
Zortech C ++ w/ source	269
Zortech C++ Debugger	150
Zortech C ++ Dev. Edition	399

OS SUPPORT

DESQview	109
OS/286	589

OTHER LANGUAGES

Logitech's Modula-2 Dev. Syst.	229
TopSpeed Modula-2	189
StonyBrookProf. Modula-2	249

OTHER PRODUCTS

Carbon Copy Plus	159
Dan Bricklin's PageGarden	89
Fast!	89
Flow Charting III	199
HEADROOM	89
HiJaak	139
LapLink III	129
Link & Locate ++ - ROM MSC	349
Math Advantage	475
Norton Utilities 5.0	149
pcANYWHERE IV	159
PC Tools Deluxe 6.0	119
PC-KWIK Power Pak	119
Pre Cursor	96
Remote2	139
SpinRite II	89
System Sleuth	89
The Duplicator Toolkit-Pro 3.0	119
Time\$heet Prof.	135

TURBO PASCAL

Turbo ASYNCH PLUS	119
Turbo Pascal 6.0 by Borland	Call
Turbo POWER TOOLS PLUS	98
Turbo Professional	109

TEXT SCREEN ADD-ONS

AEWINDOS	459
C Communications Toolkit	129
C Worthy w/Forms w/ARCH	359
Greenleaf DataWindows	339
HI-SCREEN XL Professional	289
MEWEL Window System	169
POWER SCREEN by Blaise	99
Vitamin C - source, menus	169
VC Screen - painter	119
Vermont Views Obj. + source	819

UNIX/XENIX

C++ Compiler for Unix 386 by Zortech	439
C++ for Unix by SCO of Canada	829
Computer Innovations C++	469
db_FILE/RETRIEVE MU	499
ESIX Systems	
ESIX/V 386 Dev. (2 user)	569
ESIX/V 386 Dev. unlt'd	769
Guidelines C++ for 386 V2.0	479
Informix SQL	Varies
Interactive Systems	
Architect Wrkstn Platform	1199
Architect Wrkstn Developer	1850
Norton Utilities for Unix	279
Oregon C++ by Oregon SW	979
WordTech Quicksilver Diamd.	839
XENIX 386 Dev. Sys.	689

WINDOWS & OS/2

Actor 3.0	639
Brief for OS/2	Call
Case: W Corporate Version	905
Case: PM (for C or C+++)	1469
C_talk/Views	419
C-Trieve/Windows	349
dBFAST/Windows	315
Graphics Server SDK	455
Instant Windows	895
KnowledgePro Windows	589
MKS Toolkit	229
MS Windows 3.0	119
MS Windows DDK	365
MS Windows SDK	365
Multiscope OS/2 Debugger	375
Multiscope Windows Debug.	315
Object/1	895
OS/2 PM Toolkit	369
Smalltalk/V PM	469
Tempo for Windows	89

dBXL

by WordTech



A superior alternative to dBASE, dBXL relational database is an easy to use interpretive environment adding extended language (XL) features to the dBASE language. It includes WordTech R&R Relational Report Writer, full dBASE compatibility (files & syntax), and special menus for first time database builders. Also has memory swapping, advanced memo field handling, macros, true windowing multi-dimensional arrays, graphing and EMS support. Requires 440K memory.
LIST: \$249 **PS Price: \$189**
FastFaxes 971-003

HiJaak Release 2.0

by Inset Systems Inc.



HiJaak 2.0 is a graphics conversion and capture utility that translates more than 36 graphics file formats. HiJaak provides batch conversion capability from the DOS command line or from the user interface. Supported formats include GEM, PICT I&II, CGM, HPGL, PIC, DXF, PCX, MAC, TIF, and support for more than 16 group 3 fax devices. A 5K pop-up provides capture function of text screens, graphics screens, and laser printer output.
LIST: \$199 **PS Price: \$189**
FastFaxes 1085-003

CLEAR+ for dBASE

by Clear Software, Inc.

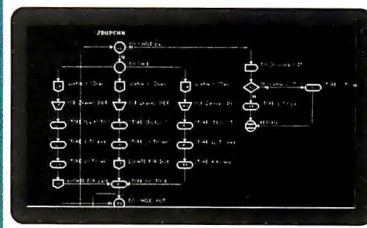

CLEAR helps dBASE developers understand and document their code by automatically producing these high-resolutions diagrams: program flow charts, systems tree charts, and formatted source listings.

While it processes dBASE applications, CLEAR analyzes program logic and reports logical inconsistencies and syntactical errors. CLEAR supports all the dBASE dialects and versions.

LIST: \$199.95 **PS Price: \$179** FastFaxes 873-006

your source for solutions!

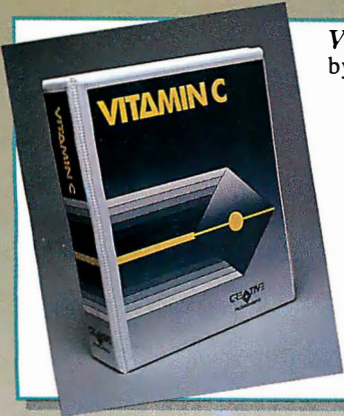

Vitamin C

by Creative Programming

Easily create a spectacular user interface with the most versatile and powerful C library available. Functions include overlapping virtual windows, data entry fields and forms, multi-level pop-up and pull-down menus, context sensitive help, a pop-up text editor, and much more! Even library source is included, and applications are royalty free. Available for DOS, OS/2, Unix, Xenix and VAX.

LIST: \$225 **PS Price: \$169**
FastFacts 0031-007

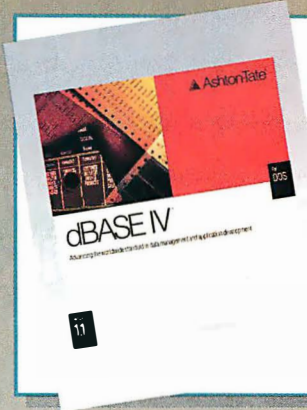

dBASE IV 1.1

by Ashton-Tate

Introducing dBASE IV version 1.1. New Dynamic Memory Management System reduces memory requirements to 450K. Built-in Disk Caching Option uses expanded or extended memory. Control Center provides easy management of data for novices. For the developer, new language enhancements have been added. An Automatic Code Generator produces structured code for any object and an integrated Debugger/Editor streamlines development process.

LIST: \$795 **PS Price: \$549**
FastFacts 1601-019

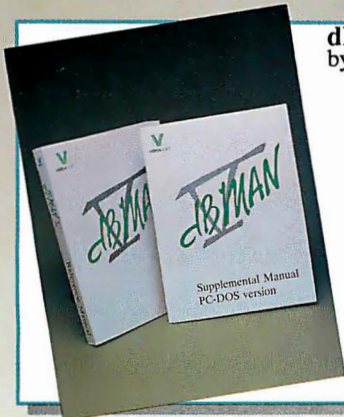

dBMAN V

by Versasoft Corporation

dBMAN V is a dBASE III Plus compatible relational database management system which allows dBASE applications to run on over 40 UNIX, and non-UNIX platforms. Applications are fully portable across platforms. It features windows, menus, UDFs, arrays, data security and more. Its report generator creates columnar and multiline reports without programming. Report layouts are designed in "bands" and edited by simple keystrokes. dBMAN V compiler supports macros.

Runtime license is available.
LIST: \$295 **PS Price: \$275**
FastFacts 1292-001

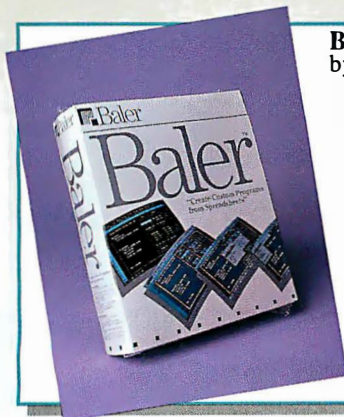

BALER

by Baler

The BALER Spreadsheet Compiler turns .WK1 worksheets into tamper-proof, standalone executable programs. BALER is easy to use—if you can use Lotus 1-2-3, you can use BALER. It is compatible with nearly all the commands and functions of your spreadsheet, including all of the Lotus Advanced Macro commands. Save time with the speed of executable files. Save money since users don't need the original spreadsheet program. And BALER is royalty free!

LIST: \$495 **PS Price: \$399**
FastFacts 0808-002

FREE Catalog!

THE PROGRAMMER'S SHOP CATALOG is the definitive source book for serious software development professionals.

Over 1,700 development products listed, including:

- applications
- books/training
- communications
- hardware
- languages
- LANs
- libraries
- operating systems
- tools
- UNIX/XENIX
- utilities

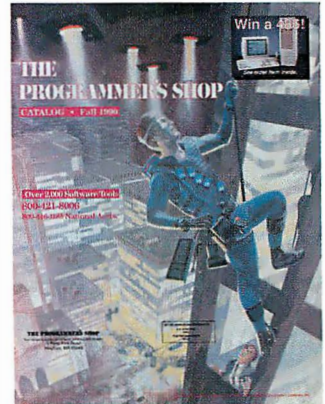

Call today for this valuable guide to programming productivity.

What is FastFacts?

You now have access to literature on any of our products via FAX machine. **FREE!**

1. Call 617-740-0025 from your FAX machine's phone.
2. Follow the voice computer's instructions and enter your product's code number (listed in each product box or in our catalog).
3. Hang up the phone and await your instant print out of product literature.

Call 617-740-0025 from any fax phone!

THE PROGRAMMER'S SHOP

800-421-8006 National Accounts 800-446-1185

MEMBER
MMCA
of the Direct Marketing Association, Inc.

5 Pond Park Road, Hingham, MA 02043 • Canada 800-446-3846 • Mass. 617-740-2510 • FAX: 617-749-2018
Credit card orders processed *only* when product is shipped. All prices subject to change. Int'l. prices will vary.

BY1290

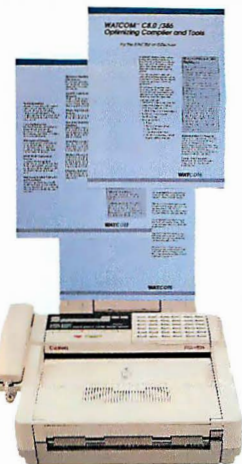

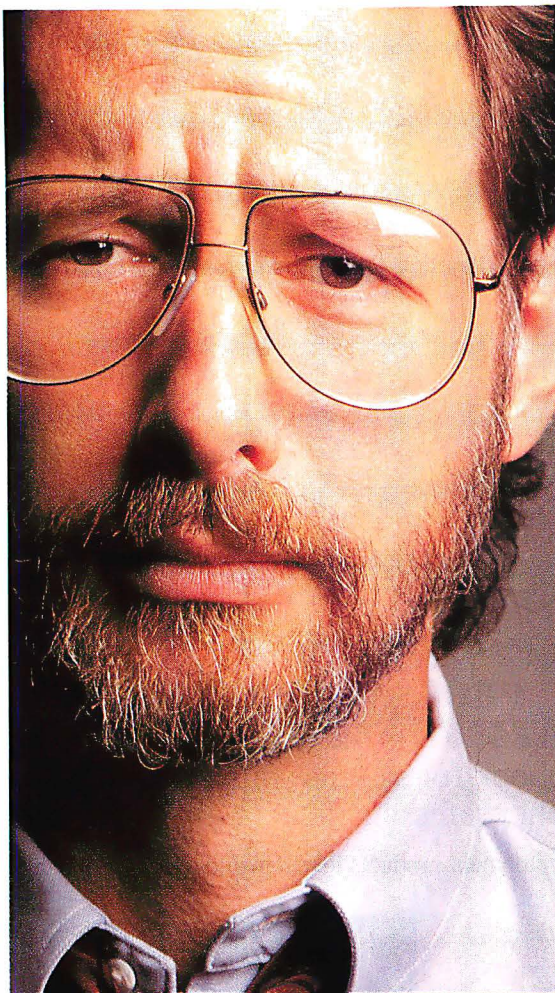

SUBJECT:
V.P., Engineering

PROBLEM:
Your competitor has announced the product.
Your Engineering team isn't even working on it.
Your customers want it now.
What's your answer?

SOLUTION:
MICRONICS

Today, time-to-market is everything. Everyone wants the latest technology. You have to have a product when the demand is hot. And it has to work.

Before investing time and money now, and still miss the window, turn to Micronics for your system board needs.

Dedicated to advanced engineering, Micronics has a full line of 80386 and 80486 ISA/EISA products.

We provide excellent time-to-market and superior design without sacrificing performance or reliability. In fact, we have a proven record with hundreds of thousands of system boards in the field today.

Our own designs, FCC certification, complete compatibility testing and less than 1% field failure rates make Micronics system boards the industry leaders.

Micronics is your answer. Give us a call today.

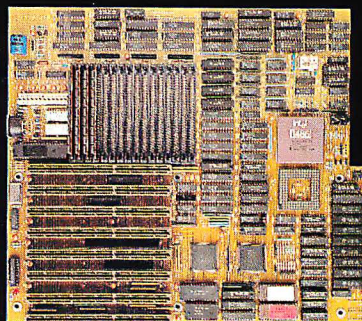

MICRONICS
COMPUTERS INC.

The Power

232 E. Warren Avenue
Fremont, California 94539
(415) 651-2300
Fax (415) 651-5666

REVIEW

NCR's S486/MC33 Has Unique Approach to Reliability

The new 33-MHz i486-based systems are increasingly taking over tasks that were previously dedicated to minicomputers and RISC-based workstations. The latest entry from NCR's Workstation Products Division, the S486/MC33, is no exception. This system has been designed from the ground up for high performance, maximum expandability, and unmatched reliability. It is also one of a handful of 33-MHz i486-based systems with the Micro Channel bus architecture.

All this performance, expandability, and reliability come at a price. The base price for the S486/MC33 is \$13,995, which includes only the base unit and a single 3½-inch 1.44-megabyte floppy disk drive. The BYTE evaluation unit included 16 MB of error-correcting DRAM (\$8400), an NCR SCSI host adapter board (\$500), a 670-MB Maxtor SCSI hard disk drive (\$6500), a 16-inch Super VGA monitor (\$1995), a keyboard (\$100), and MS-DOS 4.01 (\$150), for a total system cost of \$31,640.

While this price will keep away most home computer users, it is in the price range traditionally accepted for minicomputers and high-performance workstations, where increased productivity can quickly pay back such investments. The system also incorporates reliability features not found on any other 486 system, and it is backed by the quality and service that NCR has become known for—second not even to Big Blue.

The size of the S486/MC33's tower case is substantial: At 29 by 29½ by 7½ inches and a weight of 83 pounds with a hard disk drive, it seems to be trying hard to match the system's hefty price tag (see the photo). Nevertheless, the well-designed chassis is tailored for easy access and uncompromised expandability. It includes nine drive bays, four memory-board slots, one slot for the SCSI controller, one 16-bit Micro Channel expansion slot with video extension, and six 32-bit Micro Channel expansion slots.

Once unlocked, the system cover glides easily along guide rails to provide ready access to the system internals. You can remove it completely for accessing the drive bays. Rollers at the front and rear bottom of the cabinet let you easily tip and roll the system.



As the size of its case suggests, the NCR S486/MC33 has plenty of room for expansion. It is also one of the fastest 33-MHz 486 systems BYTE has tested.

Bulletproof Design

The main processor board is impressive. Built almost entirely with surface-mount technology for reduced size and greater reliability, the large board includes an i486 processor, a Weitek WTL4167 math coprocessor socket, a 600- by 800-pixel Super VGA video controller with 1 MB of RAM, a floppy disk drive controller, two serial ports, one parallel port, a PS/2-style mouse port, and 12 expansion slots. Oddly, the two serial ports are brought out to a single 25-pin connector. The first port, COM1, uses the IBM RS-232C pin-out. To use both ports, however, you must connect the included Y cable to the system's serial connector, which then provides you with separate connectors for COM1 and COM2.

Because DRAM chips require periodic refreshing of on-chip capacitors to maintain stored bit values, they are prone to occasional bit loss from such things as alpha particle hits (naturally occurring background radiation). As the amount of

memory in a system increases, so does the likelihood of bit losses, with single-bit losses being the most common.

High-end computers such as the S486/MC33 typically incorporate a lot of memory—often 16 MB or more—so NCR decided to design the memory subsystem for greater reliability. Instead of the simple parity-detection circuit found in most PCs, the NCR memory boards incorporate error detection and correction circuitry, which is capable of correcting any single-bit errors that occur on the fly and can also detect and notify the processor of any double-bit errors. So if you're wondering why the 16-MB memory board costs more than your entire PC, it's because NCR designed it for reliability with a capital R.

NCR offers 4-MB and 16-MB memory boards for the S486/MC33. With four available memory slots, the system supports 64 MB of memory. The memory board slots are uniquely designed, with connections to both the processor's



DOS BENCHMARKS

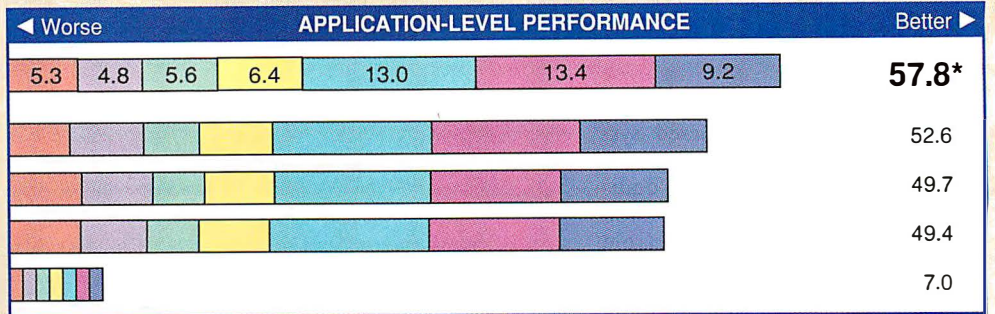

Word Processing Desktop Publishing Database Compilers CAD Scientific/Engineering Spreadsheet

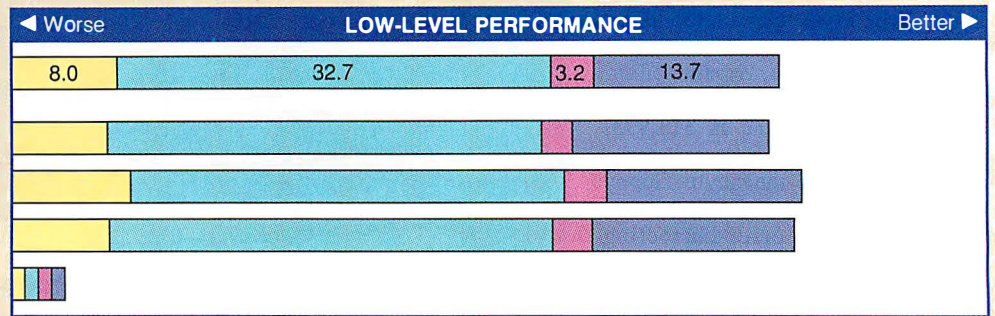

CPU FPU Disk Video

CONVENTIONAL BENCHMARKS

	LINPACK (single) (MFLOPS)	Dhrystones (Dhry./sec.)
NCR S486/MC33	0.8822	26929.4
Everex Step 486/33	0.8959	26912.9
Club Hawk III 486/33	0.9263	27472.3
AST Premium 486/33	0.8947	25849.4

* For application and low-level benchmarks, results are indexed and show relative performance; for each individual index, an 8-MHz IBM AT running MS-DOS 3.30 = 1. For all benchmarks, higher numbers indicate better performance.

The BYTE low-level benchmark suite identifies performance differences between machines at the hardware level; the application benchmarks evaluate real-world performance by running a standard test suite using commercially available applications. Application indexes include tests using the following programs: Word processing: WordPerfect 5.0; Desktop Publishing: Aldus PageMaker 3.0; Database: Borland Paradox 3.0 and Ashton-Tate dBASE IV; Compilers: Microsoft C 5.1 and Turbo Pascal 5.5; CAD: AutoCAD release 10 and Generic CADD level 3 1.1.5; Scientific/Engineering: Stata release 2, MathCAD 2.5, and PC-Matlab 3.5f; and Spreadsheet: Lotus 1-2-3 release 3.0 and Microsoft Excel 2.1.

The BYTE Lab introduced version 2.0 of the DOS benchmarks in the August issue (see "BYTE's New Benchmarks: New Looks, New Numbers"). Benchmark results for machines reviewed under previous versions aren't directly comparable. To obtain a copy of the benchmarks, join the listings area of the byte.bmarks conference on BIX or contact BYTE directly.

UNIX BENCHMARKS



C Compiler DC Arithmetic Tower of Hanoi System Loading Dhrystone 2 Floating Point

* The graph above summarizes the results of the Unix benchmarks (version 2.6). All results are indexed to show relative performance; for each test, an Everex Step 386/33 running Xenix 2.3.1 = 1. The cumulative index is formed by summing the indexed performance results for the tests. Comprehensive results are available by contacting BYTE.

NCR Model S486/MC33**Company**

NCR Corp.
Workstation Products Division
1700 South Patterson Blvd.
Dayton, OH 45479
(513) 445-5000

Components (as reviewed)

Processor: 33-MHz Intel i486; socket for 33-MHz Weitek WTL4167

Memory: 16 MB of error-correcting DRAM, expandable to 64 MB; reprogrammable BIOS in Flash EPROM

Mass storage: 670-MB 12-ms Maxtor SCSI hard disk drive; Teac 3½-inch 1.44-MB floppy disk drive

Display: 16-bit Super VGA controller on motherboard; 16-inch Super VGA color monitor

Keyboard: IBM Enhanced 101-key

I/O interfaces: Dual serial port; parallel port; PS/2 mouse port; video port; keyboard connector; SCSI port; one 16-bit and six 32-bit Micro Channel expansion slots

Price

\$31,640

Inquiry 1107.

local bus and the Micro Channel bus. This dual-ported design permits Micro Channel bus masters to access the memory, in addition to the i486 itself. The memory subsystem is designed for interleaved operation for improved performance, typically averaging less than one wait state. There is no secondary cache in the system; instead, the system relies on the i486's own 8K-byte four-way set-associative cache.

Like its main memory subsystem, the S486/MC33's ROM BIOS is unique. As with most computers in this performance range, the BIOS is placed into shadow RAM for faster operation after boot. Unlike other systems, however, the S486/MC33 uses a flash EPROM to store its BIOS. Unlike conventional EPROMs, flash EPROMs can be electrically erased and reprogrammed in the system. This allows NCR to change or upgrade the system BIOS simply by inserting a disk with the new BIOS and running a utility to program the flash memory. No more replacing BIOS EPROMs.

A vertical backplane runs almost the full height of the case along the back of the drive bays. A "drive carrier" is mounted to each drive, which then slides into a drive bay and connects the drive to the backplane. The backplane is cabled

to the SCSI host adapter board and the floppy disk drive interface connector on the main processor board. The top two half-height drive bays are reserved for 3½-inch floppy disk drives or a tape drive. The remaining four half-height bays and three full-height bays are available for SCSI devices, including hard disk drives, optical disk drives, and tape drives. The SCSI host adapter board can support up to seven devices simultaneously, and it includes an external connector for connecting to SCSI devices outside the S486/MC33 cabinet, such as scanners and laser printers.

NCR offers several SCSI hard disk drives, optical drives, and tape drives for its S486/MC33 system, including a 327-MB hard disk drive, a 670-MB hard disk drive, a 600-MB CD-ROM drive, a 200-MB tape drive, and a 320-/525-MB tape drive. On the flexible side, only the 3½-inch 1.44-MB floppy disk drives are offered. NCR also offers a non-SCSI 80-/120-MB tape drive that installs in the lower floppy disk drive bay.

A World-Class System

The S486/MC33 is clearly designed for the world market. Its 385-watt power supply, for example, is an auto-switching unit that works properly at a nominal 115 volts or 230 V and at 50 or 60 Hz. NCR also offers keyboards for nine different languages, and the installation manual is presented in five languages. The system documentation consists of several manuals, and, as expected from a company like NCR, all of them are complete, well organized, and heavily illustrated.

The keyboard, with its PS/2-style connector, has a very nice feel but no key click. The 16-inch monitor included with the evaluation unit also provides a good-quality display, with sharp images and good color renditions.

The system comes with a set of utility and driver disks. These include complete system diagnostics, setup utilities, and device drivers. There are device drivers that support the enhanced video modes, as well as SCSI drivers for OS/2 and Unix. I ran the system using the MS-DOS 4.01 operating system that came with the evaluation unit. I saw no evidence of any compatibility problems after running numerous DOS applications on the system—it just ran very fast.

How Fast Is It?

The S486/MC33 proved to be one of the fastest systems ever tested by the BYTE Lab. With a CPU index of 8.0, the system is faster than both the AST Premium 486/33 (at 7.2) and the Club Hawk III

486/33 (at 7.4). The Everex Step 486/33, however, showed a higher performance level, probably because of its secondary cache, with a CPU index of 9.0.

NCR is one of the largest manufacturers of SCSI controller chips, so it isn't surprising to find that the S486/MC33's SCSI disk subsystem outperforms those of all the other systems in its class. In contrast, the S486/MC33's VGA video circuitry, while still fast, lags slightly behind all its competition.

In addition to admirable performance in the low-level benchmarks, the S486/MC33 also outperformed the other 33-MHz 486 systems in most of the application-level benchmarks. It was slightly lower only in the desktop publishing and word processing benchmarks.

The S486/MC33 also performed well on the BYTE Unix benchmarks. Its 11.3 cumulative index was almost twice that of the baseline Everex Step 386/33.

A Step Ahead of IBM

The S486/MC33's design has been well thought out and well implemented. Traditional IBM customers will feel right at home with the high-quality construction, reliable design, complete documentation, and Micro Channel architecture. In addition to high performance and multiple-master support, Micro Channel offers the ability to configure plug-in boards via software, without having to use jumpers and DIP switches.

Until recently, IBM offered little to compete with the S486/MC33. IBM's PS/2 Model 70 486-B21 is merely the company's Model 80 386 design with an i486 processor card replacing the 386 card. It has no system optimization to take advantage of the i486's features.

Its good points notwithstanding, the S486/MC33's price must be reckoned with. To justify that price tag, its performance and reliability must result in savings for the user. Based on the performance results, this should be the case for many users. For example, the S486/MC33 is well positioned as a high-end network server, where its high processing speed and fast disk accesses will keep even large networks running with minimal downtime. The S486/MC33 will also shine as an engineering workstation, where complex calculations can tax the CPU. ■

Roger C. Alford is the president of Programmable Designs, a Michigan-based consulting firm. He is the author of Programmable Logic Designer's Guide (Howard W. Sams & Co., 1989). You can reach him on BIX c/o "editors."

Now you can afford to

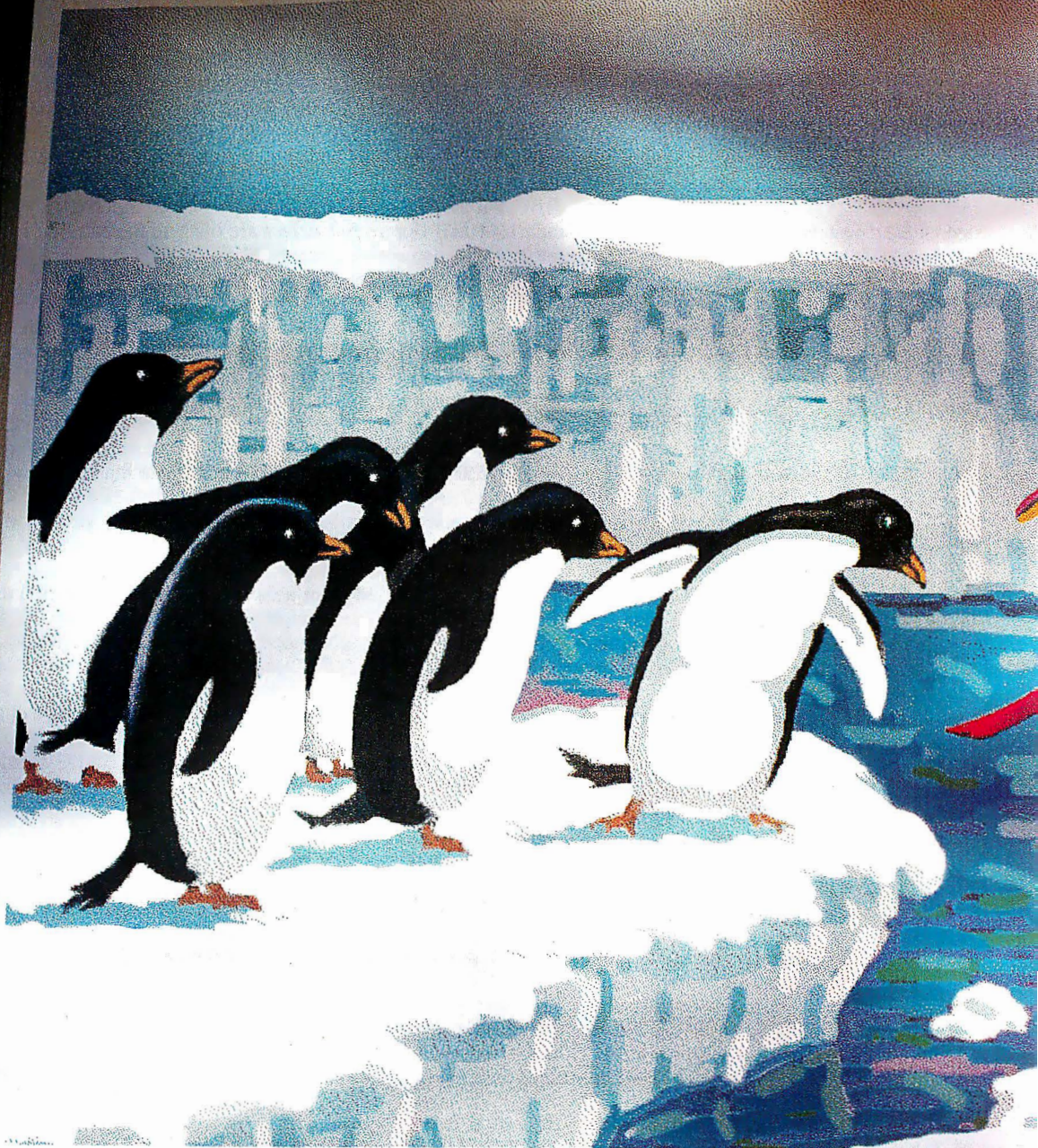

show your true colors.



No longer does your world have to be black and white.

With millions of different color shades produced by high-quality inkjet technology, the HP PaintJet printer family makes it easy for you to look brilliant.

Better yet, it doesn't take much green to get this kind of color. Only \$1,395* for the PaintJet. Or for even faster printing, larger formats, and more font capabilities, only \$2,495* for the PaintJet XL.

Of course, HP PaintJets are DOS and Macintosh compatible. Work with all your favorite graphics software. And print on transparencies as well as paper.



So call **1-800-752-0900, Ext. 1632** for your nearest authorized HP dealer. And get a firsthand demonstration of what the PaintJet family can do for your business communications.

You'll be surprised how high you can fly with color.

 **HEWLETT
PACKARD**

There's more to comparing LaserJet printer sharing options than just the name

	Pacific Data Products Pacific Connect™	Hewlett-Packard HP ShareSpool®
Price	\$399	\$495
Upgradeable memory buffer	Yes	No
Cables and adapters included*	Yes	No
Centronics interface	Yes	No
Warranty	Lifetime	Two Years

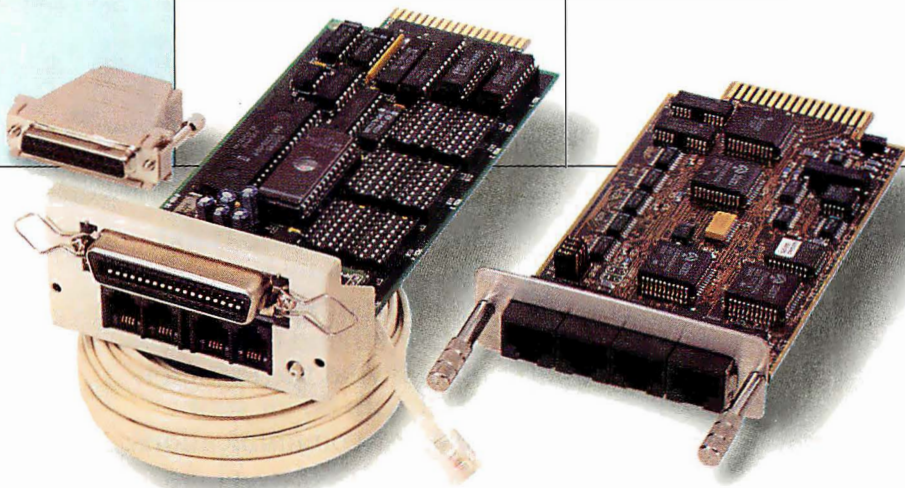

Don't settle for less just to buy the HP name. For LaserJet printer sharing devices that offer you more features for less cost, choose **Pacific Connect** from Pacific Data Products. It's the low cost way to give up to five PC or four Macintosh users access to a LaserJet Series II, IID, III or IIID printer.

Completely transparent to users, Pacific Connect is easy to install and use. It even comes with four cables and serial adapters. And to handle large print files or to spool documents sent simultaneously to the printer, its memory buffer is upgradeable from 256k to 1.25 MB.

To learn how you can get more for less, call your nearest dealer or contact: Pacific Data Products, 9125 Rehco Road, San Diego, CA 92121, (619) 597-4609, Fax (619) 552-0889.

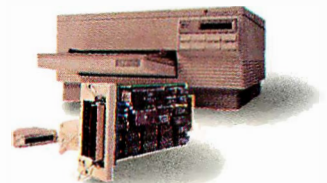

PACIFIC
DATA PRODUCTS

Pacific Connect includes two 25 ft serial cables, two 50 ft serial cables and four DB-25 to RJ-11 connectors. Prices are suggested retail list price. Pacific Connect is a trademark of Pacific Data Products, Inc. ShareSpool is a registered trademark of Extended Systems, Inc. All other company and product names are trademarks of the company or manufacturer respectively. © 1990 Pacific Data Products, Inc.

REVIEW

DR DOS Offers Hope for the RAM-Crammed

```
C:\>chkdsk
Volume in drive C does not have a label

67,926,816 bytes total disk space
 92,168 bytes in 3 hidden files
118,784 bytes in 51 directories
28,899,672 bytes in 679 user files
 77,824 bytes in bad sectors
47,538,176 bytes available on disk

655,344 bytes total memory
648,864 bytes available

C:\>ver

DR DOS Release 5.0

C:\>_
```

DRDOS can reclaim upper memory and locates the DOS kernel in high memory to give you more work-space memory than you get with MS-DOS.

While you can use various expedients to break the 640K-byte straitjacket that MS-DOS imposes on RAM, the most straightforward way is to switch to a new operating system. But then you would have to abandon your MS-DOS applications and learn new ones—and that's not a very popular course.

But there is a middle ground, and Digital Research, Inc. (DRI), the firm that was behind the CP/M operating system in the 1970s, has provided it with DR DOS 5.0. This \$199 operating system for PCs and compatibles is a precise emulation of MS-DOS—no small feat—with embellishments that will interest users who need to load an application, a hardware driver (e.g., a network interface), and a TSR program all at once, but need more than 640K bytes to do it.

I tested DR DOS on a 16-MHz Club American 386 with Hercules graphics, a 40-megabyte 28-millisecond hard disk drive, and 4 MB of RAM.

I installed DR DOS with a setup command that demands little of the user, and it ran immediately. No disk reformatting was necessary. DR DOS automatically loaded its own version of all the MS-DOS command and utility files (using the same names that DOS uses), plus a few extras. The only incompatibility with my existing MS-DOS CONFIG.SYS file was that DR DOS wanted all text in the file to be in uppercase letters. A side from slight differences in some of the screen messages (and the ECHO command's producing a carriage return, disrupting any carefully positioned AUTOEXEC.BAT screen menus you have written), you'd need the VER command to reas-

sure yourself that you're in a new operating system.

But there are differences—potentially big ones—in the way the two operating systems handle RAM.

Down Memory Lane

To illustrate what DR DOS does, I'll define some terms and map out the tortured world of PC memory. *Conventional memory* is the first 640K bytes (655,360 bytes) of RAM. You generally can't use all of it for applications, since DOS and various device drivers must consume some of it. (With MS-DOS 3.3, I usually end up with 542,848 bytes available; this is called the *transient program area*.) The amount of available memory is important, because PC software can normally run only when it's in conventional memory.

Meanwhile, the 384K bytes between 640K bytes and 1 MB (1024K bytes) is called *upper memory*. RAM above 1 MB

is called *extended memory* (unless you're talking about *expanded memory*, which swaps pages of RAM in and out of conventional memory). The first (or lowest) 64K bytes of extended memory is called *high memory* and should not be confused with upper memory.

DR DOS takes advantage of the fact that while upper memory is reserved for video RAM and the ROM BIOS, much of it remains unused. The amount that is unused varies with the configuration of the machine and the kind of video you're using, but it's probably more than 100K bytes between the VRAM and the ROM BIOS. Some of the VRAM immediately above 640K bytes may also be unused. Both blocks could be reclaimed for an application, except that MS-DOS can't raise its eyes above the 640K-byte mark.

What DR DOS does is supply a memory manager, EMM386.SYS, that opens up available RAM in upper memory. It also handles expanded and extended memory support. After installing the memory manager, you can use the DR DOS HILOAD command to load and run an application in upper memory. To see what RAM you have available in upper memory, DR DOS supplies a function called MEM, which not only lists the names and locations of all applications and drivers currently in RAM, but also graphically maps the state of your RAM.

With DR DOS loaded and EMM386.SYS installed, I found I had 720,880 (704K) bytes of conventional memory (640K bytes plus 64K bytes that EMM386.SYS can reclaim from VRAM if you are using a Hercules, CGA, or MDA display), of which 689,040 bytes was unused. Plus, there was another 148,096 bytes of free upper memory above the VRAM. As compared to the 542,848 bytes that I had previously, DR DOS had given me almost 300,000 bytes—memory that had been there all along, overlooked by MS-DOS.

Thus, using the HILOAD command can be astonishing—like pitching a cinder block into a puddle and seeing it disappear without a splash. For instance, I was able to HILOAD GWBASIC into upper memory, where it took up about 80K bytes, and I still had about 60K bytes of upper memory free—about all GWBASIC can use for programs and data. Thus, I was able to run a full GWBASIC installation without affecting the amount of conventional memory available. (Well, almost—DOS's environment data for each application is still loaded in conventional memory, and in this case, it took up about 500 bytes.) I could even use the SHELL command to

DR DOS 5.0

Company

Digital Research, Inc.
70 Garden Court
Monterey, CA 93942
(408) 649-3896

Hardware Needed

IBM PC, XT, AT, or compatible

Price

\$199

Inquiry 1064.



leave GWBASIC and load another program, Xerox Ventura, in conventional memory, run it, leave it, and then return to GWBASIC using the EXIT command from DOS. While they were coresident, the two programs were not running at the same time—this is still DOS, not Unix or OS/2.

I could load a TSR program (in this case, SideKick), and as far as the conventional memory count from CHKDSK was concerned, it had disappeared with hardly a trace. It was in there, however, and it popped up and ran on demand.

DR DOS also has a HIDEVICE command that you can use within the CONFIG.SYS file to load device drivers into upper memory. Obviously, it replaces the MS-DOS DEVICE command.

And DR DOS exploits high memory, whose 64K bytes generally goes unused. Using the HIDOS.SYS driver, DR DOS will load the 37K-byte DOS kernel into high memory. The result is less dramatic than with EMM386.SYS, but equally magical; DOS still runs, but for all intents and purposes, it takes up no space.

DR DOS also has its own CACHE command, which sets up a disk cache in

user-defined amounts of extended or expanded memory. It caches only disk reads, so a power glitch won't wipe out any data that was waiting to be written to the disk from the cache. While CACHE doesn't need EMM386.SYS or HIDOS.SYS, once it's invoked it's still part of the operating system, and applications use it automatically.

No Free Lunch

There is, of course, no free lunch—even if DR DOS does seem to be serving up multi-K-byte servings of RAM gravy. As you probably guessed from the name, the EMM386.SYS memory driver that accomplishes most of these wonders requires a 386 (or i486) processor. HIDOS.SYS will work with a 286 and will also function much the same as EMM386.SYS if you're using Leap or Neat 286 processors from Chips & Technologies.

Also, if you're already using a memory manager (such as HIMEM.SYS in Microsoft Windows or QEMM.SYS in Desqview), you cannot use EMM386.SYS, and the advantages of reclaiming upper memory are lost. However, you

can still use HIDOS.SYS to get that extra 37K bytes by relocating DOS to high memory. If you are already using such a third-party memory manager, you're probably already using large amounts of extended memory, and a few score K bytes of upper memory may not seem important.

You may also be using applications or drivers that, for whatever reason, won't run in upper memory, or already use high memory. DRI doesn't think there are many software packages with this problem, but DR DOS's devices come with options and switches that let you disable any feature that causes trouble.

EMM386.SYS can also set up shadow ROM, where it remaps the video-control portion of the ROM BIOS to a sector of extended memory, on the theory that RAM is faster than ROM. Therefore, this should make your screen display faster. Many clones nowadays come with shadow ROM already built in; mine did not, but invoking the feature produced no noticeable speedup in the screen display. A technician at Club American said I could expect only about a 10 percent improvement, although a faster machine,

ScanWedge: the ScanPlus that Swallowed the MiniBar

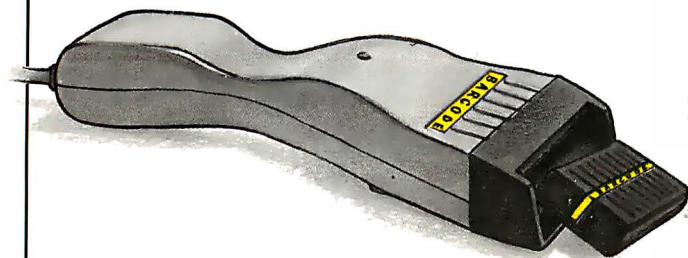

ScanPlus is Barcode's high performance, non-contact scanner based on CCD technology. With a reading speed of 200 scans per second, comfortable ergonomics, and superior reliability, it has revolutionized bar code scanning in point-of-sale and industrial applications. *MiniBar* is Barcode's universal wedge reader. It has broken new ground with on-board interfacing to over 100 popular terminals and PCs. Now *ScanWedge* combines the power of Scanplus with the interfacing capabilities of the MiniBar. ScanWedge connects directly to terminals and PCs between keyboard and screen, affording immediate compatibility with the user's hardware and software.

*For Barcode,
the Nineties Promise the World.*

ScanPlus, MiniBar, and ScanWedge are trademarks of Barcode Industries, Inc.

Barcode Industries, Inc.

12240 Indian Creek court, Beltsville, MD 20705,
Tel: (301) 498-5400, FAX: (301) 498-6498, Tlx: 506 144

BARCODE

I N D U S T R I E S

Introducing The Total LAN Plan. Only Emerson UPS has it.

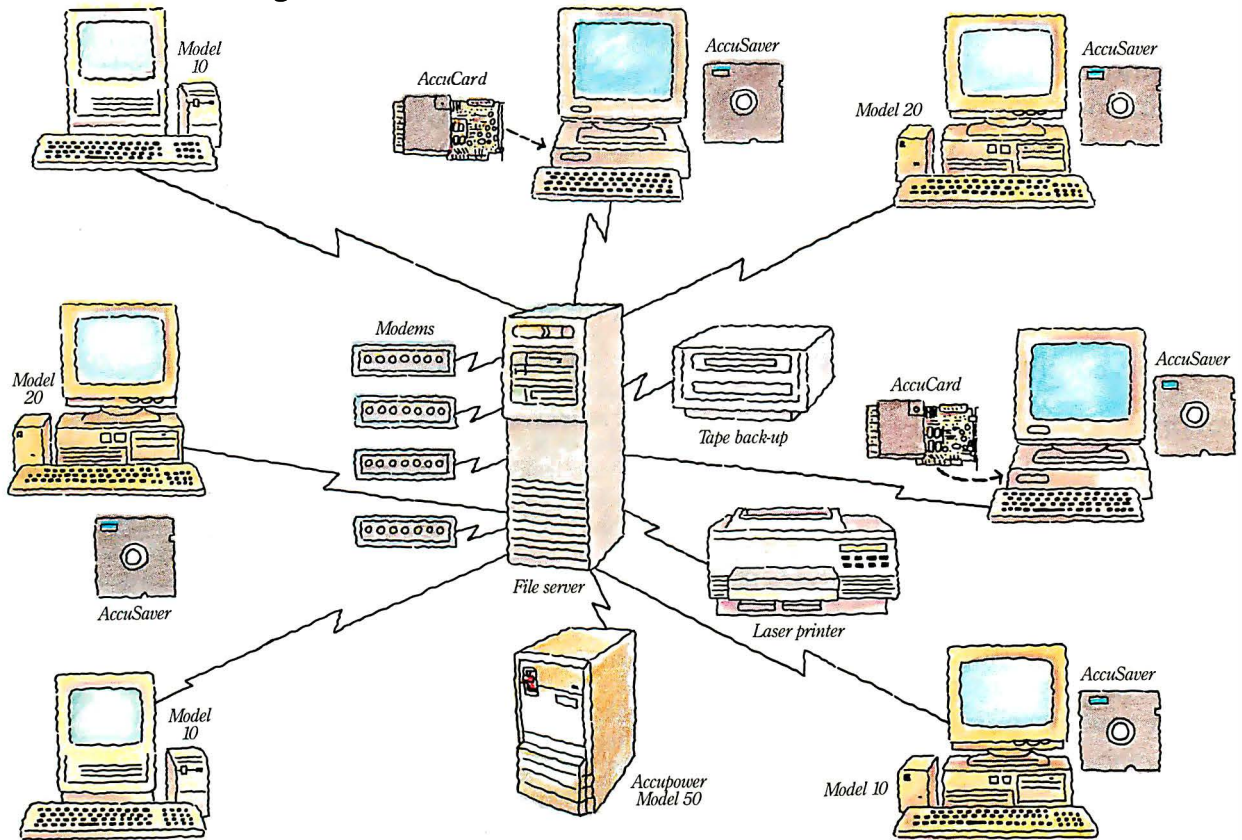

Novell
Banyan
3Com
LAN Manager
UNIX

It's the first systems approach to network power protection.

Total network protection.

With the price breakthroughs we've achieved on our Accupower® line, you can now protect a file server and five to six PC nodes. All for what you'd expect to pay just for file server protection.

And Emerson UPS has the broadest range of LAN interface cables and software in the industry. From Novell's Netware to the new IBM RS/6000 AIX.

But that's just the first of many unique solutions that only Emerson offers.

A UPS that fits in a slot.

There's our unique AccuCard™ for instance.

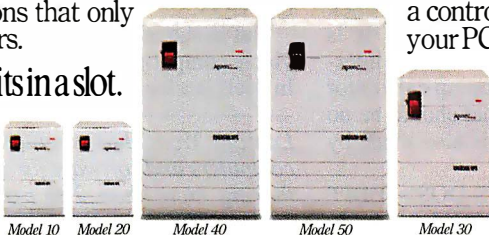

A low-cost UPS-on-a-card that fits right into an unused slot in your PC. It features complete data save and restore, self-diagnostics and unattended operation on your nodes.

And cable adapters make AccuCard compatible with virtually all desktop computer brands.

Plus there's our proprietary AccuSaver™ software.

AccuSaver software is activated by any data-threatening power problems. While the battery backup capability of the Emerson UPS supplies emergency power to the system, our AccuSaver software orchestrates a controlled shutdown on all your PC nodes.

Then, when power is restored, you can either manually or automatically restore your workstation.

And you get our money back guarantee.

We're so confident in the absolute reliability of our network protection systems, we'll refund your money if, for any reason, you're not satisfied with your UPS system.*

Think about it. Absolute reliability. More power protection solutions than any other company offers.

And a money-back guarantee. All at truly affordable prices.

The Total LAN Plan.

For more information or the name of the distributor nearest you, just call 1-800-BACK-UPS.

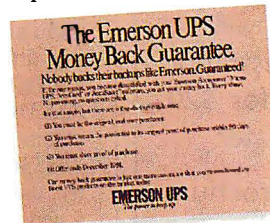

EMERSON UPS
The power to keep up.

Accupower is a registered trademark and AccuCard, AccuSaver and the Total LAN Plan are trademarks of Emerson Computer Power, a division of Emerson Electric. PC is a registered trademark of International Business Machines Corporation. LAN Manager is a registered trademark of Microsoft Corporation. Novell and Netware are registered trademarks of Novell, Inc. UNIX is a registered trademark of AT&T Bell Labs. Banyan and 3Com are registered trademarks of those respective companies. *Some restrictions apply. See your reseller for details or call Emerson UPSdirect. Offer ends December 1991. ©1990 Emerson Computer Power, a division of Emerson Electric Co.

kyOS

Planning for Retirement

Quickly and easily determine the income you need to retire comfortably. Our president adds this comment, "Although this planning tool is primarily intended for individuals, everyone dealing with retirement benefits could profit by owning a copy."

Some factors considered are:

- inflation
- how spending changes with age
- IRA, Keogh, (RRSP in Canada), etc.
- the tax bite
- capital and its growth
- life insurance, annuities, government and corporation pension plans

...and on it goes.

kyOS Planning for Retirement helps you develop concrete and attainable plans for a secure retirement. Now available for \$79 U.S.; a demonstration kit is also available for \$20. Requires DOS 3.0 or later.

Call or write for a brochure on our retirement planning seminars.

For orders or information

(8 AM to 5 PM Mtn.)
MC and VISA accepted

call

(403) 241-9011

write

kyOS Systems Inc.
Suite 393, 918 - 16 Ave. N.W.
Calgary, Alberta, Canada
T2M 0K3

REVIEW

DR DOS OFFERS HOPE FOR THE RAM-CRAMMED

such as a 33-MHz 386, might show a 30 percent improvement.

My applications ran at about the same speed under DR DOS as they did under MS-DOS. However, loading EMM386.SYS slowed disk-based activities down by about 10 percent. If the extra memory EMM386.SYS makes available means that an application needs to perform dramatically fewer disk accesses, the slowdown might be negated, but I encountered no such situations. On the other hand, using CACHE does speed things up noticeably, especially for programs that normally swap code to and from RAM. After being invoked the first time, a function would often run without producing any disk activity, since the necessary code was in the RAM cache. The difference was less evident when reading through data files, and it did not make up for EMM386.SYS.

There was no particular difference between the print speeds of DR DOS and MS-DOS. However, an odd problem—and the only real bug I encountered—surfaced when I was copying files in binary format to the printer port (using COPY /B PRN) to load emulation software into a laser printer. The initial version of DR DOS that I had couldn't do this at all. A second version—which DRI said is the version of DR DOS that is now being shipped—did work, but it took 55 seconds to transmit a file that MS-DOS transmitted in just 4 seconds.

DOS Embellishments

Beyond memory management features, there are a number of small but interesting differences between MS-DOS and DR DOS. The most obvious difference is that DR DOS inserts commas into byte counts, so you get "655,360" instead of "655360." Beyond this boost to legibility, usability also gets a boost, thanks to a new help-screen option for most DOS commands. If, for instance, you can't remember how to do a backup, you can just type BACKUP /H and a help screen will appear.

And you don't have to type anything at all to use DR DOS if you don't want to, because it comes with a point-and-click graphical shell called ViewMax. It is strongly reminiscent of the GEM interface, right down to the pop-up calculator and digital clock. And that should be no surprise, because GEM is also made by DRI.

DR DOS replaces MS-DOS's EDIT line-at-a-time text editor with a handy full-screen editor that uses WordStar control keystrokes. Unsurprisingly, it's named EDITOR.

You can assign varying levels of password protection to files and subdirectories. The TREE command can produce a graphical diagram of your disk directories. FORMAT only works with floppy disks. To wipe out a hard disk, you have to use the FDISK command. Since the program is menu-driven, you'll be less likely to absentmindedly vaporize your data with it. And if you do use FDISK, you'll find that DR DOS supports disk partitions of up to 512 MB. For examining file contents, there's an extended version of DIR called XDIR, which shows more information than DIR.

For laptop users, DR DOS has a utility called FileLink for file transfers over serial cables. Functionally, it's comparable to Traveling Software's Desk-Link. Also for laptops is a CURSOR function for changing the shape and blink rate of the cursor to make it easier to find on an LCD screen. DRI says that power management techniques to extend battery life for portable computers are also built into DR DOS, but those features must be integrated by hardware manufacturers.

The Ultimate Answer?

If you have a 386 and need extra RAM (perhaps because of a need to pile on device drivers), DR DOS may be your salvation. It frees up more than enough RAM to hold the average network driver, which is usually 64K bytes to 128K bytes in size. And it does it without affecting your applications in any way—you don't have to convert to OS/2 or some other environment to escape the RAM cram.

Otherwise, the \$199 you'd have to pay for DR DOS may or may not be worth it. Many considerations are involved. File-Link may make it a good value if you're a laptop user. The password function and the 512-MB disk partition may be interesting for certain applications. The help screens, screen editor, and ViewMax generally make it an easier DOS to use. One consideration that you should not overlook is that Microsoft can be expected to hatch an answer to DR DOS with its own further enhancements to MS-DOS.

But in the meantime, DRI has added a viable competitor to the DOS world. That in itself is a long-overdue development. ■

Lamont Wood has evaluated personal computers and software for 13 years, authoring more than 200 articles on the subject. He currently writes a computer column for the San Antonio Business Journal. You can contact him on BIX as "lwood."

...Nor Dark of Night

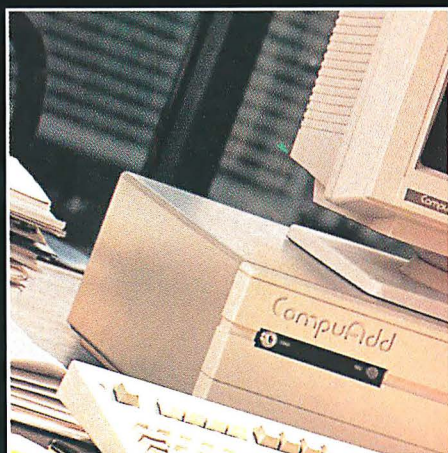

"The CompuAdd 325 is a good example of the type of product that has kept the company going while others have disappeared in the night."

— PC Magazine, July 1990

CompuAdd Keeps You in the Spotlight!

CompuAdd's NEW DX Success Kit \$1995

Lower Priced Than Other Competitor's System Alone — Get the Printer, Software and Mouse FREE! A \$573 Additional Value

CompuAdd answers your demands for affordable 386-powered systems — and goes one better with the NEW CompuAdd DX Success Kit.

The 320 system *alone* was \$2259. Now you *save* \$264 and get a *FREE* Panasonic KX-P1180 printer — a \$299.95 value! Add to that, a *FREE* CompuAdd mouse *plus* *FREE* software worth over \$230, and you have a deal that appeals to the shrewdest executive.

The NEW DX Success Kit gives you the power of our 20MHz 386 system with the convenience of our popular "plug-and-go" kits. *FREE* CompuAdd Windows 3.0, *FREE* Microsoft Working Models and *FREE* CompuAdd MS-DOS 4.01 come preloaded on your hard drive, so your system is ready to go right out of the box!

With the 320 at the heart of your kit, you have power for the most demanding tasks — detailed spreadsheets, complex databases, desktop publishing and even CAD/CAM. Compatible with OS/2 and Novell operating systems as well as MS-DOS and SCO XENIX, the 320 also makes an excellent network file server or powerful workstation.

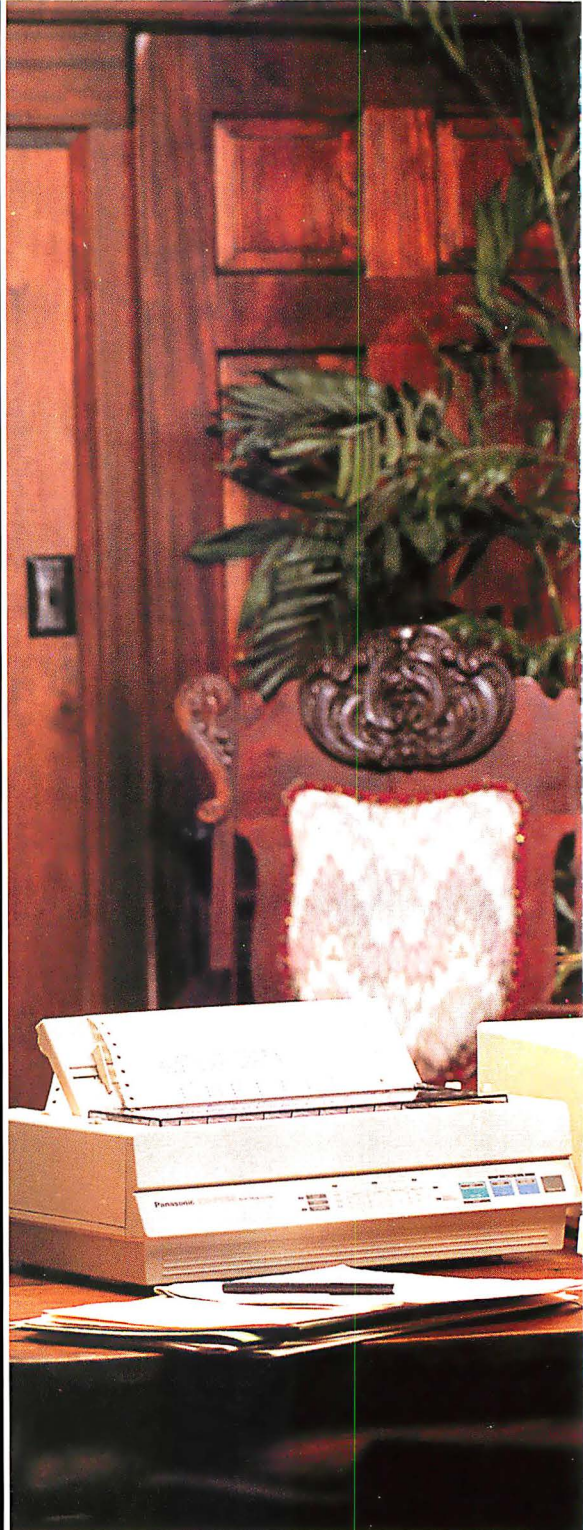

CompuAdd's NEW DX Success Kit Features:

- ▲ 80386 microprocessor running at 20MHz
- ▲ 1 MB DRAM expandable to 16MB
- ▲ 0 wait-state cache memory
- ▲ 40MB (28ms) hard drive
- ▲ 5.25" 1.2MB or 3.5" 1.44MB diskette drive
- ▲ Dual diskette controller
- ▲ Dual IDE hard drive interface
- ▲ Six 16-bit and two 8-bit expansion slots
- ▲ Five 5.25" half-height drive bays
- ▲ Built-in parallel and two serial ports
- ▲ High-performance MGA monitor and graphics adapter
- ▲ *FREE* Panasonic KX-P1180 printer \$299.95 value
- ▲ *FREE* CompuAdd mouse \$34.95 value
- ▲ *FREE* CompuAdd Windows 3.0 preloaded \$149 value
- ▲ *FREE* Microsoft Working Models preloaded
- ▲ *FREE* CompuAdd MS-DOS 4.01 preloaded \$89 value

Part Number 66674



"Few manufacturers would do what CompuAdd does: It takes DOS and Windows and installs them on your system's hard disk, configuring everything so that it will run right out of the box. You just plug it in and get to work!"

— PC Magazine, July 1990

*Get Ahead with 386 Power.
Stay Ahead with CompuAdd Value!*

Call 800-999-7103

CompuAdd®

Customer driven, by design.™

CompuAdd's Top-of-the-Line Technology at Bottom-Line Prices

CompuAdd SX Success Kit

The SX Success Kit has been one of our best sellers since the day we introduced it!

CompuAdd was the first to offer convenient plug-and-go computer kits, and no one else matches the value we build into every package.

We put all the compatible components together

for you — there are *no more pieces to buy!*

We even include *FREE* CompuAdd Windows 3.0, *FREE* CompuAdd MS-DOS 4.01, *FREE* Microsoft Working Models and a *FREE* CompuAdd mouse.

The heart of the SX Success Kit is the CompuAdd 316s, designed by CompuAdd engineers for maximum performance with the 16MHz Intel®386SX microprocessor. The SX Success Kit comes with the 9-pin Panasonic KX-P1180 printer, or you can upgrade to the 24-pin Panasonic KX-P1124. Both printers were chosen *PC Magazine* Editor's Choice (11/89 and 1/90).

Call today and let the CompuAdd SX Success Kit put you in the lead and keep you there!

CompuAdd 316s and 320s

CompuAdd designed these systems around the Intel®386SX microprocessor, running at 16MHz on the 316s and 20MHz on the 320s. *PC Magazine* (Jan. 30, 1990) says the 386SX processor is "perfect for entry-level users in today's corporate market."

The CompuAdd 316s and 320s systems give you 32-bit processing power at 16-bit prices. Get the most from Windows 3.0, work with complex spreadsheets and large databases, or run computation-intensive applications like CAD/CAM. Both systems are compatible with MS-DOS, SCO XENIX, OS/2 and Novell operating environments.

Call today and get advanced computing power with CompuAdd's 386SX systems. Remember to ask about our monitor and hard drive options. All at an unbeatable CompuAdd value.

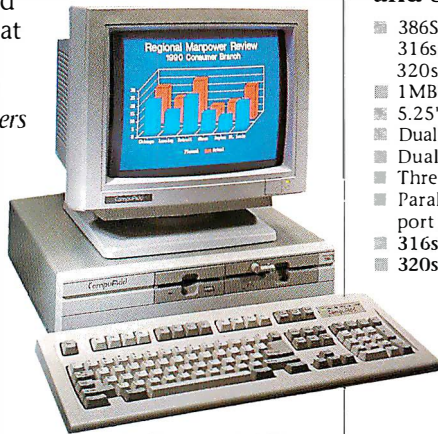

Think Technology, Think CompuAdd!

CALL TODAY! or visit a CompuAdd Superstore for these savings.

800-999-7103

Hours: Monday - Friday 7:00am to 9:00pm CST; Saturday 9:00am to 5:00pm CST

CompuAdd SX Success Kit Features:

- 80386SX microprocessor rated at 16MHz
- 1MB DRAM expandable to 4MB
- 0 wait-state page-mode memory
- 40MB (28ms) hard drive
- 5.25" 1.2MB or 3.5" 1.44MB diskette drive
- Dual diskette drive controller
- Dual IDE hard drive interface
- Parallel port, two serial ports and game port interface (cable required)
- 80387SX math coprocessor support
- Three 16-bit and two 8-bit expansion slots
- High-performance MGA monitor and graphics adapter
- *FREE* CompuAdd serial mouse \$34.95 value
- *FREE* CompuAdd Windows 3.0 \$149 value
- *FREE* CompuAdd MS-DOS 4.01 \$89 value
- *FREE* Microsoft Working Models
- 9-pin Panasonic KX-P1180 printer with cable
- **Basic Kit Price: \$1895 (66314)**

CompuAdd 316s and 320s Features:

- 386SX microprocessor
- 316s: running at 16MHz (8, 16MHz)
- 320s: running at 20MHz (7, 20MHz)
- 1MB DRAM expandable to 4MB
- 5.25" 1.2MB or 3.5" 1.44MB diskette drive
- Dual diskette drive controller
- Dual IDE hard drive interface
- Three 16-bit and two 8-bit expansion slots
- Parallel port, two serial ports and game port interface (cable required)
- **316s Base Price: \$1195 (64787)**
- **320s Base Price: \$1395 (66537)**

CompuAdd®

Customer driven, by design.™

12303 Technology, Austin, Texas 78727

Telex: 763543 COMPUADD AUS
 Fax: 512-335-6236
 Technical Support: 800-999-9901
 Outside US: 512-258-5575
 Canada: 800-387-3266
 Mexico: 95-800-010-0401
 United Kingdom: 0800-373535
 Germany: 0130-6009

We accept MasterCard, VISA, money orders, certified checks and personal checks (please allow ten days for processing). CODs (500 minimum order), company and institutional purchase orders (minimum initial purchase \$500, thereafter \$50), and wire transfers. Please add 2% to all purchases for shipping and handling (minimum \$1). Shipping outside the continental United States will increase cost. Add 8% for shipping and handling to AFMPO addresses (minimum \$10). Please add appropriate local sales tax. Thirty-day money-back guarantee does not include return freight or shipping and handling. Opened software, videotapes, other consumables and shipping costs are non-refundable. All return items must be accompanied by a return merchandise authorization (RMA) number. Prices and product descriptions are subject to change without notice. CompuAdd is not liable for damage due to omissions or typographical errors. Call 800-666-8772 for a copy of CompuAdd's complete warranty.

REVIEW

On Becoming a ClockWise Scheduler

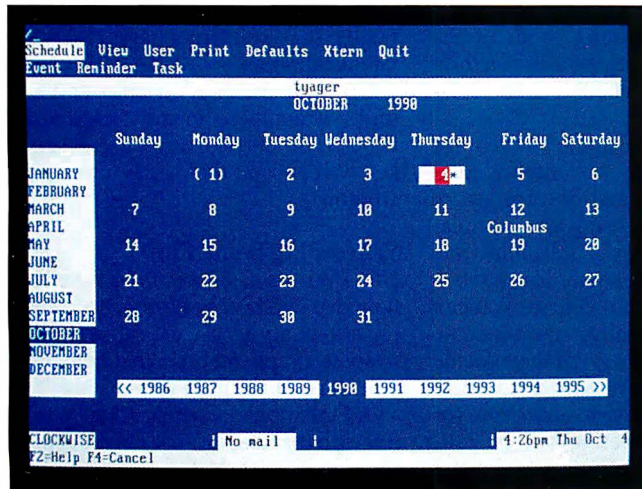

ClockWise provides a wide, readable view of your workgroup's calendar.

It's been a bad day. Your meeting had to be postponed because someone else was using the conference room. The boss is peeved because his favorite project is behind schedule, and all because someone whom you gave responsibility to dropped the ball.

Well, buck up, because Phase II Software has an answer: ClockWise. This application taps Unix's multiuser power to bring you a distributed scheduling database. Users can create their own schedules, reserve conference rooms and other resources, and plan meetings based on the availability of other users. Management can delegate tasks to subordinates and check on their progress. And for those moments when the boss isn't looking, ClockWise even gives you the current phase of the moon, tides, and a daily trivia question or pithy quote.

I installed ClockWise 1.1 on an ALR PowerVEISA 486/25 with 13 megabytes of memory, Interactive Unix 2.2, and the X Window System running on a Matrox MG Series 8514/A card.

Did It Have to Be Unix?

Until ClockWise, there was no widely available tool for bringing users of dissimilar systems together. Since ClockWise runs under Unix, users can connect to it through either a network link or a serial cable. ClockWise's interface is strictly text-based, so you can tap in with a dumb terminal, a DOS system, a laptop, or a Unix workstation. All that's required is a terminal or emulator that is supported by the flavor of Unix that you select to run ClockWise.

The database is best kept on a single system. Running ClockWise from a serial port or via remote network log-in ensures this, but it is also possible to share the database while running a local copy of ClockWise on your desktop system. Using Remote File System or Network File System (or whatever file-sharing scheme your system supports), you can mount the remote database directory where ClockWise expects to find it.

In addition, the program's variety of connection types makes it possible to use ClockWise from a dial-up terminal. Fast, error-correcting modems are be-

coming quite common, and running full-screen applications like ClockWise through them works nicely. Field personnel can dial in and update their schedules, and branch offices can exchange selected databases with the main office via modem.

Individual Scheduling

Even as a single-user application, ClockWise has a good deal to recommend it. It opens with a large, readable view of the month's calendar. Dates for which an activity has been scheduled are highlighted. There is an array of function keys across the bottom of the screen. You can access most of the important features of the program from here, but the oft-used slash key will bring up a Lotus-style menu.

The ClockWise database is really a collection of files, each with a specific purpose. Each user has his or her own protected group of files, which hold information on schedules, notes, names and phone numbers, access permissions, and groups of users.

ClockWise distinguishes between two types of schedule items: *events* and *tasks*. An event is something that is tied to a particular date or range of dates. It stands alone and is forgotten once the date passes. A task is a part of a to-do list, a milestone in a project time line that *must* be done. The user is reminded about tasks at appropriate times and can see at a glance when something has slipped behind schedule.

ClockWise is not a massive project management system, and it lacks many of the features of commercial project management programs. Its strength is in its ability to make individual scheduling easy enough that people will actually do it, and to make the information accessible to those who make financial or planning decisions based on progress.

The database can also hold information about *resources*, those pesky things that nobody can get to when they are needed. Conference rooms, overhead projectors, VCRs, and other presentation-related items are all good candidates for ClockWise scheduling.

It's Better in a Group

When you've defined a group in ClockWise, you can schedule events and tasks for that group simply by specifying the name of the group. New items will be



ClockWise 1.1

Company

Phase II Software Corp.
238 Broadway
Cambridge, MA 02139
(617) 354-8771

Hardware Needed

286- (Xenix only), 386-, or i486-based PC with 2 MB of memory and 1 MB of free hard disk space.

Software Needed

Interactive Unix 2.0 or higher; AT&T and SCO Unix, ESIX, and AT&T 3B2 also supported

Price

\$995 (unlimited users; other license terms available)

Inquiry 1060.

Rack & Desk PC/AT Chassis

Integrand's new Chassis/System is not another IBM mechanical and electrical clone. An entirely fresh packaging design approach has been taken using modular construction. At present, over 40 optional stock modules allow you to customize our standard chassis to nearly any requirement. Integrand offers high quality, advanced design hardware along with applications and technical support *all at prices competitive with imports*. Why settle for less?

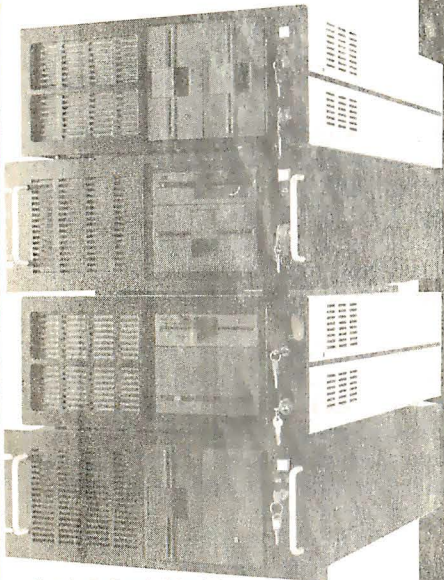

Rack & Desk Models

Accepts PC, XT, AT Motherboards
and Passive Backplanes

Doesn't Look Like IBM

Rugged, Modular Construction

Excellent Air Flow & Cooling

Optional Card Cage Fan

Designed to meet FCC

204 Watt Supply, UL Recognized

145W & 85W also available

Reasonably Priced

Now
Available

Passive
Backplanes

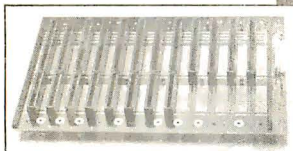

INTEGRAND

RESEARCH CORP.

Call or write for descriptive brochure and prices:
8620 Roosevelt Ave. • Visalia, CA 93291

209/651-1203

TELEX 5106012830 (INTEGRAND UD)

FAX 209/651-1353

We accept Bank Americard/VISA and MasterCard

IBM, PC, XT, AT trademarks of International Business Machines
Drives and computer boards not included.

REVIEW

ON BECOMING A CLOCKWISE SCHEDULER

distributed to the individual databases of the group members. So, for instance, if you schedule a meeting at 3:00 and attach a reminder to the database entry, all the members of your group will get a mail message informing them of the meeting. Users will see the entry in their schedules, with the scheduling authority identified.

If you attempt to schedule an event for someone who already has another commitment, ClockWise will inform you of the conflict. You can bring up a summary graph that displays a schedule time line for each group member for the date you're dealing with. Of course, you can override conflict warnings and schedule those individuals anyway. If they decide not to attend, all they have to do is delete the item from their schedule. You (or whoever called the meeting) will be notified of the deletion by E-mail, and a box will pop up on your screen the next time you view the event.

ClockWise has a mild integration with the mail system. You can attach reminders to any event, and they will use the Unix at command to spool a mail message for delivery at a certain date and time. This makes it possible for you to be reminded of an event even if you're not running ClockWise. If you're running a windowing environment, you might have the luxury of running ClockWise constantly in the background. In that case, reminders can pop up on the bottom line of the ClockWise display window. Either way works about as well, since ClockWise also notifies you when new mail has come in.

Interfacing 'Round the Clock

The ClockWise user interface is, without a doubt, this program's best feature. Even though I take points away from companies whose programs blandly follow the slash menu scheme (a slash is *not* an intuitive way to pop up a menu), the rest of ClockWise's interface makes perfect sense.

Entering dates, for example, is more easily done here than in most applications I've seen. Enter a date in just about any format you can think of, and ClockWise will take it in. In a few places, ClockWise will try to guess the proper date for a field. If the guess is close but not quite there, you can use simple expressions, such as "+10," which adds 10 days to the date. There aren't as many ways to format time expressions, but ClockWise is forgiving.

In virtually any place where a field requires an entry that conforms to a list (e.g., user or group names), you can

press a function key to pop up a window with the list. The name database (which holds names, telephone numbers, and related information) is always a function-key press away, making it easier to fill in fields that require contact names or phone numbers.

You can attach a variable-length note (e.g., a database memo field) to most ClockWise entries. Pressing a function key will expand the memo into a pop-up window.

Scheduling Some Fun

ClockWise's designers must have known how dry and boring most scheduling applications are to use, because they built in some simple features that help prevent you from taking it all too seriously.

As mentioned earlier, ClockWise has a screen that displays the current phase of the moon, sketched out in text characters. The moon screen also shows the tides and has a space reserved for a witticism. You can select a daily quote, a fortune (usually just an unattributed witty saying), or a trivia question. ClockWise comes loaded with a database that will supply a different saying or question for each day. The trivia question answers appear only on the *next* day, and you can't cheat.

What place is there for features like this in serious business software? I won't debate the topic, except to say that it's about time someone worked a little fun into what is otherwise a rather tedious affair. As nice as ClockWise is to work with, entering every worthwhile happening into it would get to be a bit of a drag after a while.

All this furious data entry would be for naught if you couldn't print it out, and can you ever. Phase II Software took the time to make custom layouts for daily, weekly, monthly, project, and other print formats. If you have a PostScript printer, ClockWise's output is very functional, and it looks good enough to hang on a wall. If you only have access to a text printer, you can still get a usable printout, but the PostScript output is simply eye-popping.

ClockWise is now right up there on my list of useful Unix tools. If you're not an organized person, it can help, but you still need to get into the habit of writing everything down. ClockWise isn't the full realization of the potential of workgroup computing, but it still won me over. ■

Tom Yager is a technical editor and Unix expert for the BYTE Lab. You can contact him on BIX as "tyager."

Speed. Guaranteed.

**AND
COMPATIBILITY.
GUARANTEED.**



Here's a chance to buy our \$99 Math Coprocessor at no risk whatsoever!

High Speed, Low Price.

The performance benefits of a coprocessor are enormous. Now they're affordable too. Before the AMD 80C287 you had no choice but to pay over \$200 for a fast math coprocessor. Now you can get a coprocessor compatible with the Intel® NMOS 80287 for a terrific price - direct from AMD.

Speed up hundreds of software applications.

The AMD 80C287 increases the performance of general business software applications like 1-2-3®, dBASE™, Excel, and hundreds of others. You can expect calculations on your favorite software to run two to ten times faster with an AMD 80C287 installed. Your graphs will draw faster, your spreadsheets will recalculate faster - your work will get done faster.

Compatible.

The AMD 80C287 is compatible with your 80286 based PC and the hundreds of commercially available software packages written for your 80286 PC. You'll also be glad to hear that it's compatible with the Intel NMOS 80287.

Easy to Install.

The AMD 80C287 drops easily into a socket already inside your 80286 based PC. In five minutes you can be up and running. Just pop it in and go - FAST! The AMD 80C287 comes with free floating point and fractal software to show you the immediate performance boost you'll get.

Here's Our Risk Free Triple Guarantee.

Guarantee #1

If the AMD 80C287 Math Coprocessor doesn't do everything we promise, if it doesn't double or triple the speed of mathematical calculations of your favorite software applications, or if you are unsatisfied for any reason, AMD will refund 100% of your purchase price within 30 days of your purchase.

Guarantee #2

If your AMD 80C287 Math Coprocessor ever fails to perform for any reason, AMD will replace it free of charge - no questions asked.**

Guarantee #3

AMD guarantees that the AMD 80C287 Math Coprocessor is compatible with your 80286 based hardware and software. If you have any compatibility problems with the AMD 80C287 during the first year, we will gladly refund the purchase price.

To Order Call Now: **1-800-888-5590**



EXT. 2600
Outside of USA (512) 345-1728

I want to double or triple the calculation speed of software running on my 286 based PC. Send me an AMD 80C287 Math Coprocessor risk free for only \$99*. I understand that I can return the AMD 80C287 for a full refund within the first 30-days if I am not completely satisfied.

Call for a free demo disk and literature

Name _____

Visa/MC # _____

Type of PC _____

C.O.D. orders accepted

Advanced Micro Devices 

© 1990 Advanced Micro Devices, Inc.

1-2-3 is a registered trademark of Lotus Development Corporation. dBASE is a trademark of Ashton-Tate Corporation. Intel is a registered trademark of Intel Corporation

*Plus tax, shipping and handling. Volume or Dealer inquires welcome.

**Limited to two lifetime replacements per person.

Circle 38 on Reader Service Card

Northgate® SlimLine™ 386™/20

Full Sized 386 Performance,

Small Footprint Case!



Buy now...
no payments
for 90 days!

When charged to
your Big 'N' card,
see credit offer
for details.

SlimLine 386 Monochrome System Features

- ◆ 20 MHz Intel® 80386™ processor
- ◆ 4Mb 32-bit DRAM on motherboard using Single Inline Memory Modules (SIMMs)—expandable to 8Mb (total of 16Mb addressable memory using 16-bit memory boards)
- ◆ 40Mb IDE hard drive
- ◆ 12" high resolution VGA monochrome monitor
- ◆ 1.2Mb 5.25" and 1.44Mb 3.5" floppy disk drives
- ◆ Down-scaled American-made motherboard
- ◆ Five open expansion card slots—Three full-length 16-bit slots; Two half-length 8-bit slots
- ◆ 80387 coprocessor support
- ◆ One parallel and two serial ports
- ◆ Long life encapsulated battery CMOS chip
- ◆ Built-in VGA adapter; 256K video memory
- ◆ Exclusive *OmniKey*® keyboard
- ◆ Microsoft® Windows™ 3.0 and mouse
- ◆ MS-DOS 4.01 and GW-BASIC software
- ◆ AMI™ BIOS with setup and diagnostics in ROM
- ◆ On-line User's Guide
- ◆ 100 watt quiet power supply
- ◆ SlimLine (only 3.85" high), small footprint case
- ◆ Front mounted controls for high/low speed operation, and system reset
- ◆ 1-year system warranty; 5 years on keyboard
- ◆ FCC Class B Certified

The power user's solution! You want high-powered 386 performance, in a space saving case, here's SlimLine 386! SlimLine is Northgate's best-selling system because it satisfies power hungry computer users—at a price other companies charge for less-powerful, entry-level systems.

SlimLine's space-saving advantage! Northgate's sleek, swift SlimLine 386 is ideal for any sized home or office. You'll save valuable work space, and you'll marvel at how efficiently SlimLine 386 pours out state-of-the-art processing power!

The heart of the system is Northgate's exclusive precision engineered motherboard. It's smaller than a sheet of legal paper, but it gives you unparalleled 32-bit processing performance.

Power when you need it most! Run the latest multi-tasking applications under Microsoft® Windows™ 3.0. Go ahead! Create complex graphics, design intricate software, streamline your business computing. SlimLine handles your heaviest workload with speed and accuracy ... just what you'd expect from Northgate!

Get to know Northgate better— new 60-day no-risk trial!

Full-compatibility with industry standard hardware and software too—thanks to SlimLine's ROM-based AMI™ BIOS. So, you'll enjoy plenty of upgrade and expansion potential.

Step up to enhanced Northgate 386 power! Start with a full megabyte of super-fast 32-bit RAM. Build up to 8Mb RAM on the motherboard—up to 16Mb with optional memory card. SlimLine's motherboard also integrates a high quality VGA video adapter with 256K video RAM, a 80387 math coprocessor socket, one serial and two parallel ports.

More built-in performance features! Store your data reliably with SlimLine's large 40Mb IDE hard drive. It's supercharged with Smartdrive disk caching software to speed data to and from the CPU!

You also get both 1.2Mb 5.25" and 1.44Mb 3.5" floppy drives! And, to squeeze all the speed possible out of the storage drives, Northgate integrates the hard and floppy drive controllers right into the motherboard!

Flexibility for the future! Use SlimLine's five open expansion slots to add a Local Area Network adapter, mainframe terminal adapter, tape back-up, FAX card, or modem ... SlimLine supports all industry standard add-on tools!

Plus, you get industry-leading support! Northgate gives you free on-site service to most locations for a full year if we can't solve your problems over the phone. Plus, toll-free technical assistance 24 hours-a-day, 7 days-a-week.

Northgate's generous warranty protects your investment for a full year—five years on the *OmniKey* keyboard. And, if you ever need a part, we'll ship it to you overnight—before we receive your part! It's no wonder *PC Magazine* reported: "If you're looking for the subjective winner for customer loyalty, Northgate takes first prize."^{**}

SlimLine 386 SVGA Color System

Start at the top with Northgate's deluxe SlimLine 386 SVGA Color System. You get all the high-performance of the monochrome system with these useful extras:

- ◆ 100Mb hard drive—15 ms access
- ◆ 14" SVGA color monitor with 1024 x 768 resolution

FREE Performance Software Package with SVGA color system purchase!

Limited time only! Select Northgate's SVGA color system and you'll get Samna® Ami™ Professional word processing and Informix® Wingz™ graphics spreadsheet—FREE!

Now! Use SlimLine 320 for 60 days—Risk Free! If it doesn't exceed your highest expectations, we'll buy it back—and return every penny you paid—no questions asked! When you buy from Northgate your satisfaction is guaranteed!

ORDER TODAY! Call toll-free 24 hours every day. Don't forget to ask about custom configurations, leasing and financing programs.

SlimLine 320 Monochrome System

\$2499⁰⁰ Delivered To
Your Home
or Office!
SVGA Color System \$3199⁰⁰

EASY FINANCING: Easy payment options. Use your Northgate Big 'N', VISA, MasterCard ... or lease it. Up to five year terms available.

CALL TOLL-FREE 24 HOURS EVERY DAY

800-548-1993

New ... FAX your order toll-free! 800-323-7182
Northgate's Hearing Impaired: Northgate now has TDD capability:
800-535-0602



"We hear you!"

7075 Flying Cloud Drive, Eden Prairie, MN 55344

*PC Magazine Sept. 25, 1990. ©Copyright Northgate Computer Systems, Inc. 1990. All rights reserved. Northgate, OmniKey and the Northgate Big 'N' logo are registered trademarks of Northgate Computer Systems. 80386 and 80486 are trademarks of Intel. All other products and brand names are trademarks and registered trademarks of their respective companies. Prices and specifications subject to change without notice. Northgate reserves the right to substitute components of equal or greater quality or performance. All items subject to availability. We support the ethical use of software. To report software copyright violations, call the Software Publishers Association's Anti-Piracy Hotline at 1-800-388-PIR8.

Circle 212 on Reader Service Card

REVIEW

Battle for the Best Unix V/386

For many users, an operating system is an invisible layer. But some of us prefer to keep in step with the latest developments. The BYTE Unix Lab has been working with new releases from Interactive Systems Corp. (ISC) and The Santa Cruz Operation (SCO), and we've found both companies have made some small but important changes for the better in their products.

Interactive Unix 2.2

In almost every noticeable way, the upgrade from ISC is actually a new product. With release 2.2, even the name changes: 386/ix has become Interactive Unix.

The 386/ix 2.0.2 operating system had a flurry of demerits: an inept installation procedure; incomplete, poor-quality manuals; and a lack of on-line manual pages. With Interactive Unix 2.2, all these concerns have been addressed, but ISC didn't stop there.

With regard to the installation procedure, Interactive Unix has one of the best that we've seen. The entire installation process is managed by a full-screen color program that walks new users through every step with concise help text. Context-sensitive help is only an F1-key press away.

Our only complaint is that this interface was not carried through to other parts of the operating system. It would have made a wonderfully friendly front end for `sysadm`, for example.

ISC's addition of both paper and elec-

tronic documentation eliminates one of SCO's longtime advantages in this area. ISC always had a quality operating system, but the lack of decent documentation cast a black shadow over it. Prior to release 2.2, the documentation was sparse and perfect-bound (the kind of book that never stays open). Now, the manual set is complete, and it comes in stiff cardboard binders with clearly marked index tabs. On-line manual (`man`) pages for commands and library functions are standard now. Unfortunately, pages are not added when you install the X Window System and OSF/Motif. That's an oversight that needs attention.

In addition to answering age-old complaints with release 2.2, ISC has rolled in some new ingredients of its own. Interactive Unix now complies with the POSIX 1003.1 operating-system specification; developers select System V or POSIX program behavior at compile time. POSIX compliance also brings an important feature, *job control*, to Interactive Unix. With this, it is possible to suspend a process and resume it later.

ISC provides a new C shell that activates and manages this job control. Here is how it works: While a program is running, you can press a special "switch" character to suspend the program and place it in the background. A shell prompt then appears. The C-shell command `bg` sets a job running again in the background (control returns to the shell), and `fg` makes the suspended session the

active one. For example, you can suspend a `vi` editor session to do a compile and easily resume the `vi` editor session afterward.

Also taken from POSIX are the portable archiver, `pax`, and the ability to assign membership in multiple groups to a single user. The `pax` archiver is compatible with both `tar` and `cpio`, but it also has an enhanced data-storage format and an interface of its own. Multiple groups allow system administrators to fine-tune file access.

Also included in Interactive Unix 2.2 are a number of useful features, such as additional and enhanced device drivers (with floppy disk and SCSI tape foremost among them); new versions of `sendmail` and `smail`; multiple EGA and VGA fonts; a `setcolor` command for modifying the console character colors; and extended (secondary) DOS partition support.

ISC has also upgraded its TCP/IP, VP/ix, Software Development System, and X products significantly. The company claims to have sold more 386 3.2 Unix packages than any other vendor, and with Interactive Unix 2.2 and these other upgrades, that trend should continue.

SCO Unix 3.2 Version 2.0

Version 2.0 of SCO's Unix 3.2 contains much more than just a few patches and fixes. It is SCO's statement about the new AT&T Unix System V release 4, a release that is slowly starting to come out of the porting labs and into the real world. We would verbalize SCO's statement as "take the most sought-after (and easiest to implement) features of V.4 and implement them under V.3.2." The most obvious of these features is the Korn shell with full job control, and SCO's new release has it.

The Korn shell has all the features of the Berkeley C shell, including command-line history, aliases, and internal handling of `test` and arithmetic operations from scripts. What the Korn shell has that the C shell lacks is an internal editor (emulating either `vi` or `emacs`) for editing commands in the history list before reissuing them. (This is even better than the command history in VMS, Digital Equipment's operating system for VAX computers.)

Having the Korn shell with job control makes complex Unix sessions almost as

SCO Unix 3.2 version 2.0

Company

The Santa Cruz Operation
400 Encinal St.
Santa Cruz, CA 95061
(408) 425-7222

Hardware Needed

386- or i486-based PC with at least 2 MB of memory (3 MB or more recommended) and 40 MB of free hard disk space

Price

Single-user: \$595
Multiuser: \$895
Update: \$95-\$150

Inquiry 1062.

Interactive Unix 2.2

Company

Interactive Systems Corp.
2401 Colorado Ave.
Santa Monica, CA 90404
(213) 453-8649

Hardware Needed

386- or i486-based PC with at least 4 MB of memory and 40 MB of free hard disk space

Price

Single-user: \$495
Multiuser: \$795
Update: \$100

Inquiry 1063.



Interactive
Unix has one of the best
installation procedures
we've seen. The process
is managed by a full-
screen color program
that walks new users
through every step.

easy as running in an X environment, though not quite as scenic. Job control is not supported for the C shell in SCO Unix, even though it is in Unix V.4 and ISC Unix 2.2.

Other significant elements of SCO Unix 3.2 version 2.0 include a way to make shared library operations of non-SCO Unix systems work with SCO Unix, as well as support for High-Sierra and ISO9660 CD-ROM drives. There are numerous enhancements to SCO's already serious "trusted system" implementation. The vi, sh, and mail utilities have been "internationalized," and they now handle 8-bit characters. (The 2-byte-character internationalization of strings is still not a standard part of any Unix system.) This new version also includes more POSIX 1003.1 features, including pax.

SCO and Microsoft (the trademark holder of Xenix) have influenced what is included in AT&T's V.4. And, despite its effort to *be* Unix, SCO tends to put more energy into adding value to Unix than into following the standard path. The company has publicly stated that it has not made plans to adopt AT&T's V.4, but this doesn't mean that SCO isn't going to continue to implement what it thinks are the operating system's best features. ■

Ben Smith and Tom Yager are technical editors who run the BYTE Unix Lab. You can contact them on BIX as "bensmith" and "tyager," respectively.

Word is getting around.

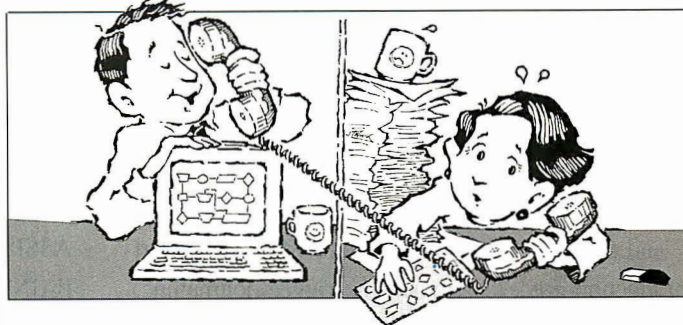

The news is spreading fast!

Our 80,000 ecstatic customers are telling their friends about how much time they save on flowcharts and data flow diagrams.

EasyFlow, unlike most "screen draw" programs, is dedicated to fast composition and modification of flowcharts and data flow diagrams.

They're spreading the news about the automatic line routing, automatic text centering and the slick cut & paste.

They say you can create charts and then cleanly move them into a desktop publishing program.

EasyFlow works with most matrix printers, laser printers and plotters and comes with a 200 page manual. They say you get all this plus 350 context sensitive help messages on screen for only \$149.95 and RUSH delivery is available.

They're telling their friends but not their bosses. Their bosses think they had to sweat bullets to come up with these amazing results. You mean you still do?!

With 80,000 customers talking, it's amazing that you haven't heard. Give us a call and find out for yourself what everyone else is talking about! Then call a few friends and tell them about the wonders of **EasyFlow**.



Flowcharting Made Easy!

HavenTree Software Limited

P.O. Box 1093 - A Thousand Island Park, NY 13692

Order Desk: 1-800-267-0668

Info: (613) 544-6035 ext.80 Fax: (613) 544-9632

From our fax to yours... Info Fax: (613) 544-2049

The Recital Database Score.

More than dBASE...

NO UNFINISHED SYMPHONY HERE.

Not only does Recital fully support the dBASE family of languages, (dBASE III, IV, FoxBASE and Clipper) but it continues with what these products left unfinished. For starters, it offers over 500 extensions, a revolutionary applications data dictionary, and powerful user interface support. And support for production-grade features such as triggers, journaling, rollback and data recovery.

There's nothing unfinished about Recital.

More than ORACLE...

SIMILAR MUSIC BUT MUCH EASIER TO PLAY.

Oracle offers many of the sophisticated features and performance of Recital, but Recital is much more approachable. Recital is more than advanced new technology. It offers not only a 4GL but a fully integrated fourth-generation environment. For developers and end-users alike. Powerful application tools and a friendly interface to SQL-based data are combined with multi-architecture compatibility and a client server architecture for reading and updating data in external databases.

Great music but not hard to play at all.

Available for:
VAX/VMS, ULTRIX
INTERACTIVE UNIX
SCO UNIX, SCO XENIX
AT&T UNIX ... and other
popular UNIX
systems.

dBASE III, III+, IV are registered trademarks of Ashton-Tate Corporation. INFORMIX is a registered trademark of INFORMIX Corporation. FoxBASE is a registered trademark of Fox Software. Clipper is a trademark of Nantucket Corporation.

More than INFORMIX...

NOT A 78 rpm SECOND GENERATION PRODUCT.

Recital is a sophisticated, highly visual, high performance application development system. Recital provides comprehensive object-oriented development tools such as ADVANCED ASSISTANT, SCREEN PAINTER, REPORT WRITER, advanced security features and integrated PC-like "Pop-up" utilities. High quality, highly-polished applications couldn't be easier.
Compatible and new technology.

Recital - Complete Data Orchestration.

ONLY RECITAL OFFERS COMPLETE AND COMPATIBLE DATA ORCHESTRATION IN EVERY DIMENSION.

Convenient utilities will migrate your existing dBASE, Clipper or FoxBASE applications. Recital's rich and powerful fourth-generation environment makes short work of creating new applications complete with modern, sophisticated user interfaces. But at the same time, Recital offers high end, integrated database support across a broad array of system architectures. Over 40 different workstation, multi-user and networking platforms are supported.

For your own Recital audition call 508-750-1066 in the U.S., or 071-401-2727 in the UK.

Recital

Recital Corporation, Inc.
85 Constitution Lane, Danvers, MA 01923 USA
Recital Corporation Limited
South Bank Technopark
90 London Road, London SE1 6LN, UK

Circle 264 on Reader Service Card (RESELLERS: 265)

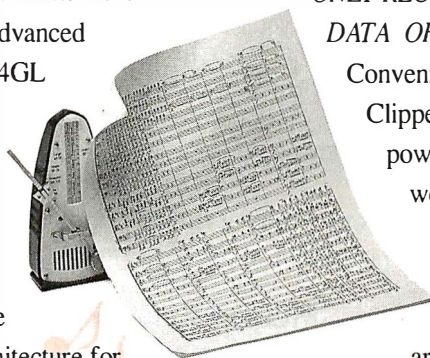

REVIEW

Microsoft Word Brings PC-Style Word Processing to Unix

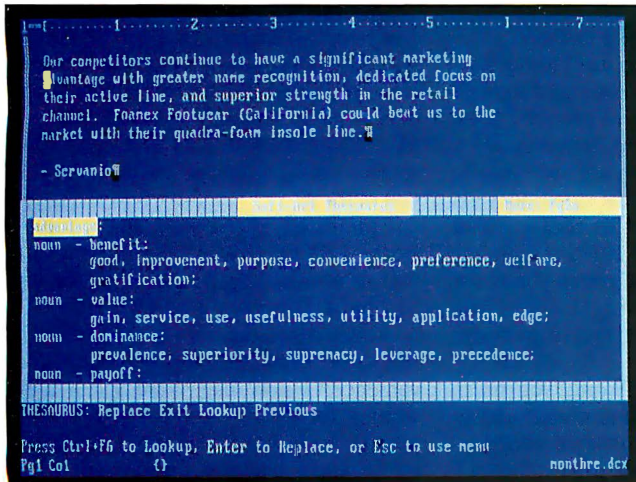

Microsoft Word for Unix looks and acts just like Word for DOS.

If you are a seasoned Unix user, you might wince at the thought of a PC program cluttering up your "serious" Unix computer. The Unix vi or emacs editor (with a little nroff or troff formatting code) is all you think you will ever need (or want). If this is your attitude, classify yourself a bigot. Open your eyes, and widen your view. Microsoft Word is a word processing (and nearly a desktop publishing) program, not a

text editor. There's a world of difference.

I'm not saying that there aren't some tried-and-true Unix word processing programs around, but I assure you that you wouldn't want to compare them to Microsoft Word, arguably the most popular multiplatform word processing program. On the other hand, there are some real gotchas in having a personal computer program on Unix—a multiuser, multitasking operating system with a rich history and set of traditions.

Full-Featured Word Processing

Shrink-wrapped Unix applications are a goal of The Santa Cruz Operation. It is its packaging of Microsoft Word 5.0 that makes this a reality. As with any SCO-supported package, installation requires little more expertise than being able to find the floppy disk drive and knowing which way to insert the four disks. You do need to know what kind of printer you have.

Microsoft Word's massive functionality is delivered in an easy-to-use style. Users at all levels will find it appropriate for writing the most complex as well as the simplest text files, memos, and even programs. If you wish, you can save your files as plain text files without any embedded formatting information. You can read and write to PC Microsoft Word files, allowing seamless interchange of files among the Unix, Macintosh, Windows, and DOS versions.

Word provides you with on-line help,

multicolumn page layout, style sheets, graphics importing, printer-font loading, mail merge, redlining, optional postponement of editing changes, hidden text, and sorting. (Take a breath here. . . .) There's also index generation, outline generation and expansion, spreadsheet links, an interactive spelling checker and thesaurus, a built-in calculator that you can apply to columns of numbers in your text, a macro-language processor that you can prime with captured keystrokes, document management across multiple directories, and multiple windows on the same file or across separate files.

Simple Escape-key sequences invoke most commands, but all are mapped to function keys and Alt keys for people who like to let their fingers jump all around the keyboard. But any Microsoft Word user is used to all these features.

What is different is that this is a Unix application. Unix is very different from the MS-DOS, Microsoft Windows, and Macintosh environments. First, Unix is a multiuser operating system, meaning that there has to be a way to prevent more than one person from editing the same file at the same time; Word has file locking. Each user must be able to have his or her own Word options environment; there is an `mw.ini` configuration file in each user's home directory, and a master file in Word's library directory.

Unix application programs can make no assumptions about the user's display and keyboard. Unlike MS-DOS, the display isn't limited to one of a predictable set. With Unix, there are as many different displays as there are different printers.

SCO has this problem pegged. If you are working at the console, the fit is flawless. Every function key, cursor motion, and Alt-key combination is identical to what you find on the PC version of Microsoft Word. Where there is a conflict (e.g., SCO Unix uses an Alt/function-key combination to switch between virtual terminals), standard Word key combinations are given precedence, but an alternate is given to the conflicting combination (in this case Control-Alt-function key).

More amazingly, Word works as well on terminals as on the console; even the function keys and Alt keys are consistent. Word's method of selecting text (without a mouse) is Shift-arrow key. Although far from a common combination on character terminals, even this is implemented.

With SCO's Microsoft Word for Unix you also get manuals, installation notes,

Microsoft Word 5.0 for Unix



Company

The Santa Cruz Operation, Inc.
400 Encinal St.
P.O. Box 1900
Santa Cruz, CA 95061
(408) 425-7222

Hardware Needed

Computer running AT&T Unix 386 release 3.2 or higher (including SCO, Interactive, and other AT&T derivatives) and 3.8 MB of disk space, assuming one printer, 1.5 MB of memory for first user, and 500K bytes for each additional user. Versions also available for many AT&T computers.

Price

Unlimited number of users: \$995

Inquiry 1005.

and other goodies (e.g., keyboard templates) that are as good as what you get with the MS-DOS version of Word. You also have excellent (though not always timely) support from SCO where the technicians not only know Word, but are also experienced with Unix.

What You Don't Get

DOS users may be disappointed to find that the Learning Word program is missing. Similarly, the preview function, which lets you see your page layout before printing, isn't there. You also don't get mouse support or on-screen fonts.

On the Unix side, there isn't much integration with the Unix shell and utilities (a feature of emacs-type editors). Word doesn't follow many of the Unix traditions, such as naming the initialization file something like `.mswrc` so it doesn't clutter up your home directory listing. You can get around this by changing an environment variable.

You may also need to edit the `termcap` file (a description of terminals' attributes) to get Word to use color and different text modes (e.g., italic, bold, and underline). All these deficiencies are really minor when you put them up against what you *do* get. What is surprising is that this is not implemented as an Open Desktop application. Open Desktop is SCO's shrink-wrap Unix workstation software. It is basically an X Window System/Motif environment with bundled applications: networking, virtual MS-DOS machine, and DBMS.

What is lacking in Open Desktop is the rest of the office-automation soft-

ware, primarily a word processor. What is lacking in Microsoft Word for Unix is a way to use the mouse and to display fonts, features that Open Desktop offers through Motif and X Window.

Who Is It For?

Microsoft Word for Unix is for those 386 Unix users who want an easy-to-learn and feature-loaded word processor.

I should add "easy to use" to the list. For instance, to save a file and quit with WordPerfect, you need to press F7 (better have your keyboard template or a good memory) and then a Y (for yes) to save the document. If the document already exists, you need to confirm that you want to replace the existing file: another yes. This has only gotten you to the point of saving and closing that file. You still have to tell WordPerfect to go away: *another* yes.

But with Microsoft Word, you press Escape (for the command menu) and Q (for quit). If you have unsaved changes, Word will ask if you want to save them (Y for yes), but that is the only step that may come between you and returning to the Unix shell. Much simpler, and there is no magic key to remember.

Now, compare Microsoft Word with the Unix `vi` editor. To cut and paste a block of text with `vi`, you must move to the top of the block and place a mark with a command like `mt`. You then move to the bottom of the block and yank the block to the unnamed buffer; the command is `y't`. Now move to the new position and "put" the buffer in with the command `p`. This amounts to six key presses for `vi`

(not counting moving the cursor to the new point and problems with working with blocks that are only lines).

With Microsoft Word, you position yourself at the beginning of the block and then hold the Shift key while you move to the end of the block. Having marked the block, you press either Escape and then C (for the command menu method for Copy—a two-key-press operation) or the Alt-F3 combination (1½ keystrokes). Now you move to the new location and press the Insert key (one keystroke). Microsoft Word wins with 3½ keystrokes; plus, you can see the block as you mark it.

I prefer an emacs-style editor for my work at BYTE (I won't go into the rigamarole for copying blocks with emacs). My book publisher's editors, however, do all their editing with (you guessed it) Microsoft Word. So, for the sake of convenience, I now use Word when I am writing for them. I don't have any complaints. In fact, I found Word much easier to learn and use than WordPerfect (Word's biggest competitor).

If you are already well established using Unix editors and formatting programs, you probably won't be drawn to Word until it has better support for the Unix and/or X environment. But if you are running Unix on a 386 or 486 computer and want a real word processor, Microsoft Word is an excellent choice. ■

Ben Smith is a BYTE technical editor and author of Unix Step By Step (Howard Sams, 1990). He can be reached on BIX as "bensmith."

Avoid screen building headaches with SMP

Screen Manager Professional, the advanced interface design library for C programmers, gives your applications:

- Windows
- Menus
- Mouse Support
- Keyboard Support
- Context Sensitive Help
- Low RAM Overhead / High Speed

To order SMP call: : Magee Enterprises, Inc. 1-800-662-4330
 Demo Available: 404-446-0271
 BBS: 404-446-6650

For 4 to 64 ports, we have your PC connection.

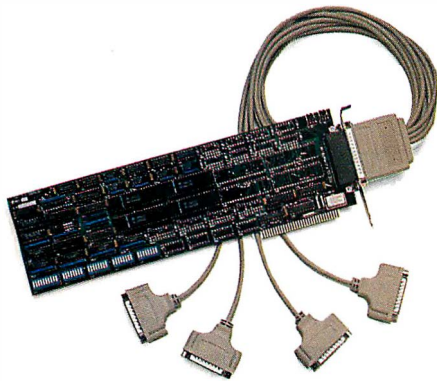

DigiCHANNEL PC/X. 4, 8 or 16 asynchronous RS-232 channels. Ideal for applications that don't require on-board processing.

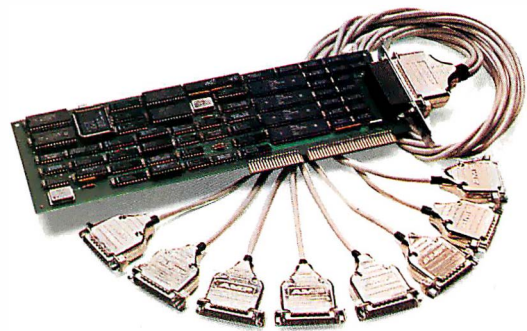

DigiCHANNEL PC/Xe. 4, 8 or 16 asynchronous channels. 8 MHz 80186 processor. 64K RAM. Unbeatable performance for terminal applications in multiuser environments.

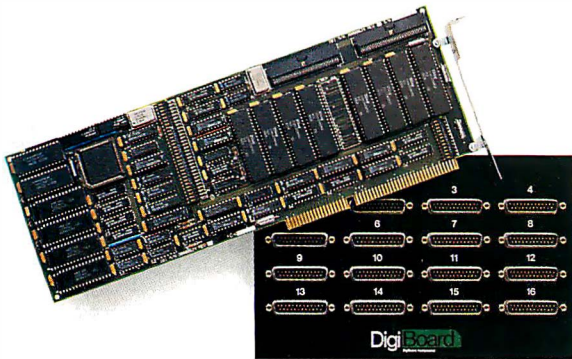

DigiCHANNEL PC/Xi. 8 or 16 asynchronous channels. 12.5 or 16 MHz 80186 processor. 128K or 512K RAM. Synchronous channel option. For multichannel applications that demand speed, configuration flexibility and programmability.

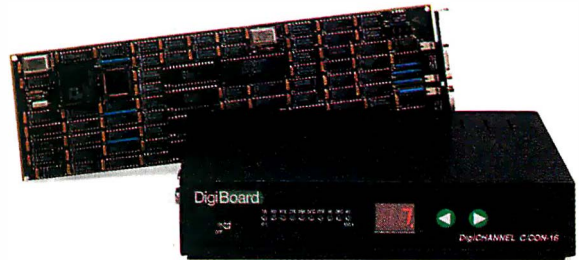

DigiCHANNEL C/X System. Connects up to 64 users to the Host Adapter Card via up to 4 intelligent DigiCHANNEL C/CON-16 concentrator boxes. Provides 38.4KB performance for all 64 users.

Increase your PC system's connectivity with DigiCHANNEL. Industry tests prove that DigiCHANNEL boards are unsurpassed in performance and reliability, whatever your operating

system, from AIX to XENIX. And whatever your platform; ISA, Micro Channel, EISA or NuBus. So call today. Ask about our 30-Day No-Risk Trial Offer.

DigiBoard
Connectivity Solutions from Digi International

6751 Oxford Street, Minneapolis, MN 55426 • 800-344-4273 • MN, 612-922-8055

CompUSA

Name-brand PC's, Peripherals and Software at Guaranteed Lowest Prices!

To Order Call 1-800-932-COMP or Fax (214) 702-0300

COMPU DYNE 286-16



80286, 16MHz
0 wait state
1 MB RAM
1.2 MB 5 1/4" Drive
IDE HD controller
8 expansion slots
\$489

12" Amber 750 x 350 14" VGA Color .41 dp 640x480

40MB 28ms	\$859	\$1079
71MB 28ms	\$949	\$1169
89MB 19ms	\$999	\$1239
124MB 19ms	\$1059	\$1279

Video Card Included!

Leading TECHNOLOGY 6800SX



80386SX, 16MHz
0 wait state
1 MB RAM
1.2 MB 5 1/4" Drive
IDE HD controller
DOS 4.01
\$799

12" Amber 750 x 350 14" VGA Color .41 dp 640x480

40MB 28ms	\$949	\$1289
71MB 28ms	\$1049	\$1379
89MB 19ms	\$1219	\$1449
124MB 19ms	\$1249	\$1489

Video Card Included!

COMPU DYNE 386-25C



80386, 25MHz
0 wait state
1 MB RAM
1.2 MB 5 1/4" Drive
IDE HD controller
8 expansion slots
\$1239

14" VGA Mono .41 dp 640x480 14" VGAColor .31 dp 800x600

40MB 28ms	\$1689	\$1829
71MB 28ms	\$1849	\$1989
89MB 19ms	\$1889	\$2029
124MB 19ms	\$2279	\$2419

Video Card Included!

Laptops

Arima ACT 286-410



12MHz 80C286
VGA display
Keybd detaches
40MB 27 ms HD
1.44 MB floppy
\$1899

- Toshiba T1000SE \$1999
- Toshiba T1200XE \$1999
- Toshiba T3100SX \$3779
- Megahertz T224
2400bps modem \$129
- PacRim 1.2MB ext. drive \$159

Monitors



Leading TECHNOLOGY 1451V
VGA Color
640x480 res.
.41 dot pitch
\$245

- Leading Tech 12" Mono \$69
- NEC Multisync 2A VGA \$459
- CompuDyne 14/800V \$299
- CompuDyne 14/1024V \$349
- Sony 1304 VGA 1024 x 768 \$649

Storage Devices

Seagate ST157A



40MB 28 ms HD
complete with
IDE controller
3 1/2" drive
\$255

Hard Drives

- Seagate ST225 20MB
w/controller \$228
- Seagate ST238R 30MB
w/controller \$239
- Seagate ST1102A 89MB \$489
- Seagate ST1144A124MB \$569
- Seagate ST1239A 211MB \$889
- Toshiba MK134 65MB \$313
- Toshiba MK156 150MB \$839
- Micropolis 1578-15 330MB \$1439
- Plus Development
40MB Hardcard II \$379

Floppy Drives

- Toshiba 5 1/4" 1.2MB \$62
- Sony 3 1/2" 1720K \$55
- Sony 3 1/2" 1.44MB \$62
- Pacific Rim 5 1/4" ext. \$199

Tape Backups

- CompuDyne 60MB Int \$229
- CompuDyne 120MB Int. \$319

Miscellaneous

I/O Boards

- Suntek I/O Extension
AT Parallel/ Serial \$33

Memory Boards

- STB Rapidmeg AT OK \$159

Math Co-Processors

- Intel 80287-8 \$189
- Intel 80387SX \$285
- Intel 80387-20 \$365
- Intel 80387-25 \$459

Accessories



C9 Mouse



Serial Mouse
with Paint
software
\$62

- Genius Dynamouse 6000 \$29
- Microsoft Serial Mouse \$84
- Microsoft Mouse
w/ Windows 3.0 \$145
- Kraft KClIII Joysticks \$14
- CH GameCard \$33
- Logitech ScanMan+ \$165

Software

Over 500 titles, including:
Windows 3.0



Newest version of
Microsoft
Windows
\$85

- Microsoft Word 5.0 \$199
- PFS: Professional Write 2.2
w/Professional File \$139
- WordPerfect 5.1 \$245
- Lotus 1-2-3 2.2 \$319
- Lotus Works 1.0 \$99
- Microsoft Excel
for Windows 2.1d \$298
- Microsoft PC Works 2.0 \$88
- Quattro Pro 1.1 \$299
- Freelance + 3.01 \$299
- Harvard Graphics 2.3 \$269
- PageMaker 3.01 \$479
- Ventura Pub. 3.0 / Windows .. \$499
- DAC Accounting 4.1 \$76
- Quicken 4.0 \$35
- Wealthbuilder \$131
- Q & A Version 3.0 \$214
- Microsoft QuickBasic \$59
- Turbo C++ \$125
- Check It 3.0 \$78
- DesqView 386 2.3 \$109
- Direct Access 5.0 \$52
- Norton Utilities 5.0 \$109
- PC Tools 6.0 \$79
- QEMM 386 5.1 \$52
- Sideways 3.3 \$35
- WinSleuth \$69
- Carbon Copy+ 5.2 \$107
- PC Anywhere IV \$89
- Procomm Plus 1.1B \$52
- Prodigy 3.1 \$23
- Chessmaster 2100 \$29
- F-19 Stealth Fighter \$38
- Falcon AT \$29
- Leisure Suit Larry \$22
- PC Globe + \$35
- Populous \$29
- SimCity \$28
- Where in Time is
Carmen Sandiego? \$27

Graphics Cards

ATI Basic VGA/16



16 Bit VGA
640x480, 16 color
Switchless install
\$75

- CompuDyne VGA 800
640 x 480 \$69
- CompuDyne VGA 1024
1024 x 768 \$99
- ATVGAWonder256
1024 x 768 \$179
- Leading Tech MGP Mono \$24
- Leading Tech CGA Color \$25

Printers

NEC P2200XE

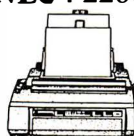

24 Pin printer
80 column
192 cps draft
64 cps NLQ
Part#431513
\$245

- Epson 810 9-pin \$169
- Epson LQ510 24-Pin \$275
- Panasonic KX-P1180 \$158
- Panasonic KX-P1624 \$399
- Panasonic KX-P4420 laser \$829
- TI microLaser PS17 \$1549

Modems

COMPU DYNE 2400i



2400 baud
Internal modem
Viscom software
\$59

- ATI 2400i w/MNP5 \$145
- CompuDyne ext.2400 \$69
- Complete Fax 4800 \$139
- Complete Answering Machine \$219
- Complete Communicator \$389

Sony Diskettes

Stock up in boxes of 10!

- 5 1/4" DS/DD \$4⁹⁹
- 5 1/4" DS/HD \$8⁷⁹
- 3 1/2" DS/DD \$7⁴⁹
- 3 1/2" DS/HD \$13⁹⁹

Switches, Surges

- 2-pos ser. switch \$7.99
- 6-outlet EMI/RFI
Surge w/6'cord \$6.99
- 6-outlet EMI/Modem
Surge w/6'cord \$8.99

Cables

- IBM Parallel Printer Cables
6 foot \$2.29
- Modem Cables
6 ft. 9-25 pin AT \$1.99

CompUSA, Inc.
15151A Surveyor
Addison, TX 75244
1-800-932-COMP
Hours of operation (CST):
Monday - Friday 8am - 7pm
Saturday 9am - 4pm

Guaranteed Satisfaction!

If you find a current lower advertised price in this magazine, we will beat that price, guaranteed!

No-Questions-asked 30-day money back guarantee on hardware. Money back guarantee does not include shipping.

All returns must be in "as new" condition, w/ original packaging, w/o modifications or damage. Returns must have an RMA (Return Merchandise Authorization) Number.

Defective Software exchanged for same item only.
Defective hardware will be repaired or replaced

at CompUSA's discretion.

Most orders placed before 2pm Central Time will be shipped same day.
COD, Visa, Mastercard, Discover, Checks and Cashier Checks accepted
Texas residents add sales tax.
Add 3% freight charges - minimum \$5/order

Orders shipped UPS Ground - call for overnight freight charges.

Not responsible for typographical errors, errors in photography, or errors of omission.
Prices and availability subject to change.
Due to changing market conditions, call us toll free for current pricing and availability.

REVIEW

Plug-and-Play Unix Machine

The Dell Station 425E is a turnkey Unix system that Dell hopes will snare PC system users who are migrating to Unix. Built around the company's 486/25E Extended Industry Standard Architecture (EISA) system, the Dell Station bundle includes Unix and applications software that together form a powerful integrated system. Dell clearly designed the 425E with first-time Unix users in mind, and the success of this design distinguishes the 425E from its competition.

The Dell Station's \$9687 base price looks steep until you consider what it buys. On the hardware end, the workstation is a 25-MHz 486 EISA computer with 8 megabytes of RAM, a 5¼-inch 1.2-MB or 3½-inch 1.4-MB floppy disk drive, a 15-millisecond, 100-MB Intelligent Drive Electronics (IDE) hard disk drive, and a 150-MB quarter-inch cartridge tape drive. The system also includes a Dell Super VGA color graphics adapter and an 800- by 600-pixel color monitor, a serial mouse, and an IBM Enhanced 101-key keyboard.

For software, the 425E includes a Dell-licensed version of Interactive Systems' Unix System V 3.2, the X Window System, an easy-to-use X.Desktop icon file manager environment, MS-DOS emulation, and a full suite of Uniplex Advanced Office System applications running in the X.Desktop environment. TCP/IP and Network File System software are optional.

Dell installs the operating system and applications software on the hard disk drive, so all you have to do is connect the system components and turn on the power. An easy-to-follow installation routine then takes you through the steps of setting the date and time, initializing user accounts, and making passwords for the administrative accounts.

Inside the Station

The Dell Station fits in a full-size IBM AT-type case. The components are laid out with three half-height bays on the right side, with two half-height bays beside them. My review system had high-density 5¼-inch and 3½-inch floppy disk drives in the top two right-hand bays and the tape drive in the bottom right-hand bay. Instead of the standard 100-MB IDE hard disk drive, the review system had an optional Micropolis 330-MB ESDI hard disk drive. The unit also in-



The Dell Station 425E turnkey system smooths the road for new Unix users. Bundled software includes X.Desktop and the Uniplex II Plus Advanced Office System software.

cluded an extra floppy disk drive, which brought the total price to \$10,725.

The computer has six EISA slots and two 16-bit ISA slots. The ESDI hard disk drive controller card and VGA color graphics adapter occupied the two 16-bit slots in my test machine, and two of the 32-bit slots held 16-bit Ethernet and tape controller cards. The motherboard accepts up to eight 1- or 2-MB single inline memory modules, for a maximum of 16 MB of 80-nanosecond RAM.

The Super VGA graphics adapter and color monitor provide adequate detail for the icons and graphics on the X.Desktop interface, but Dell should have included a higher-resolution graphics option. The Interactive X port that Dell used as the basis for the operating system includes drivers for 8514 graphics as well as for hardware graphics accelerators.

The motherboard integrates two serial ports and one parallel port. The Dell mouse (which is made by Logitech) plugs into one of the serial ports. For multiuser configurations, Dell furnishes serial port expansion boards to support

up to 32 remote terminals over asynchronous lines.

The Dell Station's cooling fan is one of the noisiest that I have come across in years. I had the system set up about 6 inches from a wall, which may have enhanced the sound, but you could tell when the computer was turned on from anywhere in the house.

Big Software Bundle

Dell Unix System V release 1.1 is a licensed version of Interactive Systems' 386/ix release 2.0.2, which is an implementation of AT&T Unix System V 3.2. Dell has enhanced it to include new X drivers, an on-line manual, and several other features. The company has taken great pains to relieve the average user of ever having to deal with the nitty-gritty of Unix.

The Dell Station 425E is designed to make it easy for non-Unix users to get started. You never have to learn the intricacies of `grep`, `awk`, or `sed`. The menu-driven `sysadm` program makes mundane system management relatively effortless.

continued

NO NOISE improves PC working environments.

NO NOISE removes the constant humming noise which is a daily irritation to PC operators.

It's not that the noise is high — it's more a matter of its constantly being there, from the moment you start up in the morning and until the office closes.

Constantly — for hours on end — day in and day out.

This noise comes from the PC's cooling fan.

The cooling fan is designed and constructed to function in air temperatures all the way up to 110°-120° F. It always runs at maximum speed. This is where the constant noise arises.

In our part of the world, we no longer need to put up with this irritating noise — thanks to NO NOISE.

How to stop the noise.

NO NOISE gradually reduces the speed of the fan until it corresponds with the surrounding temperature and your PC's cooling requirement. The fan is practically soundless at temperatures from 70°-90° F.

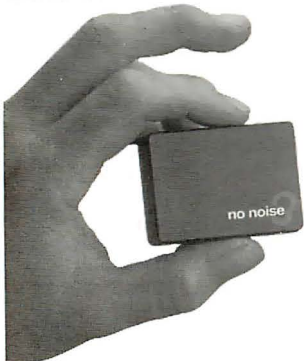

Built-in safety

If a fault should occur, a built-in safety circuit in the NO NOISE automatically ensures that the fan converts to maximum performance. This ensures the necessary ventilation/cooling under all conditions.

NO NOISE suits all PC models.

Thousands of units are already in use worldwide by computer manufacturers, major corporations and individual users, who realise that excessive noise in the work environment can lead to fatigue and stress, ultimately affecting performance and productivity.

NO NOISE is extremely simple to install; your customary PC dealer can provide you with further details and provide this service if required. NO NOISE comes with a five-year warranty and a 30-day trial.

WHAT THE REVIEWS SAY

"...it worked perfectly...noise level was dramatically reduced."

PERSONAL COMPUTER WORLD, U.K.

"...NO NOISE worked exactly as advertised, reducing fan noise to nil."

BYTE, International Section, February 1990

NO NOISE USA—NO NOISE UK—NO NOISE SWEDEN—NO NOISE AUSTRIA—NO NOISE NETHERLANDS—NO NOISE GREECE—NO NOISE AUSTRALIA



ORDER NO NOISE NOW at \$99.95 by calling 1-800-SILENCE (1-800-745-3623)

or contact your local dealer. We accept MC/VISA, P.O.s, Cashier and Personal Cheques. Please add \$4.95 for shipping and handling. All FL deliveries add 6% sales tax. VARS Dealers and OEMs call (407) 220-0100.

NO NOISE Inc., 3601 SE Ocean Blvd., Sewall's Point, Stuart, Florida 34996. Tel: (407) 220-0100 Fax: (407) 220-0101

©NO NOISE 1990

REVIEW

PLUG-AND-PLAY UNIX MACHINE



Dell Station 425E

Company

Dell Computer Corp.
9505 Arboretum Blvd.
Austin, TX 78759
(800) 274-3355

Components (as reviewed)

Processor: 25-MHz Intel i486; socket for Weitek 4167 math coprocessor

Memory: 8 MB of SIMM RAM

Mass storage: High-density 5¼-inch and 3½-inch floppy disk drives; 330-MB ESDI hard disk drive; 150-MB internal cartridge tape drive

Display: 14-inch Dell VGA color monitor; 800- by 600-pixel Dell Super VGA adapter

Keyboard: 101-key IBM Enhanced layout

I/O interfaces: Two serial ports; one parallel port; one thin Ethernet port

Software

Dell Unix System V 3.2 with the X Window System, X.Desktop interface, OSF/Motif window manager, VP/ix, Uniplex II Plus Advanced Office System version 7, Uniplex Advanced Graphics System, and Uniplex Windows

Price

\$10,725

Inquiry 1108.

Another difficulty of making Unix a viable operating system for naive or inexperienced users has been the absence of application programs that have a uniform interface. The Uniplex suite of business applications goes a long way toward overcoming this difficulty. Uniplex's software tools include a word processor, a spreadsheet, a database (Informix), presentation graphics, an appointment calendar, an E-mail system, and several other utility programs. All these programs present you with the same general interface so that you have to learn only one basic set of keyboard and mouse actions.

GUI and Text Interfaces

The Dell Station offers two graphical user interfaces and a text-oriented user interface. When setting up a new user account, the system administrator has the option of making that user's interface either a standard X GUI running an xterm window and xclock, or a special X environment with the OSF/Motif window manager running X.Desktop and Uniplex. The latter is totally window- and icon-based and lets you perform nor-

mal operations such as changing directories, opening applications, viewing text files, and deleting files using the mouse. When you need to get into a Unix shell, you need only click on the desktop area to open a shell window. You can access three text-oriented, full-size Unix screens for use as standard log-in sessions. One of these screens is the logical Unix console that displays system messages.

The MS-DOS Connection

Dell uses Interactive's VP/ix to support MS-DOS applications. You can run DOS applications in two environments. While you're in the X.Desktop environment, you can open a monochrome, text-only DOS window, or switch to a different terminal session (by simultaneously holding down the Control, Alt, and Sysrq keys and pressing either F1, F2, or F8) to use a full-screen window. After you log in, you can type run VP/ix to start a full-screen DOS window with complete enhanced VGA support for graphics or text. You can switch back to the original X screen any time you like by simply holding down Control, Alt, and Sysrq and then pressing F3.

Running an MS-DOS session in a full-size VGA window offers excellent software compatibility. I ran Flight Simulator (to stress-test graphics compatibility), WordPerfect 5.0, and Procomm, and I didn't experience any problems. You can run as many as three separate full-screen MS-DOS sessions and switch among them.

The first DOS session that you start or DOS window that you open has control of the floppy disk drive (or drives). If you want to access the drive from another window or terminal, the original DOS session must release the device.

MS-DOS can access and use Unix files, but DOS users must have at least Unix read access to those files. Unix filenames that are illegal under DOS are parsed to unique DOS filenames when listed with the DOS dir command. Also, the DOS copy command has switches to convert between Unix and DOS ASCII text files. (MS-DOS gives each line both carriage-return and linefeed characters; Unix, on the other hand, uses only a linefeed.)

But Does It Perform?

If you're accustomed to working on a computer with a windows-based interface, you'll be impressed with the Dell Station's performance. When you click on a window that's partially covered by other windows, it snaps to the top of the

Is Windows 3.0 the end of DESQview?

Not if you're still using DOS programs.

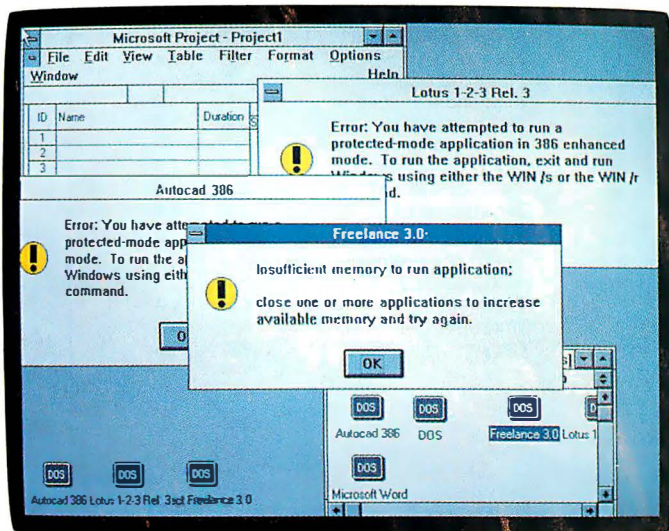

Windows 3.0. The multitasking, windowing environment.

Are you still using MS-DOS programs on your PC?

You may want to use DESQview as your primary operating environment.

The new DESQview 2.3 and DESQview 386 2.3 let you use your favorite DOS and DOS-extended programs in windows side-by-side on 80286, 80386 and i486 PCs. As you can see above, you can even run Windows programs

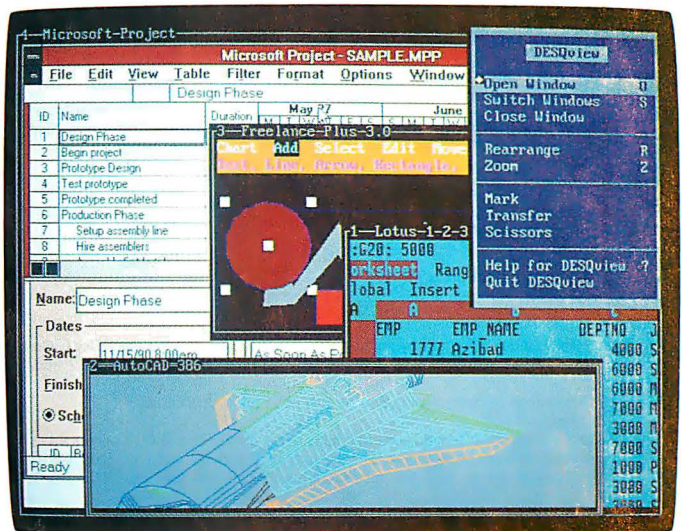

DESQview 386 2.3. The multitasking, windowing environment.

within DESQview 386. So the next time you get error messages like the ones at the left in Windows, remember how the same set of programs look running in DESQview.

Whatever standard you use—DOS, extended DOS or Windows—DESQview is still the best way to get the most out of the hardware and software you own today.

DESQview. The obvious choice.



Quarterdeck Office Systems, 150 Pico Boulevard, Santa Monica, CA 90405 (213) 392-9851 Fax: (213) 399-3802

This comparison was made using a system like the one you might run: Both shots show an ALR FlexCache 33/386 running DOS 3.3 with VGA display adaptor, Novell NetWare v3.01 Rev. A, with IPX/SPX v3.01 Rev. A, Microsoft Mouse 7.00, and Microsoft SMARTDrive v3.03 disk cache. Buffers were set to 20. For the Windows screen, we ran Microsoft Windows 3 HIMEM.SYS and EMM386.SYS. For the DESQview screen, we ran QEMM 386 v5.1.

Trademarks: Microsoft, Windows, MS-DOS, 80386, i486, ALR, FlexCache, Novell, NetWare. ©1990 Quarterdeck Office Systems

Circle 252 on Reader Service Card



UNIX BENCHMARKS

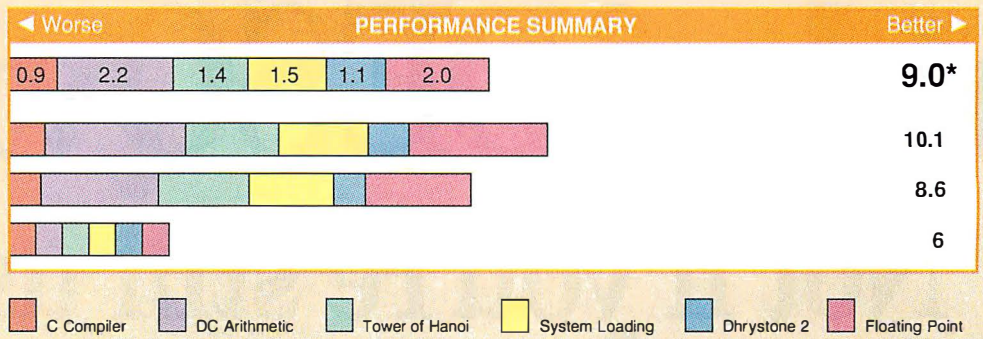

HIGH-LEVEL PERFORMANCE

	Time	Index
C Compiler	2.3	0.9
DC Arithmetic	0.3	2.2
Tower of Hanoi (17-disk problem)	0.4	1.4
System Loading¹		
1 concurrent background process	3.2	1.3
2 concurrent background processes	4.2	1.4
4 concurrent background processes	6.8	1.4
8 concurrent background processes	11.6	1.5

LOW-LEVEL PERFORMANCE

	Time	Index		Time	Index
Dhrystone 2 (without registers; Dhry./sec.)	15625	1.1	Throughput		
Arithmetic (10,000 iterations)			System call overhead (5 x 4000 calls)	0.8	1.4
Arithmetic overhead	0.2	3.6	Pipe throughput (read and write 2048- x (512-byte blocks))	0.8	1.2
Register	3.1	0.9	Pipe-based context switching (2 x 500 switches)	0.6	1.0
Short	3.8	0.9	Process creation (100 forks)	0.5	2.3
Integer	3.1	1.0	Excel throughput (100 execs)	1.2	2.8
Long	3.1	1.0	Filesystem throughput (1600 1024-byte blocks in Kbytes/sec.)		
Floating Point			Read	648	N/A
Double	6.1	2.0	Write	364	N/A
	6.3	2.1	Copy	236	N/A

* Cumulative index is formed by summing the indexed performance results for C Compiler, DC Arithmetic, Tower of Hanoi, System Loading (with 8 concurrent background processes), Dhrystone 2, and Floating Point tests.

¹ System loading performed using Bourne shell scripts and Unix utilities.

Note: All times are in seconds unless otherwise specified. Figures were generated using the BYTE Unix benchmarks version 2.6. Indexes show relative performance; for all indexes, an Everex Step 386/33 running Xenix 2.3.1 = 1. N/A = Not applicable. For a description of all the benchmarks, see "The BYTE Unix Benchmarks," March BYTE.

stack instantly. When you drag or resize a window, it pops into its new size or location without hesitation. This instant visual feedback adds greatly to the qualitative feeling of working with a high-performance computer. However, the speed is at least partially due to the fact that the Dell Station has to manage only a 4-bit color plane with 800- by 600-pixel resolution.

Overall, the Dell Station scored well against other i486-based machines that the BYTE Lab has tested. The Dell outperformed the Tangent Model 425 and Compaq Deskpro 486/25, and it ranked just behind the 33-MHz AST Research Premium 486/33 overall (for more on the comparison systems, see "486 EISA Machines: A Slow Start in the Fast Lane," October BYTE, and "High-Performance 486 ATs," November BYTE). The Dell Station's one weak point was its floating-point test scores, but it outperformed all

three of its competitors on the Dhrystone 2 tests. And none of the comparison machines can compete in terms of price when you consider the Dell Station's bundled software.

A PC in a Unix World

In a world of RISC workstations, the Dell Station bucks the trend by combining a state-of-the-art CISC-based hardware platform with its Unix. Dell has used this platform to run an X-based version of Unix that makes the system as user-friendly as possible. To that extent, Dell has succeeded, although some users may be disappointed with the graphics subsystem.

Considering the wealth of software that the Dell Station includes, the price isn't bad. The new Sun SPARCstation IPC, which retails at just under \$10,000, is a similar hardware package, but it lacks an OSF/Motif-type interface—at

least until the next release of SunOS Unix—and it includes no applications software (BYTE will review the SPARCstation IPC in an upcoming issue). With the addition of the optional Dell Station Partner Kit (\$399), you can use MS-DOS PCs as X terminals networked to the Dell Station, and the cost per user for this system drops rapidly.

The Dell Station isn't going to convert any engineering workstation users, but if you're new to Unix or you're recommending a Unix system for the people in your office, the Dell Station requires a lot less hand-holding than other Unix alternatives. And that should make everyone happy. ■

John Unger is a scientist working for the U.S. government in the Washington, D.C., area. He does most of his work on a Sun-3. You can reach him on BIX at "junger."



The Brick
The fastest 386SX™ ...

- ▲ 16 or 20 MHz 386SX
- ▲ 44 to 212 MB HD
- ▲ 1 to 8 MB RAM
- ▲ 1024 x 768 VGA
- ▲ 2,400 bps modem
- ▲ 3" x 8" x 11"
- ▲ 16-bit expansion slot

...in just 8.3 lbs!

3" x 8" x 11"

THE BRICK™

"A Tote-able that Outperforms the Desktops..."

— PC MAGAZINE, Sept. 1990

This new generation PC is remarkable for the performance and the practicality it provides. The Brick is powerful enough for the most demanding applications, while its elegance, quietness and size make traditional PC's seem downright obtrusive by comparison.

More Practical Than a Portable

For multisite computing, the Brick offers an alternative to the usual trade-offs of laptops or multiple PC's. Just keep your preferred keyboard and full size monitor, plus power supply at your regular destinations and carry only the 8 lb. Brick in between.

Bricks are available with 16 or 20 MHz 386SX, 1-8 MB of RAM,

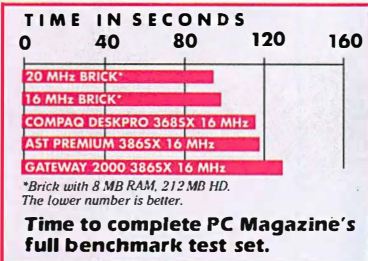
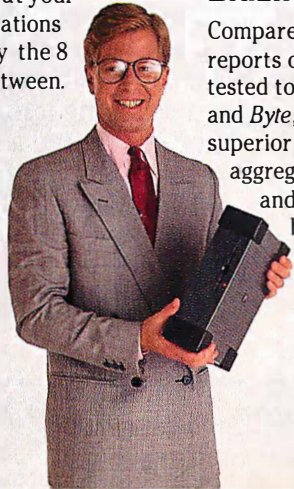

a fast 44, 104 or 212 MB Conner or Teac IDE hard disk, and a 387 coprocessor socket. A 2,400 bps Hayes compatible modem is standard.

The fast VGA graphics features up to 1024 x 768 non interlaced resolution with a full 1 MB of video memory.

Blazingly Fast

Compared to published reports of all 386SX machines tested to date by *PC Magazine* and *Byte*, the Brick offers superior performance on the aggregate of system, video and hard disk benchmarks.

Surprisingly Expandable

The Brick is only about the size of a ream of copier paper, yet you can still add up to two ISA half cards internally. A docking port allows easy connection to our Docking

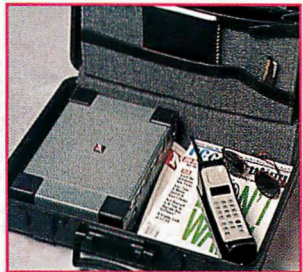

Terminal, which instantly hooks up all cables and provides another 16-bit slot.

Satisfaction Guaranteed

All Ergo products have a 30 day, money back guarantee, a One Year Warranty, unlimited 800 toll free support, and advanced diagnostics and updates via modem. You'll find complete information on the Brick, plus a full complement of enhancement products in our 32-page free catalog.

\$2,495

Includes

- ▲ 16 MHz Intel 386SX
- ▲ 1 MB RAM, Exp. to 8 MB
- ▲ 44 MB hard disk
- ▲ 1024 x 768 VGA
- ▲ 2,400 bps modem
- ▲ 3.5" 1.44 MB floppy
- ▲ 16-bit half card exp. slot
- ▲ Freight included

\$2,695

with 101 Keyboard & 12" Mono VGA Monitor

\$2,995

with 101 Keyboard & 14" Color VGA Monitor



A COMPUTER COMPANY

One Intercontinental Way, Peabody, MA 01960
 Tel: (508) 535-7510 Fax: (508) 535-7512

Order Factory Direct

1-800-633-1925

Free 32-Page Catalog

Circle 105 on Reader Service Card

BY1290

The Joneses.

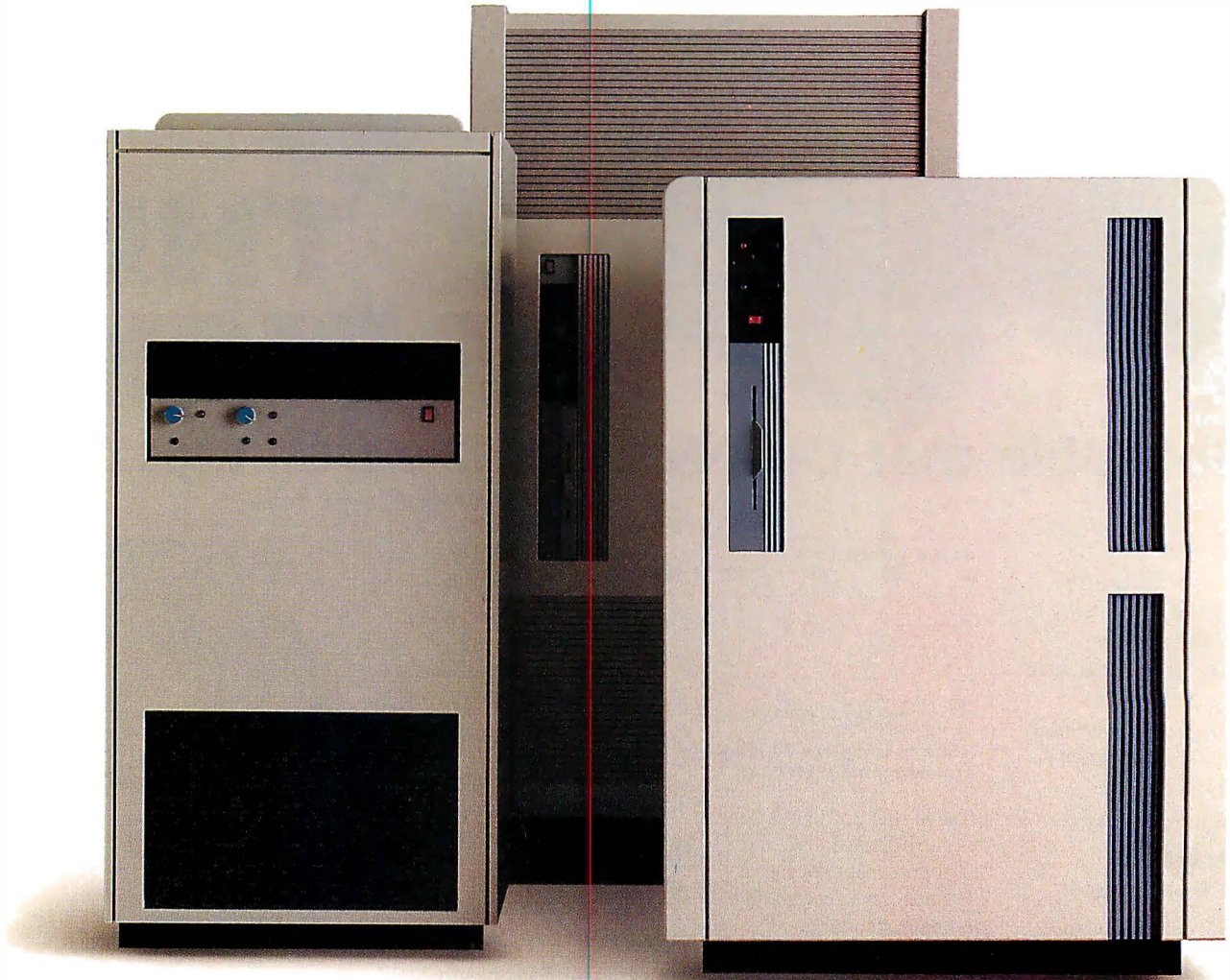

Check out the benchmarks. When it comes to speed, pure and simple, mainframes are no longer the main attraction.

Introducing the Everex STEP 486/33 and STEP 486/25. Along with the STEP 486*is*, they give you desktop performance that was previously unheard of.

There are two reasons. The first, of course, is the 486™ chip. The other is AMMA™, Everex's proprietary Advanced Memory Management Architecture.

STEP 486/33	34,000 Dhrystones (19.4 MIPS)
CRAY-X-MP 48	17,857 Dhrystones
IBM 3083	16,666 Dhrystones

AMMA uses "write-back" cache technology instead of the "write-through" technologies used in most PC's. The write-back cache was developed for mainframes. Everex was the pioneer in developing it for the PC. And in doing so, opened a whole new dimension in desktop performance.

With AMMA, you can write directly to the STEP 486's cache in nearly all cases. With write-through techniques, on the other hand, you lose most of the performance benefit of the cache.

And how to keep up with them.

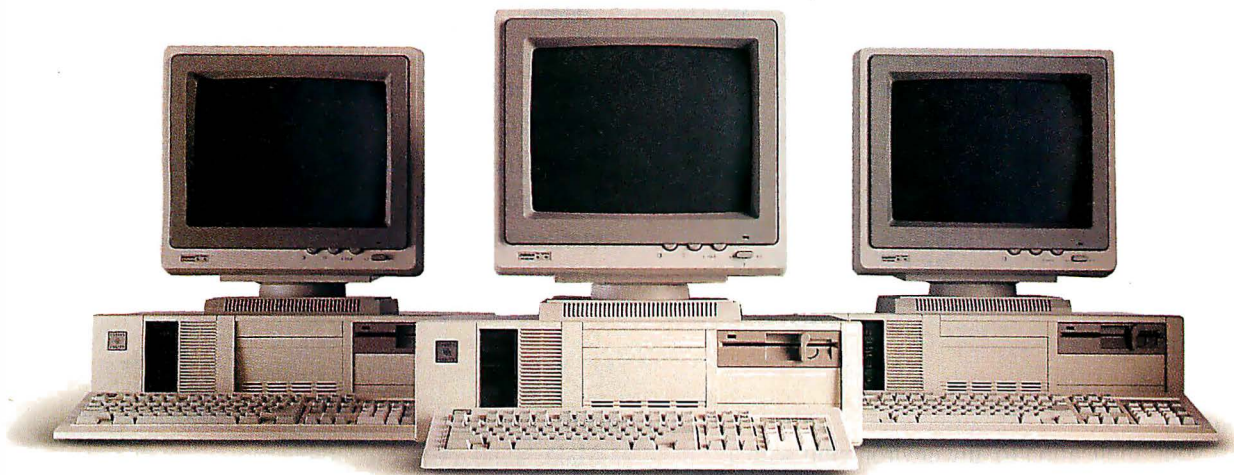

That's because write-through forces you to write to main memory much more often. And main memory is slower than the cache.

This is especially important in 486 computing, where the CPU performs as many as four times the write operations as in 386. Which makes AMMA's write-back architecture, combined with the 486's embedded cache, a powerful combination indeed.

But the STEP 486 machines give you more than just speed. They come with Programmable Drive Select. If your drive isn't listed on the set-

up table, PDS™ lets you custom-configure the BIOS. It's good for virtually any hard drive.

What's more, all STEP systems come with a one-year extendable warranty and a one year renewable on-site service contract that also covers all Everex peripherals in the system.

To find out more, call 1-800-334-4552* for the name of your nearest Authorized Everex Reseller—every one a high performance expert.

Then you can let the Joneses try keeping up for a change.



C Speed C Portability C Flexibility

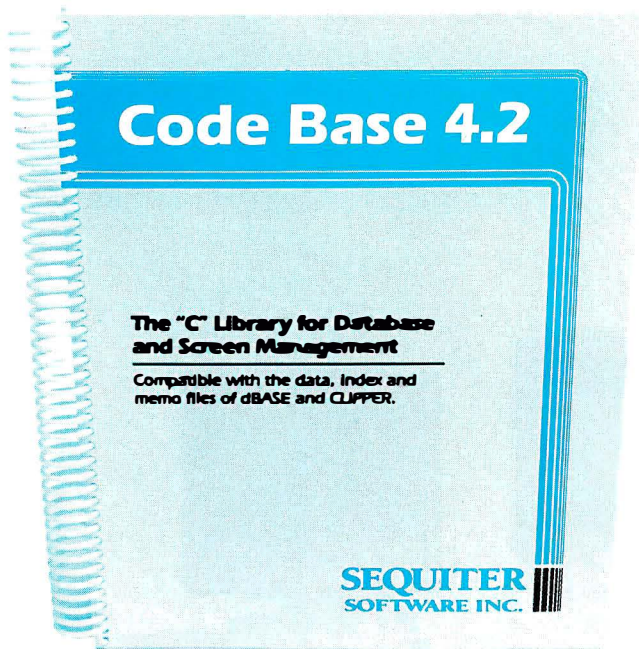

dBASE Power

Build a multi-user, dBASE compatible application which is several times faster than dBASE IV, Clipper or Fox Pro. Watch its windows and menus appear instantly on any computer.

Portable

Port your application to any environment with a C or C++ compiler. Access megabytes of memory using 386 DOS compilers, OS/2, Unix or Microsoft Windows.

Compatible

As you directly use the data, index and memo files of dBASE III through IV or Clipper, you can use Code Base 4.2 with any dBASE compatible product.

Easy

Consult examples in the 280 page user's guide as you interactively execute Code Base 4.2 routines from a learning utility. You will remember the routines which are named like dBASE commands.

Small

Make stand alone executable files as small as 14K. Code Base 4.2 executables are 1/2 to 1/3 the size of corresponding Clipper executables.

Complete

Enjoy the benefits of complete dBASE functionality, including browse, edit, menus, windows, multiple index files per database, dBASE expression evaluation, relations and filters.

Order Today

Order the DOS-OS/2 version for \$295. Call (403) 448-0313 or fax (403) 448-0315. Discover why Sequiter Software Inc. and most software dealers offer a 60 day money back guarantee. Source is included and there are no royalties!

REVIEW

LAN Manager 2.0: A Force to Be Reckoned With

Everybody loves a good horse race. In the realm of PC networking, that's just how industry watchers like to portray the contest between Novell and Microsoft. Novell's NetWare, eight lengths ahead, suddenly finds Microsoft's LAN Manager thundering in hot pursuit.

The battle for mind- and market-share won't end in a photo finish under the wire. But it will increasingly clarify an evolving vision of advanced network computing. Here are the essential ingredients of that vision: A network operating system should be easy to use and administer, work smoothly with other kinds of networks, support distributed (client/server) applications, run with blazing speed, exploit advanced hardware, protect its resources with a rock-solid security system, and scale up gracefully from small to very large installations.

LAN Manager's latest version, 2.0, scores well on all these fronts. Some of its new features, notably local security at the server and disk fault tolerance, match long-standing NetWare capabilities. Other features, such as limited multiprocessor support and domainwide user accounts, break new ground.

Read the Books First

Five well-written manuals document the system. The installation process, while dead simple, requires choices that you can't intelligently make until you read the books and know the big picture. And make no mistake, it is a *big* picture. You will likely be working with both OS/2 and DOS machines. On the OS/2 side, you've got to consider which file system to use: the DOS-style file allocation table (FAT) or OS/2's High Performance File System.

Any OS/2 system benefits from the standard features of HPFS: banded allocation, caching, B-tree directory lookup, and long filenames. But a LAN Manager server gets extra mileage out of HPFS; drive mirroring and duplexing require it. On a 386 machine, an alternate installable file system called HPFS386 runs in native 32-bit mode. (A dual-processor version that runs HPFS386 and the network I/O subsystem on a dedicated processor should be available by the time you read this.) HPFS386 can distribute

permissions for files throughout the file system, storing them in HPFS *extended attributes* rather than in a separate database file. That is the basis of *local security*, which enables you to protect the server's entire file system, not just the resources it shares with the network. As with a Unix machine, you log on for local access.

Although it is possible to run a LAN Manager server on a FAT partition, I can't think of any good reason for doing so. For OS/2 workstations, it's another matter. If you're going to dual-boot DOS and OS/2, you'll need a FAT partition. Even so, savvy users will dedicate most of the disk to the superior HPFS.

Next you've got to choose whether to make an OS/2 machine a workstation, a peer server, or a full-blown server. As you'd expect, memory requirements increase as you move up the ladder, from 3 to 3.5 to 6 megabytes, respectively. I knew I wanted to make a 12-MB Compaq Systempro a server, but I erred in installing my second OS/2 system, a Dell 386/25, as a workstation. The extra half-megabyte required for a peer server buys you more than a limited ability to share disk, printer, and other resources. A peer server can also be a backup *domain controller*. That means it keeps an automatically updated copy of the primary server's user accounts database. When I learned that, I promoted the Dell 386/25 to a peer server, which meant removing and reinstalling the workstation software. Like I said, read the books first.

The DOS Connection

Since DOS is a much less complex beast than OS/2, it recovers more easily from a wrong choice. LAN Manager comes in two flavors for DOS: basic (big) and enhanced (bigger). The basic version, a minimal MS-Network work-alike, can use the high-memory area (HMA—the first 64K bytes of extended memory) to shrink its memory footprint. With HIMEM.DOS, the version of the HIMEM.SYS driver that comes with LAN Manager, the basic workstation software used 69K bytes on a Gateway 386SX running DOS 4.01.

The enhanced version adds all the beef: resource browsing, messaging, the named-pipes protocol (required to ac-

cess, for example, SQL Server), and queue manipulation. It can also use the HMA (and, in certain circumstances, EMS as well); with HIMEM.DOS in place, the enhanced version ate up 120K bytes on an Arche Legacy 386/33.

The enhanced workstation offers to install a Windows 3.0 driver. Presumably, you could run the basic version under Windows, but without the network support for browsing available servers and queues and for receiving messages, it wouldn't buy you much. The enhanced version, on the other hand, dovetails nicely with Windows. You can use the File Manager to browse network drives, the Control Panel to locate and connect to network printers, and the Print Manager to monitor and control print queues. A utility called WinPopup receives and displays messages. You can also send out messages from within Windows; that's a convenience that the NetWare driver for Windows doesn't currently offer.

Plumbing the Physical Layer

LAN Manager 2.0 and NetWare 386 handle network infrastructure—adapter drivers and protocols—in a similar way. LAN Manager's NDIS (the Microsoft/3Com network driver interface specification) and NetWare 386's ODI (for open data-link interface) both do the same job: They separate hardware drivers from transport protocols. Network drivers used to be "monolithic": Adapter manufacturers had to incorporate transport protocols in their driver software. With NDIS or ODI, driver writers need only conform to a generic transport-protocol interface—a simpler (though hardly trivial) task. Moreover, both interfaces support two kinds of multiplexing. Different protocols can share an adapter so that, for example, LAN Manager's NetBEUI (the NetBIOS extended user interface) and TCP/IP can coexist on the same physical network.

It works the other way, too—multiple adapters can share a protocol. In that case, the protocol spans two physical networks. Just for fun, I converted my test LAN Manager network from a single Ethernet segment to two, joined at the Systempro server. With only four machines, there was no reason to divide the cabling. However, it's a strategy that comes into play when managing large, congested networks. It took me 10 minutes to add a second network adapter to the Systempro and to rearrange the cables, and another 5 minutes to tell LAN Manager to "bind" the NetBEUI protocol to the second adapter.

In the two-segment configuration, all



LAN Manager 2.0

Company

Microsoft Corp.
1 Microsoft Way
Redmond, WA 98052
(800) 426-9400
(206) 882-8080

Hardware Needed

Server: 286, 386, or 486 system with 6 MB of RAM
OS/2 workstation: 286, 386, or 486 system with 3 MB of RAM and OS/2 1.1 or higher
OS/2 workstation with peer service: 286, 386, or 486 system with 3.5 MB of RAM
DOS basic workstation: 8086 or higher system with 640K bytes of RAM
DOS enhanced workstation: 8086 or higher system with 640K bytes of RAM; extended or expanded memory recommended

Software Needed

Server and workstation with peer service: OS/2 1.2 Standard Edition (CSD XR04053) or higher
DOS workstation: DOS 3.1 or higher

Price

Five-user license: \$995
Additional 10-user license: \$995

Inquiry 1065.

workstations communicated with the common server and vice versa. But they couldn't all talk to each other. LAN Manager 2.0 doesn't permit a machine on one physical network to communicate directly with a machine on the other. That's something that third parties will have to provide.

More interesting than multiple adapters, though, is the notion of multiple protocols. Users increasingly want Macs, PCs, Unix workstations, and Digital Equipment and IBM hosts to be plug-and-play. Each of these cultures relies on deeply entrenched network protocols. Microsoft's NDIS, like Novell's ODI, is an architecture that enables a network to participate in several cultures at once. However, the core LAN Manager 2.0 doesn't capitalize on that opportunity. Just as NetWare 386 ships only with its native IPX protocol, LAN Manager 2.0 ships only with its native NetBEUI. For now you'll have to look elsewhere—most likely to 3Com—for the extra pieces you need to connect a LAN Manager network to a Macintosh or Unix network.

LAN Manager workstations, like

servers, bind one or more protocols to one or more adapters at run time. That means a LAN Manager OS/2 or DOS (enhanced) client can fit cleanly into a heterogeneous environment. (Although NetWare 286 clients are monolithic, NetWare 386 clients can also multiplex protocols by means of ODI.)

In general, it's a snap to install and rearrange NDIS drivers. My only gripe is that there's no sanity-check utility like Unix's ping or NetWare's comcheck. I always like to test out basic connections before layering on a lot of network software. But when I encountered a faulty adapter configuration, I didn't discover the problem until the domainwide security system failed to initialize.

Locking the Gate

Under LAN Manager 1.x, you could walk up to a server, toggle from the LAN Manager session to an OS/2 command window, and proceed to snoop around in the server's file system. People rightly complained about that, and version 2.0 solves the problem—with a vengeance.

When you install a 2.0 server on a 386 system, you can opt for local security. I did that, and when the server booted, it prompted me for the administrator's name and password. I typed "admin" and "password" per the manual's directions but failed to gain administrative privileges.

As I later discovered, the first batch of LAN Manager 2.0 disks were shipped with a password expiration date (a policy that has since changed), and mine had expired. The result was a convincing demonstration of local security—I was simply locked out of the file system. I couldn't even edit CONFIG.SYS to prevent the server software from starting. Not that that would have helped, since local security is intrinsic to the file system and doesn't depend on the network software. It looked as though I'd have to wipe the disk and start over. Although there was a workaround—one that Microsoft supplied and would probably prefer I keep to myself—it's clear that the new LAN Manager has really battened down the hatches.

Local security applies only to the server's console. From the network perspective, server security comes in two flavors: share-level and user-level. Share-level security mimics MS-Net and PC-LAN networks, which can password-protect shared resources but can't specify levels of access by user. User-level security enables much more precise control. You can specify how each user (or group) can access each

shared file, directory, print or serial device queue, or named pipe. (While NetWare 386 also supports file-level permissions, NetWare 286 does not.) When a server runs user-level security, it can also audit who does what with its shared resources. While it's more powerful and generally more desirable than share-level security, user-level security demands more administrative effort. In most cases it'll be worth the trouble, but it's handy to have the simpler, more open share-oriented method available as an option.

Domains and Log-on Security

A domain can weld a group of servers and workstations into a single administrative unit. It sounds simple, and in a way it is, but you've got to work with the domainwide log-on security system for a while to sort through all its implications. Domain-based security is optional. Nothing prevents you from setting up a network with one or more stand-alone servers, each (as with NetWare) responsible for its own user accounts. In that case, however, each server accessible to a workstation has to maintain privileges for that user. Conversely, the user must supply a password each time he or she tries to attach to a shared resource.

To activate domain security, you first name a primary domain controller and one or more backup domain controllers, join the controllers to a special group (called "servers"), and then start the netlogon service on each participating server. This makes sense even on a single-server network. Once the server validates your log-on request, you're in. For the rest of that session, you can use any resource your permissions entitle you to use, no questions asked.

The real purpose of domainwide security, of course, is to simplify multi-server administration. Within a domain, all servers running the netlogon service share identical copies of the user accounts database. The primary domain controller owns the master copy, which replicates automatically to the backups. Any domain controller can validate a log-on request, and, in fact, Microsoft recommends that you configure workstations to prefer different domain controllers to spread out the burden of log-on processing.

This arrangement simplifies the network administrator's life, because a single accounts database governs all access to a pool of servers. Conversely, for users it means that a single log-on request will grant access to the pool of servers. If the primary controller should ever fail, you can promote a backup controller to

PC-MOS

The Multiuser DOS Platform For The '90s

The 386 and now the 486 microprocessors have focused a lot of attention on the multiuser, multitasking possibilities of advanced PCs. A myriad of software and hardware manufacturers are promising a new age of multiuser options in the '90s.

But when you take a closer look, only one solution focuses on the features you want and anticipates the capabilities you need to use your PCs to their greatest potential. That solution is PC-MOS™ from The Software Link, the first DOS-compatible, multiuser, multitasking operating system.

A Network Alternative

The advantage to the PC-MOS shared processing solution is its ability to maximize the available memory on your PC, taking full advantage of extended memory and sharing it with up to 25 users on inexpensive terminals or monitors. You can share data with the same speed and integrity of a network solution without the expense of network cards and the waste of under-utilized PCs. And no additional investment is required to get the multitasking capabilities inherent in PC-MOS.

A Network Enhancer

For affordable network expansion, PC-MOS servers can be connected to other servers with The Software Link's LANLink or with the PC-MOS

GATEWAY™ to Novell's NetWare®. This connectivity lets a business configure its automation systems for departmental efficiency and expand affordably as needs grow with LANs or even WANs.

DOS Compatible

The PC-MOS alternative is clear: DOS compatibility means your users can continue to use all the popular software packages. And that means no investment loss, no retraining and no limitations in available applications.

An Unbeatable Solution

The next decade of shared processing will be clouded with choices. Only one operating system was first to offer you DOS-compatible, multiuser, multitasking solutions. Only one operating system continues to provide unbeatable multiuser solutions for over 150,000 users. PC-MOS from The Software Link. Call today and set your computing sights on a more productive horizon.



THE SOFTWARE LINK

1-800-451-LINK

3577 Parkway Lane, Norcross, GA 30092
(404) 448-5465 FAX: (404) 263-6474 TELEX: 4996147 SWLINK

VARS and RESELLERS:

Ask about our Sales Support Program

GSA Schedule/GS00K 90 AGS6448

Circle 310 on Reader Service Card (RESELLERS: 311)

PC-MOS is a trademark of The Software Link. All other products referenced are trademarks of their respective companies. Prices, policies and specifications subject to change without notice.

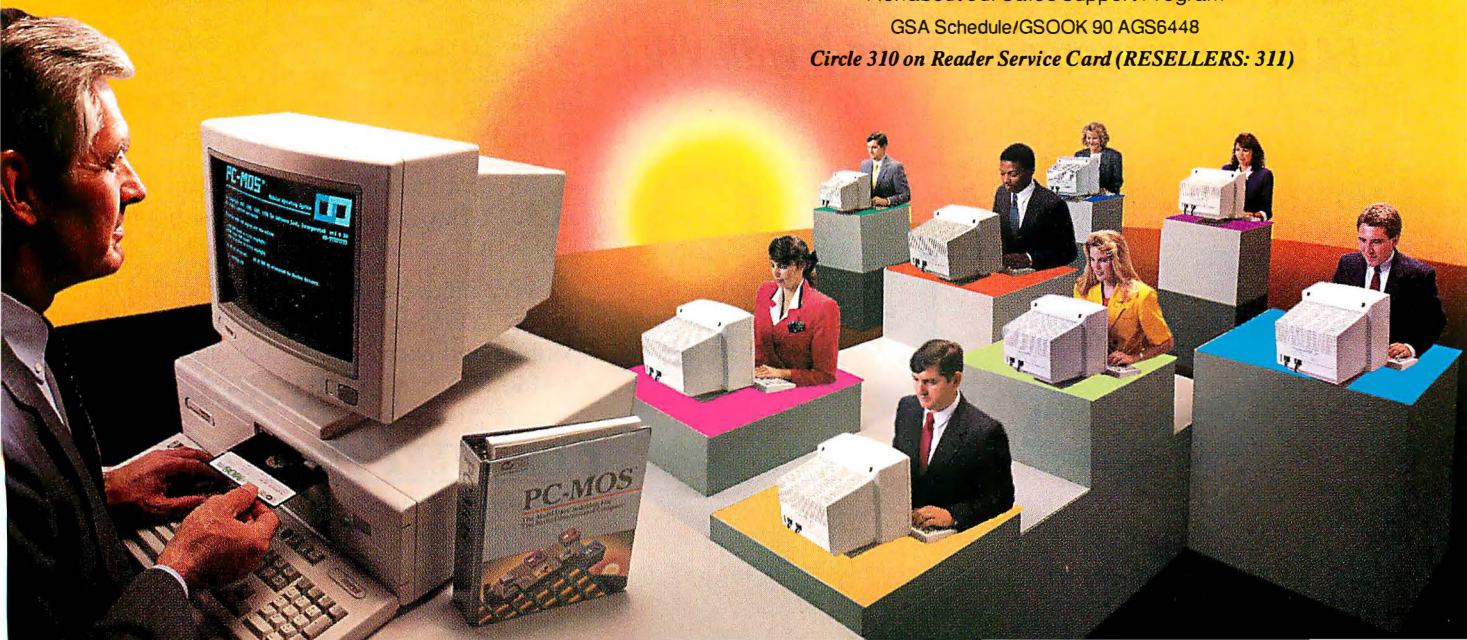

take its place.

What confused me at first was the distinction between domains and log-on security. Domains exist whether or not you run log-on security. When you start a workstation, it comes up in a "workstation domain" and can see only the servers in that domain. You might want to partition a large multiserver network into several such domains.

Within each domain there can be stand-alone servers and/or domain controllers. Moreover, a single server can be both a stand-alone controller and a domain controller at the same time. That's what happened when I set up the Dell 386/25 (a peer server) as a backup controller. I kept thinking that the permissions I assigned in the domainwide accounts database would apply to resources that the Dell shared. But they didn't; I couldn't access the Dell system from other workstations. Eventually it dawned on me that the Dell wasn't running the netlogon service. Peer servers can't run netlogon; only full servers can. Despite the fact that it was acting as a backup domain controller, the Dell needed its own accounts database to support its role as a peer server. Unix LAN administrators routinely deal with these kinds of subtleties. But if you are used to simpler PC networks, the full implications of LAN Manager 2.0's distributed security may take a while to sink in.

Printer and Communication Queues

One of NetWare 286's more annoying peculiarities is that you have to define all your printer queues during installation.

But with LAN Manager 2.0, as with its predecessors, that's not the case. It treats disk, printer, and serial-device resources in pretty much the same manner. You pick a share-name, specify its resource type, and assign the necessary permissions. Of course, before you can share a printer with the network, the printer first has to be installed locally—that is, its driver must be registered with the OS/2 Print Manager.

Printer queues integrate well with the messaging service. LAN Manager keeps you posted when a print job holds, resumes, or finishes, and when the printer goes off-line (which is most helpful). However, DOS workstations running the basic client service can't receive these helpful messages. They must monitor queues manually by means of the net print command.

Communication queues enable OS/2 workstations to share modems, scanners, and fax machines. For example, I installed a modem in the Systempro and shared it as NETMODEM. Using Hilgraeve's HyperAccess/5 for OS/2 on the Dell, I connected to the remote modem and logged onto BIX. You can also pool modems. For example, the protocol to share a pair of modems would be

```
net share netmodem=com1: ,com2:
```

at the server, and then, at the workstation,

```
net use com1 \\server\netmodem
```

LAN Manager searches the list of mo-

dem and connects the client to the first available one.

Distributed Computing

Two LAN Manager features—remote administration and the netrun facility—hint at the remote processing capabilities that underlie LAN Manager. To remotely administer a server, you run net admin and set the focus to the remote target. For example, once I granted administrative privileges on the Systempro to the Dell's account, I was able to run net admin on the Dell, switch to the Systempro, and remotely add to its list of shared resources.

Behind the scenes, the two machines establish an RPC (remote procedure call) session. In fact, many of the LAN Manager application programming interface calls take a server-name parameter that governs whether the function executes locally or remotely. While remote administration is a nice touch, what this really means is that any developer of LAN Manager-aware distributed software has a huge head start. Tools for building client/server applications are part of the basic fabric of the network operating system.

The netrun service executes entire programs on the server. A named pipe connects the client's standard input and output handles to a proxy that executes on the server. It's a tad awkward to set up. On the server side, you've got to specify a *runpath* that lists directories containing programs that the client can run. The client has to use a directory on the server and then make that its current directory.

continued

ViVa 2400 baud Modems

FAX It - Compress It - Send It with ViVa!



The ViVa 24, 24fx and 24m external modems expand your world with standard 2400 baud transmission rate, built-in FAX capability, or MNP 5 data compression.

All ViVa internal and external modems are 100% Hayes compatible and support the Hayes "AT" Command Set.

ViVa modems fit easily into your IBM PC, XT, AT, PS/2, 386, 486 and IBM compatibles and each is backed by a FIVE YEAR WARRANTY. **1-800-854-7600**

COMPUTER PERIPHERALS, INC.™

667 Rancho Conejo Blvd. • Newbury Park, California 91320 • 805-499-5751

HOW TO FIND THE PERFECT MOUSE IN YOUR FUTURE.

Unbroken Heart Line means you form lasting relationships. You drive a 1959 vintage T-Bird. You and your Logitech™ mouse will work hand-in-hand for many years.

Long index finger shows investment savvy. You go for the hot price on the Series 9 mouse with Microsoft® Windows™ 3.0 for Logitech.

Prominent Head Line means you're a perfectionist. The word "compromise" makes your face twitch. You are drawn to the speed and precision of Logitech's Series 9 mouse.

Head Line and Life Line converge. You plan for the future. You see that three buttons on the Series 9 mouse make it perfect for WordPerfect® and many other applications.

No matter what forces shape your destiny, there's a Series 9 mouse in your future. It's the world's most sophisticated mouse. And now it comes with the world's hottest graphical interface—Windows 3.0. With adjustable resolution, the Series 9 mouse lets you tune its performance to fit your application. So when you're working on Windows 3.0, you can really enjoy the view. **T**he sleek,

ergonomic, Series 9 mouse is Microsoft compatible and works with any application on an IBM® PC (or compatible). Suggested retail price: \$215 Bundle, \$119 Mouse.



Includes Logitech's lifetime hardware warranty. **F**or more information call Logitech's Customer Sales Center: (800) 231-7717, ext.349. In California: (800) 552-8885. In Canada: (800) 283-7717. In Europe: ++ 41-21-869-9656.

Circle 176 on Reader Service Card (RESELLERS: 177) **Tools That Power The Desktop.**

TM/®: trademarks or registered trademarks of their respective holders.



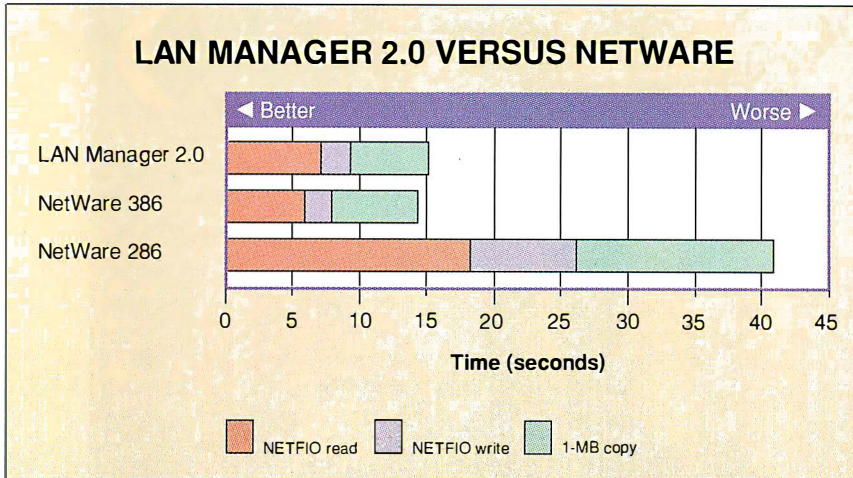

NetWare 386 holds a slight edge over LAN Manager 2.0, which more than doubles the performance of NetWare 286. The NETFIO test opens multiple files and performs seeks, reads, and writes in a pattern designed to simulate a typical database application. LAN Manager and NetWare 386 were tested on a Compaq Systempro running 32-bit NE3200 Ethernet; NetWare 286 was tested on an 8-MHz NEC PowerMate 286 running 16-bit InterLAN Ethernet. A Gateway 20-MHz 386SX running DOS 4.01 was used as the client machine.

Even then, with only standard input and output to work with, you're limited to TTY-style batch processing. The netrun service is a stone ax in comparison to Unix's elegant X Window System. What is it good for? You might want to index piles of text at the server without clogging the wire with packets. More generally, it's another reminder that OS/2—and, thus, LAN Manager—has the basic interprocess communications mechanisms needed to support distributed computing.

Days of Reckoning

Network consultants around the world are now subjecting LAN Manager to close scrutiny. No one I've spoken to doubts that version 2.0 deserves to play in the major leagues. It has the requisite performance (see the figure), security, and scalable architecture, along with strong support for heterogeneous networking and distributed computing.

The question is not whether LAN Manager 2.0 will succeed, but to what extent. The answer depends on a host of

variables, including price, third-party support, and the relative fortunes of DOS, Windows, OS/2, and NetWare. Although price may not be the major concern of large-scale network purchasers, NetWare 386's \$7995 price tag has caused considerable sticker shock among smaller fry. A 25-node LAN Manager 2.0 installation costs less than \$3000 yet delivers many comparable features.

To date, more database servers support LAN Manager than NetWare. But although LAN Manager 2.0 and NetWare 386 servers are roughly comparable, their strengths differ on the client side. LAN Manager favors the OS/2 workstation; NetWare favors DOS. Since OS/2 has yet to displace DOS on many desktops, chalk up a serious advantage for NetWare. I'm perversely optimistic about OS/2's future—version 2.0 is tantalizingly close to displacing Windows on my everyday machine—but you can't ignore basic 640K-byte DOS machines. While we're waiting for client/server software to materialize, we have to keep doing our jobs.

Still, the events of the last year or so have proved, once again, that you should never say never. DOS was never going to bust out of 640K bytes. Windows was never going to succeed. NetWare would never be easy to install. Unix could never look good. Macs would never be cheap. I think I'll wait and see what next year holds for OS/2 and LAN Manager. ■

Jon Udell is a BYTE senior editor at large and administrator of the editorial LAN. He can be reached on BIX as "judell."



Make All The Right Connections With GTEK!

**PCSS-8I
Eight Port Intelligent
Coprocessor**

The PCSS-8I is GTEK's popular, cost effective, intelligent, 8 port serial I/O card featuring DYNAMEMORY™. The 15 MHz on board processor dynamically allocates and deallocates on board buffer ram to transmit and receive queues as necessary. The new lower price makes this board the obvious choice if you want an intelligent serial I/O card. Dos, SCO™ XENIX® and SCO™ UNIX® drivers included.

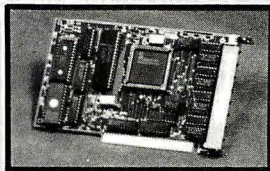

FULL
1 YEAR
WARRANTY



**PCSS-8T
Compact Eight Port
Serial Board**

The PCSS-8T is GTEK's popular PCSS-8 on a half sized card. It provides 8 serial ports for an even lower price than the PCSS-8I. Modular RJ-11 jacks like those on the PCSS-8I provide 8 ports without any external brackets or spider cables. A Dos driver is included and a special version is available for SCO™ XENIX®.

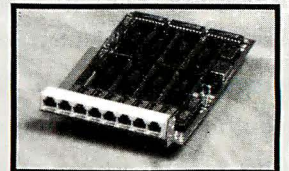

All trademarks are property of their respective companies.

Order Now Toll Free 1-800-282-GTEK (4835)

Development Hardware & Software • P.O. Box 2310 • Bay St. Louis, MS 39521-2310 • Fax 601-467-0935 • MS & Technical Support 601-467-8048



Until now, you've only seen a tulip standing in a vase. Until now, there's only been one way of looking at data. Now there's **ThinX**[™] software. The revolutionary Windows[®] program that finally links graphic images with databases and spreadsheets and lets you see data in a whole new way. 1-800-688-4469.

© Bell Atlantic

[®]Windows is a trademark of Microsoft Corporation.

Bell Atlantic
We're More Than Just Talk.[®]

Circle 45 on Reader Service Card

 **TELCON[®]**

M | I | C | R | O | B | A | G



Germany:
TELCON GmbH
Prinzregentenstr. 120
8000 MÜNCHEN 80
Tel.: 089 / 470 50 76
Fax : 089 / 470 82 11

USA:
TELCON USA
7270 S.W. 48th Street
MIAMI, FL 33155
Tel.: 305 / 669 19 81
Fax : 305 / 667 70 59

Spain:
TELCON Ibérica S.L.
Plata Castilla, 3 Piso 14-D1
28046 MADRID
Tel.: 1 / 733 73 67
Fax : 1 / 733 73 67

**DEALER
INQUIRIES
WELCOME**

Circle 304 on Reader Service Card

REVIEW

A Digital "Quill" for Mac Video Displays



VideoQuill operating on a Mac IIcx using a ColorCapture 2.0 display board. Note the heavy lines in the title bars for the Tools, Palette, and document window. These lines are 2 pixels wide to reduce flicker on an interlaced display.

Working with live composite video on a Mac II-class computer has never been easier. Many new NuBus boards now display live video in a Mac window and copy a freeze-frame digital video image to a disk file. Unfortunately, video-oriented software has been slow in coming. One of the first to arrive is Data Translation's VideoQuill, a \$495 program that lets you combine

text, graphics, and video for impressive presentations.

VideoQuill uses outline fonts and a variety of special effects to render high-quality text painted with 16- or 24-bit colors. The software's real strengths, however, lie in working with live or captured video. You can display high-quality text over live video (video titling), or you can merge text and graphics with video (live or captured) for multimedia presentations. (To use VideoQuill with live video, you'll need a videographics board, such as Data Translation's Color-Capture 2.0, and an extra monitor.)

Full-Spectrum Text and Color

You'll get your best results from VideoQuill on 16- and 24-bit color displays. While VideoQuill functions in 8 bits, it's difficult to gauge how your work will look without using deeper displays. When you first create a VideoQuill document, a dialog box prompts you for the document's pixel depth (either 16 or 24 bits, which can be independent of the display's depth that you're working on), window size (using either the current display's size or values that you type in), and the window's position on the display. Inside the document window you design a layout composed of rectangles or text; VideoQuill doesn't provide tools to let you draw arcs or circles. The package's text quality and fine color control partially compensate for this shortcoming.

The software's own set of outline fonts draws high-resolution text in type sizes of from 5 to 2000 points. Eighteen default sizes (ranging from 12 to 800 points) reside in the Text menu; in this menu, an Other selection lets you enter values outside of these sizes. You can rotate text either by clicking on a rotate tool and dragging the text string or by typing a degree value for the rotation angle in a dialog box. The latter is handy for precision work. You can modify the text's kerning, leading, and word spacing. Using other tools, you can color and position drop shadows along the text. VideoQuill uses its own antialiasing algorithm to prevent ragged text by blending the character's colors with the background colors.

VideoQuill works with outlines supplied by URW, a German type foundry, not Adobe Type 1 fonts. These outlines exist as separate files that you copy into a VideoQuill Fonts folder. Nine typefaces arrive in the standard package; 47 additional typefaces cost \$495.

You can select color ranges for the current object (either text or a rectangle), and the background from the Palette menu's color palette. An object can have a single (flat) color, or if you use a range, a smooth blend from the starting to the ending hue. You can adjust the object's color transparency, and instead of a color, you can import an image into the object. For example, you might type the text string "sunset," select Picture from the Color menu, and choose a file that contains a scanned sunset image. The sunset appears within the text's outline.

You can paste the Clipboard's contents in front of or behind the current object, move the current object a layer forward or backward, or bring the current object to the front or the rear. Unfortunately, VideoQuill lacks a grouping operation that would let you combine and treat a collection of objects as a whole.

VideoQuill imports graphics and images in TIFF, PICT, or MacPaint formats. You use the Picture Box tool to select a point in the window and drag out a box outline with the mouse. Next, a Standard File dialog box prompts you for the image's filename. The software pastes a full-size image into the newly drawn box. You can also use the Clipboard to import images, but the other method offers more precise control over where and how much of an imported image shows in the window. You can import all of an image (by not drawing the box) or use a Hand tool to move the image until the desired portion appears in the box. You can also scale the image to fit the box and adjust its transparency.

continued

VideoQuill 1.0



Company

Data Translation, Inc.
100 Locke Dr.
Marlborough, MA 01752
(508) 481-3700

Hardware Needed

Mac II family or SE/30 computer; 2 MB of RAM; color display (16- or 24-bit color preferred); hard disk drive; for work with video, a videographics board and interlaced monitor are required

Software Needed

System 6.0.3 or higher with 32-Bit QuickDraw

Price

\$495

Inquiry 1224.



NOW SHIPPING
5.0
Upgrade Now!

Your Left Brain Needs Clipper.

Organization is everything in business. The left side of your brain knows this. It wants order. Economy. Precision. All reasons your left brain appreciates Clipper 5.0, the premier application development system for PCs.

An open architecture programming system, Clipper provides a flexible environment for developing precisely the application you need, not a messy approximation. Its user-definable commands and functions let you configure the Clipper language for your exact requirements. Its compiler generates .EXE files for rapid execution and cost-free distribution. Its new linker even lets you build and run applications larger than available memory! And its elegant network support yields high performance on even the largest systems.

So, if you're charged with coaxing order out of chaos for your business, put Clipper in your programming arsenal today. It has exactly the programming power you need!

Clipper® 5.0

The Application Development Standard

213/390-7923

Ask For Department-A

 **Nantucket**®

Circle 197 on Reader Service Card

Trial Run

For my evaluation, I used two systems: a Mac IIci with 4 megabytes of RAM, a SuperMac Spectrum/24 Series III board, and a 19-inch display; and a Mac IIx with 8 MB of RAM, an Apple 8•24 display board, and an AppleColor 13-inch monitor. Both of these systems ran System 6.0.5 software and had 80-MB hard disk drives. I used a Data Translation ColorCapture 2.0 videographics board to provide live video and capture 16-bit images. A RasterOps 364 video board captured 24-bit video images and previewed the video output from the Color-Capture board. I installed these boards in the Mac IIx. My video source was a Pioneer VP-1000 laser disk player.

The application operates in a 3-MB MultiFinder partition. This leaves little room for running anything other than VideoQuill on the IIci, but applications that handle 16- and 24-bit data routinely require lots of memory. I managed to shoehorn MindWrite in with VideoQuill to see how well the latter coped with low-memory situations (and to write this review). VideoQuill did quite well operating in a less-than-optimal partition size, and it popped up alerts warning of low memory without crashing. The application worked without a hitch on the IIx.

VideoQuill helps you produce impressive documents and snazzy slides suitable for presentations. However, the software's real purpose is to work with video. The video capabilities of the application worked flawlessly. For example, video is one of the "colors" you can pick for objects. When you use VideoQuill with a videographics board, the software substitutes live video for this object's color. VideoQuill accomplishes this by modifying bits in the object's alpha channel. The alpha channel modifies or describes an object's characteristics; in this case, it handles video control. The channel is a bit in size for 16-bit color and a whole byte for 24-bit color.

This feature provides some unique effects. Since the background is an object, you can let it pass video except where text is present. This makes VideoQuill useful for video titling, but its capabilities don't end there. For example, you could type "TV" and select video for the text's color. A videographics board driving an interlaced monitor would show a colored background, with live video filling the T and V characters on the screen. Or you could make a business chart and draw a box in the corner that would pass the video. You retain this alpha channel information when you save the window as a VideoQuill document. VideoQuill can

also export documents as either TIFF or PICT files.

On the interlaced monitor I connected to the ColorCapture 2.0 board, text looked fine at every point size, and color blending was superb. VideoQuill readily accepted images that were captured by the RasterOps 364. Trying to let video bleed through areas of a scanned image proved to be a bit tricky using VideoQuill itself. First, using an image-manipulation application, such as PhotoMac or PhotoShop, I selected a color in the image to pass video and had the application strip out regions with that color. Then, after selecting the transparent background color option, I pasted the image into the VideoQuill document. Finally, I set the background to the video color.

I found it easier to use Data Translation's ColorCapture application bundled with the ColorCapture board to select a range of colors in the image and set the alpha channel bit. ColorCapture saves the image as a PICT file, and VideoQuill recognizes the alpha channel information once you import the file. For example, using a scanned autumn scene with blue sky and red-orange trees, it was easy to use ColorCapture's color controls to set the alpha channel bit to pass video for the sky tones. When I pasted the image into VideoQuill, the trees appeared superimposed over live video.

You can print VideoQuill documents, but only at screen resolution (i.e., 72 dots per inch). When I printed from VideoQuill to a 300-dpi Tektronix Phaser color printer using the 6.0 LaserWriter driver, the output looked dark and muddy. I got better results by saving the document as a TIFF file, importing it into Photoshop, and printing.

More Tools

VideoQuill has some shortcomings. Circle and arc tools would make for better layouts, and the lack of a grouping tool makes complicated designs difficult. It would also be nice to incorporate some of ColorCapture's color controls that operate on the alpha channel into VideoQuill.

Despite these flaws, VideoQuill does work, and the results with video can be quite spectacular. It provides features not found in some presentation packages, and it breaks new ground working with the video medium. For those who have to work with video now, VideoQuill can help you pen a solution. ■

Tom Thompson is a BYTE senior editor at large with a B.S.E.E. degree from Memphis State University. He can be reached on BIX as "tom_thompson."



Your Right Brain Wants It!

While your left brain duly notes the benefits of Clipper programming, the right half is wild about how you get them! Imagine a programming environment with no limits! The language can be easily extended with your own routines and you can even integrate code from other languages, like C and Assembler. You're always free to configure Clipper to suit your own programming style.

Hey, let's say you want to read and write data in some format other than the .dbf structure Clipper already supports. It's no problem since Clipper 5.0 sports a replaceable database driver, even allowing multiple drivers to be used concurrently in the same application! There's no end to the possibilities you can pursue with Clipper!

Clipper's open architecture system will fire your imagination with unparalleled freedom. It's spray paint for a developer's mind. So, if you want your imagination to inspire your applications, indulge yourself with Clipper 5.0. It has everything you need and anything you'd want.

Clipper® 5.0

The Application Development Standard

213/390-7923

Ask For Department-A

 nantucket®

Circle 198 on Reader Service Card

Nantucket Corporation, 12555 West Jefferson Boulevard, Los Angeles, CA 90066, 213/390-7923 FAX: 213/397-5469 TELEX: 650-2574125. Nantucket, the Nantucket logo and Clipper are registered trademarks of Nantucket Corporation. Other brand and product names are used for identification purposes only and may be trademarks or registered trademarks of their respective holders. Entire contents copyright © 1990 Nantucket Corporation.



The joy of C-scape

Elegant graphics and text

The C-scape™ Interface Management System is a flexible library of C functions for data entry and validation, menus, text editing, context-sensitive help, and windowing. C-scape's powerful Look & Feel™ Screen Designer lets you create full-featured screens and automatically generates complete C source code.

C-scape includes easily modifiable high-level functions as well as primitives to construct new functions. Its object-oriented design helps you build more functional, more flexible, more portable, and more unique applications—and you'll have more fun doing it.

The industry standout. Many thousands of software developers worldwide have turned to the pleasure of

C-scape. The press agrees: "C-scape is by far the best. . . . A joy to use," wrote *IEEE Computer*. Major companies have selected C-scape as a standard for software development.

C-scape's open architecture lets you use it with data base, graphics, or other C and C++ libraries. C-scape runs in text or graphics mode, so you can display text and graphics simultaneously. To port from DOS or OS/2 to UNIX, AIX, QNX, or VMS, just recompile. C-scape also

Graphics. Run in color in text or graphics mode. Read images from PCX files.

Object-oriented architecture. Add custom features and create reusable code modules. C++ compatible.

Mouse support. Fully-integrated mouse support for menu selections, data entry fields, and to move and resize windows.

Portability. Hardware independent code. Supports DOS, OS/2, UNIX, AIX, VMS, others. Autodetects Hercules, CGA, EGA, VGA. Supports Phar Lap and Rational DOS extenders.

Text editing. Text editors with word wrap, block commands, and search and replace.

Field flexibility. Masked, protected, marked, required, no-echo, and named fields with complete data validation. Time, date, money, pop-up list, and many more higher-level functions; create your own.

Windows. Pop-up, tiled, bordered and exploding windows; size and numbers limited only by RAM.

Menus. Pop-up, pull-down, 123-style, or slug menus; create your own.

Context-sensitive help. Link help messages to individual screens or fields. Cross reference messages to create hypertext-like help.

Code generation. Build any type of screen or form with the Look & Feel™ Screen Designer, test it, then automatically convert it to C code.

Screen flexibility. Call screens from files at run time or link them in. Automatic vertical/horizontal scrolling.

International support. Offices in Berlin, Germany, with an international network of technical companies providing local training, support and consulting.

supports Phar Lap and Rational DOS extenders.

Trial with a smile. C-scape is powerful, flexible, portable, and easy to try. Test C-scape for 30 days. It offers a thorough manual and function reference, sample programs with source code, and an optional screen designer and source



code generator. Oakland provides access to a 24-hour BBS, telephone services, and an international

network of companies providing in-country support. No royalties, runtime licenses, runtime modules. After you register, you get complete library source code at no extra cost.

Call 800-233-3733 (617-491-7311 in Massachusetts, 206-746-8767 in Washington; see below for International). After the joy of C-scape, programming will never be the same.

DOS, OS/2 (Borland and Microsoft support): with Look & Feel, \$499; library only, \$399; UNIX, etc. start at \$999; prices include library source. Training in Cambridge and Seattle each month. Mastercard and Visa accepted.

OAKLAND

BY1290

Oakland Group, Inc. 675 Massachusetts Ave., Cambridge, MA 02139 USA. FAX: 617-868-4440. **Oakland Group, GmbH.** Alt Moabit 91-B, D-1000 Berlin 21, F.R.G. (030) 391 5045, FAX: (030) 393 4398. **Oakland International Technical Network** (training, support, consulting): **Australia** Noble Systems (02) 564-1200; **Benelux** TM Data (02159) 46814; **Denmark** Ravenholm (042) 887249; **Austria-Germany-Switzerland** ESM 07127/5244; **Norway** Ravenholm (02) 448855; **Sweden** Linsoft (013) 111588; **U.K.** Systemstar (0992) 500919. Photo by Jessica A. Boyatt; Kanji by Kaji Aso. Picture shows a C-scape program combining data entry with video images loaded from PCX files. C-scape and Look & Feel are trademarks of Oakland Group, Inc.; other trademarks belong to their respective companies. Copyright © 1990, by Oakland Group, Inc. Features, prices, and terms subject to change.

Circle 216 on Reader Service Card

REVIEW

Unix and 1-2-3

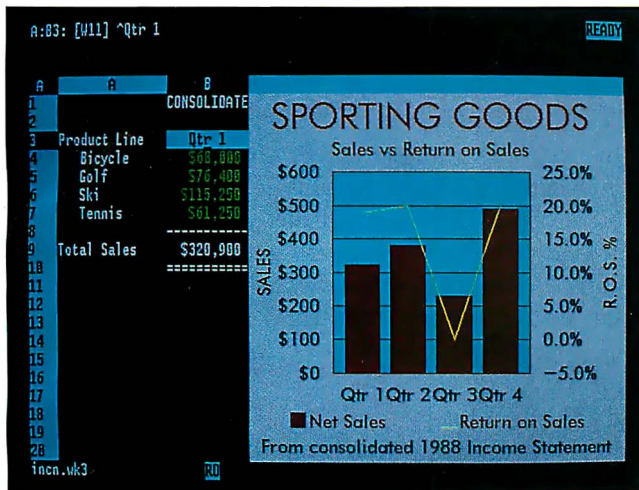

Lotus 1-2-3 for Unix System V sports multiple views and graphics support.

Spreadsheets are no longer the domain of single-user personal computers. As personal computers approach the throughput of workstations, many users are abandoning DOS for more powerful multiuser operating systems. Lotus Development has noted this, and Lotus 1-2-3 for Unix System V is its solution.

Lotus 1-2-3 for Unix System V is essentially a port of Lotus 1-2-3 release 3.0, dressed up to take advantage of the multitasking, multiuser environment of Unix System V/386.

The package consists of a user's guide,

a reference manual, and six 1.2-mega-byte floppy disks. The documentation has the qualities normally associated with Lotus: clear and to the point.

Installation under SCO Unix System V took only 20 minutes. Lotus took advantage of SCO's custom installation program, which handles all the file extraction, copying, and permission setting necessary to build the Lotus directory hierarchy in the location of your choice.

Will You Recognize It?

Running 1-2-3 on the console of a computer running Unix System V/386 is much like running 1-2-3 release 3.0 under DOS. VGA and EGA are supported, with a choice of text resolutions ranging from 25 rows by 80 columns to 60 by 80. Graphs are displayed on supported adapters.

One enhancement added for Unix System V is the ability to simultaneously display up to 26 worksheets in *perspective* mode. The number of worksheets to be displayed must be selected on the command line, though, so if you have already started work and decide that you need to display more than the three default worksheets, you must save your work, exit the program, and restart 1-2-3 to use this feature.

The familiar 1-2-3 command keys, such as "/" to bring up the menu bar and arrow keys to select items, are used, but combinations that would normally use the Alt or Control keys are implemented in a more portable way. For instance, moving from one sheet to the one above it is invoked with Control-PageUp in DOS

and Control-A PageUp in Unix. Likewise, the Alt-function keys are invoked by typing Control-F and then pressing the function key. This lets the same keystrokes work from a variety of input devices.

I didn't run any exhaustive performance tests, but a macro that took 13 seconds to run under DOS (on a 25-MHz 386, with no 80387) executed in 29 seconds on an identical Unix machine under a fairly heavy multiuser load.

Running 1-2-3 from a remote computer is more of an adventure. Except in special circumstances (as with the Sun-River Fiber Optic Station), graphics are not supported; therefore, you cannot display graphs. In addition, since terminal keyboards rarely match PC keyboards, an adjustment is necessary in the command keys. For instance, the command to move to cell A1 on the first spreadsheet is normally Control-Home; on a Wyse WY-50 terminal, the command sequence is Control-A PF2 7 (7 is the PC numeric keypad key for Home).

Working Together

Lotus 1-2-3 for System V can retrieve any file on your Unix network that you normally have permission to access. Since worksheets can be saved in both .WK3 and .WK1 formats, it is possible to have a central repository of worksheets for all the users on the network, both DOS and Unix.

An important point, however, is that file locking is available only for files on the machine 1-2-3 is running on. File locking across the network is not supported from within 1-2-3. It is a good idea to store worksheets on the 1-2-3 server to avoid the loss of information caused by two users updating the same worksheet at the same time.

Lotus 1-2-3 for System V is licensed for one CPU: This means that to access 1-2-3, you must log onto the licensed computer. Note that this is distinctly different from a file-server license, where the executable code is actually running on your local machine.

Lotus 1-2-3 for Unix System V provides the industry-standard spreadsheet to users of Unix System V for the PC. It extends the base 1-2-3 release 3.0 product with features suited to Unix-style networking, and it can even be run from ASCII terminals. It tries hard to preserve the look and feel of the DOS version of 1-2-3, and it largely succeeds. ■

Rick Farris is a principal at RF Engineering, a custom software house. He can be reached on BIX c/o "editors."

Lotus 1-2-3 for Unix System V



Company

Lotus Development Corp.
55 Cambridge Pkwy.
Cambridge, MA 02142
(617) 577-8500

Hardware Needed

Compaq, IBM, or compatible 386 PC with 4 MB of RAM and 5 MB of free disk space

Software Needed

System V 3.2 from SCO, AT&T, or Interactive, or SCO Xenix 2.3

Price

Single-user: \$695
10 users: \$1295
Four additional users: \$495

Inquiry 1148.

WEITEK[®] makes the difference!



The 4167's 10 MFLOPS performance delivers 3X the speed of the 486!

The new Weitek 4167 coprocessor outperforms the 486 by 3 to 1 in numeric processing. Capable of 10 MFLOPS, the 4167 has sockets in some of the most sophisticated 486 systems on the market, including Compaq, Intel, Hewlett-Packard, and Microway. The 4167 is object-code compatible with the WEITEK 3167 FPU and Microway's mW3167-PS add-in card for the MicroChannel—offering easy access to a broad base of existing CAD/CAM, scientific and engineering applications like Mathematica, CADKEY, HOOPS and Microway's NDP compilers. And look for 4167 support on upcoming products from Autodesk!

Number Smasher[®]-486 converts your old AT or 386 into a powerful 486 workstation. In a review of 25 MHz 486 motherboards, Mike George of *Personal Workstation* magazine wrote, "Microway's Number Smasher-486 gives you top 486 numeric performance for the best price...Number Smasher's numeric performance exceeds that of all 25 MHz 486 systems we've tested to date." Running the Microway Benchmark Suite, the 4167-equipped Number Smasher-486 achieves 11.9 MegaWhetstones. The board features a Burst Bus[™] memory interface that makes it stand out in numeric problems that involve large arrays. Burst cycle response in a 486 system is much more important than second level caches, which are usually too small to be of any use on the megabyte arrays found in real world problems.

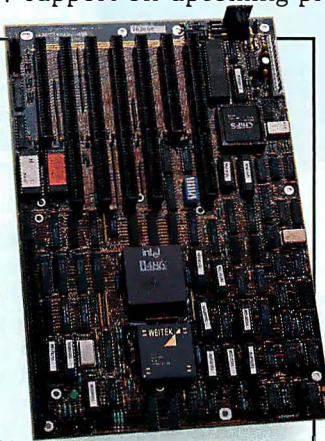

The ideal solution for numerically or I/O intensive applications is Microway's new Number Smasher-486/33T workstation. Two configurations are available, each incorporating state-of-the-art power and cooling with 300 to 600 megabyte drives.



NDP Fortran-486, NDP C-486 and NDP C++ are your keys to unlocking the power of the 4167. Each compiler generates globally optimized, main-frame quality code and has special features that take advantage of the 4167, such as register caching, loop unrolling and automatic inlining of small procedures. These optimizations are handed off to a code generator that is tuned for the 4167, and takes advantage of its advanced instructions like multiply accumulate. In addition, the 486 versions of NDP Fortran, C++ and C properly sequence 486 and 4167 instructions so that the 486's prefetch queue has time to "breathe." NDP compilers are also available for the 386SX, 386 and i860 under DOS, UNIX, XENIX and SunOS. Thousands of Microway's satisfied customers have discovered that you can't buy a better scientific Fortran or C compiler. And our technical support is the best in the industry.

For more information, please call 508-746-7341.

Microway[®]

The World Leader in PC Numerics

Circle 189 on Reader Service Card (RESELLERS: 190)

Corporate Headquarters, Research Park, Box 79, Kingston, MA 02364

TEL. 508-746-7341 • FAX 508-746-4678

U.K. - 32 High St., Kingston-Upon-Thames, 081-541-5466 • Italy 02-74.90.749

Holland 40 836455 • Norway 9 876656 • Japan 81 3 222 0544



REVIEW

A "More Filling" Generation of Tape Backup

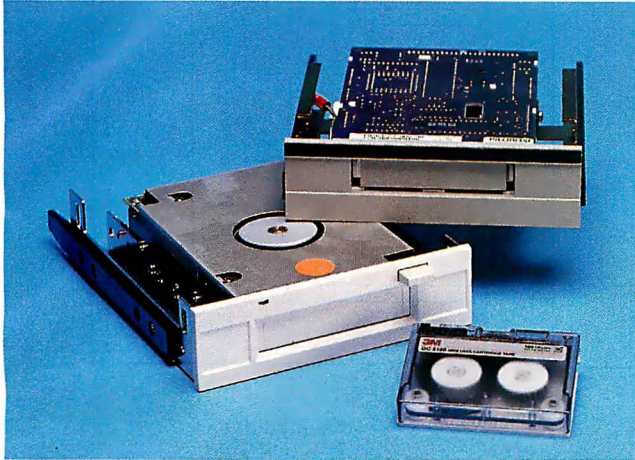

Coretape Light (left) and the Jumbo 250 up the ante of tape capacity for today's megabyte hard disk drives.

You've heard it all before: If you want to avoid despair, back up the data on your hard disk drive. However, as standard hard disk drive capacities break the 100-megabyte barrier, the backup process becomes more and more of a chore. Backup is especially painful if you're using floppy disks; soon you begin to feel like a high-tech short-order cook, flipping disks like so many thin black pancakes.

A tape backup unit is the obvious answer. No disk flipping, no piles of ill-marked floppy disks. You can start the backup and partake of another cup of coffee, or schedule the backup to start automatically at a predetermined time. TBUs aren't exactly new, but in keeping

with hard disk trends, the latest generation of QIC-80 (quarter-inch cartridge) TBUs offer higher capacities. I tested two of the new incarnation: the Jumbo 250 from Colorado Memory Systems and Coretape Light from Core International.

Both units use varying forms of data compression to pack lots of bits on a tiny tape. As its name implies, the Jumbo 250 fits up to 250 MB of data on a DC-2120 tape; Coretape Light fits up to 300 MB on the same cartridge size. (Without compression, DC-2120 tapes hold a maximum of 120 MB.)

QIC Developer

Colorado Memory Systems isn't new to the backup game; nearly a decade ago, it

was instrumental in developing the QIC standard that nearly all TBUs use. The Jumbo 250 (\$499), like its predecessors, is a well-built unit that stands up to hard daily use. In its basic configuration, it mounts in a half-height drive bay and hooks up to your system's floppy disk drive controller as the second drive. But that limits you to the maximum 500,000-bps data transfer rate of an AT floppy disk (250,000 bps with a PC).

An optional \$129.95 add-in board boosts the data transfer rate to 1 megabit per second (500,000 bps on a PC). The controller also lets you use a second floppy disk drive or mount the Jumbo 250 in an external enclosure that you can easily transport from system to system.

More interesting is the top-of-the-line "jumperless" board that I tested with the Jumbo 250 (this board isn't available for XT's—only AT's, PS/2's, and compatibles). In addition to the high-speed controller, it includes hardware data compression using the proprietary STAC chip. At \$299.95 (\$399.95 for the Micro Channel version), it's not exactly a low-cost option, but it's a boon for the truly hurried. Without the add-in board, the Jumbo 250 still offers data compression, albeit in a software version, whose speed is highly dependent on the speed of your system's processor.

The Jumbo 250 is easy to install. I just slid it into a free drive bay, plugged in the 16-bit add-in compression board, connected power to both using an included Y-adaptor, and hooked a cable between them.

The automatic software installation is a revelation, especially when you're installing one of the add-in boards. The utility checks your system and sets the jumperless board for interrupt, DMA channels (two are needed with the compression board), and I/O base address. It saves lots of hair-tearing, but it's not foolproof, nor did I expect it to be.

After I installed the Jumbo 250 and attempted to start a backup, the software kept telling me that I didn't have a tape unit installed. I finally figured out that the culprit was my Microsoft Bus Mouse, which was using the same interrupt as the tape board. (Since the mouse wasn't moving, the automatic installation utility didn't "see" it.) I moved a jumper on the mouse board, and everything was fine.

Trendy TBU

I cringed slightly when I found that Core planted the Coretape *Light* moniker on its \$545 TBU; it sounds just a tad too trendy for me. Coretape Light accommodates a slide-in mount in a free drive bay. Core

Jumbo 250

Company

Colorado Memory Systems, Inc.
800 South Taft Ave.
Loveland, CO 80537
(303) 669-8000

Hardware Needed

IBM AT, PS/2, or compatible

Price

\$499; controller, \$129.95; controller with hardware compression, \$299.95; controller with hardware compression for Micro Channel systems, \$399.95

Inquiry 1105.

Coretape Light

Company

Core International
7171 North Federal Hwy.
Boca Raton, FL 33487
(407) 997-6055

Hardware Needed

IBM AT, PS/2, or compatible

Price

\$545

Inquiry 1106.



BACKUP AND RESTORE TIMES

Jumbo 250

- With optional controller, hardware compression on
- With optional controller, hardware compression off
- Without optional controller, software compression on
- Without optional controller, software compression off

Coretape Light

- Full software compression
- No compression

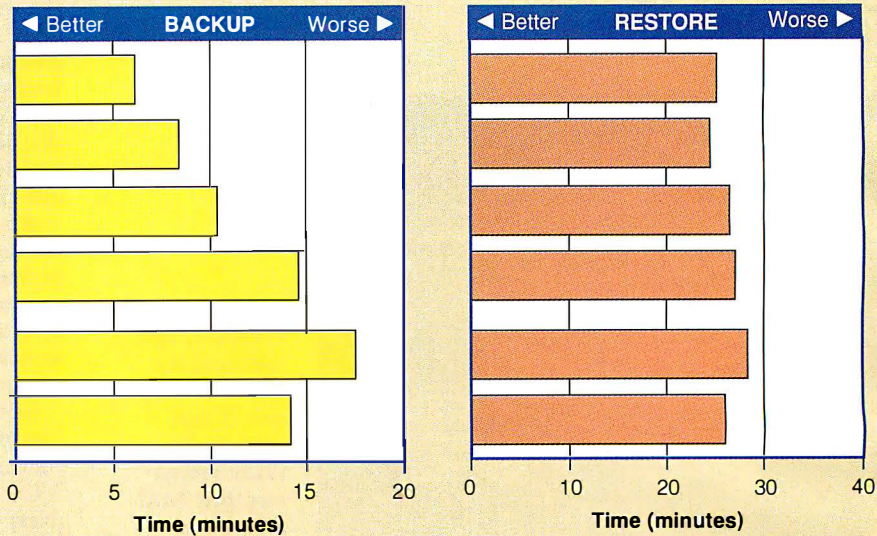

The compression scheme used by the Jumbo 250 sped up most processes. All tests were run on a 20-MHz 386-based AT clone using a Quantum 170 SCSI hard disk drive hooked up to a DPT 4-Mbps SmartConnex controller. Logical drive D (containing 31.3 MB of data) was used in all cases.

Harvard Graphics[®]
 And The HP LaserJet III
 Invite You To A
 Very Exciting Presentation.

also offers an \$89 controller (not reviewed) that lets you run a second floppy disk drive or mount Coretape Light as an external drive. Even with the optional controller, Coretape Light is limited to the slower data transfer speed of the AT floppy disk drive controller. Coretape Light is even more of a snap than the Jumbo 250 to install. You slide it in, plug in power and the second floppy disk drive connector, and install the software.

Both the Jumbo 250 and Coretape Light offer extensive software options. There are the usual options for formatting blank tape (since it takes about an hour, most tapes come preformatted), verifying tape usability, and choosing full or partial backups. Coretape Light's software offers a few more choices, including an exhaustive test of a blank tape and a "Retension" procedure that re-adjusts the tension of a new cartridge or one that's been in storage for a long time.

Both TBUs also have unattended backup options—TSR programs that will perform backups at the time you determine. It's a handy option that lets your computer (instead of you) work overtime to do the backup. I set my system to back up

my new data daily at 2 a.m., with a full backup once a week. Unattended backups are a great way to make sure the job gets done (of course, you have to remember to put the tape in the drive).

I've always thought that comparing backup operation speeds isn't a valuable exercise since you "set and forget" it while you're away from your computer. A couple of minutes one way or the other really isn't a big deal. But for comparison, I timed the backup and restore operations of both drives with and without their various options (see the figure). As the results show, the Jumbo 250 with the hardware compression board (and compression on) actually speeds up the backup process. Software compression is much slower, simply because it has to steal cycles from your system's processor. But the Jumbo 250's software compression is still quite fast.

No matter how you set things up, a restore operation takes considerably longer than the backup. Coretape Light has a large edge in locating an individual file on a tape, using something called Rapid Random Restore. With the Jumbo 250, I restored a single file from the middle of a

backup in 2 minutes, 25 seconds; Coretape Light restored the same file in only 24 seconds, or about five times faster.

QIC Pick

Both of the basic drive units are well constructed, and the slightly higher price of Coretape Light reflects its ability to fit more bits on a tape. It also has a glass-ferrite record/read head that should hold up longer than the conventional head used in the Jumbo 250. For versatility, the Jumbo 250 is a better choice, especially if you have a free slot that you can use to take advantage of the higher throughput and/or hardware compression.

In this world of gee-whiz computer technology, TBUs are often-neglected, albeit necessary, peripherals. To me, the ability to pack up to 300 MB on a tape that's smaller than a pack of playing cards is wondrous indeed.

It's 2 a.m. Do you know where your data is? ■

Stan Miastkowski is the *BYTE* senior editor for new products. He can be reached on *BIX* as "stanm."

Yours.

Harvard Graphics 2.3 from Software Publishing Corporation brings new dimensions to presentation graphics. The Hewlett-Packard LaserJet III printer writes a new chapter in printing history.

Put them together and your presentation becomes a major event.

Harvard Graphics is packed with easy-to-use new features that will dazzle your audience—like a gallery of pre-designed charts and DrawPartner™, an integrated advanced drawing package.

The HP LaserJet III has raised the standard of printing excellence with HP's exclusive Resolution Enhancement technology. Your graphics will look unusually sharp—better than ever before.

With Harvard Graphics and the HP LaserJet III, your next presentation is certain to be well attended. And well received.

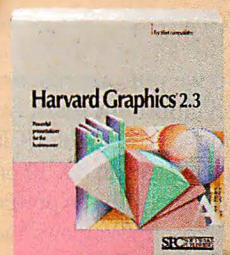
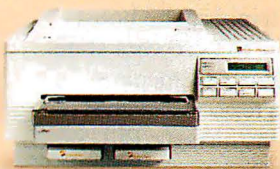

SPC SOFTWARE PUBLISHING CORPORATION

Circle 286 on Reader Service Card

New From Northgate... 20 MHz Powered Up



Color monitor shown available as option.

Buy now...
no payments
for 90 days!
When charged to
your Big TV card.
See credit offer
for details.

Yes, we're a bit late to the party with SX systems. How come? We just couldn't bring ourselves to market another ho-hum SX.

So we put our research and development team on it. Boy, did they rise to the challenge! Now you can get an SX 16 or 20 MHz machine with the power to run Microsoft® Windows™ and other 32-bit software at flashing cache-enhanced speeds. And, they packaged all this power and performance into our

exclusive space-saving case—a favorite of Northgate customers!

The secret to SlimLine's space-saving design? A fully integrated motherboard designed and manufactured by Northgate! This design reduces bus load—makes the system faster and more reliable!

Motherboard features include a built-in VGA adapter (with 256K video RAM), one parallel and two serial ports, fully integrated floppy disk

controller and IDE hard drive controller. Motherboard integration also makes it easier to install modems and add-on cards.

SlimLine's triple cache boosts performance to zero wait state! You get a built-in 64K memory SRAM cache to accelerate the execution of instructions; PLUS, hard drive caching to accelerate I/O transactions; and disk caching software to speed data to and from the CPU!

SlimLine™ 386SX 16 Or With 64K Cache!

Plus! Northgate pumps up trial offer. . . now use SlimLine SX for 60-days RISK-FREE!

Unbeatable service! Your SlimLine 386SX is backed by toll-free technical support, 24 hours-a-day, 7 days-a-week. PLUS, FREE on-site service to most locations for one year if we can't solve your problems over the phone. And if you ever need a replacement part, we'll ship it overnight — at our expense — before you return your part.

*PC Magazine** says:
“... Northgate stops
at nothing to please
its customers.”

Of course, you also get Northgate's full-year warranty on parts; five years on the *OmniKey*® keyboard. It's no

wonder *PC Magazine* reported:
“If you're looking for the subjective winner for customer loyalty, Northgate takes first prize.”

Now use SlimLine for 60-days — Risk Free! It won't take you 60 days to recognize the excellent quality of SlimLine SX. But we don't want to rush you. Take your time putting SlimLine to the test. If you aren't completely satisfied after 60 days, you can return it. Northgate guarantees your satisfaction. Order Today!

SlimLine 386SX VGA Monochrome System Features:

- 16 or 20MHz Intel® 80386SX processor
- 1Mb of 32-bit DRAM (expandable to 8Mb on motherboard — 16Mb using 16-bit memory boards)
- Down-scaled, U.S.-made motherboard
- 40Mb IDE hard drive; AT bus interface; 1:1 interleave; DisCache: 32K look ahead disk caching; 19ms access
- 64K SRAM memory cache; read/write-back caching
- High density 1.2Mb 5.25" and 1.44Mb 3.5" floppy drives; also read/write low density disks
- Five open expansion slots; three full length 16-bit and two half length 8-bit
- 16 or 20MHz 80387SX and Weitek coprocessor support
- One parallel and two serial ports
- Built-in 16-bit SVGA with up to 1024 x 768 resolution; 256K video memory
- Clock/calendar chip rated at 5 years
- 100 watt power supply
- Small footprint SlimLine case with room for two exposed and one internal half-height devices
- Front mounted system reset and high/low speed controls
- Exclusive Northgate *OmniKey* keyboard
- 12" VGA monochrome monitor
- MS-DOS 4.01 and GW-BASIC software installed
- On-line User's Guide to the system and MS-DOS 4.01
- QA Plus diagnostic and utility software
- Smartdrive disk caching software
- 1 year warranty on system parts and labor; 5 years on keyboard
- FCC Class B Certified
- Other configurations available, just ask!

16 MHz System **\$1999⁰⁰**

20 MHz System **\$2199⁰⁰**

Delivered to your home or office.
Call for other configurations and pricing.

EASY FINANCING: Easy payment options. Use your Northgate Big 'N', VISA, MasterCard ... or lease it. Up to five-year terms available.

CALL TOLL-FREE 24 HOURS EVERY DAY

800-548-1993

New...FAX your order toll-free! **800-323-7182**

Notice to the Hearing Impaired: Northgate has TDD capability. Dial 800-535-0602.

 **NORTHGATE COMPUTER SYSTEMS** "We hear you!"

7075 Flying Cloud Drive, Eden Prairie, MN 55344

*PC Magazine Sept. 25, 1990. ©Copyright Northgate Computer Systems, Inc. 1990. All rights reserved. Northgate, *OmniKey* and the Northgate 'N' logo are registered trademarks of Northgate Computer Systems. 80386 and 80486 are trademarks of Intel. All other products and brand names are trademarks and registered trademarks of their respective companies. Prices and specifications subject to change without notice. Northgate reserves the right to substitute components of equal or greater quality or performance. All items subject to availability. We support the ethical use of software. To report software copyright violations, call the Software Publishers Association's Anti-Piracy Hotline at 1-800-388-FR8.

Northgate® Announces...

SlimLine™ 386/33

Plus! A new 60-day no-risk trial!



First time ever! Now you can have Northgate Elegance™ power, speed and performance in our popular space-saving SlimLine case! Elegance 386 computers shocked the industry with a #1 and #2 sweep of *InfoWorld's* 1989 best product awards; AND three Editors' Choice awards from *PC Magazine*.

Cache! Cache! Cache! Like our powerful Elegance systems, Slimline 386 features 64K SRAM

cache to zip through the execution of instructions. For even more speed, we've added a hard drive cache that makes short work of I/O transactions. To top it off, SlimLine 386 comes with Smartdrive DOS disk caching software that anticipates the information you'll need and brings it into the cache for fast access.

Better features across the board! SlimLine's motherboard is fully integrated, allowing

maximum system features in the smallest possible space. There's room for up to 16Mb of 32-bit RAM, one parallel and two serial ports, a built-in floppy disk controller and IDE hard drive controller. Plus an integrated SVGA video with 512K video RAM to speed bus throughput — makes the system faster and more reliable! And there's plenty more room for add-on peripherals — with SlimLine you get five open expansion slots.

Cache System!

SlimLine 386 comes with Intel®'s 386DX 33MHz processor. For faster math-based applications — budgets, forecasts, spreadsheets and databases — it features 80387 coprocessor support for adding floating point unit (FPU) speed enhancements.

All purpose system! SlimLine Cache is the perfect network workstation or stand-alone system for business and home use. It also provides excellent support for advanced desktop publishing and graphics applications.

Or select our SlimLine 386 SVGA Color System — the same great features as the mono system plus:

- 200 Mb hard drive — 15ms access
- 14" SVGA 1024 x 768 color monitor

FREE Performance Software Package with SVGA color system purchase!

Limited time only! Select Northgate's SVGA color system and you'll get Samna® Ami™ Professional word processing and Informix® Wingz™ graphics spreadsheet — FREE!

Industry's finest 24-hour toll-free technical support! Your SlimLine 386 Cache is backed by expert technical support any time you need it. Call toll-free, 7 days a week, 24 hours a day. PLUS, free on-site next day service to

most locations if we can't solve your problems over the phone.

More great support! Your new SlimLine 386 Cache also comes

SlimLine 386 Mono System Features:

- 33MHz Intel® 80386DX processor
- 4Mb of 32-bit DRAM (expandable to 16Mb on motherboard)
- Down-scaled, U.S.-made motherboard
- 40Mb fast access hard drive; AT bus interface; 1:1 interleave; 32K look ahead disk caching
- 64K SRAM memory cache; read/write-back caching
- High density 1.2Mb 5.25" and 1.44Mb 3.5" floppy drives; also read/write low density disks
- Five open expansion slots; three full length 16-bit and 2 half length 8-bit
- 25 or 33MHz 80387 or Weitek coprocessor support
- One parallel and two serial ports
- Built-in 16-bit SVGA with up to 1024 x 768 resolution; 512K video memory
- Clock/calendar chip rated at 5 years
- 100 watt power supply
- Small footprint SlimLine case with room for two exposed and 1 internal half-height devices
- Front mounted reset and high/low speed controls
- Exclusive Northgate *OmniKey* keyboard
- 12" VGA monochrome monitor
- Microsoft® Windows™ 3.0 and mouse
- MS-DOS 4.01 and GW-BASIC software installed
- On-line User's Guide to the system and MS-DOS 4.01
- QA Plus diagnostic and utility software
- Smartdrive caching software
- 1 year warranty on system parts and labor; 5 years on keyboard
- FCC Class B Certified

with a one year warranty on parts and labor; five years on the *OmniKey* keyboard. And, if a part fails, we'll ship a replacement to you overnight at our expense — before you return your part!

Now use SlimLine for 60 days — Risk Free! We're sure you'll want to keep your SlimLine Cache — so we won't rush you. Put it to the test in your office or home for a full 60 days. If it doesn't live up to everything we say, return it for a full refund — no questions asked.

Order Today! Ask About Custom Configurations.

Monochrome System

\$2999⁰⁰

SVGA Color System \$3999⁰⁰

Delivered to your home or office

EASY FINANCING: Easy payment options. Use your Northgate Big 'N', VISA, MasterCard... or lease it. Up to five-year terms available.

CALL TOLL-FREE 24 HOURS EVERY DAY

800-548-1993

New! Fax your order toll free! **800-323-7182**

Notice to the Hearing Impaired: Northgate has TDD capability. Dial 800-535-0602.

 NORTHGATE
COMPUTER
SYSTEMS

"We hear you!"

7075 Flying Cloud Drive, Eden Prairie, MN 55344

© Copyright Northgate Computer Systems, Inc. 1990. All rights reserved. Northgate, *OmniKey* and the Northgate 'N' logo are registered trademarks of Northgate Computer Systems. 80386 and 80486 are trademarks of Intel. All other products and brand names are trademarks and registered trademarks of their respective companies. Prices and specifications subject to change without notice. Northgate reserves the right to substitute components of equal or greater quality or performance. All items subject to availability. We support the ethical use of software. To report software copyright violations, call the Software Publishers Association's Anti-Piracy Hotline at 1-800-388-PIR8.

Northgate® Elegance™ 386™/33 System...

Now! Northgate Slashes Price... Doubles No-Risk Trial To 60 Days!

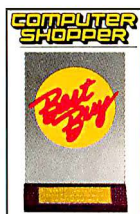

**Buy now...
no payments
for 90 days!**
When charged to
your Big 'N' card.
See credit offer
for details.



Award winning 386 performance! Sizzling Northgate Elegance 386/33 and 386/25 systems won *PC Magazine* Editors' Choice awards, were rated #1 and #2 products (respectively) in *InfoWorld* AND received *Computer Shopper* "Best Buy" recognitions. No other company can make that claim! Here's how we did it!

Elegance 386's high performance motherboard is designed and manufactured by Northgate. With a 16Mb 32-bit DRAM capacity, it's consistently rated in the top 1% of performance — at 25 and 33MHz, Elegance 386 is the fastest in its class!

Tri-caching started here! Elegance was Northgate's first triple caching machine. It comes with 64K read write-back SRAM cache to accelerate the execution of instructions. (Northgate exclusive 256K system cache available.) A 32K hard drive cache controller accelerates I/O transactions while Smartdrive DOS disk caching software increases overall system throughput.

Zip through demanding programs. Multi-stage caching easily handles even a heavy overhead of video programs, I/O intensive tasks, network servers, large data bases and advanced desktop publishing programs.

Desktop or tower... your choice! Elegance 386 comes standard in our elegant five bay desktop case. Our popular seven bay tower case is also available. Either way, you get plenty of room for all kinds of I/O boards, and internal/external peripherals.

Start with our monochrome system! Northgate uses a modular approach that lets you add the components you need. Northgate's Elegance 386 mono system includes 4Mb of RAM, a 40Mb fast access hard drive, 1.2Mb 5.25" and 1.44Mb 3.5" floppy drives, a 14" high resolution monochrome monitor and our exclusive *OmniKey*® keyboard.

PC Magazine said: Elegance "combines top performance, good components and aggressive pricing...an excellent performer all around."*

Tell us what you need . . . we'll build your system! Performance options include: hard drives up to 1.2 gigabytes with 15ms access; VGA and SVGA color cards and monitors; Intel and Weitek math coprocessors; CD ROM and optical drives; tape backups; printers and a host of others!

Industry's finest 24-hour toll-free technical support! Your Elegance 386 is backed by expert technical support any time you need it. Call toll-free, 7 days a week,

24 hours a day. PLUS, free on-site next day service to most locations if we can't solve your problems over the phone.

Elegance 386 is backed by a one year warranty on parts and labor; five years on the *OmniKey* keyboard. If a part fails, we'll ship a replacement to you overnight at our expense — before you return your part!

Now! Use Elegance 386/25 or 33MHz RISK FREE for 60 days! If it fails to meet your expectations, return it. No questions asked.

Select our Elegance 386 SVGA Color System! We took our popular Mono System and added even more power-packed features! You get:

- Super-fast 200Mb Maxtor hard drive with 15ms access
- 14" SVGA 1024 x 768 color monitor
- 16-bit SVGA adapter with 512K video memory

FREE PERFORMANCE Software Package with SVGA color system purchase!

Limited time only! Select Northgate's SVGA color system and you'll get Samna® Ami™ Professional word processing and Informix® Wingz™ graphics spreadsheet — FREE!

ORDER TODAY! ASK ABOUT CUSTOM CONFIGURATION.

25MHz Monochrome System

\$2799⁰⁰

SVGA Color System \$3999⁰⁰

33MHz Monochrome System

\$3099⁰⁰

SVGA Color System \$4299⁰⁰

Delivered to your home or office

EASY FINANCING: Easy payment options. Use your Northgate Big 'N', VISA, MasterCard ... or lease it. Up to five-year terms available.

CALL TOLL-FREE 24 HOURS EVERY DAY

800-548-1993

New...FAX your order toll-free! **800-323-7182**

Notice to the Hearing Impaired: Northgate has TDD capability. Dial 800-535-0602.

 **NORTHGATE COMPUTER SYSTEMS** "We hear you!"

7075 Flying Cloud Drive, Eden Prairie, MN 55344

Elegance 386 Monochrome System Features:

- 25 or 33MHz Intel® 80386DX processor
- 4Mb of 32-bit RAM (expandable to 8Mb on motherboard; total system RAM of 16Mb with optional 32-bit memory card)
- U.S.-made motherboard
- 40Mb fast access hard drive; 16-bit controller with 1:1 interleave; 32K disk read-look-ahead cache buffer
- 64K SRAM memory cache; read/write-back caching
- High density 1.2Mb 5.25" and 1.44Mb 3.5" floppy drives; also read/write low density disks
- Eight expansion slots; one 32-bit slot; six 16-bit and one 8-bit slot
- Weitek math coprocessor support
- One parallel and two serial ports
- Hercules compatible video adapter
- Clock/calendar chip rated at 5 years
- 200 watt power supply (220 watt power supply in tower case)
- Desktop case with room for three exposed and 2 internal half-height devices; optional seven bay tower case has room for three exposed and four internal half-height devices
- Front mounted reset and high/low speed controls
- Exclusive Northgate *OmniKey* keyboard
- 14" high resolution monochrome monitor
- Microsoft® Windows™ 3.0 and mouse
- MS-DOS 4.01 and GW-BASIC software installed
- On-line User's Guide to the system and MS-DOS 4.01
- QA Plus Diagnostic and Utility software
- 1 year warranty on system parts and labor; 5 years on keyboard
- FCC Class B Certified

*PC Magazine, October 31, 1989

© Copyright Northgate Computer Systems, Inc. 1990. All rights reserved. Northgate, *OmniKey* and the Northgate 'N' logo are registered trademarks of Northgate Computer Systems. 80386 and 80486 are trademarks of Intel. All other products and brand names are trademarks and registered trademarks of their respective companies. Prices and specifications subject to change without notice. Northgate reserves the right to substitute components of equal or greater quality or performance. All items subject to availability. We support the ethical use of software. To report software copyright violations, call the Software Publishers Association's Anti-Piracy Hotline at 1-800-388-PIR8.

New Northgate® Elegance 486i™ System...

“Editors’ Choice” said *PC Magazine!**

(Adding: “Northgate stops at nothing to please its customers...97% would buy again!”**)

InfoWorld labs scored it 9.1-top rating ever!†

Incredible power and unmatched performance at a price you'd expect to pay for a 386™!

\$5199⁰⁰

Delivered to Your Home or Office

Whether 80286, 386 or 486 technology, Northgate consistently brings you top rated systems. Our value and performance is unexcelled when you look at the experts' opinions. Northgate is a company in which you can place your trust — perhaps our most important advantage!

In January, 1988, Northgate won its first Editors' Choice for the 286/12 SuperMicro. Northgate leadership prevailed again when *PC Magazine* benched 386 systems. One couldn't do better. Three Editors' Choice — one for each speed in our Elegance line of 20, 25 and 33MHz systems. Northgate is the only company who can make this claim!

PC Magazine then called for 486 ISA systems for review. Result: there was no question about it. “Only one machine stands out,” they said, “you could pay less for a 486 system, but not get the bonuses that are offered with the Elegance.”*

Along the way, we added another Editors' Choice of our *OmniKey*® keyboard. There you have it...

A record five Editors' Choice Awards in one year's time!



About the same time, the tough testers at *InfoWorld* were thoroughly and methodically examining Elegance 486i. They reported you could buy the next highest ranked system (scoring 8.2 vs. our 9.1) but you'd also pay three times as much!†

InfoWorld's editors concluded that Northgate's 486i “leads the pack by a comfortable margin. It offers impressive performance, exceptional expandability and it is tops in support and value.”†

InfoWorld showed Elegance 486i leading the pack again as a network file server and stand-alone system as well.

And, as if we had planned it, *PC Magazine* came along with its Service and Reliability issue in which Northgate's dedication to

customer support was well evidenced. “As we learned more about its service policies, it became clear that Northgate stops at nothing to please its customers.” No wonder “Northgate was the hands-down winner when it came to customer loyalty.”**

That's the story. Designed and built to perform. Proven by the industry's most demanding testing. Fairly priced. And backed by people with a passion to serve you with a support policy that inspired one magazine columnist to say:

“What WordPerfect is to software support, Northgate is to hardware and there are even a few things that WordPerfect could learn from the folks in Minneapolis. Northgate is fast becoming the Nordstrom of the computer world.”††



NOW! Northgate leads the pack again with a new 60-day no-risk trial!

The secret to Northgate's state-of-the-art power! The 486 processor combines the capabilities of an enhanced 386, an advanced internal cache controller and 8K of supporting static cache memory. The chip also incorporates an enhanced 387 FPU (Floating Point Unit). You get increased performance for the most demanding math-based applications.

Northgate caching enhancements give you greater speed! We've added a 64K read write-back SRAM cache (Northgate exclusive 256K system available) to further accelerate the execution of instructions. I/O transactions are faster than ever thanks to a 32K hard drive cache controller. Finally, we armed Elegance 486/25 with Smartdrive DOS disk caching

software. Result? Processing speed you must see to believe!

Elegance 486i ISA is the perfect high performance graphics/software workstation or network server. Its multi-stage caching is an excellent match for tough number-crunching operations.

Look at everything you get! Elegance 486i comes complete with the spectacular 100Mb super-fast hard drive! This hard drive operates so quietly only the flashing red light tells you it's running.

PLUS, you get 4Mb of RAM, 1.2Mb 5.25" and 1.44Mb 3.5" floppies, desktop case, 14" SVGA color monitor with 1024 x 768 resolution, 16-bit SVGA video adapter with 512K memory and exclusive *OmniKey*®

keyboard. We've even included Microsoft® Windows™ 3.0 and a mouse!

FREE Performance Software Package with SVGA color system purchase!

Limited time only! Select Northgate's SVGA color system and you'll get Samna® Ami™ Professional word processing and Informix® Wingz™ graphics spreadsheet — FREE!

Support power! Elegance 486i ISA is backed by expert toll-free technical support 24 hours a day, seven days a week. PLUS, free on-site next day service to most locations if we can't solve your problems over the phone AND a 1 year parts and labor warranty; 5 years on *OmniKey*® keyboard.

Northgate doubles no-risk trial offer! We're so sure you'll love Elegance 486i, we'll let you use it RISK FREE for 60 days! If it fails to meet your expectations, return it for a full refund. No questions asked!

ORDER TODAY! ASK ABOUT CUSTOM CONFIGURATIONS.

Complete SVGA Color System

ONLY \$5199⁰⁰

EASY FINANCING: Easy payment options. Use your Northgate Big 'N', VISA, MasterCard ... or lease it. Up to five-year terms available.

**CALL TOLL-FREE
24 HOURS EVERY DAY
800-548-1993**

New! Fax your order toll free! 800-323-7182

Notice to the Hearing Impaired: Northgate has TDD capability. Dial 800-535-0602.



7075 Flying Cloud Drive, Eden Prairie, MN 55344

Elegance 486i SVGA Color System Features

- ◆ 25MHz Intel® 80486 processor
- ◆ 4Mb of 32-bit RAM (expandable to 8Mb on motherboard; total system RAM of 16Mb with optional 32-bit memory card)
- ◆ U.S.-made motherboard
- ◆ 100Mb IDE hard drive; 16-bit controller with 1:1 interleave; 32K disk read-look-ahead cache buffer
- ◆ 64K SRAM memory cache; read/write-back caching
- ◆ High density 1.2Mb 5.25" and 1.44Mb 3.5" floppy drives; also read/write low density disks
- ◆ Eight expansion slots; one 32-bit slot; six 16-bit and one 8-bit slot
- ◆ Weitek math coprocessor support
- ◆ One parallel and two serial ports
- ◆ 14" SVGA color monitor with 1024 x 768 resolution
- ◆ 16-bit SVGA adapter with 512 K video memory
- ◆ Clock/calendar chip rated at 5 years
- ◆ 200 watt power supply (220 watt power supply in tower case)
- ◆ Desktop case with room for 3 exposed and 2 internal half-height devices
- ◆ Front mounted reset and high/low speed controls
- ◆ Exclusive Northgate *OmniKey* keyboard
- ◆ MS-DOS 4.01 and GW-BASIC software installed
- ◆ On-line User's Guide to the system and MS-DOS 4.01
- ◆ QA Plus Diagnostic and Utility software
- ◆ Microsoft Windows 3.0 and mouse
- ◆ 1 year warranty on system parts and labor; 5 years on keyboard
- ◆ Unlimited 24-hour toll-free technical support
- ◆ FCC Class B Certified

Select the options you need... let Northgate custom build them into your system today!

- ◆ Hard drives up to 1.2 gigabytes
- ◆ Laser quality and dot matrix printers
- ◆ Tape back up devices
- ◆ SVGA color monitors and cards
- ◆ Floppy, CD ROM and optical drives
- ◆ Weitek coprocessors
- ◆ Modems

©Copyright Northgate Computer Systems, Inc. 1990. All rights reserved. Northgate, *OmniKey* and the Northgate 'N' logo are registered trademarks of Northgate Computer Systems. 80386 and 80486 are trademarks of Intel. All other products and brand names are trademarks and registered trademarks of their respective companies. Prices and specifications subject to change without notice. Northgate reserves the right to substitute components of equal or greater quality or performance. All items subject to availability. We support the ethical use of software. To report software copyright violations, call the Software Publishers Association's Anti-Piracy Hotline at 1-800-388-1PR8.
*PC Magazine, September 11, 1990 *PC Magazine, September 25, 1990
†PC World, July 30, 1990 †Computer Currents, August, 1990

Reviewer's Notebook provides new information—including version updates, new test data, long-term usage reports, and reader feedback—on products previously reviewed in *BYTE*.

A Colorful Luggable



Although the Dolch C-P.A.C. 486-25 can produce only eight colors, the screen is bright and clear, and the colors are adequate for many CAD applications.

High-powered portables are nothing new; luggable 386s have been around almost as long as their desktop-bound cousins. But while desktop 386 and 486 systems have supported high-end color graphics from the start,

portables have generally been limited to low-contrast, 1-bit LCDs or gas-plasma displays.

Dolch's new C-P.A.C. color portable brings color to the high-end portable, and it does it brilliantly. I looked at the color display option on a P.A.C. 486-25 (see "World's Fastest Lunchbox," May *BYTE*). Unfortunately, the price of the display is too high to make this—or any machine that uses the current generation of color LCDs—much more than a novelty.

A Hitachi thin-film transistor LCD array forms the foundation for the Dolch display. The backlit TFT, or active-matrix, display, generates a bright, uniformly high-contrast image at VGA resolutions.

Each pixel is made up of three LCD elements that are sandwiched between two polarizing filters. Each element in the pixel group looks out through a different color filter—one red, one blue, and one green. A fluorescent backlight shines white light through the pixel groups.

When in the off state, the LCD elements twist light that is polarized by the rear filter so that the light cannot pass through the forward filter. When you apply a current to the LCD elements, they straighten out, and the light can pass

through unimpeded. By turning different combinations of the red, green, and blue elements on and off, you can get eight colors.

Active-matrix technology uses a transistor for each element to switch current on and off and to maintain current while the LCD controller is addressing other elements. The result is a high-contrast, high-speed display: Dolch claims that the screen updates in 40 milliseconds, compared to 300 ms for passive-matrix designs.

Although the C-P.A.C. provides only eight colors, it supports all the VGA modes except mode 19, which is 320 by 200 pixels by 256 colors. The 16-color modes simply lose eight colors. The video circuitry "thresholds"—in other words, it decides whether, for example, the shade of green that the software wants to display is closer to bright green or to black, and then outputs the appropriate color.

This leads to weird effects in Windows, which uses a lot of grays in the default palette. The C-P.A.C. sees most of Windows' grays as white, so grayed-out menu choices and icons can disappear into the background.

Dolch is working on a driver that will limit Windows to the eight available colors. Meanwhile, the company suggests that current users simply modify the default palette.

However, the Dolch C-P.A.C. will probably find its biggest market among CAD users, and for this application there should be no problems. AutoCAD ran fine, and the display is easily fast enough to display pointer movements without blurring. In addition, since most CAD drawings use only a few bold colors, the eight-color limitation is not a major drawback.

At just under \$4000, the portable color display is definitely only for applications for which color is essential. However, if LCD production yields improve, as many are predicting, the era of the personal, portable color computer may not be so very far off. The Dolch C-P.A.C. provides a glimpse of a bright future for portables.

—Steve Apiki

Dolch C-P.A.C. 486-25



Company

Dolch Computer Systems
2029 O'Toole Ave.
San Jose, CA 95131
(408) 435-8260

Components (as tested)

Processor: 25-MHz i486 CPU
Memory: 8 MB of RAM
Mass storage: 200-MB Intelligent Drive Electronics hard disk drive; 3½-inch 1.44-MB floppy disk drive
Display: TFT color
Keyboard: 84-key IBM AT-style with 12 function keys
I/O interfaces: One serial port; one parallel port

Price

Monochrome system: \$12,995
TFT color screen option: \$3995

Inquiry 1075.

Order Your Northgate[®] Computer Today, Make No Payments For 90 days!*

Just say "charge it"
to your Big 'N'
credit card!

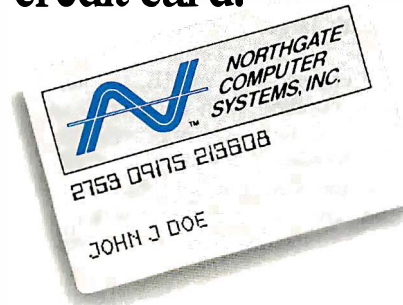

Get your new Northgate without
spending a penny this year!

Simply fill in the Big 'N' information
form and send it to Northgate. You'll
get prompt attention! Once you're
approved, call our systems consultants,
toll-free, to select the Northgate
configuration that perfectly matches
your needs!

You'll free your other credit cards!
Big 'N' lets you easily increase your
credit power. Best of all, you'll make
no payments for your new computer
for 90 days after shipment! But, don't
delay, computers must be ordered
by December 31, 1990 to qualify for
deferred billing!

Northgate leases systems too!
Choose from flexible terms up to five
years in length. It's never been easier
to get Northgate computer systems
than it is now!

Call Northgate Now!
800-548-1993
HOURS: Monday - Friday 7 a.m. - 8 p.m. CST

NORTHGATE
COMPUTER
SYSTEMS
7075 Flying Cloud Drive, Eden Prairie, MN 55344

OPEN YOUR CREDIT CARD ACCOUNT BY FILLING OUT THE APPLICATION BELOW.

Please complete all appropriate sections, providing at least two years residence and employment history. If you are self-employed, please be sure to complete section d. **THIS IS NOT A CREDIT AGREEMENT!** One will be sent to you upon authorization of an account. (This Form Must Be Signed To Process Your Order.) All Financed Purchases Are Subject To Credit Approval. If You Have Any Credit Questions, Please Call For Assistance. Thank You!

A married person may apply for individual credit. I am applying for (check one box, please):

- JOINT CREDIT with another person. Complete entire application.
 INDIVIDUAL CREDIT complete only individual section.
 INDIVIDUAL CREDIT but rely on income of another. Complete entire application.

*If you are a married Wisconsin applicant, you must provide your spouse's information as indicated, even though your spouse may not be signing the contract.

NOTICE TO WISCONSIN APPLICANTS
You must disclose your marital status:
 married
 unmarried
 legally separated

a. Personal Information

NAME _____ HOME PHONE (____) _____
SOCIAL SECURITY NUMBER _____ DATE OF BIRTH ____ / ____ / ____
PRESENT ADDRESS _____ CITY _____ ST _____ ZIP _____
DATE OF RESIDENCE MO. _____ YR. _____ BUY RENT OTHER _____
PREVIOUS ADDRESS _____
EMPLOYER _____ DATE OF EMPLOYMENT MO. _____ YR. _____
MONTHLY GROSS SALARY \$ _____ BUSINESS PHONE (____) _____
PREVIOUS EMPLOYER _____ DATES OF EMPLOYMENT _____ TO _____

Income from alimony, child support or separate maintenance payments need not be disclosed if you do not wish to have it considered as basis for repaying the obligation.

ADDITIONAL MONTHLY INCOME \$ _____ SOURCE _____

b. Credit Information

PLEASE TELL US IF YOU HAVE: CHECKING ACCOUNT (Y/N) _____ SAVINGS ACCOUNT (Y/N) _____
BANK LOAN (Y/N) _____ HOW MANY? _____ VISA (Y/N) _____ HOW MANY? _____
MASTERCARD (Y/N) _____ HOW MANY? _____ FINANCE COMPANY LOAN (Y/N) _____ HOW MANY? _____
DEPT. STORE CHARGE CARD (Y/N) _____ HOW MANY? _____ CREDIT UNION ACCOUNT (Y/N) _____ HOW MANY? _____
OTHER MAJOR CHARGE CARDS (Y/N) _____ HOW MANY? _____

c. Joint Applicant's Personal Information

JOINT APPLICANT'S NAME _____ HOME PHONE (____) _____
SOCIAL SECURITY NUMBER _____ DATE OF BIRTH ____ / ____ / ____
ADDRESS _____ CITY _____ ST _____ ZIP _____
DATE OF RESIDENCE MO. _____ YR. _____
JOINT APPLICANT'S EMPLOYER _____ DATE OF EMPLOYMENT MO. _____ YR. _____
MONTHLY GROSS SALARY \$ _____ BUSINESS PHONE (____) _____
NAME AND ADDRESS OF NEAREST RELATIVE NOT LIVING WITH YOU _____
RELATIONSHIP _____

d. Self-Employment Information

BUSINESS NAME _____ BUSINESS PHONE (____) _____
TYPE OF BUSINESS Proprietorship Partnership Corporation IN BUSINESS SINCE _____
YOUR ANNUAL INCOME FROM BUSINESS Gross \$ _____ Net \$ _____
PERSONAL BANKER'S NAME _____ BANKER'S PHONE (____) _____

e. Customer Authorization

I authorize Northgate Computer Systems or its assignees to investigate credit records and to report my performance hereunder to credit agencies. I hereby certify that the following information is furnished to you for the purpose of obtaining credit and is true and correct of the best of my knowledge and belief. There are costs associated with the use of this credit card. To obtain more information about these costs, call us at 1-800-548-1993 or write to P.O. Box 59080, Minneapolis, MN 55459-0080.

NY—A consumer credit report may be requested in connection with this application or in connection with updates, renewals or extensions of any credit granted as a result of this application. If I subsequently ask for this information, I will be informed whether or not such a report was requested and, if so, the name and address of the agency that furnished the report.

OH—THE OHIO LAWS AGAINST DISCRIMINATION REQUIRE THAT ALL CREDITORS MAKE CREDIT EQUALLY AVAILABLE TO ALL CREDIT-WORTHY CUSTOMERS AND THAT CREDIT REPORTING AGENCIES MAINTAIN SEPARATE CREDIT HISTORIES ON EACH INDIVIDUAL UPON REQUEST. THE OHIO CIVIL RIGHTS COMMISSION ADMINISTERS COMPLIANCE WITH THIS LAW.

APPLICANT'S SIGNATURE _____ DATE _____

JOINT APPLICANT'S SIGNATURE _____ DATE _____

FOR MARRIED WISCONSIN APPLICANTS:

I acknowledge that the obligation described herein is being incurred in the interest of my marriage or family.

BUYER'S SIGNATURE _____ DATE _____

*You must request deferred billing when ordering. Payments will be deferred for three billing cycles after shipment. Interest will accrue during the deferred period at a rate of 1.5% per month (18% APR).

This is not an application. A completed application and agreement must be on file prior to approval for credit.

dBASE IV 1.1: Ashton-Tate Answers the Critics

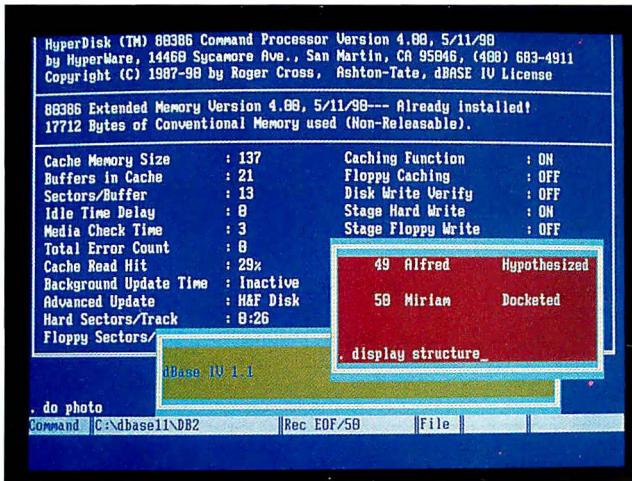

dBASE IV 1.1's new DBCACHE dramatically improves the disk performance of dBASE applications.

It should have been a minor update, one of those software releases sent out to registered users without much fanfare. But given Ashton-Tate's problems with the initial release of its bread-and-butter product, I awaited dBASE IV 1.1 with anticipation and skepticism. Would the new release fix the problems, and

would it allow Ashton-Tate to rebound from its current slide?

Certainly, dBASE IV 1.1 boasts some important improvements. The biggest of these is the revamped memory system. dBASE IV 1.0 ate up so much RAM that it often required extra hardware to run over a network. In some situations, each of the workstations running dBASE required an additional memory card. Version 1.1 has slimmed down, requiring a maximum of 450K bytes at run time (versus 516K bytes for version 1.0). Ashton-Tate claims that the new dynamic Memory Management System (dMMS) can swap program code overlays more efficiently.

dBASE IV 1.1 also includes a DOS environment variable (DBHEAP) that allows you to specify the amount of memory allocated for application space. For large applications, you can set DBHEAP to a higher value, freeing up additional memory for the application. For basic dBASE Control Center operations and for programs with extensive menus or windows, a lower DBHEAP value delivers additional memory for overlay swapping.

The new swapping scheme should translate into improved performance. I ran BYTE's dBASE benchmark suite under both versions of dBASE. Version 1.1 negotiated the delete/pack benchmark and the sort benchmark signifi-

cantly faster than version 1.0 did. The increased speed should be even more noticeable with large, menu-intensive applications.

When I enabled DBCACHE, the new disk cache bundled with each copy of version 1.1, performance improved dramatically. Version 1.1 with DBCACHE halved the indexing time and the delete/pack time, and the sort benchmark ran almost four times faster than under version 1.0.

Ashton-Tate has also made some enhancements to the dBASE language. The most significant of these is the SET DBTRAP command. When you have DBTRAP turned on, it prevents critical errors from occurring when a routine is interrupted. For instance, it will not allow you to start a second Edit session from within a current Edit session.

The SET DBTRAP command can enhance the utility of user-defined functions. The UDF or other interrupt routine can change the dBASE environment, thus confusing the original interrupted program; DBTRAP can resolve such conflicts. And with DBTRAP off, advanced programmers have virtually unlimited control over UDFs.

The INDEX command now supports a FOR clause. The FOR clause limits the index to records meeting certain criteria. Searches are faster, and less disk space is consumed, because the index tracks only those records meeting the defined criteria. And you can now create or modify an index directly from a Browse or Edit screen.

It looks like Ashton-Tate has resolved some of dBASE 1.0's most glaring faults. The decreased RAM demand enhances network support and improves performance. More efficient overlay swapping translates into snappier operation, especially with larger applications. And Ashton-Tate has apparently fixed the bug that caused incorrect results from certain Structured Query Language queries. It looks like a strong product—but will it rebuild Ashton-Tate's reputation as the premier manufacturer of PC databases? Only time and an extensive user community can tell. ■

—Stan Diehl

dBASE IV 1.1



Company

Ashton-Tate
20101 Hamilton Ave.
Torrance, CA 90509
(213) 329-8000

Hardware Needed

IBM PC, XT, AT, PS/2, or compatible with 640K bytes of memory (450K bytes available) and 4 MB of disk space

Software Needed

MS-DOS 2.10 or higher

Price

dBASE IV 1.1: \$795
Developer's Edition: \$1295
LAN Pack: \$995
(Free to registered owners of dBASE IV 1.0)

Inquiry 1077.

SAVINGS CERTIFICATE

This certificate entitles you to **BYTE** at a savings of over 40% off the cover price. You'll also receive the annual IBM PC Special Issue as part of your subscription.

YES! Please send me 1 year (12 issues) for \$24.95. (I'll **save over 40%** off the newsstand cost!)

Payment enclosed

Bill me

No-Risk Guarantee: If dissatisfied, cancel anytime for a full 100% refund. Your subscription will start in 6-8 weeks. Watch for it!

Name

Company

Address

City/State/Zip

IW0D091

BYTE

Save Over
40%



NO POSTAGE
NECESSARY
IF MAILED
IN THE
UNITED STATES

BUSINESS REPLY MAIL

FIRST CLASS MAIL PERMIT NO. 42 HIGHTSTOWN, NJ

POSTAGE WILL BE PAID BY ADDRESSEE:

BYTE

Subscription Department

P.O. Box 558

Hightstown, N.J. 08520-9409



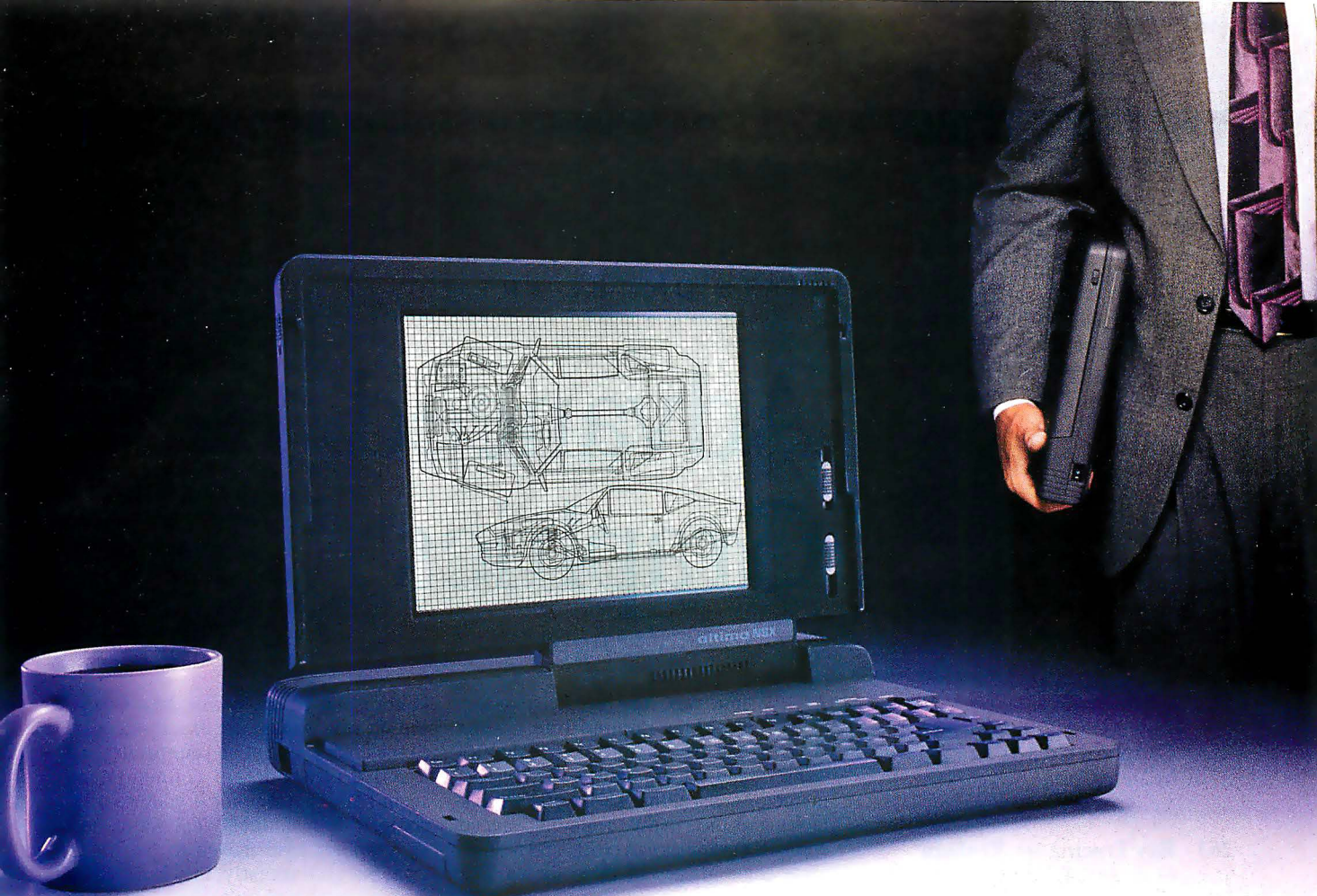

386SX under the hood. Light weight under your arm.

In the computer world, power and speed translate into weight and bulk. That means if you're a person on the go, you'd have to play part-time weight lifter, or be willing to sacrifice megahertz and megabytes.

But now those days are over. Because now there's the Altima NSX notebook computer. It's light. It's sleek. And, oh my, is it powerful.

The 80386SX, 32-bit microprocessor runs at 16 MHz. Plus there are two megabytes of RAM that can expand all the way up to eight. The Altima NSX also has a built-in 1.44 megabyte floppy and a 20 megabyte hard drive.

What's more, all of this is packed into a handsome 9 lb. package that can easily fit inside most briefcases.

So now you don't have to carry your attaché in one

hand, a portable computer in the other, and your airline tickets between your teeth.

But the exciting part is when you begin working. You'll appreciate the exceptional resolution of the paper white LCD display. You'll admire the VGA screen with its 32-level gray scaling. And you'll be pleased knowing that the 2400 baud modem didn't cost you a penny extra.

If all this isn't enough, how about being able to send a FAX? That's right—a FAX. Altima NSX features a send FAX mode capability that'll let any party with a FAX machine receive an actual paper document.

It's obvious that Altima has thought of everything. But what's nicest of all is they thought of you when putting on the price tag.



altima

Altima Systems, Inc., 1390 Willow Pass Rd., Suite 1050, Concord, CA 94520 800/356-9990

Circle 22 on Reader Service Card

STATE OF THE ART

Advanced Graphics

- 253 Graphics Go 3-D**
by Steve Upstill
- 263 Ray Tracing for Realism**
by Andrew S. Glassner
- 275 Color WYSIWYG Comes of Age**
by Frank Vaughn
- 281 True Color for Windows**
by Adam Bellin and Pier Del Frate
- 289 Putting the Squeeze on Graphics**
by Nick Baran
- 297 HDTV Sparks a Digital Revolution**
by Andrew Lippman
- 307 Graphics Engines**

Time was, the words *computer graphics* implied line graphs and bar charts. Now, graphics and photography seem to have merged—at least, that's what you'd think looking at the results. Today, advanced computer graphics can create and manipulate color images in three dimensions with photographic precision and photo-realism.

When you want graphics to convey three dimensions instead of two, there's a lot more involved than just adding a coordinate. The world of three-dimensional images brings with it the added expectation of realism: The images need to resemble real-world objects. In "Graphics Go 3-D," Steve Upstill discusses the challenges involved in creating photo-realistic 3-D images.

One such challenge is ray tracing. Different companies have different methods for handling the effects of light on a scene: shading, light reflection, and color modification. But for a scene or an object to approach the appearance of realism, you must deal, in one way or another, with ray tracing. In "Ray Tracing for Realism," Andrew S. Glassner discusses the concepts and techniques necessary to imitate the effects of various types of light rays on color in a 3-D image.

Color in advanced graphics is another area where significant progress is being made. Putting great colors and a great many colors on the screen has been viable for some time now. In fact, some companies offer more colors than I can even imagine trying to choose from. The chances of being able to match a specific color on the screen are extremely high. But what happens when you print it out? In "Color WYSIWYG Comes of Age," Frank Vaughn shows how to calibrate

your display device so that the colors you see on your screen are exactly the same as the colors you get on your printer.

All this wonderful color talk may seem like a moot point if you use a PC-compatible machine. Workstation-quality graphics have moved to the Macintosh, but until recently, they hadn't made the trek into DOS land. Well, times have changed. Windows 3.0 provides the capability for 24-bit graphics to migrate to PCs. In "True Color for Windows," Adam Bellin and Pier Del Frate show how you can obtain high-quality images in true color on a DOS machine.

And what do you need when you have workstation-quality color graphics? You need tons of storage to hold an image—all that color and high resolution to boot can take literally megabytes for a single image—or some form of image compression. In "Putting the Squeeze on Graphics," Nick Baran investigates the new compression standards that are taking hold for full-color graphics and full-motion video.

Where do graphics go from here? Predictions are hinting loudly at TV, and the bridge between computers and TV is under construction. Have you noticed the number of new TVs touting digital capabilities? And only high-definition TV will meet the needs of high-end computer graphics. In "HDTV Sparks a Digital Revolution," Andrew Lippman describes HDTV and its impact on computer graphics and on the future.

From bar charts to wire-frame models to photo-realism, from low-resolution monochrome monitors to high-resolution color monitors to HDTV—when you're speaking of the graphics world, one line says it all: You've come a long way, baby.

—Jane Morrill Tazelaar
Senior Editor, *State of the Art*

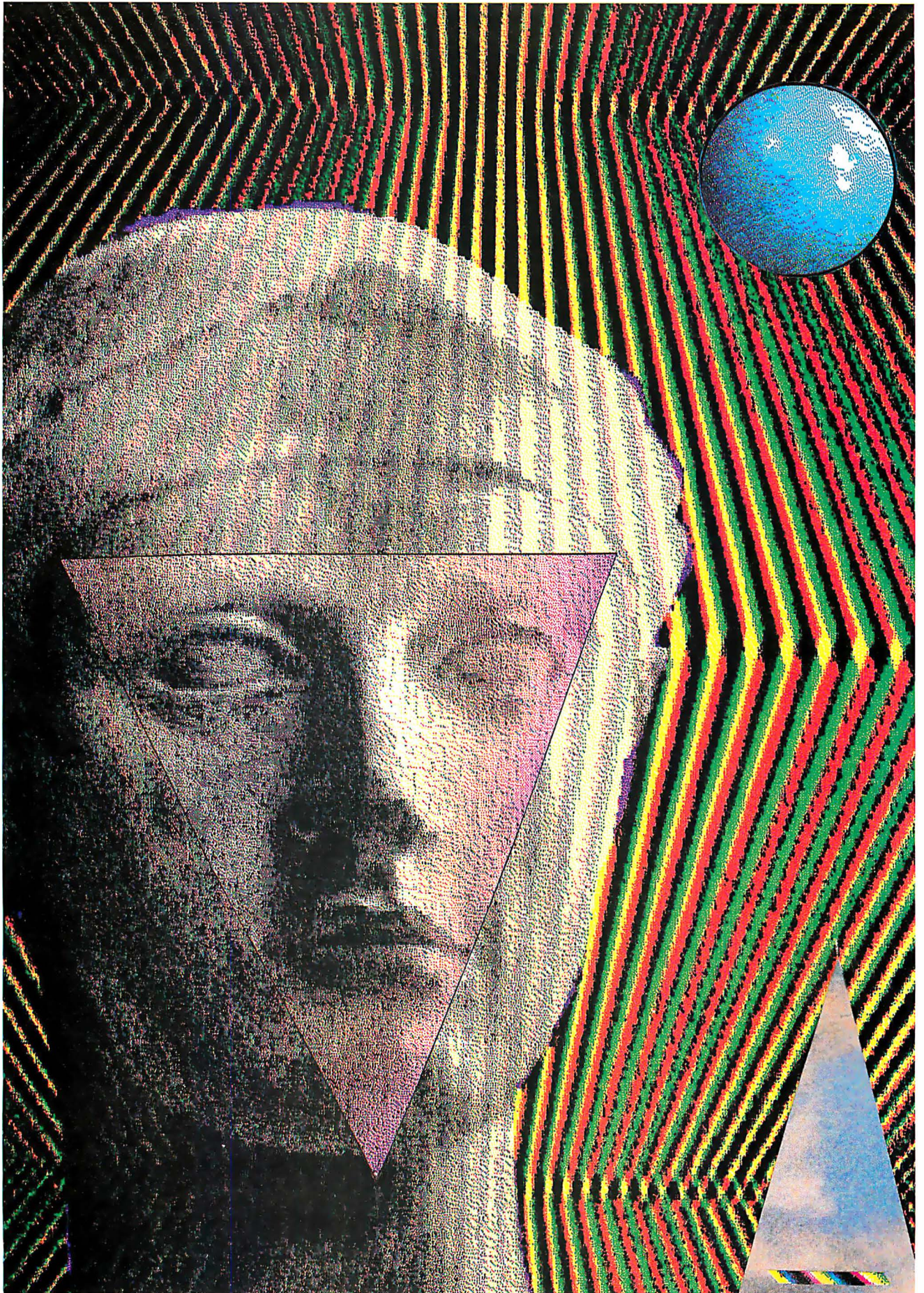

Give your eyes a break.

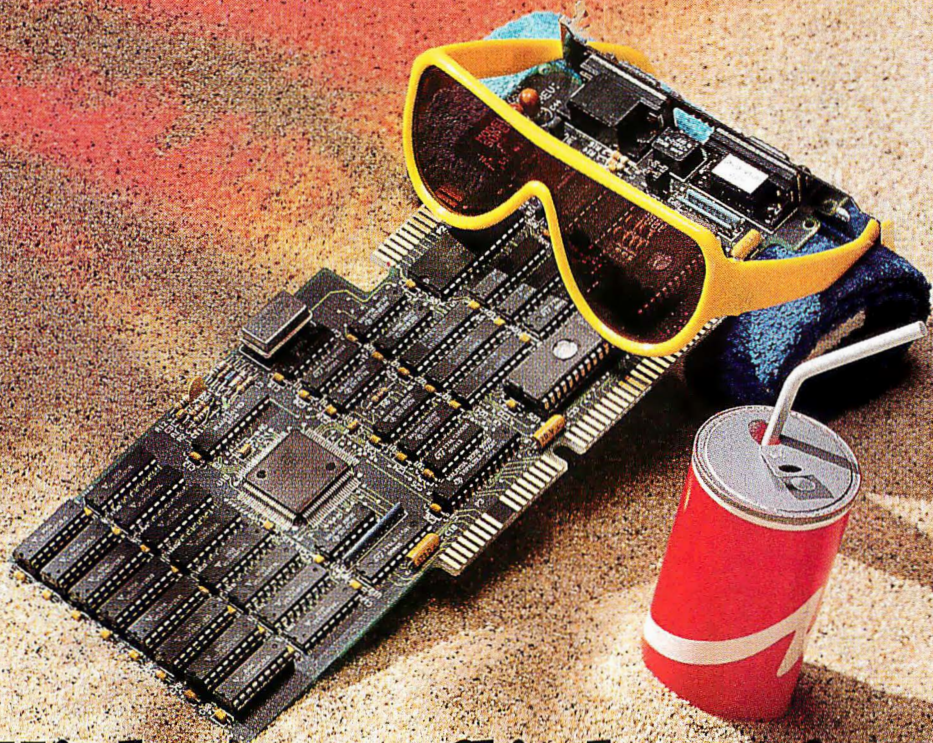

With new flicker-free 1024 x 768 70-Hz SUPERVGA.

Our new VGA card has hi-res color made in the shade. Thanks to its refresh rate of 70Hz and higher, it helps reduce eyestrain. You get the brightest, sharpest, most stable images imaginable. So you aren't left starry-eyed.

You get up to 1024 x 768 resolution in 16 colors, both interlaced and non-interlaced, plus other 256-color modes. All made possible by our proprietary ASIC chip technology.

Genoa's SuperVGA card works with just about everything. With analog and multi-frequency monitors. With PS/2® and PC®/XT®/AT® computers. With most popular software packages. And with all standard operating systems.

To check our specs, call (408) 432-9090 today. Or write Genoa, 75 E. Trimble Road, San Jose, CA 95131, FAX (408) 434-0997, London 44-923-33737, Taiwan 886-02-776-3933.

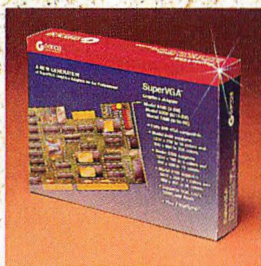

Insist on
Genoa Value.
GENOA

Circle 121 on Reader Service Card

Graphics Go 3-D

Photo-realism demands that 3-D figures look exactly like real-world objects; that's the challenge

Steve Upstill

What's the big deal? 3-D isn't new. Maybe not, but three-dimensional computer-generated photo-realism is. And the tools and techniques to bring this realism to the microcomputer on your desk definitely are.

Going to three dimensions isn't just a matter of incrementing the dimension count by 1. There are fundamental expectations that 3-D graphics must fulfill, because the world that we live in is a 3-D world. For 3-D images to appear real, you must deal with all sorts of challenges that are entirely different from those faced in two dimensions.

The Challenges of 3-D

In the most formal terms, 3-D graphics programs manipulate and create images of entities that are described geometrically, as coordinates in 3-D space. This process becomes more difficult because the 3-D images must be represented on a two-dimensional surface. Any number of programs can put 2-D circles, squares, lines, curves, patterns, and other entities on a 2-D screen or page.

In some sense, a 2-D graphic is complete by itself. You don't expect a busi-



ness bar chart to resemble anything you would see on the street in real life. A rich graphical language for entities in the 2-D world exists (type is one), most business people know how to interpret them, and you don't expect them to be more than they are. On the other hand, 3-D figures only make sense to the extent that they resemble actual things in the real world.

The corollary to this forms the second

difference between two and three dimensions: The expectation of realism means that the surfaces of 3-D entities need correct optical properties to be properly interpreted. In addition, the problem of creating shapes in three dimensions is much more difficult than that of creating 2-D shapes in two dimensions (see photo 1).

While normally you don't need to represent the interiors of 3-D figures, describing the undulations of the surface itself is by definition much harder than creating curves and regions in two dimensions. You're not just putting a curve into a higher dimension, you're also squaring the amount of information involved.

Furthermore, in three dimensions, topology becomes a problem. While curves on a page can be connected arbitrarily, the connection of surfaces without erroneous discontinuities in three dimensions is at best difficult.

Finally, working in three dimensions is tougher than working in two dimensions because you face the problem of manipulating a 3-D world on a 2-D surface. This is more than 50 percent more difficult than manipulating a 2-D entity

Photo 1: A series of steps involved in modeling and rendering a photo-realistic 3-D image: (a) The wire-frame stage; (b) the polygon-fitting stage; (c) the polygon-smoothing result;

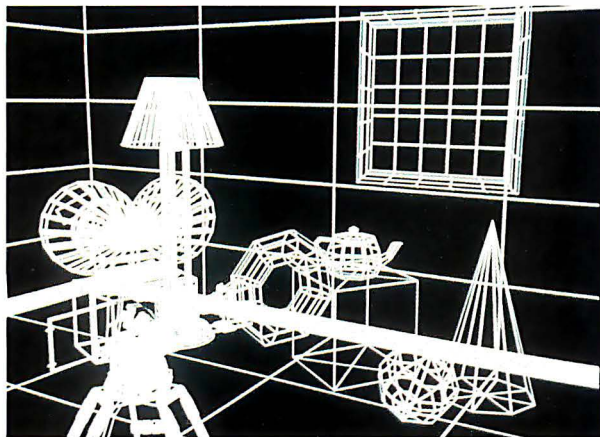

(a)

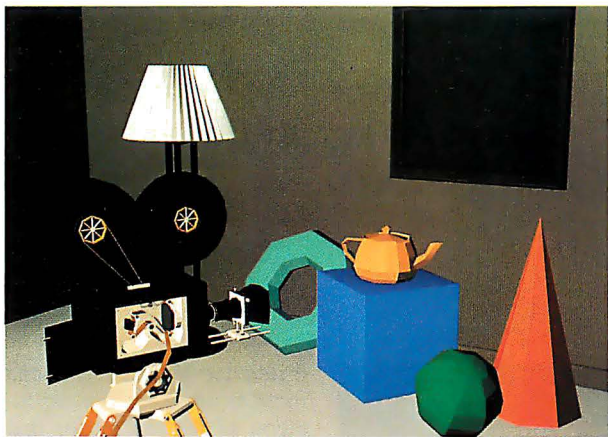

(b) (c)

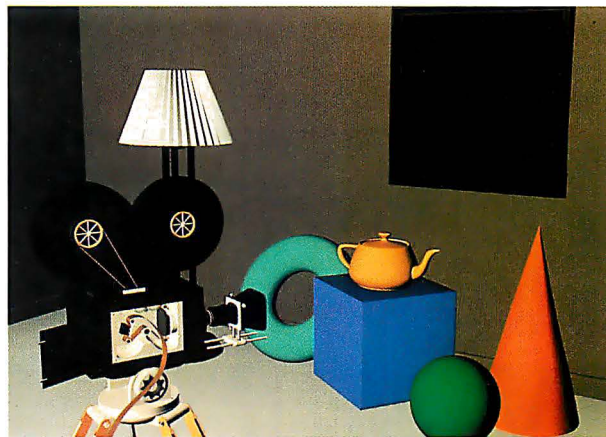

(d) (e)



(d), (e), and (f) show increasing realism due to advanced shading techniques. All these images were created with Pixar's PhotoRealistic RenderMan software and designed by Thomas Williams and H. B. Siegel. (Used by permission from Pixar.)

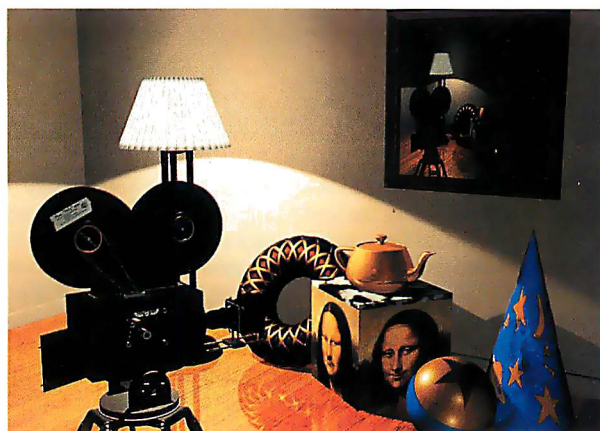

(f)

on its home 2-D surface.

I am enumerating these problems to suggest why 3-D graphics have lingered so long in the background, seemingly poised to move in but never quite able to. The problems are very difficult, and until they are solved (whether or not they are recognized explicitly), the technology will languish regardless of how much hardware support it gets.

Creating 3-D Graphics

Currently, 3-D computer graphics use a mathematical description of objects in space to create an image suitable for viewing on a CRT or in a photograph. (Perhaps someday, interactive holography will allow these surfaces to be viewed more directly, but for now, the problem of converting 3-D graphics to 2-D graphics must be handled.) In the case of 2-D WYSIWYG, graphical manipulation is the same as image creation, but in three dimensions, objects and their images require a two-step process:

- *Modeling*: Creating objects, moving them around to arrange a scene, defining camera and lights, and determining how each object will look (see photo 1a).
- *Rendering*: Making a realistic image out of the resulting geometric description by applying surface characteristics (see photos 1b through 1f).

The Difficulties of Modeling

There are many reasons why 3-D modeling is more difficult than the 2-D analog, but two stand out. Fundamentally, if you're trying to design a 3-D object, you must do it in a fashion similar to a worker who handles highly radioactive material by looking through a window and manipulating a robotic arm. The 3-D designer actually has a harder task, however.

- The uranium handler looks through a window but has the benefit of depth perception and perspective—both eyes work together to provide a sense of depth, and the person's head can be easily moved to provide a different view.
- The uranium handler can see the object itself, not a wire-frame approximation of it; the 3-D graphics modeler must manipulate through a mouse (at best).
- The uranium handler isn't trying to build anything, only to move things around. The most complex task to be faced is opening a container.

Several developments have made it easier to approach interactive modeling. The increasing speed of general-purpose

processors has made it easier to provide appropriate interactivity. When you can make mistakes much faster, you can correct them much faster, too. Just a few years ago, many reasonably priced 3-D displays required a bright yellow flash to reinitialize the screen before redraw.

Still, the compute-intensive nature of even sketching a scene with line segments (projecting a constantly changing set of points from a 3-D scene into a 2-D screen space) means that you must interact with only the crudest representation of your work. It is now the primary re-

When
*you can make mistakes
much faster, you can
correct them
much faster, too.*

sponsibility of software and interactive systems design to improve the state of the art. For example, Symbolics has merged 3-D and 2-D graphics into a single unified graphics system, the XL1200.

It sounds like a slogan from Orwell's *1984*—Weakness is Power—but a tool can often be made more usable by making it less general. In that sense, the generality of 3-D work is a limitation. The trick is to find the right places to bound the problem.

Paring Down the Problem

Many modern modelers work on a subset of the full 3-D problem. Frequently, the first functions you encounter in a modeler are *lathing* and *extrusion*. Lathing takes a 2-D curve and rotates it about an axis to create a surface of revolution. Extrusion takes a 2-D shape and moves it along a path (sometimes simply a straight line) to sweep out a surface. These capabilities make good boxes, walls, and goblets, but creating convincing trees, telephones, and dinnerware is somewhat more complicated.

Another simplifying approach concerns the basic task of moving objects around. It can be frustrating and tiring to rotate objects into a particular orientation using a mouse, or to set an object onto a surface. It can help to realize that, flying logos aside, most people live in a

geocentric world. That is, horizontal and vertical are very important directions, and a lot of surfaces are flat: floors and tables, for example. A modeling system with a geocentric bias will be seen as useful, not restrictive.

Therefore, setting the default so that an object, when "born" into the world, is oriented vertically and placed on some default reference plane will make life a lot easier. Perhaps you have to slide it around on the surface of the reference plane or turn it about its vertical axis, but these tasks are relatively simple.

Many 3-D systems let you place objects and the camera anywhere in space, yet the *viewing volume* of the screen (the portion of space over which objects are visible) is only a small portion of that larger space. In trying to navigate under these conditions, it is easy to get lost, winding up with a blank screen as the camera points off into space in what has been called the "black-hole effect." In this situation, simple commands can help tremendously to reorient you, even if they don't provide the ultimate placement of the camera.

For instance, a "turn to" command might cause the camera to rotate in the direction of a particular object, the scene as a whole, or the reference plane. If the current viewing direction is more important than the camera's location, a similar command can move the camera without changing its orientation. The command moves the camera so that the viewing volume comes to include the appropriate objects and they become visible.

Another navigational aid is possible if the camera is defined in terms of both its location and a "look-at" point that determines the direction of the view from any location. If the look-at point changes, the camera turns. If the location changes, both the camera's viewpoint and its direction change (unless the movement is directly toward or away from its look-at point). Locking the look-at point at an object's center lets the camera orbit about the object without losing sight of it.

Perhaps the most dramatic and simplifying realization is that designing 3-D models from scratch is inherently difficult and much harder than designing in two dimensions. No matter how powerful a 3-D modeler is, it is likely to require significant effort both to learn how to use it and, once mastered, to maintain fluency with it. This is really the final problem for perhaps 90 percent of everyday users, who would use 3-D graphics if they could use them easily.

The most radical step, therefore, is to make it possible to create 3-D pictures

without becoming modelers. After all, you don't build every object you use in the real world. Why should you have to when creating 3-D pictures?

The bottom line is that a key element in the success of 3-D graphics is the availability of 3-D libraries analogous to 2-D clip art. While there are comparatively few such packages today (NEC, Abvent, and Paracomp have them), this should be a growth industry in the near future. Similarly, 3-D systems that make it easy to manipulate preexisting geometry (as opposed to creating it wholesale) will find a very friendly reception.

The Difficulties of Rendering

Once a series of shapes has been arranged into a scene, the picture-creation problem is only half over: The rest of the process requires *rendering*. Rendering starts at the end of the modeling process, with a description of how objects are arranged in the scene, the materials they are supposedly made of, the lights that fall on them, and the placement of the camera. Rendering ends with a finished image, a 2-D array of pixels.

Part of the rendering process is well defined, pertaining to the way light moves around the world: It begins at a light source and reflects from or is refracted by one or more surfaces, and some of it eventually winds up entering the camera lens to be recorded on film. Simulating this process is complex and computationally intense, but straightforward (for a more detailed description, see "Ray Tracing for Realism" on page 263). Correctly executed, this process determines what the camera should be seeing for a given geometric configuration, what objects obstruct what other objects, where shadows are cast, how brightly lit objects are, and so on.

There is no shortage of synthetic images that meet this criterion of success. Photo 1c, with its smooth-shaded objects, shows a simple example. While it looks "correct" in some sense, it suffers from a certain blandness, or lack of interesting information. The objects are sharply defined, but their surfaces look like plastic.

The most interesting part of the rendering process is shading, which concerns how each object looks in itself. It is not that synthetic images are "too perfect," it's just that they don't come close to displaying the variety that you see in the real world. The shapes are accurate enough, but the objects don't look like they're supposed to. Very few objects in the real world have a perfectly smooth surface in a single, uniform color.

Surface Variety

There are two kinds of variety required to improve this situation. First, there must be enormous flexibility in the range of looks available for objects. Most people can spot many distinct surface appearances from any particular vantage point. Thus, it's hard to make a convincing synthetic scene without a similar amount of flexibility.

The more important kind of variety, though, occurs across a particular surface. Any given surface probably has variations not only in color (wood grain

a 2-D graphic (the map) onto a 3-D shape. All laminated surfaces are planar, are singly curved (not compound), or consist of several joined planar surfaces. Any other methods would require stretching the laminate, if it were possible, in a way that distorted the grain.

But this is almost a modeling problem. Even if a texture can be properly projected onto a surface, it still does not "look" quite right. Two more problems lie at the heart of texture and bump mapping.

There is an interesting property of wood that a texture map cannot capture. Wood in the tree consists of alternating concentric rings of sapwood and heartwood. These materials differ not only in color (which is addressed by a texture map) and response to tooling (given by the bump map), but in their absorption of finish. Heartwood absorbs much less finish than sapwood. Consequently, the shininess of wood changes right along with its color and texture, and the renderer must calculate this mathematically.

The final issue with direct bump and texture mapping concerns bumpiness at the microscopic level. In reality, virtually every "smooth" surface is unrecognizably complex when viewed through a microscope. This fine structure affects the appearance of the surface subtly. For instance, most people can distinguish dozens of different kinds of paper products at arm's length even if the paper color is the same.

The fine structure of a material determines the way that material responds to light almost as much as its color and visible bumpiness do. The surface of paper consists of millions of short fibers; plastics typically have particles of pigment embedded in a smooth white surface material; metals can be modeled as an aggregate of millions of microfacets. Surfaces can seem dull or glossy, and their glossiness can vary in a subtle way across the surface. The visible difference lies in how the material interacts with its optical environment.

The basic problem with texture maps is that their visual information is fixed when the map is produced. Texture mapping is fundamentally akin to wrapping a photograph of a surface around an object rather than constructing the object of the material itself. You might be able to choose whether the photograph is matte or glossy, and you might also be able to apply a matched bump map. But at some subtle level, you will never be able to fully mimic the "look" of the actual material.

For some uses, this may be enough.

Few objects
in the real world
have a perfectly smooth
surface in a single,
uniform color.

is a common example) but in undulations that violate its smoothness. (The best word for this is *texture*, but *bumpiness* also applies.) "Smooth as glass" refers to the rare surface without this texture.

Examples of materials with color variation include wood, stone, fabric, fur, leather, and any kind of printed matter. The skin of an orange and stippled plastic are good examples of interesting textures due only to random variations in the surface. Two phenomena, texture mapping and bump mapping, underlie the two common techniques for improving the realism of images.

In addition to color and bumpiness, however, there is a finer level of detail that escapes either technique. Contrast the appearance of real wood with that of a cheap plastic pseudowood laminate. The latter is nothing more than a photograph of wood layered over particleboard or some other wood substitute: in other words, a texture map.

Most people can tell the difference between a texture map and the real thing. Even if a bump map were added to replicate the fine structure of a wood surface in a synthetic image, it still wouldn't look quite right. There are several reasons for this, and they generalize to most surfaces "replicated" with texture maps and bump maps.

First, there are the problems of putting

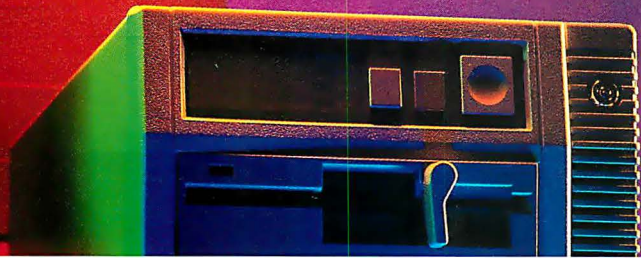

486/25
\$4,860

- Intel 80486, 25 MHz, 4MB
- 128K SRAM cache

“Without a doubt, the Tangent is the overall price/



- Fastest Super VGA adaptor in the industry
- 1024 x 768 VGA monitor
- 80 MB (19ms), w/cache
- 1.2 MB or 1.44 MB Teac
- 1 parallel & 2 serial ports; Enhanced 101 keyboard

performance winner of the group, and perhaps even



386 SVGA Systems
(2MB, 42MB HD):

- 80386SX, 20 MHz \$1995
- 80386, 25 MHz \$2295
- 80386, 33 MHz \$2995 w/cache

of 486 systems in general.” (Personal Workstation,



For a Quote or to Order,
Call 800-223-6677

415-342-9388

FAX 415-342-9380

Corporate P.O.s accepted



8/90 review of Tangent, Compaq, and AST).

In Personal Workstation's review, the Tangent 486/25 clearly outperformed both Compaq and AST. And Tangent was priced as much as 67% less! Get breathtaking graphics and unparalleled hard disk performance. Plus a 30-day unconditional money-back guarantee, and a lifetime, toll free technical support hotline. Call today, for this and other Tangent review reprints, and for a quote on a wide choice of EISA and ISA configurations.



Tangent Computer, Inc., 197 Airport Blvd., Burlingame, CA 94010.

© Copyright 1990 Tangent Computer, Inc.

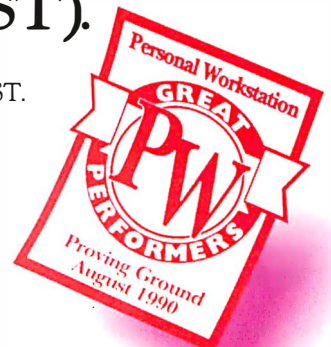

Circle 300 on Reader Service Card

Photo 2: An example of the creativity and photo-realism possible on computers today with 3-D tools and techniques. The Pixar Shrink-wrapped Magic poster was produced on computers by Mitch Prater using Pixar's Developer's RenderMan. (Used by permission from Pixar.)



But for true realism, you need a more flexible model, one that allows interaction to occur dynamically while the image is being rendered. This model must be flexible enough to deal with the incredible variety of the material world.

Procedural Shading

In rendering, a procedural model leaves a "hook" in the renderer for calculating the appearance of a surface on the fly, taking into account all relevant scene elements, including lights. A new surface material would be defined as a procedure that, when called, would have access to the lights hitting the surface, plus any relevant texture maps, bump maps, shading information, and so on.

The RenderMan Interface, developed by Pixar (Richmond, CA), supports a rendering system that uses the procedural model. It defines entities called *shaders*, written in the RenderMan Shading Language, for just this purpose. When invoked, a shader's job is to determine the color of a surface as seen from a particular point of view, as illuminated by all defined light sources.

The shader has ultimate freedom in calculating the color. It can use any number of texture maps, bump maps, shadow maps, environment maps, and light sources. It can use an elaborate materials simulation (the pseudopod sequence in the motion picture *The Abyss*, for example, used a ray-tracing surface shader) or no color model at all. (For further discussion on RenderMan and other rendering systems that use procedural shading, see "The RenderMan Interface" by Tony Apodaca, Graphics Supplement, April 1989 BYTE.)

Procedural shading is the next logical step beyond texture and bump mapping. In many cases, a procedural approach can solve the problem of mapping 2-D surfaces onto 3-D objects. Certain naturally occurring materials such as wood and stone have a structure that can be procedurally simulated. A point on a surface can be colored as though it were a point in a solid material, resulting in an object that looks like it was carved out of the material in question.

A second capability, provided by a procedural approach, addresses the "fine structure" issues. While it is impractical to duplicate the appearance of these surfaces empirically by simulating geometric optics, it is possible to mimic their behavior procedurally.

For example, paper has a special kind of diffuseness that can be procedurally imitated, not at the microscopic level, but at the level of its larger appearance on the screen. Of course, the higher the definition of your display, the more obvious these fine-structure issues will become. (For a discussion of the overlap between high-definition TV and computers, see "HDTV Sparks a Digital Revolution" on page 297.)

Procedural shading can work together with texture maps for other novel effects. For example, a shader might use a piece of line art to change the material it simulates in different parts of the surface, to produce a net effect like inlay. Texture maps, in fact, can describe any relevant attribute and be interpreted in any way by a shader.

A texture map could be used to vary the color of a surface depending on the angle of incoming light (real metals have

this kind of behavior). Of course, a shader can use a texture map exactly as intended, which illustrates that the procedural approach subsumes the mapping-only method as well.

Creating Curves

A final, qualitative concern crosses the boundary between modeling and rendering: the availability of curved surfaces to represent objects in a scene. Traditionally, flat polygons have been used because they're computationally easier to handle.

However, not many objects in the world can be accurately represented entirely with flat surfaces. While there are tricks for making the best of their limitations, polygons can only provide a reasonable approximation of curved surfaces, and that at the cost of substantially larger data storage.

A Tall Order

Creating photo-realistic 3-D graphics is a tall order. It involves powerful computer hardware, user-interface design, and complex simulations of geometric optics.

However, just about all the foreseeable obstacles to this brave new 3-D world have yielded or are dissolving. Current products contain the information required to properly render a surface, including several different types of shading and many different kinds of maps (see photo 2). ■

Steve Upstill is a product manager for Pixar (Richmond, CA). He has a Ph.D. in computer science from the University of California at Berkeley. You can reach him on BIX c/o "editors."

They Left out Features.... We Left out the **COMMA!!**

The only thing missing...

is the comma in the price. If you look at the chart on the right you will see prices charged by our competition. All but one contain a comma. **DesignCAD 3D** sells for \$399.00. Period. No Comma!

In order to draw the complex pictures shown below it is desirable to have the following 3D features:

- Interactive design with 3D cursor
- Blending of surfaces
- Boolean operations such as add, subtract, and intersection
- Complex extrusions
- Cross sectioning
- Block scaling
- On screen shading
- Shaded output to printers and plotters

All of these competitors left out one or more of these desirable features in their standard package. They didn't forget the most horrible feature - the comma.

DesignCAD 3D offers **ALL** the listed features plus many more!

If **DesignCAD 3D** has the power to create the 3D objects shown below, imagine how it could help with your design project!

DesignCAD 3D sells for \$399. We left out the comma. We didn't think you would mind!

PC MAGAZINE SAYS...

DesignCAD 3D, the latest feature-packed, low-cost CADD package from American Small Business Computers, delivers more bang per buck than any of its low-cost competitors and threatens programs costing ten times as much. For a low-cost, self-contained 3D package... DesignCAD's range of features steals the show."

\$399

American Small Business Computers • 327 South Mill Street • Pryor, OK 74361 U.S.A.

AutoCAD rel. 10	\$3,000.00	AutoCAD AEC \$1,000.00	AutoShade \$500.00
CADKEY 3.12	\$3,195.00	Solids \$995.00	IGES translator \$1,995.00
DataCAD with DC Modeler	\$3,990.00	DataCAD Velocity \$2,000.00	
DesignCAD 3D ver. 2.0	\$399.00	NO expensive options! IGES Free, Shading Free	
MaxxiCAD 1.02	\$1,895.00	N/A	
Mega Model	\$995.00	MegaDraw \$195, List \$295, MegaShade \$395	
MicroStation PC 3.0	\$3,300.00	Customer Support Libraries \$1,000.00	
ModelMate Plus 2.8	\$1,495.00	N/A	
VersaCAD Design 5.4	\$2,995.00	N/A	

Source: Byte Magazine

BYTE MAGAZINE SAYS...

"At \$399, DesignCAD 3D was the least expensive package we saw, yet it was one of the more powerful. ..Don't be fooled by the remarkably low price, this program can really perform."

May 1989, page 178

Complete 3-Dimensional design features make it easy for you to construct realistic 3-D models. With full solid-object modeling capabilities you can analyze your drawing to determine the volume, surface area or even center of gravity! **DesignCAD 3-D** even permits you to check for interference between objects! Aeronautical Engineers can now find the center of gravity for a new airplane design with a couple of keystrokes. The Architect can determine the surface area of a roof for decking in a matter of minutes. The Civil Engineer can calculate the volume of a lake or dam in seconds. The Mechanical Engineer will know for sure if certain parts fit together without interference. The uses for **DesignCAD 3-D** are only limited by YOUR imagination!

HOW DO I GET ONE?

DesignCAD 3-D and **DesignCAD 2D** are available from most retail computer stores, or you may order directly from us. If you have questions about which program to purchase please give us a call. All you need to run **DesignCAD 3-D** is an IBM PC or compatible computer with 640 K RAM memory and a hard disk. Both products support most graphics cards, printers, plotters and digitizers. Free Information and a demo disk are available by faxing (918) 825-6359 or telephoning:

1-(918) 825-4844

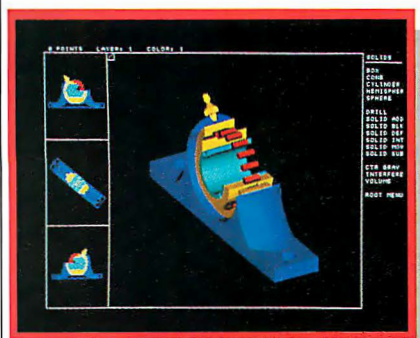
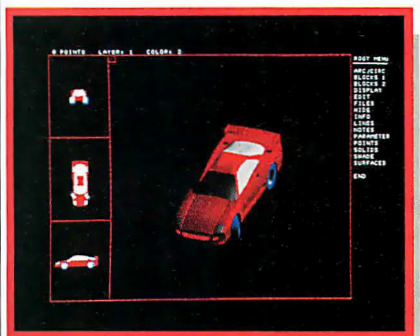
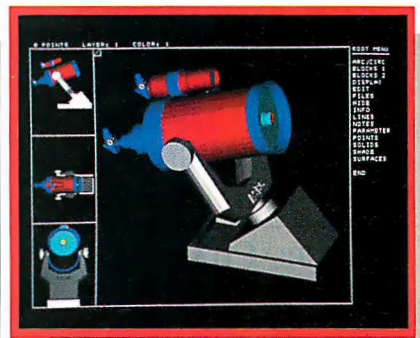

Don't look now, but moving on

Suddenly, IBM Personal System/2[®]s with Micro Channel™ on desks everywhere are exhibiting some pretty wild and wonderful tendencies. They're creating incredible on-screen presentations. Interactive tutorials with full-motion video and stereo sound. Graphics, text and animation in harmonious coexistence. What makes it all possible is the multimedia capability of the IBM PS/2[®] with Micro Channel.

MICRO CHANNEL MAKES IT LOOK EASY.

The PS/2 itself is designed to put multimedia applications to their best use. Micro Channel has always given the PS/2 extremely fast data rates and better multitasking capabilities. But in multimedia applications, it really gets a chance to shine. The multilane highway design of Micro Channel Architecture is perfect for processing complex multimedia applications. Most conventional PCs just don't have the power or the data paths to do it at all. Plus, Micro Channel in the PS/2 lets you use

the new IBM CD-ROM that gives you the storage equivalent of over 400 diskettes on

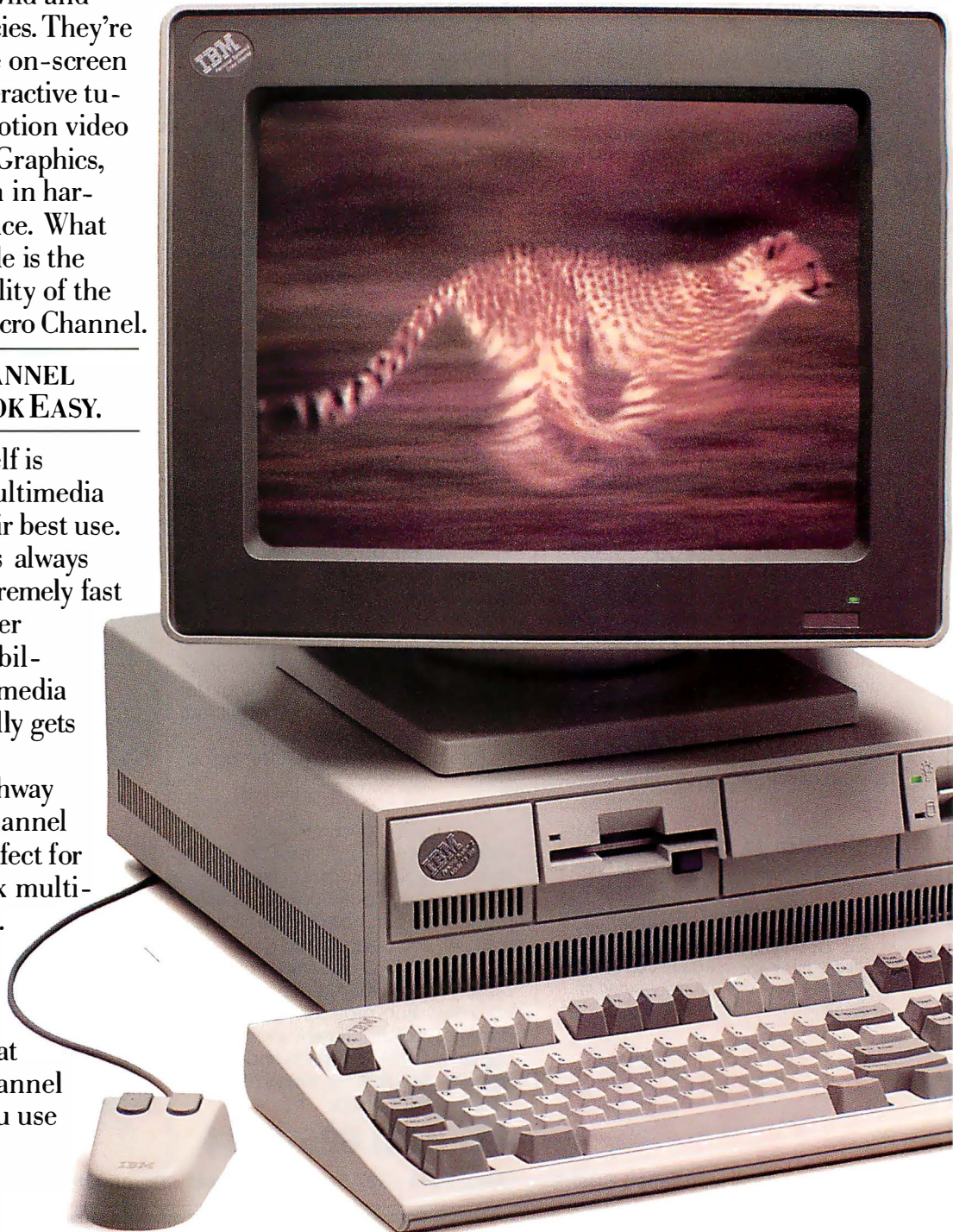

there's something your desk.

a single CD, so you can have access to all kinds of data-intensive material like clip art and digital stereo sound.

DO IT ALL. ALL AT ONCE.

With a PS/2 with Micro Channel, you can start using some hot products right now. One is IBM's Audio Visual Connection™. It's both a software and a hardware tool that allows your PS/2 to import high-quality audio, dazzling still images, even special effects, as well as text, graphics and other data. Then, you can edit and present it in any combination you like right on your PS/2 screen, share it with a network or project it on a wall. It's impressive, but don't take our word for it—IBM's Audio Visual Connection received *PC Magazine's* Technical Excellence Award for 1989.

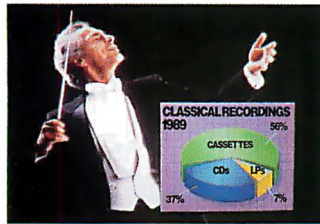

Another exciting multimedia product is the IBM M-Motion Video Adapter/A™. Coupled with the power of Micro Channel, it lets you incorporate full-motion video and high-quality sound from sources like video disks, VCRs and video cameras, digitize them, and display them in an endless array of formats.

And for software developers, there are ActionMedia™ cards, a collaborative effort between IBM and Intel.

ActionMedia cards use the latest DVI™ Technology, which allows full-motion video and analog sound

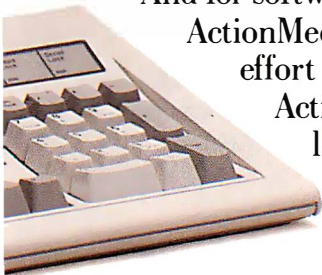

to be compressed, digitized, stored on a hard or optical disk and played back in real time, with incredibly sharp resolution.



YOU'VE ALREADY GOT THE BEST SEAT IN THE HOUSE.

Best of all, you can do it all today with the Micro Channel PS/2s you've already got. No special monitors to buy. And you'll be perfectly poised for tomorrow's most exciting multimedia technology, like interactive touch displays and much more.

Contact your IBM Authorized Dealer or IBM marketing representative. For a free demonstration videocassette or a dealer near you, call 1 800 255-0426, ext. 20.

Your desk will never be the same.

For a free PS/2 MultiMedia demonstration videocassette call 1 800 255-0426, ext. 20 or send this completed coupon to: IBM Corporation
P.O. Box 92835, Rochester, NY 14692

Name _____

Title _____ Phone _____

Company _____

Address _____

City _____ State _____ Zip _____

If you are a software developer, check here.

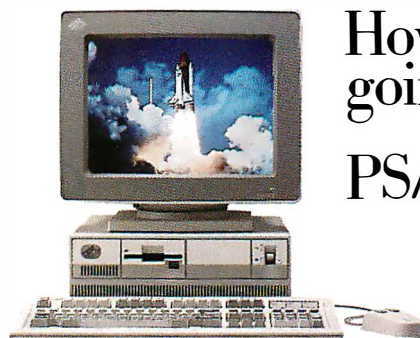

How're you
going to do it?
PS/2 it!



Finally. An input device based on your input.



Introducing SummaSketch® II.

New Limited
Lifetime Warranty

The new SummaSketch II tablets were created with one thing in mind—you, the people who use tablets every day. You said you wanted a complete plug and play package, so we're giving you the works—both in PC and Macintosh® SE and II versions. A 12" x 12" or 18" x 12" graphics tablet with a 4-button cursor and 2-button stylus, or 16-button cursor for the PC.

The PC version includes interface cables for the IBM® PC, AT, PS/2 and compatibles. A utilities diskette with test and reset software, an Autodesk® Device Interface™ driver, Universal Mouse Emulator™ and a Microsoft® Windows driver. And an offer for

a free tablet template (US and Canada only) worth over \$245.

The Macintosh version has an Apple® Desktop Bus™ interface device to connect the tablet to the computer.

You'll also get the most software compatibility with over 350 PC programs and all Macintosh SE and II software written under the Apple Software Developers guidelines.

SummaSketch II tablets have a standard accuracy measurement of ± 0.015 inches, selectable resolution of up to 1,016 lines per inch and high proximity so you can trace from documents up to 1/2" thick. Add in convenience features such as a power/proximity light, on-off switch, wedge shape design for easy use, lightweight construction for portability—and it's easy to see why SummaSketch is the industry standard and the

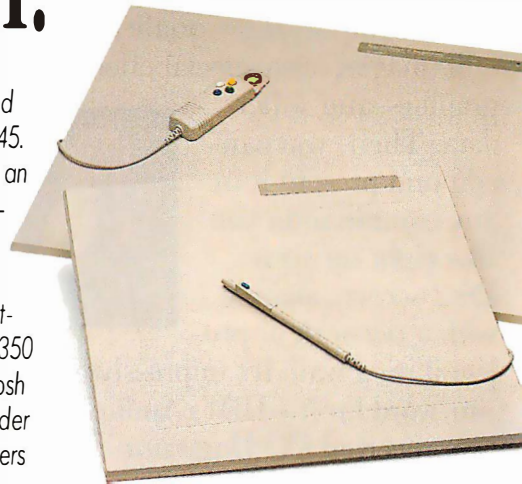

obvious choice of today's computer professionals.

Best of all, you get all of these benefits at an affordable price. And that's why our new SummaSketch II is the easiest buying decision you have to make. Find out more about SummaSketch II today. For literature and the name of a local dealer call 1-800-888-2028, Ext. 304. For technical information call 203-881-5400.



November 28, 1989
SummaSketch II

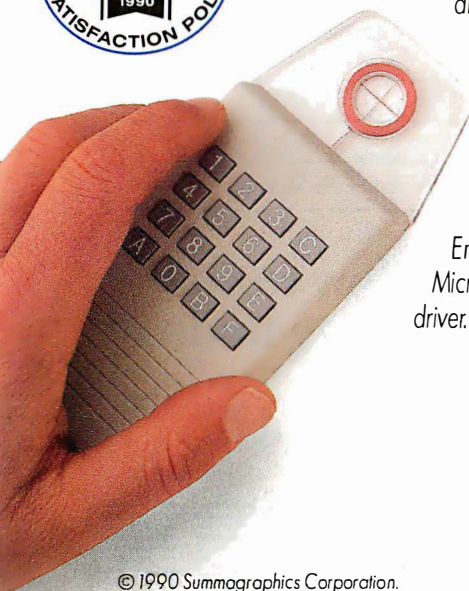

Summagraphics™

Every decision should be this easy.™

For IBM/Compatible information circle 294; For Macintosh information circle 295,
For Reseller inquiries circle 296 on Reader Service Card.

Ray Tracing for Realism

*Photo-realism is within your grasp.
Follow the light.*

Andrew S. Glassner

Photo-realism is an elusive goal; the real world is a web of subtle and complex phenomena that scientists don't fully understand, and computer-generated pictures can only reflect current levels of understanding. You can create images that come close, though, using a variety of photo-realistic techniques. One of the most popular is called *ray tracing*.

What Is Ray Tracing?

The ray-tracing approach attempts to simulate light rays within a three-dimensional scene. You begin creating an image by describing a scene as a collection of objects and light sources. The objects are 3-D shapes in space—for example, spheres, polygons, and boxes. A light source is often nothing more than a single point that radiates light uniformly in all directions.

By convention, objects never radiate light, and light sources are never directly visible (this separation of light emitters from other surfaces is a computational convenience, which can be relaxed if you're willing to write more complex programs). You view a scene from a point in space called the *eye*, through a

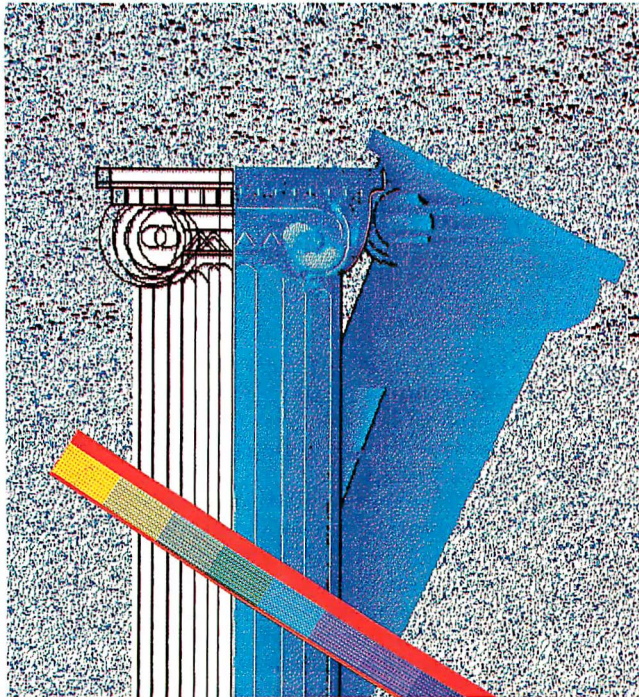

rectangular window in space called the *viewplane*.

The image on the viewplane in the 3-D world is the image that you will eventually show on your monitor screen. There is a direct correspondence between each point on the screen and each point on the viewplane. Figure 1 shows a typical environment.

Probably the most straightforward

way to create an image is to follow light particles (called *photons*) from the light sources to the objects; this is called *forward ray tracing*. But forward ray tracing is not always practical. For example, suppose a light ray left a light source, reflected off a shiny telephone, and then passed through the viewplane into the eye. In this example, you would see the telephone at that point on the viewplane. In general, what you see through each point on the viewplane is the object that's visible along the line passing through both the eye and that point on the viewplane.

If you actually followed light away from the light sources, you would find that your image was created very slowly; many rays would never come anywhere near going through the viewplane

and into your eye, so they wouldn't contribute much (if anything) to the image. It would be sheer luck if any given ray made it all the way to the eye.

A more efficient way of creating a photo-realistic image is to reverse the process. For example, if you select a point on the viewplane, you know that any object visible at that point lies on the line connecting your eye and that point

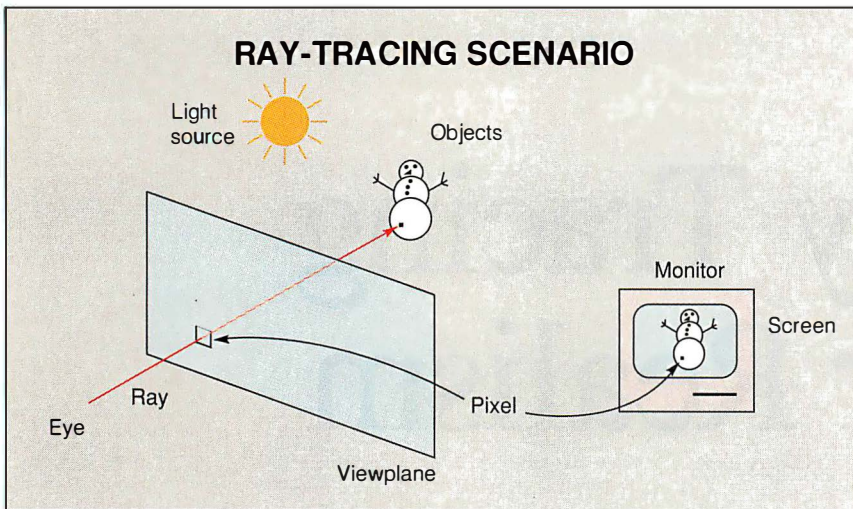

Figure 1: A typical ray-tracing environment. Each pixel in the viewplane has a corresponding pixel on the screen. Light sources are represented by points, and objects are collections of simple shapes. The world is viewed from a point called the eye.

on the viewplane. So you create a ray (called the *eye ray*) that begins at the eye and passes through that viewplane point and on into the world. The first object along that ray is the object that will be visible from that point on the viewplane and thus displayed on the corresponding point on the screen. This is called *reverse ray tracing*, because you're following rays from the eye back into the scene.

Typically, the screen is made up of a

rectangular grid of squares called pixels, and your goal is to find the right color for each pixel on the screen. Figure 1 shows a ray starting at the eye, continuing through one pixel on the screen, and on into the world, where it strikes a sphere.

Incident Light

Now that you know the object visible at each point, you need to know its color. Suppose the first object struck by an eye

ray is a white sphere; I'll call the point of intersection *P*. You want to know the color of the light leaving *P* and traveling back to the eye; the path back to the eye is found by following the eye ray backward.

The color of the light leaving *P* is completely due to the light arriving at *P*, called the *incident light* (remember that no objects emit light of their own). You can separate incident light into two categories: the light ultimately reflected off the surface and the light transmitted by the surface (transmitted light is the light that passes through a transparent or translucent surface).

Each type of incident light is passed on by the surface in two ways: *specular propagation* and *diffuse propagation*. Specular propagation is the result of a perfect reflection or transmission, just like a basketball bounced off a smooth floor. The angle at which the ball leaves the floor is completely determined by the angle at which it arrives.

Diffuse propagation is like bouncing a basketball off a very rough surface; you're never sure what direction it will go in, and if you try bouncing many basketballs into one little area, you'll find that they go off in all directions. Diffuse propagation is the theoretical limit of this type of action; diffusely reflected or transmitted light arrives at a surface and then leaves with equal intensity in all directions (this reflected intensity is less than that of the incoming light). For this reason, diffuse propagation is sometimes also called *diffuse scattering*, since the light is scattered in all directions.

Light can be propagated from a surface in four ways: reflection and transmission, both specular and diffuse. But where does this incident light come from? Basically, you have two choices: directly from light sources or propagated by other surfaces. Each of these two possible contributors of incoming light can be propagated in any of the four ways, for a total of eight possible ways for light to be propagated from a surface (this is a simplified model, but it works surprisingly well).

A ray-tracing program should look at each of these possibilities when it computes the color leaving a point—this process is called *shading*. Not all eight effects are going to be appropriate at all times, and two of them are very expensive to compute.

Direct Light

I'll begin with light arriving directly from the light sources. First, you must determine on a source-by-source basis if light from each source is arriving at point

Vector Shorthand

Vector equations are just a handy way to represent several different equations in one place. Each vector is formed of three components, named *x*, *y*, and *z*. Each component is just a single number. You can think of a vector as an arrow, starting at the origin. The components of the vector give the location of the tip of the arrow. You write the *x* value of a vector **V** as *V_x*, the *y* value as *V_y*, and the *z* value as *V_z*. Vectors are used to make notation more compact.

To make a vector longer or shorter, you can scale it. To scale a vector, you write $\mathbf{A} = s\mathbf{B}$, where *s* is just a single number. The length of a vector **A** is written $|\mathbf{A}|$ and is computed as the square root of the sum of the squares of its components. To scale a vector so that it has length 1.0, divide each component by the vector's length. Thus, for any vector **A** (except $\mathbf{A} = (0,0,0)$), vector-

$\text{Length}(\text{unitVector}(\mathbf{A}))$ is 1.0.

The last two vector operations are the dot product and the cross product. These are extremely useful operations in computer graphics.

The dot product of two vectors **A** and **B** is a single number. Symbolically, you write $d = \mathbf{A} \cdot \mathbf{B}$, where *d* is the result. The value of the dot product is the cosine of the angle between the two vectors, multiplied by their lengths: $\mathbf{A} \cdot \mathbf{B} = |\mathbf{A}| |\mathbf{B}| \cos(\theta)$, where θ is the angle between **A** and **B**. If both vectors have length 1.0, you can compute the cosine of the angle as the sum of the pairwise products of the components.

The cross product of two vectors **A** and **B** is a new vector perpendicular to both. Symbolically, you write $\mathbf{C} = \mathbf{A} \times \mathbf{B}$, where **C** is the new vector. The order of the arguments matters; $\mathbf{A} \times \mathbf{B} \neq \mathbf{B} \times \mathbf{A}$.

~~Interlaced~~



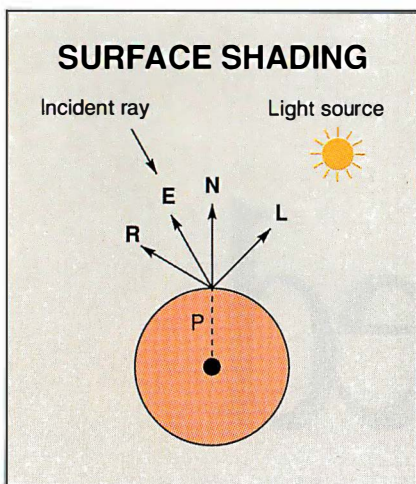

Figure 2: Computing the shading on a sphere. **L** points toward a light source; this light is reflected into vector **R**. **N** is the normal to the sphere at point **P**.

P. To see if **P** is illuminated by source **S**, you should notice a simple fact: If light **S** can see point **P** (and thus illuminate it), then point **P** can see source **S**. To determine if **P** can actually see **S**, create a new ray (called an *illumination* or *shadow ray*) starting at point **P**, directed toward source **S**.

If this ray reaches **S** without striking any object along the way, **P** is illuminated by **S**, and you can proceed to find out how much of the light from **S** is propagated back to the eye. If the ray from **P** to **S** is blocked (i.e., if the ray intersects any object at all), **P** is in shadow with respect to **S**; simply ignore source **S** for this point.

In the following discussion, I'll use vector notation. Points will continue to be represented by uppercase letters, such as **A**, and vectors will be in boldface, **A**. If you're not familiar with vector notation and operations, see the text box

"Vector Shorthand" on page 264 for a quick summary. I will assume that all vectors are normalized; that is, they have length 1.0. When I build new vectors, I will assume that they are immediately scaled to length 1.0 before using them in any computations.

Shading

I will present a simple shading model that ignores many important details but is a good first approximation. Suppose that **P** is illuminated by source **S**. Every point on the surface of most objects (including spheres) has an associated surface normal; this is a vector that points away from the surface, normal to the tangent plane at that point. For a sphere, the normal is along the line from the center to that point, as in figure 2. I'll call the normal vector **N** and create a new vector, **L**, which also begins at **P** and points back to light source **S**.

Bending Light

The equations for finding the direction of reflected and refracted (or transmitted) rays come directly from the field of geometrical optics. I have given the equations in terms of some arbitrary vectors; you'll need to match the appropriate vectors to the appropriate arguments when you use the procedures.

Also make sure that your input vectors are pointing in the correct directions. The direction of each vector is important, and some of the vectors in this text box might point in the opposite direction to the vectors that you have on hand. To reverse a vector, you scale it

by -1.0 .

Specular reflection takes as input an incident vector **V** and a surface normal **N**; the output is a reflected vector **R**:

$$\mathbf{R} = \mathbf{V} + 2\mathbf{N}d, \text{ where } d = -(\mathbf{V} \cdot \mathbf{N})$$

The vectors must all be pointing with respect to the point of reflection, as shown in figure A, where the incident vector is pointing toward the surface, and the normal is pointing away.

Specular transmission isn't quite so easy. The difference is that a light ray changes direction when it passes between two materials with different densities; this is because the speed of light is different in the two materials.

The ratio of the speed of light in a vacuum with respect to the speed of light in some material is known as that material's index of refraction, usually written with the symbol η . When light passes between two materials, the amount by which it bends is dependent on the indexes of refraction of both the material it is coming from (the incident material) and the material it is passing into (the transmitted material) and the wavelength (which I am ignoring here). The indexes of refraction of these two materials are written η_i and η_t ; you will want their ratio $\eta_{it} = \eta_i / \eta_t$. The formula below is based on rays with an orientation relative to the point of transmission, as shown in figure B.

The formula to compute a transmitted vector, **T**, is

$$\mathbf{T} = \eta_{it} \mathbf{V} + \frac{(\eta_{it} C_i - \sqrt{1 + \eta_{it}^2(C_i^2 - 1)})}{C_i} \mathbf{N}$$

where $C_i = -\mathbf{V} \cdot \mathbf{N}$. Note that the value $(1 + \eta_{it}^2(C_i^2 - 1))$ might be less than 0; in that case you can't take the square root. This indicates total internal reflection. In general, **T** computed this way will not have length 1.0.

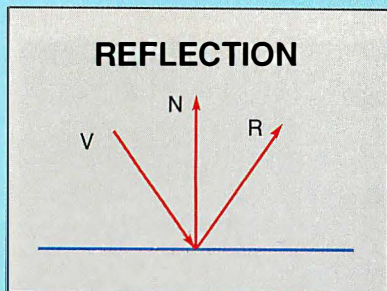

Figure A: Specular reflection takes as input an incident vector **V** and a surface normal **N**; the output is a reflected vector **R**: $\mathbf{R} = \mathbf{V} - 2\mathbf{N}(\mathbf{N} \cdot \mathbf{V})$. The vectors must all be pointing as indicated with respect to the point of reflection.

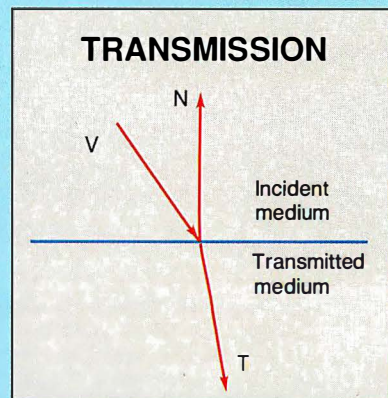

Figure B: When light passes between two materials, the amount by which it bends is dependent on the indexes of refraction of both the material it is coming from (the incident material) and the material it is passing into (the transmitted material).

Non-interlaced

The Optiquest 2000

The 15" Non-Interlaced Color Monitor

You're looking at the future of high resolution monitors. It's the Optiquest 2000. The Optiquest 2000 has a maximum resolution of 1024 x 768 non-interlaced.

Your facts and figures appear crisp and clear, and text looks clean and bright.

Plus, the Optiquest 2000 offers a flat, square screen with a fine 0.28mm dot pitch and an unlimited

THIS IS AN EXAMPLE OF AN INTERLACED VIDEO SCREEN. ONLY HALF THE LINES ARE REFRESHED EACH TIME, SO YOU SEE A CONTINUOUS FLICKER

Interlaced

THIS IS AN EXAMPLE OF OUR NON-INTERLACED SCREEN. EVERY LINE IS REFRESHED EACH TIME, SO YOU SEE A SMOOTH, FLICKER-FREE IMAGE

Non-interlaced

Interlaced monitors only refresh every other line of pixels on the screen, and return later to refresh the missed lines. Not so with the Optiquest 2000. It actually refreshes every pixel on every line continuously. So, the picture is flicker-free.

palette of colors.

Also available, the Optiquest 3000 featuring a super-fine 0.25 dot pitch.

Their interlaced monitors, or our non-interlaced monitors? The choice is clear.



OPTIQUEST™

The Non-interlaced CompanySM

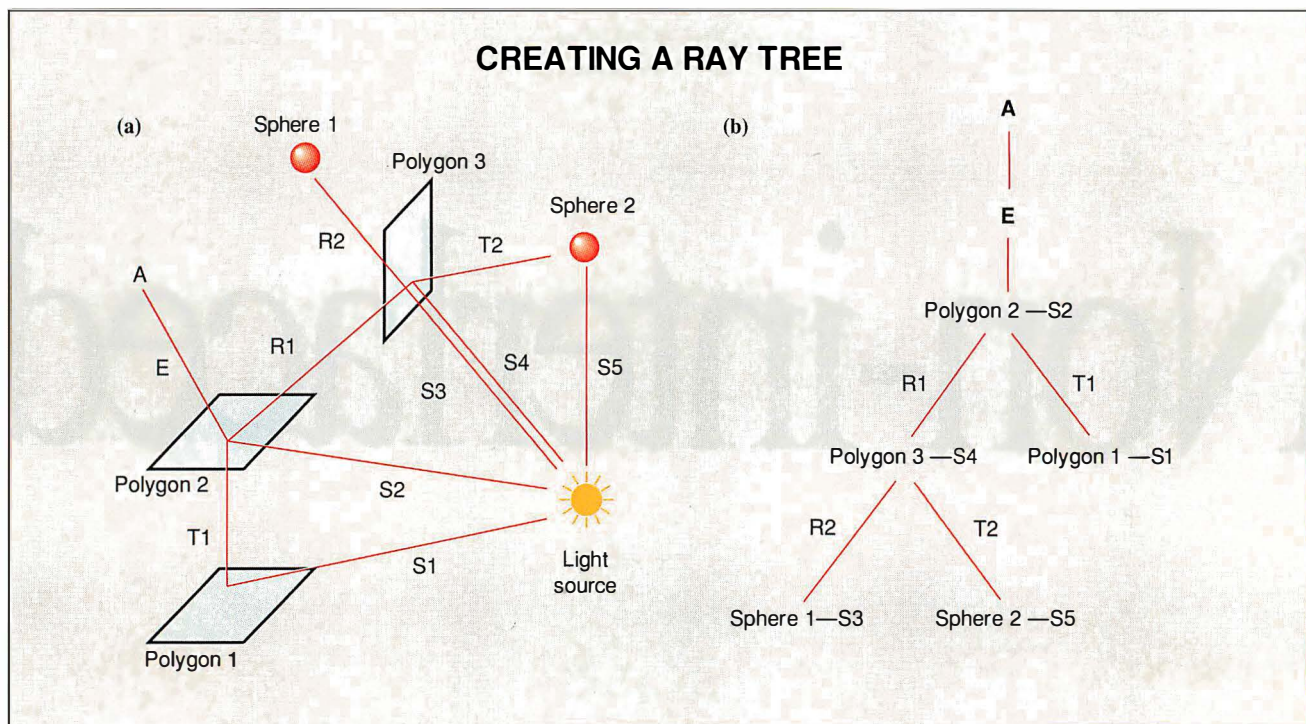

Figure 3: (a) Each time a ray intersects an object, the color of the light leaving that object back along the ray must be computed. This color is found by creating shadow rays that point back to the light source, and reflected and transmitted rays that find the color of the light reflected and transmitted by the surface. This collection of rays can be represented abstractly with a ray tree (b). Shading is accomplished by passing colors of objects from the bottom up to the top.

Suppose source S has intensity I . If S is on the inside of a sphere, its light is transmitted through the surface; otherwise its light is reflected off the surface. You can find which situation holds by computing the dot product of N and L ; if $N \cdot L < 0$, then S is behind the surface, and if $N \cdot L > 0$, then S is in front. If $N \cdot L = 0$, then S is on the plane tangent to the surface and sheds no light on it. Assume $N \cdot L > 0$, so the light source is reflected.

The amount of light reflected diffusely is the same in all directions and is given by $DR = I(N \cdot L)$; that is, the intensity of the diffusely reflected light, DR , is given by the intensity of the light source itself, I , scaled by $N \cdot L$. This equation comes directly from a law of physics known as Lambert's law.

The amount of light specularly reflected back to the eye will form a highlight, which is the reflection of the light source off the surface. This depends on where the eye is. Construct a new vector, E , which begins at P and points back to the eye, as in figure 2. If L points to the light source, the law of specular reflection tells you that $R = 2Nd - L$, where $d = N \cdot L$ and the direction of R is the direction of the reflected light. You can find how much of this light goes into the eye by finding how much R and E line

up; this is given by $R \cdot E$. Commonly, you raise this dot product to some power; the larger the exponent, the sharper the highlight becomes (this achieves a crude approximation of surface roughness). Thus, $SR = I[(E \cdot R)^k]$ where SR is the intensity of the specularly reflected light, and k controls the surface roughness.

Similar arguments hold for the transmission of light from the sources. The only difference is a correction factor that accounts for the bending of the light when it passes between media (the reason why a spoon appears bent in a glass of water). This is not hard to derive. The re-

sult is presented in the text box "Bending Light" on page 266. For more explanation, see reference 1.

Your next goal is to find the incident light coming from other objects. Suppose again that you struck a white sphere at point P with an eye ray. What light is specularly reflected back along the eye ray? Above, I provided the relation between a reflected ray and its incoming direction; if you want to find the ray that reflects into E (the vector pointing back along the eye ray), it must be coming from $R' = 2N(E \cdot N) - E$ (this is just a rewrite of the law of specular reflection). I've written the result as R' instead of R to remind you that this computed reflection vector is backward from the direction from which the light arrives. Thus, any light that is specularly reflected back along E must be coming in along R' . What is the light that is arriving along direction R' ?

The answer to that question is the big trick to recursive, backward ray tracing. To find the light coming into P along R' , pretend that R' is an eye ray and ask what object it hits first. When you find the color of the light leaving that object in the direction of the eye ray that hit it (really R'), you know the color of the light arriving at P along R' .

The screen is
made of a rectangular
grid of pixels, and
your goal is to find
the right color for each
pixel on the screen.

The whole process, then, is recursive: To find the color of the reflected light, you find the first object that it hit and then find the color of the light leaving that object. Its color is a combination of the light arriving directly from the light sources and the light it's reflecting and transmitting, which it finds by the same techniques I just used. The light specularly transmitted along ray T' is found the same way (T' is to T what R' is to R): You build T' (as in the text box "Bending Light") and treat it as the eye ray.

The result is a ray tree, as shown in figure 3b. The eye ray first hits an object and spawns illumination rays back to the light sources to determine direct illumination and a reflected and transmitted ray to find the light specularly reflected and transmitted by that object (see figure 3a). Each of those latter two rays then hits an object, and the process recurs. A common technique in simple ray-tracing programs is to stop the recursion at some predetermined depth (this produces artifacts in the image, but if things are not too shiny or transparent and your cutoff depth is large, it will serve as a first step).

Now that you've built the tree, you can begin to fill in the colors from the bottom up. The colors of the bottommost objects are simply due to the light sources; those colors are passed up to the next object as its reflected and transmitted colors, and so on up the tree until you've computed the color of E .

You may have noticed that I've ignored light that is diffusely reflected and transmitted off other objects. Handling this effect efficiently is still a research issue, and many systems just add in a small amount of constant light (called *ambient light*) at every intersection to "fake" this light.

Another point that I left dangling is the phenomenon of *total internal reflection*. Notice that the computation of ray T' involves a square root. If the value under the radical sign is negative, the whole expression for T' becomes imaginary. The physical significance of this result is that the light does not pass through the surface at all; instead, it is reflected off the surface.

At all angles less than the *critical angle*, where the value under the square root is less than or equal to 0, the light is transmitted; at angles greater than this value, the light is specularly reflected off the inside of the surface. This is the principle behind optic fibers: They are translucent so that they can transmit light, but they are designed so that whenever the light strikes the inside of the tube, it is

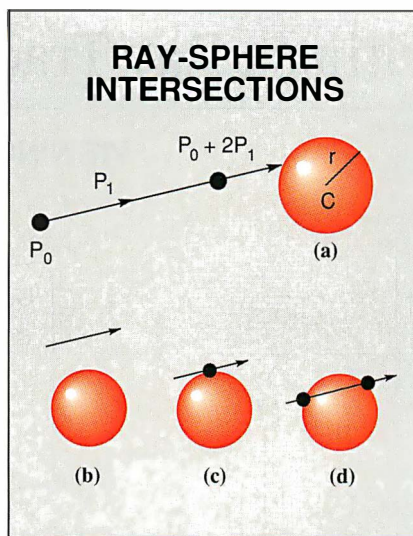

Figure 4: A ray-sphere intersection (a). The value of d in the ray-sphere intersection equation tells you whether there are 0, 1, or 2 intersections between a ray and a sphere (b, c, d). If the intersections are behind the origin of the ray, their t values will be negative; ignore such intersections.

reflected back into the shaft rather than transmitted out.

You can see this effect if you put a spoon into a glass of water. Look very closely right beneath the surface of the water and you'll see that the spoon seems to disappear. The light right near the surface is striking the bottom of the air-water boundary at a very shallow angle and is reflected back into the water rather than transmitted into the air.

Computing Intersections

Finding ray-object intersections is one of the most important issues in ray tracing. Finding which object is first intersected by a ray is probably the most time-consuming part of any ray tracer. The most straightforward approach is to find the intersections (if any) of each ray with every object and then find the object with the nearest intersection. This method is tedious, but it works well.

Suppose you want to find the intersection of a ray and a sphere. Things will be easiest with vector notation. Suppose the ray begins at point P_0 and travels in direction P_1 . Any point P on this ray is given by $P = P_0 + P_1t$, for an appropriate value of t . Since you want only points in front of the ray, you're only interested in intersections along the ray with $t > 0$ (t is often called the ray parameter). Figure 4a shows a sample ray hitting a sphere. The sphere has center C and radius r . It

turns out that every point Q on the sphere satisfies $(Q - C) \cdot (Q - C) - r^2 = 0$; expand this out in coordinates and you'll find a familiar formula from geometry (try using $C = 0$, so the sphere is centered at the origin; then $Q \cdot Q = r^2$, so the distance of every point Q from the origin is a constant, which is one definition of a sphere).

If the ray intersects the sphere, there must be some point, Q , that is on both the ray and the sphere at the same time. If point Q is on the ray, then $Q = P_0 + P_1t$. And if point Q is on the sphere, then $(Q - C) \cdot (Q - C) - r^2 = 0$. You can find points that satisfy both by plugging the ray equation into the sphere equation. Substitute the first into the second to get $(P_0 + P_1t) \cdot (P_0 + P_1t) - r^2 = 0$.

If you multiply this all out and then solve for t , you'll have a quadratic equation: $at^2 + bt + c = 0$, where $a = P_1 \cdot P_1$, $b = 2P_1 \cdot G$, and $c = G \cdot G - r^2$, where $G = P_0 - C$. You are interested in the values of t that satisfy this equation. Recall that any quadratic equation has two solutions: $t_1 = (-b + d)/2a$, and $t_2 = (-b - d)/2a$, where $d = b^2 - 4ac$.

The value of d is very important. Remember that you can't take the square root of a negative number, so if d is negative, you can't evaluate the square root. The physical interpretation of this is that the ray misses the sphere completely—there is no intersection at all. Figure 4b shows this case. If d is 0, the ray grazes the sphere at just one point, as shown in figure 4c.

If d is positive, the ray intersects the sphere in two places, as in figure 4d. If there are any intersections, each intersection point is given by $P = P_0 + P_1t$, using the appropriate value of t . If there are two intersections, you want the nearer one; this is the one given by the smaller value of t (as long as that value is positive; if either or both values of t are negative, they give intersection points behind the origin of the ray).

Coping with Complexities

The simplest form of ray tracer builds a single ray for each pixel on the screen and fills in the pixel with the color of that ray. This can result in a picture with aliasing (or "jaggies"), which comes from using just that single color value for the whole pixel. A pixel can display only a single color, so how can you possibly do better? One answer is to take several samples distributed within each pixel and average their colors together—it's the averaged color that you use as the pixel's color value. To build a complete ray tracer, see the text box "Writing a

Writing a Ray Tracer

You begin to build a complete ray tracer by computing the eye rays. There are several ways to specify the location of the eye and the viewplane in space; I will present one of the common schemes. You need a few pieces of information to specify the viewing setup, as shown in figure a. You need the position of the eye (call this point E). You need to know how far away the viewplane should be (call this distance d) and in what direction you're looking (call this vector G , for gaze).

You also need two viewing angles, which tell how much perspective to apply to the picture; call the horizontal angle θ and the vertical angle ϕ . Now you know just where the viewplane should be, but it can spin freely about G ; you need to specify an "up" vector U to indicate the orientation of the viewplane (again, assume that all vectors have length 1.0).

Next, put a coordinate system on the viewplane that mimics the one on your real screen. Suppose your physical hardware displays images at a resolution of 640 pixels wide by 480 pixels tall, with the origin at the lower left. Any point on the screen has coordinates (x,y) ; you can scale these to $(x',y') = (x/640, y/480)$ so now you have $(0,0)$ at the lower left and $(1,1)$ at the upper right. You now need to find the point S in the three-dimensional viewplane that corresponds to a particular (x',y') on the screen.

First, however, you'll need to do a little construction, shown in figure a. Create two new vectors, $X = G \times U$ and $Y = X \times G$. The plane containing X and Y is parallel to the viewplane. To find the viewplane itself, you need only one point in the plane; you can easily find the point at the center of the screen as $M = E + dG$. Now scale X and Y so that they span half the screen. From figure a, you can work out that the horizontal width of the screen is $d \tan(\theta)$ and the vertical height is $d \tan(\phi)$. Knowing this, you can create vectors H and V that are the horizontal and vertical axes of the viewplane, since you have both the directions and lengths. From the above observations, $H = (d \tan(\theta))X$ and $V = (d \tan(\phi))Y$. So now you can find the point S associated with any point with coordinates (x',y') on the screen by $S = M + (2x' - 1)H + (2y' - 1)V$.

Now you are ready to trace rays.

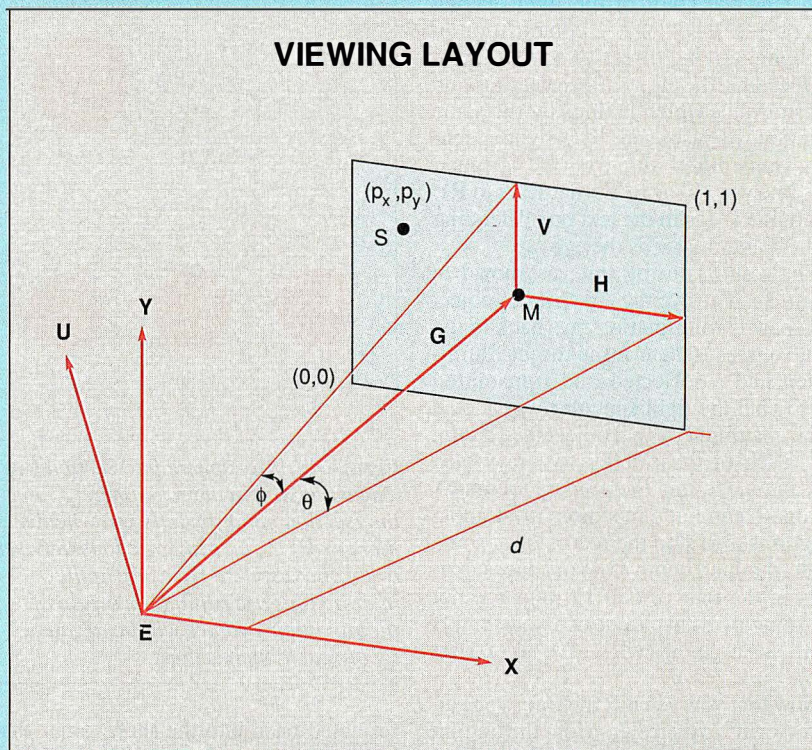

Figure a: Computing the viewing geometry. You supply the position of the eye, E , the gaze direction, G , the distance to the viewplane, d , half-angles to control perspective, θ and ϕ , and an "up" vector, U . The system builds vectors X and Y , which become H and V . M is computed as the point in the center of the screen. Now any point S can be written as M plus some amount of H and V .

Select a point on your screen and find its coordinates (x',y') . Build your eye ray with origin $P_0 = E$, and a direction that takes it from E into point S on the screen, so $P_1 = S - E$. Now check that ray against every sphere, one by one, and look for the sphere with the closest intersection; this will be the sphere with the smallest positive t value. If you don't hit any spheres, color this ray with a default background color and continue on to the next ray.

Suppose you hit a sphere at point Q . To find the illumination directly from the light sources, build new rays that begin at Q and trace them to the light. Since your light sources are just points, the location of some light source (call it number n) is a single point. To create a ray for light source n (which is a point at location L_n), your illumination ray has origin $P_0 = Q$ and $P_1 = L_n - Q$.

You then intersect this ray against every sphere; if you hit any sphere, stop and move on to the next light source. If

you test every sphere and hit none, you can add in the light from that source to the incident light at point Q .

Now you build the reflected and transmitted rays R' and T' . You find the nearest sphere for each and then repeat the process to determine their colors. At some point, you'll find that you've reached your recursion limit and don't want to spawn new rays. You'll find the shading of the last points just from their direct illumination and pass those values back up the tree as the colors of reflected and transmitted rays. Finally, you'll reach the top and have a color for the eye ray, as in figure 3 in the main text.

The transmitted and reflected rays are not needed at every surface. You'll probably want to assign a specular reflectivity and transparency value to each sphere. If a sphere is not at all specularly reflective, there's no need to trace a reflection ray, and the same goes for transparency rays.

Ray Tracer" at left.

I have hardly begun to explore the possibilities of ray tracing. The first thing you'll probably want to do is add more objects. I recommend you add polygons first and then quadric surfaces. Since a polygon is planar, the first step in ray-polygon intersection is a ray-plane intersection; this is even easier than a ray-sphere intersection test.

The second step is to determine if the intersection point is actually within that part of the plane enclosed by the polygon. Many techniques have been proposed to solve this problem. The ray-polygon intersection test can be subtle to understand because there appear to be many special cases to handle. In fact, the problem can be solved cleanly and simply; I recommend the approach given by Eric Haines (see reference 2).

The next big problems to attack are aliasing and efficiency. A good approach to antialiasing is stochastic ray tracing (see reference 3), which involves choosing your rays very carefully. Chapters in reference 1 discuss important aspects of ray tracing, including efficiency, object intersections, acceleration, and more details on writing a ray tracer. You may also wish to consult references 4 and 5 to see where ray tracing fits into computer graphics in general.

Photo-realism is the making of pictures that are indistinguishable from photographs of the real thing. Certainly, ray tracing is a powerful tool for achieving that goal. ■

REFERENCES

1. Glassner, Andrew S., ed. *An Introduction to Ray Tracing*. San Diego, CA: Academic Press, 1989.
2. Haines, Eric A. "Essential Ray Tracing Algorithms." In *An Introduction to Ray Tracing*, Andrew S. Glassner, ed. San Diego, CA: Academic Press, 1989.
3. Cook, Robert L. "Stochastic Sampling in Computer Graphics." *ACM Transactions on Graphics*, vol. 5, no. 1 (January 1986), pp. 51-72.
4. Foley, J. D., and A. van Dam. *Fundamentals of Interactive Computer Graphics*. Reading, MA: Addison-Wesley, 1982.
5. Newman, W. M., and R. F. Sproull. *Principles of Interactive Computer Graphics*, 2nd ed. New York: McGraw-Hill, 1979.

Andrew S. Glassner is a member of the research staff at the Xerox Palo Alto Research Center (PARC) in California, where he studies realistic image synthesis, modeling, and animation. He can be reached on BIX c/o "editors."

PUT dBASE® ON TOP

Dr. Switch-ASE puts dBASE on top. On top of the charts, spreadsheets, word processors or on top of DOS. Right where it belongs, on top of any graphics or text program when you need it. Neatly tucked away when you don't. Dr. Switch-ASE turns any dBASE language program into a 16-20K RAM resident program. So now you can have dBASE power at the touch of a key, anywhere, anytime and from any program.

dBASE TSR's, easy as ASE

With Dr. Switch-ASE you don't have to be an Assembly language whiz or a C code maven to create TSR's. The Doctor includes an integrated cut & paste feature for transferring data between programs. It also supports both Expanded and Extended memory and is fully network compatible.

The doctor speaks your language

Dr. Switch-ASE* supports all of the dBASE dialects. So it works directly from Clipper, dBASE III PLUS, dBASE IV, FoxBASE+ and FoxPro. No need to learn a new dBASE syntax and no new environments to wrestle with.

When the doctor's in, dBASE is on top.

Call and place your order today!
212-787-6633

DR. SWITCH-ASE
\$179.95**



Black & White International Inc.
PO Box 1040
Planetarium Station
New York, NY 10024-0541



Dr. Switch, Dr. Switch-ASE, Dr. Switch-OnCall and Dr. Switch-TSR are trademarks of Black & White International, Inc. All others are trademarks or registered trademarks of their respective holders.
*Plus Shipping/Handling: U.S. orders add \$6.00 for 2nd Day Air, \$3.00 for Ground. Canadian and foreign orders add \$8.00. COD add \$3.50. NY residents add sales tax. All payments U.S. funds/U.S. Banks only!
**Includes royalty-free runtime version.

HEWLETT PACKARD NETWORKING

NEC TOSHIBA LASER PRINTERS

EPSON LAPTOPS COMPACT LITE

PACKARD BELL TEXAS INSTRUMENT TOSHIBA

COMPUTERS

MODEMS FAX/MODEM

HARD DRIVES

MONITORS

PRINTERS/F/LAPTOP

SOFTWARE

NOVELL In Store

EVERETT

MITSUBISHI ELECTRONICS

SON

Microsoft

TOSHIBA

NOVELL

EVEREX

NEC

HP

Logi

PANASONIC PHONES

FLATBED SCANNERS

PRINTERS/F/LAPTOP

MONITORS

SOFTWARE

NOVELL In Store

EVERETT

MITSUBISHI ELECTRONICS

SON

Microsoft

TOSHIBA

NOVELL

EVEREX

NEC

HP

Logi

PANASONIC PHONES

FLATBED SCANNERS

PRINTERS/F/LAPTOP

MONITORS

SOFTWARE

NOVELL In Store

EVERETT

MITSUBISHI ELECTRONICS

SON

Microsoft

TOSHIBA

NOVELL

EVEREX

NEC

HP

Logi

PANASONIC PHONES

FLATBED SCANNERS

PRINTERS/F/LAPTOP

MONITORS

SOFTWARE

NOVELL In Store

EVERETT

MITSUBISHI ELECTRONICS

SON

Microsoft

TOSHIBA

NOVELL

EVEREX

NEC

HP

Logi

PANASONIC PHONES

FLATBED SCANNERS

PRINTERS/F/LAPTOP

MONITORS

SOFTWARE

NOVELL In Store

EVERETT

MITSUBISHI ELECTRONICS

SON

Microsoft

TOSHIBA

NOVELL

EVEREX

NEC

HP

Logi

PANASONIC PHONES

FLATBED SCANNERS

PRINTERS/F/LAPTOP

MONITORS

SOFTWARE

NOVELL In Store

EVERETT

MITSUBISHI ELECTRONICS

SON

Microsoft

TOSHIBA

NOVELL

EVEREX

NEC

HP

Logi

PANASONIC PHONES

FLATBED SCANNERS

PRINTERS/F/LAPTOP

MONITORS

SOFTWARE

NOVELL In Store

EVERETT

MITSUBISHI ELECTRONICS

SON

Microsoft

TOSHIBA

NOVELL

EVEREX

NEC

HP

Logi

PANASONIC PHONES

FLATBED SCANNERS

PRINTERS/F/LAPTOP

MONITORS

SOFTWARE

NOVELL In Store

EVERETT

MITSUBISHI ELECTRONICS

SON

Microsoft

TOSHIBA

NOVELL

EVEREX

NEC

HP

Logi

PANASONIC PHONES

FLATBED SCANNERS

PRINTERS/F/LAPTOP

MONITORS

SOFTWARE

NOVELL In Store

EVERETT

MITSUBISHI ELECTRONICS

SON

Microsoft

TOSHIBA

NOVELL

EVEREX

NEC

HP

Logi

PANASONIC PHONES

FLATBED SCANNERS

PRINTERS/F/LAPTOP

MONITORS

SOFTWARE

NOVELL In Store

EVERETT

MITSUBISHI ELECTRONICS

SON

Microsoft

TOSHIBA

NOVELL

EVEREX

NEC

HP

Logi

PANASONIC PHONES

FLATBED SCANNERS

PRINTERS/F/LAPTOP

MONITORS

SOFTWARE

NOVELL In Store

EVERETT

MITSUBISHI ELECTRONICS

SON

Microsoft

TOSHIBA

NOVELL

EVEREX

NEC

HP

Logi

PANASONIC PHONES

FLATBED SCANNERS

PRINTERS/F/LAPTOP

MONITORS

SOFTWARE

NOVELL In Store

EVERETT

MITSUBISHI ELECTRONICS

SON

Microsoft

TOSHIBA

NOVELL

EVEREX

NEC

HP

Logi

PANASONIC PHONES

FLATBED SCANNERS

PRINTERS/F/LAPTOP

MONITORS

SOFTWARE

NOVELL In Store

EVERETT

MITSUBISHI ELECTRONICS

SON

Microsoft

TOSHIBA

NOVELL

EVEREX

NEC

HP

Logi

PANASONIC PHONES

FLATBED SCANNERS

PRINTERS/F/LAPTOP

MONITORS

SOFTWARE

NOVELL In Store

EVERETT

MITSUBISHI ELECTRONICS

SON

Microsoft

TOSHIBA

NOVELL

EVEREX

NEC

HP

Logi

PANASONIC PHONES

FLATBED SCANNERS

PRINTERS/F/LAPTOP

MONITORS

SOFTWARE

NOVELL In Store

EVERETT

MITSUBISHI ELECTRONICS

SON

Microsoft

TOSHIBA

NOVELL

EVEREX

NEC

HP

Logi

PANASONIC PHONES

FLATBED SCANNERS

PRINTERS/F/LAPTOP

MONITORS

SOFTWARE

NOVELL In Store

EVERETT

MITSUBISHI ELECTRONICS

SON

Microsoft

TOSHIBA

NOVELL

EVEREX

NEC

HP

Logi

PANASONIC PHONES

FLATBED SCANNERS

PRINTERS/F/LAPTOP

MONITORS

SOFTWARE

NOVELL In Store

EVERETT

MITSUBISHI ELECTRONICS

SON

Microsoft

TOSHIBA

NOVELL

EVEREX

NEC

HP

Logi

PANASONIC PHONES

FLATBED SCANNERS

PRINTERS/F/LAPTOP

MONITORS

SOFTWARE

NOVELL In Store

EVERETT

MITSUBISHI ELECTRONICS

SON

Microsoft

TOSHIBA

NOVELL

EVEREX

NEC

HP

Logi

PANASONIC PHONES

FLATBED SCANNERS

PRINTERS/F/LAPTOP

MONITORS

SOFTWARE

NOVELL In Store

EVERETT

MITSUBISHI ELECTRONICS

SON

Microsoft

TOSHIBA

NOVELL

EVEREX

NEC

HP

Logi

PANASONIC PHONES

FLATBED SCANNERS

PRINTERS/F/LAPTOP

MONITORS

SOFTWARE

NOVELL In Store

EVERETT

MITSUBISHI ELECTRONICS

SON

Microsoft

TOSHIBA

NOVELL

EVEREX

NEC

HP

Logi

PANASONIC PHONES

FLATBED SCANNERS

PRINTERS/F/LAPTOP

MONITORS

SOFTWARE

NOVELL In Store

EVERETT

MITSUBISHI ELECTRONICS

SON

Microsoft

TOSHIBA

NOVELL

EVEREX

NEC

HP

Logi

PANASONIC PHONES

FLATBED SCANNERS

PRINTERS/F/LAPTOP

MONITORS

SOFTWARE

NOVELL In Store

EVERETT

MITSUBISHI ELECTRONICS

SON

Microsoft

TOSHIBA

NOVELL

EVEREX

NEC

HP

Logi

PANASONIC PHONES

FLATBED SCANNERS

PRINTERS/F/LAPTOP

MONITORS

SOFTWARE

NOVELL In Store

EVERETT

MITSUBISHI ELECTRONICS

SON

Microsoft

TOSHIBA

NOVELL

EVEREX

NEC

HP

Logi

PANASONIC PHONES

FLATBED SCANNERS

PRINTERS/F/LAPTOP

MONITORS

SOFTWARE

NOVELL In Store

EVERETT

MITSUBISHI ELECTRONICS

SON

Microsoft

TOSHIBA

NOVELL

EVEREX

NEC

HP

Logi

PANASONIC PHONES

FLATBED SCANNERS

PRINTERS/F/LAPTOP

MONITORS

SOFTWARE

NOVELL In Store

EVERETT

MITSUBISHI ELECTRONICS

SON

Microsoft

TOSHIBA

NOVELL

EVEREX

NEC

HP

Logi

PANASONIC PHONES

FLATBED SCANNERS

PRINTERS/F/LAPTOP

MONITORS

SOFTWARE

NOVELL In Store

EVERETT

MITSUBISHI ELECTRONICS

SON

Microsoft

TOSHIBA

NOVELL

EVEREX

NEC

HP

Logi

PANASONIC PHONES

FLATBED SCANNERS

PRINTERS/F/LAPTOP

MONITORS

SOFTWARE

NOVELL In Store

EVERETT

MITSUBISHI ELECTRONICS

SON

Microsoft

TOSHIBA

NOVELL

EVEREX

NEC

HP

Logi

PANASONIC PHONES

FLATBED SCANNERS

PRINTERS/F/LAPTOP

MONITORS

SOFTWARE

NOVELL In Store

EVERETT

MITSUBISHI ELECTRONICS

SON

Microsoft

TOSHIBA

NOVELL

EVEREX

NEC

HP

Logi

PANASONIC PHONES

FLATBED SCANNERS

PRINTERS/F/LAPTOP

MONITORS

SOFTWARE

NOVELL In Store

EVERETT

MITSUBISHI ELECTRONICS

SON

Microsoft

TOSHIBA

NOVELL

EVEREX

NEC

HP

Logi

PANASONIC PHONES

FLATBED SCANNERS

PRINTERS/F/LAPTOP

MONITORS

SOFTWARE

NOVELL In Store

EVERETT

MITSUBISHI ELECTRONICS

SON

Microsoft

TOSHIBA

NOVELL

EVEREX

NEC

HP

Logi

PANASONIC PHONES

FLATBED SCANNERS

PRINTERS/F/LAPTOP

MONITORS

SOFTWARE

NOVELL In Store

EVERETT

MITSUBISHI ELECTRONICS

SON

Microsoft

TOSHIBA

NOVELL

EVEREX

NEC

HP

Logi

PANASONIC PHONES

FLATBED SCANNERS

PRINTERS/F/LAPTOP

MONITORS

SOFTWARE

NOVELL In Store

EVERETT

MITSUBISHI ELECTRONICS

SON

Microsoft

TOSHIBA

NOVELL

EVEREX

NEC

HP

Logi

PANASONIC PHONES

FLATBED SCANNERS

PRINTERS/F/LAPTOP

MONITORS

SOFTWARE

NOVELL In Store

EVERETT

MITSUBISHI ELECTRONICS

SON

Microsoft

TOSHIBA

NOVELL

EVEREX

NEC

HP

Logi

PANASONIC PHONES

FLATBED SCANNERS

PRINTERS/F/LAPTOP

MONITORS

SOFTWARE

NOVELL In Store

EVERETT

MITSUBISHI ELECTRONICS

SON

Microsoft

TOSHIBA

NOVELL

EVEREX

NEC

HP

Logi

PANASONIC PHONES

FLATBED SCANNERS

PRINTERS/F/LAPTOP

MONITORS

SOFTWARE

NOVELL In Store

EVERETT

MITSUBISHI ELECTRONICS

SON

Microsoft

TOSHIBA

NOVELL

EVEREX

NEC

HP

Logi

PANASONIC PHONES

FLATBED SCANNERS

PRINTERS/F/LAPTOP

MONITORS

SOFTWARE

NOVELL In Store

EVERETT

MITSUBISHI ELECTRONICS

SON

Microsoft

TOSHIBA

NOVELL

EVEREX

NEC

HP

Logi

PANASONIC PHONES

FLATBED SCANNERS

PRINTERS/F/LAPTOP

MONITORS

SOFTWARE

NOVELL In Store

EVERETT

MITSUBISHI ELECTRONICS

SON

Microsoft

TOSHIBA

NOVELL

EVEREX

NEC

HP

Logi

PANASONIC PHONES

FLATBED SCANNERS

PRINTERS/F/LAPTOP

MONITORS

SOFTWARE

NOVELL In Store

EVERETT

MITSUBISHI ELECTRONICS

SON

Microsoft

TOSHIBA

NOVELL

EVEREX

NEC

HP

Logi

PANASONIC PHONES

FLATBED SCANNERS

PRINTERS/F/LAPTOP

MONITORS

SOFTWARE

NOVELL In Store

EVERETT

MITSUBISHI ELECTRONICS

SON

Microsoft

TOSHIBA

NOVELL

EVEREX

NEC

HP

Logi

PANASONIC PHONES

FLATBED SCANNERS

PRINTERS/F/LAPTOP

MONITORS

SOFTWARE

NOVELL In Store

EVERETT

MITSUBISHI ELECTRONICS

SON

Microsoft

TOSHIBA

NOVELL

EVEREX

NEC

HP

Logi

PANASONIC PHONES

FLATBED SCANNERS

PRINTERS/F/LAPTOP

MONITORS

SOFTWARE

NOVELL In Store

EVERETT

MITSUBISHI ELECTRONICS

SON

Microsoft

TOSHIBA

NOVELL

EVEREX

NEC

HP

Logi

PANASONIC PHONES

FLATBED SCANNERS

PRINTERS/F/LAPTOP

MONITORS

SOFTWARE

NOVELL In Store

EVERETT

MITSUBISHI ELECTRONICS

SON

Microsoft

TOSHIBA

NOVELL

EVEREX

NEC

HP

Logi

PANASONIC PHONES

FLATBED SCANNERS

PRINTERS/F/LAPTOP

MONITORS

SOFTWARE

NOVELL In Store

EVERETT

MITSUBISHI ELECTRONICS

SON

Microsoft

TOSHIBA

NOVELL

EVEREX

NEC

HP

Logi

PANASONIC PHONES

FLATBED SCANNERS

PRINTERS/F/LAPTOP

MONITORS

SOFTWARE

NOVELL In Store

EVERETT

MITSUBISHI ELECTRONICS

SON

Microsoft

TOSHIBA

NOVELL

EVEREX

NEC

HP

Logi

PANASONIC PHONES

FLATBED SCANNERS

PRINTERS/F/LAPTOP

MONITORS

SOFTWARE

NOVELL In Store

EVERETT

MITSUBISHI ELECTRONICS

SON

Microsoft

TOSHIBA

NOVELL

EVEREX

NEC

HP

Logi

PANASONIC PHONES

FLATBED SCANNERS

PRINTERS/F/LAPTOP

MONITORS

SOFTWARE

NOVELL In Store

EVERETT

MITSUBISHI ELECTRONICS

SON

Microsoft

TOSHIBA

NOVELL

EVEREX

NEC

HP

Logi

PANASONIC PHONES

FLATBED SCANNERS

PRINTERS/F/LAPTOP

MONITORS

SOFTWARE

NOVELL In Store

EVERETT

MITSUBISHI ELECTRONICS

SON

Microsoft

TOSHIBA

NOVELL

EVEREX

NEC

HP

Logi

PANASONIC PHONES

FLATBED SCANNERS

PRINTERS/F/LAPTOP

MONITORS

SOFTWARE

NOVELL In Store

EVERETT

MITSUBISHI ELECTRONICS

SON

Microsoft

TOSHIBA

NOVELL

EVEREX

NEC

HP

Logi

PANASONIC PHONES

FLATBED SCANNERS

PRINTERS/F/LAPTOP

MONITORS

SOFTWARE

NOVELL In Store

EVERETT

MITSUBISHI ELECTRONICS

SON

Microsoft

TOSHIBA

NOVELL

EVEREX

NEC

HP

Logi

PANASONIC PHONES

FLATBED SCANN

What does Compaq give 386 users who expect the moon?

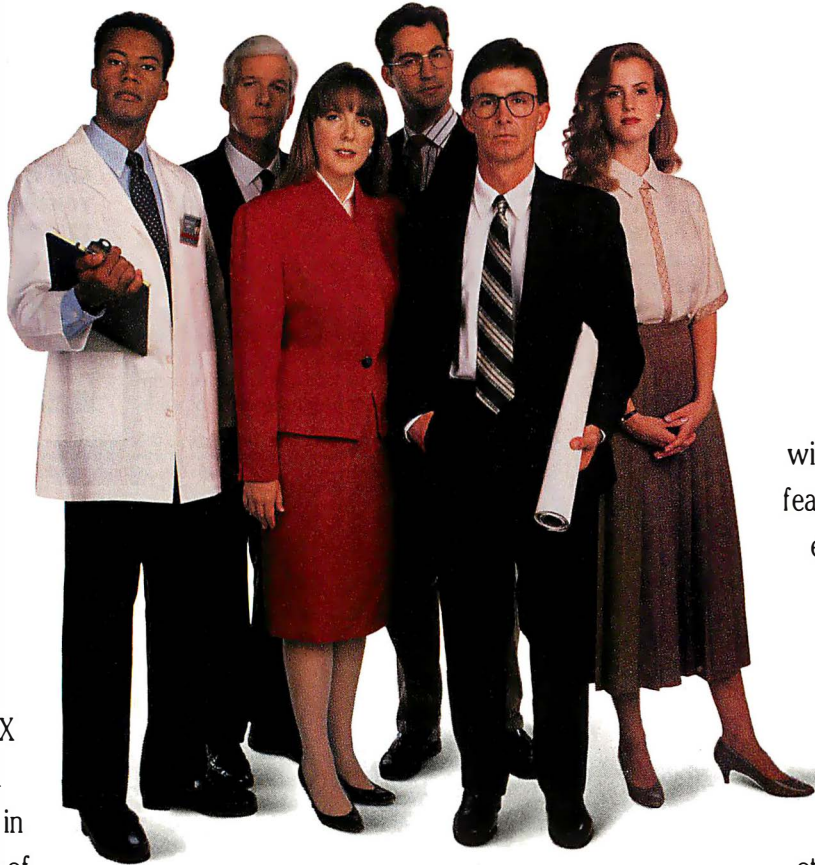

Giving demanding users the best PC possible is a tradition at Compaq. A tradition we upheld when we introduced the world's first PCs based on Intel's 386 and 386SX microprocessors. And a tradition that continues in our comprehensive line of desktop PCs.

Within this line you'll find six different levels of 386 performance and affordability. And a PC designed to give you the perfect balance of features and power. You'll find the reliability and compatibility you've come to expect from Compaq. Plus the flexibility to choose from a wide array of optional features.

You'll also find an Authorized COMPAQ Computer Dealer, who's trained to match the right peripherals and software with the right PC. And to tailor a solution to your exact needs. All at prices that are more competitive than ever.

Come look at the COMPAQ DESKPRO 386N Personal Computer, for example. It's a full-function PC

with breakthrough features for networked environments. As a stand-alone PC, its 16-MHz 386SX microprocessor handles all of the general business applications our other 386SX-based PCs

run. With so many integrated features, you can take care of your expansion needs using only two slots.

And it comes with a host of unique network features like multilevel security, making it the best full-function PC for connected environments. All of this fits neatly into a space-saving design.

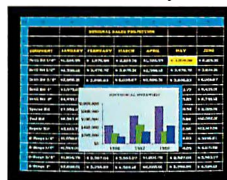

The COMPAQ DESKPRO 386s Personal Computer is also designed to handle general business applications. Its 16-MHz 386SX

microprocessor gives you exceptional 386 performance. And its 32-bit architecture lets you run today's popular business software. It also offers the flexibility to run tomorrow's advanced business software.



The stars.



Project managers and other general business users will find everything they need to manage databases and speed through complex spreadsheets in the COMPAQ DESKPRO 386s/20 Personal Computer. It delivers the maximum in 20-MHz 386SX performance and a broad range of integrated features.



The COMPAQ DESKPRO 386/20e Personal Computer is for experienced users. It's perfect for demanding applications like presentation graphics. And it's loaded with high-performance features like an advanced cache architecture. So it runs up to 50% faster than other 20-MHz, non-cached 386-based PCs.

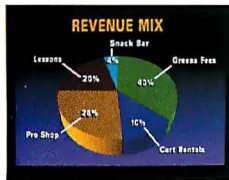

For users doing similar jobs, but with more stringent performance needs, we offer the COMPAQ DESKPRO 386/25e Personal Computer. Its 25-MHz 32-bit performance lets you fly through financial analysis as well as other demanding applications.

It's the perfect personal computer for people who are serious number crunchers, administrators

who manage massive loads of information and engineers who work on generating complex two-dimensional CAD drawings.

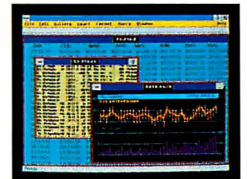

At the most demanding level of 386 computing are the power users who do graphic-intensive applications like 3-D CAD drawings and other performance-intensive applications. These people need the kind of high performance that the COMPAQ DESKPRO 386/33L Personal Computer delivers. It combines the fastest 386 chip with high-performance innovations. And it lets you easily upgrade to the power and performance of a 486 chip.

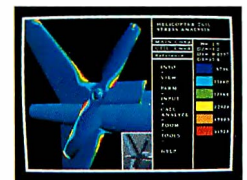

If you're looking for the 386 desktop PC that simply works better for whatever you do, call 1-800-231-0900, Operator 129. In Canada, call 1-800-263-5868, Operator 129.

COMPAQ

It simply works better.



Outperforms the competition. Colors you can touch.

PerfectView.™ The winning 1024 x 768 VGA card in 256 colors with memory up to 1MB!

We're not bragging, merely stating facts. According to an independent lab, Benchmark Speed Tests proved that **PerfectView** outperformed the competition. Of six leading VGA cards, **PerfectView** rated the highest on overall performance plus the fastest on direct screen access and windowed scrolling.

2-year warranty

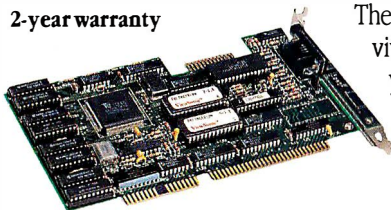

The picture is so sharp and vivid, you might find yourself trying to "feel" the images and colors on your monitor, especially if it's a ViewSonic.

Compatible with interlace and non-interlace monitors in all high resolution modes, **PerfectView** supports Windows 286/386/386 3.0, AutoCad, AutoShade, Lotus 1-2-3, Ventura, GEM, CADvance, Framework II, WordPerfect and DrawPerfect.

PerfectView, our incredible VGA card. It's a winner!

CALL TODAY to learn more about our full line of **PerfectView** VGA cards and ViewSonic monitors.

Dealers: Call for information on our \$99 PerfectView demo program — FREE!

ViewSonic

a Keypoint Company

12130 Mora Drive

Santa Fe Springs, CA 90670

(213) 946-0711

FAX: (213) 944-9559



ViewSonic™

ViewSonic and PerfectView are registered trademarks of Keypoint Technologies, Inc. All other products and brand names are registered trademarks of their respective companies.

Circle 162 on Reader Service Card (RESELLERS: 163)

Color WYSIWYG Comes of Age

*Finally! What you see in color on your screen is
what you get in color on your printer!*

Frank Vaughn

Truly graphical computers, such as the Mac, and sophisticated laser printers have brought WYSIWYG capabilities to word processing and black-and-white desktop publishing. With the proper hardware and software, you can be assured that your hard-copy output will match what you see on your computer display. Until recently, the same was not true of color desktop publishing. You have had no assurance that the colors on your display would match those of the final printed output.

The advent of many enabling technologies has recently advanced the state of color WYSIWYG to where it is an affordable desktop technology. Display systems with "true-color" capabilities and graphics acceleration are available and affordable for desktop computers running the more popular operating systems.

Apple Computer, for example, has established a color standard for the Macintosh called 32-Bit QuickDraw, while Microsoft has defined a 24-bit color standard for Windows 3.0. Both companies are enjoying increasing hardware and software support for these standards. On

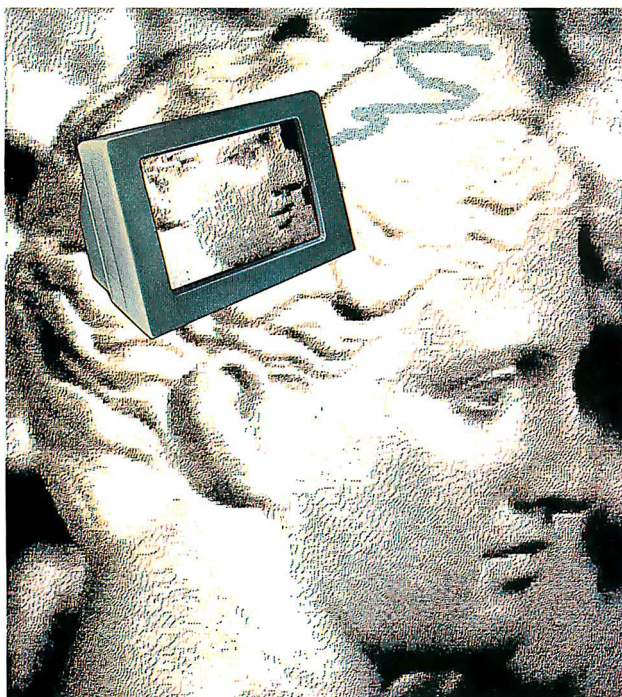

the peripherals side, color scanners with the capabilities required by serious designers are available to input true-color images, and cost-effective color hard-copy output devices are also available. None of these systems, however, ensures that the color you see on your display will be the color you get in print.

To be useful as a color-proofing system as well as a layout tool, a color desk-

top publishing system must ensure that the colors you see on your display are similar or identical to the colors on the final printed output. All the colors also need to be consistent from one display to another so that different designers in the same company can work with the same colors. Such color consistency may seem straightforward to the casual observer, but it is actually quite a difficult problem to solve. To see how you can achieve color consistency, you need some facts about how different technologies handle color.

What You See

Your perception of color is a function of the sensitivity of your retina to a range of wavelengths in the visible light spectrum. The human retina contains three types of cone cells, each of which responds to different wavelengths of visible light. The color you perceive depends on the relative response of each type of cone to the light striking it. The wavelengths you can detect vary from 3900 to 7000 angstroms, where an angstrom is a hundred-millionth of a centimeter.

You perceive the shortest wavelengths as blues and violets and the longest as

oranges and reds. Black is the absence of any wavelengths in the visible spectrum. An even mix of the spectrum of wavelengths is perceived as white, although different light sources have their own

particular mixtures for white. Each particular white has a color temperature associated with it. You can measure the color temperature of an illuminant (also known as its *white point*) by heating a

blackbody radiator (a heated cavity with an exit aperture) to a temperature measured on the Kelvin scale. A cool-white fluorescent lamp has a white point of 4300 K, and an incandescent bulb has a white point of 2900 K. The table at left lists some common sources of light and their color temperatures.

An object's perceived color varies when you view it under illuminants with different white points. This is known as *color shift*. A red car appears to be gray when illuminated by a yellow sodium street lamp, because the red color shifts when mixed with the yellow lamp. More subtle differences are evident if the car is viewed in daylight or in a dealer showroom under fluorescent lighting.

Quantifying What You See

In an effort to organize the range of possible colors in a predictable and useful manner, the concept of the color space (also known as a color model) has been developed. Color display systems use the RGB color space, and color printing systems typically use the CMYK (cyan, magenta, yellow, black) model. These color spaces use component colors as the parameters for the model. Other color spaces may use other parameters, such as brightness. For the most sophisticated color spaces, these parameters are based on psychophysical metrics that have been experimentally determined.

The goal of a color space is to allow any color sample to fit in that space and be quantified from the combination of the component parameters at that point. Color spaces are therefore good for selecting and specifying colors and communicating color information.

Nearly all defined color spaces are based on three parameters. They are most useful for experimentally determining differences between perceived colors. The international standard for specifying color is the xyY color space, defined in 1931 by the Commission Internationale L'Eclairage (CIE). The three primary coordinates (*x*, *y*, and *Y*) are combined, with positive weights, and can define all colors in the human color-perception range. Any color can be specified with these weights. The same cannot be said for the RGB and CMYK color spaces.

The RGB space refers to colors known as the additive primaries: red, green, and blue. They are primary in the sense that they are the only three colors required to create white light. This is done by combining the light of each one in a process known as *additive mixing*.

The CMYK space uses the color com-

COLOR TEMPERATURES OF LIGHT SOURCES

The color temperatures for some common light sources. The different color temperatures affect how you perceive color illuminated by different sources.

Source	Temperature (kelvins)
North-facing skylight	7500
Average daylight	6500
Xenon camera flash	6000
Cool-white fluorescent	4300
Tungsten-halogen lamps	3300
Warm-white fluorescent	3000
100-watt tungsten	2900
Sunset	2000
Candle flame	1900

DOMAINS OF COLOR TECHNOLOGIES

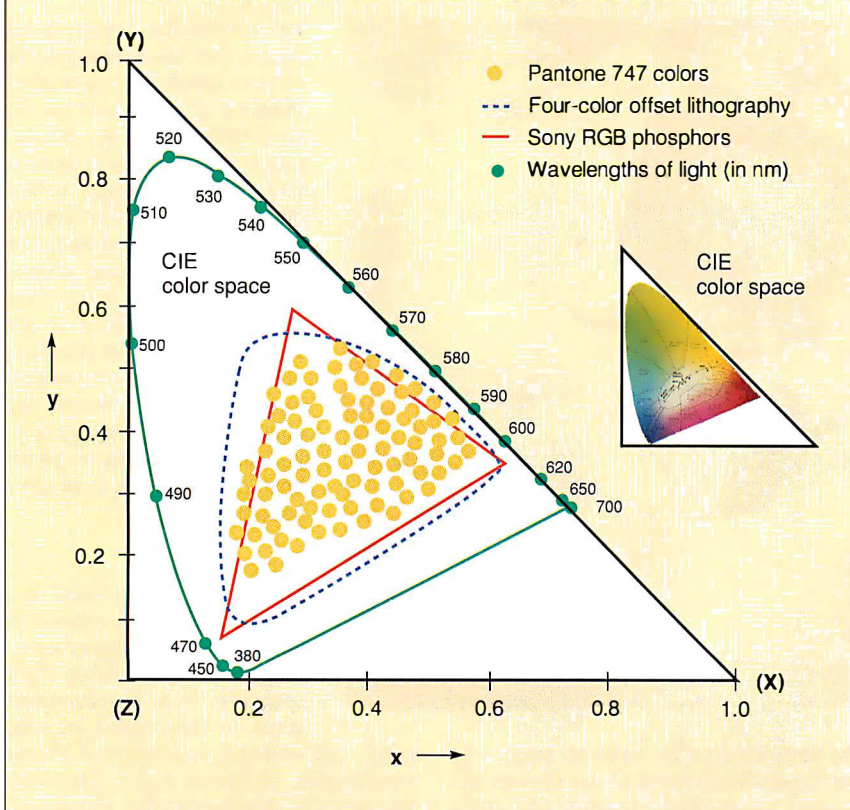

Figure 1: The CIE color space projected into two dimensions. This is really a three-dimensional space that contains all the colors visible to the human eye. The triangular area outlined by the coordinates of the Sony RGB phosphors is a projection of its color gamut onto the color space. Pantone colors are discrete points within the space, while four-color offset lithography projects a gamut similar to the RGB gamut.

plements of the primaries: cyan, magenta, and yellow (the K refers to black, which is used for better print quality). These complements are the colors that result when a primary color is subtracted from white light. Cyan is the complement of red (white light - red light = cyan light), magenta is the complement of green, and yellow is the complement of blue.

In the CMY space, colors mix in a process known as *subtractive mixing*. That is, the complements mix to form black. This is a theoretical ideal; because of pigment limitations, it is necessary to add the black parameter to achieve true black in hard-copy reproduction. CMYK is the color space used to define colors for most four-color printing.

The RGB and CMYK spaces can only produce a portion of the human color-perception range. By plotting each component color of the RGB or CMYK space (ignoring black) for all brightness levels (the Y in xyY), you define a subarea within the xyY space. This range of possible colors is known as the *color gamut*. Figure 1 shows the color gamuts for a few color display and hard-copy systems.

What You Get

Color display systems achieve unique colors by "adding" different intensities of red, green, and blue for each pixel on the display. The combination of full intensities of red, green, and blue phosphors for a particular pixel generates a "white" pixel. The number of intensities for each red, green, and blue component is dependent on the format used.

The 32-Bit QuickDraw format is actually a 24-bit format with 8 bits, or 256 levels, of coding for the red, green, and blue phosphors making up a pixel. The other 8 bits are undefined and reserved for future use by the standard. Given this format, the number of color combinations is 256 by 256 by 256, or around 16 million. In a display with a resolution of 1152 by 882 pixels, you have roughly 1 million pixels. Software can assign a different color to each pixel from the 16 million possible combinations.

The color gamut for displays from different manufacturers varies because they each use different types of phosphors. Thus, identical combinations of RGB intensities do not produce identical color on different RGB monitors because of the phosphor differences. Even the characteristics of a monitor change as it gets older and the phosphors wear out, which they do at different rates (blue phosphors typically degrade faster than red).

Besides phosphor differences, there is

another problem in relating the intensity level of each of the red, green, and blue components to the actual luminance viewed at the screen surface. For a black pixel, the intensity level of all three components is 0—practically no light is emitted for that pixel. For a maximum "white," all the intensity levels are at 256, resulting in maximum illumination.

For each intensity level from 0 to 255, however, the displayed luminance is not linear. In other words, an intensity of 128 isn't double the luminance of an intensity of 64. The relationship of the intensity level to the luminance can be plotted to form the *gamma curve* for the display.

To find the gamma curve of a display, the logarithm of the input voltage is plotted against the logarithm of the luminance. The slope of the central portion of the resulting curve is the gamma curve. TV sets and other video displays have a gamma curve of about 2.8. Scanners typically have a gamma curve of 1.0. Figure 2 shows three common gamma curves plotted in linear space.

The gamma curves for different dis-

plays of the same type or model are typically not consistent. To achieve accurate and consistent colors on a display, you must be able to read accurately the luminance of the display that corresponds to a given intensity level. To do this, a device measures the actual intensity of light received at the display surface for each of the 256 levels of red, green, and blue.

With this information, the loop is closed around the display system. The luminance for each intensity can now be accurately set and stored in a *gamma correction* table. This table contains an output level for each of the 256 input levels, which makes it possible to control the perceived gamma curve with software.

To control the perceived gamma curve, the viewed luminance at each input level must be set to match a particular gamma curve setting. With a gamma correction table and accurate luminance data, any gamma curve that the applications software requires can be set.

Anyone with a calibrated display, whether in the same office or across the country, will see consistent colors when viewing the same image at a particular

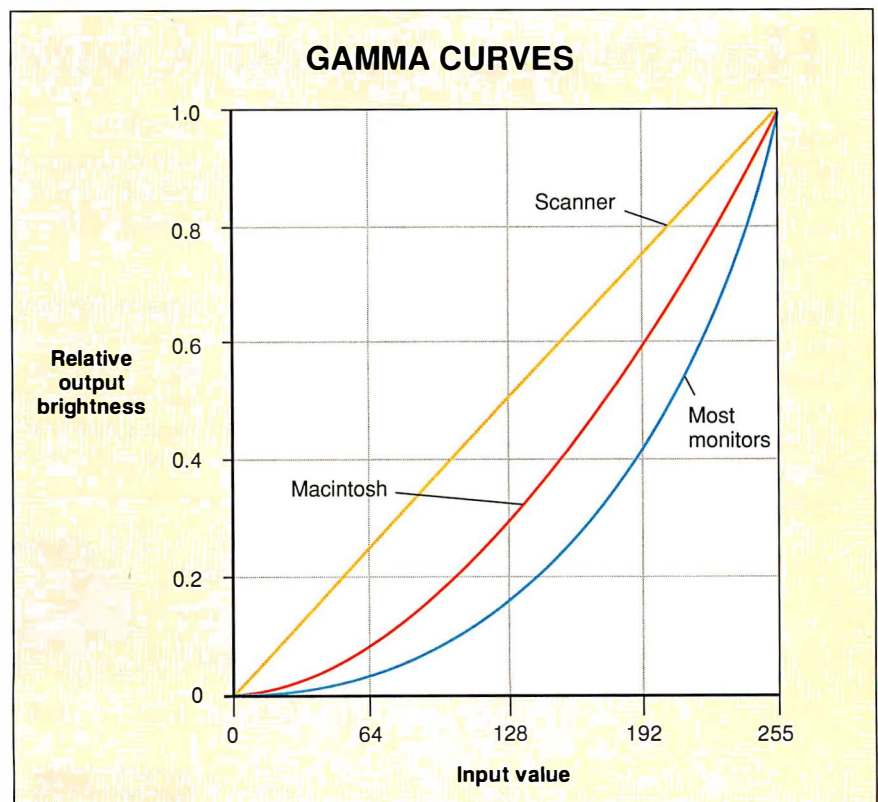
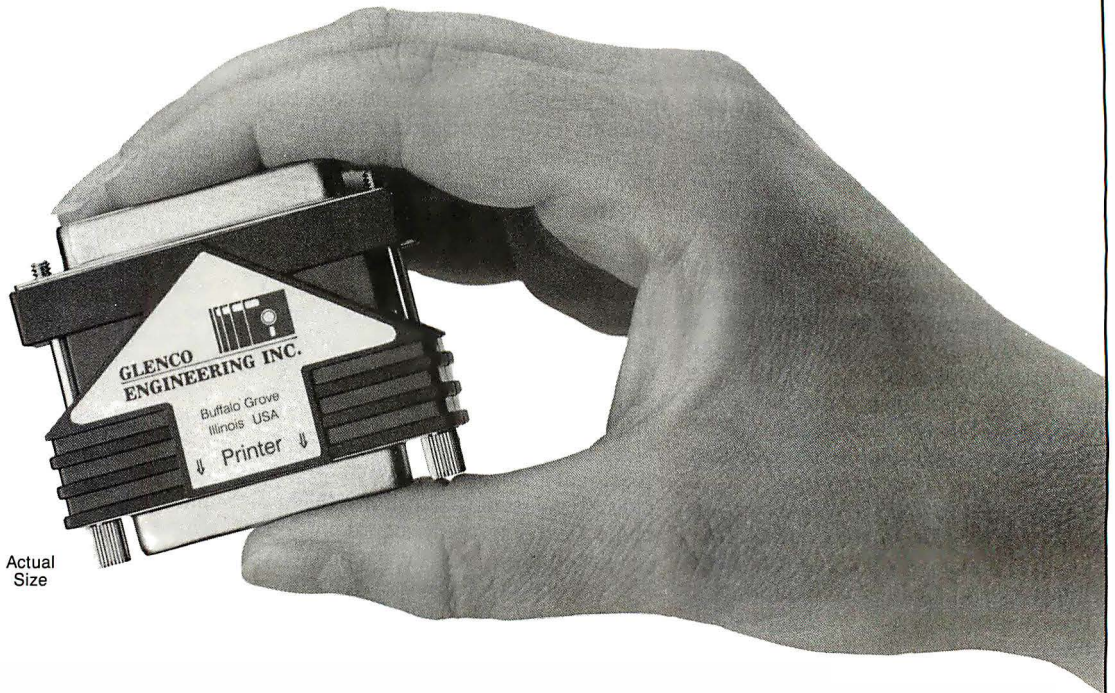

Figure 2: The gamma curve is calculated by plotting the logarithm of the input level of a display against the logarithm of the luminance. It describes how luminance at the surface of the display changes as the intensity setting of the monitor changes. Shown are gamma values for scanners, the Macintosh, and other personal computers and workstations.

I N T R O D U C I N G HARDLOCK™



Actual Size

The Ultimate in Hardware Based Copy Protection

Compatible

Hardlock is designed for the "real world". Side effects from printers, laptops and technical issues such as static and true IBM printer port compatibility are virtually non-existent.

Reliable

Our unique ASIC (Application Specific Integrated Circuit) extends the Hardlock's operating range below 2 volts. Since no idle current is required, there is no additional loading on the printer. Electronically erasable memory **requires no battery**.

Flexible

Field programmability is now possible. Additionally our optional Crypto Programmer board permits the Hardlock to be uniquely programmed for your company.

Space-Saving

Hardlock measures only 1.75". Three of our units fit in approximately the same space as only two others. Hardlock with Memory may also be purchased on the smallest PC board you've ever seen. Perfect for those who don't want the device on the exterior of the computer.

Hardlock
Hardlock with (128 bytes) Memory
Hardlock with Memory on a Board

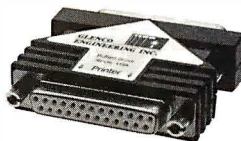

**Hardlock...
Not Hardluck**

The Security System You've Asked For.

GLENCO
ENGINEERING INC.

SERVING THE SOFTWARE INDUSTRY SINCE 1979

1-800-562-2543

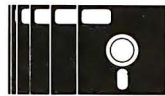

Hardlock is a trademark
of Fast Electronic GmbH.

270 Lexington Drive · Buffalo Grove, IL 60089 · 708-808-0300 · FAX 708-808-0313

Circle 122 on Reader Service Card

gamma setting. As a display ages, you can recalculate the intensity information to restore a consistent calibration of the gamma curve and color temperature.

Refining What You Get

Color calibration is done by calibration hardware that measures the outputs of pixel phosphors and either adjusts the levels of the electron beams in the monitor or changes the entries in the display system's gamma correction table. The first approach usually relies on internal sensors and requires that each color workstation have its own calibration hardware, which makes this the more expensive solution. The second approach normally requires an external sensor that can be used with multiple displays, so this is the more cost-effective solution. In a schematic overview, the external calibrator is a relatively simple device. It consists of three principal components:

1. The sensor, or luminance-measurement device, which inputs a light level and outputs a current;
2. the amplifier, which converts the current into a voltage; and
3. the A/D converter, which samples the voltage and turns it into a number—a digital representation of the luminance. This number can then be compared with other values stored, for example, in the gamma correction table of the Mac.

The combination of a calibrator and knowledge about the display being calibrated (i.e., the xyY values for the representative phosphors) enables you to calibrate the display. Measuring all the intensities for each color gun separately generates enough information to calibrate the display.

Radius has designed a solution—the PrecisionColor Calibrator—that enables you to quickly calibrate a display, correcting individual display biases and display variations that occur over time. It measures light output from the display and realigns the red, green, and blue color-gun values.

Calibrating different displays is important, but it doesn't ensure that what you see in print will match what shows up on the displays. To span the display-output gap, Radius has obtained an exclusive license from Pantone to calibrate and display Pantone Color Simulations on-screen. The Pantone Matching System is a standard method used to define spot colors in the printing industry.

When a display is calibrated accurately and you know the CIE coordinates of each phosphor, sufficient information

exists to display Pantone colors accurately. Pantone has measured the CIE coordinates for the colors of the Pantone Matching System for each of two light sources: D50, the standard graphic-arts illuminant, and D65, a popular daylight illuminant. If you select a particular Pantone color, a software package called the Pantone Color Toolkit performs a CIE-to-RGB calculation. This toolkit is packaged with the PrecisionColor Calibrator.

The white point of the calibrated monitor can be adjusted to match either of Pantone's color temperatures. If the white point is set to D50, the white screen of the monitor looks more like a press sheet illuminated in a printing plant. Identifying the monitor's characteristics and then controlling or adjusting for any variations from a preset standard allows Pantone colors or any CIE coordinate color to be simulated and displayed on RGB devices. This means that the design and page-layout process also produces an accurate color preview of the finished piece.

The calibrated display acts as a preview device for Pantone spot colors. The CIE information on Pantone colors enables the Color Toolkit to simulate these colors on four-color process printers. The Toolkit can also be set to directly simulate Pantone colors for printing systems using Pantone inks. The colors for these two output processes can differ slightly because of differences in the color gamut for RGB displays, CMYK printers, and Pantone inks. The Color Toolkit can adjust for these variations within the limits of the color gamut of the RGB display. This enables the graphics artist to preview work for either output process.

Clearing the Way

There are many complexities associated with the use of color in WYSIWYG desktop publishing. The ability to accurately match the colors viewed on the display to the colors that will be output to film or hard copy is critical to making true WYSIWYG color production a reality.

Display calibration is a significant step toward using the personal computer for color design, providing a consistent measure with which to preview and match final output in the color layout and design process. This technology clears the way for more widespread use of color on the personal computer. ■

Frank Vaughn is director of engineering operations at Radius, Inc. You can reach him on BIX c/o "editors."

VISA **COMPUTER IMAGES** MasterCard



Super VGA

Also VGA/EGA/HGC/CGA and Animation

1024 x 768 x 256

Photographic Quality Real Color Images
ASTRONOMY • NATURE • SCENIC
FULL COLOR VIDEO MOVIES
HUGE ADULT SECTION • GIRLS
You must be at least 21 for adult images.

Now you can experience your computer's maximum graphics ability! We create the world's highest quality images and video movies. In business since 1979, we helped pioneer the color imaging market.

GIF images for MS-DOS, MAC II, Amiga, Atari and most other computers in your favorite GIF resolutions, EGA to VGA 320x200x256 to SVGA 1024x768x256 and all resolutions between. Viewing computer images is much easier than you might think. We have all the image utilities for printing, display and editing.

TWO WAYS TO BUY OUR IMAGES

32 Line BBS: 503-697-5100 • You'll have full unlimited access to 1400 megabytes of images and programs on our 24-hour 32-line BBS. Only \$10/hr., no uploading required, no time limits. No charge to look around. 9600 baud: Call for 9600 baud numbers.

Must be 21 for adult areas. Buy time online with credit card on the world's largest Online Graphics System!

CATALOG MAIL ORDER: 503-697-7700 • Save long distance phone charges. Order anything found online through our Mail Order Catalog. Also ask about our Starter Packages, any resolution, category including adult; \$39 ea. World-wide shipment. Credit card, cash, check. Same day shipment, US Mail, UPS, FEDEX, anywhere.

Free Disk Catalog: If you don't have a modem or wish to order by mail and need more info then call for our free MS-DOS CATALOG on diskette with full description of Images and Order Forms. Easy and fast. Call 503-697-7700 9am to 9pm.

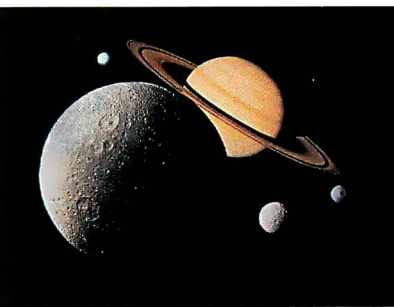

Super VGA

Event Horizons

141 N. State St., Suite 350
Lake Oswego, OR 97034
Information 503-697-7700
BBS: 503-697-5100
Fax 503-636-0495 24 hrs.

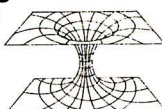

AMONG THE WORLD'S GREATEST TIME-SAVERS



Introducing a remarkably fast new route to Windows™ 3.0

Complete Windows 3.0 applications in half the time

You don't need a miracle to complete Microsoft® Windows 3.0 applications quickly and easily.

Just the latest development tools from The Whitewater Group. They help you take advantage of all the new features of Windows 3.0 with unprecedented speed.

No matter what kind of application you're developing... whether it's a prototype or a complete system... we have a time-saving Windows solution for you:



Actor® 3.0, the complete Windows development system...
ObjectGraphics™, our new portable graphics library...
Whitewater Resource Toolkit™ for creating and customizing Windows resources...
WinTrieve™ for indexed file management... and more.

For more information including your copy of our detailed brochure "The Fast Route to Windows Development"—plus your copy of The Official Instructions for The First Annual Whitewater Historic Time-Savers Contest—

"Whitewater's Actor 2.0, Resource Toolkit for Windows, and WinTrieve deliver benefits that any organization planning to use Microsoft Windows or the OS/2 Presentation Manager can ill afford to do without."

William F. Zachmann

(Reprinted from PC Magazine, April 24, 1990.
© 1990 Ziff Communications Company)

Phone 1-800-869-1144 today!

Or FAX your request for information to 708-328-9386



The Whitewater Group®

1800 Ridge Avenue, Evanston, IL 60201-3621 USA 708-328-3800

© Copyright 1990 The Whitewater Group, Inc.

Circle 312 on Reader Service Card

True Color for Windows

With the right hardware and software, you can display and manipulate photo-realistic images under Windows 3.0

Adam Bellin and Pier Del Frate

For the past few years, the Macintosh has led the way in bringing 24-bit, workstation-quality graphics to personal computers. Applications written to the 32-Bit QuickDraw standard can easily use photo-realistic images, providing you with a level of creativity never before available on personal computers.

Until recently, IBM PCs and compatibles have not offered the same ability to work in true color. Most MS-DOS software is written to take advantage of the standard display adapters—CGA, EGA, and VGA—which are limited in the number of colors they can display. Applications that work with true color images must be written for a specific display board, such as a Targa board. The advent of Windows 3.0, however, is changing all that.

The Windows Advantage

Besides providing a graphical user interface that is well suited to graphics applications, Windows 3.0 provides a graphics device interface (GDI) that frees applications developers from having to support every display adapter ever made. Developers need to write code to support

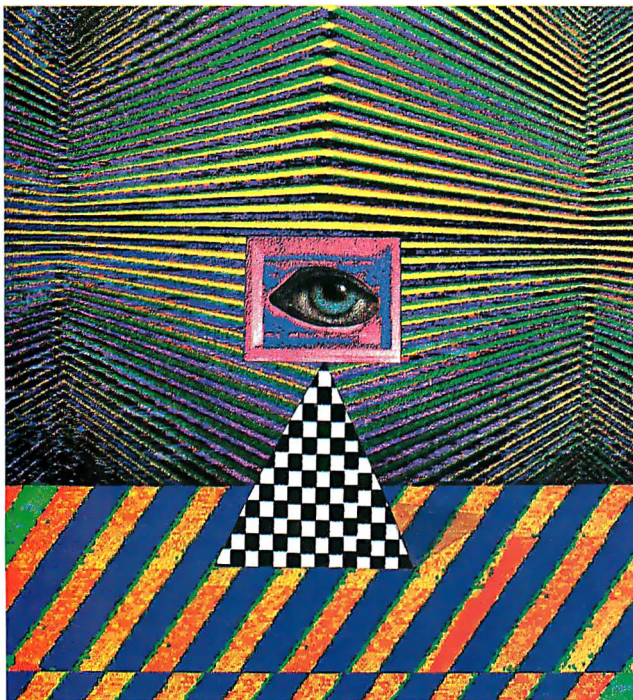

the GDI only; graphics-board manufacturers then provide a single driver that translates instructions to the GDI device into commands that the graphics hardware can understand.

Perhaps the most significant feature of the Windows 3.0 GDI is its support for 24-bit graphics. It lets an application use up to 24 bits of information to define the color of a single pixel on the screen.

Now, using Windows 3.0, you can see images on the screen as they will appear when printed, and you can develop quality presentations that incorporate photo-realistic images.

When running under Windows 3.0, applications can work with 24-bit images without regard to the display device you have in your system. The driver for the display device takes care of converting colors and images to its format, operating transparently to the applications.

If a Windows display device, such as the RasterOps ColorBoard 1024MC, supports 24 bits per pixel, then applications will be able to work with and display any of 16.7 million (2^{24}) colors. The ability to work with 24-bit images on-screen provides for a photo-realistic graphical environment that can support sophisticated desktop-publishing, multimedia, business-presentation, color-illustration, and image-processing applications. A computer that is running Windows 3.0 and equipped with a 24-bit video display becomes a powerful graphics workstation, able to run major graphics applications simultaneously with standard DOS applications.

continued

The 24-bit Advantage

A few applications, such as Power Point from Microsoft and Corel Draw from Corel Systems, have already been written to the Windows 3.0 24-bit standard, although display boards that support the standard are only now becoming avail-

able. Such applications not only let you view scanned or frame-grabbed images that have the same quality as the original, but, with the ability to simultaneously display 16.7 million colors, they let you create smooth-shaded objects or show a color gradient (or "fountain fill")

with enough colors to eliminate all banding effects.

The VGA provided on the motherboard of PS/2s produces a display with a resolution of 640 by 480 pixels by 4 bits per pixel (16 colors). Other display devices, such as Super VGA and 8514/A, let you display as many as 256 colors in higher resolutions. Although these are adequate for preliminary work in layouts and presentations, they are inadequate if you want to see the screen as it will appear in its final, hard-copy format.

Photo 1 shows a screen rendered in standard VGA, while photo 2 shows a similar display rendered in 24 bits. The displays were created on the same machine by switching between the VGA Windows 3.0 driver and the 1024MC Windows 3.0 driver. Note the difference in quality between the two. With both Corel Draw and Power Point, the fountain fills used for shading are greatly enhanced by providing 16.7 million true colors that don't rely on a dithered pattern to approximate the desired colors.

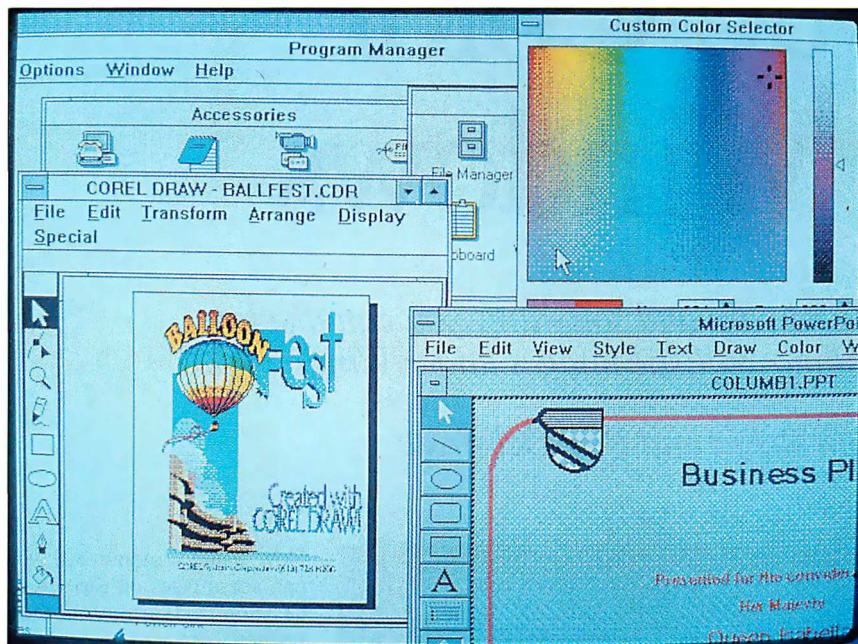

Photo 1: Standard VGA display. Under Windows 3.0, you must use dithering when a program attempts to display more colors than the display adapter supports.

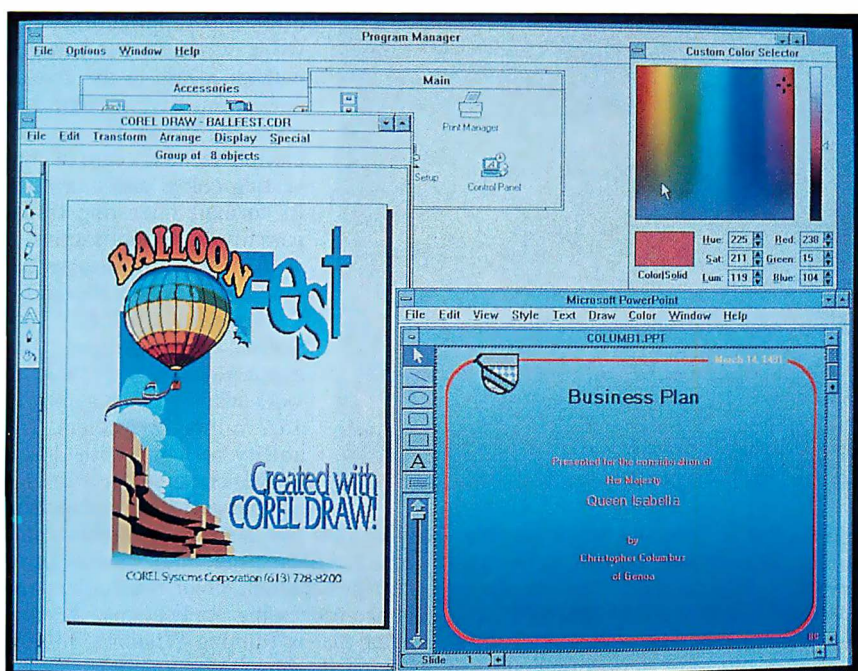

Photo 2: A 24-bit display. With a 24-bit graphics board such as the RasterOps 1024MC, Windows 3.0 doesn't have to resort to dithering or approximations; it outputs the true colors called for by the application.

Drive That Display

The display driver links the video display hardware to the Windows environment. It provides the low-level functions required by Windows to do everything from drawing a single pixel on the screen to displaying images and drawing geometric shapes such as lines and curves.

Most of the drawing functions must also support many raster operations (ROPs) at drawing time. A ROP defines the logical operation or pattern that the BitBlt (bit block transfer) function uses when it combines the source and destination bits during a drawing operation. A ROP is applied to each pixel involved in the drawing operation. Windows 3.0 supports 256 different ROPs for the BitBlt routines, and the display driver must support all of these. (Actually, there are 128 ROPs; the second set of 128 ROPs is the same as the first with a negate operation appended.)

If the display hardware has acceleration or drawing support on-board, it can greatly increase the speed of some of the ROPs that are supported in hardware. Some display devices can support BitBlt operations without performing pixel processing; in these cases, the display driver must be able to differentiate between the operations supported in hardware and those supported by the driver.

Upping the Hardware Ante

A driver that supports 24 or 32 bits per pixel differs greatly from a 4- or an 8-bit display driver. When you do work with

27 Symbol Libraries for under \$50.00 each.
 Call 1-800-223-2521 for details.

Now Available!

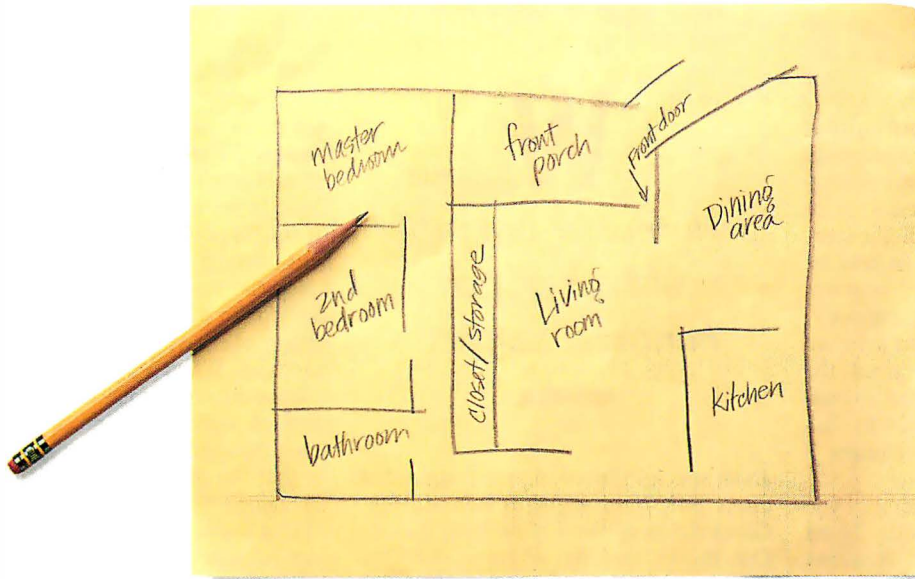

Sketch.

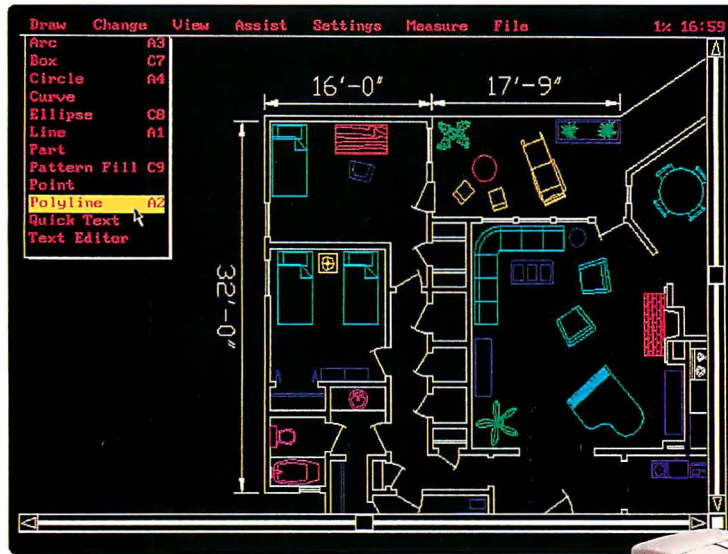

AutoSketch®

If you can sketch, you can AutoSketch. Which gives you real CAD power—speed, accuracy and easy revisions—all without a long, drawn-out learning curve.

With AutoSketch version 3, you have our easiest CAD yet with pull-down menus and on-screen icons. You also have DXF™ file

compatibility and associative dimensioning. It's what you'd expect from the makers of AutoCAD®, the world's most popular CAD package.

For a brochure or ordering information, call 1-800-223-2521.

We'll sketch in the details.

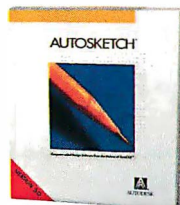

U.S. \$249

AUTODESK

large pixel depths—and larger spatial resolutions—your memory requirements go up dramatically, both for the display and for temporary buffers used to store images off-screen. For example, a standard VGA screen, operating at 640 by 480 pixels by 4 bits per pixel requires about 154K bytes of display memory, with a like amount required to store an image off-screen. At 8 bits per pixel, the same screen requires 307K bytes. In contrast, a screen operating at 1024 by 768 pixels by 24 bits per pixel requires 3 megabytes.

Given the large amount of memory you have to manipulate when using 24-bit images, the performance of Windows can suffer without proper hardware support. This is why the 1024MC comes with a 386-only display driver. Drivers running on the 386 can move 32 bits of data at a time, whereas the 286 can only move 16 bits at a time.

Also, the segmented-memory architecture of the 286 slows down processing when an image is larger than 64K bytes, as is the case with just about all 24-bit images. Using 4-gigabyte memory segments, 386 drivers don't need to worry

Windows' performance can suffer without proper hardware support.

about special processing for images that cross 64K-byte segment boundaries. Given the limitations of the 286, RasterOps thinks that the Windows 3.0 386 enhanced mode is vital if you want to limit the performance penalty you incur when using true color. The 286 simply does not have the horsepower to manipulate 24-bit images fast enough to satisfy most people.

Windows Without 24-bit Hardware

Under Windows 3.0, colors in the palettes kept by applications and by the system are defined as 24-bit values (8 each for red, green, and blue). When these

values are output to a device that can't display 24 bits, the display driver converts them to a value the display can produce. Some of these conversions are done on the fly, but a well-behaved application will usually request that logical 24-bit colors be translated into physical colors early on in the program so that the application can save the physical colors for later use. When a particular 24-bit color is passed to the display driver, the driver, through translation and approximation, must decide on the closest matching color or that the physical device is capable of displaying.

One feature that helps a display device approximate colors it can't produce is the ability of Windows applications to paint and draw with brush objects. A brush is normally an 8- by 8-pixel pattern used to paint the screen. Windows or an application can request that the display driver create a brush that has a foreground and/or a background color. If the display device cannot output the colors requested in the brush, the driver generates an 8- by 8-pixel dithered pattern that most closely represents the colors requested.

The advantage of using a brush over a

The DGIS™ SDK and a TI 34010-based High-Performance Graphics Board for one amazing price.

High performance, high resolution graphics are the wave of the future. With the DGIS Software Developer's Kit™ (SDK), qualified software developers can write for the future today.

The DGIS Developer's Kit provides everything needed to develop applications and drivers for DGIS-compatible 34010 graphics boards—boards from companies such as Compaq, Dell, Hewlett-Packard, NCR, NEC, TI and more than 30 others worldwide. Software developed with this kit can access the full power of the 34010, supporting the greatest number of high resolution graphics boards at the highest levels of performance, resolution and color.

DGIS, the premier and most widely-shipped interface for the TI 340X0 family of graphics coproces-

THE POWER OF HIGH RESOLUTION GRAPHICS PROGRAMMING CAN BE REACHED WITH ONE EASY NUMBER:



sors, provides an outstanding feature-rich programming model with 100+ graphics functions. The DGIS SDK includes documentation and language bindings for the DGIS interface, device drivers for Windows 3.0, utilities, and the GSS AT1050™ 1024X768 34010 graphics board (which normally sells for \$1295 alone).

The DGIS SDK is compatible with most C compilers and supports the XMS standard as well as DOS Extenders from Rational and PharLap.

Stepping up to the big screen has never been easier or more attractive. Call today.



Call (503) 641-2455.
Ask for Dept. DGIS-1.

All prices subject to change without notice.
GSS, DGIS, The DGIS Software Developer's Kit, GSSAT 1050 are
trademarks of Graphics Software Systems Inc. All other trademarks
belong to their respective owners.

“When I bought my TARGA[®] board back in '85, it was the most sophisticated product on the market. It still is.”

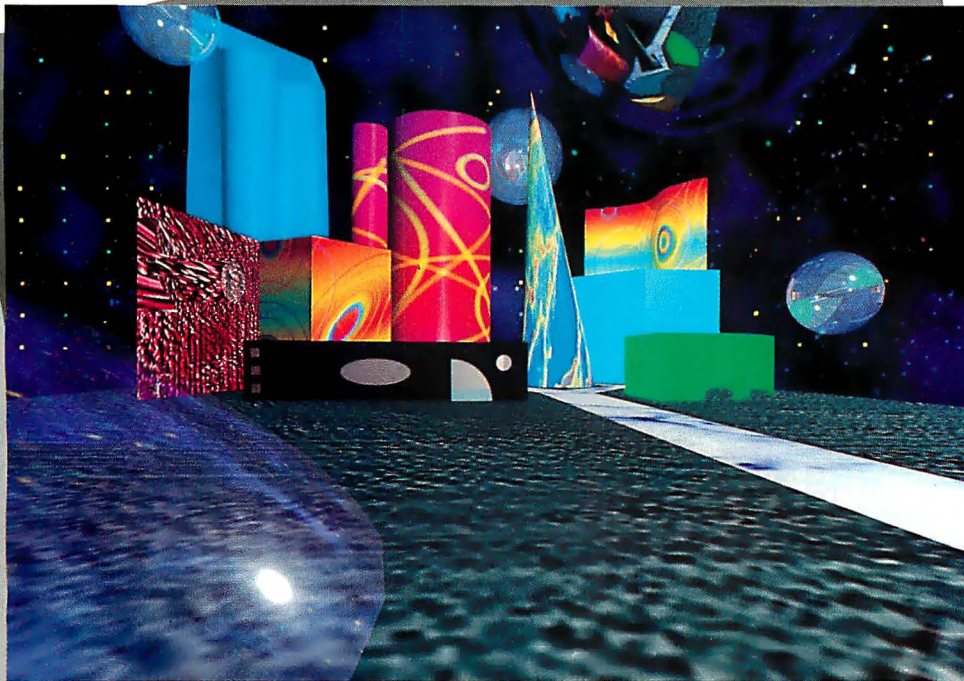

Graphic created by Jonathan Herbert, using the TARGA board with TIPS[®], RIO[™] and TOPAS[™]. For more information contact Jonathan Herbert at (718) 383-1251.

Just look at us now. Today's TARGA+ supports multiple platforms, including PS/2, and multiple display resolutions in both interlaced and non-interlaced modes. And, with our new VGA overlay feature, you can superimpose VGA graphics directly onto your non-interlaced output. Looks like we've done it again.

Introducing the Truevision TARGA+. The next generation TARGA for the next generation TARGA user.



7340 Shadeland Station, Indianapolis, IN 46256
INTERNATIONAL: Canada 416/940-8727 France 33-1-3-952-6253 Italy 39-2-242-4551
Switzerland 41-1-825-0949 U.K. 44-628-77-7800 West Germany 49-89-612-0010 Other 617/229-6900
RIO and TOPAS are trademarks of AT&T. Circle 326 on Reader Service Card (RESELLERS: 327)

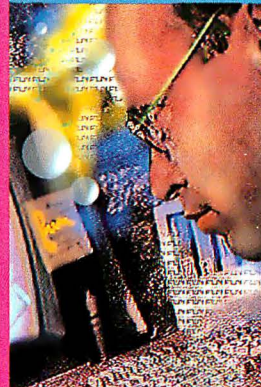

Jonathan Herbert
Computer
Illustration
New York, New York

“I bought one of the first TARGA boards ever made. Now, there are lots of other boards on the market, but I've never given them a second look.”

Call
800-858-TRUE
For more information

SX your AT

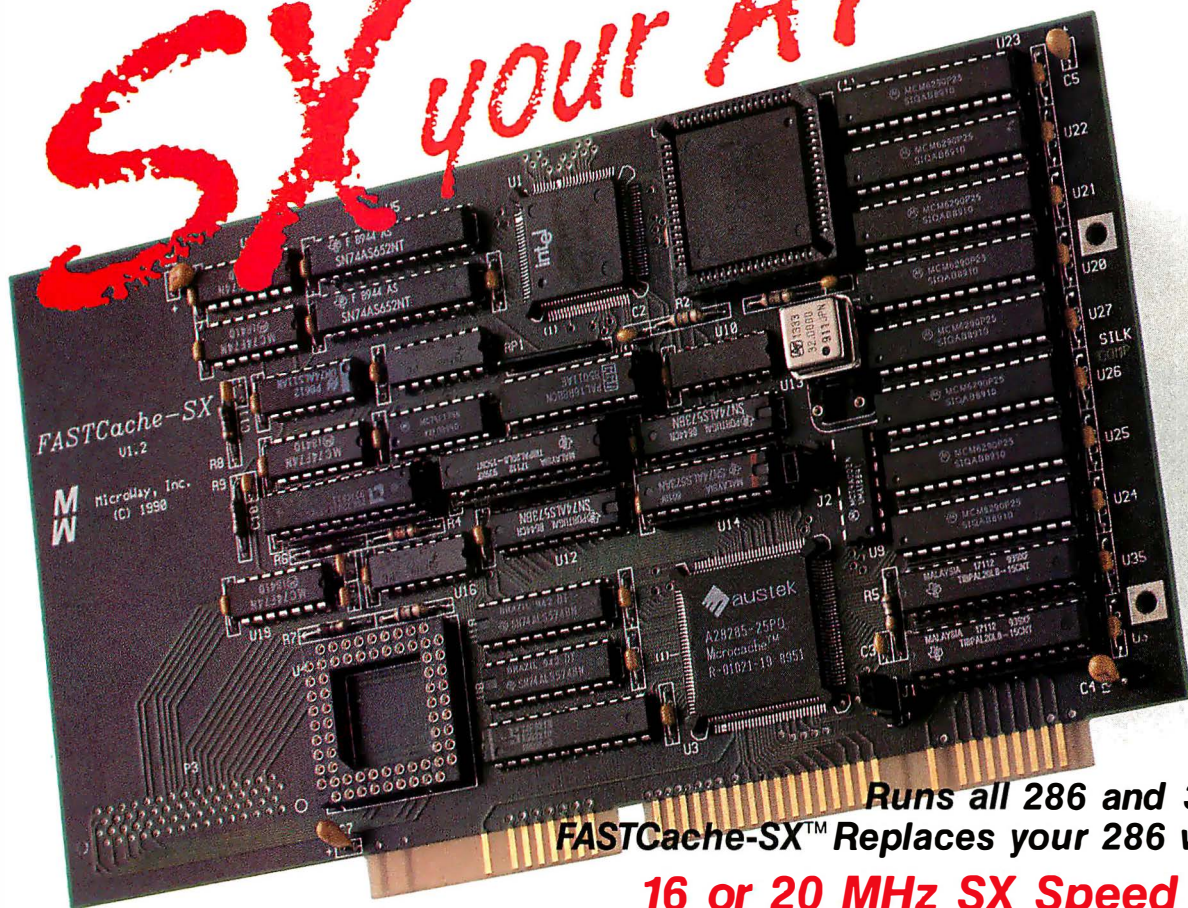

Runs all 286 and 386 Software!
FASTCache-SX™ Replaces your 286 with a 386SX!
16 or 20 MHz SX Speed from \$495

If you currently use an 80286 and are hamstrung by the 640K memory limit or need more speed, you owe it to yourself to try a Microway accelerator. The FASTCache-SX plugs into your 80286 socket replacing it with a 16 or 20 MHz 80386SX. It is fed by a large four-way cache similar to the one built into the 80486. This results in zero wait state performance using ordinary AT memory.

Running on a 20 MHz FASTCache, the Landmark benchmark delivers 27 MHz for the CPU and 49 MHz for the FPU - four and eight times the throughput of the 286 and 287 that came with the original AT. It is 100% compatible with most 286 powered ATs running all your 286 and 386 software, including protected mode applications like Windows 3.0, DESQview-386 and, of course, Microway's NDP C-SX and Fortran-SX.

The Microway NDP Fortran-SX and NDP C-SX compilers generate the best code to take advantage of your 386SX. They feature excellent global optimizations not found in 16 bit compilers, plus the ability to take advantage of the 4 gigabyte address space of the SX. In addition, our complete line of ancillary products, including symbolic debuggers, profilers, virtual memory, plotting packages, windowing packages, graphics libraries and the NAG numerics libraries, can save you hundreds of hours moving your mainframe code to the SX. We also support the dialects you need, like VMS Fortran and ANSI C with the MS C DOS and graphics extensions. However, the best feature of these products is their price, just \$595 including the DOS Extender tools needed to run the SX in protected mode!

At a suggested list price of just \$495, the FASTCache-SX-16 is a real bargain!

Limited Offer - If you purchase a FASTCache-SX before October 15, we will bundle in a copy of the SX version of NDP-C, NDP-Fortran or NDP-Pascal for half price. For just \$795 plus the cost of an 80387SX you will be able to convert your 286 AT into a 32 bit development platform that will provide you with VAX performance for a fraction of the price! To order please call 508-746-7341.



Microway

Corporate Headquarters
P. O. Box 79, Kingston, MA 02364 USA
TEL 508-746-7341 • FAX 508-746-4678

World Leader in PC Numerics

U.K. 32 High St., Kingston-Upon-Thames, 081-541-5466
Germany 069-75-2023 Italy 02-74.90.749
Holland 40 836455 Japan 81 3 222 0544

single color that approximates the requested color is that it lets the display driver blend two or more different colors that it can display side by side within the 8- by 8-pixel area. This creates a visual effect that can more closely resemble the original color that Windows requested. When a brush is not used, the driver must simply find the closest color it can display and use that, which may not be close enough to the color requested to be visually satisfying.

The disadvantage to dithering is that it effectively reduces the spatial resolution of the area being dithered, since it may take three or more pixels to approximate a color that, on a 24-bit display, would be displayed in one pixel. Dithering is also used in converting bit maps from 24 bits per pixel to 8, 4, or 1 bit per pixel. The original color image may come from a Windows application as a bit map of 4, 8, or 24 bits, and the driver will process the image and add dithering if needed. Because an application can inquire about the display device that it is currently running on, it can perform the dithering itself and pass processed data to the display driver.

Every
pixel can display any
one of the 16.7 million
colors available.

True Color for DOS

A 24-bit display device can display any 24-bit color information or bit map directly, without dithering, palette look-ups, or color translations. Every pixel on the screen can display any one of the 16.7 million colors available. When an application requests a 24-bit color, the display driver has no problems, since no conversion, translation, or dithering is needed. Thus, an application, such as PageMaker 4.0 under Windows, can include photo-realistic images within documents and produce professional-quality output.

Using color-illustration packages such as Corel Draw, Power Point, or Arts and

Letters (to name a few), you can create color gradients and smooth-shaded objects without any banding or distortion. Depending on the display resolution, you may be able to compose color screens that look as good as or better than the final, color-separated output. Plugging a 24-bit card into a Micro Channel-equipped PC and running Windows 3.0 literally transforms an ordinary computer into a high-end color workstation.

If you're involved with electronic publishing, electronic pre-press, desktop publishing, graphic arts, or photo-realistic rendering, the 24-bit capabilities of Windows 3.0 add another platform to choose from. Porting 24-bit applications to Windows 3.0 from the Mac and Unix will increase the level of file sharing and interoperability among these platforms. It will also stimulate the production of 24-bit video boards with a variety of resolutions and capabilities. With Windows 3.0, true color for DOS is here to stay. ■

Adam Bellin is manager of IBM engineering, and Pier Del Frate is director of IBM marketing, at RasterOps Corp. You can reach them on BIX c/o "editors."

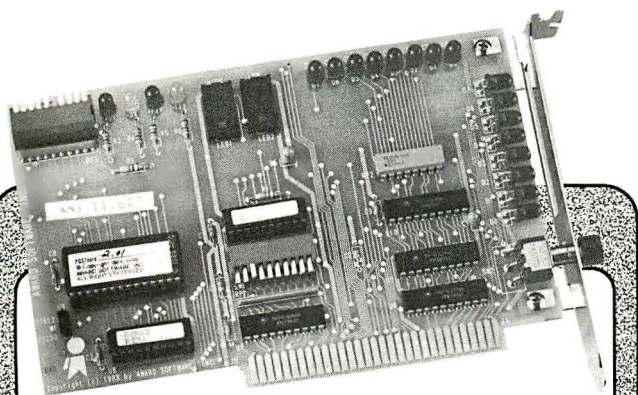

AWARD POSTCARDTM DIAGNOSTIC CARD

- DOS not required for diagnostic functions
- POST (Power On Self Test) routine monitoring
- Supports XT/286/386 based microcomputers
- Works with most BIOS versions including AWARD, AMI, PHOENIX, QUADTEL
- Built in comprehensive diagnostic functions in ROM
- Fits into any 8/16 BIT slot
- Optional digital diagnostic diskettes for floppy disk alignment
- Serial and parallel loop back connectors included

• **New Low Price \$249.00**

Order Now 1-800-800-2467

UNICORE
SOFTWARE

599 Canal Street
Lawrence, MA 01840

(508) 686-6468
FAX: (508) 683-1630

Circle 330 on Reader Service Card

GRAPHIC TOOLS LIBRARY



PC_VDI: Virtual Device Interface. Graphics library with examples. Display and Printed graphics. High Speed, high quality draw and print at 60 to 600 dpi. Outline font factory. Text at any angle. Scale text on demand. Draw on page. All GKS draw. Object manipulations. Segmentation. POLYARC engine. Plots & charts. Bitmaps. All drawing & mouse functions support Super VGA modes. **\$395.**

PHONTM: THE FONTMAKER. Interactively create scaleable, expandable and fillable outline, stroke and bitmap fonts, figures or logo's. Scale to various size fonts. Laser loader. Shaded & pattern fill fonts. Kerning. Create hand-writing or multi-lingual fonts. Import/Export font/logo images for editing and conversion to scalable drawing. **\$395.**

SCANLIB: Image tools library. Scale image up or down (integer and fraction sfactor) or auto scale to fit in a window. Animation. Image rotate, stretch, skew, mirror, tile fill and window scroll. Virtual bitmaps and graphic pop-ups. Includes Text & mouse functions. Drag image. Support for multiple (TIFF, PCX, KPS) file formats. Image database. Print and scroll view scanned images. ASCII file to Fax conversion. Clipper version. ANSI compatible. Faster. **\$295.**

MEGAUDI: Mega Virtual device interface. Draw and manipulate large CAD drawings and scanned images. Bitmap up to 15 MB is size with selectable pixel depth. Image pan, smooth scroll, rotate, hspeed-scale, zoom. Import PCX or TIFF images in a large bitmap for processing. Color print/plots with Pre-View. HP-GL and PaintJet. **\$895.**

All products: Modes from Hercules to 1024X768X256. Most 'C' and C++, Pascal, Fortran, MS QuickBasic 4.0 to 7.1



NOVA INC. 708-882-4111

2500 W. Higgins Road, #1144
Hoffman Estates, IL 60195

DOWN LOAD
DEMO'S & INFO

FAX: 708-882-4173

BBS: 708-882-4175

Circle 214 on Reader Service Card DECEMBER 1990 • B Y T E 287

From this day on, you'll never want an external UPS again.

Introducing the InnerSource™. The first computer power supply with a built-in UPS.

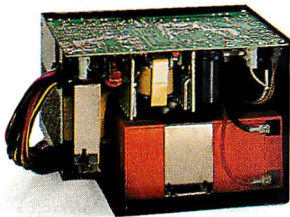

Engineered to work *inside* your computer.

It's a first. The InnerSource is the only drop-in replacement power supply that is engineered with a built-in UPS. The InnerSource gives you the

functionality of two products and stays out of sight—neatly inside your computer.

Because the InnerSource drops into your AT or 386 computer, it eliminates the need, and expense, of a bulky external UPS. And because of its computer-ready DC output, there's no more worrying about square-waves, sine-waves and transfer times.

Under normal power conditions:

When AC line voltage is present, the UL approved InnerSource operates as a high quality computer power supply. Its wide input range protects against the hazards of power-line sags and surges and its EMI filter minimizes power-line noise.

When the power is interrupted:

In the event of a blackout, an alarm sounds, and the InnerSource's integrated, battery-backed, 550VA-equivalent power system keeps both the PC and monitor running for 5 to 10 minutes, long enough for an orderly shutdown. Automatic recharging is provided.

The InnerSource is the internal solution to computer power protection.

The InnerSource is ideal for PCs, LAN file servers and LAN remote stations. By combining the functions of a DC power supply and on-line UPS, the InnerSource not only saves space, but also provides the most reliable, cost-effective computer power protection available today.

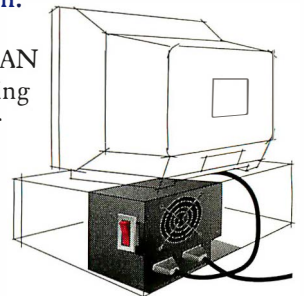

***Two vital functions.
One revolutionary new idea.***

PC POWER & COOLING, INC.

31510 Mountain Way, Bonsall, CA 92003 • (619) 723-9513 • (800) 722-6555 • FAX (619) 723-0075

Circle 228 on Reader Service Card (RESELLERS: 229)

Putting the Squeeze on Graphics

Image-compression technology promises to make graphics and video data as easy to manipulate as text and numbers

Nick Baran

Full-color, 32-bit images are indeed a wonder to behold on today's large, high-resolution monitors. Computer companies love to impress the media and potential customers with demonstrations featuring dazzling bouquets of flowers and Ferrari sports cars looking so vivid and real that you're ready to climb in and go for a test drive. Marketing managers wax poetic about the revolutionary potential of multimedia and scientific visualization, all for just \$6995.

But beneath all the dazzle lies a big problem: 32-bit color images require enormous amounts of storage space. That full-color machine for just \$6995 probably comes with an 80-megabyte hard disk drive, which, after you load the operating system and a few applications, has barely enough free space for a handful of single 32-bit color screen images. That's because the definition of a single full-color 32-bit screen image on a typical high-resolution display requires about 3 MB of data. If you intend to display animated graphics, your storage requirements go through the roof, and you also have to deal with the problem of moving all that



image data from disk to your display adapter.

The technology of image compression can solve these problems. Dedicated image-compression processors have begun to appear that can compress a 25-MB color image down to 1 MB in less than a second. These processors are finding their way to the system boards of some computer manufacturers. Within

the next several years, you'll see image-compression processors in all sorts of video recording and display devices, as well as on the system boards of low-cost personal computers. I'll discuss some of the emerging standards for image compression and some of the dedicated processors currently on the market.

The Graphics Bottleneck

A high-resolution monitor displays about 1 million pixels (1024 by 768, 1120 by 832, and 1280 by 1024 are typical resolutions). A black-and-white image requires 1 bit per pixel (on or off) or about 1 million bits (125K bytes) per screen image. Gray-scale images with 8 bits per pixel (selecting from a possible 2^8 or 256 shades of gray) require about 1 MB per image.

Full-color images (16.7 million possible colors) require the definition of 24 bits per pixel (8 bits each for red, green, and blue) and may require an additional 8 bits to define the degree of transparency (the *alpha channel* in Macintosh terminology), or about 4 MB per screen image. So, that bargain for \$6995 turns out to cost a few thousand dollars more after you have purchased a big 300-MB or 600-MB hard disk drive for

U.S. POSTAL SERVICE
STATEMENT OF OWNERSHIP, MANAGEMENT
AND CIRCULATION
(Act of August 12, 1970, Section 3685, Title 39,
United States Code)

1. Title of publication: BYTE MAGAZINE
- 1A. Publication No.: 03605280
2. Date of filing: October 1, 1990
3. Frequency of issue: Monthly plus one additional issue in October
- 3A. Number of issues published annually: 13
- 3B. A nual subscription price: \$29.95
4. Location of known office of publication: One Phoenix Mill Lane, Peterborough, NH 03458
5. Location of headquarters or general business offices of the publisher: McGraw-Hill, Inc., 1221 Avenue of the Americas, New York, NY 10020
6. Names and addresses of publisher, editor, and managing editor: Publisher: Ronald W. Evans—One Phoenix Mill Lane, Peterborough, NH 03458; Editor: Fred Langa—One Phoenix Mill Lane, Peterborough, NH 03458; Managing Editor: Anne Fischer Lent—One Phoenix Mill Lane, Peterborough, NH 03458
7. Owner: McGraw-Hill, Inc., 1221 Avenue of the Americas, New York, NY 10020. Stockholders holding 1 percent or more of stock are: Donald C. McGraw Jr.; Harold W. McGraw Jr.; John L. McGraw; William H. McGraw; June M. McBroome; Elizabeth McGraw Webster; all c/o McGraw-Hill, Inc., 1221 Avenue of the Americas, New York, NY 10020. Texas Teachers Retirement Fund c/o Chemical Bank, 200 Jericho Quadrangle, Jericho, NY 11753.
8. Known bondholders, mortgagees, and other security holders owning or holding 1 percent or more of total amount of bonds, mortgages, or other securities: None
9. Not applicable.
10. Extent and nature of circulation:

	Average No. Copies Each Issue During Preceding 12 Months	Actual No. Copies of Single Issue Published Nearest to Filing Date
A. Total No. Copies Printed . . .	638,131	694,900
B. Paid Circulation		
1. Sales through dealers and carriers, street vendors, and counter sales	133,502	142,057
2. Mail subscriptions	387,459	436,937
C. Total Paid Circulation	520,961	578,994
D. Free Distribution by Mail, Carrier, or Other Means; Samples, Complimentary, and Other Free Copies	11,674	8,009
E. Total Distribution	532,635	587,003
F. Copies Not Distributed		
1. Office use, left over, unaccounted, spoiled after printing	2,612	2,684
2. Return from newsagents	102,884	105,213
G. Total	638,131	694,900

11. I certify that the statements made by me above are correct and complete.

—Ronald W. Evans
Publisher

S *torage*
and communications
limitations are only part
of the story.

storing high-resolution color images.

And then there's the problem of printing and transmitting these images. While color looks great on the screen, the ultimate goal is often color output on slides or paper. But because color laser printers still cost \$10,000 or more, you usually find them on a network or in a service bureau that can receive your files electronically for printing. Sending a 3-MB file over the phone is a slow and error-prone process. Using a 9600-bps modem, it takes about 45 minutes to transmit a 3-MB file.

Storage requirements become astronomical when you digitize full-color photographs from a scanner or video camera. An 8½- by 11-inch color photograph at 300 dots per inch requires 25 MB of data (93½ square inches with 90,000 dots per square inch and 24 bits per dot). Similarly, color output devices must process 25 MB to print the same image. Transmitting such an image over a 9600-bps modem would take about 6 hours.

Storage and communications limitations are only part of the story. The other is performance, particularly with regard to animation applications requiring the storage and display of hundreds of screen images in sequence. Full-motion video requires the display of 30 frames per second. NTSC video with a resolution of 640 by 480 pixels and 24 bits per pixel translates into 1 MB of data per frame or 30 MB per second. Today's desktop computers cannot deliver 30 MBps to the screen. In addition, 1 minute of full-motion video requires a storage capacity of almost 2 gigabytes.

Hard disk drives typically have data transfer rates of 1 to 2 MBps, far from adequate for full-motion video applications. Even if the drives were faster, most microcomputer buses transfer data at rates under 20 MBps (NuBus transfers data at 10 MBps; the AT bus runs at about 6 MBps). CD-ROM drives, which can store hundreds of megabytes of data on removable cartridges and so are ideal for storing graphics images, are several times slower than hard disk drives.

The size of graphics images is also a crucial issue in the consumer electronics and communications markets. Digital video cameras, video games, color fax, and subscription over-the-phone-line movies and videos are all hampered by the size of graphics images.

The Solution: Image Compression

The solution to this problem is clearly the use of data compression to reduce the size of the files representing graphics images. Data compression is already widely used for archiving and transmitting binary and text files, and there are various standard data-compression algorithms for this purpose (see "Saving Space," March BYTE). Standards for image compression, however, are just beginning to emerge.

For both text and image compression, the principle is the same: Reduce the data to an abbreviated or shorthand form that still retains the basic information contained in the file. For either text or image compression, the technique involves finding redundant or unnecessary information and substituting an abbreviation or shorthand symbol for that information. In the case of image compression, it is sometimes possible to discard parts of the information altogether, since some of the pixel attributes may not be visible to the human eye and thus contribute little to the quality of the image.

While text-compression schemes deal with character strings and the ASCII table, image compression deals with pixels and the visual attributes (color and transparency) attached to each pixel. Because images generally have regions of uniform color or patterns, particularly in the background (e.g., a blue sky or a white wall), it is possible to represent these regions of uniformity by a much smaller entity than the definition of each individual pixel in that region. For example, you can define a group of pixels rather than individual pixels.

Two standard algorithms for image compression are emerging: the Joint Photographic Experts Group algorithm for still images, and the Motion Picture Experts Group algorithm for motion picture images (full-motion video). Both JPEG and MPEG are sponsored by the CCITT and the International Standards Organization.

An obvious question is why different algorithms are needed for still images and for motion video images. While motion video images are time-dependent and related to other frames in a sequence, still images are independent entities. Motion video generally includes

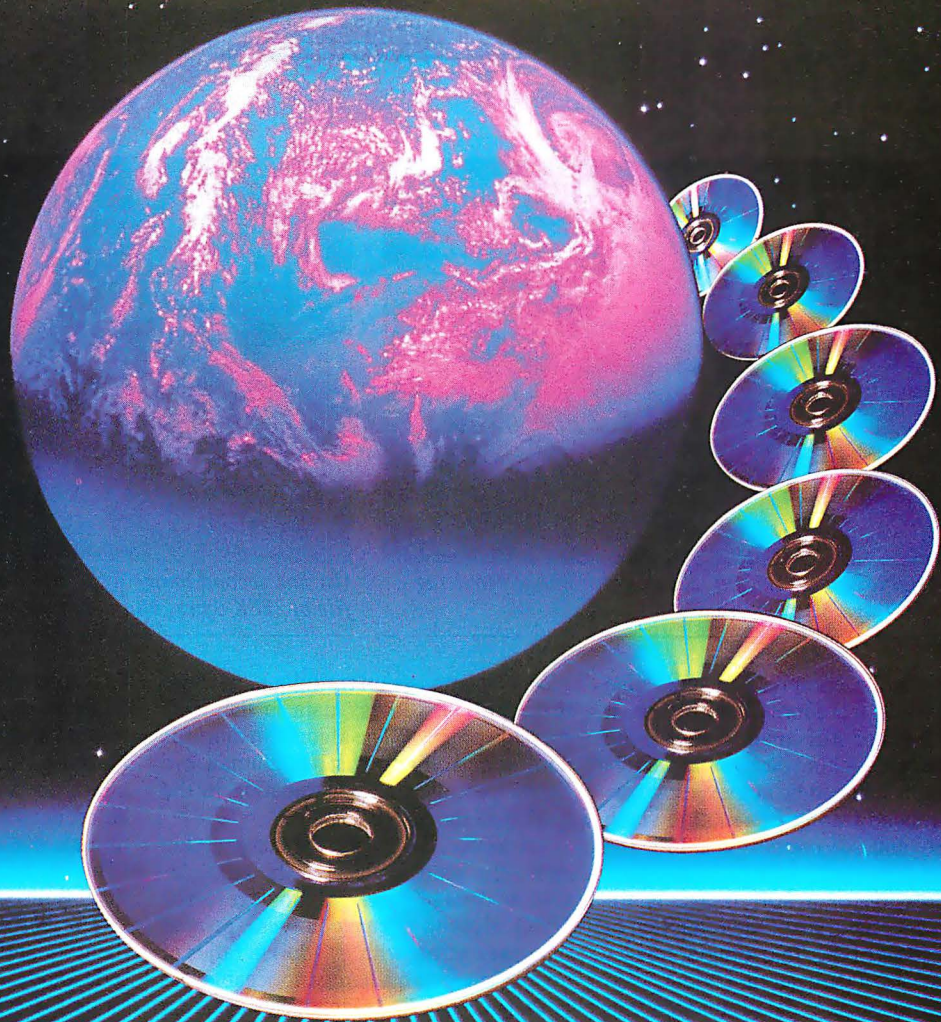

COREL

The Universal Choice for Optical Innovation

As the world's leading creator of interface software for optical disk drives, Corel Systems Corporation continues its tradition of excellence with its growing line of industry-leading mass storage products. Whether you need our DOS, OS/2, Macintosh or Novell interface kits, our complete WORM, erasable and multi-

function sub-systems, our LUMINAR developer's toolkit for optical jukeboxes, or our LS series of low cost, high performance SCSI cards, you can count on Corel for reliable, trend setting optical storage solutions.

Corel's award-winning products are the choice of these leading manufacturers:



TEL: (613) 728-8200
FAX: (613) 728-9790



Circle 358 on Reader Service Card



(a) The original image is a full 32-bit color image requiring 3.2 MB of storage.

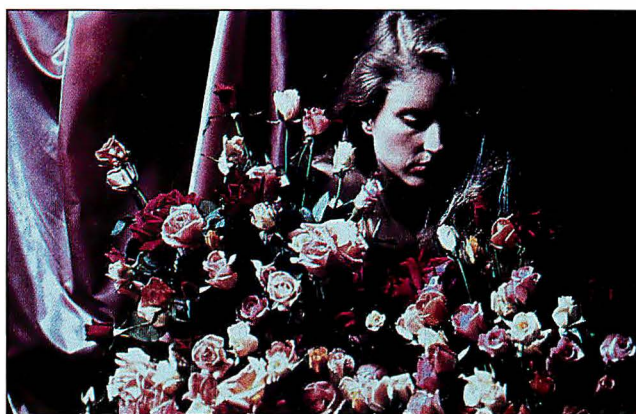

(b) The second image was compressed by 14 to 1, yielding a file of 228K bytes, and then decompressed and displayed.

sound, so audio compression must also be included in a compression scheme. It is possible to use still-image compression for motion video, but you lose the performance gains that can be achieved by correlating related frames in a motion video sequence, and, of course, you lose the audio compression.

Compression of a still image is focused on one major task: the reduction of the data describing that single image. Compression of full-motion video also performs this type of data reduction, but it can gain further reduction of each frame's data size by retaining objects in the frame from previous frames.

For example, if the video shows a man walking across a street with a blue sky background, there is no need to redraw the sky or the street in each frame. It is also unnecessary to redefine the man, pixel by pixel. Instead, it is more efficient to define a vector that moves the pixels representing the man from one location to another. By taking advantage of the redundant data in each frame of the sequence, you can greatly reduce the amount of data needed for each frame.

The JPEG Algorithm

The JPEG algorithm is emerging as the standard for still-image compression. While only in a draft version at the time of this writing, the JPEG algorithm is expected to be finalized by the end of this year. Several commercial software and hardware implementations of JPEG are already available in the marketplace and will presumably be compatible with or upgraded to the final version of the algorithm.

The JPEG algorithm is termed symmetrical because it compresses and decompresses the image in the same number of operations and therefore in the same amount of time. It is also called a

“lossy” compression technique, because it discards or “loses” data in the compression process. The algorithm discards data selectively so that the human eye barely perceives any degradation in the quality of the image.

Of course, the greater the compression ratio, the more noticeable the degradation in image quality. However, the JPEG algorithm can compress printed images (starting with 300 dpi) in ratios of up to 25 to 1 with a hardly noticeable loss of image quality. Screen images (starting with 70 or 80 dpi) can be compressed up to about 15 to 1 without a major loss in image quality. The photos show a full-color screen image in its original form (a) and compressed to 14 to 1 (b).

The JPEG algorithm is an open standard, and JPEG software packages that include source code are available from C-Cube Microsystems and Kodak. The first step in the execution of the JPEG algorithm is to reduce the data redundancy in the image's pixel values. This is done by using the discrete cosine transform (DCT), which is similar to the Fourier transform but includes only the cosine part of the function.

The DCT technique involves breaking up the image into arrays of 8 by 8 pixels. These arrays are approximated as a region of varying color and intensity represented by light-frequency values assigned to each pixel. The DCT is applied to the array to concentrate the energy represented in that region into a few coefficients representing the frequencies. The higher frequencies outside the range of visible light are discarded, and the lower frequencies are preserved. This process accounts for most of the data reduction.

Although the JPEG algorithm is independent of color, implementations of the algorithm for compressing RGB images

first convert the color components to YUV before executing the DCT. (Y represents luminance; U and V represent chrominance components.) The chrominance portion of the color definition can be reduced by half without affecting the human eye's perception of the image. (The chrominance value in every other pixel is discarded.)

The resulting DCT coefficients are then “quantized” to reduce their magnitude and to increase the number of zero-value coefficients. Finally, run-length and Huffman encoding are applied to represent runs of consecutive 0s and to further compress the data symbols representing the image. The figure shows a schematic of the JPEG scheme.

Note that the decompression process is exactly the inverse of the compression steps (hence the “symmetry” of the JPEG algorithm). Although the decompression process reproduces the original image, the data defining that image has been greatly reduced. Ratios of up to 25 to 1 for print images and up to 15 to 1 for screen images reproduce the original image with minimal loss in image quality.

JPEG in Hardware

The JPEG algorithm can be implemented in either hardware or software. It performs slowly in software, however. The JPEG algorithm running on a standard 25-MHz 68030 machine takes about 15 minutes to compress a 25-MB image by 25 to 1. Using a C-Cube Microsystems (San Jose, CA) image-compression processor, the same compression process takes 1 second.

C-Cube Microsystems' CL550 image-compression processor exemplifies the future direction of image-compression technology. The CL550 is a single-chip processor with built-in units for execut-

ing the DCT, quantization, and Huffman encoding operations. According to the company's specifications, the chip has 400,000 transistors and over 300 stages of pipeline, allowing it to perform over 300 steps of the JPEG algorithm concurrently.

The processor comes in 10-MHz and 30-MHz versions. The 10-MHz version can compress 5 million pixels per second and is designed strictly for still-image compression. The 30-MHz version can compress 14.7 million pixels per second, which provides adequate performance for displaying 30 frames per second of NTSC video (each frame is compressed to between 50K and 100K bytes). Up to four CL550 processors can be operated in parallel, allowing high-definition TV images to be compressed in real time, according to C-Cube Microsystems.

JPEG and CD-ROM

The 30-MHz CL550 is an example of how the JPEG algorithm can be used for full-motion video. However, there are some significant limitations. First, the JPEG algorithm has no audio-compression capability. Second, even the blazing speed of the 30-MHz CL550 is only adequate for real-time video compression using hard disk drives with transfer rates of 1 MBps or more. The process is not fast enough to allow the use of CD-ROM drives as the storage medium for full-motion video. According to C-Cube's marketing manager, Mauro Bonomi, the compression algorithm has to be "about three times faster" to work with CD-ROM drives. The way to achieve this increase in speed is to take advantage of the correlation between frames in motion video sequences.

The ability to support CD-ROM drives is crucial for the commercial application of real-time video compression. Obviously, it's not practical to send movies on

hard disks. Nevertheless, the JPEG algorithm has tremendous potential for still-image compression and for some applications of real-time video. (See the text box "Video Keying" on page 294 for a description of how you can mix graphics and video images.)

According to Bonomi, computer manufacturers have shown tremendous interest in the CL550. NeXT has built the CL550 into its Nextdimension color board (see "Fast New Systems from NeXT," November BYTE). And C-Cube recently announced add-in CL550 compression boards for PCs and Macs. These add-in boards include image-compression software, allowing you to compress TIFF, PIC, and TIGA files. C-Cube also offers the Image Compression Interface, allowing third-party developers to compress files directly from their applications. The 10-MHz and 30-MHz chips are priced at \$95 and \$155, respectively, in quantities of 10,000, making them affordable even on high-end consumer electronics products; such as digital cameras and VCRs.

While C-Cube may be one of the first hardware manufacturers to produce a single chip running the JPEG algorithm, the competition is sure to heat up in the next few years. Intel (Santa Clara, CA) has announced plans to incorporate JPEG support into its i750 processor. Other members of the JPEG committee, such as IBM and NEC, are also probably developing compression processors.

Full-Motion Video Compression

Work on the MPEG algorithm for full-motion video is in an earlier stage of development than JPEG's, and no technical details have been released as of this writing. According to a speech by Intel's Art Kaiman, delivered at the International Multimedia Conference in New York in September, the goal of MPEG is "to de-

fine a standard that can reproduce VCR/TV-quality video and CD-quality audio after it has been compressed to a data rate in the 1- to 1½-megabit-per-second range, typical of a CD-ROM or PC hard disk. This requires data compression well in excess of 100 to 1."

The MPEG algorithm will also use the DCT. Several subcommittees are working on video-compression, audio-compression, and system-integration issues, according to Kaiman. However, some 17 algorithms proposed by over 20 companies are being considered by MPEG. The challenge is to merge the best features of the various proposals into a single algorithm acceptable to the MPEG members.

Intel's involvement in MPEG is noteworthy because Intel now owns the Digital Video Interactive technology for compressing real-time video images on CD-ROM (see "Multimedia: DVI Arrives" in BYTE's *IBM Special Edition*, Fall 1990). DVI has been around since 1986 but has had limited success in the marketplace. Until recently, DVI development hardware required several add-in boards that cost about \$20,000, and the video image quality was considerably lower than on a VHS VCR. Developers were reluctant to get involved.

Since Intel has taken over, DVI seems to be gaining momentum. Intel claims to have over 100 software developers in the DVI camp, and it recently announced a joint project agreement with IBM.

The current DVI development platform is based on the i750 processor, which was designed before Intel took over DVI. A complete image capture and compression system requires two boards, each of which costs about \$2000. The development software costs an additional \$4500. DVI currently uses two proprietary video-compression algorithms called Real Time Video and Production Level Video. The RTV algorithm can

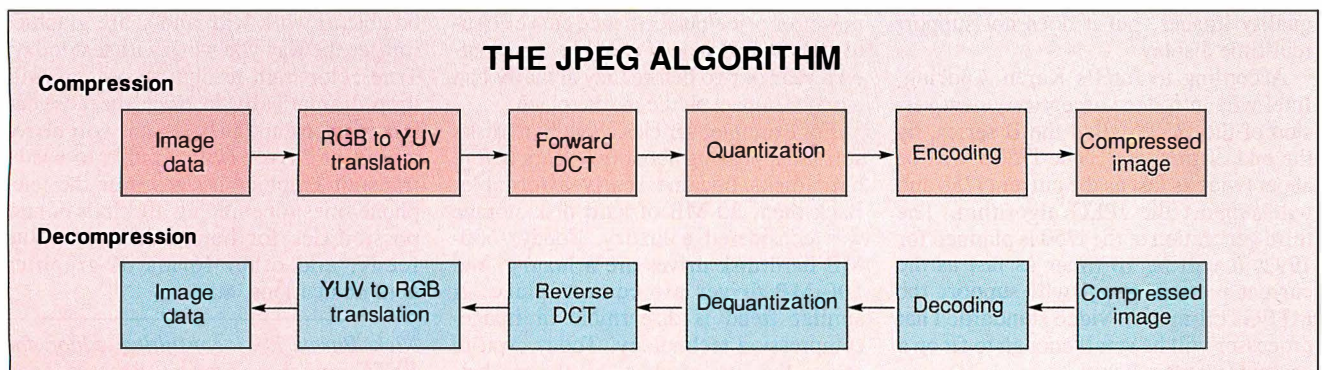

The image compression scheme used in the JPEG algorithm. Note that the compression and decompression processes are the inverse of each other, making the algorithm symmetrical. (Courtesy C-Cube Microsystems)

Video Keying

Carl Calabria

In the language of video engineers, *keying* refers neither to telegraphy nor to data entry; rather, it's a synonym for the mixing of images. Until the dawn of the digital computer era, keyers were confined to the video production studio because of their cost and size. Today, however, digital keyers have migrated to the desktop, where they let you dynamically mix two signal sources—typically, video and computer graphics—and create a professional-quality product.

Binary keying is the simplest but least versatile technique. Like a stencil, a binary key cuts a hole in live video and replaces it with a computer-generated graphic. If a binary keyer is used to overlay text on a video background, unsightly jagged edges can result.

Linear keying, a feature traditionally found on \$50,000 to \$100,000 video production switchers, can smooth or soften those edges, yielding a more attractive foreground-to-background transition. More important, linear keying also allows the mixing or blending of specific portions of two sources. Although the technique can be effected in the analog domain with T-bar actuators, digital implementations usually produce more consistently reliable and accurate results, and at lower cost.

In a 32-bit-per-pixel digital color system, three 8-bit bytes define the relative intensities of the red, green, and blue components of the computer-generated

image. The fourth byte, often referred to as the *alpha channel*, can be used to define the extent to which the computer-generated RGB image is mixed with a live video signal.

For a given pixel, an alpha of 0 will produce an output that is totally computer-generated. If alpha = 255, the pixel will be wholly live video. If alpha = 32, the pixel will be composed of 33 of 256 parts computer-generated image and 223 parts live video; the overall appearance will be that of a highly translucent graphic superimposed on live video.

With up to 256 levels of mixing available for each pixel on the screen, you can create beautiful superimpositions of text and graphics over live video. This is done by selective mixing at the edges of the computer graphic to create a smooth, blended edge. A digital linear keyer can also be operated globally on all pixels to produce professional-looking transitions, such as fading live video to or from a specific color, or cross-fading between live video and computer graphics or between two computer-generated images.

In a linear keyer, the information that dictates the level of mixing is provided by a computer. By contrast, a chroma keyer uses the information in the live video signal to determine where, and to what extent, to mix that video with a computer-generated graphic.

Everyone has seen a meteorologist

standing in front of a weather map on the evening news. Actually, the meteorologist is standing in front of a plain blue or green screen. The computer continually analyzes the video signal and replaces all occurrences of that blue (or green), within a narrow range of chrominance, with the computer-generated weather map. Of course, it is essential that the meteorologist not wear anything within that specific color range. (The screen is actually a special color not likely to be found in a standard wardrobe.) Sophisticated chroma keyers can also preserve shadows and eliminate fringing effects at boundaries.

Advances in miniaturization are largely responsible for the spread of keying techniques outside the video production studio and onto the desktop. For example, on Truevision's Targa+ and NuVista+ videographics boards for PC compatibles, PS/2s, and Macintoshes, an entire digital linear and chroma keyer has been integrated onto a single 10,000-gate application-specific IC. Also resident on the boards are a 32-bit-per-pixel frame buffer, three 8-bit A/D converters, three 8-bit D/A converters, and a video encoder/decoder, providing all the essential ingredients for a desktop video production system.

Carl Calabria is executive vice president of engineering and cofounder of Truevision (Indianapolis, IN). You can reach him on BIX c/o "editors."

display 30 frames per second in real time, but it yields a low-quality image. The PLV algorithm produces higher-quality images, but it does not support real-time display.

According to Intel's Karen Andring, Intel will introduce an entirely new version of the i750, called the B series, by the end of this year. The i750B will be about twice as fast as the current i750 and will support the JPEG algorithm. The third generation of the i750 is planned for 1992. It will be 10 times as fast as the current processor and will support the MPEG full-motion-video standard. That processor will be small enough to fit on a computer system board.

The Next Hurdle

If you look at the evolution of the per-

sonal computer, there have been milestones all along the way that have signaled major improvements in computing power or price/performance curve. Usually these milestones could be anticipated a year or two before they actually had a major impact on the marketplace.

For example, articles about hard disks started appearing about two years before hard disks became really affordable. Back then, 20 MB of hard disk storage was considered a luxury. Today, 600-MB hard disk drives are a luxury, and 100-MB drives are commonplace. A similar trend is discernible in image-compression technology. Today, you're seeing the first products hit the market. In a couple of years, image-compression processors may be as commonplace as hard disk drives.

When image compression really takes hold, it could have a revolutionary impact on the way you use computers. You will be able to work with and share graphics images the way you work with text today. True color high-resolution systems will drop dramatically in price, because far less memory and disk storage will be required. And you will be able to easily transmit graphics images over the telephone lines, opening up all kinds of new possibilities for home video, satellite feeds, and other forms of graphics communications. ■

Nick Baran is a consulting editor for BYTE and the editor of Baran's Tech Letter, a newsletter covering the NeXT computer. He can be reached on BIX as "nickbaran."

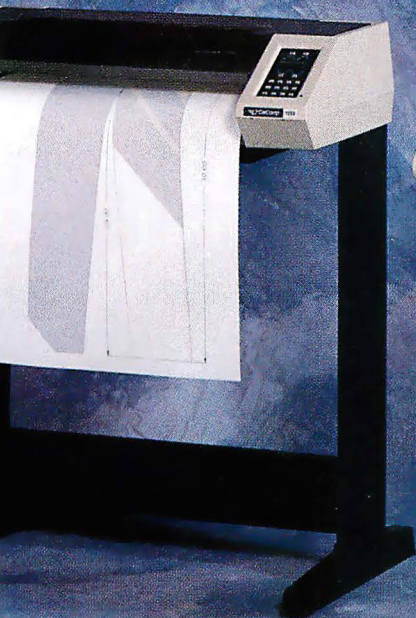

CalComp® 1023

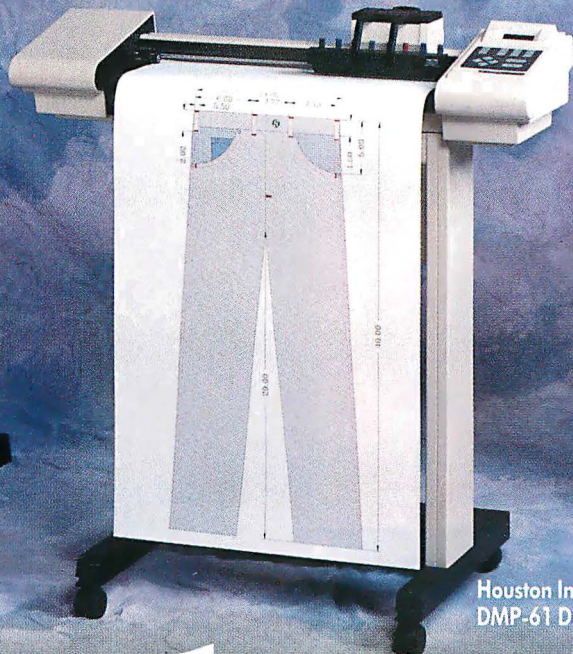

Houston Instrument
DMP-61 DL



Hewlett Packard
DraftPro® DXL

Simply stated, we beat the pants off the competition.

O.K., let's settle this performance thing once and for all. **SPEED.** In a recent comparison of throughput for the three top selling plotters, the Houston Instrument DMP-61 DL came out on top. One-third faster than the CalComp 1023. Over three times faster than the HP DraftPro DXL. In



SCAN-CAD™ Option

Turn your HI DMP Series plotter into a scanner with SCAN-CAD. This exclusive option attaches to your plotter to scan up to E-size drawings—all at a fraction of the cost of a stand-alone scanner.

and superior same pen repeatability.

VERSATILITY. Only the Houston Instrument plotters offer Quick Scale™ where any size drawing can be

easily scaled and plotted at the current media size, plus the capability to save up to six different user configurations in memory—all standard.

PRICE. Best of all, the HI DMP-60 DL Series helps you beat the pants off **your** competition all at a very competitive price. For more information on the DMP-60 DL Series plotters call 1-800-444-3425.

other words, whatever you plot in one hour with us could take you all afternoon with them. **QUALITY.** We also deliver unsurpassed quality with identical mechanical resolution to CalComp and HP,

Plotter Throughput*
(Percent of plot completed in 2:36)

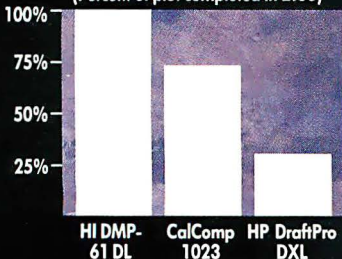

HOUSTON INSTRUMENT™
A Summagraphics Company

For IBM/Compatible information circle 136; For Macintosh information circle 137; For Reseller inquiries circle 138 on Reader Service Card.
*D-size Columbia plot using AutoCAD® Release 10 with the HP 7585 driver on a COMPAQ® 386 16 MHZ computer with math coprocessor. Plotters were set to manufacturer's recommended settings for pen and media combinations used for check plot and final plots. © 1990 Summagraphics Corporation, Seymour, CT 06483. All rights reserved.



SHARP PRESENTS THE CASE FOR A VGA 286 NOTEBOOK COMPUTER.

VGA DISPLAY.

The first in a notebook computer. It's bright, paper-white, with a crisp 640 x 480 resolution and 16 shades of gray.

TRUE NOTEBOOK SIZE.

8.5" x 11" x 1.4",
4.4 lbs.



12Mhz 286.

Runs the latest software with exhilarating efficiency. And it's fully expandable.

20MB HARD DISK.

With a speedy 23ms access time.

THE PC-6220.

About the only thing you *don't* get with the Sharp PC-6220 is another piece of luggage to carry. It's a mere 8½" x 11" and weighs only 4.4 lbs., yet has the kind of power you need. To run Windows™. To do desktop publishing. To have instant access to your programs and files.

Find out how you can put a serious computer in your briefcase. Without taking everything out of it. Call 1-800-BE-SHARP.



SHARP
FROM SHARP MINDS
COME SHARP PRODUCTS™

HDTV Sparks a Digital Revolution

You can expect high-end computer graphics to integrate HDTV into normal use as the price drops

Andrew Lippman

For almost 20 years, people have been predicting a merger of computer graphics and broadcast TV, and slowly it has been happening. Early raster-scan computer graphics systems that used TV-resolution monitors and memory arrays were developed in the 1970s. Videotape became part of the graphics lab, and graphics intruded into TV broadcasts.

However, while computer graphics gradually moved to higher resolution, TV remained at 525 lines. Only video games and special-purpose, home, or personal computers interfaced directly with standard TV systems; professional workstations left TV in the dust.

Research to develop high-definition TV (HDTV) now promises to complete the merger (see the text box "High-Definition History" on page 300). New TV systems are being developed that contain sufficient resolution for "serious" use, and new ways to record, distribute, process, and display the video signal are appearing.

Perhaps the most important aspect of this new evolution of TV is the recent emergence of all-digital approaches,

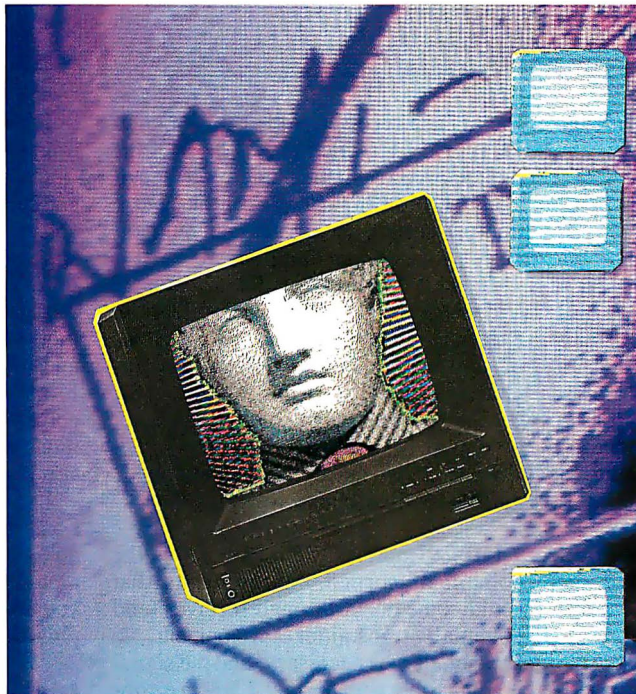

where the image chain avoids any analog steps and is even broadcast as a digital signal. This is manifest both in proposals for high-definition broadcasting and in new ways to compress current NTSC programs to multiplex many of them in a single channel. TV is literally learning the language of the computer.

The development of consumer TV technology is retarded by problems of in-

ternational standards and the huge installed base of NTSC 525-line receivers (there are more TV receivers than bathrooms in America). But so much energy has been directed at improving video displays that the personal computer community can no longer leave TV in the living room.

TV will reenter the lab and work environment as a full-quality, wide-screen partner on computers ranging from high-end workstations to hand-held video games; and it will bring new thresholds of pictorial realism and unprecedented opportunities. In the 1990s, the shift will be to high-definition and digital pictures, and the face of the industry will change. Even if you don't watch movies on HDTV in your home, you will witness the fruits of its development on your computer.

The by-products of HDTV contain the real gold. Our imaging systems are at the threshold of a transformation from simple analog devices to high-speed digital image processors. The impact of research in TV systems has effects that range from new ways to process high-rate image data to techniques for scaling, representing, compressing, and display-

REPRESENTATIVE HDTV SYSTEMS

Current HDTV and EDTV research systems. All numbers are approximate and subject to change as proposals change. Some resolution figures are computed from available literature. The Sarnoff Labs and Philips systems are shown as examples of EDTV systems. A unified Philips/Thomson/Sarnoff all-digital system is expected by the end of this year.

Organization	Name	Type	Raster, image resolution	Color resolution	Modulation	Notes
MIT	Channel compatible	Simulcast	787.5 progressive, 720 by 1280 pixels	360 by 640 pixels	Hybrid, 10-MBps digital image, data and audio, with analog detail	Sub-band coding; broadcast system is part of Open Architecture Concept.
Zenith	Spectrum compatible	Simulcast	787.5 progressive, 720 by 1280 pixels	Not applicable	Hybrid, 1.5-MBps digital image, data and audio, with analog detail	Sub-band analysis with block-coded detail.
General Instrument	Digicipher	Simulcast HDTV and direct broadcast satellite	1050 interlace, 960 by 1408 pixels	480 by 352 pixels	Digital, 16-QAM, 19.43-Mbps	Motion-compensated block coder (discrete cosine transform).
NHK	MUSE	Simulcast Narrow MUSE	1125 interlace, 568 by 946 pixels (1035 by 1920 pixels active raster)	Approximately 284 by 473 pixels	Explicit, time-interleaved analog samples	Subsampled image with motion-compensated detail added.
Sarnoff Labs	ACTV-I	EDTV-1	1050 interlace, 512 by 480 pixels	Same as NTSC	NTSC with additional subcarriers	Image composed of central and peripheral regions; wider and more detailed than NTSC.
Philips	HD-60	EDTV-2	1050 interlace, 480 by 490 pixels	Approximately NTSC	Augmentation channel (digital)	Second, linked channel contains augmentation data; base channel is NTSC.

ing moving-image data. This knowledge is useful at any resolution and in any system.

New TV Systems

To understand new TV systems, you need to realize the vast changes that have been made in electronics since the last TV systems were designed—in the 1950s in the U.S. and the 1960s in Europe. In those days, video storage did not exist (videotape recording was invented in 1955), and all processing was done on the analog signal, usually on a point-by-point basis.

Since this processing was expensive, the design goal was a consumer receiver that cost as little as possible. Even so, the first color TVs introduced in 1954 cost the equivalent of \$3000 today.

This design approach has caused the TV industry to evolve only slowly, with cost reductions as the major technical landmarks. While it's hard to envision a new personal computer whose main feature is a 25-cent lower manufacturing cost, that has been the rule with TV; real technical advances have been few and far between.

All new systems exploit the fact that the ground rules of consumer electronics are changing. Today's HDTV systems require at least one frame of video stor-

age in each receiver. At least one manufacturer, ITT (which makes most of the digital circuitry in the modern set), envisions 100-million-floating-point-operation-per-second processing as commonplace by the middle of the decade.

General Instrument, the inventor of VideoCipher, a direct broadcast satellite encoding system, has recently proposed an end-to-end digital system that includes digital broadcasting. In the U.S., even the cellular telephone network is not all digital.

Four divisions are commonly made among TV distribution systems.

- **IDTV:** Improved-definition TV is the domain of normal improvements that could come about through receiver (and potentially transmitter) development. No new standard is necessary, and the signal is compatible with normal TV. An example of IDTV that is available in existing sets (although imperfectly done) is scan conversion in the receiver to a noninterlaced display.

Yves Faroudja has shown NTSC encoders that eliminate cross-talk components, and companion decoders that are optimized for processing such a prefiltered signal. Some of these improvements are the result of inexpensive digital processing and are outside the domain

of HDTV. But such equipment is already improving broadcast TV.

- **EDTV-1:** Extended-definition TV involves modifying the signal to include special components that an advanced receiver will use to provide a better picture. NTSC color was an EDTV-like modification to the then-existing black-and-white standard: It added the color information to the signal so that a new receiver would display color but existing monochrome receivers would not be severely impaired.

Examples of modern EDTV suggestions include adding new signals that enable a special receiver to add width to the picture or obtain additional resolution. If you own an EDTV set, you get a better picture; if not, you still get something.

- **EDTV-2:** A second version of EDTV that can be productively distinguished from the first uses two broadcast channels. One contains the standard NTSC signal and is available to existing receivers. The second channel, which may contain more or less bandwidth than a normal TV channel, contains augmentation information that a special receiver can use to provide a better picture. "Side curtains" for extra width and additional detail information are usually suggested

for the second channel.

Two-channel image-coding systems were first proposed by Schreiber (see reference 1) and have recently been adapted and modified for HDTV. Basically, the difference between the normal NTSC image and the HDTV one is encoded into the second channel.

- **HDTV:** The term *HDTV* is usually reserved for incompatible systems that require a new receiver and a new, presumably higher, bandwidth channel, such as NHK's MUSE. But recently, there has been renewed interest in 6-MHz systems that provide for improved quality within the bandwidth of existing channels by avoiding any link with the design of NTSC. These systems fit into existing broadcast channels but avoid existing TV-signal formats.

The FCC has declared that all new TV systems for use in the U.S. will be restricted to the bandwidth of existing TV channels. In the U.S., most HDTV systems envision simulcasting, where a program is broadcast on a normal channel at the same time that it is broadcast on its HDTV counterpart. (For a list of current HDTV research systems, see the table.)

Among these four common divisions, there are some implicit assumptions about available channels and the means of distribution. All these enhancements assume the primacy of over-the-air broadcasting; this is a supposition that is not carved in stone but is certainly the most difficult aspect of video communications to change.

Two-channel systems, for example, require additional bandwidth and demand that the receiver equitably tune in both channels. Many viewers have problems getting even one channel with reasonable quality. Clearly, systems that hypothesize a new, incompatible channel must also suggest where the bandwidth and programming for that channel will originate.

Any new channel allocation, whether for enhancements or for an independent HDTV broadcast, will trade potential diversity for quality. Also, cable systems, direct-broadcast satellite, VCRs, and disks all lack broadcast's bandwidth constraints and legal obstacles and can therefore easily provide a better picture than the local affiliate.

Another option is a set of systems collectively called MAC, for multiplexed analog components (see references 2 and 3). These avoid NTSC artifacts (for details on artifacts, see the text box "High-Definition History") by compressing the

luminance and color components in time and sequentially transmitting them. MAC is the outgrowth of new computer technology: Accurate clocks are now easier to construct than accurate filters, so separating the components temporally is potentially better than interleaving them in the frequency domain, as NTSC does.

European satellite-broadcasting systems are extensions of MAC. S-VHS, an improvement to home VCRs, is related to

The term *HDTV* is usually reserved for incompatible systems that require a new receiver and a new, presumably higher, bandwidth channel.

MAC in that the signal on the tape need never have been cast into broadcast NTSC form.

Most of the standard scenarios for evolution from IDTV to HDTV are staged. The tacit assumption is that people will begin to trade in their TV sets for successive improvements that will take place over a number of years. In some instances, this has not quite been the case: For example, NHK is already broadcasting 6 hours a day of 1125-line HDTV via its satellite service, yet manufacturers are introducing EDTV receivers that extend the definition of terrestrially distributed signals.

Extensible TV

There is a scenario for the evolution of TV that bypasses the jump to double the number of lines and entails a new architecture for image distribution. This approach has been championed by a dedicated few, starting at MIT, but it is gaining currency among computer manufacturers and those who are already committed to digital imaging.

The technical feature of note is that images no longer need to be defined by the number of lines or the frame rate.

continued

BBS Sysops

- Are you looking for ways to improve your board? Something that will set you apart from other boards in your area?
- Are your subscribers interested in Microcomputers? Listen to this!

Announcing the Bulletin Board EXchange

The Bulletin Board Exchange allows you to become a publisher of Micro-BYTES Daily, an on-line news service from BYTE. Bulletin Board Exchange/MicroBYTES is a custom package of news and features designed especially for local BBSes, and is available only to sysops.

Every Monday through Friday you get articles about developments in micro-computing, telecommunications and selected new product announcements. Get the latest news about MS DOS machines, Macintoshes, Unix workstations, Amigas, Atari STs, peripherals and software. All the stories are reported, written, and edited by the staff of BYTE Magazine, BYTEweek and BIX, and our world-wide network of reporters and editors.

Not only do you get a great resource for your subscribers, but you also get access to BIX which will cut your cost of exchanging information and conducting BBS network business.

All this is just \$49 a quarter.

Your one-year subscription to the Bulletin Board Exchange (billed quarterly) may be cancelled any time without further charge; just notify us. If you prefer, you may subscribe for three months only, at just \$69.

If you call BIX direct, you pay no hourly telecommunications charge. If you call using Tymnet, the rates are only \$3/hour on evenings and weekends and \$6/hour on weekdays. You may also purchase unlimited off-peak Tymnet for just \$20 a month.

Subscribe today.

BIX

One Phoenix Mill Lane
Peterborough, NH 03458
800-227-2983
In NH 603-924-7681

High-Definition History

It is reasonable to date the genesis of high-definition TV (HDTV) from the late 1960s. In those years, NHK, the Japanese broadcaster, began an effort to investigate the parameters of a new broadcasting system of far higher quality than the existing NTSC standard that has been in place since 1953.

The work was directed by Dr. Takashi Fujio at NHK Labs and was coordinated with a plethora of Japanese equipment manufacturers who attacked the various component technologies. Sony addressed cameras and recorders; Ikegami developed cameras as well; and NEC, Mitsubishi, and others developed display devices, including projectors, tubes, and processing electronics.

The main effort at NHK was directed at a new system that could become a world standard for TV broadcasting. It was designed for direct-broadcast satellite distribution and required a 30-MHz channel. Fujio's lab concentrated on the psychophysics of image viewing and coordinated the new standard.

The results of this work surfaced in the late 1970s. The first HDTV system that was shown was a scaled-up version of NTSC, based on analog processing and featuring 1125 lines displayed with a 5-to-3 aspect ratio.

To avoid the artifacts that are present in NTSC TV, the system incorporated new signal-modulation methods. The artifacts of NTSC are familiar, if not especially objectionable, in normal viewing. The two main ones are cross-color, where high-frequency edges generate spurious colors on the display, and cross-luminance, where color transitions result in crawling dots adjacent to or under the transition itself. The artifacts are particularly troublesome in computer-generated graphics, because computers do not have to obey any of the normal physical limitations on image sharpness and resolution that most real-image systems suffer from.

The NTSC frame rate and interlaced scanning pattern weren't changed in the NHK system. In fact, you could characterize the system as roughly doubling NTSC's ability to display still images.

Perhaps the most immediately evident change was the apparent picture width. A 5-to-3 aspect ratio is close to most movie-exhibition standards and is wide enough to contain two 8½- by 11-inch sheets of paper displayed side by

side. The extra width is obvious even before the set is turned on—this is a distinctly different TV system.

In 1979, the NHK system was demonstrated worldwide, and efforts to initiate a universal broadcasting standard were begun shortly thereafter. The rest of the world was scooped.

One result of this work was that the rest of the world woke up and began HDTV efforts of its own. Recognizing that TV was an important technology for consumers, defense, and industrial applications, America and Europe started new research. Nations that had been using 50-Hz TV systems were particularly troubled by the Japanese initiative, since the NHK system operates at 60 Hz and there is no known way to perfectly translate (transcode) from one frame rate to another.

In 1981, a compressed format for the 30-MHz NHK studio standard, called MUSE, was shown. The concept of a production standard as distinct from a distribution standard arose, and NHK efforts centered on getting agreement on a worldwide production standard.

This was a major change in the notion of how you process TV, and its import should not be neglected. Previously, all work at NHK had concentrated on analog technology: better tubes, cameras, recorders, and systems. The notion that TV is synchronously viewed remained: The same scanning standard was used in the camera, the channel, and the receiver; they all operated together.

By 1981, it became evident that digital processing of the TV signal in real time was reasonable within the lifetime of the system and was mandatory for achieving the compression necessary to broadcast the signal; 30 MHz is just too much bandwidth for normal broadcasting, cable TV, and satellites. The popularity of home recording equipment contributed to the initiation of MUSE: A whole generation of disks and VCRs could then process the HDTV signal.

In 1985, NHK applied for certification as an international production standard at the plenary session of the CCIR, the international standards-setting body sanctioned by the United Nations International Telecommunications Union (ITU). This effort failed, however, largely through the energies of the Europeans, who noted technical flaws in the NHK system, such as artifact-prone

transcoding to 50-Hz systems.

Although NHK demonstrated high-quality standards-conversion equipment, it was expensive and imperfect. The Europeans were also concerned about accepting any totally foreign system; they wanted European TV to remain the province of European industry. Nevertheless, the sleeping giants of the world had been awakened, and once in motion were hard to stop. Also, the stakes were high.

The Europeans began a coordinated multinational effort called Eureka-95 that premiered an all-European HDTV system in 1988, and the FCC opened a notice of inquiry in 1987 requesting proposals for an American broadcast standard for any new TV system that could increase quality and justify the continued (albeit sparse) use of the much-fought-over UHF band. As of this writing, there are at least seven proposals before the FCC, each vying for the American imprimatur. Selection could be as early as 1993.

One impediment to HDTV is the consumer's demonstrated lack of interest in the quality of the TV image. There is no grass-roots demand for a new system, and few consumers when faced with the question of what is wrong with today's TV will answer "artifacts." In fact, one recent test of stereophonic sound elicited the response that the image on the stereo receiver was better.

Further, a shadow-mask CRT display becomes dimmer as its resolution increases. High-resolution workstations are not nearly as bright as home TV sets and are usually used in controlled-lighting situations not at all like a modern living room. The tubes are bulky and deep. Thus, unless you are willing to dim the lights, share the room with a major piece of furniture, and reinforce the floor, the full quality of higher definition may well not be available until new flat panels are perfected.

BIBLIOGRAPHY

- Fujio, T. "High Definition Television." *Proceedings of the IEEE*, vol. 73, no. 4, April 1985.
- Ninomiya, Y. *Transmission of HDTV by the MUSE System*. IBS, 1985.
- Ninomiya, Y., et al. "A Single Channel, NTSC Broadcast System—The Muse." *NHK Laboratory Note*, no. 304, September 1984.

Instead, you specify the precision or resolution of the image in terms of clarity and frame rate. The underlying bandwidth (or storage requirement) of an image is proportional to the volume it occupies in a three-dimensional space where the axes are its resolution vertically, horizontally, and temporally.

For example, imagine a cube that is as wide as the image is clear, as tall as it is sharp, and as deep as the frame rate. The theme of extensible TV is that the bandwidth is proportional to the volume of the cube but the actual system can allow many different shapes.

You would use this notion to build a TV system in which each component in the image chain processes its image data to the best of its ability, independently. Movies, for example, have extremely high spatial resolution but a relatively low frame rate; TV systems generally have higher frame rates but significantly lower clarity. To some extent, the bandwidth requirements of movies and TV are similar. The choice between line rates and frame rates could literally be made on a moment-to-moment basis.

Such an approach to TV is extensible as the technology of cameras, processors, channels (or storage media), and displays evolve. A 5-inch TV receiver that fits under the kitchen counter need not have 1000 lines to produce a high-quality image. It need not process the complete signal or display all the detail that may be there. Similarly, with a 1000-line image, the 25-inch monitor at the foot of the bed may look as good as the kitchen receiver, but a wall-size panel may require yet more lines and a higher frame rate.

This is the same approach to imaging that the computing industry uses. In personal computers and workstations, the number of lines on a display is determined by its size: Larger monitors have more lines, as do bigger pages. Lines per inch rather than lines per page is the operative parameter. Building a larger monitor by taking the same number of lines and literally stretching them to fit is counterintuitive and seldom done.

Similarly, in print, the measure of a picture is its point density. Laser printers are described in those terms; you would not expect a 400-dot-per-inch printer to print an image smaller than that of a 300-dpi printer. The image is the same size, but it's printed in more detail.

The approach is called "extensible" because it makes no attempt to define the "right" line count for TV systems that will come into existence in the indefinite future. Instead, the system is allowed to

grow, as laser printers and computer screens do.

Extensible TV also brings with it some potential to solve the 50-Hz/60-Hz dilemma facing any new TV system proposed for worldwide use. By deliberately avoiding biasing its design toward one or the other of these numbers, extensible TV can be designed to work with either or both. In fact, this is desirable, since neither 50 Hz nor 60 Hz is the best number for a display.

Workstations are moving to higher frame rates to eliminate objectionable flicker. Popular personal computers have also deviated from the local broadcast standard to improve quality, and this has made interfacing to the world of video problematic. Ideally, a new TV system should be useful with workstations if only to allow sophisticated use of imaging components in those environments.

Some work has proceeded to define a video format that breaks up the 3-D spatial and temporal region defining resolution into smaller building blocks. In an extremely high-resolution and high-bandwidth TV system, all the blocks

contain some important picture information—either fine-detail or precise-motion information. However, not all the blocks are equally important for a high-quality viewing experience, nor can they all necessarily be transmitted through existing channels or stored on available media. In some images, some of the blocks are empty.

For example, a high-resolution still image doesn't require as high a frame rate for transmission as it does for display. It is wasteful to send the same picture repeatedly when you could instead send additional detail—more spatial blocks.

The advantage of such a design is that each channel sends only as many blocks as it can afford. If you envision using floppy disks for TV, then the low-density ones can contain the same images as double-density disks, but the latter's images are clearer. Likewise, the computer prepared to display only a small image needs to interpret only the low-resolution blocks.

The cost of such an approach is that every signal source has to transform the signal into an intermediate format to

Microsoft makes sure you fly realistically. It's up to you to fly responsibly.



So you get an urge to buzz the Golden Gate Bridge. Okay. You can ignore the FAA—but not the crosswinds. Because in the world of Microsoft® Flight Simulator® 4.0, everything that happens is true to life.

Banking, climbing or dodging thunderheads, your plane responds with perfect realism to your every move. Plus, you have 100,000,000 square miles of land to fly over. And four planes to choose from: a Cessna, a Lear Jet, a sailplane, or a dogfighter's dream—the Sopwith Camel.

Ask your Microsoft dealer about PC Flight Simulator.

Take it into the air. And find out what they really mean by "the wild blue yonder."

Microsoft
Making it all make sense™

For more information, call (800) 541-1261, Dept. M51. Customers in Canada, call (416) 673-7638. Outside North America, call (203) 882-8661. ©1990 Microsoft Corporation. All rights reserved. Microsoft and the Microsoft logo are registered trademarks, and Making it all make sense is a trademark of Microsoft Corporation. Flight Simulator is a registered trademark of SubLOGIC Corporation, used under license by Microsoft Corporation.

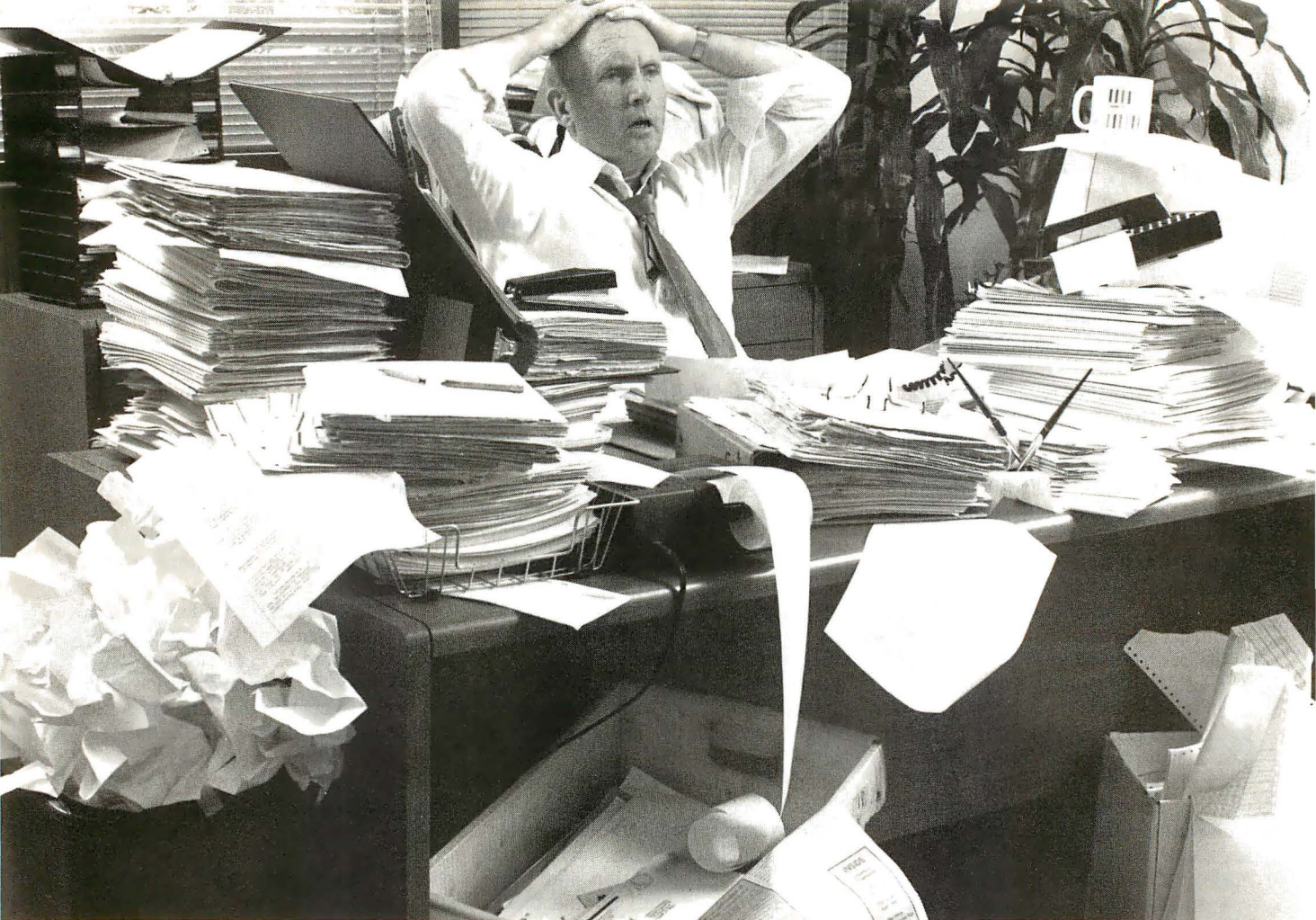

DESK NOT BIG ENOUGH?

*17 million business documents
are lost or misfiled each day.*

Announcing a major breakthrough in image storage and retrieval:

**Paper
Tamer**

PaperTamer offers more power and flexibility than other existing document storage and retrieval systems—and *PaperTamer* costs 1/10th of the price.

PaperTamer is designed to eliminate the need to run to the file room every time you need information. *PaperTamer* provides immediate access to over a million images, documents, memos and articles.

Flagstaff Engineering offers a complete line of peripheral products to provide complete image storage and retrieval systems including scanners, optical drives and mass storage devices.

No one delivers rock solid solutions like Flagstaff Engineering, the company that continues to help people read a world of information.

**FLAGSTAFF
ENGINEERING**

Domestic Sales and Marketing
1120 Kaibab Lane
Flagstaff, AZ 86001
(602) 779-3341 / FAX (602) 779-5998

International Sales
1930 S. Alma School #C202
Mesa, AZ 85210
(602) 831-5100 / FAX (602) 831-0684

GSA APPROVED

Circle 112 on Reader Service Card

process the lines and frames of the image sequence and deal them into the appropriate block. This replaces the explicit format of the image that TV has used for the past 50 years. Also, each receiver must be built to recombine the blocks to suit its particular line count and frame rate.

Such an idea is anathema to those who believe that the electronics in consumer devices are expensive, and it is somewhat daunting to broadcasters and programmers as well. Many in those industries prefer a steadier ground on which to tread; they do not like the potential for obsolescence implied by an ever-growing standard.

Extensible TV is far more closely related to the computer industry. Computer users are acclimatized to systems that perform better with each generation and do a job with a speed and precision proportional to the investment that is made in them. The image of a TV broadcast whose very format is like a computer program is not as strange to that industry as it is to broadcasters.

Perhaps the only traditional video category interested in extensible TV is the production community. For them, the benefits of easy international interchange and evolution are valuable.

Intelligent TV

Another scenario for the development of TV requiring no new regulated standard involves the evolution of TV receivers into personal computers optimized for display. In many broadcasts, digital information is already included in the signal as closed-caption information; special equipment decodes this data and subtitles the broadcast for the hearing-impaired.

A complete set of options could exist for digitally augmenting the signal, both visually and with text, to generate higher-quality programs as well as individualized telecasts. Ultimately, the program could literally be composed in the TV set as the result of negotiation between the viewer and the information in the channel.

For example, the picture could depend on the screen size, with added width for large screens and added height for smaller sets. Or it could process only as many lines as the display technology is capable of rendering.

Even the camera angles used in a program could change from one household to the next. It is well known that TV shows are designed for a small screen and movies for the exhibition hall. There are more close-ups on TV and more pan-

oramic views in the movies. Yet, if many of the viewers have wall-size screens, should those screens be used to enlarge the flaws in the newscaster's makeup or to give a broader view? Perhaps a way of avoiding this decision is to leave it to the viewer. Think of TV the same way you think of a CAD program that lets you select the viewpoint to suit the needs of the moment.

The data can also be used to vary the content of the program, allowing for alternative languages, additional data to print a higher-quality still derived from the broadcast, or an edited version suited to the tastes of a particular audience (see reference 4).

This intelligent receiver has been suggested in different forms by various people. Schreiber and Lippman describe an open-architecture receiver with a bus that can accept decoders for a variety of standards. This bus can also be the site of a processor that receives the transmission data as a generalized language, or a set of instructions that the receiver interprets to generate a picture.

For example, the frame rate can be made variable, in trade for additional

spatial resolution (or vice versa), to suit various types of content. Graphics can be locally generated to suit the viewer's situation: fewer characters for small displays, and greater screen percentage for larger ones.

At the limit, once the signal is digital, it is inherently divorced from synchrony with the broadcaster and from real time. The data stream exists independently of any physical constraints. A complete 2-hour program can be compressed to seconds of transmission time, allowing new freedoms of composition and diversity at the time and place of viewing. The receiver can "broadcast" a plethora of information that becomes a program only when you decide to make it one. The channel can be dynamically allocated between spatiotemporal detail and content-based information.

Computers and TV

There is little question that all forms of image communication are poised to move into the digital era. HDTV is the most visible manifestation of this, but it is not the only one. While it may be true that new computers will appear similar

How to land a 747 in an area no bigger than your desk.



What do you need to bring in a 400-ton, five-story jetliner? Nerves. Skill. And the new Microsoft Flight Simulator Aircraft & Scenery Designer.

Add it to our Flight Simulator 4.0, and you're off on the most realistic flight

experience this side of a PC. You get a Boeing 747-400, complete with computerized flight display. You can also try out a Piper Archer, a Beechcraft Starship or a seaplane. Fly them stock, or push the envelope and modify them to your own specs.

See a Microsoft dealer.

Because now it's possible to buy excitement. In the jumbo size.

Microsoft
Making it all make sense™

For more information, call (800) 541-1261, Dept. M51. Customers in Canada, call (416) 673-7638. Outside North America, call (206) 882-8661. © 1990 Microsoft Corporation. All rights reserved. Microsoft and the Microsoft logo are registered trademarks and Making it all make sense is a trademark of Microsoft Corporation. Flight Simulator is a registered trademark of SubLOGIC Corporation, used under license by Microsoft Corporation.

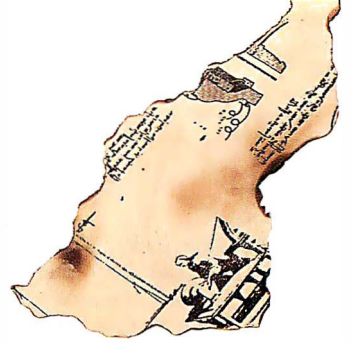

See the Future.

The ideal 16-inch ergonomic monitor for professional graphics and business applications.

Maximum performance for CAD/CAM, spreadsheets, databases, WYSIWYG word processors and desktop publishing. Designed for PCs and Macintosh II.

1024 x 768 resolutions. Supporting the new, higher refresh rate of 70Hz and above for a flicker-free display. No distortion. Sharply focused. Bright images across the entire screen.

An anti-static, non-glare screen. Low magnetic radiation. No interference between two monitors separated by a mere six inches, for dual-display applications.

Microprocessor-controlled configuration for your applications, memorizing size and position of the screen settings you prefer.

Other monitors compete against the standards. **FLEXSCAN®** sets them.

NANAO®

NANAO USA CORP.

23510 Telo Ave., Suite 5
Torrance, CA 90505 USA

Phone (213)325-5202

Fax (213)530-1679

Circle 195 on Reader Service Card
(RESELLERS: 196)

FLEXSCAN 9080i

16" (15V), 0.28mm-dot pitch CRT
1024 x 768 Super high resolution with 70Hz
high refresh rate
Scan Frequency: Automatic Adjustment
H: 30-64KHz V: 50-90Hz
VGA, 8514/A and Mac II Compatible

to HDTV consumer sets, the research done in the past few years on TV at all bandwidths and quality levels is the direct cause of much excitement in the computer world.

The same techniques used to squeeze a high-resolution image through a broadcast channel can also be used to compress high-quality images onto audio compact discs and to distribute movies through computer networks. Much of this work will bear fruit long before any agreement on HDTV occurs and will almost certainly exceed it in popularity for quite a few years.

Examples abound. In September 1990, Kodak announced a digital still-photography system in which a high-resolution digital version of each photograph is stored on CD. This high-resolution image can be viewed on home TV receivers or sent to a photo refinisher for digital darkroom effects and printing. By the time the system becomes available, you can expect those pictures to reside on a floppy disk and be printed in the home.

The General Instrument HDTV system that was introduced in June has extensions that make it useful at data rates as low as 2.5 megabits per second. At these rates, a full-resolution broadcast image looks better than that of home VCRs, and it approaches the best signal that you can get on a home set. Extensions of this to computers are obvious and inevitable.

An international group, the Motion Picture Experts Group, has been working for the past two years on a standard for digital images at bandwidths that are usable on audio CDs—approximately 1.1 Mbps for the picture. MPEG expects to release a draft proposal for a standard in December, with manufacturers beginning to construct chips for it in early 1991.

A still-picture standard, called JPEG, for the Joint Picture Experts Group, has drafted a standard for still images at any resolution, from teletext to graphic arts quality, and makers of new computer systems (e.g., NeXT) are preparing workstations that incorporate chips to process JPEG-encoded images at video rates. (MPEG and JPEG are discussed in detail in "Putting the Squeeze on Graphics" on page 289.)

Whether these systems are called HDTV or just advanced imaging is a moot point. E-mail that includes sync-sound movies is around the corner, and those pictures can be as good as you wish, from VCR quality to HDTV and beyond.

The Future

HDTV has placed us at a crossroads in the way we deal with moving pictures. The pictures will certainly get clearer, but the underlying technology will shift from low-capability analog receivers to high-power digital signal processors. As with all major technological changes, the transition may not be smooth, and mistakes may be made along the way, but the direction is inevitable.

You can expect high-end computer graphics to integrate HDTV technology into normal use as equipment drops in price. The wide screen is immediately useful in some applications. Recording equipment is critical in all cases where TV output is normally used, and it will become available. This is obvious and unquestionable.

For the rest of the personal computer world, the value is not hidden in the lines but between them. HDTV and its derivatives are initiating a digital revolution that is beginning now and gathering steam. The challenge is not the new definition of the image, but the new definition of programming that this technology forces us to make. ■

REFERENCES

1. Schreiber, W. F., and R. R. Buckley. "A Two-Channel Picture Coding System: II—Adaptive Companding and Color Coding." *IEEE Transactions on Communications*, vol. 29, no. 12, December 1981, pp. 1849-1858.
2. Baldwin, J. L. E. "Analog Components, Multiplexed Components, and Digital Components—Friends or Foes?" *SMPTE Journal*, vol. 92, no. 12, December 1983, pp. 1280-1286.
3. *MAC—An Enhanced TV Signal Format for Satellite Broadcasting*. Independent Broadcasting Authority Information Service, U.K., November 1981.
4. Bender, W., and P. Chesnais. "Network Plus." *Proceedings of the SPSE Electronic Imaging Devices and Systems Symposium*, January 1988.

Andrew Lippman is associate director of the Media Lab at MIT in Cambridge, Massachusetts. He is responsible for research programs addressing the future of TV, movies, consumer entertainment systems, and multimedia workstations. You can reach him on BIX c/o "editors."

Create a scene in your living room.

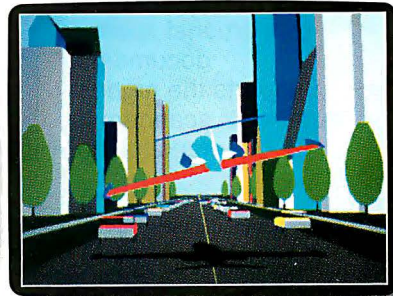
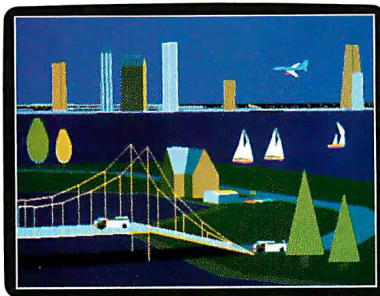

Make mountains. Build bridges. Give rise to rivers and runways. When you add Microsoft Flight Simulator Aircraft & Scenery Designer to Flight Simulator 4.0, the world is literally yours.

Because now you can choose from 34 different objects—natural or man-made—and change their size, shape, color and even location to your liking. Ask your Microsoft dealer about it.

You'll get the biggest kicks in the air. While you're having the most fun on earth.

Microsoft
Making it all make sense™

For more information, call (800) 541-1261. Dept. M51. Customers in Canada, call (416) 673-7638. Outside North America, call (206) 882-8661. ©1990 Microsoft Corporation. All rights reserved. Microsoft and the Microsoft logo are registered trademarks and Making it all make sense is a trademark of Microsoft Corporation. Flight Simulator is a registered trademark of SubLOGIC Corporation, used under license by Microsoft Corporation.

RECOGNITA PLUS

SPEED, ACCURACY AND FLEXIBILITY!

Speed

The fastest omnifont OCR software available on the market. Recognition rates of appr. 100–140 cps (Microsoft Windows) or appr. 180–250 cps (MS-DOS)

Speaks Your Language

A unique program that reads and understands English, Spanish, French, German along with most other European languages—even when they are within the same document.

Flexibility

Operates in the MS-DOS and the Microsoft Windows environment. Accepts complex page layouts, mixed fonts and proportional spaced documents. Supports the highest number of scanners in the marketplace.

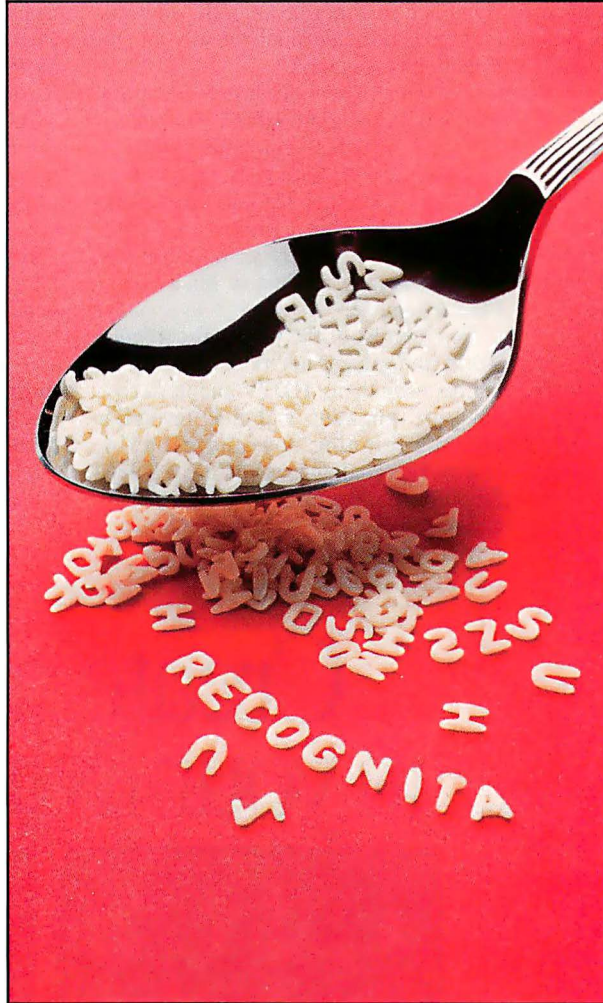

Innovation

One of the first proven OCR programs on the market to run under Microsoft Windows 3.0 in protected mode.

No additional boards.

Feeds on characters not on memory: all it needs is 40 KB RAM and 3 MB on your hard disk.

Intelligence

Automatic separation of text and images.

Automatic recognition of page layout.

Supports all popular word processing programs.

Price/Performance

Outstanding performance, added flexibility, high accuracy rate at a price that is affordable to all PC users.

Call for your demo diskette today: (1-800-255-4-OCR), P.O. Box 0218 Los Angeles, CA 90048 Tel: (408) 749-9935 Fax: (408) 730-1180

Distributors:

AUSTRALIA
• Dataserv
Tel: 61-2/957-2066

AUSTRIA
• Artaker
Tel: 43-222/588-05-0

BELGIUM
• Maxcom
Tel: 32-2/526 9411

• Tritech
Tel: 32-2/466-7535

CZECHOSLOVAKIA
• IV Agency
Tel: 42-2/840970

DENMARK
• Torsana-dtp data
Tel: 45-43/43-35-99

FINLAND

• CommNec
Tel: 358-0/493100

FRANCE
• Apsylog
Tel: 33-1/40 26 22 32

GERMANY
• Computer 2000
Tel: 49-89/790-40-0

• Frank Audiodata
Tel: 49-7254/505-0

• Macrotron
Tel: 49-89/42-08-0

• Recognita
Büroautomatisierung
Tel: 37-41/7957-256

GREECE
• Electel
Tel: 30-1/3607-521

ICELAND

• Höfudlausn
Tel: 354-1/687033

IRELAND

• Saunders Acquisition Systems
Tel: 353-1/366-522

ITALY

• Vecomp
Tel: 39-45/577500

JAPAN

• Suehiro Koeki Kaisha, Ltd.
Tel: 81-52/251-3721

LUXEMBOURG

• Burovision
Tel: 352-470951

MEXICO

• Misemi
Tel: 52-5/207-05-02

NORWAY

• ICT Databolin
Tel: 47-2/79-58-80

POLAND

• FX Przd. Inf.
Tel: 48-12/56-57-76

SPAIN

• Computer 2000 España
Tel: 34-3-473-16-60

• CSEI SA
Tel: 34-3/336-33-62

• STI
Tel: 34-1/45-869-45

SWEDEN

• Isogon AB
Tel: 46-8/732-87-37

SWITZERLAND

• ScanSet
Tel: 41-56/96-49-83

TURKEY

• EKSPA
Tel: 90-4-139-66-11

UNITED KINGDOM

• Intac Data Systems
Tel: 44-709/547177

• MSL Dynamics (for Africa)
Tel: 44-293/547-788

YUGOSLAVIA

• LTS
Tel: 38-11/190-572

OEM Partners:

• Accret
SWEDEN
Tel: 46-766/355-30

• Deutsche Nichimen
GERMANY
Tel: 49-211/3551-202

• EHG
GERMANY
Tel: 49-7451/7051-2

• Future Technology
AUSTRIA
Tel: 43-222/866350

• Getronics
HOLLAND
Tel: 31-20-5861509

• Hewlett-Packard
AUSTRIA
Tel: 43-222/25-00-0

• Microtek Electronics
Europe
GERMANY
Tel: 49-211/52607-0

• Microtek International
TAIWAN
Tel: 886-35/772155

• Mitsubishi Electric
Europe
GERMANY
Tel: 49-2102/486359

• Pentax Europe
BELGIUM
Tel: 32-2725 0570

• Ricoh Europe
GERMANY
Tel: 49-211/5285-0

Recognition speed measured on an IBM AT/386, 33 MHz
Microsoft Windows and MS-DOS are trademarks of Microsoft Corp.

Graphics Engines

The stunning graphics images available on today's desktops are products of a new generation of graphics hardware. Below are listed manufacturers of high-resolution graphics boards for PC, Macintosh, and Unix systems.

Abaton
(Everex)
48431 Milmont Dr.
Fremont, CA 94583
(415) 683-2226
Inquiry 1225.

ADEX Corp.
1750 Junction Ave.
San Jose, CA 95112
(408) 436-9700
Inquiry 1226.

Apple Computer, Inc.
20525 Mariani Ave.
Cupertino, CA 95014
(408) 996-1010
Inquiry 1227.

Artists Graphics
(Control Systems Corp.)
2675 Patton Rd.
St. Paul, MN 55113
(612) 631-7800
Inquiry 1228.

ATI Technologies, Inc.
3761 Victoria Park Ave.
Scarborough, Ontario,
Canada M1W 3S2
(416) 756-0718
Inquiry 1229.

Bell & Howell Co.
Quintar Division
370 Amapola Ave.,
Suite 106
Torrance, CA 90501
(213) 320-5700
Inquiry 1230.

Boca Research, Inc.
6401 Congress Ave.
Boca Raton, FL 33487
(407) 997-6227
Inquiry 1231.

Calcomp, Inc.
2411 West
La Palma Ave.
Anaheim, CA 92801
(714) 821-2000
Inquiry 1232.

Compaq Computer Corp.
20555 State Hwy. 249
Houston, TX 77070
(713) 370-0670
Inquiry 1233.

Data Translation, Inc.
100 Locke Dr.
Marlborough, MA
01752
(508) 481-3700
Inquiry 1234.

Desktop Computing, Inc.
2635 North First St.,
Suite 203
San Jose, CA 95134
(408) 943-9409
Inquiry 1235.

Enertronics Research, Inc.
5 Station Plaza
1910 Pine St.
St. Louis, MO 63103
(314) 421-2771
Inquiry 1236.

General Parametrics Corp.
1250 Ninth St.
Berkeley, CA 94710
(415) 524-3950
Inquiry 1237.

Generation X Technologies, Inc.
333 West El Camino
Real, Suite 310
Sunnyvale, CA 94087
(408) 739-4570
Inquiry 1238.

Genoa Systems
75 East Trimble Rd.
San Jose, CA 95131
(408) 432-9090
Inquiry 1239.

Groundhog Graphics
101 East Mahoning St.
Punxsutawney, PA
15767
(814) 938-8943
Inquiry 1240.

Headland Technology
46221 Landing Pkwy.
Fremont, CA 94538
(415) 623-7857
Inquiry 1241.

Hercules Computer Technology, Inc.
921 Parker St.
Berkeley, CA 94710
(415) 540-6000
Inquiry 1242.

Hewlett-Packard Co.
19091 Pruneridge Ave.
Cupertino, CA 95014
(408) 725-8900
Inquiry 1243.

Imaging Technology, Inc.
600 West Cummings
Park
Woburn, MA 01801
(617) 938-8444
Inquiry 1244.

Imagraph Corp.
11 Elizabeth Dr.
Chelmsford, MA 01824
(508) 256-4624
Inquiry 1245.

LaserMaster Corp.
7156 Shady Oak Rd.
Eden Prairie, MN 55344
(612) 944-9330
Inquiry 1246.

Logos Technology
809 South Lemon Ave.
Walnut, CA 91789
(714) 869-7789
Inquiry 1247.

Matrox Electronics Systems, Ltd.
1055 St. Regis
Dorval, Quebec,
Canada H9P 2T4
(514) 685-2630
Inquiry 1248.

MegaGraphics, Inc.
439 Calle San Pablo
Camarillo, CA 93010
(805) 484-3799
Inquiry 1249.

Megatek
9645 Scranton Rd.
San Diego, CA 92121
(619) 455-5590
Inquiry 1250.

Metheus Corp.
1600 Northwest
Compton Dr.
Beaverton, OR 97006
(503) 690-1550
Inquiry 1251.

Micron Technology, Inc.
2805 East Columbia Rd.
Boise, ID 83706
(208) 383-4000
Inquiry 1252.

Microway
Research Park
P.O. Box 79
Kingston, MA 02364
(508) 746-7341
Inquiry 1253.

Monolithic Systems Corp.
7050 South Tucson Way
Englewood, CO 80112
(800) 526-7661
Inquiry 1254.

Mylex Corp.
47650 Westinghouse Dr.
Fremont, CA 94539
(415) 683-4600
Inquiry 1255.

continued

Graphics Engines

National Design
9171 Capital of Texas
Hwy. N
Austin, TX 78759
(512) 343-5055
Inquiry 1256.

**NEC
Technologies, Inc.**
1414 Massachusetts
Ave.
Boxborough, MA 01719
(508) 264-8000
Inquiry 1257.

**New Media
Graphics Corp.**
780 Boston Rd.
Billerica, MA 01821
(508) 663-0666
Inquiry 1258.

NSA
800 South St.
Waltham, MA 02154
(617) 893-5700
Inquiry 1259.

**Number Nine
Computer Corp.**
725 Concord Ave.
Cambridge, MA 02138
(617) 492-0999
Inquiry 1260.

Nutmeg Systems
25 South Ave.
New Canaan, CT 06840
(203) 966-3226
Inquiry 1261.

**OmniComp
Graphics Corp.**
1734 West Belt N
Houston, TX 77043
(713) 464-2990
Inquiry 1262.

**Orchid
Technology, Inc.**
45365 Northport
Loop W
Fremont, CA 94538
(415) 683-0300
Inquiry 1263.

PC Tech, Inc.
907 North Sixth St.
Lake City, MN 55041
(612) 345-4555
Inquiry 1264.

**Personal Computer
Peripherals Corp.**
4710 Eisenhower Blvd.,
Building A-4
Tampa, FL 33634
(813) 884-3092
Inquiry 1265.

**Princeton Graphic
Systems**
1100 Northmeadow
Pkwy., Suite 150
Roswell, GA 30076
(404) 664-1010
Inquiry 1266.

**Princeton Publishing
Labs, Inc.**
19 Wall St.
Princeton, NJ 08540
(609) 924-1153
Inquiry 1267.

Radius, Inc.
1710 Fortune Dr.
San Jose, CA 95131
(408) 434-1010
Inquiry 1268.

Ramtek Corp.
1525 Atteberry Lane
San Jose, CA 95131
(408) 954-2700
Inquiry 1269.

RasterOps Corp.
2500 Walsh Ave.
Santa Clara, CA 95051
(408) 562-4200
Inquiry 1270.

Renaissance GRX, Inc.
226 116th Ave. NE
Bellevue, WA 98004
(206) 454-8086
Inquiry 1421.

Sigma Designs, Inc.
46501 Landing Pkwy.
Fremont, CA 94538
(415) 770-0100
Inquiry 1422.

Sota Technology, Inc.
559 Weddell Dr.
Sunnyvale, CA 94089
(408) 745-1111
Inquiry 1423.

STB Systems, Inc.
1651 North Glenville,
Suite 210
Richardson, TX 75081
(214) 234-8750
Inquiry 1131.

SuperMac Technology
485 Potrero Ave.
Sunnyvale, CA 94086
(408) 245-2202
Inquiry 1132.

Symbolics, Inc.
8 New England
Executive Park
Burlington, MA 01803
(617) 221-1000
Inquiry 1133.

Tecmar, Inc.
6225 Cochran Rd.
Solon, OH 44139
(216) 349-0600
Inquiry 1134.

**Trident
Microsystems, Inc.**
321 Soquel Way
Sunnyvale, CA 94086
(408) 738-3194
Inquiry 1135.

Truevision, Inc.
7351 Shadeland Station,
Suite 100
Indianapolis, IN 46256
(317) 841-0332
Inquiry 1136.

Tseng Labs, Inc.
10 Pheasant Run
Newtown, PA 18940
(215) 968-0502
Inquiry 1137.

**Univision
Technologies, Inc.**
3 Burlington Woods
Burlington, MA 01803
(617) 221-6700
Inquiry 1138.

Vectrix
111 Pacifica, Suite 2150
Irvine, CA 92718
(714) 727-2452
Inquiry 1139.

Ventek Corp.
31336 Via Colinas,
Suite 102
Westlake Village, CA
91362
(818) 991-3868
Inquiry 1140.

**Vermont
Microsystems, Inc.**
11 Tigan St.
Winooski, VT 05404
(802) 655-2860
Inquiry 1141.

**Western Digital
Imaging**
2445 McCabe Way
Irvine, CA 92714
(714) 863-0102
Inquiry 1142.

Inclusion in the resource guide should not be taken as a BYTE endorsement or recommendation. Likewise, omission from the guide should not be taken negatively. The information here was believed to be accurate at the time of writing, but BYTE cannot be responsible for omissions, errors, or changes that occur after compilation of the guide.

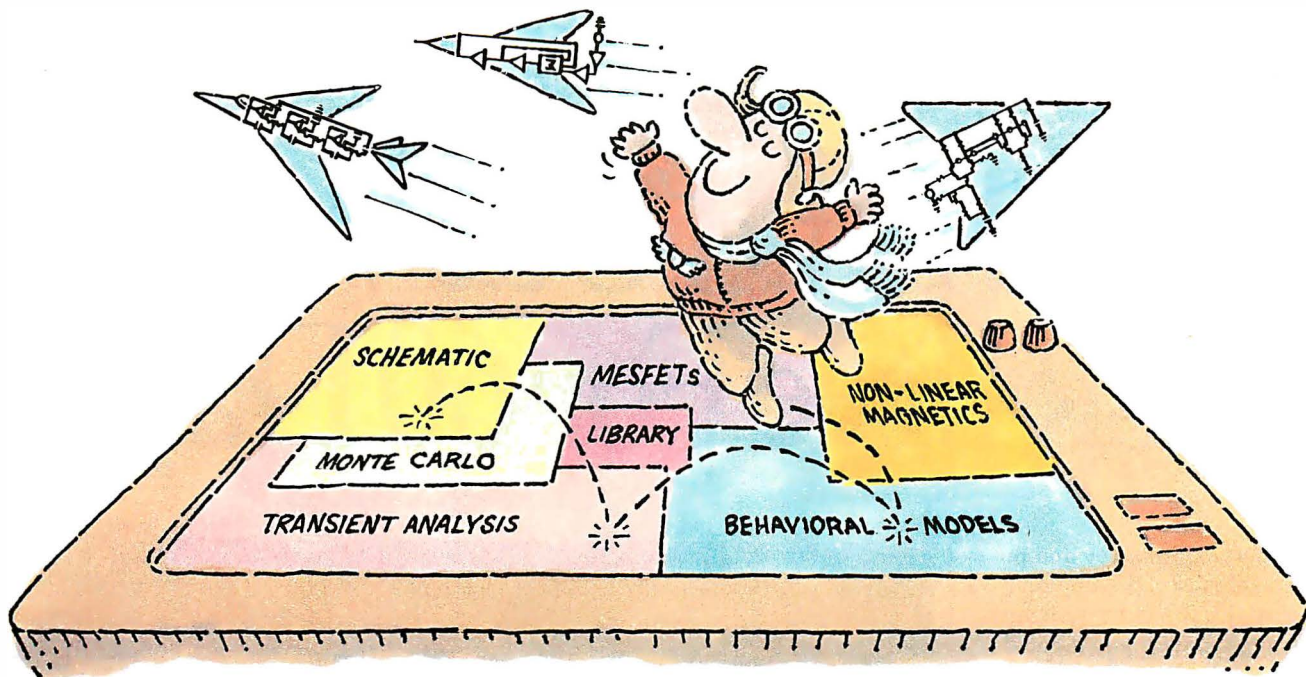

THE NEW MICRO-CAP III.[™] SO YOU CAN TEST-FLY EVEN MORE MODELS.

It wasn't easy. But we did it. Made the long-time best-selling IBM® PC-based interactive CAE tool even better.

Take modeling power. We've significantly expanded math expression capabilities to permit comprehensive analog behavioral modeling. And, beyond Gummel Poon BJT and Level 3 MOS, you're now ready for nonlinear magnetics modeling. Even MESFET modeling.

Analysis and simulation is faster, too. Because the program's now in "C" and assembly language. That also means more capacity—for simulating even larger circuits.

As always, count on fast circuit creation, thanks to window-based operation and a schematic editor. Rapid, right-from-schematics analysis—AC, DC, fourier and transient—via SPICE-like routines. The ability to combine digital/analog circuit simulations using integrated switch

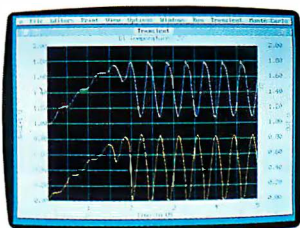

Transient analysis

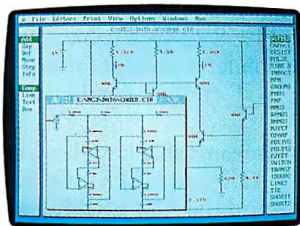

Schematic editor

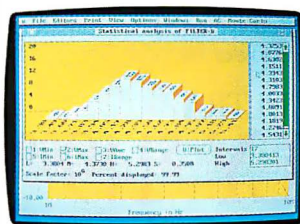

Monte Carlo analysis

models and parameterized macros. And stepped component values that streamline multiple-plot generation.

And don't forget MICRO-CAP III's extended routine list—from impedance, Nyquist diagrams and BH plots to Monte Carlo for statistical analysis of production yield. The algebraic formula parsers for plotting virtually any function. The support for Hercules, CGA, MCGA, EGA and VGA displays. Output for plotters and laser printers.

Cost? Still only \$1495. Evaluation versions still only \$150. Brochure and demo disk still free for the asking. Call or write for yours today. And see how easily you can get ideas up and flying.

spectrum

1021 S. Wolfe Road
Sunnyvale, CA 94086
(408) 738-4387

Every Day, Hundreds Of People Abandon Their Keyboard And Buy Northgate® *OmniKeys*®.

NOW! Find Out Why Risk Free For 60 Days!

FULL
5-YEAR
WARRANTY

Order an *OmniKey* and put it to the test ... if you don't think it's worth every penny you paid, we'll buy it back!

There is no faster—or better—way to type! See for yourself! With *OmniKey*, you don't need to "eye check" the monitor to know you've made an entry. Crisp ALPS key switches let you know with sound and sensation!

Put an *OmniKey* to the test. You'll see, *OmniKey* is not just a replacement keyboard, it's a system upgrade! Order now and we'll deliver one to your home or office for 60 days **RISK FREE!** You have nothing to lose ... everything to gain!



OmniKey/ULTRA With F-Keys On Top And Left!

All *OmniKeys* Have These Outstanding Features:

- Unmatched Compatibility; Ask us! We have a keyboard for your IBM type computer!
- LED Indicators show SCROLL, CAPS, and NUM lock status at a glance.
- FCC Class B Certified
- 5-Year Warranty—the industry's strongest! If you have any problems of materials or workmanship, Northgate will repair or replace your keyboard AT NO CHARGE!

PC Computing said "keyboards don't get any better than this." (July '90) ULTRA gives you 12 Function-keys on left. PLUS 12 switchable Special Function keys on top, for one-key CTRL, ALT, SHIFT combination commands.

ULTRA's Interchangeable keys let you swap CTRL, ALT and CAPS LOCK keys on left—and the ASTERISK and BACKSLASH keys on right. ULTRA's one-piece steel base is self-stabilizing for sure-handed typing. The ultimate keyboard for power users!

OmniKey/ULTRA

ONLY \$149⁰⁰

***OmniKey/ULTRA* Features:**

- Deluxe 119 key layout.
- 12 Function (F) keys on left.
- 12 Special Function (SF) keys on top—use them as duplicate F-keys or create macro functions of combined CTRL, ALT or SHIFT combination commands.
- Interchangeable ALT, CAPS LOCK and CTRL keys on left.
- Switchable ASTERISK and BACKSLASH on right.
- Separate diamond-shaped cursor keypad.
- Calculator style numeric keypad with extra equals key.
- Period/comma lock—locks out <>, punctuation in!
- Lifetime quality double injected keycaps.
- Keys color coded for use with WordPerfect.

F-Keys on left, top or both—it's up to you!



OmniKey/102 With F-Keys On Left

First keyboard to get back to the basics! Most people learned to type with function keys on left for fast, one-hand combination commands. *OmniKey/102* delivers this and more. That's why readers of *Computer Shopper* made *OmniKey/102* their

"Best Buy!" You can customize *OmniKey/102*, too! If you prefer the standard IBM enhanced layout, you can swap the CTRL, ALT and CAPS LOCK keys. The best 102 key keyboard available works with virtually every IBM-type personal computer.

OmniKey/102 Features:

- Innovative 102 key layout.
- 12 Function keys on the left.
- Interchangeable ALT, CAPS LOCK, and CTRL keys.
- Large L-shaped ENTER key.
- Separate inverted T cursor keypad.
- Calculator-style numeric keypad with added Equals key.
- Interchangeable Backslash and Asterisk keys.
- Lifetime quality double injected keycaps.
- Keys color coded for use with WordPerfect.

OmniKey/102

ONLY \$99⁰⁰



OmniKey/101-I With F-Keys On Top

Many people have become accustomed to the standard IBM layout. For you, we've duplicated, well nearly, the IBM layout (we couldn't resist making a couple of improvements). We made *OmniKey/101-I* with a footprint 20%

smaller than IBM's—saves desk space! We also weren't willing to compromise *OmniKey's* double wide BACKSPACE key and large L-shaped ENTER key—they mean too much in terms of increased speed and accuracy. Customers worldwide agree!

OmniKey/101-I Features:

- Enhanced 101 key layout.
- 12 Function keys on top.
- Interchangeable CAPS LOCK and left CTRL keys.
- Large L-shaped ENTER key.
- Double size BACKSPACE.
- Inverted T cursor control pad.
- Calculator-style numeric keypad with added Equals key.
- Lifetime quality double injected keycaps.
- Keys color coded for use with WordPerfect.

OmniKey/101-I

ONLY \$89⁰⁰

CHARGE IT! We accept VISA and MasterCard.

800-526-2446

HOURS: Mon.-Fri. 7 a.m. to 10 p.m.; Sat. 8 a.m. to 4 p.m. Central. Dealer and distributor prices available. **Se habla español por su conveniencia.**

FAX Your Order! 612-943-8332
Notice to the Hearing Impaired: Northgate now has TDD capability: 800-535-0602

 **NORTHGATE
COMPUTER
SYSTEMS**
"We hear you!"

7075 Flying Cloud Drive, Eden Prairie, MN 55344

©Copyright Northgate Computer Systems, Inc. 1990. All rights reserved. Northgate, *OmniKey* and the Big 'N' logo are trademarks of Northgate Computer Systems. Other brand names are trademarks or registered trademarks of their respective owners. Specifications subject to change without notice. Subject to occasional inventory shortages. We support the ethical use of software. To report software copyright violations, call the Software Publishers Association's Anti-Piracy Hotline at 1-800-388-PIR8.

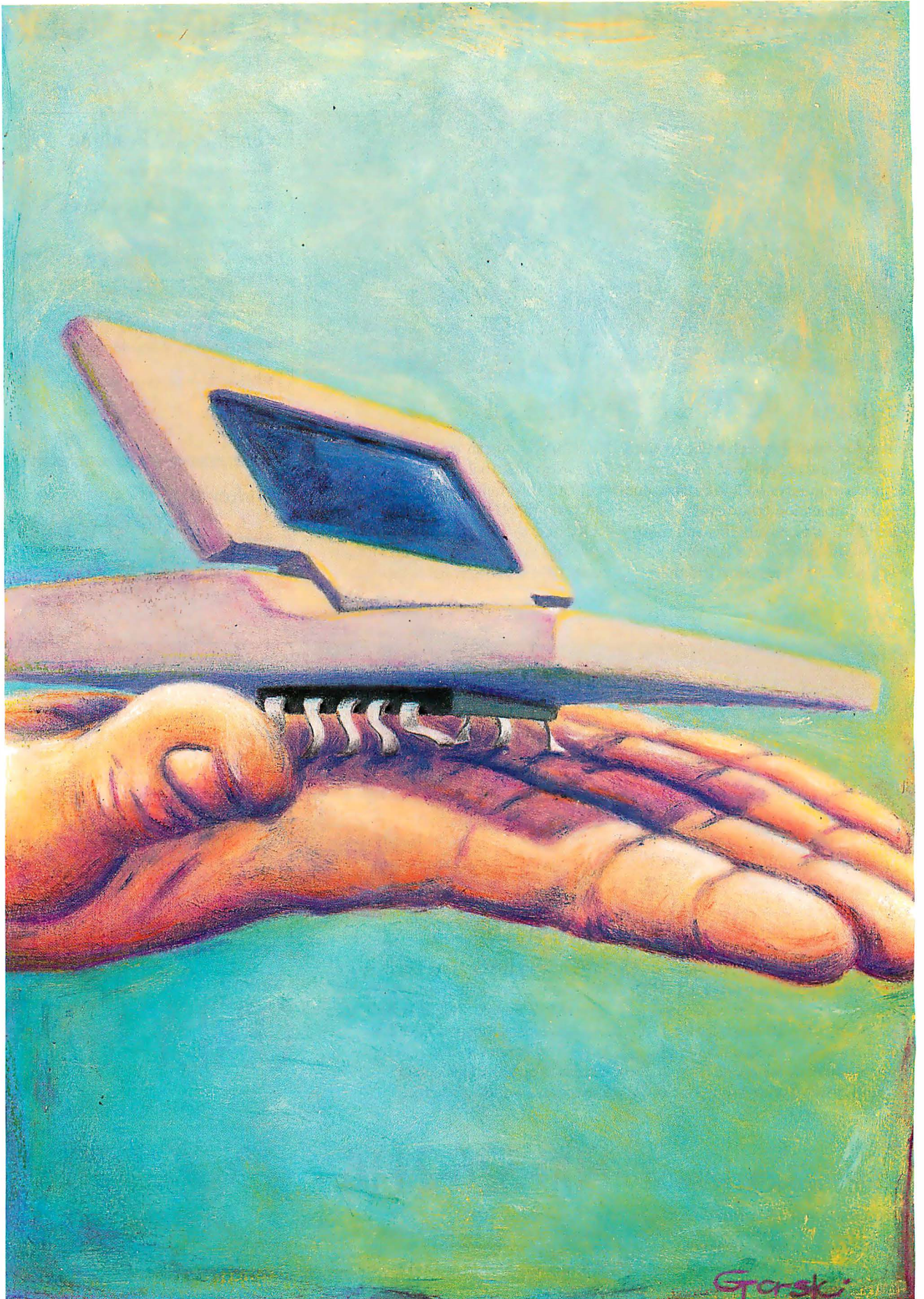

PORTABLE CHIPS

*Chip designers are helping make laptops smaller,
more powerful, and more efficient*

Owen Linderholm

The original IBM PC was designed with circuitry to help the CPU drive the other parts of the system: the bus, keyboard, display, peripherals, and memory. These logical functions required a number of ICs, which took up a great deal of board space and system real estate.

As other companies started to copy the PC, they looked for ways to build systems more economically. They began to make chips that performed a number of the functions involved in the system logic, a trend called *integration*.

Since the introduction of original PC, there have also been numerous technological developments in mass storage, memory, processors, and displays. IBM and others have used these techniques in ATs and compatibles, providing increasingly powerful solutions that nevertheless remain backward compatible. Driven by these factors, chip manufacturers have been able to decode all the logic required to build a PC compatible and put it on a few chips, simplifying the process of manufacturing a PC.

These manufacturers—companies such as Intel, Advanced Micro Devices (AMD), and Chips & Technologies—are always looking for ways to make their chip sets stand out above those of their competitors. One area where this is becoming increasingly possible is in the laptop market.

Let's Get Small

Laptops call for design philosophies and techniques that are substantially different from those of desktop systems. The manufacturers of laptop chip sets need to consider size, form factor, weight, power consumption, displays, mass storage options, memory, performance, and price. Interestingly, it is in laptops that manufacturers stray farthest from the IBM standard. IBM has never produced a successful laptop, so there are no de facto standards to adhere to except that of DOS compatibility.

The result has been a proliferation of laptop styles, ranging from the basic PC compatible with a single floppy disk drive

and a crude CGA LCD screen (e.g., the Toshiba T1000) to the brand-new 4-pound, hard disk-equipped VGA wonders from Sharp and Texas Instruments to innumerable 386SX-based laptops that have more power but are heavier. Another innovation that may point the way to the future is the "palmtop" IBM compatible, such as the one from Poqet. A palmtop has more power than the original PC in a package that's not much larger than a calculator (see photo 1).

Chip-Set Basics

Before looking into the special nuances of laptop chip sets, I want to review the typical functions of the chip sets found in most PC or AT compatibles. Basically, the chip set provides support logic for the processor, transforming instructions and signals from the processor into signals that can be understood by other components of the system and vice versa. Typical chip sets now operate in four or five main areas:

- The *bus controller chip* carries signals from the processor to the system bus. It provides timing and arbitration signals for the bus and, when necessary, performs buffering to feed signals along the bus so they won't conflict with each other.
- The *peripheral controller chip* generally controls hard and floppy disk drives and, often, the parallel port. It controls the flow of data between the processor and these peripherals.
- *Memory-control chips* perform similar functions for the RAM and ROM in a system, physically fetching data from the RAM and returning it to the processor. They also control memory refresh, passing signals to periodically update memory so the RAM contents don't fade.
- There is usually an *I/O chip* that controls serial I/O and, sometimes, the parallel port and other peripheral devices in the system.
- Finally, most chip sets now include a *display controller* in some form. This may be combined with the I/O chip in the case of a simple monochrome display but is more commonly a separate VGA controller chip.

continued

Correct
clocking is more important
to a microcomputer than a steady
heartbeat is to the human body.

Most chip sets also control timing for the whole system, including the processor. They take signals from the system's clock crystals and use them to keep the various parts of the system operating in sync. This is probably the single most important function of the chip set, since correct clocking is more important to a microcomputer than a steady heartbeat is to the human body. Chip sets also usually control parity generation, accesses to memory, shadowing RAM and ROM, data and address buffering, and other less important functions.

Currently, most computers use three or four chips to control these functions. However, several companies have announced that they have integrated all of them onto a single chip. This allows manufacturers to build systems using a processor, a chip set on one chip, some RAM chips, and various other nonsilicon electronic devices. Such high levels of integration are allowing manufacturers to make system boards that are only a few inches on a side. This means that it's possible to fit all the other components of a system—slots, disk drives, and the power supply—into a much smaller box than what used to be needed.

Today's Laptop

The average laptop today is an AT compatible with a floppy disk drive and a hard disk drive. It has a flat-panel LCD screen, which may be either high-quality CGA or low-quality VGA. There are numerous problems with building such systems, which is why far fewer companies are making laptops than there are companies making desktop systems.

The first issue is size. Generally speaking, the smaller the laptop, the more successful it will be. But it takes more engi-

neering expertise to put all the components of a desktop system into a unit that will fit on your lap. Manufacturers want chip sets that are highly integrated so the motherboards will be more compact and take up less space. They also want chip sets to be flexible, making it easier to design a board layout that works well with the physical design of the system.

The next issue, and probably the most important, is power. This is the issue that drove the development of special chip sets for laptops, and it is the area that manufacturers almost uniformly focus on. Manufacturers either use a DC-to-DC converter to ensure a good-level voltage from the power supply to the system, or they try to supply a good voltage directly, in the form of a high-quality battery pack.

The battery approach is a little more risky, especially when a battery starts to run out. As power gets low, power levels can fluctuate. To avoid permanent damage to the system, manufacturers must use components that are more resistant to voltage fluctuations (and therefore more expensive). The disadvantage of using a DC-to-DC converter is that it has a small power overhead and decreases overall battery life by about 15 percent. In both cases, manufacturers try to extend the battery life as long as possible.

In addition, many components of a laptop system are sources of heavy power drain. The clearest example is a backlit LCD screen. Although backlighting makes the screen much easier to read, it drains a significant amount of power from the system. Chips & Technologies, perhaps the biggest chip-set manufacturer, estimates that under the best conditions the backlight uses about 12 percent to 15 percent of the system power.

A simple solution—found early on by the chip-set manufacturers—was to switch the backlight off when it wasn't needed. To do this, most chip sets monitor keyboard activity and turn off the backlight (and often the whole display) if you don't hit a key within a certain period of time. This solution, while saving power, has its problems. If you're simply looking at the screen thinking about what to do next, or if the system is performing a long and difficult calculation, turning off the backlight may not be desirable. Some chip sets are designed to monitor processor and video activity to determine when the backlight and display should go off.

Chip sets can also save power by powering down the whole system when it is not being used. This is not the same thing as

Photo 1: The high levels of integration in Intel's 386SL and 82360SL chips allow all the basic components of a computer to fit on this 4- by 6-inch motherboard, an experimental design for palmtop systems.

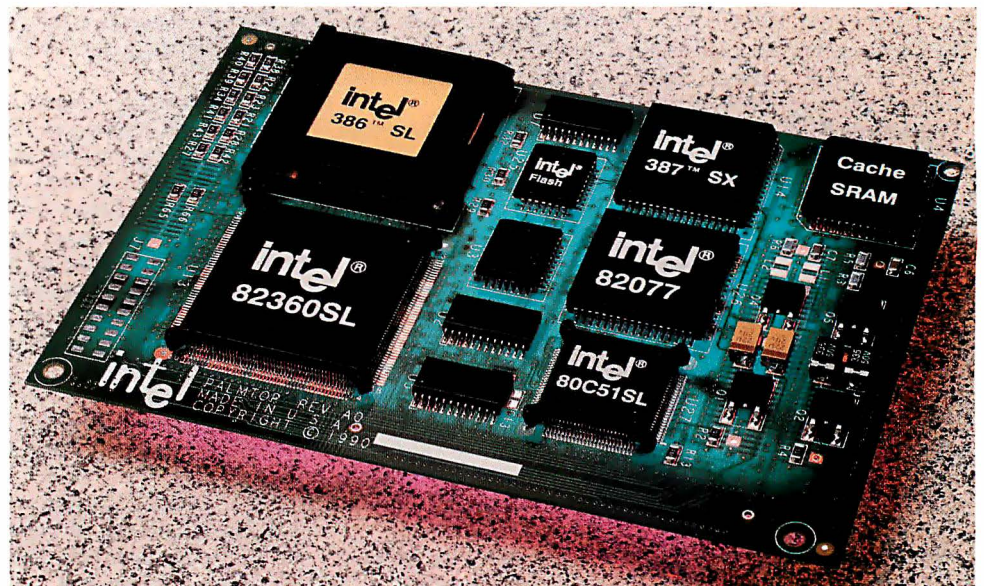

Intel
has stated that its goal is
a single-chip AT that includes
processor, chip set, and memory.

turning the system off. Most laptops now have the ability to suspend and resume operation. They do this by powering down the entire system except memory and the processor—or even everything but the memory, if they take the trouble to store processor values in memory first. This technique is usually under the direct command of the user or kicks in after prolonged periods of inactivity.

Similarly, some disk drive manufacturers have now put low-power and power-down modes of operation into their drives. Chip-set makers are starting to support them by having their chip sets put hard disk drives into idle when they are not used, or even sometimes powering them down.

Following the trend toward using lower-power components, chip-set makers now provide versions of their chip sets that consume less power. These, of course, are more expensive, as are the chip sets that include power-saving features. Memory makers are also bringing out DRAM chips that need to be refreshed far less often. Chip-set manufacturers have not yet brought out many products to support these, but more should be available soon.

Controlling Displays

Another issue for laptop makers is what display to use. Users are voting for higher-quality displays by buying systems that have them. To meet this demand, chip makers are now supplying low-power VGA chips as part of their laptop chip sets.

Closely linked with the display is the question of the user interface. For most laptop users, this means the keyboard and DOS. However, since the advent of 386SX-based laptops, users have begun to use graphical user interfaces, such as Windows 3.0. This means that they will also want pointing devices, such as mice. Some systems now have built-in devices, such as trackballs, that let you control these graphical environments more readily.

Many manufacturers foresee pen-based and voice-based interfaces as the way forward for laptops, and perhaps for all computers. These kinds of interfaces and the applications driving them will require more computing horsepower—at the very least, a 386SX. The added horsepower in turn requires more power to drive it, taking manufacturers back to the question of power consumption.

Working Together

One last big issue remains for the makers of laptop chip sets: compatibility. This may seem trivial, but the specialized chip sets for laptops, particularly in the power management area, put an added strain on the processor and operating system. In particular, system logic chips make tremendous use of hardware interrupts to the processor to coordinate and deliver all the signals to and from the processor. Every interrupt slows down some other operation of the processor by a small margin. Power management features slow the processor down a lot,

Plotters for people who want more, but can't afford expensive.

Now, you don't need a big budget to get quality and performance from your plotter. That's why Zericon's large format plotters are becoming so popular.

\$1695.-\$2995.

Our D size starts at \$1695 and our A-E model is only \$2995 direct from Zericon.

Call us today for a free sample plot and info about

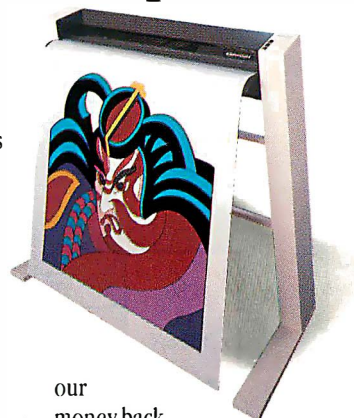

our money back guarantee. 40491 Encyclopedia Circle, Fremont, CA 94536.

In CA (415) 490-8380
FAX: (415) 490-3906

(800) 727-8380



ZERICON
More Plotter. Not More Money.

BACKPACK. IT'S A DRIVE OF A DIFFERENT COLOR.



Add a disk drive without horsing around inside your computer—just plug Backpack into your parallel port! Connect your printer to the Backpack drive. No tools. No hassles. No interface cards. Backpack works with IBM and compatibles including PCs, XTs, ATs, PS/2s, PS/1s, and

laptops. It's available in 5.25" and 3.5" and comes complete with everything you need. So see your dealer or get it straight from the horse's mouth and call us about Backpack today!



MicroSolutions
Computer Products
132 W. Lincoln Hwy., DeKalb, IL 60115
815-756-3411 Fax: 756-2928

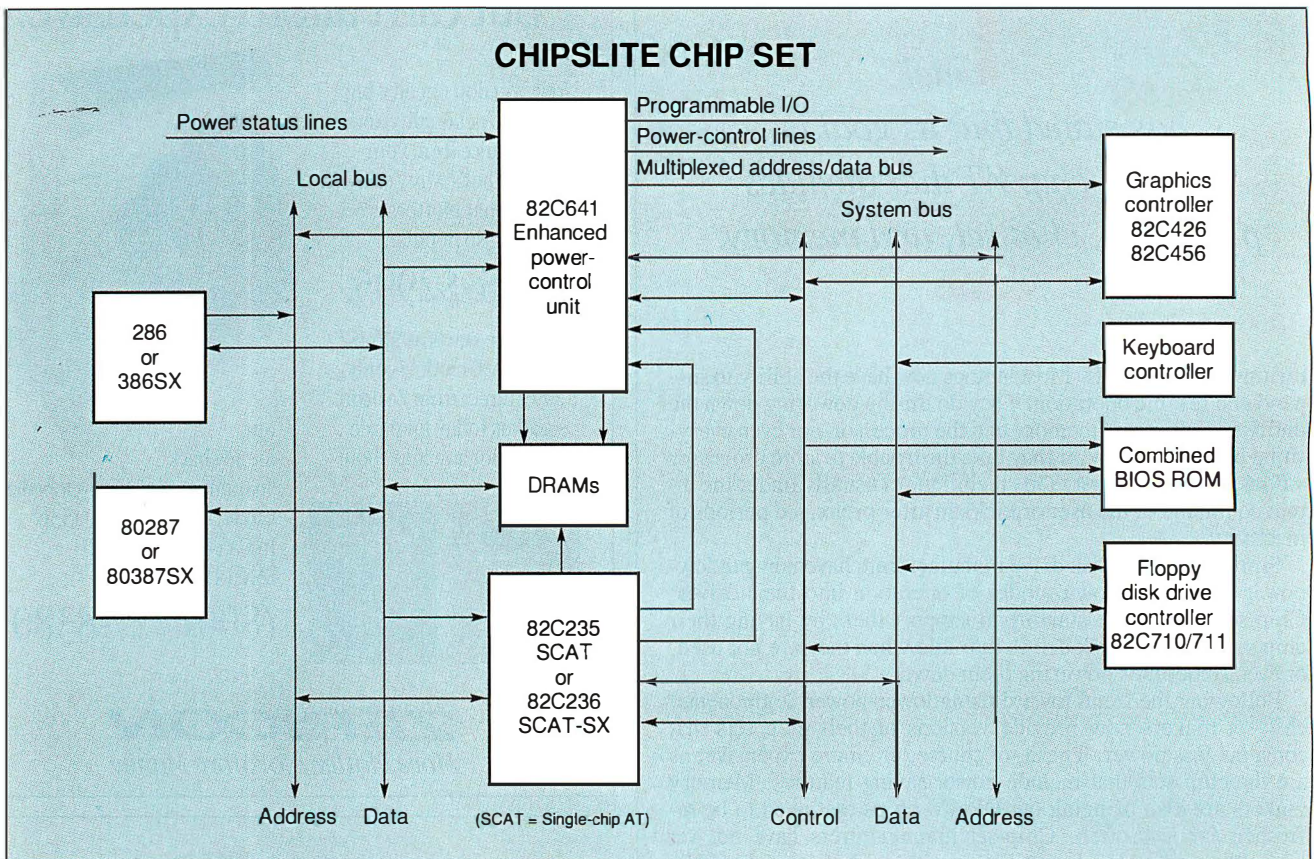

This block diagram shows the CHIPS�ite chip set from Chips & Technologies. In addition to standard circuits that control graphics, keyboard, and I/O devices, the chip set includes an 82C641 power management chip. The 82C641 supports SmartSleep, a technique for determining when the system can safely be put into sleep mode.

because the chip-set logic is continually monitoring the processor to see if it can shut some portion of the system down.

Turning parts of the system on and off takes interrupts. If done at the wrong time, interrupts can result in system crashes and data loss. In particular, applications using external high-speed communications (e.g., networking) or add-in cards are likely to suffer from being interrupted by power management features.

Correct access to memory is another area that may be affected by power management features in a laptop chip set. This is a special concern in a protected-mode environment where memory could be switched off at the command of one paused application even though others are still running.

Laptop Chip-Set Solutions

Currently, laptop chip-set makers address these problems in various ways. The most common method for dealing with size is to assume that more integration means a smaller form factor and less weight. Intel has gone so far as to state that its goal is a single-chip AT that includes processor, chip set, and memory.

A single chip such as this would allow laptop manufacturers to follow two paths. One would be to make extremely small, basic AT-compatible systems: palmtops or even smaller machines. The more likely path would be to free up space on the motherboard to allow future extensions to a laptop, such as networking devices (and even wireless networking), Flash memory cards, pen-input technology, much larger memories, fax modems, and voice-recognition devices.

Chip sets for dealing with alternative display and user-input devices are already being produced. To ease the limitations of color laptop displays, a couple of companies are making RAM-DACs: specialized display chips that provide display RAM, D/A converters for the display, and controls for color lookup tables.

Cirrus Logic is producing a RAMDAC that allows existing color flat-panel screens to display far more colors than they currently can—up to full 256-color VGA modes—without modifying the display itself. Edsun Labs is making a chip that provides automatic antialiasing and can make a regular VGA monitor display thousands of colors rather than the usual 256. Technologies like these are rapidly making good color displays for laptops a reality.

However, minimizing power consumption is where the main problem still lies. Semiconductor technology is advancing rapidly, but power and battery-storage technology is improving far more slowly. Most companies are using brute-force approaches to power management where selected parts of the system are turned off when not needed. In addition, most of their new chip sets now support modes that slow down or even turn off the CPU when not needed, and many support lower DRAM refresh rates.

A good example of this is the new 286LX from AMD (see "AMD Gets Closer to Building an AT Motherchip," October Microbytes). The 286LX is a complex single chip that performs many of the functions that are usually performed by several chips. It includes AMD's 80C286 CPU on the chip. The

INTRODUCING THE 4860[®] MOTHERBOARD. YOUR ULTIMATE BUILDING BLOCK.

The Dynamic Duo. The 4860 is an industry-first MotherBoard that packs the power of the Intel 80486 CPU with the Intel 80860 RISC processor ($i486 + i860 = 4860$). With it, you can build mainframe power into PC's for applications including CAD, LAN and desktop publishing. Equally impressive, our 4860 pumps up performance in your UNIX workstations.

A PC Revolution. In the PC environment, the 4860 is a 486-based MotherBoard which runs over 2 times faster than 386 computers. It's fully compatible with DOS, IBM's OS/2, Novell Netware and UNIX. What's more, Hauppauge's 4860 supports up to 64 MBytes of memory *without* a RAM expansion board!

RISC-Y Business. Thanks to the 4860's symmetrical architecture, both the *i486* and the *i860* processors can access the full range of memory, I/O system, and the 64-bit expansion bus. The result? Unprecedented dual processor performance.

You'll find that the *i860* processor is ideal in graphics applications, performing up to 25 million floating-point operations per second. That's more than 10 times faster than the *i486* processor alone! There's even an optional 64-bit frame

buffer card for ultra high-performance workstation graphics.

For UNIX Workstations, Too. The 4860 board makes a great foundation for high-performance RISC workstations that run advanced UNIX applications. Many workstation vendors are choosing the *i860* processor as a standardized vehicle for CAD and simulation systems, and the 4860 is perfectly compatible with these applications.

Technical Features: ■ 4 Megabytes of high speed RAM expandable to 64 MBytes shared between *i486* and *i860* processors ■ Socket for optional 128K static RAM cache module for the *i486* ■ Full size PC/AT form factor ■ Eight EISA I/O slots ■ 64-bit expansion slot ■ 1 parallel, 2 serial ports.

The 4860 MotherBoard. Built with the world's highest performing microprocessors. So you can build the world's highest performing PC's and workstations.

Hauppauge Computer Works, Inc.
91 Cabot Court
Hauppauge, New York 11788
Toll Free: 1-800-443-6284
In New York: 516-434-1600
In Europe: (49) 2161-17063

Hauppauge!

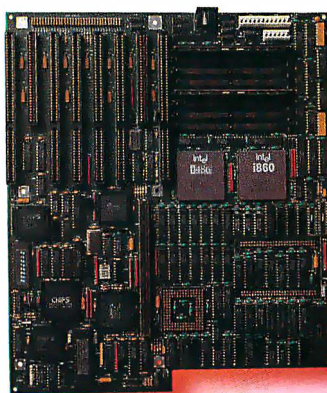

Trademarks: IBMAT and OS/2: IBM. Intel 386, i486 and i860: Intel Corp. DOS and XENIX: Microsoft Corp. 4860 MotherBoard: Hauppauge Computer Works, Inc.

Circle 129 on Reader Service Card

INTEL 386SL

Cache tag SRAM

Clock

Cache control logic

Internal bus controller

Memory controller

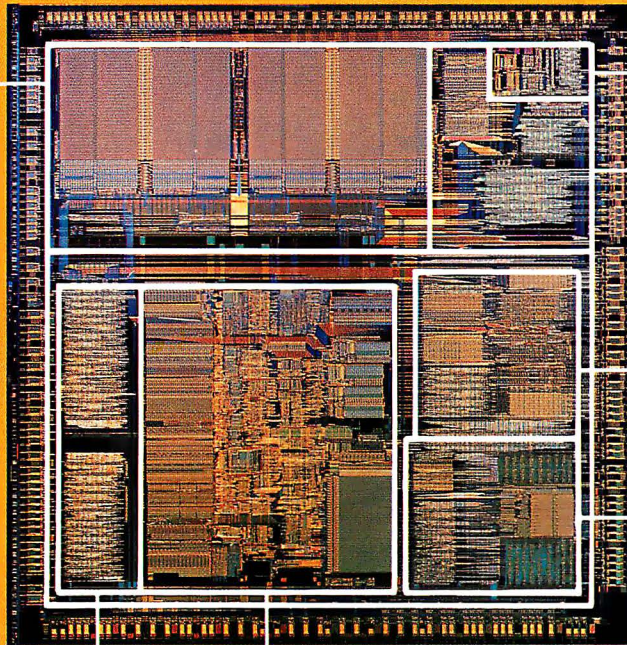

AT bus controller

386SX CPU core

Photo 2: The 386SL, a version of the 386 processor designed for laptops, is actually slightly faster than the 386SX. The 386SL features integrated cache memory control, a high-speed peripheral bus, and a system management interrupt (SMI) that will, among other things, let hardware manufacturers program in new power management features.

INTEL 82360SL

Power management

Real-time clock

Parallel I/O

Nonmaskable interrupt

I/O control

Serial I/O

Timers

Interrupt control

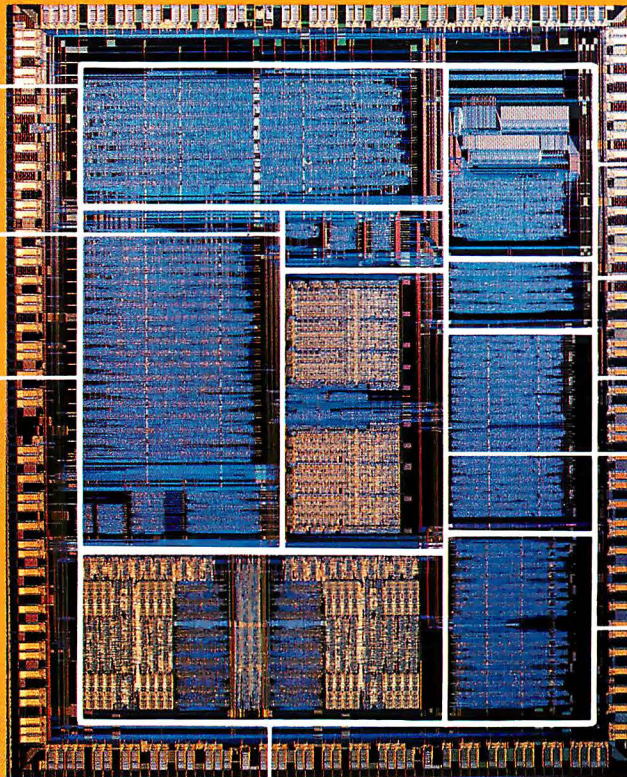

DMA control

Photo 3: The 82360SL, a companion chip to Intel's 386SL, provides the Industry Standard Architecture bus and most of the I/O necessary to build a complete system. The chip's power management facilities support Intel's Flash memory system, which, in suspend mode, can power the system for several weeks.

286LX has a CPU-shutdown mode that turns off the 80C286 portion of the chip, and a standby mode that turns off all system clocking except for DRAM refresh. DRAM refreshing is staggered so that the power drain is more constant and peak current demands are reduced. This chip is extremely well integrated and could be used to build a laptop with fewer than 20 chips on board, including DRAM.

However, as advanced as this solution is, it doesn't save enough power to dramatically increase battery life. Chips & Technologies is taking an approach that, while similar, uses more on-chip intelligence to examine power usage and determine the best way to turn off parts of the system to reduce power requirements but keep the system operating efficiently. The new CHIPS lite chip set (see the figure) offers a less well-integrated solution that should, however, perform better at power management.

The CHIPS lite chip set uses between five and seven chips. It features Chips & Technologies' own BIOS, which includes power management routines. The chips provide address buffers, address and data multiplexers, a special power management chip, an integrated BIOS, a peripheral interface, an I/O interface, and a keyboard controller.

The important chip in this set is the 82C641 power management chip. It supports sleep modes, standby modes, automatic backlight shutoff, modem ring, and slow-refresh DRAMs. The 82C641 uses a new refresh technique that reduces power requirements, and you can program it to power on at a preset time.

However, what sets the 82C641 apart is a technique that Chips & Technologies calls SmartSleep. SmartSleep is an advanced algorithm that makes a statistical analysis of how often an application polls the keyboard. It looks at the number of calls between certain time periods and then sets minimum and maximum values. It then sets a spread of values to determine when it is safe to put the system into sleep mode.

Sleep mode conserves power by stopping or slowing clocks to the CPU, taking advantage of the CMOS property that CMOS gates do not consume power except when they are switched. Stopping or slowing the transitions thus reduces the amount of power used.

The 80C286 processor is a static chip that can keep values even when stopped, so sleep modes on 286-based laptops actually stop the CPU altogether. The 386SX and 386DX chips are dynamic and therefore need to be refreshed by clocking. This can be done at speeds as low as 2 or 4 MHz—rather than the usual 16 MHz or higher—saving a considerable percentage of the power consumed by the processor.

All these transitions take place so fast that it is often safe to put the processor into sleep mode between keystrokes while a user is typing. Thus, using sleep modes effectively can save a considerable amount of power. However, sleep modes must be used carefully because it is conceivable that some event may occur while the processor is asleep. For example, an extremely rapid typist might lose keystrokes if the processor went too quickly into sleep mode. Chips & Technologies estimates that up to 35 percent of system power is saved when it is operating in sleep mode.

It is clear that carefully planned sleep modes can save considerable power and protect users from losing data. Most chip sets take a conservative approach and use sleep modes only when a certain interval has passed without keyboard activity. The Chips & Technologies SmartSleep technique allows the system to analyze usage patterns and intelligently determine when to turn sleep on and off. The algorithm is coded in firmware on the 82C641 chip and is user-configurable. You can

even save usage patterns for different applications to customize SmartSleep for the application being run.

Standby modes turn more of the system off—everything except the memory, which could be slow-refresh memory. This mode can save over 95 percent of the power required by full operation. Chips & Technologies claims that its combination of low power consumption, SmartSleep, and other power-saving devices can extend the battery life of a typical laptop by a third or more.

Intel's Solution

Most chip-set solutions may now be obsolete, however. Intel has recently introduced a new version of the 386SX processor, the 386SL, designed for laptops. It is slightly faster than the 386SX and works with the 82360SL, a new companion chip that provides the Industry Standard Architecture bus architecture and most of the necessary I/O for a system.

The 386SL (see photo 2) has several unique features. It has integrated cache memory control, consumes less power, and is a static design. It also includes a high-speed peripheral bus that is intended for use with high-performance graphics, Flash memory, and disk systems.

However, the 386SL's biggest innovation is the addition of a new system management interrupt (SMI) and separate system management memory and I/O address spaces. This new interrupt is transparent to the rest of the processor and to any operating system running on the processor. It is designed for use by hardware manufacturers who want to program in power management features. The SMI provides the ability to suspend and resume operations, send peripherals such as hard and floppy disk drives into standby modes, control the CPU clock speed, and control uninterruptible power supplies. The SMI can be externally programmed so that manufacturers can add their own extensions for any form of power management.

The SMI is a hardware-level interrupt that takes priority over all other interrupts on the system. As such, it could conceivably be used for functions other than power management. Intel claims that, despite the obvious performance penalty for the rest of the processor when the SMI takes over, the overall performance of the 386SL is better than that of the 386SX. Intel also anticipates that using these chips and other low-power parts could extend the battery life of a system by 50 percent.

Intel has also put power management facilities into the 82360SL support chip (see photo 3), which includes timers, controls I/O, and has event recognizers to trigger the SMI for the 386SL. It also can support Intel's Flash memory system, powering a computer for several weeks when in suspend mode, rather than the usual few hours.

Good Things in Small Packages

Chip manufacturers are currently prototyping chips that will be smaller and more efficient and will feature even higher levels of integration than today's chips offer. In the near future, you can expect to see a single-chip AT that will allow powerful systems to fit into very small packages. Features like Intel's SMI will allow portables to incorporate new power-saving techniques and other management functions.

It's only been in the last few years that manufacturers have taken laptop chip-set technology seriously, and already great advances have been made. It seems likely that chip sets will soon be able to make up for battery-life limitations and dramatically extend the lives of portable computers. ■

Owen Linderholm is a news editor for BYTE in San Francisco. He can be reached on BIX as "owenl."



"... the fastest product we tested"
3/27/89

"... led the pack in remote control software"
6/12/90



Any Other Questions? 800-322-9440

If you follow the press, you already know about CO/Session. *InfoWorld* called it "the fastest product we tested." *PC Magazine* noted that it was faster by far at transferring files than any of its competitors, and claimed "CO/Session led the pack in remote control software performance." So, you probably thought we couldn't improve on the Performance Leader in remote screen updates and file transfers. Well, we have - with version 5.0.

Of course, you'll be able to operate one PC from another with CO/Session 5.0. But now we've added such features as reduced memory requirements, remote mouse support and faster screen updates. In fact, with a long list of new features not found in Carbon Copy Plus, pcAnywhere or Close-Up, we're leaving the competition further and further behind.

To find out more about CO/Session and how to order and where to buy it, call 1-800-322-9440. We'll be happy to talk with you - and you'll be glad you called.

See us at NetWorld and Fed Micro.



Triton Technologies Inc. • 200 Middlesex Turnpike, Iselin, NJ 08830
(201) 855-9440 • Fax (201) 855-9608

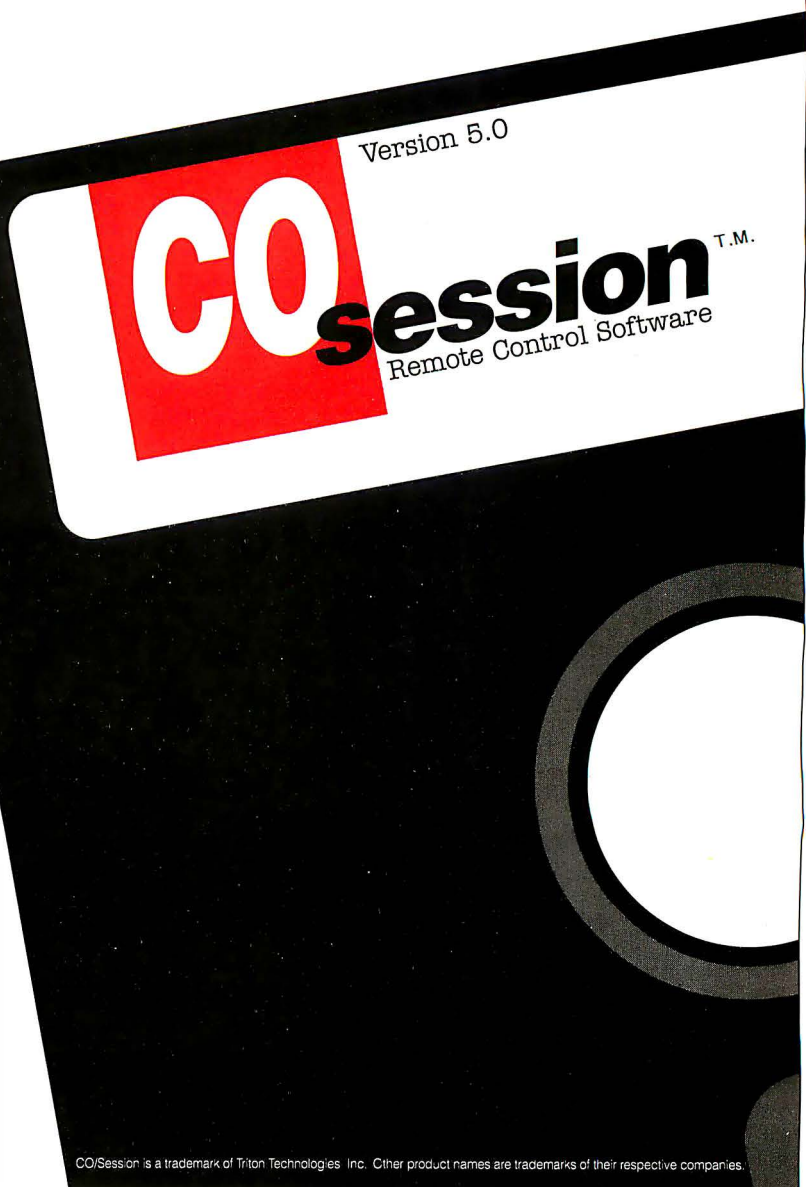

CO/Session is a trademark of Triton Technologies Inc. Other product names are trademarks of their respective companies.

RELATIONAL DATABASES: THE REAL STORY

*Are you sure you're using a relational database manager?
Think again.*

Steven J. Vaughan-Nichols

Have you noticed that every food product in the land is now advertised as being "light"? It doesn't matter at all if there is any truth to the claims. *Light* is one of the new buzzwords, so everyone is using it.

Of course, food vendors aren't the only ones to play fast and loose with language. Computer companies do the same thing. Computer vendors use hype phrases like "turbo" and "object-oriented." One term with a precise definition, *relational database management system (RDBMS)*, has been bandied about so much that even veteran computer users have lost track of its meaning. Companies have been using this phrase for years. There's only one problem: Few programs even come close to being relational database managers.

A Rose by Any Other Name?

Even database professionals believe that an RDBMS is any program that can access more than one database at a time. Nothing could be further from the truth. Just because a program allows you to view two different tables with its procedural language doesn't mean it's relational.

The sad thing is that there's no real excuse for this confusion. The relational database model has been around since 1970, when Edgar Codd, then an IBM researcher, intro-

duced it to the world in his classic *Communications of the ACM* paper entitled "A Relational Model for Large Shared Data Banks."

Since then, Codd and his colleagues have been beating the drum for RDBMSes, both within and outside the walls of IBM. To make certain that everyone got the idea, Codd summed up the definition of RDBMS in a set of rules (see the text box "Codd's Commandments" on page 322).

In a way it's funny that so many programs try to wrap themselves in the RDBMS mantle. During its first years of existence, nobody except Codd and his followers supported the RDBMS model. The concept, based firmly on mathematical theory and predicate logic, was disliked for its break with traditional database thought. It was reviled as being too theoretical. Many said that it would never be practical.

The prevailing database model of the day was the hierarchical model. In this still-popular system, data is stored in a tree structure, and every data element is defined as being a member of a group. These groups are themselves data elements and can be members of a higher group. Under this scheme, your ZIP code is a data element that is part of another data element, your address. These elements could then be a part of another data element—a mailing list,

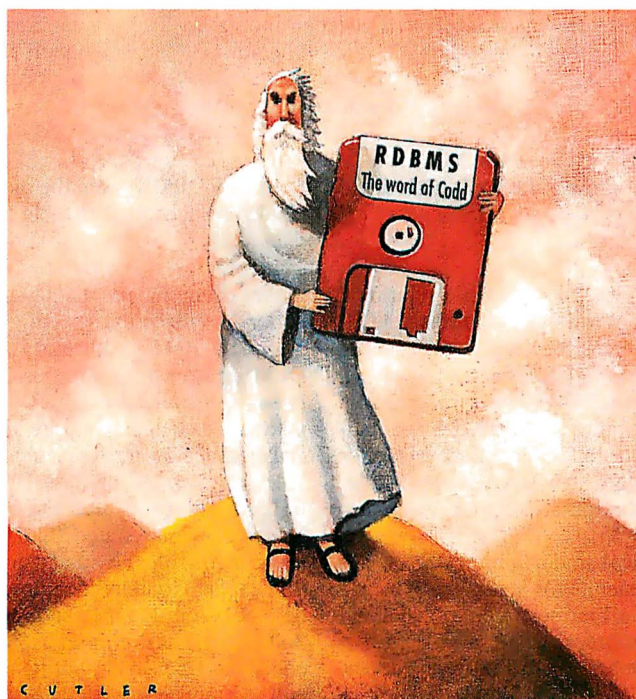

Codd's Commandments

In the late 1960s, Edgar Codd was an IBM researcher who questioned the way DBMSes were designed. Over time, he became disgusted with the prevailing database theories of his day and decided to try to improve the situation. From his efforts, the relational model was born. As his model grew more popular, he was dismayed by the fact that DBMS designers were adopting only the word *relational* and ignoring the rest of the relational model. It was then that he formulated rules to define exactly what a relational DBMS is.

In theory, an RDBMS must meet Codd's rules or it isn't a relational database manager. In practice, most relational databases implement only some of these rules. Building a true RDBMS is easier said than done. A full discussion of Codd's rules is beyond the scope of a single article, but here is a brief summary of Codd's commandments:

Rule 0: Any RDBMS must be able to manage databases entirely through its relational capabilities. If a DBMS depends on record-by-record data-manipulation tools, it's not truly relational.

Rule 1: All data in a relational database is explicitly represented (at the logical level) as values in tables. Data cannot be stored in any other way.

Rule 2: Every data element must be logically accessible through use of a combination of its primary key value, table name, and column name.

Rule 3: Null values are explicitly supported. Nulls represent missing or inap-

plicable information.

Rule 4: The database description, or catalog, is also stored at the logical level as tabular values. The relational language—Structured Query Language (SQL), for instance—must be able to act on the database design in the same manner in which it acts on data stored in the structure.

Rule 5: An RDBMS must support a clearly defined data-manipulation language that comprehensively supports data manipulation and definition, view definition, integrity constraints, and transactional boundaries and authorization. SQL is the most well known of these languages.

Rule 6: All views that can be updated must be updatable by the system. This is a major stumbling block for would-be RDBMS designers. Many implementations don't allow updatable views at all. Those that do have many restrictions on when a view can be updated. In a true RDBMS, most, though not all, views would be updatable.

Rule 7: An RDBMS must do more than just be able to retrieve relational data sets. It has to be capable of inserting, updating, and deleting data as a relational set. Many RDBMSes that fail the grade fall back to a single-record-at-a-time procedural technique when it comes time to manipulate data.

Rule 8: Data must be physically independent of application programs. The underlying RDBMS program, or "optimizer," should be able to track physical changes to the data. For instance, an

RDBMS's application programs should not have to change when an index is added to a table.

Rule 9: Whenever possible, applications software must be independent of changes made to the base tables. That is, RDBMS programs should not need to be modified to reflect any changes in the underlying data tables. For example, no code should need to be rewritten when tables are combined into a view.

Rule 10: Data integrity must be definable in the relational language and stored in the catalog. This law is another one that has proved difficult to put into practice. Data-integrity constraints can be built into applications. However, this approach is foreign to the intent of the relational model. In this model, data integrity should be inherent in the database design.

Rule 11: An RDBMS has distributional independence. This is one of the more attractive aspects of RDBMSes. Database systems built on the relational framework are well suited to today's client/server database designs.

Rule 12: If an RDBMS has a single-record-at-a-time language, that language cannot be used to bypass the integrity rules or constraints of the relational language. Thus, not only must an RDBMS be governed by relational rules, but those rules must be its primary laws. Simply tacking SQL onto a database program won't turn it into a relational database any more than painting racing stripes on a VW Bug turns it into a Ferrari.

for instance. These structures can grow quite complicated and require pointers and indexes to properly track information.

The "Real" Thing

RDBMSes take a much simpler view of data. In a relational database, two-dimensional arrays of rows and columns hold all the information. This structure seems too easy, and, to some extent, that criticism is valid. Not every kind of information can be conveniently accessed under an RDBMS. Imaging information, for instance, doesn't easily fit into an RDBMS's neat patterns of data. Still, an RDBMS works fine for most textual or numeric data. Although an RDBMS's structure may be simple, its inherent data-retrieval and manipulation powers are unparalleled.

In part, an RDBMS's theoretical underpinnings allow for easy coding. In a relational system, for example, finding records between two points (say, all names in an alphabetical list between "Vau" and "Vo") is a breeze. The same search in conventional databases requires many record-by-record comparisons.

In an RDBMS, even the most complicated data relationships can be reduced to 2-D table formats via *data normalization*, a data-analysis process used to find the simplest possible data structure for a given collection of information. This format makes changing and displaying information far easier than it is under a hierarchical system.

An RDBMS is a fundamental improvement over most DBMSes because you can add, delete, or change data throughout an entire database by treating it as a single set. Ordinary database managers require record-by-record updates that can drastically slow performance.

Ingres, Oracle, R:base 3.0, and IBM's mainframe-driven DB2 all attempt to meet the demands of the RDBMS model. At one time, Codd stated that an RDBMS needed to meet only seven of his rules. By that standard, some have been successful. Since then, Codd has declared that all his commandments must be met before a database manager can be called "relational." So far, none has, although a few have come close. The RDBMS concept sounds easy, but its full implementation is more difficult in practice than in theory.

There's more to comparing LaserJet PostScript® Language Emulation Cartridges than just the name

	Pacific Data Products PacificPage™ P•E	Hewlett-Packard PostScript® Cartridge
Price	\$499	\$695
Emulation switching	Yes	No
Font cartridge option	Yes	No
Upgrade program	Yes	No
Warranty	Lifetime	One Year



Don't settle for less just to buy the HP name. Ask for Pacific Data Products' PacificPage P•E. It's the PostScript language emulation cartridge for HP LaserJet IIP, IID, III and IIID printers that offers you more for less.

Compare its lifetime warranty, upgrade program for keeping current with the latest version, and ability to switch between PostScript and PCL language emulation modes. And compare the optional companion cartridge, PacificType.

There is also an option available for connecting your PacificPage P•E equipped printer to a Macintosh computer.

To learn how you can get more for less, call your nearest dealer or contact: Pacific Data Products, 9125 Rehco Road, San Diego, CA 92121, (619) 597-4608, Fax (619) 552-0889.



PACIFIC
DATA PRODUCTS

This cartridge is compatible with the HP LaserJet models IIP, IID, III and IIID. Prices are suggested retail list price. PacificPage P•E and PacificType are trademarks of Pacific Data Products, Inc. PhoenixPage is a registered trademark of Phoenix Technologies Ltd. Copyright 1987, 1988 Phoenix Technologies Ltd. Macintosh is a registered trademark of Apple Computer, Inc. PostScript is a registered trademark of Adobe Systems Inc. Pacific Data Products, 9125 Rehco Road, San Diego, CA 92121, (619) 552-0880, Fax (619) 552-0889, © 1990 Pacific Data Products, Inc.



An RDBMS
must meet Codd's rules
or it isn't a relational
database manager.

Playing by the Rules

The fundamental rule of an RDBMS is that all information must be manageable entirely through relational means. On the logical level, then, everything in a relational database must be represented by values in tables. Here is where many database managers fall short. It is all too tempting for database designers to take a shortcut in data representation or manipulation for the sake of short-term efficiency. Unfortunately, this easy road leads quickly away from the basic model.

Other rules reinforce this concept. In a true RDBMS, the database description, or catalog, must be contained in tables and controlled by the data-manipulation language.

Perhaps the most troublesome rule in relational theory is the one dealing with null values (rule 3). In an RDBMS, nulls represent missing or inapplicable data, and they are a vital part of

the relational concept. But nulls aren't the same thing as empty or blank fields or the concept of zero.

Nulls represent information that isn't known at the time of a record's creation or modification. For instance, a hospital keeps birth records. Sometimes parents don't have a first name for their new offspring. The baby could be given a false name, such as "John Doe" or "Smith's daughter," and the record could later be changed to the real name. This method will work, but it makes both the updating and the reporting of records more complicated. Under an RDBMS, any missing information is represented by a null value.

But even within relational theory, there is no agreement on how to manipulate record sets containing null values. Debate continues on how to handle nulls. Since this question is at the heart of Codd's theory, it can't just be disregarded.

Structured Query Language, the most popular relational language, identifies primary record keys by the combination of their unique identities and by being "not null." Codd has further muddied the waters by suggesting that two types of nulls should be recognized. One would represent missing information, and the other would represent inappropriate data. There's no sign that a definite answer to this thorny question will be forthcoming anytime soon.

Another rule that is difficult to implement is that an RDBMS must have distributional independence. In other words, the data manager must be able to cope with distributed databases. In an RDBMS, data should be independent of hardware architecture and physical location. A true RDBMS would be able to display a view on your screen made up of a table from your PC and an-

**486 EISA
NOW SHIPPING**

WE'RE CERTIFIED...

Novell Labs Tested & Approved

SCO
THE SANTA CRUZ OPERATION

Quarterdeck

BANYAN

While many computer manufacturers say they are compatible, CSS Laboratories'™ MaxSys™ file servers are certified to work with your network operating system. Our MaxSys 386MT/33, for example, has passed testing by Novell,® Banyan,® SCO® and Quarterdeck.® And our new 486 EISA line offers unsurpassed compatibility, while providing all the power and features to carry your network well into the future.

There are MaxSys systems with up to ten drive bays

and 400 watt power supplies, and all come with our exclusive 12-slot motherboard. If you need a heavy-duty file server, this is it. All of our 286, 386SX, 386 and 486 tower and desktop systems come with a full one-year warranty, a national 800 number for technical support, and optional on-site service. And they are all certified to provide uncompromising performance and reliability.

other table from a VAX located across the country.

Distributed database systems are an area in which developers are making rapid progress. Companies are rushing to bring distributed database managers to market. LAN database administrators lust after the power they provide; thus, database servers and clients are the hottest products in the DBMS field. The RDBMS model is well suited for this development, because the relational model's simple design and data-integrity rules have made it the cornerstone of most distributed databases.

The Best of Both Worlds?

Is it possible to combine the best features of an RDBMS with other systems? Many software companies have thought it could be done. They have tried to put a coat of relational paint on top of other systems. Codd addresses this in his final rule, the gist of which is that an RDBMS can have both relational and ordinary single-record-at-a-time elements. A relational system, however, must be governed by the logic of the relational model.

The reason why Codd devised his final rule is that the relational model is different from other ways of viewing and manipulating data. Therefore, a true hybrid system could never produce the full gains promised by relational theory.

In some circles, talking about database theory is like talking about religion or politics: You're sure to have an argument. I favor the relational model, but I'm the first to admit that it does have some problems—like nulls—that need a clearer definition.

RDBMSes have one practical problem as well. They require comparatively large amounts of RAM and disk storage. To put it more bluntly, they are resource hogs. Without sufficient

Talking
about database theory
is like talking about
religion or politics.

hardware support, RDBMSes run extremely slowly.

Most hierarchical database managers work quite well within their theoretical constraints. In point of fact, most database programs, including such popular favorites as dBASE, FoxPro, Clipper, Superbase, and Paradox, owe more to the conventional database model than they do to the relational one.

Still, as time goes by, the theoretically superior relational model will be successfully implemented on more platforms. Only then will there be products that can honestly be labeled as being relational. Until that time, the best one can say of most programs is that they include some relational features. ■

Steven J. Vaughan-Nichols is a freelance writer and programmer/analyst for Bendix Field Engineering Corp. (Seabrook, MD). He can be reached on BIX as "sjvn."

THEY'RE SATISFIED.

"I would like you to know how pleased we are with the CSS Labs equipment installed on our network. Your unique design has allowed us to grow the services to our users beyond what was planned in our budgets." "... the higher performance and reliability has been commented on by the network users." "... Also, please extend my sincere thanks to your technical support staff for their fantastic response in resolving our recent compatibility issue." "... My staff was amazed that the solution was delivered the next day! This type of service is rare in the industry."
—Roger Spangler, Network Service Manager, Fujitsu America, Inc.

"... ample provisions for drive and add-on board expansion make this system a fine choice in network or multiuser applications."—PC Magazine

"Our records confirm that over 25,000 CSS boards are in the field now, and judging by the low rate of return, their performance and integration in our systems, is outstanding."

—Bob Ziegler, Purchasing Manager, Datamedia Corporation

"... the combination of large- and small-record test results makes it quite impressive over the full range of data-handling hurdles." "Apparently CSS has found some semi-magical combination of medium technology that will yield sterling performance..."

—PC Magazine

"... a great example of a PC on steroids." "This machine is more than the sum of its parts. Power file server builders should keep an eye on CSS."—LAN Times

Circle 78 on Reader Service Card (RESELLERS: 79)

CSS
LABORATORIES, INC.
A Solid Investment

Ask About
On-Site Service

When you're evaluating a new system, it helps to know what experience others have had. CSS Laboratories' customer list is a long and happy one. Not to mention the computer press, who have also had some nice things to say.

These people all agree, that CSS systems don't just perform well, they offer unsurpassed reliability and compatibility. Add to this our reputation for customer service, and you can see why people are recommending us. For dealer information, call 1-800-966-CSS1. Find out why we call CSS Laboratories "A Solid Investment."

DEALERS CALL (800) 966-CSS1

All the features of HP BASIC, and more. For less.



HTBasic	BASIC FEATURES:	HP BASIC
YES	IEEE-488 GPIB (HP-IB), RS-232 Instrument Control	YES
YES	Integrated Environment: Mouse, Editor, Debugger, Calculator	YES
YES	Supports 16 Megabytes of Memory (breaks DOS 640K barrier)	YES
YES	Engineering Math: Matrix Math, Complex Numbers	YES
YES	High Level Graphics: Screen, Plotter, Printer	YES
YES	Structured Programming with Independent Subprograms	YES
YES	Runs on Industry Standard Personal Computers	NO*
YES	Industry Standard Graphic Printer Support: Epson, IBM, lasers, etc.	NO
YES	Industry Standard Network Support: Novell, IBM, Microsoft, NFS, etc.	NO
YES	Industry Standard IEEE-488 Support: National Instruments, IOtech, etc.	NO
YES	Exchange data files with Industry Standard PC applications	NO*
YES	No-charge Telephone Technical Support	NO
YES	Instant on-line HELP system	NO

A Costly Situation. Every engineer needs the power and features of a "Rocky Mountain" BASIC workstation, but not everyone can have one. They simply cost too much. Fewer workstations, less productivity. **The Best Way.** TransEra HTBasic software provides the *only* way for serious technical computer users to turn their PC into a workstation without having to add costly hardware. Powerful workstations for everyone means greater productivity. **Extraordinary Versatility.** In addition, TransEra HTBasic works with the Industry Standard Personal Computer hardware, software, and networks. It even allows you to easily exchange data between your favorite DOS programs and the files you create in the BASIC workstation environment. All at a fraction of the cost of other solutions.

More compatibility. More versatility. More possibilities.
Less expense. Less hassle.

To find out more, call 1-801-224-6550.

TransEra
Engineering Excellence for 15 Years™

Circle 320 on Reader Service Card (RESELLERS: 321)

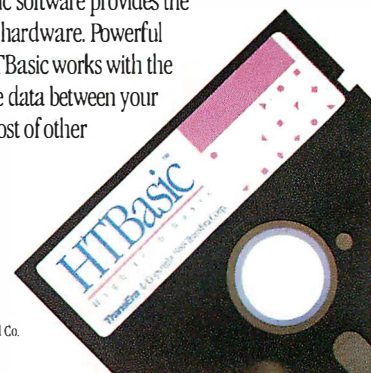

CONCURRENT C

*A language for programming
multiprocessor systems*

Narain H. Gehani and William D. Roome



Concurrent C is an upward-compatible superset of C that provides parallel programming facilities. Concurrent (parallel) programming has become increasingly important because multi-computer architectures, particularly networks of microprocessors, have become attractive alternatives to traditional mainframe computers.

There are some good reasons for programming in a language that supports concurrent processing:

- Concurrent programming languages usually provide the structure and have a convenient notation for writing programs for systems in which many events occur at the same time (e.g., operating systems, real-time systems, and database systems).
- A concurrent application is best expressed with the concurrency stated explicitly; otherwise, the program will not reflect the application's structure.
- Concurrent programming makes the best use of multiprocessor architectures.
- Concurrent programming can reduce program execution time even on uniprocessors, by allowing I/O operations (usually with DMA and an independent I/O processor) to run in parallel with computation.

Concurrent programming has only one disadvantage: It adds complexity to a programming language. On the other hand, writing a parallel application in a sequential language requires writing code to simulate the parallelism, a nontrivial task that requires knowledge of the hardware, the operating system, and the interprocess-communication facilities. Tailoring the application to specific hardware and system software results in code that is difficult to port to a different computer system.

A System of Processes

A Concurrent C program consists of a set of processes that execute in parallel and that interact with each other by sending messages. Messages are sent to and replies are received from

another process by calling transactions associated with the process.

At Bell Labs, we designed Concurrent C to harness together numerous computers. We picked C as the basis for our work on parallel programming because it is an immensely popular language and we use it. However, since it does not have parallel facilities, we needed to enhance it. Our objectives were

- to provide a concurrent programming language that can be used for writing systems on genuinely parallel hardware, such as a network of microprocessors or workstations;
- to provide a test-bed for experimenting with high-level concurrent programming facilities; and
- to design a practical concurrent programming language.

Our first implementation of Concurrent C was done in 1984 and 1985. Since then the language has evolved; it has been integrated with C++ and is now in a fairly stable state.

In this article, we will give an overview of Concurrent C and Concurrent C++. Specifically, we will discuss the selection of the concurrent programming model and some of the initial design decisions, summarize the concurrent programming extensions to C, describe in detail the important facilities in Concurrent C, illustrate the use of Concurrent C with some examples, discuss the integration of Concurrent C with C++, and summarize our experience using Concurrent C. We will assume that you are familiar with C or C++.

Selection of the Concurrent C Model

We selected the *extended rendezvous* (or transaction) concept for Concurrent C. A *rendezvous* is an interaction of two processes when they establish a point of synchronization, exchange information, and then continue their individual activities. A simple rendezvous involves only unidirectional communications, whereas an extended rendezvous allows bidirectional information transfer using only one rendezvous.

After the synchronization is established, information is

Listing 1: *The specification for the lockMngr process.*

```
typedef long lockid;
process spec lockMngr()
{
    trans void lock(lockid id); /*wait if busy*/
    trans void release(lockid id);
};
```

Listing 2: *The body of the lockMngr process.*

```
#include "lock.h"
process body lockMngr()
{
    lockid xid;

    for (;;)
        select {
            accept lock(id) suchthat(isfree(id))
                xid = id;
                lock(xid);
            or
            accept release(id)
                xid = id;
                unlock(xid);
        }
    /*isfree(id) returns true if id is unlocked*/
    /*lock(id) locks id*/
    /*unlock(id) unlocks id*/
}
```

Listing 3: *Using the lockMngr process. Pseudocode is in italics.*

```
#include "lock.h"

main()
{
    process lockMngr lm;
    lockid id;
    ...
    lm = create lockMngr();
    ...
    lm.lock(id);
    access item;
    lm.release(id);
    ...
}
```

copied from the process requesting service—the client—to the server. The client process is then forced to wait while the server process performs the requested service. Upon completion of the service, the results, if any, are returned to the client, which is then free to resume execution. From the client's viewpoint, an extended rendezvous is just like a function call.

Initially, we considered several categories of concurrent programming models:

- those based on shared memory;
- those based on asynchronous (nonblocking) message passing;
- those based on synchronous (blocking) message passing; and
- a combination of message passing and shared memory.

We rejected the shared-memory models because we wanted Concurrent C programs to run efficiently on nonshared-memory multiprocessors, such as workstations connected by a LAN. That left us with asynchronous and synchronous message-passing models. These two models are equivalent in that either set of primitives can be implemented using the other. We eliminated the asynchronous model for the following reasons:

- Most interprocess interactions are synchronous, not asynchronous: The client requests a service and waits for it. This matches the synchronous model perfectly. Thus, while the asynchronous model is more flexible, few people would actually use this extra flexibility.
- A synchronous model can be implemented more efficiently than an asynchronous model for which data must always be copied into and then out of a message buffer. For the synchronous model, data can be copied directly from the client process

to the server, without going through an intermediate buffer, and the server's reply can be copied directly to the client. Thus, the synchronous model saves space and time.

Despite the theoretical equivalence of the asynchronous and synchronous message-passing models, some users of Concurrent C have a preference for asynchronous message passing because it maximizes concurrency. The debate over synchronous and asynchronous message passing has been the subject of much controversy among researchers. Preference for either can become a religious issue.

Reacting to this preference, we decided to take another look at asynchronous message passing. Eventually, we came to the conclusion that asynchronous message passing can indeed be beneficial in many situations. Consequently, we extended Concurrent C to provide this kind of message passing.

Some final comments about shared memory are in order. First and foremost, we wanted Concurrent C to allow (and encourage) programmers to write portable programs that will run efficiently on multiprocessors with or without shared memory. This is why we chose a message-passing model and why we have not added any language constructs for dealing with shared memory or for simulating shared variables in a nonshared-memory environment.

On the other hand, we did not want to forbid programmers from using shared memory altogether, as long as they accept the resulting limitations on portability. If we tried to prevent the use of shared memory in a shared-memory multiprocessor, programmers would just refuse to use Concurrent C. Therefore, Concurrent C does not forbid processes from referencing global variables, nor does it forbid processes from exchanging pointers. However, programmers do so at their own risk; such programs will not work as expected unless run on a computer with shared memory.

Overview of Concurrent C

Concurrent C extends C for parallel programming by providing facilities for

- specifying process types;
- creating processes;
- specifying the processor on which a process is to run;
- specifying, querying, and changing process priorities;
- synchronous and asynchronous transactions;
- delays and time-outs;
- interrupt handling;

- waiting for a set of events, such as transactions;
- accepting transactions in a user-specified order;
- process abortion; and
- collective termination.

A Lock Manager

You can get a taste of Concurrent C by seeing how you might implement a lock manager for large collections of items. In this demonstration, client processes can lock and release items. If an item is already locked, a process requesting a lock on this item waits until the item is released. Listing 1 is the specification of the lockMngr process. This specification declares two transactions: lock and release, which other processes can call to set and release locks.

Listing 2 is the body of the lockMngr process. This process accepts a lock request whenever the requested item is free, and always accepts release requests. Functions isfree, lock, and unlock manipulate a lock table. Only one process, lockMngr, calls these functions, so they do not have to worry about concurrent access to the lock table.

Listing 3 illustrates how a lockMngr process can be created and used.

A Simple Disk Scheduler

Listing 4 is the specification for a disk scheduler that uses the "elevator" algorithm. It is the same algorithm used to control elevators in high-rise buildings. An elevator alternates between handling all the calls from passengers wanting to go up and all the calls from passengers wanting to go down. This same algorithm implemented as a disk scheduler first handles all the calls to move the disk head in one direction. Then when there are no more such requests, the algorithm changes direction and accepts requests in the other direction. The elevator algorithm eliminates long delays in handling requests for cylinders at the edges of the disk.

The specification of the diskScheduler process declares one transaction, request, that can be called by other processes to read data from or write data to the disk. The body of the diskScheduler is in listing 5. The blkno parameter is the logical-disk block number for the block to be read or written.

The Concurrent C implementation of this scheduling algorithm has two phases. In phase 1, the scheduler does not have a current direction; all pending requests have already been handled (or none have yet been issued). The scheduler starts in phase 1 and returns to phase 1 when it again has no pending requests. In phase 1, the scheduler accepts the request for the cylinder nearest to the current disk head position. The scheduler moves the disk head in the direction of that cylinder, handles the request, and enters phase 2.

In phase 2, the scheduler has a current direction; it moves the head in this direction, accepting requests as it goes (see listing 5). The variable phase indicates the current phase, and in phase 2, the variable dir indicates the current direction.

The select statement has two alternatives: an *accept* alternative and a guarded *immediate* alternative. If the process has an outstanding transaction call that satisfies the accept alternative, the select statement takes that alternative. If not, and if the guard is true (i.e., it is nonzero), then the select statement takes the immediate alternative. And if the guard is false, the select statement waits for a transaction call to arrive.

The accept alternative has a suchthat clause. In phase 1, any request satisfies this clause. In phase 2, only requests for the current cylinder or those for cylinders in the current direction satisfy it. Of those requests that satisfy the suchthat clause, the by clause selects the one that is nearest to the current

Listing 4: The specification for diskScheduler.

```
typedef enum {D_READ, D_WRITE} opcode;
process spec diskScheduler()
{
    trans void request(long blkno, opcode op, char *buf);
};
```

Listing 5: The body of diskScheduler. Pseudocode is in italics.

```
#include "disk.h"
#define BLK_CYL (19*32) /*blocks per cylinder*/
#define CYL(x) ((x)/BLK_CYL) /*cylinder number*/
#define ABS(x) ((x)>0?(x):-x)
process body diskScheduler()
{
    int pos = 0, phase = 1, dir;

    for (;;)
        select {
            accept request(blkno, op, buf)
                suchthat(phase == 1
                    || CYL(blkno) == pos
                    || CYL(blkno) > pos == dir)
                by(ABS(CYL(blkno)-pos)) {
                if (CYL(blkno) != pos) {
                    dir = CYL(blkno) > pos;
                    phase = 2;
                    pos = CYL(blkno);
                    seek to pos;
                }
                start disk operation;
                wait for disk operation to complete;
            }
            or (phase == 2):
                phase = 1;
        }
}
```

cylinder. Once a request has been accepted, if it involves disk movement, the scheduler sets the current direction and shifts to phase 2. The scheduler then does the disk operation. The immediate alternative is executed only when the scheduler is in phase 2 and when there are no pending requests that satisfy the suchthat clause. The immediate alternative returns the scheduler to phase 1.

Note that the scheduler does not poll. If the scheduler is in phase 1 and there are no pending requests, the scheduler waits for a request to arrive. When the scheduler is in phase 2, the immediate alternative is open and will be taken when there are no requests that satisfy the accept alternative. The immediate alternative returns the scheduler to phase 1. This closes the immediate alternative and causes the scheduler to wait for the next request.

Concurrent C ++

Concurrent C, as a compile-time option, also works with C++, an object-oriented superset of C. Although data-abstraction facilities are important for writing concurrent programs, we did not provide them in Concurrent C because we did not want to duplicate the C++ research effort. Instead, we decided that we would eventually integrate C++ and Concurrent C

A process that is called by many clients can become a bottleneck.

facilities to produce a language with both data-abstraction and parallel-programming facilities. This was a pragmatic decision. We decided that it would be better if it had the same data abstraction as C++ because this would make the new language upward-compatible with C++ and would then be more attractive for C++ users interested in writing concurrent programs.

Both C++ and Concurrent C have been implemented as C preprocessors. Anticipating the need for eventually merging C++ with Concurrent C, we used the C++ preprocessor as the starting point for the Concurrent C preprocessor. We also tried to use syntax for the concurrent programming facilities that was similar in spirit to the class syntax.

For example, as in C++, parameter types must be explicitly specified. A compile-time option determines whether the Concurrent C preprocessor accepts just Concurrent C or Concurrent C++.

Our goal was to accept both languages. Our reasoning for having both was to maximize our audience and at the same time

keep up with the evolutions of C. Many potential users of our concurrent programming extension know C but not C++. We thought that many of those programmers would be reluctant to use our work if they first had to learn C++. And programmers who know C++ would be reluctant to use any programming language that did not provide data abstraction and would consider Concurrent C a step backward from C++.

Using Classes vs. Processes

Classes and processes are both abstraction facilities. You can use processes to implement abstract data types, such as queues and complex numbers, which are typically implemented using classes. However, this can be very expensive in terms of computer resources, because processes incur additional run-time overhead for context switching and process scheduling.

Some abstractions cannot be implemented as pure classes and must be implemented with processes (e.g., inherently parallel applications, such as operating systems; programs for controlling robots; and embedded tactical systems for airplanes).

Objects that are shared by multiple processes can be encapsulated in a process to enforce sequential access. For example, you can enclose a queue shared by many processes within a process to ensure that items are added to and removed from the queue one at a time.

So, when designing a new data abstraction, you must ask yourself how that abstraction should be structured. It can be structured purely as a class, or purely as a process, or as a mixture—an interface class hiding a process.

The advantage of classes is that the overhead of invoking a

Laptop

External SCSI Hard Drive

for your Laptop Computer

Tulin Corporation now offers a full line of SCSI hard drives for the laptop computers. A-Hive, Hermit Crab, Half Shell are now available for both the desktop computers and the laptop computers using the parallel port. Tulin continues their tradition of serving their customers with affordable price and performance in their products.

A-Hive	(9.9"X9.6"X4.3")
	30MB
	48MB
	65MB
	85MB
	100MB
	120MB
	170MB
	200MB
	340MB
	675MB
	1000MB
Cartridge Drive	44MB

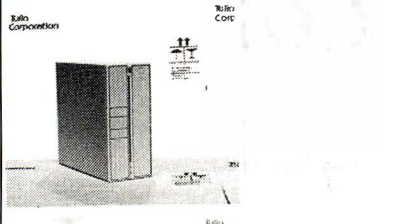

A-Hive Jr.	(7.1"X7.1"X2.2")
	30MB
	65MB
	80MB
	100MB
	120MB
	170MB
	200MB



Hermit Crab	(7.5"X5.5"X1.5")
	20MB
	40MB



Half Shell	(7.5"X5.5"X1.5")
	20MB
	40MB



Tulin Corporation

2156H O'Toole Ave., San Jose, CA 95131

Tel: 408-432-9025

Fax: 408-943-0782

Introduction

C++ / Views™

for Microsoft Windows

An application development framework with the **most complete C++ object class library** for MS Windows 3.0 development.

A powerful object-oriented development environment with the **first fully functional object class Browser for C++**.

A cost-effective productivity tool for the next generation of software. **Order today** at the introductory price of **\$495.00** (plus shipping). **Comes with full source code for over 65 classes - NO Royalties.**

CNS, Inc. - Software Products
7090 Shady Oak Rd., Minneapolis, MN 55344
612-944-0170, Fax 612-944-0923



... providing and advancing
object-oriented methodology.

MUCH MORE SECURE

Reproduced from
advertising in



DISK PACK, THE INDUSTRY STANDARD IN REMOVABLE HARD DISKS.

SECURE

DISK PACK protects confidentiality. Sensitive data? Insecure work environment? Remove the PACK and leave nothing behind. Whatever the application (Defense, Research, Banking), DISK PACK provides the security you need.



FAST AND RELIABLE

DISK PACK's 10 ms access time puts it among the fastest hard disks. A 42 Mb disk is backed-up in only 2 minutes! Use DISK PACK and your work rate will increase for years to come..

COMPATIBLE

DISK PACK is SCSI based and compatible with: Apple, IBM (and clones), DEC or SUN. You can use it with your operating system (MS DOS, XENIX, UNIX) and with your network (NOVELL, 3-COM, APPLESHARE, etc..)

EXPANDABLE

DISK PACK's wide range of capacities (42, 84, 105, 120, 170, 210, 340 Mb) allows your system to grow with your applications. You can swap PACKS on the fly or daisy-chain up to 4 bases (2 Gb on-line).

PORTABLE



DISK PACK's hard disk fits easily in your briefcase. Take it home with you or ship it anywhere!

USER-FRIENDLY

DISK PACK is extremely easy to install and use. It works just like a floppy with hard disk performance.

**FIVE TIMES BETTER
FOR THE SAME PRICE!**

Manufacturer	I.E.F.	IOmega
Product	DISK PACK	Bernoulli Box
Capacity range	42 to 340 Mb	20 or 44 Mb
Access time	10 to 17 ms	32 or 40 ms
Error rate	10 ⁻¹⁴ bit	10 ⁻¹² bit
MTBF (Hours)	50,000	25,000
Max. capacity by module	340 Mb	44 Mb
Max. on-line capacity	2,380 Mb	88 Mb
Compatibility	PC, AT, PS/2, Macintosh DEC, Workstations	PC, AT, PS/2, Macintosh N/A

MASS SYSTEMS INC.
MEMORY
DISK PACK®

The memory you'll never forget™

Disk Pack is manufactured in the USA for Mass Memory Systems by Dictaphone Corp.
 Disk Pack is a registered trademark of I.E.F. All other company and product names are trademarks of the company or manufacturer respectively.
 ©Mass Memory Systems 1990. All rights reserved.

For more information, please fill in and mail to:
Mass Memory Systems, Inc. 1414 Gay Drive Winter Park - FL 32789

Company:
 Name:
 Address:
 City: State: Zip:
 Phone: Fax:

End-user
 VAR
 Dealer
 Distributor

(800)347-5722 (407)629-1081 Fax: (407)628-3862

member function is much lower than the overhead of interacting with a process. The disadvantages of classes are that they do not provide concurrency and it is difficult to share an instance of a class among several processes (i.e., the processes must use some mechanism other than the class to ensure the necessary synchronization).

The advantages of processes are that they allow operations to happen in parallel and they provide mechanisms for mutual exclusion. The disadvantages of processes are that a transaction call is much slower than a member function call, and a process that is called by many clients can become a bottleneck.

We have devised some informal guidelines for selecting the structuring technique for a data abstraction. First, you should get a rough idea of the interface that the clients would like to see: one that is clean and convenient and natural. Then, if it is possible to implement the abstraction as a pure class, do so.

Classes should be used for passive data objects, such as strings, queues, complex numbers, or symbol tables. A key point is that these objects are not shared by several processes, so there is no need for synchronization.

Another point is that once an operation starts, it runs to completion. Thus, if the object is implemented as a process, then that process can only execute when handling a transaction call from a client. There is no performance increase from using processes, because the object process can never execute in parallel with its clients.

When you cannot implement the abstraction purely as a class, then you must use a process. The choice then becomes whether to implement the abstraction as a pure process or as a

process plus an interface class. In other words, should the process be visible to the client of the abstraction, or should it be hidden?

To decide which is best, first determine what kind of interface is needed between the client process and the abstraction (server) process: What transactions are needed, what data is passed and returned, what is the protocol for calling those transactions, how often are they called, and so on.

Design your process interface for efficiency. Keep in mind that transaction calls are relatively slow, so the number of calls should be minimized. If some operations can be done by either the client processes or the server process, then you must decide which will do them. If the client cannot proceed until these operations have completed, then, in general, the client should do them.

If you suspect that the server process could become a bottleneck—for example, if it is shared by many clients—then it is best to have the clients do as much as possible. But if the operations can be done in parallel with the client, and if the server is not a bottleneck, then the server should do them, because this will increase parallelism.

You should compare the interface to the server process with the desired interface for the data abstraction. If they are a good match—if the server-process interface is simple and natural, and you do not expect that it will change—then implement the data abstraction as a pure process. In this case, the process interface becomes the interface of the abstraction.

However, if the interface to the server process is complicated or unnatural, or if you think that the process interface might

UPGRADE
YOUR COMPUTER
TO 386-33 w/ 64 K CACHE
..... \$1,499

No Budget For A New Computer?
Upgrade your existing one for
a fraction of your repair budget.

.....
Price includes:
Motherboard 4 MB RAM Case & Power
.....
486-25 for \$2,899

Hard Drives	CD Drives
200 MB Conner \$875	Panasonic internal
330 MB Maxtore \$1450	5.25 WORM 940 MB
760 MB Maxtore \$1895	\$2,885
Syquest 40 MB \$525	New Systems
Removable cartridge \$85	Available

ABTECH Mini Laptop
w/40 MB \$1,995
Convert your Macintosh into a laptop!!! Call

ABTECH Inc. 1-800-992-1978
1431 N. Potrero Ave. Tel: (818) 575-0007
S. El Monte, CA 91733 Fax: (818) 575-1500

AccSys™ for
dBASE

- Set of C libraries for easy access to dBASE data and index files.
- Source available but not required.
- Increased performance shortens processing time.
- Total control over data memo, MDX and NDX index files.
- Network and single-user versions available.

Copia International Ltd.
1964 Richton Drive, Wheaton, Illinois 60187
708/682-8898 FAX: 708/665-9841
Instant info. via FaxFacts: 708/924-7465 Press: 889832#

Mi-TAC
MiStation 316S
386 SX
Intelligent Terminal
Also a PC!

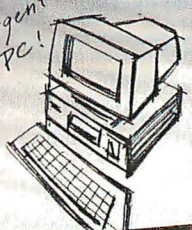

Mi-TAC MPC4000G
High-end Fileserver.
Great Price!



Mi-TAC
MiStation 212
Cost-effective
or-LAN
286 PC
Station.



Connectivity's
Easier with Mi-TAC
Equipment and Support



Link Intelligent
terminals via
Ethernet,
Arcnet
or Token-
ring



Networking is a Simple Concept, Your Network Solution Should Be Too

If you are involved in networking, you know how complicated it is to plan a network, source various vendors' hardware and software, put it together, and make it all work as planned. To help make your task easier, Mi-TAC complements its powerful networking computers with the services of its Connectivity Support Group.

From Mi-TAC's high performance, Novell-certified 33 MHz MPC4000G server to its cost-effective MiStation 316S LAN node, Mi-TAC computer products are designed for networking.

Specifically, Mi-TAC engineers have tested hundreds of software and hardware products in Novell, Banyan, 3Com and even Unix environments. The Connectivity Support Group gives you access to this wealth of experience along with Mi-TAC's recommendations and the advice of its trained technical personnel.

For more information about networking with Mi-TAC products and for a guide to Mi-TAC's complete line of computers, please call American Mi-TAC Corporation at (800) 648-2287 x 348.



In the U.S., please call for the name of your nearest authorized Mi-TAC distributor. (800) 648-2287. Canadian distribution is handled by Technical Logistics Support. (416) 478-1971.

American Mi-TAC Corp. is an affiliate of Mi-TAC International Corp., Taiwan, 30250-0001. All trademarks mentioned are property of their respective holders.

Want to save Time, Money,
& Headaches?



GET SUPERSOFT'S
SERVICE DIAGNOSTICS

All the software, alignment diskettes, parallel/serial wrap-around plugs, ROM POSTs and extensive, professional documentation to provide the most comprehensive testing available for IBM PCs, XTs, ATs and *all compatibles* under DOS or Stand Alone. No other diagnostics offers such in-depth testing on as many different types of equipment by isolating problems to the board and chip level.

NEW: SuperSoft's ROM POST performs the most advanced Power-on-Self-Test available for system boards that are compatible with the IBM ROM BIOS. It works even in circumstances when the Service Diagnostics diskette cannot be loaded.

NEW: 386 diagnostics for hybrids and PS/2s!

For over nine years, major manufacturers have been relying on SuperSoft's diagnostics software to help them and their customers repair microcomputers. End users have been relying on SuperSoft's Diagnostics II for the most thorough hardware error isolation available. Now versions of Service Diagnostics are available to save everyone (including every serious repair technician) time, money, and headaches in fixing their computers, even non-IBM equipment.

All CPUs & Numeric Co-processors	All Color Graphics & Monochrome Monitors
System Expansion & Extended Memory	Parallel & Serial Ports
Floppy, Fixed & Non-standard Disk Drives	Mono, CGA, Hercules & EGA
Standard & Non-standard Printers	Adapters
System Board: DMA, Timers, Interrupt, Real-time Clock & CMOS config. RAM	All Keyboards & the 8042 Controller

"EDITOR'S CHOICE" — PC MAGAZINE August 1990

Service Diagnostics for PC, PC/XT, and compatibles only.....	\$169
Alignment Diskette for PC, PC/XT and compatibles (48 tpi drives).....	\$ 60
Wrap-around Plug for PC, PC/XT and compatibles (parallel and serial).....	\$ 30
Service Diagnostics for AT and compatibles only.....	\$169
Alignment Diskette for AT and compatibles (96 tpi drives).....	\$ 60
Wrap-around Plug for AT (serial).....	\$ 15
ROM POST for PC, PC/XT and compatibles only.....	\$245
ROM POST for AT and compatibles only.....	\$245
Service Diagnostics: The KIT (Includes all of the above—save \$502).	\$495
Service Diagnostics for PS/2 models 25/30 50/60 or 70/80 and compatibles (please specify).....	\$195
Service Diagnostics for 386 or V2, V30, or Harris, etc. (please specify).....	\$195
Diagnostics II is the solution to the service problems of users of all CP/M-80, CP/M-86 and MS-DOS computers.....	\$125
Alignment Diskette for PS/2 and compatibles (3.5 inch).....	\$ 60

To order, call 800-678-3600 or 408-745-0234
FAX 408-745-0231, or write SuperSoft.

your microcomputer repair solution

SuperSoft

FIRST IN SOFTWARE TECHNOLOGY P.O. Box 4178, Mountain View, CA 94040-0178
(408) 745-0234 Telex 270365

SUPERSOFT is a registered trademark of SuperSoft, Inc.; CDC of Control Data Corp.; IBM PC, AT & XT of International Business Machines Corp.; MS-DOS of MicroSoft Corp.; NEC of NEC Information Systems, Inc.; PRIME of PRIME INC.; Sony of Sony Corp.

change, then hide the process interface from the clients by implementing the data abstraction as an interface class and a process. For example, you should use an interface class if some operations can be done by either the client processes or the server process but you do not know which would be better. Design the interface class so that it provides the abstraction that the clients desire. This class converts the client's operations into the appropriate transaction call to the server.

The Benefits

Concurrent C is a tool for writing distributed programs under several versions of the Unix system: System V, BSD 4.2, and NRTX (a stripped-down real-time version of Unix) running on VAX computers, AT&T 3B computers, and Sun workstations, among other uniprocessor machines. The Concurrent C program runs as one Unix process on these implementations; the Concurrent C run-time library provides a scheduler that switches between Concurrent C processes as needed.

Concurrent C has also been implemented on multiprocessor configurations. One is a loosely coupled network of independent computers connected by a LAN (Ethernet), each running the Unix operating system. Here, both the hardware and software are loosely coupled.

Another multiprocessor system, the AT&T 3B4000, also has several Unix processors connected via a bus, but this system looks like one virtual Unix system (e.g., the file system is shared among all processors). In this system, the hardware is loosely coupled, but the operating-system software is tightly coupled.

Another system on which we have Concurrent C is a shared-memory multiprocessor. Here Concurrent C is implemented on top of a real-time multitasking kernel. In this system, both the hardware and the software are tightly coupled.

Concurrent C is being used for such applications as simulation studies, graphics, image analysis, and network protocol experiments, and for a network file server that has an optical disk "jukebox." The file server is completely written in Concurrent C, including the disk drivers and interrupt handlers, and has been in production use since January 1989.

That file server has 30 processes of 20 distinct types and takes only about 20,000 lines of code. Even at that, more than half the code is in the drivers for the optical disks and for the jukebox robot that moves disks in and out of drives. As you can see, it is an efficient language for this kind of application.

In a large Concurrent C program, such as the optical disk driver, most of the code is ordinary sequential C, with a small amount of Concurrent C code used as "glue logic" to let the processes communicate. The advantage of Concurrent C is that it lets the programmer transform a large concurrent programming problem into a series of small sequential programming problems that can be solved independently.

AT&T recently announced the availability of Concurrent C to the general public. The Concurrent C translator and run-time source code are available from AT&T to both academic and commercial users. For more information on the translator, please call (800) 828-8649. For more information on the language, see the book *The Concurrent C Programming Language* by Gehani and Roome (Summit, NJ: Silicon Press, 1989). ■

Narain H. Gehani and William D. Roome are members of AT&T Bell Labs' technical staff. Both have doctorates in computer science from Cornell University and have worked on building operating systems, file servers, and languages. They can be reached on BIX c/o "editors."



A Complete 386-33 MHz Cache System For Under \$2,000.



Finally, you can afford to put the fastest 386™ computer at your fingertips to enjoy the performance that once only belonged to the ranks of File Servers, Multi-user host Computers and CAD/CAM/CAE Workstations.

Other manufactures with their simple-minded direct-mapped Cache architectures were obsessed with churing out the best benchmark numbers. We, however, were not convinced DOS and Power Meter 1.3 is any example of a typical real life application (registering at 8.003 MIPS, we are not too shabby either). With Two-Way Set Associative Cache capability, our 386™ is also more attuned to run the emerging multi-tasking operating systems like OS/2® and UNIX™, where modular code

sizes (of less than 32K) and frequent code-switching are norms. Worrying about compatibility? Both IBM® and COMPAQ® endorsed the same INTEL® 82385 Cache Controller. Furthermore, we enhanced it with page-mode and interleaved memory in the event of a cache miss. It is the closest to a true 0-wait-state implementation on the market.

Nobody does it better, Nobody!

MIS 386™-33MHz STANDARD

- 1MB 80NS RAM
- 32K 25NS SRAM CACHE
- INTEL®/WEITEK® MATH CO-PROCESSOR SOCKET
- TEAC® 5.25" 1.2MB FLOPPY DRIVE
- TEAC® 3.5" 1.44MB FLOPPY DRIVE
- 43MB 28MS AT HARD DISK DRIVE
- 2 SERIAL, 1 PARALLEL AND 1 GAME PORTS
- MGP ADAPTER
- SAMSUNG® 12" AMBER MONITOR
- MICROSOFT® COMPATIBLE SERIAL MOUSE
- NMB® 101-KEY ENHANCED KEYBOARD
- DESKTOP CASE WITH FIVE DRIVE BAYS
- 220W POWER SUPPLY
- ONE YEAR PARTS AND LABOR WARRANTY
- 30-DAY MONEY BACK GUARANTEE

\$1,995

386-25MHz STANDARD System w/ 32K Cache	\$1,845
386-25MHz STANDARD System (Non-Cache)	\$1,595
386SX-16MHz STANDARD System	\$1,145
286-12MHz STANDARD System	\$ 945
486-25MHz STANDARD System w/ 64K Ext. Cache	\$3,795

VGA (640x480) Upgrade	Add	\$ 360
P-VGA (1024x768) Upgrade	Add	\$ 500
80MB/212MB Hard Drive Upgrade	Add	\$250/750
4MB RAM Upgrade	Add	\$ 300
64K Cache Upgrade (386-25/33 MHz)	Add	\$ 120
Vertical Case	Add	\$ 150
Mini Vertical Case	Add	\$ 75
CALL FOR ADDITIONAL UPGRADE OPTIONS		

MIS Computer Systems

P.O. Box 70897 Sunnyvale, CA 94086-0897

Order Now

1-800-733-9188

Office Hours: M-F 9:00 am-6:00 pm Pacific Time



Prices and terms are subject to change without notice. 30 days money back does not include shipping charge. CA residents add appropriate sales tax. No surcharge on credit card purchases. Personal and company checks require 2 wks clearance. All names mentioned are registered trademarks of their respective companies.

Circle 186 on Reader Service Card

KnowledgePro®

... a world beyond ToolBook?



ROBERT
TINNEY

The press decide...

PC WEEK July 16, 1990... "KPWIN is more responsive than ToolBook ... fully exploits the Windows environment ... the result is extraordinary development productivity."

PC MAGAZINE October 30, 1990...

"KnowledgePro's support for Windows objects is much richer than ToolBook's... doesn't suffer from the speed or bitmap size problems that ToolBook does..."

INFOWORLD October 1, 1990... "KPWIN runs faster than ToolBook ... so easy you'll think you've forgotten something. ...

In the same class as Next Step and far above the clunkier competition..."



YOU decide...

If you buy **KPWIN** and choose to send it back within 60 days we'll refund your money.

KnowledgePro Windows (**KPWIN**) is fast and doesn't limit you to single windows with 64k boundaries. Interactive tools get you started and a rich **OOP** language gives you the control you need for serious applications. **Hypertext** and **hypermedia** give your applications depth and built-in **expert systems** technology lets you create **smart** programs. Links to the outside world are easy with **DDE** and **DLL's**.

KPWIN costs \$695 with no runtime fees for applications, Amex, Visa, M/C and COD accepted. Dealers welcome.

To order call **518-766-3000**

FAX 518-766-3003 or write to:

Knowledge Garden
473A Malden Bridge Rd.
Nassau, NY 12123, U.S.A.



STRENGTH (AND SAFETY) IN NUMBERS

*RAID, a new disk storage technology,
offers PCs higher performance and reliability*

Michael H. Anderson

An old adage says, "The difference between a computer and a supercomputer is the difference between a CPU bottleneck and an I/O bottleneck." As desktop computers move into the double-digit million-instructions-per-second range, I/O bottleneck is quickly becoming a reality.

Look at current technology. The newest generation of intelligent disk drives offers much higher performance than its predecessors. The data rates for 5¼-inch hard disk drives have reached 3 megabytes per second. Intelligent embedded controllers use sophisticated techniques to improve speed. SCSI controllers transfer data to host systems at speeds of up to 5 MB per second. Caching algorithms used by these drives maximize the use of on-board caches (from 64K to 256K bytes in size) with techniques that can double transaction rates.

Still, these performance improvements pale in comparison to advances in CPU technology. When benchmarks are run on new high-performance PCs, they often show a 30-to-1 performance increase (or better) over the standard IBM PC. In contrast, disk drive performance shows an increase of only 10 to 1 over the original 10-MB XT hard disk drive. This difference indicates that present systems achieve only one-third the relative performance

from their disk I/O subsystem as the original IBM PC.

Performance benchmarks confirm this lopsided increase in relative performance. Figure 1 shows how the percentage of time devoted to disk I/O increases as the CPU speed increases.

Then there's reliability. Top-quality disk drives, in general, offer a *mean time between failures (MTBF)* of about 150,000 hours. Although this sounds like a lifetime, an installation with top-quality disk drives will experience a failure rate of about 6 percent per year. A system with 16 disk drives would experience a failure about once a year. For many installations, this failure rate would not be acceptable.

Network systems like Novell NetWare address the requirement for high data availability by using a technique called *mirroring*. This host device driver technique writes data to two disk drives simultaneously. If one drive fails, a copy of all the data is immediately available on the other drive. Data availability is ensured unless the second device fails before the first device is replaced, a very unlikely event. Mirroring is a good solution to data availability, but it requires users to purchase twice as much storage as they need to hold their data and programs.

RAID, a Better Solution

A better solution was described in a paper by David A. Patterson, Garth Gibson,

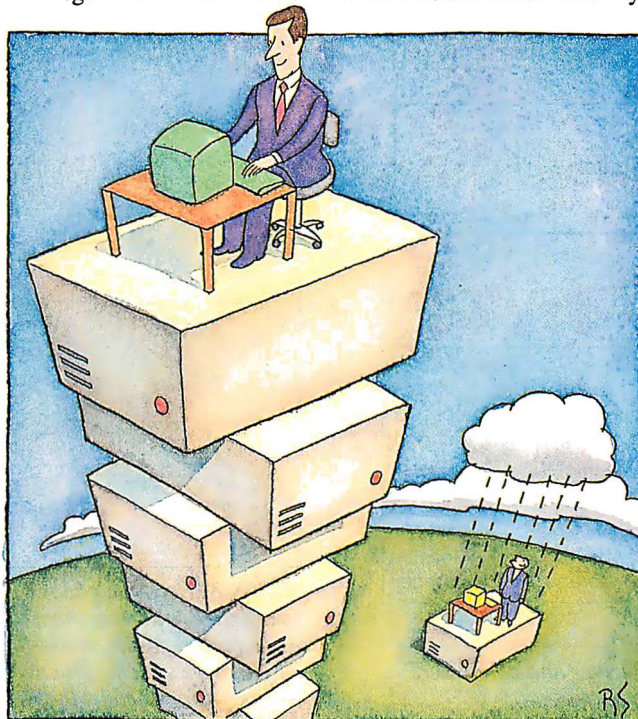

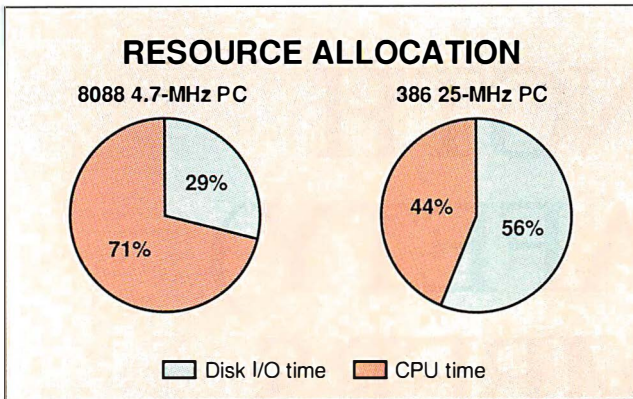

Figure 1: As CPU speed increases, the percentage of time that programs wait for disk I/O to complete increases proportionately.

and Randy H. Katz of the University of California at Berkeley, entitled "A Case for Redundant Arrays of Inexpensive Disks, or RAID" (Report No. UCB/CSD 87/391, December 1987).

A RAID system is a group of disk drives under the control of a single device driver. By grouping several drives together into a single subsystem and using clever techniques to arrange the data, a RAID offers much higher performance than single disk drives. You can build a RAID system from several types of disk drives, among them SCSI, which is an inexpensive approach commonly used by several vendors (see figure 2).

Figure 3 shows how data can be "striped" (i.e., a process of interleaving data blocks) across several drives so they can all work together. Since each drive transfers data in parallel with the others (multiplying the data rate), a four-drive RAID system can complete large read requests in one-fourth the time of a traditional system that puts all the data on a single disk.

Another benefit of a RAID is the rate at which small trans-

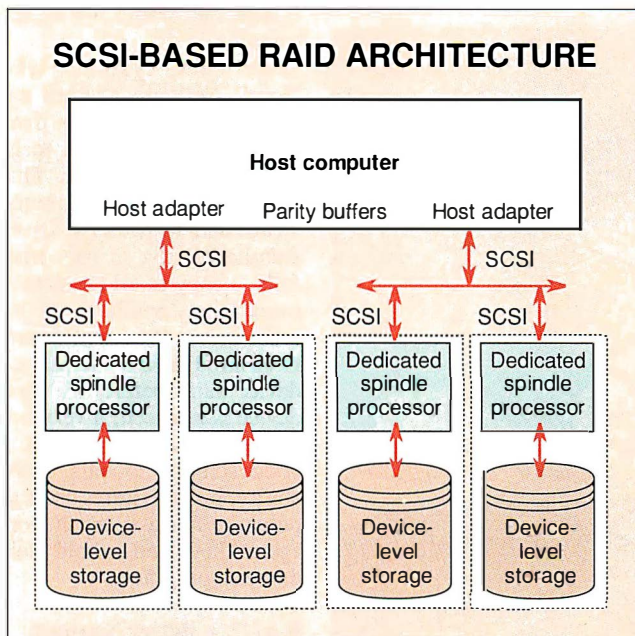

Figure 2: PCs can use SCSI disk drives and controllers to provide RAID storage at low cost.

fers can be satisfied. Since data from a single file is spread over multiple disk drives, each disk drive can satisfy a small read at the same time. A RAID can independently position each disk drive (multiplying the transaction rate) allowing a four-drive RAID to satisfy four times as many small read requests as a traditional disk drive. This high transaction rate is especially important to users of network servers.

The final benefit of a RAID is its ability to withstand the failure of any single disk drive. By storing "check bytes," the RAID can reconstruct data from the remaining drives, should any single drive fail. A check byte is a byte that holds the "sum" of the data stored on the other drives (in the same position).

Using check bytes takes up an amount of storage equivalent to the total capacity of a disk drive. Nevertheless, a check-byte system provides fail-safe operation at a much lower cost than a mirror system. While a mirror system uses half the drives in a group for fail-safe operation, a RAID system uses the storage equivalent of only one drive. Thus, larger RAID systems have proportionately lower overhead.

This difference is transparent to the host computer. All that has changed is that data transfers are performed faster and the host can continue to operate even if one disk drive completely fails. A RAID can use off-the-shelf disk drives. All the logic to arrange the data and provide high performance can be contained in a software driver.

Building a RAID

To understand how to build an effective RAID, take a look at how existing disks interface to PCs. Older device-level interfaces, such as ST506 and ESDI, did not allow more than one disk drive to be active at the same time. In addition, most older controller boards used a technique called *programmed input/output*. PIO is a software technique that uses the IN instruction, which requires the CPU to transfer data from the controller board to memory.

Newer "buffered" interfaces, such as SCSI, allow up to

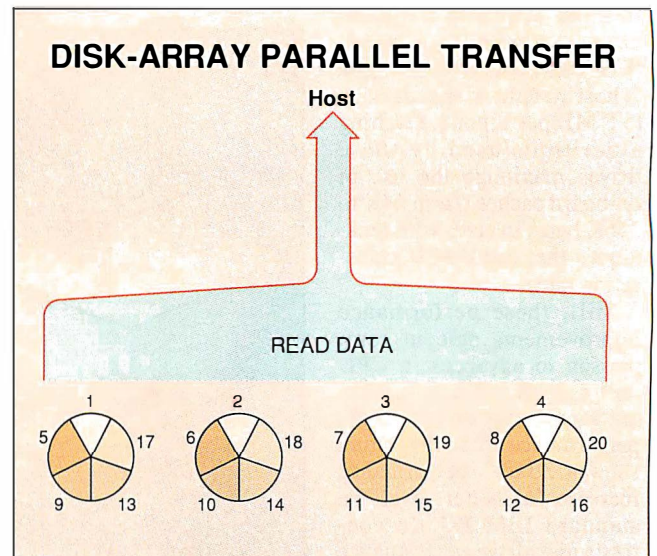

Figure 3: Here you can see how data can be striped across four drives, allowing them to work in parallel and complete large read requests in one-fourth the time of a traditional single-drive system. The numbers represent the logical block number as defined by the RAID device driver.

seven disk drives on a single bus to simultaneously stage data in high-speed memory. Also, many SCSI controller boards use a technique called *first-party DMA*. This is a hardware technique, defined by the AT bus, that does not require the CPU to transfer data.

In addition, first-party DMA uses only half as many cycles as PIO to read or write data, thus transferring twice the data in the same amount of time. Since the CPU is not involved in transferring data, multiple boards can work together to increase performance even more. Combined, these techniques can be applied to realize a twofold to 20-fold increase in disk subsystem performance.

Now I'll explain how you can generate check bytes and use them to provide fail-safe operation. Suppose you have three storage devices, each of which can hold 1 byte (8 bits) of data. Two devices will hold all the data that you wish to retrieve. The third device will hold a check byte generated by an arithmetic function called exclusive OR (XOR).

If device 1 holds the value 00110000, and device 2 holds the value 00000011, then the check byte stored in device 3 is generated by performing an XOR on these two values together, giving 00110011.

By storing this check byte in the third device, you can reconstruct the data of any of the three devices by examining the value of the other two (see table 1). This technique works for devices of any size, whether they hold a single byte or a billion bytes. Also, it works in systems with three devices or 300 devices.

This fail-safe feature is attractive to mission-critical systems. Even if one disk drive in the set fails, the RAID system can continue operating. However, the failed drive should be replaced right away. If a RAID system is properly maintained, it is likely to keep data on-line and available longer than the useful life of the host system.

How much does having this kind of data availability cost? Because of the high speed of current CPUs, check bytes can be generated rapidly without requiring any additional hardware. A typical 25-MHz Intel 386 can generate check bytes at the rate of 8 MB per second by using its powerful 32-bit instruction set. Higher-speed processors, like the i486, can generate check bytes even faster.

Layout of Check Bytes

So far, I've shown how a RAID offers high performance by striping data, and how data availability is improved by using the XOR function to generate check bytes and to reconstruct the data of a failed drive. To complete the analysis, here's how to manage the data on your disk drives to attain the most efficient operation.

To keep your check bytes current, they must be modified each time you write data to any drive. If you choose to store all the check bytes on a single disk drive, you could create a bottleneck, slowing overall performance of your RAID system.

To avoid this problem, it is more efficient if you store some data and some check-byte information on each drive (as shown in table 2). Spreading the check bytes over several drives allows multiple simultaneous writes. In a four-drive RAID, this technique offers double the small-block-write performance of a system with all the check bytes on a single drive. As the number of drives increases, the performance increases proportionately.

RAID Performance Measurements

Measurements of prototype systems show that the RAID architecture can sustain data transfer rates of over 13 MBps on Extended Industry Standard Architecture and Micro Channel ar-

RECONSTRUCTING DATA FOR A FAILED DRIVE

Table 1: Check bytes help multiple-drive systems provide fail-safe operation. The figures here represent three imaginary disk drives, each of which holds just 1 byte (8 bits) of data. By performing an XOR on the values on drives 1 and 2 (top), you generate a check byte, to be stored on drive 3. In the event that a drive fails (in this case, drive 1) you can reconstruct its data by performing an XOR on the check byte from drive 3 with the data from drive 2 (bottom).

	00110000	Drive 1	(Data drive)
XOR	00000011	Drive 2	(Data drive)
	00110011	Drive 3	(Check drive)
	00000011	Drive 2	(Data drive)
XOR	00110011	Drive 3	(Check drive)
	00110000	Drive 1	(Data drive)

EFFICIENT RAID SUBSYSTEM DATA LAYOUT

Table 2: Storing all the check bytes on a single disk drive can create a bottleneck. Spreading the check bytes over several drives allows multiple simultaneous writes to occur. Here, four drives store 12 blocks of data and the check bytes necessary to ensure the integrity of the data. As the number of drives increases, the performance increases proportionately.

	Drive 1	Drive 2	Drive 3	Drive 4
Adr 1	Block 1	Block 2	Block 3	CB (1-2-3)
Adr 2	Block 5	Block 6	CB (4-5-6)	Block 4
Adr 3	Block 9	CB (7-8-9)	Block 7	Block 8
Adr 4	CB (10-11-12)	Block 10	Block 11	Block 12

chitecture systems. Transaction rates of 250 to 300 I/Os per second can be sustained under heavy load conditions. RAID systems can offer a 10-fold performance improvement over current disk I/O subsystems.

Many major computer suppliers already use SCSI disk storage devices and controller cards. These suppliers include IBM, Hewlett-Packard, Digital Equipment, AST Research, Wang, Sun Microsystems, and many others. The RAID architecture can be implemented as a device driver on any operating system in software. A large installed base already exists that could exploit the potential of RAID systems.

The cost, performance, and data-availability features offered by the RAID architecture are so attractive that there is little doubt a new generation of I/O subsystems will become available in the near future. As this technology emerges, you may notice that the incessant "blinkety blink" of your disk drive LED will fade to just a flicker. ■

Michael H. Anderson is director of subsystem engineering at Micropolis Corp. (Chatsworth, CA), a manufacturer of 5¼-inch hard disk drives. Previously, he designed large, fault-tolerant caching controllers and performance-analysis tools for IBM, CDC, and Unisys mainframe systems. You can reach him on BIX c/o "editors."

WE'D LIKE TO SUGGEST A FEW NEW CRITERIA FOR CHOOSING FORMS SOFTWARE.

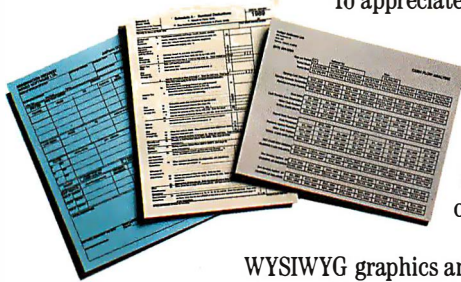

To appreciate the benefits of JetForm™ software, we invite you to first examine the subject of business forms themselves. And why every business has so many.

It's because forms are the proven way to gather information. Communicate it. Store it, and process it. Which is precisely the point of view from which JetForm was developed.

Naturally, JetForm gives you complete WYSIWYG graphics and font control, using the industry standard Microsoft® Windows interface.

But we also give you something else. And that's a set of capabilities that turns forms software from a handy way to replace pre-printed forms into a powerful way to run a business.

Which is why you'll find JetForm prints faster on the laser printers that businesses use most.

And connects more effectively to networks. So both forms and the information they contain can be better shared and communicated - across departments, or entire organizations. And not just with IBM® PCs, but with HP®3000s, HP9000s, DEC® VAXs™ and UNIX® machines.



Combined with our optional JetForm-Merge and JetForm-Server software, JetForm makes it possible to completely automate and streamline the entire information management process. From design and forms completion, to printing and integration with your existing dBASE® files.

As years pass, other software makers may discover the true purpose of business forms, and upgrade their products to the capabilities of JetForm. But JetForm has them today. And a new business day starts tomorrow.

Call 800-267-9976 for complete information on the full family of JetForm forms software.

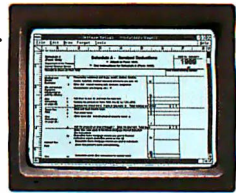

THEY'RE MORE THAN JUST FORMS. THEY'RE YOUR BUSINESS.

SPEED

Find out how fast it prints on HP LaserJet® printers, and the new IBM LaserPrinter 4019. You'll find JetForm is three times faster than others.

RANGE

How well does it work in a network? Sending forms around the office is one thing. Managing information throughout your organization, across multiple platforms, is quite another.

CAPACITY

Will it handle all your forms needs? Including complex policies and contracts, as well as bar code labels? Will it handle them in the volume you'll need as your forms applications grow?

CONTROL

Just because it "links" to your database doesn't mean it takes full advantage of database links. JetForm verifies data, performs calculations, and fully reads and writes dBASE files.

DESIGN

Make sure you get a full set of flexible, easy to use, WYSIWYG design tools tailored to forms design. After all, this isn't desktop publishing. It's information management.



Call (800) 267-9976 (US only) or (613) 594-3026. Indigo Software Ltd., 560 Rochester Street, Suite 400, Ottawa, Canada K1S 5K2

© 1990 Indigo Software Ltd. JetForm is a trademark of Indigo Software Ltd. All company and product names are trademarks or registered trademarks of their respective owners.

Circle 142 on Reader Service Card (RESELLERS: 143)

X.400: STANDARDIZING E-MAIL

*An OSI protocol brings new life
to E-mail*

Steven J. Vaughan-Nichols

For many years, E-mail has not lived up to its promise. Early data communications prophets hailed E-mail as the next revolution in communications. It hasn't worked out that way. Instead, fax machines have become the mainstay of modern office communications. Messaging has been around a long time: Fax is a technology with its roots in the nineteenth century, and couriers date back to the runner bearing the results of the battle of Marathon to Athens.

In today's business world, where faster is always better, E-mail, which is unparalleled in speed, would seem to be the perfect mode of communication. However, few businesspeople and PC users have bought into this line of thinking. There are a number of reasons why.

E-mail requires users to do more than merely insert a document into a fax machine. And, more important, until recently E-mail systems were proprietary, closed systems—each an island unto itself. You could send messages from one isle to another, but it required telecommunications wizards to keep these links and their gateways working.

Each E-mail system was developing on its own path, and each evolutionary step meant that communications between networks needed constant adjustment. Even when the connections worked

well, they required users to do a lot.

Every E-mail system has its own addressing scheme. To send messages to people at their ARPANET mailboxes, for instance, you had to use a totally different address format than if you were mailing a note to someone on MCI Mail. The result was that E-mail faltered from lack of public acceptance. X.400 may be the answer to this problem.

X.400 may sound like the name of the Air Force's newest stealth fighter, but it's really a telecommunications standard that lets E-mail users send messages to users on different

E-mail systems. This rapidly growing telecommunications addressing standard is making E-mail an attractive alternative to fax and overnight mail services.

X.400 provides a single addressing scheme that works on every E-mail system. No longer do users have to remember whether an address has to include an exclamation mark, a slash, an at symbol, or some combination thereof.

The X.400 Standard's Family

X.400 is a CCITT standard that defines how an intersystem mail message is addressed. Working X.400 systems include not only an addressing standard but also a host of other CCITT standards. Among them are X.401, which describes the basic intersystem service ele-

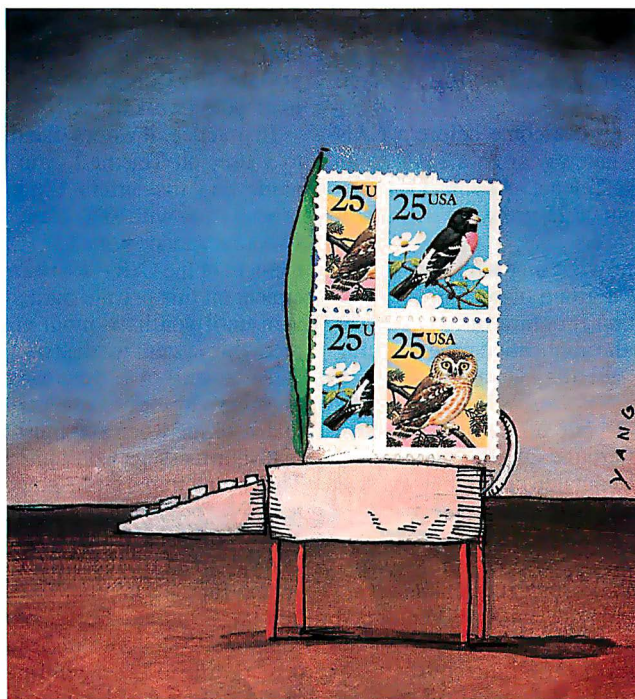

Where once
*you could easily reach only
 subscribers to your own system,
 X.400's new addressing scheme
 allows you to reach out to E-mail
 users on all the major systems.*

ments, and X.411, which defines message-transfer protocols.

The most important member of the X.400 family, though, is probably X.410, which defines mail-handling protocols. Specifically, X.410 is concerned with how standard Open Systems Interconnection protocols work to support E-mail applications. True E-mail connectivity is possible when you bring E-mail systems into accordance with OSI protocols—the backbone of network standardization. The first mature product from the topmost OSI applications layer is X.400.

Like any other new standard, X.400 has had its share of teething problems. A prime example is that you can't reliably send binary files or Group 3 faxes (today's most popular high-speed fax standard) from one network to another. The ability to do so is part of X.400, but real-world implementation has been spotty.

As X.400 becomes the international standard for E-mail, many systems are introducing foreign E-mail connections. U.S. Sprint, with its established base of systems using its Telemail software, leads the way in this area.

Telemail private mail domains, however, may not have access to all external systems. This situation is not the result of a technical problem. Rather, administrators of these networks have decided not to activate connections with all possible E-mail domains. Some IBM proprietary E-mail systems, though, have X.400 gateways to Telemail.

There are other difficulties to be overcome before a LAN E-mail system can use X.400. A gateway from a LAN to an X.25 packet-switching network like Telenet or Tymnet is a necessary part of an X.400 system, but X.25 gateways still aren't commonplace.

Many E-mail manufacturers are wrestling with how to implement and test X.400. In 1989, a group of vendors successfully founded the X.400 Application Program Interface Association. APIA's goal is to develop the application programming interface between LAN E-mail systems, wide-area-network E-mail systems, gateways, and X.25 networks. Now, products using the X.400 API can connect your office's mail system (whether it be LAN-based or built around Digital Equipment's All-in-One system on a VAX) to the outside world, but you still can't simply plug in a black box and go.

So Why X.400?

The advantages of X.400 outweigh the disadvantages, however. From a system administrator's standpoint, an X.400-equipped E-mail network can easily transfer messages to another X.400 system without any of the headaches of earlier methods.

New communications connections to foreign E-mail systems

can take only a few days (and considerably less sweat) instead of months to implement. Tracking down why a message hasn't been delivered is also much simpler. In transfers between non-X.400 systems, though, it can be impossible to figure out the fate of a mislaid message.

For users, X.400 provides several clear advantages. The first is that they won't have to contend anymore with a dozen different, confusing addressing schemes filled with @ and % signs. But the most dramatic advantage that X.400 brings to the E-mail universe is that its standardized addressing makes contacting other systems' subscribers almost as easy as calling Frank next door. The number of people you can reach by E-mail has expanded enormously.

Where once you could easily reach only those on your own system, the new addressing scheme allows you to reach out to E-mail users on all the major systems, such as U.S. Sprint's Telemail and MCI Mail. With this ease of connectivity, E-mail visionaries with multiple mailboxes will be able to close down all but one of their network addresses.

Elementary, Mr. Watson

X.400 addressing is a straightforward process. The E-mail system administrator assigns a unique originator/recipient name to every user. The format for the O/R is "keyword:value, keyword:value." Each keyword represents an address element. More than 10 address combinations are possible, but most E-mail systems use far fewer for most O/Rs.

Every address contains some common elements. For instance, all X.400 addresses include an ADMD—Administrative Management Domain. An ADMD is a public mail system (such as MCI Mail, AT&T Mail, or Telemail) that serves as a message-transfer system. Private mail domains, or PRMDs, such as Goddard Space Flight Center (GSFC), NASA mail systems (NASAMail), or a LAN E-mail system, can be attached to public networks like Telemail or MCI Mail.

Individuals are uniquely identified in their home mail system by a user name, user number, or a combination of first name and surname. Each keyword must be assigned a value. So, for example, a NASAMail user O/R would look like this: ADMD:Telemail, PRMD:NASAMail, FN:John, SN:Doe. The exact order in which the keywords and values are listed is unimportant. SN:Doe, FN:John, PRMD:NASAMail, ADMD:Telemail would work as well.

In practice, it works like this: To send a note from MCI Mail to a user on Telemail, you would type in the receiver's last name and the letters EMS in parentheses. MCI Mail then prompts you with EMS. Here, you key in the ADMD name. The system responds with MBX:. At this point, you type in a single element of the O/R—for example, PRMD:NASAMail, for a recipient on this private mail system. You would continue in this vein until you have input enough pieces into the O/R for the receiving system to identify the addressee.

To be sure of getting a message to someone, however, you must have his or her exact electronic address. It is still difficult to determine when you must use an elaborate address to ensure that your message won't just disappear into the electronic haze. That is one important element of E-mail that has yet to be perfected before it can offer effortless, universal communication. X.500 will solve this problem, but it is still a few years away.

As defined by the CCITT, X.500 is a directory assistance system for the computer age. X.500 database systems will contain the E-mail addresses of all users with accounts in X.400-compliant systems around the world. This global directory may take a while to appear in final form. By 1992, though, enough of the system will be up to empower X.400 communications.

continued

In college, you would have killed for MathCAD. So why aren't you calculating with it now?

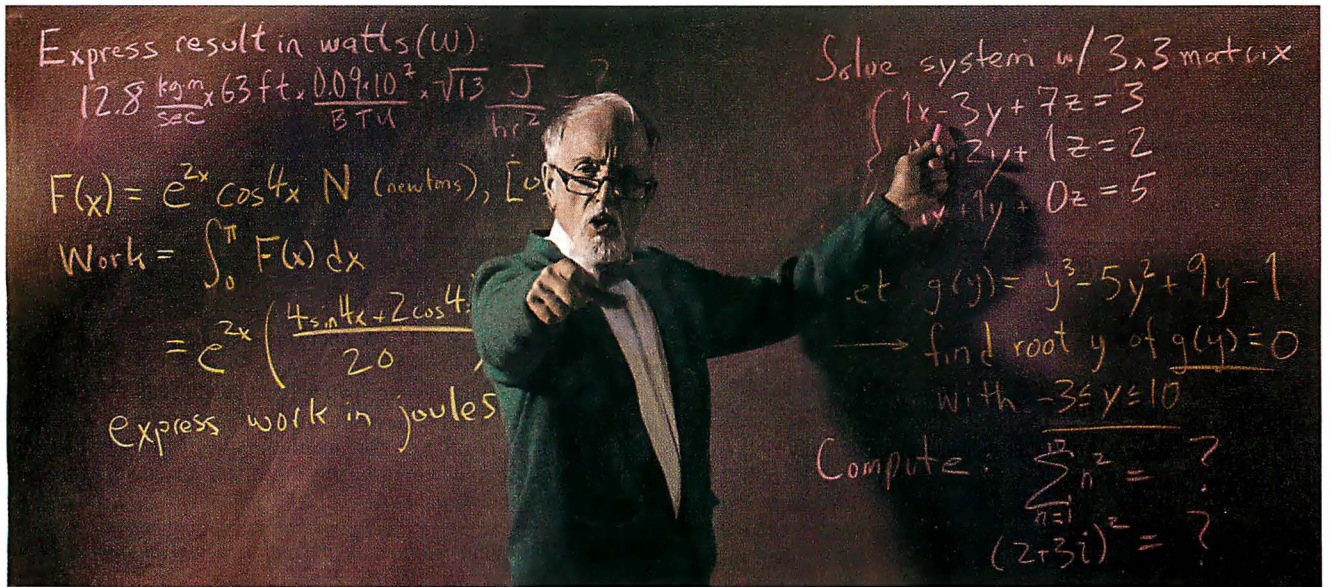

100,000 engineers and scientists already let MathCAD do their calculations for them.

Now that college is far behind you, perhaps it's time you graduated from spreadsheets, calculators and programming.

Because in today's working world of engineering and science, there's no time for anything less than MathCAD. The software that lets you perform engineering and scientific calculations in a way that's faster, more natural, and less error-prone than any calculator, spreadsheet, or program you could

write yourself.

Thanks to MathCAD's live document interface™, you can enter equations anywhere on the screen, add text to support your work, and graph the results.



March 14, 1989 issue.
 Best of '88
 Best of '87

It also comes complete with over 120 commonly used functions built right in. Perfect for creating complex equations and

formulas, as well as exponentials, differentials, cubic splines, FFTs and matrices.

You get three-dimensional plotting, vivid graphing, and the ability to import HPGL files from most popular CAD programs, including AutoCAD®.

Done calculating? MathCAD prints *all* your analyses in presentation-quality documents, even on PostScript® compatible printers.

All of which has made MathCAD far and away the best-selling math software in the world. In fact, it's used by over 100,000 engineers and scientists — just like you.

There's MathCAD for the PC. MathCAD for the Mac, written to

take full advantage of the Macintosh® interface. And a Unix® version that utilizes the speed and unlimited memory of your Unix workstation.

We also have Applications Packs for Advanced Math, Statistics, Mechanical, Chemical, and Electrical Engineering. Each is a collection of adaptable mathematical models, designed to let you start solving your real world problems right away.

For a free MathCAD demo disk, or upgrade information, dial 1-800-MATHCAD (in MA, 617-577-1017). Or see your software dealer.

Available for IBM® compatibles, Macintosh computers, and Unix workstations. TM and ® signify manufacturer's trademark or registered trademark, respectively.

1-800-MATHCAD

MathCAD®

MathSoft, Inc., 201 Broadway, Cambridge, MA 02139

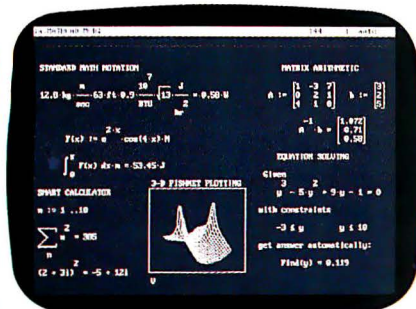

MathCAD 2.5 includes 3-D plotting, HPGL sketch import, and PostScript output.

MAJOR U.S. E-MAIL VENDOR X.400 CONNECTIONS

More connections are being made between E-mail carriers every day. On-line services such as CompuServe are also working on implementing X.400. Telemail private mail domains may not have access to all systems.

E-mail service	AT&T	IBM	MCI	U.S. Sprint (Telemail)	Telecom Canada	Tymnet	Western Union
AT&T			X	X	X	X	X
IBM	X		X	X			X
MCI	X	X		X		X	X
U.S. Sprint (Telemail)	X	X	X				X
Telecom Canada	X						
Tymnet	X		X				
Western Union		X	X		X		

X = Presence of an existing X.400 link between the two systems.

This super phone book will remove X.400's last technical problem.

End of Message

There is one other business consideration that may delay the day when X.400 becomes the be-all and end-all in E-mail: billing—who gets billed, why, when, and how. With dozens of proprietary and open E-mail systems stretching around the world, it's not easy to agree on this matter. Progress has been made, though, and X.400 connections are either in existence or being completed among all major E-mail systems. See the table for

current status of X.400 connections between major E-mail vendors.

X.400 has been a slow-growing force. Although the technical and administrative groundwork has taken years to complete, the first fruits are now available. With the maturity of X.400, E-mail may become the dominant force in business communications. ■

Steven J. Vaughan-Nichols is a freelance writer and a programmer/analyst for Bendix Field Engineering Corp. (Seabrook, MD). He can be reached on BIX as "sjvn."

PC Compatible
Single Board Computers
for the OEM
 DR DOS® Now Available

Quark®/PC +

- NEC V-40® Processor
- Video/LCD Controller
- 8 or 10 MHz Frequency
- Up to 768K Memory

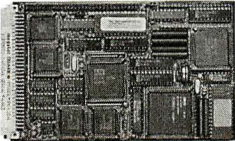

4" x 6"

Quark®/PC II

- 80386 SX based
- EGA® Video/Color LCD Controller
- SCSI Hard Disk Control
- Floppy Disk Control
- Up to 4 Mbytes Memory



4" x 6"

To order or enquire call us today.
Megatel Computer Corporation
 (416) 245-2953 FAX (416) 245-6505
 125 Wendell Ave., Weston, Ontario M9N 3K9

REPS: Italy 39 331 256 524 Austria 43 222 587 6475
 W. Germany 49 6074 98031 Finland 358 0757 1711
 U.K. 44 959 71011 Sweden 46 4097 1090
 Netherlands 31 838 541 301 Norway 47 986 9970
 Australia 61 03 568 0988 Denmark 45 244 0488
 France 1 47 46 94 52

Trademarks: Quark - F. + K. Manufacturing Co.
 DRDOS - Digital Research Ltd. EGA - IBM Corp. V-40 - NEC Corp.

megatel

"Parlez-vous Q-TEL™?"



Oui...Si...Ja...now the answer is Yes wherever you go internationally—thanks to our new Q-TEL International database. Domestically, you've seen how our Q-TEL databases bring you the most current and accurate rate and tariff information. Now Q-TEL International database brings it to you *worldwide*. It has the same superior performance packaging, and easily adapts to your applications.



If you're speaking bottom line savings, parlez with CCMI today.
 Call 1-800-526-5307 ext.: 290.
 Ask for our new and expanded catalog!

CCMI First-Rate Information



BYTE...The Perfect Gift

Reward the computer enthusiasts on your gift list with a year's subscription to BYTE — the definitive guide to personal computing.

Each gift will include 12 issues, plus a bonus issue dedicated to IBM PC's. Your first gift will cost only \$22.95 with additional gifts costing even less; only \$19.95 each — both great money saving rates when you consider that one year of BYTE purchased at the newsstand would cost \$42! (Canada: first gift C\$33.95, additional gifts C\$29.95 each.)

Don't get caught in the holiday rush, send us your gift list today or call 1-800-257-9402 and we'll do the rest. For Canadian orders, call 609-426-5535.



YES! I want to send gift subscriptions to the following people and save money off the newsstand price!

TO: (1st Gift — \$22.95; Canada C\$33.95)

Name _____

Address _____

City/State/Zip _____

(Each additional gift — \$19.95; Canada \$29.95 each)

Name _____

Address _____

City/State/Zip _____

Name _____

Address _____

City/State/Zip _____

Name _____

Address _____

City/State/Zip _____

FREE BONUS — A gift announcement will be sent in your name to the recipient.

FROM:

Name _____

Address _____

City/State/Zip _____

Payment enclosed* Bill me

Charge to: VISA MasterCard AMEX

Acct. # _____

Exp. Date _____

Signature _____

*Please send this order card with payment in an envelope to: P.O. Box 550, Hightstown, NJ 08520-9893

Please allow 6-8 weeks for processing.



BYTE...The Perfect Gift

Reward the computer enthusiasts on your gift list with a year's subscription to BYTE — the definitive guide to personal computing.

Each gift will include 12 issues, plus a bonus issue dedicated to IBM PC's. Your first gift will cost only \$22.95 with additional gifts costing even less; only \$19.95 each — both great money saving rates when you consider that one year of BYTE purchased at the newsstand would cost \$42! (Canada: first gift C\$33.95, additional gifts C\$29.95 each.)

Don't get caught in the holiday rush, send us your gift list today or call 1-800-257-9402 and we'll do the rest. For Canadian orders, call 609-426-5535.

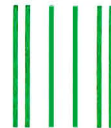

No Postage
Necessary
If Mailed
In the
United States

BUSINESS REPLY MAIL

First Class Mail Permit No. 42 Hightstown, NJ

Postage Will Be Paid By Addressee

BYTE

Computers and Communications Information Group
P.O. Box 550
Hightstown, NJ 08520-9886



UNIX WITH A MICROSCOPE

*Minix isn't for everyone,
but it's a great low-cost Unix to study*

Tom Yager

PART Five

Imagine the benefits of writing your own operating system. You would know where everything was and just how everything worked. If anything stopped working, you'd merely make some changes to the source code and recompile.

Universities have long enjoyed this type of arrangement with Unix. Although the University of California at Berkeley is most renowned for its Unix work, many institutions have Unix source licenses and use Unix code as the subject of study. Those of us *not* involved in the educational system, however, have a tougher time of it. A Unix source license costs thousands of dollars, well out of the reach of most individuals.

A few years ago, Andrew Tanenbaum changed the face of computer education with his book *Operating Systems: Design and Implementation* (Prentice-Hall, 1987). The book describes a Unix-like operating system, Minix, and includes pages of source code and lucid discussions of operating-system concepts. I thought it was the best book on operating systems I'd ever read. Back then, you could send \$79 to Prentice-Hall, and it would send you the disks for the Minix operating system, *with full source code*. What's more, Minix required only an ordinary PC to run and didn't need a hard disk drive.

Fast Forward

Some time has passed, and now Tanenbaum, along with Prentice-Hall and a handful of associates, has introduced Minix 1.5. It still runs on a plain old 8088 PC, but some new twists have been added.

The Minix of today includes software development, full-screen editing, and text-processing tools. On a 286 or better, Minix runs in protected mode, using all the extended memory you have available. It works with PC hard disk drives. Versions of 1.5 are also available for the Atari ST, the Amiga, and the Macintosh.

If you're one of those hung up on having "the real thing," you should know that Minix is system-call compatible with ver-

sion 7 of Unix. That's about as close to complete emulation as you can get; an amazing feat, considering that no AT&T source code was used. Many of the Unix faithful believe that version 7 was the last worthwhile release of Unix (the argument is that it has become too fat and unmanageable since then).

Getting There

Minix comes on 17 360K-byte disks and is accompanied by a 680-page manual (over half of which is a source code listing). The packaging is almost suggestive of a commercial-quality product, but don't be fooled: You won't be running your spreadsheets and database managers in Minix.

PC Minix always boots from a floppy disk, according to the documentation. The operating system is small; booting it takes three disks but only a few seconds. It starts up with a menu that allows you to select the root device, change keyboard maps, and set the size of the RAM disk. That's an important point: Minix is optimized to run with its root partition on a RAM disk. Booting entirely from floppy disks includes loading a root file system image into the RAM disk.

Installing Minix on a hard disk is something of an ordeal, but it is an education in itself. As with the rest of the documentation, there is very little of the hand-holding typical of modern operating-system manuals. It is likely that, even if you're an experienced Unix user, you'll wind up going through the installation process more than once. In my case, I had to switch from a Compaq Deskpro 386/25e to a genuine IBM AT because the installation would not work properly on the Compaq.

As an example of how Spartan the Minix installation process is, consider the disk-partitioning software, `fdisk`. You need to supply it with the number of heads and sectors on your hard disk, and it won't stop you from allocating cylinders that extend past the end of the disk.

Is this a problem? Is the lack of a "do everything" installation script a problem? I guess users expecting a commercial Unix might see things that way, but anyone who bought Minix for the right reasons would see it instead as a challenge: If you

ITEMS DISCUSSED

Minix 1.5.....\$169
Versions available for the IBM PC, Atari ST, Amiga, and Macintosh.
Prentice-Hall
Microservice Dept.
200 Old Tappan Rd.
Old Tappan, NJ 07675
(800) 624-0023
Inquiry 1005.

don't like the way fdisk works, you've got the source code; change it or write your own!

A User's Point of View

I was surprised almost to the point of shock at just how complete the new Minix environment is. Not only will you find the standard Unix utilities but also some of the things that make living in Unix easier to bear: clones of popular Unix extensions, like the vi and emacs full-screen editors and even a slimmed-down nroff text-formatting tool.

A few key things are missing, with UUCP (Unix-to-Unix copy) topping the list. (Unix connectivity doesn't even start until you have UUCP.) You can achieve some file transfer in Minix with Kermit and ZMODEM, both of which, some would argue, have advantages over UUCP. You'll probably see UUCP eventually, since large portions of Minix 1.5 are the result of source code donations from some talented programmers.

The vi clone (called elvis), for example, is accompanied by the README file that identifies the author and places the code in the public domain. There are over 16,000 participants in the Usenet newsgroup comp.os.Minix, which is always overflowing with tips and new programs just for Minix.

Among the missing elements in Minix are certain features in a few of the programs. The nroff and emacs clones, for instance, are missing enough functionality that macro files imported from other systems probably won't run. Again, you should take these shortcomings as "exercises for the reader." Actually, most of the hard work has been done for you; if you see something you think you'd like, add it. As a courtesy to other Minix hackers, upload the changes to the Usenet. Your code may end up in the next release of the operating system.

Developing an Interest

A discussion of Minix would be worthless without talking about its most valuable asset—the source code. There are some 125,000 lines of C code—tiny by modern operating-system standards—all copied to your hard disk during installation.

I have worked with source code from AT&T, Berkeley (BSD Unix), and the Open Software Foundation, and I can attest that most Unix source code is abominable and obscure. In contrast, even the Minix kernel source code is impeccably commented. You can flip to any page in the source listing, read a few lines, and actually understand what's going on. With Tanenbaum's book as a companion, you could transform yourself into a qualified operating-system hacker in no time.

For those with less lofty aspirations, Minix's source code still holds value. As long as you don't resell it, you have the right to modify Minix any way you please.

For example, imagine that you wanted to set up a multiline BBS or customer-support system. Minix has all the building blocks in place: serial-line support, full-screen terminal control, text editors, file I/O, E-mail—everything you need to get

started. A primary concern on a BBS is security, so you might set about "fixing" a number of utilities (e.g., log-in, mailers, and text editors) so they could save files only to a certain area, and they'd check to ensure that users weren't taking up too much space. You could climb all the way down to the code that controls the file system, making sure even the cleverest BBS buster can't touch restricted files.

Minix includes a Kernighan and Ritchie-compliant C compiler (for which source code is optional). The make files for each major operating-system component are provided; recompiling any portion of Minix usually requires only that you change to the appropriate directory and type make.

In addition to hacking on Minix sources, the Minix environment is quite useful for producing original programs. The console understands ANSI escape sequences, and a library of termcap-compatible display-control functions can be blended into your programs. Minix C supports over 225 library calls, and since version 7 compatibility is included, you can port some public domain Unix programs. But, here again, something is missing: a debugger. The Motorola 68000-based versions of Minix support debugging, but the PC version lacks any sort of debugging tool. There is a disassembler, but that's it. Some programmers can't work without debuggers, while for others, stuffing printf statements into their code is sufficient.

We Need to Talk

One unusual part of Minix, buried in the back of the manual, is its networking capability. The PC version of Minix includes support for a proprietary network using Western Digital Ethernet cards. At the protocol level, Minix's networking is based on remote procedure calls (RPCs) and works at a level very close to the hardware. The documentation claims that this results in file transfer rates three times higher than TCP/IP. It is *not* TCP/IP, so you won't be connecting it to your Unix LAN.

The networking support is not proprietary to Minix, but rather to another operating system called Amoeba. Developed at the Vrije University in Amsterdam, Amoeba is a distributed operating system built to handle dozens of processors. For Amoeba, its self-styled RPC mechanism is the method of choice for intermachine communications, and this mechanism is compatible with the one rolled into Minix.

Even though there is no Network File System-like file sharing, you can create seamless connections between machines with crafty use of the Minix networking utilities. A program called to, for example, allows Minix shell pipes to connect two machines. Minix also includes the tools necessary for creating and operating custom-built clients and servers.

Let's Hear It for the Little Guy

If you want to get your hands on a well-written Unix, including source, Minix is the most inexpensive way to do it. Be aware of what you need. If all you really need is a compact Unix system for the 286, get Xenix, for which there are hundreds of commercial application programs. Don't expect to run anything under Minix that you didn't compile yourself. This degree of do-it-yourself spells joy for some and misery for others.

Minix is not an operating system for general use, although it held up well to the beating I gave it. It is an operating system for studying, even if you're not a student. Those who have no use for the source code would be better off with Coherent or Xenix. But, even if you don't think operating-system hacking is for you, you won't lose from working with Minix. ■

Tom Yager is a technical editor for the BYTE Lab. He can be reached on BIX as "tyager."

EEF

ELEX ELECTRONIC FILING

The ELEX Electronic Filing System (EEF) is a hardware/software system designed to reduce the frightening volumes of paperwork that burden businesses on a daily basis. As paper is eliminated, transactions are made in a fraction of the time required by traditional means, costly storage facilities are reduced, data security and integrity is enhanced, and work quality and quantity is increased. These factors all give companies and individuals the competitive advantage they need to excel in the business environment of the 90's.

Filing vs. Archiving

Document image processing is a new technology which has just begun to evolve. The myriad of hardware devices on the market, and the lack of an industry standard protocol for communicating between them, make the integration of an electronic filing system a formidable task. And without intelligent software to control all aspects of the storage, management, and retrieval of documents, the filing system will be nothing more than a micro-fiche machine in disguise.

With these considerations in mind, EEF was designed as a turn-key solution which relieves the clients of all the intricacies involved in integrating a truly functional electronic filing system. Yet its flexible design allows continuous and smooth upgrade as the users needs grow and change.

Open Architecture

EEF is designed as a totally open architecture system. Rather than being a closed package, EEF is composed of individual building blocks defined by their area of electronic

filing functionality. These blocks are not bound to specific hardware/software limitations. As such, they can be combined in a variety of forms on each of the following operating platforms, to achieve optimal satisfaction of an application's specific demands:

- A single user workstation under the **DOS** or the **OS/2** operating system.
- A local area network - **Novell NetWare 286** and higher or any **DOS 3.1** compatible network.
- A **host computer** under the **UNIX, VAX/VMS** or **IBM AS/400** system with a PC connection.

Input
Scanner, Fax, Word Processing, Host Computer, Etc.
Processing
Document Manager, Retrieval Engine, Hyper-Media, Database Application Generator, Turn-key Solution.
Output
Printer, Plotter, High Res. Display, Fax, Host Computer

EEF Applications

The EEF system opens a vast new world of opportunities for you. The possible applications are limitless, and to name a few:

Management Systems

Any application which requires original documents and forms (e.g. verification of signatures and L/C in the banking area).

Scientific and Engineering Data

Any application in these fields that requires maps, charts, logs,

sketches, etc.

Medical Uses

The kind of visual information which is so essential for medical applications is handled by EEF in a natural, straightforward manner.

Art Catalogs

Making multi/media presentations of art works, for example at auctions, can provide an exciting new display method.

Real Estate / Travel Agency

EEF can be used to take the customers on an on-site electronic tour without ever leaving the office, thus shortening the process of selection.

EEF Pilot System

For prospective clients wishing to enter the field, we have prepared a pilot system, enclosing in one package the full range of functions necessary for electronic filing. The system components are:

Hardware

386 base micro-computer at 33MHz with 64K cache, 8 MB RAM, 1.2GB with access time of 0.8MS (disk caching), proprietary scanner and printer interfaces, high resolution (1660 x 1200) CRT display, laser printer 300 dpi at 8 ppm, scanner 300 dpi with 100 page feeder.

Software

The EEF software package, including the document manager, the retrieval engine, the hypermedia interface, and 20 hours of customization services.

Total cost for the pilot system is 30,000 US\$.

For further details and literature, please contact:

EUROPE: ELEX INFORMATION SYSTEMS SA

65, Rue de Lausanne 1202 Geneva Switzerland Tel. + 41 22 738 11 88 Fax. + 41 22 738 11 90

USA: ELEX INFORMATION SYSTEMS INC.

125-127 North 4th Street Philadelphia, PA 19106 USA Tel. + 1 215 627 7202 Fax. = 1 215 627 2342.

Trademarks: DOS, OS/2, Microsoft Corp; NetWare, Novell, Inc.; UNIX, SCO Corp; AS/400, IBM Corp; VAX/VMS, Digital Equip. Corp.

Bugs are expensive. Can you afford them?

Richard Fink, President of RainTree Computer Systems, writes, "...What it [Periscope] offers is probably the most comprehensive debugging capability on the market today. And for you and me, that means getting to market sooner. Getting to market with a cleaner product. That's an objective we all know about."

Periscope handles the level of debugging you need.

Whether you're developing applications written in a high-level language, doing low-level system development, or something in between, Periscope can help you find the bugs. Randy Brukaradt, a developer of the Janus Ada compiler, writes, "I couldn't imagine using anything else...It is just as useful debugging my Ada code at the source level as it is for finding bugs in assembler code, even TSRs and device drivers."

There's just not much you can't debug with Periscope.

For example, you can debug device drivers and TSRs, child processes, and software interrupts. You can trace DOS and debug foreground and background programs in the same session. Large programs are no problem. Periscope supports Plink and RTLink overlays, and Windows

3.0 programs in real mode. You can monitor software running on another system. And you can debug the boot process, hardware interrupts, and real-time code. The Periscope software runs on 8088 through 80486 machines, supports 80386/80486 debug registers, and runs with 386 control programs in the system.

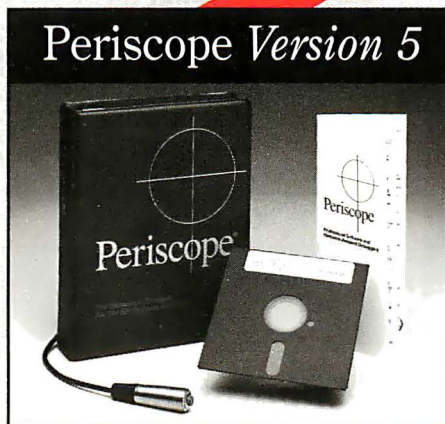

Periscope Model II includes a break-out switch and the new Version 5 software. The new software, included with all models, features a menu system that makes Periscope easier than ever to learn and use.

There's a Periscope model for every budget.

Prices start at \$195 for software-only Model II-X. Model II with its handy break-out switch is \$225. Model I with 512K of write-protected RAM is \$595 for PCs and \$695 for PS/2s. Model IV with its real-time hardware trace buffer and breakpoints is \$1895 to \$2395, depending on your processor and its speed. We'll be happy to help you decide which model you need.

Start saving money today. Call Toll-Free: 800-722-7006

Overseas, call: UK - Roundhill Computer Systems, 0672 84 535; Germany - H+B EDV, 07542 6353; ComFood, 02534 7093; Sweden - LinSoft, 013 124780; Denmark - Ravenholm Computing, 02 88 72 49; Australia - BJE Enterprises, 02 858 5611.

The
Periscope
Company, Inc.

1197 Peachtree St., Atlanta, GA 30361, USA • 404/875-8080
FAX 404/872-1973

EASIER STRINGS FOR THE MAC

Get a handle on Mac strings with this C++ class

Jan G. Eugenides

One of the goals of any programmer is to write reusable code, especially when programming for the Macintosh. The C++ language structure encourages this goal, and I find it easier to “encapsulate” or consolidate routines that I once had to copy time and again into each new program. I’m making a real effort to put together a useful library of C++ classes. Here’s one that lets you easily manage a certain resource.

The Mac has a STR# resource type (usually referred to as a *string list*) that’s very useful in Macintosh programming. That’s because text stored in a string list resource can be changed later, without recompiling the application code. This makes it easy to change an application’s dialog box messages or menu items. This also allows the application’s menus and dialog boxes to be converted to different languages (a process known as *localization*). The STR# resource begins with a short integer value that indicates the number of strings in the list, followed by a variable number of Pascal-style strings (which is a length byte followed by ASCII characters).

A Class Is Born

As useful as the STR# is, however, the Macintosh ROM Toolbox provides only one procedure, `GetIndString()`, for accessing an individual string from the list. There are no Toolbox routines for creating string lists, adding strings to lists, deleting strings from lists, or inserting strings into lists. That leaves it up to programmers to write their own code to accomplish this. To that end, I designed a C++ “StringList” class that provides all these missing functions in one easy-to-use package.

Listing 1 is the declaration of the StringList class. The source code for the functions is too long to include here, but it is available in electronic format (see page 5 for details).

Creating and Destroying Strings

Use the StringList class whenever you need to manipulate a list of Pascal strings, perhaps in a pop-up menu or a dialog box.

Better still, the StringList class is valuable anytime your strings change dynamically at run time.

There are two constructors provided for the class, `StringList(short id)` and `StringList(short id, Str63 name)`. (A constructor initializes an instance of the class of which it is a member.) Using either of them is easy. You use `StringList(short id)` when you want to load and manipulate an existing STR# resource. If you assume the target STR# has a resource ID of 500, you pass this value to C++’s new operator, like so:

```
StringList* myList = new StringList(500);
```

If you want to create a new STR#, use the second constructor, passing in the value of the STR# ID you wish to create, along with a name for it, as a Pascal-style string. For example, to create an STR# with an ID of 600 and the name “Messages,” you would write

```
StringList* myList =
    new StringList(600, "\pMessages");
```

When you are finished with a StringList, you can free the memory it occupies by calling the C++ delete operator, like this:

```
delete myList;
```

All changes you make to strings in the list are saved to disk continually. Calling `delete` removes only the copy in memory. If you need to remove the disk copy, use the Toolbox call `RmveResource()`, since string lists are resources.

Handling Strings

Once you have made a StringList (by either loading an existing STR# or creating a new one), you can use the six public member functions of the StringList class to manipulate it. These functions are listed in the table, and I’ll provide brief descriptions of what they accomplish here.

continued

Listing 1: The declaration of the *StringList* class, a group of routines for such functions as creating string lists, adding strings to lists, deleting strings from lists, and inserting strings into lists.

```
#define INDEXOUTOFRANGE 100

class StringList{
protected:
    short    resID;        //The resource ID of this
                        //string list (STR#)
    OSErr    errcode;     //Error code of last operation
    Handle   stringsH;    //Handle to loaded resource

    Boolean  Valid(short index);
    void     Increment(void);
    void     Decrement(void);
    void     Save(void);
    void     Revert(void);
public:
    StringList(short id,Str63 name);
    StringList(short id);
    ~StringList(void)
    void     ReturnIndString(short index,Str255 str);
    void     SetIndString(short index, Str255 string);
    void     AddIndString(Str255 string);
    void     InsertIndString(short index,Str255 str);
    void     DeleteIndString(short index);
    OSErr    Error(void){ return errcode; }
};
```

The `ReturnIndString()` function is analogous to `GetIndString()`: It returns in `str` a string from the list referenced by `index`. Passing 1 for `index` returns the list's first string, 2 returns the second string, and so on. `SetIndString()` replaces any existing string in the list with the contents of `string`. If `index` is out of range, an error condition results and no action is performed (see the description of `Error()`, below). `AddString()`, as its name implies, adds a string to the end of the list. `InsertIndString()` inserts `str` before the string indicated by `index`. For example, if there are five strings in the list, the following line of code would insert the string "Hi There" before the fourth string in the list:

```
myList->InsertIndString(4, "\pHi There");
```

"Hi There" becomes the new fourth string in the list, and the previous fourth string now becomes the fifth string. `DeleteIndString()` deletes the string indicated by `index` from the list and moves any succeeding strings to fill the gap. Finally, `Error()` returns the error code produced by the last operation on the class. It should be checked after any operation. It returns the appropriate Mac OS error code in most cases, such as insufficient memory (-108) or a resource error (-192 through -199).

Private Members

The `StringList` Class contains five private members. They are

```
Boolean Valid(short index);
```

People are talking about us.

F77L-EM/32

Port 4GB mainframe programs to 80386s with this 32-bit DOS-Extender compiler. The Winner of *PC Magazine's* 1988 Technical Excellence Award just got better. New Version 3.0 and OS include: Editor, Make Utility, Virtual Memory Support, DESQview Support, New Documentation and Free Unlimited Runtime Licenses. F77L-EM/32 \$895 OS/386 \$395

F77L

The compiler of choice among reviewers and professionals. Includes a Debugger, Editor, Profiler, Linker, Make Utility, Weitek and 386 Real-Mode Support, Graphics. \$595

Lahey Personal Fortran 77

New Version 3.0: Full ANSI 77, Debugger, Editor, Linker, Library Manager, Microsoft and Borland C interfaces, 400 page Manual, Unbeatable Price. \$99



**When people talk about FORTRAN
the name mentioned most often is**



Contact us to discuss our products and your needs. **(800) 548-4778**
Lahey Computer Systems, Inc. P.O. Box 6091, Incline Village, NV 89450
Tel: (702) 831-2500 FAX: (702) 831-8123 Tlx: 9102401256

FORTRAN IS OUR FORTE

Printer Sharing Solutions



**8 Parallel and 2 Serial Ports
Now Available With New SL**

SL 10 Ports from \$495

New Model - SLP™ has 8 parallel and 2 serial ports: The original SL™ has 4 parallel and 6 serial ports. Both can share any combination of ten printers or PCs; automatic switching, queuing, and serial-to-parallel conversion

Improved Data Throughput - True 115,200 bps: use other vendors' file transfer software with serial connected PCs

Pop-up Menu via Hotkeys: Keyboard selection of printers

Simple Installation: Just plug in your cables and run the menu-driven installation software

User Upgradable Memory: From 256KB to 4MB buffer

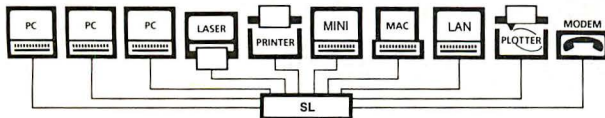

Save by Sharing Resources: The SL enables everyone to share lasers, printers, plotters, and modems. Greater access by more users reduces unproductive idle time and the expense of purchasing additional peripherals. All users can simultaneously send print data and quickly release their PCs to continue working.

BUFFALO®

45 Day Money Back Guarantee

CALL TODAY (800) 345-2356

Fax (503) 585-4505

Buffalo Products, Inc. 2805 19th St. SE, Salem, OR 97302-1520

Circle 399 on Reader Service Card



HWP 5 Ports from \$275

All ports are parallel and user configurable as either 3 inputs to 2 outputs with a pop-up menu, or 4 inputs to 1 output as a buffered auto-switch; memory is user upgradable from 256KB to 16MB buffer

AS-41 5 Ports \$200

4 parallel inputs to 1 parallel output, automatic switch with no buffer; use the AS-31 for up to 3 inputs to 1 output, \$175

CE 2 Ports from \$175

Printer buffer with 1 parallel input to 1 parallel output, from 256KB to 4MB buffer

SPPS Converter \$100

Combination serial-to-parallel, or parallel-to-serial interface converter in a single unit, no power supply needed, serial transfers to 115,200 bps, DIP switch configurable

RCJ Toshiba Memory Module

Memory expansion module for the Toshiba T1000SE, T1000XE, or J3100SS laptop (notebook) computer, 1MB - \$299, 2MB - \$549

Cables & Adapters

High quality, 24 gauge shielded cables, parallel or serial; modular cable adapters

STRINGLIST CLASS FUNCTIONS

Once you have made a *StringList*, you can use the six public member functions of the *StringList* class to manipulate it. See the text for descriptions of these functions.

Constructors for StringList class

```
StringList
(short id);
StringList
(short id, Str63 name);
```

Member functions of StringList class

```
void ReturnIndString
(short index, Str255 str);
void SetIndString
(short index, Str255 string);
void AddString
(Str255 string);
void InsertIndString
(short index, Str255 str);
void DeleteIndString
(short index);
OSErr Error
(void);
```

```
void Increment(void);
void Decrement(void);
void Save(void);
void Revert(void);
```

Because they are private members, they cannot be called by any code outside the class. They are used internally and are invis-

ble to the caller. Another class may contain a routine called *Valid()*, for example, and it would not be confused with the *Valid()* routine in this class. Private functions are, well, private.

Valid() is called by the *SetIndString()*, *DeleteIndString()*, and *InsertIndString()* functions to ensure that the parameters are meaningful. This allows the calling program to detect error conditions via the *Error()* routine, which returns *errcode*. It also prevents the damage to the *STR#* that might be caused by operating with faulty parameters. The *Save()* and *Revert()* functions are used to save the *STR#* to disk, and to revert to the last saved version, respectively.

The *Increment()* and *Decrement()* functions simply modify the short integer at the beginning of the *STR#* to reflect the current number of strings in the list. Since this operation occurs regularly, I made them into separate functions for efficiency's sake.

Unfortunately, I don't have room here to describe exactly how the various functions work. I have commented the source code, however, so you should be able to tell what's going on fairly easily. If you have to deal with lots of strings inside your Mac application, I'm sure you will find the *StringList* class a handy addition to your private toolbox. If you have comments, I can be reached on BIX or by mail. ■

Jan G. Eugenides is a senior software engineer at Solutions, Inc. (Williston, VT). Recent programs he has helped create include SuperGlue II, FaxGATE, and LinkSaver. He can be reached on BIX as "j.eugenides."

Time to Relax and Unwind

with **FRACTOOLS™**

AN ELECTRONIC KALEIDOSCOPE OF NATURE'S GEOMETRY

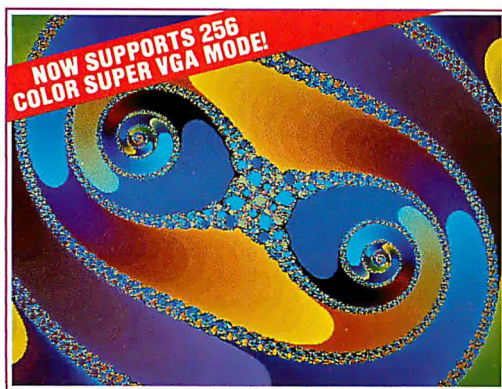

FracTools is the ultimate graphics software "toy" for experiencing the infinite and beautiful world of **fractals**. Easy enough for a child to use, **FracTools** opens a window to explore the world of **chaos science** in a vividly visual environment. Rich in animation and special effects, **FracTools** will provide hours, days... of creative and artistic relaxation. Create dynamic and mesmerizing **Slide Shows** that change images, effects and colors, automatically. They would have killed for this in the "Sixties".

"You can think of **FracTools** as the professional's fractal investigation toolbox." —Dr. Jerry Pournelle - *Byte* 6/90

Supports 16 color **EGA** and **VGA**, and 256 color **SuperVGA** with multi-synch analog monitor. Requires IBM PC/XT/AT/PS2 or compatible, 512K of RAM, DOS 2.0 or higher, and a hard disk.

Suggested Retail - \$69 To order, call 800-289-1347



Bourbaki Inc.

REvolutionary SOFTWARE

P.O. Box 2867, Boise, Idaho 83701, (208) 342-5849

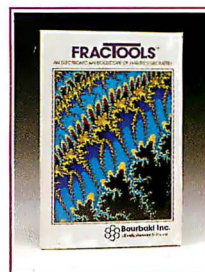

JMP™ to a Higher Level of Discovery

With JMP Software for Statistical Visualization

Make a quantum leap in data analysis with JMP software for your Apple Macintosh®. JMP combines traditional statistics with today's most innovative graphics.

Discover more.

▲ Fit regression and Analysis of Variance models, but see them in a new way with leverage plots, showing how each point contributes to each hypothesis test.

▲ Fit means, but see the significance of their differences visually with comparison circles. ▲ Analyze high-dimensional data and extract principal components, but see both the points and variables in the same graph with a biplot, one that spins in 3D. ▲ Examine a correlation matrix, but see more with a matrix of scatterplots with density ellipses. See high-dimensional outlyingness of points with Mahalanobis distance plots. ▲ See your data always displayed in a familiar spreadsheet grid.

Interact more.

▲ Point and Click to view, edit, or manipulate your data...to get an analysis...to identify points...to customize...to get context-sensitive help...to choose colors and marker symbols for your points in every graph. ▲ Point and Click on a calculator panel to make formulas for variables. ▲ Point and Click on your data in one graph, and the corresponding points will be highlighted in all the other graphs instantly. ▲ Click and Drag to change the intervals for histograms instantly...to spin your 3D graph smoothly in real time...to resize any graph. Cut and Paste your data within JMP or to other applications. ▲ Cut and Paste reports to other applications or journal them to a file.

Understand more.

▲ JMP is simple to use, so you can spend your time studying your data, not your software. ▲ JMP presents statistical results visually, so you are always

looking at graphs as well as numbers, finding patterns, and noticing points that don't fit patterns. ▲ JMP organizes its statistical methods in a unified way. You approach your data more directly with fewer frustrations regarding the statistical recipes. You always have a method that takes into account the variable's measurement level: nominal, ordinal, or interval.

MacWEEK says "JMP is powerful and easy to use. The programmers' delight in writing JMP is evident throughout and makes the program intuitive and a pleasure to use."

A Free Video Preview

For a free video preview of JMP, call our JMP Sales Department at (919) 677-8000. In Canada, call (416) 443-9811. Or, write us at the address below.

 **From SAS Institute Inc.,
the number one name in data analysis software.**

SAS Institute Inc. □ JMP Sales Dept.
Box 8000 □ SAS Circle □ Cary, NC 27512-8000
Phone (919) 677-8000 □ Fax (919) 677-8123

To use JMP, you need an Apple Macintosh with 1+ meg, 2 meg recommended.

JMP is a trademark of SAS Institute Inc., Cary, NC, USA.
Apple and Macintosh are registered trademarks of Apple Computer, Inc.
Copyright © 1990 by SAS Institute Inc. Printed in the USA.

BREAK AWAY FROM BLACK, WHITE AND GRAY!

Presenting DFI's CHS-4000 Color Handy Scanner®



Depart from the humdrum of ordinary handheld scanners. To get your message across in a world of color, the usual black, white and gray just don't measure up. Until now. Presenting DFI's CHS-4000 Color Handy Scanner.

For the serious scanning enthusiast, the CHS-4000 has the features that let you realize your full creative potentials. 400 dpi resolution, color gray scale output, six gamma correction patterns among others. Plus PC Paintbrush IV+, the world's best. And the quality that you've come to expect from the company that started handheld scanning.

Live up to your creative scanning possibilities with DFI's CHS-4000. Who knows where it will lead you to?

Circle 88 on Reader Service Card

DFI®

West Sacramento, CA
Tel: 916 373 1234
Fax: 916 373 0221

East Brunswick, NJ
Tel: 201 390 2815
Fax: 201 390 2817

Miami, FL
Tel: 305 477 1988
Fax: 305 594 0607

West Germany
Tel: 040 234 766
Fax: 040 233 666

United Kingdom
Tel: 81 462 9290
Fax: 81 462 7538

Taiwan, ROC
Tel: 02 543 3966
Fax: 02 537 7458

VGA TO THE MAX

VESA creates a software standard for Super VGA

Ever since companies reverse-engineered IBM's EGA and produced compatible adapters, they have been pushing the IBM standards to their limits—first with Super EGAs, and more recently with Super VGAs. Both the EGA and VGA architectures (which are similar in many respects) suggest rather obvious extensions to accommodate higher resolution and more colors.

However, for many users, owning a Super VGA adapter hasn't been all it's cracked up to be. Dreams of glorious high-resolution color soon fade when you realize how few programs support the extended modes. Typically, you can get Super VGA-aware drivers for AutoCAD, Lotus 1-2-3, and, if you're lucky, Windows. But that's it. Most programs treat a Super VGA just like an ordinary VGA adapter. Why? There's been no standard way for programs to test for the presence of a Super VGA adapter, to identify what type of Super VGA is present, or to find out how to use its extended modes.

Enter VESA, the Video Electronics Standards Association, made up of several dozen leading manufacturers of graphics adapters, monitors, and software. The VESA Super VGA extensions let real-mode DOS programs recognize and exploit Super VGA hardware in a consistent manner. I'll focus on how manufacturers have extended Super VGA and how the VESA standard helps applications use those extensions.

Beefing Up VGA

The first natural VGA extension involves boosting the resolution of the display. Because of its bit-plane architecture, which

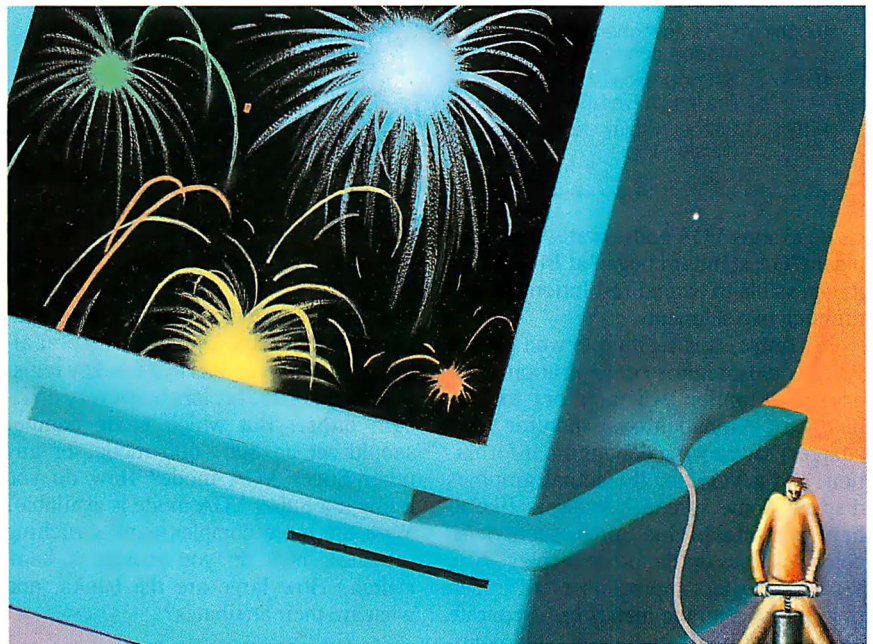

locates several layers (or planes) of video memory in a single address range, VGA requires only 64K bytes of address space for its 256K bytes of on-board memory. Each high-resolution mode uses one linear bit for each pixel displayed. The highest standard VGA resolution, 640 by 480 pixels (hereafter expressed as 640×480), consumes only 38K bytes of the available 64K bytes. Boosting resolution to 800×600 fills 60K bytes of address space while maintaining square pixels and a simple addressing scheme. It also pushes close to the upper limit of the early multifrequency displays. Thus, 800×600 became one of the more popular high-resolution extensions.

The second natural extension is additional color. VGA memory is usually arranged in a planar configuration: four bit planes, or 16 simultaneous colors (2⁴). But VGA has 8-bit registers. The Map Mask Register, which controls CPU writes to the various planes, usually re-

serves 4 unused bits. By enabling these (and making internal hardware changes to accommodate the extensions), Super VGA could support 256 colors. However, I've yet to see an adapter that works that way, probably because of the hardware modifications required.

Another possibility (implemented by the standard VGA mode 13 hexadecimal) is to address each pixel with one linear data byte, again allowing 256 colors. This method wastes CPU address space, requiring almost the entire 64K-byte segment for 320×200. But it greatly simplifies address calculations—you just multiply the *x* and *y* coordinates to get the byte offset of the pixel. This eliminates the bit offset calculation required by the planar modes.

The next step involves using more than one segment for linear byte-wise storage. The memory IBM reserved for video includes the 128K bytes that comprises the A and B segments. Fortunately, IBM

VESA FUNCTION CALLS

Table 1: *With VESA calls, you can identify whether Super VGA is present and, if so, how to control its video modes and bank switching.*

4F00h	Return Super VGA information.
4F01h	Return Super VGA mode information.
4F02h	Set Super VGA video mode.
4F03h	Return current video mode.
4F04h	Save/restore Super VGA video state.
4F05h	CPU video memory window control.
4F06h	Set/get logical scan-line length (version 1.1).
4F07h	Set/get display start (version 1.1).

chose to start VGA address at A000h (the older CGA standard began at B800h), so it is possible to extend resolutions by addressing two segments.

Of course, this technique won't work with a dual-monitor configuration. Programmers prefer two monitors for debugging: a monochrome monitor (and adapter) for viewing debugging information, and a VGA for the actual graphics display. Some spreadsheet users like to have a monochrome spreadsheet with color graphics on the other display. And some CAD users appreciate a full screen of graphics with the menus on a separate display. But in all such cases, the monochrome adapter uses address B000h, eliminating the B segment for VGA memory expansion.

Nevertheless, there are Super VGAs on the market that support 1024x768, 4- and 16-color modes (a 96K-byte footprint), and high-resolution 256-color modes with linear addressing (up to 480K-byte footprints). And these adapters still allow dual monitor configurations.

How do they squeeze such a large footprint into a 64K-byte segment? With an old technique popularized by the LIM/EMS standard: bank switching. The adapter lets the program select which bank (usually 64K bytes) of memory should appear at the A000h segment. Thus, a 1024x768 mode might have two 64K-byte banks, numbered 0 and 1. The first 512 rows would be in bank 0 and the last 256 rows in bank 1.

Extending VGA does create some problems. The easiest ones to deal with (from the programmer's view) are the adapter's internal timings and address-

VESA MODES

Table 2: *Version 1.0 standardized the popular 800x600, 256-color mode and left plenty of room for growth. Version 1.1 added enhanced text modes.*

Version 1.0	
100h	640x400, 256 colors
101h	640x480, 256 colors
102h	800x600, 16 colors
103h	800x600, 256 colors
104h	1024x768, 16 colors
105h	1024x768, 256 colors
106h	1280x1024, 16 colors
107h	1280x1024, 256 colors
Version 1.1	
108h	80x60 text
109h	132x25 text
10Ah	132x43 text
10Bh	132x50 text
10Ch	132x60 text

ing. Such parameters are set once and, except for unusual applications, never altered. Adding new bits to a few key registers for additional colors is not very difficult, either. But which mode number should set an 800x600 mode, or any other Super VGA mode? How do you know if a Super VGA mode is available? With the more complex bank-switching schemes, how do you request a bank switch? How large are the banks, and what are their attributes?

VESA: Passport to the Extended Modes

The first VESA standard, which was created in April 1989, established mode 6Ah as an 800x600, 16-color mode. Except for the larger address space, programming mode 6Ah is identical to working with standard mode 12h (640x480, 16 colors). Both are planar modes with a 64K-byte address map—one plane for each primary color, and one to represent intensity. With the palette registers and the D/A converter, you can map a plane combination to any one of 262,144 different colors.

Before writing data to the adapter, a program must set the color to be written

or the bit planes to modify. When reading data, the program must select a single plane (four reads to retrieve all data in a byte) or a particular color (16 reads to retrieve all data). In Super VGA mode 6Ah, a program accomplishes these tasks just as in mode 12h—that is, by standard VGA registers.

The Super VGA modes require faster scan rates for the display. Other timings, such as the retrace and overscan, require compensating adjustments. These timings can affect image size and placement on the display. In some cases, you may find yourself adjusting the screen controls every time you switch applications (for example, from an older 640x480 program to a newer Super VGA program). Accordingly, VESA has also set some display signal-timing specifications for 800x600 modes.

The next set of standards (October 1989) extended the BIOS calls. It established eight new graphics modes (all the way up to 1280x1024, 256 colors), five function calls, and several attribute tables. All the new calls are implemented as subfunctions of interrupt 10h, function call 4Fh. As with the IBM-defined video BIOS calls, register AH takes the function call (4Fh), and the subfunction goes in register AL. A revision of these standards (May) added five new text modes and two new function calls. All VESA revisions will be backward-compatible to the original. A list of the functions appears in table 1. The new modes appear in table 2.

VESA Functions

Function 0 (Return Super VGA information) confirms that a VESA adapter exists. The calling program must reserve a 256-byte area and pass a pointer via registers ES:DI. The VESA function returns a table of information that includes the current VESA version supported and a pointer to the valid video modes.

The program may determine the attributes of a mode by calling function 1 (Return Super VGA mode information). Like function 0, a pointer to a 256-byte reserved area passes through register ES:DI. The CX register receives the mode number. This function returns operational information such as memory layout and window properties (discussed later). The standards define enough detail so that a vendor can describe unusual non-VESA modes such as nonstandard resolutions or memory mapping (e.g., extended CGA).

Functions 2 and 3 simply set and return the video mode. Unlike the standard video BIOS routines, which use an 8-bit

COMPANY INFORMATION

VESA
1330 South Bascom Ave., Suite D
San Jose, CA 95128
(408) 971-7525
Inquiry 1004.

They have a way of dealing with line noise.

WARNING:
File Transfer
Aborted.

We have a better way.

Take one last look at this screen shot. Hopefully, you'll never see it again.

BLAST® is the communications software designed to shrug off line noise. It was born twelve years ago into the world of high-stakes mainframe file transfers – where one lost bit can be a million dollar mistake.

We developed a unique full-duplex, sliding window protocol that was naturally resistant to noise. Then we added data compression, and the incredible ability to restart transfers from the point of interruption. When we put it on the test bench we found that, in addition to the safest mode of transferring files, we had produced the fastest protocol available.

We set out to build a tank and ended up with a sports car – a sports car with armor.

We named it BLAST and, starting today, it's available, through distribution, to virtually anyone with a business computer – any business computer. Call your distributor for the whole story.

No one can eliminate line noise as a problem. *We have* managed to outmode warning messages as a solution.

BLAST®
Communications Research Group
A U.S. Robotics Company

For more information call:
800-24 BLAST (242-5278)
(504) 923-0888
FAX: (504) 926-2155

Or write:
Communications Research Group
5615 Corporate Boulevard
Baton Rouge, LA 70808

mode number, the VESA routines use a 16-bit mode number. Programs get and set the mode number by way of the BX register.

Function 4 saves all, or selected portions of, the Super VGA video state. The complete video state includes all the registers (including vendor-specific registers) and BIOS data areas, but not the video memory.

Function 5 (CPU video memory window control) sets or reads the current window (bank); it's a prelude to bank

switching. Register BH sets the current mode (0 for set, 1 for read), BL selects the window (0 for A, 1 for B), and DX holds the bank number. VESA also provides a direct call for setting the current window—the address of the call is returned through function 1.

Version 1.1 of the specification adds two function calls that support scrolling and multiple display pages. Function 6 sets the logical screen width. A line longer than the display width may be subject to horizontal scrolling. Additional-

ly, longer logical lines are useful for rounding out odd-length lines, so windows always break between scan lines rather than within scan lines. For example, a 640-column graphics mode (80 bytes wide) does not divide evenly into 64K bytes. This can be fixed by rounding up to 128 bytes (1024 columns).

Function 7 sets and reads the display start address. This allows for panning across wider logical screens set through function 6, for scrolling vertically, or for switching between two or more display pages.

The standards recognize that some adapters have unique modes or limited abilities. VESA provides information about vendor-specific modes in the form of mode lists and mode attribute tables. A program can search for a specific resolution, find the closest matching resolution (either VESA or vendor-specific), and determine the necessary programming information—all with VESA calls. Note that an adapter does not have to support each, or any, of the VESA standard modes. For example, I have yet to see a 1280×1024 VGA.

Memory Windows

The standard VESA modes return information, too. This is especially critical for the bank-switching modes, such as 1024×768, and all the extended-memory modes (e.g., those that require VGA with 512K bytes of memory). There are three separate bank-switching techniques: single-window (see figure 1), dual overlapping windows (see figure 2), and dual non-overlapping windows (see figure 3). In each case, programs accomplish bank-switching with a VESA call or with a direct call to a bank-switch routine located with a VESA call.

With the *single-window* technique, the CPU can both read and write to the same address range—typically, a full 64K-byte segment. *Dual overlapping windows* map to the same address, but one window is read-only while the other is write-only. The two windows can map to the same bank, thus emulating the single-window technique (but requiring two function calls to switch banks). *Dual nonoverlapping windows*, a variation on the basic dual-window theme, occupy different segments—typically A000h and A800h—and are 32K bytes long. Nonoverlapping windows can also emulate a single window, in this case by selecting consecutive 32K-byte banks (also requiring two calls to switch banks).

Most programmers will probably emulate single windows to simplify their plotting routines. So why bother with

Figure 1: In this diagram (right), the offset in video memory has changed from 0 to 1000h (the CPU continues to address segment A000h). The shaded area is the displayed memory in 1024-by-768-pixel, 16-color mode.

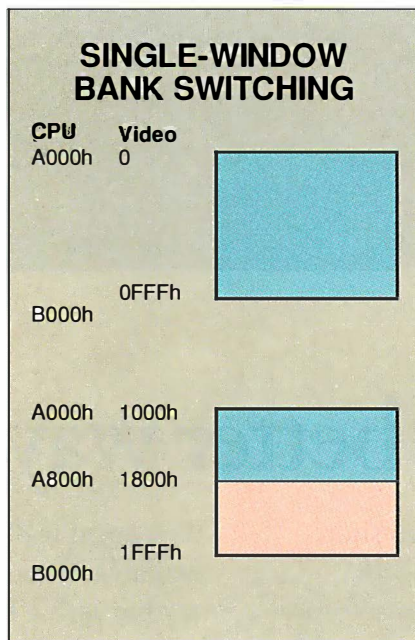
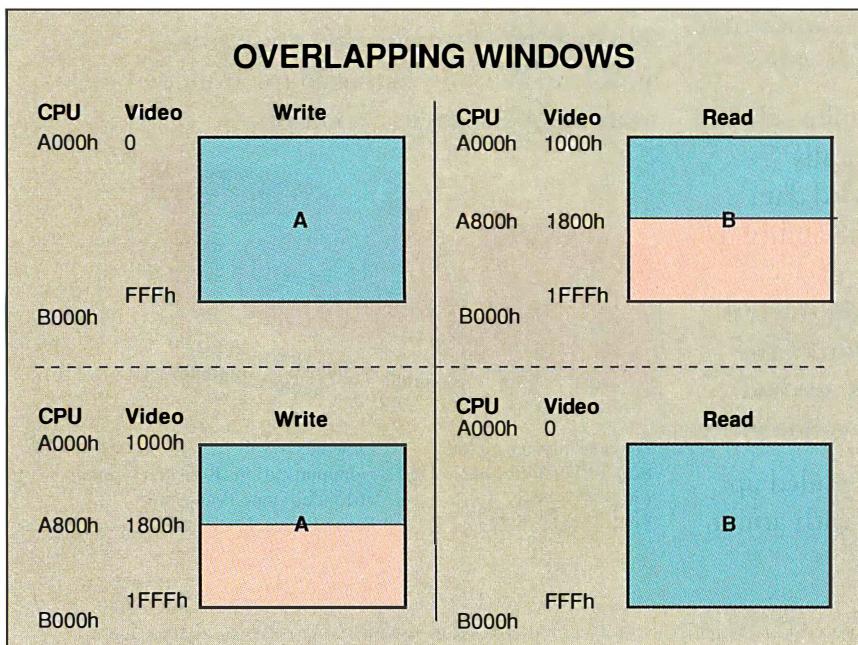

Figure 2: Window A (below) is write-only, and Window B is read-only. Both are 64K bytes in length and addressed at segment A000h. The top half of the diagram represents an arbitrary initial state where you can read video memory at offset 1000h and write to video memory at offset 0. You might use this configuration to transfer an object from the nondisplayable memory in Window B to Window A. Moving to the bottom, both banks are switched, so you read from video offset 0 and write to video offset 1000h (e.g., to store background information from Window B in the nondisplayable area).



dual windows? To improve performance when you are moving data between display areas. Since each window is independently addressable, you can move data from one area to any other without reloading segment registers. Applications that do animation or that maintain libraries of frequently drawn images (e.g., fonts) will work much faster if they exploit dual windows.

Programmers must be very careful not to assume that attributes for one adapter will apply to another, similar adapter (or even from mode to mode on a single adapter—I've seen multiple windowing methods on a single adapter). For example, you cannot assume that single-window systems will have 64K-byte banks—the banks may be smaller than the window size. The smallest address step is called the *granularity*.

Most Super VGAs use a 64K-byte window and 64K-byte granularity, but Paradise Super VGAs use dual nonoverlapped Windows with a 4K-byte granularity. Each window is 32K bytes: one at segment A000h and the other at A800h. Each window can be individually programmed to 4K-byte offsets within the adapter memory. A single-window emulation would use banks 0 and 8, not banks 0 and 1.

Once you master the bank switching, programming with VESA is basically the same as with the standard VGA modes. The addressing generally follows either the 4-bit planar model (e.g., 640×480, 16 colors) or the linear packed-pixel model (e.g., 320×200, 256 colors).

What VESA Means to You

One of the unique features of the VESA standard is that it supports existing hardware. In an industry that is driven by selling new hardware, I think it's exciting to see some recognition of a large installed base that has been underutilized. By August of this year, most of the major manufacturers had implemented version 1.0 VESA BIOS calls as TSR programs for their existing VGAs. A few had the VESA calls in BIOS.

The next big step is software that supports VESA. As of August, several shareware programs supported VESA. Two CAD applications, Microstation and Generic CADD, had VESA drivers. Although CAD and paint applications will be the first adopters of VESA, the extended text-mode support in version 1.1 will make VESA attractive to spreadsheet and word processing applications.

Of all the people I've talked to about VESA, Everex's Gary Lorensen is the most enthusiastic, and it's easy to see

In an industry driven by selling new hardware, it's exciting to see some recognition of a large, underutilized installed base.

why. Everex has several Super VGA models with different architectures. With VESA, Everex can distribute programming information that applies to all its VGA models rather than trying to document the differences.

Of course, there are still benefits to be had by writing for a specific chip set. By knowing which registers control bank-switching, or through special features such as direct-latch register writes, a programmer can improve the performance of an application—at the expense of portability to different adapters. I expect to see growing support for generic VESA drivers within programs over the next few years. But I doubt that customized drivers for popular programs will disappear. VESA primarily helps the software developer and those hardware vendors

who have to support multiple architectures.

Note, however, that VESA is distinctly a real-mode standard. Writing a VESA driver for Windows 3.0 (which is something of a real-mode/protected-mode hybrid) would be a very difficult task due to the tight integration of the virtual device driver with the underlying hardware. Microsoft is looking into VESA but has not yet decided whether to participate. VESA is not useful for protected-mode applications such as Xenix, Unix, and OS/2. This is perhaps the biggest weakness of VESA—it is a software standard rather than a hardware standard. This is what makes VESA a significant advance, insofar as it supports old hardware, but it also restricts it from advancing to new operating systems.

VESA is unlikely to adopt a Super VGA hardware standard, for several reasons. Foremost, perhaps, is the fact that a hardware standard would give some companies an edge, since it would likely be built around an existing architecture. Also, a hardware standard would not be backward-compatible to the installed base of Super VGAs.

The VESA committee is looking at a generalized protected-mode library that could work across platforms such as the Phar Lap extensions, Xenix, Unix, and OS/2. But a generalized driver would be difficult to design and may not be practical if Super VGA is only a transitory phase on the way to graphics coprocessors.

continued

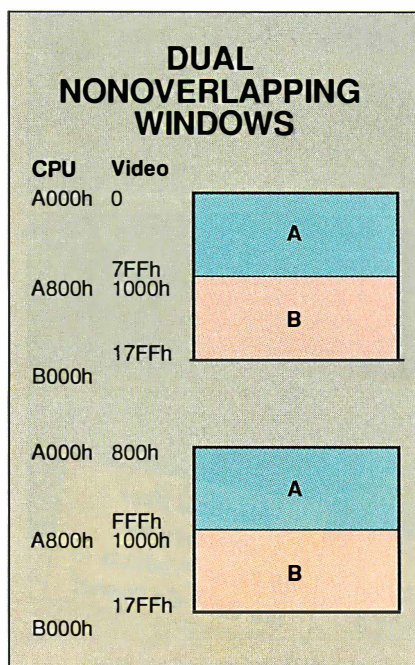

Figure 3: The CPU addresses two segments: A000h and A800h. In the top half, the CPU can read or write to either the first or last 32K-byte portion of displayable memory. In the bottom figure, Window A has been moved to the second 32K-byte bank, while Window B continues to address the last displayable bank. In 1024- by 768-pixel, 16-color mode, there will be at least one more 32K-byte bank of nondisplayable memory, which could be used as supplementary storage for commonly used characters or objects.

A Graphics Coprocessor in Every PC?

Will graphics coprocessors make VESA obsolete before it establishes a significant installed base? I doubt it. Already, VESA is available to most Super VGA owners for the price of a software update (either free or for a minimal charge) or a call to a vendor-supported BBS. This gives a potential installed base of millions of computers. The next stage is VESA support in applications software. I

expect rather quick adoption here. It's difficult for developers to ignore higher resolutions and additional colors when the conversion from existing VGA programs is straightforward.

Despite the initial excitement over the Texas Instruments Graphics Architecture and the 8514/A, adoption of these graphics coprocessor standards has been slow. I think the primary factor working against graphics coprocessors is price. You still pay a premium for a graphics

coprocessor—not just for the adapter, but for the monitor, too. Once resolutions push past 800×600, monitor prices go up dramatically. And although many coprocessors work at lower resolutions, the target market is 1024×768 and above.

Even when coprocessor prices drop (and they almost certainly will), the changeover from VGA to graphics coprocessors may be more evolutionary than revolutionary. One of the interesting aspects of the IBM-compatible market is that every aspect of a system must be cost-justified. Each computer is a collection of components tailored to an individual's budget and needs. Thus, even a few hundred dollars' difference between a coprocessor and Super VGA could tilt the balance in favor of VGA unless the coprocessor appears to improve performance significantly.

There are plenty of character-based applications that form the cornerstone of DOS-based computing. Graphics is more of a perk than a foundation for programs such as spreadsheets, databases, and, to some extent, word processors. Does it matter whether a 1-2-3 graph displays a few tenths (or perhaps only a few hundredths) of a second faster? Compared to spreadsheet recalculation times, minor improvements in graphics speed are practically insignificant.

The fate of Super VGA is probably more closely tied to acceptance of graphical-user-interface systems, such as Windows and OS/2—the areas where the VESA extensions are weakest. And since all GUI applications rely on graphics, a coprocessor begins to look more like a requirement than an option.

I think the VESA Super VGA standards have at least a few good years ahead. They should fill an important gap in the transition from VGA to whatever coprocessor standard establishes itself in the marketplace—and may have some staying power considering the older hardware standards that are still in use.

The VESA standard demonstrates a commitment to improve products that have already been sold, rather than to always push for something newer and better. It's a refreshing example of how cooperation between competing manufacturers can benefit the entire computer industry. ■

Bradley Dyck Kliever is the author of EGA/VGA: A Programmer's Reference Guide, Second Edition (McGraw-Hill, 1990) and principal of DK Micro Consultants, a microcomputer consulting business in Minneapolis, Minnesota. You can reach him on BIX as "bkliever."

Free Demo

You can start your debugging with this **FREE** demo simulator. You can load up to 512 bytes of code, assembler, C, or PL/M and do full debugging/simulation in assembly and source level. A great way to get started for **FREE**. Fantastic for schools! Just call and we'll send it!

Full Simulator

The full-blown simulator is an extension of the DEMO. You can load up to 64K of code and use 64K of XDATA space. You can program an "external environment" to interact with your code to simulate your target system. The emulator is the hardware extension of the simulator!

In-Circuit Emulation

The 24MHz real-time emulator has been the industry standard for years. With its complex breakpoint logic and advanced trace, nobody can beat it for performance. Plug-in or RS-232 configuration. All 8051 derivatives are supported!

NOHAU
CORPORATION

51 E. Campbell Avenue, Campbell, CA 95008
(408) 866-1820 • FAX (408) 378-7869

Australia (02) 654 1873, Austria (0222) 38 76 38, Benelux +31 1858-16133, Canada (514) 689-5889, Denmark (42) 65 11 11, Finland 90-452 1255, France (01)-69 41 28 01, Great Britain 0962-73 31 40, Israel (03) 48 48 32, Italy (011) 771 00 10, Korea (02) 784 784 1, New Zealand (09) 392-464, Portugal (01) 81 50 454, Sweden, Norway (040) 92 24 25, Singapore (065) 284-6077, Spain (93) 217 2340, Switzerland (01) 740 41 05, Taiwan (02) 7640215, Thailand (02) 281-9596, West Germany 08131-1687.

Subscribe to BYTE now
and

**SAVE up to
52%**

PLUS,

get the annual IBM PC
Special Issue as an

**EXTRA
BONUS!**

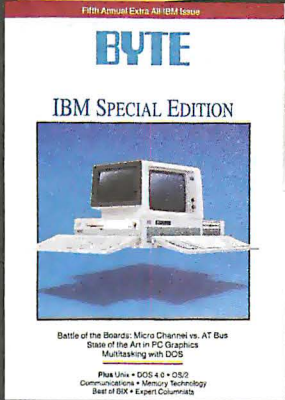

- Stay in the know on all major microcomputer products and innovations
- Save time and money—invest in the best equipment for your needs
- Harness the maximum power of your micro.

**Subscribe today
and save!**

**In a hurry?
Call Toll-Free
1-800-257-9402**
weekdays 9-5 EST.
In NJ, call
1-609-426-5535.

Enjoy **MORE SPEED!** SAVE up to \$66.05 **PLUS**

get the extra IBM PC Special Issue

Send me **BYTE** for:

- 1 year (12 issues) for \$24.95
(Save 40% off the newsstand cost)
- 2 years (24 issues) for \$44.95
(Save 46% off the newsstand cost)
- 3 years (36 issues) – \$59.95
SAVE 52% off the newsstand cost
(20% off the basic subscription price)

Name _____

Company _____

Address _____

City/State/Zip _____

Payment enclosed **Bill me**

No-Risk Guarantee: If dissatisfied, cancel anytime for a full 100% refund. Your subscription will start in 6-8 weeks. Watch for it!
Single copy \$3.50. The basic annual subscription rate is \$29.95.

IB0D066

Profit from **MORE POWER!** SAVE up to 52% **PLUS**

get the extra IBM PC Special Issue

Send me **BYTE** for:

- 1 year (12 issues) for \$24.95
(Save 40% off the newsstand cost)
- 2 years (24 issues) for \$44.95
(Save 46% off the newsstand cost)
- 3 years (36 issues) – \$59.95
SAVE 52% off the newsstand cost
(20% off the basic subscription price)

Name _____

Company _____

Address _____

City/State/Zip _____

Payment enclosed **Bill me**

No-Risk Guarantee: If dissatisfied, cancel anytime for a full 100% refund. Your subscription will start in 6-8 weeks. Watch for it!
Single copy \$3.50. The basic annual subscription rate is \$29.95.

IB0D066

Gain **MORE APPLICATIONS!** SAVE up to 52% **PLUS**

get the extra IBM PC Special Issue

Send me **BYTE** for:

- 1 year (12 issues) for \$24.95
(Save 40% off the newsstand cost)
- 2 years (24 issues) for \$44.95
(Save 46% off the newsstand cost)
- 3 years (36 issues) – \$59.95
SAVE 52% off the newsstand cost
(20% off the basic subscription price)

Name _____

Company _____

Address _____

City/State/Zip _____

Payment enclosed **Bill me**

No-Risk Guarantee: If dissatisfied, cancel anytime for a full 100% refund. Your subscription will start in 6-8 weeks. Watch for it!
Single copy \$3.50. The basic annual subscription rate is \$29.95.

IB0D066



BUSINESS REPLY MAIL
FIRST CLASS MAIL PERMIT NO. 42 HIGHTSTOWN, NJ

POSTAGE WILL BE PAID BY ADDRESSEE:

BYTE

Subscription Department
P.O. Box 558
Hightstown, N.J. 08520-9409

NO POSTAGE
NECESSARY
IF MAILED
IN THE
UNITED STATES



BUSINESS REPLY MAIL
FIRST CLASS MAIL PERMIT NO. 42 HIGHTSTOWN, NJ

POSTAGE WILL BE PAID BY ADDRESSEE:

BYTE

Subscription Department
P.O. Box 558
Hightstown, N.J. 08520-9409

NO POSTAGE
NECESSARY
IF MAILED
IN THE
UNITED STATES



BUSINESS REPLY MAIL
FIRST CLASS MAIL PERMIT NO. 42 HIGHTSTOWN, NJ

POSTAGE WILL BE PAID BY ADDRESSEE:

BYTE

Subscription Department
P.O. Box 558
Hightstown, N.J. 08520-9409

NO POSTAGE
NECESSARY
IF MAILED
IN THE
UNITED STATES

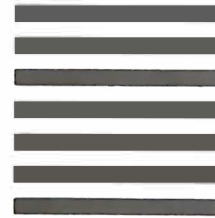

Detach and mail card
now to

**SAVE up to
52%**

on BYTE . . .

PLUS,
get the annual IBM
PC Special Issue as
an

**EXTRA
BONUS!**



Order even faster by
phone:

**Call
Toll-Free**

1-800-257-9402
weekdays 9-5 EST.
In NJ, call
1-609-426-5535.



MORE THAN JUST FAST

How to control SCSI devices on Macs and MS-DOS machines

Some time ago, I got the documentation on SCSI from ANSI. The documentation came in a binder I was reluctant to open. It was large, and any skimming I did got me lost in pages of command descriptor blocks. I decided I'd let someone else investigate SCSI.

But then the 300-megabyte hard disk drives started rolling into the BYTE Lab for our November Product Focus. There were printers, too, and optical-character-recognition devices. And they were all SCSI. So, I decided maybe SCSI was something I should investigate after all.

This month, I'll look at what goes into building programs to talk to a SCSI port. I hope you can take this information and carry it on to more sophisticated applications. And make no mistake, SCSI will let you get as sophisticated as you can bear.

You probably think (as I originally did) that the only place you'll see a SCSI bus is between a computer and some storage device—usually a hard disk drive or a tape drive—but I have seen SCSI ports tacked onto more and more peripherals. I've already mentioned some. My favorite, however, was a device that lets you connect a large-screen color video monitor to a Mac Plus through the SCSI port.

SCSI and the Mac

Macintoshes, beginning with the Mac Plus, have included a built-in SCSI port for attaching hard disk drives. Although the internal details of the SCSI hardware have changed (more on this later), externally the SCSI connection looks much

the same on all Macs. There are some minor variations regarding power for terminating resistors, but most Mac-compatible SCSI peripherals are designed to work across the Mac line.

From the perspective of a programmer, the Mac Toolbox provides a remarkable amount of "precooked" support software. Table 1 shows a list of the functions offered by the Macintosh's SCSI manager. Communicating with a SCSI device involves a detailed series of phase transitions that your driver software must cope with. The SCSI manager will do much of that coping for you.

In particular, the manager includes routines for reading and writing data to a target device: SCSIRead and SCSIWrite (also, SC SIRBlind and SCSIWBlind—the "blind" I/O routines, which I will cover in a moment). When you ask the SCSI manager to execute a SCSIRead or SCSIWrite, you also pass in the address of a transfer instruction block, which is actually a series of instructions in a kind

of pseudo assembly that the manager interprets and executes.

This pseudosubroutine tells the manager what to do with the bytes being transferred: how many there are, the buffer address in the Mac's memory to read from or write to, whether to do a byte-by-byte comparison while the data is incoming, and more. I've given a more detailed discussion of the SCSI manager routines in the March *Some Assembly Required*, "Foreign File Systems."

Differences and Details

All members of the Mac family (beginning with the Mac Plus) use at least some version of the NCR 5380 SCSI chip as the heart of their SCSI port. As with any family, though, the siblings have their differences. In the Mac family, these differences are in the hardware, which translates into differences in any software you build that has to talk to the SCSI port.

The difference between regular and

MACINTOSH SCSI MANAGER FUNCTIONS

Table 1: Notice that the SCSI manager handles the protocol details for common I/O—reading and writing—so you don't have to.

0	SCSIReset. Resets the SCSI bus.
1	SCSIGet. Manages the arbitration phase.
2	SCSISelect. Selects a target for future SCSI communications.
3	SCSICmd. Lets you pass a SCSI command to the SCSI bus.
4	SCSIComplete. Returns status and message information at the completion of a SCSI command.
5	SCSIRead. Reads bytes from a SCSI target.
6	SCSIWrite. Writes bytes to a SCSI target.
8	SCSIRBlind. Reads bytes from a SCSI target. Unlike SCSIRead, SC SIRBlind performs no handshaking. It's not a good idea on the Mac Plus.
9	SCSIWBlind. Writes bytes to a SCSI target without handshaking.
10	SCSIStat. Returns a 16-bit word whose bits reflect the condition of various SCSI signals.
11	SCSISelAtn. Identical to SCSISelect, with the exception that this command sets the SCSI ATN line. This signals the target device that you want to send it a message.
12	SCSIMsgIn. Receives a message from a target device.
13	SCSIMsgOut. Sends a message to a target device.

NCR 5380 REGISTERS

Table 2: A short description of each of the 5380's internal registers.

Current SCSI data: A read-only register that provides a snapshot of the current state of the SCSI data bus.

Output data: This write-only register is your program's portal to the SCSI data bus.

Input data: Provides latched data from the SCSI bus. This is distinct from the current SCSI data register, which simply reads the bus's current state. Data is latched into this register in response to an active-going signal on either the SCSI ACK or REQ lines (depending on whether the 5380 is in the initiator or the target mode; ACK is driven by an initiator, and REQ is driven by a target).

Initiator command: You can read and write this register. In read mode, it lets you monitor most of the SCSI bus status signals. Information gleaned from this register will also tell you whether arbitration is in progress and whether you've lost arbitration. In write mode, you can set most of the SCSI bus status signals. One bit in this register controls gating the output data register onto the data bus.

Mode: This is also a register that you can read and write to. As the name implies, flags in this register control the behavior of the chip: whether it's acting as target or initiator, whether DMA mode is active, and whether parity checking is enabled. Other bits in this register enable interrupts for the chip: parity error interrupt and end-of-process interrupt (used to signal the completion of a DMA transfer).

Target command: Yet another readable and writable register, it monitors those signals on the SCSI bus that determine the current bus phase. A target device would write to this register to set bus phases.

Current SCSI bus status: A read-only register whose contents reflect the current state of the SCSI bus status signals. Signals coming in through this register that indicate the current bus phase must match those you've written into the target command register before some bus transactions can proceed.

Select enable: A write-only register that lets you mask out a single ID during a selection phase. Simply put, you can use this register to trigger an interrupt if you attempt a selection to a specific target and the selection succeeds.

Bus and status: This read-only register returns the state of status signals not covered by the current SCSI bus status register. You can also monitor several internal states using this register—if a DMA transfer has completed, for example.

Note: *The remaining four registers are not registers in the true sense; there is nothing "in" them. Rather, an I/O operation on these locations triggers a specific event.*

Start DMA send: A write operation to this register begins a DMA send operation.

Start DMA target receive: Writing to this location causes the 5380 to begin a DMA receive operation in target mode.

Start DMA initiator receive: Same as the above register, only the 5380 acts as an initiator.

Reset parity/interrupt: This is a read-only register. A read operation to it resets the parity error bit, the interrupt request bit, and the busy error bit in the bus and status register.

blind I/O routines on the Mac Plus is obvious: The first mode is very picky about handshaking and checks the DRQ (data request) line on the 5380 before transmitting each character; the second mode checks DRQ only at the start of the transfer. Although the regular mode is slower (because an extra fetch and comparison must take place for each byte transferred), it is "safe" when compared to the blind mode (which checks DRQ only at the outset of a multibyte transfer).

Furthermore, on the Mac Plus, there are no real handshake connections between the CPU and the 5380, other than through the read/write control and data lines. Thus, if you want to watch goings-

on on the SCSI bus, you have to monitor the 5380's internal registers.

Because the Mac SE and Mac II have hardware handshaking, their versions of SCSIrBlind and SCSIwBlind take advantage of this hardware. However, the blind versions on those machines can run aground on CPU bus errors if the bytes don't arrive quickly enough (about 270 milliseconds on the Mac SE and 16 microseconds on the Mac II).

Even if you use blind mode on the Mac Plus, you won't be violating any speed limits. You can only get up to a transfer rate of about 260K bytes per second on the Mac Plus. (In regular mode on the Mac Plus, the transfer rate is down to

around 170K bytes per second.) However, blind mode I/O on the Mac II and Mac SE/30 can crank along at over 1 MB per second.

The Mac IIfx uses a custom SCSI chip—the SCSI DMA. This circuit has a built-in 5380. Thanks to the SCSI DMA, the Mac IIfx is the first Mac that can handle true DMA transfers along the SCSI bus; all Macs before it could—at best—use CPU-assisted pseudo-DMA transfers. Even with true DMA, it's important to point out that the CPU is not entirely out of the picture. DMA transfer moves only data; driver software must continue to execute on the CPU to handle all the protocol details.

DMA transfers can be 32 bits wide (doubleword-wide) rather than byte-wide. In fact, the SCSI DMA adjusts transfers to perform them at the 32-bit width. If you try to transfer, for example, data that begins on a word—rather than a doubleword—boundary, the SCSI DMA will perform the first transfer as a 16-bit word and the remaining transfers as 32-bit doublewords.

Having pointed out all the strengths of the SCSI DMA chip, I must finally pop its balloon and point out that, under Finder and MultiFinder, the DMA capabilities of that chip provide no real performance win. You'll get a speed advantage only when you're using a preemptive operating system—A/UX, for example. Happily, most SCSI software will run as is on the SCSI DMA (Apple's documentation indicates that software that uses hardware handshaking will have to be modified).

NCR 5380

The SCSI bus is really nothing more than a special-purpose bidirectional parallel interface. It doesn't take a great deal of hardware to put together a SCSI. In fact, I've seen some IBM SCSI cards that are not much more than bidirectional bus transceivers. These interface cards required software drivers that carried all the intelligence; that is, the software handled all the details of the protocol (e.g., when to set this bit and when to look for an active condition on that line).

I believe it was Don Lancaster who, in a *Kilobaud Microcomputing* article, said that the most efficient microcomputer solutions aren't all software and aren't all hardware; they are a proper combination of both. Enter the NCR 5380.

The NCR 5380 is much more than a parallel-interface adapter chip; it is specifically designed to support the SCSI bus. The 5380 has special on-chip high-current drivers that permit you to wire it

directly to the SCSI bus. The only additional components needed are terminating resistors that SCSI cabling demands.

The NCR 5380's critical internal organs are its registers. There are 13 registers on the chip; some you can only read, some you can only write, and three you can read or write. I don't think a painfully complete table of the registers and their contents would be worthwhile here. It will be more informative if I present them in the context of a SCSI data transfer example. For your convenience, table 2 gives a short description of each member of the 5380's register set. If you want a more intricate description of the 5380, see the May and June 1986 BYTE Circuit Cellar columns.

Life as Seen by the 5380

A good way to get an idea of using the 5380 is to step through the different bus phases, examining how you must set—and respond to—the 5380's registers. I'll assume that the 5380 is connected to a host as an initiator. I'll also assume that the SCSI transaction that's about to take place is a simple one, consisting of the following phases (in order):

1. Arbitration
2. Selection
3. Command out
4. Data in or data out
5. Status
6. Message in

As you will see, there's also a possible message-out phase that can take place between steps 2 and 3. Before the arbitration phase and after the message-in phase, the SCSI bus is said to be in the "bus free" phase.

Arbitration is where contenders vie for the right to use the bus. In the simplest case—a host computer talking to one or more disk drives—this is no big deal. There's no one else to fight over the bus with. First stop: the mode register.

As its name implies, you use the mode register of the 5380 to set the chip's personality. Flags in this register control items like the following: whether the chip is operating as initiator or target, whether DMA is active, and whether interrupts are enabled.

To enter arbitration phase, you clear bit 0 of the mode register (the arbitration bit), load your SCSI ID into the output data register, and flip the arbitration bit to 1. That last flip sends your SCSI ID out on the data bus and starts arbitration.

Your next job is watching for bit 6 of the initiator command register to spring to a 1. This is the arbitration-in-progress

bit, and it indicates when the 5380 has recognized that an arbitration phase is in the works. Once bit 6 is a 1, you look at bit 5 in the same register; bit 5 is the lost arbitration bit. If it's set, you've been beaten by someone else with a higher SCSI ID, and you'll just have to wait for the bus to become free again. Otherwise, you win, and you're allowed to go on to the next phase.

Now that you've won the arbitration, it's time to decide whom you want to talk

to. This is the selection phase. When you pick whom you'll be conversing with, you've got to mention who you are as well. (This is to support reselection, which I won't get into here. It lets the initiator and target break their connection—letting others use the SCSI bus—while the target completes some time-consuming task. The understanding, of course, is that the initiator and target will renew their transactions in the future.)

To start the selection phase, you set



PC Proof. The People's Choice for Better Writing.

AT LAST.

PERFECT PROPOSALS,
PROFESSIONAL LETTERS
AND PRIZEWINNING
PRESENTATIONS.

Grin the wicked grin of confidence. Get to the point. Organize. Never worry about mistakes in spelling or usage.

PC Proof is fully interactive and easy to use. Corrections are made instantly and the original document is updated, with no separate printouts to review.

Whether it's a business proposal, a letter or manual, a contract or a speech, PC Proof can help you refine your writing until it's letter perfect.

PC Proof. Proofreading and text-revision software for IBM and compatibles by Lexpertise. Now for only \$159.00 (suggested retail price). MacProof available for Apple Macintosh. For more information, contact your local dealer or call toll free 1-800-354-5656.

PC Proof requires 640K RAM and runs on MS-DOS or PC-DOS version 2.1 or higher. PC Proof is format-compatible with Microsoft Word 3.0, 4.0, and 5.0 and WordPerfect 4.2, 5.0 and 5.1. It is text-compatible with all ASCII files. Call Lexpertise for further information on product compatibility at 1-800-354-5656.

PC Proof. YOUR ENGLISH PROOFREADER BY LEXPERTISE

SCSI INFORMATION TRANSFER PHASES

Table 3: You can determine the current bus phase by watching the three SCSI status lines: I/O, C/D, and MSG.

Phase	I/O	C/D	MSG
Data out	0	0	0
Command out	0	1	0
Message out	0	1	1
Data in	1	0	0
Status	1	1	0
Message in	1	1	1

READ AND WRITE COMMAND BLOCKS

Table 4: SCSI command blocks for read and write operations. Block numbers are 21-bit values. The command format shown is for group 0 commands; the group 1 versions of the commands allow for 32-bit block numbers and 16-bit transfer sizes.

Byte offset	Description
0	Operation code; 8 for a read command, 10 for an operation mode.
1	Logical unit number in high 3 bits combined with the most significant 5 bits of the block number in bits 0 through 4.
2	Bits 8 through 15 of the block number.
3	The least significant 8 bits of the block number.
4	The number of blocks to transfer.
5	Various flags. The top 2 bits are vendor-unique. The low 2 bits control command linking, which lets your program construct a series of commands that are logically treated as a single operation.

the bits corresponding to both IDs. The result goes into the output data register on the 5380. You then set bit 0 (assert data bus) and bit 2 (assert select) of the initiator command register. This places the ID onto the data bus and turns on the selection bit. Immediately, you turn off the arbitration bit (by clearing bit 0 in the mode register), disable the select enable register (by filling it with zeros), and clear the BSY line by clearing bit 3 of the initiator command register.

Now you wait. The target, if it's there, should set the BSY line in about 250 ms. You monitor this line by polling bit 6 of the current status register. If it goes active, you've got a partner. Otherwise, it's time to jump to an error handler.

Assuming you've linked up with a target, you clear all the bits of the initiator command register except for bit 3, which keeps the BSY line active.

Next comes "Command out," which says, "Here's what I want you to do." (The SCSI protocol allows for any of the other phases at this point—a message-out phase is typical. The message-out phase lets the host send a message to the target. SCSI defines a number of message codes, ranging from the simple [e.g., "com-

mand completed successfully"] to the complex [e.g., "can you support synchronous data transfers?"]. The Mac, however, is atypical, and most targets skip directly to the command-out phase. I'll stick to the Mac as the host here.)

In this and the remaining phases, your job as initiator is the job of a servant; what you do—whether you send or receive—is selected by the target. (Seems backward, I agree, but I didn't write the standard.) You can determine the bus phase by watching bits 2 through 4 of the current SCSI bus status register. These bits reflect the condition of the SCSI bus I/O, C/D, and MSG lines, which in turn determine the current bus phase. (Table 3 shows status line settings and associated bus phases.) Additionally, you must set the low 3 bits of the 5380's target command register to reflect their counterparts in the current status register.

The rest is simply a repeated four-step process. Assuming you're in the command-out phase, it goes like this:

Step 1: Place the data byte to be sent in the output data register.

Step 2: Poll the current status register, waiting for bit 5 (REQ) to go active. This

indicates that the target is requesting a byte.

Step 3: Set bit 4 of the initiator command register, turning on ACK and informing the target that the requested byte is on the bus.

Step 4: Poll the current status register, waiting for REQ to go inactive. When it does, you know the target has received the current data byte and is ready for the next. Turn off ACK, return to step 1, and repeat the process for the number of bytes you need to send.

During a command phase, the bytes you send down the SCSI bus in the above steps constitute the command descriptor block. Depending on the command type, the CDB can be 6, 10, or 12 bytes long. (Since the first byte of the CDB is the command code, the target can immediately determine how many bytes to expect during the command-out phase.) In table 4, I have shown the format of the 6-byte command versions for read and write operations.

The other phases—data in, data out, status, and message in—proceed just like the command phase. The only operational difference is the setting of the three SCSI status lines (MSG, C/D, and I/O). Finally, each phase I haven't mentioned yet serves a separate purpose; here are their typical uses:

Data in: Data requested with a read command is transferred from the target to the initiator.

Data out: The host has issued a write command; during the data-out phase, the data passes from the initiator to the target.

Status: The target sends a status byte to the initiator. It's hoped that the contents of the status byte indicate that the target has successfully completed the command.

Message in: The reverse of the message-out phase described above. The target sends a message to the initiator. The pseudocode in listing 1 should clarify the machinations of the SCSI phases I've described. There are three pseudoroutines in the listing that show arbitration, selection, and data transfer phases.

DOS and ASPI

The preceding discussion of the Mac and 5380 should have you seasoned for a visit to the DOS world. I will use Adaptec's advanced SCSI programming interface (ASPI) as a segue into SCSI programming on PC clones.

ASPI seeks to simplify the job of talking to a SCSI port; in a lot of ways, it's a

Listing 1: *These pseudocode routines show how to pilot the 5380 through fundamental SCSI operations. They presume the presence of a number of functions named after the 5380's registers (see table 2). These functions let you manipulate bits within the 5380's registers. For example, translate SCSI_MODE(ARBITRATE,SET); to mean "set the arbitrate bit in the 5380's mode register." These routines assume that you're operating as an initiator.*

```

{ This routine handles the arbitration phase and assumes
  that you've already loaded the global variable MY_ID
  with your SCSI ID bit set. }
DO_ARBITRATION:
{ Clear arbitration bit, place our ID in the
  output data register, and set arbitration. }
SCSI_MODE(ARBITRATE,CLEAR);
SCSI_OUTPUT_DATA:=MY_SCSI_ID;
SCSI_MODE(ARBITRATE,SET);

{ Place contents of output data register onto
  SCSI data lines. }
SCSI_INITIATOR_COMMAND(ASSERT_DBUS,SET);

{ Wait for arbitration in progress bit. }
REPEAT
WHILE(SCSI_INITIATOR_COMMAND(ARB_IN_PROG,VALUE)<>1);

{ Get result of arbitration }
RESULT:=SCSI_INITIATOR_COMMAND(LOST_ARB,VALUE)

{ Disable output data register }
SCSI_INITIATOR_COMMAND(ASSERT_DBUS,CLEAR);

RETURN(RESULT);
{ This routine selects the target device identified by
  the value stored in global variable HIS_ID. }
DO_SELECTION:

{ Logically OR together target id (HIS_ID) and
  initiator id (MY_ID). }
OUR_IDS:= HIS_ID OR MY_ID;
SCSI_OUTPUT_DATA:=OUR_IDS;

{ If you wanted to send a message to the target, you'd
  set the ATN bit in the next step. }
SCSI_INITIATOR_COMMAND(ASSERT_DBUS,SET);
SCSI_INITIATOR_COMMAND(ASSERT_SEL,SET);
SCSI_MODE(ARBITRATION,CLEAR);
{ Not generating an interrupt for the selection of
  our intended target. }
SCSI_SELECT_ENABLE:=0;

SCSI_INITIATOR_COMMAND(ASSERT_BUSY,CLEAR);

{ Wait for the BSY line to become active. This loop
  should have some sort of time-out control to handle the
  situation of an unresponsive-possibly absent-
  target. }
REPEAT
WHILE(SCSI_INITIATOR_COMMAND(ASSERT_BUSY,VALUE)<>1);

{ Turn off output data register to bus. }
SCSI_INITIATOR_COMMAND(ASSERT_DBUS,CLEAR);

RETURN;

{ The following pseudoroutine assumes global variables
  BUFADDR, which points to the start of a buffer that
  will hold the bytes received from the SCSI bus, and
  NBYTES, the number of bytes to read.
  DO_POLLED_READ reads bytes from the target using the
  polled mode; the CPU monitors the handshaking lines. }
DO_POLLED_READ:

I:=0;{ Will act as index. }

REPEAT
{ Wait for the REQ line. }
REPEAT
WHILE(SCSI_CURRENT_STATUS(REQ,VALUE)<>1);

BUFADDR[I]:=SCSI_CURRENT_DATA;
I:=I+1;

{ Handshake loop. }
SCSI_INITIATOR_COMMAND(ASSERT_ACK,SET);
REPEAT
WHILE(SCSI_CURRENT_STATUS(REQ,VALUE)=1);
SCSI_INITIATOR_COMMAND(ASSERT_ACK,CLEAR);

NBYTES:=NBYTES-1;
WHILE(NBYTES<>0);
RETURN;

```

potential PC counterpart to the Mac's SCSI manager. (I'm not endorsing ASPI, just pointing out its parallel to the Mac SCSI manager.) From what you've seen to be involved in communicating directly to the 5380 on the Mac, the concept of ASPI is a welcome one. In a capsule, the ASPI driver suffers all the timing headaches so your application doesn't have to. You simply tell ASPI what SCSI command you want executed, and it does all the rest. You don't even see arbitration phases and message phases and so on.

The ASPI routines are loaded as a device driver. You insert a DEVICE = ASPI4DOS.SYS line in your CONFIG.SYS file, and when your machine boots, the driver is loaded into RAM. (There are a number of options you can specify

when the driver loads; in the interest of simplicity, I won't go into them.) You can then access the driver using the DOS file-open function (INT 21 hexadecimal, function 3Dh). The driver's name is SCSIMGR\$, and the open call will return the handle to the ASPI driver. Next, you issue a DOS IOCTL (I/O control) read function (INT 21h, function 44h), which returns to your application with the entry point to ASPI tucked into the DS:DX registers. With the entry point in hand, you're ready to roll; you can close the driver with a DOS close (INT 21h, function 3Eh).

Calling ASPI is simply a matter of filling up a table called the SCSI request block and issuing a FAR CALL to the driver's entry point. The SRB varies

from command to command; each, however, is preceded by a header whose format I've shown in table 5. Bluntly put, the SRB holds everything ASPI needs to know to complete the current request.

ASPI decodes your command, does your SCSI dirty work for you, and returns the results to a location you've designated in the SRB. Your program has a choice of methods to use for watching for the completion of the command: polling the status byte or specifying a post routine. In polled mode, your application simply samples the status byte in the SRB. A 0 in the status field means the command is still in progress; a 1 means the command has completed successfully; anything else means something went wrong.

continued

ASPI'S SCSI REQUEST BLOCK HEADER

Table 5: The SRB varies from command to command; each, however, is preceded by this header.

Offset	Description
0	A 1-byte command code. The ASPI documentation I used defined six commands and reserved the rest.
1	A 1-byte status code. This code is returned by the ASPI driver and indicates whether the command is still in progress, completed successfully, or completed with an error.
2	A 1-byte host adapter number. ASPI supports multiple adapters in a single machine.
3	A 1-byte flags field. The ASPI documentation I used defined only one command—execute SCSI I/O request—that used this field. You set the field to zero for all other commands.
4	A 4-byte field reserved for expansion.

Posting mode lets the driver and your application operate in a multitasking fashion. If you enable posting (by setting bit 0 in the SRB's SCSI request flag) and store the address of a "post routine" in the SRB prior to calling ASPI, the driver will return control to your program before the SCSI command is completed. Your application can then proceed while ASPI does its job. When the SCSI com-

mand is completed, ASPI will call your designated posting routine. It then becomes the task of your posting routine to do any necessary cleanup work.

The documentation that I had recommended using post routines only for TSR programs and device drivers under DOS. Applications should use the polling technique. However, posting routines under a multitasking operating system (e.g.,

OS/2) should be mandatory if you expect to achieve maximum performance.

Widely read readers will recognize the SRB as being similar in function to the NetBIOS control block. As with the SRB, the NCB was the command and its attendant data all bundled in one structure that you handed to NetBIOS saying, in essence, "Here, do this."

One member of the NCB—the NCB_RETCODE field—is set to 0FFh by NetBIOS to indicate that the command associated with the NCB is "in progress." Your software polls NCB_RETCODE to determine when the command completes. A zero value in NCB_RETCODE is an "all's well" indication; anything else is an error condition.

NetBIOS also supports the idea of the post routine. In fact, post routines are critical in network applications, which must frequently operate concurrently with foreground applications. When you consider such concurrent operation, you uncover a programmer's bear trap that is also hidden in the ASPI implementation of the SRB. Specifically, once you've handed an NCB to NetBIOS, your application may not tinker with the internals

**"Writing a TSR is exceptionally easy"
... and now it's inexpensive too!**

Now you can turn Turbo Pascal programs into rock solid TSRs with ease. **TSRs Made Easy** lets you create conventional TSRs or swapping TSRs that use only 6K of RAM. **TSRs Made Easy** provides ■ TSR swapping to EMS, XMS, or disk ■ selectable hot keys ■ keyboard macros ■ unloadable TSRs ■ 8087 TSR support ■ interface to transient programs ■ ISR handling, and more.

TSRs Made Easy includes full source, complete documentation, and plenty of small example and demo programs. You pay no royalties.

"Writing a TSR. . . is exceptionally easy. The documentation is extremely readable and well done."

Computer Language, May 1990

One of programming's most formidable tasks is now very simple. . . and very affordable!

TSRs Made Easy, only \$49.

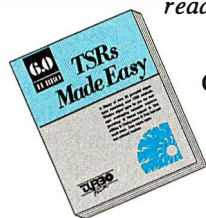

TSRs Made Easy has exactly the same TSR routines as OPro. TSRs Made Easy requires Turbo Pascal 6.0, 5.5 or 5.0. OPro requires Turbo 6.0 or 5.5. 5.25" and 3.5" disks included. Add \$5 per order for standard shipping in U.S./Canada. Call for other shipping charges. Registered owners of OPro may update to version 1.1 for \$20, include your serial number.



**New! Object Professional
for Turbo Pascal 6.0**

Object Professional version 1.1 is fully updated for Turbo Pascal 6.0. New are SAA/CUA style dialog boxes, draggable windows, XMS/EMS 4 support, and more.

Object Professional includes over 100 object types that will multiply your productivity. Included are windowing and menu systems, menu and data entry screen generators, data object types, and routines that provide swapping TSRs.

You'll get up to speed fast with clear documentation, on-line help, full source code, and hot demo programs.

"The range of objects is fantastic. Object Professional could save you man-years of effort."

Jeff Duntemann

Object Professional, only \$189.

Call toll-free to order: 1-800-333-4160

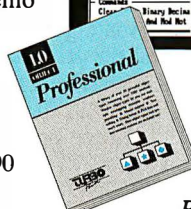
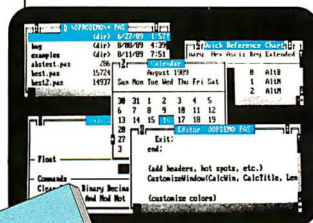

9AM-5PM PST Monday through Friday, USA & Canada.
For more information call (408) 438-8608, fax to (408) 438-8610,
or send mail to CompuServe ID 76004,2611
TurboPower Software PO Box 66747 Scotts Valley, CA 95067-0747

Power

Incredible Value!



Don't take our word for it, take theirs...

Power C Trace Debugger

"Do you know what the underground bargain C compiler of this year is? It's the Mix Power C compiler. For under \$25 with shipping, it is one heck of a good compiler."

Victor Schneider
Dr. Dobb's Journal, June 88 (Letter to the editor)

"Overall, Power C's performance is remarkable for the price. Quite compatible with the Microsoft C and Turbo C "standards", Power C is a heavyweight contender in the educational, hobbyist, and perhaps even the professional market — at a bantamweight price."

Stephen Davis
PC Magazine, September 13, 88 (Review)

"Power C is an unbelievable product for \$19.95, and is very competitive with Turbo C, Microsoft C, and Microsoft's new Quick C in both features and performance. It is excellent for the beginner who wants to learn C, or for the experienced programmer who wants to develop professional applications. The manual alone is worth the price of this package, and the generous library source code and assembler offer adds to the value of it. If you have any desire to program in C, or want a more powerful C compiler, get a copy of Power C!"

Michael Cortese
Computer Shopper, August 88 (Review)

"The Ctrace debugger is where Mix really shines. It is magnificent. It's not only better than the stripped down debugger Microsoft includes with Quick C, it's better than the full debugger Microsoft provides with its high-end compiler (Codeview)."

David Weinberger
Computer Shopper, November 88 (Review)

Circle 191 on Reader Service Card



Technical Specifications

Power C includes: Power C compiler with integrated Make, Power C Linker, Power C Libraries (450 functions), the Power C book (680 pages), and support for...

- ✓ ANSI standard
- ✓ IEEE floating point
- ✓ 8087/80287 coprocessor
- ✓ auto-sensing of 8087/80287
- ✓ automatic register variables
- ✓ unlimited program size
- ✓ mixed model (near & far pointers)
- ✓ graphics on CGA, EGA, VGA, & Hercules

Optional Products:

- ✓ Power Ctrace debugger
- ✓ Library source code
- ✓ BCD business math

Order now by calling our toll free number or mail the coupon to Mix Software, 1132 Commerce Drive, Richardson, TX 75081.

1-800-333-0330

For technical support call: 1-214-783-6001
Minimum System Requirements:
DOS 2.0 or later, 320K memory, 2 floppy drives or hard drive.
Runs on IBM PC, XT, AT, PS/2 and compatibles.

60 day money back guarantee

Name _____
Street _____
City _____
State _____ Zip _____
Telephone _____
Paying by: Money Order Check
 Visa MC AX Discover
Card # _____
Card Expiration Date _____
Computer Name _____ Disk Size 5 1/4" 3 1/2"

Product(s) (Not Copy Protected)

<input type="checkbox"/> Power C compiler (\$19.95)	\$ _____
<input type="checkbox"/> Power Ctrace debugger (\$19.95)	\$ _____
<input type="checkbox"/> Library Source Code (\$10.00)	\$ _____
(includes assembler & library manager)	
<input type="checkbox"/> BCD Business Math (\$10.00)	\$ _____
Add Shipping (\$5 USA - \$20 Foreign)	\$ _____
Texas Residents add 8% Sales Tax	\$ _____
Total amount of your order	\$ _____

B

Cloak and Data Revisited: The Winners

Regular readers of this column will recall that in the June installment ("Cloak and Data") I presented a code-cracking contest. I am happy to announce the winners of that contest; the first five win BYTE sweatshirts.

For those of you unable (or unwilling) to break the code, I'll simply say that the message was doubly encrypted. The first encryption technique was a Vernam cipher; the second was a simple 16-element knapsack cipher.

The first-place winner is Emil Wacker, a founding partner of Harcom Security Systems in New York, who began the decryption under the mistaken belief that I had used a Vignere cipher. He soon discovered that such was not the case and proceeded to put together a quick program in Debug to XOR the ciphertext with "BYTE"—an obvious choice for the first key. This got enough text deciphered so that it wasn't long before he guessed "BYTEMAGAZINE" as the complete key.

At first, Mr. Wacker didn't know that the message was doubly encrypted. He was surprised to find the string of numbers in the text and thought that they constituted the winning message that he would have to recite over the phone. More decrypting revealed that it was a message encrypted with a knapsack. He wrote a brute-force knapsack decryption program in C and ultimately refined it to execute in about 7 seconds on an IBM PS/2 Model P70.

Second place goes to the two-man

team of Peer Wichmann and Hans-Joachim Knobloch, who work at the European Institute for System Security at the University of Karlsruhe in Germany. These fellows are also members of the International Association for Cryptologic Research.

They used a Mac IICI, keyed the cryptogram in by hand, and began examining the cipher for repetitions. They found the pattern "4444" repeated frequently and determined that the greatest common divisor of the distance between instances of this pattern was 24 (which is simply the least common multiple of the key length, 12).

Knowing that the file was produced on an MS-DOS machine, they attacked the code based on the fact that <carriage return><linefeed> characters would be frequent digraphs. This ultimately led them to part of the key: "MAG." From this, they took a first guess at "BYTEMAGAZINESANNIVERSARY"—which turned out to be incorrect—and finally got "BYTEMAGAZINE."

The rest was easy for these guys. They immediately recognized a 16-element Merkle-Hellman knapsack and wrote a C program that hammered out a solution the brute-force way. The program takes about 0.8 second on the Mac IICI to decipher the text.

Third place goes to Owen Michael of Oakdale, Pennsylvania, who cracked the code using Turbo Basic on a 20-MHz 386 system. He found that the

hardest part of cracking the first level was keying in the listing as printed in the magazine. Decrypting the knapsack was simple, once he discovered his mistake of inverting the bit-ordering.

Fourth place goes to Etienne Cornu of Toronto, Ontario, Canada.

Fifth place was claimed by Douglas French of Clinton, Connecticut, who actually used Brief to inspect the code and determine the Vernam key.

Honorable mentions (in no particular order) to:

Bob Martin at the Department of Mathematics and Computer Science at Middlebury College in Vermont, who began decrypting the message on a computer at work. That evening, his son was on the home computer, so Bob finished the knapsack by hand.

Vernon Crawford, who sent in a *one-line* Vernam-cipher program written in—what else?—APL.

Benny N. Cheng, an applied statistician, who fought his way through the first level of decryption with nothing more than pen, paper, and the SideKick pop-up calculator. He conquered the second level using Scheme.

James Grinter of Lincolnshire, England, who broke the code using a 6502-based Acorn BBC microcomputer running BBC BASIC.

And to Richard Langlois of Quebec, Canada, Ton Dennenbroak of The Netherlands, Steve Tate at Duke University, and all the others who broke the code—my congratulations.

of the NCB—other than to read the contents of NCB_RETCODE—until the command has completed.

The same applies to the SRB: It becomes the property of the ASPI driver until the command defined by the SRB has finished. Consequently, if your program allocates memory to the SRB (e.g., using malloc() or the DOS memory allocation function), that SRB must remain allocated until the command has finished. . . even if the command was something simple like a SCSI reset. Failure to do so means that ASPI could go stomping through memory that *used* to be the SRB but has been allocated by some unrelated and unsuspecting program.

What's Inside

As I write this, ASPI defines six commands—the rest are reserved for either vendor-unique operations or future expansion. The defined commands are as follows:

Host adapter inquiry, which lets you determine how many SCSI adapter cards are plugged into your system. You can also retrieve a 16-character manufacturer-supplied name that is programmed into each card.

Get device type, which retrieves a device-type code (1 byte) from a SCSI peripheral device. The code indicates what sort of peripheral you're dealing with

(e.g., readable and writable hard disk drive, CD-ROM drive, or tape drive).

Execute SCSI I/O request requires that you append a SCSI CDB to the end of the SRB. ASPI will execute the command defined in the CDB and manage all the phase transitions for you. This is the real workhorse command of ASPI.

Abort SCSI I/O request is handy if you want to attach a time-out to a particular SCSI command. You pass this command the pointer to an SRB that defines an operation that is still pending completion, and the abort SCSI I/O request will pull the plug.

Reset SCSI I/O device resets a target peripheral. This is what comes from all

SOME ASSEMBLY REQUIRED

A PLEA FOR SOFTWARE THAT WORKS

these intelligent peripherals. Occasionally, one will get confused, and you've got to restart it from square one.

Set host adapter parameters is more or less a software DIP-switch block for an adapter card: You can custom-configure the card to your installation.

On the Bill

This month's source code includes offerings for both the Mac and the IBM PC. Admittedly, the programs for this month are more "experimental" than usual, but you can use them for guidance as you explore SCSI programming. For the Mac users, I've provided LLSCSI.4TH, written in Mach II Forth on the Mac. The routines included let you perform polled reads and writes using either CPU-controlled or pseudo-DMA transfers.

On the PC side, there is F83-compatible source code for SCSI read and write routines using ASPI. I've also included source code for talking to Western Digital and Future Domain SCSI controllers.

As you begin working with SCSI, expect to be daunted by the number of commands and the complexity of the bus phases. Stick with it, and once you've put together a library of working routines, you'll find it's a lot easier than you expected. The benefits are sizable, too; SCSI is a lot more than just fast. ■

Editor's note: *Listings are available in electronic format. See page 5 for details.*

FURTHER INFORMATION

Aside from the two-part Circuit Cellar article mentioned in the text, L. Brett Glass has provided a good treatment of SCSI's ins and outs in "The SCSI Bus" (February and March BYTE). Macintosh users should delve into chapter 31 of Inside Macintosh, volumes IV and V. Additionally, it wouldn't hurt to order a copy of Macintosh Family Hardware Reference (Addison-Wesley, 1987). For SCSI in general, the contact is John B. Lohmeyer, NCR Corp., 3718 North Rock Rd., Wichita, KS 67226, (316) 636-8703. You can also find SCSI-related information on the SCSI BBS at (316) 636-8700.

Rick Grehan is the director of the BYTE Lab. He has a B.S. in physics and applied mathematics and an M.S. in computer science/mathematics from Memphis State University. He can be reached on BIX as "rick_g."

Your questions and comments are welcome. Write to: Editor, BYTE, One Phoenix Mill Lane, Peterborough, NH 03458.

continued from page 420

likely to see that you've made a mistake. Likewise, a compiler can cause a program to check its own answers for reasonableness. If a pointer points to an invalid location, a variable isn't initialized, or a value falls outside a specified sub-range, run-time error-checking code can detect the problem at once.

Some languages are better than others at checking their (and your) work. C, for instance, performs only very weak static checks, and it has no facility to generate automatic run-time checks. It was a procedure in the standard C library—which failed to include a check on array boundaries—that allowed Robert Morris's worm program to enter and infect thousands of machines on the Internet two years ago.

Pascal, Modula-2, and Ada do better; they allow programmers to specify the range of values that a variable can assume. And Ada, the most robust language of the group, has built-in features to allow graceful recovery should an integrity check fail.

Alas, even these languages don't go as far as they should. Few implementations check to see that a variable is initialized before its value is used—one of the most common programming pitfalls. Nor can these languages automatically check a variable if the constraints on it are more complex than a simple maximum and minimum—if, for example, the variable *a* should always be an odd number between 3 and 17 or between 51 and 73.

Another essential feature lacking in many of today's programming tools is the ability to make certain that every straight-line path of execution is tested before the program goes out the door. Too often, it's an option none of the testers bothered to try that causes a program to fail in the real world. Programmers and testers should use a profiler—a utility that can tell which parts of a program are executed, and how often—to ensure that all the code is covered.

Finally, programming environments should provide simple ways to "bench test" individual pieces of a program. Each time a programmer writes a procedure or function, it should be possible to automatically provide that subprogram with a range of inputs and watch the output—without having to build an entirely new program for the test.

Ethics, Pride, and Programming

Many programmers have such complete faith in their ability to write bug-free programs—or are so sure that bugs will be caught during testing—that they scoff at the idea of using a language that pro-

vides automatic consistency checking. This attitude not only is highly unprofessional, but is, in a very real sense, unethical. As users trust computers to handle more and more aspects of their daily lives, it becomes increasingly important that developers supply them with reliable software. Even the best programmers make mistakes. It's hubris to believe otherwise. And, certainly, if programmers feel strongly that they produce high-quality software, they should have no fear of putting it to the test.

Some programmers may also grouse that integrity checks will slow down their code—but this, again, is a specious argument. Today's fast, cached 386s and 486s are more than 50 times as fast as the original IBM PC, and even faster chips are on the way. Wouldn't you, as a user, be willing to sacrifice 5 percent to 10 percent of your machine's performance for some convincing assurances that it was coming up with the right answers?

When hardware engineers design a new chip, they adhere to rigorous design rules at every stage of the engineering process. Then, when the work is complete, they subject their designs to exhaustive automatic tests. Software designers, by contrast, usually test their programs by allowing users to experiment with them—when they test at all. Perhaps that's why advances in software technology have been so slow in coming, while hardware performance has increased by leaps and bounds.

Now that the hardware is fast enough to shoulder the burden, it's time to start designing operating systems and languages in which software and system integrity are paramount. I want my computers to run an operating system with full memory protection and complete task isolation, developed in a type-safe language with advanced run-time consistency checks. I'm sure that anyone who uses computers for "mission-critical" tasks would agree. Companies cannot afford to lose millions of dollars every year due to software bugs. And I can't afford to wonder why Windows—said to be among the most heavily tested applications ever—crashes so often during relatively simple operations.

It's time for consumers to expect more than software that runs fast; they must demand that it run *right*. Speed is important, but it's far more important to have software that works. ■

Brett Glass is a programmer, hardware designer, author, and consultant in Palo Alto, California. He can be reached on BIX as "glass."

Intelligent multiport, supports RS-422

SmartLynx AT™ intelligent 4-port serial adapter for PC-AT and compatibles supports RS-422 and most multi-user operating systems. On-board processor takes burden off CPU.

For order info, call:
1-800-553-1170



662 Wolf Ledges Parkway
Akron, OH 44311

PC-AT is a trademark of IBM Corporation.

Circle 240 on Reader Service Card

Eight Serial Ports One Board

Quatech's ES-100 provides eight RS/232 serial ports in a single AT slot. RJ-11 modular connectors. 16450 UARTS are standard. Optional buffered 16550 UARTS. PC-AT, ISA, or EISA compatible. Priced below \$500! Quantity Pricing Available!

Call for our PC Interface Handbook:
1-800-553-1170



662 Wolf Ledges Parkway
Akron, OH 44311

PC-AT is a trademark or registered trademark of IBM Corp.

Circle 241 on Reader Service Card

RS-422/RS-485 Boards for AT, Micro Channel

RS-422/RS-485 asynchronous serial communication boards from Quatech available in 1 to 4 ports for PC-AT and compatibles and 1 to 4 ports for PS/2 Micro Channel.

Call for our free PC Interface Handbook:
1-800-553-1170



662 Wolf Ledges Parkway
Akron, OH 44311

PC-AT, Micro Channel, and PS/2 are trademarks or registered trademarks of IBM Corp.

Circle 242 on Reader Service Card

Synchronous Communication Boards for AT

Quatech synchronous/asynchronous serial boards for PC-AT and compatibles support RS-232, RS-422, and RS-485 communication.

Call for our free PC Interface Handbook:
1-800-553-1170



662 Wolf Ledges Parkway
Akron, OH 44311

PC-AT and PC are registered trademarks of IBM Corp.

Circle 243 on Reader Service Card

Communications Data Acquisition



"PC-AT (ISA) Interfaces"



"PS/2 Micro Channel Interfaces"



Phone: (216) 434-3154 • FAX: (216) 434-1409
TELEX: 510-101-2726

PC-AT, PS/2 and Micro Channel are registered trademarks of IBM Corporation.

Circle 244 on Reader Service Card

Digital I/O Board

Single-slot Quatech PXB-721 for PC-AT has 72 digital I/O lines. Connect three choices of data acquisition modules. Supports Labtech Notebook™

Call for our free PC Interface Handbook:
1-800-553-1170

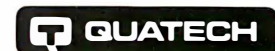

662 Wolf Ledges Parkway
Akron, OH 44311

LabTech Notebook is a trademark of Laboratories Technologies Corp.

Circle 245 on Reader Service Card

Joystick Adapter for PS/2

GPA-1000 works with IBM Micro Channel for PS/2 Models 50, 60, 70, and 80. Connect two joysticks or four paddles. Also compatible with IBM Game Control Adapter for PC-XT and AT.

Call our toll free order line:
1-800-553-1170



662 Wolf Ledges Parkway
Akron, OH 44311

IBM, Micro Channel, PS/2, PC-XT, AT, and Game Control Adapter are trademarks or registered trademarks of IBM Corp.

Circle 246 on Reader Service Card

2 parallel, 2 serial, 1 board

Quatech DSDP-402 for PC-AT has two parallel ports, and two serial ports for any combination of RS-232, 422, and 485 communication. DSDP-100, two parallel and two RS-232 ports, available at lower cost.

For order info, call:
1-800-553-1170



662 Wolf Ledges Parkway
Akron, OH 44311

Circle 247 on Reader Service Card

Wave Form 20MHz - 32K \$1290

The WSB-100 Wave Form Synthesizer Board from Quatech has the best set of numbers in the market. With speed to 20MHz and a 32K memory at \$1290, it's making waves in more ways than one. The WSB-100 is also a star performer as a digital pulse/word generator with the optional digital module.

Call for our free PC Interface Handbook
1-800-553-1170



662 Wolf Ledges Parkway
Akron, OH 44311

Circle 248 on Reader Service Card

BYTE

PRODUCT SHOWCASE

- BUYER'S MART
- BYTE BITS
- PRODUCT SPOTS
- MICRO PRODUCT CENTER
- CATALOG SHOWCASE



Catalog Showcase

The Card Shop



The Memory Board Experts at The Card Shop would like to introduce ourselves through some of our better-known associates, for example: PARITY PLUS by MEMREL, INTEL, AST, DFI—and our exciting new offer, WINDEX.

We invite you to call and talk to our knowledgeable, courteous staff about all of your memory board needs.

You'll also appreciate the Ten-Day, Money-Back Free Trial, Generous Warranties and Commitment to Excellence in all of the product lines that we carry.

1-800-346-0055 FAX 602-948-8458
Scottsdale, AZ

Circle 307 on Reader Service Card

Programmers Connection

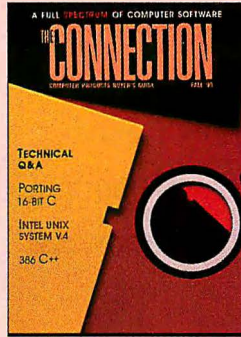

"An Indispensable reference"

THE CONNECTION is your Ultimate Buyer's Guide to the highest quality software available for your IBM PC. You'll find its easy-to-use cross references will guide you to a description of EVERY product including its system requirements, cross product compatibility, version numbers and more. THE CONNECTION is the *Only* software reference guide you'll ever need.

Call for your FREE copy!
USA 800-336-1166
CANADA 800-225-1166
FAX 216-494-5260

Circle 236 on Reader Service Card

RAD Data Communications



RAD offers quality data communication and LAN products, including: short-range modems, muxes, sharing devices, interface converters, PC products, data compressors, fiber-optics, DDS products and Token-Ring connectivity. Also included are intelligent cabling systems and routing bridges for Ethernet and Token-Ring.

For a free catalog, write or call RAD Data Communications, 151 W. Passaic Street, Rochelle Park, NJ 07662.

201-587-8822 FAX: 201-587-8847

Circle 257 on Reader Service Card

Intel Development Tools

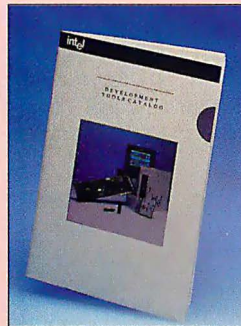

Choosing the right architecture and development support are two of the most important decisions you face today. For successful microcomputer development, Intel offers you the total solution with the most up-to-date and powerful tools available.

And we also offer you the easiest way to buy. Our Development Tools Catalog lists all our tools products in one guide. Call us at 1-800-874-6835, or FAX us at 503-696-4633 to get your free copy today.

Intel Corporation, Development Tools Operation, 5200 NE Elam Young Parkway, JF1-15, Hillsboro, OR 97124

1-800-874-6835 FAX 503-696-4633

Circle 149 on Reader Service Card

National Instruments



Free 488-page full-color catalog describing instrumentation hardware and software products for personal computers and workstations. Application software for data analysis and presentation and for collecting data using instruments and plug-in boards. Features GPIB interfaces, data acquisition and DSP boards, driver level software, signal conditioning and VXI controllers.

1-512-794-0100

Circle 199 on Reader Service Card

Specialized Products Co.



Electronic tools and test equipment

Color, illustrated 250-page catalog details comprehensive selection of toolkits, test equipment, telecom equipment and datacommunication products. Special emphasis on in-house and field service. Indexed catalog shows digital multimeters, breakout boxes, oscilloscopes, BERT testers, hand tools and extensive selection of instrument and shipping cases, plus over 50 standard tool kits. Complete specifications and prices are provided for all products.

Specialized Products Company, 31 31 Premier Drive, Irving, TX 75063 USA.

1-214-550-1923 FAX: 214-550-1386

Circle 288 on Reader Service Card

Businessland Direct

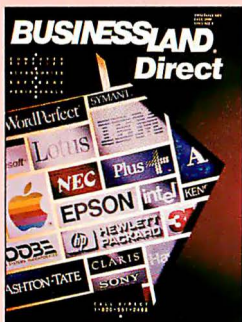

The most convenient, quick and inexpensive source for your complete business computer, supply and accessory needs. The Businessland Direct catalog features more than 1,000 products from 750 top manufacturers, with factual and comparative product information organized to help you make educated buying decisions for your company.

Call and ask for the free Businessland Direct catalog, and start getting computer product pricing and selections designed especially for business.

1001 Ridder Park, San Jose CA 95131

1-800-551-2468

Circle 56 on Reader Service Card

BYTE Catalog Showcase



Advertisers: The Catalog Showcase is the most effective low-cost way to promote your product line to an influential audience.

Call Ellen Perham for more details.
603-924-2598 FAX: 603-924-2683

Circle 349 on Reader Service Card

THE BUYER'S MART

A Directory of Products and Services

THE BUYER'S MART is a monthly advertising section which enables readers to easily locate suppliers by product category. As a unique feature, each BUYER'S MART ad includes a Reader Service number to assist interested readers in requesting information from participating advertisers.

Effective January 1, 1991.

RATES: 1 issue—\$675 3 issues—\$625 6 issues—\$600 12 issues—\$525
Prepayment must accompany each insertion. VISA/MC Accepted.

AD FORMAT: Each ad will be designed and typeset by BYTE. Advertisers must

furnish typewritten copy. Ads can include headline (23 characters maximum), descriptive text (250 characters is recommended, but up to 350 characters can be accommodated), plus company name, address and telephone number. Do not send logos or camera-ready artwork.

DEADLINE: Ad copy is due approximately 2 months prior to issue date. For example: November issue closes on September 8. Send your copy and payment to THE BUYER'S MART, BYTE Magazine, 1 Phoenix Mill Lane, Peterborough, NH 03458. For more information call Brian Higgins at 603-924-2656. FAX: 603-924-2683.

ACADEMIC COMPUTING

166 MHz PC

Proprietary technologies allow us to deliver our PC compatible workstation years ahead of the industry. Take advantage of inexpensive PC software (vs. UNIX), and the performance our platform offers, to execute applications previously run on minis and supers. We're offering the first 5000 of our 1993 production units at wholesale pricing. Educational and quantity discounts.

Eclectech, Inc.

Dept. 4142, P.O. Box 12887, Research Triangle Park, NC 27709

Inquiry 701.

ARTIFICIAL INTELLIGENCE

NeuralWorks Explorer

NeuralWorks Explorer is a neural net tutorial that provides the novice user with a method of learning neural net theory as well as an environment in which to build practical real time applications such as targeted marketing, stock prediction, process control and more. PC and MAC. Price \$199. VISA/MC accepted.

NeuralWare, Inc.

412-787-8222

Inquiry 706.

BAR CODE

PRINT BAR CODES/BIG TEXT FROM YOUR PROGRAM

Add bar codes and big graphics characters to your program. Print from ANY MS-DOS language. Bar codes: UPC, EAN, 2 of 5, MSI, Code 39. Epson, Oki, IBM dot matrix text up to 1/2". LaserJet up to 2". Font cartridges not required. \$179-\$239. 30-day \$\$ back.

Worthington Data Solutions

417-A Ingalls St., Santa Cruz, CA 95060

(408) 458-9938

(800) 345-4220

ACCESSORIES

RADIOACTIVE?

Plot it on your PC with The RM-60 RADIATION MONITOR Set at or printer port. Detects: ALPHA • BETA • GAMMA • X-RAY. MicroR, 1000 times the resolution of standard geiger counters.

Excellent for tracking RADON GAS. Find sources. Plot: • Background • Cosmic Rays • Clouds • Foods Cal/Write for PC MAGAZINE review. • TSR • GM Tube VISA/MASTER Phone orders. Not satisfied? Full refund.

Tel: (302) 655-3800

Aware Electronics Corp.

P.O. Box 4299, Wilmington, DE 19807 \$149.50

Inquiry 702.

Software Engineer Do Your Own Windows!

At last a LISP programming environment which takes advantage of a GUI and protected mode on the PC. Software Engineer™ for Windows™ 3.0 is a complete programming environment. It includes a LISP-aware text editor, allowing quick, easy and interacti e Windows development. Software Engineer supports DDE, GDI, the clipboard, dialog boxes and menus. Software Engineer is priced at \$249.95.

Raindrop Software Corporation

845 E. Arapaho, Suite 105, Richardson, Texas 75081
(214) 234-2611 Fax (214) 234-2674

Inquiry 707.

BAR CODE READERS

Keyboard emulation for PC/XT/AT & PS/2's, all clones and any RS-232 Terminal. Transparent to your operating system. Available with Steelwands, Lasers, Slot & Magstripe Readers. Same day shipping, 30-day money-back guarantee. One-year warranty. Reseller discounts available.

AMERICAN MICROSYSTEMS

2190 A Regal Parkway, Eubess, TX 76040

(800) 648-4452 (817) 571-9015 FAX (817) 685-6232

BAR CODE

LABELING SOFTWARE

On EPSON, IBM, OKI dot matrix or LaserJet. Flexible design on one easy screen. Any format/size. Up to 120 fields/label, 18 text sizes to 3*readable at 100'. AIAG, MIL-STD, 2 of 5, 128, UPC/EAN, Code 39. File Input & Scanned logos/symbols (PCX)—\$279. Other programs from \$49. 30-day \$\$ back.

Worthington Data Solutions

417-A Ingalls St., Santa Cruz, CA 95060

(408) 458-9938

(800) 345-4220

BAR CODE PRINTING SOFTWARE

- MS/PC DOS SYSTEMS
- 9 & 24 PIN DOT MATRIX
- H-P LASER JET/PLUS/SERIES II
- MENU-DRIVEN or MEMORY/RESIDENT
- CODE 39, 1 2/5, UPC A/E, EAN 8/13
- BIG TEXT & BAR CODE SOFTFOUNTS

AMERICAN MICROSYSTEMS

2190 A Regal Parkway, Eubess, TX 76040

(800) 648-4452 (817) 571-9015 FAX (817) 685-6232

CUT RIBBON COSTS!

Re-ink your printer ribbons quickly and easily. Do all cartridge ribbons with just one inkler! For crisp, black professional print since 1982. You can choose from 3 models: Manual E-Zee Inkler — \$39.50

Electric E-Zee Inkler — \$94.50
Ink Master (Electric) — \$189.00
1000s of satisfied users. Money-back guarantee.

BORG INDUSTRIES

525 MAIN ST., JANESVILLE, IA 50647
1-800-553-2404 In IA: 319-987-2976

Inquiry 703.

BAR CODE

BAR CODE READERS

For PC, XT, AT, & PS/2, Macintosh, and any RS-232 terminal. Acts like 2nd keyboard, bar codes read as keyed data. With steel wand—\$399. Top rated in independent reviews. Works with DOS, Xenix, Novell, Alloy, -ALL software. Lasers, magstripe, & slot badge readers. 30-day \$\$ back.

Worthington Data Solutions

417-A Ingalls St., Santa Cruz, CA 95060

(408) 458-9938

(800) 345-4220

BAR CODE PRINTING

Print bar codes from your custom program. ANSI C routines generate and print Code39, 125, Codabar, UPC A/E, EAN 8/13 and supplements. Supports LaserJet, OKI, and EPSON and custom printers. Works with UNIX/XENIX, MSDOS and others. All SOURCE CODE included. No royalties. Single pattern \$85. All patterns \$250.

Infinity Computer Services, Inc.

P.O. Box 269, Coopersburg, PA 18036

Voicel: 215-965-7699 BBS: 215-965-8028

Inquiry 708.

EXTENDER: Attach KB/Monitor up to 600' from CPU
COMPANION: Add a 2nd or 3rd KB/Monitor—600' from CPU
COMMANDER: Control 2 to 96 CPU's with a single KB/Monitor
PHONEBOOT: Boot or reboot PC by Phone

FREE DEALER KIT

CYBEX CORPORATION

2800-H Bob Wallace, Huntsville, AL 35805
205-534-0011 International Fax 205-534-0010

Inquiry 704.

HEWLETT PACKARD Buy — Sell — Trade

Laser Jet II/III Color Pro (7440)
Laser 2000 2 Meg/4 Meg HP-7550A
Desk Jet Draft Pro DXLJEXL
Rugged Writer Draftmaster III
Electrostatic Plotters C1600 (D Size)/C 1601 (E Size)
Science Accessories Corporation Sonic Digitizers
36" x 48" (2750) 60" x 72" (3175)

T. E. Dasher & Associates

4117 Second Ave. S., Birmingham, AL 35222
Phone: (205) 591-4747 Fax: (205) 591-1108
(800) 638-4833

Inquiry 705.

PORTABLE READER

Battery-operated, handheld reader with 64K static RAM, 2x16 LCD display, 32-key keyboard, Real-Time-Clock. Wand or laser scanner. Program prompts and data checking through its own keyboard. Easy data transfer by RS-232 port or PC, PS/2 keyboard. Doubles as On-Line Reader. 30-day \$\$ back.

Worthington Data Solutions

417-A Ingalls St., Santa Cruz, CA 95060

(408) 458-9938

(800) 345-4220

PC-Wand Bar Code Solutions

Bar codes are easy with a FULL line of readers & printers. They plug & play with your existing systems, most all makes of CPU/printer/terminal/software in your office, store, truck, factory or warehouse. Our bar code DOS programs print on matrix or laser printers. 30 day refund, 1 year warranty.

International Technologies & Systems Corp.

655-K North Berry St., Brea, CA 92621

TEL: (714) 990-1880 FAX: (714) 990-2503

Inquiry 709.

THE BUYER'S MART

BAR CODE

Introducing ASP BAR CODE READERS

- Keyboard and RS232 readers distinguished by superior wand — \$395
 - Portable reader doubles as fixed reader — \$799
 - Wand, bar code printing utility, cable and wand holder included in price.
 - Reads all major bar codes
 - Works with IBM compatible and non-standard PCs, terminals.
 - 5 years experience with bar code solutions.
- Dealer inquiries welcome.

PACIFIC MICROSYSTEMS

2560 9th Street, Suite 214M, Berkeley, CA 94710
(800) 242-5271 (415) 849-4147

Inquiry 710.

BAR CODE

VARIANT MICROSYSTEMS BAR CODE READERS DELIVER

WAND/LASER/MAGNETIC CARD CONNECTIVITY

- Keyboard wedges (Internal/External) for IBM PC/XT/AT, PS/2 and portables.
 - RS232 wedges for WYSE, Link, Kimtron terminals
 - Bar code and label printing software
 - Full two-year warranty
 - 30-Day Money-Back Guarantee
 - Extensive VAR/Dealer Discounts
- 3140 DeLa Cruz Blvd., Suite 200/Santa Clara, CA 95054/(408) 990-1880
800-666-4BAR FAX: (415) 623-1372

Inquiry 715.

CAD/CAM

CAD/CAM Developer's Kit

Save months writing AutoCAD ADS or standalone CAD/CAM applications!

(617) 628-5217

Building Block Software

PO Box 1373 Somerville, MA 02144

Inquiry 721.

BASIC CLIP MUSIC

300 Songs & Sounds + 180 Pg. Book

Besides being a fun jukebox & music source, this new version of *The Enter-tainer* teaches even more oos. basic, bat files, display tricks, & fun musical projects! Great for beginners, yet it teaches even pros how to run music behind QB or C apps. Includes source code, no royalties. 3.5" or two 5.25" disks. Money-back guarantee. Needs basic 2.0 or later. \$45 + \$4 s&h (Europe, Canada & Mexico s&h=\$8, others=\$11, 1st class air). For fast visam/corders, call: **(800) 727-4140**

POI Music Software, 1511 48th St., Boulder, CO 80303 (303) 440-4140

Inquiry 716.

5-YR. WARRANTY AT PERCON

PERCON decoders are now covered by a five-year limited warranty. That means you won't spend one cent replacing your PERCON bar code decoder for five full years. That's reliability you can count on!

PERCON

1710 Willow Creek Circle, Eugene, OR 97402-9153
Phone: (800) 873-7266 FAX: (503) 344-1399
 See our ad on page 383.

Inquiry 711.

BUSINESS

EXPERT NEGOTIATION

Learn to negotiate for success. NEGOTIATOR PRO's™ expert system analyzes personal styles, gives 27 win-win tactics and 35 key planning questions. For Mac and PC.

BEACON EXPERT SYSTEMS, INC.
\$299 MCM/ISA (617) 738-9300

Inquiry 717.

HPGL- >SOURCE.PAS

Unique full-function viewer for HPGL and automatic code generator (requires Turbo Pascal)
 HPGL- >PAS ver. 1.0 Lit. 60000 (about \$67) plus S&H. Visa/MasterCard Accepted
 DRAW with AutoCAD, DesignCAD3D, MathCad, Freelance, Orcad, etc. . . . PLOT to file; RUN HPGL- >PAS: view, zoom, pan, scale, cut. . . and ENTER: your code is ready. NEW: with source for custom output TPU, demo programs, 3.5" and 5.25" media, manual.

Ing. Marco Sillano

Via Massimi 154, 100136 — ROME, ITALY

Inquiry 722.

ENV

Prints bar coded envelopes for fast delivery
 E...easy to use. N...nationally listed by USPS. V...value packed ENV bar coded envelopes are quickly sorted and delivered by the US Post Office. Postage discounted when over 200 bar coded pieces. • Use with any Word Processor or Mail Merge package • ENV Batch, Pop-up and Mail Merge versions on disk • Print return address, special messages and logos • for HP Laserjets and EPSON LD series printers. No new equipment required. Great program for any type and size business, church, club or association. Order for MSDOS computers NOW \$49.95

Pike Creek Computer Company
 2 Galaxy Dr., Newark DE 19711-2920
 To Order: (302) 239-5113 Dealers call (800) SELL LOW

Inquiry 712.

P-C-B ARTWORK MADE EASY!

Create and Revise Printed-Circuit-Artwork on your IBM or Compatible
 • Menu Driven • Supports Mice
 • Laser Printer Artwork • Libraries
 Requirements: IBM or Compatible PC, 384K RAM, DOS 3.0 or later.
 LAYOUT • AUTO-ROUTER • SCHEMATIC
 \$99.00 ea. DEMO PKG: \$10.00

PCBoards

2110 14th Ave. South, Birmingham, AL 35205
(205) 933-1122

Inquiry 723.

PC BAR CODE SPECIALISTS

Bar code readers designed for fast, reliable, cost-effective data entry. They emulate your keyboard, so scanned data looks just like it was typed in! Choose from stainless steel wand, laser gun, card slot reader, and magnetic stripe scanner. Also, powerful Bar Code and Text printing software. Great warranty. Generous dealer discounts.

Seagull Scientific Systems
 15127 N.E. 24th, Suite 333, Redmond, WA 98052
206-451-8966

Inquiry 712.

CABLE CONVERTERS

Cable TV Converters Attention Cable Viewers

Jerrold, Zenith, Oak, Hamlin, Scientific Atlantic, Tocom, and many others.

BEST PRICES!! • 1-800-826-7623

Visa, American Express, MasterCard

B&B INC., 4030 Beau-D-Rue Dr., Eagan, MN 55122

Inquiry 718.

CD-ROM

Largest Selection and Best Price
 Microsoft Programmers Library & Drive \$949.
 Computer Library \$695 • Public Domain S/W \$49.
 NEC PC or Mac Drive Kit \$749 • Bookshelf-Best Price!

Drives from \$499. Hundreds of titles from \$29.
 MCM/ISA/AMEX/COD, Money-back Guarantee.
 Call or write for free 120-page catalog.

Bureau of Electronic Publishing

141 New Road, Parsippany, NJ 07054

800-828-4766

THE SOURCE FOR CD-ROM

Inquiry 724.

BAR CODE READERS

Among the best and most widely used bar code decoders. Reads all major codes (39, I 2/5, S 2/5, UPC/EAN/JAN, CODABAR, MSI). Connects between keyboard and system. IBM, PS/2, MAC, DEC-VT compatible. OS & software independent. Same day ship. 2 Year Warranty (pen incld).

Large Reseller Discounts

Solutions Engineering

4705 Langdrum Lane, Bethesda, MD 20815
(800) 635-6533 (301) 652-2738

Inquiry 713.

CAD

\$99 Electro-CAD \$99

- Do your own Schematics / 2xPCB's / SMT
- Rubber-Banding / Inter-trace FLOOD
- Context-sensitive Hypertext HELP
- Graphics libraries w/EDITOR
- Total control of EGA/VGA for layout

FREE DEMO DISK

AEROUX Engineering

32 West Anapoux, Suite 228, Santa Barbara, CA 93101
(805) 962-9695

Inquiry 719.

CD ROM, Inc.

CO-ROM, WORM, MAGNETO-OPTICAL DRIVES, CD-ROM DISCS FOR IBM AND MAC. OPTICAL CONSULTING SERVICES
 * PUBLISHING * DISTRIBUTION * NETWORKING
 QUALITY PRODUCTS AND SERVICES AT COMPETITIVE PRICES
 FREE CATALOG

TEL. 303-231-9373

1667 COLE BLVD., SUITE 400, GOLDEN, CO 80401
 FAX: 303-231-9581, CIS: 72007,544
 VISAMC/AMEX/GOV'T. Pds

Inquiry 725.

DATA INPUT DEVICES

Bar Code, Magnetic Stripe Readers & SmartCard Encoder/Reader for microcomputers & terminals, including IBM PS/2 & others, DEC, Macintosh, AT&T, CT, Wyse, Wang. All readers connect on the keyboard cable & are transparent to all software. UPC & 39 print programs, magnetic encoders, & portable readers are also available.

TPS Electronics

4047 Transport, Palo Alto, CA 94303
415-856-6833 Telex 371-9097 TPS PLA
1-800-526-5920 FAX: 415-856-3843

Inquiry 714.

CAD-DRAWING VIEWSTATION

Allows non-CAD users to view drawings on PCs, print, plot, attach personal notes, and hyper-link between files. Change views and layers. Accurate entity representation. Easy to use.
 • SirInn VIEW/DWG for AutoCAD DWG files: \$295
 • SirInn VIEW/PLUS for DWG, DXF, HPGL and dBase: \$395
 Developers: ask about linkable SirInn VIEW/LIB. Dealers welcome.

SirInn Computer Corporation

225 Lowell Road, Hudson, NH 03051
(603) 595-0420 Fax (603) 595-7779

Inquiry 720.

COMMUNICATIONS

PC SDLC SUPPORT

Use Sangoma hardware and software to provide a cost effective, robust and easy to use SDLC link from MS-DOS, XENIX, AIX, PIGK, PC-MOS, etc. All real time communication functions performed by intelligent co-processor card.

X.25 support also available.

Sangoma Technologies Inc.

(416) 474-1990
 7170 Warden Avenue #2, Markham, Ontario, Canada L3R 8B2

Inquiry 726.

THE BUYER'S MART

COMPUTER INSURANCE

INSURES YOUR COMPUTER

SAFWARE provides full replacement of hardware, media and purchased software. As little as \$49 a year provides comprehensive coverage. Blanket coverage; no list of equipment needed. One call does it all. Call 8 am-10 pm ET. (Sat. 9 to 5)

TOLL FREE 1-800-848-3469

(Local 614-262-0559)

SAFWARE, The Insurance Agency Inc.

Inquiry 727.

COMPUTER UPGRADE

THE COMPLETE XT UPGRADE

The K-311 Upgrade Kit converts your XT to full 32-bit, 20MHz 80386 CPU and high speed disk performance. The K-311 Kit includes 20MHz 80386 w/1Mb RAM, 16-bit Adaptec 1:1 controller, 63Mb 28Ms Mitsubishi disk drive, choice of 1.2 or 1.4Mb diskette drive, Key Tronic 101 Plus keyboard, 200 W PS, new drive cables. Matches or exceeds the performance of a new system but at far less cost. Top quality, easy installation, 1 year warranty. \$1,795

5G Corporation

4131 Spicewood Springs Road A-4, Austin TX 78759
800-333-4131 512-345-9843 Fax 512-345-9575

Inquiry 728.

CROSS ASSEMBLERS

CROSS ASSEMBLERS

Universal Linker, Librarian
Targets for 36 Microprocessors
Hosts: PC/MS-DOS, micro VAX, VAX 8000

ENERTEC, INC.

BOX 1312, 811 W. Fifth St.
Lansdale, PA 19446

Tel: 215-362-0966 Fax: 215-362-2404

Inquiry 729.

CROSS ASSEMBLERS/SIMULATORS

New unique full-function simulators for the 8096 and 80C196 controllers, featuring ALL MODES of interrupts, plus the HSI, HSG, and A/D functions.

We also support the 804849, 8080/85, 8051/52, and Z80 controllers with excellent, reasonably priced Cross Assemblers and Simulators.

Lear Com Company

2440 Kipling St., Ste. 206, Lakewood, CO 80215
(303) 232-2226 FAX: (303) 232-8721

Inquiry 730.

CROSS ASSEMBLERS

Relocatable
Macros
PC Compatible

**GUARANTEED,
SUPPORTED**

DEBUG SIMULATORS • DISASSEMBLERS
EPROM PROGRAMMERS

MICRO COMPUTER TOOLS CO.

Phone Toll Free (800) 443-0779
In CA (415) 825-4200

912 Hastings Dr., Concord, CA 94518

Inquiry 731.

Cross-Assemblers Simulators Disassemblers

PseudoCorp

See our ad on page 400.

Inquiry 732.

CROSS DISASSEMBLERS

PROFESSIONAL PC SOFTWARE

- CROSS-DISASSEMBLERS
Analytic, Automatic Label Generation
- CROSS-ASSEMBLERS
Relocatable, Macro, Universal Linker + Librarian
- C CROSS COMPILERS
- SOURCE TRANSLATION UTILITIES
Support for Intel, Motorola, Zilog, TI, RCA

Order Today: (408) 773-8465

LOGISOFT

PO Box 61829, Sunnyvale, CA 94086
FAX: (408) 773-8466

Inquiry 733.

DATA CONVERSION

CONVERTING YOUR DISKETTES? ENTRUST THEM TO US!

2500 Word Processor & Computer formats, 3 1/4", 5 1/4", 8" Disks, Mag Tapes, Mag Cards, Cartridges & Cassettes, Custom Conversions, Programming & Applications Development

**DISK DUPLICATION
OCR SCANNING SERVICES
HIGH VOLUME LASER PRINTING**

Call us for Quality, Best Prices and Quickest Turnaround Time.

COMPANY COMPENDIA, INC., 55E. Washington St., #237, Chicago, IL 60602 TEL: 312-419-6771 FAX: 312-419-1390

Inquiry 734.

MEDIA CONVERSION/DATA TRANSLATION

More than just a straight dump or ASCII transfer!

Word Processing, DBMS, and Spreadsheet data on Disks or Tapes transferred directly into applications running on Mainframes, Minis, Micros, Dedicated Word Processors, Typesetters, and Electronic Publishing systems.

IBM PS/2 & Macintosh supported
#1 in the translation industry!

CompuData Translators, Inc.

3345 Wilshire Blvd., Suite 407, Los Angeles, CA 90010
(213) 387-4477 1-800-825-8251

Inquiry 735.

DBMS/COPY

CONVERTS YOUR DATA INTO INFORMATION

Now your favorite stat package can access any database. DBMS/COPY can directly convert any database or spreadsheet file (ORACLE, PARADOX, dBASE, LOTUS etc.) into any stat package file (SAS, SPSS, SYSTAT, etc.) and vice versa. The PLUS version allows sorts, selections, and recalculations. \$195, 30-day guarantee. VISA/MC/AMEX/POCOD. Call for free limited version.

CONCEPTUAL SOFTWARE INC.

P.O. Box 56627, Houston, TX 77256
(713) 667-4222 FAX: (713) 667-3FAX
1-800-STATWOW

Inquiry 736.

☆ America's Leaders In Data Conversion ☆

DISK ⇄ DISK • TAPE ⇄ DISK
OPTICAL SCANNING

WE CONVERT MORE FORMATS THAN ANYONE ELSE!!!
IBM, DEC, VAX/VMS, APPLE, WANG, XEROX, NBI, LANIER,
CPT, UNIX, Wordperfect...

QUICK—RELIABLE—HIGHEST QUALITY

NATIONAL DATA CONVERSION INSTITUTE
5 East 16th St., NY, NY 10003 (212) 463-7511

Inquiry 737.

DATA RECOVERY

CRASHED?

Your valuable data can be recovered!

- 95% success rate • Fast turnaround
- Servicing Novell, DOS, Macintosh, Unix, Xenix, OS/2, Bernoulli and more!

ONTRACK DATA RECOVERY, INC.

Keeping you in business is our business.

1-800-872-2599

Inquiry 738.

DATA RECOVERY

DATA RECOVERY

Data lost from 1/4" cartridges of 1/2" tape can be recovered almost every time. We have helped Banks, Insurance Companies, Telephone Companies, Commodity Dealers, Hospitals, Software Houses, Government Departments. The list is endless.

We charge a small fixed fee for investigation and then on a time and materials basis.

The QICPAK Cartridge Interchange People

Vogon Enterprises Ltd.

94 Easthampstead Road, Wokingham, Berkshire RG11 2JD ENGLAND
Tel 0734-784511 or 0734-890042 Fax 0734-890040

Inquiry 739.

DATA/DISK CONVERSION

BILLIONS OF BITS CONVERTED!

Disk Interchange Service Company specializes in transferring files between incompatible computers. Our direct disk-to-disk conversion service is fast, efficient, and cost effective.

Disk Interchange Service Company

2 Park Drive • Westford, MA 01886 (508) 692-0050

Inquiry 740.

THE #1 CHOICE

In disk & tape conversion

for many leading corporations, government agencies, law firms, and companies in every industry—world-wide.

Free test • Satisfaction guaranteed

Graphics Unlimited Inc.

3000 Second St. North, Minneapolis, MN 55411

(612) 588-7571 or (612) 520-2345

FAX: (612) 588-8783

Inquiry 741.

QUALITY CONVERSIONS

to or from virtually

ANY TAPE OR DISK FORMAT!

Horan Data Services converts over 2000 formats incl. 9-track tape, 3480 Cartridge and 8", 5 1/4" or 3 1/2" diskettes. All densities & most operating systems supported. Formats include EBDCIC, ASCII, databases, spreadsheets, and dedicated or PC word processors.

Call 1-800-677-8885

Hours 8:00AM to 5:30PM Eastern Time
817 Main Street, Third Floor, Cincinnati OH 45202

Inquiry 742.

IBM PC ⇄ TO ⇄ HP FILE COPY FASTER EASIER TO USE

Update version uses windows: Call for free demo! IBM PC <to> HP File Copy allows IBM PCs, PS/2, compatibles to interchange files with Hewlett-Packard Series 70, 80, 200, 300, 1000, 9000s.

Oswego Software

Box 310 708/554-3567
Oswego, IL 60543 FAX 708/554-3573

Inquiry 743.

CONVERSION SERVICES

Convert any 9-track magnetic tape to or from over 2000 formats including 3 1/2", 5 1/4", 8" disk formats & word processors. Disk-to-disk conversions also available. Call for more info. Introducing OCR Scanning Services.

Pivar Computing Services, Inc.

165 Arlington Hgts. Rd., Dept. #B
Buffalo Grove, IL 60089 (800) Convert

THE BUYER'S MART

DATABASE

INFO-TRAK

INFO-TRAK is a new menu-driven database/cataloguer program for the professional and the beginner. Ideal for business, home inventory, collections (books, stamps, coins, artworks, etc.), investments etc. Features include SEARCH, add/delete lines, edit data, create custom formats, PRINT and more. (IBM XT, AT and compatibles, DOS 2.0 & up)

Only \$59, \$3 shipping/handling (check or money order only)

JA-DAL TECHNOLOGIES

P.O. Box 611, Yaphank, NY 11980
(NY res. add 7.5% tax)

Inquiry 744.

DATABASE MGMT SYSTEMS

SAVE TIME & MONEY!

CELOT2—THE SQL is a stand-alone database engine with a complete DB2 compatible SQL interface for developers who use BASIC, C, PASCAL, or COBOL.

- packs the full power of SQL into a 640KB PC;
- requires only 320KB RAM for program development;
- outperforms the rest!

For IBM and clones: \$195 & up. Free info.

CELOT COMPUTER SERVICES INC.

#1502, 10025-106 Street, Edmonton, AB, Canada, T5J 1G7
(403) 421-4187

Inquiry 745.

dBASE file access from C

CodeBase 4 is a library of C routines which gives complete dBASE or Clipper functionality and file compatibility. Use DOS, Unix, OS/2 or MS Windows.

\$295 with Source! FREE DEMO

Sequit Software Inc.

Call (403) 448-0313 Fax (403) 448-0315
See our ad on page 220.

Inquiry 746.

DISASSEMBLERS

80x86 .EXE/.COM to .ASM

- Accurately reconstruct, study & modify [84K+] programs with a minimum of input or editing of output.
- Assembly language output is MASM 5.x-compatible.
- Exhaustive flow-trace distinguishes code from data.
- Best formats for each. Commented BIOS calls/DOS functions. SEGMENT/PROC/other vital pseudo-ops.

PC-DISnDATA (5 1/4" disk & manual) \$165

PRO/AM SOFTWARE

220 Cardigan Road, Centerville, OH 45459
(513) 435-4480 (9 A.M.-5 P.M. EST M-F)

Inquiry 747.

NO Source? ... NO Problem for DISIDOC PROFESSIONAL

Automatically Disassembles EXE, COM, BIN, SYS, PGM files and ROM or RAM memory with interactive ability to change code, data or comments online. Disassembles 8086 to 80486 with no file size restrictions. Built in utility program EXE Unpacker, for unpacking packed files and BIOS's Admission for disassembling BIOS's are included.

To order call (800) 336-1961 or Info (203) 953-0238

Or write: **RJSWANTEK INC.**
178 Brookside Rd., Newington, CT 06111
* Only \$249.95 MCV/ISA accepted

Inquiry 748.

DISK DRIVES

BEST BUY!!!

HD Kits for AT: Drive, Controller, Rails & Cables

40MB - MFM	- \$ 339
65MB - RLL	- 459
80MB - MFM	- 689
150MB - ESDI	- 1099

NEW, ONE YEAR WARRANTY

Jb TECHNOLOGIES, INC.

5105 Maureen Lane, Moorpark, CA 93021
(805) 529-0908 Fax (805) 529-7712

Inquiry 749.

DISK DRIVES

PS/2 DRIVES FOR PCs ATs

CompatiK/PC \$279
CompatiK/AT \$219

Built-in floppy controllers—no problem.

Supports multiple drives and formats. Lets your computer use IBM PS/2 1.4M diskettes *plus more!* Call for further information or to place an order.

VISA/MC/COD/CHECK.

Micro Solutions Computer Products

132 W. Lincoln Hwy., DeKalb, IL 60115 615/756-3411
See our ad on page 315.

Inquiry 750.

DOCUMENT CONVERSIONS

Doc-to-Doc

Quickly and cleanly convert your documents to and from WordPerfect, MICROSOFT WORD, WordStar, MultiMate, ASCII, Tandy, DeskMate Text, Lotus 1-2-3, Enable, Wang and DisplayWrite. Retain special attributes and reformatting. Doc-to-Doc gives you professional quality conversions at a consumer price — \$99.

The MCS Group

2465 W. Chicago St., Rapid City, SD 57702
(605) 341-2166

Inquiry 751.

EDUCATION

B.S. & M.S. In COMPUTER SCIENCE

The American Institute for Computer Sciences offers an in-depth correspondence program to earn your Bachelor of Science and Master of Science degrees in Computer Science at home. B.S. subjects covered are: MS/DOS, BASIC, PASCAL, C, Data File Processing, Data Structures & Operating systems. M.S. program includes subjects in Software Engineering and Artificial Intelligence.

AMERICAN INST. for COMPUTER SCIENCES

2101-BY Magnolia Ave. South, Ste. 200, Birmingham, AL 35205
800-767-2427 205-323-6191

Inquiry 752.

ENTERTAINMENT

WHERE ADULTS COME TO PLAY! ACCESS LA! BBS

- Designed for Adult modem users • Low cost local access numbers covering 850 cities! • Live online chat with other users! • Large software file library! • "Bulletin board" style Forums! Interactive online games! • Matchmaker dating database! • And much, much more. 24 hours a day!

We also can provide your company with national BBS services. Call (818) 358-0938 for details!
Information and Signup By Modem
(818) 358-6968 (312/24 Baud, 8/N/1, Must be over 18)
Voice Information (818) 357-8570

Inquiry 753.

SHAREWARE

FOR IBM™ AND COMPATIBLES

**FREE 112 PAGE CATALOG
OVER 3000 PROGRAMS**

CALL 1-800-245-BYTE (2983)

BEST BITS & BYTES

P.O. Box 8225-B, Van Nuys, CA 91409
FOREIGN COUNTRIES SEND \$4.00 FOR SHIPPING

Inquiry 754.

YOUR PHOTO CAN BE A PUZZLE

A Great Christmas Gift!

Send Us: * Your photo(s), which will be returned
\$14.95 for 1 photo; additional photos \$2.95 each
* Specify disk size 3.5" or 5.25"
We'll Send You: * "Picture Puzzler", a VGA game for all ages, using your photo(s) and other images
* 256 color PCX file of each photo (320x200 pixels)
* Additional PCX images included
VISA / MC / COD / Check / Money Order

MICROSCAN

P.O. Box 237, Bountiful, UT 84010 (801) 292-9898

Inquiry 755.

ENTERTAINMENT

NEMESIS™ Go Master®

Go, a game of strategic elegance, has been a way of life in the Orient for over four thousand years. Many consider Go to be the secret of the Japanese business man's success. "While chess is a game of war, Go is a game of market share" (President of Nikko Hotels).

Chaos Manor 1989 User's Choice Award
BYTE 4/90, p.62

Toyogo, Inc. The Leader in Computer Go.
PO Box F, Dept. Y, Kaneohe, HI 96744
(808) 254-1166 or 1-800-TOYOGO-9

Inquiry 756.

FINANCIAL

NEVER BALANCE YOUR CHECKBOOK AGAIN!

Amazing new software instantly reads and balances your check register with a hand-held scanner. Allows you to enter hand-printed check data into your PC WITHOUT A KEYBOARD. Supports other personal financial software.

CheckScan software with premium hand-held scanner only \$289.00 (software only \$96.00).

800-762-5542 or FAX: 919-828-5196

PAI, 611 Tucker Street, Raleigh, NC 27603

Inquiry 757.

FINANCIAL SOFTWARE

BrainMaker:

"The most fascinating computer software I've ever seen... learn about this stuff!" *John Dvorak, PC Mag.* Predicts stocks, bonds, sales, inventories. Comprehensive documentation. Menus. Only \$195! Certified by Intel and Micro Devices

Free Brochure: 916/477-7481

California Scientific Software

Inquiry 758.

FLOWCHARTS

WINDOWS FLOWCHARTER \$129

RFFlow 2.0 is a professional drawing tool for flowcharts & org charts. Requires Microsoft Windows 3.0. 100 shapes auto adjust in size. Diagonal lines and curves. Auto line routing and re-routing. Click on a shape to bring up a sub-chart. Move charts to other apps. via the Clipboard. Call for free trial disk.

RFF ELECTRONICS

1053 Banyan Court, Loveland, CO 80538
Phone: (303) 663-5787 FAX: (303) 669-4889

Inquiry 759.

FORTRAN TOOLS

CLARIFY YOUR FORTRAN

- Program CLARIFY:
- Visualizes FORTRAN program control and flow
 - Brings algorithmic logic into sharp relief
 - Makes code debugging, development easier, quicker
 - Makes your documentation, QA more effective
 - Enhances program maint.
 - Delineates do loops, block ifs, nesting, transfers

IBM compat, Intra. offer: \$95 till Jan. 31, 1991

Q-KELTIC Software

9 South 450 Parkway Dr., Downers Grove, IL 60516-4734
708-985-5190

Inquiry 760.

FRAME GRABBER

FRAME GRABBERS

Publishers' VGA 256 Grey scales \$855.00

Publishers' Color 256 colors \$830.00

VGA-to-Video Adapter

VGA-TV GE/O Genlock overlay \$830.00

(Overlay text and graphics on live video

and record it on a VCR)

Manufactured in the U.S.A.

3 Year Manufacturers Warranty

THE KRUEGER COMPANY

(800) 245-2235 (602) 820-5330

Inquiry 761.

THE BUYER'S MART

GRAPHICS

YOUR PHOTOS-SUPER VGA

Integrated Images can convert your photographs, slides, and VHS or 8 mm video tapes to 640 by 480 (or 320 by 200), 256 color images. Many file formats available, including PCX, GIF, CUT and others. Prices start at \$325 per picture. Discounts for quantity orders. Call or write for more information.

Integrated Images Incorporated
P.O. Box 10021, Lansing, MI 48901
(517) 485-6636

Inquiry 762.

EGAD Screen Print

Prints contents of VGA, EGA, CGA displays on variety of dot-matrix and laser printers. Prints in gray tones or color. Crop box lets you print any region of the screen. Enlarge graphics 1 to 4 times (reduction too). Setup program for picking printer colors, etc. \$35.00 Postpaid. Call or write for free catalog.

LINDLEY SYSTEMS
4257 Berwick Place, Woodbridge, VA 22192-5119
(703) 590-8890

Inquiry 763.

IMAGE CAPTURE BOARD

Capture images from any VCR or Camcorder. Resolution up to 512 x 480 pixels; 65,536 colors or 256 shades of gray. Images saved in GIF, PCX, TIFF formats and more. For XT/AT/PS2. Includes user friendly software and user's guide. One year warranty. VGA required. Can capture from live video (eliminates need for expensive digital video). Ideal for Desktop publishing, CAD, Animation, and Pictorial Databases.

\$749 VISA/MC/AMEX/C.O.D.

PEGA Micrographics

P.O. Box 713, Westerville, OH 43081, (614) 885-1007
1-800-477-PEGA

Inquiry 764.

HARD DRIVE REPAIR

Beat the cost of replacement!

10% Off Discount **REPAIR** Coupon 10% Off

HARD DISC and FLOPPY DRIVES
FULL WARRANTY PROTECTION
Fast Turnaround • Data Recovery

jb TECHNOLOGIES, INC.

5105 Maureen Lane, Moorpark, CA 93021

(805) 529-0908 Fax (805) 529-7712

Inquiry 765.

HARD DISC DRIVES

Sales • EXCHANGE • Repair

Trade in your defective drive for NEW, with FULL WARRANTY!
TREMENDOUS SAVINGS!

TECHNICAL SUPPORT OF COURSE!

Large Inventory Hard and Floppy Drives

jb TECHNOLOGIES, INC.

5105 Maureen Lane, Moorpark, CA 93021

(805) 529-0908 Fax (805) 529-7712

Inquiry 766.

DATA RECOVERY

SALES of new, remanufactured and removable disk drives

FULL TECHNICAL SUPPORT

ROTATING MEMORY SERVICE

1506 Dell Avenue, Campbell, CA 95008

(408) 370-3113

Inquiry 767.

HARD DRIVES ASSISTANCE

HAVING HARD DRIVE PROBLEMS?
NEED TECHNICAL ASSISTANCE?

CALL THE EXPERTS AT H&W micro labs

1-800-235-0221 ext 911

HAVE YOUR MC, VISA OR AMEX READY

Inquiry 768.

HARDWARE

FREE INTERFACE CATALOG

Interfaces for IBM compatibles. Digital I/O (8255) and Analog input 8 bit resolution (0-255). Control relays, motors, lights, measure temperature, voltage. Sample interconnect circuits, BASIC programs, and I/O map are included.

John Bell Engineering, Inc.

400 Oxford Way, Belmont, CA 94002
(415) 592-8411 9am to 4pm Pacific Time

Inquiry 769.

LATEST AWARD BIOS

User definable hard drives, 101/102 keyboard and 3.5" 1.44Mb floppy support are now available in Award BIOS Ver. 3.1 for the IBM AT, 286 and 386 compatibles.

KOMPUTERWERK, INC.

851 Parkview Blvd., Pittsburgh, PA 15215

Orders: 800-423-3400

Tech: (412) 782-0384

Inquiry 770.

APPLE® II & MACINTOSH®

• Systems • Peripherals • Parts

Look for us at
COMDEX
LAS VEGAS
(the Sands
Convention Center)
Booth #N2591

Call for a CATALOG
USA & Canada:
800-274-5343
International: 617-891-6851
Fax: 617-891-3556

Save up to
50%
on Mac
CPUs.

Pre-Owned Electronics, Inc.

30 Clematis Avenue • Waltham, MA 02154

Inquiry 771.

ROM BIOS UPGRADES

For Your IBM or Compatible • A New BIOS Upgrade Will:
• Support Windows 3.0 • Support 360K, 720K, 1.2 MB & 1.44 MB Floppy Drives • User defined hard drive types • Supports VGA • Novell & Netware compatible • Expanded hard drive table • Enhanced 101/102 keyboard • 100% IBM compatible • Complete documentation • Latest version • Complete set up in ROM.

Order/Dealer inquiries Welcome Authorized Award Software Inc. Dist.
800-800-BIOS Fax 508-683-1630
800-800-2487 508-686-6468

Unicore Software

599 Canal Street, Lawrence, MA 01840

See our ad on page 257.

Inquiry 772.

APPLE • LAPTOPS • SOFTWARE

Reasonable prices on Macintosh, IBM, Compaq, HP, Everex, Toshiba, NEC, Sharp, Panasonic, Seiko, Houston Instruments, Roland, Calcomp, CD-ROMs, Scanners. All products carry manufacturer's warranty.

Microsoft Windows 3.0 \$89 • Home Lawyer 1.0 \$68

Computer Books — Over 2400 Titles

Call **UCC 213-921-8900 Fax 213-802-0831**

13738 Artesia Blvd. 150, Cerritos, CA 90701

C.O.D. Cash Only

INTERNATIONAL ORDERS WELCOME

Inquiry 773.

HARDWARE/COMPUTERS

What do you look for in board computers?

Small size? Low power? High level language? TDS9092 has LCD and keyboard interfaces, on-board multitasking, interrupts, dual serial ports, RAM, EEPROM, I/O bus and 35 I/O lines. Optional precision A-D and battery-backed RAM. A data logger can run 12 months on a small battery. Forth, the language of choice for embedded systems meets with assembler. Used world-wide for machine control, data logging, robotics and automation.

Call or fax for full details. 30-day Sale or Return. Only \$179 (25qty)
Saelig Company
1193 Moseley Rd., Victor, NY 14564
Phone (716) 425-3753 Fax (716) 425-3635

Inquiry 774.

HARDWARE/COPROCESSOR

DIGITAL SIGNAL PROCESSOR

DSP products for the IBM PC/XT/AT. Our TMS320C25 based Model 250, with extensive software, features 250 Khz multi-channel A/D and D/A, up to 192 Kwords RAM, very high throughput to PC RAM and disk, and is priced competitively with traditional Analog I/O boards. Call us about your applications.

DALANCO SPRY

89 Westland Ave., Rochester, NY 14618
(716) 473-3610

Inquiry 775.

INVENTORY MANAGEMENT

STOCK-MASTER 4.0

Commercial grade inventory management software at micro prices.

- Supports all 12 transaction types
- Trend Analysis
- Quality Control
- Multiple Locations
- Purchase Order Tracking
- Open Order Reporting
- Serial/Lot # Tracking
- Stock Status Reporting
- Activity History Analysis
- Bill of Materials
- Purchase Order Writing
- Order Entry
- Material Requirements
- On Line Inquiries

Applied Micro Business Systems, Inc.

177-F Riverside Ave., Newport Beach, CA 92663 714-759-0582

Inquiry 776.

dFELLER Inventory

Business inventory programs written in modifiable dBASE source code.

dFELLER Inventory \$150.00

Requires dBASE II or III, PC-DOS/CPM

dFELLER Plus \$200.00

with History and Purchase Orders

Requires dBASE II or dBASE III Plus (For Stockrooms)

Feller Associates

550 CR PPA, Route 3, Ishpeming, MI 49849

(906) 486-6024

Inquiry 777.

LANS

The \$25 Network

Try the 1st truly low-cost LAN

- Connect 2 or 3 PCs, XTs, ATs
- Uses serial ports and 5-wire cable
- Runs at 115K baud
- Runs in background, totally transparent
- Share any device, any file, any time
- Needs only 14K of RAM

Skeptical? We make believers!

Information Modes

P.O. Drawer F, Denton, TX 76202

817-387-3339 Orders 800-628-7992

Inquiry 778.

LAPTOP COMPUTERS

Laptop Savings

Laptops: Toshiba • Zenith • NEC • Sharp

• Epson • Mitsubishi • Compaq

Also Laptop Accessories: Modems, Fax Modems, External Drives, Portable Printers, Memory, Key Pads, Hard Drives, Batteries, and Auto Adapters.

Computer Options Unlimited

12 Malden Lane, Bound Brook, NJ 08805

Phone: 201-469-7678 (Fax: 201-469-7544)

Hours: 9am/10pm 7 days Worldwide sales

Inquiry 779.

THE BUYER'S MART

LAPTOP PERIPHERALS

LAPTOP BACKLIGHTS

Factory Installed • 90-Day Warranty
Toshiba, Amstrad, Sanyo, DG,
Kaypro, IBM, HP, etc. **\$295**

The Portable Peripherals People

Axonix Corporation
(801) 466-9797

Inquiry 780.

TOSHIBA LAPTOP ENHANCEMENTS

FAX/MODEMS: 9600/2400 bps, software, acoustic port
MODEMS, INTERNAL: 2400 bps, acoustic or serial port
MODEM, DEDICATED: 2400 bps (T1200, T1600, T3200SX)
SERIAL IO CARDS: RS232, RS422, SCSI, HPIL, Barcode
BATTERY PACKS: 12V external battery + vehicle adapter
Contact us for more information:

PRODUCT R&D Corporation (Call)
805/546-9713, Fax: 805/546-9716

Inquiry 781.

MEMORY BOARDS

YOUR SALES MESSAGE

about the special computer product or service
that you provide belongs in print.

THE BUYER'S MART
can help you reach computer professionals and
produce valuable inquiries for your company!
Call Brian Higgins for more information

603-924-3754
or
Fax: 603-924-2683

Inquiry 782.

S.S.T. MEMORY UPGRADES

IBM PS/2
2MB module—Model 50, 70 \$230
2-8MB expan. bds—Model 55, 70 \$520
COMPAQ
4MB module—DESKPRO 386/20E, 25, S \$460
4MB expan. brd—DESKPRO 386/20E, 25, S \$540
8MB single slot module—SYSTEMPRO \$1600
H P LASER JET
2MB up grades \$229
1-800-688-8993 5 YR. WARRANTY

Inquiry 783.

MEMORY CHIPS

PRICE MEETING & BEATING!

DRAMS
64K x 1-12, 10
64K x 4-80
256K x 1-15, 12, 10, 80, 70, 60
256K x 4-80
1MEG x 1-10, 80, 70, 60
INTEL/CYRIX/ITT MATH CO'S
80287F-10
80387SX, 16, 20, 25, 33
CALL DRAM COMPANY (800) 488-DRAM
P.O. Box 590127 • S.F., CA 94159 (415) 398-2987

Inquiry 784.

PROGRAMMERS' TOOLS

HYPERINTERFACE™ II

Menu Creator™ — An interactive WYSIWYG editor to
generate a menu-driven user interface for your software.
Screen Creator™ — An interactive WYSIWYG editor for
quick and easy screen design and a screen database
manager for your software. **Advanced Library** — E-
tended capability for data entry for your programs. FOR-
TRAN, Pascal, C, BASIC supported.

Avanpro Corp.
P.O. Box 969, Pacific Palisades, CA 90272
(213) 454-3866

Inquiry 785.

378 B Y T E • DECEMBER 1990

PROGRAMMERS' TOOLS

TLIB™ 5.0 Version Control

"TLIB" is a great system!" — *PC Tech Journal 3/88*.
Full-featured configuration mgmt for software profes-
sionals. All versions of your code instantly available. Very
compact, only changes are stored. Check-in/out locks,
revision merge, branching, more. Mainframe deltas for
Pansophic, ADR, IBM, Unlays. DOS \$139 (OS/2 \$195).
5-station LAN \$419 (OS/2 \$595)

BURTON SYSTEMS SOFTWARE
P.O. Box 4156, Cary, NC 27519 (919) 233-8128

Inquiry 786.

The EE-100 EPROM Emulator™

Power ul, Versatile, and Compact Prog. Tool Closed loop
operation capability from source code generation thrugh
in-circuit debugging.

STANDARD EQUIPMENT

1-EE-100 Command Unit • 2-24 pin 2716-32 Detachable
Header Cable • 2-28 pin 2764-256 Detachable Header Cable
• 1-28 pin 27512 Detachable Header Cable • 1-DeskTop
Power Supply 110V AC to 5V DC • 1-User's Guide Manual

For more information call:

CompuLynk 1-800-969-9889
180-B Tumpike Rd., Westboro, MA 01581
Tel (508) 896-3731 • Fax (508) 896-2548

Inquiry 787.

Bsupport for Btrieve®

The "Norton Util files" for Btrieve users.
Bed'it: DISPLAY, UPDATE, COPY, and DELETE.
EXPORT SDF to dBASE & LOTUS. RECOVER damaged files.
Edit/insert using Data Dictionary.
Bbug: TSR Btrieve debugger. Displays in pop-up window.
Brun: BUTIL replacement with Run-Time and C source.
Bedit/Bbug: \$120. Brun: \$150. VISAMC/COD/IFO

800/359-2721 FAX: 517/887-2366

Information Architects, Inc.
P.O. Box 4184, East Lansing, MI 48826-4184

Inquiry 788.

GW-BASIC PROGRAMMERS

Create professional programs for the IBM PC with all
the bells and whistles! Contains Subroutines & Pro-
grams. The 46 source code files include:

- Bar Menus
- Shell Sort
- ANSISYS
- Screen Manager
- Key Handlers
- "Walk" Dir Tree
- Draw Forms
- Find File
- Font Demo

1-800-345-3808 (VISAMC) Toolbox 1—\$29.00

MIPS, Inc. • Box 3072 • Hammond, LA 70404

Inquiry 789.

SPEED FORTRAN DEVELOPMENT AND CUT MAINTENANCE COSTS

FORTRAN — Finds common programming errors such as mismatched
parameter lists and common blocks, and uninitialized variables. Prints
detailed cross-references and call-tree diagrams. \$329
FORTRAN DEVELOPMENT TOOLS — includes Pretty (indents, renumbers,
changes GOTOs to IF-THEN-ELSE, etc.) and 6 more tools. \$129.
For IBM PC. Also for UNIX—ask for details.

Qubus Enterprises, Inc.

3340 Marble Terrace, Colorado Springs, CO 80906
(719) 527-1384

Inquiry 790.

• MULTITASK Real Time

• **SERIAL COMMUNICATION by Interrupt**
MTASIC® Professional was designed for the specific re-
quirements of *Scientific Laboratories* and *Robotics*
Departments. Gratis: demonstration diskette.
Available for the present, for Turbo Pascal, Turbo C,
Quick Pascal, Turbo Basic. Evaluation software for only
\$49. Price \$495 + Shipping \$20. Taxes not included.

RAMSI® International

53 rue Bernard Iske, F-92350 Plessis Robinson, FRANCE
International FAX: 33 (1) 46.32.48.37

Inquiry 791.

PROGRAMMERS' TOOLS

EDITOR WITH SOURCE \$49

A full-screen text editor, written in QuickBASIC 4.5,
with fully commented source and .EXE files. Make
any changes you like, and resell as many editors as
you want. Pay no royalties! Includes manual on
disk. Prepaid orders shipped free in U.S.

TARBELL ELECTRONICS
5881 John Avenue, Long Beach, CA 90805
(213) 423-2792

Inquiry 792.

PUBLIC DOMAIN

325 MEGABYTES Virus Free Share Ware

Dealers/Sysope/Educators. Instant IBM Shareware Library for your
Customers, user group or Students. Distributed in 25 Megabyte in-
crements on HD 1.2/1.4 diskettes. \$39.00 for first 25 Megabytes, then
add \$40.00 for each 25 Megabyte increment.

Add \$3.00 postage for each 25 Megabyte increment.

Add \$4.00/26 Meg increment for 1.44 diskettes.

Orders Only: 1-800-876-8496
Info/Tech: 1-405-524-5233

SHARE-NET

POB 12368, Okla City, OK 73157

No Surcharge for Visa/MasterCard

We gladly accept PC's from Educational, Fed/State Agencies

Inquiry 793.

FREE SOFTWARE FOR IBM® PC's

TRY US! Get our SOLID GOLD HITS—Winter 1991
edition 15/5.25" or 6/3.5" disks full of our best-
selling software—FREE! Great graphics, program-
mers utilities, desktop publishing, finance, games,
education, and catalog.

Pay only \$5.00 for shipping — VISA/MC/AMEX

SMC SOFTWARE PUBLISHERS
CALL TODAY 619-942-9995

Inquiry 794.

SOFTSHOPPE, INC.

Selected Programs, Latest Versions, As Low
as \$1.50, Same Day Shipping, and No
Minimum Order. For FREE CATALOG for
IBM PD/Shareware, CALL 800-829-BEST
(2378) or FAX 313-761-7639.

SOFTSHOPPE, INC.

P.O. BOX 3678, Ann Arbor, MI 48106-3678

Inquiry 795.

SDK85 (8 bit) and SDK86 (16 bit)

NOW AVAILABLE ONLY FROM URDA, INC. which has an
exclusive, world-wide, manufacturing and marketing license
from Intel, Inc. The URDA SDK85 and SDK86 educational
trainers and microprocessor development systems are now
furnished fully assembled and boxed with manuals. Call
URDA, Inc. for new, low prices and delivery schedules. Other
8, 16 and 32 bit systems are available.

Phone URDA, Inc.

1-800-338-0517 or 412-683-8732

Inquiry 796.

SECURITY

FIGHT PIRACY!

Since 1986, companies worldwide have been choosing Az-Tech
security products. If you demand the strongest protection available,
why not choose one of these "proven leaders":

- EVERLOCK Copy Protection/development systems are now
- EVERTRAK Software Security
- EVERKEY Hardware "Key". Software Security

For IBM and Compatibles. 30 day money back guarantee. Free info
and demo disk available.

Az-Tech Software, Inc.

305 East Franklin, Richmond, MO 64085

(800) 227-0644 (816) 776-2700

Fax: (816) 776-8398

Inquiry 797.

THE BUYER'S MART

SECURITY

THE ULTIMATE COPY PROTECTION

- Completely Menu Driven
 - Defeats all Hardware/Software Copiers
 - No Source Code Changes
 - Multiple Layering
 - No Damaged Media
 - Full Hard Disk Support
 - Unlimited Metering
 - FREE Demo Disk
- Quite Simply The Best Ways To Protect Your Valuable Software Investment*
- STOPVIEW™ STOPCOPY PLUS™**
- BBI COMPUTER SYSTEMS®** (301) 871-1094
1405 Heritage Ln., Silver Spring, MD 20906 FAX: (301) 460-7545

Inquiry 798.

COP's Copylock II

- Protects on standard diskettes
 - Cannot be copied by any device incl. Option Board
 - Fully hard disk installable
 - Normal back-up of protected programs
 - LAN-support
 - Creates safe demo version of your software
- Standard Version \$975, Automatic Version \$1950

DANCOTEC Computer

In Us: 2835 Sierra Rd., San Jose, CA 95132 408-729-8162 or 1-800-244-2545
Int'l: 2880 Bagsvard, Denmark Phone +45-44440322 Fax: -444-0722

Inquiry 799.

BIT-LOCK® SECURITY

Piracy SURVIVAL 5 YEARS proves effectiveness of powerful multilayered security. Rapid decryption algorithms. Reliable/small port-transparent security device. PARALLEL or SERIAL port. Complemented by economical KEY-LOK™ and multifeatured COMPU-LOCK™ including countdown, timeout, data encryption, and multiproduct protection. (Dos/Unix/Mac)

MICROCOMPUTER APPLICATIONS
3167 E. Otero Circle, Littleton, CO 80122
(303) 770-1917

Inquiry 800.

HANDS OFF THE PROGRAM® OPERATING SYSTEM SECURITY

Secures subdirectories, files, printers and floppies
Keyboard lock — automatic or manual
Log PC boot, program exec, file opens, login/logouts
Prevents DOS FORMAT and most viruses
Drive A: Boot Protection / Hard Disk Lock
IBM PC or 100% comp. — DOS V3.0+ — \$89.95 + \$3.75 S/H

SYSTEMS CONSULTING INC.
PO BOX 111209, Pittsburgh, PA 15238
(412) 781-5280

Inquiry 801.

SERVICES

900-258-SAVE

Call **REFUNDED** if not fully satisfied
Find out who sells the product you're looking for at the best price **BEFORE** your next mail order. **WIDE** price variations exist for even low-cost products. Our system allows you to easily find software and hardware and hear vendors sorted by price. (\$1.50/min.)

The Consumer Connection™, Inc.
PO Box 399, Princeton, MA 01517
508-464-5041

Inquiry 802.

SOFTWARE/ACCOUNTING

PC TIME CLOCK

AutoTime is an Employee Management System that allows you to turn any PC into an Electronic Time Clock. AutoTime provides Time & Attendance, Job Costing, Payroll Interface, and Labor Distribution reporting. Network compatible. Prices start at \$495. Other Business Products: Network FAX, Absence Call-In, db-EDI.

Chase Technologies

1617 Kingman Ave., San Jose, CA 95128
(408) 998-2917

Inquiry 803.

SOFTWARE/ACCOUNTING

dBASE BUSINESS TOOLS

- GENERAL LEDGER
 - ORDER ENTRY
 - JOB COSTING
 - BILL OF MATLS
 - PAYROLL
 - PURCH ORD/INVENTORY
 - ACCOUNTS RECEIVABLE
 - JOB ESTIMATING
 - SALES ANALYSIS
 - ACCOUNTS PAYABLE
- \$99 ea. + S&H

DATAMAT SYSTEMS Cred. Card-Check-COD

4876-B Santa Monica Ave.
San Diego, CA 92107 (619) 223-3344

Inquiry 804.

SOFTWARE/BUSINESS

DATA ENTRY SOFTWARE

Full featured, heads-down data entry with two-pass verification, edit language, operator stats, much more! Designed for the PS/2®, PC, XT, AT or compatibles.
PC's from \$395 LAN version available

FREE 30 day trial

Computer Keys Tel: 206/776/6443
21929 Makah Rd., Fax: 206/776-7210
Woodway, WA 98020 USA: 800/356-0203

Inquiry 805.

LOCATE HARD-TO-FIND BUSINESS AND STATISTICAL SOFTWARE

Econometrics • Biometrics • Cluster Analysis • Multivariate Analysis
• Marketing Statistics • Experimental Statistics • ANOVA • Regression
• Linear Programming • Project Planner • Forecasting & Time-Series
• Sales & Market Forecasting • Quality Control and Industrial Experiments • Parameter and Tolerance Design • And Many More!

SEND FOR FREE PRODUCT GUIDE!

Lionheart Press, Inc.
P.O. Box 379, Alburt, VT 05440
(514) 933-4918 FAX: (514) 939-3087

Inquiry 805.

StaffMinder™

Staff Administration Software — A must for all managers!
Named for its inherent ability to "keep an eye on your staff!" StaffMinder™ handles the following:

- Attendance tracking and analysis
- Vacation planning and scheduling
- Skills inventory
- Salary, review, and bonus tracking
- Compliance reporting
- Employee information

StaffMinder™ provides numerous informative reports. Free serial mouse included with each order. Simple point and click interface allows for easy implementation. **Source code available.**
List price \$395. Ask for details on current special pricing!

NEXT GENERATION SOFTWARE
Suite 1445, 3340 Peachtree Road, Atlanta, GA 30326
CALL (800) 966-0707

Inquiry 806.

SOFTWARE/BUSINESS SALES

AWARE SALES LEAD SYSTEM

More sales less time

- Customer information
- Contact history
- Create customer lists
- Write/edit/merge letters
- Follow-up lists
- Reports
- Mail labels

FREE call forms/letters

PNI
800-286-6826
V/MC \$180 + \$2.50 S/H

Inquiry 807.

SOFTWARE/ENGINEERING

ENGINEERING TOOLBOX

Scientific/Engineering Graphing & Calculation Utility. Much better than many \$500+ programs. **ONLY \$199!** Color-Graphs—Linear, log & semi-log to visually every plotter, printer and monitor. **Curve-fitting**—Generate your own equations for catalog and other data—9 equation types. **Statistics & Histograms**—Reports and Plots **Matrix Math**—From simultaneous equations to eigenvalues, complex calcs made easy. **Other Great Utilities**—Interpolation, pop-up stack calculator, filters, sorting, 3-D rotation, transforms & many other very sharp features. Imports—Lotus, DIF & ASCII data files. Support—Competent, Friendly & Free.

BDIZ Engineering Software Solutions
606, 734-7 Av. SW. Calgary, AB, T2P 3P8
Ph 403-261-3931 Fax 403-269-4196

Inquiry 808.

SOFTWARE/ENGINEERING

Affordable Engineering Software

FREE APPLICATION GUIDE & CATALOG
Circuit Analysis • Root Locus • Thermal Analysis • Plotter Drivers • Engineering Graphics • Signal Processing
• Active/Passive Filter Design • Transfer Function/FFT Analysis • Logic Simulation • Microstrip Design • PC/MS-DOS • Macintosh • VISA/MC

BV Engineering Professional Software
2023 Chicago Ave., Suite B-13, Riverside, CA 92507
(714) 781-0252

Inquiry 809.

Mass2—MASS & VOLUME CALCULATOR with MATERIALS DATABASE

Easily calculate the volume & weight of hundreds of shapes. Never need to look up material densities again! Differential and proportional comparisons made automatically. Menu driven with on-line context sensitive help. Flexible input system accepts Decimal, Fractional, and Exponential notation. For IBM PCs and Compatibles with 384K free.

DEMPSEY'S FORGE, Software Division
Rt 2 Box 407, Gladys, VA 24554

Inquiry 810.

Analog Circuit Simulation

- Macintosh and PC CAE
- Schematic Entry
- SPICE Simulator
- Model Libraries
- Monte Carlo Analysis
- Plotting/Graphics Output

Intusoft has a complete PC-based system including everything from schematic entry through SPICE simulation using extended memory to comprehensive interactive post processing. Starting at \$95 for IS-SPICE, the complete system sells for just \$790.

Intusoft
The leader in low cost, full featured CAE software

P.O. Box 6607, San Pedro, CA 90734
(213) 833-9710 FAX (213) 833-9558

Inquiry 811.

MICROSTRESS CORP.

New **MICROSAFE 2D/3D Rel. 3.**
Finite Element Analysis program for IBM PCs, MAC II Fam., and compatibles. Number of nodes, elements and conditions limited by disk space and model bandwidth (11000 d.o.f.). Color graphics support on various display cards (EGA, VGA, VEGA and Hercules) \$250. SAFECAD (bi-directional AUTOCAD interface) \$95. GRAFPLUS \$55. Plus S/H.

Accept VISA/MasterCard. Send for brochure.
P.O. Box 3194, Bellevue, WA 98009
Tel./Fax (206) 643-9941

Inquiry 812.

SIMULATION WITH GPSS/PC™

GPSS/PC™ is an MS-DOS compatible version of the popular mainframe simulation language GPSS. Graphics, animation and an extremely interactive environment allow a totally new view of your models. If you are contemplating the creation or modification of a complex system you need GPSS/PC to help you predict its behavior. Call now.

MINUTEMAN Software
P.O. Box 171/Y, Stow, Massachusetts, U.S.A.
(508) 897-5662 ext. 540 (800) 223-1430 ext. 540

Inquiry 813.

Circuit Analysis — SPICE

Non-linear DC & Transient; Linear AC.
★ Version 3B1 with BSIM, GaAs, JFET, MOSFET, BJT, diode, etc. models, screen graphics, improved speed and convergence.
★ PC Version 2G6 available at \$95.
Call, write, or check inquiry # for more info.

Northern Valley Software
28327 Rothrock Dr., Rancho Palos Verdes, CA 90274
(213) 541-3677

Inquiry 814.

THE BUYER'S MART

SOFTWARE/ENGINEERING

ACTIVE™

Versatile! • Fast! • Easy! • Thorough!
Menu driven Active filter design in 3 easy steps:
1) Specify characteristics, 2) Select real components, 3) Analyze performance.
Butterworth, Chebyshev, Bessel Realpole, etc. Full set of reports, graphs and tables.

• IBM-PC • \$745 • Call for FREE demo

Tatum Labs Inc.

3917 Research Park Dr. B-1, Ann Arbor, MI 48108
313-663-8810

Inquiry 815.

TUTSIM™, USA's #1 Program for Linear and Non-Linear Continuous System Simulation now has PERSONAL Prices for PERSONAL Use: \$129.50! Full Featured 999 block program, full text and examples. An analog computer in your "IBM compatible."

Until March 1991: \$97.50 + \$5 S&H + (in CA) State Tax. (Same program as our \$595 professional version)

TUTSIM Products, 200 California Ave., #212, Palo Alto, CA 94306; (415) 325-4800

Personal TUTSIM is not licensed for corporate use, government agencies, or classroom instruction. No PO's, COD's. No fooling!

Inquiry 816.

SOFTWARE/GEOLOGICAL

GEOLOGICAL CATALOG

Geological software for log plotting, gridding/contouring, hydrology, digitizing, 3-D solid modelling, synthetic seismogram, fracture analysis, image processing, scout ticket manager, over 50 programs in catalog. Macintosh tool! Please call, or write, for Free Catalog!

RockWare, Inc.

4251 Kipling St., Suite 595, WheatRidge, CO 80033 USA
(303) 423-5645 Fax (303) 423-6171

Inquiry 817.

SOFTWARE/GRAPHICS

FORTRAN TECHNICAL GRAPHICS

TEKMAR is a graphics library for the VGA, EGA or Tecmar Graphics Master. Similar to PLOT-10, includes WINDOW, VIEWPORT, AXIS. Support for HP, HI plotters. Curve fitting, completeplotting program. Log, semi-log, multi-axis, 3-D, contours. Jerry Pournelle (Aug 86 Byte): "As good as any I have ever seen..." Demo disks, literature available.

Advanced Systems Consultants

21115 Devonshire St. #329, Chatsworth, CA 91311
(818) 407-1059

Inquiry 817.

SEGS 2.1 Scientific Engineering Graphics System

- Logarithmic, Time/Date & Linear Axes.
- Easy Curve Fitting and Data Smoothing.
- 1-2-3 Interface & Numeric Spreadsheet.
- Supports all Video & Device Standards.
- 10 Curves with up to 16,000 points each.

Advanced Micro Solutions

3817 Windover Dr. 405-340-0697
Edmond, OK 73013 800-284-3381

Inquiry 817.

James Gleick's CHAOS: The Software™

Explore Chaos in nature for yourself, in a hands-on, visual way. Autodesks worked with James Gleick to transform some of the most famous equations from the new science of Chaos into a series of six interactive programs that let you create stunning visual patterns in high resolution color and sound. \$59.95

For IBM PC/XT/AT, PS/2 or compatibles with 640KB RAM, MS-DOS/PC-DOS, EGA/VGA

Autodesk, Inc.

2320 Marinship Way, Sausalito, CA 94965
(800) 223-2521

Inquiry 818.

380 B Y T E • DECEMBER 1990

SOFTWARE/GRAPHICS

QuickGeometry Library

All the C geometry and DXF routines you expect... and more!

(617) 628-5217

Building Block Software

PO Box 1373, Somerville, MA 02144

Inquiry 819.

FRACTAL GRAFICS

is a radical new drawing program for your PC. Create breathtaking images and scientific models interactively with your mouse. Add dramatic effects to any PCX image. On-line tutorial, extensive Guidebook, and 200+ hands-on examples help you use and understand fractals and Chaos. Only \$79. FREE Brochure!

Cedar Software

Rt Box 5140, Morrisville, VT 05661
(802) 888-5275

Inquiry 820.

The Ultimate CAD/CAM Engine

TurboGeometry Library 3.0. The most complete tool box of 2D & 3D routines available today! Over 300 routines. Surfacing, Solids, Hidden line, Volumes, Areas, Transforms, Perspectives, Decomp, Clipping, Tangents & more. 30 day guar., \$199.95 w/source S&H Incl. Foreign \$225.00. MS/PC DOS 2.0+. Turbo Pascal, Turbo C, MSC, MIX C, Zortec C++. VISA/MC, PO, Chk, USA funds only.

Disk Software, Inc.

2116 E. Arapaho Rd., #487, Richardson, TX 75081
(214) 423-7288, (800) 635-7760, FAX (214) 423-7288

Inquiry 821.

RAINDROP™

FAST, compact PrtScr Utility for end users AND developers. Hardcopy as fast as 10 secs. Average binary size - 6 kbyte. 14 video graphic standards. Scale, rotate, colorize and more. 'CALL' from user-written programs. Complete 9- & 24-pin dot-matrix, inkjet, and laserjet library \$44.95+\$3 s/h.

ECLECTIC SYSTEMS

6106 St. David Ct., Springfield, VA 22153
(703) 440-0064

Inquiry 822.

PEN PLOTTER EMULATOR

FPLLOT turns your dot matrix or laser printer into an HP pen plotter. Fast hi-res output. No jagged lines. Vary line width, color. Works with Autocad, Draflix, etc. Supports NEC P5/P6, IBM Proprietary, Epson LQ/FX, Toshiba, HP Laserjet, Okidata 29x/39x, Hercules/CGA/EGA/VGA. \$64 check/m.o./VISA/MC

Fplot Corporation

24-16 Steinway St., Suite 605, Astoria, NY 11103
718-545-3505

Inquiry 823.

GRAPHICS PRINTER SUPPORT

AT LAST! Use the PrtSc key to make quality scaled B&W or color reproductions of your display on any dot matrix, inkjet, or laser printer (incl. Postscript) in up to 64 shades of gray or 256 colors. GRAFPLUS supports all versions of DOS with IBM (incl. EGA, VGA, Super VGA), Hercules, or compatible graphics boards. Linkable/OEM versions available. \$59.95

Jewell Technologies, Inc.

4740 - 44th Ave. SW, Seattle, WA 98116
1 (800) 284-2574 (206) 937-1081

Inquiry 824.

SOFTWARE/GRAPHICS

GRAPHIC TOOLS LIBRARY

XGLIB: Very fast. User coordinates. User defined Window & viewpoints. Circles, ellipses, ovals, sectors, polygons & splines. Thick lines & arcs. Fill & hatch patterns. POLYARC engine. Plots and charts. Text scale, align. Screen print and T&R utility. All drawing and mouse functions work in Super VGA modes. Draw in bitmaps. Modes up to 1024x768x16-256. \$195. Most "C", Pascal, Fortran, MS Basic 4.0-7.1.

NOVA INC.

2500 W. Higgins Road, #1144 CALL 708-882-4173
Hoffman Estates, IL 60195 FAX 708-882-4175
See our ad on page 287.

Inquiry 825.

SOFTWARE/LANGUAGES

DRUMA FORTH-83

Break the 64K barrier without speed/space penalty. Powerful, attractively priced. '83 Standard.

- 1MB+ automated memory management
- Full OS interface, extensive utilities
- On-line documentation, ASCII/block files
- Other products: windows, modules, profiler
- IBM PC/XT/AT including 386 compatibles

FREE learn/utility disks with purchase

DRUMA INC.

6448 Hwy. 290 East E103, Austin, TX 78723
Orders: 512-323-5411 Fax: 512-323-0403

Inquiry 826.

FINAL LIQUIDATION!

IBM * Compilers, SAVE UP TO 80%!

Title	Retail Sale
COBOL V2.0 (3 1/2" & 5 1/4")	\$900 \$100
Prof. FORTRAN V1.3 (3 1/2" & 5 1/4")	\$795 \$ 90
C Compiler (3 1/2" or 5 1/4")	\$395 \$ 50
BASIC Compiler V2.0 (3 1/2")	\$495 \$ 50
Macro Assembler V2.0 (3 1/2" or 5 1/4")	\$195 \$ 40
VISA, MC, Check accepted, S and H fee \$10 per order	

THE COMPUTER PLACE, INC.

12105 Darnestown Rd. #9A Tel: (301) 330-6016
Gaithersburg, MD 20878 Fax: (301) 926-3415

Inquiry 827.

SOFTWARE/MARKETING

The "Software Success Reference Book (1987-1988)" is a MUST READ if you want to market your software products successfully. Written by David H. Bowen, publisher of Software Success™ the monthly newsletter on successfully running a software business, the Reference Book is a 265-page guide, organized by topic. Covers Lead Generation, Promotion, Pricing, Distribution, Support, etc. Only \$25. Check or Credit Card (Visa/MC/AEX).
100% Money Back Guarantee

Software Success

PO Box 9006, San Jose, CA 95157
(408) 446-2504 FAX (408) 255-1098

Inquiry 828.

SOFTWARE/MATHEMATICS

Fast WYSIWYG Editor

Leo — the best math editor available. See equations as you type. Menu and control key operation. Reads and writes TeX files.

Leo for PCs — \$199

ABK Software

4495 Ottawa Pl., Boulder CO 80303
(303) 494-4872

Inquiry 829.

MATH EDITING FOR THE PC

$$x_i^2 = \sum_{k=0}^{\infty} [x_k^{2i} (\eta)] + \left(\frac{1}{\sqrt{\alpha \pm \beta x}} \right)$$

- MathEdit constructs math equations to be inserted into WordPerfect, Word, WordStar, and others.
- WYSIWYG interface—no codes need to be learned.
- MathEdit—\$199

K-TALK COMMUNICATIONS

30 West First Avenue, Suite 100
Columbus, Ohio 43201
(614) 294-3535

Inquiry 830.

THE BUYER'S MART

SOFTWARE/MATHEMATICS

ORDINARY/PARTIAL DIFFERENTIAL EQN SOLVER

FOR THE IBM PC & COMPATIBLES

MICROCOMPATIBLES, INC.
301 Prelude Dr., Silver Spring, MD 20901
(301) 593-0683

Inquiry 831.

DERIVE®

A Mathematical Assistant

Makes math more inspiration and less perspiration! Combines the power of computer algebra with 2D & 3D plotting and a friendly menu-driven user interface. Does equation solving, calculus, trigonometry, vector & matrix algebra, and more. Derive requires a PC compatible computer & 512K memory.

Soft Warehouse, Inc.

3615 Harding Ave., Suite 505, Honolulu, HI 96816
(808) 734-5801

Inquiry 832.

SOFTWARE/MEDICAL

Medical Systems with ECS

PPM offers a complete line of medical software ranging from simple insurance claims processing to comprehensive A/R management. **PC CLAIM PLUS**—claims processing with ECS to over 100 major insurance carriers—30-day money-back guarantee. **THRESHOLD**—complete A/R, patient billing, comprehensive practice management statistics. **CLAIM NET**—Nationwide electronic claims clearinghouse transmits claims to over 100 insurance carriers. Dealer inquiries welcome. Software prices start at \$459.00.

Physicians Practice Computers

350 E. New York, Indianapolis, IN 46204
800-428-3515 317-634-8080

Inquiry 833.

SOFTWARE/SCANNERS

Optical Character Recognition

PC-OCR™ software will convert typed or printed pages into editable text files for your word processor. Works with HP ScanJet, Canon, Panasonic & most other scanners. Supplied with over 20 popular fonts. User trainable: you can teach PC-OCR™ to read virtually any typestyle, incl. foreign fonts. Proportional text, matrix printer output, Xerox copies OK. From \$99. Check VISA/MC/AmExp/COD

Essex Software Publishing, Inc.

P.O. Box 391, Cedar Grove, NJ 07009
(201) 783-6940

Inquiry 834.

SOFTWARE/SCIENTIFIC

NEW From DSI!

NLF: NonLinear Forecasting

For Chaotic Dynamical Systems.
IBM PCs & Compatibles - \$200

Dynamical Systems, Inc.

P.O. Box 35241, Tucson, AZ 85740
602-292-1962

Inquiry 835.

FREE CATALOG 800-942-MATH

MicroMath Scientific Software
Salt Lake City, UT 84121-0550

Inquiry 836.

SOFTWARE/SORT

OPT-TECH SORT/MERGE

Extremely fast Sort/Merge/Select utility. Run as an MS-DOS command or CALL as a subroutine. Supports most languages and file types including Btrieve and dBASE. Unlimited file sizes, multiple keys and much more! MS-DOS \$149. OS/2, XENIX, UNIX \$249.

(702) 588-3737

Opt-Tech Data Processing

P.O. Box 678 — Zephyr Cove, NV 89448

Inquiry 837.

SOFTWARE/UTILITIES

Duplicate Disks Fast!

DiskDupe duplicates, formats and compares disks amazingly fast—up to 200 disks an hour! Its unique RELAY feature lets you quickly duplicate lots of master disks effortlessly. And you can protect your masters by storing disk images on your hard disk. Also supports high-density formats—plus a whole lot more! \$79+S/H, Money Back Guarantee.

Micro System Designs, Inc.

4962 El Camino, Suite 204, Los Altos, CA 94022
(415) 964-2844 Fax: (415) 964-4529

Inquiry 838.

SOFTWARE/VOICE

MULTI-VOICE® TOOLS

Multi-Voice Tools is a complete development Toolkit for Pascal or "C" to access all the features of the WATSON or DIALOGIC Speech Boards. It is also a high level library of procedures to build MULTI-LINE VOICE RESPONSE systems in minutes. A powerful TELEPHONE ANSWERING program is given as an example with source code. DIALOGIC, RHETOREX, VBX \$599, WATSON \$99, Visa/MC. N w available; Fax Tool Kit.

ITI Logiclel

1705 St. Joseph E, Suite 4, Montreal, PQ, Can. H2J 1N1
(514) 861-5988

We can also write your Voice Response application programs.

Inquiry 839.

STATISTICS

Cover all the bases of design. . .

with Methodologist's Toolchest™, a comprehensive package of five programs to aid in research design and analysis. Specifically, these programs offer assistance in sampling, data collection procedures, statistical analyses, experimental design, and measurement and scaling. \$499.95+s/h. VISA, MC, AMEX, PO, Checks accepted.

The Idea Works, Inc.

100 West Briarwood, Columbia, MO 65203
1-800-537-4866 FAX 314-445-4589
Outside USA 314-445-4554

Inquiry 839.

NCSS 5.x Series — \$125

Easy-to-use menus & spread sheet. Multiple regression. T-tests. ANOVA (up to 10 factors, rep. measures, covariance). Forecasting. Factor, cluster, & discriminant analysis. Nonparametrics. Cross Tabulation. Graphics: histograms, box, scatter, etc. Reads ASCII/Lotus. Many new add-on modules.

NCSS

329 North 1000 East, Kaysville, UT 84037
Phone: 801-546-0445 Fax: 801-546-3907

Inquiry 840.

UNINTERRUPTIBLE POWER

PROTECT YOUR COMPUTER! BATTERY BACK UPS

MICRO UPS provides standby emergency power a d voltage irregularity protection! When irregularities occur, UPS kicks in immediately with the necessary power insuring continuous operation.

200 Watt #29033 \$149.00
400 Watt #29034 \$199.00

FREE CATALOG \$5.00S/H
With y ur order. Call 1-800-776-3700 or send order to:

AMERICAN DESIGN COMPONENTS
Dept. 211-120 815 Fair View Ave., P.O. Box 220, Fairview, NJ 07022

Inquiry 841.

UNINTERRUPTIBLE POWER

HOW TO PROTECT YOUR COMPUTER And Make It Last Longer

FREE money-saving literature tells you how to protect your computer and make it last longer with an uninterruptible power supply. 500VA through 18KVA models from the world's largest manufacturer of single-phase UPS.

Best Power Technology, Inc.

P.O. Box 280, Necedah, WI 54646
Toll-Free (800) 356-5794, Ext. 1799
Telephone: (608) 565-7200, Ext. 1799

Inquiry 842.

DATASAVER AC POWER BACKUP

Pro ideas reliable, affordable power protection for LAN Systems, Fileservers, CAD/CAM Systems, and all Desktop Microcomputers. Low profile, convection cooled and auto shutdown capabilities are some of the many user benefits. Highest quality. Made in the U. S. A. (Dealer, VAR, OEM inquiries welcome)

For Free Information Call or Write:

CUESTA SYSTEM CORPORATION

3440 Roberto Court, San Luis Obispo, CA 93401
(800) 332-3440 (805) 541-4160

Inquiry 843.

UTILITIES

EZ-"DISK" COPY PLUS™

UP TO 300/HR/Machine of FLAWLESS DISKETTES! on the PCs you already own! THIS IS SOFTWARE ONLY! Bypasses DOS for the utmost speed. Great for publishers, developers, MIS directors, etc. 2X+ faster than DOS. Read diskette once, then, quickly & accurately mass duplicate 5.25" & 3.5" disks on your own PC/XT/AT/etc. Formats, copies, verifies, optionally SERIALIZES & PRINTS LABELS, in 1 smooth operation. Save images to HD, more. . . Replaces dedicated hardware worth \$1000s. Only \$139 +s&H (for 1 machine); or only \$495 (NCP for up to 10 machines.) ©

EZX, 917 Oakgrove Dr. #101-B1190, Houston, TX 77058

INFO: 713/280-9900; FAX: 713/280-0525; BBS: 713/280-8180
Test/Drives, Orders (V/M/A/D), Catalogs: 1 * 800 * 800 * 2468 81290

Inquiry 844.

COPY AT TO PC—BRIDGE-IT 3.5

"CPYAT2PC" RELIABLY writes 360KB floppies on 1.2 MB drives, saving a slot for a second hard disk or tape backup. Only \$79.00 + SH
"BRIDGE-IT 3.5" is a DEVICE DRIVER supporting 3 1/2" 720KB/1.44MB drives for PC/XT/AT without upgrading DOS/BIOS. Only \$39.00 + SH
BRIDGE-IT 3.5 BUNDLED WITH INTERNAL 1.44MB DRIVE AT \$129.00 + SH

MICROBRIDGE COMPUTERS

655 Sky Way Suite 220, San Carlos, CA 94070
1-415-593-8777(CA) 1-415-593-7675 (FAX)
1-415-855-1993 (CANADA) 1-800-523-8777
0908-260-188 (UK) 4711 4020 (FRG)

Inquiry 845.

Recover deleted files fast!

Disk Explorer now includes automatic file recovery. You type in the deleted file's name. Disk Explorer finds and restores it. Disk Explorer also shows what's really on disk; view, change or create formats, change a file's status, change data in any sector. MS-DOS \$75 U.S. Check/Credit card welcome.

QUAID SOFTWARE LIMITED

45 Charles St. E. 3rd Fl.
Toronto, Ontario, Canada M4Y 1S2
(416) 961-8243

COPYWRITE

CopyWrite
Removes
Copy Protection
No more diskettes,
manuals or
codewheels. **US \$75**
1000's of products copied.

QUAID SOFTWARE LIMITED

45 Charles St. E. 3rd Fl, Dept B.
Toronto, Ontario, Canada M4Y 1S2
(416) 961-8243 Fax (416) 961-6448

THE BUYER'S MART

UTILITIES

REMOVE HARDWARE LOCKS

Software utility allows for the removal of hardware locks. Don't wait for your lock or key device to fail or be stolen.

Guaranteed to work! The following packages are available:
 PCAD \$199.00 CADKEY \$ 99.00
 MICROSTATION \$99.00 PERSONAL DESIGNER \$199.00
 MasterCAM \$250.00 SmartCAM \$250.00
 TANGO PCB \$ 99.00 CADVANCE \$99.00

PLUS SHIPPING AND HANDLING

PHONE (204) 889-4839 FAX (204) 886-3566

VISA and MASTERCARD Welcome

SafeSoft Systems Inc.

191 Kirlystone Way, Winnipeg, MB, Canada, R2G 3B6

Inquiry 846.

WINDOWS TOOLS

Hermes DDE Library

The Hermes DDE Library is a powerful library of high level routines for MS-Windows™ programmers. Hermes provides support for DDE at a much higher level than that provided in the Windows SDK. Your program attains added functionality by interacting and communicating with other Windows applications. Compared to the Windows SDK, Hermes reduces the code required to implement DDE by hundreds of lines of 'C'. Hermes is priced at \$295.

Raindrop Software Corporation

845 E. Arapaho, Suite 105, Richardson, Texas 75081
 (214) 234-2611 Fax (214) 234-2674

Inquiry 848.

WORD PROCESSING

DuangJan

Bilingual word processor for English and: Armenian, Bengali, Burmese, Euro/Latin/African, Greek, Gujarati, Hindi, Khmer, Lao, Punjabi, Russian, Sinhalese, Tamil, Telugu, Thai, Ukrainian, Viet. . . . Only \$109+\$5 s/h (foreign + \$12 s/h). Font editor included. For any IBM compatibles with dot-matrix & LaserJet printer. Demo \$9+\$1 s/h. Visa/MC

MegaChomp Company

3438 Cottman Ave., Philadelphia, PA 19149-1606
 (215) 331-2748 FAX: (215) 331-4188

Inquiry 850.

WORD PROCESSING

FARSI / GREEK / ARABIC / RUSSIAN

Hebrew, all European, Scandinavian, plus either Hindi, Punjabi, Bengali, Gujarati, Tamil, Thai, Korean, Viet, or IPA. Full-featured multi-language word processor supports on-screen foreign characters and NLO printing with no hardware modifications. Includes Font Editor, \$355 dot matrix; \$150 add'l for laser; \$19 demo. S/H in U.S. Incl'd. Req. PC, 640K, graphics, 30-day Guarantee. MCVISA/AMEX

GAMMA PRODUCTIONS, INC.

710 Wilshire Blvd., Suite 609, Santa Monica, CA 90401
 213/394-8622 Tlx: 5106008273 Gamma Pro SNM

Inquiry 849.

MULTI-WRITER™

MULTI-LINGUAL Word processor, 30+ languages! English, Eastern & Western European, Russian, Hebrew, Arabic, etc. No hardware modifications necessary! Font editor allows design & print out of custom-made characters. Customize keyboard layouts. Edits from right to left. Mail merge. Supports 9 & 24 pin printers \$ Laser Jet II. Req: IBM/PC/XT/AT/256K. Only \$200+\$12 s/h. Demo \$10 \$4 s/h. Visa/MC/Eurocheques

Summit Software Ltd.

PO Box 2265, Jerusalem, Israel 91022
 Tel: 972-2-241003 Fax: 972-2-259239

Inquiry 851.

Why You Want BATCOM!

BATCOM is a batch file compiler that transforms your .bat files to .exe files to make them faster. BATCOM extends DOS with many new commands so you can read keyboard input, use subroutines, and much more. In addition, BATCOM protects your source code. No royalties! Only \$59.95. Order today!

Wenham Software Company

5 Burley St., Wenham, MA 01984
 (508) 774-7036

Inquiry 847.

UNIVERSAL MEMORY PRODUCTS

1378 LOGAN AVE SUITE E COSTA MESA CA 92626

CALL 800-678-8648

FAX 714-751-2023

NO SURCHARGE ON VISA/MC
 PO'S FROM QUALIFIED FIRMS UNIVERSITIES
 AND GOVT AGENCIES WE SHIP COD
 M-F 7AM-5PM SAT 8AM-2PM
 20% RESTOCK FEE ON NON-DEFECTIVE

IBM PS/2 MEMORY

6450604.....\$139
 2MG MODULES FOR
 55SX, 50Z, 70E61/121
 6450608.....\$159
 2MG MODULE FOR 70A21
 6450379.....\$247
 2MG FOR 80-111/311
 6450375.....\$135
 1MG MODULE FOR 80-041
 34F2933.....\$419
 4MG MODULES
 30F5360.....\$149
 2MG KIT FOR 30-286
 6450605.....\$460
 2-8MG BOARD W/2MG
 MODEL 70 & 80
 6451060.....\$550
 4MG FOR 80-A21/A31
 34F3011.....\$920
 4-16MB BOARD W/4MB
 MODELS 70&80

SIMM SIPP MODULES

4X9-80NS.....\$355
 1X9-70NS.....\$59
 1X9-80NS.....\$53
 1X9-100NS.....\$52
 1X9-120NS.....\$51
 256X9-60NS.....\$29
 256X9-70NS.....\$24
 256X9-80NS.....\$19
 256X9-100NS.....\$17
 256X9-120NS.....\$15
**MAC/AMIGA
SIMMS**
 1X8-80NS.....\$62
 1X8-100NS.....\$55

HP LASERJET

SERIES II & IID
 1MG.....\$99
 2MG.....\$165
 4MG.....\$295
SERIES IIP & 3
 1MG.....\$100
 2MG.....\$169
 4MG.....\$299

**AST PREMIUM
1MG MODULES
ONLY \$69**

DRAM CHIPS

1MG X 1
 1MGX1-80NS.....\$5.50
 1MGX1-100NS.....\$5.25
 1MGX1-120NS.....\$5.10
256K X 4
 256X4-80NS.....\$5.75
 256X4-100NS.....\$5.50
256K X 1
 256X1-70NS.....\$2.95
 256X1-80NS.....\$1.99
 256X1-100NS.....\$1.85
 256X1-120NS.....\$1.95
 256X1-150NS.....\$1.50
64KX4
 64X4-120NS.....\$2.25
 64X4-100NS.....\$2.50
 64X4-80NS.....\$2.95
64KX1
 64X1-150NS.....\$1.05
 64X1-120NS.....\$1.50
 64X1-100NS.....\$2.00

STATIC COLUMN
 256X1-100NS.....\$2.50
 256X1-80NS.....\$3.00
 256X1-70NS.....\$3.95

MATH CO'S

IIT
 2C87-8.....\$169
 2C87-10.....\$199
 2C87-12.....\$255
 2C87-20.....\$289
CYRIX
 83D87-16.....\$289
 83D87-20.....\$329
 83D87-25.....\$429
 83D87-33.....\$519
**NEW CYRIX
FOR 386SX**
 83S87-16.....\$270
 83S87-20.....\$350
INTEL
 8087-2.....\$115
 80287-8.....\$179
 80287-10.....\$179
 80287XL.....\$220
 80387-16.....\$305
 80387-20.....\$350
 80387-25.....\$450
 80387-33.....\$549
 80387-SX.....\$299

EXPANSION- BOARDS FOR ALL PC'S

BOCA RESEARCH

BOCARAM AT..\$119
 TO 2MG EXP FOR AT,S
BOCARAM XT..\$119
 UP TO 2MG EXP FOR XT'S
BOCARAM.AT/IO+
 2-4MG W/SER & PAR \$157
BOCARAM50Z.....\$159
 2MG FOR PS2 50&60

ORCHID

RAMQUEST 16/32
 2-8MG LIM 4.0 FOR PS2
 W/SER & PAR PORT
ONLY \$299 W/2MG \$419

AST

RAMPAGE PLUS 286
 UP TO 8MG LIM 4.0 FOR AT'S
ONLY \$289 W/2MG \$399

**576K MEMORY
BOARD PC/XT'S
ONLY \$49**

TOSHIBA LAPTOP

1MG FOR T1000SE/XE \$287
 2MG FOR T1000SE/XE \$369
 2MG FOR T1200XE.....\$183
 2MG FOR T1600.....\$193
 2MG FOR T3100SX.....\$183
 4MG FOR T3100SX.....\$543
 2MG FOR T3100E.....\$183
 2MB FOR T3200SX.....\$183
 4MB FOR T3200SX.....\$583
 3MB FOR T3200.....\$274
 2MB FOR T5100.....\$193
 2MB FOR T8500.....\$183

MONTHLY SPECIALS SAVE \$\$\$

BOCARAM AT PLUS
 2-8MG LIM 4.0
ONLY \$119 W/2MG \$227

**3.5" FDD
FOR COMPAQ ONLY
1/3 HEIGHT
ONLY \$129**

**AST
RAMVANTAGE
UP TO 3MG
EXTENDED MEMORY
W/128K ONLY \$47**

**INTERNATIONAL ORDERS ACCEPTED
5 YEAR WARRANTY ON ALL PRODUCTS
CALL THE PC UPGRADE SPECIALISTS !!!**



**YOU NEED THIS UTILITY!!!
FastBreak™**

FastBreak™ - Cookie-cut, hatch, 'break' and/or 'trim' thousands of AutoCAD® entities: 3DFACES, 3DPOLYLINES, 3DLINES, SOLIDS, TRACES, ARCS, CIRCLES, LINES, POLYLINES, exploded SURFACES, MESHES, and 3D-CONSTRUCTION... and ALL within seconds in a single 'window' or 'crossing' point and pick

YES! YES! YES! - 3DFACES, SOLIDS, TRACES, surfaces, splines, 3D-meshes, and any 2D or 3D-construction can be broken and/or trimmed using FastBreak™!!!

AutoCAD® will not break or trim 3DFACES and other 3D-construction.

FastBreak™ can do the job - quickly, accurately, and reliably in any UCS. The drawing shown is SITE-3D.DWG with four enlarged insert clips added. All four inserts were made on a 386-PC using FastBreak in less than two minutes!!!

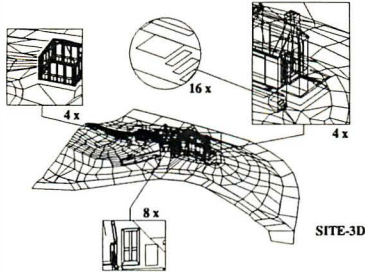

ClipView™ - is integrated into FastBreak and performs Automatic clipping or trimming of the above entities to create inserts. Options include: Box or Bubble boundaries, Inside or Outside (makes a hole) trim, and borders.

FastBreak™ and **ClipView™** are integrated into DOS executable code, run interactively in AutoCAD shells from 256K, use fast block binary database, virtual memory paging, user friendly AutoLISP® interface, and perform FAST, FAST, FAST in any AutoCAD Rel. 9 through Rel 10-386.

FastBreak™ and **ClipView™** are licensed in a single user package. Contact your dealer or buy direct (credit or money order, for UPS Next Day add \$6. shpg. fee) from:

BZ Technical

P.O.Box 10, Bothell, WA 98041

Phone: 206/258-1568 or FAX: 206/487-1357

Retail price: \$399.⁹⁵ Demo: \$25.⁰⁰

NOT Copy protected, NOT AutoLISP® encrypted, FULL documentation, technical support, 3.5" and 5.25" media.

"Quality software development located near the home of MICROSOFT® in Bothell's High Technology Corridor."

AutoCAD and AutoLISP are registered trademarks of Autodesk Inc. FastBreak and ClipView are trademarks of BZ Technical.

**Only your imagination
limits how you benefit
from PERCON®
keyless data collection.**



Checking out books or checking in employees—input data quickly and accurately using bar codes or magnetic stripes. PERCON has proven bar code solutions for IBM®, DEC™, and Apple Macintosh®. Call 1-800-8-PERCON.

PERCON

1710 Willow Creek Circle, Eugene, OR 97402-9153
(503)344-1189 FAX(503)344-1399

©1989 Percon, Inc. PERCON, IBM, DEC and Apple Macintosh are trademarks.

VOICE MASTER KEY® SYSTEM II

**VOICE RECOGNITION & SPEECH RESPONSE
FOR IBM PC/XT/AT/386, PS/2, LAPTOPS, COMPATIBLES**



FOR PRODUCTIVITY, PRESENTATIONS, SOFTWARE DESIGN, ENTERTAINMENT, LANGUAGE TRAINING, EDUCATION, MORE...

SPEECH/SOUND RECORDING AND PLAYBACK. Desktop Audio sound editing allows you to create custom sound applications. Variable sample rate (to 20 KHz) and compression levels. A four-voice music synthesizer is included also!

VOICE RECOGNITION TSR utility allows you to add voice command keyboard macros to your CAD, desktop publishing, word processing, spread sheet, or entertainment programs. Up to 64 voice commands in RAM at once—more from disk.

HARDWARE SYSTEM contains built-in speaker with separate volume and tone controls, external speaker and headphone jacks. Enclosure made of sturdy vinyl-clad steel. Attaches to parallel printer port without affecting normal printer operation (U.S. Patent 4,812,847). Headset microphone, printer cable, 9 volt AC adapter (110 volt UL/CSA listed), and comprehensive user manual included.

QUALITY THROUGHOUT. MADE IN USA. ONLY \$219.95

ORDER HOTLINE: (503) 342-1271 Mon-Fri, 8 AM to 5 PM PST

Visa/MasterCard, company checks, money orders, CODs (with prior approval) accepted. Personal checks subject to 3 week shipping delay. Specify computer type when ordering. Add \$5 shipping charge for delivery in USA and Canada. Foreign inquiries contact Covox for C&F/CI/F quotes. OEM configurations available.

30 DAY MONEY BACK GUARANTEE IF NOT COMPLETELY SATISFIED.

CALL OR WRITE FOR FREE PRODUCT CATALOG



COVOX INC.
675 Conger Street
Eugene, Oregon 97402

TEL (503) 342-1271
FAX (503) 342-1283
BBS (503) 342-4135

**Santa got his wish...
Caller ID+Plus!**

*The Complete Caller Identification
and Contact Management System*

Because your business needs to be well organized but retain a personal touch, you need Caller ID+Plus. Know who is calling before you answer. Instantly display caller records. Record notes on each contact. Memory resident. Import/export data.

For more information contact:

Rochelle Communications, Inc.
8716 N. Mopac, Suite 200
Austin, TX 78759

Call: 1-800-542-8808
Outside U.S.: +1-512-794-0088



LAST•BAT™

The Only Lifetime Setup Battery System for PC/AT and Compatible Computers

\$49⁹⁵ +\$5.00 SHIPPING

- Permanent
- Easy to Install
- Replaces IBM part #8286121
- For IBM PC/AT, Compaq 286, 386 and all AT Compatibles
- Made in the U.S.A.



LIFETIME WARRANTY

ACCUMATION, Inc. will replace a malfunctioning LAST•BAT for as long as the original purchaser uses it in the machine in which the LAST•BAT was originally installed, providing, of course, that the LAST•BAT is installed and used correctly.

Christmas Delivery

ACCUMATION™



ACCUMATION, INC.
8817 SOUTHWEST 129 TERRACE • MIAMI, FLORIDA 33176
305-238-1034

LAST•BAT and ACCUMATION are trademarks of Accumation, Inc. IBM is a registered trademark of International Business Machines Corporation. Compaq 286 & 386 are registered trademarks of the Compaq Corporation.

© Copyright Accumation, Inc. 1988.

POWERFUL•AFFORDABLE INSTRUMENTS

200 MHz Logic Analyzer

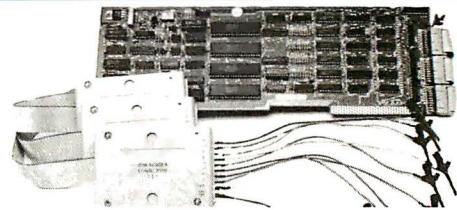

- 200 MHz max sampling rate
- 16K samples/channel
- 3 External Clocks and 12 Quality lines
- FREE software updates on 24 Hour BBS
- 24 Channels Timing and state
- 16 Levels of triggering
- Variable, TTL, ECL threshold levels

\$ 799-LA12100 (100 MHz)
\$1299-LA27100 (100 MHz)
\$1899-LA27200 (200 MHz)

Price is complete
Pods and Software included

UNIVERSAL PROGRAMMER

PAL
GAL
EPROM
EEPROM
87xxx...
8 & 16BIT

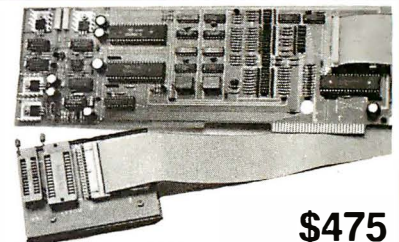

\$475

- 20 and 24 pin PALs, EPLDs
- 16V8, 20V8, 22V10 GALs
- 26V12, 20RA10, 18V10 GALs
- 2716-4MEG. EPROMs
- 87xxx MICROS
- EEPROMs (incl. 8 pin serial)
- 16 bit EPROMS
- Byte Split/Merge (16 & 32 bit)
- JEDEC, INTEL HEX, Motorola 'S' files
- Dallas NVS RAM programming
- PC/XT/AT COMPATIBLE
- FREE software updates on BBS



Call - (201) 994-6669

Link Computer Graphics, Inc.

4 Sparrow Dr., Livingston, NJ 07039 FAX:994-0730



Spectacular Performance. Now Playing On 9-Track Tape.

If you're looking to connect 9-track tape to your PC, Overland Data offers an all-star cast of complete subsystems. They are equally at home playing for all IBM PC compatibles or PS/2's, under DOS, UNIX, XENIX, PICK & NOVELL, 800 to 6250 bpi. They perform EBCDIC-ASCII conversions and backup brilliantly. And the supporting cast can't be beat. **Two year warranty on controllers**, one year on tape drives. Expert help by phone. 30 day, money back application guarantee. And ten years experience as founder and leader of the industry. All of which means spectacular performance play after play. To reserve your seat, call us at:

1-800-PC9-TRAK

OVERLAND DATA
San Diego, CA

1-800-729-8725 • 1-619-571-5555 • FAX 1-619-571-0982 • TELEX 754923 OVERLAND

NEW! RS-232 DATA MONITOR LETS YOU SEE WHAT'S ON THE LINE \$595!

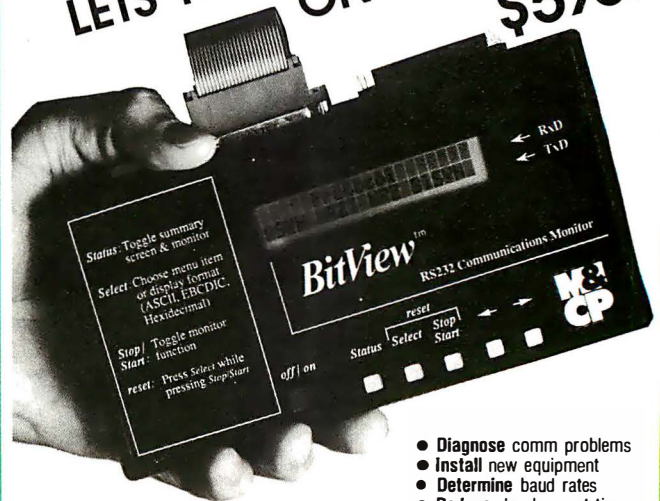

- Diagnose comm problems
- Install new equipment
- Determine baud rates
- Reduce development time
- Troubleshoot faster
- RS-422 option available
- SDLC, HDLC, X.25, BISYNC
- Parity & CRC check
- 40 hours on 9v battery
- 8K buffer with printer dump

BitView shows you bidirectional data in ASCII, EBCDIC, or Hex for async and sync data lines at baud rates from 64 Kbs to 38400 baud. Now find your comm problems in minutes instead of hours!

Call (212)662-6012 or Fax (212)678-6143
MEASUREMENT & CONTROL PRODUCTS, INC.
415 Madison Avenue, 22 Fl. New York, NY 10017



48 CHANNEL 25MHz LOGIC ANALYZER

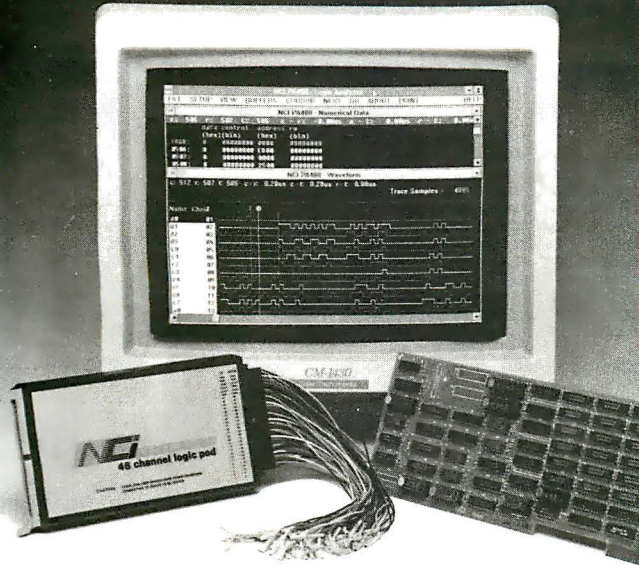

PA480 \$1595 + POD PRICE

***New WINDOWS 3.0 Compatible Software**

- 48 Channels @ 25 MHz x 4K word deep
- 16 Trigger Words/16 Level Trigger Sequence
- Storage and Recall of traces/setups to disk
- Disassemblers available for: 68000, 8088, 8086, 6801, 6811, Z80, 8085, 6502, 6809, 6303, 8031.

NCI □ 6438 UNIVERSITY DRIVE
HUNTSVILLE, AL 35806 • (205) 837-6667

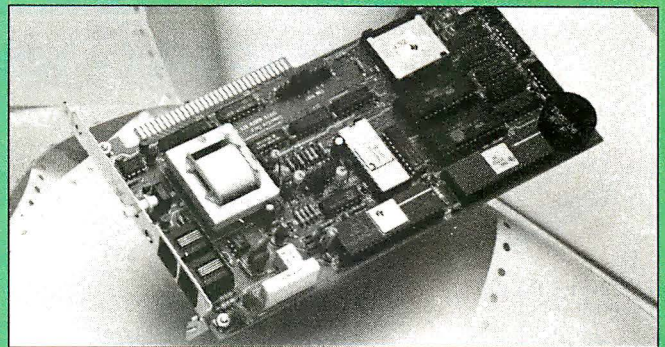

COMPUCOM

9,600-38,400 bps MODEM+FAX...\$279

NOW you can afford a **SPEEDMODEM**™. Raw speed of 300 - 9600 bps and 4:1 data compression push throughput up to 38,400 bps. Dynamic Impedance Stabilization™ provides robust performance on noisy telephone circuits. A 9600 bps send/receive, full-featured FAX is included on the same card. Total communications capability--only \$279. It comes with a 30-day money back guarantee and a 5-year warranty. **BYTE** magazine said our 2400 bps modem was "a real deal"™...well we've done it again... our **COMBO**™ is setting a new standard for value and performance. See for yourself... *3/89p.102

(408)732-4500 **CALL NOW 800 ACT ON IT** (800)228-6648

YOUR SOURCE FOR MEMORY UPGRADES

FIRST **SOURCE** INTERNATIONAL, INC.

WE ACCEPT INTERNATIONAL ORDERS
3 day International delivery available via Federal Express or DHL!
CALL (714) 588-9866 OR FAX 24-HOUR S-A-DAY FAX (714) 588-9872

TOLL FREE FROM ANYWHERE IN THE U.S. OR CANADA

ORDER NOW 1-800-535-5892



LAPTOP MEMORY

TOSHIBA

Model 1000SE/XE	1MB	\$289.00
	2MB	\$399.00
Model T1200XE	2MB	\$249.00
Model T1600	2MB	\$249.00
Model T3100	2MB	\$249.00
Model T3100SX	2MB	\$249.00
	4MB	\$689.00
Model T3200SX	2MB	\$249.00
	4MB	\$689.00
Model T3200	3MB	\$349.00
Model T5100	2MB	\$249.00
Model T5200,T8500	2MB	\$249.00
	8MB	\$1300.00

COMPAQ

Portable LTE 286	1MB	\$189.00
	2MB	\$269.00
SLT-286	1MB	\$239.00
	4MB	\$1325.00
SLT-386	1MB	\$325.00
	2MB	\$495.00

ZENITH

SuperSport 286 and 286e	1MB	\$189.00
SuperSport SX and 286e	2MB	\$449.00
SuperSport SX	2MB Alpha	\$549.00
	2MB Beta	\$549.00

NEC

ProSpeed 286	1MB	\$209.00
	4MB	\$899.00
ProSpeed 386	2MB	\$450.00
	8MB	\$2250.00

IBM MEMORY

Model PS/1		
512K	1057035	\$89.00
2MB	IBM PN N/A	\$399.00
Models 30-286, Exp. Board 1497259		
512K Kit	30F5348	\$54.00
2MB Kit	30F5360	\$179.00
Models 70-E61/121,55SX,65SX		
1MB	6450603	\$89.00
Models 70-E61/121,50Z,55SX,65SX		
2MB	6450604	\$169.00
Models 55SX, 65SX, 34F3077 & 34F3011		
4MB	34F2933	\$509.00
Model 70-A21		
2MB	6450608	\$169.00
Models 80-A21/A31		
4MB	6451060	\$659.00
All Models 70 and 80		
2-8MB w/2M	6450605	\$499.00
2-14MB w/2M	34F3077	\$599.00
Models 50, 55Z, 60 & 65SX		
2-16MB w/2M	6450609	\$625.00

LASER PRINTER MEMORY

Hewlett-Packard LaserJet IIP, III & IID		
1MB	33474B	\$99.00
2MB	33475B	\$169.00
4MB	33477B	\$299.00
Hewlett-Packard LaserJet II & IID		
1MB	33443B	\$99.00
2MB	33444B	\$169.00
4MB	33445B	\$299.00
Apple Laserwriter II and II/NTX		
1MB	M6005	\$89.00
4MB	M6006	\$349.00
IBM Laser 4019 and 4019e		
1MB	1039136	\$209.00
2MB	1039137	\$375.00
3.5MB	1038675	\$489.00
Canon LBP-8II, 8IIR, 8IIT		
2MB	S63-1880	\$189.00

COMPAQ MEMORY

DeskPro 286-E,386-20/20E/25		
1MB	113131-001	\$139.00
4MB	113132-001	\$349.00
DeskPro 386S/16		
1MB	113646-001	\$139.00
4MB	112534-001	\$349.00
DeskPro 286N, 386N and 386SX and 20		
1MB	118688-001	\$99.00
2MB	118689-001	\$169.00
4MB	118690-001	\$509.00
DeskPro 386-33, 486-33 & SystemPro		
2MB	115144-001	\$200.00
8MB	116561-001	\$1899.00

AST MEMORY

Premium 386C and 386-16		
1MB Kit	500510-007	\$95.00
4MB Kit	500510-008	\$349.00
Premium 386-20		
1MB Kit	500510-003	\$129.00
4MB Kit	500510-004	\$369.00
Bravo 386-SX		
2MB Kit	500510-002	\$179.00
4MB Kit	500510-008	\$349.00
Premium 386-SX/16/25/33 and all 486 Models		
1MB	500718-002	\$95.00
Premium 486		
2MB	500718-004	\$342.00

HEWLETT-PACKARD MEMORY

Vectra QS/20PC, RS/25PC and 20C		
1MB Kit	D1640A	\$105.00
4MB Kit	D1642A	\$349.00
Vectra 486 PC and 386/25 PC		
1MB Kit	D2150A	\$104.00
4MB Kit	D2151A	\$592.00
8MB Kit	D2152A	\$1199.00
Vectra 386/25 PC		
2MB Kit	D2381A	\$266.00

MEMORY BOARDS

Everex RAM 3000 Deluxe

Up to 3MB of base, expanded and/or extended memory. EMS 4.0 compatible with no wait states. Uses 256Kx1 Dram.

with 2MB: SIM159-512 \$139.00

BocaRam/AT Plus

Up to 8MB for any AT or 16 bit compatible machines running up to 33MHz. Offers conventional, expanded and/or extended memory, provides a maximum of 8MB LIM/EMS 4.0. Uses 1x1 Dram.

with 2MB: SIMAT82 \$279.00

SIMMS

IBM TYPE

4Mx9-80	\$365.00	1MX1-12	\$6.50
1Mx9-12	\$65.00	1MX1-10	\$7.00
1Mx9-10	\$70.00	1MX1-80	\$7.50
1Mx9-80	\$75.00	1MX1-70	\$8.00
1Mx9-70	\$80.00		
256x9-12	\$18.50	256KX1-12	\$1.85
256x9-10	\$20.00	256KX1-10	\$2.00
256x9-80	\$22.50	256KX1-80	\$2.20
256x9-60	\$30.00	256KX1-70	\$2.50

DRAM

1MX1

PLEASE SEND ALL P.O.'S AND MAIL ORDERS TO:
First Source International, Inc.
36 Argonaut, Suite 140
Aliso Viejo, California 92656

TERMS AND CONDITIONS

- ✓ NO SURCHARGE ON MC OR VISA
- ✓ Terms: Visa, MasterCard, AMEX (AE 4%). COD, Net 30 on purchase orders from qualified firms.
- ✓ 20% Restocking fee on all non-defective returns & refused orders. RMA # required.
- ✓ Manufacturers part numbers are for your convenience. All products third party.
- ✓ PRICES AND AVAILABILITY SUBJECT TO CHANGE.

UNICORN - YOUR I.C. SOURCE!

EPROMS

COLLIMATOR PEN (INFRA-RED)



- Output: 2.5 mW (max.)
- Current: 90-150 mA
- Operating Voltage: 2.2-2.5V
- Wavelength: 820nm
- Collimation: .18mrad (typ.)
- Size: 11mm diameter

STOCK # PRICE
SB1052 \$39.99

LASER DIODE (INFRA-RED)

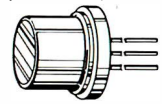

- Output: 10 mW (max.)
- Current: 90-150 mA
- Operating Voltage: 2.2-2.5V
- Wavelength: 820nm

STOCK # PRICE
SB1053 \$9.99

LASER DIODE (VISIBLE-RED)

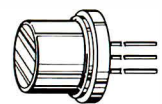

- Output: 5 mW (max.)
- Current: 65-100 mA
- Operating Voltage: 1.75-2.2V
- Wavelength: 780nm

STOCK # PRICE
LS022 \$19.99

LASER DIODE (VISIBLE-RED)

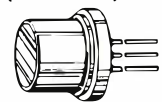

- Output: 4 mW (max.)
- Current: 20 mA
- Operating Voltage: 2.2-3.0V
- Wavelength: 665nm

STOCK # PRICE
LS3200 \$129.99

POWER SUPPLY

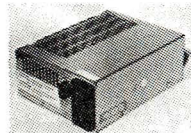

- Input: 115/230v
- Size 7" L x 5 1/4" W x 2 1/2" H
- Output: +5 volts @ 3.75 amps
- Output: +12 volts @ 1.5 amps
- Output: -12 volts @ .4 amps

STOCK # PRICE
PS1003 \$19.99

STOCK #	PINS	DESCRIPTION	1-24	25-99	100+
1702	24	256 x 4 1us	3.99	3.79	3.41
2708	24	1024 x 8 45ns	6.49	6.17	5.55
2716	24	2048 x 8 450ns (25v)	3.29	3.13	2.82
2716-1	24	2048 x 8 350ns (25v)	3.79	3.60	3.24
TMS2716	24	2048 x 8 450ns	6.29	5.98	5.38
27C16	24	2048 x 8 450ns (25v-CMOS)	3.99	3.79	3.41
2732	24	4096 x 8 450ns (25v)	3.79	3.60	3.24
2732A-2	24	4096 x 8 200ns (21v)	3.79	3.60	3.24
2732A	24	4096 x 8 250ns (21v)	3.69	3.51	3.16
2732A-4	24	4096 x 8 450ns (21v)	3.19	3.03	2.73
TMS2532	24	4096 x 8 450ns (25v)	5.79	5.50	4.95
TMS2532P	24	4096 x 8 450ns (25v-One Time Programmable)	1.99	1.89	1.70
27C32	24	4096 x 8 450ns (25v-CMOS)	4.19	3.98	3.58
2764-20	28	8192 x 8 200ns (21v)	3.99	3.79	3.41
2764	28	8192 x 8 250ns (21v)	3.79	3.60	3.24
2764A-20	28	8192 x 8 200ns (12.5v)	3.99	3.79	3.41
2764A	28	8192 x 8 250ns (12.5v)	3.29	3.13	2.82
TMS2564	28	8192 x 8 250ns (25v)	6.79	6.45	5.81
27C64	28	8192 x 8 250ns (21v-CMOS)	4.19	3.98	3.58
27128-20	28	16,384 x 8 200ns (21v)	5.79	5.50	4.95
27128	28	16,384 x 8 250ns (21v)	5.09	4.84	4.35
27128A	28	16,384 x 8 250ns (21v)	5.79	5.50	4.95
27C128	28	16,384 x 8 250ns (21v)	5.79	5.50	4.95
27256-20	28	32,728 x 8 200ns (12.5v)	5.29	5.03	4.53
27256	28	32,728 x 8 250ns (12.5v)	4.79	4.55	4.09
27C256	28	32,768 x 8 250ns (12.5v)	5.29	5.03	4.53
27512-20	28	65,536 x 8 200ns (12.5v)	7.49	7.12	6.41
27512	28	65,536 x 8 250ns (12.5v)	6.99	6.64	5.98
27C512	28	65,536 x 8 250ns (12.5v-CMOS)	6.99	6.64	5.98
27C1024	32	131,072 x 8 200ns (12.5v-CMOS)	17.99	17.09	15.38
68764	24	8192 x 8 450ns	13.99	13.29	11.96
68766	24	8192 x 8 450ns	14.99	14.24	12.82



UNICORN ELECTRONICS



ORDER BY PHONE!

10010 Canoga Ave., Unit B-8 • Chatsworth, CA 91311
 OUTSIDE CALIFORNIA: (800) 824-3432 (Orders Only)
 IN CALIFORNIA: (818) 341-8833
 ORDER BY FAX: (818) 998-7975

Minimum Order \$15.00

Scottsdale Systems

— Since 1980 —

1-800-777-2369

Scottsdale 386-SX 16 MHz

2MB of RAM,
2 Serial, 1 Parallel, and
Game Port
101 Click Keyboard
12 Floppy Disk Drive,
1.44 Floppy Drive
200 Watt Power Supply w/Desktop
230 Watt power Supply w/Verticle
16 BIT 1024 x 768 CARD WITH
512 K RAM
14" VGA 1024 x 768 MONITOR
28 MM DOT PITCH
66 Megabyte hard Disk RLL
28 Milliseconds
DOS 3.3 OR 4.01 \$1980.00
32K Cache Add 165.00

ALL SYSTEMS HAVE A
1 YEAR WARRANTY
OUR SYSTEMS EXCEL
IN PERFORMANCE!

Scottsdale 386-20 MHz

1.2 Disk Drive 1.44 Disk Drive
4 MB RAM, 64K Cache, 101
Keyboard
111 MB I.D.E. DRIVE,
15 MS ACCESS TIME
2 Serial 1 Parallel & GAME PORT
DOS 4.01 or 3.3
14" VGA 1024 x 768 MONITOR
28 DOT PITCH
16 BIT 1024 x 768 CARD
W/152 K RAM \$2975.00
BUY WITH CONFIDENCE
POWER UP WITH A
SCOTTSDALE SYSTEMS
COMPUTER

Scottsdale 486-33 MHz

4 MB RAM 128 K Cache
2 Serial, 1 Parallel
1.2 Floppy Drive, 1.44 Floppy Drive
211 MB IDE HARDDISK DRIVE
15 MS ACCESS TIME
14" VGA 1024 x 768 MONITOR
28 MM DOT PITCH
16 BIT 1024 x 768 CARD WITH
512 K RAM
CHOICE OR FULL DESKTOP CASE
W/200 WATT POWER SUPPLY OR
Large Vertical Case W/230 WATT
POWER SUPPLY DOS 4.01
or 3.3 \$6737.00

INTERNATIONAL ORDERS
WELCOME

386-33 25 MHz Open Architecture

1.2 Disk Drive / 1.44 Disk Drive
1 to 1 Controller Card
4 MB RAM, 64K Cache
2 Serial, 1 Parallel, and Game Port
101 Keyboard
16 BIT 1024 x 768 VIDEO CARD
W/512 K RAM
14" VGA 1024 x 768 MONITOR, 28 MM
DOT PITCH
200 Watt Power Supply with Desktop
230 Watt Power Supply with Vertical
160 MB CDC 16MS ESDX Hard Drive
DOS 4.01 or 3.3 \$3599.00

THE 386-25 MHz IS
UPGRADABLE TO 486
CLASS MACHINE!
CALL SCOTTSDALE
FOR DETAILS

386-33 MHz Open Architecture

1.2 Disk Drive / 1.44 Disk Drive
1 to 1 Controller, 101 Keyboard
2 Serial, 1 Parallel, and Game Port
230 Watt Power Supply w/Vertical
200 Watt Power Supply/Desktop
14" VGA 1024 x 768 MONITOR
28 MM DOT PITCH
16 BIT 1024 x 768 VIDEO CARD
W/512 K RAM
160 MB CDC 16MS ESDX Hard Drive
DOS 3.3 or 4.01 \$3860.00

THE 33 MHz IS ALSO
UPGRADABLE TO
486 STATUS
CALL US FOR CUSTOM
CONFIGURATIONS

SOFTWARE

Computone 4to 16 Port Boards Unix & Xerox
compatible 99 year warranty SAVE
Santa Cruz Operations
SCO UNIX 386 \$657
SCO XENIX OS OPERATING
SYSTEM 458
SCO DEVELOPMENT 524

WE CARRY ALL SCO
MODULES
All software sales are final!

NOVELL

ARCNET
Coax Star Topology \$112
16 Bit Coax 380

MATH CO-PROCESSORS
SAVE

PRINTERS

AUTHORIZED SERVICE
FOR OTC

CANON

BJ-130E \$685
BJ-10E 345

CITIZEN

2 Year Warranty SAVE
We also carry Panasonic, Fujitsu, Ozonix,
NEC, T.I., Genicom, Canon, and Printers &
Lasers!

CALL SERVICE
FOR REPAIRS ON
Printers, Terminals, Monitors,
Computers

MONITORS

NEC 2A/3D \$399/649
NEC 4D/5D 1160/2365
Mitsubishi Diamond Scan 528
Hitachi Super Scan 1999
Phillips 20" Hi-Res 2059

OTHER MONITORS AVAILABLE

VGA 14"
1024 x 768 and ultrafine, 28 dot pitch,
110-220 volts \$399

TERMINALS

WY-30 G/A - w/Keyboard \$290
WY-50 G/A - w/Keyboard 377
WY-60 G/A - w/Keyboard 399
WY-90 G/A - w/Keyboard 487
WY-150 G/A/A - w/Keyboard 387
WY-212 G/W - w/Keyboard 1489
WY-Height A Adjustable Arm 95

AUTHORIZED SERVICE FOR WYSE

I-PROTECT
Radiation and Anti-Glare Filters
relieves eye strain, improves resolution and
contrast, and provides x-radiation and U.V.
protection \$99.00

MODEMS

8 M.B. RAM, 35 fonts, postscript compatible,
unlimited colors, all for under \$8000.00. Call
for details.

CANON

LP8-811 \$1795
LP8-4 SAVE

TEXAS INSTRUMENTS

T.I. Microlaser \$1135
T.I. Microlaser PS 1845

PLOTTERS

UNITED INNOVATIONS
1 Year Warranty
Mural 7000-1 \$1899
Mural 8000-1 2059
Mural 9000-1 2829
Mural 7000-8 2205
Mural 8000-8 2428
Mural 9000-8 3241
Tilt Stand 238
88K Builder 238
Pen/Pencil Hldr 75
FIBER OPTIC
Digitizing Sight 60

THE MURAL PLOTTER

A to E size flatbed plotter with unsurpassed
performance and durability at a remarkable
low price.

Authorized Service For United Innovations
Mural Plotters.

HOUSTON INSTRUMENT

AMT ACCEL
500 Inset-plot \$1549
ENTER SP608 599

ROLAND

CAMM MACHINES
HEWLETT PACKARD SAVE

PLOTTERS

IOLINE
A thru D LP 3500 \$2225
A thru E LP 3700 2964
LP3700-8 LP4000-1 3095/3494
LP400-8 3715

VINYL CUTTING MACHINES

BLADES & HOT TIPS
CALCOMP
1023/1025 \$3533/4616
1026 6131
10430M/1044 6532/6734
5902/5902A SAVE
DM 5224 11,919

OPTICAL SCANNER & SOFTWARE

Data Copy Jrethead or 730 GS your
choice \$1425

DIGITIZERS

KURTA
Lifetime Warranty on Kurta IS-1
IS-1 12x12 Cordless 4-button cursor, pen
stylus and interface kit \$439
IS-1 12x17 cordless 4 button cursor, pen
stylus and interface kit \$629

CALCOMP

Calcomp 23120 12x12 \$385
Calcomp 9100 Series SAVE
Calcomp 9500 Series SAVE
Calcomp Wiz 1000 DP \$165

SUMMAGRAPHICS

Lifetime Limited Warranty
12x12 summsketch 11 \$350
12x18 Professional 620

HITACHI

Pump pro 12x12 \$380
PUMA 12x17 625
PUMA 15x15 435

CALL FOR PRICING ON LARGER DIGITIZER

1555 W. University Dr. #101, Tempe, AZ 85281

Prices listed are for cash, Discovery, MasterCard and Visa, no surcharge. AZ residents add 6 1/2% tax, add 3% for C.O.D., add 5% for P.O. International orders welcome. All items are new with manufacturer's warranty. Returned products subject to 20% restocking fee and in new condition in original packaging, with all warranty cards, manuals and cables. No credit issued after 30 days from date of shipment. We do not guarantee compatibility. Personal and company checks take up to 5 days to clear. Prices and specifications subject to change. Product subject to availability; all applicable trademarks recognized and on file. 602-966-8609 SERVICES (Mon.-Fri.) 602-731-4742 FAX 602-966-8634



CORPORATE PURCHASE ORDERS... CALL 800-654-7762

COMPAQ (BOARDS & MODULES)

Compaq Model	Memory Added	Compaq Equiv. Part #	Your Low Price
DESKPRO 286	512K Kit	113012-001	59 ⁰⁰
DESKPRO 286N, 386N	1MB Module	118688-001	138 ⁰⁰
386S/20	2MB Module	118689-001	219 ⁰⁰
DESKPRO 386/16	4MB Module	118690-001	56 ⁰⁰
	1MB Board	108069-001	299 ⁰⁰
	2MB Board	108069 W/71	499 ⁰⁰
	1MB Kit	108071-001	199 ⁰⁰
	4MB Board	108070-001	699 ⁰⁰
	4MB Kit	108072-001	449 ⁰⁰
DESKPRO 386s	1MB Board	113633-001	248 ⁰⁰
	4MB Board	113634-001	548 ⁰⁰
	1MB Module	113646-001	138 ⁰⁰
	4MB Module	112534-001	318 ⁰⁰
DESKPRO 386/20, 25 286E	1MB Module	113131-001	130 ⁰⁰
DESKPRO 386/20e	4MB Module	113132-001	295 ⁰⁰
DESKPRO 386/33, 486/25	1MB Board	113644-001	248 ⁰⁰
SYSTEMPRO	4MB Board	113645-001	548 ⁰⁰
	2MB Module	115144-001	218 ⁰⁰
	8MB Module	116511-001	1499 ⁰⁰
	32MB Module	116568-001	6480 ⁰⁰
- PORTABLES -			
PORTABLE III	512K Kit	107331-001	89 ⁰⁰
	INTFC BD	107808-001	99 ⁰⁰
	EXP BD	107811-0012	249 ⁰⁰
	2MB Kit	107332-001	179 ⁰⁰
	4MB Kit	107332-001	349 ⁰⁰
	6MB Kit	107332-001	499 ⁰⁰
SLT/286	1MB Module	110235-001	249 ⁰⁰
	4MB Module	110237-001	999 ⁰⁰
LTE/286	512K Board	117077-001	199 ⁰⁰
	1MB Board	117081-001	199 ⁰⁰
	2MB Board	117081-002	249 ⁰⁰
PORTABLE 386	1MB Kit	107651-001	249 ⁰⁰
	INTFC BD	107651-001	99 ⁰⁰
	4MB Board	107653-001	799 ⁰⁰
	4MB Ext Board	107654-001	799 ⁰⁰
SLT/386S	1MB Module	108303-001	349 ⁰⁰
	2MB Module	108304-001	499 ⁰⁰

SIPP ADD \$5.00 SIMM MODULES

Description	120NS	100NS	80NS	70NS	60NS
256 x 9 IBM	1 ⁹⁰	2 ⁴⁰	2 ⁹⁰	2 ⁶⁰	3 ⁹⁰
1Meg x 8 Apple	5 ⁸⁰	6 ¹⁰⁰	6 ⁴⁰	7 ¹⁰⁰	7 ⁹⁰
1Meg x 9 IBM	5 ⁹⁰	6 ²⁰⁰	6 ⁵⁰	7 ³⁰⁰	—
4Meg x 9 IBM	—	33 ⁹⁰	34 ⁹⁰	39 ⁹⁰	—

AST MEMORY

AST Model	Memory Added	AST Equiv. Part #	Your Low Price
BRAVO/286	128K Kit	500510-011	49 ⁰⁰
PREMIUM WKST/286	512K Kit	500510-010	59 ⁰⁰
	2MB Kit	500510-002	169 ⁰⁰
	4MB Kit	500510-008	359 ⁰⁰
BRAVO/386SX	2MB Kit	500510-002	169 ⁰⁰
	4MB Kit	500510-008	359 ⁰⁰
PREMIUM 286	512K Kit	500510-010	79 ⁰⁰
ADVANCE	1MB Kit	500510-007	99 ⁰⁰
WKST 386SX	2MB Kit	500510-002	189 ⁰⁰
	4MB Kit	500510-008	359 ⁰⁰
PREMIUM	1MB Kit	500510-003	149 ⁰⁰
386	4MB Kit	500510-004	369 ⁰⁰
PREMIUM	1M SIMM	500718-001-2	79 ⁰⁰
386/25, 16sx, 586/33	1-16MB	500722-004	649 ⁰⁰
PREMIUM 486/	1M 5 MM	500718-002	99 ⁰⁰
2ST, 25TE, 25, 25E	2MB SIMM	500718-004	2349 ⁰⁰
	1-16MB	500722-004	649 ⁰⁰

BOCA AT PLUS MEMORY BOARD

16 BIT MEMORY BOARD FOR 286, 386 AT
 OK-8Meg Board • 4.0 LIM Compatible • New 5 Yr. Warranty
 • Conventional, Expanded and Extended Memory
 • Supports DOS, OS/2, LIM/EMS & EMS
 • Operates with CPU Speeds to 33 MHz
 OK — 129⁰⁰ 2 Meg — 246⁰⁰ 4 Meg — 353⁰⁰ 8 Meg — 577⁰⁰

TOSHIBA MEMORY

Toshiba Model	Memory Added	Toshiba Equiv. Part #	Your Low Price
PORTABLE T1000SE & XE	1MB Kit	PC14-PA8311U	299 ⁰⁰
PORTABLE T1200xe	2MB Kit	PC14-PA8312U	449 ⁰⁰
	2MB Kit	PC13-PA8306G	259 ⁰⁰
	4MB Kit	PC13-PA8307U	699 ⁰⁰
PORTABLE T1600	2MB Kit	PC8-PA8302U	259 ⁰⁰
PORTABLE T3100e	512K Kit	PC9-PA8340U	149 ⁰⁰
	2MB Kit	PC9-PA8341U	199 ⁰⁰
PORTABLE T3100SX	2MB Kit	PC15-PA8308U	259 ⁰⁰
	4MB Kit	PC15-PA8310U	589 ⁰⁰
PORTABLE T3200	3MB Kit	PC6-PA7377U	399 ⁰⁰
PORTABLE T3200SX	2MB Kit	PC12-PA8307U	249 ⁰⁰
	4MB Kit	PC12-PA8309U	589 ⁰⁰
PORTABLE T5100	2MB Kit	PC7-PA8301U	259 ⁰⁰
PORTABLE T5200	2MB Kit	PC10-PA8304U	259 ⁰⁰
DESKTOP T8500	4MB Kit	PC10-PA8313U	1495 ⁰⁰

IBM HP & CANON LASER JETS

Model	Memory Added	HP Equiv. Part #	Your Low Price
LASER JET II & IID	1MB Module	334438	99 ⁰⁰
	2MB Module	334448	149 ⁰⁰
	4MB Module	334458	249 ⁰⁰
HP & HP3	1MB Module	33474A/B	118 ⁰⁰
	2MB Module	33475A/B	168 ⁰⁰
	4MB Module	N/A	268 ⁰⁰
CANON LBP 811, 811R, 811T	1MB Module	N/A	199 ⁰⁰
	2MB Module	N/A	224 ⁰⁰
	4MB Module	N/A	429 ⁰⁰
LASER PRINTER MODEL 4019	1MB Board	1039136	199 ⁰⁰
	2MB Board	1039137	299 ⁰⁰

IBM PS2 (BOARDS & MODULES)

IBM PS/2 Model	Memory Added	IBM Equiv. Part #	Your Low Price
PS/2 25/286	3.5MB Board	1038675	449 ⁰⁰
30-286, 50 & 60	512K Kit	30F5348	80 ⁰⁰
PS/2 50Z & 55-SX	2MB Kit	30F5380	174 ⁰⁰
	1MB SIMM	6450603	98 ⁰⁰
	2MB SIMM	6450604	169 ⁰⁰
	512K Kit	30F5348	48 ⁰⁰
	2MB Kit	30F5380	179 ⁰⁰
55SX-031, 061, 65SX	4MB Module	34F2933	468 ⁰⁰
50, 50Z, 55 & 60	2-8MB Board	1497259	499 ⁰⁰
PS/2	1MB SIMM	6450603	98 ⁰⁰
70-E61, 061, 121	2MB SIMM	6450604	169 ⁰⁰
PS/2 70-A21 AX1, BX1	2MB SIMM	6450608	179 ⁰⁰
PS/2 80-041	1MB Module	6450375	135 ⁰⁰
PS/2 80-111, 121, 311, 321	2MB Module	6450379	248 ⁰⁰
80-A/21, A31	4MB Module	6451060	559 ⁰⁰
PS/2	2-32MB Board	6450605 OR	489 ⁰⁰
ALL 70s & 80s	4-32MB Board	34F3077	589 ⁰⁰
	8-32MB Board	34F3011	989 ⁰⁰

RAM CHIPS

Description	150NS	120NS	100NS	80NS	70NS
64 x 1	1 ⁹⁰	1 ⁸⁰	2 ⁴⁰	—	—
64 x 4	1 ⁹⁰	1 ⁹⁰	2 ⁴⁵	3 ⁵⁵	—
256 x 1	—	—	1 ⁹⁵	1 ⁹⁵	1 ⁹⁵
256 x 4	—	—	5 ⁰⁰	6 ⁰⁰	8 ⁰⁰
1 Meg x 1	—	—	4 ⁹⁵	5 ⁴⁵	6 ⁹⁵

ZENITH MEMORY

Zenith Model	Memory Added	Zenith Equiv. Part #	Your Low Price
Z386/33	1MB Module	ZA3800ME	99 ⁰⁰
	2MB Module	ZA3800MG	199 ⁰⁰
Z386/25, 20	1MB Module	ZA3600ME	99 ⁰⁰
	2MB Module	ZA3800MG	199 ⁰⁰
	4MB Module	ZA3800MK	649 ⁰⁰
Z248, Z286LP, Z386SX	4MB Module	Z4005-1	249 ⁰⁰
TURBO SPRT 386, 386e	1MB Kit	ZA3034ME	549 ⁰⁰
SUPER SPRT SX	2MB Kit	ZA180-64	449 ⁰⁰
	2MB Kit	ZA180-87	449 ⁰⁰
SUPER SPRT 286	1MB Kit	ZA180-66	249 ⁰⁰
286e, SX	2MB Kit	ZA180-64	449 ⁰⁰

EVEREX MEMORY BOARDS

RAM 3000 DELUXE Up to 3 Meg. (EMS) 4.0 OS/2. Back up base memory and expanded and/or extended memory. Uses 256K D-RAM ... **9900**
 RAM 8000 0-8MG capacity base, extended or expanded memory any combination. Compatible w/Lotus, Intel, Microsoft, EMS 4.0, EFMS, Supports Multi-tasking & DMA Multi-tasking in hardware. Uses 1MG D-RAM ... **19900**
 RAM 10000 0-10MB extended or expanded memory. Compatible with Lotus, Intel, Microsoft, EMS 4.0. Uses 1 MB D-RAM ... **17900**

CANON FLATBED SCANNER IX-12F

• 300 DPI • 16 Secs per page • 32 Level Gray Scale
 • 1 year warranty • Ready to go Interface card cable included
 List 1595 Your Price 599⁰⁰
 OPTIONS: OCR 199⁰⁰ PC Paint By Z-Soft 1.65 79⁰⁰
 Sheet Feeder (also works with HP) 299⁰⁰

— YEAR END CLEARANCE —

WHILE SUPPLIES LAST — WITH 1 YEAR WARRANTY
 195 Left
 242 Left

FAX CARD

• Automatic Group III Digital Fax • Background operation
 • Send & receive, screen images, scanned pages
 • Fax 9600/7200/4800/2400
 • Software - telephone cord • New, factory sealed
 List 695 Your Price 199⁰⁰

WANGTEK TAPE BACKUPS

• 65MB per minute
 • Wangtec 5099EN24 drive
 • w/controller • Menu driven • Software
 • DC600 cartridge • Easy installation
 List 999⁰⁰ Your Price 499⁰⁰
 Wangtek 40MB backup works off floppy controller 189⁰⁰

DAISY WHEEL PRINTER

• 14CPS Letter Quality
 • Manufactured by Silver Reed
 • IBM Centronics Parallel Interface
 • New 90 day warranty
 List 1149⁰⁰ Your Price 99⁰⁰
 12 CPS version for 89⁰⁰ Tractor Feed 79⁰⁰

FULL PAGE SCANNER BY AT&T

• IBM Interface & Cable
 • PagePower Software.
 • A complete draw;
 • Scan, fax packages
 • 200DPI • Automatic Sheet Feeder
 OCR Software 199⁰⁰ List 999⁰⁰ Your Price 269⁰⁰

MODEMS

• Fully Hayes Compatible • Monitor Speaker with Volume Control
 • 2400/300 Baud Transmission Rate • Addressable COM 1,2,3,4
 • Compatible with IBM PC, XT, AT and Compatibles
 • Full Duplex Operation • Complete with Software
 • Two Year Manufacturer's Warranty • Auto Dial/Auto Answer
 Internal 199⁰⁰ External 79⁰⁰

POWER SUPPLIES

IBM DIRECT REPLACEMENT
 150 WATT XT Comp. • UL Appr. • 110/20V input switch • 4 drives 49⁰⁰
 200 WATT AT comp. • UL Appr. • 110/220V input switch 69⁰⁰

SEAGATE HARDDRIVE

Model	Capacity	Access Time	AT KIT	XT KIT
ST125-0	20MB	40msec 3.5"	\$249	\$299
ST125-1	20MB	28msec 3.5"	\$269	\$319
ST138-0	30MB	40msec 3.5"	\$289	\$339
ST138-1	30MB	28msec 3.5"	\$309	\$359
ST125	20MB	65msec	\$189	\$249
ST238R (RL)	30MB	65msec	\$219	\$279
ST257-1	42MB	28msec	\$269	\$339
ST227R-1 (RL)	65MB	28msec	\$339	\$389
ST4096	80MB	28msec	\$549	\$599
ST4144 (RL)	120MB	28msec	\$649	\$699

XT kits include cables, software (over 32MB) controller
 AT kits include cables, ralls, software (over 32MB)

VIDEO CARDS

EGA Card 59⁰⁰
 MonoGraphics (Hercules Compatible) with Par. Port 29⁰⁰
 Color Graphics (Hercules Compatible) with Par. Port 39⁰⁰
 Mono Card Text Only 109⁰⁰
 VGA Card 1024 x 768 (256K Exp 512K) 109⁰⁰
 STB mono/color card 29⁰⁰

INTEL COPROCESSORS

Model	Speed	Price	Model	Speed	Price
8087	5MHz or less	79 ⁰⁰	80807-16	16MHz	299 ⁰⁰
8087-2	8MHz	114 ⁰⁰	80387-20	20MHz	349 ⁰⁰
8087-1	10MHz or less	149 ⁰⁰	80387-25	25MHz	449 ⁰⁰
	16 Bit		80387-33	33MHz	549 ⁰⁰
80287	6MHz	149 ⁰⁰	80387-SX		298 ⁰⁰
80287-8	8MHz	189 ⁰⁰	80387-SX20		328 ⁰⁰
80287-10	10MHz	205 ⁰⁰	80287-XL		218 ⁰⁰
80C287-12	Laptop	239 ⁰⁰	80287-XLT		228 ⁰⁰

CONNER HARDDRIVE

40 Meg 18 Mil. Sec. 399⁰⁰ 100 Meg 18 Mil. Sec. 549⁰⁰
 200 Meg 18 Mil. Sec. 849⁰⁰

CONTROLLERS

FOR HARDDRIVES
 IDE Controller 39⁰⁰ 8 Bit WD Controller 59⁰⁰
 16 Bit WD Controller 2:1 109⁰⁰ 16 Bit Everex HD/Floppy 1:1 99⁰⁰
 FOR

Industrial & Lab Automation with PCs
ADVANTECH

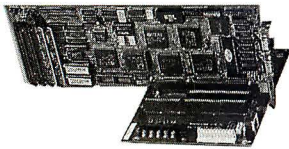

**All-in-One 80286-12
CPU Card**

- PCA-6125 \$395**
- 12MHz 80286 microprocessor
 - Socket for 80287 math coprocessor
 - AMI BIOS assures compatibility
 - Memory configuration: 512K, 1M, 2M & 4M
 - Built-in interface for 2 IDE H/D and 2 F/D
 - On-board: 1 parallel/2 serial ports
 - VLSI CMOS for low power consumption

408-293-6786

1340 Tully Rd., #314, San Jose, CA 95122 FAX 408-293-4697

Circle 23 on Reader Service Card

Industrial & Lab Automation with PCs
ADVANTECH



**PC-Based Universal
PC-UPROG Programmer \$695**

- For E/EE/PROMS, PALS, PEELS, FPLAS, GALS, EE/EPLDs and MICROS
- Programs virtually any device up to 40 pins
- 40-pin ZIF socket with all pins individually programmable
- 100% menu driven and user friendly

408-293-6786

1340 Tully Rd., #314, San Jose, CA 95122 FAX 408-293-4697

Circle 23 on Reader Service Card

Industrial & Lab Automation with PCs
ADVANTECH

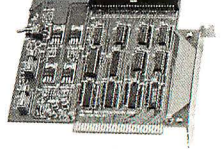

**PC-Bus Switch/Extension Card
PCL-756 \$160**

- No more PC power-off for removing or inserting add-on cards
- Protects mother board while trouble shooting or testing add-on cards
- Fully transparent PC/XT bus extension
- All bus signals buffered
- Easy-to-access ON/OFF control switch
- LED display for power & fuse status

USA & Canada: San Jose, CA
Europe & Asia: Taipei, Taiwan
Tel: 886-2-9184567 Fax: 9184566

Circle 23 on Reader Service Card

Sure it's insured?

SAFEWARE® Insurance provides full replacement of hardware, media and purchased software. As little as \$49/yr. covers:

- Fire • Theft • Power Surges
- Water Damage • Auto Accident

For information or immediate coverage call:

1-800-848-3469

Local 1-614-262-0559

Subject to underwriting and availability by state.
On CompuServe. GO SAF On GENie. SAFEWARE

SAFEWARE

SAFEWARE, The Insurance Agency, Inc.
2929 N. High St., P.O. Box 02211
Columbus, OH 43202

Circle 272 on Reader Service Card

DYNAMIC RAMS

4Mx9	80ns	\$235.00
PS2 2M	604/608	\$110.00
1Mx9	80ns	\$ 45.50
1Mx8	80ns	\$ 42.00
256x4	100ns	\$ 4.75
✓ 1Mx1	100ns	\$ 4.50
✓ 41464	100ns	\$ 2.40
✓ 41256	120ns	\$ 1.90
51258	80ns	\$ 2.95
4164	120ns	\$ 1.70

* For quantity discount, high-speed parts, SIPP Please Call!

MATH COPROCESSORS	3C87	ITTC/VRX	\$ CALL	
80387-33	33MHz	2C87-20	22MHz	\$235.00
80387-25	25MHz	2C87-12	12MHz	\$184.00
80387-20	20MHz	2C87-10	10MHz	\$176.00
80387-16	16MHz	2C87-8	8MHz	\$160.00
80387SX	16MHz	V-20	8/10MHz	\$8.5/15

I.C. EXPRESS

15140 Valley Blvd. City of Industry, CA 91744
Customer Service: (818) 333-8800 FAX: (818) 369-1236

ORDER: (800) 877-8188 (Mon.-Fri. 8-5PST)
CALL FOR CURRENT PRICES & VOLUME DISCOUNTS.
Price Shown list each. MasterCard/Visa and 3%. Prices are subject to change.
Minimum order \$100. Shipping & Handling: U.P. \$10 and \$5.00 A/R \$7.00 (1 lb.)
ALL MERCHANDISE IS 100% GUARANTEED WITH PROMPT DELIVERY.

Circle 153 on Reader Service Card

**MULTI-SPEED !!!
9 TRACK TAPE SUBSYSTEM
for IBM PC/AT/386**

1 YEAR WARRANTY

- IBM/ANSI compatible at 800*/1600/3200 bpi
- Controller, cables and software included
- Interfaces for PS/2*, Xenix* and DEC*
- SCSI*, AT or MCA* Bus I/O at 25/50/100 ips.

*OPTIONAL SHOWN W/OPTIONAL DUST COVER

AKSystems Inc.
20741 Marilla St. Chatsworth CA 91311
TEL:818/709-8100 FAX: 818/407-5889

Circle 17 on Reader Service Card

33 MHz 80486 Motherboard

Faster than the Everex Step™ & ALR
15 MIPS! \$2,990 Qty 1 (Ok)

Features:

- 64K or 256K Write Back Cache
- 8K Internal Cache
- Dual Read/Write Cache
- Transparent Refresh
- UL/FCC B Available
- True32-Bit Memory Exp. to 16MB
- Support Wattek
- UNIX, OS2 & Novell Compatible
- 1 Year Full Warranty
- Complete Documentation

	MIPS	Cache	Ok	4M
486/33	15.2	64K	2990	3290
486/25	11.4	64K	2599	2899
386/33	8.3	64K	1429	1729
386/25	6.2	64K	1229	1529

Technology Power Enterprises, Inc.
47273 Fremont Blvd, Fremont CA 94538
Tel (415) 623-3818 FAX (415) 623-3840

Circle 301 on Reader Service Card

SuperSound TurboSound

SoundFX-III, -Stereo, -Mono, -Eng, -Jr
SoundBytes, SoundJr, SoundCard,
Digital Audio Authoring Workstation,
MSC/TurboC/Windows 3.0 Libraries,
Custom Sound Hardware/Software
ALL WE DO IS SOUND!!

IBM-PC DIGITAL VOICE / SOUND
from only \$20 (Player module) to \$640 (Developer's Kit)

Pro Quality Software / Hardware - in use worldwide, even Japan!
30 Day Money-Back Guarantee if not Satisfied!

- JUST LIKE HAVING A CASSETTE TAPE RECORDER IN A PC.
- Fastest, easiest Editors with the most features for the price.
- Quick, simple hardware / software installation.
- Use for Foreign Language training / communications.
- For Business: Training, Slide Shows - with Graph, Show/Printer F/X ...
- For Engineering: Function Gen., Clear Voice Alarms, Storage Scope...
- For Fun: Create Your Own Sounds For Games, Alter Your Voice...

Orders: 800-969-4411 by **Silicon Shack** FAX: 408-374-4412
5120 Campbell Ave. #112, San Jose, CA 95130.

Technical: 408-446-4521
Ask for FREE PRODUCT CATALOG of IBM-PC sound products.
Developers: Add TurboSound - PC audio engine to your product.

* SuperSound, SoundFX, SoundCard, SoundBytes, and TurboSound are trademarks of Silicon Shack, Ltd.
Other Product names are trademarks of their manufacturers.

Circle 284 on Reader Service Card

Terminal Emulation

TEK 4105/4010

- Tektronix 4105
- Tektronix 4010/4014
- VT320, VT220, VT102
- Picture files
- VGA and EGA support
- High resolution hardcopy

VT320

- VT320, VT220, VT102 emulation
- File transfer
- 132 column modes
- Color support
- Hot key
- Extensive network support

Diversified Computer Systems, Inc.
3775 Iris Avenue, Suite 1B
Boulder, CO 80301 (303) 447-9251
FAX 303-447-1406

Trademarks: VT102, VT220 - DEC; Tektronix - Tektronics Inc.

Circle 100 on Reader Service Card

T-10 UNIVERSAL PROGRAMMER

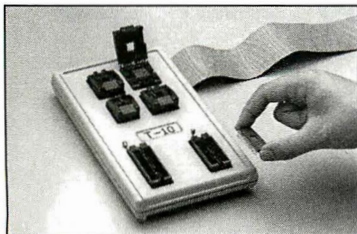

EPROM ■ PLD ■ Bipolar PROM

- Built-in LCC & SMT ZIF sockets to 44 pins
- Individual pin driving
- Point & shoot menus, with MOUSE support
- Device updates on disk & BBS
- Built-in margin testing
- Vector testing
- User definable test parameters
- Full screen editing in 21 formats
- Intelligent identifier

SUNRISE ELECTRONICS, INC.

524 S. Vermont Ave. ■ Glendora, CA 91740

(818) 914-1926

Circle 297 on Reader Service Card

80C51 BASIC-52 BOARD
FOR DISTRIBUTED DATA ACQUISITION

\$220 US includes:

- Intel 80C51FA, new PWM array
- RS422/485, auto RX/TX flow
- RS232, auto override select
- 64K static RAM, battery back up
- 32K CMOS EPROM, 8K Basic-52
- Battery operated & NiCd charge
- On board power supply, 300ma
- Hitachi LMxx LCD driver port
- PC communication software

★★★ **OPTIONS** ★★★

Prototyping Board (Dig.+Analog) . . \$39US
PC/RS232 ↔ RS422/485 \$44US
80C51 Kit form \$99US

BINARY DATA ACQUISITION CORP.

1735 Bayly Street, Pickering, Ontario L1W 3G7
Canada, Phone (416) 420-8029 Fax (416) 831-0510
Cashiers Cheque or Visa

Circle 46 on Reader Service Card

PC Communications Coprocessors

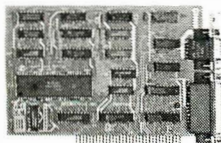

Our communications coprocessors offload serial and parallel communications tasks from PC's used in dedicated applications. RS232 and RS485 style communications. Easily programmed using C. A memory mapped interface to the host PC allows high speed data transfer and simple buffer schemes. From 64k to 512k of memory local to the coprocessor but accessible from the host PC. Used in many industrial and business systems to dramatically improve performance compared to standard PC serial port implementations.

Z-World Engineering

1340 Covell Blvd., Davis, CA 95616

(916) 753-3722

Fax: (916) 753-5141

Circle 346 on Reader Service Card

VT240 Keyboard for your PC

Turn your PC into a VAX workstation with the PowerStation.™

- an exact VT200/VT300 layout keyboard to plug into your PC, and
- ZSTEM 240 or 220 terminal emulation software



3738 North Fraser Way, Unit 101
Burnaby, B.C., Canada V5J 5G1

Tel: (604)431-0727 Fax: (604)431-0818

Order Desk Toll-Free: 1-800-663-8702

ZSTEM and PowerStation are trademarks of KEA Systems Ltd.

Circle 160 on Reader Service Card

VCR Backup Board

Statistically, your hard disk is going to crash sooner or later. And accidentally erasing something is a common mistake. Don't be the guy who skips this ad and loses all his data. Call us today and let us send you the complete info on the VCR Backup Board. 30 day money back guarantee if not satisfied!

- Backup/Restore only the files you wish
- 2 Hr. tape holds up to 100 Megabytes
- Infra-Red cable fully controls the VCR
- Fast Forward seek of desired files
- Easy to Install and Easy to Use
- Works with VHS & Beta VCRs
- Compatible with PC/XT/AT
- Uses low cost VCR Tapes
- Very High Reliability
- Automated Backups

No More Floppy Disk Backup Hassles Ever!

Only \$229.00! Dont Delay! Call us today at

1-800-765-5576

Omnitronix, Inc. (206) 624-4985
760 Harrison St. Seattle, WA 98109 - Fax (206) 624-5610

Circle 361 on Reader Service Card

Little Giant™

C Programmable Controller

This shirt pocket sized computer interfaces directly to the outside world. Use it to control anything. Instantly programmable using your PC with Dynamic C. ROM and battery backed RAM to 1024k bytes. 8 Channel, 10/12 bit, A/D with conditioning. High voltage and current drivers. Battery backed time and date clock. Watchdog and power fail. 4 serial channels. 24 parallel I/O lines. Timers. Integral powersupply. Terminations for field wiring. Expansion connector. Plastic or metal field packaging available. OEM versions from \$199.00.

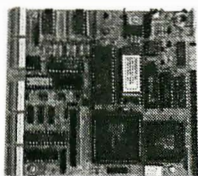

Z-World Engineering

1340 Covell Blvd., Davis, CA 95616

(916) 753-3722

Fax: (916) 753-5141

Circle 347 on Reader Service Card

KNAPCO

MASTER DISTRIBUTORS

TOSHIBA UPS



TRUE ON-LINE UPS SYSTEMS

SINE - WAVE

TOTALLY SELF CONTAINED

LESS THAN 3% THD. GELL - CELL

BATTERIES FOR UP TO 30 MIN.

RS232 PORT STANDARD,

PROTECTS AGAINST BLACKOUTS,

BROWNOUTS, SAGS, SPIKES &

LINE NOISE. NOW UPS SHIPPABLE

*NEW SMALLER PROFILE



	LIST	DEALER
500 VA.	\$ 1499.	\$ 1199.
750 VA.	\$ 1799.	\$ 1399.
1K VA.	\$ 2099.	\$ 1494.
2K VA.	\$ 3999.	\$ 2999.
3K VA.	\$ 6599.	\$ 3999.
5K VA.	\$ 9379.	\$ 6499.

TOSHIBA UPS

ORDER HOT LINE

800-827-4718

INTERNATIONAL TRANSFORMERS

220v. / 110v. STEP up / down

100 WATT. TRANSF	\$ 28.
300 WATT. TRANSF	\$ 40.
500 WATT. TRANSF	\$ 59.
1000 WATT. TRANSF	\$ 89.
1300 WATT. TRANSF	\$ 98.
*2000 WATT. TRANSF	\$116.
*3000 WATT. TRANSF	\$197.

*** SELECTABLE VOLTAGE TAPS

VOLTAGE REGULATORS & CONDITIONERS

TVR 500 500 WATT 110 / 220v. \$259. \$128.

TVR1000 1000 WATT 110 / 220v. \$349. \$196.

** ABOVE WITH STEP UP OR DOWN TRANSFORMERS

MY 2K 2000 WATT 220v. ONLY \$429. \$229.

YR2KD 2000 WATT 110 / 220v. \$649. \$379.

110 VOLT REGULATORS

MY 500 500 WATT \$119.

AUTOMOBILE INVERTERS FOR YOUR FAX OR PORTABLE TELEPHONE \$79.

SHAPE LINE TAMERS

FERRO POWER CONDITIONER

Surge Suppressor with +3% REGULATION,

4 Outlets, 6 ft. Cord, IEEE Std. 987 for noise.

	Retail	Dealer
300 VA.	\$220.	\$165.
450 VA.	\$285.	\$214.
600 VA.	\$330.	\$247.
800 VA.	\$485.	\$309.
1000 VA.	\$540.	\$319.

813 - 449 - 0019

FAX 813 - 449 - 0701 Q-22

KNAPCO

QUALITY DISTRIBUTION FOR 45 YEARS

1201 HAMLET AVE. CLEARWATER FL. 34616

EPSON® 386/20

\$1098

List Price \$3299

- 386-20 MHz, Zero Wait States
- 2 MB RAM expands to 16 MB
- 1.2 MB 5¼" disk drive
- Parallel printer port
- Serial RS-232C port
- 8 open expansion slots
- Top-rated 101 keyboard
- Five drive bays
- DOS 3.3 & GW-BASIC



BRAND NEW!
FULL EPSON WARRANTY!
LIMITED QUANTITY!

Complete Systems

	No Hard Drive	40 MB Hard Disk	80 MB Hard Disk	150 MB Hard Disk	660 MB Hard Disk
Monochrome Monitor & Card	\$1198	\$1498	\$1648	\$2498	\$3598
VGA 640 x 480 Monitor & Card	\$1498	\$1798	\$1948	\$2798	\$3898
VGA 1024 x 768 Monitor & Card	\$1598	\$1898	\$1998	\$2898	\$3998

Full Page Scanner

\$268

List Price \$1190



- Included FREE**
- IBM compatible card & cable
 - Microsoft PagePower software
 - Windows 2.0 (Runtime)
 - Scan, Draw & Modem/FAX
 - Automatic Sheet Fed
 - Contrast adjust for half-tones
 - 200 DPI full page, 400 DPI half page
 - 1 year AT&T warranty

Deluxe OCR Software \$98
When purchased with scanner, \$198 when purchased separately

EPSON® Printers

LX-810 ___ **\$172**
LQ-510 ___ **\$273**
LQ-1010 ___ **\$418**
LQ-850 ___ **\$468**
LQ-860 ___ **\$568**
LQ-950 ___ **478**

All models and accessories
ON SALE, CALL US!

Smartcard Modem

2400 Baud

\$74

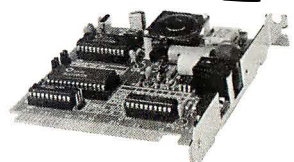

Including FREE Software

MEMORY UPGRADES

HEWLETT-PACKARD

LaserJet II 1 MB ___ **\$135** LaserJet IIP 1 MB ___ **\$148**
and 2 MB ___ **\$188** and 2 MB ___ **\$224**
LaserJet IID 4 MB ___ **\$344** LaserJet III 4 MB ___ **\$368**

TOSHIBA

T1000SE 2 MB Card ___ **\$428** T3200SX 2 MB Card ___ **\$298**
T1600 2 MB Card ___ **\$298** T3200 3 MB Card ___ **\$468**
T3100e 2 MB Card ___ **\$298** T5100 2 MB Card ___ **\$298**
T3100SX 2 MB Card ___ **\$298** T5200 2 MB Card ___ **\$298**
4 MB & 8 MB Card Available

IBM

PS/2 MDL 30/286 512K *78 2 MB *218
PS/2 MDL 70 1 MB *118 2 MB *238
PS/2 MDL 80 1 MB *168 2 MB *298
Laser Printer 1 MB *128 2 MB *258 3.5 MB *398

COMPAQ

LTE 1 MB *218 2 MB *398
SLT/286 1 MB *288
DeskPro Upgrades as low as \$144

ZENITH

SuperSport 286 1 MB *288
386-20/25/33 1 MB *108 2 MB *238 4 MB *798

AST

ALL MODELS
AVAILABLE CALL

JADE COMPUTER

Technicon Printer 5102

Limited Quantity! **\$128**

List Price \$299

- 120 CPS, 9 PIN Printer
- Near Letter Quality Printing
- EPSON/IBM Compatible
- Full Graphics
- Built-in 8K Buffer
- Friction Feed and Tractor Feed
- One Year Warranty

No Surcharge for Credit Cards!



California

Torrance, Costa Mesa, Woodland Hills, San Diego, Sunnyvale

Texas Georgia Arizona
Dallas, Houston Smyrna Phoenix

Not all items in stock at our nine retail locations.

JADE COMPUTER

4901 W. Rosecrans Ave., Box 5046, Hawthorne, California 90251-5046

(213) 973-7707

Continental U.S.A. **1-800-421-5500** Inside California **1-800-262-1710**

10 Day Money Back Guarantee

We accept checks, credit cards (or purchase orders from qualified firms and institutions). No surcharge on credit card orders. CA., TX., GA. & AZ. residents add sales tax. Prices and availability subject to change without notice. \$4.00 minimum shipping and handling charge.

NEW FREE 384 PAGE DATA ACQUISITION & CONTROL HANDBOOK FOR IBM PC/XT/AT, PS/2 AND COMPATIBLE COMPUTERS

NEW 1990 HANDBOOK



- A/D BOARDS
- SIGNAL CONDITIONING
- COMMUNICATION
- INDUSTRIAL CONTROL
- PC INSTRUMENTS
- IMAGE ACQUISITION

*SEND TODAY FOR YOUR FREE 384 PAGE METRABYTE DATA ACQUISITION & CONTROL HANDBOOK

KEITHLEY METRABYTE

440 Myles Standish Blvd., Taunton, MA 02780
(508) 880-3000 TLX: 503989 FAX: (508) 880-0179

Circle 161 on Reader Service Card

MARYMAC®



of discounting
Tandy® computers,
Fax and Radio
Shack® products

Radio Shack® Tandy®

**We will meet or beat...
GUARANTEED LOWEST PRICES**

MARYMAC INDUSTRIES INC.
22511 Katy Fwy.
Katy (Houston), TX 77450
1-713-392-0747 FAX (713) 574-4567

Toll Free 800-231-3680

Circle 181 on Reader Service Card

DATA ACQUISITION

- Systems for Lab, Factory & Field
 - PC Software Included
 - Serial, Modem, & Bus
 - Stand Alone Ability
 - Laptop & Handheld
 - PC & MAC Cards
 - Inexpensive
 - OEM & VAR
 - RTU's



FREE CATALOG & DEMO DISK!

Manufacturers of Measurement & Control systems for Laboratory, Industrial, & Field applications. Specialists in Battery-Powered systems.



Call for applications info: (201) 299-1615
P.O. Box 246; Morris Plains, NJ 07950 U.S.A.

ELEXOR

Circle 102 on Reader Service Card

VIDEO FRAME GRABBERS

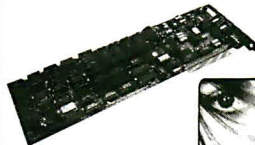

MODEL	RESOLUTION	
HRT 256-4	256 x 256 x 4	495
HRT 256-8	256 x 256 x 8	795
HRT 512-8	512 x 512 x 8	995
HRT 512-24	512 x 512 x 24	1995

- IBM PC/XT/AT COMPATIBLE
- DIGITALIZE IN REAL TIME
- COMPOSITE VIDEO IN
- 24 BIT RGB OUT except model HRT 256-4
- 16 level gray scale out
- SOFTWARE LIBRARY OF IMAGE ANALYSIS ROUTINES
- FREE SOFTWARE UPGRADES TO REGISTERED OWNERS
- FULL CREDIT ON UPGRADE PURCHASE IN FIRST YEAR
- RETURN OLD BOARD AND JUST PAY DIFFERENCE



HRT

HIGH RES TECHNOLOGIES
P.O. BOX 76
LEWISTON, N.Y. 14092

PHONE 416-497-6493

FAX 416-497-1988

Circle 134 on Reader Service Card

Free leaflets and catalogues

Info#	Topic
00011	Printer buffers. Perhaps the simplest way to speed up a computer system.
00021	The ideal interface is like a cable: Easy to install. Invisible in use.
00031	T-Switches and Auto-switches. Optimised for easy operation.
00041	Data cables. Highly flexible. Simple to install. A well thought-out system.
00051	Interface Cards. Carefully developed to eliminate application problems.
00401	ToolArt: Useful art for computer professionals.
00511	Brains beats money. Enhancements you can install yourself.
00521	UNIX-Installations. Tips&products.
00531	The right way to install a computer.

W&T Products Corp.
2209 NE 54th Street
Ft. Lauderdale, FL 33308
Phone 1-800-628-2086
Fax 1-305-351-9099

W&T PRODUCTS®

Circle 152 on Reader Service Card

Introducing ITR VISION Software

\$695⁰⁰
Special Offer

Save Thousands Over Hardware Based Products

- Software Only-No Extra Hardware Needed
- IBM Compatible MS-DOS 3.0 or Higher
- Source Code and License Available
- Multiple Modes Based On ITR's Patented VARI[®] Technology
- Includes Proposed JPEG Mode
- Transmit a Full Screen Image in 15 Seconds Using A Modem and Phone Line
- Store Up To 10,000 Full Screen Images On A 100 Meg Hard Drive
- Will Drop Into Any Existing Imaging Platform
- High Quality Image Databases With 1000's Of Images Now Possible on PC's

**CALL NOW TO ORDER
1-800-966-4487**

MAJOR CREDIT CARDS ACCEPTED
Visual Approximation Reduction of Images

Circle 340 on Reader Service Card

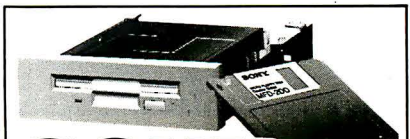

SONY®
3.5" (2.0 MB) DISK DRIVE
internal fits 5.25" slot for
IBM PC, XT, AT, & Compatibles

67.00 each

plus 4.00 shipping for 2 day air delivery
DISKETTE CONNECTION

3M



Authorized Distributor Data Storage Products

DISKETTES

5.25" DS	5.55	• Pre-Formatted...	6.20
5.25" HD	9.85	• Pre-Formatted...	10.60
3.50" DS (1 MB)....	8.00	• Pre-Formatted...	8.80
3.50" HD (2 MB)....	14.75	• Pre-Formatted...	15.95

DATA CARTRIDGES

DC 2000.....	15.00	DC 300 XLP.	18.95
DC 2080.....	16.75	DC 600A.....	21.00
DC 2120.....	19.25	DC 6150.....	21.85

TAPE BACKUP PRODUCTS

Black Watch Tape (700-2400-C55).....	12.29	
3480 Tape Cartridges.. (12514) ...	4.59	
DEC TK-50.....	24.99 * DEC TK-70.....	37.50

**** We Stock The Full Line of 3M Computer Supplies ****
DISKETTE CONNECTION

maxell®

5.25" D-Side / D-Density	4.99	5.25" High Density	8.99
3.50" DS (1 MB)	7.29	3.50" HD (2MB)	13.99

OPTICAL DISKS - CALL FOR PRICES
DATA CASSETTES

CS-500 HD.....(50 MB).....	13.13
CS-600 HD.....(60 MB).....	15.25
CS-600 XD.....(155 MB).....	15.95

DISKETTE CONNECTION

DISKETTE CONNECTION

NORTHEAST & CANADA

1 (800) 451-1849

PO BOX 10247, WILMINGTON, DE. 19850

SOUTHEAST

1 (800) 940-4600

PO BOX 4163, DEERFIELD BEACH, FL 33442

MIDWEST

1 (800) 654-4058

PO BOX 1674, BETHANY, OK. 73008

WEST - HAWAII & ALASKA

1 (800) 621-6221

PO BOX 12396, LAS VEGAS, NV. 89112

Minimum Order: \$20.00 NO SURCHARGE on VISA / MC
COD orders add \$3.50 Shipping charges determined by
items and delivery method required by customer.
(Prices are subject to change without notice)

FAX (405) 495-4598

SHECOM

386 SX-16 MHZ

386-25 MHZ 0 CACHE

386-25 w/64K CACHE

386-33 MHZ w/64K CACHE

BABY CASE W/200 WATT P/S

- 1 MEG MEMORY
- 1.2 MB FLOPPY DISK DRIVE
- 40 MEG HARD DISK DRIVE
- 2 SERIAL/1 PARALLEL GAME PORT
- MONOCHROME GRAPHICS CARD
- 12" AMBER MONITOR
- 101 KEYBOARD
- 1st YEAR, PARTS & LABOR
- 2nd YEAR, LABOR

STANDARD FEATURES:

- 2 MEG MEMORY
- 1.2 MB FLOPPY DISK DRIVE
- 1.44 MB FLOPPY DISK DRIVE
- 65 MB HARD DISK DRIVE
- WA6 1:1 RLL CONTROLLER
- MONOCHROME GRAPHICS CARD
- 12" AMBER MONITOR
- 2 SERIAL/1 PARALLEL AND GAME PORT
- 101 KEYBOARD
- 1st YEAR, PARTS & LABOR
- 2nd YEAR, LABOR

STANDARD FEATURES:

- 2 MEG MEMORY
- 1.2 MB FLOPPY DISK DRIVE
- 1.44 MB FLOPPY DISK DRIVE
- 65 MB HARD DISK DRIVE
- WA6 1:1 RLL CONTROLLER
- 14" VGA MONITOR
- HI RES VGA CARD w/512K
- 2 SERIAL/1 PARALLEL AND GAME PORT
- 101 KEYBOARD
- 1st YEAR, PARTS & LABOR
- 2nd YEAR, LABOR

STANDARD FEATURES:

- 2 MEG MEMORY
- 1.2 MB FLOPPY DISK DRIVE
- 1.44 MB FLOPPY DISK DRIVE
- 65 MB HARD DISK DRIVE
- WA6 1:1 RLL CONTROLLER
- 2 SERIAL/1 PARALLEL AND GAME PORT
- 1024 x 768 MULTI SYNC MONITOR
- HI RES VGA CARD w/512K
- 101 KEYBOARD
- 1st YEAR, PARTS & LABOR
- 2nd YEAR, LABOR

\$1,095.00

\$1,595.00

\$2,295.00

\$2,595.00

SIMM/SIP

256K X 8 70, 80, 100 NS
256K X 9 70, 80, 100 NS

1 MEG X 8 60, 70, 80, 100 NS
1 MEG X 9 60, 70, 80, 100 NS

4 MEG X 8 80 NS
4 MEG X 9 80 NS

MEMORY UPGRADES

IBM, COMPAQ, APPLE, MACINTOSH, EVEREX, HEWLETT PACKARD, TOSHIBA, ZENITH, AST, AT&T, EPSON, NORTHGATE, SHARP, MITSUBISHI, SUN MICRO SYSTEMS, ALR

MATH CO-PROCESSORS

IIT

8087-3
8087-2
8087-1

CYRIX

80287-6
80287-8
80287-10

80287-12
80287-XL
80387-SX-16

INTEL

80387-16
80387-20
80387-25
80387-33



SHECOM
HITEK
KEYBOARD

\$42

DEXXA
By Logitech

\$35

WA6
1:1 MFM
CONTROLLER
w/Cables

\$75

HI RES
VGA
CARD
w/256K
(exp 512)
\$95

SHECOM COMPUTERS
22755-G Savi Ranch Parkway
Yorba Linda, CA 92686
Tel: 714-637-4800
FAX: (714) 637-6293

HOURS (PDT)
M-F 8 AM-6 PM



Quantity Pricing Available
All Merchandise carries
full manufacturers
warranty.
Prices subject to change
without notice.

Circle 283 on Reader Service Card

SALES ORDERS CALL 1-800-366-4433

Up to date. Down to earth.

Changing the world. UNIX is changing the world of computers, the world of business—quite simply, changing the world. It's revolutionizing office automation. It's required for U.S. government computer contracts. It's the backbone of information strategies worldwide.

The information you need. That's why you need *UNIXWORLD*—the magazine that keeps you up to date on the rapidly changing world of open systems computing. Each issue brings you the latest product trends and technical advances that can affect your business. The inside story on some of the world's

biggest high-tech companies. Easy-to-understand programming tips and tutorials that can help you and your company use UNIX to its fullest. And unbiased hardware and software reviews to help you invest wisely when you buy.

The whole UNIX-verse.

UNIXWORLD's in-depth features go beyond dry technical facts, to show how the pieces fit together—to tell you what's important about the advances and the strategies that are changing your world. And *UNIXWORLD* consistently offers the freshest, most down-to-earth writing you'll find in any computer publication.

Subscribe and Save. Subscribe today, and receive the next 12 issues of *UNIXWORLD* for just half the regular newsstand price. Save even more by ordering for two or three years. You can't lose—every subscription to *UNIXWORLD* comes with a no-risk guarantee.*

1 year \$18.00 (save 50%)
2 years \$32.00 (save 55%)
3 years \$42.00 (save 60%)

**Subscribe now! Call toll-free:
1-800-341-1522**

UNIXWORLD

If you're into UNIX, you need *UNIXWORLD* MAGAZINE.

UNIX® is a registered trademark of AT&T. UNIX WORLD is not affiliated with AT&T.

*UNIXWORLD's no-risk guarantee: If not satisfied, cancel and receive a full refund for the balance of your subscription.

A McGraw-Hill publication



MAIL ORDER DIVISION

Computer Memory and Peripherals

SIMM/SIPP MODULES						
	150ns	120ns	100ns	80ns	70ns	60ns
4MG X 9	---	---	\$335	\$359	\$395	---
1MG X 9	---	\$59	\$62	\$65	\$73	\$76
1MG X 8	---	\$50	\$55	\$62	\$71	---
256 X 8	\$16	\$24	\$29	---	---	---
256 X 9	\$12	\$18	\$20	\$21	\$26	\$27

D-RAM						
	150ns	120ns	100ns	80ns	70ns	60ns
1MG X 1	---	\$5.00	\$5.50	\$6.00	\$6.50	\$9.00
256 X 1	\$1.30	\$1.50	\$1.60	\$1.75	\$1.90	\$2.20
256 X 4	---	\$5.50	\$6.50	\$7.00	---	---
64 X 1	\$1.00	\$1.40	\$1.50	---	---	---
64 X 4	\$2.25	\$2.50	\$2.75	\$3.00	---	---
256 X 4 Static Col	---	---	\$10.00	\$11.00	---	---
256 X 1 Static Col	---	---	\$2.25	\$3.00	\$4.25	---

286 MATH CO-PROCESSORS					
	6MHz	8MHz	10MHz	12.5MHz	20MHz
IIT (2C87)	---	\$169	\$195	---	\$280
INTEL (80287)	\$120	\$183	\$195	\$269	---

8088 MATH CO-PROCESSORS				
	5MHz	8MHz	10MHz	
INTEL (8087)	---	\$79	\$114	\$159

386 MATH CO-PROCESSORS					
	16MHz	20MHz	25MHz	33MHz	SX
CYRIX (83D87)	\$279	\$319	\$389	\$479	16-\$280
IT (3C87)	\$299	\$319	\$389	\$499	20-\$325
NTEL (80387)	\$299	\$350	\$450	\$549	16-\$290

ZENITH 386 SIMM MODULES				
For Model	1MG	2MG	4MG	
386/20;25;33;33E	\$89	\$225	\$599	
386/SX	\$89	\$225	\$599	

ZENITH EXPANSION CARDS			
For Model	1MG	2MG	
SuperSport SX;286E	\$269	\$425	
SuperSport SX		\$425(Alpha)	
SuperSport SX		\$425(Beta)	

PS-2 PRODUCT

MODEL 70 & 80 SIMM	MODEL 30-286 SIMM
34F2933 - 4MG Memory Module for 55SX; 65SX Memory Option IBM P/N 34F3077;34F3011 \$469	1MG x 9 - 100ns\$75
6450372 - 2MG Module for 6450367\$309	30F5360(Kit-2ea)\$150
6450375 - 1MG Memory Bd for 80-041\$139	256 x 9 - 120ns\$24
6450379 - 2MG Memory Bd for 80-111;311-121;321\$249	30F5348 (Kit-2ea)\$48
6450603 - 1MG Module for 70-E61;-121, Adaptor Board IBM P/N 6450605, 6450609, 34F3011 & 34F3077\$95	
6450604 - 2MG Module for 70-061;E61;-121,502;55SX;65SX;P70	
Adaptor Board IBM P/N 6450605, 6450609, 34F3011 & 34F3077\$185	
*10 or more units\$175	
6450608 for Model 70A21, A61, B-21, B61,\$185	
6451060 - 4MG Memory Bd for 80-A21;-A31 \$559	

MEMORY EXPANSION BOARDS	
6450605 - w/2MG Expands to 8MG.\$499	
1497259 - w/2MG Expands to 8MG.\$499	
34F3011 - w/4MG Expands to 16MG.\$749	

LAPTOP MEMORY	
1MG Card-Toshiba Portable T1000SE & SX.....\$349	
2MBCard-Toshiba Portable T1000SE & XE.....\$449	
2MG Card-Toshiba Portable T1200e.....\$445	
2MG Card-Toshiba Portable T1600.....\$275	
2MG Card-Toshiba Portable T3100SX.....\$275	
4MG Card-Toshiba Portable T3100SX.....\$275	
512K Card-Toshiba Portable T3100e.....\$149	
2MG Card-Toshiba Portable T3100e.....\$269	
2MG Card-Toshiba Portable T3200SX.....\$299	
4MG Card-Toshiba Portable T3200SX.....\$699	
3MG Card-Toshiba Portable T3200.....\$429	
2MG Card-Toshiba Portable T5100.....\$275	
2MG Module-Toshiba Portable T5200.....\$275	
2MG Module-Toshiba Desktop T8500.....\$349	

CITIZEN	
120D.....\$139	
180 D.....\$299	
GSX 140.....\$299	
GSX 200 GX Color.....\$199	
HSP500.....\$329	
HSP550.....\$449	

EPSON Memory Up-Grade for Model LP6000		IBM Memory Upgrade for Model 4019, 4019E	
1MG.....\$154	1MG.....\$146	2MG.....\$213	2MG.....\$198
2MG.....\$213	2MG.....\$198	3MG.....\$336	3.5MG.....\$277

AST 386 MEMORY MODULES			
1MG 386/25-33SX.....\$79	4MG 386/16.....\$299		
1MG 386/16.....\$79	4MG 386C.....\$299		
1MG 386C.....\$79			

Retail Office
1025 E. TWIN
Las Vegas, NV 89109
Phone: (702) 732-8689
FAX: (702) 732-0390
1-(800)-843-8414
Mon - Fri 8am - 6pm
Sat 8am - 2pm

HOLIDAY SPECIALS

Cyrix
MATH COPROCESSOR
For 386SX Systems
Includes Sockets
83587-16.....\$280
83587-20.....\$360

MARSTEK
HAND SCANNERS
MARS 105 PLUS
100-400 DPI, 105 MM
Scanning Width, 11
Tone Levels, 3 Patterns,
1 line art.\$189
MARS 800
800 DPI, 64 Greys, Res
6-400 dot-in, 12
patterns.\$278

CONTROLLERS
IDE/WFD.....\$49
MFM/WFD.....\$89
RL/WFD.....\$79

HEWLETT-PACKARD
LASERJET MEMORY

2P & 3
9K.....\$79
1MG.....\$99
2MG.....\$149
4MG.....\$249

QTY PRICING AVAILABLE

2 & 2D
9K.....\$89
1MG.....\$119
2MG.....\$169
4MG.....\$269

NEW FAST PRODUCT

RAMVantage!
for 286 AT Systems.
Split Memory
Addressing. Does
Backfill to 640K and
extended memory up
to 3MG. Uses
256 D-RAM.
SuperPak Software
only...\$47

SIX PAK 286
Up to 4 MB EMS 4.0
extended, expanded
and/or backfill to
640K, 1 serial &
1PAR port. For AT &
systems. Uses 256K
or 1MG SIMMs.
Software included.
with 9K.....\$119
with 512K.....\$159
with 4MG.....\$379

RAMPAGE PLUS 286
Up to 8MG Expanded
Memory. Uses 256 x
9 or 1MG x 9 SIMM.
Supports LIM4.0 and
OS/2 - Up to 12.5MHz
bus for AT (16 bit bus)
with 9K.....\$299
with 2MG.....\$409

TERMS AND CONDITIONS
No charge for MC or VISA
Terms: MC - VISA - COD - CASH - AMEX add 4%
Purchase Orders from qualified firms.
20% restocking fee on non-defective returns.
Prices subject to change.

We Accept Purchase Orders from Qualified Firms,
Universities and Government Agencies
FROM ANYWHERE IN THE U.S.,
CANADA, PUERTO RICO AND
THE VIRGIN ISLANDS. **1-(800)-533-0055**

We Accept International Orders
with fast delivery via DHL, Federal Express, Air Mail
INTERNATIONAL ORDERS: (714) 251-8689

MEMORY EXPANSION BOARDS

COMPAQ MEMORY

ADD-ON MODULES			
MODEL	1MG	4MG	
386/20/20E/25/25E DESK PRO 286E,386S	\$129	\$350	
MODEL	2MG	8MG	32MG
386/33, 486/25 & SYSTEM PRO	\$269	\$1695	\$7900

MEMORY EXPANSION BOARDS					
MODEL	512K	1MG	2MG	4MG	8MG
386/16	\$325	\$495	\$799	\$1299	
386/20E/25E 386S		\$209		\$529	
Portable386				\$895	
PortableLTE	\$139	\$169	\$299		
SLT/286		\$199		\$999	

MEMORY UPGRADE KITS			
MODEL	512K	2MG	4MG
Portable III	\$70	\$178	
DESKPRO 386/16		\$199	\$499

ORCHID

RAMQUEST 8/16 The only card
expandable to 32MG, for IBM PCs, XT's, AT's,
PS/2 Model 30-286 as well as compatibles.
Supports both 8 and 16 bit bus. Uses 256K,
1MG or 4MG Modules. w/ 9K.....\$239

RAMQUEST EXTRA 16/32The only 9-8MG,
9 wait state card for PS/2 mod 50, 60, & 80
which fully supports both 16 and 32-bit memory
access. Includes 1 SER and 1 PAR port plus
free serial cable. EMS 4.0 and OS/2 compatible.
Uses 256K and/or 1MG SIMMS\$299

ACCELERATORS
TINY TURBO 286 Low cost, high speed, half slot
PC/XT - Accelerates your PC/XT with a 8MHz 80286
microprocessor. 80287 math chip socket.....\$229

TINY TURBO XT High speed half slot accel-
erator for PC/XT - Accelerates your PC/XT up to 4
times faster with a 12 MHz 80286 microprocessor.
80287 Math chip socket.....\$259

D-RAM TESTERS

UNI-002 RT\$139
Tests speed plus parameters

UNI-003 RT\$189
Tests standard SIMM Modules
256 X 8, 256 X 9, 1MG X 9, 1MG X 8
CALL FOR OTHER OPTIONS AVAILABLE

BOCA RESEARCH

1024 VGA 1024 X 768 in 16 simultaneous
colors. 640/480 in 256 colors. 132 col X 50,
43.25. 1024 X 768 + 800/600 drivers/ 132 col
.....\$159

**SUPER VGA 800 X 600 Resolution/ 256K
RAM/ 8 or 16 bit. 132 col X 50,43,25/ LIM
Drivers/ 800 X 600 drivers for Windows, Auto
CAD\$109**

**VGA 640 X 480 Resolution/ 256K RAM, 8 or 16
bit\$99**

Multi EGA 640 X 480 Resolution on multiple
frequency monitors- 640 X 480 + 752 X 410/
256K RAM/Drivers for AutoCAD, Windows and
Lotus.....\$89

ATI TECHNOLOGIES

VGA WONDER 256™(256K video memory,
user upgradable) Same as VGA wonder 512™,
except with 800x600 in 16 colors and 1024x768
in 4 colors. Includes Microsoft compatible
mouse\$249

UNITEK

**EGA CARD 640 X 480, 16 color, EGA/MGA/
CGA/Hercules\$89**

**VGA CARD 1024 X 768, 16 color, VGA/EGA/
MGA/CGA\$119**

MONO CARD w/parallel port\$25
CGA CARD w/parallel port\$25

BOCA RESEARCH

TOPHAT - Does backfill conventional memory
from 512 to 640K on AT/ with 9K\$69

BOCARAM/XT Provides up to 2MG of expanded
memory for 8 bit bus. Operates up to 12 MHz -
Uses 256K D-RAM/ with 9K\$109
with 1MG\$170

BOCARAM/AT Provides up to 2MG LIM EMS 4.0
and/or 4MG of extended, expanded or backfill
memory. For 16 bit bus. Operates up to 16MHz.
Uses 256K D-RAM/with 9K\$109
with 512K\$169

BOCARAM/AT PLUS Provides up to 8MG of
extended, expanded or backfill memory.
Operates up to 33MHz and is set thru software.
Uses 1MG D-RAM/ with 9K\$119
with 2MG\$235

BOCARAM/I/O PLUS Provides up to 4MG of
extended, expanded or backfill memory. For 16
bit bus. Operates up to 33 MHz and is set thru
software. Has serial and parallel port. Uses
1MG D-RAM/ with 9K\$165
with 2MG\$319

BOCARAM 30 Provides up to 2MG of
expanded memory for IBM PS/2 model 25, 30
and 8-bit bus PC that utilize 3.5 in. floppy disks.
Uses 256K D-RAM/ with 9K\$149
with 2 MG\$289

BOCARAM 50Z Provides up to 2MG, 0 wait
state, expanded or extended memory for IBM
PS/2 model 50, 50Z,60. Uses 1MG D-RAM/
with 9K\$149
with 2MG\$270

BOCARAM 50/60 Provides up to 4MG
extended, expanded or backfill memory for PS/
2 model 50, 60. Uses 1MG D-RAM/
with 9K\$160
with 2MG\$299

I/O XT 02 41 For 8-bit bus. Has clock, parallel
port, serial port, and optional 2nd serial port.....\$49

I/O AT For 16-bit bus. Has parallel port, serial
port, and optional 2nd serial port.\$69

I/O SER 2 Add 2nd serial port. to I/O AT or I/O
XT\$15.95

BOCA MCA PARALLEL CARD Adds 1
parallel port to PS/2 System\$69

**BOCA MCA SERIAL/PARALLEL
CARD** Adds 2 serial and 1 parallel port to
PS/2 System\$119

EVEREX

RAM 3000 DELUXE Up to 3MG. Selectable
memory addresses, Expanded Memory
Specifications (EMS) 4.0 / OS/2. Can be used to
backfill base memory up to 640K and the rest
as expanded and/or extended memory. Uses
256K D-RAM\$99
With 512K\$139

RAM 8000 Up to 8MG capacity/support to
base, extended or expanded memory in any
combination. Fully compatible with Lotus, Intel,
Microsoft, EMS 4.0, EEMS. Supports Multi-
Tasking and DMA Multi-Tasking in hardware.
Software configurable (no dip switches to set).
Full 16MG window for future expansion - Zero
wait state, uses 1MG D-RAM\$219

RAM 10000 Up to 10MG capacity/support to
base, extended or expanded memory in any
combination. Compatible with Lotus, Intel,
Microsoft, EMS 4.0. Operates with no additional
waitstates. Uses 1MG D-RAM\$159

UNITEK

DFI3 BUTTON MOUSE -Microsoft Com-
patible w/ software included.....\$35

384 Multifunction Card\$89
for PC/XT Expands to 384K SER/PAR/CLK/
Game port. Uses 64K DRAM

MARSTEK 3 BUTTON MOUSE
Microsoft/ Mouse Systems Compatible
Adjustable DPI up to 1280 (software)
SOFTWARE INCLUDED\$39

NO SLOT CLOCK Runs on any empty ROM
Socket for XT.
Only\$25

PRICES SUBJECT TO CHANGE WITHOUT NOTICE. NOT RESPONSIBLE FOR TYPOGRAPHICAL ERRORS.



Unitex, Inc

MAIL ORDER DIVISION

Computer Systems and Hardware

We Accept Purchase Orders from Qualified Firms, Universities and Government Agencies

FROM ANYWHERE IN THE U.S., CANADA, PUERTO RICO AND THE VIRGIN ISLANDS.

1-(800)-533-0055



CHECK OUT THE NEW, LOWER PRICES!!

Look at these Great Computer Systems Buys !!



SPECIALS

MINI-SCRIBE AT-XT HARD DISK
40 MG 26ms WITH CONTROLLER
\$299

200MB Hard Drives
Conner 3204
\$819
Rodime RO3259A
\$799

I/O CARDS
AT or XT-1P/2S/1G
\$25
SERIAL, PAR OR XT GAME PORT
\$15 ea.
XT-W/FDC 360K
\$49

Mono VGA Monitor
12" Paper White, Tilt & Swivel Base
\$89 ea.
\$79-10 or more

HARD DRIVES

Kalock 20MB XT 20MB,MFM,3.5 HH,40ms\$225
Micro Science HH1096 66MG RLL, 5.25HH, 28ms...\$320
Conner CP3104 105MG RLL, 3.5HH, 25ms.....\$519
Conner CP3204 200MG RLL/IDE, 3.5HH, 16ms.....\$819
Rodime RO3259A 200MG IDE, 3.5HH, 16ms.....\$799

MODEMS

EVEREX
Internal 1200 BAUD\$69
Internal 2400 BAUD\$129
Internal 2400 BAUD w/MNP 5\$169
External 2400 BAUD w/MNP 5\$199

Unitex (HAYES COMPATIBLES)

Internal 1200 BAUD\$59
External 1200 BAUD\$99
Internal 2400BAUD\$69
External 2400 BAUD\$129
Internal 2400 BAUD w/MNP5 & 7.....\$79
External 2400 BAUD w/MNP5 & 7.....\$139

FAX BOARDS

Calculus EZ-FAX *Now works with Windows 3.0!*
The most highly functional, Fully loaded, Cost effective FAX board manufactured.
CCT Group III

Provides fully concurrent background operation. Allows user to transmit, receive and view documents on screen. Once in memory, the transmissions may be edited for retransmission, printed, stored for future, or discarded off your hard drive. SOFTWARE INCLUDED
CAL 001FX (4800 baud) Unitex Price **\$189**
CAL 002FX (9600 baud) Unitex Price **\$269**

ZOLTRIX 96/24 9600 baud, send/receive fax card with 2400 baud modem.
SOFTWARE INCLUDED.....**\$239**

SCANNERS

LOGITECH SCAN MAN Compatible with the Calculus EZ-FAX. Scan man is a 1-400 Multi-Resolution Scanner. Real time screen image generation while scanning. Using this hand scanner makes faxing your scanned images a simple wave of the hand.
CAL 002BL **INCLUDES CALCULUS EZ-FAX \$339**

DEST PERSONAL SCAN Hand held or sheet fed, full page scanner with OCR software. 300 dots per inch and 64 shades of gray.

ONLY.....**\$649**

UNITEX COMPUTER SYSTEMS

WITH FULL 1 YEAR WARRANTY

The New 386 Personal Computer Systems from Unitex have some incredible features that outperform machines that cost hundreds of dollars more! We have the configuration with exactly the options you want.

ALL SYSTEMS INCLUDE DOS 3.3 AND GW BASIC

UNITEX 386 SX/16

- 14" VGA Paper White Monitor
- Phoenix Bios.
- 1MG on Board Memory (expandable to 8)
- 1.2MB Floppy Drive
- 2 EA. Serial and Parallel Ports
- 1 Game Port
- 101-Key Click Keyboard
- Supports EMS/LIM 4.0
- Has Math-Co Socket

INCLUDES 60 MB HD

OUR PRICE \$1295

UNITEX-386-20

- 20MHz
- 1 MG RAM (expandable to 8 MB)
- 1.2MB Floppy Drive
- Fast IDE 1.1 hard/floppy drive controller
- 200 Watt Power Supply
- FCC Class B approved
- 101 keyboard
- Supports EMS/LIM 4.0
- Has Math-Co Socket

OUR PRICE \$899

UNITEX-386-25

- 25MHz
- 1MG RAM (expandable to 8 MB)
- 1.2MB Floppy Drive
- Fast IDE 1.1 hard/floppy drive controller
- 200 Watt Power Supply
- FCC Class B approved
- 101 Keyboard
- Supports EMS/LIM 4.0
- Has Math-Co Socket

AVAIL. WITH 64K CACHE

OUR PRICE \$1199

UNITEX-386-33

- 33MHz
- 1MG RAM (expandable to 8 MB)
- 1.2MB Floppy Drive
- Fast IDE 1.1 hard/floppy drive controller
- 200 Watt Power Supply
- FCC Class B approved
- 101 keyboard
- Supports EMS/LIM 4.0
- Has Math-Co Socket

INCLUDES 64K CACHE

OUR PRICE \$1899

UNI-286-12/UNI-286-16

- 286-12/16 System Board
- Expandable to 4MG
- 80287 Coprocessor Socket
- 5 Drive Case & 200 W PS
- Built-In Clock & Calendar
- 1MG 0 Wait State RAM
- One 1.2 MB Floppy Drive
- (1:1) HD/FD Controller
- 2 Serial/1 Par./1 Game Port
- Enhanced 101 Keyboard

12MHz \$510

16MHz \$570

SYSTEM OPTIONS (Add-ons to systems only)

CABLES	MONITORS	VIDEO CARDS	CASES	POWER SUPP.
HDD/FDD.....\$5.25	√ 12" Amber w/tilt and swivel base.....\$79	√ Monochrome(720X) or Color Graphics(320X) with parallel port.....\$25	ALL CASES HAVE 200W OR BETTER POWER SUPPLY.	√ XT-150W.....\$39
XT HD.....\$4.49	√ 14" Paper w/tilt and swivel base.....\$89	√ Boca EGA(640x480).....\$89	√ Baby AT.....\$69	√ XT-200W.....\$59
Serial(6).....\$7.95	√ EGA Color.....\$4.49	√ Boca VEGA(640x480).....\$99	√ Mini Tower.....\$139	√ AT 230W.....\$59
KB Ext.(6).....\$4.49	√ VGA Color.....\$319	√ Super VGA(640x480).....\$109	√ Full Size Tower.....\$189	√ PS/2-200W.....\$69
Monitor Ext.(6).....\$4.49	√ Super VGA Color.....\$419	√ Super VGA(800x600).....\$109	√ Std. XT.....\$39	FLOPPY DRIVES
Cen to Cen(6).....\$7.95	√ NEC-2A Multi-Sync.....\$495	√ 1024 VGA(1024x768).....\$159	√ PS/2.....\$159	√ 360K.....\$60
Cen to Ce(10).....\$10.95	√ NEC-3D Multi-Sync.....\$695	√ ATI-VGA Wonder with (1024x768).....\$249		√ 720K.....\$75
Par. Printer(6).....\$5.95				√ 1.2MB.....\$79
Par. Printer(10).....\$9.95				√ 1.44MB(3.5").....\$89

Retail Office
1025 E. Twain
Las Vegas, NV 89109
Phone: (702) 732-8689
FAX: (702) 732-0390
1-(800)-843-8414
Mon - Fri 8am - 6pm
Sat 8am - 2pm

TERMS AND CONDITIONS

Terms: Cash • MC or VISA - no surcharge
AMEX only add 4% handling fee
COD. Purchase Orders from qualified firms.
20% restocking fee on non-defective returns.
Prices subject to change.

SEND ALL MAIL ORDERS TO
P.O. Box 19772
Irvine, CA 92713

Mail Order Division & Retail Store

17222 Armstrong Ave. • Irvine, CA 92714
Phone: (714) 251-UNTX(251-8 6 8 9)
Fax: (714) 251-8943

1-(800)-533-0055
Mon - Fri 7am - 5pm
Sat 8am - 2pm

PRICES SUBJECT TO CHANGE WITHOUT NOTICE. NOT RESPONSIBLE FOR TYPOGRAPHICAL ERRORS.



PS/2 model 30/286-30 meg 1795
 PS/2 model 50Z/286-60 meg 2395
 PS/2 model 55SX/386SX-60 meg .. 2695
 PS/2 model 70/386-120 meg 5595
 PS/2 model 80/121-120 meg NEW

*** Monitor Extra ***



Compaq 286E-40 meg 1995
 Compaq 386/20E-100 meg
 with 4 meg memory 3595
 Compaq 386S-100 meg
 with 2 meg memory 2795
 Other Models CALL

*** Monitor Extra ***

Macintosh

Mac SE/30-40 meg 3195
 Mac IIcx-80 meg 4595
 Mac Portable-40 meg 4795
 Other Models CALL
 *** Keyboard & Monitor Extra ***

LOW PRICE LEADER

SINCE 1983

LAPTOP

Texas Instruments TM2000 2595
 Compaq LTE/286-40 2975
 Sharp 6220 2595

CALL FOR OTHER BRANDS

LAPTOP ACCESSORIES

Memory
 1 meg Toshiba 1000SE 190
 2 meg Toshiba 3100SX 210
 2 meg Toshiba 3200SX 210
 2 meg Toshiba 5200 220
 1 meg Compaq SLT 280



Everex System 1 1545

Everex Step 286/12 - 1 meg
 40 meg VGA card and monitor

Everex System II 2195

Everex Step 386SX - 2 meg
 40 meg VGA card and monitor

Everex System III 4850

Everex Step 386/33 - 4 meg
 150 meg VGA card and monitor

* CALL FOR MODELS & CONFIG *

AGI Computer

AGI 386SX-1 meg 1595
 40 meg VGA card and monitor



AST 386SX - 2 meg 2195
 40 meg VGA card and monitor

CALL FOR OTHER MODELS

DISKS

DYSAN 5 1/4 HD / 3 1/2 HD 13/26
 MAXELL 5 1/4 HD / 3 1/2 HD 12/25
 Min. 10 Boxes Order

WE STOCK

CITIZEN
 OKIDATA
 EVEREX
 GOLD STAR

TOSHIBA
 NEC
 WYSE
 HITACHI

PRINCETON GRAPHICS
 SONY
 ACER
 HOUSTON INSTRUMENTS

AMDEK
 HAYES
 SAMSUNG
 CALCOMP

PC MOUSE
 MICROSOFT MICE
 LOGITECH
 MITSUBISHI

IRWIN & ARCHIVE
 TAPE BACK
 TAXAN
 MAGNOVOX

Intel Coprocessors

8087-3 105
 8087-2 145
 80287-8 225
 80287-10 249
 80387-16 395
 80387-20 425
 80387-25 495
 80387-33 599

SOFTWARE SPECIALS

dBase IV 455
 Wordperfect 5.1 260
 Aldus Pagemaker 495
 Ventura Publisher 525
 Clipper 435
 WordStar 5.5 150
 EasyExtra 40



NOVELL
 Authorized Dealer

SPECIALS

HP Scan Jet 1425
 HP Paint Jet 965
 Lotus Ver. 3.0 355
 Kodak 150P 355
 Complete Fax Board 399
 Okidata 391 625
 Epson LQ1050 660
 Panasonic 1124 319
 HP-7475 Plotter 1595
 SummaGraphic 365

LASER PRINTERS

HP Laser IIID 2550
 HP Laser 2P 995
 HP Laser III 1695
 Panasonic 4450 1395
 Brother HL-8-E 1895
 Nec LC 890 3195
 Toshiba Laser 6 1095

MONITORS

Nec Multisync IIA 499
 Nec Multisync 3D 625
 Emerson VGA 340
 Nec Multisync 5D 2350
 Sony 1304 659
 Sony 1302 619

PACIFIC DATA PRODUCTS

P. Page II 395
 P. Page IIP 365
 P. 1-2-4 Mem II 140
 P. One Meg IIP 160
 P. 25 in One III 250
 P. Headlines 245

LAN BOARDS

8 bit Arcnet 110
 16 bit Arcnet 220
 8 bit Ethernet 190
 16 bit Ethernet 275
 8 port Active Hub 325
 Token Ring Card 399
 Tokenhub 4-port 355
 Call for other LAN Accessories

MODEMS

Everex 2400 Int/Mnp 179
 Hayes 2400B 315
 Hayes 9600B 875
 USRobotics Hst/Dual 1150
 More in Stock Call

ALL QUOTED PRICES ARE CASH PRICES ONLY.
 Visa and MasterCard 3% higher, American Express 5% higher

EXPORTS Available

COMPUTERLANE

HOURS:
 M-F 9-6
 S 10-6

1-800-526-3482 (Outside CA)
(818) 884-8644 (In CA)
(818) 884-8253 (FAX)

22107 ROSCOE BLVD.
 CANOGA PARK
 1/2 BLOCK W. OF TOPANGA
 CA 91304

CORPORATE ACCOUNTS WELCOME
 CALL FOR VOLUME DISCOUNTS
 CONSULTANTS CALL FOR PRICING

Prices subject to change without notice
 * Quantities are limited

Compaq is a Registered Trademark of Compaq
 IBM is a Registered Trademark of International Business Machines

BY HAND. OR BY NOON.

Announcing **Flow Charting™ 3:** Powerful new features— for greater speed, flexibility, and ease-of-use!

- Single-page, multi-page or canvas charts— portrait or landscape
- Custom fonts support high resolution laser and 24-pin dot matrix printers
- 35 standard shapes, 10 text fonts
- Suggested retail price: only \$250

PATTON & PATTON
Software Corporation

See your dealer today! Or, for a "live," interactive demo disk, call: 800-525-0082, ext. BY40. International: 408-778-6557, ext. BY40.

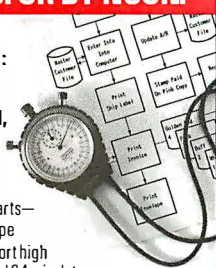

Circle 227 on Reader Service Card

EZ-ROUTE VERSION II

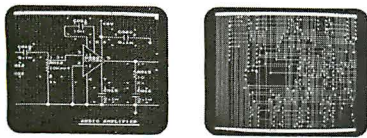

SCHEMATIC TO PCLAYOUT \$500 INCLUDES AUTO ROUTER

EZ-ROUTE Version II from AMS for IBM PC, PS/2 and Compatibles is an integrated CAE System which supports 256 layers, trace width from 0.001 inch to 0.255 inch, flexible grid, SMD components and outputs on Penplotters as well as Photo plotters and printers.

Schematic Capture \$100, PCB Layout \$250, Auto Router \$250.

FREE EVALUATION PACKAGE
30 DAYS MONEY BACK GUARANTEE
1-800-972-3733 or (305) 975-9515

ADVANCED MICROCOMPUTER SYSTEMS, INC.
1321 N.W. 65 Place - Ft. Lauderdale, FL 33309

Circle 39 on Reader Service Card

COPROCESSOR SPECIALIST

		AMD AM80C287-10 with manual & disc \$ 99.00 !	
8087	5MHZ	78.	
8087-2	8MHZ	109.	
8087-1	10MHZ	145.	
80287-8		177.	
80287-10	197.	2C87-8	164.
80387DX-16	299.	2C87-10	178.
80387DX-20	340.	2C87-12.5	189.
80387DX-25	420.	2C87-20	239.
80387DX-33	519.	3C87-16	259.
80C287A-12	245.	3C87-20	279.
80287XL	189.	3C87-25	359.
80287XLT	189.	3C87-33	449.
80387SX-16	269.	3C87SX-16	298.
80387SX-20	289.	3C87SX-20	CALL
WEITEK		CYRIX	
3167-20	340.	X83D87-16	259.
3167-25	569.	X83D87-20	295.
3167-33	699.	X83D87-25	368.
4167-25	747.	X83D87-33	448.
4167-33	990.	X83S87-16	230.
		X83S87-20	252.

ANN & ANTHONY (DAI)
2464 El Camino Real, Suite 420
Santa Clara, CA 95051

Tel: (408) 988-5083 Fax: (408) 988-3986

Circle 360 on Reader Service Card

IEEE 488

Easiest to use, GUARANTEED!

- IBM PC, PS/2, Macintosh, HP, Sun, DEC
- IEEE device drivers for DOS, UNIX, Lotus 1-2-3, VMS, XENIX & Macintosh
- Menu or icon-driven acquisition software
- IEEE analyzers, expanders, extenders, buffers
- Analog I/O, digital I/O, RS-232, RS-422, SCSI, modem & Centronics converters to IEEE 488

Free Catalog & Demo Disks
(216) 439-4091

IoTech

25971 Cannon Rd. • Cleveland, OH 44146

Circle 150 on Reader Service Card

Arlington Electronics

386-25

\$ 1549

286-12 40Mb	\$ 989
386-SX 40Mb	\$1198
386-33 40Mb	\$1889
64K Hi speed cache	

VGA III \$ 449
Windows 3.0 \$ 59
Installed on color system

All systems include:

- Mono graphics monitor
- 40 Mb Teac IDE HDD
- 1.2 or 1.44 Mb Teac FDD
- 1 Mb 80ns main memory
- 101 Keytronics keyboard
- MS-DOS™ 3.3 or 4.01
- Choice of 3 case designs
- 1 year warranty

3% Shipping charge Visa
1-800 833-3590 MasterCard
AMEX

Circle 35 on Reader Service Card

TWIX PC CASH REGISTERS NEW MODELS, LOW PRICES



- NEW 3011/12 "REGISTER HEADS": Receipt printer, register keyboard, cash drawer & monitor in a sleek package for hook-up to a XT/AT or PS-2.
- NEW 3041 "REGISTER TERMINAL": TV950 terminal emulation for multi-user oper. systems with built in controls for drawer, receipts, scanners & more.
- NEW 3081 "REGISTER COMPUTER": Standalone "AT" compatible w/hard & floppy drives, 1 MB Ram.
- NEW "TWIX ADVANTAGE" RETAIL POS Software: Advanced features, network, scanner interface.

TWIX INTERNATIONAL CORP.
4401 S. BROADWAY, ENGLEWOOD, CO 80110
(303)789-5333 FAX (303)788-0670

Circle 362 on Reader Service Card

Circle 59 on Reader Service Card

LOW COST INTERFACE CARDS FOR PC/XT/AT

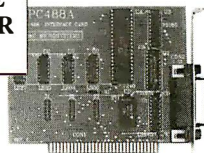

RS-485/422 Card [PC485] \$95/125

- Serial Async. Communication up to 4,000B; 2 or 4 wires; NS16450 UART;
- Can be configured as COM1/COM4; Maximum Baud Rate 56KB
- Flexible configuration options; RTS or DTR control of transmission direction.
- Full/Half duplex operation. Supports hardware handshaking (RTS,CTS).
- Dual drivers/receivers; Handles 64 devices; Compatible with most comm. software.
- High speed version available (supports baud rates up to 256KB) - \$165

Dual-Port RS-485/422 [PCL743] \$175

- Two independent channels / UARTs; 2 or 4 wire operation. Max. Baud 56KB.
- Dipswitch configurable as COM1-4 (IRQ2-7). On board terminator resistor.

IEEE-488 Card [PC488A] \$145

- Includes DOS Device Driver and sample Communication program in BASIC.
- Additional sample programs in C, Pascal & Assembly - \$50.
- IRQ (1-6). DMA channel 1 or 2. Up to 4 boards per computer.
- Compatible with most IEEE-488 Software packages for IBM-PC.
- I/O Addresses and Control Registers compatible with NT's GPIB-PCIA.

**IEEE-488 Card [PC488C]
With Built-In Bus Analyzer \$445**

- Software Support for BASIC, QuickBASIC and GWBASIC.
- Additional libraries for C, Pascal, FORTRAN, Assembly available - \$50 (all)
- Full range of Talker, Listener, Controller, Serial/Parallel Poll, SRQ, etc...
- Powerful menu-driven BUS ANALYZER can be run in the background while 488 programs or commands are executed; Features Program Stepping, Break points, Real Time Bus Data Capture (4K buffer), Instant Screen Toggling.
- Complete Controller /Talker / Listener capability. Based on NEC-7210.
- Memory-resident Printer Port Emulation Utility included (LPT1-3).
- Compatible with NT's GPIB-PCII. TMS-9914 based card - \$345.

DIGITAL I/O Card [PCL720] \$175

- Input: 32 TTL compatible channels; Input load is 0.2 mA at 0.4V.
- Output: 32 TTL compatible channels; Sinks 24mA(0.5V); Sources 15mA(2.0V)
- Counter/Timer: DC to 2.6MHz; 3 channels; 16 bit counters; 6 counting modes.
- Breadboard area for prototyping. Dipswitch I/O port selection (200-3F8 hex).

LOW COST DATA ACQUISITION & CONTROL CARDS FOR PC/XT/AT

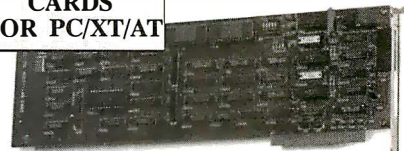

12 BIT A/D & D/A [PCL711s] \$295

- A/D converter: 8 single-ended channels; Device: AD574; Conversion time less than 25µsec; Input range: ±5V; Software Trigger Mode only.
- D/A converter: 1 channel; 12 bit resolution; 0 to +5V I/OV Output Range.
- Digital I/O: 16 Input / 16 Output channels; All I/Os TTL compatible.
- External Wiring Terminal Board with mounting accessories included.
- Utility Routines and Demo/Sample Programs for BASIC and Quick-BASIC.

12 BIT A/D & D/A [PCL812] \$395

- A/D converter: 16 single ended inputs; Device: AD574; Conversion time less than 25 µsec; Built-in programmable pacer; Input ranges: ±10V, ±5V, ±1V.
- D/A converter: 2 channels; 12 bit resolution; Output Range 0-5V.
- Digital I/O: 16 Input / 16 Output channels; All I/Os TTL compatible.
- Counter: 1 channel programmable interval counter/timer; Uses Intel 8254.
- DMA and interrupt capability. Utility software for Basic included.

FAST 12BIT A/D/A [PCL718] \$795

- A/D converter: 16 single ended or 8 differential channels; 12 bit resolution; Programmable scan rate; Built-in Interrupt and DMA control circuitry. Conversion speed 60,000 samples/sec (standard), 100,000 samples/sec (optional).
- Input ranges: Bipolar ±10V, ±5V, ±2.5V, ±1V, ±0.5V; Unipolar 10, 5, 2.5, 1V.
- D/A converter: 2 channels; Resolution 12 bits res; Settling time: 5µsec; ±5V
- Digital I/O: 16 OUT, 16 IN; TTL compatible; All I/Os TTL compatible.
- Counter: 16 bit programmable interval counter/timer; Uses Intel 8254; Pacer clock;
- Software: Utility software for BASIC and QuickBASIC included. Supported by LabDAS (\$195/495), ASYST, LABTECH, UnkelScope

6 Channel 12 bit D/A [PCL726] \$495

- Output Ranges: 0 to +5V, 0 to +10V, ±5V, ±10V or sink 4-20mA.
- Settling time: 70µs. Linearity: ±1/2bit. Voltage output driving capacity: ±5mA
- Digital I/O: 16 digital inputs and 16 digital outputs; TTL compatible.

STEPPER MOTOR CARD \$395

- Capable of independent and simultaneous control of up to 3 stepper motors.
- Speed: Programmable from 3.3 PPS to 3410 PPS; Built-in acceleration control.
- Output Mode: One clock (Pulse, Direction) or two clock (CW, CCW pulses)
- Step position Read-back; Opto-isolated outputs; Crystal based timing.
- Includes 8 bit digital input/output port. Order PIN [PCL-7388]

MC / VISA / AMEX

Call today for datasheets!

Circle 60 on Reader Service Card



B&C MICROSYSTEMS, INC.

750 N. PASTORIA AVE., SUNNYVALE, CA 94086 USA
TEL: (408)730-5511 FAX: (408)730-5521 BBS: (408)730-2317

DECEMBER 1990 • B Y T E 397

**486/25MHz
64K Cache Series
\$1995**



**i486/25MHz CPU w/8K Cache
64K External Cache Memory
Expand 8Mb Memory On-Board
Burst Mode for Max Throughput
Baby-Size (8.5 by 13 in)
AMI 486 BIOS w/Setup
Intelligent Memory Refresh Scheme**

HOMESMART COMPUTING
800-627-6998
(713)496-9110/Fax Info Line
14760 Memorial Dr., Houston, TX 77079

Prices Reflect Discount for Cash/MC/VISA
All Prices Subject to Change Without Notice

Circle 135 on Reader Service Card

UNIVERSAL PROGRAMMER \$585

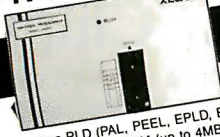

- Programs PLD (PAL, PEEL, EPLD, EEPLD, FPLD, GAL), E(EPROM (up to 4Mbits), BIPOLAR PROM, & Microcontroller
- Tests TTL/CMOS Logic & D/S Ram
- Reliable and fast programming with Normal, Intelligent, Interactive, Quick pulse algorithms
- Accepts JEDEC, INTEL Extended HEX, Motorola S, Tektronix HEX, Binary formats
- Manages 8, 16, and 32-bit word split
- Supports most compilers in JEDEC format
- Software controlled 40-pin universal device programmer
- Interfaces with the IBM PC/XT/AT/386 or compatibles
- High speed parallel interface card

XELTEK
764 San Aleso Ave., Sunnyvale, CA
Tel (408) 745-7974 Fax (408) 745-1401

DUNCAN IN CANADA
(416) 742-4448

Circle 343 on Reader Service Card

R & R Electronics
6050-X, McDonough Drive, Norcross, GA 30093
(404) 368-1777 • Fax (404) 368-9659
We accept VISA MC Am Exp. & Discover + Fees

D-RAMS		SIMMS/SIPPS	
256K-120	\$2.00	256Kx9-80	\$18
256K-80	\$2.25	1Mx8-80	\$45
64Kx4-100	\$1.90	1Mx9-80	\$50
256Kx4-80	\$5.25	1Mx9-60	\$75
1Mx1-80	\$5.00	4Mx9-80	\$350

INTEL/WEITEK		ITT/CYRIX	
8087-2	\$115	2C87-8	\$170
80287-XL	\$225	2C87-10	\$188
80387-SX61	\$288	2C87-12	\$200
80387-20	\$350	3C87-20	\$310
80387-25	\$448	3C87-25	\$420
80387-33	\$545	3C87-33	\$505

PS/2-1mg	\$ 95	VGAcard 256K	\$ 99
PS/2-2mg	\$180	2400 Modem	\$ 66
HP laserjet 2mg	\$175	Dexa Mouse	\$ 40
1.44 F/D	\$ 70	SVGA Monitor	\$375
Boca AT +	\$149	Card 2S, PG	\$ 26

CALL FOR OTHER COMPONENTS

1-800-736-3644

Circle 271 on Reader Service Card

ICs PROMPT DELIVERY!!!
SAME DAY SHIPPING (USUALLY)
QUANTITY ONE PRICES SHOWN FOR OCT. 28, 1990

OUTSIDE OKLAHOMA: NO SALES TAX

DYNAMIC RAM		
4M Board for hp LJs w/2MB		\$170.00
SIMM 2M IBM PS/2 Model 70		175.00
SIMM 1M AST Prem386/33Mhz		125.00
SIMM 1Mx9 80 ns		53.00
SIMM 256Kx9 100 ns		20.00
1Mbit 1Mx1 60 ns		10.95
1Mbit 1Mx1 80 ns		5.95
41256 256Kx1 80 ns		2.85
41256 256Kx1 100 ns		2.05
41256 256Kx1 120 ns		1.85
4464 64Kx4 100 ns		2.00
41264* 64Kx4 100 ns		5.95

EPROM		
27C1000 128Kx8	200 ns	\$15.00
27C512 64Kx8	120 ns	5.25
27256 32Kx8	150 ns	6.75
27128 16Kx8	250 ns	3.75

STATIC RAM		
62256P-10 32Kx8	100 ns	\$6.50
6264P-12 8Kx8	120 ns	4.25

OPEN 6 DAYS, 7:30 AM-10 PM; SHIP VIA FED-EX ON SAT.

SAT DEL ON FED-EX ORDERS RECEIVED BY: Th \$2 \$6.25 4 lb Fr \$4 \$17.00 1 lb COD AVAILABLE

MasterCard/VISA or UPS CASH COD MICROPROCESSORS UNLIMITED, INC. 24,000 S. Peoria Ave. (918) 267-4961 BEGGS, OK, 74421 No minimum order. Please note: prices subject to change! Shipping, insurance extra, up to \$1 for packing materials.

Circle 188 on Reader Service Card

**X.25 SDLC
QLLC HDLC
ADCCP PAD**

- C source code
- ROM-able
- Full porting provided
- No OS required

GCOM GCOM, Inc.
1776 E. Washington
Urbana, IL 61801
(217) 337-4471

Specialists in Computer Communications
FAX 217-337-4470

Circle 118 on Reader Service Card

ROM BIOS UPGRADES

ROM BIOS FEATURES
THE ROM BIOS UPGRADES SUPPORT 360K, 720K, 1.2MB & 1.44MB FLOPPY DISK DRIVES, COMPLETE SET-UP IN ROM, EGA AND VGA SUPPORT; OPTIONAL BUILT-IN DIAGNOSTICS IN ROM (AMI ONLY); NOVELL AND NETWARE COMPATIBLE; SUPPORTS UP TO 48 DIFFERENT TYPES OF HARD DRIVES PLUS TWO USER DEFINED; 84, 101 & 102 KEY KEYBOARD SUPPORT; 100% IBM COMPATIBLE; SUPPORTS 0.1 OR 2 WAIT STATES; COMPLETE DOCUMENTATION; LATEST VERSIONS. WE ARE THE LARGEST STOCKING BIOS DISTRIBUTOR IN AMERICA!

XT BIOS UPGRADES	
AMI-XT BIOS	49.95
PHOENIX-XT BIOS	49.95

AT 286 BIOS UPGRADES	
AMI-286 INTEL BIOS	69.95
AMI-286 VLSI BIOS	69.95
TECH BIOS	69.95
PHOENIX-286 AT BIOS	69.95

AT 386 BIOS UPGRADES	
AMI-386 INTEL BIOS	69.95
AMI-386 CHIP & TECH BIOS	69.95
AMI-386 VLSI BIOS	69.95
PHOENIX-386 INTEL BIOS	69.95
AMI-386-SX INTEL BIOS	69.95
PHOENIX-386 COMPAQ BIOS	69.95
AMI-386-SX CHIP & TECH BIOS	69.95
PHOENIX-386-SX INTEL BIOS	69.95

IBM BIOS UPGRADES	
PHOENIX-IBM-PC BIOS	69.95
PHOENIX-IBM-AT BIOS	69.95
PHOENIX-IBM-XT BIOS	59.95

KEYBOARD BIOS UPGRADES	
AMI-286/386 KEYBOARD BIOS	34.95
AWARD-286/386 KEYBOARD BIOS	34.95
PHOENIX-286/386 KEYBOARD BIOS	34.95

UPGRADES ETC. INCORPORATED
13822 N.E. 165TH ST. WOODBRIDGE, VA 22092
(800) 541-1943 ORDERS
(206) 882-3634 TECH SUPPORT
(206) 881-8294 FAX

VISA MC * COD

Circle 335 on Reader Service Card

Circle 61 on Reader Service Card

Made in USA!

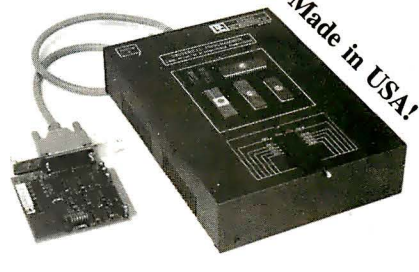

PC BASED UNIVERSAL DEVICE PROGRAMMER \$695/895

- Programs EEPROMs, MICROS, BIPOLARS, PALs, GALs, EPLDs, PEELs (current libraries support over 900 devices by over 35 manufacturers).
- Software driven pin drivers. D/A generated programming voltages (8 bit DACs used to generate voltages from 5-25V with 0.1V resolu on for all pins).
- Fast device programming / verify / read via dedicated parallel interface.
- Upgradeable for virtually any future programmable devices up to 40 pins.
- Self-subsistent operation. No additional modules or plug-in adapters required.
- Includes user friendly MEMORY BUFFER FULL SCREEN EDITOR. Commands include: Fill, Move, Insert, Delete, Search. Data entry can be done in ASCII or HEX form. FUSEMAP EDITOR for Logic devices.
- Friendly Menu-Driven interface. Device selection by P/N and Manufacturer.
- Supports 816/32 bit data word formats.
- Programming algorithms: Normal, Intelligent I & II, Quick Pulse Programming. Automatic selection of fastest algorithm for any given part.
- Verify operation performed at normal & worst case operating voltage.
- Functional test: JEDEC standard functional testing for logic devices. TTL Logic functional test for 74xx/54xx series devices and memory devices. Test library can be updated by the user. User definable test pattern generation.
- File Formats accepted: JEDEC (full), JEDEC (kernel), Binary, MOS Technology, Motorola Hex, Intel Hex, Tektronix Hex.
- Base price (\$695) includes Interface card, cable, Memory+ Micro + Bipolar library, TTL/CMOS/MEMORY device test capability, one year free updates.
- Complete price (\$895) includes all of the above plus Logic Device Library.
- Library updates can be received via floppy or B&C Customer Support BBS.
- Full 1 year warranty. Customer support via voice line, Fax & dedicated BBS.

UNIVERSAL RS-232 PROGRAMMER \$345/495



Made in USA!

- Programs EE/EPROMs, ZPRams, Intel Micros, Flash EProms, Memory Cards.
- Stand-Alone Mode for EE/EPROM and Memory Card Duplication / Verify.
- All24/28/32 pin EE/EPROMs to 4 Mbits (upgradeable to 32 megabits).
- Micros: 8741A, 2/A, 4, 8, 9, 51, C51, C51FA/B, 52, 53, 55, C521, C541, 9761.
- Model UP100 (\$345), Model UP200 (\$495) accepts dedicated modules.
- Memory Cards Programming Module (Seiko/Epson/Fujitsu) - \$145.
- GANG Programming Module (4 sockets) - \$145.
- Optional built-in Eraser/Timer module - \$50; Conductive foam pad.
- On-Board Programming capability; Customer modules available.
- User friendly, Menu-Driven Interface Program for IBM-PC and Macintosh.
- Can be operated with any computer containing an RS-232 serial port.
- OEM open board programmer configurations available (from \$245).
- One year free software updates and Customer Support.
- Customer support via voice line, dedicated BBS or fax; Full 1 year warranty.

INTELLIGENT ROM EMULATOR \$395



Made in USA!

- Emulates 2716 through 27512 EProms (2k to 64k bytes) with a single unit.
- Megabit parts can be emulated with multiple units (Mega adapter required).
- Connects to the standard parallel printer port. Uses standard printer cable.
- FAST data loading via parallel printer port (64k bytes in less than 10 seconds).
- Intelligent "In-Circuit-Emulator" type features include: Address Compare (with HALT output), Address Snapshot (for target addr. bus monitoring), Trigger Input (for external events monitoring), Programmable Reset Output.
- Powerful Memory buffer editor. Selectable word sizes (8,16,32).
- User friendly software. Command set includes: Load, Write, Display, Run, Type, Edit, Fill, Run-Command-File, Monitor, Port, Reset, Help, Calculator.
- Cascadable to 8 units. Includes target cable with Trigger, Halt & Reset clips.
- CMOS model with NiCad rechargeable 9V battery backup - \$495. (Can be used in stand-alone mode; Built-in battery recharging circuitry.)
- File formats accepted: Binary, Intel Hex, Motorola S.

MC / VISA / AMEX Call today for datasheets!

B&C MICROSYSTEMS INC.
750 N. PASTORIA AVE., SUNNYVALE, CA 94086 USA
TEL: (408) 730-5511 FAX: (408) 730-5521 BBS: (408) 730-2317

GraphicTM

"gives you all the C language routines you need to write an impressive scientific graphing program of your own. Highly recommended.*"
 — PC Magazine

Fresnel Integrals

$$C(z) = \int_0^z \cos(0.5\pi t^2) dt$$

$$S(z) = \int_0^z \sin(0.5\pi t^2) dt$$

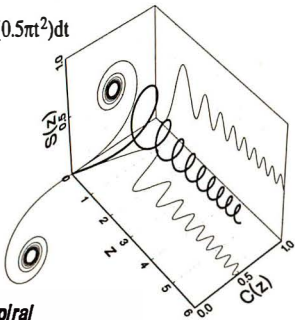

Cornu's Spiral

IBM[®] PC (with source code) \$395
 Circle 275 on Reader Service Card

Macintosh[®] (no source code) \$295
 Circle 276 on Reader Service Card

Licensed for personal use only

VTEK-HPTM 1.0

New!

DEC[®] VT220/102/52
 & Tektronix[®]
 4010/4014/4105
 Terminal Emulator
 for IBM[®] PCs

Circle 277 on Reader Service Card
 VTEK-HP has added full
 VT220 emulation to VTEK
 New High Performance features:

- ▶ TIFF export
 - ▶ Color PostScript[®] and viewable EPS
 - ▶ HP-GL/2TM and PaintJet XLTM support
 - ▶ Full national character set support
 - ▶ Telephone dialer
 - ▶ faster and uses less memory
 - ▶ requires '286 or '386 and VGA/EGA
- VTEK-HP \$245 VTEK \$195

Scientific Endeavors
 508 North Kentucky Street
 Kingston, TN 37763 USA
 (615) 376-4146 FAX:(615) 376-1571

New,
 Improved!

8051/8052 BASIC COMPILER!

Full floating-point numbers, integer, byte and bit extensions. Fully compatible with MCS BASIC 52. Runs on IBM-PC or compatible.

\$295.00

Call Now! 603-469-3232

Binary Technology, Inc.
 Main Street • P.O. Box 67 • Menden, NH 03770

FACTORY SALE

AST[®] RamPage[®] Plus 286

Expanded Memory Board
 For
 IBM XT[®] /286 AT[®] and compatibles
 Up to 8Mb of EMS 4.0 Expanded Memory

Configurations

0Kb	\$230.00
512Kb	\$275.00
2Mb	\$350.00
8Mb	\$675.00

- * Two Year Factory Warranty
- * FREE Shipping on PrePaid Orders
- * Immediate Delivery
- * Dealer Inquiries Welcome

Galaxy Electronics Inc.

33 Freeman Street
 Newark, NJ 07105
 516 374-3020 FAX 516 374-4170

Circle 117 on Reader Service Card

PLD Design Software

Get Started with CUPLTM for only
\$149.95

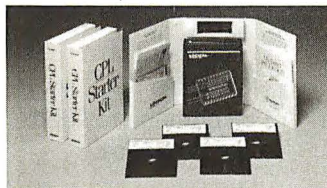

Now you can have a PLD Starter Kit that gives you all the horsepower that the CUPL PLD compiler offers, at a fraction of the cost. For more information, call 1-800-331-7766 or 305-974-0967.

**LOGICAL
 DEVICES, INC.**

Circle 170 on Reader Service Card
 (RESELLERS: 171)

Program Your Chips

In Sets of 4 for \$495.00

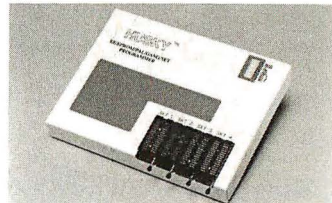

Special offer Now Includes:

Free UV eraser, CUPL starter Kit and a \$300.00 Factory Rebate with the PDT-1 EPROM, EPLD, Micro Programmer.

**LOGICAL
 DEVICES, INC.**

1-800-331-7766

Circle 172 on Reader Service Card
 (RESELLERS: 173)

Cross-Assemblers from \$50.00

Simulators from \$100.00

Cross-Disassemblers from \$100.00

Developer Packages

from \$200.00 (a \$50.00 Savings)

Make Programming Easy

Our Macro Cross-assemblers are easy to use. With powerful conditional assembly and unlimited include files.

Get It Debugged—FAST

Don't wait until the hardware is finished. Debug your software with our Simulators.

Recover Lost Source!

Our line of disassemblers can help you re-create the original assembly language source.

Thousands Of Satisfied Customers
 Worldwide

PseudoCorp has been providing quality solutions for microprocessor problems since 1985.

Processors

Intel 8048 RCA 1802.05 Intel 8051 Intel 8096,196c
 Motorola 6800 Motorola 6801 Motorola 68HC11 Motorola 6805
 Hitachi 6301 Motorola 6809 MCS Tech 6502 WDC 65C02
 Rockwell 65C02 Intel 8080.85 Zilog Z80 NSC 800
 Hitachi HD64183 Met. 68k-2,10 Zilog Z8 Zilog Super 8

* All products require an IBM PC or compatible.

For Information Or To Order Call:

PseudoCorp

716 Thimble Shoals Blvd, Suite E
 Newport News, VA 23606

(804) 873-1947

FAX:(804)873-2154

FREE CATALOG

RS-232C INTERFACE & MONITORING
 EQUIPMENT CATALOG

WRITE OR CALL for YOUR FREE
 COMPREHENSIVE B & B
 ELECTRONICS CATALOG TODAY!

Pages and pages of photographs and illustrated, descriptive text for B&B's complete line of RS-232C converters, RS-422 converters, current loop converters, adapters, break-out boxes, data switches, data splitters, short haul modems, surge protectors, and much, much more. Most products meet FCC Part 15.1. Your RS-232 needs for quality service and competitive prices will be more than met by B&B ELECTRONICS. Manufacturer to you, no middleman! Money-back guarantee! Same-day shipment! One-year warranty on products! Technical support is available.



Order direct
 from manufacturer
 TODAY & SAVE!

Write For Your FREE Catalog Today!

B & B electronics
 MANUFACTURING COMPANY

4002M Baker Road P.O. Box 1040 • Ottawa, IL 61350

Phone: 815-434-0846

Circle 40 on Reader Service Card

Trend Systems

T R E N D S Y S T E M S I N C .

Memory Expansion Boards



ORCHID

RAMQUEST 8/16 Card expandable to 32MG, for IBM PCs, XT's, AT's, PS/2 Model 30-286 and compatibles. Supports 8 and 16 bit bus. Uses 256K, 1 MG or 4MG Modules. w/OK \$289

RAMQUEST EXTRA 16/32 0-8MG, 0 wait state card for PS/2 Mod 50, 60 & 80 fully supports 16 and 32-bit memory access. Includes 1 SER and 1 PAR port. Free serial cable, EMS 4.0 and OS/2 compatible. Uses 256K and/or 1MG SIMMS w/OK \$279.

EVEREX

RAM 3000 DELUXE Up to 3MG. Selectable memory addresses. Expanded Memory Specifications (EMS) 4.0/ OS/2. Can be used to backfill base memory up to 640K and the rest as expanded and/or extended memory. Uses 256K D-RAM. w/OK \$ 89

RAM 8000 Up to 8MG capacity/support 16 base, extended or expanded memory in any combination. Fully compatible with Lotus, Intel, Microsoft, EMS 4.0, EEMS, Supports Multi-Tasking and DMA Multi-Tasking in hardware. Software configurable (no dip switches to set). Full 16MG window for future expansion. Zero wait state. Uses 1MG D-RAM w/OK \$189

BOCA RESEARCH

BOCARAM/AT Provides up to 2MG LIM EMS 4.0 and/or 4MG of extended, expanded or backfill memory. For 16 bit bus. Operates up to 16MHz. Uses 256K D-RAM w/OK \$109

BOCARAM/AT PLUS Provides up to 8 MG of extended, expanded or backfill memory. Operates up to 33MHz and is set thru software. Uses 1MG D-RAM w/OK \$129

BOCARAM/AT I/O PLUS Provides up to 4MG of extended, expanded or backfill memory for 16 bit bus. Operates up to 33 MHz and is set thru software. Has serial and parallel port Uses 1MG D-RAM w/OK \$145

COMPAQ MEMORY

ADD-ON MODULES

MODEL	1MG	2MG	4MG	8MG
386/20/20E/25/25E				
DESK PRO 286E, 386S	\$135		\$375	
386/33, 486/25 & SYSTEM PRO		\$320		\$2,495

MEMORY EXPANSION BOARDS

MODEL	512K	1MG	2MG	4MG	8MG
386/16		\$425	\$675	\$1375	\$2495
386/20E/25E 386S		\$250		\$725	
Portable 386				\$1250	
Portable LTE	\$219	\$325		\$495	
SLT/286		\$279			

Fax Boards

CALCULUS E2-FAX

Now works with Windows 3.0! Manufactured CCITT Group III. Provides fully concurrent background operation. Allows user to transmit, receive and view documents on screen. Once in memory, the transmissions may be edited for retransmission, printed, stored for future, or discarded off your hard drive. SOFTWARE INCLUDED.

001FX (4800 baud)	Trend Price	\$189
002FX (9600 baud)	Trend Price	\$289

Modems

EVEREX		TREND	
Internal 1200 BAUD	\$ 69	Internal 1200 BAUD	\$ 59
Internal 2400 BAUD	129	External 1200 BAUD	99
Internal 2400 BAUD w/MNP 5	169	Internal 2400 BAUD	69
External 2400 BAUD w/MNP 5	199	External 2400 BAUD	129

Laptop Memory

2MG Card-Toshiba Portable T1200e	\$435
2MG Card-Toshiba Portable T1600	259
2MG Card-Toshiba Portable T3100SX	265
4MG Card-Toshiba Portable T3100SX	615
512K Card-Toshiba Portable T3100e	149
2MG Card-Toshiba Portable T3100e	259
2MG Card-Toshiba Portable T3200SX	289
4MG Card-Toshiba Portable T3200SX	689
3MG Card-Toshiba Portable T3200	419
2MG Card-Toshiba Portable T5100	265
2MG T5200	265
2MG Module-Toshiba Portable	265
2MG Module-Toshiba Desktop T8500	345

Memory Products

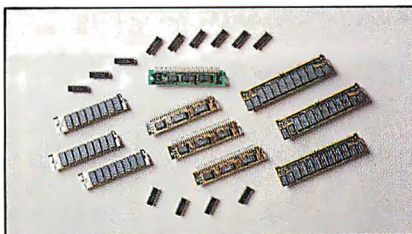

SIMM/SIPP MODULES

	150ns	120ns	100ns	80ns	70ns	60ns
4MG X 9	—	—	—	\$415	\$385	—
1MG X 9	\$ 50	\$ 53	\$ 55	\$ 60	\$ 80	—
1MG X 8	—	\$ 62	\$ 60	\$ 69	—	—
256 X 8	\$ 16	\$ 24	\$ 39	—	—	—
256 X 9	—	\$ 13	\$ 16	\$ 20	\$ 24	—

D-RAM

ALL PACKAGES & SPEEDS AVAILABLE

286 MATH CO-PROCESSORS

	6MHz	8MHz	10MHz	12MHz	12.5MHz	20MHz
IT (2C87)	—	\$185	\$219	—	\$280	\$324
INTEL (80287)	\$120	\$183	\$208	\$280	—	—

8088 MATH CO-PROCESSORS

	5MHz	8MHz	10MHz
INTEL (8087)	\$88	\$115	\$165

386 MATH CO-PROCESSORS

	16MHz	20MHz	25MHz	33MHz	SX
CYRIX (83D87)	\$305	\$350	\$450	\$549	—
IT (3C87)	\$305	\$350	\$450	\$549	—
INTEL (80387)	\$305	\$350	\$450	\$549	\$290

HP MEMORY

	HP II & II D	HP II P & III	
1 MB	\$109	1 MB	\$ 62
2 MB	\$179	2 MB	\$ 94
4 MB	\$309	4 MB	\$289
TONER	\$ 74	TONER	\$ 70

IBM PS-2

34F2933 - 4MG Memory Module for 55SX, 65SX	
Memory Option IBM P/N 34F3077; 34F3011	\$599
6450375 - 1MG Memory Bd for 80-041	149
6450379 - 2MG Memory Bd for 80-111;311-121; 321	320
6450603 - 1MG Module for 70-E61; -121, Adaptor Board	95
IBM P/N 6450605, 6450609, 34F3011 & 34F3077	
6450604 - 2MG Module for 70-061; E61; -121, 50Z,	165
55SX 65SX; P70	
Adaptor Board IBM P/N 6450605, 6450609, 34F3011	185
& 34F3077	
6450608 for Model 70A21	185
30F5360 (Kit-2 ea)	190
30F5348 (Kit-2 ea)	72



WE WILL MEET OR BEAT ANY ADVERTISED PRICE

1-800-678-2818

#9 Exchange Place, Suite 900
Salt Lake City, Utah 84111

Local 801-350-9180 Fax 801-350-9179

Trend 386-25 MHz COMPUTER SYSTEM



- DTK Motherboard
- Intel 80386-25 MHz Microprocessor
- Intel 80387 Socket
- 8/25 MHz Clock Speed
- Page Mode Interleave/Shadow RAM
- 8 Expansion Slots: 2x8 bit, 5x16 bit, 1x32 bit
- 1 MB On Board Expandable to 8 MB
- 1.2 or 1.44 Disk Drive
- IDE/1:1 Hard/Floppy Controller
- Serial/Parallel
- Baby AT Desktop Case w/200 W Switch Power Supply
- 101 Enhanced Keyboard
- Speed Rating: Landmark 31.7, Norton SI 27.1, Power Meter (MIPS) 4.35
- FCC Class B Approved/UL, TUV Listed

TREND PRICE
\$1159

Trend 386SX/16 COMPUTER SYSTEM

60MG Hard Drive/14" Monitor

- 14" VGA Paper White Monitor
- VGA Board w/ 256
- Phoenix Bios.
- 1 MG On/Bd Memory
- 1.2 Floppy Drive
- 60MB RLL Hard Drive
- 2 Serial Ports
- 2 Parallel Ports
- 1 Game Port
- 101-Key Click Keyboard
- 3 Button Mouse
- 3 Year Warranty

TREND PRICE
\$1259

Hard Drives

KALOCK 20MB XT 20 MB, MFM, 3.5 HH, 40 ms	\$225
MITSUBISHI 40MB, 5.25HH, MFM, 28ms	319
MITSUBISHI 60MB, 5.25HH, RLL, 28ms	849
CONNER 3204 200MB, 3.5HH, RLL/IDE, 16ms	900

Video Adapters

TREND

EGA CARD 640 X 480, 16 color EGA/MGA/CGA/Hercules	\$ 89
VGA CARD 1024 X 768, 16 color, VGA/EGA/MGA/CGA	119
MONO CARD w/parallel port	25
CGA CARD 2/parallel port	25

Specials

DFI MOUSE	\$ 35
3-Button Mouse with Selectable Sensitivity. Software - up to 400	
STAR MICRONICS	\$159
Dot Matrix Printer 180 cps 34cps/nlq NX1000/2	
360K FLOPPY DRIVES	\$45
Panasonic & Mitsumi XT Only DS/DD	185
MONO VGA MONITOR	\$99
14" Paper White, Tilt & Swivel Base	10 or more \$89

The Trend To Follow . . .

AST Upgrades		D-RAM	
500718-001 386/25	...\$65	256x1- 150ns	...\$1.59
500718-002 386/33	...\$70	256x1- 120ns	...\$1.69
500510-004 386/p	...\$350	256x1- 100ns	...\$1.79
		256x1- 80ns	...\$1.89
		256x1- 70ns	...\$1.99
COMPAQ		256x1- 60ns	...\$2.25
113131-001 386/25	...\$425	1x1-1 100ns	...\$4.50
113131-001 386/25	...\$425	1x1-1 80ns	...\$4.75
115144-001 386/33	...\$325	1x1-1 70ns	...\$4.99
		1x1-1 60ns	...\$7.99
SIMM-SIPPS		256x4 80ns	...\$4.99
1x9-100	...\$49	256x4 70ns	...\$5.99
1x9-80	...\$52	256x4 60ns	...\$7.99
1x9-70	...\$54	4464- 120ns	...\$1.75
1x9-60	...\$65	4464- 100ns	...\$2.00
1x8-100 MAC	...\$45	4164- 120ns	...\$1.50
1x8-80 MAC	...\$47	4164- 100ns	...\$1.75
256x9-100	...\$15		
256x9-80	...\$20		
256x9-70	...\$22		
256x9-60	...\$25		

AMT
International
(408) 432-1790

PS2 SIMMS	
30F348 512K	...\$55
30F5360 2MEG	...\$160
6450603 1 MEG	...\$85
6450604 2MEG	...\$170
6450608 2MEG	...\$175

2393 QUME Drive
San Jose, CA 95131
FAX: (408) 944-9801

Circle 363 on Reader Service Card

AMX

REAL-TIME MULTITASKING KERNEL

8086/88, 80x86/88 80386	68000/10/20 Z80, 64180, 8080/85
----------------------------	------------------------------------

- Fast, reliable operation
- Compact and ROMable
- PC peripheral support
- DOS file access
- C language support
- Preemptive scheduler
- Time slicing available
- Configuration Builder
- Full documentation
- InSight™ Debugging Tool
- Intertask messages
- Message exchanges
- Dynamic operations
 - task create/delete
 - task priorities
 - memory allocation
- Event Manager
- Semaphore Manager
- List Manager

**No Royalties
Source Code Included**

Demo Disk	\$25US	KADAK Products Ltd.
Manual only	\$75 US	
AMX 86	\$3000 US	206-1847 West Broadway Vancouver, B.C., Canada V6J 1Y5

Call for prices for other processors.
AMX, AMX 86, InSight are trademarks
KADAK Products Ltd. ☎ Fax: (604) 734-8114
Z80 is trademark of Ziog, Inc.

Circle 159 on Reader Service Card

9 Track Tape Subsystem for PC/XT/AT/386/PS2



\$1995 for 1600/3200 BPI
\$4995 for 1600/6250 BPI
\$6995 for 800/1600/3200/6250 BPI
CALL 1-800-289-4TAPÉ

Laguna Conversion Systems
1401 South Pacific Coast Highway
Laguna Beach, CA 92651

Circle 167 on Reader Service Card

486

\$1995

Made in U.S.A.

JC GOLD CARD

The JCS 486, the New Performance Leader In Personal 486 Systemboards

11.1 MIPS

- Intel 80486/286(B6) CPU
- 8KB Cache integrated in CPU
- Math Coprocessor integrated in CPU
- Shadow RAM for Video & System BIOS
- Second Level Cache Memory expandable to 512KB
- Wattek 4157 numeric coprocessor socket
- **30 DAY MONEY BACK GUARANTEE**

486 Complete System . . . \$3385
Include 4MB Memory, 150MB ESDI HDD, ESDI Cache Controller, 12 or 144MB FDD, MS DOS, AT IO, 101 Keyboard

80386/20 CPU Bd, C&T chipset	\$615
80386/25 CPU Bd, C&T chipset	\$665
80386/25 Cache Bd, C&T chipset	\$845

Dealer inquiries welcome

Jemini Electronics TEL: (408)727-9986
3400 De La Cruz Blvd, Unit T FAX: (408)727-7687
Santa Clara Ca, 95054

Circle 157 on Reader Service Card

ARC TANGENT PROFESSIONAL MAIL

\$695

Complete Mailing List Management Software

The most advanced, professional-level mailing list management system available for IBM and compatible microcomputers. Save thousands of dollars on postage, printing, and processing costs.

- Unlimited number of names and addresses
- Sophisticated merge/purge duplicate detection
- Complete postal presorting and barcoding
- Custom letters, labels, reports
- Convert data from dBase, ASCII, other formats

Arc Tangent, Inc.
121 Gray Avenue
Santa Barbara, CA 93101-1831
(805) 965-7277

Circle 33 on Reader Service Card
(RESELLERS: 34)

There is a Difference. Lifetime Free Updates

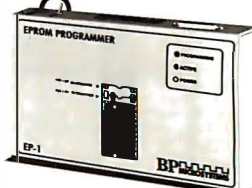

EP-1 \$349

A programmer is not just another programmer. That is why BP Microsystems is committed to bringing our customers the highest quality programmers at an affordable price. A good example of this commitment is the EP-1 EPROM Programmer. The EP-1 supports virtually every 24- or 28-pin E/EPROM. And, all of our programmers include lifetime free software updates and an unconditional money back guarantee.

BP MICROSYSTEMS
1-800-225-2102
(713) 461-9430

Circle 53 on Reader Service Card

DON'T MOVE WITHOUT TELLING

BYTE

CLIP OUT THIS FORM AND MAIL →

TO:
BYTE Magazine
P.O. Box 555
Hightstown, NJ 08520

(please print)

Name _____ Apt. _____
Address _____ Zip _____
City/State _____

Print CURRENT ADDRESS
(or affix the mailing label from your current BYTE Magazine here)

NAME _____
ADDRESS _____
CITY/STATE _____ ZIP _____

9-Track Tape Subsystem for the IBM PC/XT/AT



Now you can exchange data files between your IBM PC and any mainframe or mini-computer using IBM compatible 1600 or 6250 BPI 9-Track tape. System can also be used for disk backup. Transfer rate is up to 4 megabytes per minute on PCs and compatibles. Subsystems include 7" or 10 1/2" streaming tape drive, tape coupler card and DOS compatible software. For more information, call us today!

QUALSTAR®

9621 Irondale Ave., Chatsworth, CA 91311
Telephone: (818) 882-5822

Circle 251 on Reader Service Card

A-BUS™ NEWS

New Products

Alpha Products proudly announces two new product lines: **C-Net** serial communications devices, and **Alpha Box** interfaces. These new products are not merely A-Bus accessories, but complete sets of products for all of your interfacing needs.

All the products are used to connect different types of devices to your computer. Our communications devices help you connect devices that have computer interfaces already built in. **C-Net** provides the option of connecting many different RS-232 devices to a single serial port on your computer. We also carry converters to other standards, including RS-422, RS-485 and IEEE-488. **C-Net Adapter**. Connects the master control computer to C-Net. \$74

Quad C-Net Module: Connect 4 RS-232 serial devices to C-Net. Each device is configurable (baud rate, parity, etc.) and has 1.8K byte input and output buffers. \$695
C-Net Device Module: Connect any RS-232 Device to C-Net for data collection or communication, with handshaking. \$195

Alpha Boxes and A-Bus cards both provide ways to interface other types of devices to your computer. **Alpha Boxes** sense, measure, switch and govern. They feature: Each box is an attractively packaged self contained module that connects directly to the computer and includes power supply. The input boxes offer the option of logging data "off-line" and downloading it rapidly to the computer. Built-in intelligence provides a simple and consistent interface to your software.

A Sampling of Alpha Box Products:

Digital Input: 64 TTL/CMOS/0.5V input channels. \$495

Digital Output: 64 TTL/CMOS/0.5V level outputs. \$495. 120VAC control available.

Digital I/O: 32 TTL Level (0.5V) Inputs and 32 Outputs. \$495

Analog Input: 16 channels. 0-5.1V, 20mV steps (8 bit). 2000 readings/sec. \$495.

Expansion Option: 16 more channels. \$100
12 Bit Analog Input: 16 channels, programmable gain. 10000 inputs/sec. max. \$995. Option: 16 more inputs. \$200

Analog Output: 4 channel. 12 bit D/A. ±5.1V outputs. \$495. Expander Option: 12 more outputs. \$200

Counter: 16 inputs, 24 bit. \$595

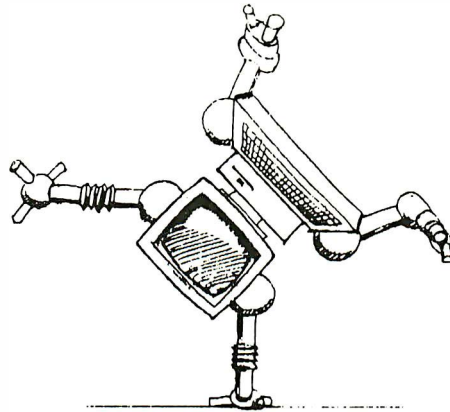

"We can make your PC do things you wouldn't believe."

C³ From Your PC

- Command
- Control
- Communications

Bring new dimensions to your computer with A-Bus, C-Net and Alpha Boxes. No longer is your computer limited to number crunching or word processing. Now you can connect to all types of equipment, sensors or machines. This offers unprecedented power from production lines to experiments to home control.

Each product is designed to fit your needs: They're **affordable**. Compare our prices; the cost of a solution is surprisingly low. They're **simple** and easy to connect to your computer and your application, and carefully designed to adapt to your software easily. They're **versatile**. An infinite number of combinations is possible; one of them is right for you. Easily expanded or changed for future projects.

They're **proven** by customers around the world, including Fortune 100 companies, universities, governments and individuals.

Call for a Catalog (800) 221-0916

Overseas distributors

Asia: Batam DA, Singapore

Tel: 473-4518

Fax: 479-6496

Japan: Japan Crescent

Tel: 03-824-7449

Fax: 03-818-8914

Scandinavia: A/S Con-Trade Norway

Tel: (04) 41 83 51

Fax: (04) 41 94 72

Spain: Arteca S.C.P.

Tel: (93) 423.77.05

Fax: (93) 325.70.16

Low Cost Data Acquisition and Control

A-Bus Sensing & Measuring:

Read switch status. Detect or measure voltage. Read pressure, temperature, weight and other sensors. For example:

- * High-Speed 12-bit A/D converter: 8 10µs analog inputs. 1 mV resolution \$179
- * 8 Bit A/D: 8 inputs, 0-5.1V in 20mV steps. 7500 conversions/sec. \$142
- * 12 Bit A/D: ±4V in 1mV steps. 130mS conversion time. 1 input, expandable \$153
- * Temperature Sensor: 0-200°F 1° Accuracy. 10mV/°F. \$12
- * Digital Input: 8 opto-isolated. Read voltage presence, switch closure. \$65
- * Latched Input: Each individually latched to catch switch closures or alarm loops. \$85
- * Touch Tone Decoder: \$87
- * Counter/Timer: 3 16-bit counters. Generate or count pulses. Time events. \$132
- * Clock with Alarm: real time clock with calendar and battery backup. \$98

A-Bus Switching & Governing:

Switch any type of electrical device. Adjust level or position. A sampling:

- * Relay Card: 8 individually controlled industrial relays. 3A at 120VAC, SPST. \$142
- * Digital Output Driver: 8 outputs: 250mA at 12V. For relays, solenoids... \$78
- * Reed Relay Card: 8 individually controlled relays. 20mA @ 60VDC, SPST. \$109
- * Multiplexer: Switch up to 32 channels to a single common. \$83
- * Smart Stepper Motor Control: Microprocessor controls 4 motors. English commands for position, speed, units, limits, etc. \$299
- * Telephone Control Card: On/off hook, generate and decode touch tones, call progress detection. \$159
- * X-10 Controller: Control and sense standard wall outlet power modules. \$149
- * Voice Synthesizer: Unlimited vocabulary, text to speech software built in. \$159
- * D/A: Four 8 Bit Outputs. Adjustable full scale. \$149
- * 24 line TTL I/O: Connect 24 signal, TTL 0/5V levels or switches. (8255A) \$72

A-Bus Adapters and Software:

Adapters connect A-Bus cards to your particular computer.

- * Plug-in adapters for IBM PC/XT/AT/386 and compatibles (\$69), Micro-Channel (\$93), Apple II, Commodore, TRS-80.
- * Serial adapters for Mac, PC, etc.
- * Odin PC compatible software. Control relays from analog inputs or time schedules. Logging. Runs in background. \$129

ALPHA Products

242-B West Ave, Darien, CT 06820 USA (203) 656-1806 Fax 203 656 0756

TOSHIBA
FLOPPY LINK
ONLY \$49.

UPGRADED LAPTOPS AT DOWNGRADED PRICES!

**WE MAY BE CLOSED
FOR THE HOLIDAYS
FROM DEC. 26 THRU JAN. 7**

MATH COPROCESSORS
80387-25...\$399. 80387-20...\$309.
80C287-12...\$180. 80287-8...\$179.
80387SX-16....\$259.

TOSHIBA T5200/200MB
WITH 4MB RAM.....\$5,689.
WITH 6MB RAM.....\$5,889.
WITH 8MB RAM.....\$6,089.

2400B INTERNAL MODEM
WITH MNP-5 SOFTWARE
FOR T5200, T3200SX
T3200, & T3100e
ONLY \$99.

9600B INTERNAL FAX
FOR T5200, T3200SX,
T3200, & T3100e
ONLY \$199.

T1200XE
W/ 3MB RAM...\$2,499.
W/ 5MB RAM...\$2,599.

BATTERY PACK
FOR T3100SX
JUST \$79.

ONLY \$169.
FOR THE FOLLOWING
2MB FOR T1200XE
2MB FOR T3100e
2MB FOR T3100SX
2MB FOR T3200SX
2MB FOR T5100
2MB FOR T5200

4MB CARD
FOR T3100SX
ONLY \$489.

4MB MODULE
FOR T3200SX
ONLY \$529.

2MB FOR
1000SE/XE
ONLY \$299.

2MB FOR
T1600
ONLY \$189.

ALL BOARDS FULLY
TESTED AND COME WITH
LIFETIME WARRANTY

ORIGINAL TOSHIBA
5-SLOT EXPANSION CHASSIS
ONLY \$299.

3MB FOR
T3200
JUST \$299.

8MB MODULE
FOR T5200
JUST \$1,189.

8-BIT ARCNET
LANCARD
JUST \$79.

AST MEMORY
PREMIUM WORKSTATION
286/386SX & BRAVO 286
512K.....\$ 59.
2MB.....\$159.
386C & 386/16
1MB.....\$ 89.
4MB.....\$329.
486/33TE, 486/25TE,
386/33TE, 486/25T,
386/33T, 486/33E,
486/25E, 486/33,
486/25, 386/33,
386/25, 386SX/16
1MB.....\$ 89.
BRAVO 386SX,
BRAVO/286,
PREMIUM/286,
SIXPAK 286,
RAMPAGEPLUS 286,
2MB.....\$159.

LAPTOP, DESKTOP, & LASER MEMORY AT MEMORABLE PRICES

NO SURCHARGE FOR
MEMORY PURCHASES
WITH CREDIT CARDS

ASK YOUR PRESENT SUPPLIER
TO GUARANTEE THAT THEIR
MEMORY WILL WORK
THE FIRST TIME AROUND!

AND GUARANTEED ZERO DEFECT RATE !!!

COMPAQ

DP 286e, 386e, 386/20,
386/20e, 386/25 & 386/25e
1MB MODULE.....\$129.
4MB MODULE.....\$359.
DP 386/33, 486/25, &
SYSTEM PRO 386/33
2MB MODULE.....\$219.
386/20e & 386/25e
1MB BOARD.....\$229.
SLT/286
1MB.....\$169.
4MB.....\$799.
LTE/286
1MB.....\$ 139.
2MB.....\$ 189.
4MB.....\$ 799.

COMPAQ LTE/286
MODEL 40 WITH 5MB
ONLY \$3,999.

LASER PRINTER MEMORY

<p>EPSON EPL-6000 TOSHIBA PAGE LASER 6 FACTIT P6060 PACKARD BELL PB9500 MANNESMANN TALLY 905 AT&T 593 LASER NCR 6435 LASER 1MB.....\$179. 2MB.....\$269. 4MB.....\$329.</p>	<p>HP II/III/III/III/III CANON LBP 8II/8IIR/8IIT OLIVETTI PG-108/PG-208 1MB.....\$ 89. 2MB.....\$159. 4MB.....\$279. IBM 4019/4019e 1MB.....\$189. 2MB.....\$299.</p>
--	---

tote-a-lap

"experts in portable intelligence"

550 PILGRIM DRIVE, FOSTER CITY, CA 94404
(415)578-1901 EXT. 924 | FAX (415)578-1914
NOT RESPONSIBLE FOR TYPOS. PRICES SUBJECT TO CHANGE W/O NOTICE.

SHARP

PC-6220 NOTEBOOK
1MB.....\$189.
2MB.....\$359.
TEXAS INSTRUMENTS
TRAVELMATE 2000
1MB.....\$189.
2MB.....\$359.
MICROLASER
1MB.....\$129.
2MB.....\$229.
3MB.....\$329.
4MB.....\$409.

PANASONIC LASER
KX-P4420 & KX-P4450i
1MB.....\$149.
2MB.....\$199.
3MB.....\$249.
4MB.....\$299.

BLAST YOUR MESSAGE THRU!

VOICE MAIL • TELEMARKETING CALL PROCESSING

Let Powerline transform your PC/XT/AT/386 into a multi-line voice processing command center. Have your computer intelligently process your sales, inquiries and messages. Complete package.

Single Line (BigmOut) . . . \$295.00
Multi-Line \$895.00
 (Developer/OEM packages available)
 VISA - MC - AMEX - COD

Call: (415) 522-3800
 FAX: (415) 522-5556

TALKING TECHNOLOGY, INC.
 1125 ATLANTIC AVE., ALAMEDA, CA 94501

Circle 299 on Reader Service Card

QUARTERHORSE

High Capacity Tape Subsystems

for Disk Backup, Data Acquisition, and Archiving

Everything you need in a single, high-quality package: Drive, SCSI Host Adapter, Enclosure, and DSI's Backup Software.

- 320/520 Mb 1/4" CT . . . \$1,495
- 1.2 Gb 4mm DAT \$3,195
- 2.3 Gb 8mm HS \$3,695

New: 450 Mb 3480 Ct . . . \$4,295

Optional Application Interface Library (in "C") available. Full Support.

Terms: U.S.-Visa, COD, pre-approv. credit.
 Other: Prepaid wire transfer, International letter of credit.

DATA STRATEGIES INTERNATIONAL, INC.

9020 Capital of TX Hwy, Ste. 420, Austin, TX 78759
 (512) 338-4745 FAX (512) 345-1328

Circle 83 on Reader Service Card

6800/6809 Micro Modules

OEM 6800/6809 MICROCOMPUTER MODULES for dedicated control and monitoring. Interfaces for sensors, transducers, analog signals, solenoids, relays, lamps, pumps, motors, keyboards, displays, IEEE-488, serial I/O, floppy disks.

Wintek Corp.
 1801 South Street
 Lafayette, IN 47904
 317-742-8428

Circle 341 on Reader Service Card

UNIVERSAL PROGRAMMER & TESTER

ALL-03 IMPROVED \$695
 (FREE UPDATE)

SOFTWARE FEATURES:

- E(P)ROM: NMOS, CMOS (Up-to 4-MB) • BPROM, PAL, CMOS PAL, GAL, PEEL, EPLD, FPL • Microcomputer (8748, 51, -C51 828 Series) • IC & MEMORY TEST • HEX to BINARY (INTEL, 8086, MOTOROLA, SI, SZ, TEKTRONICS).
- 2-Way or 4-Way BINARY File Splitter and shuffler. • Dump file to console in BINARY format. • Function include screen editing for BINARY DATA, ASCII and JEDEC FUSE MAP. • Security programming, Auto Programming and much more.

HARDWARE FEATURES:

- 40-Pin test socket with 40-Sets of software controlled circuit and 40-Sets of TTL I/O.
- 3 Groups of programmable D/A VOLTAGE SOURCE & 2 Groups of OSC output source.
- 60% of Digital components in high speed CMOS HCT type.
- Hardware expendable for complex device programming.
- Hardware Configuration is available for Software Designers.
- 'GO'-key & 'GOOD'-LED permit stand-alone machine operation.
- Various Adapters (1 to 4 Sockets)—Optional.

*** 1-Year Warranty & 30 Days Money-Back Guarantee ***
 TEL: (408) 748-8491, FAX: (408) 748-8492

C & J MICRONICS
 1400 Coleman Ave, Suite D-13, Santa Clara, CA 95050
 Call Toll Free (for Orders Only): 1-800-433-3449

Circle 82 on Reader Service Card

MEMORY UPGRADES

IBM PS/2, APPLE
 AST, COMPAQ
 HEWLETT PACKARD
 ZENITH, SUN MICRO
 STANDARD SIMMS
 LAPTOP MEMORY
 (NEC, TOSHIBA, APPLE, COMPAQ)
 LASER PRINTER MEMORY
 (HP, CANON, TEC ENGINE)

NO RISK, BEST PRICE, BEST QUALITY

ADD ON AMERICA
 A DIVISION OF ROHM CORPORATION
 433 N. MATHILDA AVE. SUNNYVALE, CA 94088
 TEL (408) 746-1590 FAX (408) 746-1593

1-800-292-7771

Circle 16 on Reader Service Card

New, Gridless, 100% Autorouting

Create schematics and PCBs quickly and simply with **HIWIRE-Plus®** and your IBM PC. With the new, gridless, multilayer autorouter (AR) for HIWIRE-Plus, creating printed-circuit layouts is even faster. AR and HIWIRE-Plus are each \$895 and come with 30-day money-back guarantees. Credit cards welcome.

WINTEK Corporation
 1801 South St., Lafayette, IN 47904
 (800) 742-6809 or (317) 742-8428

Circle 342 on Reader Service Card

3M DATA CARTRIDGES

5.25" 720 kb DS 4.89	Pre-Formatted 5.69
5.25" 1.2 mb HD 8.89	Pre-Formatted 9.69
3.50" 1.0 mb DS 6.99	Pre-Formatted 7.69
3.50" 2.0 mb HD 13.79	Pre-Formatted 14.69

Price Each

DC-2000 13.95	DC-600A 18.99
DC-300XLP 17.39	DC-6150XTD 19.99

(Call for others and also formatted)

TAPE AND BACKUP

700-1/2"-2400'-C55 11.95	777-1/2"-2400'-C55 10.95
DEC-TK-50 23.95	DEC-TK-52 35.95
IBM-3480 4.55	Opt Rewrite Disks 159.00

3M HIGHLAND DISKETTES

5.25" 720 Kb DS 3.79	5.25" 1.2 mb HD 6.49
3.50" 1.0 mb DS 6.79	3.50" 2mb HD 11.99

BASF

DS-DD Export Quantity Discounts Available	DS-HD
449 PER BOX 5.25" BASF Brand Diskettes	749 PER BOX
679 PER BOX 3.50" BASF Brand Diskettes	1199 PER BOX

Verbatim DataLifePlus
 Teflon/Preformatted

* TEFLON / PREFORMATTED #

DS-DD Quantity Discounts Available	DS-HD
529*# PER BOX 5.25" DataLife Plus Diskettes	899# PER BOX
719 PER BOX 3.50" DataLife Diskettes	1399 PER BOX

maxell.

5.25" DS/DD	5.25" DS/HD	3.50" DS/DD	3.50" DS/HD
4.89	8.89	7.19	13.89

KAO COLOR BULK

DS-DD "No-Logo"	DS-HD
.39 5.25" Color Diskettes69
.59 3.50" Color Diskettes99

BULK DISKETTES

5.25" DS/DD	5.25" DS/HD	3.50" DS/DD	3.50" DS/HD
.28*	.42*	.39	.79

*WITH SLEEVES, LABELS AND W/P TABS

HEWLETT PACKARD Canon

Laserjet Series I-II-III **Laserjet Toners** **74.95**
 Laserjet Series II P **60.95**

digital DEC

Compactape for TK50 & TZ30	24.95
Compactape II for TK70 & TK52	38.95
LN03 Maintenance Kit	159.90

EPSON Original DFX5000 18.29

WE BEAT ANY PRICE!!

TERMS: No surcharge on VISA, Mastercard or AMEX. Order packaging and processing = \$2.95 per order. COD orders add \$3.95. PO's accepted from recognized institutions on Net 30 days L/C, T/T and Bank Draft acceptable. Price quoted for case (100 disks or 10 cartridges). For quantities less than 1 case add 10% SHIPPING: UPS surface \$1.95/5 cartridges, \$0.95/50 diskettes. (Prices subject to change without notice. Errors and omissions not accepted. All warranties are from manufacturers.)

Toll Free Order Line: **1-800-523-9681**
 Information Line: **1-801-255-0080**
 TLX-9102404712 FAX-801-572-3327

DISKCOTECH
 213 Cottage Avenue
 P.O. Box 1339 Sandy, Utah 84091

EDITORIAL INDEX BY COMPANY

Index of companies covered in articles, columns, or news stories in this issue
Each reference is to the first page of the article or section in which the company name appears

Company, Page #	Inquiry #		
A			
Abaton, 307	1225	D	
Accton Technology, 58	1294	DanCraft Enterprises, 50	1284
Acer, 19		Data General, 119	
Adaptec, 361		Data Translation, 229, 307	1224
Adex, 307	1226		1234
Advanced Matrix Technology, 156	1111	Dataproducts, 156	1118
Advanced Micro Devices, 312		DCA Software, 72	1310
AEG Olympia, 156	1112	Dell Computer, 213	1108
Alps America, 156	1113	Desktop Computing, 307	1235
American Mitac, 44	1273	Digital Equipment, 119, 125, 337	
AMT, 19		Digital Research, 197	1064
Antic Publishing, 19		Discovery Systems, 19	
Apple Computer, 19, 119, 156, 275, 307, 420	1114	Dolch Computer Systems, 246	1075
	1227	Dynacomp, 70	1308
	1287	E	
Ariel, 50	1228	Edsun Labs, 312	
Artists Graphics, 307	1304	Eltech Research, 44	1274
Aselco, 66	1311	Enable Software, 93	1222
Ashlar, 72	1077	Enertronics Research, 307	1236
Ashton-Tate, 246		Epson America, 156	1119
AST Research, 337		Ernst & Young, 66	1305
AT&T, 19, 327		Erudite, 66	1303
AT&T Mail, 341		Everex Systems, 132	1060
ATI Technologies, 19, 46, 307	1229	Evergreen Systems, 58	1293
	1281	F	
Autodesk, 72	1313	Facit, 156	1120
Automated Design, 54	1289	Farallon Computing, 19	
		Fortis Direct Connect, 156	1121
		Fujitsu America, 156	1122
B			
Beacon Expert Systems, 66	1302	G	
Bell & Howell, 307	1230	General Instrument, 297	
Bitstream, 19		General Parametrics, 307	1237
BLX, 119		Generation X Technologies, 307	1238
Boca Research, 307	1231	Generic Software, 72	1312
Borland International, 62	1300	Genoa Systems, 307	1239
Boston Museum of Science, 418		Goddard Space Flight Center, 341	
Brother International, 19, 156	1115	GoldStar Technology, 44	1275
		Grandmaster, 73	1156
		Graphic Software Systems, 19	
		Groundhog Graphics, 307	1240
C			
C-Cube Microsystems, 19, 289		H	
C-Tech Electronics, 156	1116	Half Moon Press, 418	
Calcomp, 307	1232	Headland Technology, 307	1241
Canon USA, 19, 156	1117	Hercules Computer Technology, 307	1242
Ceres Software, 105	1146	Hewlett-Packard, 45, 156, 307, 337	1123
Chips & Technologies, 19, 312			1243
Cirrus Logic, 312			1276
Claris, 19		Houghton Mifflin Software, 73	1149
Colorado Memory Systems, 235	1105	HP/Apollo, 119	
Commodore Business Machines, 19, 132	1064	I	
Compaq Computer, 19, 307	1233	IBM, 19, 119, 289, 321, 337	
CompuAdd, 140	1067	Imaging Technology, 307	1244
CompuServe, 101, 119		Imagraph, 307	1245
Comsoft, 66	1301	Intel, 19, 289, 312	
Conceptual Software, 62	1298	Intelligent Environments, 62	1297
Core International, 235	1106	Interactive Systems, 178, 206	1060
Corel Systems, 281			1063
		Interleaf, 19	
		Internet, 119	
		IsiCAD, 182	1061
J			
		Jandel Scientific, 70	1309
		Joint Photographic Experts Group, 19	
K			
		Kodak, 19	
L			
		Landmark Research International, 73	1154
		LaserMaster, 307	1246
		Logos Technology, 307	1247
		Lotus Development, 19, 58, 233	1148
			1296
M			
		Mannesmann Tally, 156	1125
		Mars Microsystems, 119	
		Mass Optical Storage Technologies, 19	
		Matrox Electronics Systems, 307	1248
		Maxtor, 19	
		MCI Mail, 341	
		MegaGraphics, 307	1249
		Megatek, 307	1250
		Metheus, 307	1251
		Micro Logic, 73	1153
		Micron Technology, 307	1252
		Microsoft, 19, 119, 125, 221, 275, 281, 420	1065
		Microtest, 54	1288
		Microway, 307	1253
		MIPS Computer Systems, 172	1109
		Mirror Technologies, 58	1292
		MIT, 297	
		MIT Press, 418	
		Monolithic Systems, 307	1254
		Motorola, 19	
		Mylex, 307	1255
N			
		Nakamichi Peripherals, 19	
		National Design, 308	1256
		NCR, 19, 191, 361	1107
		NEC, 44, 289	1271
		NEC Technologies, 156, 308	1126
			1257
		New Media Graphics, 308	1258
		NexGen, 19	
		NeXT, 289	
		NHK, 297	
		Northgate Computer Systems, 73	1150
		Novell, 19, 119, 125, 337	
		NSA, 308	1259
		Number Nine Computer, 308	1260
		Nutmeg Systems, 308	1261
O			
		Occam Research, 132	1062
		Ocean Microsystems, 19	
		Oki, 19	
		Okidata, 19, 156	1127
		Olivetti, 19	
		OmniComp Graphics, 308	1262
		Orange Micro, 46	1280
		Orchid Technology, 308	1263
P			
		Panasonic Communications & Systems, 156	1128
		Pantone, 275	
		PC Tech, 308	1264
		Performance Technology, 62	1299
		Personal Computer Peripherals, 308	1265
		Phase II Software, 201	1060
		Philips, 297	
		Pixar, 253	
		Plus Development, 132	1065
		Poqet Computer, 312	
		Practical Peripherals, 58	1295
		Prentice-Hall, 345	1005
		Princeton Graphic Systems, 308	1266
		Princeton Publishing Labs, 308	1267
Q			
		Qualitas, 19	
		Quark, 19	
		Qume, 156	1129
R			
		Racal-Redac, 70	1307
		Radius, 19, 275, 308	1268
		Ramtek, 308	1269
		Rasna, 70	1306
		RasterOps, 308	1270
		Renaissance GRX, 308	1421
		Ricoh, 54	1290
S			
		Samsung Information Systems America, 19, 44	1272
		The Santa Cruz Operation, 206, 209	1062
		Sarnoff Labs, 297	
		Second Wave, 50	1285
		Seiko, 19	
		Seikosha America, 156	1130
		Sharp Electronics, 73, 312	1159
		Sigma Designs, 308	1422
		Smith Corona, 19	
		SoftKlone, 54	1291
		Solbourne Computer, 140	1068
		Soltec, 46	1283
		Sony, 45	1278
		Sony Microsystems, 119, 172	1110

Sota Technology, 308	1423
Spectral Innovations, 46	1282
Star Micronics America, 19, 156	1057
STB Systems, 308	1131
Sun Microsystems, 119, 140, 327, 337	1066
SuperMac Technology, 308	1132
Supra, 45	1277
Symantec, 73, 178	1056 1152
Symbolics, 308	1133
Systems Compatibility, 105	1147

T

Tandy, 156	1058
Tate Gallery, 418	
Tecmar, 132, 308	1063 1134

Telemail, 341	
Texas Instruments, 73, 151, 312	1076 1157

Toshiba America Information Systems, 156	1059
Touchstone Software, 73	1150
Traveling Software, 73	1155
Trident Microsystems, 308	1135
Truevision, 289, 308	1136
Tseng Labs, 308	1137

U

University of California, 337	
University of Evansville, 19	
Univision, 308	1138
Usenet, 119	
U.S. National Computer Security Center, 19	

V

Vectrix, 308	1139
Velox Computer, 132	1061
Ventek, 308	1140
Verbum, 19	
Vermont Microsystems, 308	1141
VESA, 355	1004
Video Seven, 19	
ViewSonic, 45	1279
Voice Connexion, 50	1286

W

Wang Laboratories, 93, 337	1221
Warner Books, 418	
Western Digital, 19	
Western Digital Imaging, 308	1142
WordPerfect, 93	1223

Z

Zenith Data Systems, 73, 297	1158
------------------------------	------

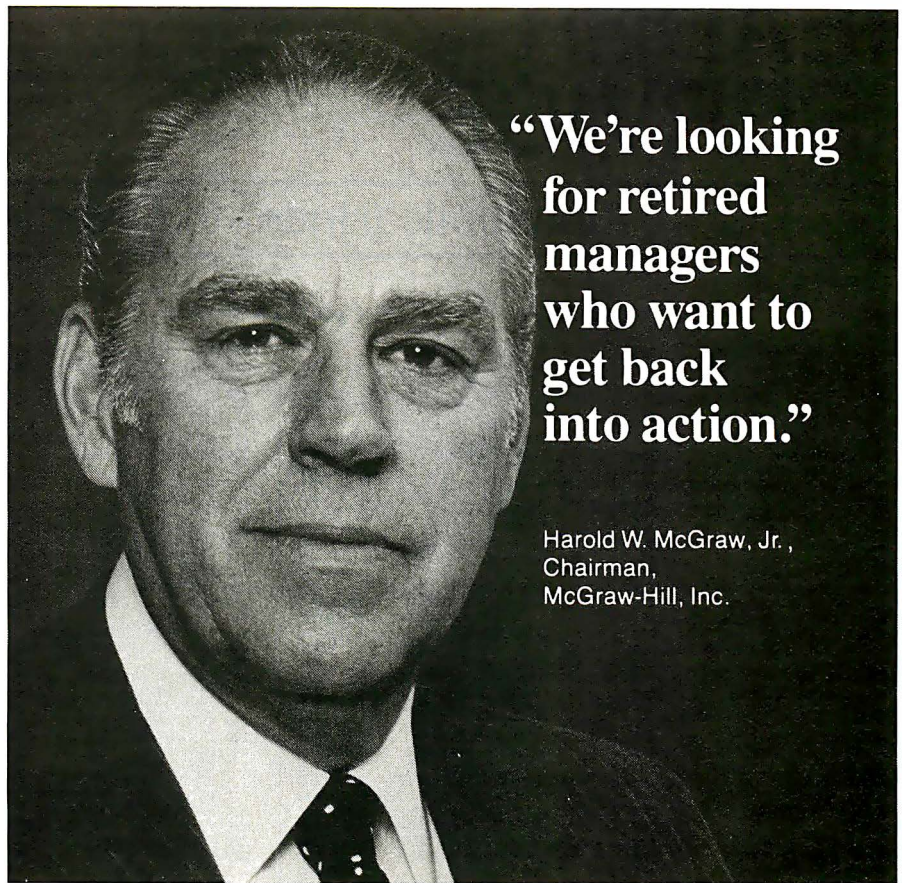

**“We’re looking
for retired
managers
who want to
get back
into action.”**

Harold W. McGraw, Jr.,
Chairman,
McGraw-Hill, Inc.

I'm a volunteer supporter of the International Executive Service Corps, a not-for-profit organization with a vital mission:

We send retired U.S. managers overseas to help businesses in developing countries, which often respond by increasing their imports of U.S. goods. In fact, developing countries consume about 40 percent of U.S. exports.

As an IESC volunteer, you would not get a salary. But you would get expenses for you and your spouse, plus a world of personal satisfaction.

IESC leads the field in this kind of work. We've done over 9,000 projects in 81 countries. We could have a project that's just right for you. To find out, send this coupon to: Harold W. McGraw, Chairman, McGraw-Hill, Inc., P.O. Box 10005, Stamford, CT 06904-2005.



International Executive Service Corps

It's not just doing good.
It's doing good business.



A Public Service of
This Publication

Dear Mr. McGraw: Tell me more about becoming an IESC volunteer. I am a recently retired manager or technician—or am about to retire—from a U.S. company. I'm free to accept an overseas assignment. I understand that volunteers receive expenses for themselves and their spouses, but no salary.

Name _____
Address _____
City _____ State _____ Zip _____

M2

READER SERVICE

Inquiry No.	Page No.	Inquiry No.	Page No.	Inquiry No.	Page No.	Inquiry No.	Page No.
440 MAYFAIR MICROS	IS-37	* GATEWAY 2000	IS	811 COMPUTER PERIP. DIRECT, INC.	NE-21	824 H.CO COMPUTER PRODUCTS	PC-13
441 MICROGRAFX	IS-31	* REASONABLE SOLUTIONS	IS	612 COMPUTER PERIP. DIRECT, INC.	NE-21	625 IME COMPUTERS	PC-15
442 MICROPRESS	IS-72	* TOUCHBASE SYSTEMS	IS	583 COMPUTER SALES PROF., INC.	NE-9	828 IME COMPUTERS	PC-15
443 MICROPRESS	IS-72			584 COMPUTER SALES PROF., INC.	NE-9	829 IRIS SOFTWARE PRODUCTS	PC-3
444 MINOLTA GMBH	IS-13			585 COMPUTER SALES PROF., INC.	NE-13	630 IRIS SOFTWARE PRODUCTS	PC-3
445 PECAN SOFTWARE EUROPE LTD.	IS-75			586 COMPUTER SALES PROF., INC.	NE-13	837 MACWORLD EXPO	PC-9-11
446 PHILIPS	IS-7			587 DERBYTECH COMPUTERS	NE-24	838 MACWORLD EXPO	PC-9-11
447 PHILIPS PERIPHERALS	IS-29			588 DERBYTECH COMPUTERS	NE-24	631 METAWARE, INC.	PC-17
448 PROGRAMMERS ODYSSEY	IS-18			589 ESI/CAD WAREHOUSE	NE-4	634 MICROCOM COMPUTERS	PC-19
451 PROLOG DEVELOPMENT	IS-10			590 ESI/CAD WAREHOUSE	NE-4	* MICROCOMPUTER MKTG. CNCL.	PC-23
452 PROLOG DEVELOPMENT	IS-10			593 FD MICROSYSTEMS	NE-7	639 MYODA, INC.	PC-21
453 SHENG LABS, INC.	IS-56			594 FD MICROSYSTEMS	NE-7	640 MYODA, INC.	PC-21
454 SIMPLE TECHNOLOGY, INC.	IS-79			595 GLASGAL COMM., INC.	NE-23	642 PROSPERO SOFTWARE, INC.	PC-2
455 SOFT WAREHOUSE EUROPE GMBH	IS-28			596 H.CO COMPUTER PRODUCTS	NE-17	643 PROSPERO SOFTWARE, INC.	PC-2
* SOFTLINE	IS-45			597 H.CO COMPUTER PRODUCTS	NE-17	644 STRATEGIC MAPPING	PC-15
456 SOFTWARE CONSTRUCTION CO., LTD	IS-67			598 IME COMPUTERS	NE-2	645 VERIDATA	PC-5
* SOFTWARE DEVELOPMENT SYS.	IS-35			599 IME COMPUTERS	NE-2	646 VERIDATA	PC-5
457 SOLO UNIBIT	IS-57			602 MANCHESTER EQUIPMENT	NE-1		
458 SURAH, INC.	IS-78			* MANCHESTER EQUIPMNT	72NE-A,B		
459 TEAC	IS-24			605 MICROCOM COMPUTERS	NE-18		
461 TERRA DATENTECHNIK	IS-70			606 MYODA, INC.	NE-10		
462 TERRA DATENTECHNIK	IS-58			607 MYODA, INC.	NE-10		
463 TOP LINK COMP. CO., LTD.	IS-20			609 PACE UNIVERSITY	NE-5		
460 TP ENTERPRISE LTD.	IS-68			610 SIMPLE TECHNOLOGY, INC.	NE-14		
464 TRIANGLE DIGITAL SERV., LTD.	IS-76						
465 TWINHEAD	IS-39						
466 USA SOFTWARE	IS-19						
467 V.D.S. SPA	IS-55						

REGIONAL SECTIONS	
Midwest	72MW1-16
551 BSI	MW-13
552 BSI	MW-13
553 DERBYTECH COMPUTERS	MW-16
554 DERBYTECH COMPUTERS	MW-16
555 ESI/CAD WAREHOUSE	MW-4
556 ESI/CAD WAREHOUSE	MW-4
559 IME COMPUTERS	MW-2
560 IME COMPUTERS	MW-2
563 IRIS SOFTWARE PRODUCTS	MW-3
564 IRIS SOFTWARE PRODUCTS	MW-3
567 MICON COMPUTERS	MW-1
568 MICROCOM COMPUTERS	MW-11
569 MYODA, INC.	MW-8,9
570 MYODA, INC.	MW-8,9
572 UNITED INNOVATIONS	MW-5
Northeast	72NE1-24
577 ADI CORP.	NE-3
578 BITWISE DESIGNS, INC.	NE-11
579 BITWISE DESIGNS, INC.	NE-11
580 BRIGHTBILL-ROBERTS	NE-6
581 BSI	NE-19
582 BSI	NE-19
* BYTE CARD DECK	NE-14
* COMPUTER GRAPHICS SHOW '91	NE-15
Pacific Coast	72PC1-24
613 ACI CORP.	PC-1
614 BRIGHTBILL-ROBERTS	PC-7
615 BSI	PC-6
616 BSI	PC-6
617 DERBYTECH COMPUTERS	PC-24
618 DERBYTECH COMPUTERS	PC-24
619 ESI/CAD WAREHOUSE	PC-4
620 ESI/CAD WAREHOUSE	PC-4
623 H.CO COMPUTER PRODUCTS	PC-13

SOUTH	
South	72SO1-16
651 BSI	SO-3
652 BSI	SO-3
655 CHAUMONT & ASSOCIATES	SO-5
658 DERBYTECH COMPUTERS	SO-16
659 DERBYTECH COMPUTERS	SO-16
660 ESI/CAD WAREHOUSE	SO-4
661 ESI/CAD WAREHOUSE	SO-4
656 EXPO BUSINESS SYSTEMS	SO-7
657 EXPO BUSINESS SYSTEMS	SO-7
664 FD MICROSYSTEMS	SO-1
665 FD MICROSYSTEMS	SO-1
666 IME COMPUTERS	SO-2
667 IME COMPUTERS	SO-2
672 MICROCOM COMPUTERS	SO-13
673 MYODA, INC.	SO-8,9
674 MYODA, INC.	SO-8,9

INT'L DIRECT RESPONSE POSTCARDS

- * ARNET
- * BYTEWEEK
- * C++ REPORT
- * COMPUTER SOLUTIONS
- * COMPUTER SOLUTIONS, N.W.
- * COMPUTER SUPPORT CORP.

BYTE ADVERTISING SALES STAFF:

Steven M. Vito, Associate Publisher/V.P. of Marketing, One Phoenix Mill Lane, Peterborough, NH 03458, tel. (603) 924-9281
 Arthur Kossack, Eastern Advertising Director, Two Prudential Plaza, 180 North Stetson Ave., Chicago, IL 60601, tel. (312) 616-3341
 Jennifer L. Bartel, Western Advertising Director, 14850 Quorum Drive, Suite 380, Dallas, TX 75240, tel. (214) 701-8496
 Liz Coyman, Inside Advertising Sales Director, One Phoenix Mill Lane, Peterborough, NH 03458, tel. (603) 924-2518

NEW ENGLAND
 ME, NH, VT, MA, RI, CT, ONTARIO
 CANADA & EASTERN CANADA
 Dan Savage (617) 860-6344
 Scott Gagnon (603) 924-2651
 McGraw-Hill Publications
 29 Hartwell Avenue
 Lexington, MA 02173
 FAX: (617) 860-6999

EAST COAST
 NY, NJ, DE, PA
 Kim Norris (212) 512-2645
 Ariane Casey (212) 512-2368
 Patricia Payne (603) 924-2654
 McGraw-Hill Publications
 1221 Avenue of the Americas—
 28th Floor
 New York, NY 10020
 FAX: (212) 512-2075

MIDWEST
 IL, MO, KS, IA, ND, SD, MN,
 WI, NE, IN, MI, OH
 Kurt Kelley (312) 616-3328
 MaryAnn Goulding (603) 924-2664
 McGraw-Hill Publications
 Two Prudential Plaza
 180 North Stetson Ave.
 Chicago, IL 60601
 FAX: (312) 616-3370

**SOUTHWEST,
 ROCKY MOUNTAIN**
 CO, OK, TX,
 Alison Keenan (214) 701-8496
 Patricia Payne (603) 924-2654
 McGraw-Hill Publications
 14850 Quorum Drive
 Suite 380
 Dallas, TX 75240
 FAX: (214) 991-6208

NORTH PACIFIC: Campbell, CA
 SILICON VALLEY, HI, WA, AK,
 W. CANADA
 Bill McAfee (408) 879-0381
 Leslie Hupp (408) 879-0381
 McGraw-Hill Publications
 1999 South Bascom Ave.
 Suite #210
 Campbell, CA 95008
 FAX: (408) 879-9067

SOUTH PACIFIC: Los Angeles, CA
 LOS ANGELES COUNTY, AZ,
 NM, SOUTHERN NEVADA
 Alan El Faye (213) 480-5243
 Jonathan Sawyer (603) 924-2665
 McGraw-Hill Publications
 3333 Wilshire Boulevard #407
 Los Angeles, CA 90010
 FAX: (213) 480-5249

BYTE BITS (2x3)
 Mark Stone (603) 924-6830
 BYTE Publications
 One Phoenix Mill Lane
 Peterborough, NH 03458

The Buyer's Mart (1x2)
 Brian Higgins (603) 924-3754
 BYTE Publications
 One Phoenix Mill Lane
 Peterborough, NH 03458

Regional Advertising
 James Bail (603) 924-2533
 Barry Echavarría (603) 924-2574
 Larry Levine (603) 924-2637
 BYTE Publications
 One Phoenix Mill Lane
 Peterborough, NH 03458

BYTE Deck
 Ed Ware (603) 924-2596
 BYTE Publications
 One Phoenix Mill Lane
 Peterborough, NH 03458

Catalog Showcase
**BYTE International Direct
 Response Postcards**
 Ellen Perham (603) 924-2598
 BYTE Publications
 One Phoenix Mill Lane
 Peterborough, NH 03458

Peterborough, NH Office
 Inside Sales FAX: 603-924-2683
 Advertising FAX: 603-924-7507

SOUTHEAST
 NC, SC, GA, FL, AL, TN, VA,
 MS, AR, LA, DC, MD, WV, KY
 John Y. Schilin (404) 843-4782
 Patricia Payne (603) 924-2654
 McGraw-Hill Publications
 4170 Ashford-Dunwoody Road
 Suite 520
 Atlanta, GA 30319
 FAX: (404) 252-4056

NORTH PACIFIC: San Francisco, CA
 NORTHERN CA, OR, ID, MT,
 WY, NORTHERN NV
 Roy J. Kops (415) 954-9728
 McGraw-Hill Publications
 425 Battery Street
 San Francisco, CA 94111
 FAX: (415) 954-9786

SOUTH PACIFIC: Costa Mesa, CA
 ORANGE COUNTY,
 SAN DIEGO COUNTY, UT
 Ron Cordek (714) 557-6292
 Jonathan Sawyer (603) 924-2665
 McGraw-Hill Publications
 3001 Red Hill Ave.
 Building #1—Suite 222
 Costa Mesa, CA 92626
 FAX: (714) 557-2219

International Advertising Sales Staff:

Uwe Kretschmar, European Advertising and Marketing Manager, BYTE Publications, McGraw-Hill Publishing Co., Wimbledon Bridge House, One Hartfield Road, Wimbledon, London, SW19 3RU, England, Tel: 44 81 543 1234, Fax: 44 81 540 3833

**GERMANY, SWITZERLAND,
 AUSTRIA**
 Uwe Kretschmar (44-81-545-6268)
UNITED KINGDOM
 Roz Weyman (44-81-545-6269)
 McGraw-Hill Publishing Co.
 Wimbledon Bridge House
 One Hartfield Road
 Wimbledon, London SW19 3RU
 England
 Tel: 44 81 543 1234
 FAX: 44 81 540 3833
 TELEX: 892191

BENELUX
 Ellen Pardede
 Batenburg 103
 3437 AB Nieuwegein
 The Netherlands
 Tel: 31 34 02 49496
 FAX: 31 34 02 37944

FRANCE, ITALY
 Zena Coupé, Amanda Blaskett
 A-Z International Sales Ltd.
 4 Ashmount Road, Horsney Lane
 Highgate, London N19 3BH
 England
 Tel: 44 71 281 4116
 FAX: 44 71 281 8224

ISRAEL
 Dan Ehrlich
 Ehrlich Communication International
 P.O. Box 11297
 Tel Aviv 61112
 Israel
 Tel: (972) 3 449823
 FAX: (972) 3 5468168

JAPAN
 Masaki Mori
 McGraw-Hill Publishing Co.
 Overseas Corp.
 Room 1528
 Kasumigaseki Bldg.
 3-2-5 Kasumigaseki,
 Chiyoda-Ku
 Tokyo 100, Japan
 Tel: 81 3 581 9811
 FAX: 81 3 581 4018

SWEDEN
 Media Marketing AB
 Karlbergsvagen 89A
 S-10031 Stockholm
 Sweden
 Tel: 46 8 301280

HONG KONG
 Stephen Marcopoto
 Seavex Ltd.
 503 Wilson House
 19-27 Wyndham St.
 Central, Hong Kong
 Tel: 852-868-2010
 Telex: 60904 SEVEX HX
 FAX: 852 810 1283

SINGAPORE
 Jocelyn Domingo
 Seavex Ltd.
 400 Orchard Road, #10-01
 Singapore 0923
 Republic of Singapore
 Tel: 65 734 9790
 Telex: RS35539 SEAVEX
 FAX: 65 732 5129

TAIWAN
 Anita Chen
 Acer TWP
 977 Min Shen E. Road, 1-4 Flr.
 Taipei 10581, Taiwan ROC
 Tel: 886 2 763 0052
 Fax: 886 2 765 6874

READER SERVICE

To get further information on the products advertised in BYTE, fill out the reader service card by circling the numbers on the card that correspond to the inquiry number listed with the advertiser. This index is provided as an additional service by the publisher, who assumes no liability for errors or omissions.

* Correspond directly with company.

Index to Advertisers by Product Category

Inquiry No.	Page No.	Inquiry No.	Page No.	Inquiry No.	Page No.	Inquiry No.	Page No.
HARDWARE							
926	ADD INS	297	SUNRISE ELECTRONICS, INC. 369	196	NANAO 304	65	CDA COMPUTER SALES 109
38	ADVANCED MICRO DEVICES 203	462	TERRA DATENTECHNIK IS-56	203	NEC HOME ELECTRONICS 30,31	655	CHAUMONT & ASSOCIATES SO-5
23	AMERICAN ADVANTECH 388	343	XELTEK 399	219	OPTIQUEST 267	66	CLUB AMERICAN TECHNOLOGY 195
23	AMERICAN ADVANTECH 388	931	INSTRUMENTATION	220	OPTIQUEST 267	*	COMFAC COMPUTER 272,273
23	AMERICAN ADVANTECH 388	102	ELEXOR ASSOCIATES, INC. 391	446	PHILIPS IS-7	*	COMPUADD 104A-D
363	AMT INT'L 402	200	NATIONAL INSTRUMENTS CII	162	VIEWSONIC 274	*	COMPUAD 200A-D
360	ANN & ANTHONY (DAI) 397	932	KEYBOARDS/MICE	163	VIEWSONIC 274	583	COMPUTER SALES PROF. INC. NE-9
43	BAY TECHNICAL ASSOCIATES 166C	84	DATALUX 168D	523	NETWORK HARDWARE	584	COMPUTER SALES PROF. INC. NE-9
44	BAY TECHNICAL ASSOCIATES 166C	85	DATALUX 168D	43	BAY TECHNICAL ASSOCIATES 168C	585	COMPUTER SALES PROF. INC. NE-13
46	BINARY DATA ACQUISITION CORP 389	429	GTCO IS-69	44	BAY TECHNICAL ASSOCIATES 168C	586	COMPUTER SALES PROF. INC. NE-13
63	CAPITAL EQUIPMENT CORP 88	430	GTCO IS-69	399	BUFFALO PRODUCTS 351	86	DELL COMPUTER CORP. CII, 1
64	CAPITAL EQUIPMENT CORP 89	160	KEA SYSTEMS 389	*	CLEO COMMUNICATIONS, INC. 124	553	DERBYTECH COMPUTERS MW-16
413	COMPEX IS-53	174	LOGITECH, INC. 48,49	74	CONTROL CORP. 122,123	554	DERBYTECH COMPUTERS MW-16
414	COMPEX IS-53	175	LOGITECH, INC. 48,49	78	CSS LABS 324,325	588	DERBYTECH COMPUTERS NE-24
74	CONTROL CORP. 122,123	176	LOGITECH, INC. 225	79	CSS LABS 324,325	589	DERBYTECH COMPUTERS NE-24
89	DIGIBOARD 211	177	LOGITECH, INC. 225	418	CYBEX CORPORATION IS-60	618	DERBYTECH COMPUTERS PC-24
98	DISTRIBUTED PROCESSING TECH 127	208	NORTHGATE COMPUTER SYS. 236,239	89	DIGIBOARD 211	658	DERBYTECH COMPUTERS SO-16
99	DISTRIBUTED PROCESSING TECH 127	233	PERCON 383	98	DISTRIBUTED PROCESSING TECH 127	659	DERBYTECH COMPUTERS SO-16
121	GENOA 252	344	ZENY COMPUTER SYS., INC. 120	99	DISTRIBUTED PROCESSING TECH 127	105	ERONEX IS-61
123	GRAPHIC SOFTWARE SYSTEMS 284	933	MASS STORAGE	113	FLYTECH TECHNOLOGIES 51	555	ESICAD WAREHOUSE MW-4
124	GRAPHIC SOFTWARE SYSTEMS 284	17	AK SYSTEMS 386	432	INES GMBH IS-70	556	ESICAD WAREHOUSE MW-4
133	HERCULES COMP. TECH. 108	93	DATA STRATEGIES INT'L 405	183	MEASUREMENT & CTRL. SYS. 384	589	ESICAD WAREHOUSE NE-4
134	HIGH RES TECHNOLOGIES 391	112	FLAGSTAFF ENGINEERING 302	184	MEASUREMENT & CTRL. SYS. 384	590	ESICAD WAREHOUSE NE-4
135	HOMESMART COMPUTING 399	425	FLAGSTAFF ENGINEERING IS-46	*	PACIFIC DATA PRODUCTS 196	619	ESICAD WAREHOUSE PC-4
146	INTEL CORP. 63-65	359	I.E.F. 331	447	PHILIPS PERIPHERALS IS-29	620	ESICAD WAREHOUSE PC-4
147	INTEL CORP. 63-65	167	LAGUNA CONVERSION SYSTEMS 402	261	RAINBOW 15	660	ESICAD WAREHOUSE SO-4
150	IO TECH 397	187	MICRO SOLUTIONS COMP. PROD. 315	262	RAINBOW 15	661	ESICAD WAREHOUSE SO-4
438	JC INFO SYSTEMS CORP. IS-27	188	MICROPROCESSORS UNLIMITED 399	267	ROCHELLE COMMUNICATIONS 383	662	ESICAD WAREHOUSE SO-4
169	MICROWAY 234	222	OVERLAND DATA 384	268	ROCHELLE COMMUNICATIONS 383	352	EVEREX SYSTEMS 218,219
190	MICROWAY 234	231	PERCEPTIVE SOLUTIONS, INC. 81	310	THE SOFTWARE LINK 223	109	FALCO DATA PRODUCTS 67
*	MICROWAY 288	232	PERCEPTIVE SOLUTIONS, INC. 81	311	THE SOFTWARE LINK 223	593	FD MICROSYSTEMS NE-7
193	MYLEX CORP. 103	234	PINNACLE MICRO 107	594	FD MICROSYSTEMS NE-7	594	FD MICROSYSTEMS NE-7
194	MYLEX CORP. 103	251	QUALSTAR CORPORATION 402	664	FD MICROSYSTEMS SO-1	665	FD MICROSYSTEMS SO-1
361	OMNITRONIX, INC. 389	459	TEAC IS-24	113	FLYTECH TECHNOLOGIES 51	427	GOLDSTAR TECHNOLOGY IS-22,23
231	PERCEPTIVE SOLUTIONS, INC. 81	934	MISCELLANEOUS	*	GATEWAY 2000 32A-D	596	H.C.O. COMPUTER PRODUCTS NE-17
232	PERCEPTIVE SOLUTIONS, INC. 81	18	ALPHA PRODUCTS 403	136	HOUSTON INSTRUMENT 295	597	H.C.O. COMPUTER PRODUCTS NE-17
240	QUA TECH, INC. 370	76	COVOX, INC. 383	137	HOUSTON INSTRUMENT 295	623	H.C.O. COMPUTER PRODUCTS PC-13
241	QUA TECH, INC. 370	77	COVOX, INC. 383	138	HOUSTON INSTRUMENT 295	624	H.C.O. COMPUTER PRODUCTS PC-13
242	QUA TECH, INC. 370	559	IME COMPUTERS MW-2	444	MINOLTA GMBH IS-13	139	IBM WORKSTATION 260,261
243	QUA TECH, INC. 370	560	IME COMPUTERS MW-2	217	OKIDATA 154,155	559	IME COMPUTERS MW-2
244	QUA TECH, INC. 370	598	IME COMPUTERS NE-2	224	PACIFIC DATA PRODUCTS 198	560	IME COMPUTERS MW-2
245	QUA TECH, INC. 370	599	IME COMPUTERS NE-2	225	PANASONIC DOT MATRIX PRTR 37-39	598	IME COMPUTERS NE-2
246	QUA TECH, INC. 370	625	IME COMPUTERS PC-15	230	PENTAX TECHNOLOGIES 163	599	IME COMPUTERS NE-2
247	QUA TECH, INC. 370	626	IME COMPUTERS PC-15	458	SURAH, INC. IS-78	625	IME COMPUTERS PC-15
248	QUA TECH, INC. 370	666	IME COMPUTERS SO-2	302	TEKTRONIX 170,171	626	IME COMPUTERS PC-15
271	R&R ELECTRONICS 399	667	IME COMPUTERS SO-2	303	TEKTRONIX 170,171	666	IME COMPUTERS SO-2
284	SILICON SHACK LTD 388	144	INTEGRAND 202	572	UNITED INNOVATIONS MW-5	667	IME COMPUTERS SO-2
301	TECHNOLOGY POWER ENTER. 388	434	IQ ENGINEERING IS-21	345	ZERICON 315	356	INTEL CORP. 148,149
308	THE PERISCOPE COMPANY 348	435	IQ ENGINEERING IS-21	939	PRINTER RIBBONS/SUPPLIES	357	INTEL CORP. 148,149
309	THE PERISCOPE COMPANY 348	205	NCI 385	*	PACIFIC DATA PRODUCTS 323	353	IVERSON COMP. CORP. 176,177
480	TP ENTERPRISE LTD. IS-68	202	NCI 385	940	SCANNERS/IMAGE PROCESSORS	155	JMECCO 42,43
484	TRIANGLE DIGITAL SERVICES LTD. IS-76	205	NO NOISE, INC. 214	41	BARCODE INDUSTRIES 198	157	JEMIN ELECTRONICS 12,13
328	TRUEVISION, INC. 285	206	NO NOISE, INC. 214	42	BARCODE INDUSTRIES 198	184	KNAPCO 389
327	TRUEVISION, INC. 285	206	PACIFIC DATA PRODUCTS 323	88	DFI 354	165	KNAPCO 389
330	TRUCORE SOFTWARE 287	299	TALKING TECHNOLOGY, INC. 405	*	EPSON AMERICA 22,23	*	MANCHESTER EQUIPMENT 72NE-A,B
335	UPGRADES, ETC. 399	362	TWIX INT'L 397	941	SOFTWARE SECURITY	602	MANCHESTER EQUIPMENT NE-1
162	VIEWSONIC 274	331	UNICORN ELECTRONICS 388	404	ALADDIN IS-65	185	MEGATEL COMPUTER CORP. 344
163	VIEWSONIC 274	346	Z-WORLD ENGINEERING 389	424	FAST ELECTRONIC IS-40	188	METRA INFORMATION SYSTEMS 335
467	V.D.S. SPA IS-55	347	Z-WORLD ENGINEERING 389	122	GLENCO ENGINEERING 278	567	MICON COMPUTERS MW-1
927	DRIVES	935	MODEMS/MULTIPLEXORS	249	PROTECH MARKETING 135	568	MICROCOM COMPUTERS MW-11
401	3EST USA IS-76	43	BAY TECHNICAL ASSOCIATES 168C	250	PROTECH MARKETING 135	605	MICROCOM COMPUTERS NE-18
187	MICRO SOLUTIONS COMP. PROD. 315	44	BAY TECHNICAL ASSOCIATES 168C	942	SYSTEMS	634	MICROCOM COMPUTERS PC-19
328	TULIN CORPORATION 330	71	COMPUCOM 385	12	ABTECH, INC. 332	672	MICROCOM COMPUTERS SO-13
928	FACSIMILE	72	COMPUTER PERIPHERALS 224	13	ABTECH, INC. 332	569	MYODA, INC. MW-8,9
164	KNAPCO 389	116	GALACTICOMM 52,53	402	ACER IS-2	570	MYODA, INC. MW-8,9
165	KNAPCO 389	132	HAYES 71	403	AGC IS-59	806	MYODA, INC. NE-10
929	GRAPHICS TABLETS	350	INTEL CORP. 82,83	19	ALR 2,3	607	MYODA, INC. NE-10
294	SUMMAGRAPHICS 262	351	INTEL CORP. 82,83	20	ALR 2,3	639	MYODA, INC. PC-21
295	SUMMAGRAPHICS 262	235	PRACTICAL PERIPHERALS 29	21	ALTEC 100	840	MYODA, INC. PC-21
296	SUMMAGRAPHICS 262	317	TOUCHBASE SYSTEMS, INC. 74	22	ALTIMA SYSTEMS, INC. 249	873	MYODA, INC. SO-9,9
930	HARDWARE PROGRAMMERS	339	VERMONT CREATIVE SOFTWARE 35	26	AMERICAN MITAC 339	674	MYODA, INC. SO-9,9
23	AMERICAN ADVANTECH 388	938	MONITORS	*	APPLE COMPUTER 25	209	NORTHGATE COMPUTER SYS. 240,241
23	AMERICAN ADVANTECH 388	613	ADI CORP. PC-1	35	APPLE COMPUTER 26,27	210	NORTHGATE COMPUTER SYS. 242,243
23	AMERICAN ADVANTECH 388	422	ETAP NE-3	35	ARLINGTON ELECTRONICS 397	211	NORTHGATE COMPUTER SYS. 244,245
*	BINARY TECHNOLOGY, INC. 400	141	IYAMA ELECTRIC CO., LTD. A168	578	BITWISE DESIGNS, INC. NE-11	212	NORTHGATE COMPUTER SYS. 204,205
53	BP MICROSYSTEMS 402	559	IME COMPUTERS MW-2	579	BITWISE DESIGNS, INC. NE-11	213	NORTHGATE COMPUTER SYS. 310,311
82	C&J MICROCNICS 405	560	IME COMPUTERS MW-2	551	BSI MW-13	258	RADIO SHACK CIV
127	GTEK, INC. 226	598	IME COMPUTERS NE-2	552	BSI MW-13	282	SHARP ELECTRONICS 296
128	GTEK, INC. 226	599	IME COMPUTERS NE-2	581	BSI NE-19	457	SOLO UNIBIT IS-57
169	LINK COMPUTER GRAPHICS 384	625	IME COMPUTERS PC-15	562	BSI NE-19	290	STANDARD COMPUTER 88,89
172	LOGICAL DEVICES, INC. 400	626	IME COMPUTERS PC-15	615	BSI PC-6	298	SUPERSOFT 334
173	LOGICAL DEVICES, INC. 400	666	IME COMPUTERS SO-2	616	BSI PC-6	300	TANGENT COMPUTER 257
207	NOHAU CORP. 360	433	INTERQUAD LTD IS-5	651	BSI SO-3	306	TEXAS MICROSYSTEMS 180,181
		195	NANAO 304	652	BSI SO-3	*	TEXAS MICROSYSTEMS 180A-B

READER SERVICE

* Correspond directly with company.

Inquiry No.	Page No.	Inquiry No.	Page No.	Inquiry No.	Page No.	Inquiry No.	Page No.
943	UPS	953	IBM/MSDOS COMMUNICATIONS	961	UNIX/OTHER — CROSS DEVELOPMENT	111	FIRST SOURCE INTERNATIONAL . 385
14	ACCUMATION, INC. 384	49	BLAST/COMM. RESEARCH GROUP 357	51	BORLAND INTERNATIONAL 11	117	GALAXY ELECTRONICS, INC. 400
15	ACCUMATION, INC. 364	50	BLAST/COMM. RESEARCH GROUP 357	52	BORLAND INTERNATIONAL 11	428	GREY MATTER IS-71
103	EMERSON UPS 199	126	COMMUNIQUE FAX 9600 96	118	GCOM, INC. 399	596	H.CO COMPUTER PRODUCTS NE-17
104	EMERSON UPS 199	100	DIVERSIFIED COMPUTER SYSTEMS 388	197	NANTUCKET CORPORATION 230	597	H.CO COMPUTER PRODUCTS NE-17
164	KNAPCO 389	115	FTP SOFTWARE 340	198	NANTUCKET CORPORATION 231	431	IMS/FINATOR IS-60
185	KNAPCO 389	323	TRITON TECHNOLOGIES 320		* SOFTWARE DEVELOPMENT SYS. IS-35	149	INTEL CORP./DEV. TOOLS 372
226	PARA SYSTEMS, INC. 77	324	TRITON TECHNOLOGIES 320		* TEXAS INSTRUMENTS 16,17	153	I.C.EXPRESS 388
228	PC POWER & COOLING 288			962	UNIX/OTHER — LANGUAGES	151	I.S.C. POWER SYSTEMS 130,131
229	PC POWER & COOLING 288					154	JADE COMPUTER 390
SOFTWARE		954	IBM/MSDOS GRAPHICS			155	JAMECO 42,43
944	APPLE/MAC APPLICATIONS Business/Office	469	ART MACHINES IS-76		* BINARY TECHNOLOGY, INC. 400	6	JDR MICRODEVICES 413-416
114	FOX SOFTWARE 104	36	ASHTON-TATE 150		67	JDR MICRODEVICES 413-418	
644	STRATEGIC MAPPING PC-15	37	ASHTON-TATE 150			* MARK WILLIAMS COMPANY 75	
945	APPLE/MAC APPLICATIONS Scientific/Technical	45	BELL ATLANTIC 227		107	FAIRCOM CORP. 118	
274	SAS INSTITUTE, INC. 353	441	MICROGRAFX IS-31		108	FAIRCOM CORP. 118	
946	APPLE/MAC APPLICATIONS Miscellaneous	214	NOVA, INC. 287		631	METAWARE, INC. PC-17	
270	ROYKORE 64	227	PATTON & PATTON 397	963	UNIX/OTHER — UTILITIES		
644	STRATEGIC MAPPING PC-15	252	QUARTERDECK 215	470	COBALT BLUE IS-78		
947	APPLE/MAC COMMUNICATIONS	286	SOFTWARE PUBLISHING CORP. 236,237	125	GREENVIEW 76		
49	BLAST/COMM. RESEARCH GROUP 357	325	TRIVISION, INC. 285	436	IXI LTD IS-44		
50	BLAST/COMM. RESEARCH GROUP 357	329	TRIVISION, INC. 285				
948	APPLE/MAC LANGUAGES	338	VENTURA PUBLISHER 7	964	DESKTOP PUBLISHING		
	* COPIA INTERNATIONAL LTD. 332	955	IBM/MSDOS — LAN	442	MICROPRESS IS-72		
949	IBM/MSDOS APPLICATIONS Business/Office	101	ELEX INFORMATION SYS 347	443	MICROPRESS IS-72		
33	ARC TANGENT, INC. 402	280	SERVER TECHNOLOGY 126	269	ROSE ELECTRONICS 129		
34	ARC TANGENT, INC. 402	281	SERVER TECHNOLOGY 126	338	VENTURA PUBLISHER 7		
417	COMPUTER SUPPORT CORP. IS-33	956	IBM/MSDOS LANGUAGES				
	* COPIA INTERNATIONAL LTD. 332	67	CNS, INC. 330	965	EDUCATIONAL/ INSTRUCTIONAL		
358	COREL SYSTEMS 291	423	EXPERT SYSTEMS LTD. IS-66	8	ABACUS SOFTWARE, INC. 167		
101	ELEX INFORMATION SYS 347	107	FAIRCOM CORP. 118	9	ABACUS SOFTWARE, INC. 167		
114	FOX SOFTWARE 104	108	FAIRCOM CORP. 118	28	ANNABOOKS 120		
426	GAMMA PRODUCTIONS IS-34	168	LAHEY 350		* BYTE BACK ISSUES IS-54		
129	HAUPFAUGE COMPUTER WORKS 317		* MICROSOFT 147		* BYTE CARD DECK NE-14		
130	HAVENTREE SOFTWARE 207	191	MIX SOFTWARE 367		* BYTE SUB MESSAGE IS-64		
131	HAVENTREE SOFTWARE 207	451	PROLOG DEVELOPMENT IS-10		* CCMI 344		
142	JETFORM 340	452	PROLOG DEVELOPMENT IS-10		* COMPUTER GRAPHICS SHOW '91 NE-15		
143	JETFORM 340	348	PSUDOCORP 400	161	KEITHLEY METRABYTE 391		
367	LEXPERTISE 363	292	STONY BROOK SOFTWARE 102	637	MACWORLD EXPO PC-8,11		
368	LEXPERTISE 363	293	STONY BROOK SOFTWARE 102	638	MACWORLD EXPO PC-8,11		
180	MAP INFO 128	461	TERRA DATENTECHNIK IS-70	609	PACE UNIVERSITY NE-5		
	* MICROSOFT 97-99	312	THE WHITEWATER GROUP 280		* UNIXWORLD 393		
	* ORACLE 145		* ZORTECH 41		* UNIXWORLD 392A-B		
	* PROGRAMMER'S SHOP 186,187		* ZORTECH 41	340	WIESEMANN & THEIS GMBH 391		
	* PROGRAMMER'S SHOP 188,189	957	IBM/MSDOS UTILITIES				
259	RAIMA CORP. 47	10	ABACUS SOFTWARE, INC. 175	966	MAIL ORDER/RETAIL		
260	RAIMA CORP. 47	11	ABACUS SOFTWARE, INC. 175	16	ADD ON AMERICA 405		
264	RECITAL CORPORATION, INC. 208		* AVOCET SYSTEMS 80	405	AMDS LTD. IS-48		
265	RECITAL CORPORATION, INC. 208	47	BLACK & WHITE INTERNATIONAL. 271	407	ATICO IS-62,63		
266	RECOGNITA CORP. 306	48	BLAISE COMPUTING 6	40	B & B ELECTRONICS 400		
950	IBM/MSDOS APPLICATIONS Scientific/Technical	580	BRIGHTBILL-ROBERTS NE-6	56	BUSINESSLAND DIRECT 372		
364	BOURBAKI, INC. 352	614	BRIGHTBILL-ROBERTS PC-7	58	BZ TECHNICAL 383		
365	BOURBAKI, INC. 352	409	CLARION SOFTWARE IS-9	59	B&C MICROSYSTEMS 397		
62	CADRE TECHNOLOGIES 21	410	CLARION SOFTWARE IS-9	60	B&C MICROSYSTEMS 397		
170	LOGICAL DEVICES, INC. 400	423	EXPERT SYSTEMS LTD IS-66	61	B&C MICROSYSTEMS 399		
171	LOGICAL DEVICES, INC. 400	125	GREENVIEW 76	655	CHAUMONT & ASSOCIATES SO-5		
178	MAGEE ENTERPRISES, INC. 210	563	IRIS SOFTWARE PRODUCTS MW-3	68	COMP USA 212		
179	MAGEE ENTERPRISES, INC. 210	564	IRIS SOFTWARE PRODUCTS MW-3	415	COMPCLASSICS IS-51		
366	MICRONICS 190	629	IRIS SOFTWARE PRODUCTS PC-3	468	COMPUSAVE INT'L IS-77		
275	SCIENTIFIC ENDEAVORS 400	630	IRIS SOFTWARE PRODUCTS PC-3	611	COMPUTER PERIP. DIRECT, INC. NE21		
276	SCIENTIFIC ENDEAVORS 400	152	ITR 391	612	COMPUTER PERIP. DIRECT, INC. NE21		
277	SCIENTIFIC ENDEAVORS 400	437	I.M.T. FRANCE IS-72	416	COMPUTER QUICK IS-50		
289	SPECTRUM 309	188	KNOWLEDGE GARDEN 336	583	COMPUTER SALES PROF. INC. NE-9		
291	STATSOFT 85	178	MAGEE ENTERPRISES, INC. 210	584	COMPUTER SALES PROF. INC. NE-9		
951	IBM/MSDOS APPLICATIONS Miscellaneous	179	MAGEE ENTERPRISES, INC. 210	585	COMPUTER SALES PROF. INC. NE-13		
87	DESKTOP TECHNOLOGY CORP. 164	439	MASHOV IS-49	586	COMPUTER SALES PROF. INC. NE-13		
106	EVEN HORIZONS 279	215	NU-MEGA TECHNOLOGIES 78	73	COMPUTER ANE 396		
158	JYOS SYSTEMS, INC. 200	216	OAKLAND GROUP, THE 232	553	DERBYTECH COMPUTERS MW-16		
952	IBM/MSDOS — CAD	218	OPENETWORK 126	554	DERBYTECH COMPUTERS MW-16		
27	AMERICAN SMALL BUSINESS 259	445	PECAN SOFTWARE EUROPE LTD. IS-75	587	DERBYTECH COMPUTERS NE-24		
39	A.M.S. 397	642	PROSPERO SOFTWARE, INC. PC-2	588	DERBYTECH COMPUTERS NE-24		
119	GENERIC SOFTWARE 283	643	PROSPERO SOFTWARE, INC. PC-2	617	DERBYTECH COMPUTERS PC-24		
120	GENERIC SOFTWARE 283	255	RACINE TECHNOLOGIES 104	618	DERBYTECH COMPUTERS PC-24		
341	WINTEK CORPORATION 405	256	RACINE TECHNOLOGIES 104	658	DERBYTECH COMPUTERS SO-16		
342	WINTEK CORPORATION 405	308	THE PERISCOPE COMPANY 348	659	DERBYTECH COMPUTERS SO-16		
		309	THE PERISCOPE COMPANY 348	95	DISKCO TECH 405		
		312	THE WHITEWATER GROUP 280	96	DISKCO TECH 405		
		318	TOUCHSTONE 79	97	DISKETTE CONNECTION 391		
		319	TOUCHSTONE 79	420	ELEX INTERNATIONAL IS-73		
		320	TRANS ERA 326	555	ESI/CAD WAREHOUSE MW-4		
		321	TRANS ERA 326	556	ESI/CAD WAREHOUSE MW-4		
		323	TRITON TECHNOLOGIES 320	589	ESI/CAD WAREHOUSE NE-4		
		324	TRITON TECHNOLOGIES 320	590	ESI/CAD WAREHOUSE NE-4		
		329	TURBOPOWER 366	610	ESI/CAD WAREHOUSE PC-4		
		958	UNIX/OTHER APPLICATIONS Business/Office	620	ESI/CAD WAREHOUSE PC-4		
		45	BELL ATLANTIC 227	661	ESI/CAD WAREHOUSE SO-4		
		264	RECITAL CORPORATION, INC. 208	656	EXPO BUSINESS SYSTEMS SO-7		
		265	RECITAL CORPORATION, INC. 208	593	FD MICROSYSTEMS NE-7		
		959	UNIX/OTHER APPLICATIONS Miscellaneous	594	FD MICROSYSTEMS NE-7		
		453	SHENG LABS, INC. IS-56	664	FD MICROSYSTEMS SO-1		
		960	UNIX/OTHER — CAD	665	FD MICROSYSTEMS SO-1		
		182	MATHSOFT 343	110	FIRST SOURCE INTERNATIONAL 385		

REQUEST FREE PRODUCT INFORMATION BY FAX

Just fax this page to 1-413-637-4343. Save time because your request for information will be processed *immediately*.

1 Circle the numbers below which correspond to the numbers assigned to advertisers and products that interest you.

2 Check off the answers to questions "A" through "E".

3 Print your name, address, and fax number clearly on the form.

4 Remove this page or copy this page clearly and fax it to the number above.

Fill out this coupon carefully. PLEASE PRINT.

Name _____
 Title _____
 Company _____
 Address _____
 City _____
 State/Province _____ Zip _____
 Country _____ () _____ () _____
 Phone Number _____ Fax Number _____

A. What is your primary job function/principal area of responsibility? (Check one.)

- 1 MIS/DP
- 2 Programmer/Systems Analyst
- 3 Administration/Management
- 4 Sales/Marketing
- 5 Engineer/Scientist
- 6 Other

B. What is your level of management responsibility?

- 7 Senior-level
- 8 Middle-level
- 9 Professional

C. Are you a reseller (VAR, VAD, Dealer, Consultant)?

- 10 Yes
- 11 No

D. What operating systems are you currently using? (Check all that apply.)

- 12 PC/MS-DOS
- 13 DOS + Windows
- 14 OS/2
- 15 UNIX
- 16 MacOS
- 17 VAX/VMS

E. For how many people do you influence the purchase of hardware or software?

- 18 1-25
- 19 26-50
- 20 51-99
- 21 100 or more

Inquiry Numbers 1-495

Inquiry Numbers 496-990

Inquiry Numbers 991-1479

1	2	3	4	5	6	7	8	9	10	11	496	497	498	499	500	501	502	503	504	505	506	991	992	993	994	995	996	997	998	999	1000	1001
12	13	14	15	16	17	18	19	20	21	22	507	508	509	510	511	512	513	514	515	516	517	1002	1003	1004	1005	1006	1007	1008	1009	1010	1011	1012
23	24	25	26	27	28	29	30	31	32	33	518	519	520	521	522	523	524	525	526	527	528	1013	1014	1015	1016	1017	1018	1019	1020	1021	1022	1023
34	35	36	37	38	39	40	41	42	43	44	529	530	531	532	533	534	535	536	537	538	539	1024	1025	1026	1027	1028	1029	1030	1031	1032	1033	1034
45	46	47	48	49	50	51	52	53	54	55	540	541	542	543	544	545	546	547	548	549	550	1035	1036	1037	1038	1039	1040	1041	1042	1043	1044	1045
56	57	58	59	60	61	62	63	64	65	66	551	552	553	554	555	556	557	558	559	560	561	1046	1047	1048	1049	1050	1061	1052	1053	1054	1055	1058
67	68	69	70	71	72	73	74	75	76	77	562	563	564	565	566	567	568	569	570	571	572	1057	1058	1059	1060	1061	1062	1063	1064	1085	1086	1067
78	79	80	81	82	83	84	85	86	87	88	573	574	575	576	577	578	579	580	581	582	583	1068	1069	1070	1071	1072	1073	1074	1075	1076	1077	1078
89	90	91	92	93	94	95	96	97	98	99	584	585	586	587	588	589	590	591	592	593	594	1078	1080	1061	1082	1083	1084	1085	1086	1087	1088	1089
100	101	102	103	104	105	106	107	108	109	110	595	596	597	598	599	600	601	602	603	604	605	1090	1091	1092	1093	1094	1095	1096	1097	1098	1099	1100
111	112	113	114	115	116	117	118	119	120	121	606	607	608	609	610	611	612	613	614	615	616	1101	1102	1103	1104	1105	1106	1107	1108	1109	1110	1111
122	123	124	125	126	127	128	129	130	131	132	617	618	619	620	621	622	623	624	625	626	627	1112	1113	1114	1115	1116	1117	1118	1119	1120	1121	1122
133	134	135	136	137	138	139	140	141	142	143	628	629	630	631	632	633	634	635	636	637	638	1123	1124	1125	1126	1127	1128	1129	1130	1131	1132	1133
144	145	146	147	148	149	150	151	152	153	154	639	640	641	642	643	644	645	646	647	648	649	1134	1135	1136	1137	1138	1139	1140	1141	1142	1143	1144
155	156	157	158	159	160	161	162	163	164	165	650	651	652	653	654	655	656	657	658	659	660	1145	1146	1147	1148	1149	1150	1151	1152	1153	1154	1155
166	167	168	169	170	171	172	173	174	175	176	661	662	663	664	665	666	667	668	669	670	671	1156	1157	1158	1159	1160	1161	1162	1163	1164	1165	1166
177	178	179	180	181	182	183	184	185	186	187	672	673	674	675	676	677	678	679	680	681	682	1167	1168	1169	1170	1171	1172	1173	1174	1175	1176	1177
188	189	190	191	192	193	194	195	196	197	198	683	684	685	686	687	688	689	690	691	692	693	1178	1179	1180	1181	1182	1183	1184	1185	1186	1187	1188
199	200	201	202	203	204	205	206	207	208	209	694	695	696	697	698	699	700	701	702	703	704	1189	1190	1191	1192	1193	1194	1195	1196	1197	1198	1199
210	211	212	213	214	215	216	217	218	219	220	705	706	707	708	709	710	711	712	713	714	715	1200	1201	1202	1203	1204	1205	1206	1207	1208	1209	1210
221	222	223	224	225	226	227	228	229	230	231	716	717	718	719	720	721	722	723	724	725	726	1211	1212	1213	1214	1215	1216	1217	1218	1219	1220	1221
232	233	234	235	236	237	238	239	240	241	242	727	728	729	730	731	732	733	734	735	736	737	1222	1223	1224	1225	1226	1227	1228	1229	1230	1231	1232
243	244	245	246	247	248	249	250	251	252	253	738	739	740	741	742	743	744	745	746	747	748	1233	1234	1235	1236	1237	1238	1239	1240	1241	1242	1243
254	255	256	257	258	259	260	261	262	263	264	749	750	751	752	753	754	755	756	757	758	759	1244	1245	1246	1247	1248	1249	1250	1251	1252	1253	1254
265	266	267	268	269	270	271	272	273	274	275	760	761	762	763	764	765	766	767	768	769	770	1255	1256	1257	1258	1259	1260	1261	1262	1263	1264	1265
276	277	278	279	280	281	282	283	284	285	286	771	772	773	774	775	776	777	778	779	780	781	1266	1267	1268	1269	1270	1271	1272	1273	1274	1275	1276
287	288	289	290	291	292	293	294	295	296	297	782	783	784	785	786	787	788	789	790	791	792	1277	1278	1279	1280	1261	1262	1283	1284	1285	1266	1287
298	299	300	301	302	303	304	305	306	307	308	793	794	795	796	797	798	799	800	801	802	803	1288	1289	1290	1291	1292	1293	1294	1295	1296	1297	1298
309	310	311	312	313	314	315	316	317	318	319	804	805	806	807	808	809	810	811	812	813	814	1299	1300	1301	1302	1303	1304	1305	1306	1307	1308	1309
320	321	322	323	324	325	326	327	328	329	330	815	816	817	818	819	820	821	822	823	824	825	1310	1311	1312	1313	1314	1315	1316	1317	1318	1319	1320
331	332	333	334	335	336	337	338	339	340	341	826	827	828	829	830	831	832	833	834	835	836	1321	1322	1323	1324	1325	1326	1327	1328	1329	1330	1331
342	343	344	345	346	347	348	349	350	351	352	837	838	839	840	841	842	843	844	845	846	847	1332	1333	1334	1335	1336	1337	1336	1339	1340	1341	1342
353	354	355	356	357	358	359	360	361	362	363	848	849	850	851	852	853	854	855	856	857	858	1343	1344	1345	1346	1347	1348	1349	1350	1361	1352	1353
364	365	366	367	368	369	370	371	372	373	374	859	860	861	862	863	864	865	866	867	868	869	1354	1355	1356	1357	1358	1359	1360	1361	1362	1363	1364
375	376	377	378	379	380	381	382	383	384	385	870	871	872	873	874	875	876	877	878	879	880	1365	1366	1367	1368	1369	1370	1371	1372	1373	1374	1375
386	387	388	389	390	391	392	393	394	395	396	881	882	883	884	885	886	887	888	889	890	891	1376	1377	1378	1379	1380	1381	1382	1383	1384	1385	1386
397	398	399	400	401	402	403	404	405	406	407	892	893	894	895	896	897	898	899	900	901	902	1387	1388	1389	1390	1391	1392	1393	1394	1395	1396	1397
408	409	410	411	412	413	414	415	416	417	418	903	904	905	906	907	908	909	910	911	912	913	1398	1399	1400	1401	1402	1403	1404	1405	1406	1407	1408
419	420	421	422	423	424	425	426	427	428	429	914	915	916	917	918	919	920	921	922	923	924	1409	1410	1411	1412	1413	1414	1415	1416	1417	1418	1419
430	431	432	433																													

FREE PRODUCT INFORMATION

Want More Information About the Products and Advertisers Featured in this Issue?

- 1** Circle numbers on reply card which correspond to numbers assigned to items of interest to you.
- 2** Check all the appropriate answers to questions "A" through "E".
- 3** Print your name and address and mail.

Fill out this coupon carefully. PLEASE PRINT.

Name _____
 Title _____ (_____) Phone _____
 Company _____
 Address _____
 City _____ State _____ Zip _____

- A. What is your primary job function/principal area of responsibility? (Check one.)**
 MIS/DP
 Programmer/Systems Analyst
 Administration/Management
 Sales/Marketing
 Engineer/Scientist
 Other
- B. What is your level of management responsibility?**
 Senior-level Professional
 Middle-level
- C. Are you a reseller (VAR, VAD, Dealer, Consultant)?**
 No Yes
- D. What operating systems are you currently using? (Check all that apply.)**
 PC/MS-DOS UNIX
 DOS + Windows MacOS
 OS/2 VAX/VMS
- E. For how many people do you influence the purchase of hardware or software?**
 1-25 200-500 or more
 26-50 51-99
 Please send me one year of BTE Magazine for \$24.95 and bill me. Offer valid in U.S. and possessions only.

DECEMBER
IRSD002

Inquiry Numbers 1-493																	Inquiry Numbers 494-986																	Inquiry Numbers 987-1479																
1	2	3	4	5	6	7	8	9	10	11	12	13	14	15	16	17	494	495	496	497	498	499	500	501	502	503	504	505	506	507	508	509	510	987	988	989	990	991	992	993	994	995	996	997	998	999	1000	1001	1002	1003
18	19	20	21	22	23	24	25	26	27	28	29	30	31	32	33	34	511	512	513	514	515	516	517	518	519	520	521	522	523	524	525	526	527	1004	1005	1006	1007	1008	1009	1010	1011	1012	1013	1014	1015	1016	1017	1018	1019	1020
35	36	37	38	39	40	41	42	43	44	45	46	47	48	49	50	51	528	529	530	531	532	533	534	535	536	537	538	539	540	541	542	543	544	1021	1022	1023	1024	1025	1026	1027	1028	1029	1030	1031	1032	1033	1034	1035	1036	1037
52	53	54	55	56	57	58	59	60	61	62	63	64	65	66	67	68	545	546	547	548	549	550	551	552	553	554	555	556	557	558	559	560	561	1038	1039	1040	1041	1042	1043	1044	1045	1046	1047	1048	1049	1050	1051	1052	1053	1054
69	70	71	72	73	74	75	76	77	78	79	80	81	82	83	84	85	562	563	564	565	566	567	568	569	570	571	572	573	574	575	576	577	578	1055	1056	1057	1058	1059	1060	1061	1062	1063	1064	1065	1066	1067	1068	1069	1070	1071
86	87	88	89	90	91	92	93	94	95	96	97	98	99	100	101	102	579	580	581	582	583	584	585	586	587	588	589	590	591	592	593	594	595	1072	1073	1074	1075	1076	1077	1078	1079	1080	1081	1082	1083	1084	1085	1086	1087	1088
103	104	105	106	107	108	109	110	111	112	113	114	115	116	117	118	119	596	597	598	599	600	601	602	603	604	605	606	607	608	609	610	611	612	1089	1090	1091	1092	1093	1094	1095	1096	1097	1098	1099	1100	1101	1102	1103	1104	1105
120	121	122	123	124	125	126	127	128	129	130	131	132	133	134	135	136	613	614	615	616	617	618	619	620	621	622	623	624	625	626	627	628	629	1106	1107	1108	1109	1110	1111	1112	1113	1114	1115	1116	1117	1118	1119	1120	1121	1122
137	138	139	140	141	142	143	144	145	146	147	148	149	150	151	152	153	630	631	632	633	634	635	636	637	638	639	640	641	642	643	644	645	646	1123	1124	1125	1126	1127	1128	1129	1130	1131	1132	1133	1134	1135	1136	1137	1138	1139
154	155	156	157	158	159	160	161	162	163	164	165	166	167	168	169	170	647	648	649	650	651	652	653	654	655	656	657	658	659	660	661	662	663	1140	1141	1142	1143	1144	1145	1146	1147	1148	1149	1150	1151	1152	1153	1154	1155	1156
171	172	173	174	175	176	177	178	179	180	181	182	183	184	185	186	187	664	665	666	667	668	669	670	671	672	673	674	675	676	677	678	679	680	1157	1158	1159	1160	1161	1162	1163	1164	1165	1166	1167	1168	1169	1170	1171	1172	1173
188	189	190	191	192	193	194	195	196	197	198	199	200	201	202	203	204	681	682	683	684	685	686	687	688	689	690	691	692	693	694	695	696	697	1174	1175	1176	1177	1178	1179	1180	1181	1182	1183	1184	1185	1186	1187	1188	1189	1190
205	206	207	208	209	210	211	212	213	214	215	216	217	218	219	220	221	698	699	700	701	702	703	704	705	706	707	708	709	710	711	712	713	714	1191	1192	1193	1194	1195	1196	1197	1198	1199	1200	1201	1202	1203	1204	1205	1206	1207
222	223	224	225	226	227	228	229	230	231	232	233	234	235	236	237	238	715	716	717	718	719	720	721	722	723	724	725	726	727	728	729	730	731	1208	1209	1210	1211	1212	1213	1214	1215	1216	1217	1218	1219	1220	1221	1222	1223	1224
239	240	241	242	243	244	245	246	247	248	249	250	251	252	253	254	255	732	733	734	735	736	737	738	739	740	741	742	743	744	745	746	747	748	1225	1226	1227	1228	1229	1230	1231	1232	1233	1234	1235	1236	1237	1238	1239	1240	1241
256	257	258	259	260	261	262	263	264	265	266	267	268	269	270	271	272	749	750	751	752	753	754	755	756	757	758	759	760	761	762	763	764	765	1242	1243	1244	1245	1246	1247	1248	1249	1250	1251	1252	1253	1254	1255	1256	1257	1258
273	274	275	276	277	278	279	280	281	282	283	284	285	286	287	288	289	766	767	768	769	770	771	772	773	774	775	776	777	778	779	780	781	782	1259	1260	1261	1262	1263	1264	1265	1266	1267	1268	1269	1270	1271	1272	1273	1274	1275
290	291	292	293	294	295	296	297	298	299	300	301	302	303	304	305	306	783	784	785	786	787	788	789	790	791	792	793	794	795	796	797	798	799	1276	1277	1278	1279	1280	1281	1282	1283	1284	1285	1286	1287	1288	1289	1290	1291	1292
307	308	309	310	311	312	313	314	315	316	317	318	319	320	321	322	323	800	801	802	803	804	805	806	807	808	809	810	811	812	813	814	815	816	1293	1294	1295	1296	1297	1298	1299	1300	1301	1302	1303	1304	1305	1306	1307	1308	1309
324	325	326	327	328	329	330	331	332	333	334	335	336	337	338	339	340	817	818	819	820	821	822	823	824	825	826	827	828	829	830	831	832	833	1310	1311	1312	1313	1314	1315	1316	1317	1318	1319	1320	1321	1322	1323	1324	1325	1326
341	342	343	344	345	346	347	348	349	350	351	352	353	354	355	356	357	834	835	836	837	838	839	840	841	842	843	844	845	846	847	848	849	850	1327	1328	1329	1330	1331	1332	1333	1334	1335	1336	1337	1338	1339	1340	1341	1342	1343
358	359	360	361	362	363	364	365	366	367	368	369	370	371	372	373	374	851	852	853	854	855	856	857	858	859	860	861	862	863	864	865	866	867	1344	1345	1346	1347	1348	1349	1350	1351	1352	1353	1354	1355	1356	1357	1358	1359	1360
375	376	377	378	379	380	381	382	383	384	385	386	387	388	389	390	391	868	869	870	871	872	873	874	875	876	877	878	879	880	881	882	883	884	1361	1362	1363	1364	1365	1366	1367	1368	1369	1370	1371	1372	1373	1374	1375	1376	1377
392	393	394	395	396	397	398	399	400	401	402	403	404	405	406	407	408	885	886	887	888	889	890	891	892	893	894	895	896	897	898	899	900	901	1378	1379	1380	1381	1382	1383	1384	1385	1386	1387	1388	1389	1390	1391	1392	1393	1394
409	410	411	412	413	414	415	416	417	418	419	420	421	422	423	424	425	902	903	904	905	906	907	908	909	910	911	912	913	914	915	916	917	918	1395	1396	1397	1398	1399	1400	1401	1402	1403	1404	1405	1406	1407	1408	1409	1410	1411
426	427	428	429	430	431	432	433	434	435	436	437	438	439	440	441	442	919	920	921	922	923	924	925	926	927	928	929	930	931	932	933	934	935	1412	1413	1414	1415	1416	1417	1418	1419	1420	1421	1422	1423	1424	1425	1426	1427	1428
443	444	445	446	447	448	449	450	451	452	453	454	455	456	457	458	459	936	937	938	939	940	941	942	943	944	945	946	947	948	949	950	951	952	1429	1430	1431	1432	1433	1434	1435	1436	1437	1438	1439	1440	1441	1442	14		

FREE PRODUCT INFORMATION

Want More Information About the Products and Advertisers Featured in this Issue?

1 Circle numbers on reply card which correspond to numbers assigned to items of interest to you.

2 Check all the appropriate answers to questions "A" through "E".

3 Print your name and address and mail.



NO POSTAGE
NECESSARY
IF MAILED
IN THE
UNITED STATES

BUSINESS REPLY MAIL

FIRST CLASS MAIL PERMIT NO. 176 PITTSFIELD, MA

POSTAGE WILL BE PAID BY ADDRESSEE

BYTE

READER SERVICE
PO Box 5110
Pittsfield, MA 01203-9926
USA



Fill out this coupon carefully. PLEASE PRINT.

Name _____ (_____) _____
 Title _____ Phone _____
 Company _____
 Address _____
 City _____ State _____ Zip _____

A. What is your primary job function/principal area of responsibility? (Check one.)

- 1 MIS/DP
- 2 Programmer/Systems Analyst
- 3 Administration/Management
- 4 Sales/Marketing
- 5 Engineer/Scientist
- 6 Other

B. What is your level of management responsibility?

- 7 Senior-level
- 8 Middle-level
- 9 Professional

C. Are you a reseller (VAR, VAD, Dealer, Consultant)?

- 10 Yes
- 11 No

D. What operating systems are you currently using? (Check all that apply.)

- 12 PC/MS-DOS
- 13 DOS + Windows
- 14 OS/2
- 15 UNIX
- 16 MacOS
- 17 VAX/VMS

E. For how many people do you influence the purchase of hardware or software?

- 18 1-25
- 19 26-50
- 20 51-99
- 21 100 or more

Please send me one year of BYTE Magazine for \$24.95 and bill me. Offer valid in U.S. and possessions only.

DECEMBER
IRSD002

Inquiry Numbers 1-493

1	2	3	4	5	6	7	8	9	10	11	12	13	14	15	16	17
18	19	20	21	22	23	24	25	26	27	28	29	30	31	32	33	34
35	36	37	38	39	40	41	42	43	44	45	46	47	48	49	50	51
52	53	54	55	56	57	58	59	60	61	62	63	64	65	66	67	68
69	70	71	72	73	74	75	76	77	78	79	80	81	82	83	84	85
86	87	88	89	90	91	92	93	94	95	96	97	98	99	100	101	102
103	104	105	106	107	108	109	110	111	112	113	114	115	116	117	118	119
120	121	122	123	124	125	126	127	128	129	130	131	132	133	134	135	136
137	138	139	140	141	142	143	144	145	146	147	148	149	150	151	152	153
154	155	156	157	158	159	160	161	162	163	164	165	166	167	168	169	170
171	172	173	174	175	176	177	178	179	180	181	182	183	184	185	186	187
188	189	190	191	192	193	194	195	196	197	198	199	200	201	202	203	204
205	206	207	208	209	210	211	212	213	214	215	216	217	218	219	220	221
222	223	224	225	226	227	228	229	230	231	232	233	234	235	236	237	238
239	240	241	242	243	244	245	246	247	248	249	250	251	252	253	254	255
256	257	258	259	260	261	262	263	264	265	266	267	268	269	270	271	272
273	274	275	276	277	278	279	280	281	282	283	284	285	286	287	288	289
290	291	292	293	294	295	296	297	298	299	300	301	302	303	304	305	306
307	308	309	310	311	312	313	314	315	316	317	318	319	320	321	322	323
324	325	326	327	328	329	330	331	332	333	334	335	336	337	338	339	340
341	342	343	344	345	346	347	348	349	350	351	352	353	354	355	356	357
358	359	360	361	362	363	364	365	366	367	368	369	370	371	372	373	374
375	376	377	378	379	380	381	382	383	384	385	386	387	388	389	390	391
392	393	394	395	396	397	398	399	400	401	402	403	404	405	406	407	408
409	410	411	412	413	414	415	416	417	418	419	420	421	422	423	424	425
426	427	428	429	430	431	432	433	434	435	436	437	438	439	440	441	442
443	444	445	446	447	448	449	450	451	452	453	454	455	456	457	458	459
460	461	462	463	464	465	466	467	468	469	470	471	472	473	474	475	478
477	478	479	480	481	482	483	484	485	486	487	488	489	490	491	492	493

Inquiry Numbers 494-986

494	495	496	497	498	499	500	501	502	503	504	505	506	507	508	509	510
511	512	513	514	515	516	517	518	519	520	521	522	523	524	525	526	527
528	529	530	531	532	533	534	535	536	537	538	539	540	541	542	543	544
545	546	547	548	549	550	551	552	553	554	555	556	557	558	559	560	561
562	563	564	565	566	567	568	569	570	571	572	573	574	575	576	577	578
579	580	581	582	583	584	585	586	587	588	589	590	591	592	593	594	595
596	597	598	599	600	601	602	603	604	605	606	607	608	609	610	611	612
613	614	615	616	617	618	619	620	621	622	623	624	625	626	627	628	629
630	631	632	633	634	635	636	637	638	639	640	641	642	643	644	645	646
647	648	649	650	651	652	653	654	655	656	657	658	659	660	661	662	663
664	665	666	667	668	669	670	671	672	673	674	675	676	677	678	679	680
681	682	683	684	685	686	687	688	689	690	691	692	693	694	695	696	697
698	699	700	701	702	703	704	705	706	707	708	709	710	711	712	713	714
715	716	717	718	719	720	721	722	723	724	725	726	727	728	729	730	731
732	733	734	735	736	737	738	739	740	741	742	743	744	745	746	747	748
749	750	751	752	753	754	755	756	757	758	759	760	761	762	763	764	765
766	767	768	769	770	771	772	773	774	775	776	777	778	779	780	781	782
783	784	785	786	787	788	789	790	791	792	793	794	795	796	797	798	799
800	801	802	803	804	805	806	807	808	809	810	811	812	813	814	815	816
817	818	819	820	821	822	823	824	825	826	827	828	829	830	831	832	833
834	835	836	837	838	839	840	841	842	843	844	845	846	847	848	849	850
851	852	853	854	855	856	857	858	859	860	861	862	863	864	865	866	867
868	869	870	871	872	873	874	875	876	877	878	879	880	881	882	883	884
885	886	887	888	889	890	891	892	893	894	895	896	897	898	899	900	901
902	903	904	905	906	907	908	909	910	911	912	913	914	915	916	917	918
919	920	921	922	923	924	925	926	927	928	929	930	931	932	933	934	935
936	937	938	939	940	941	942	943	944	945	946	947	948	949	950	951	952
953	954	955	956	957	958	959	960	961	962	963	964	965	966	967	968	969
970	971	972	973	974	975	976	977	978	979	980	981	982	983	984	985	986

Inquiry Numbers 987-1479

987	988	989	990	991	992	993	994	995	996	997	998	999	1000	1001	1002	1003
1004	1005	1006	1007	1008	1009	1010	1011	1012	1013	1014	1015	1016	1017	1018	1019	1020
1021	1022	1023	1024	1025	1026	1027	1028	1029	1030	1031	1032	1033	1034	1035	1036	1037
1038	1039	1040	1041	1042	1043	1044	1045	1046	1047	1048	1049	1050	1051	1052	1053	1054
1055	1056	1057	1058	1059	1060	1061	1062	1063	1064	1065	1066	1067	1068	1069	1070	1071
1072	1073	1074	1075	1076	1077	1078	1079	1080	1081	1082	1083	1084	1085	1086	1087	1088
1089	1090	1091	1092	1093	1094	1095	1096	1097	1098	1099	1100	1101	1102	1103	1104	1105
1106	1107	1108	1109	1110	1111	1112	1113	1114	1115	1116	1117	1118	1119	1120	1121	1122
1123	1124	1125	1126	1127	1128	1129	1130	1131	1132	1133	1134	1135	1136	1137	1138	1139
1140	1141	1142	1143	1144	1145	1146	1147	1148	1149	1150	1151	1152	1153	1154	1155	1156
1157	1158	1159	1160	1161	1162	1163	1164	1165	1166	1167	1168	1169	1170	1171	1172	1173
1174	1175	1176	1177	1178	1179	1180	1181	1182	1183	1184	1185	1186	1187	1188	1189	1190
1191	1192	1193	1194	1195	1196	1197	1198	1199	1200	1201	1202	1203	1204	1205	1206	1207
1208	1209	1210	1211	1212	1213	1214	1215	1216	1217	1218	1219	1220	1221	1222	1223	1224
1225	1226	1227	1228	1229	1230	1231	1232	1233	1234	1235	1236	1237	1238	1		

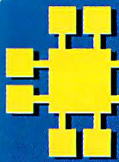

JDR Microdevices®

2233 BRANHAM LANE, SAN JOSE CA 95124

- BUY WITH CONFIDENCE FROM JDR!
- 30-DAY MONEY BACK GUARANTEE
- 1 YEAR WARRANTY
- TOLL-FREE TECH SUPPORT

DYNAMIC RAMS

PART#	SIZE	SPEED	PINS	PRICE
4116-150	16384x1	150ns	16	1.49
4164-150	65536x1	150ns	16	2.49
4164-120	65536x1	120ns	16	2.89
4164-100	65536x1	100ns	16	3.39
TMS4164-12	65536x4	120ns	16	3.95
41256-150	262144x1	150ns	16	1.95
41256-120	262144x1	120ns	16	2.15
41256-100	262144x1	100ns	16	2.25
41256-80	262144x1	80ns	16	2.75
414256-100	262144x4	100ns	20	8.95
414256-80	262144x4	80ns	20	9.95
1MB-120	1048576x1	120ns	18	7.95
1MB-100	1048576x1	100ns	18	8.35
1MB-80	1048576x1	80ns	18	9.95
1MB-70	1048576x1	70ns	18	10.75

SIMM/SIP MODULES

PART#	SIZE	SPEED	FOR	PRICE
41256A9B-80	256K x 9	80ns	SIMM/PC	33.95
421000A8B-10	1MB x 8	100ns	SIMM/MAC	79.95
421000A9B-10	1MB x 9	100ns	SIMM/PC	79.95
421000A9B-80	1MB x 9	80ns	SIMM/PC	89.95
421000A9B-60	1MB x 9	60ns	SIMM/PC	99.95
256K9SIP-80	256K X 9	80ns	SIP/PC	33.95
256K9SIP-60	256K X 9	60ns	SIP/PC	39.95
1MBx9SIP-10	1MB x 9	100ns	SIP/PC	79.95
1MBx9SIP-80	1MB x 9	80ns	SIP/PC	89.95

MATH CO-PROCESSORS

8087	5 MHz	89.95
8087-2	8 MHz	129.95
8087-1	10 MHz	169.95
80287-XLT	12MHz	247.95
80287-XL	6/8/10/12 MHz	247.95
80387-16	16 MHz	359.95
80387-SX	16 MHz	319.95
80387-SX20	20 MHz	399.95
80387-16	16 MHz	359.95
80387-20	20 MHz	399.95
80387-25	25 MHz	499.95
80387-33	33MHz	649.00



5 YEAR WARRANTY
WITH MANUAL & SOFTWARE GUIDE



*FOR COMPAQ LTE/286, TANDY 2800
**FOR ALL OTHER 286-BASED SYSTEMS

CYRIX CO-PROCESSORS

STATE-OF-THE-ART TO SAVE YOU LONGEVITY WORRIES!
MANUAL & SOFTWARE GUIDE, FULL 5-YEAR GUARANTEE!

83D87-16	16 MHz ..	\$299.95	83D87-33	33MHz ..	\$49.00
83D87-20	20 MHz	\$349.95	83S87-16 (SX)	16MHz ..	\$269.95
83D87-25	25MHz	\$439.95	83S87-20 (SX)	20MHz ..	\$329.95



Derick's HIGH-TECH SPOTLIGHT

I now feel comfortable publicly recommending CCITT V.32 and MNP communications protocols!

CCITT V.32 is a description of the electrical signals used over phone lines to move data. The CCITT is an international committee that refines the input from many modem industry experts into one accepted standard. Sometimes users or industry experts reject the efforts of standards committees and follow a single industry leader (as was the case with the IBM PC). Here, the committee prevailed.

The Microcom Network Protocol (MNP) is the product of 1 company's efforts to fix data errors and improve transmission efficiency. They've made their protocol available to others for a fee, and have been accepted by users en masse. The committee approach has not worked well in this area.

MNP-5 is an implementation of the protocol that insures reliable data transfer and compresses data at a rate of about 2 to 1. Thus, a modem operating at 9600 BPS (bits per second) provides a data transfer rate of approximately 19200 BPS—about 16 times the rate of older 1200 BPS standards!

For we end users, how standards are created is of passing interest—we want solid ones that won't be soon obsolete. CCITT V.32 and MNP-5 will be around for a long, long time.

Derick Moore, Director of Engineering

See JDR's modem selection on the next page

YOUR MOTHERBOARD CONNECTION!

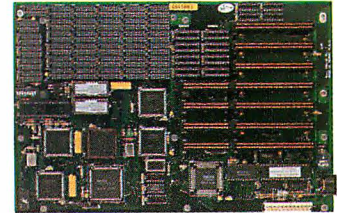
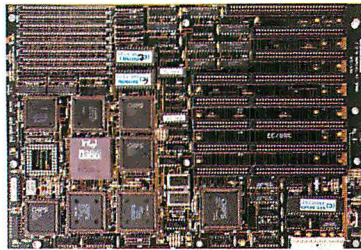

MINI 25MHz 386 \$799

• NORTON SI 26.6 • LANDMARK AT SPEED 30.1

"THE FASTEST NON-CACHING MOTHERBOARD THAT WE TESTED."—BYTE MAGAZINE, APRIL 1990.

- MEMORY INTERLEAVING FOR NEAR ZERO WAIT STATES
- SOCKETED FOR 80387 COPROCESSOR
- USES 80NS 256K OR 1MB SIMM/DIP RAMS
- 16MB RAM CAPACITY: 8MB ON BOARD, 8MB USING OPTIONAL RAM CARD (OKB INSTALLED)
- ON-BOARD RAM: 1/2MB USING 4/8 256K SIMMS OR 4/8MB USING 4/8 1MB SIMMS • FIVE 16-BIT SLOTS, TWO 8-BIT SLOTS, ONE 32-BIT SLOT FOR PROPRIETARY RAM CARD
- AMI BIOS • SIZE: 8.5" X 13"

MCT-M386-25 \$799.00

MCT-M386-M25 PROPRIETARY RAM CARD \$99.95
1/2MB USING 36/72 256KX1 DRAMS OR 4/8MB USING 36/72 1MBX1 DRAMS

33MHz CACHE 386 \$1495

• NORTON SI 45.9 • LANDMARK AT SPEED 50.8

- 33MHz 80386 CPU • 64K ZERO WAIT STATIC RAM CACHE
- 1/2/4/8MB ON-BOARD RAM USING 80NS SIMMS (OKB INSTALLED)
- 1/2MB USING 4/8 256K SIMMS OR 4/8MB USING 4/8 1MB SIMMS • SOCKETED FOR 80387-33 MATH CO-PROCESSOR
- 8 EXPANSION SLOTS (ONE 32-BIT, SIX 16-BIT, ONE 8-BIT)
- AMI BIOS ASSURES IBM COMPATIBILITY
- 8/33MHz KEYBOARD ADJUSTABLE SPEEDS

MCT-386MBC-33 \$1495.00

MCT-386MBC-25 25MHz VERSION \$999.00

MINI 25MHz CACHE 386 \$1299

WITH RAM CARD

• NORTON SI 30.5 • LANDMARK AT SPEED 40.7

- 25MHz 80386 • REQUIRES 1 OF THE RAM CARDS BELOW
- SHADOW RAM FOR ROM BIOS
- MEMORY CACHING FOR SUPERIOR PERFORMANCE
- MEMORY INTERLEAVING FOR NEAR 0 WAIT STATE OPERATION (8 BANKS OF MEMORY REQUIRED)
- SOCKETED FOR 80387 OR WEITEK 3167 COPROCESSORS

MCT-C386-25 \$1199.00

RAM CARD (REQUIRED FOR OPERATION):

1/2/4/8/16 MB USING 256K OR 1MB SIMMS (OK INSTALLED)

MCT-C386-M16 \$99.95

486 FROM A.I.R. \$2999

• LANDMARK AT SPEED 113.2

YOUR POWER SOLUTION FOR CAD/CAM/CAE WORKSTATIONS, AS WELL AS LAN SERVER APPLICATIONS!

- DESIGNED FOR MULTI-TASKING & MULTI-USER APPLICATIONS REQUIRING UNIX OR XENIX • INTEL 80486 CHIP HAS A BUILT-IN MATH CO-PROCESSOR & 8K OF RAM CACHE
- INTEL 80486-25 CPU • EXPANDABLE TO 16MB ON BOARD (OK INSTALLED) • SOCKETED FOR A WEITEK 4167 MATH CO-PROCESSOR • SUPPORTS SHADOW RAM WITH INTERNAL CACHE CONTROLLER • EIGHT 16-BIT BUS SLOTS, 6-LAYER BOARD DESIGN • COMPATIBLE WITH OS/2, NOVELL, DESQVIEW, UNIX, WINDOWS AND WINDOWS 3.0

AIR-486MB25 \$2,999.00

12.5MHz 286 \$199.95

• NORTON SI 14.3 • LANDMARK AT SPEED 16.5

- STANDARD 8088 LAYOUT
- 286 COMPATIBLE • 6/12.5MHz KEYBOARD SELECT SPEEDS
- EXPANDABLE TO 4MB ON BOARD; 512K/1MB USING 18/36 256KX1 DRAMS; 2/4MB USING 18/36 1MBX1 DRAMS (OKB INSTALLED)
- MEMORY SPEED: 120NS FOR 1 WAIT, 100NS FOR 0 WAIT

MCT-M286-12 \$199.95

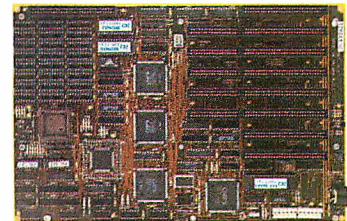

16MHz MINI 386-SX \$399.95

• NORTON SI 15.3 • LANDMARK AT SPEED 20.8

- USES 16MHz INTEL 80386SX CPU
- EXPANDABLE TO 8MB ON BOARD
- 512K/1MB USING 18/36 256KX1 DRAMS OR 2/4 256K SIPS OR 4/8 256KX4 AND 2/4 256KX1 DRAMS; 2/4MB USING 18/36 1MBX1 DRAMS OR 2/4 1MB SIPS; 6/8MB USING 36 1MBX1 DRAMS AND 2/4 1MB SIPS AMI BIOS

• CHOOSE FAST 0 WAIT STATE OR 1 WAIT STATE FOR ECONOMICAL USE OF SLOWER RAM

- FIVE 16-BIT & THREE 8-BIT EXPANSION SLOTS
- CHIPS & TECHNOLOGY NEW ENHANCED ADVANCED TECHNOLOGY (NEAT) CHIPSET
- SOCKET FOR 80387SX-16 COPROCESSOR
- 8.5" X 13" SIZE FITS IN MINI-286 AND FULL-SIZE 286 CASES

MCT-386SX \$399.95

20MHz 286 \$389.95

• NORTON SI 20.3 • LANDMARK AT SPEED 26.3

- NEAT CHIPSET HAS POWER TO COMPETE WITH 386 SYSTEMS
- EXPANDABLE FROM 512K TO 8MB; 512K/1MB USING 18/36 256KX1 DRAMS OR 2/4 256K SIPS; 2/4MB USING 18/36 1MBX1 DRAMS OR 2/4 1MB SIPS; 6/8MB USING 36 1MBX1 DRAMS AND 2/4 1MB SIPS

• 20/10MHz KEYBOARD SELECTABLE SPEEDS • AMI BIOS

- SHADOW RAM AND PAGE INTERLEAVED MEMORY
- FAST 0 WAIT STATE OR 1 WAIT STATE FOR SLOWER RAM
- 8.5" X 13" FITS MOST 8088, MINI-286 & FULL SIZE 286 CASES
- FIVE 16-BIT & THREE 8-BIT SLOTS
- SOCKET FOR 80287-12 MATH CO-PROCESSOR

MCT-M286-20N \$389.95

16MHz 286 W/NEAT CHIPSET \$289.95

MCT-M286-16N NORTON SI 16.2 / LANDMARK AT 21.1

12MHz 286 W/NEAT CHIPSET \$269.95

MCT-M286-12N NORTON SI 12.0 / LANDMARK AT 15.5

10MHz 8088 NORTON SI 2.1 \$99.95

- 8088 COMPATIBLE; OPERATES AT 4.77/10MHz
- KEYBOARD SELECTABLE CLOCK SPEEDS • SOCKET FOR 8087-7 COPROCESSOR • 8 SLOTS • MCT BIOS • 640K RAM CAPACITY (OKB INSTALLED)

MCT-TURBO-10 \$99.95



CUSTOMER SERVICE 800-538-5001



TECHNICAL SUPPORT 800-538-5002

MON-FRI. 7 A.M. TO 5 P.M., SATURDAY, 9 A.M. TO 3 P.M. (PST)

ORDER TOLL-FREE 800-538-5000

KEY CODE #1012

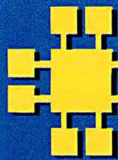

JDR Microdevices

ORDER TOLL-FREE 800-538-5000 KEY CODE 10

BUY WITH CONFIDENCE FROM JDR!

- 30-DAY MONEY BACK GUARANTEE
- 1 YEAR WARRANTY
- TOLL-FREE TECH SUPPORT

MONITORS

VGA PACKAGE \$499.95

VGA COLOR AND CLARITY AT AN EGA PRICE! • 8/16 BIT VGA CARD IS FULLY COMPATIBLE WITH IBM VGA • 640 X 480 RESOLUTION IN 16 COLORS • HIGH RESOLUTION ANALOG MONITOR • EGA/CGA/MONO AND HERCULES COMPATIBLE • DRIVERS FOR WINDOWS, GEM, LOTUS 1-2-3, SYMPHONY, AUTOCAD & VENTURA
VGA-PKG \$499.95



MULTISYNCH MONITOR \$429.95

• 14" NON-GLARE SCREEN • 800 X 560 MAX RESOLUTION • CGA/EGA/VGA COMPATIBLE • TTU/ANALOG MODE
JDR-MULTI

VGA MONITOR \$379.95

• 14" ANALOG VGA MONITOR • GLARE RESISTANT SCREEN • 720 X 480 MAXIMUM RESOLUTION • TILT/SWIVEL BASE
VGA-MONITOR

EGA MONITOR \$339.95

• 14" NON-GLARE SCREEN WITH 640 X 350 MAXIMUM RESOLUTION • DISPLAY 16 COLORS SIMULTANEOUSLY
EGA-MONITOR

14" SCREEN MONO \$139.95

• GLARE-RESISTANT 14" SCREEN WITH AMBER DISPLAY • 720 X 350 RESOLUTION • TILT/SWIVEL BASE
GM-1489

MONO-SAMSUNG SAMSUNG 12" FLAT SCREEN \$129.95

MONO-VGA PAPERWHITE VGA MONITOR \$139.95

NEC-MULTI-3D NEC MULTI-3D MULTISYNCH \$649.00

CM-1440 SEIKO DUAL FIXED FREQUENCY \$599.00

CM-1450 SEIKO 15" DUAL FIXED FREQ. \$749.00

Littlefoot™ CASE

\$249.95

- MOUNTS FOR STANDARD FULL SIZE AND MINI-MOTHERBOARDS
- INCLUDES 250WATT POWER SUPPLY
- MOUNTS FOR 3 FLOPPY AND 4 HARD DRIVES
- TURBO AND RESET SWITCHES
- SPEED DISPLAY, POWER, DISK LEDS
- MOUNTING HARDWARE, FACEPLATES AND SPEAKER INCL.

CASE-100 \$249.95

CASE-200 "SUPERFOOT"—HOLDS 11 DRIVES \$499.95

CASE-120 "MINIFOOT" W/200 WATT PS \$199.95

NOTE: CASES DO NOT INCLUDE DRIVES.

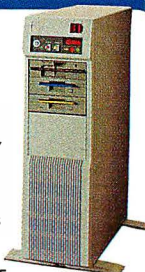

STANDARD CASES

FULL SIZE SLIDE CASE CASE-70 \$89.95

CASE-50 FOR 8088 OR MINI-86 MOTHERBOARDS \$59.95

CASE-FLIP FLIP-TOP XT-STYLE CASE \$39.95

CASE-SLIDE SLIDE TYPE XT-STYLE CASE \$39.95

CASE-JR \$149.95

WITH 150W POWER SUPPLY. FOR 8088 OR MINI-286 BOARDS.

CASE-JR-200 \$189.95

WITH 200W POWER SUPPLY. FOR 8088 OR MINI-286 BOARDS.

NOTE: CASES DO NOT INCLUDE DRIVES.



PC POWER SUPPLIES

PS-135 135 WATT FOR 8088 - U.L. APPROVED \$59.95

PS-150 150 WATT FOR 8088 - U.L. APPROVED \$69.95

PS-200X 200 WATT FOR 8088 - U.L. APPROVED \$89.95

PS-200 200 WATT FOR 286/386 - U.L. APPROVED \$89.95

PS-250 250 WATT FOR 286/386 \$129.95

UNINTERRUPTIBLE POWER SUPPLIES

CONDITIONED CRITICAL LOAD/BACK-UP DURING BLACKOUT.

PART NO. VA FREQ. CURRENT BATTERY PRICE

EMERSON-20 300 60hz 2.50A 10min. \$299.95

EMERSON-30 500 60hz 4.20A 10min. \$499.95

EMERSON-40 800 60hz 6.70A 10min. \$699.00

POST CODE DIAGNOSES SYSTEM PROBLEMS!



TO DIAGNOSE, PLUG IT INTO A CARD SLOT. READ THE INDICATOR DISPLAY & CHECK THE MANUAL FOR THE CORRESPONDING POWER-ON-SELF-TEST CODE. SWITCH-LESS AND JUMPERLESS DESIGN. COMPATIBLE W/80286 & 80386-BASED SYSTEMS.
PCODE \$49.95

CABLES AND GENDER CHANGERS

MOLDED; GOLD-PLATED CONTACTS; 100% SHIELDED

CBL-PRNTR-25	25 FT. PC PRINTER CABLE	15.95
CBL-PRNTR-RM	RIGHT ANGLE PRINTER CABLE	15.95
CBL-DB25-MA	DB25 MALE-DB25 MALE 6 FT.	9.95
CBL-DB25-MF	DB25 MALE-DB25 FEMALE 6 FT.	9.95
CBL-9-SERIAL	DB9 FEMALE-DB25 MALE 6 FT.	6.95
CBL-CNT-MM	36-PIN CENTRONICS -M/M	14.95
GENDER-VGA	DB9-DB15 ADAPTOR	4.95

HUNDREDS MORE AVAILABLE—CALL FOR MORE INFO

DISPLAY CARDS

16-BIT VGA \$169.95

• 640 X 480 IN 16 COLORS • 256K VIDEO RAM EXPANDABLE TO 512K • 64 LEVELS OF GRAY SCALE
MCT-VGA-16

MCT-VGA-8 8-BIT VERSION \$149.95

MCT-VGA-1024 1024 X 768 VGA \$189.95

MCT-VGA-1024+ 1024 X 768 IN 256 COLORS \$249.95

MCT-VGA VGA WITH TTL SUPPORT \$189.95

MONO GRAPHICS/PRINTER \$49.95

8088/286 COMPATIBLE • HERCULES COMPATIBLE MONOGRAPHICS • SUPPORTS LOTUS 1-2-3 • 720 X 348 DISPLAY • ADDRESS PARALLEL PRINTER PORT AS LP11 OR 2
MCT-MGP

MORE DISPLAY CARDS

MCT-CGP CGA GRAPHICS FOR RGB MONITOR \$49.95

MCT-EGA EGA CARD WITH 256K RAM \$149.95

DEVELOPERS' WORLD

JDR caters to the developer with a full line of prototyping and programming products. Here are just a few examples. Request our catalog for our complete line!

EPROMS

PART#	SIZE	SPEED	Vpp	PINS	PRICE
2716-1	2048x8	350ns	25V	24	4.95
2732A	4096x8	250ns	21V	24	3.95
2764	8192x8	450ns	12.5V	28	3.95
2764-250	8192x8	250ns	12.5V	28	3.95
2764-200	8192x8	200ns	12.5V	28	4.49
27128	16384x8	250ns	12.5V	28	3.95
27128A-200	16384x8	200ns	12.5V	28	4.95
27256	32768x8	250ns	12.5V	28	4.95
27C256	32768x8	250ns	12.5V	28	5.95
27512	65536x8	250ns	12.5V	28	5.95
27C101-20	131072x8	200ns	12.5V	32	17.95

EPROM PROGRAMMER \$129.95

• PROGRAMS 27XX AND 27XXX EPROMS UP TO 27512 • SPLIT OR COMBINE CONTENTS OF SEVERAL DIFFERENT SIZED EPROMS (VARIOUS FORMATS AND VOLTAGES) • READ, WRITE, COPY, BLANK CHECK AND VERIFY • HEX AND INTEL HEX FORMATS SOFTWARE
MOD-EPROM

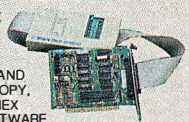

DATASE II EPROM ERASER \$39.95

• SMALL SIZE! • ERASES ALL SIZE EPROMS UP TO 4 AT A TIME—MOST IN 3 MINUTES • WALL PLUG POWER SUPPLY
DATASE II



JDR'S OWN MODULAR PROGRAMMING SYSTEM

EACH MODULE USES A COMMON HOST ADAPTOR CARD—USE JUST 1 SLOT TO PROGRAM EPROMS, PROMS, PALS & MORE!

COMMON HOST ADAPTOR CARD

• UNIVERSAL INTERFACE FOR THE PROGRAMMING MODULES! • SELECTABLE ADDRESSES PREVENTS CONFLICTS
MOD-MAC \$29.95

UNIVERSAL MODULE \$499.95

• PROGRAMS EPROMS, EEPROMS, PALS, BI-POLAR PROMS, 8748 & 8751 SERIES DEVICES; 16V8 AND 20V8 GALs (GENERIC ARRAY LOGIC) FROM LATTICE, NS, SGS • TESTS TTL, CMOS, DYNAMIC & STATIC RAMS • LOAD DISK, SAVE DISK, EDIT, BLANK CHECK, PROGRAM, AUTO, READ MASTER, VERIFY AND COMPARE • TEXT TOOL SOCKET FOR .3" TO 6" WIDE ICs (8-40 PINS)

MOD-MUP \$499.95

MOD-MUP-EA 4-UNIT ADAPTOR \$99.95

EPROM MODULE \$119.95

• PROGRAMS 24-32 PIN EPROMS, CMOS EPROMS & 16K TO 1024K EEPROMS • HEX TO OBJ CONVERTER • AUTO, BLANK CHECK/PROGRAM/VERIFY • VPP 5, 12.5, 12.75, 13, 21 & 25 VOLTS • NORMAL, INTELLIGENT, INTERACTIVE & QUICK PULSE PROGRAMMING ALGORITHMS
MOD-MEP \$119.95
MOD-MEP-4 4-EPROM PROGRAMMER \$169.95
MOD-MEP-8 8-EPROM PROGRAMMER \$259.95
MOD-MEP-16 16-EPROM PROGRAMMER \$499.95

PAL MODULE \$249.95

• PROGRAMS MM1, NS, TI20 & TI 24 PIN DEVICES • BLANK CHECK, PROGRAM, AUTO, READ MASTER, VERIFY & SECURITY FUSE BLOW
MOD-MPL



new! PDS-601

8-BIT SOLDERLESS 8088 BREADBOARD WITH DECODE \$79.95

• INCLUDES ADDRESS DECODING LOGIC, DATA BUFFERING, 2 LSI CIRCUITS FOR PROGRAMMABLE DIGITAL I/O AND COUNTER-TIMER FUNCTIONS • LOGICALLY GROUPED • ACCESSES ALL 62 I/O SIGNAL CONNECTIONS • CLEARLY LABELLED BUS LINES • ACCEPTS UP TO 24 FOURTEEN-PIN ICs • ACCEPTS 9, 15, 19, 25 OR 37-PIN D-SUBS
PDS-601 \$79.95
PDS-600 ABOVE CARD WITHOUT DECODE \$49.95

286 BUS BREADBOARD WITH DECODE \$89.95

• ADDRESS DECODING LOGIC, DATA BUFFERING, 2 LSI CIRCUITS FOR PROGRAMMABLE DIGITAL I/O AND COUNTER-TIMER FUNCTIONS • ACCESSES ALL 96 I/O SIGNAL CONNECTIONS • LOGICALLY GROUPED • OVER 2,000 PTS. • ACCEPTS 9, 15, 19, 25 OR 37-PIN D-SUB CONNECTORS
PDS-611 \$89.95
PDS-610 ABOVE CARD WITHOUT DECODE \$59.95

MORE PROTOTYPE CARDS...

JDR-PR1	8-BIT WITH +5V AND GROUND PLANE	27.95
JDR-PR2	ABOVE WITH I/O DECODING LAYOUT	29.95
JDR-PR2-PK	PARTS KIT FOR JDR-PR2 ABOVE	8.95
JDR-PR10	16-BIT WITH I/O DECODING LAYOUT	34.95
JDR-PR10-PK	PARTS KIT FOR JDR-PR10 ABOVE	12.95

MORE PROGRAMMING MODULES...

MOD-MMP	MICROPROCESSOR PROGRAMMER	\$179.95
MOD-MIC	DIGITAL IC & MEMORY TESTER	\$129.95
MOD-MBP	BI-POLAR PROM PROGRAMMER	\$259.95

PAL DEVELOPMENT SOFTWARE

ENTRY-LEVEL PAL DEVELOPMENT FROM CUPL. FULL SUPPORT FOR 16L8, 16R4, 16R6, 16R8, 20L8, 20R4, 20R8 & 20X8.
MOD-MPL-SOFT \$99.95



TERMS: Minimum order \$10.00. For shipping & handling include \$4.00 for ground and \$5.50 for air. Orders over 1 lb. and foreign orders may require additional shipping charges—contact our Sales Dept. for the amount. CA residents must include applicable sales tax. Prices subject to change without notice. We are not responsible for typographical errors. We reserve the right to limit quantities and to substitute manufacturer. All merchandise subject to prior sales. A full copy of our terms is available upon request. Items pictured may only be representative. JDR, the JDR logo, JDR Microdevices, and the MCT logo are registered trademarks of JDR MICRODEVICES, INC. Modular Circuit Technology, Littlefoot, Minifoot and Superfoot are trademarks of JDR MICRODEVICES, INC. Copyright 1990 JDR MICRODEVICES.

KEY CODE #1012

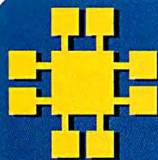

JDR Microdevices®

2233 BRANHAM LANE, SAN JOSE CA 95124

BUY WITH CONFIDENCE FROM JDR!

- 30-DAY MONEY BACK GUARANTEE
- 1 YEAR WARRANTY
- TOLL-FREE TECH SUPPORT



TI MICROLASER™ —FAST, AFFORDABLE AND EXPANDABLE!

EXPANDABLE PRINTER HAS TEXAS INSTRUMENTS QUALITY AND RELIABILITY IN A COMPACT SIZE! UPGRADEABLE TO 4.5MB AND POSTSCRIPT® • 300 DPI • 6 PPM OUTPUT • 250 SHEET DRAWER

- MANUAL FEED • 40 ENVELOPE AUTO FEED • .5MB RAM
- BASE UNIT • EMULATES HP LASERJET II

MICROLASER \$1495.00

MICROLASER-PS \$2495.00

WITH 35-FONT POSTSCRIPT® AND 1.5MB RAM

TEFAX—FAX, COPIER, SCANNER, PHONE & PRINTER

- G3/G2 FAX MACHINE • 8.5" SCAN WIDTH • 200 DPI SCANNER • SAME SIZE COPIER

• FAX SOFTWARE FOR IBM & MAC • AUTO FAX SEND
TEFAX \$995.00



JDR'S AN AUTHORIZED EPSON
DEALER—CALL US FOR QUOTES



CITIZEN 200GX COLOR PRINTER

CITIZEN EXPANDS 9-WIRE TECHNOLOGY TO THE CUTTING EDGE! OPTIONAL COLOR KIT PROVIDES VIVID COLOR OUTPUT UNRIVALLED IN ITS PRICE RANGE!

- 5 RESIDENT FONTS • 240 X 216 DPI • 213 CPS DRAFT MODE • 40 CPS LETTER QUALITY • PARALLEL INTERFACE • 8K PRINT BUFFER

CTZ-200GX-C \$199.95

200GX-COLOR COLOR ON COMMAND KIT \$59.95

KODAK DICONIX 150+ PORTABLE PRINTER

THE PERFECT COMPANION FOR YOUR LAPTOP OR OUR CARRY-1 PCI WEIGHS 5LBS AND MEASURES JUST 6.5" X 11" X 2"

- QUIET NON-IMPACT INK-JET TECHNOLOGY
- UP TO 180 CPS • DRAFT, N.L.Q. QUALITY AND CONDENSED MODES • USES CUT-SHEET OR CONTINUOUS FORM PAPER
- SUPPORTS EPSON FX-80 & IBM PROPRINTER COMMANDS

DICONIX-150 \$399.95

FUJITSU COLOR PLOTTER

COMPACT PLOTTER • HP7475A COMPATIBLE • .025MM RES.
FPG-315 \$799.00



INTRODUCING THE MINI-SIZE 286 COMPUTER

\$599

HIGH PERFORMANCE IBM-PC COMPATIBLE COMPUTER CAN COMPETE WITH A FULL SIZE PCI STAND IT UP-RIGID, SET IT UNDER A MONITOR—ITS COMPACT SIZE IS THE PERFECT SOLUTION FOR A CROWDED DESK, A COST-CONSCIOUS SCHOOL OR AN EASILY TRANSPORTABLE HOME COMPUTER.

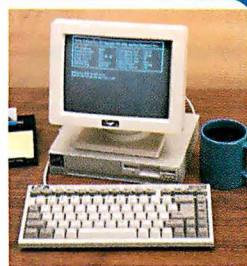

JUST 7 1/2" X 9 1/2" X 1 1/2"

- 12MHZ 80286 CPU WITH 0 WAIT STATE
- AMI BIOS WITH DIAGNOSTICS • 1MB MEMORY
- TWO SERIAL, ONE PARALLEL PORT
- BUILT-IN CGA/MGA DISPLAY ADAPTOR
- BUILT-IN 3.5" 1.44MB FLOPPY
- 7-1/2" W X 9-1/2" L X 1-3/4" H • WEIGHS JUST OVER 6 LBS.
- WORKS WITH ANY STANDARD KEYBOARD
- INCLUDES CARRY BAG, 30W POWER ADAPTOR, MINI-UPRIGHT STANDS AND MANUAL
- FCC CLASS B APPROVED

CARRY-1C WITH 1.44MB FLOPPY DRIVE \$599.00

CARRY-1D WITH 1.44MB FLOPPY & 40MB HD \$899.00

CARRY-1 8088-BASED VERSION \$299.95

CARRY-1B ENHANCED 8088 VERSION \$399.95

INCLUDES 2 FLOPPY DRIVES (720K) AND 640K RAM.

CARRY-1K 82-KEY CARRY-1 KEYBOARD \$49.95

ADD 425 FONTS WITH 1 CARTRIDGE!

\$349.95

NEW SUPERSET™ HAS THE CAPABILITIES OF THESE CARTRIDGES: PDP'S™ 25 IN ONE, HP'S MASTERTYPE™ PROCOLLECTION™, HP'S MICROSOFT™ CARTRIDGE, HEADLINE FONTS & 18 PTS AND JET-WARE'S 12/30 • FOR HP LASERJET SERIES II, IID, IIP, III AND PCL COMPATIBLE • PRINTER DRIVERS FOR WORDPERFECT, MS WORD, MS WINDOWS, EXCEL, PAGEMAKER, WORD, AMI PROFESSIONAL, VENTURA PUBLISHERS, WORDSTAR AND LOTUS 1-2-3.



SUPERSET+ \$89.95

RAM CARD FOR HP LASERJET

• FOR HP LASERJET II PRINTERS • USER EXTENDABLE TO 1/2/4MB (OK INSTALLED) • USES 1MB 120 NS DRAMS

MCT-RAMJET \$89.95

MCT-RAMJET-P \$99.95

1/2/3/4MB FOR IIP, USES 256K X 4 DRAMS

COLOR HAND SCANNER!

\$599

- 400 DPI 16-COLOR DITHER MODE
- 200 DPI 16-SHADE GRAYSCALE
- TRUE 400 DPI MONO MODE
- 3 SWITCH-SELECTABLE 64-SHADE DITHER PATTERNS
- 3.5MS/LINE SCAN SPEED
- 7-SEGMENT LED STATUS READOUT
- BRIGHTNESS CONTROL
- HALF-LENGTH 16-BIT INTERFACE CARD
- SCAN EXERCISER SOFTWARE CONFIGURES THE SCANNER, SCANS IMAGES IN ANY MODE, LETS YOU VIEW REAL TIME IMAGE, THEN SAVES IN PCX FILE FORMAT
- INCLUDES ZSOFT PAINTBRUSH V PLUS FOR EDITING AND ENHANCING YOUR IMAGE



CHS-4000 \$599.00

DFI LOW COST ETHERNET CARD

- 100% HARDWARE COMPATIBLE WITH NOVELL NE-1000 ETHERNET CARD
- FOR THICK OR THIN ETHERNET
- 15-PIN ETHERNET CONNECTOR
- BNC CONNECTOR FOR THIN ETHERNET
- DFINET-300 8-BIT VERSION ... \$159.95
- DFINET-400 16-BIT VERSION . \$189.95



NEW PRODUCTS FROM



PROMETHEUS



9600 BAUD V.32 MODEM WITH SEND/RECEIVE FAX \$629

THIS NEW EXTERNAL MODEM IS V.32 AND V.42 COMPATIBLE, THE EMERGING 9600 BPS STANDARDS. PLUS IT NOW HAS FULL GROUP 3 FAX SEND AND RECEIVE CAPABILITY. THIS MACHINE TRANSFORMS YOUR PC INTO A COMPLETE PERSONAL INFORMATION CENTER

- 9600/4800/2400/1200 BPS DATA MODEM
- CCITT V.32, V.42 ERROR CORRECTION COMPATIBLE
- MNP-5 ERROR CORRECTION AND DATA COMPRESSION FOR THROUGHPUTS UP TO 19200 BPS
- 9600 BPS GROUP III SEND AND RECEIVE FAX
- INCLUDES PRO-COMM COMMUNICATIONS SOFTWARE
- INCLUDES FAX-IT FAX SOFTWARE
- 2 YEAR WARRANTY

PRO-96EF \$229.95

INTERNAL FAX MODEM

- 2400/1200/300 BPS DATA MODEM
- 9600 BAUD SEND/RECEIVE FAX CAPABILITY
- 8088,286, 386 COMPATIBLE CARD

PRO-MAXI



MINI 2400 BPS MODEM WITH SEND ONLY FAX \$139.95

THIS TINY EXTERNAL MODEM PACKS A BIGGER PUNCH THAN YOU'D EXPECT! NOT ONLY IS IT A FULL FUNCTION 2400 BPS DATA MODEM BUT IT ALSO OPERATES AS A SEND-ONLY FAX AT A REMARKABLY LOW PRICE!

- 2400/1200/300 BPS DATA MODEM
- CCITT V.22/V.22BIS, BELL 103/212A COMPATIBLE
- 4800 BPS GROUP III SEND ONLY FAX
- MEASURES JUST 6.25 X 3.8 X 2 INCHES
- 8 STATUS LEDS
- INCLUDES PRO-COMM COMMUNICATIONS SOFTWARE
- INCLUDES FAX-IT FAX SOFTWARE
- 2 YEAR WARRANTY

PRO-EFXM

MINI-MODEM WITH 9600 BPS FAX-SEND SPEED

PRO-EFXM-96 \$169.95

2400BPS MINI MODEM \$119.95

AS ABOVE BUT WITHOUT FAX CAPABILITY

PRO-24ME



2400 BPS MNP ERROR CORRECTING MODEM \$189.95

AN ECONOMICALLY PRICED EXTERNAL MODEM THAT NOW INCLUDES MNP-5 ERROR CORRECTION AND DATA COMPRESSION CAPABILITY

- 2400/1200/300 BPS DATA MODEM
- CCITT V.22/V.22BIS, BELL 103/212A COMPATIBLE
- DATA COMPRESSION BOOSTS THROUGHPUT UP TO 4800 BPS
- 8 STATUS LEDS
- AT COMMAND SET COMPATIBLE
- AUTO DIAL AND AUTO ANSWER
- 2 YEAR WARRANTY

PRO-24EMNP

PRO-24E EXTERNAL 2400 BAUD MODEM-NO MNP . \$149.95

INTERNAL MNP MODEM \$169.95

IPUG-IN CARD MODEM HAS SAME FEATURES AS ABOVE MODEL. FOR 8088, 286/386 COMPUTERS

PRO-24MNP

PRO-24I INTERNAL 2400 BAUD MODEM-NO MNP \$99.95

VISA CUSTOMER SERVICE 800-538-5001
MasterCard TECHNICAL SUPPORT 800-538-5002
Copyright 1990 JDR MICRODEVICES.

MON-FRI. 7 A.M. TO 5 P.M., SATURDAY, 9 A.M. TO 3 P.M. (PST)
ORDER TOLL-FREE 800-538-5000

KEY
CODE
#1012

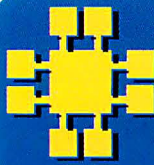

JDR Microdevices

2233 BRANHAM LANE, SAN JOSE CA 95124

- BUY WITH CONFIDENCE FROM JDR!**
- 30-DAY MONEY BACK GUARANTEE
 - 1 YEAR WARRANTY
 - TOLL-FREE TECH SUPPORT

HIGH DENSITY HARD DRIVES

NEW! NEC 153.5MB!

- 153.5MB CAPACITY
- ESDI INTERFACE
- AVG ACCESS TIME : 18MS.
- RECORDING: 19,612 BPI BIT, 1,240 TRACK DENSITIES
- 20 SEC. START/STOP TIME
- REQ. DC+5V, +12V POWER
- USES 2-7 RLL METHOD AND NRZ TRANSFER MODE



5655 \$849.00

MICROPOLIS DRIVES

KITS INCLUDE FLOPPY/HARD CONTROLLER AND CABLE.

- 1654 161 MB ESDI, 16MS KIT: \$1099 ... DRIVE: \$ 899
- 1674 158 MB SCSI, 16MS KIT: \$1199 ... DRIVE: \$949
- 1664 345 MB ESDI, 14MS KIT: \$1699 ... DRIVE: \$1449
- 1694 338.1MB SCSI, 14MS KIT: \$1749 ... DRIVE: \$1449
- 1568 676 MB ESDI, 16MS DRIVE: \$2195
- 1588 676 MB SCSI, 16MS DRIVE: \$2195
- 1598 1034 MB SCSI, 14MS DRIVE: \$3995

Seagate HARD DISKS

- 21.4MB \$199 65.5MB \$349
- 32.7MB \$219 80.2MB \$569
- 42.8MB \$299 84.9MB \$449

DRIVE KITS

- 21.4MB \$249
- 32.7MB \$279

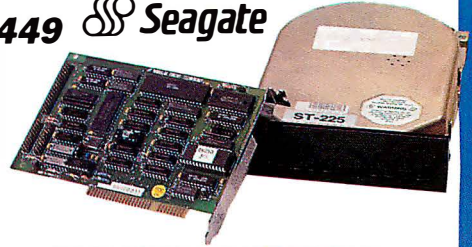

KITS INCLUDE HARD DRIVE, DRIVE CONTROLLER, CABLES AND JDR'S DETAILED INSTRUCTION MANUAL

SIZE	MODEL	AVG. SPEED	FORM FACTOR	DRIVE ONLY
21.4MB	ST-225	65MS	5-1/4"	\$199
32.7MB RLL	ST-238	65MS	5-1/4"	\$219
42.8MB	ST-251-1	28MS	5-1/4"	\$299
43.1MB SCSI	ST-251N	40MS	5-1/4"	\$419
65.5MB RLL	ST-277-1	28MS	5-1/4"	\$349
80.2MB	ST-4096	28MS	5-1/4"	\$569
84.9MB SCSI	ST-296N	28MS	5-1/4"	\$449
122.7MB RLL	ST-4144R	28MS	5-1/4"	\$699
21.4MB	ST-125	40MS	3-1/2"	\$259
32.1MB RLL	ST-138R	40MS	3-1/2"	\$289

\$99⁹⁵

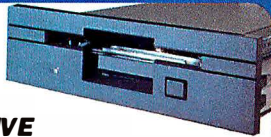

1.44MB 3-1/2" DRIVE

- 80 TRACKS • 135 TPI • HIGH DENSITY
- READY/WRITE 720K DISKS, TOO
- INCLUDES ALL NECESSARY MOUNTING HARDWARE

- FDD-1.44X BLACK FACEPLATE \$99.95
- FDD-1.44A BEIGE FACEPLATE \$99.95
- FDD-1.44SOFT SOFTWARE DRIVER \$19.95
- MF355A 3-1/2" MITSUBISHI 1.44MB, BEIGE \$129.95
- MF355X 3-1/2" MITSUBISHI 1.44MB, BLACK \$129.95
- FDD-360 5-1/4" DOUBLE-SIDED DD 360K \$69.95
- FD-55B 5-1/4" TEAC DOUBLE-SIDED DD 360K \$89.95
- FDD-1.2 5-1/4" DOUBLE-SIDED HD 1.2M \$89.95
- FD-55GVF 5-1/4" TEAC DOUBLE-SIDED HD 1.2M \$99.95

ENHANCED KEYBOARDS

- FC-3001 101-KEY, 12 F-KEYS & CALCULATOR \$74.95
- BTC-5339 101-KEY WITH 12 FUNCTION KEYS \$69.95
- BTC-5339R COMPACT 101-KEY, 30% SMALLER \$79.95
- MAX-5339 101-KEY MAXI-SWITCH (286 ONLY) \$84.95
- K103-A AUDIBLE "CLICK" 101-KEY KEYBOARD \$84.95

STANDARD KEYBOARDS

- BTC-5060 84-KEY WITH 10 FUNCTION KEYS \$59.95
- MAX-5060 MAXI-SWITCH 84-KEY(286 ONLY) \$64.95

PC-TRAC \$89⁹⁵

- HIGH RES. (200 PULSE/INCH)
- 2-AXIS POINTING DEVICE (X & Y)
- INCLUDES MAP DEVICE DRIVE WITH BALLISTIC GAIN



PC-TRAC W/RS-232C SERIAL INTERFACE FAST-TRAP THE 3-AXIS MOUSE ALTERNATIVE! \$109.95

LOGITECH TRACKMAN

- TO 300 DPI RES. • MOUSEWARE UTILITIES, MENUS, MOUSE -2.3 • REQ. 256K MIN. MEMORY
- TRACKMAN SERIAL VERSION—NO CARD REQ. \$94.95
- TRACKMAN-B BUS VERSION \$99.95
- W/SHORT CARD FOR 8088, 286, 386 OR PS/2 MODELS 25 & 30

new!

LOGITECH MICE

- 3-BUTTON SERIES 9 • 320 DPI RES. • SERIAL PS/2 COMPAT.
- LOGC9 SERIAL MOUSE \$98.95
- LOGC9-C SERIAL MOUSE (NOT PS/2 COMPATIBLE) \$79.95
- LOGC9-P SERIAL MOUSE WITH PAINTSHOW \$109.95
- LOGB9 BUS MOUSE \$89.95
- LOGB9-P BUS MOUSE WITH PAINTSHOW \$104.95

GENISCAN SCANNER \$199⁹⁵

- UP TO 400 DPI • 32 LEVELS OF GRAY SCALE
 - W/INTERFACE CARD, SCAN-EDIT II AND DR.GENIUS
- GS-4500 \$199.95



MODULAR CIRCUIT TECHNOLOGY

DRIVE CONTROLLERS

1.44MB FLOPPY \$49⁹⁵



- 8088 OR 286 COMPATIBLE • SUPPORTS 2 FLOPPY DRIVES (360K, 720K, 1.2MB & 1.44MB) • USER SELECTABLE AS A PRIMARY OR SECONDARY (3RD OR 4TH) FLOPPY DRIVE
- MCT-FDC-HD \$49.95

HIGH DENSITY 4-FLOPPY CARD \$59.95

- INTERFACES UP TO 4 FLOPPY DRIVES • CABLES FOR 4 INTERNAL DRIVES • BIOS FOR ANY COMBO OF DRIVES
- MCT-FDC-HD4

FLOPPY DISK CONTROLLER \$29.95

- INTERFACES UP TO 4 360K/720K FLOPPY DRIVES
 - DB37 CONNECTOR FOR EXTERNAL DRIVES
- MCT-FDC

HARD DISK CONTROLLER \$79.95

- SUPPORTS 16 DRIVE SIZES INCLUDING 10, 20, 30 AND 40MB • CAN DIVIDE 1 LARGE DRIVE INTO 2 LOGICAL DRIVES
- MCT-HDC

MCT-RLL RLL CARD SUPPORTS 2 RLL DRIVES \$89.95

- 1-1 INTERLEAVE FOR IMPROVED PERFORMANCE
 - CONTROLS 2 HARD & 2 FLOPPY DRIVES (360K/720K/1.2MB/1.44MB) • CONCURRENTLY USE HARD & FLOPPY DRIVES
- MCT-FAFH

IDE MULTI-IO FLOPPY/HARD \$89.95

- SUPPORTS 2 IDE HARD DRIVES & 2 FLOPPIES • 2 SERIAL & 1 PARALLEL PORT • SUPPORTS COM 1 & 2, LPT 1, 2 OR 3
- MCT-IDEIO

4800/2400 BPS FAX MODEM \$119⁹⁵

- 4800 BAUD GROUP III FAX TRANSMISSION ONLY • 2400 BPS DATA MODEM • W/MENU DRIVEN PROFAX SOFTWARE
- SENDS DOS TEXT, PCX & TIFF FILES TO FAX TRANS.

- MCT-FAXM \$119.95
- MCT-24I INTERNAL 2400 BAUD DATA MODEM \$89.95
- MCT-12I INTERNAL 1200 BAUD DATA MODEM \$59.95

VIVA 2400 BAUD MODEM \$119⁹⁵

- 2400/1200/300 BAUD OPERATION • HAYES AT COMMAND SET COMPAT. • EXTENDED S-REGISTER PROGRAMMING • SPEAKER
- 2ND PHONE JACK • AUTO DIAL TONE/REDIAL • STD. RS-232C INTERFACE

- VIVA-24E \$119.95
- VIVA-24MNP \$149.95
- ERROR CORRECTING VERSION

FAX/PHONE SWITCHER

- ROUTES CALLS FROM 1 PHONE LINE TO YOUR FAX, MODEM AND ANSWERING MACHINE! • OPERATES ON SINGLE OR MULTI-LINE SYSTEMS • AUXILIARY PORT
- FAXM-SWITCH \$109.95



CALL FOR OUR FREE CATALOG!

BARGAIN HUNTER'S CORNER

LOGITECH SERIAL MOUSE AND WINDOWS 3.0



- LOGITECH'S SERIAL MOUSE REQUIRES NO CARD—JUST A SERIAL PORT. INCL. 9-TO 25-PIN CABLE.
 - WINDOWS 3.0 IS THE 1ST TRUE INTUITIVE G.U.I. (GRAPHICAL USER INTERFACE) FOR YOUR MS-DOS COMPATIBLE PC! ADDRESS UP TO 16MB DIRECTLY!
 - NOW GET BOTH ITEMS AT ONE BARGAIN PRICE!
- LOGC9-WIN EXPIRES 11/31/90



CUSTOMER SERVICE 800-538-5001
TECHNICAL SUPPORT 800-538-5002

MON.-FRI. 7 A.M. TO 5 P.M., SATURDAY, 9 A.M. TO 3 P.M. (PST)

ORDER TOLL-FREE 800-538-5000

KEY CODE #1012

CHAOS MANOR MAIL

*Jerry Pournelle answers questions about his column
and related computer topics*

Leading Edge Format

Dear Jerry,

While reading your description of Symantec's Q&A Write, I was struck by the similarities to my experiences with the Leading Edge word processor that I use. It is very easy to learn, is fast (at least by my standards), and has more bells and whistles than I ever need. It doesn't have the old WordStar commands built in, but I don't miss them, because I never learned WordStar. It does have one feature that Q&A Write doesn't—automatic save, which can be either a blessing or a curse, depending on your temperament. And, like Q&A Write, the Leading Edge word processor stores its files in its own strange format, which wastes disk space, is difficult to exchange with anyone else, and can't be accessed by third-party programs.

When I mentioned the strange format of Leading Edge word processing files to a friend, his curiosity impelled him to look at one of them with a HEXDUMP program. Serendipitously, his HEXDUMP blocked the output in the same 512-character sectors that the Leading Edge word processor uses in manipulating its files. The first 10 sectors contain header information, and the actual text begins with the eleventh sector. If entered without any heading or modification, the text runs continuously from sector to sector, filling all but the last byte of each sector.

The text is straight ASCII with embedded control sequences in a single-line format. However, when the text is edited, the corrections are entered into the text stream in their normal location, and something has to give.

At each automatic save, the program looks to see if the text has been shortened or lengthened enough so that the sector is overfilled. If the text will not overfill the sector, the new and old material in that sector is written seamlessly at the beginning of the sector. If the old and new material will overfill the sector, the text is broken at the end of the new material, and the remainder of the material in that sector is put in a new sector at the end of

the file. Unused space at the end of any sector is stuffed with nulls (00 hexadecimal). Even though there are also some conditions that recombine under filled sectors, an edited document frequently gets to be highly fragmented and contains huge blocks of nulls. I've seen Leading Edge word processing files that are two to three times as big as the ASCII file would be.

John Laidig
Holmdel, NJ

Symantec has published the file format of Q&A Write; the important parameters are that in the decimal twenty-seventh byte of the file is a long integer that says where the text starts (in hexadecimal, of course), and the thirty-first byte gives the text size in bytes.

I don't like automatic save, since I experiment with text a lot and don't necessarily want to save what I'm doing over what I have.—Jerry

A Writer's Secret

Dear Jerry,

I appreciate Computing at Chaos Manor. The direct comparisons between products and the best product awards are valuable information that I can't get from German magazines. I am fascinated by the style of your articles—how you get data and technical information into a form that is enjoyable to read.

I am a senior engineer in a system house, and I do a lot of writing. There are technical articles for technical newspapers, training courses for our customers, product information for our marketing, internal specifications for our engineers, and requirement and functional specifications for our customers. At a given time, I have five to eight papers in different stages of completion. It normally takes several weeks to collect and sort out all the information for an article.

I have a problem that you must have solved: I am looking for a system to organize this kind of work according to personal performance. On some days, as you know, writing does not run smoothly, but on those days I collect informa-

tion that is valuable for the articles, or I have a good idea for improving the structure of an article. Do you know of a system for organizing all this information? Do you write all your information into a database or word processor, or on paper? When you start writing an article, do you mix properly formulated texts with short notes and sketches of ideas and do the complete formulation iteratively?

Can you tell me, or are these the secrets of a successful writer?

Dr. Rainer Winz
Idstein, Germany

Well, let's see: usually I keep a bunch of subdirectories under the "QW" directory, where Q&A Write resides. There's a BYTE subdirectory, one for each novel, and one for articles, under which I have different projects.

I also keep a GrandView outline called Projects, which has each major job, along with deadlines and suchlike; I collect random notes in there. Some projects will have their own GrandView file; others don't.

The secret of all this is Desqview and the Big Cheetah 386, which let me jump back and forth among all these and even have multiple Q&A Write windows.

I keep swearing I'm going to go to a different word processor, but I always end up back with Q&A Write, which is the easiest of the lot to use, at least for me, and the new GrandView imports and exports Q&A Write files, making it all even easier.

Finally, I do keep a hardbound log book in which I collect all those notes that one is forever making; I tape business cards, scraps of paper, and everything else in there, in chronological order.

I doubt my system would make sense to anyone else, though.—Jerry ■

Jerry Pournelle holds a doctorate in psychology and is a science fiction writer who also earns a comfortable living writing about computers present and future. He can be reached c/o BYTE, One Phoenix Mill Lane, Peterborough, NH 03458, or on BIX as "jerry."

PRINT QUEUE

Hugh Kenner

A Fairy-Tale Future

*Machines that can read, write, make music, and draw.
What hath man wrought?*

Although Raymond Kurzweil is a scant 43, his name, like "Xerox," seems in danger of becoming generic. A "Kurzweil," that would be a pattern recognizer. Examples: a machine that can read books aloud to the blind; another machine that can type to human dictation; yet another that combines acoustic patterns so accurately that professional musicians have thought they were hearing a \$40,000 concert grand. These are none of them dreams; they're real products. So who is better qualified to offer us a big book called *The Age of Intelligent Machines*?

Kurzweil has; and, faithful to his track record, the book (MIT Press, 1990, \$39.95) is, yes, superb. Not surprisingly, its hinge chapter is the long one on pattern recognition, something to be distinguished from the kind of sequential thought most computer programs mimic. "The trillions of computations required for the human visual system to view and recognize a scene can take place in a split second." It's all massively parallel: simultaneous processes, not sequential.

But chess is something you can analyze sequentially; that's why pretty good chess programs could be developed fairly early. The rules being unambiguous, an intensive search of position after position can be counted on to isolate "strong" moves. In about the same time as a grand master takes to decide, the machine has checked out many thousands of options. The human mind being slow at IF... THEN... ELSE, the grand master will have examined only a few. Yet (as of 1990) the grand master tends to play rather better than the machine. Somehow, pattern recognition seems to be focusing analytic energies.

If chess can fall back on brute-force programming, reading text cannot; it's too slow. Text-scanning hardware geared to a specific font can run fast because it's simply matching templates. Font-independence, as in the Kurz-

weil Reading Machine, relies on "multiple experts," watching for patterns. One expert concentrates on closed loops: *A* has one loop, *B* has two, *C* has none, and neither has *I*. A concavity expert, though, can distinguish those last two because *C* has an "east concavity" but *I* hasn't. Conversely, when east concavities are spotted in both *C* and *6*, it's up to the loop expert to make a choice. And what about *N* and *H* (each with north and south concavities, but no loops)? Well, we can keep a line segment expert on call, to distinguish "northwest to southeast" from "midwest to mideast." You see the principle.

Which is all very well, but "even a well-printed document contains a surprisingly large number of defects"; thus, a broken crossbar could deprive *A* of its loop. The solution? "Redundant experts, and multiple ways of describing the same pattern." All those experts make simple choices very fast, while an expert manager busily weighs their findings. The present

version of the Reading Machine can handle 30 to 75 characters per second, with remarkable tolerance for degraded input.

Kurzweil's running exposition is punctuated by 23 guest contributions, one of which, by Harold Cohen of San Diego, describes what I'd have sworn was impossible, a program (Aaron) that draws elaborate pictures with intricate vegetation plus numerous human figures, variously posed. After coloring by Cohen, they've been shown worldwide, from Boston's Museum of Science to London's Tate Gallery. By Cohen's account, just making a drawing is no miracle at all; like a human artist, Aaron simply "knows how to draw." And "if one can draw, then anything that can be described in structural terms can be represented in visual terms." (As the great animator Chuck Jones likes to say: If you can draw a human figure, skeletal similarities can free you to draw a rabbit, a coyote.)



Analogy from Cohen: We can get a picture of a kangaroo from an artist who's never seen one. We say that it's ratlike but much bigger; has a long, thick tail and a pouch. Corrections to the first attempt: No, it doesn't carry the pouch; the pouch is part of its belly. And it doesn't walk on all fours like a rat, but on hind legs much bigger than front legs. Further correction: The tail rests on the ground. End result? Not quite right, but close enough. Aaron works something like that, from a repertoire of structural descriptions.

Human figures? Aaron knows (1) what the body parts are, and how big in relation to each other; (2) what the type and range of movement is at each joint; (3) how movements are coordinated—for instance, what the body must do to keep its balance. Aaron elaborates a stick figure with something resembling musculature and generates the visible result, bestowing greater concentration on hands, say, than on thighs. So, "Remarkably little of the program has anything to do with art; it constitutes a cognitive model of a reasonably general kind."

A cognitive model for literary art? That's been more elusive. Racter, which I reviewed in the May 1986 BYTE, uses a store of words, random selection, and some "syntax directives" to generate stuff like this:

"Bill sings to Sarah. Sarah sings to Bill. Perhaps they will do other dangerous things together. They may eat lamb or stroke each other. They may chant of their difficulties and their happiness. They have love but they also have typewriters. That is interesting."

"Crazy thinking," Racter's creator concedes, albeit expressed in "perfect English." (Not artificially intelligent, adds A. K. Dewdney; no, "artificially insane.") It works something like this. Starting, like a chess program, from a present position ("They may eat"), Racter searches its word list for something edible, plugs in *lamb*, on a second search opts for an *or* construction, needs a further verb, searches, comes up with *stroke*, and then gladdens the programmer's heart by chancing, during yet a fourth search, on *each other* when it might have chanced on *drizzle*. Hence, "They may eat lamb or stroke each other." Artificial insanity, yes, and perfect English, the way chess programs, however dubious their moves, never violate the rules of chess. The most important contributor to a Racter session is the human who cuts it off when it's commencing to rave.

No, the root problem isn't lack of real-world knowledge. If Racter's *The Policeman's Beard Is Half-Constructed* (Warner Books, 1984) is "the first book ever written entirely by a computer," I'll add the claim that *Sentences* (Half Moon Press, sometime in 1991) will be the first book of computer-generated poems to be at all interesting as poetry. Its title page will list me as coauthor, along with Charles O. Hartman, an accredited poet. He wrote one of the programs the book derives from; I cowrote the other.

And the only real-world knowledge the programs had was embodied in 487 "sentences for analysis and parsing," prepared circa 1870 for the use of Rhode Island schoolchildren. They range from "School begins. Dogs barked." all the way to "He spoke in as noble strains as ever fell from human lips." From them, two sequenced programs quickly derived 15 works fit for performance by a cantor and massed choirs. Excerpt:

... What could ye desire not for not for
John
for glory

glory

providence learn glory . . .

There imagine a diapason . . . And it does make quite as much sense as most librettos.

Kurzweil entitles his tenth chapter "Visions." Computer

Computer

*performance per unit cost has
doubled every 22 months, an
improvement factor of 2000 in 20
years; if Detroit had done as well, the
typical auto would cost two dollars.*

performance per unit cost has been doubling every 22 months, an improvement factor of 2000 in 20 years; if Detroit had done as well in the past two decades, the typical auto would now cost about two dollars. There's no reason for such improvement to abate. So, down the road, the affordable translating telephone, moving words from language to language in real time as we speak, possibly "in the first decade of the next century." An intelligent answering machine that converses with the caller and seeks you on identifying an emergency. Invisible credit cards and keys (scanning fingerprints and voice patterns) . . . On and on. But what about the Sorcerer's Apprentice, who didn't know when to stop? Are we being seduced into a frustrating future where djinns beyond our control run blithely amok?

Well, Allen Newell has a happy answer to that. First, the djinn that kept fetching water regardless of flooding was just "a program with a bug in it." The bug was an infinite loop, and detecting those is standard practice now. Second, the better computer technology gets, "the less of our environment it consumes." Clean, unobtrusive, it uses up "little energy and little material." And it can be "saturated with intelligence, to keep accounts, to prevent errors, to provide wisdom for each decision." Newell calls that a fairy tale: a dream with a happy ending. Happy endings, he reminds us, are not forbidden.

So runs the dream. And, lo, George Gilder, whose optimism I discussed here last February, reliably chimes in: "Israel, a desert-bound society, uses microelectronic agricultural systems to supply eighty percent of the cut flowers in Europe and compete in avocado markets in New York. Japan, a set of barren islands, has used microelectronic devices to become one of the world's two most important nations. . . ."

Newell's delighting "fairy tale," he warns, will not come true of itself; it's barely past its "Once upon a time." We'll have to learn to learn, and grow into growth. But in fairy tales, "magic friends sustain our hero." Here, we're still in early stages of discerning the magic.

Meanwhile, magic has been at work. The guest contributions to this book, Kurzweil tells us, were scanned as they came to his desk by his read-to-the-blind machine, although it didn't speak audible words but sent characters to a formatter. And portions at least of his own text he spoke aloud to his type-to-dictation machine. How much editorial fiddling either process required we're not told. Under the rug: That's where glitches had best go, as we await the glitchless millennium. ■

Hugh Kenner is a professor of English at Johns Hopkins University. He writes for publications ranging from the New York Times to Art & Antiques. His recent books include Mazes and Historical Fictions. He can be contacted on BIX as "hkenner."

Your questions and comments are welcome. Write to: Editor, BYTE, One Phoenix Mill Lane, Peterborough, NH 03458.

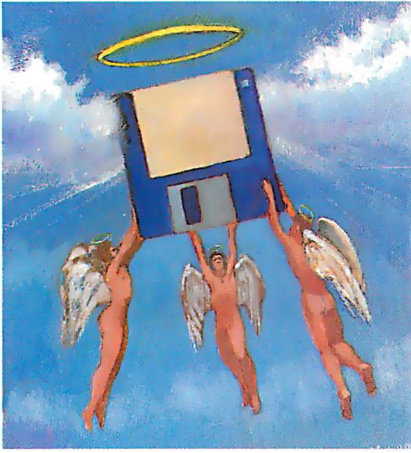

A PLEA FOR SOFTWARE THAT WORKS

Let's have software that runs *right*, not just fast

Like most computer users, I like using programs that run fast, have pretty, ergonomic displays, and are easy to learn and use. Some days, however, I'd gladly settle for software that is simply reliable.

This week, for example, I attempted to use the Paintbrush accessory in Windows 3.0 to create a large bit-mapped image—1024 by 512 pixels—to be printed on my 300-dot-per-inch laser printer. When I told the program the number of pixels I wanted in the drawing, it offered no complaint. However, as soon as I tried to use the scroll bars to move about the image, the program crashed.

The next day, I was using a Windows 3.0 DOS session to connect to BIX. Suddenly, Windows decided that my terminal emulator—a faithful program that had exhibited no bugs—had “violated system integrity” and terminated it automatically, aborting my on-line session. In theory, the system's Virtual 8086 mode should have been able to keep any one application from damaging the system. In this case, however, Windows warned me to shut down all my applications and reboot my system at once.

Finally, I decided to sidestep my problems with Windows by moving to Desqview. Alas, my disk cache program, Power Cache Plus, got into a tussle with Desqview, and it was big red switch

time. Which program was at fault? Who could tell? All I knew was that I still couldn't get things to work reliably.

House of Cards

If your computer crashes, it's easy to blame an application or the operating system for your woes. But if you look at the big picture, you see the real problem: Nearly every personal computer, regardless of make, is essentially a house of cards, ready to come crashing down as a result of a single erroneous instruction or bad memory location.

In an IBM PC, a program can change a single location—for example, the timer tick interrupt vector—and instantly cause the system to lock up solid. On the Mac, trashing the heap or the system globals can cause a brilliant, sizzling display of random pixels. It's no trick to cause a Guru Meditation on the Amiga. Even in OS/2, which in theory provides isolation between tasks, you can lock up the keyboard simply by calling the system routine `DOSEnterCritSec`. The security holes in most operating environments are not simply Achilles' heels; metaphorically speaking, they're the set of Achilles' entire body.

Such weaknesses may have been tolerable in the early days of microcomputers, but today—when millions of people trust computers with health, welfare, and livelihood—there's no longer any excuse. Operating systems must provide good protection against errant applications, and applications themselves must be designed to prevent bugs or catch them when they occur.

Button Up That OS

Unfortunately, most microcomputer operating systems do not offer consistency checking on operating-system calls. The Mac OS is one of these.

For this reason, Apple Finder author Steve Capps created a program called Discipline, which intercepts Mac OS calls and reports erroneous parameters. His

results were startling: Virtually every Mac program that he tested—including Apple's own applications—made serious illegal calls to the operating system.

OS/2 1.x, by contrast, checks every parameter passed to the operating system before it allows a system call to go through. What's more, it uses the segmentation hardware of the 286 to check every memory reference, ensuring that a program never steps out of bounds—by even a single byte. If a program tries to use any memory that does not belong to it, it is instantly terminated.

The 32-bit version of OS/2—OS/2 2.0—also checks memory references, but, ironically, it checks 32-bit programs far less stringently than it does 16-bit ones. A memory reference can be as much as 4K bytes or more off the mark before the problem is detected—if it's caught at all. This regrettable step backward is the result of Microsoft's desire to give 32-bit programs a “flat” memory model at the expense of the 386's built-in error-checking capabilities.

Writing Applications That Work

While theoreticians have shown that proving programs to be absolutely correct is an arduous task, the programmer can flush out many subtle bugs by adding *sanity checks* to the compiled code.

Every physics student learns an error-checking technique called *dimensional analysis*, which verifies that the units of measure in a result match those of the required answer. If, for example, you derived a formula to solve a problem, and the formula proceeded to add apples and oranges, you could immediately recognize the problem and correct the formula before using it on any data. This is called a *static check*, because it can be applied to a formula or program without actually running the numbers through it.

Another way of checking your answer is to ensure that it falls within a reasonable range. If you compute the weight of an apple to be 100 kilograms, you're

continued on page 369

Stop Bit is an open forum for informed opinion on topics related to personal computing. The opinions expressed are those of the author and not necessarily those of BYTE or its staff. Your contributions and comments are welcome. Write to: Editor, BYTE, One Phoenix Mill Lane, Peterborough, NH 03458.

Put LabWindows to Your Test

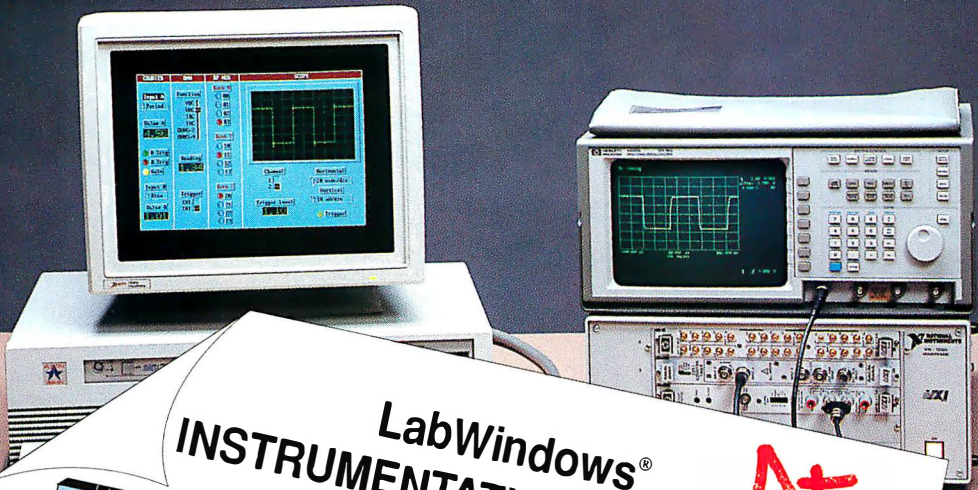

LabWindows® **A+** INSTRUMENTATION SOFTWARE

Data Acquisition

- GPIB
- Plug-in Boards
- VXI
- RS-232

Data Analysis

- Digital Signal Processing
- Statistics
- Curve Fitting
- Array Operations

Data Presentation

- File I/O
- 2D Plots
- Real Time Strip Charts
- Printer and Plotter Output

True False

- Industry standard Microsoft C, QuickC, and QuickBASIC development tools for data acquisition and instrument control.
- Instrument drivers for over 100 GPIB, VXI, and RS-232 instruments.
- Integrated support for plug-in data acquisition boards.
- Powerful analysis library for real-time data processing.
- Extensive graphics library for creating full-color displays on printers and plotters.
- Code generation and debugging tools for faster program development.
- Software development tools for production test and ATE systems.

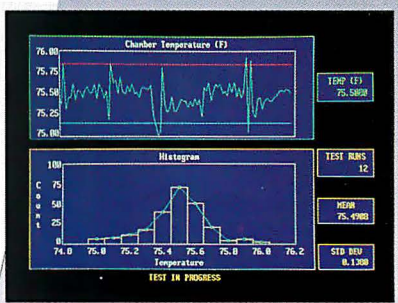
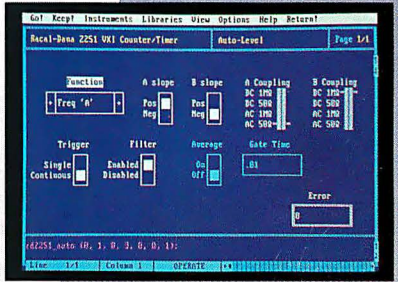

LabWindows...making industry standard programming languages work for you in data acquisition and instrument control.

NATIONAL INSTRUMENTS®
The Software is the Instrument®
6504 Bridge Point Parkway
Austin, TX 78730-5039

National Instruments Italy (02) 4830 1892
National Instruments France (1) 48 65 33 70
National Instruments Switzerland (056) 82 18 27
National Instruments United Kingdom (06) 35 523 545
Nihon National Instruments K.K. (Japan) (03) 788 1921

**Call for a FREE Demo Disk and Catalog
(512) 794-0100 • (800) 433-3488 (U.S. and Canada)**

Circle 200 on Reader Service Card

With a Tandy® laptop, PC power is always...

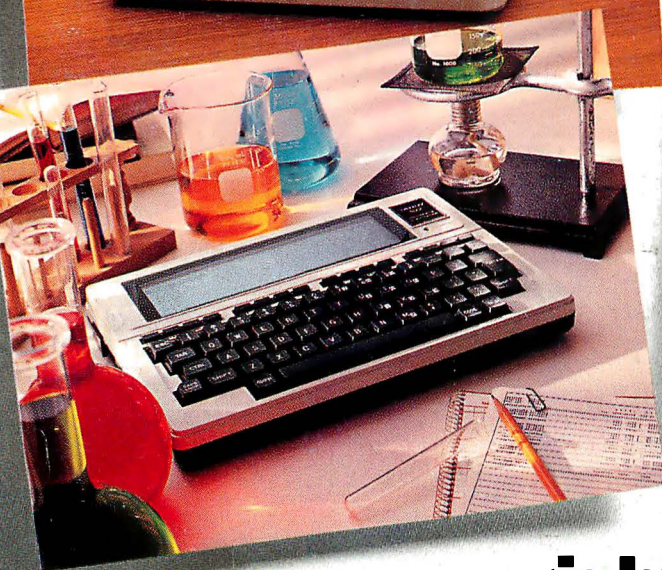
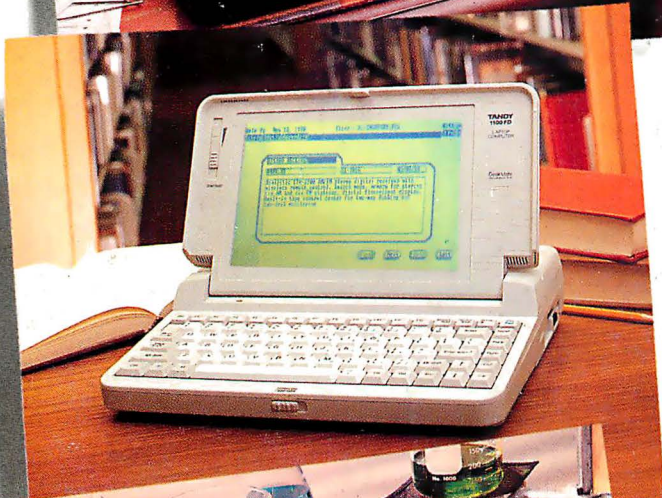
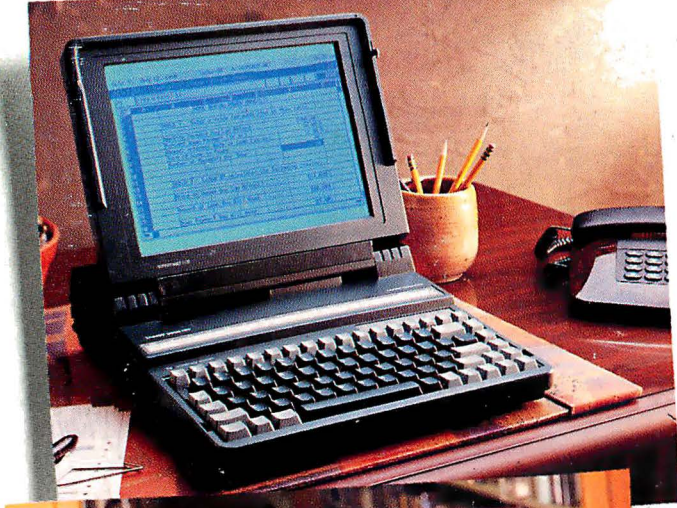

...right at hand.

With Tandy's line of powerful laptops, there's no reason to leave your computer behind.

If you like to travel light, pick up the Tandy 1100 FD—the only notebook-size PC with instant-on DeskMate® word processing built in. At only 6.2 lbs., the 1100 FD is the ultimate PC compatible for combining portability and affordability.

Or grab the slim, 6-pound Tandy 1500 HD with a 20MB hard drive and DeskMate software. If you demand 286 power, our Tandy 2800 HD is ready to run, with 640 × 400 EGA graphics. Plus, there's the Tandy 102—the 3-pound portable that started the laptop revolution.

Get your hands on a Tandy portable today . . . you'll never have to be without your computer again.

Tandy Computers: Because there is no better value.™

Radio Shack®
COMPUTER CENTERS
A DIVISION OF TANDY CORPORATION

Circle 258 on Reader Service Card