

# BYTE

THE SMALL SYSTEMS JOURNAL®

FEBRUARY 1987 VOL. 12, NO. 2

\$3.50 IN UNITED STATES  
\$4.50 IN CANADA / £1.75 IN U.K.  
A MCGRAW-HILL PUBLICATION  
0360-5280



Educational  
Computing



# Reflex:® The Database Manager

**R**eflex is the acclaimed, high-performance database manager that's so advanced it's easy to use!

## Reflex: the high-performance, state-of-the-art database manager

Whether you manage mailing lists, customer files, or you are in charge of your company's budgets, Reflex is the database manager that you've been waiting for. Reflex lets you organize, analyze and report information faster and easier than ever before.

Reflex extends database management with business graphics. Because a picture is often worth a 1000 words, Reflex lets you extract the critical information buried in mountains of data. With Reflex, when you look, you see.

### Reflex: the critics' choice

“... if you use a PC, you should know about Reflex. Reflex and Reflex Workshop may be the best bargain in software today.

**Jerry Pournelle, BYTE 11/86**

Everyone agrees that Reflex is the best-looking database they've ever seen.

**Adam B. Green, InfoWorld**

The next generation of software has officially arrived.

**Peter Norton, PC Week**”

### Reflex: don't use your PC without it!

Join hundreds of thousands of enthusiastic Reflex users and experience the power and ease-of-use of Borland's award-winning Reflex.

MACINTOSH™  
VERSION ALSO  
AVAILABLE



## Reflex: The Workshop adds 22 templates to your business repertoire

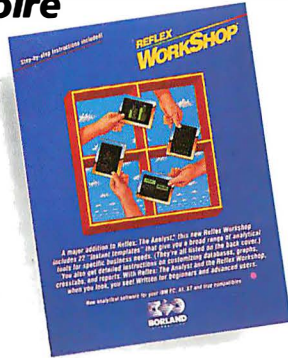

Only  
**\$69.95!**

You get 22 different ways to run your business—instantly. The formats are all there. All you do is enter your own numbers. A superb business tool.

### System requirements

Reflex: The Database Manager: IBM PC, AT, XT, or true compatibles. PC-DOS (MS-DOS) 2.0 and later. IBM CGA, Hercules Monochrome Card, or equivalent. 384K.  
Reflex: The Workshop: Requires Reflex: The Database Manager. 384K.

### For Finance/Accounting:

- Business Expense Tracking
- Petty Cash Tracking
- Line of Credit Tracking and Analysis
- Accounts Receivable Tracking and Aging Analysis
- Purchase Order Entry and Analysis
- Purchase Order Tracking System
- Leasing Inventory/Management
- Asset Inventory Tracking
- Cash Management Trial Balance
- Commercial Real Estate Tracking and Analysis

### For Administration:

- Mail Lists
- Appointment Scheduling
- Applicant Tracking and Inquiry System
- Facilities Planning
- Project Scheduling

### For Sales & Marketing:

- Sales Lead Tracking and Analysis
- Store Check Inventory Analysis
- Sales Analysis
- Trend Analysis

### For Production & Operations:

- Manufacturing Quality Assurance Tracking
- Assembly Repair Turnaround Tracking
- Product Cost Analysis and Control

“ Reflex does the job. Workshop shows you applications. The 400-page book that comes with Workshop has sections on creating accounting systems; inventory control; business expense reports; real estate management; production; operation and quality control; and just a whole bunch of other stuff.

**Jerry Pournelle, BYTE 11/86**”

Only **\$149.95!**

## REFLEX: THE DATABASE MANAGER

The high-performance database manager that's so advanced it's easy to use!

Five graphic ways of looking at your data in Lotus 1-2-3, dBASE™ and PFS: File.

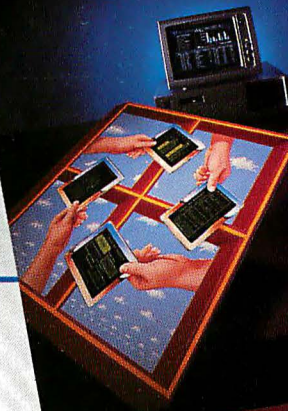

IBM™ VERSION  
PC, XT, AT, &  
True Compatibles

For the dealer nearest you or to order by phone call

**(800)255-8008**

in CA (800) 742-1133 in Canada (800) 237-1136





# Eureka: The Solver™

## Anyone and everyone who routinely works with equations needs Eureka: The Solver

It solves the most complex equations in seconds. Whether you're a scientist, engineer, financial analyst, student, teacher, or some other professional, you need Eureka: The Solver!

Any problem that can be expressed as a linear or non-linear equation can be solved with Eureka. Algebra, Trigonometry and Calculus problems are a snap.

Eureka: The Solver also handles maximization and minimization problems, does plot functions, generates reports, and saves you an incredible amount of time.

### $X + \exp(X) = 10$ solved instantly instead of eventually!

Imagine you have to "solve for X," where  $X + \exp(X) = 10$ , and you don't have Eureka: The Solver. What you do have is a problem, because it's going to take a lot of time guessing at "X." Maybe your guesses get closer and closer to the right answer, but it's also getting closer and closer to midnight and you're doing it the hard way.

With Eureka: The Solver, there's no guessing, no dancing in the dark—you get the right answer, right now. (PS:  $X = 2.0705799$ , and Eureka solved that one in .4 of a second!)

#### System requirements

IBM PC, AT, XT, Portable, 3270 or true compatibles.  
PC-DOS (MS-DOS) 2.0 and later. 384K.

### How to use Eureka: The Solver

It's easy.

1. Enter your equation into the full-screen editor
2. Select the "Solve" command
3. Look at the answer
4. You're done

You can then tell Eureka to

- Evaluate your solution
- Plot a graph
- Generate a report, then send the output to your printer, disk file or screen
- Or all of the above

### Eureka: The Solver includes

- A full-screen editor
- Pull-down menus
- Context-sensitive Help
- On-screen calculator
- Automatic 8087 math co-processor chip support
- Powerful financial functions
- Built-in and user-defined math and financial functions
- Ability to generate reports complete with plots and lists
- Polynomial finder
- Inequality solutions

### Some of Eureka's key features

You can key in:

- A formula or formulas
- A series of equations—and solve for all variables
- Constraints (like X has to be  $<$  or  $=$  2)
- A function to plot
- Unit conversions
- Maximization and minimization problems
- Interest Rate/Present Value calculations
- Variables we call "What happens?," like "What happens if I change this variable to 21 and that variable to 27?"

### All this power for only \$99.95!

Equation-solving used to be a mainframe problem, but we've solved that problem.

Eureka: The Solver is all you need—and it's yours for only \$99.95!

That kind of savings you can calculate with your fingers!

Only \$99.95!\*

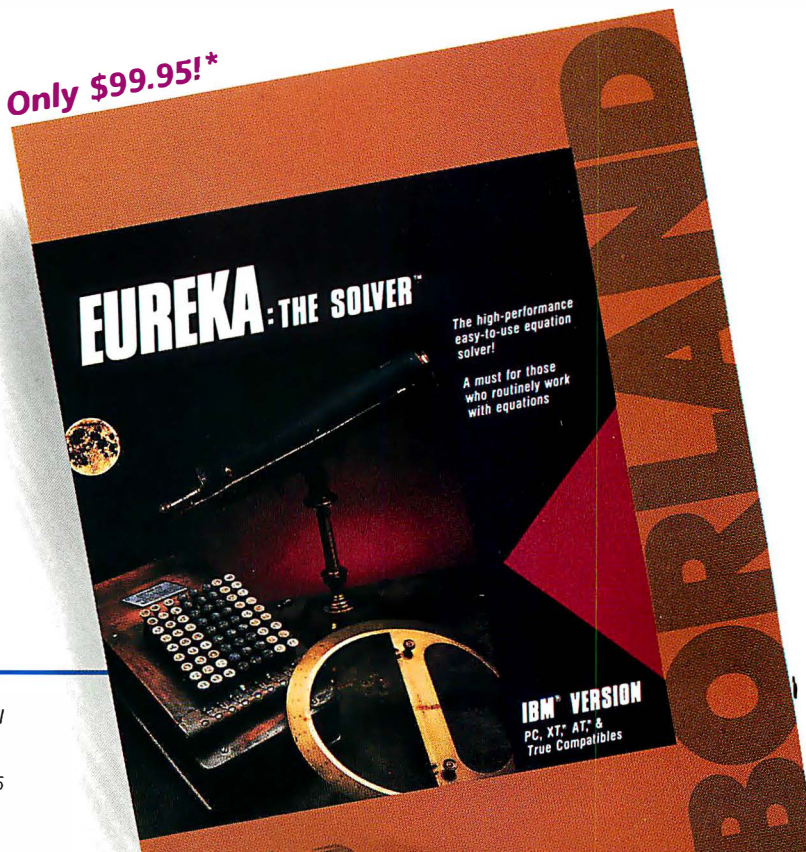

\*Introductory price—good through July 1, 1987

For the dealer nearest you or to order by phone call

**(800)255-8008**

in CA (800) 742-1133 in Canada (800) 237-1136



# Turbo Prolog™

“ If you're at all interested in artificial intelligence, databases, expert systems, or new ways of thinking about programming, by all means plunk down your \$100 and buy a copy of Turbo Prolog. **Bruce Webster, BYTE 9/86** ”

Only  
\$99.95!

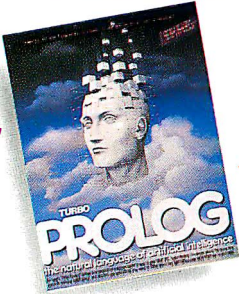

Turbo Prolog, the natural language of Artificial Intelligence, is the most popular AI package in the world with more than 100,000 users. It's the 5th-generation computer programming language that brings supercomputer power to your IBM PC and compatibles. You can join the AI revolution with Turbo Prolog for only \$99.95. Step-by-step tutorials, demo programs and source code included.

## New! Turbo Prolog Toolbox

Our new Turbo Prolog Toolbox™ enhances Turbo Prolog—with more than 80 tools and over 8,000 lines of source code that can easily be incorporated into your programs. It includes about 40 example programs that show you how to use and incorporate your new tools.

New Turbo Prolog Toolbox features include:

- ☑ Business graphic generation
- ☑ Complete communications package
- ☑ File transfers from Reflex, dBASE III, 1-2-3, Symphony
- ☑ A unique parser generator
- ☑ Sophisticated user-interface design tools

### System requirements

Turbo Prolog: IBM PC, XT, AT or true compatibles. PC-DOS (MS-DOS) 2.0 or later. 384K. Turbo Prolog Toolbox requires Turbo Prolog 1.10 or higher. Dual-floppy disk drive or hard disk. 512K.

It's the complete developer's toolbox and a major addition to Turbo Prolog. You get a wide variety of menus—pull-down, pop-up, line, tree and box—so you can choose the one that suits your application best. You'll quickly and easily learn how to produce graphics; set up communications with remote devices; read information from Reflex,\* dBASE III,\* Lotus 1-2-3\* and Symphony\* files; generate parsers and design user interfaces. All of this for only \$99.95.

Only  
\$99.95!

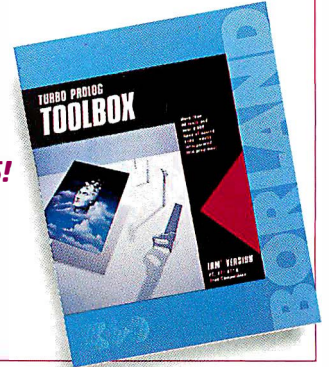

# Turbo Pascal®

The power and high performance of Turbo Pascal is already in the hands of more than half-a-million people. The technically superior Turbo Pascal is the *de facto* worldwide standard and the clear leader.

The Turbo Pascal family includes:

- Turbo Pascal® 3.0
- Turbo Tutor® 2.0
- Turbo Database Toolbox®
- Turbo Editor Toolbox®
- Turbo Graphix Toolbox®
- Turbo GameWorks®
- Turbo Pascal Numerical Methods Toolbox™



Turbo Pascal, the worldwide standard in high-speed compilers, and family.

“ The language deal of the century. **Jeff Duntemann, PC Magazine** ”

## New! Turbo Pascal Numerical Methods Toolbox

Only  
\$99.95!

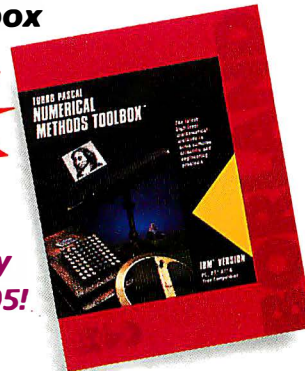

What our new Numerical Methods Toolbox will do for you now:

- ☑ Find solutions to equations
- ☑ Interpolations
- ☑ Calculus: numerical derivatives and integrals
- ☑ Differential equations
- ☑ Matrix operations: inversions, determinants and eigenvalues
- ☑ Least squares approximations
- ☑ Fourier transforms

As well as a free demo FFT program, you also get Least Squares Fit in 5 different forms:

1. Power
2. Exponential
3. Logarithm
4. 5-term Fourier
5. 5-term Polynomial

They're all ready to compile and run.

**All this for only \$99.95!**

### System requirements

IBM PC, XT, AT or true compatibles. PC-DOS (MS-DOS) 2.0 or later. Turbo Pascal 2.0 or later. Graphics module requires graphics monitor with IBM CGA, IBM EGA, or Hercules compatible adapter card, and requires Turbo Graphix Toolbox. 8087 or 80287 numeric co-processor not required, but recommended for optimal performance. 256K.

### Turbo Pascal 3.0.

Includes 8087 & BCD features for 16-bit MS-DOS and CP/M-86 systems. CP/M-80 version minimum memory: 48K; 8087 and BCD features not available. 128K.



# SideKick®: The Desktop Organizer

MACINTOSH™  
VERSION ALSO  
AVAILABLE



Only  
\$99.95!\*

One million users can't be wrong. SideKick, the first name in desktop organizers, offers a notepad, a calculator, a calendar, and a host of other tools in a window on your screen. In the middle of programs like 1-2-3, WordStar®, or Crosstalk®, you have instant access to a complete set of desk tools. Minimum memory: 128K\*\*\*

“If you use a PC, get SideKick.  
Jerry Pournelle, BYTE 10/84”

# SuperKey®: The Productivity Booster

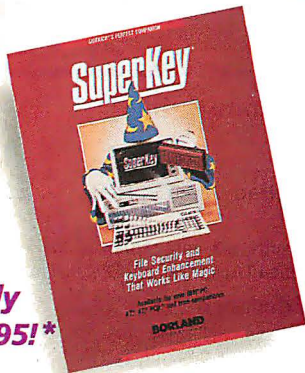

Only  
\$99.95!\*

## SuperKey eliminates repetition

SuperKey cuts down keystrokes because SuperKey's simple macros turn "Dear Customer: Thank you for your inquiry. We are pleased to let you know that shipment will be made within 24 hours. Sincerely," into the one keystroke of your choice. Like magic! SuperKey's macros are electronic shortcuts to success.

## SuperKey keeps your secrets

Without encryption, your files are open secrets. Anyone can read them. SuperKey encrypts your files and keeps confidential files confidential. Only your secret password reveals what you've written. Minimum memory: 128K\*\*\*

“... it's the most elegant program I've seen in many a moon.”  
Stephen Manes, PC Magazine

# Turbo Lightning®: The Spell-Checker and Thesaurus

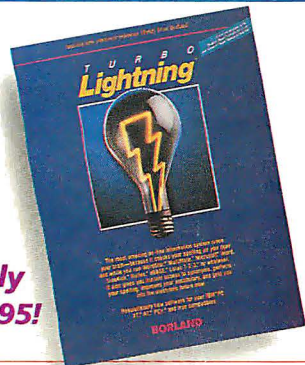

Only  
\$99.95!

Turbo Lightning adds instant spell-checking and a thesaurus to all your spreadsheets, electronic mail, documents, memos, or whatever programs you use.

Everything you type looks professional because Turbo Lightning checks your spelling as you type, while you run other programs. Turbo Lightning beeps every time there's a misspelled word, which you can correct instantly.

Need synonyms? Turbo Lightning's on-line thesaurus instantly offers you the right ones. It's that easy.

Minimum memory: 256K. Two disk drives required. Hard disk recommended.\*\*\*

\*\*\* IBM PC, XT, AT, PCjr, and true compatibles only. PC/MS-DOS 2.0 or later.

“I like 'em all, but Lightning's the one that's going to change how a lot of us use computers... simply the finest spelling checker and electronic thesaurus program extant.”  
Jim Seymour, MicroBusiness

\*Suggested list price as of February 15, 1987

\*\*If within 60 days of purchase you find that these products do not perform in accordance with our claims, call our customer service department and we will arrange a refund. All prices are suggested list prices and are subject to change without notice.

All Borland products are trademarks or registered trademarks of Borland International, Inc. or Borland Analytica, Inc. IBM, AT, PCjr and XT are registered trademarks of International Business Machines Corp. dBASE III is a registered trademark of Ashton-Tate. Lotus 1-2-3 and Symphony are registered trademarks of Lotus Development Corp. Hercules is a trademark of Hercules Computer Technology. Crosstalk is a registered trademark of Microstuf, Inc. WordStar is a registered trademark of MicroPro International Corp. MS-DOS is a registered trademark of Microsoft Corp. Macintosh is a trademark of McIntosh Laboratory, Inc. and is licensed to Apple Computer. Copyright 1986 Borland International. BI-1093A

Inquiry 41 for End-Users. Inquiry 42 for DEALERS ONLY.

## Borland Software

### Programming Languages:

Turbo Pascal 3.0	99.95
Turbo Pascal Numerical Methods Toolbox	99.95
Turbo Database Toolbox	69.95
Turbo Editor Toolbox	69.95
Turbo GameWorks	69.95
Turbo Graphix Toolbox	69.95
Turbo Tutor 2.0	39.95

### Business Productivity:

Reflex: The Database Manager	\$149.95
Reflex: The Workshop	69.95
SideKick: The Desktop Organizer	99.95*
Traveling SideKick®	69.95
SuperKey: The Productivity Booster	99.95*
Turbo Lightning: The Spell-Checker & Thesaurus	99.95
Lightning Word Wizard™	69.95

### Artificial Intelligence:

Turbo Prolog	\$99.95
Turbo Prolog Toolbox	99.95

### Scientific & Engineering:

Eureka: The Solver	\$99.95
Turbo Pascal Numerical Methods Toolbox	99.95

### Available for the Mac:

Turbo Pascal for the Mac™	\$99.95
Reflex for the Mac™	99.95
SideKick for the Mac™	99.95

### 60-DAY MONEY-BACK GUARANTEE\*\*

For the dealer nearest you, or to order by phone call (800) 255-8008  
CA (800) 742-1133  
Canada (800) 237-1136



**BORLAND**  
INTERNATIONAL

4585 SCOTTS VALLEY DRIVE  
SCOTTS VALLEY, CA 95066  
(408) 438-8400 TELEX: 172373

GF15



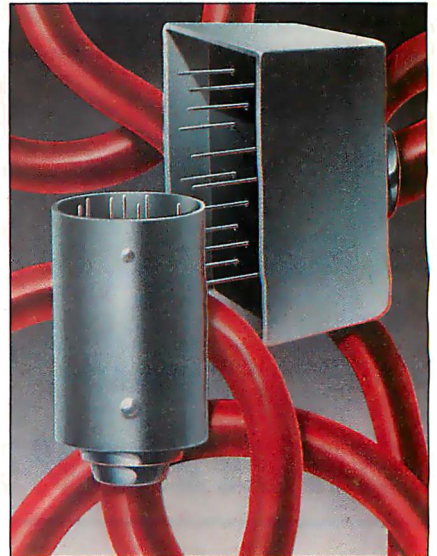

# Contents

## FEATURES

<b>Introduction</b> .....	82
<b>Workstations</b> .....	85
<i>by Charles D. Weston and George A. Stewart</i>	
An evaluation of three models offers a tantalizing glimpse of where personal computers are going.	
<b>Ciarcia's Circuit Cellar: Build an Infrared Remote Controller</b> .....	101
<i>by Steve Ciarcia</i>	
A custom hand-held transmitter and receiver.	
<b>Programming Project: Illinois Functional Programming: A Tutorial</b> .....	114
<i>by Arch D. Robison</i>	
Construct functional programs with this public domain language.	
<b>Build Your Own 256K Amiga Expansion RAM</b> .....	129
<i>by Richard F. Retter and Andrew N. Morelli Jr.</i>	
Save over a hundred dollars by building your own expansion RAM module.	
<b>Programming Insight: Calculating the Area of an Irregular Shape</b> .....	135
<i>by Rene Stolk and George Etershank</i>	
A BASIC program for calculating the areas of simple closed curves.	
<b>Programming Insight: Another Approach to Data Compression</b> .....	137
<i>by Robert J. Sciamanda</i>	
Use this set of BASIC programs to explore the Nyquist sampling theorem.	

## THEME: Educational Computing

<b>Introduction</b> .....	146
<b>Using Computers for Instruction</b> .....	149
<i>by Henry Jay Becker</i>	
A research scientist looks at the results and implications of the Second National Survey of Instructional Uses of School Computers.	
<b>The Difference in Higher Education</b> .....	165
<i>by Donna Osgood</i>	
Profiles of five colleges making good on their promise to provide campuswide access to computers.	
<b>The Quiet Revolution</b> <i>by Brock N. Meeks</i> .....	183
The author takes us inside the electronic university—does it really emulate the traditional classroom?	
<b>A Hard Look at Educational Software</b> .....	193
<i>by Adeline Naiman</i>	
The state of the art in education hardly reflects the technological advances available.	
<b>The Potential for Interactive Technology</b> .....	201
<i>by Alfred Bork</i>	
The future for learning and using technology requires vision and facts.	

## REVIEWS

<b>Introduction</b> .....	210
<b>Reviewer's Notebook</b> <i>by Jon Edwards</i> .....	213
<b>The ALR Access 386 and the Compaq Deskpro 386</b> .....	215
<i>by Stanley J. Wszola and Curtis Franklin Jr.</i>	
Two high-performance 80386 machines.	
<b>Four Portable Computers</b> <i>by John D. Unger</i> .....	221
IBM PC-compatible laptops from Toshiba, Zenith, Bondwell, and IBM.	
<b>The Atari 1040ST</b> <i>by Dave Menconi</i> .....	231
An excellent value with just a few problems.	
<b>Four Ink-Jet Printers</b> <i>by Robert D. Swearingin</i> .....	239
Offerings from Diconix, Quadram, Xerox, and Tektronix.	



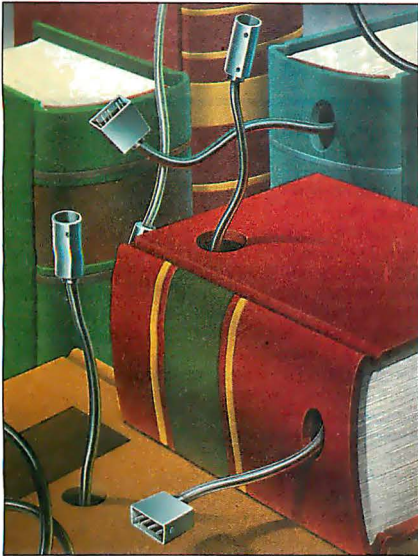

146

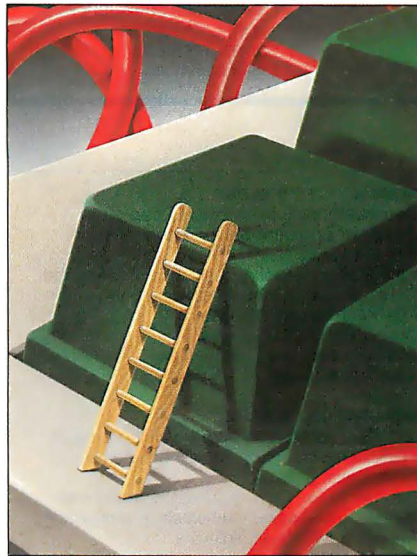

210

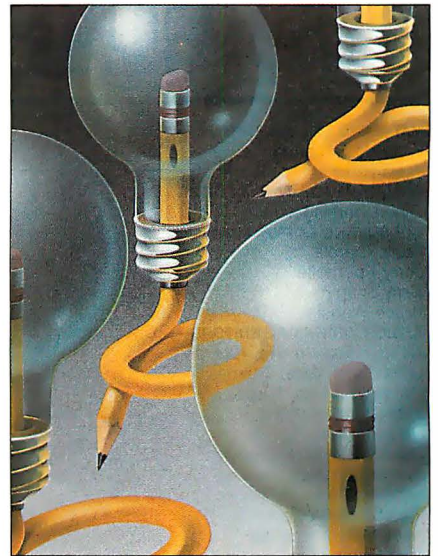

264

**Microsoft QuickBASIC 2.0** by *Dennis Dykstra* ..... 247

An integrated programming environment with many features.

**Forecast Master** by *Lowell Rosen* ..... 255

A state-of-the-art statistical package.

**Public Domain Software for the Amiga** ..... 256

by *Warren Block*

Some of the best public domain programs available.

**Review Feedback** ..... 261

Readers respond to previous reviews.

**KERNEL**

**Introduction** ..... 264

**Computing at Chaos Manor:**

**A Confederation of Hackers** by *Jerry Pournelle* ..... 267

A detailed description of WordPerfect highlights this month's column.

**BYTE U.K.: And More Clones** ..... 287

by *Dick Pountain*

Dick looks at new computers from Amstrad and Apricot.

**Applications Only: Miscellany** ..... 295

by *Ezra Shapiro*

A gigantic backlog and a guilt complex cause Ezra to consider several products.

**According to Webster: Journeys** ..... 303

by *Bruce Webster*

More on the Apple IIGS and a look at some FORTH products.

**Mathematical Recreations:**

**A Ternary State of Affairs** ..... 319

by *Robert T. Kurosaka*

The base-3 number system offers an automatic solution to a classic puzzle.

**BEST OF BIX**

Amiga ..... 331

Apple II/Macintosh ... 339

Atari ST ..... 333

BASIC ..... 341

IBM PC and

C ..... 344

Compatibles ..... 337

Pascal ..... 344

**DEPARTMENTS**

Editorial:

The Hidden Peril of  
Electronic Publishing.... 6

Circuit Cellar  
Feedback..... 60

Microbytes ..... 9

Book Reviews..... 67

Letters ..... 16

Chaos Manor Mail ... 329

What's New ..... 29

BOMB and Coming

Events and Clubs ..... 49

Up in BYTE..... 388

Ask BYTE ..... 52

Company Index ..... 389

Reader Service ..... 391

**LISTINGS**

From BIX..... 306

From BYTEnet..... (617) 861-9764

On Disk..... see card after 328

In Print..... see card after 328



BYTE (ISSN 0360-5280) is published monthly with one extra issue per year by McGraw-Hill Inc. Founder: James H. McGraw (1860-1948). Executive, editorial, circulation, and advertising offices: One Phoenix Mill Lane, Peterborough, NH 03458, phone (603) 924-9281. Office hours: Monday through Thursday 8:30 AM - 4:30 PM, Friday 8:30 AM - 1:00 PM, Eastern Time. Address subscriptions to BYTE Subscriptions, P.O. Box 590, Martinsville, NJ 08836. Postmaster: send address changes, USPS Form 3579, undeliverable copies, and fulfillment questions to BYTE Subscriptions, P.O. Box 596, Martinsville, NJ 08836. Second-class postage paid at Peterborough, NH 03458 and additional mailing offices. Postage paid at Winnipeg, Manitoba. Registration number 9321. Subscriptions are \$22 for one year, \$40 for two years and \$58 for three years in the U.S. and its possessions. In Canada and Mexico, \$25 for one year, \$45 for two years, \$65 for three years. \$69 for one year air delivery to Europe, 31,000 yen for one year air delivery to Japan, 15,600 yen for one year surface delivery to Japan, \$37 surface delivery elsewhere. Air delivery to selected areas at additional rates upon request. Single copy price is \$3.50 in the U.S. and its possessions, \$4.25 in Canada and Mexico, \$4.50 in Europe, and \$5 elsewhere. Foreign subscriptions and sales should be remitted in U.S. funds drawn on a U.S. bank. Please allow six to eight weeks for delivery of first issue. Printed in the United States of America.

Address editorial correspondence to: Editor, BYTE, One Phoenix Mill Lane, Peterborough, NH 03458. Unacceptable manuscripts will be returned if accompanied by sufficient postage. Not responsible for lost manuscripts or photos. Opinions expressed by the authors are not necessarily those of BYTE.

Copyright © 1987 by McGraw-Hill Inc. All rights reserved. Trademark registered in the United States Patent and Trademark Office. Where necessary, permission is granted by the copyright owner for libraries and others registered with the Copyright Clearance Center (CCC) to photocopy any article herein for the flat fee of \$1.50 per copy of the article or any part thereof. Correspondence and payment should be sent directly to the CCC, 29 Congress St., Salem, MA 01970. Specify ISSN 0360-5280/83. \$1.50. Copying done for other than personal or internal reference use without the permission of McGraw-Hill Inc. is prohibited. Requests for special permission or bulk orders should be addressed to the publisher. BYTE is available in microform from University Microfilms International, 300 North Zeeb Rd., Dept. PR, Ann Arbor, MI 48106 or 18 Bedford Row, Dept. PR, London WC1R 4EJ, England.

Subscription questions or problems should be addressed to: BYTE Subscriber Service, P.O. Box 328, Hancock, NH 03449



**MANAGING EDITOR, BYTE**  
Frederic S. Langa

**ASSISTANT MANAGING EDITOR**

Glenn Hartwig

**CONSULTING EDITORS**

Steve Ciarcia  
Jerry Pournelle  
Ezra Shapiro  
Bruce Webster

**SENIOR TECHNICAL EDITORS**

Cathryn Baskin, Reviews  
G. Michael Vose, Themes  
Gregg Williams, Features

**TECHNICAL EDITORS**

Dennis Allen  
Dennis Barker, Microbytes  
Richard Grehan  
Ken Sheldon  
George A. Stewart  
Jane Morrill Tazelaar  
Tom Thompson  
Charles D. Weston  
Eva White  
Stanley Wszola

**ASSOCIATE TECHNICAL EDITORS**

Curtis Franklin Jr., Best of BIX  
Margaret Cook Gurney, Book Reviews  
Brenda McLaughlin, Applications Software  
Reviews, San Francisco

**COPY EDITORS**

Bud Sadler, Chief  
Jeff Edmonds  
Nancy Hayes  
Cathy Kingery  
Paula Noonan  
Lauren Stickler  
Warren Williamson  
Judy Winkler

**ASSISTANTS**

Peggy Dunham, Office Manager  
Martha Hicks  
L. Ryan McCombs  
June N. Sheldon

**NEWS AND TECHNOLOGY**

Gene Smarte, Bureau Chief, Costa Mesa  
Jonathan Erickson, Senior Technical Editor,  
San Francisco  
Rich Malloy, Senior Technical Editor, New York  
Cindy Kiddoo, Editorial Assistant, San Francisco

**ASSOCIATE NEWS EDITORS**

Dennis Barker, Microbytes  
Anne Fischer Lent, What's New  
Stan Miastkowski, What's New

**CONTRIBUTING EDITORS**

Jonathan Amsterdam, programming projects  
Mark Dahmke, video, operating systems  
Mark Haas, at large  
Rik Jadrnicek, CAD, graphics, spreadsheets  
Robert T. Kurosaka, mathematical recreations  
Alastair J. W. Mayer, software  
Alan R. Miller, languages and engineering  
Dick Pountain, U.K.  
Roger Powell, computers and music  
Phillip Robinson, semiconductors  
Jon Shiell, high-performance systems

**ART**

Nancy Rice, Art Director  
Joseph A. Gallagher, Assistant Art Director  
Jan Muller, Art Assistant  
Alan Easton, Drafting

**PRODUCTION**

David R. Anderson, Production Director  
Denise Chartrand  
Michael J. Lonsky  
Virginia Reardon

**TYPOGRAPHY**

Sherry McCarthy, Chief Typographer  
Selinda Chiquoine  
Donna Sweeney

**PLANNING AND RESEARCH**

Michele Perron, Director  
Faith Kluntz, Copyrights Coordinator

**FINANCIAL SERVICES**

Philip L. Penny, Director of Finance and Services  
Kenneth A. King, Business Director  
Christine Lee, Assistant  
Vicki Weston, Accounting Manager  
Linda Short, D/P Manager  
Marilyn Haigh  
Diane Henry  
Vern Rockwell  
Lisa Teates  
JoAnn Walter

**PUBLISHER'S ASSISTANT**

Beverly Jackson

**EXECUTIVE EDITOR, BIX**  
George Bond

**SENIOR EDITOR**

David Betz

**ASSOCIATE EDITORS**

Tony Lockwood  
Donna Osgood, San Francisco  
**MICROBYTES DAILY**  
Dennis Barker, Coordinator, Peterborough  
Gene Smarte, Bureau Chief, Costa Mesa

Rick Cook, Phoenix  
Jonathan Erickson, San Francisco  
Martha Hicks, Peterborough  
Cindy Kiddoo, San Francisco

Anne Fischer Lent, Peterborough  
Rich Malloy, New York  
Stan Miastkowski, Peterborough  
Lynne Nadeau, Peterborough

David Needle, San Francisco  
Wayne Rash, Washington, DC  
Lamont Wood, San Antonio

**GROUP MODERATORS**

David Allen, Applications  
Frank Boosman, Artificial Intelligence  
Leroy Casterline, Other  
Marc Greenfield, Programming Languages  
Jim Howard, Graphics  
Gary Kendall, Operating Systems  
Steve Krenek, Computers

Brock Meeks, Telecommunications  
Barry Nance, New Technology  
Donald Osgood, Computers  
Sue Rosenberg, Other

Jon Swanson, Chips

**BUSINESS AND MARKETING**

Doug Webster, Director (603-924-9027)  
Patricia Bausum, Secretary  
Denise A. Greene, Customer Service  
Brian Warnock, Customer Service  
Tammy Burgess, Customer Credit and Billing

**TECHNOLOGY**

Clayton Lisle, Director, Business Systems Technology,  
MHS  
Bill Garrison, Business Systems Analyst  
Jack Reilly, Business Systems Analyst

**ADVERTISING SALES**

Dennis J. Riley, Director of Sales and Marketing  
Sandra Foster, Administrative Assistant

**ADVERTISING/PRODUCTION (603-924-6448)**

Lisa Wozmak, Supervisor  
Lyda Clark, Senior Account Coordinator  
Marion Carlson  
Virginia Carpenter  
Karen Cilley  
Brian Higgins  
Wai Chiu Li, Quality Control Manager  
Julie Murphree, Advertising/Production  
Coordinator

**MARKETING COMMUNICATIONS**

Horace T. Howland, Director (603-924-3424)  
Vicki Reynolds, Promotion Manager  
Lisa Jo Steiner, Marketing Assistant  
Stephanie Warnesky, Marketing Art Director  
Sharon Price, Associate Art Director  
Wilbur S. Watson, Operations Manager, Exhibits  
Julie Perron, Market Research Analyst  
Cynthia Damato Sands, Reader Service  
Coordinator

**CIRCULATION (800-258-5485)**

Dan McLaughlin, Director  
Laurie Seamans, Assistant Manager  
Louise Menegus  
Jennifer Price  
James Bingham, Single-Copy Sales Manager  
Cathy A. Rutherford, Assistant Manager  
Claudette Carswell  
Karen Desroches

**PERSONNEL**

Cheryl Hurd, Office Manager  
Patricia Burke, Personnel Coordinator

**BUILDING SERVICES/TRAFFIC**

Anthony Bennett, Building Services Manager  
Mark Monkton, Assistant  
Agnes E. Perry, Traffic Assistant

**RECEPTIONIST**

Donna Healy

 Officers of McGraw-Hill Information Systems Company: President: Richard B. Miller. Executive Vice Presidents: Frederick P. Jannott, Construction Information Group; Russell C. White, Computers and Communications Information Group; J. Thomas Ryan, Marketing and International. Senior Vice Presidents: Francis A. Shinal, Controller; Robert C. Violette, Manufacturing and Technology. Senior Vice Presidents and Publishers: Laurence Altman, Electronics; Harry L. Brown, BYTE; David J. McGrath, Construction Publications. Group Vice President: Peter B. McCuen, Communications Information. Vice President: Fred O. Jensen, Planning and Development.

Officers of McGraw-Hill, Inc.: Harold W. McGraw, Jr., Chairman; Joseph L. Dionne, President and Chief Executive Officer; Robert N. Landes, Executive Vice President and Secretary; Walter D. Serwatka, Executive Vice President and Chief Financial Officer; Shel F. Asen, Senior Vice President, Manufacturing; Robert J. Bahash, Senior Vice President, Finance and Manufacturing; Ralph R. Schulz, Senior Vice President, Editorial; George R. Elsinger, Vice President, Circulation; Ralph J. Webb, Vice President and Treasurer.

BYTE, BIX, and The Small Systems Journal are registered trademarks of McGraw-Hill Inc.

**EDITORIAL AND BUSINESS OFFICE:**

One Phoenix Mill Lane, Peterborough, New Hampshire  
03458, (603) 924-9281.

**West Coast Offices:** 425 Battery St., San Francisco, CA  
94111, (415) 954-9718; 3001 Red Hill Ave., Building #1, Suite  
222, Costa Mesa, CA 92626, (714) 557-6292. **New York**  
**Editorial Office:** 1221 Avenue of the Americas, New York,  
NY 10020, (212) 512-3175.

**BYTEnet:** (617) 861-9764 (set modem at 8-1-N or 7-1-E; 300  
or 1200 baud).



# HiWIRE™ Starts the Job that smARTWORK® Finishes

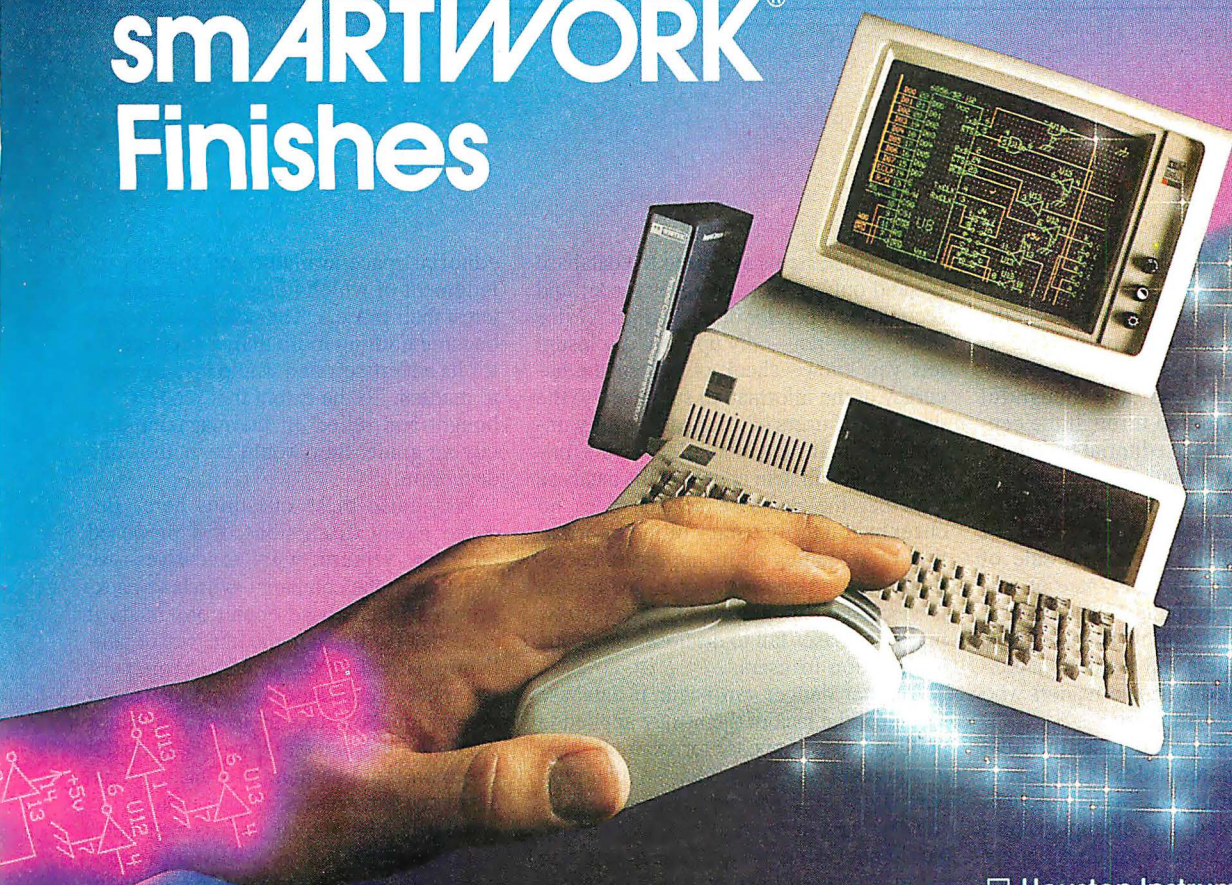

## Introducing HiWIRE™

Wintek's smARTWORK® is used by thousands of engineers to design printed-circuit boards. Now Wintek introduces HiWIRE, an electronic-schematic program that is easy to learn and use.

With a click of the mouse button, you can extract symbols from our library of over 700 common components and connect them with wires and buses. You can also easily modify the library's symbols or create your own by combining labels, lines, and arcs.

## HiWIRE Advantages

- Easy-to-learn mouse/menu-driven operation
- Complete documentation and tutorial
- Extensive TTL, CMOS, micro-processor, and discrete-component libraries
- Rubberbanding

- Moving, copying, mirroring, and rotating of symbols
- Text-string searching
- Multiple display windows
- High-quality schematics from printers and plotters
- Hierarchical-design support; netlist and bill-of-materials utilities
- Schematic/layout cross checking
- 800 number for free technical support

## System Requirements

- IBM Personal Computer, PC XT, or PC AT with 320K RAM, parallel printer port, 2 disk drives, and DOS V2.0 or later
- IBM Color/Graphics Adapter or EGA with RGB color monitor
- Microsoft Mouse
- IBM Graphics Printer or Epson FX/MX/RX-series dot-matrix printer, and/or:

- Houston Instrument DMP-40, 41, 42, 51, 52 or Hewlett-Packard 7470, 7475, 7550, 7580, 7585, 7586 plotter

## High Performance at Low Cost

At \$895, HiWIRE delivers quality schematics quickly and easily. You don't need to guess whether or not HiWIRE is right for you. Our money-back guarantee lets you try it for 30 days at absolutely no risk. Call (800) 742-6809 toll free today and put HiWIRE to work tomorrow.

**Wintek Corporation**  
1801 South Street  
Lafayette, IN 47904-2993  
Telephone: (800) 742-6809  
or in Indiana (317) 742-8428  
Telex: 70-9079 WINTEK CORP UD



"HiWIRE" is a trademark, and "smARTWORK", "Wintek", and the Wintek logo are registered trademarks of Wintek Corporation.



# EDITORIAL

## The Hidden Peril of Electronic Publishing

Although BYTE appreciates and uses the possibilities of electronic publishing as much as anyone, we also see danger lurking. Editors, journalists, and thoughtful publishers have labored through the centuries to establish basic editorial principles that are taken for granted by most print publications. Editors select and write articles to meet the interests and needs of their readers. There can be no sale of editorial coverage, nor guarantee of editorial coverage in exchange for advertisements. Print publications that violate these rules deceive readers and are held in contempt by writers, editors, and readers who recognize what is going on.

Many databases operate under different and often undeclared rules. Companies routinely pay "listing fees" to have notices appear in databases. For example, companies pay a fee to have an item appear in a real estate listing. This kind of listings service can serve both buyer and seller well as long as everyone understands two

things. First, items appear in the database if—and only if—a payment is made; and second, the operator of the listings service may or may not—only up-front disclosure lets you know—check or screen the accuracy of the information submitted to the database. If users of the database fully understand that, for example, buyers pay \$100 to have an item appear in the database and that the database service does no checking on the accuracy of the information or screening of its appropriateness, then everyone knows the rules and no one is deceived or misled. Unfortunately, many databases fail to disclose any of this information to users.

Another danger can occur if database rules—or the lack of them—are applied to publications. Suppose, for example, that a computer magazine started charging companies for coverage in the magazine. If a company refused to pay, its products would not be mentioned. The greater the payment, the greater the coverage. Magazine readers would assume that items had been selected based on the

editorial space available and the editors' judgment of which items would most interest their readers. The publication would become nothing more than a cheerleader for its advertisers and would lose its value to readers. To the extent that readers still bought and relied on the magazine as a buying guide, they would be victims of a deception.

Why raise these questions here? Because recent discussions of a proposed business venture with executives—we won't name the company—who have backgrounds in database operations made it clear that the threat to the integrity of publishing is real. "You should charge people to have items appear in your new product section," one executive said. Another suggested that we could attract advertisers to an issue by guaranteeing coverage of all the advertisers in that issue.

Respectable publishers rejected such tactics many years ago. Publishing executives who considered such tactics now would never be foolish enough to discuss them openly. But these executives with database backgrounds lacked all sensitivity to these issues. They saw the role of the publication as being simply to deliver information for companies that pay fees. There was no understanding that the publication has obligations to its readers.

To guard against the threatening degradation of publishing standards, users of databases and readers of magazines must demand to know the criteria for inclusion of material in a publication or a database. Does a vendor have to buy an ad, pay a fee, or offer some other consideration? Are those who refuse to pay excluded? Is a database comprehensive, covering every vendor, or only every vendor who pays? If the publication or database is comprehensive, do vendors who buy ads or pay other fees get preferred coverage or other special treatment?

BYTE pledges to disclose fully the conditions for inclusion of material in our electronic and print products: In all our current products, on-line and in print, editors decide all questions of coverage based solely on our understanding of the interests of our readers and subject to limitations of editorial space available. We may not always make the right choices in our coverage, but you know our standards.

—Phil Lemmons  
Editor in Chief

## BIX Happenings in February

We are planning a number of special BIX conference events for February, with topics in software, hardware, and communications highlighted.

Two events are planned in the area of data storage for small systems. The first will look at the new generation of very-high-capacity storage devices for personal computers. Magnetic hard disks with capacities of 200-plus megabytes will be the focus of this event. The second will be a discussion of the advances in recording medium and head positioning technology that are making high-capacity hard disks and very-high-density floppy disks feasible for small systems.

One of the areas of computer communications that has begun to receive a great amount of attention in recent years is microcomputer-to-mainframe links. A special conference is planned to look at the technical issues involved in terminal emulation (beyond VT52), the communications links involved, and microcomputer LAN-to-mainframe gateways.

While most programmers have

adopted new languages, thousands of lines of scientific and engineering code are still being written in FORTRAN. A BIX conference will look at the current state of this venerable language and its role in "hard sciences" computing.

Contained within the new tax laws are sections with major implications for consultants, independent engineers, and freelance programmers. A special conference looking at these sections and how professionals can minimize the negative impact of the new rules will be continuing throughout this month.

Among the other conference events the BIX staff is planning are specials covering progress in the field of artificial intelligence and an examination of the current status of the U.S. space program.

BIX also provides public domain software, technical documents, and program listings from BYTE articles for downloading from the listings section.

For information on specific starting dates of these and other special conferences and conference events, join the system.news conference on BIX.



Maxell Corporation of America, 60 Oxford Drive,  
Moonachie, NJ 07074



The gift of intelligence. Free.

You don't have to be an expert to get involved with AI (Artificial Intelligence). The Maxell AI toolbox contains a search and correlation program, Logic-Line 1 from Expansion Pgms Int'l, Inc., and an expert system shell, ESIE from Lightwave. A \$200 value, free in specially-marked 10-packs. At your Maxell dealer while supplies last.



**maxell**  
THE GOLD STANDARD



# smarterm<sup>®</sup>

## The Next Evolutionary Step in Communications Software

**In the world of communications, the result of natural selection isn't always "terminal".**

You can access your mini computer using standard terminals. But the smarter alternative is an IBM\* compatible PC and SmarTerm terminal emulation software—an advanced species of communications software.

Persoft began where most terminal emulation software companies strive to end—with exact, feature-for-feature emulation. Then Persoft took SmarTerm software to the next stage of evolution: superiority.

SmarTerm 240, the latest in the SmarTerm series, not only provides the ReGIS\* and Tektronix\* graphics capabilities of a DEC\* VT240\* terminal, but adds capabilities that are only possible through the power of a PC.

Features like error-free data transfer (using Kermit or XMODEM protocols) and programmable softkeys. And now with the new add-on network kit, you can communicate through several popular networks.

SmarTerm 240 is just one example of the most advanced line-up of DEC, Data General\* and Tektronix terminal emulation software in the industry.

Make the "natural selection." Ask your local dealer about SmarTerm terminal emulation software. Or contact:

Persoft, Inc.  
465 Science Drive  
Madison, WI U.S.A. 53711  
(608) 273-6000  
Telex 759491

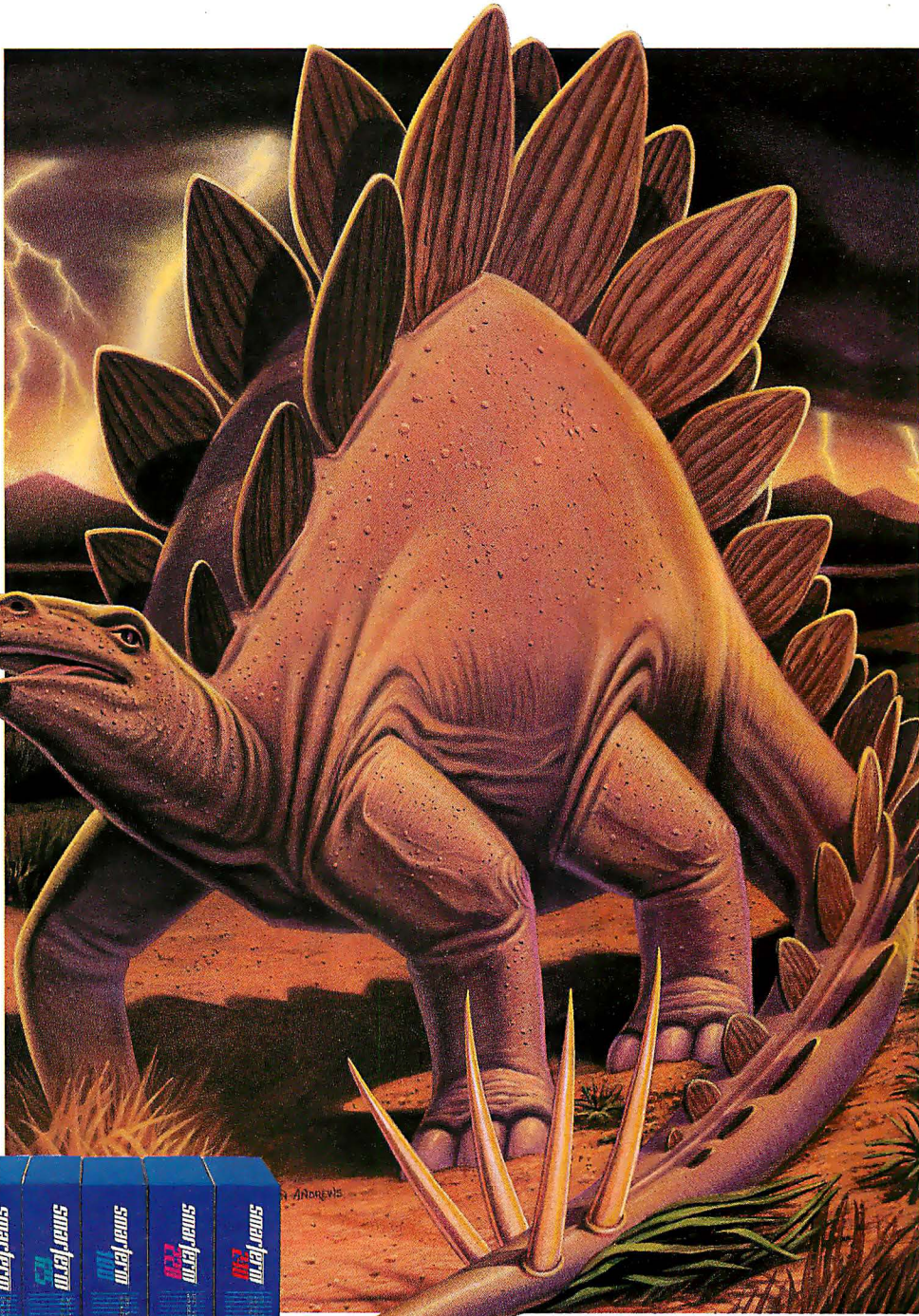

# persoft<sup>®</sup>

Inquiry 215

**SmarTerm Terminal Emulation Software  
... The Natural Selection**



# MICROBYTES

Staff-written highlights of developments in technology and the microcomputer industry.

## Organic Computing: Practical Biochip-based Systems Expected in Five Years

Primitive hybrid computers made from silicon and biochips are under development, and practical systems should be available within the next five years, according to speakers at the BioTech conference in San Francisco. The first prototype hybrids will use analog and digital logic to differentiate colors and feed that information into a computing device so that the system actually simulates the human eye.

At the heart of such a system, according to Richard Taylor, manager of Arthur D. Little's Applied Biotechnology Laboratory (Boston), are light-activated molecules that control the electron flow through the silicon chip. "The integration between the silicon and the organic biochips has already taken place," Taylor explained, "and the best features of the silicon and organic materials are being utilized." Taylor went on to say that the necessary biological molecules have been

identified and have been put on silicon using methodologies such as molecular lithography and special thin-film technology for laying down reproducible protein patterns. Asked by Microbytes Daily which companies are developing silicon/biochip computers, Taylor wouldn't specify, stating that the information is proprietary and that a race is on between manufacturers to get the first practical system to the marketplace.

Among the basic biochip devices that have been developed are amplification and threshold switches, molecular diodes that use electron-transporting dyes, photomolecular memory arrays, and biomolecular interlocked electrode circuits. Once these devices get beyond the prototype stage, practical applications will include memory-intensive systems such as 3-D graphics displays, image processing and storage, robotics, and AI.

## PC AT in Court: Micro Helps Produce Instant Transcripts

A Phoenix federal court is using an IBM PC AT to break a long-standing bottleneck in court procedure—the time it takes to get transcripts. Judge Roger G. Strand's courtroom now uses the computer to aid the court reporter in producing transcripts of proceedings. The computer can also be tied to Mead Data Central's LEXIS database of legal decisions so lawyers can do legal research from their desks.

The computer is hooked to a modified stenographic machine operated by a court reporter. The machine's output is normally a long tape with words represented by syllable marks. The tapes are unreadable by nonstenographers and must be transcribed with a typewriter or word processor. It can take days or weeks to produce a trial transcript, and such transcripts are vital for appeals and other proceedings.

In Strand's courtroom, the PC AT translates the transcript as it is created.

The text is displayed on screens on the judge's bench and on the attorneys' tables as fast as it is typed in. This lets attorneys rephrase questions and review testimony without having to ask the reporter to read back the transcript.

"Primarily what it does is increase the speed and accuracy in a number of ways without increasing cost," Strand said. He added that the system could theoretically cut the time it takes to hear an appeal from weeks to hours. "Literally, a proceeding that took place on a Monday morning could be in the 9th Circuit [Court of Appeals; the court that hears appeals from Arizona] by 11 o'clock the same morning to be reviewed that day."

The system was developed by Xcribe Corp. (Torrey Pines, CA) and was provided to the court free by Xcribe and Mead Data Central for the test. It was installed by the National Shorthand Reporters Association.

## NANOBYTES

**John Sculley**, Apple Computer's chief executive, forecasts trouble for cloners of IBM PCs. During his talk at the **Technologic Partners'** forum on the 1987 outlook for personal computing, Sculley said, "There will be some protected mode in IBM's future," referring to a move by IBM to a less-open architecture for its microcomputers. "The companies that are trying to be like IBM will have to be 100 percent compatible. A lot of compatibles companies will be squeezed out," Sculley claimed. . . . Speaking at the same forum, **Ed Esber**, Ashton-Tate's chairman, talked about Big Blue too. "IBM is going proprietary, first in silicon, then in communications, then in graphics. There's a big question about the operating system." Esber said, "There will be two standards in personal computing, or perhaps three. The IBM standard, the Macintosh standard, and perhaps the Microsoft standard if IBM goes proprietary." . . . Several sources at the conference claimed that the protected-mode DOS in the works at **Microsoft** for the 80286 processor is currently huge, with estimates ranging from 562K bytes to 1 megabyte. But another source disagreed, saying that versions distributed so far have included large amounts of debugging code and have performed well nonetheless. According to this source, the OS is totally new. . . . Another forum speaker, **Clyde V. Prestowitz**, a fellow of the Woodrow Wilson Center for Scholars and former counselor on Japan affairs to the U.S. Secretary of Commerce, said Japanese companies are rolling in cash and will try to buy U.S. firms that have strong distribution channels in this country. "Takeovers will solve the distribution problem in the U.S. for the Japanese," Prestowitz

*continued*



predicted. . . . **Quickview Systems** (Los Altos, CA) has upgraded its Zoomracks file manager for the Atari ST so that it can work as a picture database. Zoomracks II can link files from DEGAS, a color paint program, with Zoomracks data. Expect an IBM PC version of Zoomracks this year, Quickview said. . . . Another company has decided to go with DDL, the document description language from **Imagen Corp.** (Santa Clara, CA). Imagen says Ventura Publisher, designed by **Ventura Software** and distributed by **Xerox**, will be available with a DDL driver in the first quarter of next year. **Hewlett-Packard** and **Cordata** have also adopted DDL. . . . The newly formed **National Association of Desktop Publishers** (Boston) offers a bimonthly journal, buyer's guide, and discount admission to trade shows. Annual membership is \$75, according to spokesperson Michael Mahoney, who said the group's purpose is to provide "a central source for solid information on desktop publishing." . . . **Signetics** (Sunnyvale, CA) claims its CRT display controller chip set, the Bit-Mapped Alphanumeric Processor, supports bit-mapped multiple fonts at the highest text-insertion rate of any similar device. One chip controls access to display memory, another manages windows—as many as eight—in hardware. Samples are expected in the second quarter. . . . Not everyone in **New Hampshire** is a lumberjack or an editor at a computer magazine. Last year, the state led the nation in most electronics workers per 1000 people. According to the **American Electronics Association**, 40 of every 1000 Granite State citizens were employed by the electronics industry. Neighbor Massachusetts was second (37 per 1000), and neighbor Vermont tied with California for third (23 per 1000).

## Optical Disk System Uses Erasable Metal Alloys for Storage Media

An experimental read/write optical disk storage system under development at Hitachi's Thin-Film Research Center in Japan uses a thin-film, shape-memory metal alloy as the basis of the storage media. As with most optical disks, lasers are used to write information to the storage media, resulting in microscopic surface deformation on the disk. However, researchers have discovered that the shape-memory metal returns to its original shape when a higher-intensity laser beam passes over written-to areas. When the metal returns to its original shape, the data is, in effect, erased.

Hitachi America officials would not comment on the research project. But engineers familiar with both laser and shape-metal technology indicated that

the success of such a project is feasible because of advances in vapor coating techniques for shape-memory metal alloys and the availability of small but powerful high-resolution lasers. Vapor coating enables engineers to deposit very thin layers of metal alloy onto substrate material in contrast to the more conventional method of rolling metal onto a base material.

After being formed into a particular shape, shape-memory metals are able to return to their original form when heated above a certain temperature. The force generated by the isotropic shift of the atoms is so great that a square inch of alloy can move a 50,000-pound object. Memory metal alloys commonly consist of nickel-titanium or copper-zinc-aluminum.

## Scientists Try Using AI to Make Money

Scientists at the Oak Ridge National Laboratory in Tennessee are exploring the use of artificial intelligence techniques to help in the production of U.S. currency. One application is in the formulation of inks, where an expert system has been used in a somewhat limited sense to help in the mixing of ink components.

A more important goal is to develop a machine-vision system for inspecting printed notes. The current process is very labor-intensive, with each note requiring about 2 seconds to be examined by a trained worker.

Developing a system to detect flaws in printed matter as complex as a currency note is a formidable task. According to Carroll Johnson, a research scientist at Oak Ridge, the problem is

compounded by the fact that machines might recognize flaws differently than humans do. For example, a human might immediately spot a flaw in George Washington's nose but miss a flaw in one of the many scrolls on a one-dollar note. A computer, however, might do the opposite.

The Oak Ridge group is surveying human inspectors to determine what mistakes they would most likely catch, the goal being to develop a model of human perception. Later, a machine-vision system will be tailored to emulate that model. The Oak Ridge group hopes to have a working currency-inspection system ready for the Bureau of Engraving by 1990. A similar system might also be used in the production of postage stamps.

## Phoneme-based Speech System Recognizes Thousands of Words

Speech Systems (Tarzana, CA) has developed a speech-recognition device, called the Phonetic Engine, that differs from other similar systems in that it is based on phonemes—basic units of sound that are to spoken words what alphabetic characters are to written words—rather than on words or phrases. Current word-based systems are usually limited to 64 words, although one word-based system, from Kurzweil, can recognize 1000 words.

The Phonetic Engine, however, reportedly recognizes 40 phonemes

that can be combined into more than 20,000 words. In addition, these words can be spoken in a natural way, without the speaker having to pause between each word.

The Phonetic Engine turns speech sounds into phonetic codes that are transmitted through an RS-232C line to a host computer. In the computer, a program called the Phonetic Decoder then changes the codes into text according to a dictionary of phonetic codes and a set of predefined syntax

*continued*



# TEST EQUIPMENT THAT MEASURES UP TO YOUR SPECIFICATIONS



**DMM-300 \$79.95**  
3.5 DIGIT DMM / MULTITESTER

Our best model. A highly accurate, full function DMM loaded with many extra features. Audible continuity, capacitance, transistor, temperature and conductance all in one handheld meter. Temperature probe, test leads and battery included.

- \* Basic DC accuracy: plus or minus 0.25%
- \* DC voltage: 200mv — 1000v, 5 ranges
- \* AC voltage: 200mv — 750v, 5 ranges
- \* Resistance: 200 ohms — 20M ohms, 6 ranges
- \* AC/DC current: 200uA — 10A, 6 ranges
- \* Capacitance: 2000pf — 20uf, 3 ranges
- \* Transistor tester: hFE test, NPN, PNP
- \* Temperature tester: 0° — 2000° F
- \* Conductance: 200ms
- \* Fully over-load protected
- \* Input impedance: 10M ohm

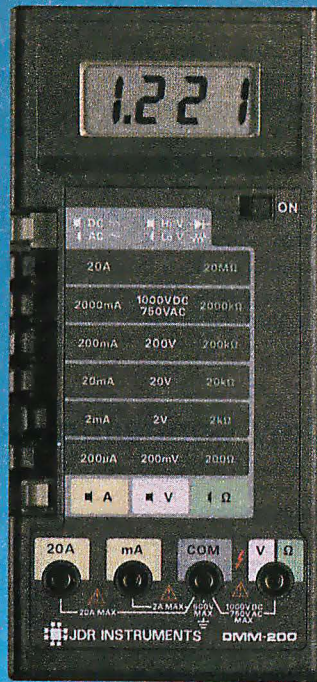

**DMM-200 \$49.95**  
3.5 DIGIT FULL FUNCTION DMM

High accuracy, 20 amp current capability and many range settings make this model ideal for serious bench or field work. Tilt stand for hands-free operation. 2000 hour battery life with standard 9v cell. Probes and battery included.

- \* Basic DC accuracy: plus or minus 0.25%
- \* DC voltage: 200mv — 1000v, 5 ranges
- \* AC voltage: 200mv — 750v, 5 ranges
- \* Resistance: 200 ohms — 20M ohms, 6 ranges
- \* AC/DC current: 200uA — 20A, 6 ranges
- \* Fully over-load protected
- \* Input impedance: 10M ohm
- \* 180 x 86 x 37mm, weighs 320 grams



**DMM-700 \$49.95**  
3.5 DIGIT AUTORANGING DMM

Autorange convenience or fully manual operation. Selectable LO OHM mode permits accurate in-circuit resistance measurements involving semi-conductor junctions. MEM mode for measurements relative to a specific reading. Probes and battery included.

- \* Basic DC accuracy: plus or minus 0.5%
- \* DC voltage: 200mv — 1000v, autoranging or 5 manual ranges
- \* AC voltage: 2v — 750v, autoranging or 4 manual ranges
- \* Resistance: 200 ohms — 20M ohms, autoranging
- \* AC/DC current: 20mA — 10A, 2 ranges
- \* Fully over-load protected
- \* Audible continuity tester
- \* Input impedance: 10M ohm
- \* 150 x 75 x 34mm, weighs 230 grams

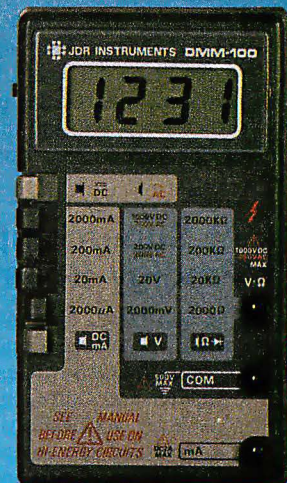

**DMM-100 \$29.95**  
3.5 DIGIT POCKET SIZE DMM

Shirt-pocket portability with no compromise in features or accuracy. Large, easy to read 5" LCD display. 2000 hour battery life with standard 9v cell provides over two years of average use. Probes and battery included.

- \* Basic DC accuracy: plus or minus 0.5%
- \* DC voltage: 2v — 1000v, 4 ranges
- \* AC voltage: 200v — 750v, 2 ranges
- \* Resistance: 2k ohms — 2M ohms, 4 ranges
- \* DC current: 2mA — 2A, 4 ranges
- \* Fully over-load protected
- \* Input impedance: 10M ohm
- \* 130 x 75 x 28mm, weighs 195 grams

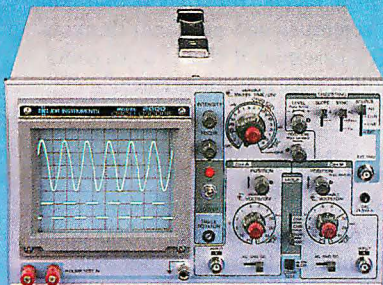

**MODEL 2000 \$349.95**  
20 MHz DUAL TRACE OSCILLOSCOPE

Model 2000 combines useful features and exacting quality. Frequency calculation and phase measurement are quick and easy in the X-Y Mode. Service technicians will appreciate the TV Sync circuitry for viewing TV-V and TV-H as well as accurate synchronization of the Video Signal. Blanking Pedestals, VITS and Verticle/Horizontal sync pulses.

- \* Lab quality compensated 10X probes included
- \* Built-in component tester
- \* 110/220 Volt operation
- \* X-Y operation \* Bright 5" CRT \* TV Sync filter

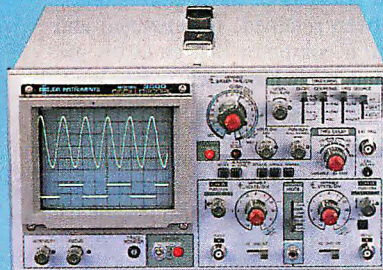

**MODEL 3500 \$499.95**  
35 MHz DUAL TRACE OSCILLOSCOPE

Wide bandwidth and exceptional 1mV/DIV sensitivity make the Model 3500 a powerful diagnostic tool for engineers or technicians. Delayed triggering allows any portion of a waveform to be isolated and expanded for closer inspection. Variable Holdoff makes possible the stable viewing of complex waveforms.

- \* Lab quality compensated 10X probes included
- \* Delayed and single sweep modes
- \* Z Axis intensity modulation
- \* X-Y operation \* Bright 5" CRT \* TV Sync filter



**DPM-1000 \$54.95**  
3.5 DIGIT PROBE TYPE DMM

Autoranging, pen style design for the ultimate in portability and ease of use. Custom 80 pin LSI chip increases reliability. Audible continuity tester and data hold feature for added convenience. Case, test leads and batteries included.

- \* Basic DC accuracy: plus or minus 1%
- \* DC voltage: 2v — 500v, autoranging
- \* AC voltage: 2v — 500v, autoranging
- \* Resistance: 2k ohms — 2M ohms, autoranging
- \* Fully over-load protected
- \* Input impedance: 11M ohm
- \* 162 x 28 x 17mm, weighs 75 grams

**2 YEAR WARRANTY ON ALL MODELS**

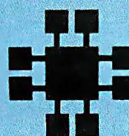

**JDR INSTRUMENTS**

110 Knowles Drive, Los Gatos, CA 95030

(408) 866-6200 • FAX (408) 378-8927 • Telex 171-110

**ORDER TOLL FREE 800-538-5000**

OR VISIT OUR RETAIL STORE  
1256 SOUTH BASCOM AVE.  
SAN JOSE, CA. (408) 947-8881



structures. The company calls its system Empirical Artificial Intelligence. The system creates a speech-discrimination model based on a series of interconnected expert systems.

Although the system has some speaker-independent capabilities, it works best after it has been trained to recognize a particular user's speech; the user reads to the machine a sample of "phoneme-rich" sentences, which

takes approximately 20 minutes. In a demonstration, a company representative read a preselected paragraph of text. The system took about two minutes to decode approximately one minute of speech.

The Phonetic Engine consists of two printed circuit boards housed in a small box that is connected to a host computer with a serial cable. Voice is input to the Engine through a telephone-style handset.

The Phonetic Decoder software is written in C and currently runs on a Sun desktop computer. The Phonetic Engine comes in two configurations. A development system, called the DS100, is available immediately for \$52,000; the PE200, an end-user system, should be available next spring for \$5000. The company wants to install the Engine on two IBM PC expansion boards and port the Decoder software to the PC as well.

## At Supercomputer Center, Mac-to-Cray Connection Aids Researchers; Prodigy Boosts Macintosh

The San Diego Supercomputer Center (SDSC) is testing a micro-to-main-frame link that involves a Cray supercomputer and "supercharged" Apple Macintosh workstations. More than one thousand researchers around the country currently tie into the center's Cray X-MP/48 to solve extraordinarily complex problems, such as designing the hypersonic jet that might someday zip from New York City to Tokyo in less than three hours.

SDSC is experimenting with two Macintosh-based Prodigy 4 systems from Levco (San Diego, CA) and plans to buy more. The \$7000 Prodigy 4 has a 16-MHz 68020, 68881 numeric coprocessor, 4 megabytes of RAM, and an SCSI interface. Curt Johnson, Levco's president, claimed that programs on the Mac Plus run 4 to 10 times faster with the Prodigy 4 installed, while programs optimized for the 68881 (using Apple-standard floating-point SANE routines) can run

as much as 100 times faster.

One of the primary functions of SDSC's Cray is to generate graphics from engineering and scientific data. "The Macintosh would be ideal for viewing and accessing that graphic data," said Serge Polevitzky, manager of peripheral systems at SDSC, "but it's limited by its 8-MHz 68000 CPU to a 320K-bytes-per-second data-transfer rate," compared to 10 megabits per second available from VAX computers via Ethernet.

"The idea behind using the Prodigy is that it gives us an idea of what the next generation of Macintosh will be like so we can plan for it," Polevitzky told Microbytes Daily.

SDSC researchers are already using 83 Macintosh Plus computers as "user-friendly shells" to the Cray and VAXes, Polevitzky said. He foresees the Cray generating animated sequences of 30 frames per second that can then be interactively edited at one

of the Levco stations or on a future Mac. "Right now, the Cray could crank all night on a given set of graphics output and upload to the Mac" and play back the different screens one at a time to provide a sense of motion, Polevitzky explained. "But you couldn't move the mouse and get a different view to see, for example, different parts of molecules moved around or rotated." Polevitzky said he hopes to have a shared editor that can run on both the Cray and the Mac to speed effective data transfer up to ten times by communicating only changes to the image. This would enable researchers to manipulate a model of a molecule and play "what if" games with an equation in a window.

"We see the Prodigy 4 as a window to the future," Polevitzky said. "We want to 'Crayize' researchers and computer scientists and get them thinking big. It's essential if the U.S. is going to maintain its lead in science."

## Doctors Using Prolog Program to Diagnose Heart Attacks

Researchers at the Medical College of Ohio (Toledo, OH) are developing an expert system written in Borland International's Turbo Prolog to help emergency room doctors determine if patients have indeed suffered heart attacks. The expert program, part of a system called Expert Scene Segmentation, evaluates data collected by ultrasound scanners.

To determine if an attack has occurred, image data of the patient's heart is gathered using a Hewlett-Packard ultrasound scanner. That data is then sent to a computer that uses

morphology algorithms (written in C) for analysis. This analysis defines the location of the heart's wall based on its "shape" in the image and defines a series of "edge" points that may or may not represent the wall. Due to the nature of ultrasonic imaging, some points may not actually represent the heart wall.

The data is then sent to an IBM PC AT running a 500-line 47-clause Turbo Prolog program that evaluates each edge point and decides if everything about the point agrees with the program's knowledge of both ultrasound

and heart-wall geometry.

The program then selects 360 points that define the heart wall and discards those that do not. An output image, which consists of those points that have been retained, is generated and sent to a computer that analyzes motion and plots how each segment of the wall moves throughout the cardiac cycle. It then compares the resultant motion to known motion patterns, using pattern-recognition techniques, and produces a report the doctor uses to evaluate the functional state of the heart.

**TECHNOLOGY NEWS WANTED.** *The news staff at BYTE is always interested in hearing about new technological and scientific developments that might have an impact on microcomputers and the people who use them. We also want to keep track of innovative uses of that technology. If you know of advances or projects that involve research relevant to microcomputing and want to share that information, please contact us. Call the Microbytes staff at (603) 924-9281, send mail on BIX to Microbytes, or write to us at One Phoenix Mill Lane, Peterborough, NH 03458.*





# INTRODUCING THE A★STAR II™

We're having a party! It's a going away party. And, it's for IBM. But, shhhhh! Don't tell them. We want it to be a surprise!

Why a party? Well, it's because we've been told that more than a few of IBM's customers have been "going away" ever since we introduced our A★Star™ PC/AT compatible micro-computer. Now that we've announced our new A★Star II, we figure a lot more of their customers will be going away. That's because the A★Star II is the *only* "network ready" PC/AT compatible that can operate at 6, 8, 10 and 12 MHz. And because it's available in a super selection of models starting at only \$995!

The A★Star II is not just another clone, it's better...*much* better! Not only is it faster and more powerful

than IBM's model, it's also incredibly less expensive. Better yet, the A★Star II is built and backed by Wells American - a company that's been making micro-computers *longer* than IBM. (We bet that surprises even you!) Plus, the A★Star II is serviced nationwide by RCA Corporation - one of the world's largest and most respected consumer electronics firms. And if that's not enough, every unit includes free schematics and a money back guarantee!

If you'd like to be a part of our IBM going away party, clip and return the coupon or call us at the number below. But don't tell IBM! If they find out how many of their customers are going away, they might just go away themselves! Of course, that would be okay with us. We never *really* invited them anyway!

**A PC/AT FOR ONLY \$995?  
WHAT A REASON TO CELEBRATE!**

**Special Introductory Offer:** Order now and receive a \$395 option - absolutely FREE! Limit one per customer. Hurry! This offer and quantities are limited.

Name: \_\_\_\_\_  
 Company: \_\_\_\_\_  
 Phone: \_\_\_\_\_  
 Address: \_\_\_\_\_  
 \_\_\_\_\_  
 City: \_\_\_\_\_  
 State: \_\_\_\_\_ Zip: \_\_\_\_\_

 **Wells American**

803/796-7800 • TWX 510-601-2645  
 Sunset Boulevard • West Columbia, SC 29169

Corporate Headquarters: 3243 Sunset Boulevard • West Columbia, South Carolina 29169 • 803/796-7800 • TWX 510-601-2645

IBM, Personal Computer AT and AT are trademarks of International Business Machines.



**"Rampage" With 2 Megabytes Of Memory Is The Perfect Addition To Our Installed Base Of PC/XTs.**

For years we've equipped all of our PCs with AST products, like SixPakPlus.\* But, Debbie ... here in accounting... needed more than 640K for her Lotus\* 1-2-3\* expanded memory spreadsheet. She suggested an

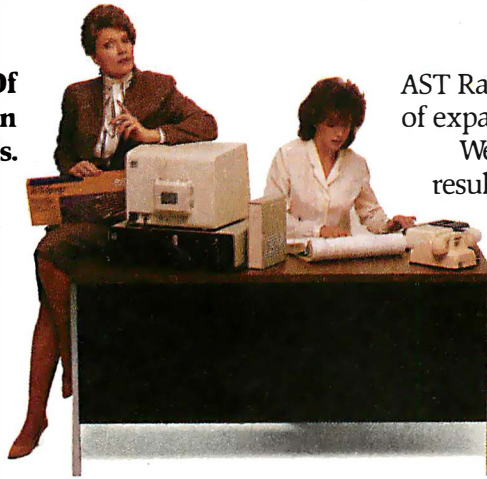

AST Rampage board with two megabytes of expanded memory.

We bought her the Rampage and the results were incredible. Now, Debbie is able to fully use her expanded memory applications.

Debbie has been promoted. And now all of our older PCs and XT's have Rampage boards!"

# "AST's Premium Ser Flexibility In

**"With SixPakPremium/EGA We Have a Versatile, Multifunction/Memory/Graphics Solution In A Single Slot.**

Meet Tony, our Financial Officer. He uses expanded memory for large spreadsheets, a parallel port for his printer, a serial port for a mouse and EGA capabilities for eye dazzling color graphics.

His XT is equipped with SixPakPremium/EGA. It delivers all the features of SixPakPremium with complete graphics capabilities — on a single board. And it's compatible with popular monochrome, color and enhanced color displays.

Tony has talked about his graphics capabilities so much

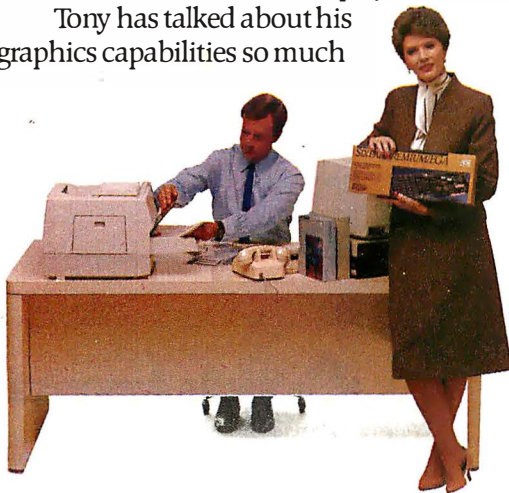



**"For New PC/XTs, SixPakPremium™ Gives Us The Right Combination Of Multifunction Features and Expanded Memory In A Single Slot.**

Today is Jim's first day. His new PC XT is equipped with AST's SixPakPremium. It gives him all the features of a SixPakPlus and Rampage—combined into a single slot.

Eventhough Jim only needs



one megabyte of memory now, as he develops his skills and projects, he'll be able to add a second megabyte of memory to the

SixPakPremium board. There's also a serial port, parallel port and battery-backed clock/calendar.

Jim represents a new generation in the company. So does SixPakPremium. They're the future!"

# ies Boards Give Us Tailoring Our PCs."

that now other departments are requesting SixPakPremium/EGA... Engineering, Sales, even Advertising.

We trust Tony to know finances. And he's found us a bargain in SixPakPremium/EGA."

**"How We Increased Our Productivity With The AST Premium Series!**

To take full advantage of expanded memory, AST includes an operating environment software package with every Premium Series board. With it Jim, Debbie and Tony can load applications into memory once in the morning. Then they're able to move instantly between the applications and even execute multiple tasks at the same time. For example, they can sort a dBASE III® file, calculate a Lotus 1-2-3

spreadsheet and edit a WordStar® document all at the same time... on the same PC!"

**To Learn More Call AST Today at (714) 863-1480.** Or send the coupon to AST Research, Inc., 2121 Alton Avenue, Irvine California 92714-4922, Attn: M.C.

AST markets products worldwide—in Europe call: 441 568 4350; in the Far East call: 852 0499 9113; in Canada call 416 826 7514. AST, the AST logo, Rampage and SixPakPlus registered trademarks and Premium Series and SixPakPremium trademarks of AST Research, Inc. Lotus and 1-2-3 registered trademarks of Lotus Development Corp. dBASE III registered trademark of Ashton-Tate. WordStar registered trademark of MicroPro International. Copyright © 1986 AST Research, Inc. All rights reserved.

YES! Send me more information today on AST's Premium Series.

Name \_\_\_\_\_

Title \_\_\_\_\_

Company \_\_\_\_\_

Address \_\_\_\_\_

City/State/Zip \_\_\_\_\_

Telephone (      ) \_\_\_\_\_

Send to: AST Research, Inc., 2121 Alton Avenue, Irvine, California 92714-4922, Attn: M. C.

01 B B058 B01 PC 2/87



**AST** RESEARCH INC.



# LETTERS

## Able, Not Willing

I have read with interest Paul Walton's article "The State of Soviet Microelectronics" (November 1986 BYTE). I feel entitled to a few comments, as I am personally experienced in this subject.

I am a political refugee from communist Poland, a naturalized U.S. citizen, an electronics engineer, and a manufacturer/exporter of computerized medical equipment to over 50 countries, including the U.S.S.R. Additionally, to my credits I have recently added 16 months' experience dealing with the U.S. Export Administration's variety of agencies, including the famous "Exodus," the U.S. Customs' high-tech counterespionage arm.

I am also under criminal investigation by the Federal Grand Jury for shipping to the Soviet Union for medical exhibition a Rat Respiration Monitor, which uses as a controller a Taiwanese IBM PC clone, (no hard disk, no color, 128K bytes of memory). Apparently the feds object to the shipping of a PC without an export license.

While I wholeheartedly agree that the technology to manufacture computers should be restricted, paranoia about export licenses for every PC is not justified. In every issue of Polish Warsaw Daily are multiple classified ads selling IBM PC/XT/ATs with a variety of peripherals. IBM maintains its offices in every communist country and is quoting and selling all models of the PC/XT/AT with short delivery times plus about 100 development programs, assemblers, compilers, etc. Companies from Taiwan and Hong Kong are offering to Soviet Bloc customers everything that is available in the U.S., with no restrictions, at prices even lower than those in the U.S. Our Western allies take convenient and lenient interpretation of COCOM (NATO Coordinating Committee) agreements and pay only formal attention to the export controls on any kind of personal computer made either in the U.S. or locally (i.e., in Italy by Olivetti or in Sweden by Ericsson, not to mention Japan).

Bulgarians, staunch Soviet allies, are assembling IBM PC XT clones with high-resolution monitor, hard disk, etc., from Taiwanese, Soviet, and Japanese components and are ready to sell them to anybody in the East or West. In fact, to prove my point and to defend myself from

absurd U.S. Customs' accusations of being a "Soviet high-tech spy," I have imported one. It runs all IBM PC software as well or better than the original IBM PC XT.

The Department of Commerce has since purchased this Bulgarian "marvel" from me. In the meantime, American exporters are waiting three to six months for export licenses for products that are available at a moment's notice to Soviets from other countries. The only limitation for Soviets in obtaining a sufficient number of PCs is not the U.S. export controls, but the Soviets' lack of hard currency and ideological restraints. They are hesitant to allow PCs to fall into the hands of millions of Soviet citizens.

In fact, as Mr. Walton briefly alluded, current export controls may be very beneficial to the Soviet Union in the long run. Soviets will start to rely more on their own research and development rather than copying Western products. It is obvious to anyone who has anything to do with new products development that the best defense in competition is to keep our own research and development efforts high and our economy vital and uncomplicated. No company or country can prosper for long by picking someone else's brains.

If we will apply cumbersome licensing bureaucracy to every IBM PC clone sent, not only to the Soviet Union, but to Taiwan or South Korea, as current export regulations require, then we will slow down our own economy to the point where it will be similar to that of the Soviet Union. The Soviets will win the technological competition without moving any faster. They will also live in a country with civil liberties similar to American ones where anyone can be labeled (by the federal Exodus agents) a spy, threatened with 5 or 10 years in prison, have his property confiscated at whim, etc. This scenario is not a dreadful nightmare of the American future, it has already happened to me here in the United States.

Ironically, Pentagon hard-liners on computer exports have full support of their counterparts in the Soviet Bloc. Here is a translation of a recent statement made by Polish General Wojtasik, head of the department of propaganda and public relations of the communist Polish Peoples' Army:

"The tendency in the mass proliferation

of (micro) computers is creating a variety of ideological endangerments (to the communistic system)."

"...Some programmers, under the inspiration of Western centers of ideological subversion are creating programs that help to form (in Polish people) anti-communistic political consciousness."

General Wojtasik is apparently not fully aware that he has full support in another (similar) professional organization on the other side of the Iron Curtain, located in Washington, D.C. Apparently, great minds always think alike.

Anyone who would like to know more about my experience with the Exodus superscope may call or write. Please be aware that my phone may be tapped and my mail may be monitored.

Jan Czekaewski  
Columbus Instruments  
950 North Hague Ave.  
Columbus, OH 43204  
(614) 488-6176

I have no quarrel with Paul Walton's facts, but I am startled by a matter of interpretation. My perception of the Soviets is based, not on direct experience, but on contact with the expatriate community while I studied the Russian language.

Mr. Walton seems to take the use of personal computers as an indicator of the level of microelectronic technology. I submit that these may be linked in our economic system, but not in the Soviets'. They seek to gain the most effective workstations possible for their loyal workers doing authorized work, while absolutely preventing the personal use of computers.

At present, those Soviet citizens who wish to circulate information not approved by the government (which controls all the printing presses) must type individual

*continued*

LETTERS POLICY: To be considered for publication, a letter must be typed double-spaced on one side of the paper and must include your name and address. Comments and ideas should be expressed as clearly and concisely as possible. Listings and tables may be printed along with a letter if they are short and legible.

Because BYTE receives hundreds of letters each month, not all of them can be published. Letters will not be returned to authors. Generally, it takes four months from the time BYTE receives a letter until it is published.





PRENTICE-HALL  
**personal  
computer**  
BOOK CLUB

### Savings Opportunity

Book #

**YES**, I want the benefits of PCBC membership. Please rush me the book indicated for 10 day free trial. If not 100% satisfied, I'll return it and owe nothing. Otherwise, I'll pay just \$3.95 (plus shipping, handling and applicable sales tax, which are added to all shipments) and agree to purchase 3 additional books at members' discounts during the year, according to the terms of this offer. (Not valid without signature.)

Signature \_\_\_\_\_

Name \_\_\_\_\_

Address/Apt. \_\_\_\_\_

City/State/Zip \_\_\_\_\_

For new members only, in the Continental USA and Canada.  
Enrollment subject to acceptance by PCBC.

Byte 71-1 PC115-BA(4)



PRENTICE-HALL  
**personal  
computer**  
BOOK CLUB

### Savings Opportunity

Book #

**YES**, I want the benefits of PCBC membership. Please rush me the book indicated for 10 day free trial. If not 100% satisfied, I'll return it and owe nothing. Otherwise, I'll pay just \$3.95 (plus shipping, handling and applicable sales tax, which are added to all shipments) and agree to purchase 3 additional books at members' discounts during the year, according to the terms of this offer. (Not valid without signature.)

Signature \_\_\_\_\_

Name \_\_\_\_\_

Address/Apt. \_\_\_\_\_

City/State/Zip \_\_\_\_\_

For new members only, in the Continental USA and Canada.  
Enrollment subject to acceptance by PCBC.

Byte 71-1 PC115-BA(4)



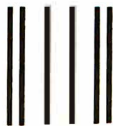

NO POSTAGE  
NECESSARY  
IF MAILED  
IN THE  
UNITED STATES

**BUSINESS REPLY MAIL**

FIRST CLASS PERMIT NO. 17 WEST NYACK, NY

POSTAGE WILL BE PAID BY ADDRESSEE

**Personal Computer Book Club**

A Prentice-Hall Book Club

P.O. Box 442

West Nyack, NY 10995

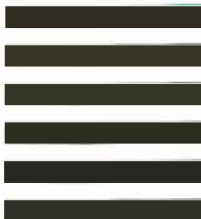

NO POSTAGE  
NECESSARY  
IF MAILED  
IN THE  
UNITED STATES

**BUSINESS REPLY MAIL**

FIRST CLASS PERMIT NO. 17 WEST NYACK, NY

POSTAGE WILL BE PAID BY ADDRESSEE

**Personal Computer Book Club**

A Prentice-Hall Book Club

P.O. Box 442

West Nyack, NY 10995

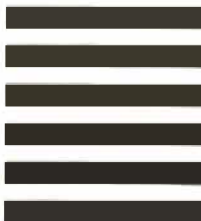



# Maximize Your Potential

Increase Your Productivity —  
at Home or on the Job.

Personal Computer Book Club puts you on line with the most up-to-date computer publications available from all the leading publishers. Each selection meets exacting PCBC standards and is chosen for its easy-to-read style, easy-to-use format, and practical value. PCBC books give you the hands-on experience you need to increase your computer skills and knowledge.

## Computer Professionals Guide You

Our advisory board of working computer professionals ensures you see only the finest computer books designed to stand the test of time.

## Books Described by Level of Sophistication

From novice to advanced programmer, you'll know the degree of difficulty each book represents — and the level of computer literacy needed to use the book most effectively.

## Dramatic Savings

You save up to \$36.00 on the introductory book, and keep saving 20-30% on every book thereafter.

## PCBC Guarantees Convenient, Reliable Service

Next time you sit down behind your PC make every minute count! PCBC books are designed to give you the expertise you need to get more work (or play!) out of your PC.

## Your Computer Bookstore by Mail

Every 3-4 weeks, you'll receive the PCBC Bulletin describing the Main Selection and Alternates. If you want the Main Selection, do nothing and it will come automatically. For an alternate selection (or none at all), mark your preference on the reply card and return it by the date specified. You'll always have at least 10 days to decide.

As a PCBC member, you are only obligated to purchase 3 books (in addition to the \$3.95 selection) during the next year, and may cancel any time after that.

Choose your first book for just \$3.95 —  
save up to \$36.00!

Book #18116-4  
Pub. pr. \$29.50



Book #44815-9  
Pub. pr. \$19.95

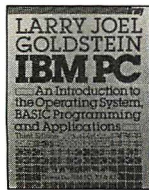

Book #53704-3  
Pub. pr. \$26.95



Book #58038-1  
Pub. pr. \$22.95

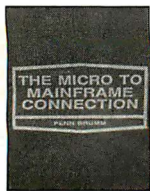

Book #D5831-5  
Pub. pr. \$21.95

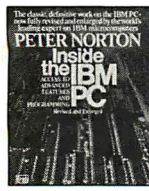

Book #69897-7  
Pub. pr. \$26.95

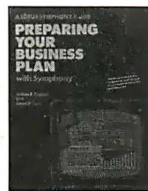

Book #15511-9  
Pub. pr. \$29.95

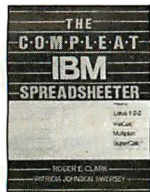

Book #15509-3  
Pub. pr. \$29.95

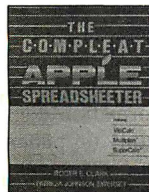

Book #33226-2  
Pub. pr. \$39.95



Book #16727-0  
Pub. pr. \$21.95

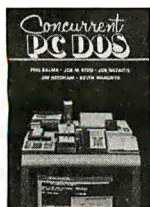

Book #R1240-2  
Pub. pr. \$32.00

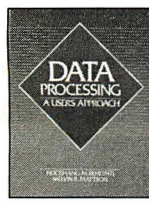

Book #55981-5  
Pub. pr. \$19.95



Book #73049-9  
Pub. pr. \$38.95



Book #88177-1  
Pub. pr. \$28.95



Book #16580-3  
Pub. pr. \$39.95



PRENTICE-HALL  
**personal  
computer**  
BOOK CLUB

Card missing? Write to:

Personal Computer Book Club  
A Prentice-Hall Book Club  
P.O. Box 442  
West Nyack, NY 10995

Inquiry 222

Personal Computer Book Club/A Prentice-Hall Book Club  
P.O. Box 442, West Nyack, NY 10995

SEND NO MONEY! Book # \_\_\_\_\_

YES, I want the benefits of PCBC membership. Please rush me the book indicated for a 10-day free trial. If not 100% satisfied, I'll return it and owe nothing. Otherwise, I'll pay just \$3.95 (plus shipping, handling and applicable sales tax, which are added to all shipments) and agree to purchase 3 additional books at members' discounts during the year, according to the terms of this offer. (Not valid without signature.)

Signature \_\_\_\_\_

Name \_\_\_\_\_

Address/Apt. \_\_\_\_\_

City/State/Zip \_\_\_\_\_

For new members only, in the Continental USA and Canada.  
Enrollment subject to acceptance by PCBC.

PC115-BA(4)





# A Hero For Our Time

We live in an age of efficiency. People want the best possible performance, the highest return on investment, that extra ounce of speed. **Modula-2** is the language that embodies that philosophy. Pecan's **Modula-2** is the implementation that best expresses that philosophy. With Pecan's professional **Modula-2** you can write fast, efficient, reliable and maintainable code.

**STATE OF THE ART:** This elegant language incorporates the best features of Pascal. In addition, it includes standard extensions for real-time programming, the module concept, improved syntax and facilities for multiprocessing and low-level machine access. **Modula-2** is suitable for programming entire computer systems, from high-level machine independent application programs to machine-specific software such as device drivers.

**COMPLETE:** Pecan includes the **Power System**, a complete, integrated development environment, along with every **Modula-2** compiler. You get a text editor, file handling utilities, library, print and file transfer utilities, in every package. And a wide variety of additional integrated program development aids are available. These include the languages **UCSD Pascal**, **FORTRAN-77**, **BASIC** and **Assembler**, so you can construct your application using modules written in your choice of languages.

**POWERFUL:** The Power System utilizes a system of fast on-screen menus so you need not learn cumbersome command structures. The sophisticated compiler/editor interface permits you to automatically correct errors as they are detected or log errors for unattended compilation. The editor itself supports editing of multiple files, dynamic function keys and virtual memory editing.

A standard set of utility modules form an integral part of Pecan's **Modula-2** implementation. These powerful modules provide facilities for input and output, random access files, disk directory operations, console I/O, storage management, program execution and process scheduling. A utility library contains modules for mathematical functions, decimal arithmetic, strings and data conversion. And the language itself supports opaque types, procedure variables, a transparent **WORD** type, an address function and interrupt-driven multitasking.

**PORTABLE:** Portability is the hallmark of the Power System and **Modula-2**. The Power System is available on more machines than any other environment. This means that programmer teams working on diverse machines will not have to learn multiple development environments. Moreover, applications developed under the Power System are themselves portable to the same wide variety of machines.

#### PECAN'S MODULA-2 FEATURES:

- Fast compilation • Native code • Separate compilation of modules • Comprehensive module library
- Integrability with UCSD Pascal, FORTRAN-77, BASIC and Assembler • Extended precision arithmetic
- Dynamic memory management • Multitasking • 8087 and BCD support (PC's and compatibles) • I/O redirection

#### **Modula-2 with the Power System environment Only \$99.95**

For PC-DOS, MS-DOS, Amiga, Atari ST, Macintosh, Apple II (including new Apple II gsl), Rainbow, Tandy, Stride, as well as most popular 8/16/32 bit systems. Also available for VAX, UNIX, PDP-11 OS's and others.

Order additional languages! Your choice of UCSD Pascal, FORTRAN-77, BASIC or Assembler for only \$79.95 with your purchase of Modula-2.

#### BUY TWO ADDITIONAL LANGUAGES AND GET ANOTHER LANGUAGE FREE!

To custom-tailor software, PECAN offers such programming tools as:

SYMBOLIC DEBUGGER .....	\$59.95	CONFIGURATION TOOLS .....	\$39.95
PROGRAM ANALYSIS TOOL KIT .....	\$59.95	DISK RECOVERY TOOL KIT .....	\$39.95
APPLICATION SERVICES INTERFACE .....	\$59.95	PRINT SPOOLER .....	\$39.95

ORDER MODULA-2 AND ALL SIX UTILITIES AND PAY ONLY \$199.95 FOR A TOTAL SAVINGS OF \$100.

Write for a complete list of our other development aids.

**ATTENTION CORPORATIONS:** Ask about our training seminars:

**SCHOOLS:** Special educational discounts.

NOT COPY PROTECTED

Mail your check or money order to:  
Pecan Software Systems, Inc.  
1410 39th Street  
Brooklyn, New York 11218  
(718) 851-3100  
ITT TELEX NUMBER: 494-8910  
CompuServe ID: 76703, 500

Inquiry 211

**PECAN**<sup>TM</sup>  
The UCSD Pascal Company

Credit Card Orders  
Call Toll Free **1-800-63-PECAN**  
(NYS) 1-800-45-PECAN

Please add \$4.50 for shipping within the US. Foreign orders add \$15.00 and make payment by bank draft payable in US dollars on a US bank. New York State residents add appropriate sales tax.

UCSD Pascal is a trademark of the Regents of the University of California

copies one at a time. This is called *samizdat* (self-publishing). Access to photocopier machines is rigidly controlled. Computers that don't generate Cyrillic characters and word processors that run in English are additional assurance that if someone did get access to a computer, it wouldn't be much good for printing or duplicating information for use by the general population.

I can imagine very few things more destructive of government control of information flow than having a million stations equivalent to our Commodore 64, randomly distributed to private citizens, with perhaps a thousand in activist hands. Even a lowly Commodore 1541 disk drive can duplicate a 160-kilocharacter disk in four or five minutes. The liberating effect of not having to individually enter every character every time information is to be shared should dramatically increase the flow of information.

Information distributed in our society is mainly on paper rather than magnetic media for reasons of cost-effectiveness: The message gets to more people per dollar. The bottleneck of *samizdat* is not money, but time. If the computers were available at any cost, it would be more effective to invest the hours now being spent in repetitive typing into earning cash to get a computer, no matter how long it took.

If I were circulating information the government didn't like in the Soviet Bloc, I would have little interest in a modem—too easily monitored. But there is a brisk underground trade in audio cassettes of Western music. Can you imagine the headaches (literal and figurative) for security agents if text files were transported by overwriting binary onto one channel in the middle of a stereo cassette of heavy metal music? One would hope it would be less risky to carry such a cassette than a disk, let alone a compromising manuscript.

At any rate, I wouldn't take the Soviets' retarded state of personal computing as an indicator of their capability in any field they want to develop.

Harry R. Meyer  
San Diego, CA

#### Good Enough for Me

I was interested in your preview of the Apple IIGS (October 1986); not necessarily the machine itself, but in your incidental comments.

The fact that Apple has chosen a "conventional" design for its GS says more about the state of the marketplace than about the state of Apple's technology. Is the machine "weighted down" by its "venerable and outdated" architecture? Really?

continued



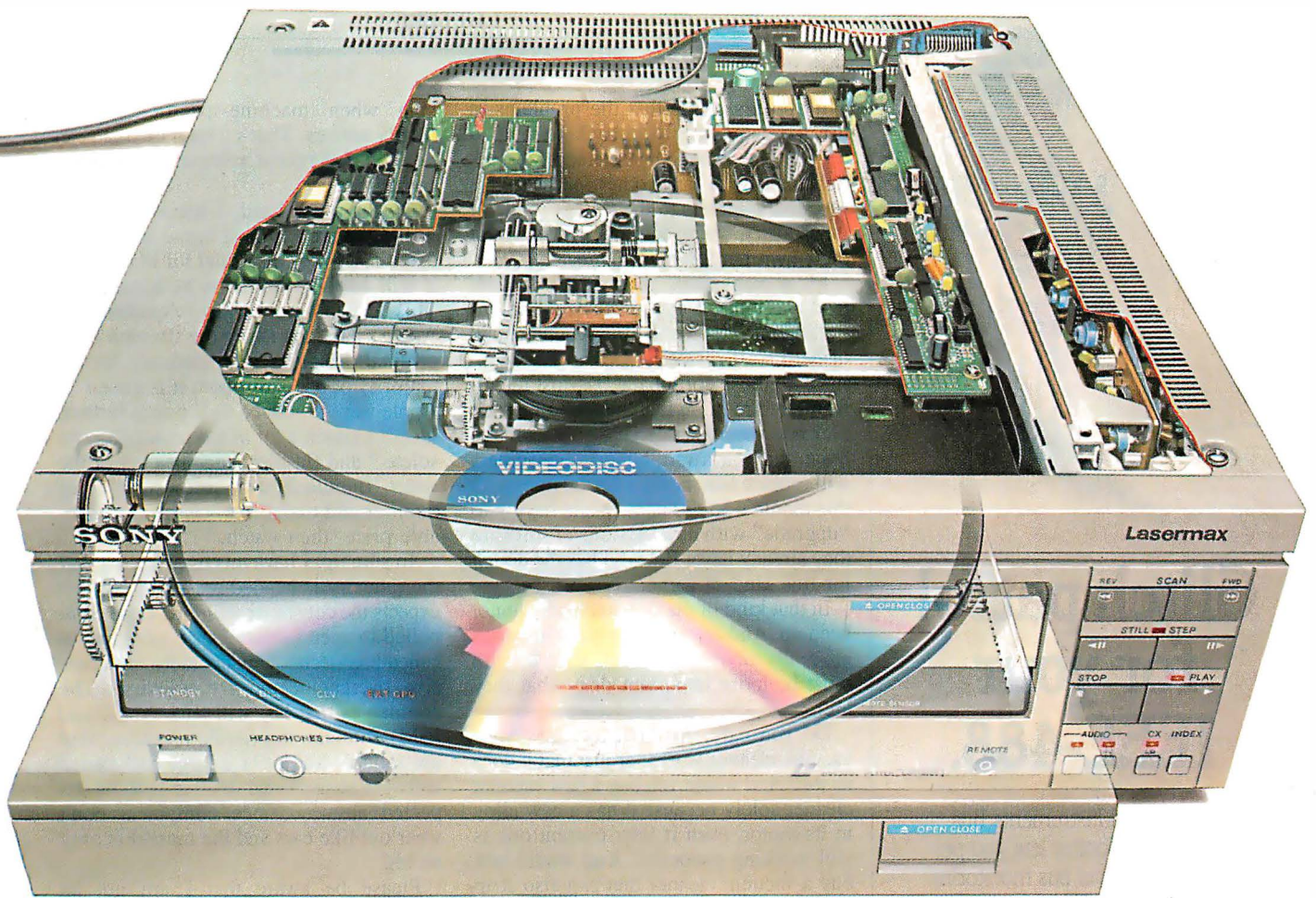

# The one videodisc player that won't box you in.

**The Sony LDP-2000.** The one and only videodisc player with the total flexibility you've been looking for. All other videodisc players limit your ability to expand. What you see is what you get. But the Sony LDP-2000 is amazingly expandable.

The LDP-2000 is the foundation of the Sony Intelligent Video™ System. It enables you to choose from five configurations to fit your application. And when your needs change, simply add the boards you need internally. The footprint always stays the same.

The LDP-2000 will work with *any* computer. It has two external interfaces: an RS-232C and an optional IEEE-488 parallel interface for high-speed digital data transmission. It can also control up to 14 players through one communication bus.

You can take the LDP-2000 anywhere with confidence because of its Automatic Optical Block

Lock—turn off the power and the optical block locks, eliminating potential damage in shipment.

Then there's the Still Frame Audio capability, for over 15 hours of compressed digital audio per videodisc side. The LDP-2000 also decodes up to 221 megabytes of digital data from the videodisc, making it a data disk and videodisc in one.

And the LDP-2000's access speed is really impressive: under 1.5 seconds from frame 1 to frame 54,000.

Of course, the LDP-2000 is an integral part of the Sony View System, the only totally integrated intelligent video system.

But if all you need now is a videodisc player, remember Sony's is the only one that won't box you in.

For more information or to arrange a demonstration, write to: Sony Information Center, Dept. A, P.O. Box 6185, Union, N.J. 07083.

**SONY**  
VIDEO COMMUNICATIONS





## Glitch patrol for your IEEE-488.

The National Instruments Bus Analyzer/Monitor lets you perform high-level bus monitoring and analysis on any IBM-PC or compatible. It can store data in memory for later analysis, or provide real-time condition information for early warning of system glitches.



You can also use our Analyzer to run user-defined files of commands and data in order to prototype and debug GPIB systems. It comes as a single plug-in circuit card, and allows the PC to maintain its standard functioning.

For more information, call 1-800/531-4742.

**NATIONAL INSTRUMENTS**  
 12109 Technology Blvd.  
 Austin, TX 78727  
 512/250-9119  
 800/531-4742

It appears to me that the problems in the microcomputer industry have more to do with the attitude that change is essential than with any other cause. This especially applies to the "home" side of the industry, where consumers must spend their own hard-earned money.

Most magazines, your own included, tend to criticize a manufacturer for not installing the latest, up-to-the-second chunk of hard stuff inside its GFRgLBx micro (love all those consonants!). Most manufacturers are more than happy to provide ever-new incompatible GFRgLBxes in the hope that hardware-hungry consumers will replace last month's \$5000 item with this month's \$6000 item, while having to "upgrade" with new versions of software they already have! But who has the dough for this kind of game?

In that kind of market, software cannot keep up. And *software* is what computers are really all about. That is, what they do must be more important than what they are.

Do you care, for instance, how your vacuum cleaner works, or just that it does its job? And would you buy a new vacuum cleaner solely because it has a new alloy in its motor, even if your current one is still working properly? And would you buy a vacuum cleaner that can also strip the old varnish from hardwood floors if your plywood floors are covered with carpet? Similarly, what user really cares that his microprocessor only has a 16-bit-wide data bus and the current latest is 73?

Hey, don't get me wrong; I like computers for what they are. I get a big thrill if I can make my disk drives read a chunk of data a quarter of a second faster. (Jeez, now I've got the time I need to conquer Europe!) I would love to be able to insert a whole meg of RAM into my computers, even though I could never use it all (if I could do it for free). But in the end, I have to use my "obsolete" machines, and since they do their jobs satisfactorily, I don't intend to buy more plastic.

Getting back to Apples: The attempt to make the new machine compatible with earlier IIs shows that the company is sensitive to the needs of the user, as opposed to the desires of the "buff." If I were looking for my first computer, I would want to know that it could run readily available, tested software. Furthermore, if I did not intend to become a computer hobbyist, I wouldn't care how it accomplished what it did.

You say that the GS will "ironically" suffer from the traditional lack of software upon its introduction. At least the consumer will be able to tap the vast market of existing Apple II software while waiting for the fancy new stuff and still be able to look forward to making the new features

sing when machine-specific software finally arrives. That's a lot more than can be said for recent releases from other companies.

On the other hand, I agree that the II would suffice for most home and school users at a lower cost, and for that reason it will likely continue to be a mainstay. This doesn't show any weakness on Apple's part, but rather the strength of its original design and its adequacy for the majority of users at whom it is aimed. If Apple were to reduce its II prices further, it could knock a lot of the newer, "unobsolete," and flashier machines out of the water. Bundle it with software, a color monitor and disk drive, charge a reasonable price, then watch.

To sum up, I have this ugly feeling that the industry is headed for a bad fall if it expects the consumer will forever be compelled to spend salaries or profits on so-called high-technology upgrades or expensive, overengineered first machines. The companies that last will (like Apple and IBM) continue to provide machines that are reliable and offer a large and varied software base. Some decline is to be expected anyway, since computers don't wear out like cars and the market is only so big.

Please be aware that I am not an apologist for Apple; they can look after themselves. I don't even own any Apple products. (I'm an Acorn user and edit an Acorn newsletter.) What I am is a computer user who wonders what all the yelling about technology is accomplishing. I use my camera to photograph, my car to drive, and my computers to compute. What else really matters?

John Lasruk  
 Toronto, Ontario, Canada

### More on Pan-Reif

In connection with the Pan-Reif iterative method of matrix inversion treated in your "number crunching" issue (April 1986), an important variant due to Alan Mackay of the University of London (*Practical Computing*, September 1981) might interest the analysts among your readers.

To possess a conventional "inverse," a matrix must be square; but Mackay proposes an  $m \times n$  "generalized inverse"  $B(m,n)$  of the  $n \times m$  rectangular matrix  $A(n,m)$ , defined by an iteration  $B_k \rightarrow B$ ,  $k = 1, 2, \dots$ . If  $I$  denotes the unit matrix, the iteration is either

$$B_{k+1}(m,n) = B_k(m,n) \times [2 \times I(n,n) - A(n,m) \times B_k(m,n)]$$

or

$$B_{k+1}(m,n) = [2 \times I(m,m) - B_k(m,n) \times A(n,m)] \times B_k(m,n),$$

continued



# ORCHID'S JET 386™: POWER FOR THE FUTURE NOW

SPECIAL  
PRICE  
\$1199.00

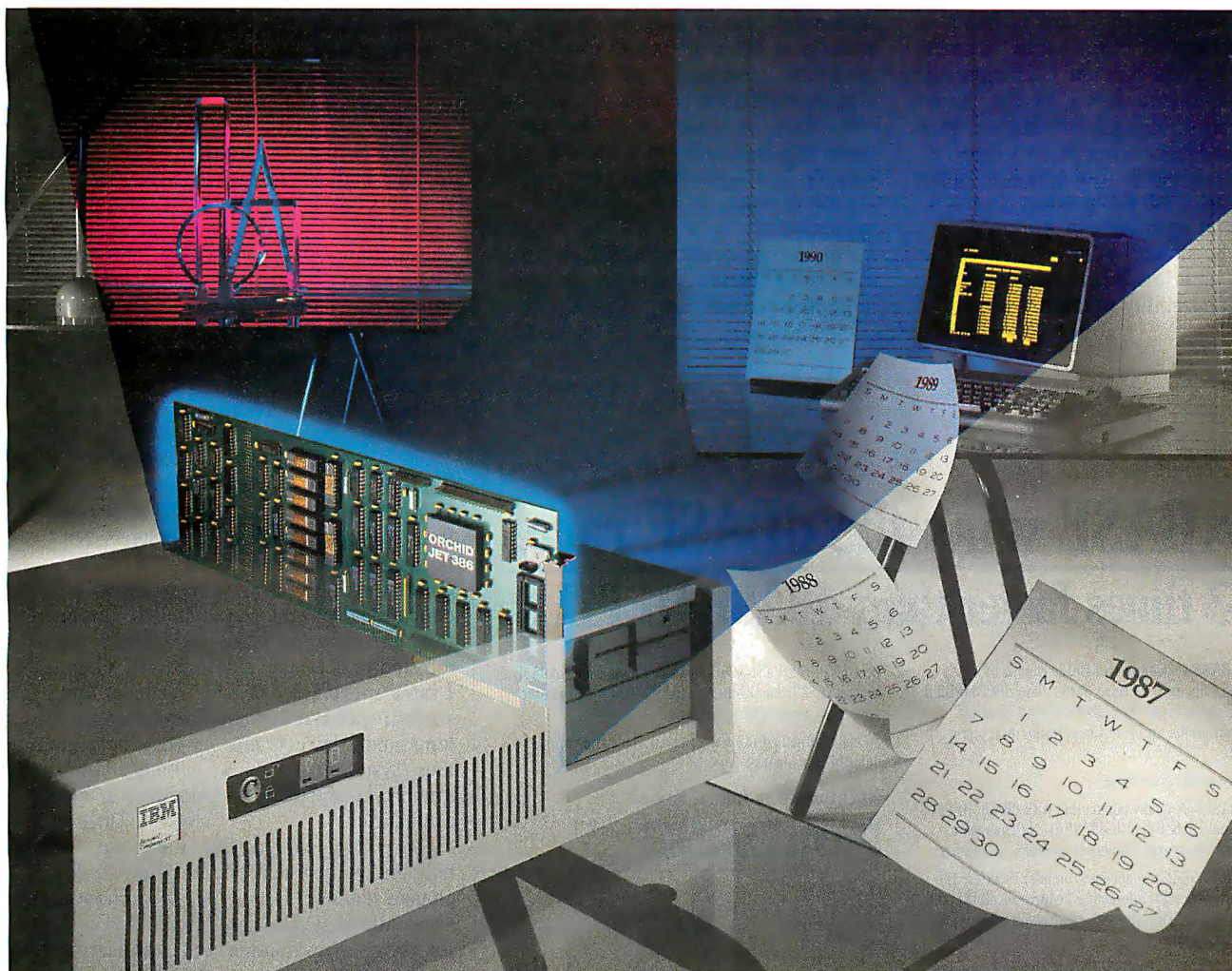

## Jet 386 is the Ultimate Accelerator Upgrade for Your AT

Announcing an end to obsolescence. Orchid Technology's Jet 386™ accelerator card extends the life of your computer investment into the 1990s—it puts power in your AT that you won't outgrow.

### Three Times Faster than an AT

It's up to three times faster than an AT depending on the application, and speed is just one benefit. Unequaled compatibility and provisions for upcoming 386 software mean your Jet 386 will handle whatever the future has in store: CAD, spreadsheets, networking...

### Easy Upgrade

Easy to use, there's nothing new to learn and no new programs to buy. At 25% of the cost of buying a new 386 PC, it's easy on your pocketbook, too.

### From the People Who Started It All

Orchid combined 80386 power with the technology perfected for the XT in the TinyTurbo and PCTurbo 286e. Like these critically acclaimed accelerators, Jet 386 is built for lasting value.

Call Orchid to find out how you can experience the future today. And ask how Orchid can modernize your whole office with turbos, graphics, networking, and multifunction products.

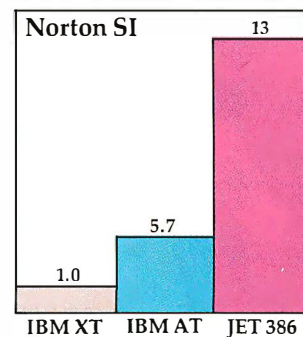

*Building for the Future*

45365 Northport Loop West  
Fremont, CA 94538  
415/490-8586 Tlx: 709289

Inquiry 191 for End-Users.  
Inquiry 192 for DEALERS ONLY.

Jet 386, PCTurbo 286e and TinyTurbo 286e are trademarks of Orchid Technology. All other products named are trademarks of their manufacturers.



the first (right inverse) being computationally more efficient for the case  $m > n$  and the second (left inverse) for  $n > m$ . Iteration may be halted when the trace (sum of diagonal elements) of the product matrix  $A \times B_k$  or  $B_k \times A$  in the square bracket ceases to increase. For an initial value, Mackay uses  $B(m, n) = k \times A(m, n)$ , where  $1/k$  is the sum of absolute values of all entries of the product matrix of  $A(n, m)$  and its transpose  $A(m, n)$ .

Though slower than Pan-Reif, the Mackay iteration possesses even more remarkable stability properties, inasmuch

as it converges regardless of whether the system of linear equations to which it corresponds is over- or underdetermined, and it shows excellent tolerance for redundancy of those equations, singularity of  $A$ , etc. If  $n$  represents the number of equations, input data, or linear constraints and  $m$  represents the number of unknowns or adjustable constants, either of the above iterations generally converges to a "best approximate" inverse matrix, whether  $n > m$ ,  $n = m$ , or  $n < m$ . These properties make it of interest for small as well as large matrix inversions. (Pan-Reif itera-

tions are of practical interest only for large matrices.) In the overdetermined case ( $n > m$ ), the approximation is best in the least-squares sense; so, least-squares fitting is accomplished automatically. In the  $n < m$  case, even more remarkably, the process assigns best-available values to all unknowns, furnishing a full solution set of  $m$  smallest (otherwise nonunique) numbers consistent with the (inadequate) input data. The importance of such a capacity for stable control (e.g., of robots operating in uncertain, off-design, or data-impooverished environments) is apparent. Mackay's generalized inversion concept should prove to be of broader interest in mathematics.

Thomas E. Phipps Jr.  
Urbana, IL

### Teachers' BBS

I am a teacher who, over the past two years, has gotten into using computers; not because I wanted to but because I needed computers in order to do my work as an educational program evaluator. In doing this, one of the areas that I have been interested in is telecommunications. Thus, I have spent a lot of time on local and sometimes far-remote bulletin board systems and I have found out that most of these systems carry the same kinds of programs and educational administration and evaluation.

Since it is evident that there are no bulletin-board systems for educators to exchange ideas on issues, nor to exchange applications which they have developed for program evaluation and administration, nor to learn about others' "impressions" on instructional software, I am setting one up for this purpose.

I would appreciate it if you would inform your readers about this service. I would also appreciate any comments or ideas you or they may have on making this BBS useful to educators. If anyone has any questions or would like to discuss this further, please leave me a message on the BBS at (616) 754-3077.

Marianne C. McFall  
Greenville, MI

### The Cowboy Did It

I have just read the Mathematical Recreations article entitled "Paradoxes of Probability" by Robert T. Kurosaka (November 1986). I draw your attention to the last part of the article, "Poker Challenge."

Mr. Kurosaka must be fairly young; I would guess under 30. Were he older, he might remember a TV show popular in the late 1950s called "Maverick," in which this hustle was illustrated.

Bart Maverick was a member of the jury

*continued*

## FoxBASE wins the dBASE race! 6.43 times faster than dBASE III PLUS

New FoxBASE+ sweeps the field: runs 2.26 times faster than Clipper, 6.69 times faster than dBCompiler, and 10.86 times faster than dMAN! And FoxBASE compiles programs up to 60 times faster than other compilers.

*The others aren't even close!*

New FoxBASE+ is totally compatible with dBASE III PLUS as is original FoxBASE with dBASE II. No changes in your present programs, databases, screens, or reports!

Though FoxBASE is a super-fast compiler, it offers the familiar, user-friendly interactive features of dBASE and the full power of "dot prompt" mode plus many significant enhancements.

Best of all, FoxBASE is economical. Single-user FoxBASE costs just \$395, multi-user FoxBASE \$595\*\*—no matter how many workstations you have.

So call (419) 874-0162 now, and ask for a copy of our detailed benchmarks. After all . . .

Nothing Runs Like a Fox.

**FOXBASE** 

Fox Software  
27475 Holiday Lane, Perrysburg, OH 43551  
(419) 874-0162 Telex: 6503040827

FoxBASE is available in single and multi-user versions for MS-DOS, XENIX, UNIX, many networks, and other environments.

\*Computed at  
speed in comparison  
of dBASE III PLUS  
for 16 benchmark  
programs. \*\*For MS-DOS.  
Multi-user XENIX version  
available at \$795. Fox-  
BASE and FoxBASE+ are  
trademarks of Fox Soft-  
ware. dBASE II and  
dBASE III PLUS are  
trademarks of Ashton-  
Tate. Clipper is a  
trademark of Borland  
- dBCompiler is a  
trademark of WorldTech  
Systems Inc. - dMAN  
is a trademark of Versa-  
Soft Corporation. - UNIX  
is a trademark of AT&T  
Bell Laboratories. -  
XENIX and MS are reg-  
istered trademarks of  
Microsoft Corporation.

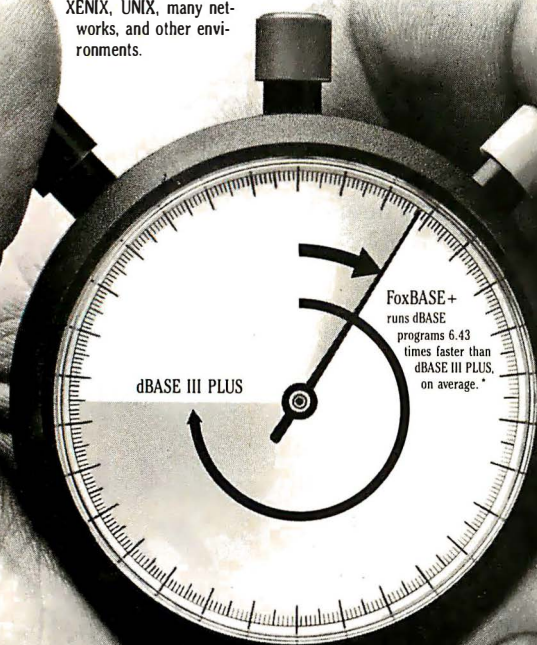



# AMAZING

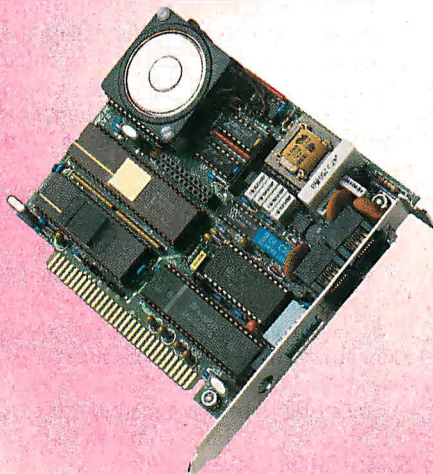

## Ten Good Reasons to Buy an Amazing Things™ Model "A" Series™ Modem

**1. Amazing Things Modems Provide Access to a Wealth of Information through Databases.**

You can access over 2,500 informational databases with an Amazing Things Modem. Research topics from astrology to zoology, stock quotes, news, weather, sports, legal references, medical information and more.

**2. Amazing Things Modems Network.**

Connect your personal computer to any other personal computer in your office or in the world.

**3. You can Telecommute with Amazing Things Modems.**

Work at home and send your data to the office via telephone. Observers believe that 15-20 percent of the office workforce will be telecommuting by 1990.

**4. Amazing Things Modems are Direct Links to any Mainframe.**

Access your company's mainframe from your office, from your home or on the road with an Amazing Things Modem.

**5. Amazing Things Modems Overcome Incompatibility Problems.**

Send documents from one personal computer to another, even if the systems are incompatible.

**6. Amazing Things Modems Bring You Electronic Banking and Shopping.**

Many banks now offer banking and investment services over the telephone. And you can shop for thousands of products — from cameras to clothing — with electronic catalogues.

**7. You Can Send and Receive Electronic Mail with Amazing Things Modems.**

Send letters and memos instantly. Mass mail them automatically, across the office or across the country.

**8. Amazing Things Modems are Inexpensive Alternatives to the Telex.**

Send and receive volumes of information overseas at a fraction of the cost of a Telex.

**9. Amazing Things Modems are Fun.**

Through various bulletin boards, you can join clubs, exchange software, advertise, meet people, find jobs and much more.

**10. Amazing Things Modems are Inexpensive.**

The Amazing Things Model "A" Series 1200B Modem is priced at **\$149.95** — about one third the price of an equivalent Hayes Modem. And the 2400B is priced at only **\$289**.

● 300-1200 Baud \$149.95

● 300-2400 Baud \$289.

● Half-Card

● Auto-Answer, Auto-Dial

● Hayes®-Compatible

● Full or Half-Duplex

● Two-Year Warranty

● For Leading Edge® Personal Computers, IBM and Compatibles

For a dealer near you or to order direct, call 1-800-835-0139, (617) 551-0880 in MA.  
MasterCard and Visa accepted.



**Amazing Things Inc.  
57 Providence Highway  
Norwood, MA 02062**

Amazing Things and Logo and Model "A" Series are trademarks of Amazing Things, Inc. Hayes is a registered trademark of Hayes Microcomputer Products, Inc. IBM is a registered trademark of International Business Machines Corp. Apple is a registered trademark of Apple Computer Inc. Leading Edge is a registered trademark of Leading Edge Products, Inc.





in a typical "western" murder trial. Maverick and all the jurors save one had all agreed to acquit. Maverick bet the remaining juror that he (Maverick) could make five "pat" hands out of the first 25 cards dealt from a deck. If successful, the odd man would change his vote to acquittal; if unsuccessful, Maverick would change his vote to guilty.

As Kurosaka indicates, Maverick won and that ended the story. When asked how often that could be done, Maverick said it worked almost every time. He called it "Maverick Solitaire."

While I was in the Navy in the mid-sixties, I won a lot of money and drinks with this same hustle. I can't remember the last time I was unsuccessful.

Scott Wagner  
Park Ridge, IL

**Anybody Here Seen Loglan?**

This is a call to whomever may know the whereabouts of any current research or activity in Loglan.

Loglan is an artificial human language developed by James Cooke Brown. It has grammar that is based on the laws of formal logic and a vocabulary derived algorithmically from the corresponding words in the eight largest natural languages. The

rules of spelling and pronunciation are designed so that any given string of spoken Loglan syllables can be parsed into words in only one way; this makes the language uniquely suited for machine transcription. The overall goal was to design a language with minimum ambiguity that could still express the full range of human thought.

It strikes me that with the proper software, current personal computers could serve as Loglan tutors; besides its potential as an international auxiliary tongue, Loglan could become the lingua franca of intelligent machines. It might also serve as an intermediate stage in machine translation between the eight natural languages.

James Cooke Brown hoped to test certain theories of linguistic philosopher Benjamin Lee Whorf. If people could become fluent enough in Loglan to think in it, the clarity and efficiency of their thinking should improve. I have not heard whether this level was reached; the most recent material I have found is from 1975. Loglan research was always a shoestring affair, largely financed by Brown himself. If the language could be made available to computer hobbyists, much more might be done.

If anyone knows the current status and

whereabouts of Loglan research, please write to me:

John Hodges  
P.O. Box 912  
Blacksburg, VA 24060

**FIXES**

**Protected-Mode Program**

Ross Nelson's "A Protected-Mode Program for the PC AT" (BYTE's *Inside the IBM PCs*, Fall 1986) included some MASM source code. When the code was written, only version 2.0 was available. Now, a number of people have the latest version (4.0) and the code will not assemble properly. The solution is to remove the statement INCLUDE protect.inc and change the line .286C to .286P. Thanks to BIXer "scoles" for pointing this out.

**Version of Turbo Pascal**

Douglas F. Yriart, in his article "Using DOS Functions from Turbo Pascal" (December 1986), states on page 105 that the program DirectoryDemo compiles correctly with version 2 and 3 of Turbo Pascal. After further testing, we have found that it compiles correctly only with version 3. ■

**THIRD GENERATION PROGRAMMERS FROM GTEK**

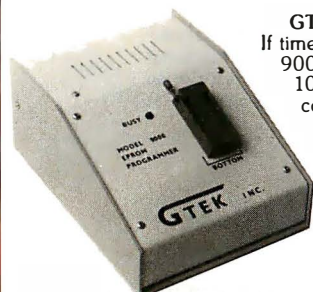

**GTEK MODEL 9000 (E)EPROM/MPU PROGRAMMER**  
If time is money, then let us save some for you. The new model 9000, using its quick pulse algorithms, can program a 2764 in 10 seconds. The 9000 offers higher performance than the competition has even begun to think about. Baud rates to 57,600. Supports thru 1024K standard, 8 meg worldwide parts with adapter. Cypress proms, mpu's. NO personality modules. As with our other programmers, RS-232, ASCII data formats, and flexible handshaking make the model 9000 compatible with virtually any computer.

Introductory price \$749

**MODEL 7228 (E)EPROM/MPU PROGRAMMER**

The standard by which other programmers are judged. With thousands in the field, the time proven 7228 has become our most popular programmer. Intelligent algorithms standard. Programs a 2764 in one minute. Supports devices thru 512K, mpu's, eeproms, cmos. NO personality modules.

price \$599.



**MODEL 7965 GANG (E)EPROM/MPU PROGRAMMER**

The 7965 can program eight 2764's in one minute using intelligent algorithms. Standard support thru 512K, eeproms, cmos, mpu's. A must for production environments. Available in stand alone configuration for ..... \$ 979 or with RS-232 interface for ..... \$1099

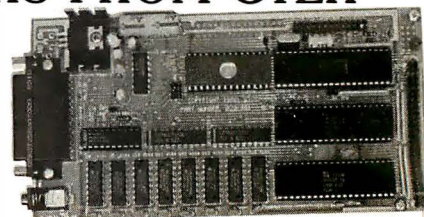

**Single Board Computer Model 210**

- 64 to 256K bytes data or program ram.
- Use 2764 or 27512 eeprom or eeprom program memory.
- Uses single ended 9V @ 500 ma supply.
- Use 8031, 8032, 8751, 8752 mpu.
- 40 BIT programmable I/O lines.
- Expansion interface connector.
- Baud rates to 57,600 baud.
- Built in 5 volt regulator.
- Built in rom monitor.
- Small — 3.5 x 7 inches.
- 8052AH basic option with EEprom

**ONLY \$299.00 WITH MANUAL**

**NEW "PX, XT, AT" PRODUCT**  
**8 PORT RS232 BOARD** — Completely DOS compatible. Satisfaction guaranteed. Call and ask about this new board.

**\$495.00**



**DEVELOPMENT HARDWARE & SOFTWARE**

Drawer 1346, Bay St. Louis, MS 39520 U.S.A.  
MS & Technical Support 1-601-467-8048; TELEX 315814 (GTEK UD)  
**INC. ORDER TOLL FREE 1-800-255-GTEK (4835)**

GTEK, PALASM, CPM, MS-DOS, PC-DOS, ISIS, TRSDOS, & CPEmulator are registered trademarks.







# Successful Te

TECH PC PORTABLE  
COMPUTERS are available  
now in 4 different base models:

TECH PC/XT\*  
PORTABLE . . . \$ 899

TECH TURBO PC/XT  
PORTABLE . . . \$ 999

TECH PC/AT\*  
PORTABLE . . . \$1799

TECH TURBO PC/AT  
PORTABLE . . . \$1999

ALL TECH PC PORTABLES  
available with tape backups,  
hard disks up to 1 gigabyte,  
networking systems, and  
hundreds of other hardware  
and software accessories.

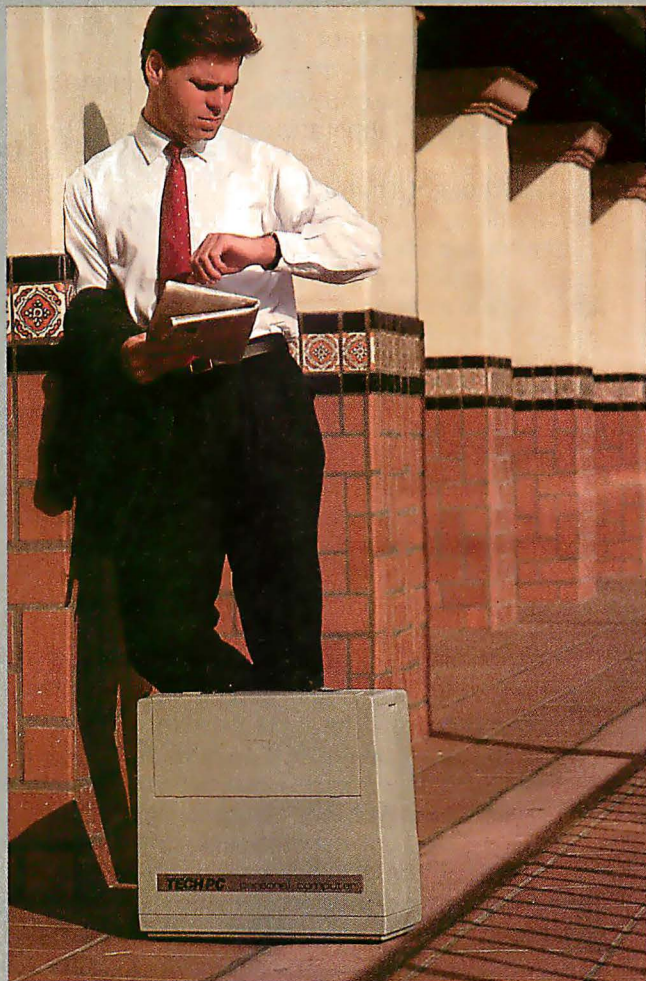

The Personal Computer has become a vital member of most successful teams, but until recently has refused to travel. Tech PC Portable Computers can perform equally well in the office or on the road without ever turning in an expense report. Now you can travel first-class and let the best of your staff ride as baggage.

For the not so mobile, Tech Personal Computers offers the PC/AT II. It has the same insatiable appetite for huge docu-

## **TECH PC**

(714) 385-1711

1911 Betmor Lane, Anaheim, California 92805  
Telex 272006 Answer Back - TECH FAX: 7143851523

Inquiry 289 for End-Users.  
Inquiry 290 for DEALERS ONLY.

# Tech



# ams.



TECH PC/AT II— \$1129

19 Inch Desktop Sized

Sturdy Case

8 MHz 80286 CPU

4 MHz 80287 Math

Co-Processor Socket

TECH PC/AT II TURBO—

\$1229

19 Inch Desktop Sized

Sturdy Case

8 to 10 MHz 80286 CPU

10 MHz 80287 Math

Co-Processor Socket

Complete MS-DOS,\* PC-DOS,\*

Xenix\* Compatibility.

Runs Lotus 1-2-3,\* dBase III,\*

Framework,\* and all other

AT software.

ALL TECH PC/AT II MODELS

available with tape backups,  
hard disks up to 1 gigabyte, net-  
working systems, and hundreds  
of other hardware and software  
accessories.

ments and massive portions of numbers as conventional 286 systems, but in a size that won't consume the lion's share of your desktop space.

At Tech PC we're out to capture your microcomputer business. Whether you're fully mobile or firmly rooted, no one matches our diverse line of high performance products, or comprehensive system of support, warranty and maintenance service options.



# Personal Computers Inc.



# EXPAND YOUR PC TO NEW HORIZONS

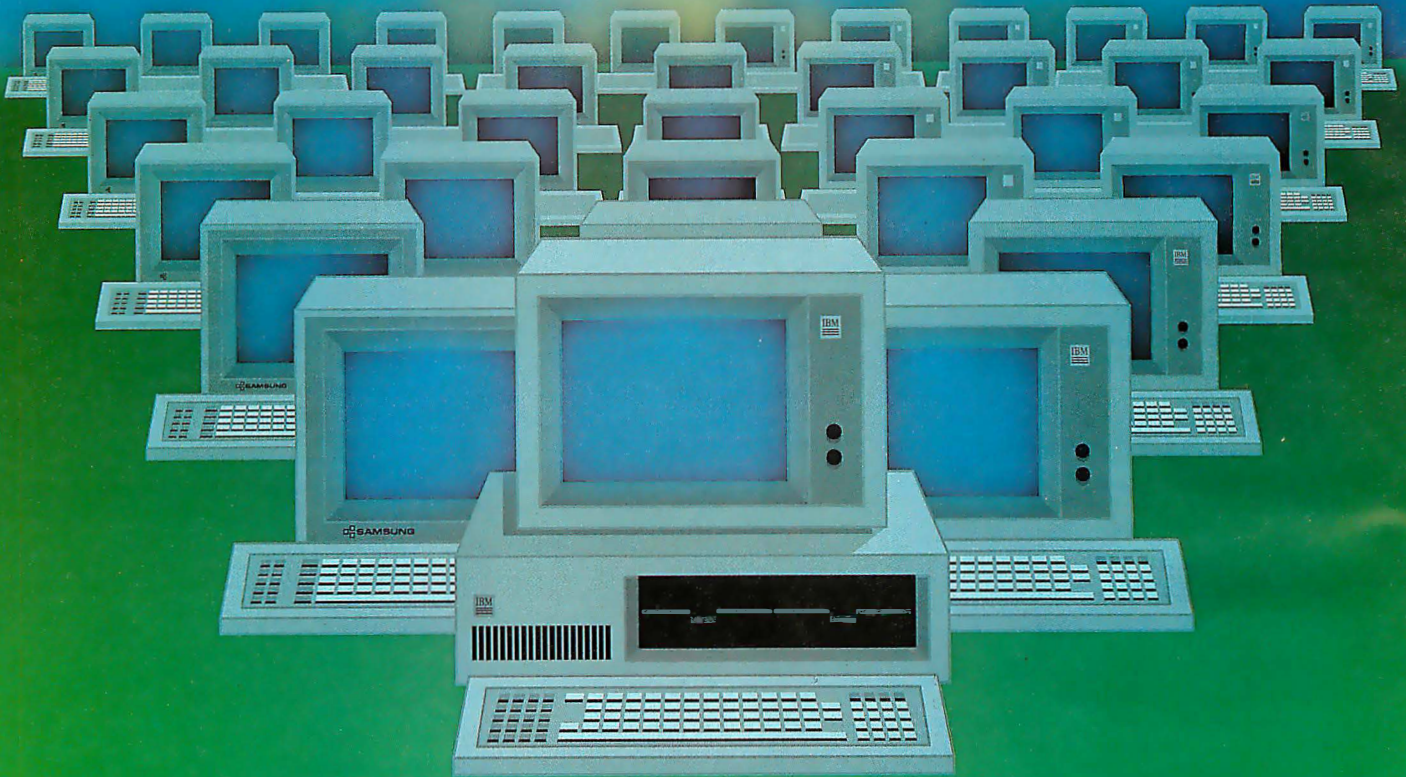

## PC II The Ultimate Two-User Card

**Advanced Digital now offers you two additional users for the price of one!**

With our PC II, you can quickly turn your personal computer into a host computer for a complete 3-user system. The PC II lets two additional users share one PC and all the expensive hardware and peripherals that you've already paid for. Plus you share access and communication between users and PC's.

Each PC II has two CPU's, two 512K bytes of memory, keyboard and monitor interface, making it possible for each user to work on the same program or two entirely different programs...as if they were two independent PC's.

PC users often ask us how to network their many PC's. The solutions are many but expensive and slow. Advanced Digital's answer — the PC II — allows you to add additional workstations at a more reasonable cost...and with much faster performance than any local area network or software package.

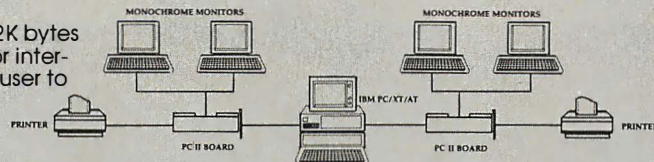
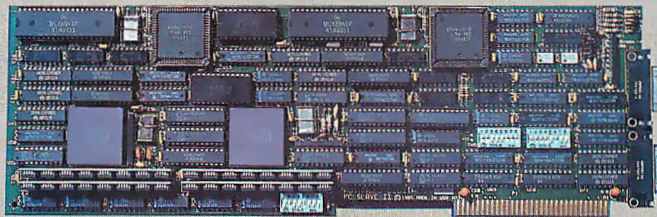

All you need to complete your 3-user system is the PC II, IBM's PC-NET software, and two low-cost monochrome monitors and keyboards. No new operating system, no new commands and no complications of a LAN.

Each PC II gives your PC the full capabilities of two PC's and can support DOS 3.1 providing each user 100%

compatibility with PC programs.

Advanced Digital offers many other PC products including the ADC-TAPE60, PC-EXBUS, PC-Slave, and more!

For more information, call 1-800-251-1801 (outside California).

Advanced Digital Corporation  
5432 Production Drive  
Huntington Beach, CA 92649  
(714) 891-4004, (800) 251-1801  
Telex 183210 ADVANCED HTBH

Advanced Digital UK. Ltd.  
21 Newman Street  
London W1-United Kingdom  
(01) 323-1120



**ADVANCED DIGITAL CORPORATION**

Inquiry 6 for End-Users.

Inquiry 7 for DEALERS ONLY.



# WHAT'S NEW

## Text and Graphics on the Apple IIGS

**G**raphicWriter is a word processor that enables you to mix graphics and text on the same page. Left, right, center, full justification, and multiple line spacing are all standard. Basic fonts and styles are also included, and a paint palette gives you a choice of 48 colors in which to print. Along the bottom of the screen are object-oriented graphic tools that you can incorporate into your documents. The program also has a feature called Canvas Mode, which lets you draw freehand and also import graphics from other programs.

GraphicWriter is compatible with Imagewriter II and LaserWriter printers. The program costs \$149.95. Contact DataPak Software Inc., 14011 Ventura Blvd., Suite 507, Sherman Oaks, CA 91423, (818) 905-6419. Inquiry 550.

## New Equity Adds Slots, Speed

**E**pson America's newest addition to its Equity line, the Equity III+, is compatible with the IBM PC AT and has an 80286 processor that can run at three different clock speeds: 6, 8, and 10 MHz (all with one wait state). The clock speed is selectable from a front panel switch. The III+ has nine full-size expansion slots, seven of which are compatible with the PC AT's 16-bit bus. System architecture supports real address and protected virtual address modes.

A unique feature of the system is that the standard memory and ROM BIOS



*Epson's Equity III+ has an 80286 that can run at three speeds.*

chips are on a removable board. Also, you can remove the motherboard itself by sliding it out through the front of the machine.

The Equity III+ comes with a 1.2-megabyte floppy disk drive, 640K bytes of memory (expandable to 15.5 megabytes), 64K bytes of ROM (selectable EPROM pairs; expandable to 128K bytes), MS-DOS 3.2, and GW-BASIC for \$2695. An enhanced version, which features a 40-megabyte hard disk, costs \$3895.

Among the available extras are a color graphics adapter, multimode graphics adapter, EGA-type board, and color and monochrome monitors.

For more information, contact Epson America, 2780 Lomita Blvd., Torrance, CA 90505, (213) 539-9140. Inquiry 551.

## Data Logger for Industry and Science

**D**esigned primarily for industry and laboratory applications, Loggernaut is a hardware/software combo for

the IBM PC that provides data logging, trend recording, alarm monitoring, and data collecting capabilities. Cyborg says Loggernaut, with 14-bit A/D resolution, 500-volt isolation, and the ability to connect directly to sensor inputs, is well suited to batch and process monitoring, quality testing, and on/off machine control. It is also designed for situations where data from instruments and sensors is collected and analyzed during various lengths of time.

Hardware consists of an interface card that plugs into a slot in the PC's backplane and an outboard sensor I/O board; the I/O board has 16 channels for analog input, 8 channels for digital input, and 8 for digital output. You can link as many as four of these boards on a single interface card for 64 analog input channels, 32 for digital input, and 32 for digital output. The on-board digital input channels can be used to monitor switches,

relays, and triggers. The digital outputs are designed to be controlled by alarm conditions set on the analog input signals.

The menu-driven software lets you define scans of up to 64 analog input signals as well as digital input and output. Scans can occur at intervals you define or can be event-driven. Data can be logged to disk automatically. Each channel is converted to engineering units. The software continues to scan and log data even while you edit signals, calculate, and handle setup routines. When an alarm condition arises, Loggernaut can change scanning conditions, switch a process on or off, print data, change the display, or log data to disk. The software also lets you display as many as 16 channels simultaneously in strip charts or bar graphs.

The basic Loggernaut system described here costs \$2950. For more information, contact Cyborg Corp., 55 Chapel St., Newton, MA 02158, (617) 964-9020. Inquiry 552.

## Integrated Business Program for the Macintosh

**M**onogram Software has announced Business Sense, a \$595 integrated business program for the Macintosh and Macintosh Plus. The program includes general ledger, accounts payable, and accounts receivable modules. The modules work together, so that when you enter information into the accounts receivable or payable modules, the general ledger is automatically updated. An

*continued*



audit trail is created in the update process.

You can use the program in a multi- or single-user environment. File locking capabilities ensure data integrity in a multiuser system. Business Sense requires a minimum of 512K RAM and an Image-writer for printing reports.

For more information, contact Monogram Software Inc., 8295 South La Cienega Blvd., Inglewood, CA 90301, (213) 215-0355.

Inquiry 553.

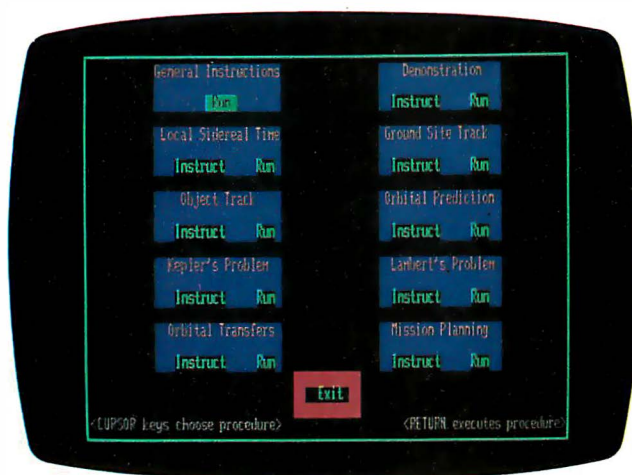

*Epoch is a program for future astrodynamicists.*

### Three That Teach

Children between the ages of 5 and 8 can learn the concepts of addition and subtraction with the series of graphic routines offered in 1st Math, a \$39.95 program from Stone and Associates. Equations, Construction, and the Freight Depot Game are the routines included.

Designed to run on the IBM PC and compatibles, the program requires 128K RAM, MS-DOS or PC-DOS 1.1 or higher, and a color graphics card. For more information, contact Stone & Associates, 7910 Ivanhoe Ave., Suite 319, La Jolla, CA 92037, (619) 459-9173.

Inquiry 554.

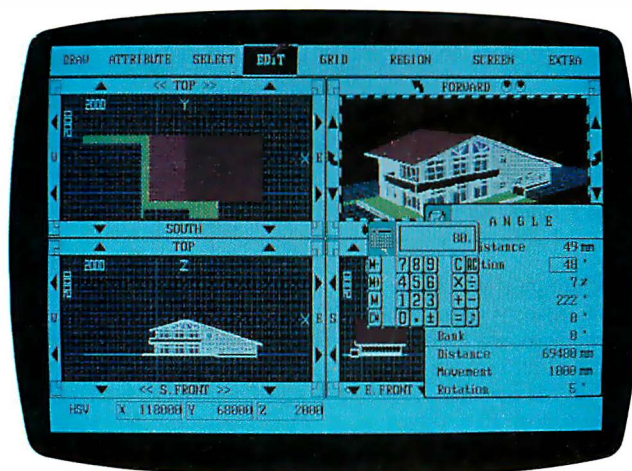

*Dynaperspective lets you model solids in 3-D.*

Epoch is an elementary orbital mechanics package intended for current and future astrodynamicists from high school age and up.

The program was designed at Virginia Polytechnic Institute by an aerospace engineering graduate student. The primary goal was to offer access to space mechanics problems from within the microcomputer environment. The result is a program that can be used in the classroom, as a pocket research guide for calculations at the college level, and as a first-guess generator for industrial applications that use mainframes.

Epoch is made up of 10 modules that you can access from the main menu. To run

the program you must have an IBM PC XT or compatible with MS-DOS or PC-DOS 2.1 or higher, an EGA or CGA, and a color or monochrome monitor.

The program costs \$49.95. For more information, contact Epoch International, P.O. Box 670, Blacksburg, VA 24060, (703) 961-3535. Inquiry 555.

Botanical Gardens has a seed room where students choose seeds; a library where they can read about the plants; two greenhouse gardens where the

seeds will grow; and graph rooms where students will record the environmental variables of light, soil, heat, and water. The program, geared toward students in grades 6 through 12, teaches how to collect experimental data and calculate averages. Students also learn to interpret data from graphs and gain insight into the advantages of systematic problem solving through control of variables.

The program sells for \$59 and runs on Apple IIs with 64K RAM. For more information, contact Sunburst Communications Inc., 39 Washington Ave., Pleasantville, NY 10570, (800) 431-1934; in New York, (800) 221-5912. Inquiry 556.

### Solid-Surface Modeling in Three Dimensions

Dynaperspective is a three-dimensional solid-modeling graphics program that combines line, shape, form, color, and shade to create renderings in two- and three-dimensional formats. It is based on solid-surface modeling using hidden-surface functions rather than wireframe modeling. You can view the renderings you create from any perspective within seconds, according to Dynaware. You can also present renderings with full surface color and light-source shading.

The main menu features draw, attribute, select, edit, grid, region, and screen selections. Extra is another selection that includes resident screen options such as calculator, ink control, and viewing parameters.

Other features include a library of frequently used symbols, walkpath capabilities for slide-show presentations, and pull-down menus with user-friendly icons.

Dynaperspective costs \$1850 and runs on IBM PCs, ATs, XTs, and compatibles with 640K RAM, a graphics card, and a monitor. For more information, contact Dynaware Division, Sun Grade Inc., 1309 114th SE, Bellefield Bldg., Suite 316, Bellevue, WA 98004, (206) 451-0200. Inquiry 557.

### Coprocessor Board Has Four 5-MIPS NEC Chips

Data Flow Imaging's peripheral processor board for the IBM PC contains four 5-MIPS NEC  $\mu$ PD7281 data-flow, or token-passing, processors that work in parallel with the PC's CPU. Suggested applications for the DF-1 include array processing, circuit simulation, digital signal processing,

*continued*







image processing and compression, data encryption, and graphics manipulation. The company claims that any algorithm that performs repetitive processing on big streams of data should run well on this board.

Besides its pipelined architecture, the chip has a 17- by 17-bit hardware multiplier; because of its inherent parallelism, Data Flow says, the processor is well suited to matrix multiplications. The DF-1 also has 128K bytes of local image memory and an NEC  $\mu$ PD9305 memory access and bus-interface chip.

The board supports DMA data transport between the PC's memory and the DF-1's image memory. It can be set up to use interrupt-driven communications with the CPU of the PC. For \$995, the DF-1 package comes with a manual, demo software, sample code, a menu-driven monitor program, and C interface software. Or you can buy the board without the NEC chips for \$695.

Contact Data Flow Imaging Inc., P.O. Box 116, Westwood, NJ 07675, (201) 666-7970. Inquiry 558.

### Video Digitizer for the Apple IIGS

**A**ST Research has developed a video digitizer for the Apple IIGS. The AST-VisionPlus is a single board that plugs into the IIGS and lets you send video images (color or black-and-white) into your computer from any NTSC device such as a video camera or a VCR. You can then display a live image or store the image and work with it later. With appropriate software—such as AST's companion program, VisionEffects—you can manipulate digitized images by painting in colors, changing gray-scale levels, zooming in and out, altering aspect ratios, and using a "pencil" tool.

Because pictures are stored in standard IIGS format, you can enhance and alter them using graphics and paint pro-



*Image generated on an Apple IIGS using AST-VisionPlus.*

grams that work with that machine. Output can be sent to an Imagewriter; when the necessary drivers are ready, output can be sent to a LaserWriter, a spokesperson said.

AST-VisionPlus has black-and-white resolution of 320 by 200 and 640 by 200 pixels; color resolution is 320 by 200. It can display 16 colors at the same time and has a memory buffer of 128K bytes.

The board comes with AST-VisionEffects software and sells for \$295. Contact AST Research Inc., Apple Products Division, 2121 Alton Ave., Irvine, CA 92714-4992, (714) 553-0340. Inquiry 559.

### Publishing Systems Mix Micro, Laser Printer, Scanner

**C**anon has packaged an IBM PC AT-type micro-computer, a laser printer, and an image scanner as its Desktop Publishing System. The 8-MHz computer comes with a 20-megabyte hard disk, 640K RAM, 1 megabyte of EMS memory, and a printer controller. The Canon Laser

Beam printer comes with a high-speed video interface. And the IX-12 image scanner has a resolution of 300 dots per inch. A color graphics monitor is also part of the configuration.

The system uses editing/page-makeup software developed by Beyond Words (Fairfax, CA). The software lets you create layouts with multiple columns, horizontal rows, and headers and footers. You can also switch layout and composition style of a whole document automatically or selectively. The word processor features search/replace, copy, and undo commands and supports keyboard macros. All text editing and manipulating is done on the composed page in WYSIWYG format.

A windows feature lets you see two views of the same material; you can transfer text between windows. The program offers nine levels of zooming; complete editing capability is available at each level. You can choose and use typefaces from ITC, Compugraphic, and Bitstream.

The Canon Desktop Publishing System costs around \$10,000 (that's as definite as Canon would be at press

time). Contact Canon U.S.A. Inc., One Canon Plaza, Lake Success, NY 11042-9979, (516) 488-6700. Inquiry 560.

**C**ordata has also put together a desktop publishing system. Intellipress consists of Aldus Corporation's PageMaker page composition software (running under Microsoft Windows), a PC AT-compatible computer, a laser printer, a 15-inch display monitor, and a mouse. A digital scanner is sold as an option.

The 80286-based computer features 640K bytes of RAM, a 1.2-megabyte floppy disk, and a 30-megabyte hard disk. The laser printer outputs eight pages per minute at 300 dots per inch. It has 1.25 megabytes of RAM. The WYSIWYG black-on-white monitor has a resolution of 1280 by 800 lines. The optional Cordata scanner offers resolution of 300 by 300 dots per inch, 16 shades of gray, and a scan rate of five pages per minute.

The Intellipress system sells for \$11,995. The scanner costs \$1495. For more information, contact Cordata, 275 East Hillcrest Dr., Thousand Oaks, CA 91360, (805) 495-5800. Inquiry 561.

### In-Circuit Emulator for Intel's 80386

**N**ew Micro's in-circuit emulator for Intel's 80386 is a self-contained unit that runs with IBM PCs, XTs, ATs, or compatibles or with a MicroVAX using VMS or Ultrix. The MICE-32/80386 implements architecture that features 32-bit-wide registers and a 104-bit-wide trace buffer.

Other features include 256K bytes of software-mappable memory, a conditional trace buffer (allowing you to

*continued*



# YOU ARE ABOUT TO BE SEDUCED BY POWER AND MONEY.

Admit it. You're intrigued with the idea of C programming. You may be working in BASIC, Pascal or Assembler now. But you're drawn to the power, portability and flexibility of C. And if money is what motivates you, imagine having it all for just \$75 with Mark Williams Let's C.®

## EVERYTHING YOU COULD ASK FOR IN A C COMPILER.

Let's C is no mere training tool. It's a complete, high quality C compiler. With the speed and code density to run your programs fast and lean. It won't get you sidetracked on some quirky aberration of C; Let's C supports the complete Kernighan & Ritchie C language—to the letter. And it comes from the family of Mark Williams C compilers, the name chosen by DEC, Intel, Wang and thousands of professional programmers.

## POWERFUL UTILITIES ARE A REAL BONUS

Let's C doesn't stop with being a high performance C compiler. It includes utilities you'd expect to pay extra for—like a linker and assembler plus the MicroEMACS full screen editor with source code included. Having the source code not only allows you to customize the editor, it offers a close up, fully commented view of C programming at its best.

## REVIEWERS ARE SOLD ON LET'S C, TOO.

"Let's C is an inexpensive, high-quality programming package...with all the tools you will need to

### Features

- For the IBM-PC and Compatibles
- Fast compact code plus register variables
- Full Kernighan & Ritchie C and extensions
- Full UNIX compatibility and complete libraries
- Small memory model
- Many powerful utilities including linker, assembler, archiver, cc one-step compiling, egrep, pr, tail, wc
- MicroEMACS full screen editor with source
- Supported by dozens of third party libraries
- Upgradeable to C Programming System for large scale applications development
- Not copy protected

Let's C Benchmark Done on an IBM-PC/XT, no 8087.  
Program: Floating Point  
from BYTE, August, 1983.

Exec Time in Seconds	
Let's C	134
MS 4.0	147

MARK WILLIAMS LET'S C  
\$75  
60 DAY MONEY BACK GUARANTEE

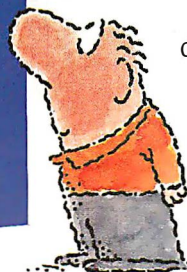
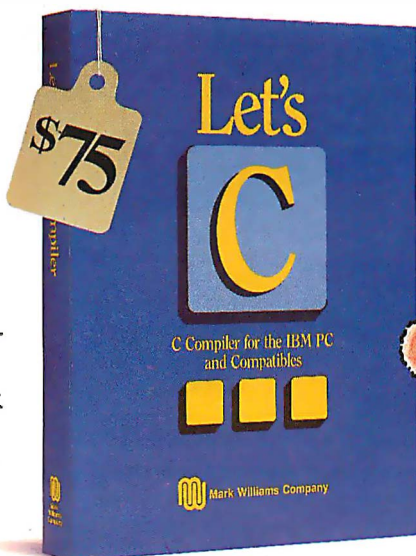

create applications."

—William G. Wong, *BYTE*, August 1986.

"Let's C is a thoroughly professional C environment loaded with tools and programming utilities...another fine Mark Williams product."

—Christopher Skelly, *COMPUTER LANGUAGE*, February 1986

"The performance and documentation of the \$75 Let's C compiler rival those of C compilers for the PC currently being sold for \$500..."

highly recommended..."  
—Marty Franz, *PC TECH JOURNAL*, August 1986

## ADD THE *csd* DEBUGGER AND CUT DEVELOPMENT TIME IN HALF.

Invest another \$75 and you've got Mark Williams revolutionary source level debugger. *csd* lets you bypass clunky assembler and actually debug in C. That's a big help when you're learning C and indispensable when you're programming. *csd* combines the interactive advantages of an interpreter with the speed of a compiler, slicing development time in half. This is how Byte Magazine summed it up: "*csd* is close to the ideal debugging environment." William G. Wong, *BYTE*, August 1986

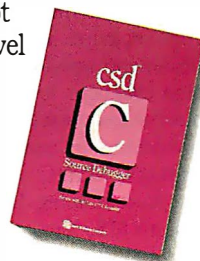

## ARE YOU STILL RESISTING?

If there's any doubt that now's the time to get your hands on the power of C, consider Mark Williams 60-day money back guarantee. You can't lose. But with Let's C and *csd*, imagine what you could gain.

Ask for Let's C and *csd* at your software dealer's, in the software department of your favorite bookstore, through the Express Program at over 5500 Tandy stores or order now by calling 1-800-MWC-1700.\*

\*In Illinois call 312-472-6659



1430 West Wrightwood, Chicago, Illinois 60614

Inquiry 158

© 1986, Mark Williams Company  
Let's C is a registered trademark of the Mark Williams Company  
UNIX is a trademark of Bell Labs.

# MARK WILLIAMS LET'S C. ONLY \$75.



specify only those machine cycles to be stored in the trace buffer), a 2048- by 104-bit trace buffer, with room enough for eight external hardware signals, real-time emulation at up to 16 MHz, and six breakpoints. The device also has two serial interfaces, or one serial and one parallel interface.

The emulator supports real and protected addressing modes; pipeline and non-pipeline address modes; multiprocessor synchronization; dynamic bus sizing, bus breakpoints, execution breakpoints, and external trigger breakpoints; and, according to New Micro, all stepping modes, including cycle and instruction stepping. The 386 emulator costs \$14,000.

To go along with its emulator, the company sells a language-oriented symbolic debugger that supports windowing, user-created macros, and waveform analysis. It also supports all Intel 8/16 OMF files. Features include an arithmetic and logical expression evaluator for use with macros, auto-execution, and provisions for user-defined softkeys. MSD-3 works with any host running DOS, VMS, MicroVMS, Ultrix, or UNIX. The PC software sells for \$840; a version for a MicroVAX is \$1650.

Contact New Micro Inc., 16901 South Western Ave., Gardena, CA 90247, (213) 538-5369. Inquiry 562.

### Add a Fax

Used with Microtek's image scanners (MS-300A or MSF-300), Microtek's MFAX card turns an IBM PC into an intelligent facsimile system. Compatible with CCITT Group 3 fax units, MFAX can transmit and receive documents to and from other fax devices at 9600 bps. The scanners can process text, line art, or photos for transmitting through MFAX to other fax machines. Or ASCII documents generated by the host



*Datavue's Spark comes with a supertwisted birefringent screen.*

and stored on the screen can be sent using the card.

The bundled software allows for storage of as many as 9999 phone numbers, which can be dialed automatically or manually. You can use delayed transmission for sending multipage documents to several locations. Other features include polling; recording times, dates, and number or pages; and support for a speaker phone.

The MFAX card costs \$995. Contact Microtek Lab Inc., 16901 South Western Ave., Gardena, CA 90247, (800) 654-4160; in California, (213) 321-2121. Inquiry 563.

Meanwhile, Electronic Information Technology has revamped its facsimile interface board, pc-FAX, to include PC-to-PC communications software that lets you poll and receive most disk files, including executable programs, source code, command files, ASCII and fax files, and scanned images. It also handles CCITT Group 3 transmissions between fax machines and microcomputers.

The card slips inside an IBM PC and hooks up to a standard phone line. It can then serve as a 9600-bps

modem. In addition to a device controller and modem, pc-FAX comes with menu-driven software that provides image handling, text-image merging, ASCII-to-fax conversion, and all CCITT functions.

The package retails for \$1095. A program that lets the fax machine double as an optical scanner retails for \$495. Contact Electronic Information Technology Inc., 373 Route 46 W, Fairfield, NJ 07006, (201) 227-1447. Inquiry 564.

### 9-pound MS-DOS Machine with Supertwisted Screen

Datavue's 9-pound MS-DOS machine, the Spark, runs an 80C88 at 4.77 or 9.54 MHz and comes with one 3½-inch 720K-byte floppy disk drive, 384K bytes of DRAM, and a blue-on-gray supertwisted crystal birefringent screen. The Spark has external RGB, composite, serial, and parallel ports. You can add another 3½-inch disk drive, an internal 300/1200-bps modem with two RJ-11 jacks, an electro-luminescent backlit screen, and a board holding 256K bytes of memory.

The screen displays 80 characters by 25 lines and has

bit-mapped graphics capability. At medium resolution, it displays 320 by 200 pixels; at high resolution, 640 by 200. The portable is equipped with an AC power adapter and will run for eight hours on rechargeable nicad batteries.

The Spark is manufactured in Japan using surface-mount technology, a spokesperson said. The basic model sells for \$995. A second 3½-inch disk drive costs "under \$200"; an internal modem, "less than \$300"; and a 256K-byte memory board, "less than \$100."

For more information, contact Datavue Corp., One Meca Way, Norcross, GA 30093-2919, (404) 564-5555. Inquiry 565.

### Silk

Daybreak Technologies has announced Silk, a \$149 spreadsheet for the IBM PC. According to Daybreak, Silk offers continual help, English-language formulas, and recording of keystrokes. The program also lets you create allocation and time-series models, and a validation command lets you create a menu of data-entry choices and acceptable data characteristics. Also included is a circular reference trace feature that pinpoints causes of circular references and a goal-seeking command that replaces complex "what if" commands.

The spreadsheet has 265 columns by 2048 rows (or 524,288 cells). To run the program you need at least 512K RAM and a monochrome or color monitor. The program supports the 8087 and 80287 coprocessors and the EGA and Hercules card. For more information, contact Daybreak Technologies Inc., 2271 205th St., Suite 103, Torrance, CA 90501, (213) 212-3030. Inquiry 566.

*continued*



# LOGITECH MODULA-2/86 HOLIDAY PACKAGE

## \$89 Price

- Separate Compilation
- Native Code Generation
- Large Memory Model Support
- Multitasking
- Powerful Debugging Tools
- Comprehensive Module Library
- Available for the PC and the VAX

Use LOGITECH MODULA-2/86 to decrease your overall development cycle and produce more reliable, more maintainable code.

### LOGITECH MODULA-2/86 \$89

Includes Editor, Run Time System, Linker, 8087 Software Emulation, Binary Coded Decimal (BCD) Module, Logitech's comprehensive library, Utility to generate standard .EXE files. AND more!

### LOGITECH MODULA-2/86 with 8087 Support \$129

### LOGITECH MODULA-2/86 PLUS \$189

For machines with 512K of RAM. Increases compilation speed by 50%.

### RUN TIME DEBUGGER (Source level!) \$69

The ultimate professional's tool! Display source, data, call chain and raw memory. Set break points, variables, pinpoint bugs in your source!

### UTILITIES PACKAGE \$49

Features a Post-Mortem Debugger (PMD). If your program crashes at run-time the PMD allows you to analyze the status of the program and locate the error. Also includes a Disassembler, Cross Reference Utility, and Version that allows conditional compilation.

### LIBRARY SOURCES \$99

Source code now available for customization or exemplification.



## \$199 Special Holiday Offer

Step up to the power of LOGITECH MODULA-2/86 at a saving of nearly \$100 off our usual low prices! We're offering a complete tool set including our compiler with 8087 support (for use with or without an 8087), our Turbo to Modula-2/86 Translator, Run Time Debugger, and Utilities in one holiday package at a special price!

### WINDOW PACKAGE \$49

Build windows into your programs. Features virtual screens, color support, overlapping windows and a variety of borders.

### MAKE UTILITY \$29

Figures out dependencies and automatically selects modules affected by code changes to minimize recompilation and relinking.

### CROSS RUN TIME Debugger and ROM Package \$199

Still available at an introductory price!

### TURBO PASCAL to MODULA-2 TRANSLATOR \$49

*"Turbo Pascal... is a very good system. But don't make the mistake of trying to use it for large programs."*

*Niklaus Wirth\**

Our Translator makes it even easier for Turbo users to step up to Modula-2/86. It changes your Turbo source code into Modula-2/86 source, solves all the incompatibilities, and translates the function calls of Turbo into Modula-2/86 procedures. Implements the complete Turbo libraries!

Call for information about our VAX/VMS version, Site License, University Discounts, Dealer & Distributor pricing.

30 Day Money Back Guarantee!  
To place an order call our special toll free number:

800-231-7717  
in California  
800-552-8885

Inquiry 151

## YES I want to step up to LOGITECH MODULA-2/86!

Here's the configuration I'd like:

- |   |       |
|---|-------|
| <input type="checkbox"/> Special Holiday Package    | \$199 |
| <input type="checkbox"/> Logitech Modula-2/86       | \$89  |
| <input type="checkbox"/> with 8087 support          | \$129 |
| <input type="checkbox"/> Plus Package               | \$189 |
| <input type="checkbox"/> Turbo to Modula Translator | \$49  |
| <input type="checkbox"/> Run Time Debugger          | \$69  |
| <input type="checkbox"/> Utilities Package          | \$49  |
| <input type="checkbox"/> Library Sources            | \$99  |
| <input type="checkbox"/> Window Package             | \$49  |
| <input type="checkbox"/> Make Utility               | \$29  |
| <input type="checkbox"/> ROM Package                | \$199 |

Add \$6.50 for shipping and handling. Calif. residents add applicable sales tax. Prices valid in U.S. only.

Total Enclosed \$ \_\_\_\_\_

Visa  MasterCard  Check Enclosed

Card Number \_\_\_\_\_ Expiration Date \_\_\_\_\_

Signature \_\_\_\_\_

Name \_\_\_\_\_

Address \_\_\_\_\_

City \_\_\_\_\_ State \_\_\_\_\_ Zip \_\_\_\_\_

Phone \_\_\_\_\_



Logitech, Inc.  
805 Veterans Blvd.  
Redwood City, CA 94063  
Tel: 415-365-9852

In Europe:  
Logitech SA, Switzerland  
Tel: 41-21-879656

In Italy: Tel: 39-2-215-5622



## SYSTEMS

**AT-compatible  
Tandon Targa**

**T**andon designed several custom chips and put them on a six-layer VLSI system board for the heart of its PC AT-compatible Targa. That same board accommodates both serial and parallel interfaces, so you don't need to buy an accessory card. A binary video card supports monochrome and color graphics monitors.

The Targa's design is compact. Set up horizontally, the main box takes up a space 12.6 inches wide and 15.7 inches deep; standing vertically, the footprint is 6.3 inches wide and 15.7 inches deep.

A 30-megabyte 3½-inch Winchester disk drive comes with the Targa, which also has a 1.2-megabyte floppy disk drive. The main board can support 1 megabyte of RAM without using any expansion slots; five full slots are available in the main unit. For software, the Targa comes with MS-DOS 3.2 and GW-BASIC.

The machine's 80286 can run at either 6 or 8 MHz.

The Targa costs "under \$3000." For more information, contact Tandon Corp., 20320 Prairie St., Chatsworth, CA 91311, (818) 993-6644. Inquiry 567.

**386-based PC, Two  
Diskless Workstations  
from Multitech**

**M**ultitech has brought out an 80386-based micro-computer that it claims can run AT applications as much as three times faster than IBM's machine and can operate under MS-DOS, UNIX, or XENIX. The basic Multitech 1100 comes with 1 megabyte of RAM on the main board, a 1.2-megabyte floppy disk drive, a 40-megabyte hard disk drive, a floppy/hard disk controller board, a battery-backed



*Tandon's Targa is a compact AT-compatible.*

clock/calendar, two serial ports, a parallel port, and a keyboard. There's room for five half-height 5¼-inch storage devices and a socket for an 80287 math chip.

Of the eight expansion slots, two can handle XT-type boards and three are for AT-compatible boards. Of the three 32-bit slots, one is a dedicated 32-bit memory bus and two accept AT boards.

The basic Multitech 1100 costs \$3995. With an 80-megabyte disk, the 1100 costs \$5995; with a 130-megabyte disk, \$6495. A color graphics board sells for \$379; a color display for \$599.

Multitech's two new diskless workstations, the LAN 900 and the LAN 500, are compatible with IBM's PC AT and regular PC, respectively. The LAN 900 has an 80286-based CPU, 640K RAM expandable to 1 megabyte on the motherboard, a video controller, a floppy drive controller, two serial ports, and room for a 5¼-inch half-height storage unit. With an ARCNet LAN card, it sells for \$1499; without the ARCNet card, it's \$1299.

The 8088-based LAN 500 comes with 512K RAM expandable to 640K and can take two 5¼-inch half-height

floppy drives. Like the LAN 900, it also has a monochrome graphics adapter, a high-resolution display, and a parallel port. With the ARC-Net card, it costs \$1059; without, \$759.

Contact Multitech Electronics Inc., 1012 Stewart Dr., Sunnyvale, CA 94086, (408) 773-8400. Inquiry 568.

**Single-Board  
80188-based Computer**

**T**he Micro-Link STD-206 is a general-purpose STD-bus computer based on the 16-bit 80188 central processor. The company says that even though the card uses the 80188's 8-MHz clock, it's still fully compatible with the 4-MHz STD-Z80 bus; accesses to the bus are synchronized to the slower speed. The card accesses its on-board RAM without wait states; the lowest 64K can be accessed by an external DMA controller (a disk controller card, for example). The board also provides dual DMA channels, three counter/timers, two serial ports, an 8-bit parallel port with DMA, and a multisource interrupt controller. It supports Z80 vec-

tored interrupts and the Z80 return-from-interrupt op codes. The 80188 interrupt controller can provide vectors and prioritization for all or some of the on- and off-board interrupts.

Besides 256K bytes of parity-protected DRAM, on-board features include two 28-pin JEDEC sockets for EPROM or static RAM and an SBX connector to permit piggybacking standard I/O boards.

The STD-206 costs \$475; quantities of more than 100 are discounted 20 percent. The board comes with a two-year warranty. For more information, contact Micro-Link Corp., 14602 North U.S. Highway 31, Carmel, IN 46032, (800) 428-6155; in Indiana, (317) 846-1721. Inquiry 569.

**Multuser 32-bitter  
Designed for OEMs**

**F**uture International says its 80386-based XA-600 can operate in multuser, multitasking environments or as a single-user 16-MHz system running PC AT programs. The XA-600 can address as much as 16 megabytes of RAM and can switch from MS-DOS to UNIX. It comes with 4 megabytes of RAM (expandable to 16) on the system board. Storage options include 1.2-megabyte floppy drives; 40-, 60-, 80-, and 130-megabyte hard disks; and tape backup. Monitor options are 12-inch monochrome, 15-inch black-and-white, and 14-inch color.

The XA-600 is sold in two styles: a low-profile four-slot, four-drive desktop version or an eight-slot, six-drive tower version. Both allow memory expansion with daughterboards. For more information, contact Future International Inc., 5820 Stoneridge Mall Rd., Suite 100, Pleasanton, CA 94566, (415) 847-2064. Inquiry 570.

*continued*



# LOGIMOUSE HOLIDAY GRAPHICS PACKAGE

**\$99**

**LOGIMOUSE C7**



**\$219**

**NEW LOGIPAIN-&-DRAW**

To place a credit card order call our special toll-free number:

**800-231-7717**

Call toll-free in California:

**800-552-8885**

Just for the holidays we've wrapped up LOGIMOUSE and its Plus Software with Generic CADD and PC Paintbrush into the graphics package of the year. LOGIPAIN-&-DRAW is the complete graphics toolkit for combining freehand and technical drawing.



## LOGICADD – Generic CADD 2.0 and Dot Plot

Generic CADD is the sensational, new CADD package that offers the features and performance of high-priced at an unbelievably low price. The package also includes DotPlot, the add-on utility that turns your dot matrix printer into a plotter.

Use LOGIPAIN-&-DRAW to design your holiday greeting, enhance your spreadsheets, graphs and memos, or create and personalize a map or mechanical. Just create your CADD drawing, import it into PC Paintbrush, and embellish it with paint sketches and fancy fonts.

At a saving of almost \$50 off our usual low prices, LOGIPAIN-&-DRAW is a holiday package you can't afford to pass up.

## LOGIPAIN – PC Paintbrush

PC Paintbrush is the most advanced paint set available for the PC. It's the preferred choice of professional users, but with its icon menus for both graphics and text it's easy and fun for beginners as well. It offers complete graphic capabilities as well as 11 type fonts and a palette of 16 colors.



LOGIPAIN-&-DRAW includes:

### LOGIMOUSE C7 with Plus Software

LOGIMOUSE is the high resolution (200-dot-per-inch) mouse that is ideal for CADD and paint. It connects directly to the serial port of any IBM PC/XT/AT or compatible, with no pad or external power supply required. The Plus Package is our top-of-the-line mouse software featuring a pop-up menu system, an automatic mouse configurator, a unique mouse interface for Lotus 1-2-3, and a mouse based text editor.

### LOGIMOUSE \$199 with Borland's Reflex

Reflex, Borland's amazing database management program, flies with LOGIMOUSE! We offer Reflex with LOGIMOUSE and the Plus Package Software at a very special price!

## YES I want to add the power of LOGIMOUSE to my holidays!

- LOGIPAIN-&-DRAW \$219
- LOGIMOUSE w/Driver 3.0 \$99
- LOGIMOUSE w/Plus Software \$119
- LOGICADD w/Logimouse & Plus Software \$189
- LOGIPAIN w/Logimouse & Plus Software \$169
- REFLEX w/Logimouse & Plus Software \$199

For my computer model: \_\_\_\_\_  
 30-Day Money-Back Guarantee  
 VISA  MasterCard  Check Enclosed  
 Add \$6.50 for shipping and handling. Calif. residents add applicable sales tax. Prices valid in U.S. only.

Card Number \_\_\_\_\_ Expiration Date \_\_\_\_\_  
 Signature \_\_\_\_\_  
 Name \_\_\_\_\_  
 Address \_\_\_\_\_  
 City \_\_\_\_\_ State \_\_\_\_\_ Zip \_\_\_\_\_  
 Phone \_\_\_\_\_

**DEALER INQUIRIES WELCOME**



Logitech, Inc.  
 805 Veterans Blvd.  
 Redwood City, CA 94063  
 Tel: 415-365-9852

In Europe:  
 Logitech SA, Switzerland  
 Tel: 41-21-879656

In Italy: Tel: 39-2-215-5622

Inquiry 152

LOGIMOUSE is a registered trademark of LOGITECH. Lotus and 1-2-3 are trademarks of Lotus Development Corp. Reflex is a trademark of Borland-Analytica. Generic CADD is a trademark of Generic Software, Inc. PC Paintbrush is a registered trademark of ZSoft Corp.



## PERIPHERALS

**Laser Printer with Malleable Fonts**

**K**yocera Unison's F-2010 Compact Laser Printer comes with 36 resident fonts that you can manipulate to design others; 1.5 megabytes of RAM; a pair of 250-sheet paper trays; a collator; and serial and parallel ports. It can print 850 characters per second and 10 pages per minute at 300 dots per inch and can handle legal-size pages and envelopes. The F-2010 can emulate the Diablo 630, Qume Sprint II, NEC Spinwriter, IBM Graphics Printer, and Hewlett-Packard LaserJet Plus.

Prescribe, Kyocera's programming language, increases the printer's font capabilities and supports some graphics: boxes, circles, pie charts, arcs, shading, and bar codes.

The F-2010 warms up in less than 30 seconds, the company says. It sells for \$5295. Contact Kyocera Unison Inc., 3165 Adeline St., P.O. Box 3056, Berkeley, CA 94703, (415) 848-6680. Inquiry 571.

**Removable Cartridge Drive for Macintosh**

**T**he Totem line of storage devices for the Macintosh uses 5¼-inch removable cartridges, each holding 20 megabytes, and implements Bernoulli technology. Each cartridge, the vendor points out, is about the size of a slice of bread and hence can be transported or stored easily. The Totem system is transparent to the Macintosh.

Three models of the Totem are available: model 1020R, with a single 20-megabyte cartridge, costs \$1495; model 1220R, with two 20-megabyte cartridges, costs \$2295; and model 1220C, which combines a 20-megabyte removable cartridge and a



*Kyocera's F-2010 comes with fonts you can manipulate.*

20-megabyte fixed disk, costs \$2295. Contact Bering Industries, 250 Technology Circle, Scotts Valley, CA 95066, (408) 438-8779. Inquiry 572.

**Amiga 20-meg Drive, SCSI Controller Card**

**C**Ltd. has introduced a 20-megabyte hard disk drive and an SCSI/hard drive controller card for Commodore Amiga users. The controller card hooks to the Amiga expansion port and conforms to the Amiga AutoConfig protocol for fixed memory devices, C Ltd. says. The controller will support as many as seven SCSI devices, including CD-ROM drives. The half-height drive is less than 3 inches tall and less than 6 inches wide.

You can buy the hard drive by itself for \$799.95, the SCSI controller card for \$299.95, or both for \$999.95. For more information, contact C Ltd., 723 East Skinner, Wichita, KS 67211, (316) 267-6321. Inquiry 573.

**Amiga Side Line**

**S**ide Effects has developed a series of products for Commodore's Amiga: an expansion box, a memory board, and a hard disk drive.

Side Arm, a six-slot expansion

card, meets all the specs to be considered a Zorro box, the company says. It has space for two half-height drives and can power two external floppy disk drives. Side Arm has its own power supply and can handle up to 8 megabytes of RAM. It costs \$949.

Side Store, a memory board with RAM disk, is available with 1 or 2 megabytes of no-wait-state RAM. The RAM disk survives warm resets and reboots, Side Effects says. With 1 megabyte, the board costs \$649; with 2 megabytes, \$799.

Side Track, a hard disk drive, holds 20 megabytes and uses direct memory access. Data is double-buffered. The drive costs \$799; just the controller, \$449.

For more information, contact Side Effects Inc., 6513 Johnsdale Rd., Raleigh, NC 27615, (919) 876-1434. Inquiry 574.

**Big Monitor Lets You See What You'll Get**

**T**he LM-300 monitor from Princeton Graphic Systems has a 15-inch portrait-mounted screen that can display a full page of graphics and text, in WYSIWYG format, without scrolling. Pixel resolution is 1200 by 1664.

Video bandwidth is 160 MHz. Scan rate is 74.63 kHz. The monitor emulates a resolution of 300 dots per inch (1:1 aspect ratio), making it compatible with many laser printers.

Other features include 42,000-character display and support for four shades of gray. The monitor is attached to a tilt-and-swivel stand. It comes with a 9-pin shielded cable that connects directly to IBM PCs and most compatibles. Suggested retail price is \$750.

Contact Princeton Graphic Systems, 601 Ewing St., Bldg. A, Princeton, NJ 08540, (609) 683-1660. Inquiry 575.

**Dot-Matrix Printer with Snap-in Color**

**Y**ou can switch Seikosha's MP-1300 dot-matrix printer from standard black output to color by snapping in a cartridge containing a seven-color ribbon and ribbon cassette spacer. With the cartridge installed, the MP-1300 can print in black, green, orange, yellow, purple, blue, and red. With software commands, you can specify the color of each dot.

Compatible with IBM graphic and Epson standards (including color software for the Epson JX-80), the MP-1300 prints at 300 characters per second in near-letter-quality mode and 60 cps in letter-quality mode. The machine offers 185 software-generated character sets and eight international fonts. Character sets can be downloaded into the 10K-byte buffer. Attributes include double strike, italic cursive, superscript and subscript, and proportional spacing.

The MP-1300 has a suggested list price of \$699. The color kit costs \$155. Contact Seikosha Company Ltd., 10080 North Wolfe Rd., Suite SW3/249, Cupertino, CA 95014, (408) 446-5820. Inquiry 576.

*continued*



Clipper is the fastest dBase III and dBase III Plus™ compiler available. Nothing else comes close. When performance counts, experts rely on Clipper for more speed, more power, and more creative freedom. You can, too. Call for details.

- *Clipper compiled programs run 2 to 20 times faster.*
- *No royalties...no runtime fees.*
- *Source code security.*
- *User defined functions.*
- *Arrays.*
- *Simple menu commands.*
- *Context sensitive help can be included with programs.*
- *More fields; more memory variables.*
- *Call C and Assembly programs.*
- *Complete debugging facilities.*
- *Multiple file relationships.*
- *IBM PC, XT, AT, 3270 compatible™.*
- *Multi-user capability.*

*Clipper*™

CLIPPER. THE dBASE COMPILER.  
A WINNING PERFORMANCE EVERY TIME.



Nantucket™

Nantucket Corporation  
5995 South Sepulveda Boulevard  
Culver City, California 90230  
(213) 390-7923  
Outside California call toll-free:  
1-800-251-8438

dBase, dBase III, and dBase III Plus are trademarks of Ashton-Tate, Inc.  
IBM PC, XT, AT, and 3270 are trademarks of International Business Machines Corporation.  
Clipper and Nantucket are trademarks of Nantucket Corporation.

LOOK FOR CLIPPER™

Autumn '86

IT MAKES NETWORKING EASY.



# COMPATIBLE DESIGN. INCOMPARABLE PERFORMANCE. INCREDIBLE VALUES.



**Hi-Res  
Monochrome**

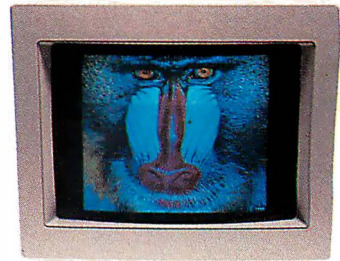

**Color Graphics  
EGA**

## CHOOSE FROM THESE FIVE GREAT VALUES.

### 8 MHz, 20 Megabyte Monochrome System **\$1795**

- Intel 80286 running at 8 MHz
- 1024K on the Motherboard
- 1.2 Megabyte Floppy Disk Drive
- Combined Floppy and Hard Disk Controller
- AT-style Keyboard
- 192 Watt Power Supply
- Clock/Calendar with Battery Backup
- One Year Warranty
- 20 Megabyte, 65 MS Hard Disk Drive
- Hercules Compatible Monochrome Graphics Card
- 2 Serials and 2 Parallel Ports
- PC's Limited Mono-II Flat Screen Monochrome Monitor with Tilt and Swivel Base

### 8 MHz, 20 Megabyte EGAds! System **\$2195**

- Intel 80286 running at 8 MHz
- 1024K on the Motherboard
- 1.2 Megabyte Floppy Disk Drive
- Combined Floppy and Hard Disk Controller
- AT-style Keyboard
- 192 Watt Power Supply
- Clock/Calendar with Battery Backup
- One Year Warranty
- 20 Megabyte, 65 MS Hard Disk Drive
- PC's Limited EGAds! Card
- 2 Serials and 1 Parallel Port
- PC's Limited EGAds! Monitor

### 8 MHz, 30 Megabyte Monochrome System **\$2195**

- Intel 80286 running at 8 MHz
- 1024K on the Motherboard
- 1.2 Megabyte Floppy Disk Drive
- Combined Floppy and Hard Disk Controller
- AT-style Keyboard
- 192 Watt Power Supply
- Clock/Calendar with Battery Backup
- One Year Warranty
- 30 Megabyte, 40 MS Hard Disk Drive
- Hercules Compatible Monochrome Graphics Card
- 2 Serials and 2 Parallel Ports
- PC's Limited Mono-II Flat Screen Monochrome Monitor with Tilt and Swivel Base

### 8 MHz, 30 Megabyte EGAds! System **\$2595**

- Intel 80286 running at 8 MHz
- 1024K on the Motherboard
- 1.2 Megabyte Floppy Disk Drive
- Combined Floppy and Hard Disk Controller
- AT-style Keyboard
- 192 Watt Power Supply
- Clock/Calendar with Battery Backup
- One Year Warranty
- 30 Megabyte, 40 MS Hard Disk Drive
- PC's Limited EGAds! Card
- 2 Serials and 1 Parallel Port
- PC's Limited EGAds! Monitor

### 12 MHz, 40 Megabyte EGAds! System **\$3695**

- Intel 80286 running at 12 MHz
- 1024K on the Motherboard
- 1.2 Megabyte Floppy Disk Drive
- Combined Floppy and Hard Disk Controller
- AT-style Keyboard
- 192 Watt Power Supply
- Clock/Calendar with Battery Backup
- One Year Warranty
- 40 Megabyte, 40 MS Hard Disk Drive
- PC's Limited EGAds! Card
- 2 Serials and 1 Parallel Port
- PC's Limited EGAds! Monitor

#### **BUILD YOUR OWN BOX.**

If none of the systems outlined in this ad suit your needs, call us and our telemarketing staff will be glad to assist you in creating the computer that's right for you. Our base price systems start at \$1495.





**30 Day  
Money Back  
Guarantee**

(Tape backup optional)

## **A GUARANTEE THAT STANDS UP.**

PC's Limited has established itself as the leader in PC technology. And the guarantee and warranty programs we offer put us ahead of the pack, too. Here are our terms in plain English.

**30-Day Total Satisfaction Guarantee**—Any item bought from PC's Limited may be returned within 30 days from the date it was shipped for a full refund of your purchase price. Returned items must be as-new, not modified or damaged, with all warranty cards, manuals, and packaging intact. Returned items must be shipped prepaid and insured, and must bear a PC's Limited Credit Return Authorization (CRA) on the shipping label.

**One Year Limited Warranty**—PC's Limited warrants the products it manufactures to be free from defects in materials and workmanship for one year following the date of shipment from PC's Limited. During the one year warranty period, PC's Limited will repair or replace, at its option, any defective products or parts at no additional charge, provided that the product is returned, shipping prepaid, to PC's Limited.



**To buy PC's Limited computers, call us directly at 1-800-426-5150.  
Calls inside Texas, 1-800-252-8336.**

1611 Headway Circle, Building 3, Austin, Texas 78754  
Sales Calls from anywhere in the country, (512) 339-6962, Technical Support Calls, 1-800-624-9896 or PC's Limited BBS (512) 339-4127  
Customer Service Calls, 1-800-624-9897 or MCI MAIL: PC's Limited, Telex No. 9103808386 PC LTD FAX (512) 339-6721



## Text-to-Speech Converter

**A**ccent is a board for the IBM PC series and compatibles that converts ASCII text into speech. It works in one of two modes: speaking the words of the text in ordinary fashion or spelling out every character, including punctuation. With software commands, you can change its speech parameters, including voice characteristics. Accent's software device driver lets you control it with any high-level language.

The board has an 800-byte wraparound text buffer. Accent can be connected to a 4- or 8-ohm speaker. An RS-232C serial port is provided for interfacing with the PC, a terminal, or a printer. You can select either the PC or the serial port as the host. Text and software commands go from the host to Accent's on-board processor.

In addition to the text-to-speech synthesizer board, you get software (device driver, demo program, and utilities) and a manual for \$495. For more information, contact Aicom Corp., P.O. Box 710310, San Jose, CA 95171-0310, (408) 238-0485. Inquiry 577.

## One Board Lets You Put Two in Compaq Portable

**A**Houston company has designed a card it says will let you fit two short cards in one long slot of a Compaq Portable. Radix Associates says most IBM PC-compatible short cards can fit in one of the two slots on its Bus Expander Card; one slot measures 4 $\frac{7}{8}$  inches, the other 6 $\frac{1}{8}$  inches. (The user will have to make special accommodations for cabling, Radix says.) After connecting the short cards on the longer card, you can fit it into the

Compaq; slot 4 is best, Radix says.

Because of the difference in chassis sizes, the Expander Card will fit in a Compaq Portable but not in an IBM PC, Radix warns. The card sells for \$79.95. Contact Radix Associates, 2314 Cheshire Lane, Houston, TX 77018, (713) 683-9076. Inquiry 578.

## Graphics Controller

**C**ADcard is an 80186-equipped 10-MHz graphics controller for the IBM PC line and compatibles. It emulates IBM's PGC and CGA, has 512K bytes of display memory, 380K bytes of user memory, and 132K bytes of on-board graphics firmware. Options include firmware development tools, software development tools, a GKS subroutine library, and a graphics accelerator that speeds drawing from 2500 to 15,000 vectors per second.

CADCard costs \$1750.

Intelligent Graphics also puts together a CADcard graphics workstation based on an 80286 computer with 640K bytes of memory, an AT-compatible BIOS, and the graphics controller. The system also has a 20-megabyte hard disk, a 1.2-megabyte floppy drive, a color monitor, two serial ports, and a parallel port. MS-DOS 3.1, CADcard diagnostics, and a demo package are also standard. The workstation costs \$7500.

For more information, contact Intelligent Graphics Corp., 4800 Great America Parkway, Santa Clara, CA 95050, (408) 986-8373. Inquiry 579.

## VMEbus Disk Controller

**M**otorola has introduced an intelligent VMEbus-compatible controller board that can handle two 5 $\frac{1}{4}$ -inch

Winchester disks and as many as four 5 $\frac{1}{4}$ -inch floppy disks. The Model MVME321 board incorporates a 10-MHz MC68010 processor. Motorola says on-board control is handled by a multitasking executive kernel that supports concurrent operations.

The board is capable of 32-bit DMA transfers at 8 megabytes per second over the VMEbus, the company says. It supports 24- or 32-bit DMA addressing.

Driver software for VERSAdos and System V/68 (Motorola's UNIX System V derivative) comes with the disk controller. "Scatter/gather" algorithms are implemented in the UNIX driver software and in the on-board firmware. Motorola says this technique relieves the host of having to buffer disk I/O data in a virtual paged environment.

The MVME321 costs \$2295. Contact the Microcomputer Division Marketing Dept., Motorola, P.O. Box 20912, Phoenix, AZ 85036, (602) 438-3501. Inquiry 580.

## Video Overlay

**U**.S. Video's Overlay! 400 lets you combine images from any NTSC-compatible source, such as a video camera or VCR, with text and graphics generated by an IBM PC and save the resulting images on a video recorder. You can also use it to build computer windows containing video images. The card overlays in opaque or transparent mode.

Overlay! 400 works with PCs, XTs, ATs, and compatibles and most CGA and EGA cards. Scan rate is 15.75 kHz. I/O is switch-selectable. The card is not dependent on a particular operating system. It retails for \$1200. For more

information, contact U.S. Video, 900 Winderley Place, Maitland Center, Suite 140, Maitland, FL 32751, (305) 875-0800. Inquiry 581.

## Accelerator, EGA Combo for PCs, XTs

**M**itsubishi says its AT/EGA Card speeds up processing on IBM PCs, XTs, and compatibles with its 8-MHz 80286 by as much as four times. The card runs PC-DOS or MS-DOS 3.1 and runs "most" PC and XT programs and "99 percent" of AT-compatible software. It performs disk caching and print buffering using the host's 8088 and uses RAM-based BIOS to execute one-wait-state, word-wide fetches. Onboard, there are 640K bytes of RAM, which is expandable to 12.6 megabytes using a piggyback socket, and 128K bytes for soft BIOS.

The EGA side of the card has 256K bytes of video RAM. The EGA BIOS runs out of 16-bit-access RAM. The card supports monitors compatible with IBM's Monochrome Display, Color Display, and Enhanced Color Display.

The card's other features include a socket for an 80287 numeric coprocessor, an AT-compatible serial port and keyboard controller, serial-port emulation of the host hardware, 16K-byte bootstrap ROM with debugger, and an on-board switching that allows the card to appear in 16 unique I/O port ranges. A 35-foot cable can hook up to a workstation; with a long-distance driver, you can run cable as far as 535 feet.

The AT/EGA card costs \$1300. Contact Mitsubishi International Corp., Embarcadero Corporate Center, 2483 East Bayshore Rd., Suite 210, Palo Alto, CA 94303, (415) 494-1545. Inquiry 582.

*continued*



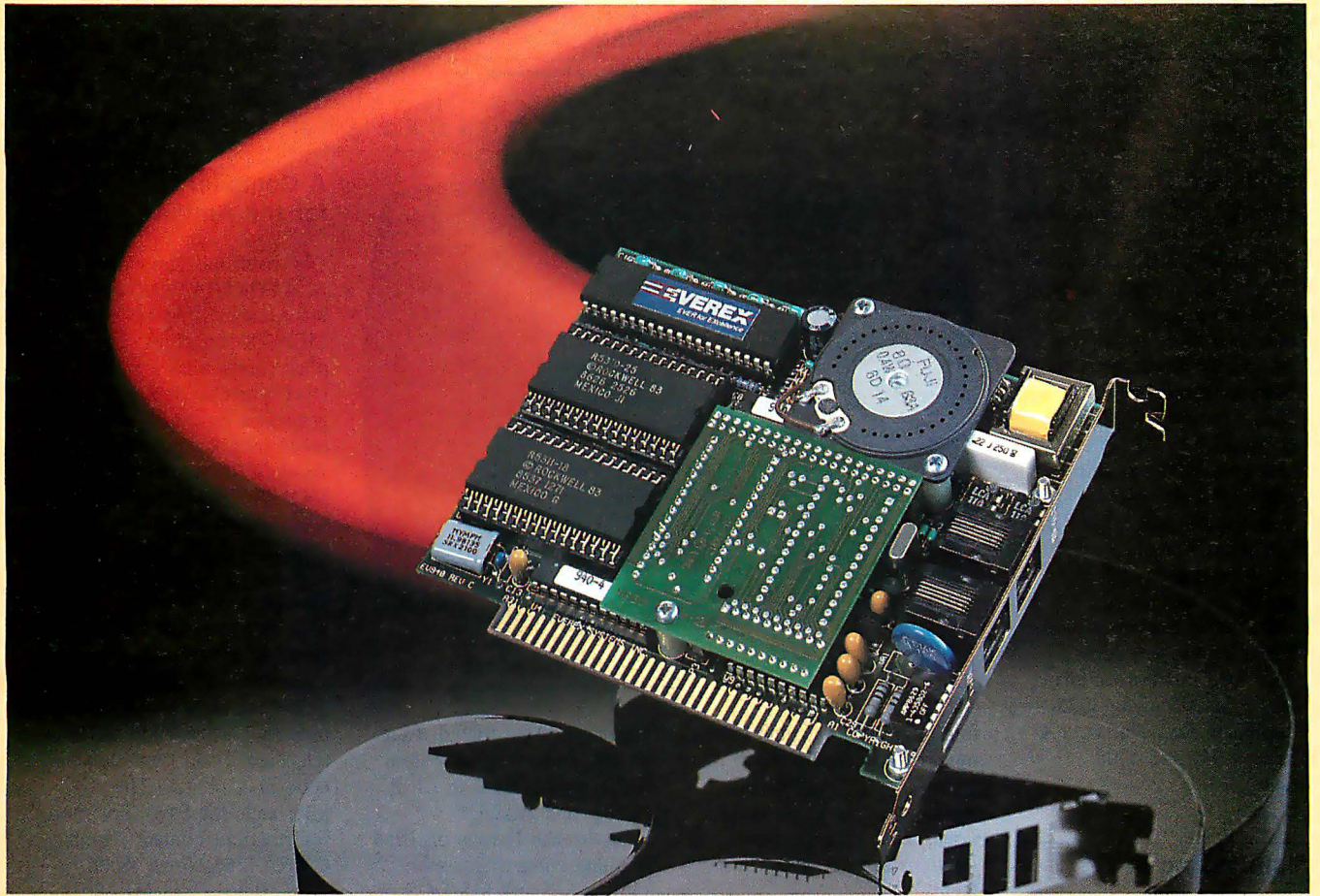

# Evercom™ 24 Goes International!

The Evercom 24 modem resides in a short slot of PC/XT/AT compatibles and extends your operation from the USA to Europe, Asia, Australia, and South America. It is fully Hayes® compatible as well as Bell 212A/103, CCITT V.22 and V.22 bis compatible.

## Sound Quality

Evercom modem's advanced signal processing and adaptive equalization make it a superior performer at 300/1200/2400 bps, even on noisy lines.

## Fully Automatic

Auto-dial and auto-answer are standard features. The Evercom automatically matches its speed to the calling modem's speed. It also senses "rotary" or "tone" dialing and redials busy numbers with only a couple of keystrokes. If you are sending data and wish to talk, just pick up your phone to switch to talk mode.

## The Software Partner

\*BitCom, a powerful menu-driven communications program, remembers up to 32,000

numbers, supports script files and also works in 132 column screen mode.

## Easy Installation

A complete installation and testing program always accompanies Evercom modems. It identifies communications devices and tests connections.

## Get 2400 Baud Speed!

Call us today at

**1-800-821-0806**

and in California it's

**1-800-821-0807**

We'll give you the location of the EVEREX dealer nearest you.

*Ever for Excellence™*

**EVEREX™**

48431 Milmont Drive Fremont, CA 94538

## Check these features for \$289:

- ★ Half-size card fits XT slot 8
- ★ 100% Tested with 48 hour burn-in
- ★ Hayes compatible
- ★ Bell 212A/103 compatible
- ★ CCITT V.22 & V.22 bis compatible
- ★ Adaptive equalization
- ★ Full/half duplex operation
- ★ Call progress monitoring
- ★ Automatic dialing, answering and redialing
- ★ Configurable from COM1 - COM4
- ★ Speaker with software volume control
- ★ Tone and pulse dialing
- ★ Automatic data-to-voice transition
- ★ Detects receiver off-hook
- ★ Reports speed mismatch and off-hook
- ★ Communications software included
- ★ Extended Hayes command set
- ★ Built-in diagnostics
- ★ Advanced digital signal processing
- ★ Installation software included



## Intelligent Backup Manages Hard Disk Data

**M**anage your hard disk with Intelligent Backup. Some of the program's features include prompting, multiple device support, a DOS-command interface, and a full screen editor. You can set many of the program's features to perform automatically. The program also has a feature called Intelligent Backup, which means that only files that have been altered are backed up.

Intelligent Backup sells for \$149.95 and is not copy-protected. For more information, contact Vamco, 10310 Markinson Rd., Dallas, TX 75238, (214) 343-5708. Inquiry 583.

## Multitasking in C

**C**ytek has added three programs to its Multi-C multitasking library for C programmers.

Multi-Comm (\$149) is a communications library that supports interrupt-driven data transfers, multiple device types in asynchronous or synchronous mode, and background communications by Multi-C tasks.

Multi-Windows (\$295) offers you the ability to create overlapping, pop-up windows.

Multi-Forms (\$149) works with Multi-Windows to produce data entry and display screens.

For more information, contact Cytek Inc., 805 Turnpike St., Unit 202, North Andover, MA 01845, (617) 687-8086. Inquiry 584.

## Turbo Pascal Numerical Methods Toolbox

**B**orland has announced the Turbo Pascal Numerical Methods Toolbox for its Turbo Pascal language development system. The toolbox is made up of 10 modules that enable you to find solutions to equations,

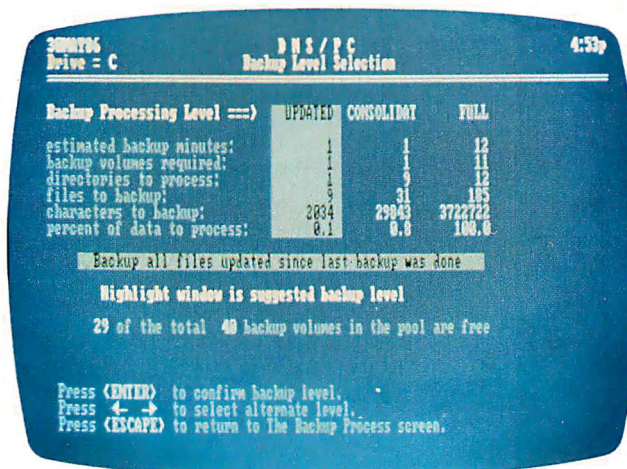

Vamco's Intelligent Backup manages data on hard disks.

interpolations, calculus with numerical derivatives and integrals, matrix operations, eigenvalues, differential equations, least-squares approximations, and Fourier transforms.

You can modify each of the modules and incorporate them into your own programs. The source code is provided.

The toolbox runs on IBM PCs, XTs, and ATs, with or without an 8087 or 80287 math coprocessor. The graphics module requires that you have a graphics monitor and the Turbo Pascal Graphix Toolbox. The Numerical Methods Toolbox sells for \$99.95 and is not copy-protected.

For more information, contact Borland International, 4585 Scotts Valley Dr., Scotts Valley, CA 95066, (408) 438-8400. Inquiry 585.

## Tools for Creating Expert Systems

**I**ntelligenceWare has announced Experteach-II, a collection of expert system tutorials, case studies, on-line and interactive teaching programs, tools with source code, sample expert systems, and artificial intelligence

languages. Also included are six rule-based expert system shells implemented in LISP, Prolog, and Pascal.

Experteach-II runs on IBM PCs and compatibles with 256K RAM and MS-DOS or PC-DOS 2.0 or higher. The program sells for \$475. For more information, contact IntelligenceWare Inc., 9800 South Sepulveda Blvd., Suite 730, Los Angeles, CA 90045, (213) 417-8896. Inquiry 586.

## Stay-Res Puts Your BASIC Programs in Memory

**M**icroHelp has announced Stay-Res, a \$95 BASIC programmer's package that makes compiled BASIC programs memory-resident. Stay-Res saves the current screen when the program is popped up, and when the program is popped down, the screen is automatically restored.

The program is not copy-protected. It requires an IBM PC, XT, AT, or compatible, MS-DOS 2.0, and a BASIC compiler. Programs compiled with QuickBASIC 2.0 require DOS 3.0 or higher.

For more information, contact MicroHelp Inc., 2220 Carlyle Dr., Marietta, GA 30062, (800) 922-3383; in Georgia; (404) 973-9272. Inquiry 587.

## A Compiler for the Amiga

**A**bsoft has announced a FORTRAN/020 compiler for Amigas using MC68020/MC68881 upgrades. The compiler comes with a source-level symbolic debugger, generates position-independent reentrant code, and supports Amiga's ROM routines and VAX and FORTRAN 8X extensions. Also featured is a linker, library manager, IEEE single- and double-precision floating-point software, virtual array support, overlay support, dynamic linking at run time, and a C interface.

The program is not copy-protected. Absoft also reports that there is no limitation on code or data size. The compiler sells for \$495. For more information, contact Absoft Corp., 4268 North Woodward, Royal Oak, MI 48072, (313) 549-7111. Inquiry 588.

## C Compiler for 80386 Applications

**I**ntel has introduced a C language compiler and utilities package for IBM PC ATs and compatibles running MS-DOS or PC-DOS 3.0 or higher. The programs were designed for the development of 80386 application software. The C 386 Compiler and RLL 386 Relocation, Linkage, and Library Tools package can be used on IBM PC ATs alone or linked with other PCs or VAX and MicroVAX computers over the Intel OpenNET network.

The C 386 Compiler is \$900, and the RLL 386 Relocation, Linkage, and Library Tools package is \$600. For more information, contact Intel Corp., 3065 Bowers Ave., Santa Clara, CA 95051, (503) 681-2279. Inquiry 589.

*continued*



Now \$999  
monitor & board

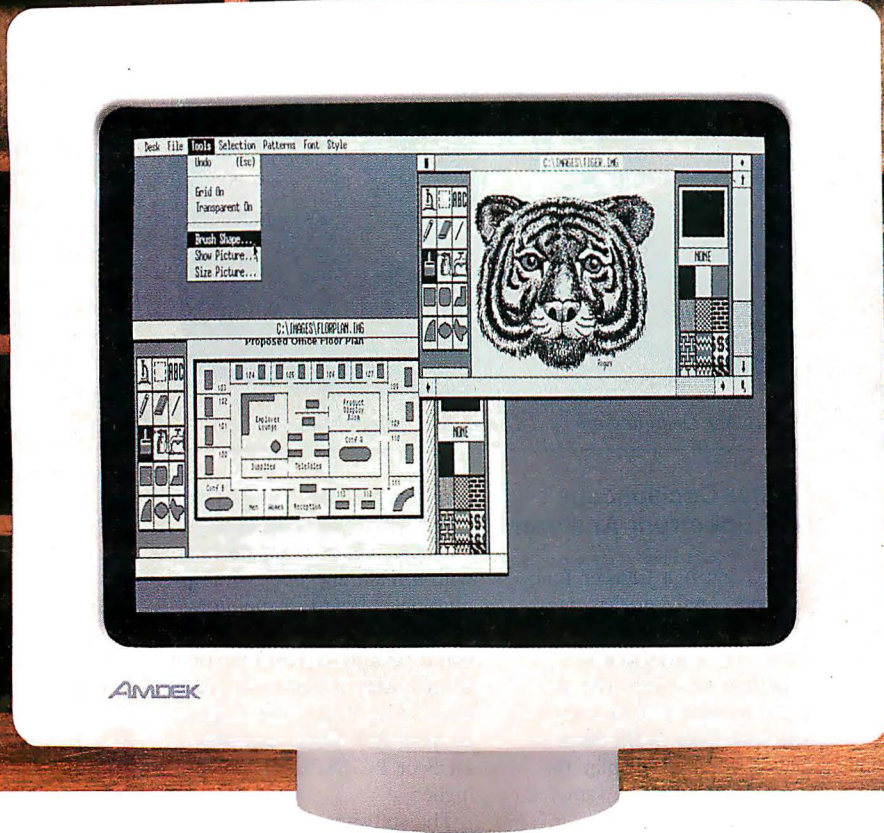

## Is this the best monitor for desktop publishing?

### You can make book on it.

Sometimes, you can't tell a book by its cover. And that's particularly true of the new 1280 graphics subsystem by Amdek. It's designed specifically for the high resolution demands of desktop publishing and CAD applications. But it's still completely compatible with all standard IBM PC software.

Amdek's 1280 consists of a high-contrast, non-glare 15" white phosphor monitor and a bit-mapped graphics board. The extra-large CRT can display up to 160 characters per line by 50 lines of text (vs. 80 x 25 for IBM).

Incredibly high resolution, 1280(H) x 800(V), plus the use of a 16 x 32 dot character (vs. 8 x 8 IBM standard), result in text and graphics that are remarkably sharp and

easy to read. So, creating high qual-

ity flyers, reports, newsletters, bulletins or whatever else you want to "publish" at your desk is as simple as ABC.

The Amdek 1280 is also supported by one of the most popular IBM PC desktop publishing software packages, Clickart by T/Maker. Compatibility with AutoCAD and CADvance gives you full CAD potential. Convenience features include front-mounted operator controls for power, brightness and contrast; and a tilt-swivel base which allows you to select the most comfortable viewing angle.

So, stop the presses—Amdek has done it again! Because everything that's fit to print looks better on an Amdek 1280.

# AMDEK

*Clearly the finest in monitors.*

Inquiry 15

2201 Lively Boulevard, Elk Grove Village, IL 60007, Phone: 312/364-1180 TLX: 280-803



## Two- and Three-Dimensional Design with VersaCAD Designer

**V**ersaCAD Designer offers two-dimensional drafting and three-dimensional modeling capabilities, materials reports, and CAD communications in a \$2995 package. Its three-dimensional modeling capabilities include color shading, automatic extrusion, various display modes, and programmability. Other features include built-in primitives, and you can also customize your own.

The program's customization ability lets you make your own menus, record and play back design operations through macros, define the screen colors, and program expert systems operations through the built-in CAD Programming Language.

From the main menu, you can move your design back and forth between two- and three-dimensional models, and you can bring two-dimensional objects into the three-dimensional database for automatic extrusion, circular sweeps, or editing.

You can display your model in orthographic, wireframe, isometric, or perspective views with hidden-line removal. The program generates planes using polygons with the number of sides you designate.

VersaCAD Designer features two-way communication links to other software and telephone support.

The program runs on IBM PC XTs and ATs with 640K bytes of RAM. A digitizer or mouse are recommended as input devices.

For more information, contact T&W Systems Inc., 7372 Prince Dr., Suite 106, Huntington Beach, CA 92647, (714) 847-9960. Inquiry 590.

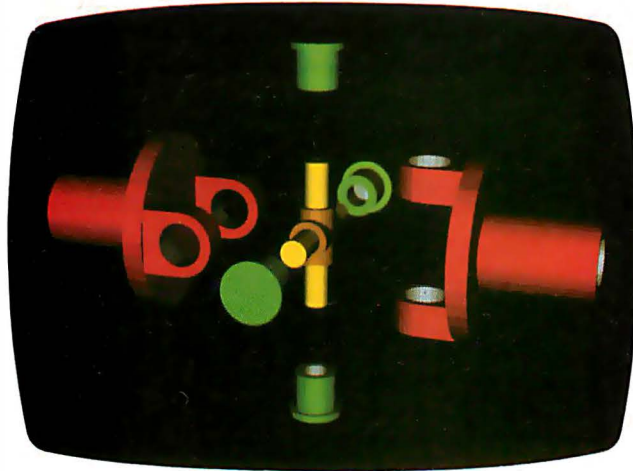

*VersaCAD Designer offers 2-D and 3-D capabilities.*

## Digital Oscilloscope and Spectrum Analyzer

**P**CGen is a transfer function analyzer that integrates the functions of a digital oscilloscope and a spectrum analyzer. The program enables you to acquire real-time data in the form of analog voltages, display the time histories of the sampled data on the screen (like an oscilloscope), and perform Fourier analysis on the data. According to Hansen Instruments, manufacturer of PCGen, no programming is required, and all functions are controlled by the function keys and menu.

Time domain functions enable you to acquire and display one or two channels at a time. You can also select the sample frequency, sensitivity, record length, and triggering. You can store time data on disk or on a time data plot, which also displays voltage and time at current position.

Frequency domain functions include computation and display of frequency spectra for either channel, both at the same time or individually.

The functions of PCGen are selectable by the 10 function keys. Through the master menu, you can select operating parameters, and setups are stored and retrieved from the setup file. You exit the pro-

gram by pressing a single key.

PCGen requires an IBM PC, XT, AT, or compatible with a math coprocessor chip, a graphics board, a monitor compatible with your graphics board, and a data-acquisition board. Your system must also have 384K RAM, one floppy or hard disk drive, and MS-DOS or PC-DOS 2.0 or higher.

The software sells for \$250. For more information, contact Hansen Instruments, 577 Gerard Ct., Pleasanton, CA 94566, (415) 846-7925. Inquiry 591.

## Analyze Stress and Vibration with Finite Elements

**M**acNeal-Schwendler has announced MSC/pal, a static and dynamic finite-element analysis program for stress and vibration analysis. Versions are available for the 512K-byte Macintosh (\$995) and 1-megabyte systems (\$1495). The 512K version can analyze models with a maximum node point limit of 300, and the larger version can analyze up to 500 node points. The program is

copy-protected.

You can use MSC/pal in the design and analysis of mechanical systems, stress analysis of mechanical components, servomechanism vibration analysis, stress analysis of pressure vessels, vibration analysis of printed circuit boards, and automotive and aerospace structural strength analysis.

Graphic capabilities include three-dimensional wireframe plotting, scaling, and rotating, deformed/undeformed overlays, element and node point numbering, and x,y plotting for element stress scanning and dynamic response.

For more information, contact MacNeal-Schwendler Corp., 815 Colorado Blvd., Los Angeles, CA 90041, (213) 258-9111. Inquiry 592.

## Image Processing

**D**T/Image-Pro from Data Translation is image processing software that runs on the IBM PC AT. The program lets you perform real-time image processing and graphics functions with the click of a mouse. Built into the program is a graphics package called HALOVision. It enables you to add labels, grids, ellipses, and lines to images, and you can paint over or cut and paste portions of the images.

The program's main menu offers image analysis, image measurement, a graphics editor, and submenus that feature acquisition, processing, and display functions.

To run DT/Image-Pro you need an IBM PC AT with 512K bytes of RAM and MS-DOS or PC-DOS 3.0 or higher, a Data Translation frame grabber, and an input device such as a mouse.

DT/Image-Pro sells for \$1495. For more information, contact Data Translation Inc., 100 Locke Dr., Marlboro, MA 01752, (617) 481-3700. Inquiry 593.



# ANNOUNCING DAC-EASY BASE

NEW  
FROM DAC-EASY

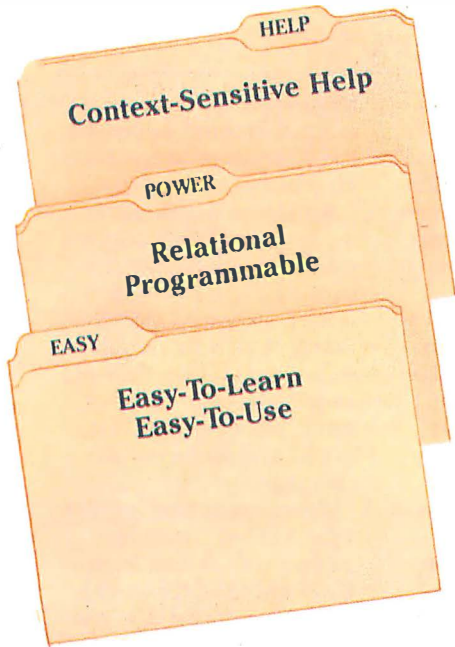

## A POWERFUL RELATIONAL DATABASE THAT IS EASY TO LEARN, VERSATILE AND BEST OF ALL, INEXPENSIVE!

Dac-Easy Base is indeed both powerful and easy to use. It offers a multitude of unique features to help you organize, locate, and sort all kinds of alphabetic and numeric data. Dac-Easy Base continues the low price/high performance tradition of the Dac-Easy Series. With worldwide sales of over 300,000 systems, Dac-Easy has become the new leader in software designed for small businesses.

### FLEXIBLE MENU SYSTEM

Dac-Easy Base is actually two systems in one. If you are a novice you will appreciate the special Beginner Menu which contains the most commonly used features for creating, editing, and printing files. The more experienced database user will find the Advanced Menu allows instant access to each and every one of the powerful routines. In both menus, you are only a keystroke away from the context-sensitive help screens. The help screens in Dac-Easy Base are so complete you may never have to consult the accompanying 200 page manual.

### EASY FILE AND REPORT CREATION

Design professional-looking data input screens without leaving the menu structure. There is no need for complex programming. Once created, the edit screen allows you to input and edit your information in a matter of minutes. Also attach special notes to any of your records with the built-in MemoWriter. The MemoWriter is the perfect way to attach specific information to a single record. Custom reports are easy to create without using the available

programming language. Column or page-style reports can be created quickly, and viewed on your computer screen or printed to paper. As with all reports generated by Dac-Easy Base, you can select which records will be included in your report and how they will be sorted. Special headings and subtotals can be added to give you the exact information you need.

### GREAT FOR ADVANCED USERS

Yes, Dac-Easy Base is easy to use, and it is also very powerful. An unlimited number of records with up to 60 fields per record, ability to access up to three files at a time, date arithmetic capability, formula fields for calculations within files, dynamic abbreviations, and keyboard macros are just a few of the powerful features available at your fingertips. Dac-Easy Base can read and convert dBASE II files and can run DBASE II programs.

### 30 DAY MONEY BACK GUARANTEE

Dac offers a 30 day unconditional guarantee on all products bought directly from Dac Software (less shipping charges). There is a \$10.00 restocking fee if the disk envelope is opened.

### Minimum Hardware Requirements:

IBM or other compatibles, 256K memory, MS-DOS or PC-DOS 2.0 or later, two DSDD drives, color or monochrome monitor.

IBM and PC-DOS are registered trademarks of International Business Machines. MS-DOS is a trademark of Microsoft Corp. dBASE II is a trademark of Ashton-Tate, Inc. Dac-Easy is a trademark, and Dac-Easy Base is a trademark of Dac Software, Inc.  
Inquiry 76

### GREAT FOR THE HOME

There are unlimited uses for Dac-Easy Base around the home. Keep track of mailing lists, birthday lists, check-books, household inventories, stamp collections, recipes, client lists; and the list goes on and on. Dac-Easy Base is so easy to learn you will create your first database in no time. Call now and take advantage of the tremendous benefits of organized data.

**TO ORDER  
CALL TOLL FREE  
1-800-992-7779**  
(IN TEXAS CALL 1-214-458-0038)



Mail to: **dac software, inc.**  
4801 Spring Vailey Rd, Bldg. 110-B  
Dallas, TX 75244

**Yes**, please rush me \_\_\_\_\_ copies of Dac-Easy Base today. I have enclosed \$49.95 (Texas residents add 7.4% sales tax) for each copy + \$7.50 for shipping.

Name \_\_\_\_\_

Company \_\_\_\_\_

Address \_\_\_\_\_

City \_\_\_\_\_

State \_\_\_\_\_ Zip \_\_\_\_\_

Phone \_\_\_\_\_

Computer Brand \_\_\_\_\_

★ ★ ★ Method of Payment ★ ★ ★  
 Check  Money Order  
 VISA  AMEX  MC

CODE 826



## Creating Graphics with Hoops

**H**oops, a graphics software program made up of a library of three-dimensional routines, has a hierarchical segment structure. The routines control geometric modeling, viewing, rendering, and user interaction. The program also contains an interactive graphics debugger. It features hidden-line removal, hidden-surface removal, and shaded image-rendering capabilities. You can transform, highlight, rotate, and scale complex objects, as well.

The routines are written in C and are callable from any C or FORTRAN application. The program is built around a device-independent interface, so an application developed on one device can be run on another without modification. Hoops runs under UNIX, VMS, and DOS operating systems. The cost of the microcomputer version of the program is \$875; licenses for additional machines cost \$250.

For more information, contact Flying Moose Systems and Graphics Co. Ltd., The Clinton House, Ithaca, NY 14850, (607) 273-3690. Inquiry 594.

## Tax Reform Act Accounted for in Software

**T**he Tax Mini-Miser is available in a Tax Reform Edition for IBM PCs (\$195) and Apple IIs (\$119).

You can calculate the potential tax savings of deferring income or taking a capital gain this year instead of next, and you can create and review up to six tax strategies and project them on the screen at the same time. According to Sunrise, the manufacturer, the program calculates a typical three-year projection in 5 to 15 seconds.

Tax Mini-Miser works with Lotus 1-2-3; however, 1-2-3 is not required to run the

program.

A California version that computes Federal and California state taxes simultaneously is also available. The IBM PC version costs \$295; the Apple version, \$149.

For more information, contact Sunrise Software Inc., 240 Twin Dolphin Dr., Suite E, Redwood City, CA 94065, (415) 595-5255. Inquiry 595.

**E**ZTax-Plan is a tax planning and projection program that runs on the IBM PC and Macintosh with a Lotus 1-2-3, Multiplan, or Excel spreadsheet. It takes the changes in the capital-gain rate into account, along with the exemption, interest deduction, and passive loss phase-out. You can analyze and compare tax strategies for each year and print out reports and summaries.

The Personal Planning Edition is \$95, and the Business/Corporate Planning edition is \$295.

For more information, contact EZWare Corp., 29 Bala Ave., Bala Cynwyd, PA 19004, (800) 543-1040; in Pennsylvania, (215) 667-4064. Inquiry 596.

**T**axworks is a tax-return preparation program that automatically stores data you enter and lets you experiment with various tax strategies. It runs on IBM PCs and CP/M computers. A Federal version designed for tax professionals prepares 18 Federal forms and schedules; it sells for \$500.

## WHERE DO NEW PRODUCT ITEMS COME FROM?

*The new products listed in this section of BYTE are chosen from the thousands of press releases, letters, and telephone calls we receive each month from manufacturers, distributors, designers, and readers. The basic criteria for selection for publication are: (a) does a product match our readers' interests? and (b) is it new or is it simply a reintroduction of an old item? Because of the volume of submissions we must sort through every month, the items we publish are based on vendors' statements and are not individually verified. If you want your product to be considered for publication (at no charge), send full information about it, including its price and an address and telephone number where a reader can get further information, to New Products Editor, BYTE, One Phoenix Mill Lane, Peterborough, NH 03458.*

Smaller versions, which contain fewer schedules, are priced from \$75 to \$175. And a California program, which transfers applicable data from the Federal to the California schedules, costs an additional \$100.

For more information, contact Hollingsworth Business Services, 881 Alma Real Dr., Suite T-2, Pacific Palisades, CA 90272, (213) 459-2746. Inquiry 597.

## Keep Your Home Finances on Balance

**O**n Balance is a home finance program with screens that work and look like a checkbook register. You can enter up to 800 financial transactions and set up 175 accounts, defining them as assets, liabilities, income, or expenses. You can also flag any tax-related expenses to simplify recall at tax time.

On Balance runs on the Apple IIe and IIc with a minimum of 128K RAM. The program sells for \$99.95.

For more information, contact Broderbund Software Inc., 17 Paul Dr., San Rafael, CA 94903-2101, (415) 479-1700. Inquiry 598.

## Business Modeling

**B**usiness Strategist is a \$249.95 business training application that lets you simulate a company's operation. Competitors and case

histories for the computer, oil and gas, brewing, automotive, and pharmaceutical industries are provided.

Simulation models within the program include economic information on real-world situations, consumers, investors, and expert analysts. During the simulation you must make business decisions on pricing, financing, advertising, and labor costs, and help is available to you at each stage.

The program runs on IBM PCs, XTs, ATs, and compatibles with at least 384K RAM and MS-DOS or PC-DOS 2.0 or higher. For more information, contact Reality Technologies, 3624 Market St., Philadelphia, PA 19104, (800) 346-2024. Inquiry 599.

## Personal Portfolio Manager

**T**his management and analysis software lets you generate reports, including Schedule B and D Federal income tax liabilities. You can keep a year-to-date transaction file, analyze different trading strategies, and flag securities that have met your buy and sell objectives. According to Abacus, the program enables you to manage as many portfolios as your computer's memory permits.

The program features the capability to update quotes automatically through the Dow Jones News/Retrieval or Warner Computer systems.

PPM runs on IBM PCs, XTs, ATs, and compatibles with 256K bytes of RAM, MS-DOS or PC-DOS 2.1 or higher, and a Hayes-compatible modem to access the on-line services. The program sells for \$79.95.

For more information, contact Abacus Software, 2201 Kalamazoo SE, P.O. Box 7211, Grand Rapids, MI 49510, (616) 241-5510. Inquiry 600.



**Abstract of Report**  
The purpose of this report is to provide a comprehensive overview of the current state of research in the field of artificial intelligence. This report covers the following areas: natural language processing, computer vision, robotics, and expert systems. The report is intended for researchers and practitioners in the field of artificial intelligence.

**Introduction**  
Artificial intelligence (AI) is a branch of computer science that aims to create machines that can perform tasks that normally require human intelligence. This includes tasks such as learning, reasoning, problem-solving, perception, and language use. AI has a wide range of applications, from healthcare to finance, and is becoming increasingly important in our daily lives.

**1.1.1. Introduction**  
The field of artificial intelligence (AI) has seen rapid growth in recent years, driven by advances in machine learning and deep learning. This report provides an overview of the current state of AI research and its applications. The report is organized into several sections, each focusing on a different aspect of AI.

**1.1.2. History of AI**  
The history of artificial intelligence (AI) can be traced back to the early 20th century, when researchers began to explore the possibility of creating machines that could think and learn like humans. This led to the development of the first AI programs, which were designed to simulate human problem-solving and decision-making processes.

**1.1.3. Current State of AI**  
Today, artificial intelligence (AI) is a rapidly growing field with a wide range of applications. AI is being used in a variety of industries, from healthcare to finance, and is becoming increasingly important in our daily lives. This report provides an overview of the current state of AI research and its applications.

**1.1.4. Future of AI**  
The future of artificial intelligence (AI) is bright, with many exciting possibilities. As AI continues to advance, it will have a profound impact on our lives and the world around us. This report provides an overview of the current state of AI research and its applications.

**Figure 1**  
The figure shows a line graph with the x-axis labeled 'Year' and the y-axis labeled 'Value'. The data points are as follows:

Year	Value
1980	10
1981	15
1982	20
1983	25
1984	30
1985	35
1986	40
1987	45
1988	50
1989	55
1990	60

**Figure 2**  
The figure shows a bar chart with the x-axis labeled 'Category' and the y-axis labeled 'Value'. The data points are as follows:

Category	Value
A	10
B	20
C	30
D	40
E	50

**Figure 3**  
The figure shows a pie chart with the x-axis labeled 'Category' and the y-axis labeled 'Value'. The data points are as follows:

Category	Value
A	10
B	20
C	30
D	40
E	50

**Figure 4**  
The figure shows a map of a region with several labeled locations. The locations are: North, South, East, and West. The map shows the relative positions of these locations and the distances between them.

**Figure 5**  
The figure shows a table with the following data:

Year	Value
1980	10
1981	15
1982	20
1983	25
1984	30
1985	35
1986	40
1987	45
1988	50
1989	55
1990	60

**Figure 6**  
The figure shows a bar chart with the x-axis labeled 'Category' and the y-axis labeled 'Value'. The data points are as follows:

Category	Value
A	10
B	20
C	30
D	40
E	50

**Figure 7**  
The figure shows a line graph with the x-axis labeled 'Year' and the y-axis labeled 'Value'. The data points are as follows:

Year	Value
1980	10
1981	15
1982	20
1983	25
1984	30
1985	35
1986	40
1987	45
1988	50
1989	55
1990	60

**Figure 8**  
The figure shows a bar chart with the x-axis labeled 'Category' and the y-axis labeled 'Value'. The data points are as follows:

Category	Value
A	10
B	20
C	30
D	40
E	50

**Figure 9**  
The figure shows a pie chart with the x-axis labeled 'Category' and the y-axis labeled 'Value'. The data points are as follows:

Category	Value
A	10
B	20
C	30
D	40
E	50

**Figure 10**  
The figure shows a map of a region with several labeled locations. The locations are: North, South, East, and West. The map shows the relative positions of these locations and the distances between them.

**Figure 11**  
The figure shows a table with the following data:

Year	Value
1980	10
1981	15
1982	20
1983	25
1984	30
1985	35
1986	40
1987	45
1988	50
1989	55
1990	60

**Figure 12**  
The figure shows a bar chart with the x-axis labeled 'Category' and the y-axis labeled 'Value'. The data points are as follows:

Category	Value
A	10
B	20
C	30
D	40
E	50

**Figure 13**  
The figure shows a line graph with the x-axis labeled 'Year' and the y-axis labeled 'Value'. The data points are as follows:

Year	Value
1980	10
1981	15
1982	20
1983	25
1984	30
1985	35
1986	40
1987	45
1988	50
1989	55
1990	60

**Figure 14**  
The figure shows a bar chart with the x-axis labeled 'Category' and the y-axis labeled 'Value'. The data points are as follows:

Category	Value
A	10
B	20
C	30
D	40
E	50

**Figure 15**  
The figure shows a pie chart with the x-axis labeled 'Category' and the y-axis labeled 'Value'. The data points are as follows:

Category	Value
A	10
B	20
C	30
D	40
E	50

**Figure 16**  
The figure shows a map of a region with several labeled locations. The locations are: North, South, East, and West. The map shows the relative positions of these locations and the distances between them.

**Figure 17**  
The figure shows a table with the following data:

Year	Value
1980	10
1981	15
1982	20
1983	25
1984	30
1985	35
1986	40
1987	45
1988	50
1989	55
1990	60

**Figure 18**  
The figure shows a bar chart with the x-axis labeled 'Category' and the y-axis labeled 'Value'. The data points are as follows:

Category	Value
A	10
B	20
C	30
D	40
E	50



a very long, very complex,





# Was your word processor



Table with 4 columns and 10 rows of data.

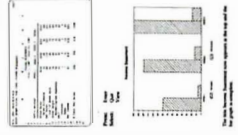

Table with 4 columns and 10 rows of data.



Text block containing several lines of text and mathematical formulas.

Text block containing several lines of text and mathematical formulas.

Text block containing several lines of text and mathematical formulas.

Text block containing several lines of text and mathematical formulas.

Text block containing several lines of text and mathematical formulas.

Text block containing several lines of text.

Text block containing several lines of text.

Text block containing several lines of text.

Text block containing several lines of text.

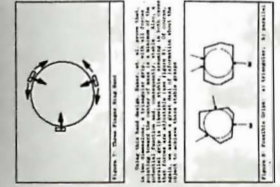
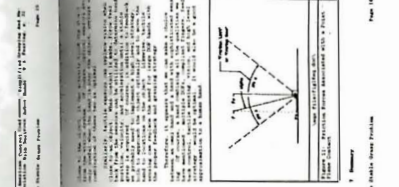
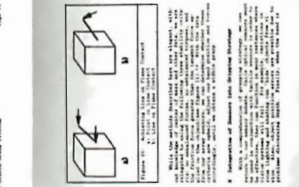

Table with 4 columns and 10 rows of data.



Text block containing several lines of text.

Text block containing several lines of text.

Text block containing several lines of text.

Text block containing several lines of text.

Text block containing several lines of text.



GENERAL CONTRACTOR AND SUBSIDIARY CORPORATION  
AND THE CITY OF BOSTON

GENERAL CONTRACTOR AND SUBSIDIARY CORPORATION  
AND THE CITY OF BOSTON

GENERAL CONTRACTOR AND SUBSIDIARY CORPORATION  
AND THE CITY OF BOSTON

GENERAL CONTRACTOR AND SUBSIDIARY CORPORATION  
AND THE CITY OF BOSTON

GENERAL CONTRACTOR AND SUBSIDIARY CORPORATION  
AND THE CITY OF BOSTON

GENERAL CONTRACTOR AND SUBSIDIARY CORPORATION  
AND THE CITY OF BOSTON

GENERAL CONTRACTOR AND SUBSIDIARY CORPORATION  
AND THE CITY OF BOSTON

GENERAL CONTRACTOR AND SUBSIDIARY CORPORATION  
AND THE CITY OF BOSTON

GENERAL CONTRACTOR AND SUBSIDIARY CORPORATION  
AND THE CITY OF BOSTON

GENERAL CONTRACTOR AND SUBSIDIARY CORPORATION  
AND THE CITY OF BOSTON

GENERAL CONTRACTOR AND SUBSIDIARY CORPORATION  
AND THE CITY OF BOSTON

GENERAL CONTRACTOR AND SUBSIDIARY CORPORATION  
AND THE CITY OF BOSTON

this time you have to do







enough of a challenge,



But wait, it's even worse,







very technical document,

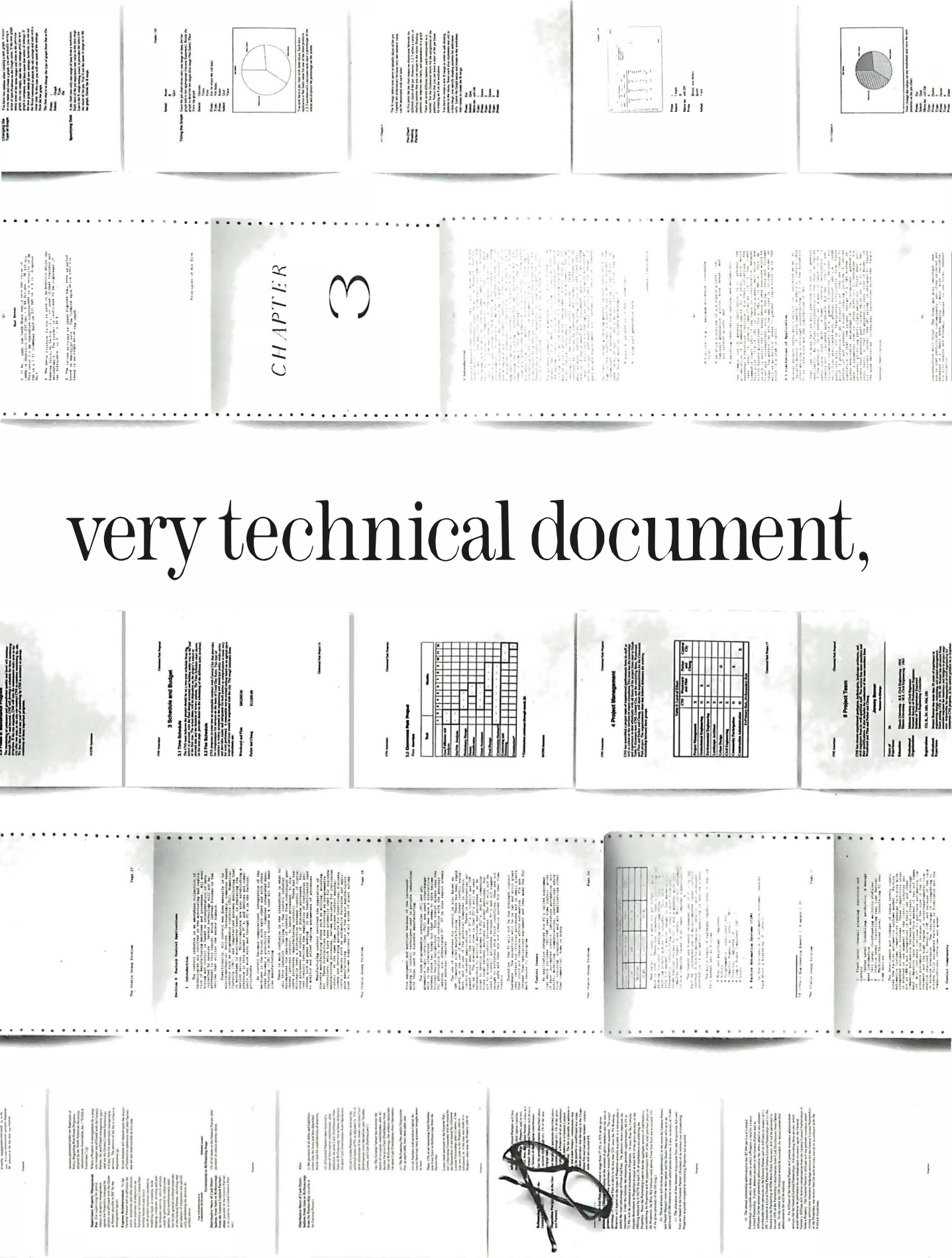







# a structured document,

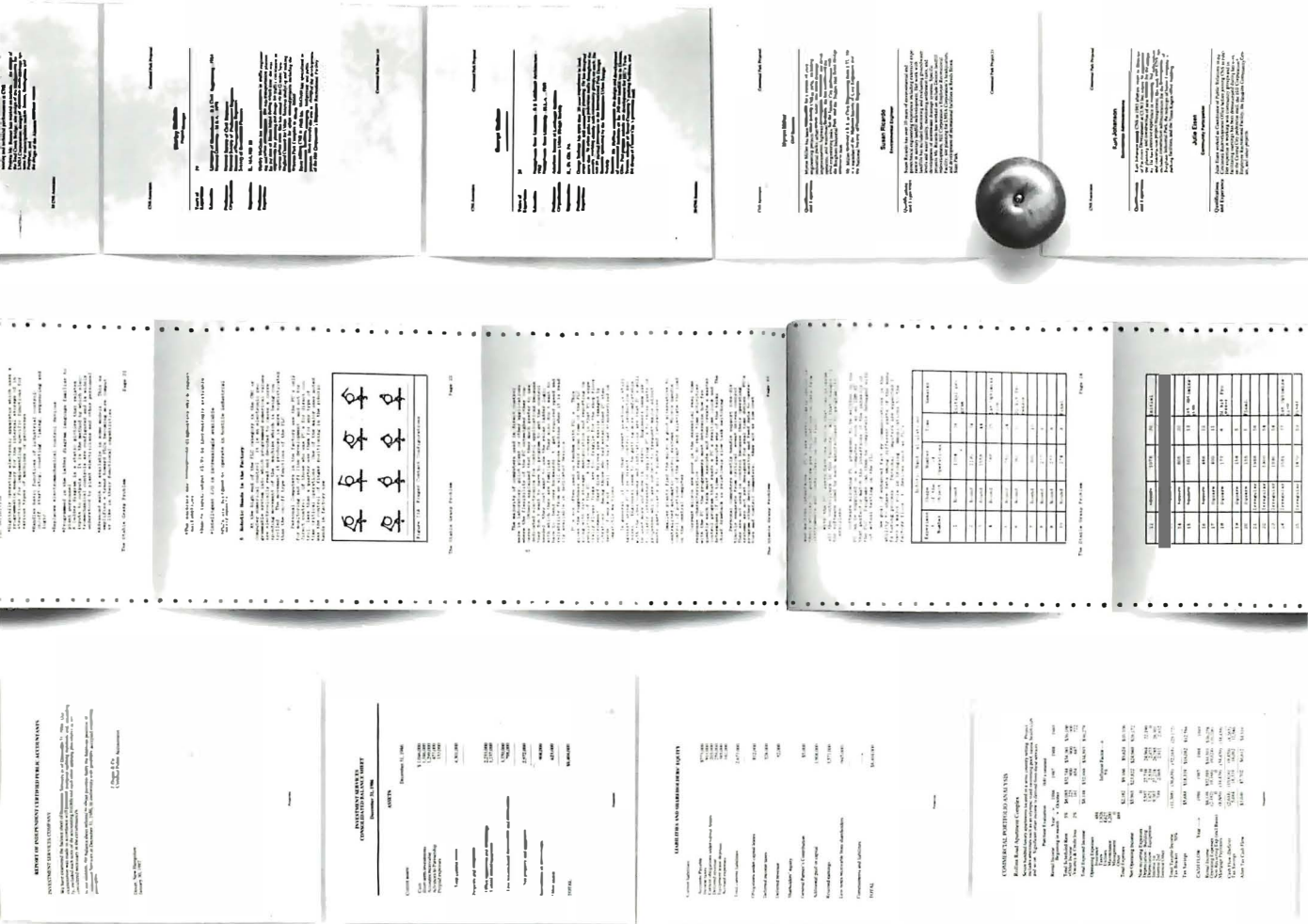

**REQUIREMENTS**

REQUIREMENTS FOR THE DESIGN OF THE STRUCTURE OF THE BUILDING...

**CONSTRUCTION**

CONSTRUCTION OF THE STRUCTURE OF THE BUILDING...

**COMPARISON**

Item	Value
Item 1	1000
Item 2	2000
Item 3	3000
Item 4	4000
Item 5	5000
Item 6	6000
Item 7	7000
Item 8	8000
Item 9	9000
Item 10	10000

**CONCLUSIONS**

CONCLUSIONS OF THE DESIGN OF THE STRUCTURE OF THE BUILDING...

**REFERENCES**

REFERENCES FOR THE DESIGN OF THE STRUCTURE OF THE BUILDING...

**APPENDIX**

Item	Value
Item 1	1000
Item 2	2000
Item 3	3000
Item 4	4000
Item 5	5000
Item 6	6000
Item 7	7000
Item 8	8000
Item 9	9000
Item 10	10000

**BIBLIOGRAPHY**

BIBLIOGRAPHY FOR THE DESIGN OF THE STRUCTURE OF THE BUILDING...

**REQUIREMENTS**

REQUIREMENTS FOR THE DESIGN OF THE STRUCTURE OF THE BUILDING...

**CONSTRUCTION**

CONSTRUCTION OF THE STRUCTURE OF THE BUILDING...

**COMPARISON**

Item	Value
Item 1	1000
Item 2	2000
Item 3	3000
Item 4	4000
Item 5	5000
Item 6	6000
Item 7	7000
Item 8	8000
Item 9	9000
Item 10	10000

**CONCLUSIONS**

CONCLUSIONS OF THE DESIGN OF THE STRUCTURE OF THE BUILDING...

**REFERENCES**

REFERENCES FOR THE DESIGN OF THE STRUCTURE OF THE BUILDING...

**APPENDIX**

Item	Value
Item 1	1000
Item 2	2000
Item 3	3000
Item 4	4000
Item 5	5000
Item 6	6000
Item 7	7000
Item 8	8000
Item 9	9000
Item 10	10000

**BIBLIOGRAPHY**

BIBLIOGRAPHY FOR THE DESIGN OF THE STRUCTURE OF THE BUILDING...

**REQUIREMENTS**

REQUIREMENTS FOR THE DESIGN OF THE STRUCTURE OF THE BUILDING...

**CONSTRUCTION**

CONSTRUCTION OF THE STRUCTURE OF THE BUILDING...

**COMPARISON**

Item	Value
Item 1	1000
Item 2	2000
Item 3	3000
Item 4	4000
Item 5	5000
Item 6	6000
Item 7	7000
Item 8	8000
Item 9	9000
Item 10	10000

**CONCLUSIONS**

CONCLUSIONS OF THE DESIGN OF THE STRUCTURE OF THE BUILDING...

**REFERENCES**

REFERENCES FOR THE DESIGN OF THE STRUCTURE OF THE BUILDING...

**APPENDIX**

Item	Value
Item 1	1000
Item 2	2000
Item 3	3000
Item 4	4000
Item 5	5000
Item 6	6000
Item 7	7000
Item 8	8000
Item 9	9000
Item 10	10000

**BIBLIOGRAPHY**

BIBLIOGRAPHY FOR THE DESIGN OF THE STRUCTURE OF THE BUILDING...

**REQUIREMENTS**

REQUIREMENTS FOR THE DESIGN OF THE STRUCTURE OF THE BUILDING...

**CONSTRUCTION**

CONSTRUCTION OF THE STRUCTURE OF THE BUILDING...

**COMPARISON**

Item	Value
Item 1	1000
Item 2	2000
Item 3	3000
Item 4	4000
Item 5	5000
Item 6	6000
Item 7	7000
Item 8	8000
Item 9	9000
Item 10	10000

**CONCLUSIONS**

CONCLUSIONS OF THE DESIGN OF THE STRUCTURE OF THE BUILDING...

**REFERENCES**

REFERENCES FOR THE DESIGN OF THE STRUCTURE OF THE BUILDING...

**APPENDIX**

Item	Value
Item 1	1000
Item 2	2000
Item 3	3000
Item 4	4000
Item 5	5000
Item 6	6000
Item 7	7000
Item 8	8000
Item 9	9000
Item 10	10000

**BIBLIOGRAPHY**

BIBLIOGRAPHY FOR THE DESIGN OF THE STRUCTURE OF THE BUILDING...

**REQUIREMENTS**

REQUIREMENTS FOR THE DESIGN OF THE STRUCTURE OF THE BUILDING...

**CONSTRUCTION**

CONSTRUCTION OF THE STRUCTURE OF THE BUILDING...

**COMPARISON**

Item	Value
Item 1	1000
Item 2	2000
Item 3	3000
Item 4	4000
Item 5	5000
Item 6	6000
Item 7	7000
Item 8	8000
Item 9	9000
Item 10	10000

**CONCLUSIONS**

CONCLUSIONS OF THE DESIGN OF THE STRUCTURE OF THE BUILDING...

**REFERENCES**

REFERENCES FOR THE DESIGN OF THE STRUCTURE OF THE BUILDING...

**APPENDIX**

Item	Value
Item 1	1000
Item 2	2000
Item 3	3000
Item 4	4000
Item 5	5000
Item 6	6000
Item 7	7000
Item 8	8000
Item 9	9000
Item 10	10000

**BIBLIOGRAPHY**

BIBLIOGRAPHY FOR THE DESIGN OF THE STRUCTURE OF THE BUILDING...



designed to write like this?



# CHAPTER

# 3

Proceedings of the 1988

1. INTRODUCTION

The first section of the chapter discusses the importance of project management in the modern business environment. It highlights the challenges faced by organizations and the need for effective project management practices. The section also introduces the key concepts and terminology used throughout the chapter.

2. THE PROJECT MANAGEMENT PROCESS

This section provides a detailed overview of the project management process, from initial planning to final evaluation. It covers the various stages of project management, including project initiation, planning, execution, monitoring, and closure. The text emphasizes the importance of communication and collaboration throughout the process.

3. SCHEDULE AND BUDGET

The third section focuses on the critical aspects of project management: scheduling and budgeting. It discusses the techniques used to create project schedules and manage resources. The text also addresses the challenges of budgeting and the importance of cost control in ensuring project success.

4. PROJECT MANAGEMENT

Task	Start	End	Duration	Resources
Task 1	1/15	1/20	5 days	2 people
Task 2	1/20	1/25	5 days	3 people
Task 3	1/25	2/5	10 days	4 people
Task 4	2/5	2/10	5 days	2 people
Task 5	2/10	2/15	5 days	3 people
Task 6	2/15	2/20	5 days	2 people
Task 7	2/20	2/25	5 days	3 people
Task 8	2/25	3/5	10 days	4 people
Task 9	3/5	3/10	5 days	2 people
Task 10	3/10	3/15	5 days	3 people
Task 11	3/15	3/20	5 days	2 people
Task 12	3/20	3/25	5 days	3 people
Task 13	3/25	4/5	10 days	4 people
Task 14	4/5	4/10	5 days	2 people
Task 15	4/10	4/15	5 days	3 people
Task 16	4/15	4/20	5 days	2 people
Task 17	4/20	4/25	5 days	3 people
Task 18	4/25	5/5	10 days	4 people
Task 19	5/5	5/10	5 days	2 people
Task 20	5/10	5/15	5 days	3 people
Task 21	5/15	5/20	5 days	2 people
Task 22	5/20	5/25	5 days	3 people
Task 23	5/25	6/5	10 days	4 people
Task 24	6/5	6/10	5 days	2 people
Task 25	6/10	6/15	5 days	3 people
Task 26	6/15	6/20	5 days	2 people
Task 27	6/20	6/25	5 days	3 people
Task 28	6/25	7/5	10 days	4 people
Task 29	7/5	7/10	5 days	2 people
Task 30	7/10	7/15	5 days	3 people
Task 31	7/15	7/20	5 days	2 people
Task 32	7/20	7/25	5 days	3 people
Task 33	7/25	8/5	10 days	4 people
Task 34	8/5	8/10	5 days	2 people
Task 35	8/10	8/15	5 days	3 people
Task 36	8/15	8/20	5 days	2 people
Task 37	8/20	8/25	5 days	3 people
Task 38	8/25	9/5	10 days	4 people
Task 39	9/5	9/10	5 days	2 people
Task 40	9/10	9/15	5 days	3 people
Task 41	9/15	9/20	5 days	2 people
Task 42	9/20	9/25	5 days	3 people
Task 43	9/25	10/5	10 days	4 people
Task 44	10/5	10/10	5 days	2 people
Task 45	10/10	10/15	5 days	3 people
Task 46	10/15	10/20	5 days	2 people
Task 47	10/20	10/25	5 days	3 people
Task 48	10/25	11/5	10 days	4 people
Task 49	11/5	11/10	5 days	2 people
Task 50	11/10	11/15	5 days	3 people
Task 51	11/15	11/20	5 days	2 people
Task 52	11/20	11/25	5 days	3 people
Task 53	11/25	12/5	10 days	4 people
Task 54	12/5	12/10	5 days	2 people
Task 55	12/10	12/15	5 days	3 people
Task 56	12/15	12/20	5 days	2 people
Task 57	12/20	12/25	5 days	3 people
Task 58	12/25	1/5	10 days	4 people
Task 59	1/5	1/10	5 days	2 people
Task 60	1/10	1/15	5 days	3 people
Task 61	1/15	1/20	5 days	2 people
Task 62	1/20	1/25	5 days	3 people
Task 63	1/25	2/5	10 days	4 people
Task 64	2/5	2/10	5 days	2 people
Task 65	2/10	2/15	5 days	3 people
Task 66	2/15	2/20	5 days	2 people
Task 67	2/20	2/25	5 days	3 people
Task 68	2/25	3/5	10 days	4 people
Task 69	3/5	3/10	5 days	2 people
Task 70	3/10	3/15	5 days	3 people
Task 71	3/15	3/20	5 days	2 people
Task 72	3/20	3/25	5 days	3 people
Task 73	3/25	4/5	10 days	4 people
Task 74	4/5	4/10	5 days	2 people
Task 75	4/10	4/15	5 days	3 people
Task 76	4/15	4/20	5 days	2 people
Task 77	4/20	4/25	5 days	3 people
Task 78	4/25	5/5	10 days	4 people
Task 79	5/5	5/10	5 days	2 people
Task 80	5/10	5/15	5 days	3 people
Task 81	5/15	5/20	5 days	2 people
Task 82	5/20	5/25	5 days	3 people
Task 83	5/25	6/5	10 days	4 people
Task 84	6/5	6/10	5 days	2 people
Task 85	6/10	6/15	5 days	3 people
Task 86	6/15	6/20	5 days	2 people
Task 87	6/20	6/25	5 days	3 people
Task 88	6/25	7/5	10 days	4 people
Task 89	7/5	7/10	5 days	2 people
Task 90	7/10	7/15	5 days	3 people
Task 91	7/15	7/20	5 days	2 people
Task 92	7/20	7/25	5 days	3 people
Task 93	7/25	8/5	10 days	4 people
Task 94	8/5	8/10	5 days	2 people
Task 95	8/10	8/15	5 days	3 people
Task 96	8/15	8/20	5 days	2 people
Task 97	8/20	8/25	5 days	3 people
Task 98	8/25	9/5	10 days	4 people
Task 99	9/5	9/10	5 days	2 people
Task 100	9/10	9/15	5 days	3 people

5. PROJECT MANAGEMENT

Task	Start	End	Duration	Resources
Task 1	1/15	1/20	5 days	2 people
Task 2	1/20	1/25	5 days	3 people
Task 3	1/25	2/5	10 days	4 people
Task 4	2/5	2/10	5 days	2 people
Task 5	2/10	2/15	5 days	3 people
Task 6	2/15	2/20	5 days	2 people
Task 7	2/20	2/25	5 days	3 people
Task 8	2/25	3/5	10 days	4 people
Task 9	3/5	3/10	5 days	2 people
Task 10	3/10	3/15	5 days	3 people
Task 11	3/15	3/20	5 days	2 people
Task 12	3/20	3/25	5 days	3 people
Task 13	3/25	4/5	10 days	4 people
Task 14	4/5	4/10	5 days	2 people
Task 15	4/10	4/15	5 days	3 people
Task 16	4/15	4/20	5 days	2 people
Task 17	4/20	4/25	5 days	3 people
Task 18	4/25	5/5	10 days	4 people
Task 19	5/5	5/10	5 days	2 people
Task 20	5/10	5/15	5 days	3 people
Task 21	5/15	5/20	5 days	2 people
Task 22	5/20	5/25	5 days	3 people
Task 23	5/25	6/5	10 days	4 people
Task 24	6/5	6/10	5 days	2 people
Task 25	6/10	6/15	5 days	3 people
Task 26	6/15	6/20	5 days	2 people
Task 27	6/20	6/25	5 days	3 people
Task 28	6/25	7/5	10 days	4 people
Task 29	7/5	7/10	5 days	2 people
Task 30	7/10	7/15	5 days	3 people
Task 31	7/15	7/20	5 days	2 people
Task 32	7/20	7/25	5 days	3 people
Task 33	7/25	8/5	10 days	4 people
Task 34	8/5	8/10	5 days	2 people
Task 35	8/10	8/15	5 days	3 people
Task 36	8/15	8/20	5 days	2 people
Task 37	8/20	8/25	5 days	3 people
Task 38	8/25	9/5	10 days	4 people
Task 39	9/5	9/10	5 days	2 people
Task 40	9/10	9/15	5 days	3 people
Task 41	9/15	9/20	5 days	2 people
Task 42	9/20	9/25	5 days	3 people
Task 43	9/25	10/5	10 days	4 people
Task 44	10/5	10/10	5 days	2 people
Task 45	10/10	10/15	5 days	3 people
Task 46	10/15	10/20	5 days	2 people
Task 47	10/20	10/25	5 days	3 people
Task 48	10/25	11/5	10 days	4 people
Task 49	11/5	11/10	5 days	2 people
Task 50	11/10	11/15	5 days	3 people
Task 51	11/15	11/20	5 days	2 people
Task 52	11/20	11/25	5 days	3 people
Task 53	11/25	12/5	10 days	4 people
Task 54	12/5	12/10	5 days	2 people
Task 55	12/10	12/15	5 days	3 people
Task 56	12/15	12/20	5 days	2 people
Task 57	12/20	12/25	5 days	3 people
Task 58	12/25	1/5	10 days	4 people
Task 59	1/5	1/10	5 days	2 people
Task 60	1/10	1/15	5 days	3 people
Task 61	1/15	1/20	5 days	2 people
Task 62	1/20	1/25	5 days	3 people
Task 63	1/25	2/5	10 days	4 people
Task 64	2/5	2/10	5 days	2 people
Task 65	2/10	2/15	5 days	3 people
Task 66	2/15	2/20	5 days	2 people
Task 67	2/20	2/25	5 days	3 people
Task 68	2/25	3/5	10 days	4 people
Task 69	3/5	3/10	5 days	2 people
Task 70	3/10	3/15	5 days	3 people
Task 71	3/15	3/20	5 days	2 people
Task 72	3/20	3/25	5 days	3 people
Task 73	3/25	4/5	10 days	4 people
Task 74	4/5	4/10	5 days	2 people
Task 75	4/10	4/15	5 days	3 people
Task 76	4/15	4/20	5 days	2 people
Task 77	4/20	4/25	5 days	3 people
Task 78	4/25	5/5	10 days	4 people
Task 79	5/5	5/10	5 days	2 people
Task 80	5/10	5/15	5 days	3 people
Task 81	5/15	5/20	5 days	2 people
Task 82	5/20	5/25	5 days	3 people
Task 83	5/25	6/5	10 days	4 people
Task 84	6/5	6/10	5 days	2 people
Task 85	6/10	6/15	5 days	3 people
Task 86	6/15	6/20	5 days	2 people
Task 87	6/20	6/25	5 days	3 people
Task 88	6/25	7/5	10 days	4 people
Task 89	7/5	7/10	5 days	2 people
Task 90	7/10	7/15	5 days	3 people
Task 91	7/15	7/20	5 days	2 people
Task 92	7/20	7/25	5 days	3 people
Task 93	7/25	8/5	10 days	4 people
Task 94	8/5	8/10	5 days	2 people
Task 95	8/10	8/15	5 days	3 people
Task 96	8/15	8/20	5 days	2 people
Task 97	8/20	8/25	5 days	3 people
Task 98	8/25	9/5	10 days	4 people
Task 99	9/5	9/10	5 days	2 people
Task 100	9/10	9/15	5 days	3 people

6. PROJECT MANAGEMENT

This section discusses the various tools and techniques used in project management, including Gantt charts, PERT networks, and resource allocation. It also covers the importance of communication and collaboration in ensuring project success.

7. PROJECT MANAGEMENT

This section discusses the various tools and techniques used in project management, including Gantt charts, PERT networks, and resource allocation. It also covers the importance of communication and collaboration in ensuring project success.

8. PROJECT MANAGEMENT

This section discusses the various tools and techniques used in project management, including Gantt charts, PERT networks, and resource allocation. It also covers the importance of communication and collaboration in ensuring project success.

9. PROJECT MANAGEMENT

This section discusses the various tools and techniques used in project management, including Gantt charts, PERT networks, and resource allocation. It also covers the importance of communication and collaboration in ensuring project success.

10. PROJECT MANAGEMENT

This section discusses the various tools and techniques used in project management, including Gantt charts, PERT networks, and resource allocation. It also covers the importance of communication and collaboration in ensuring project success.



with plenty of revisions.

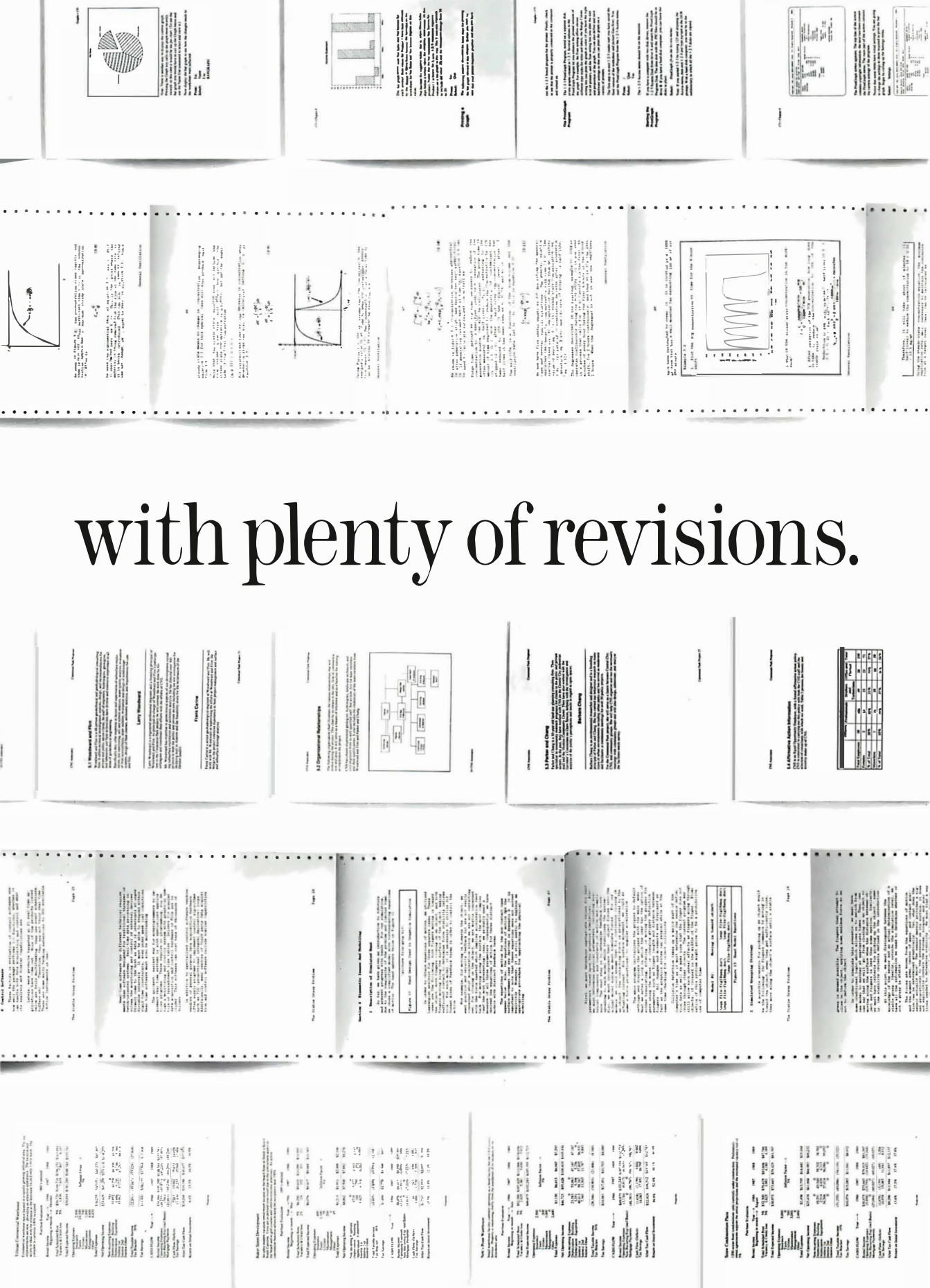



in a short amount of time.

Page 10

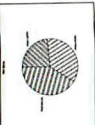

Page 11



Page 12



Page 13

Page 14

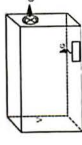

Page 15

$$x = \frac{1}{2} \sqrt{a^2 + b^2}$$
$$y = \frac{1}{2} \sqrt{a^2 + b^2}$$
$$z = \frac{1}{2} \sqrt{a^2 + b^2}$$

Page 16

$$x = \frac{1}{2} \sqrt{a^2 + b^2}$$
$$y = \frac{1}{2} \sqrt{a^2 + b^2}$$
$$z = \frac{1}{2} \sqrt{a^2 + b^2}$$

Page 17

Page 18

Page 19



Page 20

Page 21

Page 22



Page 23

Year	1950	1951	1952	1953	1954	1955	1956	1957	1958	1959	1960
Population	551,962,000	564,599,000	578,000,000	592,000,000	606,000,000	620,000,000	634,000,000	648,000,000	662,000,000	676,000,000	690,000,000
Area	9,572,947	9,572,947	9,572,947	9,572,947	9,572,947	9,572,947	9,572,947	9,572,947	9,572,947	9,572,947	9,572,947
Population Density	57.6	58.9	60.5	61.9	63.4	64.9	66.4	67.9	69.4	70.9	72.4

Page 24

Page 25

Page 26

Page 27



Yes, Lotus Manuscript™ is a very different kind of word processor. Because when you're processing long, technical documents such as proposals, specifications and reports, you have very different kinds of needs.

Needs like mixing text and graphics on the same page. Or, creating complex equations. Or, working with columns and tables. Or, making wholesale revisions.

Very often technical documents require the mixing of text and graphics on the same page. Graphics from Lotus®

even an entire chapter with just a few keystrokes.

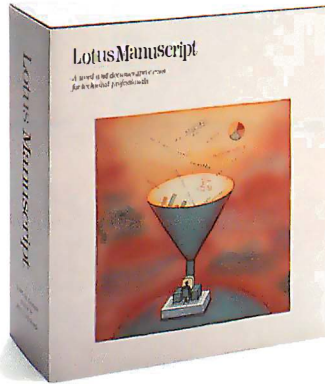

Also, because Manuscript is structured, you can globally format an entire document or format by individual sections.

over the look of your document. You can position and size graphics anywhere on the page. You can choose fonts and point sizes from a built-in typeface list. You can even save format information as a template for regular use.

As for the quality of output, Manuscript takes full advantage of today's printing technology, from dot-matrix to laser, including PostScript® printers.

Manuscript is designed to work on most IBM® PCs and compatibles.\* Its familiar 1-2-3 interface makes it easy to use. And our Manuscript evaluation

# May we suggest Manuscript.

1-2-3®, Symphony® and Freelance® Plus. With Manuscript you can import spreadsheets and charts, as well as diagrams and scanned images.

Another feature designed specifically for the writer of technical documents is Manuscript's integrated Outliner. When you collapse the document you're able to navigate the outline much easier than wading through the entire piece. You can move a page, or

Imagine changing all headlines from 14 point plain text to 16 point bold, by a simple menu selection.

How about the age old dilemma of proof reading revisions? Manuscript's Document Compare feature highlights changes between revisions. You might call it fool-proofreading.

Also, Manuscript automatically sizes and generates math equations as well as upper and lower case Greek symbols, diacritical marks and brackets. No longer do you need to literally cut and paste to create equations.

With our powerful Print Formatter you have complete control

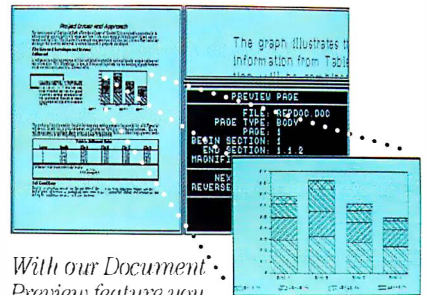

With our Document Preview feature you can see how any page will look before it's printed. Zoom capability lets you take a closer look at graphics and equations.

kit makes it easy to try. For \$10.00, you'll get a presentation disk, working software, and a tutorial manual. To get your evaluation kit, call 1-800-345-1043, ask for lot YF-1450. Or, for more information, see your authorized Lotus Dealer, or write Lotus Development Corp., 55 Cambridge Parkway, Cambridge, MA 02142.

Spreadsheets, graphs and charts from 1-2-3® and Symphony® can easily be mixed with text on the same page.

You can throw away your scissors and glue, cut and paste are a thing of the past.

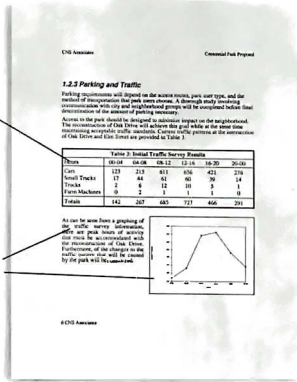



# mixing text and graphics.

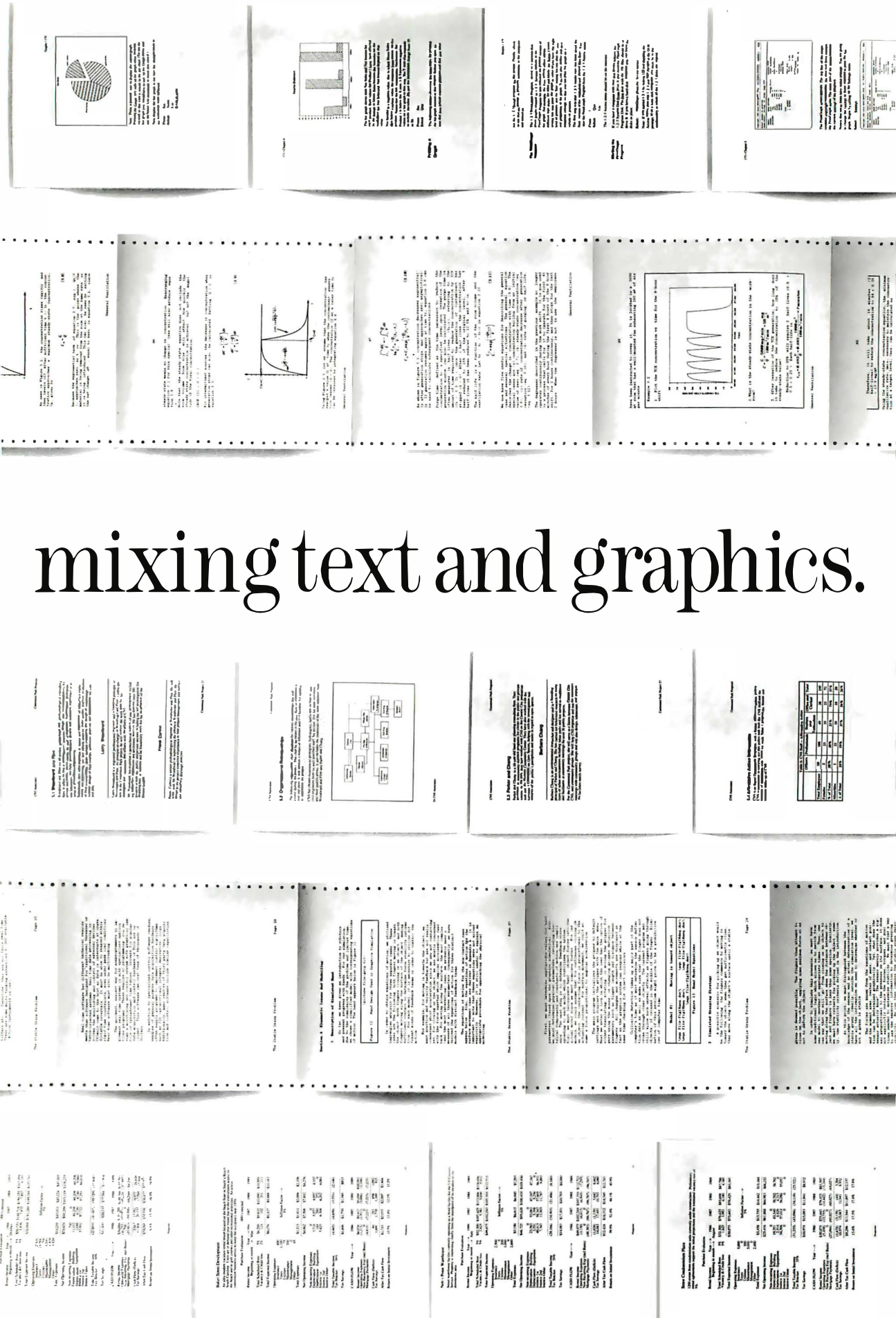



# EVENTS AND CLUBS

February 1987

## EVENTS

**1987 Computer Graphic Invitational Computer Conference**, San Jose, CA, and North Dallas, TX. Invitational Computer Conference, 3151 Airway Ave. #C-2, Costa Mesa, CA 92626, (714) 957-0171. *February*

**Third International Conference on Data Engineering**, Los Angeles, CA. Computer Science Department, Marguerite Jacks Hall, Stanford University, Stanford, CA 94305, (415) 723-0685. *February 3-5*

**Sixteenth Annual Computers in Education Conference: Macro Vision—A Broader View of Technology**, Portland, OR. Bob Hamel, Multnomah ESD, 220 Southeast 102nd, Portland, OR 97216, or call Tony Vaught, (503) 657-5154. *February 5-7*

**Sixth Annual Computers in Education Conference**, Manchester, NH. Carol Anne Eldridge, New Hampshire Association for Computer Education Statewide, 741 Chestnut St., Manchester, NH 03104, or call Michael Goldsmith, (603) 225-0815. *February 9*

**Communication Networks '87**, Washington, DC. CW/Conference Management Group, P.O. Box 9171, 375 Cochituate Rd., Framingham, MA 01701-9171, (800) 225-4698; in Massachusetts, (617) 879-0700. *February 9-12*

**1987 Systems Design & Integration Conference**, Santa Clara, CA. Electronic Conventions Management, 8110 Airport Blvd., Los Angeles, CA 90045, (213) 772-2965. *February 10-12*

**Mansfield Mid-Winter Hamfest/Computer Show**, Mansfield, OH. Dean Wrasse KB8MG, 1094 Beal Rd., Mansfield, OH 44905, (419) 589-2415. *February 15*

**Electronic Imaging West**, Anaheim, CA. MG Expositions Group, 1050 Commonwealth Ave., Boston, MA 02215, (800) 223-7126; in Massachusetts, (617) 232-5470. *February 16-19*

**Artificial Intelligence: Technology, Industry, and Applications**, Los Angeles, CA. UCLA Extension, P.O. Box 24901, Los Angeles, CA 90024, (213) 825-3344. *February 17-20*

**Fifteenth Annual ACM Computer Science Conference and SIGCSE Symposium**, St. Louis, MO. ACM, Conference Department, 11 West 42nd St., Third Floor, New York, NY 10036, (212) 869-7440. *February 17-20*

**Which Computer? Show**, Birmingham, Warwickshire, U.K. British Information Services, 845 Third Ave., New York, NY 10022, (212) 752-8400. *February 17-20*

**Second Guelph Conference on Computer Conferencing and Electronic Messaging**, Guelph, Ontario. Robert J. McQueen, Department of Communications Services, University of Guelph, Guelph, Ontario, Canada N1G 2W1. *February 18-19*

**Fifth Annual Missouri Computer-Using Educators Conference**, Columbia, MO. Michael C. Holden, 205 Hill Hall, University of Missouri, Columbia, MO 65211, (314) 882-7403. *February 20-21*

**Microcomputers in Control Systems: Hardware, Software, and Interfacing**, Washington, DC. Continuing Engineering Education, The George Washington University, Washington, DC 20052, (800) 424-9773; in Canada, (800) 535-4567; in DC, (202) 994-6106. *February 23-27*

**Computer-Aided Software Engineering Symposium**, Atlanta, GA. Digital Consulting Associates Inc., 6 Windsor St., Andover, MA 01810, (617) 470-3870. *February 24-26*

**Ohio Department of Education and the Ohio Education Data Systems Association's Sixth Annual Computer Fair**, Columbus, OH. Dan Henige, Penta Schools, 30095 Oregon Rd., Perrysburg, OH 43551, (419) 666-1120. *February 25-26*

**COMMTEX '87**, Atlanta, GA. International Communications Industries Association, 3150 Spring St., Fairfax, VA 22031-2399, (703) 273-7200. *February 26-28*

If you send notice of your organization's public activities at least four months in advance, we will publish them as space permits. Please send them to BYTE (Events and Clubs), One Phoenix Mill Lane, Peterborough, NH 03458.

## CLUBS

**Hands On!** newsletter, Technical Education Research Centers, 1696 Massachusetts Ave., Cambridge, MA 02138.

**Assembly on Computers in English**, affiliate of the National Council of Teachers of English. Contact Lenora Cook, ACE, 12 Coral Tree Lane, Rolling Hills Estates, CA 90274, (213) 377-3701.

**COMPRESS Quarterly**, newsletter on educational software, COMPRESS, P.O. Box 102, Wentworth, NH 03282.

**California Educational Computing Consortium Newsletter**, Hal Roach, Mt. San Antonio College, 1100 North Grand Ave., Walnut, CA 91789.

**Academically Speaking**, educational computing newsletter from Scholastech, P.O. Box 1545, Cambridge, MA 02238.

**T-BUG**, Chicago-area Tandy Business Users Group, Ellen D. Weinstein, 1642 Coloma Place, Wheaton, IL 60187.

**ComputAbility**, catalog of special products for handicapped IBM users, ComputAbility Corp., 101 Route 46, Pine Brook, NJ 07058, (201) 882-0171.

**SCPCUG**, for IBM PC and compatible users, P.O. Box 0396, Titusville, FL 32780, Alan Tietjen, (305) 269-7815.

**Cape PC Users Group**, Gene Neill, 131 West Heather Rd., Wildwood Crest, NJ 08260.

**Amiga Guru**, newsletter of the Cleveland Area Amiga Users' Group (CA-AUG), 3715 Townley Rd., Shaker Heights, OH 44122, BBS: (216) 341-4452.

**Tele/Tech**, BBS for real estate professionals, (703) 560-8931, or call Robert D. Weaver at (703) 560-8981.

**Sydney Kaypro Users Group (SKUG)**, Hans Schneider, 122 Murrivier Rd., North Bondi, New South Wales 2026, Australia.

**PC Life**, newsletter of the Long Island PC Users' Group, P.O. Box 280, Commack, NY 11725; South of the Bauder BBS: (516) 932-2860. ■





The leading portable.

# We're not too big

If you find portable computers that leave you hanging a little hard to take, meet MultiSpeed™ from NEC. A breakthrough of truly small proportions.

Our Multi is a mini. Just a decimal point over 11 lbs. So you can really travel light. More important, you can travel bright.

You can do more with MultiSpeed. Because it has more power (640K) and more memory. And at 9.54 MHz it runs at twice the speed of the IBM Convertible.

Of course, you can expand our competitor's capabilities. But to do that you have to add "slices." And pay the prices of the slices. Which can run hundreds of dollars. For features that come standard on MultiSpeed.

And that's not the least of it. Because the slices

make their portable more portly. Most are over two inches and weigh about a pound.

Then there's MultiSpeed's detachable screen. It has a remarkable twist: a Super Twist LCD. Compare

Feature	NEC MultiSpeed	IBM Convertible
Clock Speed	9.54/4.77 MHz	4.77 MHz
Standard Memory	640K bytes	256K bytes
Built-in Pop-up Firmware	Yes	No
Separate Numeric Keypad	Yes	No
Screen Type	S-Twist LCD	LCD
Keybd. Compat. IBM PC/XT	Yes	No*
Total Keys	85	78
Weight	11.2 lbs.	12.2 lbs.

our readability to theirs. There's no comparison. Besides a better view, you get a 15% bigger view. Best of all, there's nothing small-minded

about MultiSpeed. It can do most anything your desktop

**C&C** Computers and Communications

IBM Convertible is not compatible with IBM keyboard part No. 8529297.  
IBM & the IBM PC Convertible and PC/XT are registered trademarks of International Business Machines Inc.





The new MultiSpeed™

# *for your britches.*

PC can. And, MultiSpeed is chock-full of savvy ideas.

Like a built-in full-function word processor with a spell checker of 20,000 words.

It has a personal filing system and outliner. Plus Telcom, a powerful telecommunications package.

MultiSpeed is compatible with the IBM PC and has an optional Hayes compatible modem.

What's more, it even does windows. It has a special multiple windowing feature built right in. Which works at the touch of a single "Pop Up" key. MultiSpeed has a separate numeric keypad and the

same feel of the desktop keyboard you're used to.

And, when you discover everything it comes with, you'll be delighted at what it goes for.

So, why settle for the portable computer that's more brawny. When you can have the one that's more brainy. You'll find MultiSpeed at Bell Atlantic Business Center, Compumat, Compushop, Computerland, Connecting Point and Micro Age. For the dealer nearest you call 1-800-447-4700.

For technical information call 1-800-NEC-SOFT. Or write NEC Home Electronics, Computer Products Division, 1255 Michael Drive, Wood Dale, IL 60191-1094.

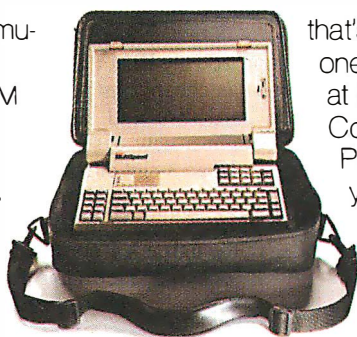

***Take the Multi and run.  
MultiSpeed™***

**NEC**



# ASK BYTE

Conducted by Steve Ciarcia

## Talking to Your Printer

Dear Steve,

I have been working in Amiga BASIC and Amiga C. I own two printers: an Epson FX-185 and an Okidata Okimate 20. The problem is that I am unable to successfully send escape codes to either printer, although the software I use—including D-Paint, Notepad, and D-Print—all work fine with either printer.

I have written directly to Commodore for help. Commodore sent a reply that included a page from the *ROM Kernel Manual* with escape sequences but no programming examples. When I tried doing what the letter suggested, I had no success.

Thanks for any help you can give me.  
Beverly Tranka  
Gansevoort, NY

*The Amiga "talks" to the printer using a piece of software called a device driver. The device driver handles, among other things, conversion of control code sequences between the Amiga and your printer. This conversion allows the Amiga to support many different printers.*

*The Amiga only understands its own set of printer control codes. For example, ESC [ 0 z is used by the Amiga to set the line spacing on your printer. Your program should send this sequence to the printer, regardless of what brand or model of printer you have connected. When you send any characters to the printer, the device driver gets them before the printer. If you are sending a control sequence, the device driver will not send it to the printer. Instead, it will translate it into the proper codes for the printer that you have selected using the Preferences utility on the Workbench. If you have selected the Epson FX-80 printer, then the above control code will be translated to ESC 0 and sent to the printer. This will set the line spacing on the Epson to eight lines per inch.*

*A complete listing of the Amiga control codes can be found in the Amiga ROM Kernel Manual, Volume I, beginning on page 3-198.—Steve*

## Desperately Seeking Printer

Dear Steve,

We have searched without success for a moderately priced, serial-interface, bottom-feed printer designed to efficient-

ly handle one-across labels on tractor-feed paper stock 6½ inches wide. The labels must be produced on demand rather than in a batch mode and, as a result, two unused labels between every pair of useful labels are wasted when each set is advanced past the tractors for removal. These pressure-sensitive labels must be bottom-fed, as they tend to pull away from the backing paper and jam the printer if they have to roll around the platen. This eliminates printers with tractors preceding the platen. Standard printers require letter-width paper. Help!

David W. Jessup  
Seattle, WA

*There are two approaches you can take to solve your problem.*

*First, you could look into the Okidata line of printers (I believe you have a dealer in Seattle), specifically the ML92, which has bottom-feed capabilities and an adjustable top tractor. To use this—or any other parallel printer that meets your needs—you will have to use a printer buffer or printer adapter to convert your RS-232C serial data to parallel format.*

*Second, you might contact Centronics Data Computer Corp. (One Wall St., Hudson, NH 03051, (603) 883-0111, Ext. 4004) for information on their nearest representative. I know that they make several printers that would meet your needs, but they are a little harder to deal with as they service large- and medium-size systems. If my past experience is any guide, a serial printer with bottom-feed in the Centronics 700 series would be in the region of \$600.—Steve*

## Upgrading an IBM PC

Dear Steve,

I want to upgrade my IBM PC to an XT (or XT clone) as cheaply as possible so I can add a hard disk and some more cards. If I bought a new case, a bigger power supply, and an 8-slot clone motherboard, could I expect my original IBM ROM BIOS chips to work in the clone board and give me a true XT compatible?

Jack G. Aubert  
Paris, France

*If your need is primarily to add a hard disk, the cheapest way is to buy one of the aftermarket hard disk drive/controller sets available for around \$400 from many*

*sources advertised in BYTE and most other personal computer magazines. There are some combination hard and floppy drive controllers available that would enable you to add the hard drive without losing a slot. One company supplying these is Maynard Electronics, 430 East Semoran Blvd., Casselberry, FL 32707, (800) 821-8782 or (305) 331-6402.*

*If you really need to add slots, then a clone is probably your most economical route. These are not usually similar enough to the IBM that you can simply transfer all the PC chips to a blank clone board, although many of the PC chips could probably be used. Since populated boards are not very expensive, your best bet might be to save your current PC board intact as a spare or sell it along with the case. I know of no clone boards that will take the IBM ROM chips; they usually use EPROMS that are not pin-compatible with the IBM ROM chips.—Steve*

## Transmitting Data over the Air

Dear Steve,

I would like to be able to transmit digital data over the airwaves. I would like to use a pulse-width modulated (PWM) scheme or some equivalent to transmit in full-duplex serial. I would also like to have a fairly powerful transmission in order to extend the range of the signal. Although this system will not be broadcasting out-

*continued*

*IN ASK BYTE, Steve Ciarcia answers questions on any area of microcomputing. The most representative questions received each month will be answered and published. Do you have a nagging problem? Send your inquiry to*

*Ask BYTE  
c/o Steve Ciarcia  
P.O. Box 582  
Glastonbury, CT 06033*

*Due to the high volume of inquiries, we cannot guarantee a personal reply, but Steve and the Ask BYTE staff answer as many as time permits. All letters and photographs become the property of Steve Ciarcia and cannot be returned.*

*The Ask BYTE staff includes manager Harv Weiner and researchers Eric Albert, Bill Curlew, Ken Davidson, Jeannette Dojan, Jon Elson, Roger James, Frank Kuechmann, Dave Lundberg, Tim McDonough, Edward Nisley, Dick Sawyer, Andy Siska, Robert Stek, and Mark Voorhees.*



## News about the Microsoft Language Family

### The Evolution of Optimization Techniques Used in Microsoft® C.

One of the reasons the Microsoft C Compiler has been chosen by leading software developers is because of the optimization techniques used in the code generator of our production-quality compilers. Microsoft's advanced optimization capabilities mean that generated code is small and fast.

*Local optimization* was implemented in Microsoft C Version 3.0. Most MS-DOS®-based C compilers implement this technique, but good local code generation such as that in Microsoft C Version 3.0 uses *pattern matching* to select optimal sequences and *register targeting* to evaluate expressions in their target destinations. *Peephole analysis* is also used and includes such optimizations as *redundant load/store* analysis. This increases the efficiency of the resulting code by removing unnecessary or duplicate instructions. The compiler also optimizes branches by shortening or removing branches where it can.

Microsoft C Version 4.0 went one step further with block optimizations that used *common subexpression elimination*. This improved code optimization still further. The advantage is the time saved by avoiding recalculation of computations which are used repeatedly in the program.

For example:

```
a = b * (c/d); will evaluate to:
```

```
    tmp = (c/d);
```

```
    a = b * tmp;
```

```
e = f * (c/d); will evaluate to:
```

```
    e = f * tmp;
```

Note: depending on the context, tmp might be a register variable rather than a memory location.

The next progression for block optimizations is to do *loop optimizations* in our future production-quality compilers. If a calculation inside a loop does not depend on any calculations inside the loop, it can be moved outside the loop. This is called *invariant code motion*. A second loop optimization technique is called *induction variables*. This means that while in a loop, multiplies by the control variable can be turned into additions.

Examples of *induction variable* optimization:

```
1. for (i = 0; i < 10; ++i)
```

```
    j += i * 7;
```

evaluates to:

```
for (i = 0; i < 70; i += 7)
```

```
    j += i;
```

```
2. char a[10];
```

```
    for (i = 0; i < 10; i++)
```

```
        a[i] = 'c';
```

evaluates to:

```
    memset (a, 'c', 10);
```

ie: the following 8086 instruction would be generated:

```
    REP     STOSB
```

There is also *loop enregistering*, in which case calculations can be kept in a register for the whole loop. Loop optimization is implemented in the new 386 C Compiler in the XENIX® 386 Software Development Toolkit.

For more information on the products and features discussed in the Newsletter,

**write to:** Microsoft Languages Newsletter

16011 NE 36th Way, Box 97017, Redmond, WA 98073-9717.

**Or phone:**

(800) 426-9400. In Washington State and Alaska,

call (206) 882-8088. In Canada, call (416) 673-7638.

#### Latest DOS Versions:

Microsoft C Compiler	4.00
Microsoft COBOL	2.10
Microsoft FORTRAN	3.31
Microsoft Macro Assembler	4.00
Microsoft Pascal	3.32
Microsoft QuickBASIC	2.00



side of a building, I'm sure the FCC will want to limit the transmission strength. Unfortunately, I don't know how to accomplish all this. All the literature I have is in reference to modems using a transmission medium such as a wire.

Since the transmission will be over the air I assume that a great deal of noise will occur. To prevent this noise from overwhelming the data, I would like to add additional error-detection/correction bits to the transmitted signal. Ideally, I would like to be able to detect and correct up to 2-bit errors using a small number of ICs (I don't have a lot of board real estate available). Are you aware of any ICs that implement such algorithms?

Also, because I will be transmitting on the open airwaves and some data may be of a sensitive nature, I would like to guard against unauthorized interception. I would like to encode this data with a key encryption scheme where the key can be set by means of data lines to an IC. I know that the National Bureau of Standards has released a Data Encryption Standard, known as the DES; is this implemented in IC form?

One last question: I was under the impression that some minicomputers and mainframes automatically detect baud

rates of terminals before the log-on sequence is fully established. Is this accomplished through hardware using an intelligent UART or USART, or does the terminal send some predefined ASCII sequence until the host machine guesses the correct baud rate and begins the session?

Thomas F. Geary III  
Cohasset, MA

*A common scheme to detect baud rate is to have the terminal send carriage returns, one at a time, to the computer. If you look at the bit pattern for a carriage return, you will see that there is a long "low" (or zero) time in the character. It is this first string of zeros that you can time in software to determine the baud rate. Of course, if the terminal doesn't send the right character, the software could end up with the wrong rate.*

*As far as sending digital information via radio frequencies, you are correct in stating that the FCC has imposed limits. In fact, you might want to get a copy of the Code of Federal Regulations, Title 47 (Telecommunications), Book 1, as well as information on frequency allocations for various services. In other words, you can have an unlicensed device meeting certain criteria or you will need to have a licensed*

*device (which requires more overhead for both you and the consumer). The rules cover low-power devices that might be of use to you. You can obtain copies of these rules from the Government Printing Office, 710 North Capitol St., Washington, DC 20402-9325.*

*A handy source of circuits for designing transmitters and receivers is The Radio Amateur's Handbook (Harper & Row, 1983).*

*To answer your questions on error correction and using an encryption algorithm, two articles in the September 1986 BYTE present some practical solutions for you. The first is my article "Build a Hardware Data Encryptor," which presents a scheme that does not use block encoding/decoding. The second is a Programming Project, "Calculating CRCs by Bits and Bytes" by Greg Morse. Since you mention full-duplex transmission and a desire to keep things reasonably simple, your system could call for retransmission upon detecting a transmission error. Another reference is published by Control Data, "A Study of Methods of Error Detection During Transmission of Binary Information." The cost is \$6 plus shipping. The address is CDC Literature Distribution*

*continued*



# Ecosoft Family of C Products

**Eco-C88 C compiler and FREE editor**

**\$59<sup>95</sup>**

A professional quality compiler in an easy to use environment.  
★ All operators and data types ★ Prototyping, structure passing - assignment, enum - void ★ Tiered error messages (selectable levels of "lint") ★ Memfiles (TM) for using memory outside the 128K limit as a file ★ Expanded library with over 200 functions (many System V) ★ ASM or OBJ output ★ 8087 runtime support ★ CC and "mini-make" (in source) for easy compiles ★ Expanded user's manual

**Ecosoft Librarian**

**\$29<sup>95</sup>**

An MSDOS/OBJ compatible librarian that's not limited to Ecosoft language products.

★ Add, delete, extract, combine, set page size, get contents or index of a library ★ With user's manual

**Eco-C88 Flexi-Graph Graphics Package**

**\$39<sup>95</sup>**

Add dramatic graphics effects into your Eco-C88 C programs.  
★ EGA, CGA, and Z100 support ★ Over 100 graphics and support functions ★ Write thru the BIOS or memory ★ Hershey fonts ★ Supports view areas, rotateable fonts, clipping, arbitrary fill areas ★ Extensive error checking ★ User's manual.

**Eco-C88 PC Compatible Windowing Library**

**\$29<sup>95</sup>**

Add pop up windows (for help, menus, error messages, special effects, etc.) to your C programs quickly and easily.

★ CGA, EGA, and monochrome support ★ Control any program that goes through the BIOS ★ Use up to 255 windows ★ No special window commands (e.g., use printf to write text to window) ★ Resize - move windows ★ Custom titles and borders

**1-800-952-0472** (Orders)  
**1-317-255-6476** (Tech. Info.)



**Ecosoft Inc.**  
6413 N. College Ave.  
Indianapolis, IN 46220





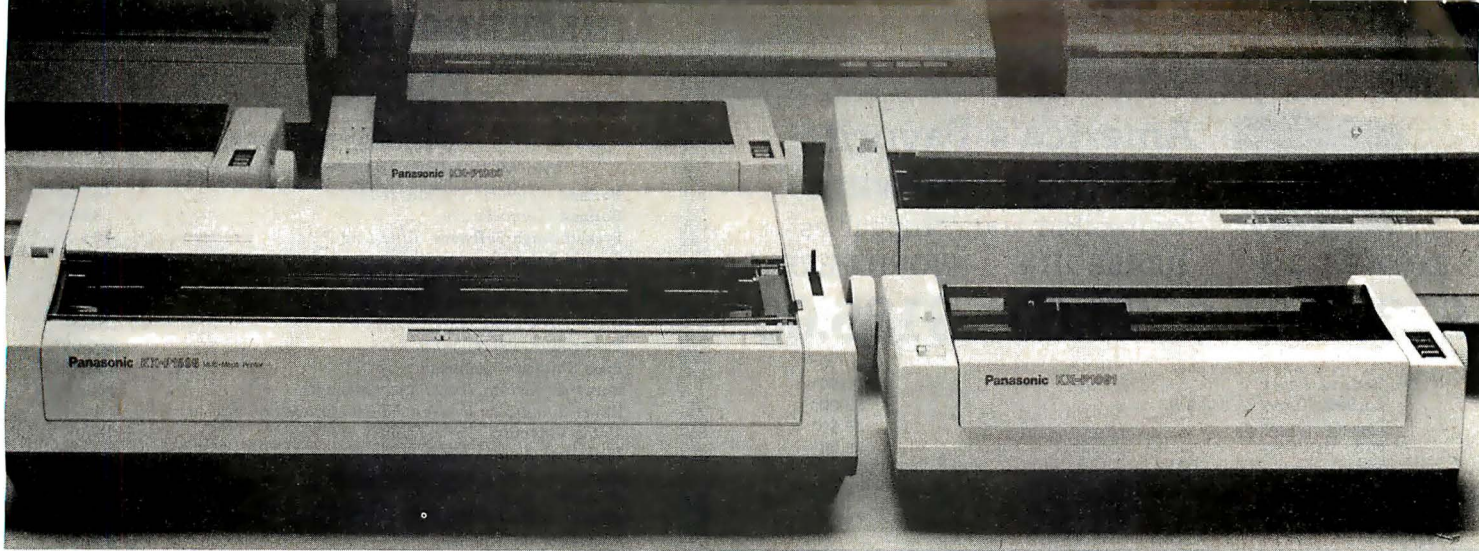

# PANASONIC® PRINTERS. THEY'RE GENERATING A LOT OF GOOD PRINT.

The good reviews keep rolling in. And, as you can see, the critics agree: Panasonic printers are real winners!

But that shouldn't come as too big of a surprise. After all, Panasonic printers offer the advanced features and ease-of-use you've come to expect from Panasonic.

So, whether your business is big, small or in-between, you'll find a printer with features to love every bit as much as the critics. Like—as one

...ad. Like their competition, the Panasonic machines are well made, sturdy printers that should serve well in the various applications for which they were designed. They are letter-quality text. About the

PC WEEK—JUNE 17, 1986

with this little printer.

As far as I'm concerned, the KX-P1091 produces not near letter quality but rather true letter quality in this mode. You'd really have to strain to distinguish it from typewriter quality. Knowing that the test output was printed to the company produced fast, courteous, and knowledgeable answers.

PC—SEPT. 17, 1985

reviewer observed—extraordinary near-letter-quality on our dot matrix models. They also come standard with impressive high-resolution graphics capability. So you can add graphs, charts, illustrations—even your company's logo.

Not to be outdone, all our daisy wheel printers give you sophisticated advances like boldface, shadow and underline.

Of course, we've put just as much care into the human side of our printers, too. You'll find

switches and buttons that let you change print sizes and styles right on the printer rather than through the computer. And, with our continuous, self re-inking ribbons, you'll find yourself changing ribbons less often. When you do, our snap-in cartridge makes it a snap.

...and performance of the KX-P3151. It is a well-built product that promises to deliver many hours of trouble-free operation. The print quality is clear and well-defined. The alignment of characters on adjacent lines is also excellent, a sign of a well-designed paper and printwheel transport system.

Finally, just when you thought all this would be hard to top, there's more: all our printers are backed with an unprecedented two-year limited warranty.

Now that you've reviewed all of this for yourself, call toll-free 1 (800) PIC-8086 for the name

...ed. It was 30.1 pounds. Like all the Panasonics we tested at, the 1592 comes with the company's exceptional two-year warranty. And like all of them, it definitely rates a look.

of the dealer nearest you. Or you can write to: Panasonic Industrial Company,

PRINTERS BUYERS GUIDE & HANDBOOK #3  
Computer Products Division, Two Panasonic Way, Secaucus, NJ 07094. You'll see how easily Panasonic printers generate good print for you.

And you'll agree: **THE EASIER, THE BETTER.**

**Panasonic**  
Office Automation 

Inquiry 198



# PC NETWORK

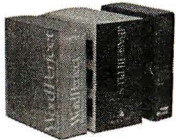

**America's Favorite Business Software**  
for the IBM and compatibles

**LOTUS 1-2-3      DBASE III+      WORD PERFECT**  
**\$285.00\*      \$375.00\*      \$185.00\***

Borland Reflex	\$80.00*
Borland Turbo Pascal 8087	53.00*
Borland SuperKey	34.50*
FGS Fastback	85.00*
Microsoft Word Latest Version 3.1	229.00*
Microsoft Quick Basic	54.00*
Microsoft Windows	51.00*

## Your #1 Source for Chips

**64K IBM™ Memory Expansion Kit**

200ns/Set of 9

**\$7.75\***

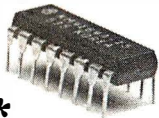

64K Memory Upgrade Kits (9 Chips)	\$7.75*
256K Dynamic Ram Chips	ea. 2.90*
128K AT Mother Board Chips	ea. 3.90*
Intel 8087 5Mhz Co-Processor	99.50*
Intel 8087 8Mhz Co-Processor	161.50*
Intel 80287 5Mhz/8Mhz	197.00*

All Chips are Guaranteed for Life

**TOLL FREE (800) 621-SAVE**

(Orders-Membership and Advice)

In Illinois call (312) 280-0002 **BB27**

Your Membership Validation Number

You can validate your membership number and, if you wish, place your first money-saving order over the phone by using your VISA, MASTERCARD or AMERICAN EXPRESS.

Our knowledgeable sales consultants are on duty:

MON.-FRI. (CST) SATURDAY

**8am-7pm 9am-5pm**



PERSONAL COMPUTER NETWORK

320 West Ohio

Chicago, Illinois 60610

FOR CUSTOMER SERVICE AND ORDER STATUS

CALL: (312) 280-1567

December Only  
Mon.-Fri.  
7am-9pm  
CST

## PC NETWORK MEMBERSHIP APPLICATION

**YES!** Please enroll me as a member in the PC NETWORK™ and send my catalog featuring thousands of computer products, all at just 8% above DEALER WHOLESALe PRICES. I will also receive "THE PRINTOUT", a special quarterly update on merchandise at prices BELOW even those in my wholesale catalog and all the other exclusive, money-saving services available to Members. I am under no obligation to buy anything. My complete satisfaction is guaranteed.

Please (✓) all boxes that apply:

- Basic Membership With 14 Days Rental**
- Business Software Rental Library \$25  add'l. per year
- Games Software Rental Library \$10  add'l. per year
- Special V.I.P. Membership With 30 Days Rental**
- BOTH Business and Game Software Rental Libraries \$30  add'l per year

Bill My Credit Card:  VISA  MasterCard  American Express

Account Number:

Exp. Date \_\_\_\_\_ mon. yr.

Check or Money Order Enclosed for \$ \_\_\_\_\_

Name \_\_\_\_\_ Apt. No. \_\_\_\_\_

Address \_\_\_\_\_ City \_\_\_\_\_ State \_\_\_\_\_ Zip \_\_\_\_\_

Telephone: ( \_\_\_\_\_ ) \_\_\_\_\_

My Computer(s) is:  IBM  IBM XT  IBM AT

Apple II  Macintosh Other \_\_\_\_\_

Signature \_\_\_\_\_

(Signature required to validate membership)  
Copyright © 1986, PC NETWORK, INC.

# MEMBERS PAY WHOLESALe AND GET 14-30 DAY

## BUSINESS SOFTWARE

(Please add \$2.50 shipping and handling for each title ordered from below.)

Borland SideKick (UnProtected)	\$42.00*
Borland Turbo Pascal	35.00*
Breakthrough Software Time Line 2.0	203.00*
Central Point Copy II PC	20.00*
Computer Associates Supercalc IV	239.95*
Computer Associates Super Project Plus	239.95*
DAC Easy Accounting	39.80*
Enertronics Energraphics 2.0	280.00*
Funk Software Sideways	32.00*
Harvard Harvard Total Project Manager	250.00*
Hayes Smartcom II—New VT 100 Emulator	68.00*
Living Videotext Think Tank	87.00*
MicroPro Wordstar 2000	210.00*
MicroPro Wordstar 2000+	259.00*
MicroRim RBase 5000	215.00*
MicroRim RBase 5000	258.25*
Microsoft C Compiler	230.00*
Microsoft Multiplan	98.00*
Monogram Dollars and Sense	85.00*
Multimate Advantage	270.00*
Multimate Multimate Latest Version	190.00*
Nantucket Clipper DBase III Compiler	350.00*
Norton Commander	36.00*
Norton Norton Utilities 3.1	43.00*
Software Publishing PFS: Professional File	132.00*
Software Publishing PFS: Professional Write	105.00*
Software Publishing PFS: Report	64.00*
Software Publishing PFS: Write, File, Graph	68.00*

**!RENT BEFORE YOU BUY**—Members are eligible to join the NETWORK'S Business and Game Software Rental Libraries to evaluate products for a full 14 days (Regular Membership) or 30 days (VIP Membership) to see if they meet your needs. And the NETWORK'S rental charges are far less than other software rental services—JUST 20% OF THE MEMBER WHOLESALe PRICE. We feature over 1,000 available titles in IBM/Apple/Mac

## PC NETWORK—THE NATION'S LARGEST COMPUTER



"THE™ PC + is well built and has enough company support behind it to make it a very attractive alternative to higher priced competition."

"THE's bottom line? The PC + is a highly compatible clone worthy of consideration..."

PC WORLD

"...the unit became the preferred computer in our office, which has several name brands as possible alternatives..."

Computer Dealer

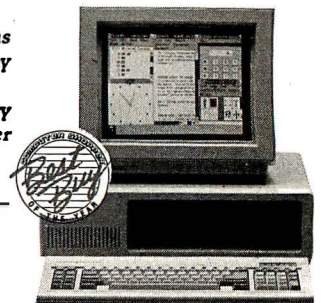

THE™ PC

100% IBM Compatible  
256K/w 360K Drive, Turbo Speed, AT Style Keyboard

**\$444.00\***

w/640K \$469.00\*

## Save on Famous Name Printers



**EPSON® FX-286**  
132CPS/200CPS LQ

**\$435.00\***

### PRINTERS

Citizen MSP-10 160CPS/80COL/Fric + Trac	\$259.00*
Citizen MSP-15 160CPS/132COL/Fric + Trac	340.00*
Citizen Premiere-35 35CPS Daisywheel 15"	420.00*
Epson EX-800 300/60CPS 132COL Par/Ser	440.00*
Epson EX-1000 300/60CPS 132COL Par/Ser	569.00*
Epson FX-85 160/35CPS 10" Par	329.00*
Epson FX-286 200/40CPS NLQ	435.00*
Epson LQ-800 180/60CPS 10" 24 Pin Par/Ser	470.00*
Epson LQ-1000 180/60CPS 15" Pin Par/Ser	665.00*
Epson LQ-2500 324/108CPS 24 Pin Par/Ser	955.00*
Epson LX-86 120/16CPS 8.5" Par w/NLQ	205.00*

## • 10 DAY HARDWARE RETURNS • CATALOG

(No Questions Asked, If You Don't Like It, Return It)

(30,000 Items Listed)



# PLUS 8% OR LESS SOFTWARE RENTALS<sup>†</sup>

## GAMES & EDUCATIONAL SOFTWARE

(Please add \$2.50 shipping and handling for each title ordered from below.)

Broderbund <i>The Print Shop</i>	\$30.00*
Broderbund <i>The Print Shop Library, Disk 1 or 2</i>	21.00*
Broderbund <i>Toy Shop</i>	34.50*
Davidson <i>Math Blaster or Word Attack</i>	23.00*
Electronic Arts <i>Amnesia</i>	29.97*
Electronic Arts <i>Music Construction Set or One on One</i>	15.97*
Infocom <i>Hitchhikers Guide, Ballyhoo</i>	20.00*
Infocom <i>Leather Goddesses of Phobos</i>	20.00*
Infocom <i>Zork II, Zork III</i>	22.00*
Microprose <i>F-15 Strike Eagle or Silent Service</i>	18.50*
Microsoft <i>Flight Simulator Vers. 2</i>	27.00*
Mindscape <i>View to A Kill/First Blood Pt. 2/The Mist</i>	21.00*
Mouse Systems <i>PC Paint + Turn Your PC into a Color Macintosh</i>	59.95*
Scarborough <i>MasterType</i>	19.75*
Sierra On-Line <i>Black Cauldron</i>	21.25*
Sierra On-Line <i>King's Quest II</i>	24.75*
Spectrum <i>Holobyte GATO</i>	18.00*
Spectrum <i>Holobyte Telesar Level 1, Orbitor</i>	24.00*
Spinnaker <i>Alphabet Zoo, Kinder Comp., Face Maker</i>	15.97*
Spinnaker <i>Delta Drawing or Most Amazing Thing</i>	20.75*
Springboard <i>Certificate Maker</i>	31.00*
Springboard <i>Newsroom</i>	29.97*
Springboard <i>Newsroom Pro</i>	64.50*
Sublogic <i>Night Mission Pinball</i>	20.00*
Sublogic <i>Jet</i>	27.50*

\*PC NETWORK MEMBERS pay just 8% above the wholesale price, plus shipping. All prices reflect a 3% cash discount. Minimum shipping is \$2.50 per order. International orders call for shipping and handling charges. Money Orders, company and personal checks please allow 10 working days to clear. All prices are subject to change without notice. All products subject to availability.

TM—Registered trademarks of Apple/Ashton-Tate/AST/Compaq/Epson/Hayes/IBM/Intel/Lotus/Macintosh/Microsoft

CALL FOR PRICING ON APPLE PRODUCTS

# PC NETWORK

## Big Values on Computer Monitors

MONITORS	
Amdek 310A Amber TTL Monitor	\$130.00*
Amdek Color 600 Hi Res RGB Monitor	365.00*
Amdek Color 722 Enhanced EGA Monitor	424.00*
Amdek Color 725 13" Ultra Hi Res	479.00*
Magnavox 14" Color RGB 640x240 Monitor	250.00*
Magnavox 12" TTL Amber Monitor	79.00*
Magnavox 14" EGA Monitor w/tilt	435.00*
Magnavox 14" Multi-mode	489.00*
Princeton HX-12 Color RGB Monitor	369.00*
Princeton HX-12E Hi Res RGB/EGA Monitor	445.00*
Princeton Max-12 12" Amber TTL	138.00*
Taxan 640 Hi Res RGB 720x400	439.00*
Zenith ZVM-1240 12" Amber Hi Res TTL	140.00*



NEC Multisync Monitor  
**\$530.00\***

## Your #1 Source for Add In Boards

THE™ EGA Graphics +  
**\$220.00\***



100% EGA/CGA/MDA compatible w/printer port & 256K

### VIDEO BOARDS

Hercules Color Card w/Parallel Port	\$135.00*
Hercules Monochrome Graphics Card	162.00*
Paradise Autoswitch EGA	336.00*
Paradise Modular Graphics Card	219.00*
Quadram Quad EGA+	323.00*
THE™ Color Card 100% IBM Compatible	60.00*
THE™ H720 Mono Graphics w/Parallel Port 100% Hercules Compatible!	69.00*

### MULTIFUNCTION CARDS

AST Advantage for AT w/28K	\$325.00*
AST Six Pak Plus w/64K	139.00*
Orchid Conquest 2.5MB RAM S/P/PCnet Conv/Clk	220.00*
Orchid Tiny Turbo 286	399.00*
THE™ Multi I/O I/O Plus Clone Ser/Par/Game/Clock	60.00*
THE™ Multi 384 w/OK Ser/Par/Game Clk/Cal	67.00*
THE™ 2MB RAMCard Lotus™/Intel™ Specs w/OK	99.00*

## PRODUCTS MAIL ORDER COMPANY

CALL FOR QUOTES ON PRODUCTS NOT LISTED

## The Best Buys in Disk Storage

### DISK DRIVES

Everex 60MB 1/2 Ht. Int. Streaming Tape Backup	\$725.00*
IOmega Dual 20MB Bernoulli Box w/Cntrl	2,199.00*
IOmega Dual 10MB Bernoulli Box w/Cntrl	1,710.00*
PC Network 1/2 Ht 360K Floppy Drive	75.00*
PC Network 10MB 1/2 Ht Hard Disk Kit	289.00*
PC Network 30MB AT Internal Hard Disk	445.00*
PC Network 30MB Capacity 1/2 Ht Hard Disk w/RLL Controller	425.00*
PC Network 10MB 1/2 Ht. Int. Streaming Tape	340.00*
PC Network 20MB 1/2 Ht. Int. Streaming Tape	520.00*
Tandon 20MB Internal Discard	435.00*
TEAC 1.2MB Add On Floppy for the IBM AT	99.00*
THE™ 20MB HD/20MB Tape B/U Combo Kit	699.00*
THE™ 20MB Hard Disk Card	375.00*

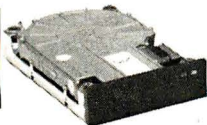

THE™ 20MB Hard Disk Kit w/controller, cables

**\$347.00\***

100% Hayes Compatible

## The Best Buy in Modems

THE™ 1200 COM External 1200 Baud w/auto dial, re-dial, speaker

**\$119.00\***

### MODEMS

Anchor Lightning-1 2400 Baud 1/2 Card	\$282.00*
Anchor Lightning-1 2400 Baud External	309.00*
Hayes Smartmodem 2400 External	525.00*
Hayes Smartmodem 1200B w/Smartcom II VT-100 Emulator	315.00*
Hayes Smartmodem 2400B Internal	478.00*
Prometheus 2400 Baud Upgradable Modem	329.50*
THE™ 1200 Com Short Slot Internal Modem w/Software	109.00*
THE™ 2400 Com External 2400BPS	259.00*
THE™ 2400 Com Internal 2400BPS	197.00*
U.S. Robotics Courier 2400BPS External	345.00*
U.S. Robotics Password 1200BPS External	172.00*

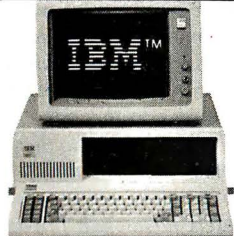

### IBM™ PC BASE SYSTEM

256K System/2 360K Drives/Keyboard

**\$1,025.00\***

### IBM™ AT BASE SYSTEM

1.2 MB Floppy w/256K Hard Controller

**\$2,204.00\***

IBM™ XT 286 System	\$2,875.00*
IBM™ PC 20MB HD	\$1,327.00*



### COMPAQ™ PORTABLE

20MB Hard Disk/360K Drive/256K RAM

**\$1,800.00\***

### COMPAQ™ DESKPRO SYSTEM

256K CPU/1 Floppy/Hard Disk

**\$1,825.00\***

AT&T 6300 PC CPU/2/640K, 2 Floppy 1 Ser/1 Par, Mono Monitor, MS DOS, Keyboard	\$1,640.00*
---	-------------

DS/DD DISKETTES

5 1/4"

BOX OF 50  
**44** ea.

BOX OF 10  
**\$7.95\***

## • NEWSLETTERS • 24 HOUR BULLETIN BOARD • SOFTWARE RENTALS

(Catalog Price Updates and Reviews)

(10,000 Free Programs to Download)

(Over 1,000 Titles in our Library)

Inquiry 206



# Boost cursor speed. Stop cursor run-on.

With all the recent hoopla over performance, it's ironic that two of the PC's ergonomic deficiencies have been overlooked — its slow cursor, and the tendency of the cursor to remain in motion (run-on) after a cursor key has been released. Finally, the solution — Cruise Control™ from Revolution Software.

Cruise Control is a new productivity tool for serious PC users. It boosts cursor speed, typically by 3-5X. It eliminates annoying cursor run-on. And it adds hands-free cursor navigation to any application.

If you use 1-2-3, Symphony, dBASE, Reflex, or Paradox, you need Cruise Control's Anti-Skid Braking. Here's what the leader of one Lotus users group said about Cruise Control:

*"Once I used it, I wanted it! Excellent idea. Very practical. One of the best programs ever sent to us for review!"*

If you use Word Perfect, MS-Word, Q&A, DisplayWrite, MultiMate, WordStar 2000, Framework, PC-Write, or SideKick, you need Cruise Control's Screen Runner, the high-performance, adjustable-speed cursor.

Cruise Control's namesake feature takes the drudgery out of paging through data base records, long documents, and large spreadsheets. It lets you repeat any key, hands-free — at the speed of your choice.

And there's more. A Chronometer "types" the time or date into your application at the current cursor position. The keyboard-controlled Screen Dimmer protects your privacy. The programmable Auto-Dimmer extends the life of your display screen.

Compatible with thousands of today's popular programs, including Lightning, SuperKey, and Ready!. Uses only 3K RAM. For DOS 2.0 or later. Not copy-protected. No risk, 60-day money-back guarantee.

## Cruise Control™

From now until 3/31/87:

### Only \$29.95.

Call now to order by credit card (VISA/MC/AX):

## 201-366-4445

Or, mail \$29.95 plus \$3.50 shipping and handling to:

## Revolution Software, Inc.

715 Route 10 East • Randolph, NJ 07869

Dept. 200

Services, 308 North Dale St., St. Paul, MN 55103.

Good luck on your project.—Steve

### Game Port Thermometer

Dear Steve,

As a science teacher, I am attempting to show my students the methods by which microcomputers can be used to gather and process laboratory data. I have built some photosensors that interface with an Apple II through the game port and am using these for timing purposes. I would like to construct temperature probes that also interface through the game port, but I am unsure of how this can best be done. Can you offer any advice or assistance?

Danny Roberts

Fort McMurray, Alberta, Canada

*The game port on the Apple II computer allows a user to connect both digital and analog devices. This connector has three 1-bit inputs, four 1-bit outputs, a data strobe, and four analog inputs.*

*The analog inputs, found on game I/O connector pins 6, 7, 10, and 11, can be hooked up using a variable resistor (typically in the range of 150,000 ohms) between the input pin and +5 volts. The variable resistance is used in a one-shot timer; as you vary the resistance, its frequency is changed, and an internal routine in the Apple converts this frequency to a value that an Applesoft program can read using the PDL() function.*

*An article in The Best of Micro Series, Volume 3 (Micro Ink, 1980), entitled "A Digital Thermometer for the Apple II" by Carl J. Kershner describes a program to read the temperature from a thermistor and convert it to a digital display.—Steve*

### Info on Lear Siegler

Dear Steve,

I was given a Lear Siegler ADM 3A terminal recently. Where can I get some technical information, such as a manual or schematics, for this device? Also, for computer systems that use battery backup for nonvolatile RAM, how does the circuitry make the switch from power supply current to battery current? You can't have both the battery and the power supply on-line during the switch, can you?

Jeffrey L. Thorssell

Towson, MD

*For information on your Lear Siegler ADM 3A, check with Howard W. Sams Inc. through their toll-free number, (800) 428-7267. They publish many service bulletins and books for computer equipment.*

*In regard to your second question, you're correct in stating that the battery and power supply are not connected at the*

*same time. The usual trick is to put a diode in series with the battery to block reverse current to the battery. Of course, a diode is a fast switch, so when the power goes away, the battery can take over. There are other, more esoteric designs that take the chip enable line into consideration as well.—Steve*

### Digitizing Feet

Dear Steve,

I need to be able to superimpose computer graphics and video from a camera in real time. My application is in the realm of biomechanics, where the computer graphics are real-time plots of the forces acting on a person's foot while walking (about 100 data points per second). The video would be a picture of the foot in motion.

Tecmar manufactures a graphics board for digitizing video images that has both RGB and composite outputs. Do you know of any company that makes a moderately priced mixer with synchronizing capabilities?

Dr. Nathan H. Cook  
North Eastham, MA

*The device you're looking for is a bit specialized, sliding out of the computer area and into the video domain. Tecmar does not make a mixer for their graphics board, and upgrading to a different board with mixer would likely cost more than the purchase of a high-end consumer or industrial video mixer.*

*Your best bet is to contact a local JVC or Sony Industrial Video dealer. Both companies manufacture full lines of video-mixing and special-effects devices that range from simple (in the \$300 to \$800 vicinity) to very sophisticated (\$5000 or more). Your specific needs and desires will dictate the right model for you.*

*The method normally used with such mixers is to use one source as a reference for sync timing (in your case, this would be the graphics card) and lock the timing of the other sources to the reference by providing a "genlock" signal to them. The camera used must have the ability to use this signal. Fortunately, many industrial and home models have such provisions. If you're unsure, contact the dealer where you bought the camera.*

*The other possible method is to correct timing using a television "frame-store" device on each source, but I won't ruin your day by telling you the cost of that equipment.*

*If this is to be a short-term project, perhaps it would be easier and cheaper to contact a video production company or TV station in your area. If they have a mobile or portable mixer system, they*

*continued*



Free 30-Day Trial!

NOT COPY-PROTECTED.

# End Financial Hassles. \$49.



**BEFORE QUICKEN:** Who doesn't want to get rid of the hassles of paying bills, managing finances, and keeping records?

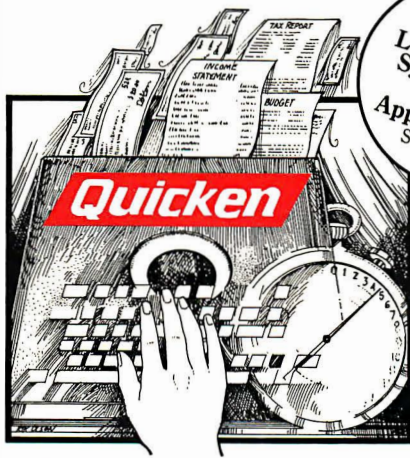

**AFTER QUICKEN:** Finally, automate your finances with software so fast and so automatic that time and hassles evaporate.

If you write checks, you need Quicken—the breakthrough software that automates financial management for business and home.

**The breakthrough is Quicken's fully automatic design.** Quicken is so automatic it remembers your recurring bills and pays them—all you do is sign the checks. Automatic macros cut laborious data entry down to two keystrokes. Quicken manages your checkbooks and even finds and fixes your mistakes. It tracks and totals your expenses by date, payee, and category.

Quicken is so completely automatic it remembers to save and backup your data, even if you forget!

And if you use Lotus or AppleWorks,\*\* Quicken will automatically fill in your spreadsheets with your financial data!

**Quicken does the paperwork for you.** It's bill-paying time. Fire up Quicken and the screen looks just like a check. Your first bill is the bank loan, you press two keys and, zap, Quicken's macros write out the full check. Next, the American Express bill. It's a biggie. You're glad Quicken knows exactly how much cash you have. Macros write the check, letting you pick how much to pay. You slip paper checks in the printer. Don't bother positioning them, Quicken does that for you.\* Sign the printed checks and slip them into Quicken's window envelopes...you're done.

**Recordkeeping? That's done for you.** With each bill, Quicken filled out your records, updated all balances, and saved it all on disk. Need to record a check you wrote at the store? No problem, Quicken's macros update your records in an instant.

Expense tracking, tax reporting, budgeting? Simple. Say you want to know your charity spending. Ask Quicken, and you get an itemized list and dollar total. You'll always know exactly where your money is going. Want spending for Job 104 or Account 3072? The answers are just keystrokes away.

**Need cost reports, P&L's or other financial reports?** Set up the spreadsheet you want in AppleWorks or Lotus\*\* 1-2-3 or Symphony. Quicken's ingenious Spreadsheet Transfer actually reads your spreadsheet and fills in the numbers you want, where you want them.

Dread reconciling the checkbook? Quicken makes it simple. And you can't go wrong: If there's a mistake, Quicken will pinpoint the error and automatically correct for it!

Also works with Lotus® 1-2-3® and AppleWorks™ See Below

## CRITICS HAIL A BREAKTHROUGH



—InfoWorld Review Board

"It's more than good—it's indispensable. Home and small business checking software used to be too expensive, too hard to use, and too rigid, and it took too long to use. Quicken has changed all that!"

—Ken Landis, A+ Magazine

## FREE! TAX REFORM ANALYZER™

The Tax Reform Act of 1986 is the biggest tax change in 50 years. What should you do to save money now?

Find out fast with Quicken's new Tax Reform Analyzer—a disk of powerful worksheet templates to use with Lotus 1-2-3, Symphony, Multiplan®, SuperCalc®, or Appleworks. And it's free, just for trying Quicken.

Just type in the key numbers from your last 1040 return. Tax Reform Analyzer shows where the new law affects you and the dollar change in your tax bill. Next it lists what specific actions you can take and the tax dollars you'll save.

Try Quicken for 30 days. If you return it, Tax Reform Analyzer is yours to keep (offer expires 3/1/87). Details are also in specially marked boxes of Quicken.

**For every business and home**—for computer experts and total novices. Quicken handles an unlimited number of transactions and accounts. Personalized checks are available for any bank; details are in the Quicken package.

**At \$49, Quicken pays for itself.** So don't waste another moment. Order now and get the new Tax Reform Analyzer free.



### TRY QUICKEN RISK FREE

CALL 800 624-8742 (CA residents call 800 468-8481)

OR send this coupon with payment to:

Intuit, 540 University Ave., Palo Alto, CA 94301 (415) 322-0573

Please send me \_\_\_\_\_ copies of Quicken and Tax Reform Analyzer at \$49.00, plus \$3.00 shipping & handling each, plus sales tax if in CA.

30 DAY RISK FREE TRIAL: If not completely satisfied, return within 30 days for refund, but feel free to keep Tax Reform Analyzer.

I M  Apple II  
 I enclose a check for \_\_\_\_\_  
Please charge my:  
 Visa  Mastercard

Card # \_\_\_\_\_ Exp. Date \_\_\_\_\_ Daytime Phone: \_\_\_\_\_

Name (Print): \_\_\_\_\_

Address: \_\_\_\_\_

City: \_\_\_\_\_ State: \_\_\_\_\_ Zip: \_\_\_\_\_



No P.O. Boxes please. No COD or purchase orders. Authorization Code: BY0287

Compatibility: IBM® PC, XT, AT, PCjr., and compatibles with 192K RAM and one or two floppy disk drives or hard disk. Any printer. No modem required. 1-2-3 and Symphony optional.

Apple® IIgs, IIc and IIe (IIe requires extended 80-column card), with one or two floppy disk drives, or UniDisk™ 3.5. Any printer. No modem required. AppleWorks optional.

Product names are trademarks of their respective manufacturers.

\*Patent Pending \*\*Lotus Transfer Utility available for \$15 from Intuit



might be willing to provide the equipment and personnel at reasonable rates.—Steve

**Limits of C-64**

Dear Steve,

I just bought a C programming package for my Commodore 64 and am very happy with it. It is a full Kernighan and Ritchie implementation and very easy to use. I have found only one problem with it: I have to wait for it to load the editor, save the source, load the compiler, compile from the disk, load the translator, save to disk, load and run the linker, load the pro-

timizer (this is actually optional), and finally load the executable file. By this time, I usually discover that I have forgotten to include a function call, so I have to go back and repeat the entire process.

I can live with the 1541 disk drive's speed (or lack thereof) in most cases, but for software development using a compiled language, the 1541 is too slow. I am considering building a RAM disk, but I haven't found any schematics for one compatible with the C-64. Can you help?

David Godshall  
Goshen, IN

Regrettably, you may be forced to live with things as they are. The C-64 is a very capable machine for what it was designed to do, but it presents major obstacles when you begin considering memory-expansion projects like a RAM disk.

The 6510 microprocessor contained in the C-64 is quite limited in register capabilities, and it is designed to address only 65,536 bytes, maximum. With these limitations taken into account, the only reasonable approach to designing a RAM disk would be to create a two-stage software addressing scheme and use bank switching to select the added memory. This would be a slow process, since the only access to the processor bus is through the expansion port; you would have to use software to select the bank, select the address, read or write the data, and manage time-sharing with the application. I'm sure you can see that there would be little benefit realized overall.—Steve

**WHAT'S THE SECRET DEBUGGING WEAPON USED BY EVERYBODY FROM BORLAND TO ORACLE? FREE 44-PAGE ANSWER FROM ATRON.**

**"WE COULDN'T HAVE DONE IT WITHOUT ATRON'S HARDWARE-ASSISTED SOFTWARE BUGBUSTERS."**

Philippe Kahn Larry Ellison  
Borland Pres. Oracle Pres.

This is the city saved by the Atron bugbusters. Your city. Full of wizards, with hundreds of millions of dollars invested in wringing every ounce of intelligence and performance out of your PC. It used to be plagued with the toughest software bugs known to mankind.

**PLAGUES OF BIBLICAL PROPORTIONS**

The first and most difficult plague was impossible to trap with software debuggers. These were carnivorous bugs which randomly overwrote programs, data, even the debugger. Nastiest were the ones that slipped in once every few hours, or changed their behavior after each new compile. Forty days and forty nights of recompiling, trying something else, caused many a would-be resident of the city to run screaming into the wilderness, never to be heard from again.

Second came the plague of not knowing where the program was, or where it had recently been. This compounded the first plague: How could anyone know what caused the random memory overwrites? Add to this random interrupts and timing dependencies, and you begin to understand *The Fear* that gripped the city.

Then came the last plague, which brought the wizards to their knees before they even started debugging. Their towering programs consumed so much memory, there wasn't enough room for their symbol table, let alone debugging software. Even if they could get past the first two plagues, this one killed their firstborn software.

**ENTER THE HARDWARE-ASSISTED SOFTWARE BUGBUSTERS**

The Atron solution came as a revelation: Monitor every memory reference and every instruction executed, by adding a hardware board to the AT or PC with an umbilical probe to the processor.

The result? Wham! The PC PROBE™ and the AT PROBE™ saved civilization as we know it. The first plague was cured with PROBE'S hardware-assisted breakpoint traps on reading, writing, executing, inputting and outputting. These could be done on single or ranges of addresses, and could include particular data values. All in real time. For a mere software debugger to attempt this, a 1-minute program would take 5 hours to execute.

The second plague, not knowing from whence you came, was cured with PROBE'S real-time trace memory. The history of program execution is saved on-board, in real time. Once a hardware trap has occurred,



PROBE displays the program execution in detail, including symbols and source code for C, Pascal, or assembly language programs. Which shows how out-of-range pointers got that way.

The third plague, not enough room for the debugging symbol table to be co-resident in memory with a large program, was cured with 1-megabyte of on-board, hidden, write-protected memory. System memory was then freed for the program. Keeping the symbol table and debugger safe from destruction.

When the job of bugbusting was done, the wizards used their PROBES as performance analyzers. So they could have both reliability and performance. So they could send only the best software into the field.

**IF YOU AREN'T AN ATRON CUSTOMER, ODDS ARE YOU WON'T BE MAKING THE TOP-TEN LIST.**

On any given week, at least nine of the top ten best-selling software packages on the Soft-Sell Hotlist come from Atron customers. Ever heard of Borland? "Without Atron," says its president Philippe Kahn, "there wouldn't be a Side-Kick™. Turbo Lightning™ would be light-years away, and Turbo Prolog™ wouldn't be shipping today."

Ever use a spreadsheet? From Enable™ to Paradox™, their bugs were busted by Atron products.

Into DBMS's? Everyone from Ashton-Tate to Oracle owns at least one Atron bugbuster.

If you use a product from one of the companies in *The City*, you owe life as you know it to Atron. Our guess is that 99% of all PCs, XT's and AT's have at least one product debugged with Atron bugbust-ers.

**FREE 44-PAGE BUGGING BIBLE COULD MAKE YOU A PROPHET, AND YOUR COMPANY A PROFIT.**

We've written a complete tutorial on state-of-the-art bugbusting. And it's yours, free for the asking. Full of examples and illustrations, it will show you how the wizards work their magic.

If you're tired of suffering the wrath of program bugs, call Atron today. You could be busting bugs, and sales records, tomorrow.



THE BUGBUSTERS

20665 Fourth Street • Saratoga, CA 95070 • 408/741-5900

Copyright © 1986 by Atron Corp. PC PROBE™ and AT PROBE™ Atron. The other fine companies mentioned through this advertisement own numerous trademarks. Adv. by TRBA.

**CIRCUIT CELLAR FEEDBACK**

**Power Interrupt Switch**

Dear Steve,

After spending a tedious hour salvaging blitzed directory areas on two of my CP/M disks, it occurred to me that you may have already designed a computer power switch that would have prevented this sort of damage.

As a fellow county-dweller, your problems are probably not much different from mine. Two years ago, I built the power-line filter you described in the December 1983 Circuit Cellar. I am very grateful for the project; I've lost no hardware to power-line surges since. (The database program I use is reputedly sensitive to minor fluctuations, but the errors I used to have disappeared after I installed the filter.)

Of course, my power-line filter does not prevent disk overwrites if the power goes off and returns a second later. Such occurrences are frequent here. The fluorescent light in our kitchen (normally kept on) goes off when the power flickers and we have to restart it manually. Is it possible to use this principle for an interrupt switch in a computer's power supply so that the power stays off (or the computer turns itself off) when the main supply fails? If so, could you design a circuit simple enough for the average user to build (i.e., those of us familiar only with soldering-iron usage and not possessing any expensive calibration meters)?

Donald J. C. Phillipson  
Carlsbad Springs, Ontario, Canada

continued



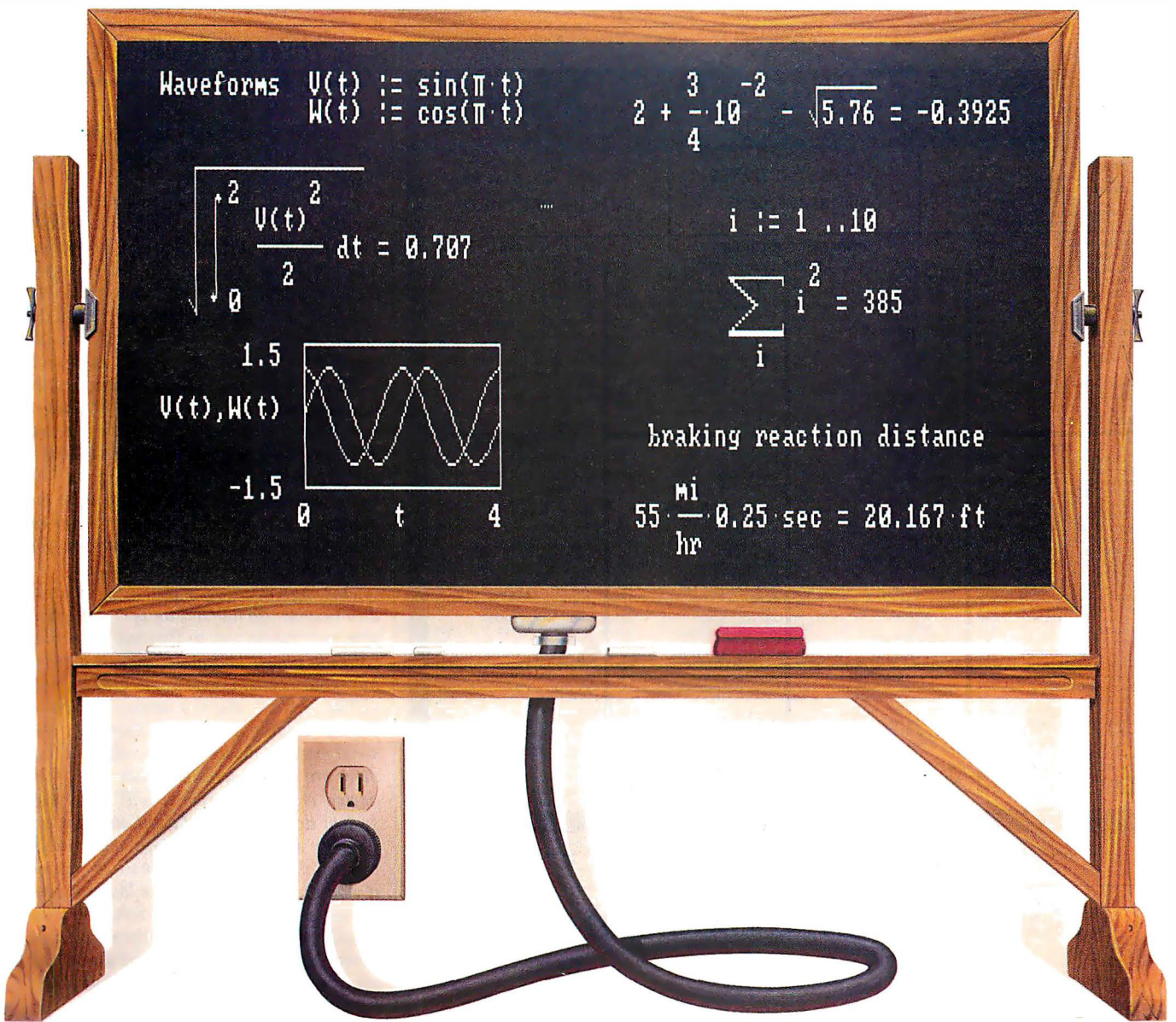

# Engineering calculation raised to a new power.

The only software program to combine the flexibility of a blackboard, the simplicity of a calculator, and the power of a personal computer.

**MathCAD**

Now you can write calculations on your PC in standard math notation—mixing text, formulas and graphics with the same free-form ease you have on a blackboard or scratchpad.

**No new languages to learn.** Simply type equations anywhere on the screen and MathCAD automatically calculates and displays

your results as numbers or graphs—exactly as you want to see them. Change anything, and MathCAD instantly recalculates the results. Add text at any point to support your work. Then print and save your entire calculation as an integrated document.

**Powerful built-in functions.** MathCAD handles both real and complex numbers and does automatic unit conversion and dimensional analysis. It has a full range of built-in functions including integration, differentiation, fft's and cubic splines. Or you can define your own. No wonder thousands of engineers use MathCAD every day, for everything from robotics

to signal processing and thermodynamics to fluid mechanics.

**Call us today.**

We're convinced that MathCAD belongs on every engineer's desk. At \$249, with our no-risk, 30-day money-back guarantee, you really can't afford not to try it. To place your order or to request further information, call us now at:

**1-800-MathCAD**  
(in Massachusetts: 617-577-1017)

MathCAD. Once you've tried it, you'll wonder what you ever did without it. Order today.

Requires IBM PC\* or compatible, 512KB RAM, graphics card. IBM PC is a registered trademark of International Business Machines Corporation. MathCAD™ MathSoft, Inc.

# MathCAD

MathSoft, Inc., 1 Kendall Sq., Cambridge, MA 02139



# HARMONY COMPUTERS

2357 CONEY ISLAND AVE., (BET. AVES. T & U) BKLYN, NY 11223  
800-VIDEO84 or 800-441-1144 or 718-627-1000

<b>KAYPRO</b> Kaypro PC 256K 2 - Drives Monitor 1269 Leading Edge Model D 512K 2 Dr. Monitor \$1149 Leading Edge Model D 30MB w/ monitor \$1849	Commodore 1571 \$223.95 STAR NX-10 \$202.95	Panasonic 1080i \$184.95 IBM PC (1) DRIVE \$915.00
<b>"PRINTER SPECIALS"</b>		
Brother HR 20 324 Brother 1509 359 Commrex 420 IBM 799 Citizen 120D 169 Citizen MSP 10 269 Citizen MSP 15 309 Citizen MSP 20 319 Citizen MSP 25 459 Citizen Premier 35 439 Epson LX80 (Homeewriter) 10 Epson LX86 214 Epson LQ800 519 Epson LQ 1000 699 Epson FX 85 339	Epson 286 479 Epson EX800 459 Epson EX 1000 599 Epson LQ2500 1059 IBM Proprieter 369 IBM Proprieter XL 519 NEC 3550 719 NEC 8850 1039 NEC P6 429 NEC P7 599 NEC P5 XL 1149 Okidata 182 204 Okidata 192+ 319	Okidata 193 Plus 489 Okidata 292 w/INTFC 468 Okidata 293 w/INTFC 599 Panasonic KXP 1080 i 185 Panasonic KXP 1091 i 244 Panasonic KXP 1092 i 312 Panasonic KXP 3131 234 Panasonic KXP 3151 369 Panasonic KXP 1592 399 Toshiba 341 529 Siekoshia Printer 164 Star NX-10 203 Star SG-10C 187
<b>IBM</b> AT Unenhanced 2295 AT Enhanced IBM 30 Meg. Model #339 8 MHz 3999 IBM PC (1) Drive 915 IBM PC XT#268 (1) Dr 1499 IBM PC XT 286# 6MHz. 640K 1.2 MB. 20 MB Hard Drive 2899 Fountain PKXT Turbo Call IBM Monitor Call AST Six Pack 384K 189 AST Advantage 128K 329 AST Six Pack Premium 189 Hercules Color Card 109 Hercules Monographic Plus 174 SIGMA EGA (NANOW) 249 Quad EGA+ 289 Video 7 EGA+ 289 Video 7 Deluxe 329 STB EGA+ 259 Paradise Auto Switch 339 Multifunction Card 109 IBM Disk Drive 104 Everex EGA Enhancer 229 Everex Graphics Edge 214 Everex Edge 219 Everex Graphics Pacer 189 Intel 8087-3 112 Intel 8087-2 174 Intel 80287-6 174 Intel 80287-8 289	<b>SEAGATE</b> Hard Drives 20 Meg. No Controller 329 10 Meg. w/controller 369 20 Meg. w/controller 399 30 Meg. w/controller 439 30 Meg. AT #4038 639 40 Meg. AT #4051 760 Tandem 20 Meg. Hard Card 409 <b>ATARI</b> 130 XE 119 55 XE 89 Atari 801 Printer 179 1050 Drive 119 Atari Writer+ 37 Atari 1027 119 Atari Modem 301 48 520 ST Color System 759 520 ST B & W System 629 <b>COMPAQ</b> Portable 256K 2-360K 1499 Compaq Drives Portable 256K 1-360K 1-20MB Hard Seagate 1899 Deskpro 840K 1-360K 1-20MB Hard Seagate 1999	Mac 512K 1259 Mac Plus 1619 Imagerwriter 2 439 Apple IIC with monitor Call <b>MONITORS</b> Amdek 300 Amber 119 310 Amber 139 Color 600 374 Color 722 454 Princeton HX12 394 Princeton HX12E 469 Princeton Max 12E SR12 148 Scan Doubler 529 NEC Multisync 159 Goldstar RGB Color 299 Goldstar TTL Amber 109 <b>MODEMS</b> Hayes 1200 354 Hayes 1200B No Smartcom 298 Hayes 1200B w/Smartcom 2 328 Hayes 300 124 Hayes 2400 559 Hayes 2400B w/Smartcom 499 Hayes 2400B No Smartcom 459 Micromodem 2E 125 Promethias 1200 External 249 Promethias 1200 Internal 149 Everex Modem Internal 119 Hayes Smartcom 2 79
Star Lv 1210 IBM 164 Star NX15 324 Star SD 10 269 Star SD 15 369 Star SR 10 387 Star SR 15 477 SR 10, SR 15 Sheetfeed 49 Star SB 10 299 Star NB 15 599 Silver Reed Exp 420 209 Silver Reed Exp 800 619 Toshiba 341 619 Toshiba 351 Model 2 985 Toshiba 351C 1099 Toshiba 321 429	<b>COMMODORE</b> Commodore 128 245 1571 Drive 219 1670 Modem 179 Commodore 64C 112 1541C Disk Drive C 176 1802 Monitor 164 1802C 199 1902A Monitor 269 MSP 1000 Printer 228 Star SG10C 187 Amiga 512K, DOS, Mouse Color Monitor 1199 <b>AT&amp;T</b> 640K 1-360K Drive 1199 640K 1-360K 1-20MB Seagate Hard Drive 1599 ATT Monitor 195 Toshiba 3100 1769 Toshiba 110 3199 <b>SOFTWARE</b> Lotus 123 Ver. 2 289 D Base 3a 375 Framework 381 Symphony 1.2 394 Microsoft Word 3.1 254 Microsoft Windows 59 Word Perfect 4.2 196 Q & A 225 PFS Write 109 Norton Utilities 49 Microsoft Mouse 109	

If it only took you a "tedious hour" to recover your disks, you must be living right. Congratulations!

Power supply design has taken a turn for the better in the last few years. IBM PCs, for example, have a signal (called "power good") coming from the supply that is active when the power supply voltages are within normal tolerances. When this signal is inactive (bad power) the 8088 is forced into a reset state so it can't do any harm. A power dropout does no harm until the power supply voltages fail, at which time the processor is reset. The power must remain off for at least 1 second to allow the "power good" to become active again, at which time the system performs a complete power-on reset. Short power dropouts require you to flip the power switch manually.

This signal ensures that low voltages don't cause too much damage; a fluctuation may cause you to lose all open files as if the power had gone out completely, but your system won't go crazy. Your CP/M system doesn't include such a signal. Adding it to your computer via some external device isn't too difficult, but there are some interesting trade-offs. If the device is too sensitive it will shut your system down, even for dropouts that ordinarily would not have caused any problems. If the device is not sensitive enough it won't solve anything. The load on your power supply determines how long the supply will continue delivering good power during a dropout, and this "survival window" will change if you add more cards or RAM.

Also, there's no good way to test the device once you've built it. You would need to remove the 120-V AC power for a specific number of cycles. This would require some fairly fancy test equipment. —Steve

### That'll Teach You...

Dear Steve,

You indicated you would like to hear from people who have been influenced by your column. Does basing a whole company on one of your write-ups qualify?

Our company manufactures an IBM PC board that lets you plug 16 complete 300/1200-baud modems in a single slot. All of this got started when I read your November 1985 column. Keep up the good work.

Tim Stryker  
Galacticomm Inc.  
Plantation, FL

Since many of my projects use the latest technology, they often serve as application examples for industrial users. I congratulate you on your product innovation and wish you luck. —Steve ■

## Software with a different flavor

**Unique 4G-PIPS "Information Processor"**

SORD's 4G-PIPS is a completely new type of product called an "information processor." Unlike conventional software systems, it provides a single, consistent operating environment for all applications and also allows you to see data as you process it. Being IBM PC/AT compatible, it's guaranteed to suit all tastes.

**SORD**

SORD COMPUTER CORPORATION  
Kyobashi K-1 Bldg., 2-7-12 Yaesu, Chuo-ku, Tokyo 104 Japan (03) 281-8130  
New York: (212) 759-0140 London: (01) 631-0787 W. Germany: (02161) 66-3077  
IBM registered trademark of International Business Machines Corp.



# Verbatim Ensures Your Data Won't Meet a Shocking End



## Introducing DataLife with DataHold for Unsurpassed Data Protection

**Static Danger is Everywhere**—Your data is vulnerable to loss from an unseen enemy—static electricity! Even small static charges could cause sudden data loss from your diskette.

And static lurks everywhere. Just walk across a carpeted floor and you build up a static charge of up to 1,500 volts—enough to ZAP your data.

**DataHold Protects Your Data**—DataHold is our ingenious diskette liner that disperses damaging static charges instantly. Compare DataLife to other popular brands which retain static charges up to four minutes and *your choice should be obvious.*

DataHold, available exclusively from Verbatim DataLife for unsurpassed data protection.



**Verbatim**<sup>®</sup>  
A Kodak Company  
Inquiry 308

323 Soquel Way  
Sunnyvale, CA 94086  
800-538-1793

**DATAHOLD  
INTRODUCTORY  
OFFER**  
Two free disks inside specially  
marked 10-packs of  
Verbatim DataLife  
minidisks.



# When you want to talk computers...

## HOME COMPUTERS.

### Atari Computers

520ST Monochrome System.....	\$619.00
520ST Color System.....	789.00
1040ST Color System.....	999.00
800XL 64K Computer.....	69.99
65XE 64K Computer.....	89.99
130XE 132K Computer.....	129.00

### Atari Peripherals

1010 Cassette Drive.....	49.99
1020 Color Printer.....	29.99
1050 Disk Drive.....	129.00
835 300 Baud Modem.....	24.99
850 Atari Interface.....	109.00
M301 300 Baud Modem.....	39.99
XM801 80-Column Printer.....	179.00
XM804 ST Printer.....	169.00
ICD PR Connection.....	59.99



### Amiga System Package **\$1199**

Includes: Amiga CPU, 256K RAM expansion, RGB Monitor, Amiga DOS, Basic, Tutorial, Kaleidoscope, Voice Library.

### Commodore Computers

Commodore-64C 64K Computer..	189.00
Commodore-64 64K Computer....	149.00
Commodore-64 System.....	479.00
Commodore-128 128K Computer.	259.00
Commodore-128 System.....	759.00
Amiga 1000 256K Computer.....	849.00

### Commodore Peripherals

1530 Data Cassette.....	34.99
1660 Commodore Modem.....	59.99
1670 Commodore Modem.....	139.00
1541C Disk Drive.....	189.00
1571 Disk Drive.....	249.00
1802 Color Monitor.....	189.00
1902 Color Monitor.....	299.00
Amiga 1010 3 1/2" Ext. Drive.....	219.00
Amiga 1020 5 1/4" Ext. Drive.....	189.00
Amiga 1080 RGB Monitor.....	269.00
C128 512K Expansion Board.....	179.00
PPI Parallel Printer Interface.....	34.99
Xetec S/Graphix 8K.....	69.99
Micro R&D MW350.....	44.99

## MS/DOS SYSTEMS.



### PC-T00 20 Meg XT-Compatible **\$999**

AT&T 6300.....	from \$1699.00
Compaq.....	from 1699.00
Cordata.....	from 899.00
IBM-PC.....	from 1099.00
IBM-XT.....	from 1699.00
IBM-AT.....	from 2699.00
Leading Edge.....	from 999.00
Toshiba 1100 Plus.....	from 1749.00
Zenith.....	from 999.00

## MULTIFUNCTION CARDS.

### AST

Six Pak Plus PC/XT.....	\$169.00
Six Pak Premium PC/XT.....	349.00
Advantage-AT 128K.....	339.00

### Everex

EV-221 Evergraphics Mono.....	139.00
EV-640 Edge Card.....	259.00

### Hercules

Color Card.....	159.00
Graphics Card Plus.....	209.00

### Fifth Generation

Logical Connection 256K.....	299.00
------------------------------	--------

### IDEAssociates

IDE-5251 Local Emulator.....	579.00
------------------------------	--------

### Intel

1110 PC Above Board.....	279.00
Inboard 386K 0K.....	Call

### NEC

GB-1 EGA.....	409.00
---------------	--------

### Quadram

Quad Ega + Graphics Adapter....	339.00
Silver Quadboard.....	239.00
Expanded Quadboard.....	119.00

### VIDEO 7

EGA Deluxe.....	389.00
-----------------	--------

### Zuckerboard

Color Card w/Parallel.....	89.99
Monochrome Card w/Parallel.....	99.99
576K Memory Card.....	59.99

## DRIVES.

### Allied Technology

Apple Half-Heights.....	\$109.00
Controller Card.....	39.99

### CMS

Drive Plus 20MB Internal Card....	399.00
-----------------------------------	--------

### Everex

Stream 20 20MB Tape-Backup....	669.00
--------------------------------	--------

### Genie Technology

210 H 10 + 10 subsystem.....	1749.00
------------------------------	---------

### Indus

Atari GT Disk Drive.....	199.00
Commodore GT Disk Drive.....	199.00

### lomega

A210H 10 + 10 Bernoulli Box..	1899.00
A220H 20+20 Bernoulli Box....	2499.00

### Irwin

110 D 10MB Tape backup.....	369.00
-----------------------------	--------

### Mountain Computer

Drive Card 20MB Internal Card..	649.00
A220 20 + 20 Subsystem.....	2199.00

### Racore Jr. Enhancements

Jr. Expansion Chassis w/DMA....	319.00
---------------------------------	--------

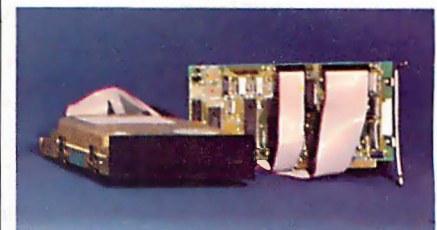

### Seagate ST-225 20 MB Kit **\$389**

Toshiba Half-Height 360K internal.....	89.99
--	-------

## DISKETTES.

### Maxell

MD-1 SS/DD 5 1/4".....	\$8.99
MD-2 DS/DD 5 1/4".....	10.99
MD-2HD Hi-Density 5 1/4".....	21.99
MF-1 SS/DD 3 1/2".....	12.99
MF-2 DS/DD 3 1/2".....	21.49
CS-500 20Mb Streamer Tape.....	11.99
CS-600 60Mb Streamer Tape.....	13.49

### Sony

MD1 SS/DD 5 1/4".....	8.49
MD2 DS/DD 5 1/4".....	9.99
MD-2HD Hi-Density 5 1/4".....	22.49
MFD-1 SS/DD 3 1/2".....	14.49
MFD-2 DS/DD 3 1/2".....	20.49



# COMPUTER MAIL ORDER



# ..... When you want to talk price.

## MONITORS.

**Amdek**  
Video 310A Amber TTL.....\$149.00  
Color 722 RGB, CGA/EGA.....499.00

**Magnavox**  
8CM515 RGB Monitor-80.....289.00  
7BM623 PC Monitor-80 Amber.....99.99

**NAP**  
873 14" Multimode.....549.00

**NEC**  
12" TTL Green or Amber.....129.00  
JC-1401P3A Multi-Sync.....Call

**Princeton Graphics**  
MAX-12 12" Amber TTL.....169.00  
HX-12 12" Color RGB.....429.00  
HX-12E 12"RGB/EGA.....499.00

**Quadram**  
8460 Quadchrome Enhanced.....499.00

**Taxan**  
640 12" Hi-Res RGB.....529.00

**Zenith**  
ZVM-1230 12" Green Composite...99.99

## MODEMS.

**Anchor**  
6480 C64/128 1200 Baud.....\$119.00  
Omega 80 Amiga.....129.00  
VM520 ST520/1040 1200 Baud...139.00  
Expressi PC-1200 Half Card.....149.00

**Everex**  
Evercom 1200 Baud Internal.....129.00

**Hayes**  
Smartmodem 300 External.....139.00  
Smartmodem 1200B Internal.....359.00  
Smartmodem 2400B Internal.....539.00

**Practical Peripherals**  
Practical Modem 1200 External...159.00

**Quadram**  
Quadmodem II 1200 Baud.....299.00

**Supra**  
MPP-1064 AD/AA C64.....69.99  
1200AT 1200 Baud Atari.....149.00

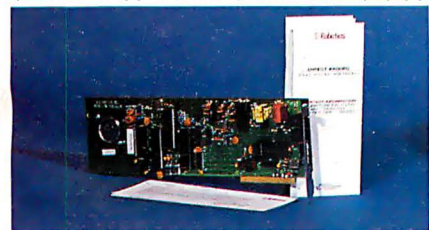

**U.S. Robotics**  
**1200 Baud Internal \$129**

## PRINTERS.

**Canon**  
LBP-8A1 Laser, 8 Page/Min....\$1899.00

**Citizen**  
MSP-10 160 cps, 80-Column.....319.00  
MSP-20 200 cps, 8K Buffer.....349.00  
Premier 35 35 cps Daisywheel...499.00

**C.itoth**  
8510-SP 180 cps, 80-Column.....Call  
310-SEP Epson/IBM 80-Column.....Call

**Cordata**  
The Desktop Printshop Laser....2199.00

**Diablo**  
Model 635 RO Daisywheel.....895.00

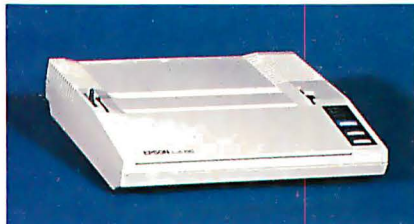

**Epson LX-86**  
**120 cps, Dot Matrix \$239**

FX-85 160 cps, 80-Column.....Call  
FX-286 160 cps, 132-Column.....Call  
EX-800 300 cps, 80-Column.....479.00  
LQ-800 180 cps, 24-Wire Printhead..Call

**Juki**  
6300 40 cps Daisywheel.....699.00  
6100 10 cps Daisywheel.....429.00  
5510C Color Dot Matrix.....449.00

**NEC**  
P5, P6, P7 Pinwriter Series.....Call  
3550 35 cps Spinwriter.....779.00

**Okidata**  
ML-182 120 cps, 80-Column.....219.00  
ML-193+ 200 cps, 132-Column.....Call  
ML-292 200 cps, 80-Column.....Call  
ML-293 200 cps, 132-Column.....Call

**Panasonic**  
KX-1080i 120 cps, 80-Column.....219.00  
KX-1092 180 cps, 7K Buffer.....339.00  
KX-1592 180 cps, 132-Column....439.00

**Star Micronics**  
SG-10C 120 cps, C64 Interface...199.00  
NX-10 120 cps, 80-Column.....219.00  
SG-15 120 cps, 132-Column.....379.00

**Texas Instrument**  
TI-855 150 cps, 80-Column.....599.00

**Toshiba**  
P321 216 cps, 24-Pin Printhead...479.00  
P341 216 cps, 24-Pin Printhead...589.00

## SOFTWARE.

**Ansa**  
Paradox.....\$459.00

**Ashton-Tate**  
d-Base III + .....429.00

**Borland**  
Reflex.....99.99  
Lightening/Word Wizard.....99.99

**Central Point Software**  
Copy II PC.....24.99

**5th Generation**  
Fastback.....89.99

**Funk Software**  
Sideways.....44.99

**IMSI**  
Optimouse w/Dr. Halo.....119.00

**IUS-Sorcim**  
Supercalc IV.....319.00

**Lifetree**  
Volkswriter III.....159.00

**Lotus**  
Lotus 1-2-3.....329.00

**Meca**  
Managing Your Money.....119.00

**MicroPro**  
Wordstar 2000 Plus.....299.00  
Wordstar Prof. w/GL Demo.....189.00

**Microrim**  
R:Base System 5.....339.00

**MicroSoft**  
MicroSoft Word 3.0.....289.00  
MicroSoft Mouse.....129.00

**Microstuf**  
Crosstalk XVI.....89.99

**Multimate International**  
Multimate 3.3.....269.00  
Multimate Advantage.....319.00

**Norton Software**  
Norton Utilities 3.1.....49.99

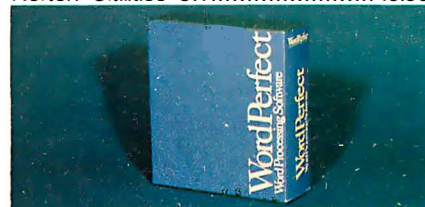

**Satellite Systems**  
**Word Perfect 4.2 \$209**

**Software Publishing Group**  
PFS: Professional Write.....129.00  
Clickart Personal Publisher.....129.00

**The Software Group**  
Enable.....369.00

In the U.S.A. and in Canada

# Call toll-free: 1-800-233-8950.

Outside the U.S.A. call 717-327-9575 Telex 5106017898

Educational, Governmental and Corporate Organizations call toll-free 1-800-221-4283

CMO. 477 East Third Street, Dept. A102, Williamsport, PA 17701

ALL MAJOR CREDIT CARDS ACCEPTED.

**POLICY:** Add 3% (minimum \$7.00) shipping and handling. Larger shipments may require additional charges. Personal and company checks require 3 weeks to clear. For faster delivery use your credit card or send cashier's check or bank money order. Pennsylvania residents add 6% sales tax. All prices are U.S.A. prices and are subject to change and all items are subject to availability. Defective software will be replaced with the same item only. Hardware will be replaced or repaired at our discretion within the terms and limits of the manufacturer's warranty. We cannot guarantee compatibility. All sales are final and returned shipments are subject to a restocking fee.



# proteus<sup>TM</sup>

There are plenty of clones but none can match PROTEUS in IBM compatibility, speed, reliability, support & delivery.



## PROTEUS features include:

- 12.5Mhz CLOCK SPEED**
  - 4MB RAM ON BOARD**
  - 8 LAYER STABLE MOTHERBOARD**
  - 3 SERIAL PORTS,**
  - 2 PARALLEL PORTS STANDARD.**
- If you look closely at what else PROTEUS comes with, you too will come to the intelligent conclusion:



- 30-DAY FULL MONEY-BACK GUARANTEE (TOTAL SATISFACTION GUARANTEED)
  - FREE NATIONWIDE ON-SITE MAINTENANCE
  - 15-MONTH FULL WARRANTY
  - UNIQUE, BUT FREE 24-HOUR ONLINE TECH SUPPORT
  - HIGH QUALITY MANUALS & UTILITIES.
  - all systems made in USA.
- 100% compatibility with AUTOCAD, NOVELL, UNIX, ZENIX

### PROTEUS-286/286 GT (A high performance AT engine)

80286-10 Intel CPU  
8-layer motherboard  
6/10Mhz, 6/12.5Mhz speed opt.  
1MB RAM expandable to 4MB on mainbd  
8 I/O slots  
selectable wait state 0-1  
3 serial ports, 2 parallel ports  
80287 coprocessor socket  
Hard disk/fl. controller  
5 Mhz DMA bus  
clock/cal. battery  
Two Floppy Drives; 1-1.2MB one 360K/choice of 3.5"  
AT Keyboard  
System Price: \$2195

**WE HAVE THE LARGEST SELECTION OF HARD DISKS, MONITORS AND ADAPTERS AT LOWEST PRICES. WE INTEGRATE AND TEST THE SYSTEM EXTENSIVELY.**

#### HARD DISKS

Seagate 20MB \$295.  
Seagate 30MB \$649.  
Seagate 40MB \$780.  
Seagate 80MB \$1195.  
Priam drives \$call

#### MONITORS

High Resol. Amber \$109.  
NEC multisync EGA \$call  
Princeton Max 12E \$179.  
Other models \$call

#### ADD-ONS

Paradise Autoswitch \$call  
Color/mono graphics card \$109  
1200B int. Modem \$139  
2400B int. Modem \$call  
80287-8 coprocessor \$249  
80287-10 coprocessor \$call  
All other cards \$call

### PROTEUS-286E AT \$1495

#### A turnkey system includes:

80286 CPU 6/10Mhz  
1MB RAM  
80287 coprocessor socket  
Clock/cal. battery  
Serial, Parallel Ports  
Hard disk/fl. controller  
1.2MB floppy drive  
195W Power Supply  
AT keyboard  
Hercules compatible Mono card  
High Resolution Mono Monitor

### PROTEUS-286 AT portable

80286 CPU, 6/10 Mhz  
1MB RAM  
Hercules compatible graphics card  
serial & parallel port  
1200/2400B Internal Modem  
20MB hard disk installed  
9" Amber Monitor  
Complete system \$2395

### PROTEUS XTi: \$838

8088-2 CPU  
4.77/8 Mhz speed  
coprocessor socket  
1MB RAM expandable to 1MB on main board  
zerowait state  
2 serial ports  
2 parallel ports  
clock/cal. battery  
Sasi Interface  
135/150W 110/220v p/s  
360K floppy drive  
AT keyboard



**TO ORDER OR FOR INFORMATION CALL US DIRECT:  
201-288-8629**

**Proteus Technology Corp  
377 RT 17  
Airport 17 Center  
Hasbrouck Heights, NJ 07604  
Overseas: Proteus, W. Germany, Proteus, France**

**TELEX 510 601 0960  
FAX 201-288-2577**



# BOOK REVIEWS

## IN SEARCH OF THE MOST AMAZING THING: CHILDREN, EDUCATION, AND COMPUTERS

Tom Snyder  
and Jane Palmer  
Addison-Wesley  
Reading, MA: 1986  
ISBN 0-201-16437-X  
154 pages, \$10.95

## A PRACTICAL GUIDE TO COMPUTER USES IN THE ENGLISH/LANGUAGE ARTS CLASSROOM

William Wresch  
Prentice-Hall  
Englewood Cliffs, NJ: 1986  
ISBN 0-13-690660-5  
200 pages, \$15.95

## THE LEGAL GUIDE TO DEVELOPING, PROTECTING AND MARKETING SOFTWARE

Thomas J. Smedinghoff  
John Wiley & Sons  
New York: 1986  
ISBN 0-471-810274  
322 pages, \$39.95

## AN INTRODUCTION TO DIGITAL IMAGE PROCESSING

Wayne Niblack  
Prentice-Hall International  
Englewood Cliffs, NJ: 1986  
ISBN 0-13-480674-3  
215 pages, \$32.95

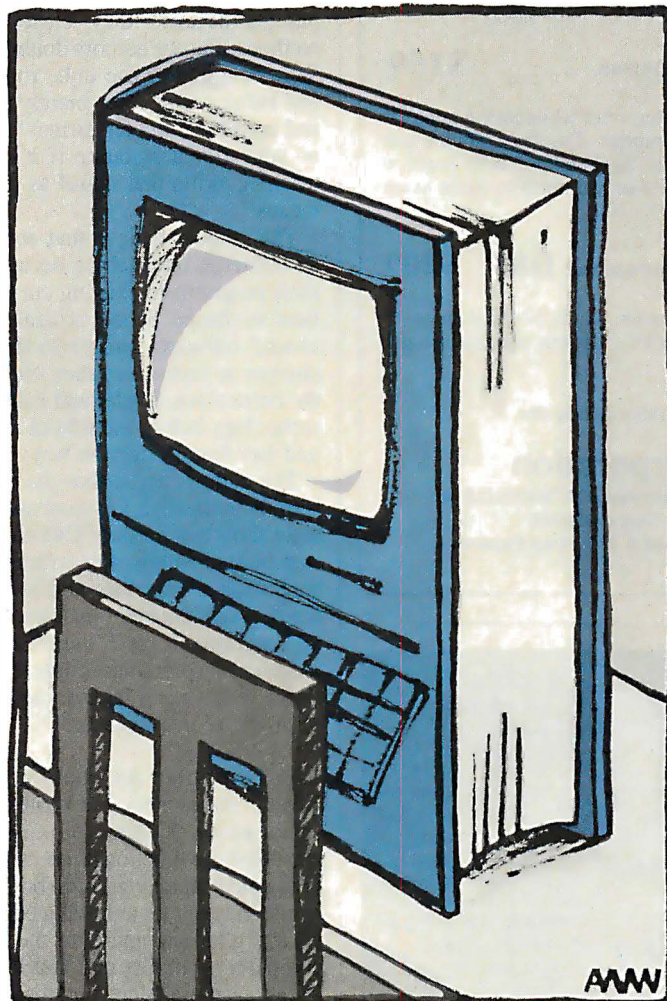

This crisis in education, with its emphasis on measurable achievement and test score results, has produced a climate in which the new technology of computers has seemed to offer a magical way to improve student performance. In this context, the authors argue that the educational community has been uncritical in its acceptance of computers. Snyder and Palmer suggest that the schools have focused on the technology rather than on providing a quality education for our children, which should be their primary objective.

The book stands on the premise that neither educators nor people who work in the software and hardware industry know how to use the new technology to support education on the scale being demanded by the public. While Snyder and Palmer grant that some educational software is effective, they dismiss most educational programs as inadequate and lacking innovation. Yet educators and parents have an "excessively high opinion of the computer's educational potency," they claim.

The authors have no sympathy for those who mindlessly embrace computers as a panacea for the ills of education.

Parents, they say, are often deluded into thinking that microcomputers in their child's classroom or bedroom will solve his or her learning deficiencies by making the child "computer literate." School boards, responding to the public pressure to have computers in their schools, have climbed on the same bandwagon.

## In Search of the Most Amazing Thing: Children, Education, and Computers

Reviewed by Karl S. Wittman

In 1983, Spinnaker Software (Cambridge, MA) published an educational program called *In Search of the Most Amazing Thing*. The game was a good computer simulation and made learning fun. Tom Snyder, who wrote the game, uses the same title for his new book. A former teacher and software publisher, Snyder teamed up with writer Jane Palmer to critique traditional concepts of educational computing. They build a strong case for developing games and simulations that help the teacher teach.

## A Crisis in Education

Recently, intellectuals and politicians have criticized the nation's schools for our children's poor performance in the basic skills.

## The Computer As an Instructional Medium

A great debate continues between traditionalists who use the notion of programmed instruction, computer-assisted instruction (CAI), and those visionaries who seek to use the computer more progressively. This tug-of-war is a recurring theme in the book.

Although CAI has been used in schools for about 15 years, its widespread acceptance and the accelerated development of software keyed to the curriculum have been apparent only since the appearance of the microcomputer. While computing power outstripping what was possible 15 years ago is potentially available on every school desk, educational software has not made

*continued*



## DeSmet C

*execution profiler included*

DeSmet C Compiler\* .....still \$109

The professional's choice for fast compilation and execution. Includes Compiler, Assembler, Binder, Librarian, and Full Screen Editor (SEE<sup>tm</sup>). Execution Profiler reports by address, procedure name or line number. Supports both disk and memory resident Overlays. Contains both 8087 and Software floating point support. Full STDIO library.

With D88 Debugger Option ..... \$159

Gain most of the benefits of an interpreter while losing none of the run-time speed of the C88 compiler. Display C source and variable contents during execution. Set breakpoints by function name or line number. Examine and set variables by name using C expressions.

With Large Case Option and D88 ... \$209

Makes a great C Compiler even better. Adds 32-Bit Pointers to C88 so you can utilize all of your PC. Groups scalar and static data for fast access.

\*D88 & Large Case Options available as add-ons.

### C Ware Corporation

505 W. Olive, Suite 767, Sunnyvale, CA 94086 U.S.A.

(408) 720-9696 — Telex: 358185

We accept VISA, MasterCard & American Express

the transition nearly as well. (See "A Hard Look at Educational Software" by Adeline Naiman on page 193). CAI's two basic modes still exist: drill and practice, and the tutorial.

Drill-and-practice software assumes that the student understands the subject-matter principles and needs practice to convert this general understanding into mastery and application of the material. The tutorial mode uses the computer to deliver instruction and attempts to imitate the student-teacher relationship.

These CAI modes are easily understood by educators and parents because they closely parallel traditional teaching methods. But the authors doubt the validity of the CAI approach. Why continue to use dull, routine CAI programs, say Snyder and Palmer, when they merely represent a transfer of workbooks and texts to computer format? The computer is being wasted as an educational resource if it is used as a delivery system for teaching skills that could as easily be taught by conventional means.

The authors believe that software publishers have too great an influence on teaching because they tend to closely correlate their programs to existing curricula, rendering it fixed and difficult to change. School officials and teachers buy so-called wrap-around software—programs that drill, test, and measure their charges to make sure they conform to the rigid parameters of the curriculum. Snyder and Palmer warn us not to institutionalize technology before the school system really knows how to teach and has found effective ways to use the computer.

The authors argue that the current crop of educational software is ineffective for most students because the technological algorithms that produce CAI are inherently linear processes. The step-by-step nature of programmed instruction, despite the most sophisticated branching and computer management of previously learned skills, cannot match a five-year-old's "creative insights and cognitive leaps." Significant learning is often intuitive, requiring interpretation, contextual references, and dialogue between teacher and learner. Simply put, CAI is not yet capable of artificial intelligence.

### The Computer As Tool

Several researchers and writers, including Henry F. Olds Jr., senior editor of *Classroom Computer Learning* magazine, have classified the functional uses of computers in schools. *In Search of the Most Amazing Thing* borrows Olds's three-part taxonomy as a foundation for analyzing educational computing. The authors clearly give low marks to the first element in Olds's scheme, computer as an instructional medium. They find computer applications more interesting than CAI but argue, for example, that a word processor cannot improve writing skills or transform a bad essay into a good one. Rather, the book makes an interesting case for inventing new and more useful software applications for the teacher.

### The Computer As Modeling Device

The authors believe that the best use of computers in education is to "create environments supportive of teaching." A good computer model helps a student learn by providing a forum for experimentation. Although adults can conceptualize the need to learn facts and processes for later application, children usually must wait a long time to appreciate their practical uses. Simulations provide a method that teachers can use to stimulate students' discovery of the application of abstract learning.

### The Role of Interaction

Game playing has many virtues that the authors see as fundamental to effective learning, and it contains some basically different approaches to traditional teaching methods. Snyder and Palmer contend that educationally effective games and simulations are

*continued*

It's  
Time  
To

### NEW SLIM DESIGN and a LIFETIME WARRANTY . . .

Two great reasons to make the switch. Only 1½" high, but still with the same high quality features you have come to expect from DATA SPEC Switch Boxes.

- Reinforced printed circuit boards
- Full shielding

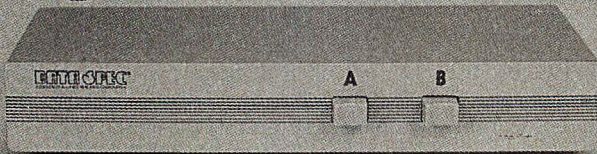

Switch  
Boxes

- Durable metal construction
- Gold-plated contacts
- All pins switched

And now, backed by a lifetime warranty.

Visit your local DATA SPEC dealer and see our full line of slim style data switch boxes and other computer accessories.

**DATA SPEC**  
A DIVISION OF ALLIANCE RESEARCH CORPORATION

THE ULTIMATE IN COMPUTER ACCESSORIES

20120 Plummer Street • P.O. Box 4029 • Chatsworth,  
CA 91313 • (818) 993-1202

In Japan: Call Data Spec Japan LTD., Tokyo, Japan, Tel. (03) 774-7741



# The Magnificent Seven.



Meticulously engineered. Exactly compatible. Incredibly priced. In the three most competitive areas, Tandon's new line of XT and AT compatibles are more than a match for any other models, from anyone. Including IBM®

For greater disk storage capacity and fast access time, few can measure up to our PCA™-40, a 40 megabyte AT compatible micro. And you'll really appreciate the magnificent view from our monitors. They're high on resolution and larger by a wide margin.

What's more, Tandon offers one of the most complete product lines in the industry. Which means we can meet

the needs of your business, large or small. And because Tandon's average price is 40% less than equivalent IBM systems, we can lower the cost of your business computing requirements.

All of which proves that for XT and AT compatibles that are reliably designed and affordably priced, your choice is magnificently simple. Tandon.

For your Tandon Fact Pack and the name of a dealer near you call us toll free now on:

**800/556-1234** Ext. 171

In California:

**800/441-2345** Ext. 171

**FREE TANDON  
FACT PACK**

B2/87

Please send me your comprehensive packet of literature and product reviews which proves why Tandon is the magnificent choice.

Name \_\_\_\_\_

Position \_\_\_\_\_

Company \_\_\_\_\_

Address \_\_\_\_\_

Telephone \_\_\_\_\_

Nature of Business \_\_\_\_\_

No. of Employees  No. of Installed PC's

**Tandon**

Less money. More micros.

405 Science Drive,  
Moorpark, CA 93021 805/378-6081

PCX™ and PCA™ are trademarks of Tandon Corporation. IBM® and IBM PC AT® are registered trademarks; IBM PC XT™ is a registered trademark of International Business Machines Corporation. Prices displayed are manufacturer's suggested prices and do not include monitor.



## PC/VI™

### UNIX's VI Editor Now Available For Your PC!

Are you being as productive as you can be with your computer? An editor should be a tool, not an obstacle to getting the job done. Increase your productivity today by choosing **PC/VI** — a COMPLETE implementation of UNIX\* VI version 3.9 (as provided with System V Release 2).

**PC/VI** is an implementation of the most powerful and most widely used full-screen editor available under the UNIX operating system. The following is only a hint of the power behind **PC/VI**:

- Global search or search and replace using regular expressions
- Full undo capability
- Deletions, changes and cursor positioning on character, word, line, sentence, paragraph, section or global basis
- Editing of files larger than available memory
- Shell escapes to DOS
- Copying and moving text
- Macros and Word abbreviations
- Auto-indent and Showmatch
- MUCH, MUCH MORE!

Don't take it from us. Here's what some of our customers say: "Just what I was looking for!", "It's great!". "Just like the real VI!". "The documentation is so good I have already learned things about VI that I never knew before." — *IEEE Software*, September 1986.

**PC/VI** is available for IBM-PC's and generic MS-DOS† systems for only \$149. Included are CTAGS and SPLIT utilities, TERMCAP function library, and an IBM-PC specific version which enhances performance by as much as TEN FOLD!

## PC/TOOLS™

What makes UNIX so powerful? Sleek, Fast, and **POWERFUL** utilities! UNIX gives the user not dozens, but hundreds of tools. These tools were designed and have been continually enhanced over the last fifteen years! Now the most powerful and popular of these are available for your PC! Each is a complete implementation of the UNIX program. Open up our toolbox and find:

- BFS
- CAL
- CUT
- DIFF
- DIFFH
- DIFF3
- GREP
- HEAD
- OD
- PR
- SED
- SEE
- STRINGS
- TAIL
- WC

All of these for only \$49.00; naturally, extensive documentation is included!

## PC/SPELL™

Why settle for a spelling checker which can only compare words against its limited dictionary database when **PC/SPELL** is now available? **PC/SPELL** is a complete implementation of the UNIX spelling checker, renowned for its understanding of the rules of English! **PC/SPELL** determines if a word is correctly spelled by not only checking its database, but also by testing such transformations as pluralization and the addition and deletion of prefixes and suffixes. For only \$49.00, **PC/SPELL** is the first and last spelling checker you will ever need!

Buy **PC/VI** and **PC/TOOLS** now and get **PC/SPELL** for only \$1.00! Site licenses are available. Dealer inquiries invited. MA residents add 5% sales tax. AMEX, MC and Visa accepted without surcharge. Thirty day money back guarantee if not satisfied! Available in 8", 5 1/4" and 3 1/2" disk formats. For more information call today!

\*UNIX is a trademark of AT&T • MS-DOS is a trademark of Microsoft.

**CUSTOM SOFTWARE SYSTEMS**

P.O. BOX 678 • NATICK, MA 01760

617 • 653 • 2555



based on the idea that children learn primarily through social interaction. That is, the game provides an environment in which youngsters, with a teacher's guidance, can act out situations, respond to the consequences of their actions, and compare and test out their new discoveries with others in the classroom.

Snyder uses his own programs as a basis for describing features that make this format desirable. Simulations succeed when they are integrated into other teaching methods and rely on things computers do best: manipulating large amounts of data and managing the many elements of a simulated setting.

If you enter a classroom where the children are successfully using a computer game, say Snyder and Palmer, you should have trouble finding the computer. Children are at the center of the action, combining conventional and computer resources under the guidance of a talented teacher. Directions for "play" don't specify information gathering and analysis, note taking, decision making, or teamwork. Yet these interactive skills are fostered because kids are compelled to develop them in order to achieve the game's objective.

### Refocus Priorities

*In Search of the Most Amazing Thing* is an important book for parents, teachers, and policymakers to read. It reminds us that education must remain focused on the child and not on the technology. The authors draw extensively on critics of the computer revolution in schools, particularly on MIT computer scientist Joseph Weisenbaum. Like Weisenbaum, the authors are clearly frustrated with the direction schools and industry have taken. As a result, the book does not present a balanced view.

The authors are frequently at odds with the thinking of classroom teachers. Case in point: Although Snyder and Palmer disapprove of traditional CAI, according to the current Johns Hopkins University survey on the educational uses of computers (see "Using Computers for Instruction" by Henry Jay Becker on page 149), CAI still accounts for about half of all computer-related activity. The authors also generally neglect to mention CAI's positive aspects and application programs and the new innovative approaches, such as *Voyage of the Mimi*, a program that combines videotapes, computer programs, and print materials.

Despite the book's harsh criticism of the educational community, readers will be pleased that it places the teacher at the center of learning. Teachers, say Snyder and Palmer, need time to assimilate the technology, to "mess around" with the promise of the computer, and, we presume, to search for that most amazing thing: sound educational practices as the school's top priority.

### A Practical Guide to Computer Uses in the English/Language Arts Classroom

Reviewed by Karl S. Wittman

Children start their formal schooling with a remarkable ability to communicate using spoken language. But getting youngsters to put those thoughts down on paper—in logical order, using correct grammar and accurate spelling—is another matter entirely. Writing teachers are always searching for strategies that capitalize on the natural eagerness of children to create.

Can computers in the classroom help do the job? Many writing teachers have enthusiastically adopted word processors and desktop publishing to strengthen student interest in language. William Wresch explores these and other applications of educational and productivity software to improve writing skills.

### Finding the Software

Wresch's book is built on the premise that while computers cannot teach writing, they can enhance a solid language arts cur-

*continued*



Turbo Pascal Enthusiasts!

# Announcing the GSI PASCAL DEBUGGER.

Debugs, deglitches,  
and degoofs faster than  
any other debugger, deglitcher,  
and degoofer in America.



**Y**ou've made one smart move. You've chosen Turbo Pascal - the best Pascal compiler in the business.

Now get really smart. With the GSI Pascal Debugger. Quite simply the fastest, most efficient Pascal Development System in America. And an indispensable complement to Turbo Pascal.

And that's not all that makes our Debugger the most. And a must. Our new Pascal Debugger is completely menu-driven. And it includes a compatible Turbo Pascal compiler. A source debugger. A full-screen editor. Help screens. And a calculator.

With it you can debug at Pascal source level without assembly language or code addresses. You can display source in a window while executing the program in another. You can set conditional break points. You can assign values to global, local or constant variables. And you can trace statement by statement.

The GSI Pascal Debugger. All the debugging power you need at a price that'll bug no one.

**Requires:** 256 K RAM, an IBM-PC/XT/AT or compatible microcomputer with MS-DOS or PC-DOS operating system, Rev. 2.0 or higher.

**gsi**<sup>TM</sup>

## GSI PASCAL DEBUGGER

**\$ 49 95**

**gsi** 1380 Old Freeport Rd.,  
PGH, PA 15238 (412) 963-7270

(plus \$5.00 shipping and handling)

Check  Money order  Visa  Master Card   
Card # \_\_\_\_\_ Expiration date \_\_\_\_\_  
Name \_\_\_\_\_  
Address \_\_\_\_\_  
City/State/Zip \_\_\_\_\_  
Telephone \_\_\_\_\_

IBM is a registered trademark of International Business Machine, Corp. PC-DOS is a trademark of IBM. MS-DOS is a trademark of Microsoft. Turbo Pascal is a trademark of Borland International.



**12 MHZ 1 & 0 WAIT STATE PC/AT  
10 MHZ 0 WAIT STATE PC/XT/AT**

- 10 MHZ 0 WAIT AT STYLE PC/XT SYSTEM**  
★ 390% FASTER THAN IBM PC/XT ! ★ **\$629**
- 10 MHZ 0 WAIT PC/AT SYSTEM**  
★ 110% FASTER THAN IBM AT ★ **\$1390**
- 10 MHZ 0 WAIT PC/XT PORTABLE**  
★ DUAL SPEED, DUAL MODE MONITOR ★  
★ IBM AT STYLE KEYBOARD ★ **\$850**
- 12 MHZ PC/AT TURBO PORTABLE**  
★ DUAL SPEED, DUAL MODE MONITOR ★  
★ 135% FASTER THAN IBM PC/AT ★ **\$1790**  
★ 6/8/10 MHZ 1 & 0 WAIT SWITCHABLE ★  
★ 12 MHZ 1 WAIT STATE ★
- 10 MHZ 0 WAIT STATE MOTHERBOARD** **\$149**
- MULTI-DISPLAY CARD** **\$139**  
★ MONO/GRA & COLOR/GRA CARD ★

**IMPERIAL COMPUTER CORP.**

**935 S. San Gabriel Blvd., San Gabriel, CA 91776**

**Tel: (818) 285-1256 ( 3 Lines )**

**Telex: 3719072 IMPERIAL FAX : (818) 285-9488**

**AUTOROUTER**  
NOW AVAILABLE FOR ADDITIONAL \$975.00

**EE DESIGNER™**  
CAE/CAD Integrated Software Package for  
IBM PC, XT or AT **\$975**

At only \$975, no electrical engineer can afford to be without this end-to-end circuit design, simulation and PCB layout tool. You can pay up to 15 times more and still not get all the features offered by EE Designer—Schematic Capture... Circuit Simulation... PCB Layout. 30 day money back guarantee. Full purchase price refunded if not completely satisfied. Call 1-800-225-5669 today to order your package. Bank cards welcome.

**VISIONICS**  
CORPORATION  
1284 Geneva Drive  
Sunnyvale, CA 94089

riculum taught by teachers willing to experiment. The author guides his readers through the large volume of published software by choosing a few programs that illustrate applications for each segment of the writing process: creating ideas, composing the text, and editing and revising the work.

Although he believes that much of today's educational software is inadequate, Wresch tries to help teachers in grades 4 through 12 squeeze the best out of what's available for microcomputers. This is a modest objective, but Wresch's slim book only partially succeeds.

**Word Processing and Writing**

Wresch provides some useful hints for using word processors. For example, he suggests that teachers focus on one type of revision at a time, such as content, transition, or sentence structure. To avoid discouraging beginners with complex word processing commands, he says, teachers should first introduce the essential text insertion, deletion, and printing functions. By starting students off with short writing assignments, Wresch believes teachers can build confidence in using the computer and software.

The book also describes a number of simple classroom activities that teachers can adapt to any available word processor. For example, a short essay is prepared without paragraphs. The text is distributed on disks to students who use a word processor to produce an indented version for critique. Another activity involves using the search-and-replace function to improve word use and build vocabulary. The teacher supplies a list of commonly overused words, and students locate those words in their own work and substitute better choices.

**Prewriting**

"Prewriting" exercises are used to help students discover ideas for their writing. Some programs mimic traditional methods by using a set of questions or brainstorming exercises to stimulate a youngster's thoughts. These idea processors can be particularly useful in helping younger students develop new writing topics, learn information organization and sequence, and explore their ideas from different perspectives.

One typical prewriting program uses outline and categorization routines to teach students to concentrate on grouping related subjects. Children learn how to bring ideas together to form a paragraph and how to create a series of connected paragraphs. Wresch wisely advises teachers to search for prewriting software capable of easily transferring its output to a word processor so that students can continue to work on their text without retyping.

**Revising and Editing**

Learning to write means learning to rewrite. Rewriting needs to be encouraged because students often see themselves as failures if their first draft is not perfect. Fortunately, with a word processor the drudgery of retyping no longer exists; youngsters with a neatly printed essay will be more willing to share their efforts with classmates. Wresch contends that the computer lowers the "cost of change" in time and effort, encouraging youngsters to rewrite more often.

Rewriting also means revising—for style, for tone, and to more clearly focus content to an audience. Wresch describes one group of programs that are able to disassemble a paragraph by placing each sentence on a new line. Seen by themselves, explains Wresch, sentence fragments can be more quickly identified, and sentences that are incoherent can be corrected.

The author describes a controversial group of programs called style analyzers. These packages identify such writing characteristics as sentence length, use of passive construction, readability

*continued*



# Softline PRICE BUSTERS



Lotus 1-2-3 <b>\$319</b>	Paradox <b>\$449</b>	dBase III Plus <b>\$399</b>	Rapid File <b>\$Call</b>	Multimate Advantage <b>\$299</b>	Word Perfect 4.2 <b>\$219</b>
--------------------------------	-------------------------	-----------------------------------	-----------------------------	--	-------------------------------------

## Software

### Word Processing

FANCY FONT	\$139
FINAL WORD II	\$199
MICROSOFT WORD 3.0	\$279
MULTIMATE	\$249
MULTIMATE ADVANTAGE	\$299
OFFICE WRITER/ SPELLER 5.0	\$259
PFS: PROF WRITE	\$149
SAMNA WORD IV	\$349
THINK TANK	\$109
TURBO LIGHTNING	\$ 65
VOLKSWRITER 3	\$159
VOLKSWRITER SCIENTIFIC	\$259
WORDPERFECT 4.2	\$219
WORDSTAR 2000	\$249
WORDSTAR 2000 +	\$289
WORDSTAR PRO	\$259
XYWRITE III	\$199

### Database Systems

CLIPPER	\$ 349
CONDOR III	\$ 339
DBASE III PLUS	\$ 399
FOXBASE +	\$ 339
KMAN 2	\$ 339
PARADOX	\$ 449
PFS: PROF FILE	\$ 149
Q&A	\$ 229
QUICKCODE III	\$ 159
QUICKREPORT	\$ 159
QUICKSILVER	\$ 359
RBASESYSTEMV	\$ 359
RAPIDFILE	\$Call
REFLEX	\$ 89
REVELATION	\$ 499

### Spreadsheets/ Integrated Packages

ENABLE	\$ 349
FRAMEWORK II	\$ 399
JAVELIN	\$Call
LOTUS 1-2-3	\$ 319
MULTIPLAN	\$ 125
OPEN ACCESS II	\$ 229
SMART SYSTEM	\$ 439
SPREADSHEET AUDITOR	\$ 99
SUPERCALC 4	\$ 289
SYMPHONY	\$ 449
TWIN	\$ 79
VP PLANNER	\$ 59

### Graphics

CHARTMASTER	\$209
CLICKART	\$119
DIAGRAPH	\$309
DIAGRAM MASTER	\$189
ENERGRAPHICS 2.0	\$299
FREELANCE PLUS	\$359
GEM DRAW	\$149
GRAPHWRITER COMBO	\$309
HARVARD PRESENTATION GRAPHICS	\$239
IN-A-VISION	\$259
MAPMASTER	\$219
MS CHART	\$189
PC DRAW	\$209
PC PAINTBRUSH PLUS	\$109
PICTURE PERFECT	\$245
PRODESIGN II	\$189
SIGNMASTER	\$139
WINDOWS/DRAW	\$119

### Project Management

HARVARD TOTAL PROJECT MANAGER	\$279
MICROSOFT PROJECT	\$249
PROJECT SCHEDULER NETWORK	\$339
SUPERPROJECT PLUS	\$269
TIMELINE 2.0	\$259

### Communications/ Productivity Tools

CARBON COPY	\$ 129
CROSSTALK XVI	\$ 99
CROSSTALK MKIV	\$ 139
PROKEY	\$ 85
RELAY GOLD	\$ 129
REMOTE	\$ 109
SMARTERM	\$Call
SMARTCOM II	\$ 99
SUPERKEY	\$ 55

### Statistics

SPSS/PC + STATGRAPHICS	\$699
STATPAC GOLD- WALONICK	\$469
SYSTAT	\$399
	\$469

### Accounting

BPI	\$309
GREAT PLAINS	\$479
IUS EASYBUSINESS	\$349
ONE WRITE PLUS	\$159
OPEN SYSTEMS	\$409
REAL WORLD	\$399

### Network Applications

CROSSTALK XVI	\$419
DBASE III LAN PAK	\$599
KMAN 2	\$899
MULTIMATE	\$639
MULTIMATE ADVANTAGE	\$749
REVELATION	\$999
WORD PERFECT SERVER	\$309
WORD PERFECT STATION	\$ 75

### Languages/Utilities

COPYWRITE	\$ 45
FASTBACK	\$ 89
LATTICE C	\$ 259
MICROSOFT C COMPILER	\$ 289
MS BASIC COMPILER	\$ 249
MS FORTRAN	\$ 229
NORTON UTILITIES	\$ 59
QUICK BASIC	\$ 69
TURBO PASCAL	\$ 69
TURBO PROLOG	\$ 69
XENIX	\$Call
ZERO DISK	\$ 70

### Desktop Environments

GEM DESKTOP	\$39
MS WINDOWS	\$65
SIDEKICK	\$59

## Hardware\*

### Mass Storage/Backup

IOMEGA 10 + 10 W/INTFC	\$1999
IOMEGA 20 + 20 W/INTFC	\$2599
IRWIN 120D 20MB TBU	\$ 469
IRWIN 145AT 40MB TBU	\$ 579
MOUNTAIN DRIVECARD 20MB	\$ 719
PLUS HARDCARD 10MB	\$ 569
PLUS HARDCARD 20MB	\$ 699
PRIAM 42MB AT	\$ 949
SEAGATE 20B W/INT	\$ 399
SYSGEN SMART IMAGE 20MB (INT)	\$ 625
TALLGRASS	\$Call
TECMAR QIC-60AT TBU (INT)	\$1199

### Multifunction Boards

AST ADVANTAGE (128K)	\$ 349
AST 6 PAK PLUS (64K)	\$ 169
AST II/O MIN II	\$ 169
AST PREMIUM PAK	\$ 359
AST RAMPAGE PC	\$ 279
AST RAMPAGE AT	\$ 439
INTEL ABOVEBOARD JRAM AT-3 (OK)	\$ 239
JRAM 3 (OK)	\$ 179
PC TURBO 286 (1MB)	\$ 799
PC TINY TURBO 286	\$ 459
QUADBOARD (64K)	\$ 139

### Display Boards

HERCULES GRAPHICS CARD PLUS	\$189
HERCULES COLOR CARD	\$159
ORCHID TURBO EGA	\$619
PARADISE AUTO SWITCH EGA	\$369
PARADISE MODULAR GRAPHICS	\$259
QUADRAM EGA + SIGMA COLOR 400	\$339
STB EGA PLUS	\$449
TECMAR EGA MASTER	\$299
TSENG ULTRA PAK	\$429
TSENG EVA 480	\$469

### Emulation Boards

AST 5211-11 +	\$ 649
AST 5251-12	\$ 499
AST BSC	\$ 489
AST SNA	\$ 599
FORTE	\$Call
IRMA	\$ 725
SMART ALEC 5251	\$ 699

### Modems

AST REACH 1200	\$359
HAYES 1200	\$389
HAYES 1200B	\$349
HAYES 2400	\$579
HAYES 2400B	\$549
TRANSNET 1000	\$279
US ROBOTICS 1200B	\$109
US ROBOTICS 2400B	\$189
VENTEL 1200	\$369
HALF CARD	\$369
VENTEL 1200 PLUS	\$299
WATSON	\$339

### Monitors

AMDEK 310A	\$159
AMDEK 600/722	\$429/539
NEC MULTISYNC	\$599
PRINCETON HX-12	\$449
PRINCETON MAX-12E	\$179
PRINCETON SR-12	\$599
PRINCETON HX-12E	\$539
PRINCETON HX-9	\$529
TAXAN 122 AMBER	\$159
TAXAN 630/640	\$469/539

### Networks

AST PC NET	\$Call
NOVELL	\$Call
ORCHID PC NET	\$Call

### Printers/Plotters

EPSON EX-1000	\$ 699
EPSON FX-85	\$ 399
EPSON FX-286	\$ 579
EPSON LQ-800	\$ 589
EPSON LQ-1000	\$ 769
HP 7475A	\$1499
NEC 3550	\$ 799
OKIDATA 192 +	\$ 389
OKIDATA 193 +	\$ 569
OKIDATA 292	\$ 539
OKIDATA 293	\$ 689
TOSHIBA P321	\$ 499
TOSHIBA P341 E	\$ 769
TOSHIBA P351 MODEL 2	\$1199

### Input Devices

KEYTRONICS 5151	\$169
KEYTRONICS 5153	\$299
MICROSOFT MOUSE	\$129
PC MOUSE W PAINT +	\$129

### Accessories

CURTIS RUBY	\$ 65
DATASHIELD S-100	\$ 79
GILTRONIX SWITCHES	\$Call
LOGICAL CONNECTION	\$259
MASTERPIECE PLUS	\$135
MICROFAZER II	\$ 269
256K RAM SET	\$ 39
8087 MATH CHIP	\$ 119
80287 MATH CHIP	\$ 189

NEC Multisync <b>\$599</b>	Plus HardCard 20 <b>\$699</b>	Quadram EGA+ <b>\$339</b>	US Robotics 1200 B <b>\$109</b>	US Robotics 2400B <b>\$189</b>	IRMA Board <b>\$725</b>
----------------------------------	-------------------------------------	---------------------------------	---------------------------------------	--------------------------------------	-------------------------------

## FREE SHIPPING

on all orders over \$1000.00, credit card orders and prepaid orders.

### Our Policy:

\* Visa or MasterCard — add 3% • C.O.D. — Cash, M.O. or bank check only — add \$5.00 per order • Prepare personal or company check — allow two weeks to clear • No sales tax on orders shipped out of NY State • Shipping via UPS surface — add \$3.00 per item • UPS Blue — add \$8.00 per item • All returns require prior authorization • Prices subject to change, call for latest prices



# 1-800 221-1260

In New York State call (718) 438-6057

# Softline

P.O. Box 729, Brooklyn, NY 11230  
TELEX: 421047 ATLN UI  
FAX: 718-972-8346



**350 Plus-IC High Performance Printed Circuit Board CAD for \$975.00!!**

All the features of Engineering Workstation CAD, on XT or AT Personal Computers—and at an affordable price!

- 1 mil data base, 32" x 32" area, up to 30 layers & 250-350 IC's
- Automatic and Interactive Placement aids, including Dynamic Rubberbanding, Connection Length Measurement, Auto Part Swapping, and other aids
- Interactive Routing on any grid from 1 mil upwards, i.e., 5, 10, 15, 20, 25, 50, etc. Thru. Blind and Buried Vias of Standard and Micro size. Filled tracks and pads at the CRT. Fine Line Design—2 tracks between IC's. Track Segment thickening. Angles at 90, 45 and 1 degree.
- Auto Routing (optional), Auto Air Gap Checking
- 2-D Drafting capability, TTL/CMOS Library included
- Full SMD and Analog Board design supported
- Post Processing to matrix printer, wet ink plotter and Gerber (optional)

**PADS-PCB \$975.00**  
Demo disk with manual \$50.00

**CAD Software, Inc.**

P.O. Box 1142, Littleton, MA 01460 (617) 486-9521

**NEW!**

**2 MEGABYTE MODEL AVAILABLE SOON!**

**THE 3.5" CONNECTION!**

This internal 720K 3.5" disk drive is a "drop-in" replacement for 5.25" drives! It's the ideal solution for exchanging data between your PC/XT/AT and the new generation of laptops. Disk format is compatible with IBM, Toshiba and Zenith portables. The Model 853W drive kit contains everything you need, including interface adapters, premium SONY drive, and complete documentation. Uses your existing disk controller (no additional slots required). Requires DOS 3.2 for maximum performance. Ask about our special prices on SONY DISKS!

**\$\$\$ SAVE \$\$\$ SONY DISKS**

**Ligertronics™ INCORPORATED**

**\$159.95 + FRT. & TAX**

2734-C Johnson Drive  
P.O. Box 3717  
Ventura, CA 93006

MasterCard VISA

**IMMEDIATE DELIVERY!**  
**Call 805-658-7466 or 805-658-7467**

ty level, and phrasing. Critics argue that computers are not able to evaluate factors that constitute a composition because analysis algorithms are based on comparing the student's work with only the style attributes of the few authors programmed into the software. Wresch conveys the limitations while suggesting the ways in which teachers might effectively use style analysis software with more advanced students. He cautions that children are ready to experiment with style analyzers only after they understand the concepts of audience, purpose, and organization and they have mastered writing mechanics.

The book also includes an informative section about using interactive story generators as a creative writing technique. These programs, modern versions of text adventure games, exploit the computer's ability to keep track of a story's complex twists and turns. Using this software, students learn concepts of plot, character development, interaction, and dialogue.

**Conclusions**

I have mixed feelings about this book. On one hand, Wresch offers many good insights and examples for writing teachers interested in just how the new computer technology can be effective for them. However, Wresch's guide suffers from the basic approach of compiling reviews for a limited number of software products. The educational computing market is rapidly expanding, and out-of-date software is quickly replaced with far superior products. Wresch considers a few classic programs but fails to describe many more recent additions offering better graphics and content.

The book's diminutive size limits the number of programs and the extent to which they can be examined. More frustrating, Wresch's book lacks the space to elaborate fully on many topics. Drill-and-practice software is the least effective application of the computer. Electronic workbooks are no better than their print counterparts to teach writing mechanics. Yet the book provides only the briefest of software evaluation checklists from the National Council of Teachers of English. I am sure that teachers, especially those new to educational computing, would appreciate a more extensive and critical analysis of how to go about evaluating software.

*A Practical Guide to Computer Uses in the English/Language Arts Classroom* has much to offer, and teachers who follow Wresch's suggestions likely will be motivated to search for additional resources. Unfortunately, the author provides no sources that will keep an interested teacher up to date on products, instructional computing methods, and hints from colleagues. I was disappointed, for example, that Wresch did not suggest his readers consult the magazine *The Computing Teacher* for its monthly column directed at language arts teachers.

Rather than devote a few pages to a superficial treatment of computer hardware, Wresch could have used the space to include sources of public domain software or an annotated list of support groups, such as Computer-Using Educators (CUE, 1776 Educational Park Dr., San Jose, CA 95133). I also expected Wresch to detail some of the more exciting developments, such as IBM's Writing to Read program and the use of bulletin board systems and on-line databases to motivate young writers.

Despite its shortcomings, this book will be a valuable addition to the library of many writing teachers. Wresch does a good job of describing the features of various types of writing software. His treatment of teaching methods and program reviews clearly illustrates how software tools can be applied to most categories of language arts instruction.

*Dr. Karl S. Wittman writes on education and computers. He is an administrator with the New York State Education Department. He can be reached at 8 Reid Place, Delmar, NY 12054.*

*continued*



# Assemblers/Simulators

## Macro Assemblers/ Cross Assemblers for Series 3.0

Series 3 requires at least 256k of memory to run under MSDOS & CP/M86 and 54k TPA of memory to run CP/M80. Series 3 products have: Full Listing Control, Conditional Assembly & Built in Cross Reference. There is Unlimited Program Size, Number of Symbols and Macros. The Linkers output: Intel Hex, Extended Intel Hex, Tektronix Hex, and Motorola S19, S28, S37 formats.

## Macro Assemblers/ Cross Assemblers for Series 4.0

Series 4 requires 512k of memory to run. These products have all the features of Series 3 plus: 32 Character Labels, Library and User Defined Sections. There is one Linker on Series 4 which outputs all the same formats as Series 3. Series 4 runs under MSDOS, UNIX, VMS and ULTRIX.

## Simulator-Debuggers

The Simulator-Debuggers run with 256k of memory. The Simulator has 16 Break-points with optional Counter Field. The Symbol Table is limited only by the amount of memory. Buffers of 256 bytes may be opened for I/O ports. The Simulators are available for MSDOS, UNIX, VMS and ULTRIX.

**To order, call toll free in U.S.  
(including HI, PR and VI):**

**1 800 843-8144**

**In Colorado: (303) 369-5001**

**For more details, ask for a  
free brochure.**

Software Product	Macro Assemblers Cross Assemblers			Simulator- Debuggers	
	Series 3	Series 4		MSDOS AT&T UNIX	VMS Zeus ULTRIX
	CP/M 80 CP/M 86 MSDOS	MSDOS AT&T UNIX	VMS Zeus ULTRIX		
Super8		199.50	995.00	149.50	499.50
Z-8	199.50	199.50	995.00	149.50	499.50
Z-80	199.50	199.50	995.00	149.50	499.50
Z-8000	299.50	299.50	1250.00		
1802	199.50				
6301	199.50	199.50	995.00	149.50	499.50
64180	199.50	199.50	995.00		
6501	199.50	199.50	995.00		
6502	199.50	199.50	995.00		
65c02	199.50	199.50	995.00		
65c816		299.50	1250.00		
6800,2,8	199.50	199.50	995.00	149.50	499.50
6801,3	199.50	199.50	995.00		
6804	199.50	199.50	995.00		
6805	199.50	199.50	995.00		
6809	199.50	199.50	995.00		
68c11	199.50	199.50	995.00		
68000,8,10	299.50	299.50	1250.00		
68020		399.50	1500.00		
8400/c00	199.50	199.50	995.00		
8044/51	199.50	199.50	995.00	149.50	499.50
80515		199.50	995.00		
8080	199.50	199.50	995.00	149.50	499.50
8085	199.50	199.50	995.00	149.50	499.50
8086/88	99.50	99.50	1250.00		
8096	199.50	199.50	1250.00		
80186/286	199.50	199.50	1250.00		
83c351		199.50	995.00		
8748	199.50	199.50	995.00	149.50	499.50
V20/30	199.50	199.50	1250.00		
Cops400	199.50				
F8/3870	199.50				
NCR32	399.50				
NEC7500	199.50				
NSC800	199.50	199.50	995.00	149.50	499.50

more formats available

Name \_\_\_\_\_ (Please Print) Product \_\_\_\_\_ Operating System \_\_\_\_\_

Company \_\_\_\_\_ Series \_\_\_\_\_ Amount \$ \_\_\_\_\_

Address \_\_\_\_\_ Shipping \$ \_\_\_\_\_ Total \$ \_\_\_\_\_

City \_\_\_\_\_ State \_\_\_\_\_ Zip \_\_\_\_\_ Signature \_\_\_\_\_

Phone \_\_\_\_\_

Check  COD (U.S. Only)

MC/VISA # \_\_\_\_\_

Expiration Date \_\_\_\_\_

**25004DSOFTWARE INC.**

17200 East Ohio Drive  
Aurora, Colorado 80017  
(303) 369-5001

Inquiry 2



# IBM PC AT performance! PCjr price!

- ★ AMPRO LITTLE BOARD/186
- 8Mhz 16 Bit 80186 CPU
- 512K RAM— No Wait-States
- 2 Serial Ports 50-38.4K Baud
- Parallel Printer Port
- 4 Drive Mini/Micro Floppy Controller
- SCSI Bus Hard Disk Interface
- DOS Compatible ROM-BIOS
- Boots PC DOS 2.x, 3.x

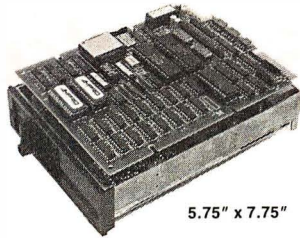

5.75" x 7.75"

- Computer Board Assembled & Tested w/Tech Manual & DOS Utilities ..... \$489.
- ★ MS DOS 3.2 & GW BASIC ..... \$89.
- ★ DRI CONCURRENT DOS 4.1 Multi-User O/S ..... \$319.
- ★ 512K EXPANSION BOARD (1Mb Total) 8087 Socket, Clock, 2 Channel RS232/422, Buffered Expansion Bus & More ..... from \$149.
- ★ AMPRO LITTLE BOARD (Z80) same as 80186 Board but Z80A CPU, 64K RAM, 16K EPROM, CPM 2.2, ZCPR3 & Manuals \$239. With SCSI Hard Disk Interface \$279.
- ☆ ENCLOSURES w/POWER SUPPLY ..... from \$99.
- ☆ 5.25" DS 360K FLOPPY DRIVE ..... \$99.
- ☆ 3.5" DS 720K MICRO FLOPPY DRIVE ..... \$139.
- ☆ XEBEC OWL 10Mb SASI DRIVE w/Built-In Controller ..... \$449.
- ☆ SEAGATE ST225N 20Mb SCSI Low Power 1/2 Ht Drive ..... \$599.
- ☆ WYSE & KIMTRON TERMINALS ..... from \$395.

Complete technical support. Complete systems available. Write or call for more information. Most orders shipped same day.

VISA, Mastercard, Money Order, COD. Checks allow two weeks. Purchase Orders welcome. Prices FOB Buffalo Grove, IL.

IBM PC AT, PCjr, PC DOS are trademarks of International Business Machines Corporation. Little Board is a trademark of Ampro Computers, Inc. Concurrent DOS is a trademark of Digital Research, Inc.

**DISKS PLUS, INC.** • 356 Lexington Drive • Buffalo Grove, IL 60089-2312  
(312) 537-7888 • TLX: 650 249 2139 MCI UW.

## DISKS PLUS

Microcomputers  
and Accessories

## The Legal Guide to Developing, Protecting and Marketing Software

Reviewed by David A. Price

Numerous technological developments have presented difficult questions to our legal system, and the computer has been no exception. To avoid unwelcome surprises in the legal realm, managers who are involved with computer software will therefore need to broaden their knowledge to include not only technical expertise but also a smattering of legal expertise. In *The Legal Guide to Developing, Protecting and Marketing Software*, Thomas Smedinghoff, a computer law specialist, ably explains some difficult aspects of the field in layman's terms.

Smedinghoff devotes the first part of his book to the protection of property rights in software, including copyright, trade secret, and patent protection. The section on copyright explains how to obtain copyright protection and how to enforce a copyright if it has been infringed. Here, as elsewhere, the author offers some practical information that may be surprising. For example, the (c) symbol, used in many programs, is not an officially accepted substitute for the international copyright symbol ©. (For domestic protection in the U.S., though, the word "copyright" in the copyright notice is enough.) The section on copyright also provides useful guidance on whether to register a program with the Copyright Office and whether to register revised versions.

The second part of the book focuses on the employer-employee relationship in software development. It examines confidentiality agreements and noncompetition agreements. In an industry such as software development, where job-hopping is common, a conflict arises because employers want to keep confidential information away from rivals, while employees want to maintain the greatest number of employment possibilities. Smedinghoff explains that such agreements are generally enforceable but that employers are not permitted to use their bargaining position to extract an unreasonably restrictive agreement.

The third part of the book is devoted to the drafting and interpretation of contracts that govern software transactions. Although Smedinghoff covers the full range of software contracts, including sale, distributorship, and development contracts, the questions surrounding "shrink-wrap" licenses are especially interesting. These licenses are meant to disclaim all or most of the developer's liability for defects while also preventing the customer from disclosing the software to others. The licenses, which are usually quite unfavorable to the customer, purport to take effect without the customer's signature—breaking the cellophane shrink wrap on the package is supposedly enough. But is it really enough? As lawsuits filter through the courts, different states are likely to decide in different ways.

The book also discusses other aspects of software law: potential tort liability for a developer of defective software, tax treatment of software, and criminal acts involving software. Finally, numerous appendixes provide sample forms and agreements.

*The Legal Guide to Developing, Protecting and Marketing Software* is written for the layman. Yet Smedinghoff does not reach for oversimplified, pat answers. He notes carefully that the laws governing many of these issues are just beginning to develop or are in a state of flux. At the same time he is not so circumspect that he fails to guide the reader. Anyone involved in the software industry—particularly in a small enterprise that cannot afford to consult an attorney at every turn—would benefit from having a book like *The Legal Guide* on his or her bookshelf.

David A. Price (III Ivy Dr., #11, Charlottesville, VA 22901) is a recent graduate of Harvard Law School and the author of several books on computer programming languages.

continued

## Tmi INTRODUCES FASTCARD®

# With 2 MBYTES for only \$295!\*

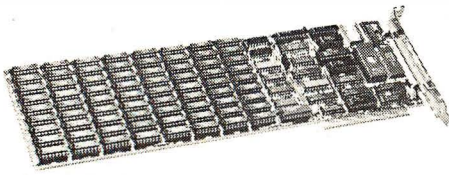

**10  
DAY  
FREE  
TRIAL!**

## The Only Expanded Memory Card Which Can Save A Day Each Week.

A major independent testing laboratory benchmarked a PC-XT equipped with FASTCARD and demonstrated a tenfold improvement over a PC-AT on typical Disk I/O operations.

- Portable between IBM PC, XT, AT and compatibles.
- Up to 2MB with Split Memory Mapping to
  - Fill memory to 640K
  - Provide Expanded memory over 640K
- Lotus/Intel/Microsoft compatible
- Unique Disk Caching
- Ram Disks (up to 8MB)
- Custom Password Security
- Print Buffering
- Built-in Diagnosis and Automatic Fault Tolerance
- Factory Installed and Tested DRAM's

\* Each FASTCARD III comes with 2 MBytes of Memory.

FASTCARD IV, available with 2 MBytes, includes serial/parallel ports, game port and a clock calendar for \$295. Offer good only while quantities last!

For additional information, call: **Tmi** PERIPHERAL MARKETING INC. (602) 483-7983  
7825 E. EVANS RD., #600, SCOTTSDALE, AZ 85260



# THE NO FRILLS PLOTTER

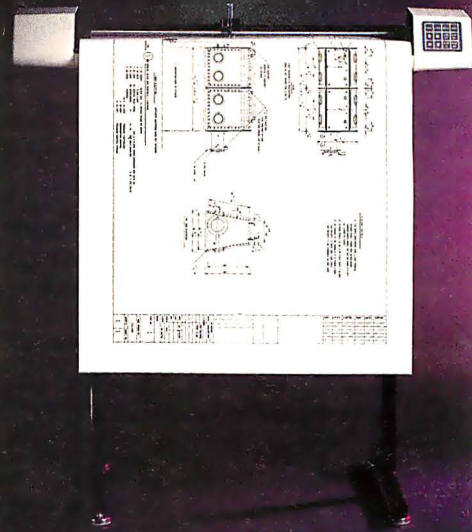

**E**nter the world of professional CAD applications with Houston Instrument's low cost DMP-41/42 series plotters. These single-pen plotters give you the features you need—C and D size plots, extensive software compatibility, and proven reliability—for a very affordable no frills price of \$3295.\*

The DMP-41/42 series' large C and D size formats are ideal for a wide range of CAD applications, from architectural elevations to assembly drawings. And a .005 inch resolution ensures crisp drawings on a variety of media—paper, matte film, or vellum.

With the DMP-41/42 series, you can choose from an impressive selection of off-the-shelf graphics software packages such as VersaCAD, AutoCAD, and CADKEY. Or, by using Houston Instrument's popular DM/PL™ language, you can create your own custom software and be assured of upward compatibility with Houston Instrument's entire line of plotters.

The DMP-41/42 series. The plotters that offer superb reliability, comprehensive graphics capabilities, and a no frills price. The proven performers for low-cost CAD.

For more information, call

1-800-531-5205 (512-835-0900 if in Texas), or write Houston Instrument,™ 8500 Cameron Road, Austin, Texas 78753. In Europe, contact Houston Instrument, Belgium NV., Rochesterlaan 6, 8240 Gistel, Belgium. Tel.: 32-(0)59-277445. Tlx.: 846-81399.

**houston**  
**instrument** **AMETEK**  
DIVISION

\*U.S. suggested retail price. Pricing subject to change. DM/PL and Houston Instrument are trademarks of AMETEK, Inc.



# AT LAST: Professional Typesetting Capability For PC Users

With **PC T<sub>E</sub>X<sup>TM</sup>** — the best-selling full implementation of Professor Don Knuth's revolutionary typesetting program T<sub>E</sub>X.

**FINEST Typeset Quality Printing From:**  
dot matrix      laser      phototypesetter

$$\sum_{i=1}^{\infty} \frac{1}{i} \begin{pmatrix} a_{11} & \dots & a_{1n} \\ a_{21} & \dots & a_{2n} \\ \vdots & \ddots & \vdots \\ a_{m1} & \dots & a_{mn} \end{pmatrix} \int_{-\infty}^{\infty} e^{-x^2} dx$$

**WIDEST Range Of Output Device Drivers:**

- Epson FX, LQ
- HP LaserJet\*
- Toshiba
- Apple LaserWriter
- Corona LP-300\*
- APS-5 phototypesetter
- Screen preview, with EGA or Hercules card

**MOST COMPLETE Product Offering:**

PC T<sub>E</sub>X (not copy protected) includes the following:

- Our specially written *PC T<sub>E</sub>X Manual*, which enables you to start using T<sub>E</sub>X right away.
- Custom "macro packages" that provide formats for letters, manuals, technical documents, etc.
- The L<sup>A</sup>T<sub>E</sub>X document preparation system, a full-featured macro package for preparing articles, books, reports, etc., and L<sup>A</sup>T<sub>E</sub>X User's Manual.
- *A<sub>M</sub>S-T<sub>E</sub>X*, developed by the *Amer. Math. Society* for professional mathematical typesetting.

Site licenses, volume discounts, and interfaces to PC Paintbrush, PC Palette, FancyFont and Fontrix are also available.

**PRICED FROM ONLY \$249.00!**

(Printer drivers and interfaces additional.)

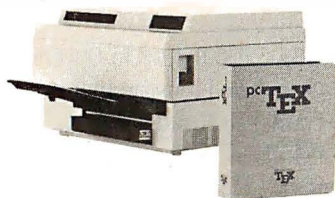

Laser printer,  
fonts & software  
from \$2995.00

For IBM PC/XT, AT or compatible, DOS 2.0 or higher, and 512K RAM. Hard disk required for printer drivers and fonts.

\*HP LaserJet and Corona require additional interface boards.

For more information call or write:

**Personal T<sub>E</sub>X, Inc.**

12 Madrona Avenue, Mill Valley, CA 94941 (415) 388-8853

This ad, with space for the photograph, produced by PC T<sub>E</sub>X. Typeset on the Epson FX80, the Corona LP-300 laser printer, and the Autologic APS-5 phototypesetter.

T<sub>E</sub>X is a trademark of the American Mathematical Society. Manufacturers' product names are trademarks of individual manufacturers.

## An Introduction to Digital Image Processing

Reviewed by John V. Olson

As the author of this book states, digital image processing is a rapidly growing field. The advent of fast, image-oriented, small computers has contributed to this growth and to the demand for information on image processing. But *An Introduction to Digital Image Processing* by Wayne Niblack is not for the uninitiated. It is for the scientist, technician, student, or programmer who has a sound background in mathematics and statistics and who is interested in an overview of image processing. It is not a book for an amateur interested in producing images with a computer.

Once the reader is introduced to the fundamental topics in image processing in the opening chapters, the groundwork is laid for further coverage. The description of the picture content using image histograms is described beginning with the basic definition of a pixel and the numerical representation of brightness. There is a brief discussion of the perception of brightness and the current definitions used in color displays. Coverage of two-dimensional digital filters and filters based on digital Fourier transforms is followed by image processing through methods including segmenting the picture, geometric transformations, mapping and scaling, and the statistical classification of picture elements. One chapter is devoted to a very brief review of convolution and principal component analysis. A few software examples are given that cover histogram matching, window processing, and IHS-RGB color transformation. Niblack includes a bibliography of useful references at the end of the book. Each chapter contains several problems and questions at the end to give the reader some practice with the topics presented.

The author has made use of images from medicine, astronomy, and the LANDSAT satellite to illustrate the techniques he covers. While these would seem sufficient, the presentation is not balanced. Most of the images are drawn from the satellite data. More than 20 examples using satellite images are covered, while a single star cluster is analyzed three times and a single medical x-ray is analyzed twice. This is not a balanced view of the subject matter of image processing.

The publisher's presentation of images detracts from the story the author has to tell. The page size, 6 by 8 inches, forces the images to such a small size that detail is lost. The format of most of the images shows a "before" and "after" rendering side by side, and this confines the images to mere 2-inch squares. The text also suffers from inadequate typography, especially in the presentation of mathematics.

This is not a textbook. *An Introduction to Digital Image Processing* would be useful as a supplementary text in a course on image processing if the instructor or the principal text were to give complete developments of the mathematical techniques presented here. In this light, though, the problems at the end of each chapter seem inappropriate. There are too few of them to properly develop the student's understanding of the material presented, and they are almost incomprehensible given the preparation in the text. One could only hope to complete them with the assistance of an instructor or with other reference materials.

This book should be useful as a guide to the techniques of image processing for the experienced user. It covers a broad range of techniques and briefly discusses their utility. If it has a fault, it is brevity. I hope the author will expand the discussions and broaden the variety of examples in later editions. ■

*Dr. John V. Olson is an associate professor of physics at the University of Alaska (Fairbanks, AK 99775).*



# Improve your image with our Signature.

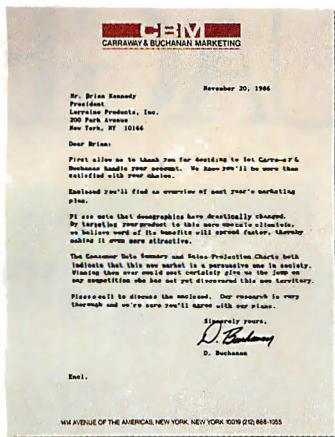

Improve the look of your letters, spreadsheets, graphics, and you immediately improve your image.

With Star's new Signature Series, your letters will be taken more seriously. Your plans will be more persuasive. Concepts more convincing. In fact, your whole business presentation will be more effective.

But what comes out of our new Signature Series printers depends on what we put into them:

**Quality** Our 24 print wires help you distinguish yourself with impressive looking text and graphics. Our 24 wires increase the clarity and resolution of your output, compared to standard 9-wire printers.

**Control** The convenient front control panel lets you select any of our highly advanced functions at a touch.

**Speed** Our printers operate at time saving draft speeds up to 300 characters per second (cps). And give the look of typewritten text with true letter quality up to 100 cps.

**Versatility** You have a wide choice of type styles, fonts, and print pitches. Plus compatibility with major computers and software. And, in our top model, maximum memory in a 16K buffer expandable to 32K.

Star's Signature Series gives you a choice of ways to distinguish yourself. From the speed of the NB-15, to the hardworking capabilities of the NB24-15.

For more information on how a new Signature can improve your image, call 1-800-447-4700.



NB-15

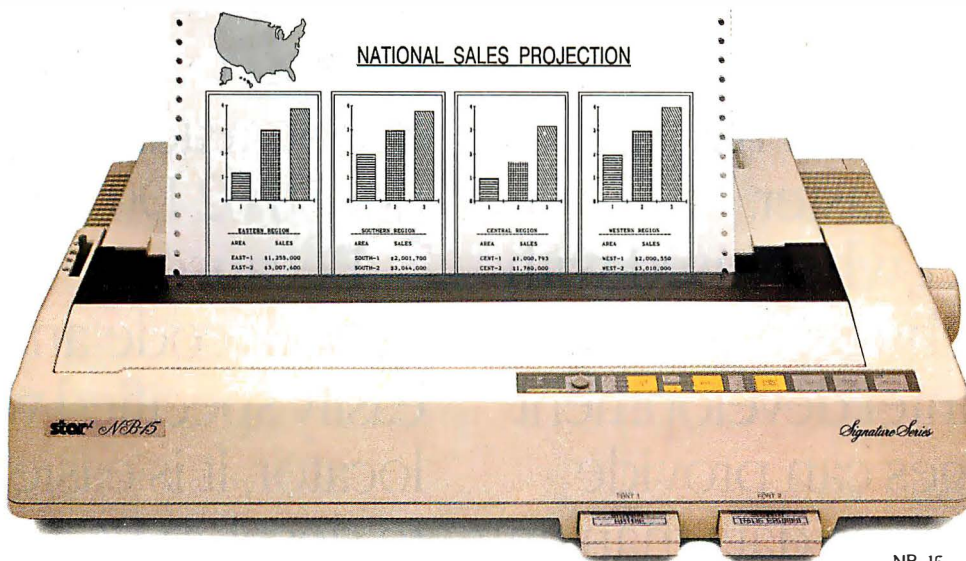
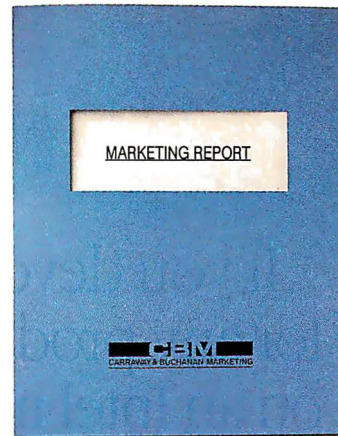
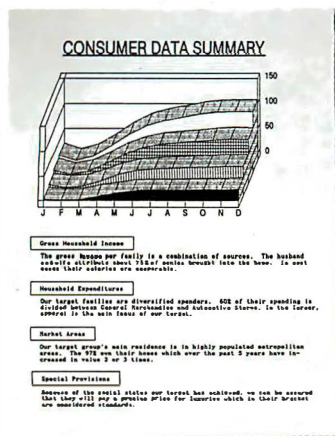
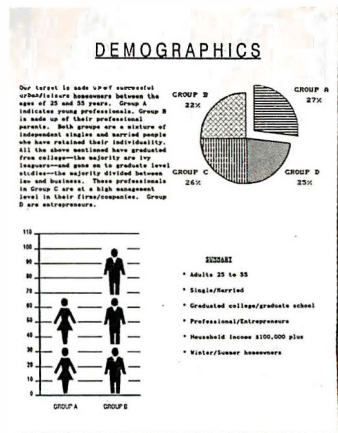

NB-15

Star Signature Series™ by **star** MICRONICS



# WRITE FASTER IN ANY LANGUAGE.

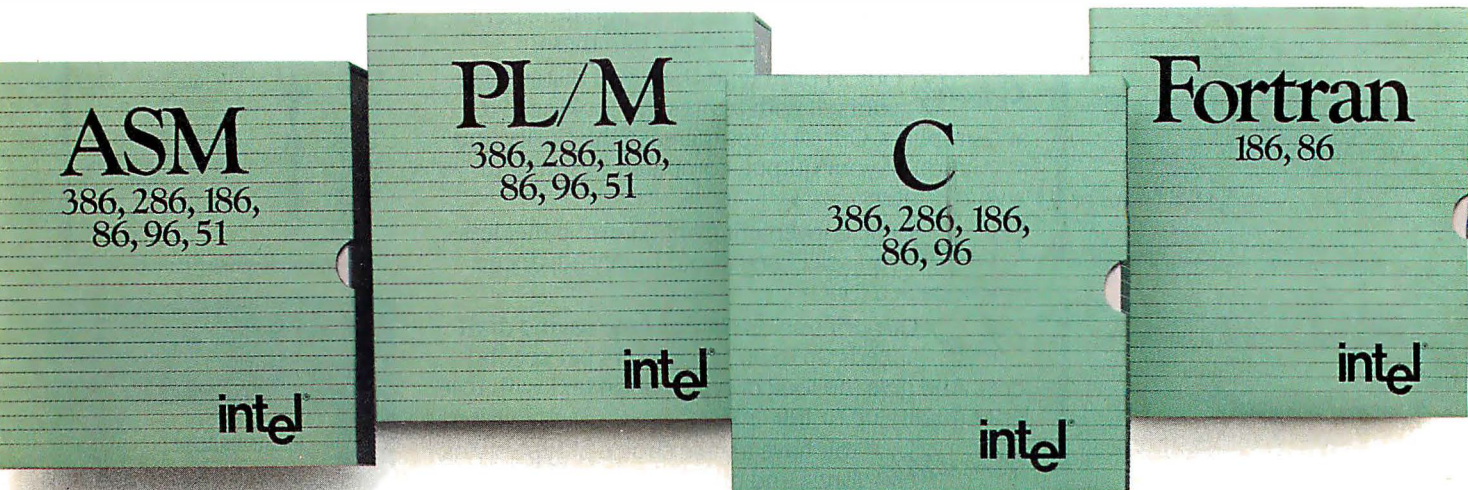

If you develop software for any product based on an Intel microcontroller or microprocessor, including the 80386, the unique debug hooks in the Intel languages will help get the job done faster.

In fact, when used with Intel debuggers and emulators, Intel development languages can provide more debug data than any other high-level language.

Debug hooks let you

symbolically debug in the same high-level language you wrote in without having to deal with machine or hex code. Which means 80.386 reads as 80.386, not 50 62 D0 C5.

Because the location of both code and data are easily specified with our locator, it is easier for you to develop ROM-based firmware.

Since Intel languages



produce identical object code regardless of the host, you can write code at a PC running DOS, a VAX\*/VMS terminal, or an Intel Development System.

**Pascal**  
286, 186, 86

intel

**Software Debuggers**  
PMON 386, Pscope 86

intel

**Utilities**  
Relocator, Linker,  
Librarian

intel

**AEDIT**  
Programmers'  
Editor

intel

Different members of the same design team can therefore choose the most effective combination of languages and systems to get the job done faster.

Intel post-sales support can also help you get the job done faster. We invented the microprocessor. We know microprocessors and languages for Intel architectures better than anyone else.

When you buy an Intel language, you have access to our customer hotline. So if you ever have a question you can talk directly to a trained

applications specialist who understands our products. And can give you the right answers. Faster.

To order today, or get more information—including a free catalog of our development tools—call toll-free 1-800-87-INTEL.

The sooner you call, the faster you'll get the job done.

**intel**<sup>®</sup>

© 1986 Intel Corporation

\*VAX is a registered trademark of Digital Equipment Corporation.



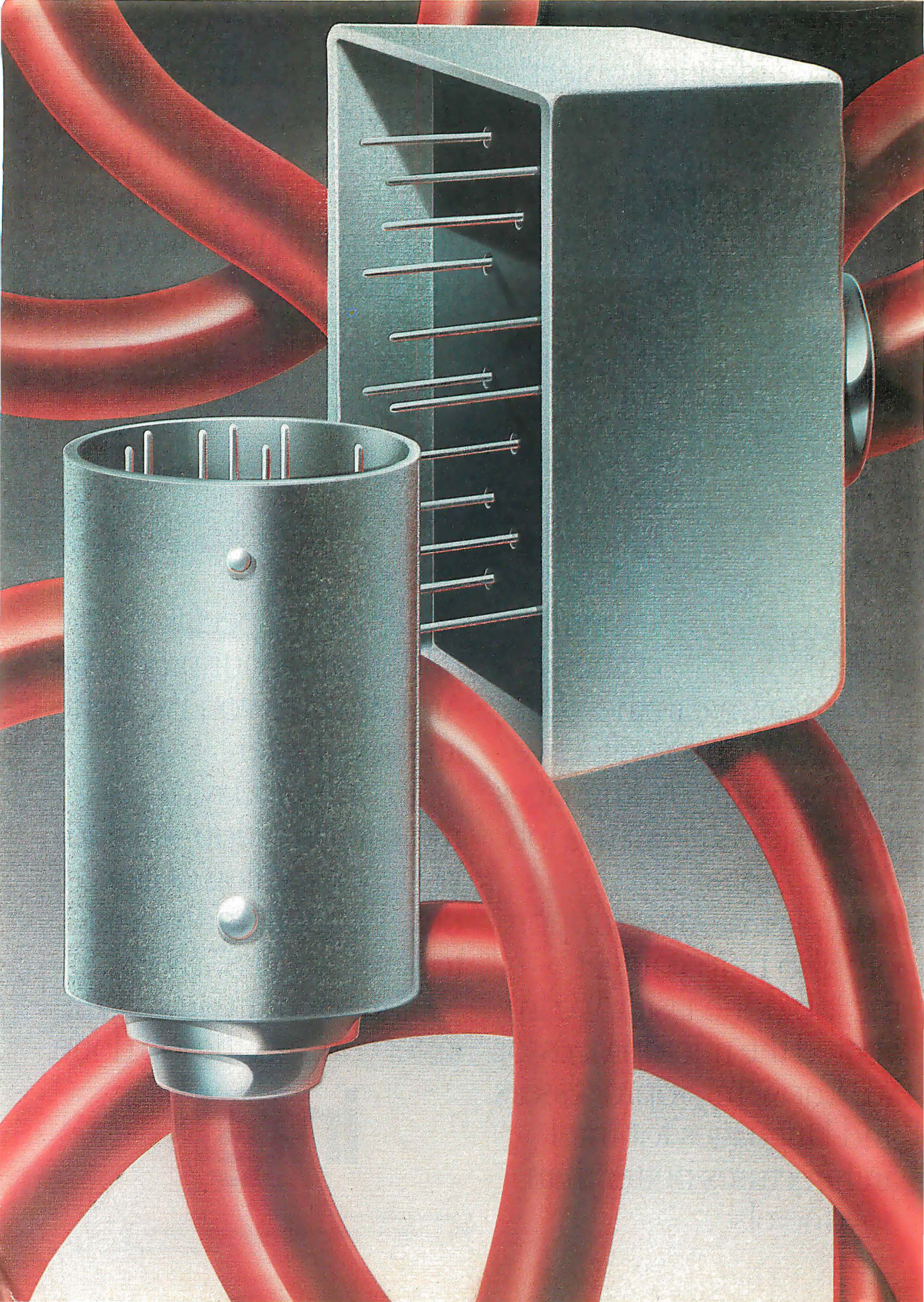



# Features

---

**Workstations**  
*by Charles D. Weston and George A. Stewart* ..... 85

**Ciarcia's Circuit Cellar: Build an Infrared Remote Controller**  
*by Steve Ciarcia* ..... 101

**Programming Project: Illinois Functional Programming: A Tutorial**  
*by Arch D. Robison* ..... 114

**Build Your Own 256K Amiga Expansion RAM**  
*by Richard F. Retter and Andrew J. Morelli Jr.* ..... 129

**Programming Insight: Calculating the Area of an Irregular Shape**  
*by Rene Stolk and George Ettershank* .. 135

**Programming Insight: Another Approach to Data Compression**  
*by Robert J. Sciamanda* ..... 137

---

THE PHRASE "WORKSTATION POWER" increasingly turns up in personal computer advertising these days, but just how exaggerated is the claim? BYTE technical editors George Stewart and Chuck Weston made a hands-on evaluation of three current workstations—the Apollo DS3000, the Sun-3/160, and the Xerox 6085—and they report their findings in this month's lead feature. What they found, in short, was a glimpse into the future of personal computers.

Steve Ciarcia returns to a topic he particularly enjoys: making life in his house easier and more comfortable. One of the problems of the many automatic features he has installed is that the only way to activate something is through the control system. A way to overcome this is a wireless remote-control device that communicates specific commands to a computerized control system. And that is precisely what we get this month in the IRCOMM, a custom hand-held infrared transmitter and receiver.

Functional programming may not be as practical as conventional languages, but according to Arch D. Robison it offers a new programming style with several important advantages. In this month's Programming Project, he introduces us to his own Illinois Functional Programming, a public domain language that runs under MS-DOS and UNIX.

If you've considered doubling your Amiga's RAM with the optional expansion cartridge, Richard F. Retter and Andrew N. Morelli Jr. can save you money. They explain how to build a 256K-byte expansion RAM and save yourself over a hundred dollars.

In a Programming Insight, Rene Stolk and George Ettershank offer an algorithm for "Calculating the Area of an Irregular Shape." They incorporate the algorithm into a program in BASIC, and the result is a versatile mathematical tool useful to any number of technical fields.

Our last feature, also a Programming Insight, is Robert J. Sciamanda's "Another Approach to Data Compression." Sciamanda has written a set of BASIC programs based on the Nyquist sampling theorem. This important software calculation tool helps you reduce a large quantity of data to a sample set and then reconstruct it later.



**“Ok...  
But why  
Tandy  
Computers?”**



**“In a word...quality.”**

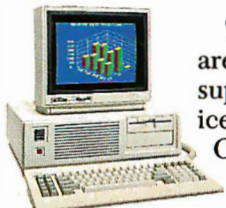

*Tandy 3000 HD*

**Tandy® computers** are designed, built, supported and serviced by Radio Shack.

Our total commitment assures a high degree of product quality and, just as important, customer satisfaction long after the sale.

Quality-built in the USA. Our MS-DOS® personal computer line is made in America in our own

manufacturing plants. We control quality, from initial assembly to completed and tested product.

**Nationwide Support.** Over 1200 Radio Shack Computer Centers are ready to help you choose the latest in computer technology, backed by quality support.

Training and specialized software instruction is available at your



*Tandy 3000 HL*



*Tandy 1000 SX*

place of business or ours, in 60 major market areas.

**We've got what it takes.** Like commercial leasing plans. And service performed by technicians who work for the same company that manufactured and sold you your computer.

You expect quality . . . and you get it from Radio Shack.

**TANDY COMPUTERS:**

**In Business...for Business™**

MS-DOS/Reg. TM Microsoft Corp.

**Radio Shack®  
COMPUTER CENTERS**

A DIVISION OF TANDY CORPORATION

Inquiry 241



# Workstations

*A hands-on evaluation of three IBM PC-compatible models offers a tantalizing glimpse of where personal computers are going*

**A**re the capabilities of workstations coming to personal computers? On the basis of hardware specifications, the answer is clearly yes. On the basis of a total system including hardware, software, and real-world applications, though, the answer is debatable. Nevertheless, the phrase "workstation power" is likely to turn up with increasing frequency in personal computer advertising.

In this article, we'll define the technological and practical issues by taking a firsthand look at three distinctive workstations: the Apollo Domain Series 3000, the Sun-3/160, and the Xerox 6085. All three systems share the ability to run MS-DOS applications in an IBM PC emulation mode—making it possible to state unequivocally that personal computer power is coming to workstations.

## Definition of a Workstation

Briefly, a workstation must provide all the computing tools that technical professionals need in their daily work routines—including specialized applications like CAD and large-scale mathematical modeling, as well as general-purpose tools for programming, writing, and sharing information over a local or wide area network. A considerable amount of the computing power and storage capacity is usually located inside the workstation, differentiating it from a terminal connected to a mainframe.

Workstations must offer true multitasking so the user doesn't spend a significant amount of time waiting for the computer to finish one job. While a lengthy job is

in process, the user expects to be able to jump into another task on the workstation without any noticeable degradation in the system's response time.

Demands on personal computers are generally not as intensive as those on workstations. A personal computer user relies on the machine for a few functions, such as word processing, accounting, programming, or spreadsheet modeling. Spooling and telecommunications often suffice for multitasking and networking.

In at least one area—ease of use—the demands on personal computers have been more rigorous than on workstations. Technical people have been willing to accept more intricate systems that presume a certain amount of programming expertise. Management and clerical workers, on the other hand, come to the personal computer expecting an appliance that is not much more difficult to master than other office equipment.

*continued*

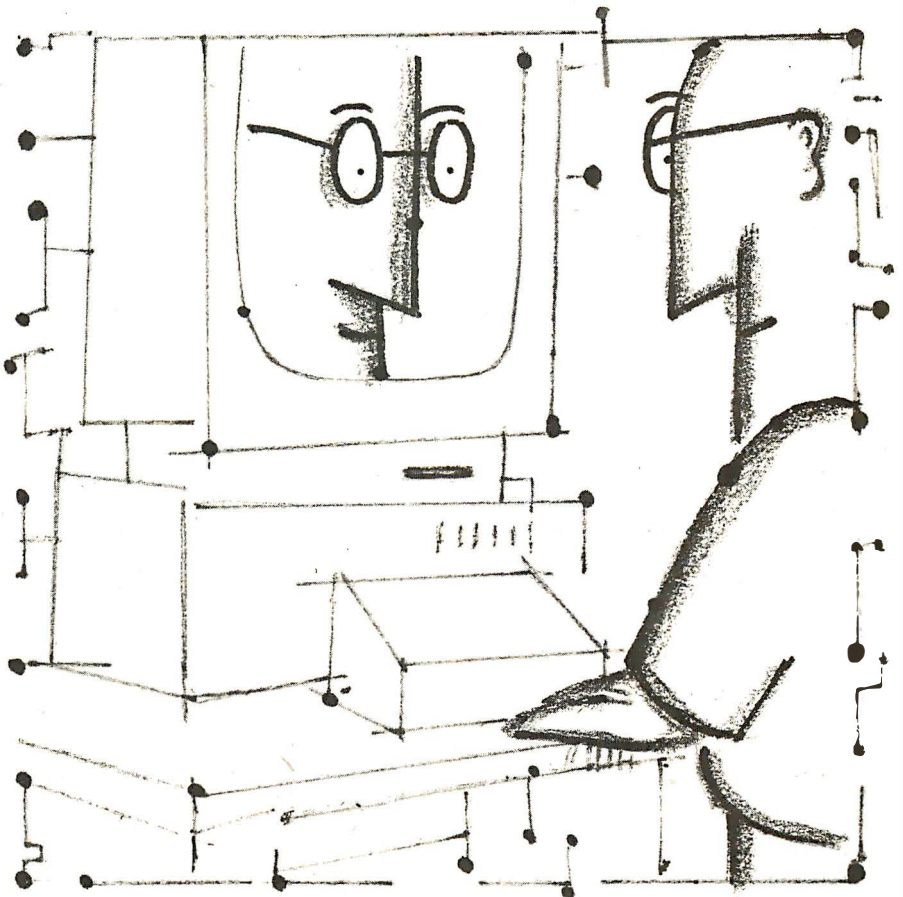

*Charles D. Weston and George A. Stewart are BYTE technical editors. They can be reached at One Phoenix Mill Lane, Peterborough, NH 03458.*



In a few areas, personal computer applications have outstripped the workstation's offerings. Electronic spreadsheeting is the best example. The widespread acceptance of MS-DOS programs like Lotus 1-2-3 has made its impression throughout the technical world, and now workstation manufacturers are offering personal computer emulation as a foot into the door of managers and other personal computer users and perhaps also to placate traditional workstation users who have eyed some IBM PC software with envy.

An additional use for PC emulation is as a means of sharing data between PCs and workstations, using the floppy disk as a transfer medium.

### Computing Power

Regardless of the particular application of a workstation—engineering, publishing, or scientific analysis—certain hardware features are needed to provide suitable computing power.

The obvious place to start is with the CPU. A 32-bit address space and an execution speed of at least 1 million instructions per second are common requirements for workstations. Optional floating-point, array, and graphics processing hardware can further improve the performance.

The Apollo and Sun systems use Motorola 68020 microprocessors; the systems are rated at 1.3 MIPS and 2 MIPS, respectively. The Xerox 6085 uses a proprietary central processor called the Mesa, which is rated at 2 MIPS, according to Xerox engineers.

Tables 1 and 2 summarize the results of standard benchmarks we tried on the three systems.

The multitasking environment requires several megabytes of main memory and a virtual memory system based on disk storage and network resources. Hard disk storage capabilities range from 20 megabytes to more than 1 gigabyte.

At first glance, the performance of high-end personal computers and low-end workstations seems to overlap. But specifications of CPU clock rates, processor MIPS, and benchmark results like Dhrystones do not tell the true story. It is not until you encounter multitasking, multiprocess operating systems that the differences begin to show up. Optimization of the internal hardware architecture to overlap as many processes as possible cannot be appreciated outside of a multitasking, networking environment.

Workstation performance is optimized by careful balancing of CPU and operating system throughput. Systems in which every component is running at its maximum rate are not necessarily faster in a multitasking environment. Integrating the speeds and data-transfer rates of devices

and processes results in a system with an overall higher throughput.

### Graphics

Large, high-resolution, and extremely fast graphic displays are probably the most obvious characteristic of workstations. Speed in particular distinguishes them from personal computer capabilities. A typical demonstration of such graphics might be the rotation of a multicolored polyhedron in real time with accurate shadowing based on an imaginary fixed light source. This show might be taking place in one window while a high-speed data transfer proceeds in a second window and a text file scrolls across a third.

Displays are as large as 19 inches diagonally, allowing several large windows to be displayed at once. Two 8½- by 11-inch "pages" can be displayed side by side on such a screen.

A screen resolution of 1024 by 800 pixels is perhaps the lowest acceptable limit for workstations, while some go as high as 1280 by 1024. Color systems can display at least 256 distinct colors simultaneously from a palette of more than 4096—or even many more—shades. This degree of color subtlety is necessary for the delicate shading, coloration, and texturing seen in many workstation displays.

One measure of graphics speed is the rate of plotting 2-D vectors; speeds for workstations range from 5000 vectors per second in a basic system to 40,000 vectors per second when a graphics accelerator is used.

To provide a versatile platform on which to run a variety of commercial graphics packages, workstations usually offer implementations of one or more graphics standards such as the ANSI Computer Graphics Interface or the ANSI Graphical Kernel System. The standards are extensible and flexible enough so that different applications can run acceptably on systems of widely varying capabilities.

### User Interface

Personal computer users who call themselves "power users" would probably enjoy the challenge of the typical workstation interface. The systems are extremely complex but, in turn, equally powerful. Some of the complexity derives from the UNIX command shell (included with most workstations) and some from the enhanced keyboards of most workstations.

One workstation feature that has already become common in personal computers is the mouse/window interface. Important distinctions between workstations and personal computers remain, however, in quality and functionality. For example, the optical mouse, which moves across a dotted surface, predominates in workstations,

while personal computer offerings are usually mechanical devices subject to degradation from wear and desktop dirt. A more important distinction is the flexibility of the user interface on some workstations. You can accomplish most functions through keyboard commands or through mouse actions involving icons. The Macintosh, as the prime example of a mouse-based personal computer, tends to rely more on mouse operations at the desktop-environment level.

### UNIX

The UNIX operating system is provided with most workstations. The operating system, most of which is written in C, was conceived of as an ideal environment for software development. It offers a powerful set of built-in tools for programming and file handling.

UNIX is particularly appropriate for use in workstations. The 32-bit microprocessors at the heart of today's workstations—particularly the Motorola 68000 family—have features that map well into UNIX. First, the microprocessors' large linear address space (32-bit addresses) makes it unnecessary to manage large sets of memory segment pointers to manipulate process images (UNIX constructs). Second, the dual operating states of these chips translate conveniently into the UNIX user and kernel modes.

Furthermore, the microprocessors' general-purpose registers can be loaded from main memory, manipulated, and stored back in memory, simplifying the changing of operating system states during UNIX context shifts. In addition, manipulating data in registers eliminates time-consuming memory cycles, thereby speeding up the UNIX context shift process.

Workstation microprocessors do not include memory management instructions, allowing great latitude in the operating system implementation. In such a hardware environment, a flexible, fairly portable system like UNIX is desirable.

### Networking

An essential part of the workstation's role is communication and data sharing over a network—often on a high-volume basis that rarely comes up in a personal computer application. The concept of an engineering "work group," in which several individuals are working at once on different aspects of a large project, makes a high-performance network an essential characteristic of a useful workstation.

Workstations communicate in local area networks (Ethernet or proprietary systems) at speeds of up to 10 to 12 megabits per second. Compare this with the 230K-bits-per-second rate of the AppleTalk net-

*continued*



New! In•a•Vision is Compatible with AutoCAD

FREE Limited Offer  
AutoCAD Translator

# Complex Drawing Made Easy

We created In•a•Vision just for you. The engineer who needs more productive drafting support. The designer who needs versatility for alternate ideas or quick revisions. The architect who needs to manage a variety of working drawings. And the businessman who needs first-class presentation materials as well as detailed flow charts and organization charts.

## Point. Click. Draw.

Now all you do to create complex technical drawings, systems designs, blueprints, diagrams, illustrations, and proposals is point, click and draw. With In•a•Vision's mouse support, windowing, icons,

and pull-down menus, you produce drawings more quickly, accurately and efficiently than ever before. In•a•Vision's advanced technology includes many features not found on comparable systems costing thousands more. For example, you can pan around in a user-definable drawing space up to 68" x 68" and zoom in on specific areas for

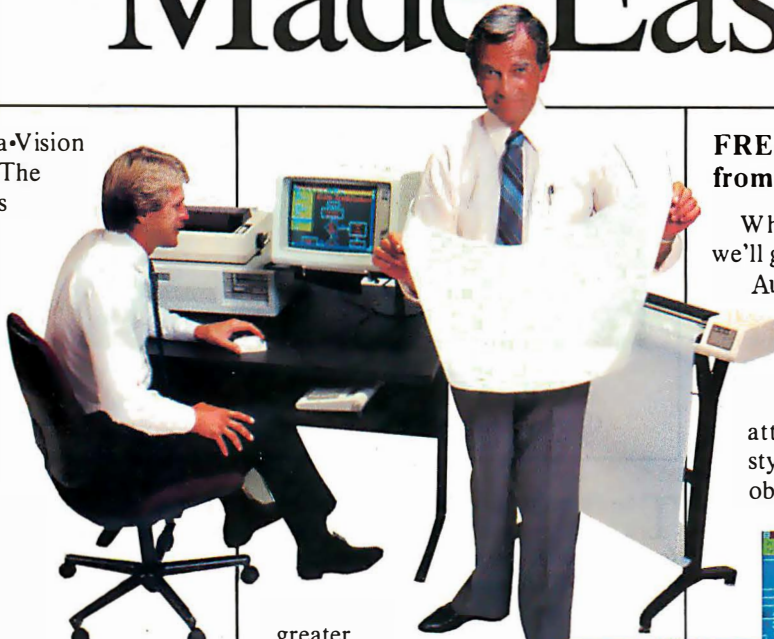

greater detail. Scale, rotate and dimension symbols, fill an area with your choices of pre-defined colors and patterns, as well as draw lines with multiple styles and widths. Other features include overlays, predefined and user-definable page sizes, rulers, grids, and templates to speed popular applications.

## Multi-tasking in a PC-based CAD system.

In•a•Vision uses multi-tasking to enable you to continue drawing while printing hard copies or edit multiple drawings simultaneously.

## FREE AutoCAD Translator from MICROGRAFX!

When you purchase In•a•Vision we'll give you a free copy of our new AutoCAD™ translator. The Micrografx AutoCAD TRANSLATOR (retail value \$100) bi-directionally transforms all drawing attributes including colors, line styles, overlays, fonts, views and object hierarchy. (Send

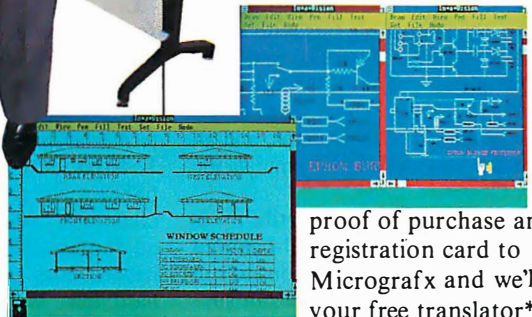

proof of purchase and your registration card to Micrografx and we'll return your free translator\*.)

We're confident you'll agree — In•a•Vision will make your complex drawing tasks simple and make you more productive. Satisfaction guaranteed.

## TO ORDER CALL: 800-272-3729

Demo disk\*\* or brochure available to qualified customers. In Texas or for customer support, call (214) 234-1769.

MICROGRAFX, Inc., 1820 North Greenville Avenue, Richardson, Texas 75081.

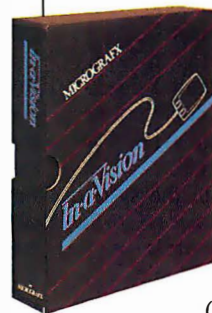

(Most popular graphics cards, plotters, and printers supported.)

Microsoft Windows-compatible. Call for specific operating environment requirements.

\*Offer good only on purchases after January 1, 1987

\*\*Demo requires MS Windows. Full demonstration system for users without Windows available for \$49.00.

**MICROGRAFX™**  
The Picture of Success.

AutoCAD is a trademark of Autodesk INC.

In•a•Vision, Micrografx AutoCAD TRANSLATOR, and MICROGRAFX are trademarks of MICROGRAFX, Inc.

Microsoft is a trademark of Microsoft, Inc.



work. The higher speeds make it practical to share memory resources through network traffic as part of the virtual memory scheme, giving workstations virtual memory spaces of 64 to 256 megabytes per process. Another application of networking is the ability to distribute processing to other systems on the network. A user can find idle systems on the network, log in remotely, and start jobs running.

The huge databases required for CAD and CAE graphic applications can exist only through this kind of virtually unlimited memory and processing power. PC networking, on the other hand, is usually limited to simple data transfers and, less frequently, to file sharing.

### PC Emulation Method

All the workstations we looked at provide PC emulation through a combination of hardware and software. All include a circuit board with an 80186 or 80286 microprocessor, RAM, and a 360K-byte or 1.2-megabyte floppy disk drive. Beyond that, the method of emulation diverges.

The IBM keyboard, screen adapter, and I/O channels are emulated in software. The Apollo Domain Series 3000 provides the most thorough PC emulation, including an AT-compatible bus with seven 16-bit AT-compatible slots and one 8-bit XT-compatible slot. The systems emulate the IBM PC monochrome and Color Graphics Adapter display systems, and all except for the Xerox 6085 also emulate the Hercules Graphics Card.

At the software level, compatibility is quite good, allowing both well-behaved and non-well-behaved applications to run without problems. Software we ran successfully includes Microsoft's Multiplan and GW-BASIC and Xyquest's XyWrite.

### Murphy's Law Revisited

The workstations we looked at range in price from around \$10,000 for the Xerox workstation to \$20,000 to \$30,000 for the Apollo and Sun systems. (The systems we tested weren't comparable in every respect, so the price differential doesn't necessarily indicate which company has the most economical or expensive solution for a given application.)

Ironically, the elements of the system that are probably of most interest to PC users are the most expensive parts—high-resolution color displays, graphics processors, and high-capacity hard disk drives. The parts of the system that represent overkill for PC users—huge amounts of RAM and high-speed computing—are the very parts that are coming down in price. Perhaps it's yet another addition to Murphy's Law: If you don't need something, you can easily afford it; if you've got to have something, it's too expensive.

## Apollo Domain Series 3000



Apollo Computer Inc.  
330 Billerica Rd.  
Chelmsford, MA 01824

The Domain Series 3000, described as a "desktop" workstation in contrast to some "deskside" workstations, features an IBM PC AT-compatible bus, complete with expansion slots. This low-end 1.2-MIPS workstation uses a triple-bus internal architecture and is based on a 12-MHz Motorola 68020 CPU and a 68881 math coprocessor. Peripherals include a 1.2-megabyte floppy disk drive, an 86-megabyte (unformatted) ESDI (enhanced small device interface) Winchester hard disk, 15-inch and 19-inch color and monochrome high-resolution displays, and Domain and Ethernet networking hardware and software.

### Bus Architecture

The central processor, math coprocessor, and memory management unit all reside on the DS3000's 32-bit internal "virtual bus." The CPU generates 32 bits of virtual address and a 3-bit function code. The virtual bus "wraps" at 26 bits (bits 27 through 31 are ignored). Once on the bus, the virtual address is translated or passed through the MMU, transferred to the 68881 floating-point coprocessor, or transferred to the interrupt-vector generation circuit to generate interrupt-acknowledge cycles for the 68020 CPU.

The system's CPU control register and status register, central processor, demand-paged MMU, floating-point unit, direct memory access controllers, and page register all reside on a "private," or physical, internal bus. So do the interrupt controllers, serial I/O ports, system timer and calendar, network ID PROM and boot

PROM, and main memory (up to 8 megabytes). This private bus supports 32-bit data (the CPU control, status, and page parity-error registers are only 16 bits wide) and 16-bit addresses. The DMA controllers and page register, interrupt controller, serial I/O ports, system timer and calendar, network ID PROM, and boot PROM are all 8-bit devices.

### AT-compatible Bus

All peripheral controllers (disk, graphics, network) and IBM PC AT options slots reside on the AT-compatible bus. (The bus actually contains six AT-compatible slots and one XT-compatible slot.) The personal computer coprocessor (PCC) supports two address spaces, the Intel-defined 16-bit I/O address space (64K bytes) and a 1-megabyte memory-address space. To accommodate the 16-bit area within the DS3000's address space (64K bytes) and provide per-page access checking and protection for I/O devices on the AT bus, the DS3000 remaps all AT-compatible I/O addresses into its own address range. The operating system maps each 8-byte group of addresses to the first eight bytes of different but consecutive 1024-byte pages. The AT-compatible bus supports all compatible devices that use 20- or 24-bit physical addresses.

The discrete MMU (DMMU) is a compatible subset of the Motorola 68851 paged memory management unit. The 68020 CPU emits 32-bit virtual addresses, but the DMMU translates only 26 bits. In mapped or virtual mode, the DMMU performs address checking and translates



26-bit addresses into 24-bit physical addresses, so the CPU can use them to access physical memory or device registers. In unmap mode the low-order 24 bits of the virtual address become the physical address. The DMA page register provides the address bits needed for the DMA controllers to access 24 bits of address space. The DMA controllers can transfer data to main memory or memory devices existing on the AT-compatible bus.

All Domain devices are mapped into an area composed of the upper 4 megabytes of the 64-megabyte virtual address space, called the "supervisor global" area, or "global B." In global B, commonly used pages can be shared by processes, eliminating per-process page replication.

### AT-compatible Coprocessor

The Domain PCC is made up of an 8-MHz Intel 80286 CPU, an optional 80287 floating-point accelerator, and 1 megabyte of on-board main memory contained on an IBM PC AT bus-compatible board. Graphics capability includes emulation of the IBM monochrome monitor, the IBM CGA, and the Hercules Graphics Card. Applications running in the PCC window have access to the DS3000 1.2-megabyte floppy disk drive and can read IBM PC-formatted disks. All DS3000 resources, including file access, disk access, and network printers, are available to the PCC user from the PCC window.

### Graphics Support

Graphics support includes 15-inch and 19-inch color and monochrome monitors. A dedicated 512K-byte image memory stores bit maps used by the four-plane color display controller. Each word in the image memory represents 16 horizontal pixels in one of the planes.

Although the color image memory contains 1024 by 1024 pixels, the display resolution is actually 1024 by 800 pixels. Image memory that is not used for the actual display is used to store fonts and other graphics elements needed by the display hardware. Similarly, the monochrome image memory (256K bytes) represents 2048 by 1024 pixels, but the screen displays only 1280 by 1024 pixels. The additional image memory is used for other graphics functions.

The DS3000's graphics resources include support for a number of popular graphics standards such as GKS (Graphical Kernel System); Apollo GSR (Graphics Service Routines), a set of graphics routines and support for their use; an emulator for the Tektronix 4014 graphics terminal; and GMR (Graphics Metafile

*continued*

# UNLOCK™ Removes Copy Protection

Produces Unprotected Backup Copies

## RUNS YOUR SOFTWARE ON ANY HARD DISK

UNlock "copying" disk allows you to make "unprotected" DOS copies of popular original program disks. **Unprotected backup copies** perform perfectly, as do copies of these copies. UNlock copies **run on any hard disk**, including Bernoulli Boxes. No original

required in drive "A." **Run on a RAM disk** simply and conveniently. Also, **copy DOS 5¼" programs to 3½" diskettes.** For IBM® PC, XT, AT, compatibles, 256K or more, DOS 2.1 or higher. Choice of the critics!

Guaranteed to work only with programs below:

**UNLOCK™ ALBUM "A" PLUS** **\$69.95**  
(Plus \$4 ship handling, Foreign orders \$10)

- dBASE III & dBASE III PLUS™
- FRAMEWORK I & II™
- CHARTMASTER™ (6.1)
- SIGNMASTER™ (5.1)
- FASTBACK™ (5.3)
- HARVARD TOTAL PROJECT MGR.™ (1.10)
- THINKTANK™ (2.0, 2.1)
- LOTUS 1-2-3™ (1.A-2.0)
- IBM WRITING ASSISTANT™ (1.01)
- IBM FILING ASSISTANT™ (1.0)
- IBM REPORTING ASSISTANT™ (1.0)
- GRAPHWRITER™ (4.3, 4.31)
- REALIA COBOL™ (1.2, 2.0)
- MULTILINK ADVANCED™ (3.02, 3.03)
- DOLLARS & SENSE™ (2.0)

**UNLOCK™ ALBUM "B" PLUS** **\$69.95**  
(Plus \$4 ship handling, Foreign orders \$10)

- SYMPHONY™ (1.1)
- CLIPPER™
- LOTUS 1-2-3 REPORT WRITER™ (1.0)
- DOUBLEDOS™
- smARTWORK™ (1.0 Rev. 8 thru 10 & 1.1)
- DISK OPTIMIZER™
- MANAGING YOUR MONEY™ (1.5, 1.51, 2.0)
- DATABASE MANAGER II—THE INTEGRATOR™ (2.0, 2.02)
- MICROSOFT WORD™ (1.15, 2.0, 2.01)
- PFS: ACCESS™ (1984 Ed.)
- PFS: PLANT™ (B)
- PFS: GRAPH™ (B)
- PFS: WRITE™ (1.01, C)
- PFS: REPORT™ (B, C)
- PFS: FILE™ (B, C)

**SPECIAL OFFER** "Best of UNLOCK" **\$74.95**  
**ALBUM "D" PLUS** (Plus \$4 ship handling, Foreign orders \$10)

- dBASE III & dBASE III PLUS™
- FRAMEWORK I & II™
- CLIPPER™
- FASTBACK™ (5.3)
- CHARTMASTER™ (6.1)
- SIGNMASTER™ (5.1)
- DOLLARS & SENSE™ (2.0)
- MICROSOFT WORD™ (1.15, 2.0, 2.01)
- LOTUS 1-2-3™ (1.A, 2.0, 2.1)
- SYMPHONY™ (1.1, 1.2)
- LOTUS 1-2-3 REPORT WRITER™ (1.0)
- DOUBLEDOS™
- HARVARD TOTAL PROJECT MGR.™ (1.10)
- MANAGING YOUR MONEY™ (1.5, 1.51, 2.0)
- THINKTANK™ (2.0, 2.1)

**UNLOCK™ FLIGHT/JET #202** **\$29.95**  
 • FLIGHT SIMULATOR™ • JET™ • SCENERY DISKS (Plus \$4 ship handling, Foreign orders \$10)

### CHOICE OF THE CRITICS!



"UNlock has two particularly endearing characteristics: it works, and works simply. I was able to quickly produce unprotected copies of Lotus 1-2-3 release 2, Symphony 1.1, Microsoft Word 2.0, dBase III 1.1, and Framework II. These copies performed flawlessly, as did copies of these copies."  
 Christopher O'Malley,  
 PERSONAL COMPUTING, April '86



"Because copy protection can interfere with the ability to back up a hard disk, business-oriented users may prefer programs like TranSec's UNlock series."  
 Winn L. Rosch, PC MAGAZINE, May 27, 1986

**BYTE** "UNlock 4.7 defeats the latest Prolok and SuperLock type of copy protection scheme. It's menu-driven and works fine on the programs it's supposed to work on: Lotus 1-2-3, dBase III, Framework, Symphony, Paradox, and several others."  
 Jerry Pournelle, BYTE, Feb. '86



ORDER TODAY TOLL FREE:  
**1-800-423-0772**  
 IN FLORIDA 1-305-276-1500



TranSec Systems, Inc., 220 Congress Park Drive, Delray Beach, FL 33445

Trademarks are the sole property of their respective owners. UNlock is for use only to improve the useability of legally acquired and operated software.



Resources), a set of 2-D and 3-D routines and a graphics database.

### Operating System

On the surface, the Domain/IX operating system looks like a twin port of both Berkeley 4.2 and AT&T System V UNIX operating systems. But it is actually an object-oriented operating system whose inner kernel is termed the *nucleus*. The nucleus acts as a higher-level manager whose tasks are page replacement, page fault control, and control of the bit-streams transferred between the lower-level processes. In this instance, the Berkeley 4.2 shell, the AT&T System V

shell, Apollo's Aegis operating system, and applications such as language interpreters and the display manager are all treated as "objects" under control of the nucleus. Data can be transferred between the objects without the nucleus requiring any knowledge of data types.

### Language System

The Domain Language System includes FORTRAN 77, ISO Pascal, Domain/C, and Domain/LISP programming languages, plus miscellaneous utilities to aid programmers. The C and LISP compilers include significant extensions to take advantage of the Domain system.

Programmers can write different portions of large programs in any of these languages, suiting the language to the problem, and then combine them into a single application.

Other tools for programmers include the software engineering environment and a mail program for communications between users on the network.

The DS3000 looks like a programmer's dream in terms of computing power and programming convenience. It is not the system for a nontechnical person, however, and could not be used to its potential outside of a computing-intensive networked environment.

## Sun-3/160

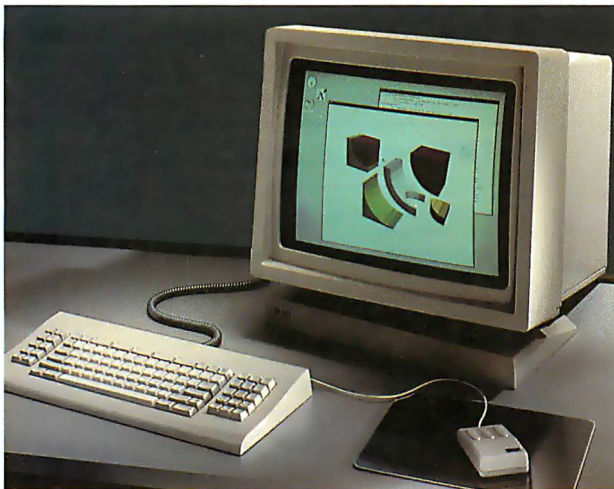

Sun Microsystems Inc.  
2550 Garcia Ave.  
Mountain View, CA 94043

Sun describes the 3/160 desktop workstation as an intermediate model on the company's price/performance scale. The company claims that performance for this machine is 2 MIPS. The Sun-3/160 uses a 16.67-MHz Motorola 68020 as its central processor and a 16.67-MHz 68881 as its math coprocessor.

This workstation is designed around the Motorola VMEbus architecture. It incorporates 16 slots for VMEbus-compatible boards in the triple-height, quad-depth Eurocard format. The hardware architecture of the 3/160 workstation incorporates two internal buses. A high-speed, synchronous 32-bit P2 bus handles access to the main memory and the optional floating-point accelerator when present. The 32-bit VMEbus handles all I/O operations.

The system can use up to 16 megabytes of main memory and 256 megabytes of

virtual memory per process. Additional memory is available to the system in the form of a graphics buffer but is not addressed as main memory and is under control of the graphics processor.

The 3/160 that we used was equipped with 8 megabytes of RAM. The central processor, graphics processor, SunIPC processor, synchronous disk controller, and RAM occupied 8 of the 16 available slots.

The Sun-3/160 graphics processor and optional graphics buffer support 19-inch monochrome, gray-scale, and color monitors at a resolution of 1152 by 900 pixels. The graphics processor can display 256 colors simultaneously in any window from a palette of 16 million.

### Disks

The 3/160 system incorporates a four-channel SCSI- and ESMD-compatible

synchronous disk controller. Hard disks are available in sizes from 71 megabytes to 1.1 gigabytes. The average access time for the 280-megabyte ESMD disks is 20 milliseconds, and the data-transfer rate is 2.4 megabits per second. The 575-megabyte disk is even faster at 18-ms average access time. A desktop SunServer can accommodate four 280-megabyte or 575-megabyte hard disks. The system that BYTE benchmarked contained one 360K-byte and one 1.2-megabyte floppy disk drive, a 280-megabyte hard disk, and a 60-megabyte 1/4-inch tape backup system.

### Operating System

Sun workstations use SunOS, a version of UNIX. The operating system is based on Berkeley 4.2BSD with enhancements from 4.3BSD. It has been extended to add System V functionality into the kernel, libraries, and utilities.

Although most functions can be combined into a single operating system, some significant differences still exist between Berkeley 4.2 and System V. For those functions that can't be combined, the System V versions are supplied in separate directories or libraries. A program developed on a Sun workstation can be either Berkeley- or System V-compatible or can take advantage of the functionality of both operating system shells. This dual functionality allows programs developed on System V to be relatively easy to port over to a Sun workstation.

The SunOS supports NFS (Network File System) for remote execution, file locking, and transparent file sharing with other nodes on the network. (At this time, more than 50 manufacturers of workstations, including Apollo, support NFS.) The virtual memory concept is extended by the use of NFS to allow demand paging across the network. Individual processes can use up to 256 megabytes of virtual memory each.



Sun workstations support Ethernet software and hardware and a wide range of communications protocols, such as OSI, SNA 3270, BSC 3270, and BSC RJE, and wide-area network protocols including X.25 and other internetwork routers.

**User Interface**

Sun uses the window and mouse environment common to all workstations. The 3/160 workstation uses a three-button optical mouse. The leftmost mouse button selects icons, the middle button adjusts or modifies a selection, and the right button activates menus.

The Sun interface is distinctive in that you can pick up commands with the mouse and copy them into the command line. When you master this system, you can issue the often forbiddingly complex UNIX commands in rapid-fire succession with a minimum of typing.

**Coprocessor Hardware**

Sun refers to its AT-compatible coprocessor as the SunIPC, or Integrated Personal Computer for the Sun workstation. The IPC hardware consists of a 10-MHz Intel 80286 CPU, an 8-MHz Intel 80287 math coprocessor, a parallel port, 1 megabyte of 100-nanosecond, dual-ported local memory available to the IPC software, MS-DOS 3.1, and PC application software (640K bytes are available to run PC application software).

The IPC also provides two emulated serial ports operating at up to 2400 bits per second, one logical hard disk (dynamically sized), two emulated printer ports (LPT1 and LPT3), and emulation of the expanded memory specification defined by Lotus, Intel, and Microsoft. The emulated printer ports actually output to the serial ports on the workstation in which the SunIPC board is installed. Remember that in a networked system like the Sun-3/160, everything, including the SunIPC board, can be shared across the network.

The window in which SunIPC runs can be selected by the keyboard command `pctool` or by icon. A 3/160 workstation can support up to four IPC boards. Typing `pctool` at the native system (UNIX) command line gets you the first available board, or you can specify the ID of the board that you wish to use. You can access a remote SunIPC by typing the node name and board ID at the `pctool` window command line.

SunIPCs are available in single-user or multi-access configuration. The multi-access configuration can be local access or remote access and can be shared by unlimited users, but only one at a time. There are some limitations to this scheme.

*continued*

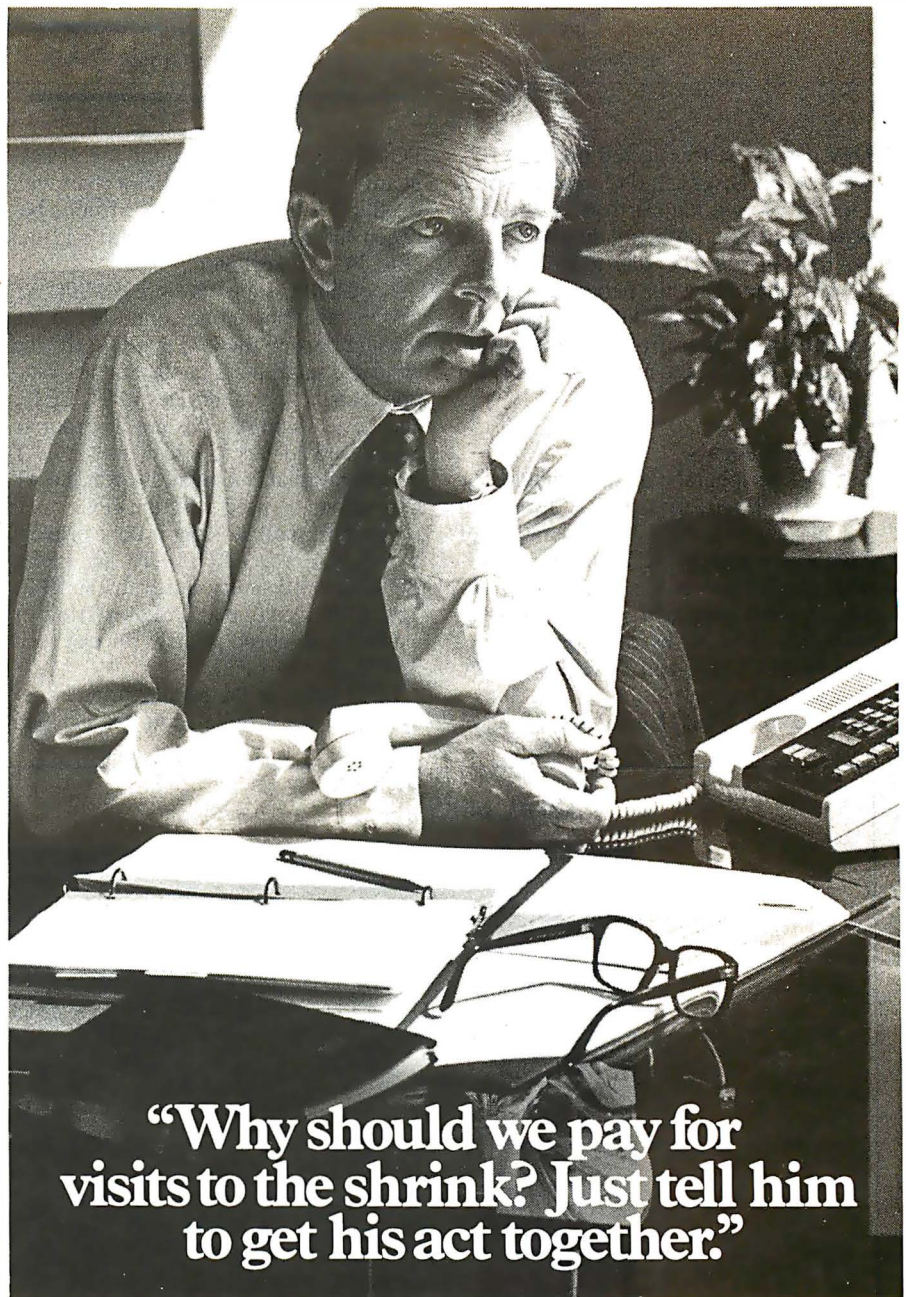

**“Why should we pay for visits to the shrink? Just tell him to get his act together.”**

In companies where professional treatment for mental illness is still viewed negatively, everybody suffers.

The employee, fearing how it will look on his record, suffers by not seeking treatment.

And the company suffers. From increased absenteeism and loss of productivity.

But you can help change all that. By recognizing that mental illness is a medical illness that requires medical treatment. And by looking into medical insurance coverage that encourages employees to seek professional treatment without fear or hesitation.

Today, many companies have successfully improved employee performance by structuring their health plans to include long and short term treatment.

Learn more. For an informative booklet, write: The American Mental Health Fund, P.O. Box 17700, Washington, D.C. 20041. Or call toll free: 1-800-433-5959. In Illinois, call: 1-800-826-2336.

**Learn to see the sickness. Learning is the key to healing.**

THE AMERICAN MENTAL HEALTH FUND





Data cannot be transferred between IPC windows because each IPC window stores files on its own logical disk. There is a way around the problem, however. You can transfer your IPC files to the network file server and have the network manager mount the Network File System that contains your files from the other IPC window. Both IPCs now share the file system.

### IPC Peripherals

SunIPC peripherals include single- or dual-drive floppy disks (360K bytes and 1.2 megabytes), NFS, an emulation of Microsoft's parallel PC mouse, the hardware parallel port on the board itself, and any of three emulated graphics display adapters—IBM 80 by 25 monochrome, 720 by 348 CGA, and Hercules 720 by 348 monochrome.

The Sun keyboard emulates the IBM

PC AT keyboard through the use of keyboard mapping. Sun supplies a chart with the SunIPC that shows the correlation between the native Sun keyboard and the IBM PC AT keyboard.

The SunIPC supports those IBM PC AT peripherals that can be connected to the parallel port on the IPC board itself, the emulated serial ports on the Sun workstation, and the logical devices LPT1, LPT2, and LPT3. SunIPC does not incorporate a hardware AT bus. Consequently, PC AT peripherals that communicate over the AT bus cannot be used with the IPC.

Sun workstations support three printers as logical devices LPT1, LPT2, and LPT3. LPT1 is the default printer for SunIPC. This printer can be a SunLaserWriter or another high-speed printer. You can send ASCII files to LPT1.

LPT2 refers to the parallel printer connected to the parallel port on the Sun

workstation you are using. LPT3 is the default printer for the Sun workstation you are using. However, the default printer for LPT3 is a SunLaserWriter that automatically converts files in Epson format into PostScript format. This enables LPT3 to handle graphics as well as text. File conversion for LPT3 is transparent to the user.

Like the DS3000, the Sun system is an extremely powerful workstation for technical professionals, especially programmers. Languages available include C, FORTRAN 77, Pascal, and assembly. Sun has also taken the unusual and very helpful effort of rewriting the UNIX documentation almost from the ground up. Based on three of the overview manuals, we can say that Sun has done an excellent job of documentation, which makes its system quite a bit more attractive to users who don't have much experience with UNIX.

## Xerox 6085

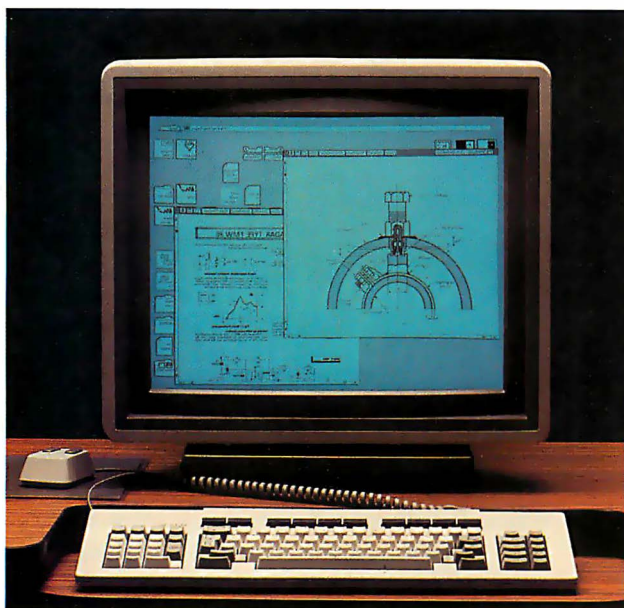

Xerox Corporation  
101 Continental Blvd.  
El Segundo, CA 90245

Xerox's latest incarnation of its Star electronic desktop machine is the 6085 Professional Computer System. Of the three workstations BYTE examined, the 6085 with its proprietary ViewPoint operating system is the most heavily applications-oriented. No programming tools are provided, nor is there a command interpreter comparable to the UNIX shell. Instead, Xerox offers a comprehensive set of applications that are all very consistently integrated into the electronic desktop. (The Xerox Development En-

vironment is available for the 6085 on a limited basis, but BYTE was unable to obtain that system for evaluation.)

The 6085 includes a stunning 19-inch monochrome screen with a resolution of 1184 by 925 pixels, for a density of 80 pixels per inch. The mouse has optical sensors to detect motion over a dotted surface, and two control buttons. The keyboard is a low-profile, 104-key tactile feedback unit with many dedicated function keys such as Copy, Move, Open, Find, and Props (for properties). A

separate, compact cabinet houses the processor boards and a 40-megabyte hard disk. On top of the cabinet is a single 360K-byte 5¼-inch floppy disk drive.

Our system came with 1.1 megabytes of main memory, which includes 128K bytes of display memory, and 1.5 megabytes of additional RAM on memory expansion boards. (The 6085 can be expanded to a system total of 3.7 megabytes.) It included a personal computer option board that allows execution of MS-DOS applications inside a desktop window. The system has two serial ports (for communications and a printer) and an optional Ethernet interface (not included in our system).

The system architecture is based on a proprietary Xerox processor called the Mesa. The architecture has a 32-bit address space and a virtual memory space of  $2^{32}$  16-bit words organized in 256-word pages. It is a stack-oriented machine with a 14-level, 16-bit stack.

The personal computer option board uses an Intel 80186 configured as a coprocessor to the Mesa. The PC subsystem shares the 1.1-megabyte main memory of the Mesa board. When the PC board is not active, all of that memory is available to the Mesa; when a PC emulation window is active, some of the main RAM is dedicated to the PC emulation (up to 640K bytes).

MS-DOS programs can access the floppy disk and hard disk, output to a local printer, and transfer data to and from the Xerox ViewPoint environment. The hard disk can also be set up to emulate multiple floppy disks.

Our system came with MS-DOS version

*continued*



# OMNI-READER™

## NOW YOUR COMPUTER CAN READ. A REVOLUTION IN TAKING WORDS FROM PAGE TO COMPUTER.

PC MAGAZINE  
PRODUCT OF '85

### WORD PROCESSOR AND COMPUTER COMPATIBILITY.

The OMNI-READER can read text into most word processors, micro and personal computers. It attaches through a Serial RS232C interface as easily as a modem.

### TYPEFACE QUALITY.

OMNI-READER has the ability to read letter quality text that has been printed on a letter quality printer or type writer in one of the four following typefaces.

### TYPEFACE RECOGNITION.

The OMNI-READER can read four of the most commonly used typefaces: Courier 10, Courier 12, Letter Gothic and Prestige Elite.

### MANUAL OPERATION.

Alpha or numeric print is scanned line by line by moving the reading head along the text. Capable of scanning both forwards and backwards, the reading head can be used to input all or selected portions of text.

### GUIDE RULE. (pat. applied for)

A specially engineered guide rule makes it easy to align text. Because of the unique clock track, the reading head can be moved at variable speed and still read text. Scan time 2-3 seconds a line.

Each OMNI-READER comes with I.B.M. PC/Compatible or Apple Macintosh software - at no extra charge. Interface Cable available for \$16.<sup>00</sup>extra. Specify I.B.M. or Macintosh.

30 Day UNCONDITIONAL Replacement  
Warranty.

TO ORDER PLEASE CALL  
TOLL FREE 1-800-523-4898  
IN TEXAS 1-800-722-6013  
TECH. ASST. 817-589-0313

Accepting major credit cards - C.O.D.:  
Visa, Master Card, and American  
Express or send money order or check to:

**G.A.S. INTERNATIONAL, INC.**  
P.O. BOX 1282, EULESS, TEXAS 76040  
Inquiry 101

**WAS \$799  
NOW \$199\***

**\* LIMITED TIME ONLY  
FREIGHT PREPAID ANYWHERE  
IN THE CONTINENTAL U.S.A.**

The OMNI-READER is a revolutionary new Text Reader (OCR). It costs a fraction of the price of your computer system. It reads the printed word and translates it into an electronic signal capable of being recognized and loaded into most computers and word processors. The need for slow and tedious retyping of already printed data is eliminated.

The quick brown fox can jump from the OMNI-READER into any computer system and onto the screen with as little effort as it takes to read "the quick brown fox."

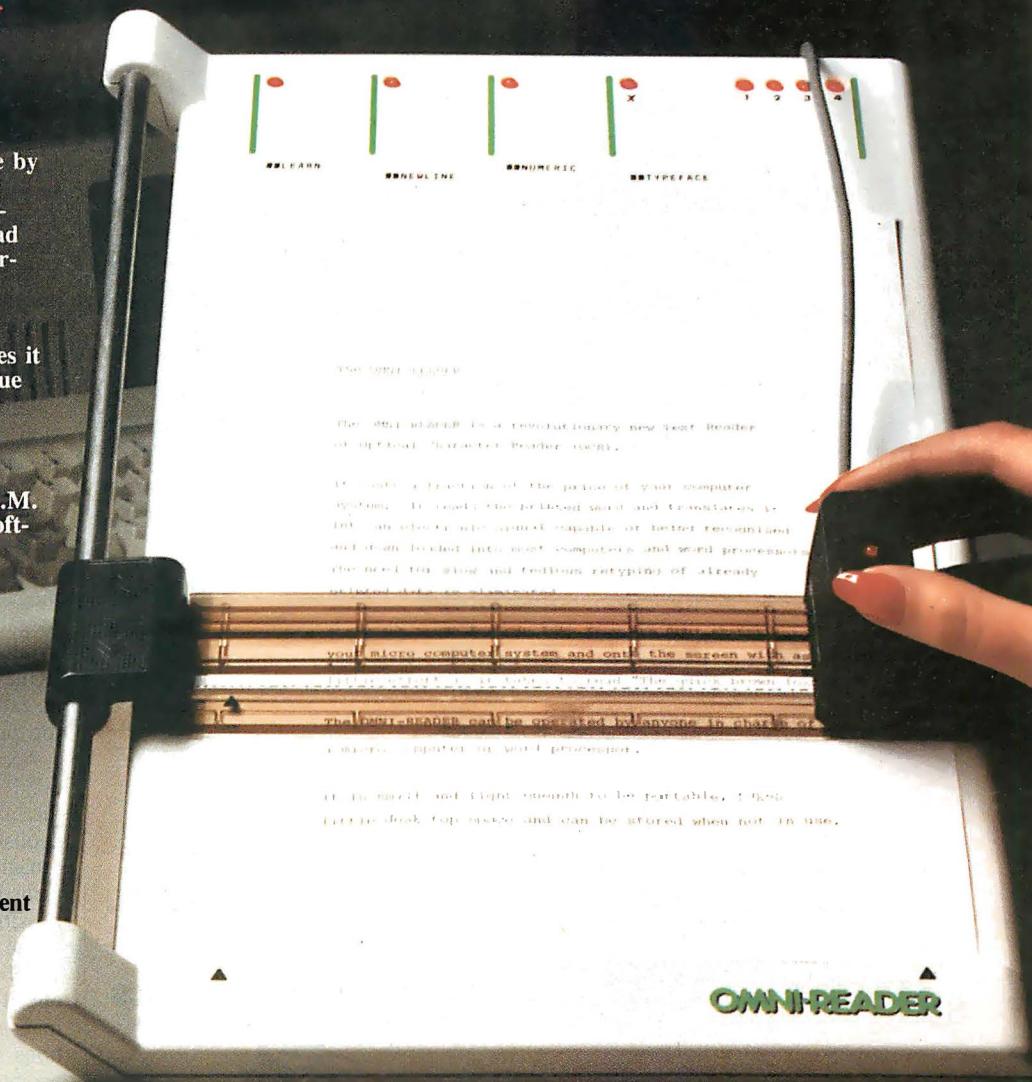



3.1 and GW-BASIC. The ROM BIOS was done by Phoenix Associates. The 6085's PC option can emulate 40- and 80-column color graphics modes in addition to the 80-column monochrome mode.

**Using the System**

Xerox advises customers to leave the system running at all times because it requires over 10 minutes to go through its power-on diagnostics and initialization routines. Once these are completed, the system displays a screen that is blank except for a keyboard icon that skips around

within the screen area. Pressing a key causes a logon window to open up.

The system supports any number of individual users, assigning a name, password, and desktop to each one. You can share data and applications between desktops by copying them to and from common areas called *file drawers*.

During operation, you frequently have to pause for the system to complete requests that would be almost instantaneous on other systems, such as opening a document. Xerox explains that the delays are due to the many layers of software that

need to be shuffled as you move in and out of various applications.

The user interface closely resembles the Macintosh's, which is to be expected since Xerox was the first company to commercialize the window/icon/mouse interface with its Star system. The major differences are in the Xerox 6085's greater sophistication and complete integration of applications. For instance, you can edit a document consisting of text, graphics, data-driven graphics, and tables in all respects without closing and reopening the document. In the Macintosh, graphics and charts that have been pasted into a document can be resized but not modified using the tools with which they were created. Similarly, text inserted into a MacPaint document becomes a bit image and can no longer be treated as text.

The quality of the ViewPoint applications is very high. The ViewPoint Document Editor offers a complete editing and page layout system with scores of typefaces, including special-purpose symbols for science, mathematics, and office use. "Data-driven graphics" are charts, tables, and graphs based on numeric tables. If the data in the tables changes, the graphics are revised accordingly. This occurs automatically, whether or not the data is explicitly present in the printed document. An equations package allows for entry of inline or displayed mathematical equations with automatic sizing and prompting for special parts of standard equation types. For instance, when entering a definite integral, the editor prompts you for upper and lower limits of integration. Braces are automatically sized to fit enclosed expressions, getting taller, for instance, if the expression is a quotient.

Coupled with the Xerox 4045 Laser Copier/Printer and appropriate software, the 6085 forms what Xerox calls its Documenter system. At \$8995 for a 10-megabyte hard disk, a 15-inch screen, 1.1 megabytes of RAM, and the 4045 laser printer (plus the cost of individual ViewPoint software items), this appears to be an extremely powerful and complete desktop publishing system.

According to the documentation, the 6085 is a foreground/background system that allows processes to execute simultaneously. However, when we attempted to repaginate a 91-page document, the cursor turned into a page counter, and it was not possible to begin any other operations until the repagination was completed. Doing a global search through the document produced a similar result. A Xerox product manager explained that only certain functions such as networking and printing operate in background. On the other hand, operations inside the PC-emulation win-

*continued*



**Announcing 2 New BYTE Collector Prints by Robert Tinney.**

**Limited Edition Classics**

We are proud to announce the annual release of two new 16" x 20" BYTE Magazine Cover Art reproductions by renowned BYTE artist Robert Tinney. Only 1,000 of these flawless Collector Edition Classics will be produced, on acid-free 100% cotton fiber stock to ensure that they will keep their brilliance and quality over the years without cracking or yellowing. The color separations for these sumptuous prints are made directly from the original paintings, guaranteeing absolutely faithful reproduction of every subtle nuance present in the originals. Each is individually inspected, signed and numbered by the artist, and accompanied by a handsome Certificate of Authenticity (also signed and numbered). The plates are then destroyed, and no future editions of any size or number will ever be published.

The price of these magnificent limited editions is just \$55, or \$45 each if you order two or more. Your prints will be shipped flat by UPS Blue Label (2-day delivery) and carry an unconditional 30-day guarantee. Order today!

**Order Form**

Please send me the following Limited Edition BYTE Collector Prints at \$55 (\$45 each for 2 or more):

Qty.	Title	Amount
_____	_____	\$ _____
_____	_____	\$ _____
\$4 Postage & handling (\$15 overseas)		\$ _____
TOTAL:		\$ _____

I enclose my  check  money order payable to Robert Tinney Graphics, or, bill:

MasterCard  VISA  American Express card

# \_\_\_\_\_ Expires: \_\_\_\_\_

NAME \_\_\_\_\_

ADDRESS \_\_\_\_\_

CITY \_\_\_\_\_ STATE \_\_\_\_\_ ZIP \_\_\_\_\_

Please send me your FREE color catalog.

VISA, MasterCard or American Express orders, call 1-504-272-7266

**ROBERT TINNEY GRAPHICS**

1864 N. Pamela Drive Baton Rouge, Louisiana 70815





# PRINCETON LS-300— LET YOUR PC SCAN NEW HORIZONS

**Scan text, images and graphics into your IBM PC or compatible as fast as 12 seconds per page at full 300 dpi resolution.**

The compact Princeton LS-300 Scanner is versatile, easy to use and appropriate for desktop use. You can also team the LS-300 Scanner with the new Princeton LM-300 Print Preview Monitor and save time by viewing a full page before you print.

**A Wide Range of Applications** The LS-300 helps you increase productivity in a variety of applications. With hardware dithering for gray levels, you can combine photographs and illustrations with reports or proposals. You can produce desktop publishing materials with extra visual impact. And, because the LS-300 reads virtually any page, you can scan in documents that can be sent at full 300 dpi resolution for facsimile transmission, or stored for future use.

To convert typewritten pages into editable text, an OCR option is available.

**A High Resolution Image** Scanning at 300 dpi, the LS-300 gives you the same resolution as the output of a quality desktop laser printer. It also maintains compatibility with your EGA software and display.

**IBM Compatibility, Princeton Reliability**

The Princeton LS-300 is designed for use with your IBM PC/XT/AT or compatible... its attractive price includes adapter card, cable and software. What's more, you can depend on the LS-300 to keep on working because it features built-in Princeton quality and durability.

**See Your Dealer for a Demonstration**

If you're ready for a versatile desktop scanner that can help you increase your productivity, see your Princeton Dealer today for a demonstration. Or call for more information.

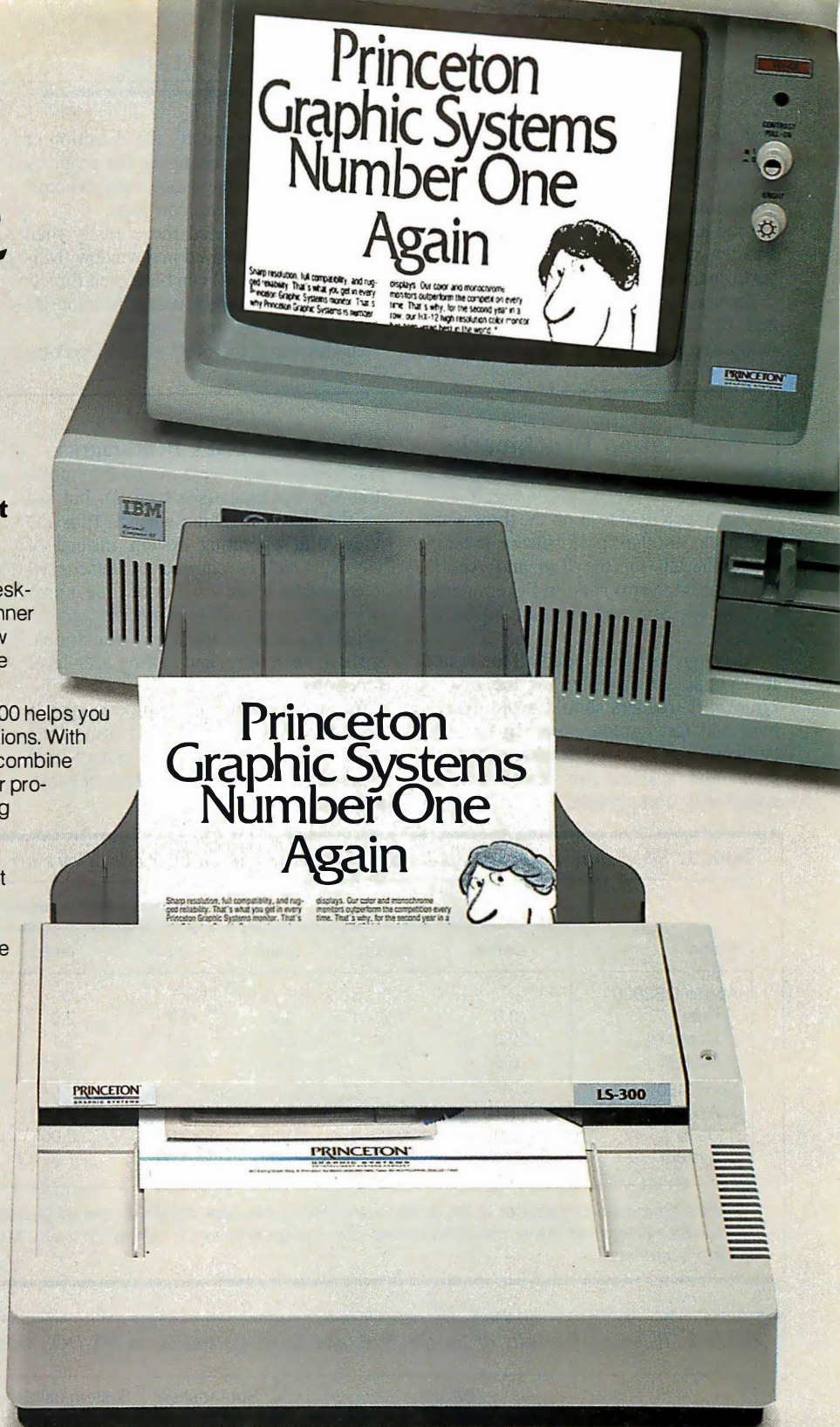

**PRINCETON®**  
GRAPHIC SYSTEMS  
AN INTELLIGENT SYSTEMS COMPANY

IBM is a registered trademark of International Business Machines Corp.

601 Ewing Street, Bldg. A, Princeton, NJ 08540.  
800-221-1490 (Extension 80), 609-683-1660 (NJ only), Telex 821402 PGS PRIN.



ow *do* operate independently of what's happening in other windows. For instance, we had a GW-BASIC graphics demo program running in one window while we created a ViewPoint free-form drawing in another, with no apparent degradation of performance in either window.

Transferring files between ViewPoint and the PC-emulation window is accomplished through a data conversion

utility. First you specify the direction of the conversion by changing the property sheet of the conversion tool, then you copy the file to the conversion icon.

Text can be copied more easily than that. Any text displayed in a window (MS-DOS or ViewPoint) can be copied directly to another window using the mouse's select button and the Copy key.

In summary, the 6085 with ViewPoint

software is a consistently designed electronic desktop system heavily oriented toward people who don't want to use technical programmer-style computer tools. Its applications are powerful and sophisticated, but the operating system is closed off from the user. Programmers interested in Xerox equipment definitely need to look at the Xerox Development Environment system instead of ViewPoint.

## Workstation Benchmarks

We ran a variety of tests on the three workstations to test their performance in native mode (68020 for the Sun and Apollo, Mesa for the Xerox) and in PC emulation (80286 for Sun and Apollo, 80186 for Xerox).

Although we've included all the results in a single set of tables for the sake of uniformity, readers should avoid making hard and fast comparisons. In terms of hardware options and working environment, the systems we tested are not necessarily comparable.

### Native-Mode UNIX Benchmarks

Native-mode tests were run on the Apollo and Sun machines (see table 1), but not on the Xerox machine since it runs the ViewPoint operating system instead of UNIX, which is required for these tests.

*User time* is the amount of time a process spends executing nonprivileged instructions (e.g., arithmetic calculations, sorting, searching, and calling user-level functions).

*System time* is the time a process spends executing privileged (kernel) commands (i.e., system calls) plus some system-level overhead (e.g., context switching between processes).

*Real time* is total elapsed time. It is often not the sum of the user and system times. The majority of missing time is spent waiting for I/O operations to complete, waiting for a signal from another process, sleeping, or being swapped out on disk while another program is running. Note that the UNIX operating system utility `/bin/tim` counts real time in 1-second increments and user time in 0.1-second increments. This accounts for some of the inconsistencies in the benchmark timings.

The `dread` and `dwrite` benchmarks test the random-access disk read and write implementation; `dwrite` creates, opens, and writes a 256- by 512-byte file, and the

**Table 1:** Benchmark results of Apollo and Sun systems in native mode. Times are in seconds.

Name	UNIX Benchmarks (native mode)							
	dwrite	dread	fcalle	fcalla	pipe	loop	sieve	scall
Apollo DS3000								
Real	0.8	1.2	0.4	0.2	2.5	1.8	0.95	5.3
User	0.6	1.0	0.3	0.1	1.1	1.6	0.8	5.1
System	0.0*	0.0*	0.0*	0.0*	0.0*	0.0*	0.0*	0.2*
Sun-3/160								
Real	1.10	1.43	0.23	0.033	2.63	1.77	0.63	2.63
User	0.00	0.00	0.20	0.00	0.00	1.53	0.57	0.53
System	0.43	0.30	0.00	0.00	1.37	0.03	0.00	2.03

\*System time does not appear in the Apollo benchmarks because the UNIX operating system runs as a user task under Domain/IX nucleus. All system time accumulated in the benchmarks is lumped into user time. The `scall` benchmark includes system overhead.

**Table 2:** Benchmark results of Apollo, Sun, and Xerox systems in an MS-DOS window. Times are in seconds.

Name	BASIC			Spreadsheet		System utilities	C Benchmarks (MS-DOS emulation)						
	Disk write 40K bytes	Disk read 40K bytes	Sieve	Calc	Paint	Disk load	Recalc	Copy 40K bytes	Sort	Sieve	Fibonacci	Float	File i/o
Apollo DS3000	8.6	6.8	43.2	13.1	7.4	3.3	0.0**	9.0	5.8	2.3	10.1	69.6	285.5
Sun-3/160	25.4	24.2	38.7	11.7	13.5	5.2	2.1	4.0*	5.1	2.3	9.0	60.5	281.3
	31.4*	30.0*				6.6*		5.3					
Xerox 6085	55.9*	29.8*	114.7	34.0	9.5	4.4*	8.2	7.7*	14.5	7.0	27.4	207.0	404.3*

\* Using a 360K-byte floppy disk drive; other disk results used a 1.2-megabyte drive.

\*\* Test was not run on this system.



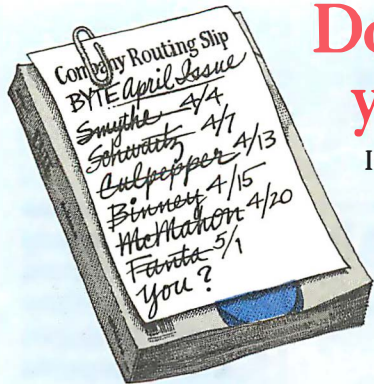

# Don't wait on line for your career to develop!

If microcomputing is your business, *BYTE has to be* your technology source. Make a career move now. Join your peers on the leading edge of microcomputer technology. Subscribe to *BYTE* at our low price introductory offer:

**Save \$20 off the newsstand price**—12 issues at \$22 instead of \$42. If you're not satisfied write "cancel" on your invoice and keep the first issue free.

- U.S. \$22.00 (1 yr.)    
  Canada/Mexico \$25.00 U.S. (1 yr.)    
  Europe-Air Delivery \$69.00 U.S. (1 yr.)    
  Worldwide-Surface Delivery \$37.00 U.S. (1 yr.)

- Bill me (North America only)  
 Payment enclosed (U.S. Funds drawn on a U.S. bank only)  
 Charge to my  VISA  MasterCard  
 Card # \_\_\_\_\_ Expires \_\_\_\_\_  
 Signature \_\_\_\_\_

Name \_\_\_\_\_  
 Address \_\_\_\_\_  
 City/State \_\_\_\_\_  
 Country \_\_\_\_\_ Code \_\_\_\_\_

Please allow 6-8 weeks for processing your subscription

For direct ordering call toll free weekdays 9:00am-5:00pm  
 EST: 800-423-8912 (in New Jersey: 201-981-1963).

472BSX

**BYTE** 





NO POSTAGE  
NECESSARY  
IF MAILED  
IN THE  
UNITED STATES

**BUSINESS REPLY MAIL**

FIRST CLASS MAIL PERMIT NO. 39 MARTINSVILLE, NJ

POSTAGE WILL BE PAID BY ADDRESSEE

**BYTE** Subscriptions

PO Box 597

Martinsville, NJ 08836-9956

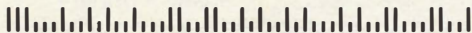



dread benchmark reads this file and then removes it.

The `fcalle` and `fcalla` (function call-empty and function call-assigned) benchmarks show how much system overhead is required for function calls. The `fcalle` column shows how long the computer takes using function calls; `fcalla` shows how long it takes to do the same thing without function calls. Subtracting the latter from the former results in the function call overhead.

The pipe benchmark is a measurement of how long it takes to set up a pipe (an I/O channel that is written into by one program and read by another) and pass 0.5 megabyte of data through it.

The loop benchmark tests long-integer arithmetic and is almost totally processor-bound.

The sieve benchmark is a test of compiler efficiency and processor throughput. It is the time required for one pass through the Sieve of Eratosthenes prime-number generator. System overhead is not very significant in this benchmark.

The `scall` (system call) benchmark queries the operating system 25,000 times concerning its process identity, using the `getpid()` system call. Because the program doesn't do much other than system calls, the elapsed time is significant here. System time and user time are less so.

For more information on benchmarking UNIX systems, see "Benchmarking UNIX Systems" by David F. Hinnant in the August 1984 *BYTE*.

### MS-DOS Benchmarks

These tests were run on all three workstations inside a PC emulation window (see table 2). (For the BASIC programs, see *BYTE's Inside the IBM PCs*, Fall 1985, page 195.)

In the BASIC disk write and read tests, a 64K-byte sequential text file is written to a blank floppy disk and then read back.

In other BASIC performance tests, the Sieve column shows how long it takes to run one iteration of the Sieve of Eratosthenes prime-number benchmark. The Calc column shows how long it takes to do 10,000 multiplication and 10,000 division operations using single-precision numbers. Paint measures how long it takes to paint a convoluted figure.

The spreadsheet tests measure how long it takes to load and recalculate a 25- by 25-cell spreadsheet in which each cell equals 1.001 times the cell to its left. The spreadsheet was Microsoft's Multiplan.

The system utilities test measures how long it takes to copy a 40K-byte file from the hard disk to a floppy disk using the MS-DOS `COPY` command.

The C benchmarks were run using the Manx Aztec C compiler. ■

# C the Advantage.



## Introducing the Lattice<sup>®</sup> MS-DOS C Compiler, Version 3.

There's never been a better time to buy Lattice C. Professional programmers the world over have made Lattice C the standard compiler for serious MS-DOS programming. Now Version 3 offers even more of the features that have made our previous versions so popular. Our new compiler features include:

ANSI language constructs including, *unsigned* as a modifier, *void* data type, *enum* data type, structure assignments, structure arguments, structure returns, and argument type checking.

The compiler also contains better aliasing algorithms, more efficient code generation, and more flexible segmentation, in-line 8087 code generation, and 80186/80286 code generation.

The library contains more than 200 new functions, including: ANSI/UNIX/XENIX compatibility; extended support for MS-DOS; extended support for networking including file sharing, file locking, and I/O redirection; and flexible error handling via user traps and exits. Plus the library has also been re-engineered to produce much smaller executables.

Try the new Version 3 C Compiler from Lattice. Because C-ing is believing.



Lattice, Incorporated  
P.O. Box 3702  
Glen Ellyn, IL 60138  
312/858-7950 TWX 910-291-2190

### INTERNATIONAL SALES OFFICES:

Benelux: Ines Datacom (32) 2-720-51-61  
Japan: Lifeboat Inc. (03)293-4711  
England: Roundhill (0672)54675  
France: SFL (1)46-66-11-55  
Germany: (49)7841/4500 (49)8946/13290



# Ctrace

253	main	[variables]	extern	unsigned char	1 0402	3
76	x[2][0]= .01;x[2][1]=.01;x[2][2]		today's.month			9
77	x[3][0]=-.02;x[3][1]=.02;x[3][2]		today's.day			23
78	printf("\n\nThe X matrix is");		today's.year			86
79	for(n1=0;n1<a;n1++) {		x[0][0] changed value			
80	for(n2=0;n2<a;n2++)		y[0][0] changed value			
81	printf("\nmx[zd][zd] is %f		x1 == 2.00000e+00			
82	}		x3 < 8.30000e+00			
83	/* slash is at left hand end */		n1 > 9			
84	for(n1=0;n1<a;n1++) {		n3 >= 33			
85	for(n2=0;n2<a;n2++) {					
86	if(n2==n1)					

## MATRIX INVERSION

Run number is 1

The X matrix is

x[0][0] is 1.000000  
 x[0][1] is 0.040000  
 x[0][2] is 0.030000  
 x[0][3] is 0.020000  
 x[1][0] is 0.020000\_

```
ptr 0x03fb
ptr->month 9
ptr->day 23
ptr->year 86
ptr->name[0] 'S'
ptr->name[1] 'e'
ptr->name[2] 'P'
ptr->name[3] '\x00'
f 9.70865e-03
t 9.99909e-01
x[0][0] 1.00000e+00
```

The perfect companion for MIX C has arrived. MIX C makes it easy to write C programs. Now Ctrace makes it easy to get them working. Introducing Ctrace, the exciting new C source debugger with animated trace.

### FUN AND EASY

Ctrace makes it so easy to debug your C programs that you'll love doing it. You no longer have to mess with assembly language or hex addresses. Ctrace presents your program in a form that's instantly familiar. Your C source code is displayed just as you wrote it. All your variables are displayed just as you named them. And wait till you see your program in action. Ctrace brings it to life on the screen. You'll see your variable values changing as you watch your source code executing. Ctrace shows you how your program works, or why it doesn't work. After one session with Ctrace, you'll wonder how you ever programmed in C without it.

### UNIQUE ANIMATED TRACE

Ctrace has a unique animated trace feature that shows you the flow of execution in vivid detail. Not just line by line, but statement by statement. It's like watching the bouncing ball as the cursor moves over your C source code, highlighting each statement as it executes. Press the space bar to execute one statement at a time, or press the return key and watch it go. It's exciting and educational. Who says learning has to be boring?

### SIMPLE OPERATION

Ctrace is easy to operate too. Commands are executed with a single keystroke. Help screens are available if you forget a command. Pop up menus list command options. You simply position the cursor to the desired option and press the return key. Pop up messages alert you when anything important happens. To use Ctrace, simply compile your program with the trace option turned on. The executable program file is created as normal. Ctrace doesn't affect the size or the behavior of the program. You can execute your program with or without the help of Ctrace.

### 4 VIEWS AT ONCE

Ctrace maintains 6 windows of information: source, output, variables, watch, symbols, and memory. You can view as many as 4 windows at the same time. The source window (top left) shows your C program. The output window (bottom left) shows the screen output from your program. The variable window (bottom right) shows all the variable names and values. The watch window (top right) shows the variables that you select along with any conditions you've defined. The symbols window shows the addresses of variables and functions. The memory window shows any area of memory using data types that you select. Eight different screen layouts are available at the touch of a key. You can even define your own screen layouts.

### COMPLETE PROGRAM CONTROL

Ctrace gives you complete control of your program. Execution options are single step, trace speed, and full speed. You can insert breakpoints on an unlimited number of statements. Execution is temporarily halted when a break point is hit. You can then

snoop around and see what your program has done to that point. You can even trace the flow of control backwards to see how your program got there. You can insert watch points on variable values. When the value of a variable satisfies the conditions you've defined, execution halts to let you examine your program. You can trace all functions or select just the ones you want to see.

### THE RIGHT PRICE

If you could buy a debugger like Ctrace anywhere else you would expect to spend major bucks. Fortunately nobody else has a debugger like Ctrace. It's only available from MIX Software. And that's great news because you know our prices are right. Ctrace is an incredible value at only \$39.95. That's Right.

**MIX**  
software

1132 Commerce Drive  
 Richardson, Tx. 75081  
 (214) 783-6001  
 Inquiry 175





Source window with profile count showing number of times each statement has executed. Pop up message indicates break point has been hit.



Source and variables windows shown side by side. Pop up message indicates that a watch point condition has been satisfied.

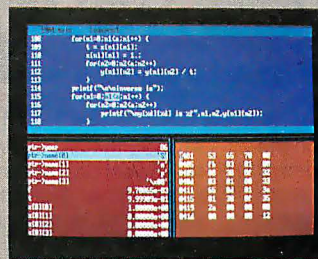

Source, variables, and memory window. Memory window lets you view any area of memory using any data type.



Change colors to suit yourself. Ctrace works with monochrome, color, Hercules, and EGA cards. Works on IBM compatibles and any computer with an IBM compatible BIOS.

# C for yourself

## THE C COMPILER

You can see that Ctrace is not your typical debugger. It's easy to understand and simple to operate. Likewise, MIX C is not your typical C compiler. It's small and fast. In fact it's the only full feature C compiler that can be operated comfortably on floppy disks. And as you would expect, MIX C is easy to use. It produces a complete program listing with all errors clearly identified and explained.

Although it's small, MIX C is not a subset. MIX C supports the full K&R standard, including the extensions that are often omitted in other C compilers. MIX C comes complete with a comprehensive 460 page book, a library of more than 175 functions, a blazingly fast linker, and tools for optimizing your programs for minimal space or maximum speed. All of this is yours for the incredibly low price of \$39.95. That's little more than the cost of most C books alone.

If you're just learning C, MIX C is your fastest, easiest, and cheapest way to master the language. If you've been frustrated by other C compilers, don't throw in the towel until you've tried ours. There's a world of difference. Our book includes a well written tutorial with lots of example programs. Our compiler includes the machine specific functions you need so you won't have to write them yourself. Compile and link operations take half as long with MIX C. That means you'll get your programs up and running twice as fast.

## THE ASM UTILITY

Our ASM utility is available if you want to link assembly language functions to your C programs. It works with Microsoft's MASM or M80

assemblers. Macros make it easy! You can call assembly language functions just like C functions. You can even call C functions from assembly language. Lots of useful assembly language functions are included as examples. And the price is right at only \$10.

## THE SPLIT-SCREEN EDITOR

Another great companion to the MIX C compiler is our split-screen editor. It makes writing programs even faster and easier. With the MIX Editor, you can compile, link, and execute your program at the touch of a key. Compiling is fast because the MIX C compiler reads the program directly from memory. Correcting errors is easy because the editor automatically positions the cursor to the first error in the program.

The MIX Editor works just like Micropro's WordStar. But through the magic of macros you can create your own custom version. You can map any key to any command. You can even define your own commands using the 100+ predefined commands. The split-screen feature is great for programming. You can edit two files at the same time and move text between files. It works great with any language. It has automatic line numbering for BASIC. It has auto-indent for structured languages like Pascal and C. It even has fill and justify for English. All these features and more are yours for the incredibly low price of \$29.95.

## THE MIX C WORKS

The combination of Ctrace with MIX C makes C programming a real joy. MIX C provides the power of a compiler while Ctrace provides an execution environment that's more

elegant than an interpreter. Add the ASM utility and our versatile split-screen editor to the package and you've got a terrific C programming system. We call it the MIX C Works. What's great is that you can buy all four products for a fraction of the cost of other C compilers alone. Yes, buy all four and we'll give you a big \$29.95 discount off our already rock bottom prices. Only \$89.90 for the MIX C Works. Now that's a deal. That's Right.

### MIX C WORKS

Only  
\$89.90

Product	Price	Total
__ Ctrace .....	(\$39.95) \$	_____
__ C Compiler .....	(\$39.95) \$	_____
__ ASM Utility .....	(\$10.00) \$	_____
__ Split-Screen Editor .....	(\$29.95) \$	_____
__ The MIX C Works .....	(\$89.90) \$	_____
(includes all of above)		
Subtotal .....	\$	_____
Texas Residents Add 6.125% Sales Tax .....		
Add Shipping Charges .....	\$	_____
In USA: add \$5 per order		
In Canada: add \$10 per order		
Overseas: add \$10 for editor		
add \$20 for compiler		
add \$30 for Works		
<b>Total of Your Order .....</b>	<b>\$</b>	<b>_____</b>

**TO ORDER CALL TOLL FREE:  
1-800-523-9520**

For technical support and for orders inside Texas please call (214) 783-6001

Or Contact one of our Worldwide Distributors direct in:

Canada: Saraguay 1-800-387-1288  
France: Info/Tech 1-43-44-06-48  
Australia: Techflow 047-586924  
Switzerland: DMB CH-523-31817

**System Requirements**  
Editor, C Compiler, & ASM Utility  
MSDOS/PCDOS 2.0 or higher  
128K Memory  
1 Disk Drive  
or CP/M 2.2 or higher (Z80)  
55K Memory  
1 Disk Drive (2 recommended)

**System Requirements**  
Ctrace:  
MSDOS/PCDOS 2.0 or higher  
IBM compatible BIOS  
256K Memory  
1 Disk Drive  
Inquiry 175

**30 Day Money Back Guarantee  
Not Copy Protected**

Please check method of payment  
 Check  Money Order  MC/VISA  
 Card # \_\_\_\_\_  
 Expiration Date \_\_\_\_\_  
 Please give name of computer  
 \_\_\_\_\_  
 Please check operating system  
 MSDOS/PCDOS  CP/M  
 Please check disk size  
 5 1/4"  3 1/2"  8"  
 Please check disk format if CP/M  
 SSSD  SSDD  DSDD  
 Your Name \_\_\_\_\_  
 Street \_\_\_\_\_  
 City \_\_\_\_\_  
 State \_\_\_\_\_ Zip \_\_\_\_\_  
 Telephone (\_\_\_\_) \_\_\_\_\_  
 Country \_\_\_\_\_

**MIX software** 1132 Commerce Drive  
Richardson, Tx 75081  
(214) 783-6001

**Ask about our volume discounts!  
Dealer Inquiries Welcome**



# ZAP-A-PAL™

# NEW FROM MICROWAY

## FastCACHE-286™

Runs the 80286 at 8.5 or 11 MHz and the 80287 at 5, 6 or 11 MHz. Includes 8 kbytes of 55ns CACHE. Works with more PCs than any other accelerator, including Leading Edge Model D, Compaq, and Turbo motherboards. Includes 8088 Reboot Switch, DCache and Diagnostics. . . . . **From \$449**

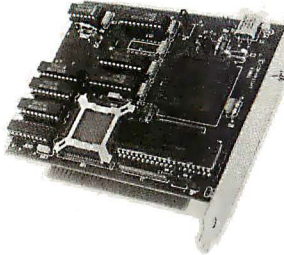

## ZAP-A-PAL™

At \$395 the ZAP-A-PAL from MicroWay is the lowest cost and most convenient PAL programmer available to the PC owner. ZAP-A-PAL is described in the January, 1987, issue of BYTE. The MicroWay version adds a number of important features including automatic calibration, software for many more PAL types and the ability to blow security fuses. ZAP-A-PAL works with virtually all 20 and 24 pin devices from MMI, TI and NSC. It plugs into the I/O channel of your PC or AT and includes a removable PAL ZIF socket that plugs into the back of your computer. The menu driven software makes it possible to effortlessly read, write and copy PALs. It accepts JEDEC files from any LOGIC Compiler such as CUPL or ABLE and comes with a copy of PALASM.

## NUMBER SMASHER/ECM™

Triples the speed of your PC, XT or compatible!

**From \$599**

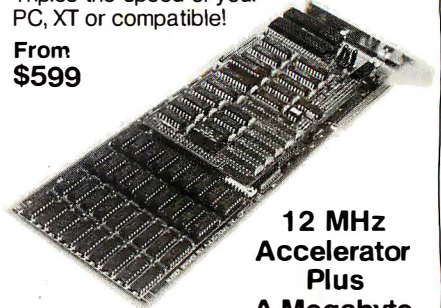

**12 MHz Accelerator Plus A Megabyte for DOS**

*PC Magazine "Editor's Choice"*

## DATA ACQUISITION and REAL TIME TOOLS

**DAL™** - "Data Analysis Language."

**Unkelscope™** - A real time data acquisition, control and process software pkg.

**87FFT and 87FFT-2**

**TransView** Menu driven FFT Spectrum/transfer analyzer. . . . . **\$250**

**RTOS - REAL TIME OPERATING SYSTEM**

A multi-user, multi-tasking real time operating system. Includes a configured version of Intel's iRMX-86, LINK-86, LOC-86, LIB-86, OH-86 and the MicroWay 87DEBUG. Runs on the IBM-PC, XT, PC-AT and COMPAQ. . . . . **\$600**

**INTEL COMPILERS** Available for RTOS FORTRAN-86, PASCAL-86, PL/M-86.

## 287 Turbo™ - 10/12

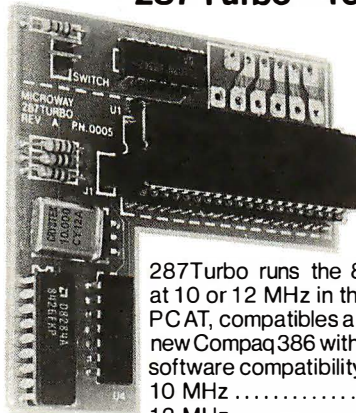

287Turbo runs the 80287 at 10 or 12 MHz in the IBM PCAT, compatibles and the new Compaq 386 with 100% software compatibility.

10 MHz . . . . . **\$450**  
12 MHz . . . . . **\$550**

*PC Magazine "Editor's Choice"*

## 8087 UPGRADES

All MicroWay 8087s include a one year warranty, complete MicroWay Test Program and installation instructions.

**8087 5 MHz** . . . . . **\$114**

For the IBM PC, XT and compatibles

**8087-2 8 MHz** . . . . . **\$149**

For Wang, AT&T, DeskPro, NEC, Leading Edge

**80287-3 5 MHz** . . . . . **\$179**

For the IBM PC AT and 286 compatibles

**80287-6 6 MHz** . . . . . **\$229**

For 8 MHz AT compatibles

**80287-8 8 MHz** . . . . . **\$259**

For the 8 MHz 80286 accelerator cards

**80287-10 10 MHz** . . . . . **\$395**

For the Compaq 386

**Call for prices on V20, V30, 64K, 128K and 256K RAM**

## A2D-160™

**The Fastest 12 bit A/D Converter**

**\$1295**

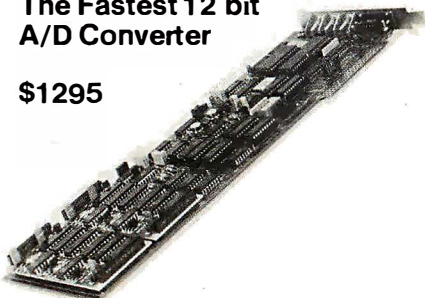

160,000 Samples per second  
Pseudo Random Noise Generator/DAC  
Optional signal conditioners  
**AFM-50** Programmable Low Pass Filter Module. . . . . **\$225**

## 8087 SOFTWARE

IBM BASIC COMPILER . . . . . **\$465**

MICROSOFT QUICK BASIC . . . . . **\$79**

87BASIC COMPILER PATCH. . . . . **\$150**

IBM MACRO ASSEMBLER. . . . . **\$155**

MS MACRO ASSEMBLER. . . . . **\$99**

87MACRO/DEBUG. . . . . **\$200**

MICROSOFT FORTRAN. . . . . **\$209**

RM FORTRAN. . . . . **\$399**

LAHEY FORTRAN F77L. . . . . **\$477**

MS or LATTICE C . . . . . **CALL**

STSC APL★PLUS/PC. . . . . **\$450**

STSC STATGRAPHICS. . . . . **\$675**

SPSS/PC+. . . . . **\$675**

87SFL Scientific Functions. . . . . **\$250**

PHOENIX PRODUCTS. . . . . **CALL**

FASTBREAK for 1-2-3 V.1A. . . . . **\$79**

HOTLINK for 1-2-3 V.1A. . . . . **\$99**

INTEL INBOARD 386 . . . . . **CALL**

## 287 TURBO-PLUS™

**Speeds up your AT**

Adjustable 80286 Clock 6-12 MHz

10 MHz 80287 Clock

Plus Full Hardware Reset. . . . . **\$149**

Optional 80286-10

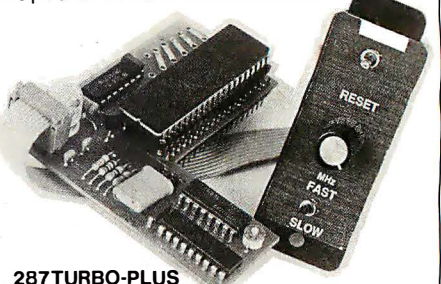

**287TURBO-PLUS**

With 80287 10 MHz. . . . . **\$549**

With 80287 12 MHz. . . . . **\$629**

**CALL (617) 746-7341 FOR OUR COMPLETE CATALOG**

**MicroWay**  
P.O. Box 79  
Kingston, Mass.  
02364 USA  
(617) 746-7341

*The World Leader  
in 8087 Support!*

**MicroWay Europe**  
32 High Street  
Kingston-Upon-Thames  
Surrey England KT1 1HL  
Telephone: 01-541-5466



Steve Ciarcia

# Build an Infrared Remote Controller

*A custom hand-held infrared transmitter and receiver*



In the last few years, I have installed a lot of automatic features in my home and the Circuit Cellar. Besides the sophisticated alarm system, computer-controlled wood stove, and perimeter lighting system (see "Living in a Sensible Environment" in the July 1985 BYTE), the Home Run Control System (HCS) has significantly increased the convenience of living in my house (see "Build the Home Run Control System" in the April through June 1985 BYTES). I have the usual remote-controlled stereos, TVs, FM radios, etc., but it is the small things like lights that automatically go on and off as I walk through the house and a voice-synthesized central monitoring system that I can call and hear a verbal status report when I'm away that have forever erased any pleasure derived from a manually oriented existence.

Just when I thought I had come to grips with electronic living, I ran into two new problems: automated living user intervention anarchy (ALUIA) and hand-held infrared controller overpopulation (HIROP). Generally speaking, these are high-tech diseases common among gadget-happy technocrats and overzealous inventor-authors who are insane enough to try to install all their designs into one house.

ALUIA is like gridlock. So many things are controlled within an environment that the only way to activate something is

*continued*

*Steve Ciarcia (pronounced "see-ARE-see-ah") is an electronics engineer and computer consultant with experience in process control, digital design, nuclear instrumentation, and product development. The author of several books on electronics, he can be reached at P.O. Box 582, Glastonbury, CT 06033.*

through the control system (if you can remember which system is controlling what device at a particular time). Unless you physically intervene, the control sequence will remain as set, and you must live with the consequences. Perhaps you have a timer controlling a series of outside lights, but one night you want them on at different times. Do you reset the automatic timer to a new cycle, override the automatic system manually at each setting, or disconnect the automatic system? The problem with many automatic systems is that they make little provision for unpredicted and unprogrammed user behavior.

In the case of the HCS, I tried to provide for such possibilities. Rather than just a timer that turns lights on and off, for example, the HCS can turn a light on in a room as long as it senses your presence via a motion detector connected to one of its hard-wired inputs. Such a control system adapts itself to your behavior—up to

a certain point! It cannot control what it cannot sense, nor can it be expected to accommodate all your wishes through passive sensors. If you want the stereo to go on when you walk into the room, it could be coordinated with the automatic lighting, but would you want it to come on even when you merely pass through the room?

Some automatic control functions are more applicable to lighting than to stereo equipment. Is the only alternative manual control if the system is not fully automatic? Not if it is designed to allow independent user input in addition to automatic control.

This control gridlock comes about when you and the system have different ideas as to what should be happening. Sometimes the only alternative is to design a system with shared control—one that executes a preprogrammed sequence but accommodates itself to selective manual in-

*continued*



**Photo 1:** Enclosed IRCOMM transmitter and receiver units.



tervention. By allowing you a means to override or direct the activities of the control system, the system retains the flexibility of independent control in the absence of user directives and lessens its potential for becoming a frustrating obstacle as your needs change.

Perhaps you want the stereo to automatically come on when you walk in the room any time between 5 and 6 p.m., but not at any other time unless you physically turn it on. You could easily program the HCS to use the motion sensor in the room to activate the stereo and lock out execu-

tion of the order except between 5 and 6 p.m. But how do you manually turn the stereo on yet still advise the control system of your action? The system needs to know that the stereo should be ON, even if it has been turned on manually. Any well-designed control system like the HCS

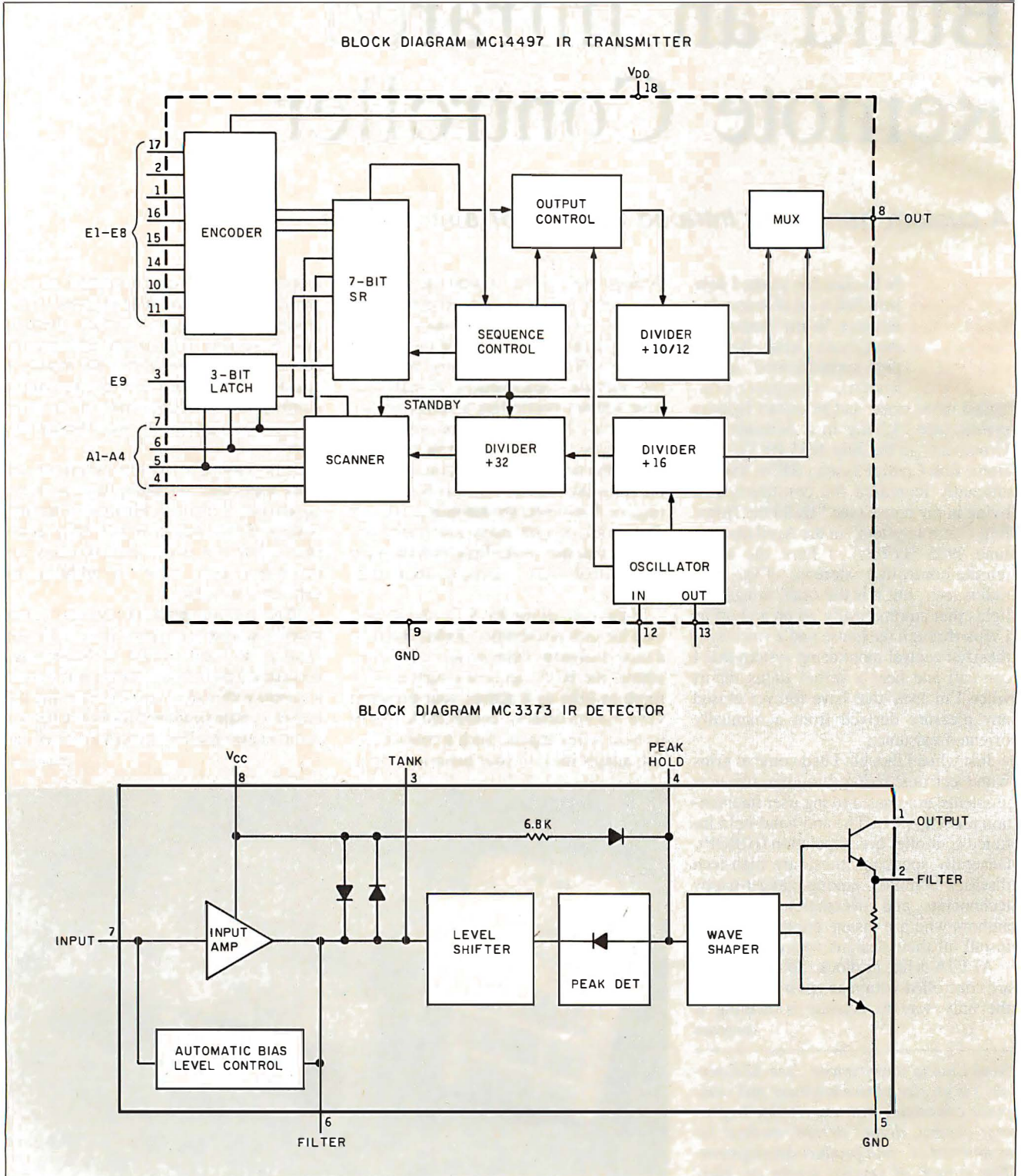

Figure 1: Block diagrams of the chips used in the IRCOMM.



periodically "refreshes" or retransmits the current status (ON or OFF) to all controlled devices, reducing concern about false activation/deactivation of the BSR X-10 remote-control modules by transients. The best way to coordinate such automatic/manual control is to do everything through the control system.

I don't expect you to run down to your Circuit Cellar and type a manual override every time you want to turn the stereo on. Since we are intending a direct and specific control action, "turn the stereo on," it only makes sense to use a direct input to the control system similar to a motion detector. A simple push button connected to one of the HCS inputs can turn on the stereo. When you press it, the control system is actually turning the stereo on, and it will coordinate this with its other functions.

While ultimately successful, if you follow this tack, you will soon find that it falls short as an easily implementable procedure. The interest in using a BSR X-10 wireless remote-control device with the HCS in the first place was to eliminate the need for wires. The more convenient alternative would be a wireless remote-control device that communicates specific commands from you to the HCS or other computerized control system. A typical example of such a device is the infrared remote control used with most TV sets.

This month's project is the design and construction of a custom hand-held in-

frared transmitter and receiver, called the IRCOMM (see photo 1). The transmitter circuit can be constructed as a small inexpensive hand-held controller or expanded to implement a 62-key wireless keyboard. The receiver is equally uncomplicated and intended to provide a convenient link between the user and the home control system.

An unfortunate side effect of creating the IRCOMM is that it adds one more IR remote-control unit to the pile you probably have and contributes to HIROP, as I stated earlier. While not intended as the first of a two-part article, next month I will make amends for contributing to IR remotes on every table and chair with my own form of population control.

### Generally Speaking

My primary consideration in the design of IRCOMM was to use it with the HCS. Therefore, hundreds of remote function keys and a 20-mile effective range were of little importance as design criteria. Much like remote controls for TVs or VCRs, the IRCOMM controller needed only to be short-range and command basic functions like "stereo system power ON," "surround sound system power ON," "projection TV ON," "mood lights ON," "entertainment system all power OFF," "room-to-room sound tracking GO," etc.

When we speak of the functions that a remote controller performs, we are actually describing what the device being con-

*Consumer electronic devices use infrared signaling because of its low cost and limited interference with other remote-controlled appliances.*

trolled (a TV, for example) does as a result of your pressing a key on the remote. The remote control is nothing other than a wireless keyboard. When you press a key, a stream of data is transmitted either as an ultrasonic, radio-frequency, or infrared signal. Present-day consumer electronic devices primarily use infrared signaling because of its low cost and limited interference with other remote-controlled appliances (like accidentally turning on the TV in the next apartment).

Infrared controllers generally use pulse position modulation (PPM) or pulse code modulation (PCM). The actual technique used is significant only to a person designing a receiver/decoder.

In designing the IRCOMM, I tried to keep both my needs and the intelligence

*continued*

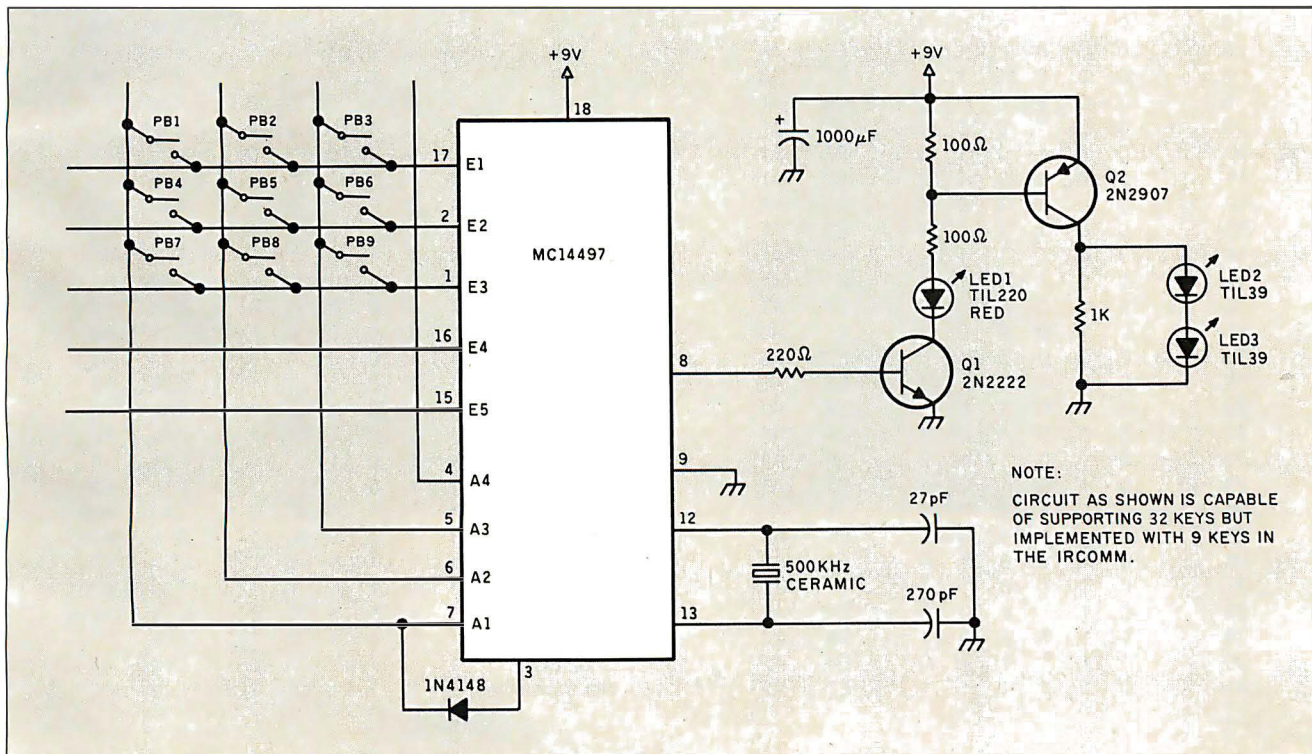
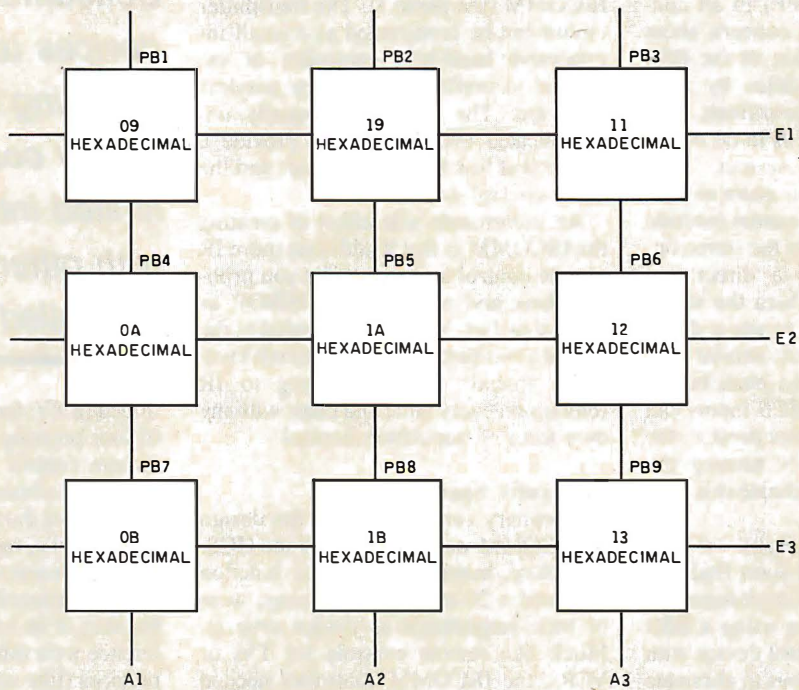

Figure 2: Schematic of the IRCOMM hand-held transmitter.



# CIRCUIT CELLAR



Channel	Code Word						Keyboard		Channel	Code Word						Keyboard	
	F	E	D	C	B	A	In	Out		F	E	D	C	B	A	In	Out
0	0	0	0	0	0	0	E8	A4	32	1	0	0	0	0	0	E8a	A4
1	0	0	0	0	0	1	E1	A4	33	1	0	0	0	0	1	E1a	A4
2	0	0	0	0	1	0	E2	A4	34	1	0	0	0	1	0	E2a	A4
3	0	0	0	0	1	1	E3	A4	35	1	0	0	0	1	1	E3a	A4
4	0	0	0	1	0	0	E4	A4	36	1	0	0	1	0	0	E4a	A4
5	0	0	0	1	0	1	E5	A4	37	1	0	0	1	0	1	E5a	A4
6	0	0	0	1	1	0	E6	A4	38	1	0	0	1	1	0	E6a	A4
7	0	0	0	1	1	1	E7	A4	39	1	0	0	1	1	1	E7a	A4
8	0	0	1	0	0	0	E8	A1	40	1	0	1	0	0	0	E8a	A1
9	0	0	1	0	0	1	E1	A1	41	1	0	1	0	0	1	E1a	A1
10	0	0	1	0	1	0	E2	A1	42	1	0	1	0	1	0	E2a	A1
11	0	0	1	0	1	1	E3	A1	43	1	0	1	0	1	1	E3a	A1
12	0	0	1	1	0	0	E4	A1	44	1	0	1	1	0	0	E4a	A1
13	0	0	1	1	0	1	E5	A1	45	1	0	1	1	0	1	E5a	A1
14	0	0	1	1	1	0	E6	A1	46	1	0	1	1	1	0	E6a	A1
15	0	0	1	1	1	1	E7	A1	47	1	0	1	1	1	1	E7a	A1
16	0	1	0	0	0	0	E8	A3	48	1	1	0	0	0	0	E8a	A3
17	0	1	0	0	0	1	E1	A3	49	1	1	0	0	0	1	E1a	A3
18	0	1	0	0	1	0	E2	A3	50	1	1	0	0	1	0	E2a	A3
19	0	1	0	0	1	1	E3	A3	51	1	1	0	0	1	1	E3a	A3
20	0	1	0	1	0	0	E4	A3	52	1	1	0	1	0	0	E4a	A3
21	0	1	0	1	0	1	E5	A3	53	1	1	0	1	0	1	E5a	A3
22	0	1	0	1	1	0	E6	A3	54	1	1	0	1	1	0	E6a	A3
23	0	1	0	1	1	1	E7	A3	55	1	1	0	1	1	1	E7a	A3
24	0	1	1	0	0	0	E8	A2	56	1	1	1	0	0	0	E8a	A2
25	0	1	1	0	0	1	E1	A2	57	1	1	1	0	0	1	E1a	A2
26	0	1	1	0	1	0	E2	A2	58	1	1	1	0	1	0	E2a	A2
27	0	1	1	0	1	1	E3	A2	59	1	1	1	0	1	1	E3a	A2
28	0	1	1	1	0	0	E4	A2	60	1	1	1	1	0	0	E4a	A2
29	0	1	1	1	0	1	E5	A2	61	1	1	1	1	0	1	E5a	A2
30	0	1	1	1	1	0	E6	A2	62(EOT)	1	1	1	1	1	0	E6a	A2
31	0	1	1	1	1	1	E7	A2	Not transmitted	1	1	1	1	1	1	E7a	A2

Figure 3: Codes generated by the MCI4497 and the IRCOMM keypad.











why not use the computer to decode the raw transmission in the first place? I never thought I'd be advocating a software solution, but I support reality.

The Motorola MC3373 wideband amplifier-detector chip is designed for use with infrared pulse-burst transmissions. The entire receiver circuit, shown in figure 5, is a two-chip envelope detector and TTL level shifter. An AC-coupled photodiode receives the infrared pulses from the IRCOMM transmitter and amplifies them. When an infrared signal of approximately 40 kHz is perceived, the output goes low. Q1 inverts this signal and applies it to a series of 4049 CMOS inverters that are capable of driving the LSTTL (low-power Schottky transistor-transistor logic) input load of the computer and lighting an additional visible LED so that you can see that data is being received.

### Decoding the PCM in Software

As I mentioned earlier, my intended application of the IRCOMM was to add remote-control features to my home control system by using it to trigger direct inputs to the HCS. Of course, the HCS was not designed with facility for IR remote control, but it does have 16 parallel input lines that can be used to trigger events. To use the IRCOMM with the parallel input of the HCS, however, another computer must be interposed between them. This special-function computer translates the IRCOMM receiver's PCM output into 9 (or 32 if you used that many keys) parallel signal lines that are attached to the HCS. I chose the BCC-52 computer/controller for this task (see "Build the BASIC-52 Computer/Controller" in the August 1985 BYTE). Figure 6a illustrates a block diagram of the connection.

The BCC-52 is programmable in BASIC or 8051 assembly language. To achieve the processing speed necessary to analyze PCM bit times, we must use an assembly language routine. The flowchart of the conversion process is given in figure 7, and a complete source listing of the necessary routine is provided in listing 1. [Editor's note: *The source for LEDPCM.ASM is available on disk, in print, and on BIX; see the insert card following page 328. The listing is also available on BYTEnet; see page 4.*]

I used the BCC-52 because it was convenient and cost-effective. Since it is bus-compatible with a variety of A/D, display, and power-control peripherals that have also been presented as Circuit Cellar projects, this suggests a far more powerful future application for the IRCOMM remote control. The IRCOMM and the computer that decodes the PCM signal are

*continued*

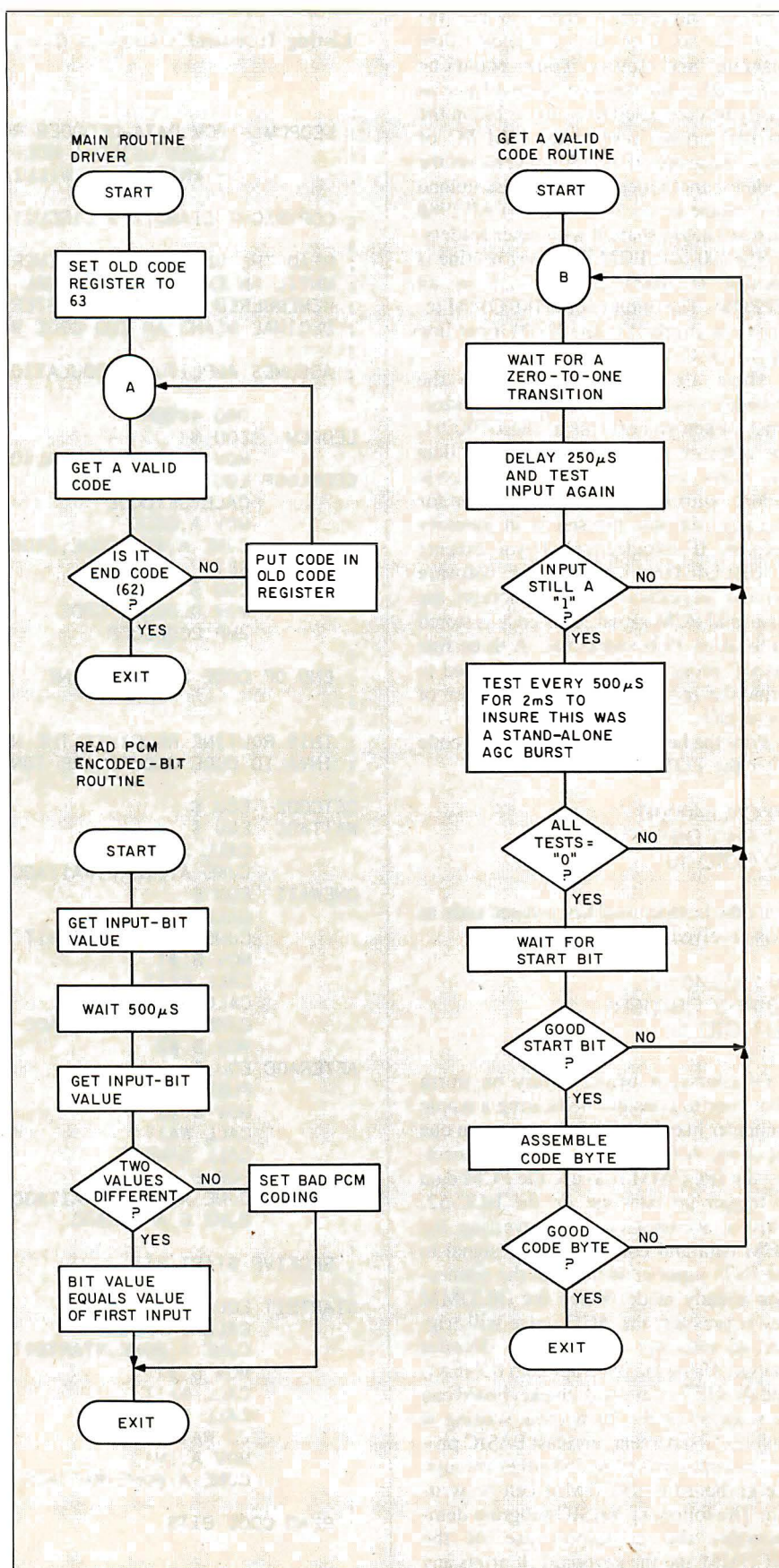

Figure 7: Flowchart of the PCM data-receiver routine.



separate, however. I chose to use the BCC-52 so that the complete flow diagram and source code could be presented as an example. It could just as easily be connected to an input bit on the parallel printer port of an IBM PC or other computer. If anyone implements the code for another computer, please upload the routine to my BBS at (203) 871-1988 so that I might share it with other readers.

The 100-byte PCM decoding routine is located at 4000 hexadecimal in an EPROM. The output of the IRCOMM receiver is attached to the INT0 input line of the BCC-52.

There are two entry points to the decoder routine: 4000 and 4011 hexadecimal. When you execute a CALL4000H, the software reads the incoming IR data but waits for a channel 62 EOT code before returning to BASIC. The code for the key that was pressed is in memory location 1F hexadecimal. If you execute a CALL4011H instead, the software returns immediately after it receives the first valid PCM signal. This code is stored in location 19 hexadecimal. A three-line BASIC program is all that is required to print the received code using either of these calls.

Print the hexadecimal key pressed code after the EOT is received:

```
10 CALL4000H
20 PHO. DBY(1FH)
30 GOTO 10
```

Print the hexadecimal key pressed code as it is received:

```
10 CALL4011H
20 PHO. DBY(19H)
30 GOTO 10
```

Of course, it would hardly be worth your time to consider dedicating a whole computer like the BCC-52 just to scan one input bit. A far superior way of connecting the IRCOMM is to use the PCM data to trigger an interrupt on the BCC-52. This is accomplished by inverting the PCM data and connecting this signal to the INTI input in addition to the connection already made. When the IRCOMM key is pressed, the AGC pulse will trigger an interrupt and call the decoder routine. Using the interrupt goto (ONEX1) and the GET command, the keyboard can be scanned on the fly without waiting at an INPUT statement, and fast BASIC programs with input provided either through the keyboard or IRCOMM can be written. The following BASIC program demonstrates the combined use of the IRCOMM and the keyboard. It prints any key pressed, either on the keyboard or the terminal, as it's entered:

**Listing 1: Assembly language listing for the PCM data-decoder routine.**

```
;
; LEDPCM - PCM DATA DECODER ROUTINE FOR READING IR LED
;          CODES USING A BCC-52 COMPUTER/CONTROLLER
;          - WRITTEN BY WILLIAM D. CURLEW
;
; COPYRIGHT CIARCIA'S CIRCUIT CELLAR 1986
;
; READ THE SERIAL IR RECEIVER INPUT. REMEMBER THE LAST CODE
; UNTIL AN END CODE (DECIMAL 62) IS RECEIVED. RETURN THE
; REMEMBERED CODE IN REGISTER 1FH. A RETURNED CODE OF 63
; DECIMAL MEANS AN END CODE WAS THE FIRST THING DETECTED.
;
; ASSUMES AMPLITUDE MODULATION MODE IS BEING USED.
;
LEDPCM   ORG 4000H
        EQU $
        MOV OLDPCODE,#INVALID ; SET UP OLD CODE AS 63
CODELOOP EQU $
        CALL GETCODE          ; GET A CODE
        MOV A, CODE           ; PUT CODE IN A REG
        CJNE A, #ENDCODE, STORE ; IF NOT END CODE, STORE & WAIT
        RET                   ; RETURN TO CALLER
STORE    EQU $
        MOV OLDPCODE, CODE    ; SAVE CODE AS OLDPCODE
        JMP CODELOOP         ; AND WAIT FOR THE NEXT CODE
;
; END OF CODE LOOP ROUTINE
;
; THIS ROUTINE RECEIVES THE NEXT VALID CODE.
; INVALID CODE GROUPS ARE IGNORED
;
GETCODE  EQU $
WAITAGC  EQU $ ; WAIT FOR AGC BURST
        CALL SAMPLE          ; GET THE VALUE AT THE INPUT PORT
        CJNE A, #ZERO, WAITAGC ; WAIT UNTIL IT IS A 0
ONEWAIT  EQU $
        CALL SAMPLE          ; GET ANOTHER VALUE
        CJNE A, #ONE, ONEWAIT ; IF NOT ONE, WAIT FOR A 1
        MOV B, #1           ; SET DELAY TO 250 US
        CALL WAIT           ; AND WAIT FOR THAT TIME
        CALL SAMPLE          ; RE-TEST INPUT BIT
        CJNE A, #ONE, WAITAGC ; IF NOT 1, FALSE AGC BURST.
        MOV B, #3           ; SET UP FOR 3 * 500 US
AFTERAGC EQU $
        PUSH B              ; SAVE ON STACK
        MOV B, #2           ; SET DELAY TO 500 US
        CALL WAIT           ; AND WAIT FOR THAT TIME
        CALL SAMPLE          ; CHECK INPUT VALUE
        POP B               ; RECOVER COUNT VALUE
        CJNE A, #ZERO, WAITAGC ; IF 1, FALSE WAIT AFTER AGC
        DJNZ B, AFTERAGC    ; CHECK IF DONE WITH WAIT
;
; RECEIVE START BIT
;
STARTBIT EQU $
        CALL SAMPLE          ; GET INPUT BIT
        CJNE A, #ONE, STARTBIT ; IF NOT 1, TRY AGAIN
        MOV B, #1           ; SET DELAY TO 250 US
        CALL WAIT           ; AND WAIT FOR THAT TIME
        CALL READBIT        ; DO PCM BIT INPUT
        JC WAITAGC          ; IF INVALID PCM, START OVER
        MOV A, IN1          ; GET BIT VALUE
        CJNE A, #ONE, WAITAGC ; IF NOT 1, BAD START BIT
;
; READ CODE BITS
```



```

;
READCODE EQU $
MOV CODE,#00 ; RESET CODE BYTE
MOV B,#6 ; DO 6 BIT INPUTS
READLOOP EQU $
PUSH B ; SAVE B VALUE
MOV B,#2 ; WAIT 500 US
CALL WAIT ; AND WAIT FOR THAT TIME
CALL READBIT ; GET PCM BIT VALUE
JC BADCODE ; IF INVALID PCM, THROW AWAY CODE
CLR C ; CLEAR CARRY FLAG
MOV A,IN1 ; GET PCM BIT VALUE
CJNE A,#ZERO,LOAD1 ; IF BIT=1 THEN DO 1
JMP ROTATE ; ELSE JUST ROTATE
LOAD1 EQU $
SETB C ; SET CARRY FLAG
ROTATE EQU $
MOV A,CODE ; GET CODE BYTE
RRC A ; ROTATE XTER RIGHT THROUGH CARRY
MOV CODE,A ; STORE IN CODE REG
POP B ; RECOVER BIT COUNT
DJNZ B,READLOOP ; IF NOT ALL BITS, DO AGAIN
RR A ; ROTATE TWO MORE
RR A ; BITS RIGHT
MOV CODE,A ; STORE IN CODE REG
CLR C ; CLEAR CARRY FLAG
JMP CODEEND ; AND EXIT
BADCODE EQU $
POP B ; RECOVER B REG FROM STACK
SETB C ; BAD CODE INDICATOR
CODEEND EQU $
RET ; RETURN TO CALLER
;
; END OF CODEEND ROUTINE
;
; THIS ROUTINE RECEIVES A VALID PCM BIT
; CARRY IS SET IF THE PCM ENCODING IS NOT VALID
;
READBIT EQU $
CALL SAMPLE ; GET INPUT VALUE
MOV IN1,A ; STORE IN IN1 REG
MOV B,#2 ; WAIT ANOTHER 500 US
CALL WAIT ; AND WAIT FOR THAT TIME
CALL SAMPLE ; GET ANOTHER SAMPLE
CJNE A,IN1,GOODPCM ; IF 2 INPUTS <>, GOOD PCM CODE
BADPCM EQU $
SETB C ; SET CARRY FLAG (BAD PCM)
JMP READEND ; AND EXIT
GOODPCM EQU $
CLR C ; CLEAR CARRY FLAG
READEND EQU $
RET ; RETURN TO CALLER
;
; END OF READBIT ROUTINE
;
; THIS ROUTINE SAMPLES THE INPUT BIT
;
SAMPLE EQU $
MOV A,INPORT ; READ BYTE AT PORT
ANL A,#ONE ; MASK OFF OUR BIT
RET ; AND RETURN TO CALLER
;
; END OF SAMPLE ROUTINE
;

```

continued

```

10 ONEX1 40
20 A=GET : IF A<>0 THEN
PRINT A
30 GOTO 10
40 PRINT"IRCOMM INTERRUPT
RECEIVED" : GOSUB 100
50 PRINT"INTERRUPT
PROCESSED"
60 RETI
100 CALL4000H
110 PHO. DBY(1FH)
120 RETURN

```

### Extending the Capabilities

With most infrared remotes, the range is limited to about 25 to 30 feet. Extending the range beyond that involves more powerful transmitters and more sensitive receivers. While I was considering doing just that, I came across a Radio Shack product called the Video Remote Control Extender that seems to adequately solve the problem.

The Extender (catalog number 15-1289) is an IR repeater. As shown in figure 6b, it consists of an infrared receiver, amplifier, and transmitter. One end, located in a room where you might also use the IRCOMM, is the receiver and the amplifier. At the other end is a splitter box with an attached infrared LED. The splitter is connected to the receiver with antenna wire. When a pulse burst is received, it is amplified and conveyed through the antenna wire to the splitter box where it is retransmitted via that IRLED. It is easy to visualize the HCS mounted in the Circuit Cellar with the IRCOMM and BCC-52 next to it. The Extender would be upstairs in the entertainment room.

More than one Extender can be used (I have three on the IRCOMM). Since their outputs are IRLEDs aimed at the IRCOMM receiver, Extenders from other rooms can also be used with their IRLEDs mounted next to each other all aimed at the IRCOMM.

### In Conclusion

I'm becoming as dependent now on the IRCOMM as I am on my automatic lighting. With it, the entertainment room comes alive in a programmed and orderly manner. Without it and the HCS, I bump into cold, dark walls of a house bathed in utter silence.

Indeed, I've solved the problem of coordinating the control of the multitude of electronic boxes in the entertainment room, but I've created an overabundance of IR remotes. The result is that I've created a terminal condition of HIROP.

Next month we'll throw away the IRCOMM and the rest of your remotes and replace them with a single Circuit Cellar IR Master. The IR Master is a

continued



MicroCom Systems  
**OUTSTANDING SOFTWARE**  
 For IBM PC's and Compatibles

**\$350 PER DISK**  
 SMALL QUANTITIES

**\$300 PER DISK**  
 FOR TEN OR MORE

\$1 OFF 5 DISKS OR MORE WITH THIS COUPON



- CAD 1** — Altamira, a four color object oriented drawing program. Color gr. req'd.
- COMM 3** — Compression/decompression and archival utilities for telecommunications.
- DATABASE 1,2** — (2 disks) PC-File III, Version 4, a user friendly database system.
- DATABASE 3** — The pBASE relational database manager with query language.
- EDUCATION 1** — Interactive DOS tutorial for new PC users. Makes learning DOS painless.
- GAMES 1** — Chess, 3-D Packman, Kong, Spacewar, JanitJoe, and more. Color gr. req'd.
- GAMES 2** — Qubert, Pango, Centipede, Monopoly, Zorro, and more. Color gr. req'd.
- GAMES 3** — Blackjack (you set rules), Arm Chair QB, and Empire (war game).
- GAMES 4** — Castle, Star Trek, and the original Colossal Caves ADVENTURE.
- GAMES 5** — The HACK adventure game from the universities. Like Rogue.
- GAMES 6** — Pinball, Othello, Dragons, Sopwith (fly one), and more. Color gr. req'd.
- GAMES 7** — Round42 (16 color graphics), Backgammon and more. Color gr. req'd.
- LANGUAGE 2** — The renowned SMALL-C compiler and a C interpreter!
- LANGUAGE 5** — Turbo Pascal interactive debugger, pop-up help, formatters, etc.
- LANGUAGE 7** — Pascal interpreter/compiler. Great for learning Pascal!
- MUSIC 1** — Many clever tunes, and an excellent color graphics music editor.
- ORGANIZER 1** — DeskMate, a Sidekick clone, and the Judy calendar program.
- ORGANIZER 3** — The PC-Outline windowing outline editor/thought organizer.
- PICTURES 2** — High res digitized graphics pictures. Color graphics required.
- PINUP 2** — Provocative high res digitized graphics pinups. Color graphics required.
- PRINTER 1** — Font and sideways utilities, spoolers, banner makers, and more.
- UTILITIES 1** — A collection of invaluable general purpose DOS utilities. A must!
- UTILITIES 2** — More invaluable DOS utilities. Too many to list here!
- UTILITIES 3** — A comprehensive set of debugging and diagnostic utilities.
- WORD 1** — PC Write 2.6, a powerful and complete word processing system.
- WORD 3** — The PC Style writing analysis program and FOG complexity index finder.

— NEW RELEASES —

- BUSINESS 1** — EZ-Forms business form generation, completion, and printing program.
- CAD 2** — An advanced 2D/3D drafting program. 640k required. Color gr. req'd.
- COMM 1,2** — (2 disks) Version 2.2 of the ever-popular QMODEM communications prog.
- COMM 4,5,6,7** — (4 disks) Latest RBBS Bulletin Board System 14.1D.
- COMM 8,9** — (2 disks) PROCOMM 2.4, an exc. modem program with terminal emulation.
- INFO 1,2** — (2 disks) Cooking recipes database with keyword/ingredient retrieval prog.
- LANGUAGE 1** — PDProlog 1.9v, 5th generation language for artificial intelligence.
- LANGUAGE 3** — A86, a full featured 8086/8088 macro assembler.
- LANGUAGE 8** — Xlisp 1.7, the standard for Artificial Intelligence programming languages.
- LANGUAGE 9** — The ICON string and structure oriented programming language.
- MUSIC 2,3** — (2 disks) PianoMan Ver 3.0 polyphonic music recording & playback prog.
- WORD 4** — The Speller spell-checking program. Includes customizable dictionary.

Catalog available, add \$2. 3.5" format add \$1/disk.

Cost of Items \_\_\_\_\_  
 CA Res 7% Tax \_\_\_\_\_  
 Ship/Handling \_\_\_\_\_ Domestic \$1./Foreign \$5.  
 Total Enclosed \_\_\_\_\_

 **MicroCom Systems**  
 (415) 325-6500   
 P.O. Box 51657, Palo Alto, CA 94303

CIRCUIT CELLAR

```

; THIS ROUTINE DELAYS 250 MICROSECONDS FOR EACH
; COUNT IN THE B REGISTER
;
WAIT EQU $
PUSH B ; SAVE B REG COUNT
DELAY250 EQU $
MOV B,#DELAYCNT ; LOAD WITH DELAY COUNT VALUE
LOOP250 EQU $
DJNZ B,LOOP250 ; BURN UP CYCLES
POP B ; RECOVER COUNTS
DJNZ B,WAIT ; IF NOT DONE, WAIT MORE
RET ; RETURN TO CALLER

;
; END OF WAIT ROUTINE
;
; SYSTEM EQUATES
;
; REGISTER ALIASES
;
IN1 EQU 18H ; FIRST HALF PCM INPUT
CODE EQU 19H ; CURRENT CODE
OLDCODE EQU 1FH ; LAST CODE READ
;
; CONSTANTS
;
ZERO EQU 0 ; ZERO BIT VALUE
ONE EQU 4 ; PORT 3, BIT 2 MASK VALUE
DELAYCNT EQU 111 ; 250 US CONSTANT
ENDCODE EQU 62 ; END CODE FROM TRANSMITTER
INVALID EQU 63 ; INVALID CODE SETTING
;
; HARDWARE PORTS
;
INPORT EQU P3 ; MEMORY MAPPED INPUT PORT
;
; END OF GLOBAL EQUATES
;
; END OF LEDPCM PROGRAM
;
ZZZZ EQU $
END
    
```

trainable remote controller that has the capacity to retain the command functions of up to 16 (yes, 16!) independent IR remotes. It uses a scrolling LCD to indicate command function and control device. A single execute ("DO IT") key is the only command button.

**Circuit Cellar Feedback**

This month's feedback begins on page 60. ■

*Special thanks to Bill Curlew for his software expertise.*

*The MCI4497, MC3373, and various other components are available from JDR Microdevices, 1224 South Bascom Ave., San Jose, CA 95128, (800) 538-5000. Call for price and availability.*

*The BCC-52 Computer/Controller is available from Micromint Inc., 4 Park St., Vernon, CT 06066, for \$199 plus shipping. To order, call (800) 635-3355; for information, call (203) 871-6170.*

There is an on-line Circuit Cellar bulletin board system that supports past and present projects. You are invited to call and exchange ideas and comments with other Circuit Cellar supporters. The 300/1200/2400-bps BBS is on-line 24 hours a day at (203) 871-1988.

**Editor's Note:** Steve often refers to previous Circuit Cellar articles. Most of these past articles are available in book form from BYTE Books, McGraw-Hill Book Company, P.O. Box 400, Hightstown, NJ 08250.

*Ciarcia's Circuit Cellar, Volume I* covers articles in BYTE from September 1977 through November 1978. *Volume II* covers December 1978 through June 1980. *Volume III* covers July 1980 through December 1981. *Volume IV* covers January 1982 through June 1983. *Volume V* covers July 1983 through December 1984.

To be included on the Circuit Cellar mailing list and receive periodic project updates and support materials, please circle 100 on the Reader Service inquiry card at the back of the magazine.



# COMPUTER WAREHOUSE

CALL TOLL FREE **1-800-528-1054**

**FREE** **FEDERAL EXPRESS**  
Air Express Shipping

See Details Below

**NOW**

**BEST PRICES**  
No Charge for Bank Cards

## HARDWARE

### PRINTERS

Alps 2000	\$715
2100	\$1145
Brother All Models	Call
Citizen MSP-10	\$260
MSP-15	\$379
MSP-20	\$319
MSP-25	\$475
Premier35	\$475
Diablo D-25	\$469
635	\$765

### EPSON

All Printer Models	Call
IBM Proprinter	\$399
NEC	
3510, 3550	\$729
8810, 8850	\$1045
P5	\$959
P6	\$429
P7	\$609

### OKIDATA

All Printer Models	Call
Panasonic 10801	\$195
10911	\$259
1092	\$295
1592	\$409
3131	\$245
3151	\$385

### STAR MICRONICS

All Printer Models	Call
Toshiba 321 Parallel & Serial	\$455
341E Parallel	\$669
351 Model II	\$1045
P351 Parallel & Serial	\$929
Laser Printer	Call

### DISKETTES

Maxell M2S (Qty 100)	\$85
Sony MD/2 (Qty 100)	\$85

### MONITORS

Amdex All Monitors	Call
NEC Multisync	\$575
Multisync XL	Call
Multisync Plus	Call
Multisync Monochrome	Call
Multisync Graphic Board	Call
Princeton Graphics	Call
Zenith All Models	Call

### VIDEO TERMINALS

Qume QVT Green 101	\$299
QVT Amber 101	\$314
Wyse 30	\$295
50	\$369
75	\$559
Wyse 85	\$439
Wyse 350	\$859
Zenith	
All Monitors	Call

### MODEMS

Anchor Automation	
Signalman Express	\$185
Practical Peripherals	
Practical 1200 Baud	\$124

### HAYES

All Modems	Call
Prometheus All Models	Call
US Robotics Courier 2400	\$349
Password 1200	\$165
Microlink 2400	\$349
Ventel	Call

### DISK DRIVES

Imega Bernoulli 10 meg	\$1195
Bernoulli 20 meg	\$1595
Bernoulli 40 meg	\$2325

### SEAGATE

20 meg w/Western I/O	\$385
----------------------	-------

### BOARDS

AST All Boards	Call
Hercules Color Card	\$149
Graphic Card	\$179
Intel Above Board PS/PC (1110)	\$239
Above Board AT (2010)	\$329
Above Board PS/AT (2110)	\$369
NEC Multisync Graphic Board	Call
Orchid Tiny Turbo 286	\$415
Turbo EGA	\$565
Paradise Five Pak	\$99
EGA Autoswitch	\$575
Plus Development	
Plus Hard Card 20 Megabyte	\$609
Quadram Tiny Turbo 286	\$355
Quad EGA+	\$359
Tec Mar Graphics Master	\$409
Captain No Memory	\$109
EGA Master	\$239
Video-7 Vega Deluxe	\$335
Vega Enhanced Graphics Adapt	\$275

### COMPUTERS

IBM	
PC 1 Drive 256K	\$1199
XT 1 Drive 256K	\$1729
XT 1 Drive 20 Meg 640K	\$2169
AT/68	\$2849
AT/339	\$4449

### COMPAQ

Portable II-2 Drive	\$1649
---------------------	--------

### PANASONIC

Business Partner Dual Drive	\$979
Sr. Partner Dual Drive	\$1169
Exec. Partner Dual Drive	\$1699
Other Models	Call

### TOSHIBA

T-1100	\$1299
T-1100 Plus	Call
T-3100	Call

### Zenith Computer Products

**SAVE up to 50%**  
All Models Call

### PLOTTERS

Epson Hi-80	Call
-------------	------

### KEYBOARDS

Keytronics 5151	\$159
-----------------	-------

### COPIERS

Canon	
«PC»	
Canon PC-25	\$929

**FCC Approved**

**\$429**

**MIT SYSTEMS Turbo PC/XT**

256 Memory, One 360K Brand Name Floppy Drive • 135 Watt Power Supply, Slide Case, AT Style Keyboard • 8 MHz Clock Speed, (Keyboard Selectable), 8 Expansion Slots

## SOFTWARE

IBM PC and 100% Compatibles

### TRAINING

Flight Simulator	\$28
PC Logo	\$75
Typing Instructor	\$27
Typing Tutor III	\$27
MS Learning DOS	\$28

### LANGUAGES

C Compiler (Microsoft)	\$249
Fortran Compiler (Microsoft)	\$195
Lattice C Compiler	\$236
MacroAssembler (Microsoft)	\$84
Pascal Compiler (Microsoft)	\$166
Quick Basic 2	\$55
Turbo Pascal w/8087 & BCD	\$55
Turbo Database Tool Box	\$38
Turbo Prolog	\$54

### PROJECT MANAGEMENT

Harvard Total Project Manager	\$262
Microsoft Project	\$219
Super Project Plus	Call
Timeline 2.0	\$205

### COMMUNICATIONS

CompuServe Starter Kit	\$19
Crosstalk XVI	\$88
MS Access	\$139
Mirror	\$33
Remote	\$88
Smartcom II	\$82

### INTEGRATIVE SOFTWARE

Enable 1.1	\$319
Framework II	Call
Smart Software System	\$389
Symphony	Call
Ability	\$55

### GRAPHICS

Chartmaster	Call
Diagram Master	Call
Energraphics 2.0	\$269
In-A-Vision	\$249
Microsoft Buss Mouse 6.0	\$106
Microsoft Chart	\$164
Microsoft Serial Mouse 6.0	\$119
Newsroom	\$31
PC Buss Plus Mouse	
w/ Paint Plus	\$115
PC Mouse w/Dr. Halo II	\$99
Click Art Personal Publisher	\$99
PC Mouse w/Dr. Halo II	\$99
PC Paintw/Mouse	\$115
Printmaster	\$29
Signmaster	Call
Turbo Graphix Tool Box	\$38

### WORD PROCESSORS

Leading Edge Word Processor	\$42
Leading Edge W/Pw/Spell & Mail	\$72
Lightening	\$55
Microsoft Word 3.1	\$249
Multimate Advantage	Call
Wordstar w/Tutor	\$162
Wordstar Pro Pack	\$233
PFS: Professional Write	Call

**Word Perfect (Ver.4.2) \$199**  
**Wordstar 2000 + 2.0 \$278**

### SPREADSHEETS

Lotus 1-2-3	Call
Multiplan	\$108
Spreadsheet Auditor 3.0	\$82
VP Planner	\$47

**Supercalc 4** Call

### MONEY MANAGEMENT

Dollars & Sense w/Forecast	\$94
Tobias Managing Your Money	Call

### UTILITIES

MS Windows	\$55
Copy II PC	\$19
1 DIR Plus	\$46
Fastback	\$84
Norton Utilities 3.1	\$48
Printworks	\$36
Sidekick	\$30
Sidekick (Unprotected)	\$47
Travelling Sidekick	\$39
Sideways 3.1	\$34
Superkey	\$39
Xtree	\$25

### DATA BASE MANAGEMENT

Clipper	\$329
Cornerstone	\$55
dBase II	Call
dBase III Plus	Call
Extended Report Writer	Call
KnowledgeMan II	\$249
Quickcode	\$138
QuickReport	\$138
Reflex	\$82
ThinkTank	\$91
PFS: Professional File	Call

**R:Base 5000 System V** \$355

Many other titles available.

Inquiry 70 for MS DOS Products. Inquiry 71 for all others.

# COMPUTER WAREHOUSE

Order Line: 1-800-528-1054  
Order Processing: 602-224-9345  
2222 E. Indian School Rd.  
Phoenix, Arizona 85016  
602-954-6109

Store Hours: Mon-Fri 10-5:30  
Saturday 9-1  
Order Line Hours: Mon-Fri 7-5:30  
Saturday 9-1  
Order Processing Hours: Mon-Fri 10-3

Product shipped in factory cartons with manufacturer's warranty. Please add \$6.00 per order for UPS ground shipping on orders up to 10 lbs. Orders 10 lbs. and under you pay for ground service, receive air service at no extra charge. Available on orders 11-30 lbs. \$17 for air service. Prices & availability subject to change without notice. Send cashier's check or money order...all other checks will delay shipping two weeks.



# Train with NRI for a servicing

**NEW!**

Train with the newest Sanyo 880 Series Computer—it's fully IBM-compatible and runs almost twice as fast as the IBM PC!

## Get started now by building this fully IBM PC compatible computer

Now you get it all... training for America's fastest growing career opportunity... training to service all computers... training on the newest total computer system, the Sanyo 880. Only NRI can give you the well-rounded training you need, because only NRI gives you a complete computer system... computer, monitor, disk drive, software, even test instruments like a digital multimeter and logic probe to work with and keep. It all adds up to training that builds the knowledge, competence, and ability you need to succeed as a computer service specialist.

### Get inside the newest, fully IBM PC compatible Sanyo Microcomputer

As an NRI student, you'll get total hands-on training



as you actually build your own latest model Sanyo 880 Series computer from the keyboard up. It's fully IBM PC-compatible and, best of all, it runs programs almost twice as fast as an IBM PC. As you assemble the Sanyo 880, you'll perform

demonstrations and experiments that will give you a total mastery of computer operation and servicing techniques. You'll do programming in BASIC language—even run and interpret essential diagnostic software.



# RUSH POSTAGE-PAID CARD FOR YOUR FREE CATALOG

- **COMPUTER ELECTRONICS** training prepares you to service all computers as you build your own 16-bit IBM PC compatible computer. Total system program includes disk drive, test equipment, bundled software, and NRI Discovery Lab.
- **TV/VIDEO/AUDIO SERVICING** includes training with a state-of-the-art 27" high resolution broadcast stereo TV for learning troubleshooting and professional bench techniques.
- **SATELLITE ELECTRONICS** training gives you the skills to service both consumer and commercial satellite earth station equipment as you assemble your own home satellite TV system.
- **ROBOTICS** training features remote-controlled, mobile, fully programmable robot you build, experiment with, and keep along with other test equipment.



**CHECK  
ONE**

Send me your free catalog  
on NRI Training in:

- Computer Electronics
- TV/Video/Audio Servicing
- Robotics
- Satellite Electronics
- Digital Electronics Servicing
- Data Communications
- Electronic Design Technology
- Industrial Electronics
- Communications Electronics
- Basic Electronics
- Building Construction and Remodeling
- Automotive Servicing
- Small Engine Servicing
- Electrician
- Air Conditioning, Heating, and Refrigeration
- Locksmithing and Electronic Security
- Telephone Servicing
- Appliance Servicing
- Photography
- Bookkeeping and Accounting

Name _____			Age _____		
<i>(Please Print)</i>					
Street _____					
City _____		State _____		Zip _____	

For career courses approved  
under G.I. Bill  Check for details.





NO POSTAGE  
NECESSARY  
IF MAILED  
IN THE  
UNITED STATES

**BUSINESS REPLY MAIL**

FIRST CLASS MAIL PERMIT NO. 10008 WASHINGTON, D.C.

POSTAGE WILL BE PAID BY ADDRESSEE

**NRI Schools**

McGraw Hill Continuing  
Education Center  
3939 Wisconsin Avenue  
Washington, D.C. 20077-9265





# high paying career computers



**MONITOR**—High resolution, green screen displays, crisp text and graphics.

**TECHNICAL MANUALS**—with complete specs on Sanyo computer and professional programs.

**DISCOVERY LAB**—Using it, you construct and test circuits like those used with computers.

**DIGITAL LOGIC PROBE**—Simplifies analyzing digital circuit operation.

at your own convenience, backed at all times by your own NRI instructor and the entire NRI staff of educators and student service support people. They're always ready to give you guidance, follow your progress, and help you over the rough spots to keep you moving toward your goal.

**100 page free catalog tells more . . . send today**

Send the postage-paid reply card today for NRI's 100 page catalog that gives all the facts about computer training, plus career training in robotics, data communications, TV/audio/video servicing, and many other fields. If the card is missing, write to NRI at the address below.

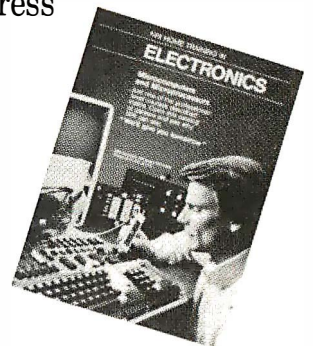

## Understanding you get only through experience

You need no previous knowledge to succeed with NRI. You start with the basics, rapidly building on the fundamentals of electronics with bite-size lessons. You perform hands-on experiments

with your NRI Discovery Lab and then move on to master advanced concepts like digital logic, microprocessors, and computer memories.

## Learn at home in your spare time

You train in your own home

**NRI** SCHOOLS  
McGraw-Hill Continuing Education Center  
3939 Wisconsin Avenue  
Washington, DC 20016  
We'll give you tomorrow









Arch D. Robison

# Illinois Functional Programming: A Tutorial

*Construct functional programs with this public domain language*

**C**onventional computer languages are direct descendants of machine language. You can trace the ancestry of features in nearly all computer languages to a machine-level counterpart. Variables are equivalent to storage locations; GOTO and IF statements mimic jump and branch machine instructions. Though these abstractions of machine language free the programmer from machine-specific detail, they still force the programmer to work on the same word-at-a-time level as the machine.

Functional programming, however, puts programming on new foundations. Functional programs have neither the control flow nor the variables of conventional languages. Instead, programs are directly constructed from smaller programs. As a result, functional programming offers a new programming style with advantages that include modular construction, program verification, parallel processing, and optimization.

I've written an interactive functional programming language called Illinois Functional Programming (IFP) that runs under MS-DOS and UNIX. You can write and edit IFP programs with a text editor such as PC-Write and execute the programs interpretively. The IFP interpreter is reasonably compact and fast, and IFP programs execute about as quickly as their BASIC counterparts. Most of the IFP interpreter is based on John Backus's original functional programming paper. (The analogy of variables to GOTOs is from Backus.) The basic syntax is loosely borrowed from Niklaus Wirth's Modula-2.

To run IFP on an MS-DOS-based system, you'll need at least 256K bytes of RAM. Extra memory for a RAM disk is convenient but not necessary. You'll also

need three programs: the IFP interpreter (IFP.EXE), which I've placed in the public domain, a text editor, and a directory lister. You must supply the text editor and directory lister. I recommend PC-Write, which works with IFP under DOS 2.0 and 3.0, and EDLIN, which works only under DOS 3.0. All three programs must reside on one disk, and you must prepare another disk to hold your IFP functions. If you have enough memory, you'll find placing the interpreter, text editor, and directory lister in a RAM disk convenient. For more information on loading and running IFP, see the text box "Running IFP" on page 120.

## Structured Data Flow

One of functional programming's advantages is that it gives you greater control of the flow of data. Let's look at the following Pascal program fragment, which computes the inner product of two vectors:

```
S := 0;
for K:=1 to N do
  S := S + A[K]*B[K];
```

At first glance, it appears to be a simply structured program. The  $S := 0$  assignment is followed by a for loop, which controls another assignment statement. Flow of program control into the latter assignment is strictly regulated by the for loop.

Appearances can be deceiving, however. Figure 1 shows the data flow for the same program fragment. The arrows show the various information transfers. Unlike the control flow, the data flow is not well structured. The statement controlled by the for loop can receive and send data around the for loop, thus breaking the hierarchical structure. Furthermore, the variables S and K have more than one arrow going to them, which implies that their values are time-dependent.

While this program example is trivial, a large program may have global variables. Although keeping variables local to procedures eliminates some of the problem, variables are still required to communicate between procedures. Just to understand such large program listings, you must sort out variable interactions and dependencies.

A variable is to data flow what GOTO is to control flow. Just as GOTO allows control to go anywhere, a variable allows data to go anywhere. You can, of course, use scope rules to limit variable interactions, but doing so is merely the same as restricting the scope of a GOTO. The more powerful solution is structured data flow. Just as a GOTO can be replaced by a control structure such as IF...THEN...ELSE or WHILE...DO, a variable can be replaced by a data-flow structure.

## Learning the IFP Language

Semantics for IFP are almost identical to Backus's Functional Programming, though the syntax is quite different. The IFP syntax reads from left to right and is block-structured in a manner similar to Pascal. Though the notation is wordy for small programs, it makes large programs easier to read by encouraging an indented style.

The IFP language consists of objects, functions, and program-forming operations (PFOs). Objects are the data structures of IFP. Functions and PFOs correspond to procedures and control structures of conventional languages; however, the

*continued*

*Arch D. Robison holds a B.S. from Case Western University and an M.S. from the University of Illinois at Urbana-Champaign, where he is currently working on his Ph.D. He can be reached at 1304 West Springfield Ave., Urbana, IL 61801.*



meanings of functions and PFOs differ radically from their conventional counterparts.

**Objects**

Objects in IFP are either atoms, sequences, or *bottom*. The latter represents an undefined value (e.g., the result of division by 0) and is written as a question mark (?). Atoms are numbers, strings, or Boolean values. A string must be surrounded by quotation marks if it looks like another kind of atom or contains nonalphanumeric characters. Some sample atoms and their types are shown in table 1.

Sequences are lists of zero or more objects surrounded by angle brackets. Below are some typical sequences.

```
<a,b,c>
<1 2 3 4 5 6>
<>
<<1 2 3> <apple banana> t>
```

Either commas or spaces can be used to separate the elements of a sequence. A sequence with no elements is simply called

empty. The elements of a sequence can be any object and do not have to be of the same type. Sequences can contain other sequences as elements, so complex data structures can be expressed. Also, IFP sequences are bottom-preserving; that is, any sequence containing ? is itself equal to ?; the sequence <a,b?,d> is equal to ?, for example.

**Functions**

In IFP, a function is applied to an object to yield another object. The application of function *f* to object *x* is written as *x* : *f*. In other words, *x* is the input to *f*. For example, the application of the cosine function to the number 0 is written as 0 : COS. To evaluate this statement on the IFP interpreter, we would enter SHOW 0 : COS;, and the interpreter would answer 1. The command SHOW indicates that we wish to evaluate an application; the semicolon marks the end of the function.

The IFP interpreter distinguishes two kinds of functions: primitive functions and defined functions. Primitive functions are built into the IFP interpreter; defined functions are created by the user. All func-

tions can be used in the same manner; neither primitive nor defined functions are privileged in any way.

**Organization**

IFP functions are stored in a tree structure analogous to the way in which MS-DOS files are stored. Each node of the tree is either a directory or a function, which is saved as a file. A function is referenced by its path, which is a sequence of names separated by slashes. On MS-DOS systems, the interpreter truncates each name to eight characters and converts all letters to uppercase. Paths follow MS-DOS file-path conventions, except that the separator is a forward slash (/), not a backslash (\). The use of a forward slash is the result of developing IFP on UNIX systems, which use a forward slash as the path separator. Paths may also contain two periods (..) to indicate a move up to the parent directory. Relative paths do not begin with a slash, indicating that the path starts at the current directory. Within function definitions, the current directory is the directory in which the function is defined—that is, saved to disk.

When you use a function from another directory frequently, you don't want to have to spell out the entire path every time. To avoid this, you can import a function into a directory from another directory. To import functions into the current directory, you can create an import file in the directory that is to receive the function. The file must be called %IMPORT, and it must contain declarations of the form FROM *directory* IMPORT *function*<sub>1</sub>, *function*<sub>2</sub>, . . . , *function*<sub>*n*</sub>. In the example, *directory* is actually the directory path. For example, a typical import file might look like this:

```
FROM /sys IMPORT distl, id, iota,
length, t1;
```

After using IMPORT you can reference any imported function as though it were defined in the directory—you only have to write the function name and not the entire path.

**Primitive Functions**

Primitive functions (those built into the IFP interpreter) have paths like any other function, except that there is no source definition for the function. Most of these functions, such as +, or, COS, and =, are familiar to programmers. These functions behave the same as they do in most languages.

Functions always have a single input and output. However, either the input, output, or both can be a sequence of objects. For example, 2+3 is written as <2 3> : +,

*continued*

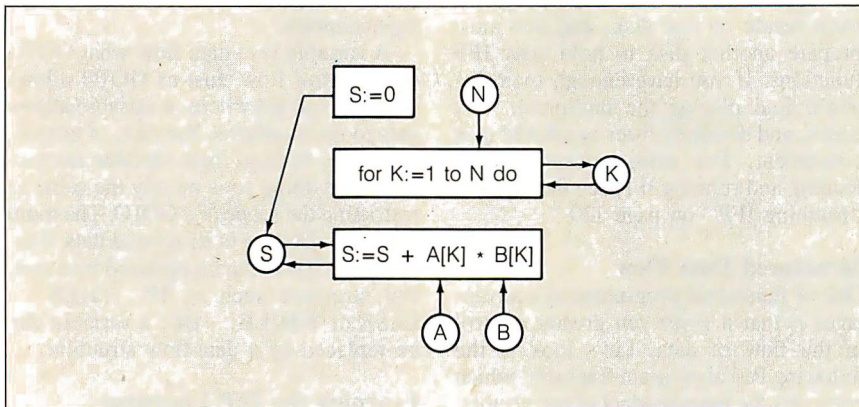

**Figure 1:** The data flow of this inner product program written in Pascal is not well structured. The statement controlled by the for loop can break the hierarchical structure by sending and receiving data around the for loop statement. Compare with the data flow in figure 3.

**Table 1:** An IFP atom can be a number, a string, or a Boolean value. If a string looks like another atom or contains nonalphanumeric characters, it must be enclosed in quotation marks.

IFP Atoms	Type
banana	string
"The cat in the hat"	string (double quotes)
'hello world'	string (single quotes)
7	number
3.1415	number
1e6	number (million)
"1.414"	string
t	Boolean true
f	Boolean false
"t"	string



# CAD — THE BEST IS EVEN BETTER!

**ProDesign II — The Easy-to-Use CAD System. It's the NUMBER ONE CAD PACKAGE for under \$1000. And it costs only \$299. With over 25,000 satisfied users, ProDesign II outshines anything in its class. It outshines many packages costing \$2000 and more! ProDesign II offers more features, more compatibility, and superior ease-of-use.**

**But now, THE BEST IS EVEN BETTER!**

**Version 2.5 of ProDesign II is now available. More than 50 additional features have been added to ProDesign II. Features such as Pattern Hatching, On-Screen Menus, Geometric Calculations, Macros, Parallel Lines, Parallel Curves, enhanced Auto-Dimensioning, Block Arrays and Circular Arrays, to name a few. Features that make ProDesign II even more powerful. Features that make ProDesign II even easier to use.**

**How much more does version 2.5 cost? None! The new ProDesign II is still \$299! Where can you get it? See your local dealer, or contact us:**

**AMERICAN SMALL BUSINESS COMPUTERS  
118 SOUTH MILL STREET  
PRYOR, OK 74361  
(918) 825-4844  
Telex 9102400302**

Inquiry 23

## PRODESIGN II — ONLY \$299!

# F-18 HORNET DRAWN USING PRODESIGN II

1. RADOME
2. 28MM ROTARY CANNON
3. AMMUNITION MAGAZINE
4. WINDSCREEN
5. INSTRUMENT PANEL
6. HEADS-UP DISPLAY
7. CANOPY
8. EJECTION SEAT
9. AVIONICS EQUIPMENT
10. SECOND SEAT SPACE
11. LEADING EDGE ROOT EXTENSION
12. FUSELAGE TANKS
13. LEADING EDGE FLAP
14. WING TANK
15. WING TANK
16. SIDEWINDER AIR-AIR MISSILE
17. MISSILE LAUNCH RAIL
18. NAVIGATION LIGHT
19. WING FOLD HINGE JOINT
20. AILERON
21. FLAP VANE
22. FLAP
23. HYDRAULIC RESERVOIRS
24. STROBE LIGHT
25. RUDDER HYDRAULIC ACTUATOR
26. NAVIGATION LIGHT
27. RADAR WARNING ANTENNA
28. FUEL JETTISON
29. MOVING TAILPLANE
30. ECA ANTENNA
31. RADAR WARNING ANTENNA
32. FORMATION LIGHTING STRIP
33. AFTERBURNER NOZZLE
34. AFTERBURNER NOZZLE ACTUATORS
35. MOVING TAILPLANE
36. TAILPLANE PIVOT MOUNTING
37. TAILPLANE HYDRAULIC ACTUATOR
38. TURBOFAN ENGINE
39. AILERON HYDRAULIC ACTUATOR
40. WING FOLD ACTUATOR
41. SIDEWINDER AIR-AIR MISSILE
42. LEADING FLAP ACTUATOR
43. WING TANK
44. LEADING FLAP DRIVE SHAFT
45. EQUIPMENT GEARBOX
46. AUXILIARY POWER TURBINE
47. REAR LANDING GEAR
48. SPARROW AIR-AIR MISSILE
49. LEADING FLAP DRIVE MOTOR
50. MAIN RETRACT ACTUATOR
51. FORWARD RETRACT ACTUATOR
52. LIQUID OXYGEN CONVERTER
53. BOARDING LADDER
54. FORWARD LANDING GEAR
55. CATAPULT LAUNCH STRAP
56. CONTROL COLUMN
57. RUDDER PEDALS
58. AMMUNITION FEED CHUTE
59. ANGLE OF ATTACK SENSOR
60. PITOT HEAD
61. FORMATION LIGHTING STRIP
62. RADAR EQUIPMENT BAY
63. FORWARD ECA ANTENNA
64. RADAR PIVOT MECHANISM
65. RADAR SCANNER

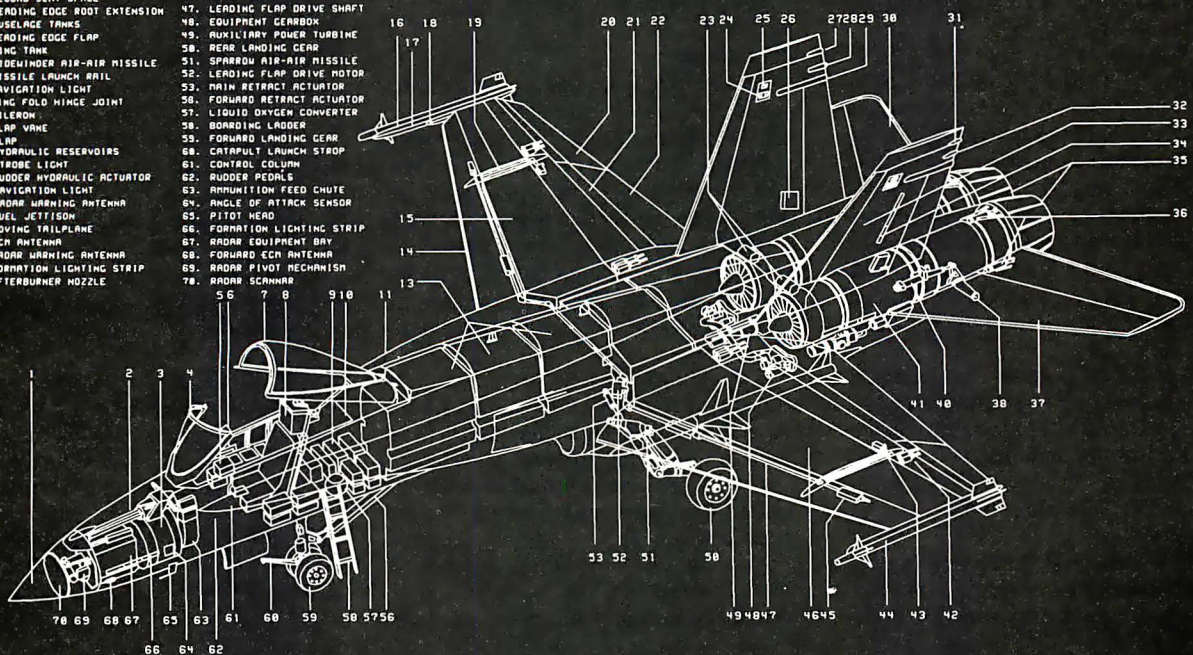



which gives the result 5.

Structural functions, another kind of primitive function, reorganize structures. For example, the function cat concatenates several sequences;  $\langle \langle a b \rangle \langle p \rangle \langle x y z \rangle \rangle$  : cat results in  $\langle a b p x y z \rangle$ . Another structural function is reverse, which reverses a sequence;  $\langle 2 4 6 8 \rangle$  : reverse results in  $\langle 8 6 4 2 \rangle$ .

Some primitive IFP functions are subsets of other primitives. For example, the sum function adds any sequence of numbers, while the + function adds a sequence of exactly two elements. Having both makes functions easier to read—providing you choose the function that best represents your intent. Table 2 lists the commonly used IFP primitive functions.

**Program-Forming Operations**

User-defined functions combine primitive and other user-defined functions. In conventional languages, functions are combined by storing intermediate results in variables. In IFP, functions are combined by PFOs. Imagine functions as boxes with a single input and output (figure 2a). The PFOs assemble function boxes to form new function boxes. Each component function is a parameter to the PFO. Like its component functions, each PFO has a single input and output. Higher-level functions can be built from the constructed functions in the same manner.

The output of a function can be connected to the input of another function with the composition PFO (figure 2b). Composition is written using a vertical bar; the composition of *f* and *g*, for example, is  $f | g$ . Composition can be defined by the equality  $x : f | g = g(f(x))$ . Also, composition is associative, so parentheses are not necessary in expressions such as  $f | g | h$ .

The construction PFO ties functions together in parallel (figure 2c). The construction of functions is written as a bracketed list of the functions; for example, the construction of functions *f*, *g*, and *h* is written as  $[f,g,h]$ .

The output is a sequence, each element of which is respectively the result of applying *f*, *g*, and *h* to the input. For example,  $\langle 12 4 \rangle : [+,-,*,\%]$  yields  $\langle 16 8 48 3 \rangle$ . (The percent sign denotes division.)

Together, composition and construction are sufficient to define many other useful functions. For example, the cotangent function may be defined as

```
DEF cotan AS [cos,sin]%;
```

Another interesting function is id (for identity), which simply copies its input to its output. The identity function permits

**Table 2: The IFP structural functions assemble, reorganize, and select data. Logical functions return Boolean values. The IFP arithmetic functions work the same as those used in conventional languages.**

**IFP PRIMITIVE FUNCTIONS**

**Structural Functions**

Appending

```
X, <y1,y2,...yn> : apndl → <X,y1,y2,...yn>
<x1,x2,...xm>, Y : apndr → <x1,x2,...xm,Y>
```

Distributing

```
<X,<y1,y2,...yn>> : distl → <<X,y1><X,y2>...<X,yn>>
<<x1,x2,...xm>,Y> : distr → <<x1,Y><x2,Y>...<xm,Y>>
```

Selecting sections of a sequence

```
<<x1,x2,...xm>,K> : pick → xK
<x1,x2,...xm> : tl → <x2,x3,...xm>
<x1,x2,...xm> : tlr → <x1,x2,...xm-1>
<<x1,x2,...xm>,K> : takel → take first K elements from left end of X
<<x1,x2,...xm>,K> : taker → take " " " " right " "
<<x1,x2,...xm>,K> : dropl → drop " " " " left " "
<<x1,x2,...xm>,K> : dropr → drop " " " " right " "
```

Regrouping—input is a sequence of sequences

```
<<a b c> <1 2 3>> : trans → <<a 1> <2 b> <3 c>>
(transpose a matrix)
<<a b> <p> <x y z>> : cat → <a b p x y z>
(catenate sequences)
```

Miscellaneous

```
X : id → X
n : iota → <1,2,...n>
<x1,x2,...xm> : length → m
<x1,x2,...xm> : reverse → <xm,xm-1,...x1>
```

replication of the input when used in conjunction with construction. For example, you could write a function that squares its input:

```
DEF Square AS [id,id]*;
```

**Constant**

Not all PFOs have function parameters; some have object parameters. One such PFO is the constant PFO, which generates constant functions. Constant functions always return the same result when applied to any object that is not ? (bottom). Constant functions are written as an object (the value to be returned) preceded by a pound sign (#). For example,  $X : \# \langle \text{cat in hat} \rangle$  will yield  $\langle \text{cat in hat} \rangle$  for any value of *X*.

The exception, of course, is that if the object is undefined, the output will also be undefined. This is another aspect of the bottom-preserving property, in which undefined input always results in undefined output—in other words, garbage in, garbage out.

Constant functions introduce constants into a calculation. For instance, a function that takes the radius of a circle as in-

put and outputs the area could be written as

```
DEF CirArea AS
[Square,#3.141592] | *;
```

**Selector**

Selector functions return the *n*th element of a sequence where *n* is a positive integer. For example,  $\langle a b c d e \rangle : 2$  outputs *b*. There is also a corresponding set of select-from-right functions, written as *nr*. These select the *n*th element of a sequence, counting from the right. For example,  $\langle \text{apple banana cherry} \rangle : 1r$  outputs cherry. All selectors return ? if the argument has no *n*th element or is not a sequence.

**Apply to Each**

The apply-to-each PFO is a distributive form that applies a function to each element of a sequence. It is written as EACH *f* END. For example,  $\langle \langle 3 7 \rangle \langle 8 5 \rangle \langle 2 9 \rangle \rangle : \text{EACH } * \text{ END}$  multiplies each pair of numbers and results in  $\langle 21 40 18 \rangle$ . The function within EACH may be a more complex function; for example,

*continued*



**Arithmetic Functions**

Dyadic functions—*input*  $\equiv$   $\langle X, Y \rangle$

- +  $\rightarrow X+Y$
- $\rightarrow X-Y$
- \*  $\rightarrow X \times Y$
- %  $\rightarrow X \div Y$
- div  $\rightarrow$  greatest integer  $\leq X \div Y$
- mod  $\rightarrow X \bmod Y$
- power  $\rightarrow X^Y$
- min  $\rightarrow \min(X, Y)$
- max  $\rightarrow \max(X, Y)$

Monadic math functions—*input* is real number

exp, ln, sqrt, sin, cos, tan, arcsin, arccos, arctan

Miscellaneous

- X : add1  $\rightarrow X+1$
- X : sub1  $\rightarrow X-1$
- $\langle X_1, X_2, \dots, X_m \rangle$  : sum  $\rightarrow \sum_i X_i$
- X : minus  $\rightarrow -X$

**Logical Functions**

Comparison—*input*  $\equiv$   $\langle X, Y \rangle$

- =  $\rightarrow$  equal
- $\sim$   $\rightarrow$  not equal
- <  $\rightarrow$  less
- <=  $\rightarrow$  less or equal
- >=  $\rightarrow$  greater or equal
- >  $\rightarrow$  greater

Boolean functions—*A* and *B* are Boolean objects

- A :  $\sim$   $\rightarrow$  not *A*
- $\langle A, B \rangle$  : and  $\rightarrow A \wedge B$
- $\langle A, B \rangle$  : or  $\rightarrow A \vee B$
- $\langle A, B \rangle$  : xor  $\rightarrow A \oplus B$
- $\langle b_1, b_2, \dots, b_m \rangle$  : all  $\rightarrow$  every *b<sub>i</sub>* is true
- $\langle b_1, b_2, \dots, b_m \rangle$  : any  $\rightarrow$  at least one *b<sub>i</sub>* is true

Tests—*input*  $\equiv$  *X*

- atom  $\rightarrow$  *X* is an atom
- boolean  $\rightarrow$  *X* is a Boolean atom
- numeric  $\rightarrow$  *X* is a numeric atom
- null  $\rightarrow$  sequence *X* is empty

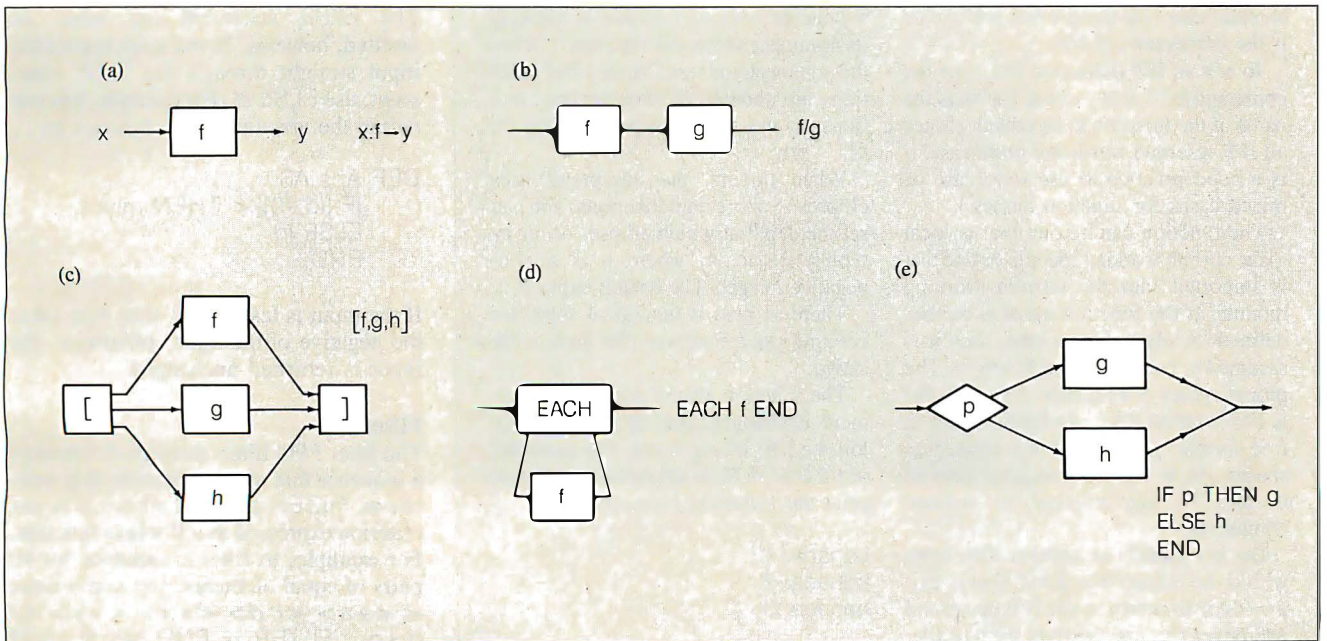

**Figure 2:** Each function has a single input and output (a). The composition PFO (b) connects the output of one function to the input of another function. The construction PFO (c) ties functions in parallel to one another. The

apply-to-each PFO (d) applies a function to each element of a sequence. The IF...THEN...ELSE PFO (e) lets you apply conditional functions.



## Running IFP

Before invoking IFP, you should set two environment variables. Set the EDITOR variable to the name of your favorite editor. The default editor is PC-Write (c:\ed.exe). Set the IFPDIR variable to the name of your favorite directory listing program. Normally you can use the AUTOEXEC.BAT file to set these variables. Below is a sample AUTOEXEC.BAT file:

```
set EDITOR = A:\edlin.com
set IFPDIR = A:\sd2.com
```

To start an IFP session, change your current working directory to a directory on the IFP functions disk. Then execute the program called ifp.exe. Your current working directory becomes your current working IFP module. There is no way to change your current working directory from within IFP; you must leave the interpreter and change directories from the command level of DOS. When IFP is ready, it will respond with the prompt ifp>.

To end an IFP session, enter the command exit at the prompt. All function definitions are kept in disk files, so you shouldn't lose anything when you exit or if the computer crashes.

To edit an IFP definition file, type the command ed *name*, where *name* is the name of the function to be edited. (Since all IFP reserved words are uppercase, it is a good practice to use lowercase or mixed cases for function names.)

The function can be one that is local to the current working module or one that is imported into the current working module. If the function name is neither defined locally nor imported, then it is assumed to be a new local function. The proper syntax of a function definition file is DEF *name* AS *f*:. Definitions are in free format; line breaks are treated as spaces. As in Pascal, matching pairs of (\* and \*) are utilized to delimit comments.

Do not switch to another file from within the editor. You must always exit the editor to return to the IFP command interpreter first and then edit the next file. Otherwise, the interpreter won't know that its internal copy of a function is invalid.

To apply an IFP function, type the statement

```
show object : function;
```

The interpreter evaluates the result of applying the function to the object. The result is then printed at the terminal.

To list your functions, type dir at the prompt. The directory listing program specified by IFPDIR will be invoked. My directory lister won't work unless I type a trailing slash (dir/). I have not tried any other directory listing program.

To delete a function, type del *f* at the prompt. The function definition file (along with the memory copy) will be deleted. Wildcards are not permitted in the function name. Do not try to delete files with extensions (such as .bak) from within IFP; since filenames are truncated to eight characters, IFP may delete the wrong file.

### Tracing Functions

Currently, IFP has a simple program trace mechanism. To trace a function, at the prompt type trace on *f*1, *f*2, . . . *f**n*:, where the *f* is the function to be traced. Whenever a traced function is invoked, its argument and result are shown. Also, the argument and result of all called functions are shown. To stop tracing functions, at the prompt type trace off *f*1, *f*2, . . . *f**n*;

When tracing, the interpreter uses ellipses to abbreviate functions. You can set the depth at which ellipses occur by typing depth *n*, where *n* is a non-negative integer. The default depth is 2.

There is also a functional form for creating trace functions. Its form is @ *string*.

The function always returns its argument unchanged, and it prints *string*: followed by its argument. For example, <1 2 3> : EACH @banana END will print the following messages:

```
banana: 1
banana: 2
banana: 3
```

This tracing form is for debugging only, since it creates a side effect—the message.

you can square a sequence of numbers: <2 10 4 3 5> : EACH [id,id] | \* END, which yields <4 100 16 9 25>. In effect, the EACH command chops the input sequence into separate objects, feeds each object to the parameter function, and assembles the corresponding outputs (figure 2d).

### IF...THEN...ELSE

The IF...THEN...ELSE PFO lets you apply conditional functions. It is written as *x* : IF *p* THEN *g* ELSE *h* END. Interpreted, that function would read, "If *p*(*x*) is true, then evaluate *g*(*x*); if *p*(*x*) is false, then evaluate *h*(*x*)" (figure 2e).

The level of nesting of conditional forms can be reduced by using ELSIF clauses. For example:

```
IF p1 THEN f1
ELSE
  IF p2 THEN f2
  ELSE
    IF p3 THEN f3
    ELSE g
  END
END
END
```

can be rewritten as

```
IF p1 THEN f1
ELSIF p2 THEN f2
ELSIF p3 THEN f3
ELSE g
END;
```

The ELSE statement can never be omitted, however. If you want to pass the input straight through the ELSE statement, use ELSE id. For example, you can define the absolute value function as

```
DEF Abs AS
  IF [id,#0] < THEN minus
  ELSE id
END;
```

If the input is less than 0, then Abs takes the negative of the input; otherwise, the input is returned unchanged.

### Filter

The filter PFO filters through elements of a sequence that meet a criterion. It is written as FILTER *p* END, where *p* is the criterion expressed as a Boolean function. For example, to filter a sequence for all pairs of equal elements, you could write <<aa> <cd> <xx> <yy> <r g>> : FILTER = END, which would result in <<aa> <xx> <yy>>. The FILTER function is an IFP extension to Backus's Functional Programming. Though FILTER can be done in terms of

*continued*



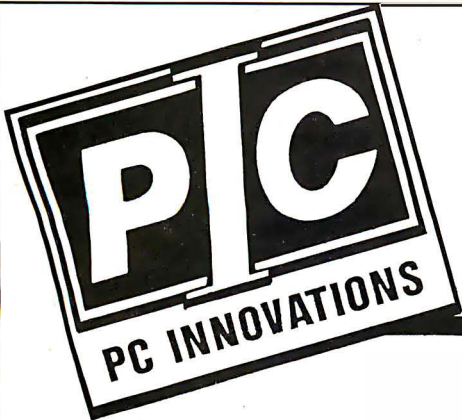

# PIC THE BEST!!!

ALL ITEMS IN STOCK AVAILABLE FOR IMMEDIATE DELIVERY

PIC A COMPLETE BUSINESS SYSTEM AND SAVE

## PIC AT 1800+

- 512K RAM Expands to 1MB
- 33% Faster Than IBM AT
- 1.2MB Floppy Drive
- 8/6 MHZ CPU 80286-8
- USA BIOS Fully Compatible
- Clock/Calendar W/Battery
- Hard Disk/Floppy Controller
- AT Style Keyboard
- 195 Watt Power Supply
- 48 Hour Burn In
- Full Documentation
- Includes Setup Software
- One Year Limited Warranty

## PIC AT 1800+

# \$995

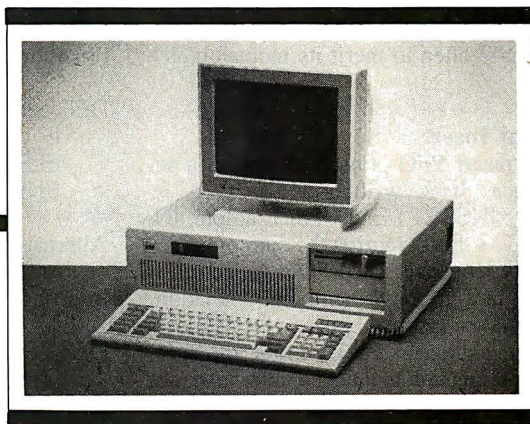

Made in U.S.A. Enhanced Keyboard Available 10 & 12 MHZ Systems Available

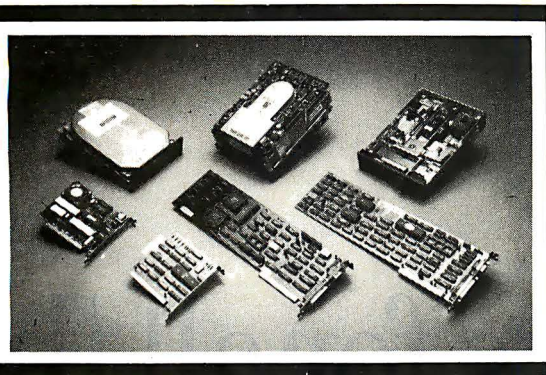

## PIC YOUR DRIVES

Seagate ST225	.....\$310
Seagate 20MB	.....\$529
Seagate 30MB	.....\$595
Seagate 40MB	.....\$679
Seagate 80MB	.....\$1099
Toshiba 72 MB	.....\$1050
Toshiba 3 1/2" Floppy Kit	..\$145

## PIC YOUR MONITORS

NEC Multisync	.....\$569
PIC EGA	.....\$439
Samsung TTL	.....\$99
PIC CGA	.....\$309

## PIC YOUR BOARDS

PIC EGA	.....\$209
Everex EGA	.....\$229
PIC CGA	.....\$99
PIC Monographics	.....\$99
AT Multifunction	
Up to 2MB	.....\$169
PIC AT/XT 2MB EMS	...\$125

## PIC YOUR PRINTERS

Epson LQ 1000	.....\$739
Epson EX 1000	.....\$739
NEC P560	.....\$975
NEC P660	.....\$475
NEC P760	.....\$650
Toshiba 321	.....\$525
Toshiba 341	.....\$757

## PIC COMMUNICATIONS

US Robotics 2400 INT	.....\$199
US Robotics 1200 EXT	.....\$119
Everex 1200 INT	.....\$128
Everex 2400 INT	.....\$249

Inquire about our Multi-User and Local Area Networks including RS232, Novell, Alloy and Xenix Systems.

VISA & MC WELCOME  
QUANTITY DISCOUNTS AVAILABLE  
PRICES SHOWN ARE CASH PRICES ONLY

## PIC XT TURBO SYSTEM

1 Floppy, 640K, and Choice of:	
20MB, Mono	.....\$1195
30MB, Mono	.....\$1295
20MB Color	.....\$1295
30MB Color	.....\$1395

FCC Approved

ALL PRICES SUBJECT TO CHANGE  
DUE TO LIMITED QUANTITIES, WE RESERVE  
THE RIGHT TO SUBSTITUTE EQUIVALENT ITEMS.

CORPORATE AND UNIVERSITY P.O.'S ACCEPTED.

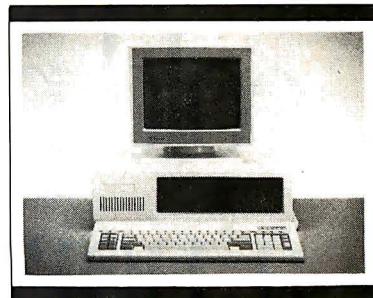

## PC INNOVATIONS

10 Hughes St., Suite A-200  
Irvine, CA 92718  
(714) 768-8130

1421 E. Goldsmith  
Plymouth, MI 48170  
(313) 451-0664

ESTABLISHED SINCE 1980

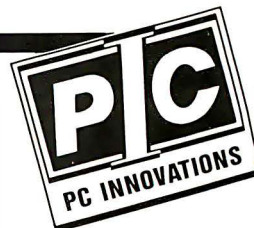



*In IFP, the notion of correspondence is implemented directly as the structural function trans.*

other functions and PFOs, it occurs sufficiently often to merit its inclusion as a PFO.

#### Right Insert

The insert PFO is used to reduce a sequence. It is written as  $\langle x_1, x_2, \dots, x_n \rangle : \text{INSERT } f \text{ END}$ . For example,  $\text{INSERT } + \text{ END}$  returns the sum of a non-empty sequence. The PFO is called insert because if  $f$  were written in infix notation, it would be inserted between the elements of the sequence. For example, the summation function mentioned above expands as  $\langle x_1, x_2, x_3 \rangle : \text{INSERT } + \text{ END}$  to yield  $(x_1 + (x_2 + (x_3 + (\dots))))$ . The  $\text{INSERT}$  PFO is much the same as  $\text{EACH}$ , except that it sends pairs of values to its parameter function.

Functions formed with  $\text{INSERT PFO}$  are always undefined for empty sequences. This differs from Backus's Functional Programming, in which such functions returned the right identity element of the parameter function. In theory, this is a convenient feature (e.g., summing an empty sequence would yield 0), but it is impractical for the interpreter to know the identity element of user-defined functions. There are so few cases in which the interpreter could know the identity element that we might as well define special functions for those cases, such as:

```
DEF sum AS
  IF null THEN #0
  ELSE INSERT + END
END;
```

Alternatively, we can append the identity element to the end of the sequence before inserting

```
DEF sum AS
  [id,#0] | apndr | INSERT +
  END;
```

Note that  $\text{INSERT}$  starts at the right of the sequence. Currently there is no "left insert" that would reduce a sequence start-

ing from the left. We can get the same effect, however, with  $\text{INSERT}$  and the sequence reversal function:  $\text{reverse} | \text{INSERT reverse} | f \text{ END}$ .

#### WHILE...DO

The last PFO is  $\text{WHILE} \dots \text{DO}$ , which allows indefinite composition. It is written as  $\text{WHILE } p \text{ DO } f \text{ END}$ ; That is, apply the fewest  $f$ s required such that  $x:f:f:\dots:p$  is true. The  $\text{WHILE}$  PFO lets us rewrite some recursive programs non-recursively. For example, consider the recursive function  $\text{Last}$ , which finds the last element of a sequence by recursively shortening the input sequence:

```
DEF Last AS
  IF t1 | null THEN 1 (* case
    of one-element sequence *)
  ELSE
    t1 | Last (* recursive
      case *)
  END;
```

(The  $t1$  function takes all but the first element from a sequence; the null function checks if a sequence is empty.) We can rewrite  $\text{Last}$  nonrecursively as

```
DEF Last AS
```

Thanks for all the  
cold pizza, drinking diet  
a 'normal' job.



```
WHILE t1 | null | ~ DO
  t1
END |
1;
```

(The tilde is the “not” function.) This version of Last keeps taking the tail of the input while there is more than one element left. The WHILE function will then output a one-element sequence for which we take the first element. In the case of Last, we could have also used the insert PFO:

```
DEF Last AS
  INSERT 2 END;
```

Note that the INSERT version of Last works from the back to the front of the input sequence; the WHILE version works from front to back.

### Replacing Subscripts and Loops

The von Neumann languages deal with scalar items directly. To handle larger structures such as arrays, loops, and subscripts, you indicate the necessary steps and connections within a computation. Consider adding two vectors  $A$  and  $B$  in a Pascal program; you would write

```
for K:=1 to N do
```

```
C[K] := A[K] + B[K];
```

In English, the algorithm would be stated, “Each element of the result is the sum of the corresponding elements of the arguments.” The key word here is “corresponding.” In Pascal, the loop and subscripts accomplish the correspondence. In IFP, the notion of correspondence is implemented directly as the structural function `trans`, which groups corresponding elements. For example,  $\langle \langle a \ b \ c \ d \rangle \langle 1 \ 2 \ 3 \ 4 \rangle \rangle$  : `trans` results in  $\langle \langle a \ 1 \rangle \langle b \ 2 \rangle \langle c \ 3 \rangle \langle d \ 4 \rangle \rangle$ . (The name `trans` comes from “transpose.” If each subsequence represents a row of a matrix, `trans` transposes the matrix.)

The vector addition program in IFP makes the correspondence and then adds each pair:

```
DEF VectorAdd AS
DEF trans|EACH + END;
```

The input to the IFP program would be a pair of vectors. For example, to add the vectors  $\langle 1,10,100 \rangle$  and  $\langle 4,3,2 \rangle$ , we would write  $\langle \langle 1 \ 10 \ 100 \rangle \langle 4 \ 3 \ 2 \rangle \rangle$  : `VectorAdd`, which would yield  $\langle 5 \ 13 \ 102 \rangle$ .

Now you should know enough to write

the IFP version of the inner product program listed at the beginning of this article. First, make the correspondence, then take each product, and finally sum the products:

```
DEF Inner AS
  trans |
  EACH * END |
  INSERT + END;
```

The corresponding data-flow graph is shown in figure 3. Compare its simplicity with the graph for the Pascal program.

Scaling a vector demonstrates another common structural function. In Pascal, you would scale vector  $A$  by scale factor  $S$  with the following program fragment:

```
for K:=1 to N do
  B[K] := S * A[K];
```

Each element of the input vector is multiplied by the scale factor. Structurally, the scale factor is being distributed over each vector element. In IFP, this distribution is done directly by the `distl` function. The name `distl` stands for “distribute from left.” It distributes the left argument over each element of the right argument. The

*continued*

# nights you spent eating soda and wishing you had

This is for Steve Klein and Dave Rolfe... two partners of Singular Solutions Engineering of Pasadena, California, and for the more than 100 other people at Lotus® who comprised the Lotus HAL™ team. Without their help, Lotus HAL would never have become what it is today: one of the most successful new releases in personal computer software since 1-2-3®. Thanks.

Lotus Development Corporation

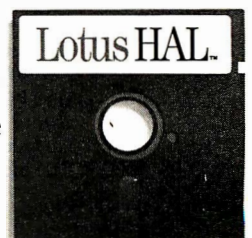



statement `<a <1 2 3 4>> : distl yields <<a 1> <a 2> <a 3> <a 4>>`.

You can apply a function to each pair formed by `distl` with the `EACH` PFO. The vector scaling function could be written as `DEF VectorScale AS distl | EACH * END;`. Each resulting pair has the distributed argument on the left side. The

mirror image of `distl` is `distr`, which distributes the right argument over the left argument. For example, `<<1 2 3 4> z> : distr results in <<1 z> <2 z> <3 z> <4 z>>`.

Another important structural function is the outer product. Suppose we want to generate a Boolean matrix that is the result

of comparing all elements in vector  $X$  against all elements in vector  $Y$ . In Pascal, we would write

```
for J:=1 to N do
  for K:=1 to M do
    C[J,K] := X[J] = Y[K];
```

To write the routine in IFP, you need a structural function that takes all possible pairs from two sequences. Such a function can be defined from functions already discussed. In the Pascal program above,  $X[J]$  does not change within the inner loop—the  $X[J]$  distributes across each  $Y[K]$ . In IFP you can compute all possible pairs by combining `distl` and `distr`; for example, you could write `<<a b c> <1 2 3>> : distr | EACH distl END`.

To make the comparisons, you could use two levels of `EACH` and apply the resulting function to the pair  $\langle X Y \rangle$ . Of course, when you have two levels of `EACH` composed, you can merge. Therefore, you could write the Compare function as the following:

```
DEF Compare AS
  distr |
  EACH
    distl | EACH = END
  END;
```

The outer product function occurs quite frequently, so you might want to define it:

```
DEF Outer AS
  distr | EACH distl END;
```

The simplicity of that definition is another advantage of structural functions. In Pascal, the outer product would be difficult if not impossible to make into a separate procedure. So whenever an outer product is necessary in Pascal, the programmer must rewrite it from for loops. In IFP, you define it only once.

At first glance you may think structural functions are grossly inefficient compared to loops and subscripts. Actually, for an interpreter structural functions are quite efficient for two reasons. First, the sequences are represented internally as shared linked lists, so when the interpreter appears to copy large chunks of data, it really just copies the top levels of the lists. Second, the structural functions are interpreted only once. An equivalent BASIC interpreter must interpret the subscript expressions every time through the loop.

### A Larger Program

All the examples so far have been trivial. To show the real power of functional programming, I'll show the quicksort algorithm in IFP. `QuickSort` sorts a sequence of keys, which in this example are real

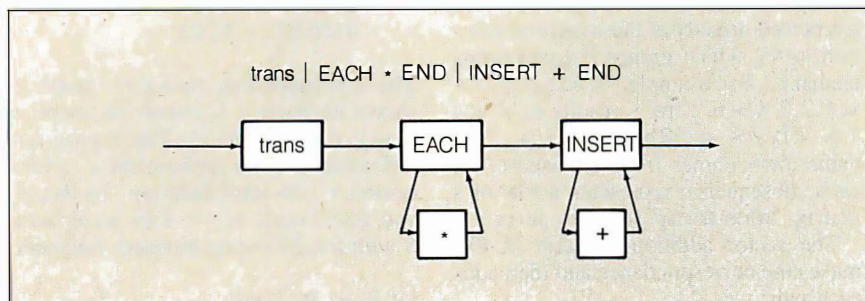

Figure 3: The data flow of the inner product program is greatly simplified when written in IFP. Compare with the data flow in figure 1.

Listing 1: The quicksort algorithm in Pascal has complicated interactions between loops and subscripts that obscure the basis of the algorithm.

```
(*
* QuickSort
*
* Sorts a sequence of numbers into ascending order using
* quicksort algorithm.
*
* Parameters:
*   A = array to be sorted
*   L = index of first element in A
*   U = index of last element in A
*)
type Sequence = array [1..100] of real;

procedure QuickSort (var A: Sequence; L,U: integer);

  var J,K: integer;

  procedure Swap (var X,Y: real);
    var T: real;
  begin
    T:=X;
    X:=Y;
    Y:=T;
  end;

  begin
    if L<U then
      begin
        J:=L;          (* A[L] is the partition key *)
        K:=U;
        repeat
          while (J < U) and (A[J] <= A[L]) do J:=J+1;
          while (L < K) and (A[K] >= A[L]) do K:=K-1;
          if J<K then Swap (A[J],A[K]);
        until J>=K;
        Swap (A[L],A[K]);
        QuickSort (A,L,K-1); (* Sort lower partition *)
        QuickSort (A,K+1,U); (* Sort upper partition *)
      end;
    end;
```



IFP TUTORIAL

**Listing 2:** In IFP, the basis of the quicksort algorithm can be identified easily. (Although the algorithms in listing 1 and 2 are not exactly the same, each implements the quicksort idea as simply as possible in the respective language.)

```
(*
 * QuickSort
 *
 * This function sorts a sequence of numbers or strings
 * into ascending order using the Quicksort algorithm.
 *
 * Examples:
 *
 * <3 1 4 1 5 9 2> : QuickSort == <1 1 2 3 4 5 9>
 *
 * <all work no play> : QuickSort == <all no play work>
 *
 * The sequence may not mix strings and numbers.
 *)

DEF QuickSort AS
  IF [length,#2] | < THEN id
  ELSE
    [id,1] | distr |
      FILTER < END | EACH 1 END | QuickSort,
      FILTER = END | EACH 1 END,
      FILTER > END | EACH 1 END | QuickSort
    ] | cat
  END;
```

numbers to be sorted into ascending order. If the sequence contains fewer than two elements, no sorting is required. If the sequence contains at least two keys, then the first element is chosen as the partition key. All elements less than the partition key are picked out and sorted recursively. Likewise, all elements greater than the partition key are also picked out and sorted recursively. The sorted subsequences are then catenated with all the elements that were equal to the partition key.

Listing 1 shows QuickSort written in Pascal. The loops and subscripts obscure the basis of the algorithm—that of restructuring the sequence into subsequences. Listing 2 shows QuickSort written in IFP. Not only is the restructuring basis of the algorithm more obvious, but the fact that all the partition-key comparisons (in the FILTER) can be done in parallel is clear. (Admittedly, the algorithms in the two listings are not quite the same; each implements the basic quicksort idea as simply as possible in its respective language.)

**Future Directions**

A lot of work is still required to make functional programming more practical than conventional languages. Input and output, graphics, abstract data typing, and efficient compilation require research and development. Backus has described how inputs to functions can be named without losing the structured flow graphs. But despite its current primitive form, functional programming is worth trying.

It will give you a new perspective on programming.

Editor's note: *IFP.TXT* (the IFP reference manual) is available on disk, in print, and on BIX. *IFP.EXE* is available on BIX for users with IBM PCs. See the insert card following page 328 for details. Listings are also available on BYTenet. See page 4. ■

**BIBLIOGRAPHY**

Backus, John. "Can Programming Be Liberated from the von Neumann Style? A Functional Style and Its Algebra of Programs." *CACM*, vol. 21, 8, pages 613-641, August 1978.

Backus, John. "The Algebra of Functional Programs: Functional Level Reasoning, Linear Equations, and Extended Definitions." *Formalization of Programming Concepts*. New York: Springer-Verlag, 1981.

Baden, Scott. "Berkeley FP User's Manual, revision 4.1." *UNIX Programmers Manual*, July 27, 1983.

Darlington, J., et al. *Functional Programming and Its Applications*. New York: Cambridge University Press, 1982.

Harrison, Peter G., and Hessam Khoshnevisan. "Functional Programming Using FP." *BYTE*, August 1985.

Robison, Arch D. "A Functional Programming Interpreter." Thesis, University of Illinois, Urbana-Champaign, 1987.

Robison, Arch D. "IFP User's Manual." Professional Workstation Research Group Technical Report #7, University of Illinois, Urbana-Champaign, 1985.



**NEIL J. RUBENKING**  
**PIANOMAN, NAMEGRAM**

Author Rubenking's goals are straightforward: to have fun with computers and get paid for it. So far he is battling 1000. Along with his technical support position he also edits a column in PC Magazine titled "Turbo Power User". His *PIANOMAN* and *NAMEGRAM* programs evolved while he was teaching himself Turbo Pascal programming. Finding basic computer tunes "offensive" his *PIANOMAN* used his musical background as a source to create music on a PC (within the limits of its 2" speaker).

*PIANOMAN* allows you to:  
Play your PC keyboard as if it were a piano, Save and edit your tunes, Compile your tunes to a self-running program & another option turns your tune into a macro for Superkey.

*NAMEGRAM* is wild, wacky and is a must for anagram (the ability to make a word or phrase from another word or phrase) freaks. After experimenting with algorithms, author Rubenking came up with a program that would handle any size of input and any size of dictionary.

- 279 *PIANO MAN V3* ..... \$6
  - 477 *NAMEGRAM/BREAK DOWN/PHONE WORD* ..... \$6
  - 5 *PC-FILE III Version 4*, an excellent database manager for labels, inventory, and form letters .... \$6
  - 78.627 *PC-WRITE VERSION 2.7/4* A powerful wordprocessor, that is easy to use ..... \$12
  - 199 *PC-CALC* Make a spreadsheet to track expenses, a budget or whatever ..... \$6
  - 212,334,621,622 *RBBS VERSION 14.1a* Set up a bulletin board for your local area ..... \$24
  - 310 *QMODEM COMMUNICATIONS* — Send letters or programs to your friends or business constituents . \$6
  - 403 *COMPUTER TUTOR* — Learn to use your computer, great for new users ..... \$6
  - 405 *DESKTEAM* — A memory resident calculator, calendar, printer utility, phone dialer, and other desk organizational tools ..... \$6
  - 480 *PC-OUTLINE* Program comparable to Thinktank \$6
- 
- PC-SIG LIBRARY ON CD ROM* ..... \$195.00
  - NEW 1987 PC-SIG DIRECTORY* ..... \$ 12.95
  - 1 YEAR PC-SIG MEMBERSHIP* ..... \$ 20.00
- (\$36 Foreign) (Includes directory, bimonthly magazine and more.)

**SPECIAL**  
**Any 5 Disks plus**  
**1-Year Membership**  
**Only \$39** (Include \$4 shipping & handling)

*Most programs have documentation on disk and request a donation from satisfied users. Please add \$4 postage and handling per order (\$10 foreign) — California residents add state sales tax. #294*

Total Enclosed \$\_\_\_\_\_ by  Check  VISA  MC  
 Card No. \_\_\_\_\_  
 Exp. date \_\_\_\_\_ Signature \_\_\_\_\_  
 Name \_\_\_\_\_  
 Address \_\_\_\_\_  
 City \_\_\_\_\_ State \_\_\_\_\_ Zip \_\_\_\_\_

**PCSIG** To order, call: 800-245-6717  
 In CA: 800-222-2996  
 For technical questions or local orders: (408) 730-9291  
 10300 East Duane Avenue Sunnyvale, CA 94086



# OTHERS PALE B

## SHIPMENTS BY MONTH

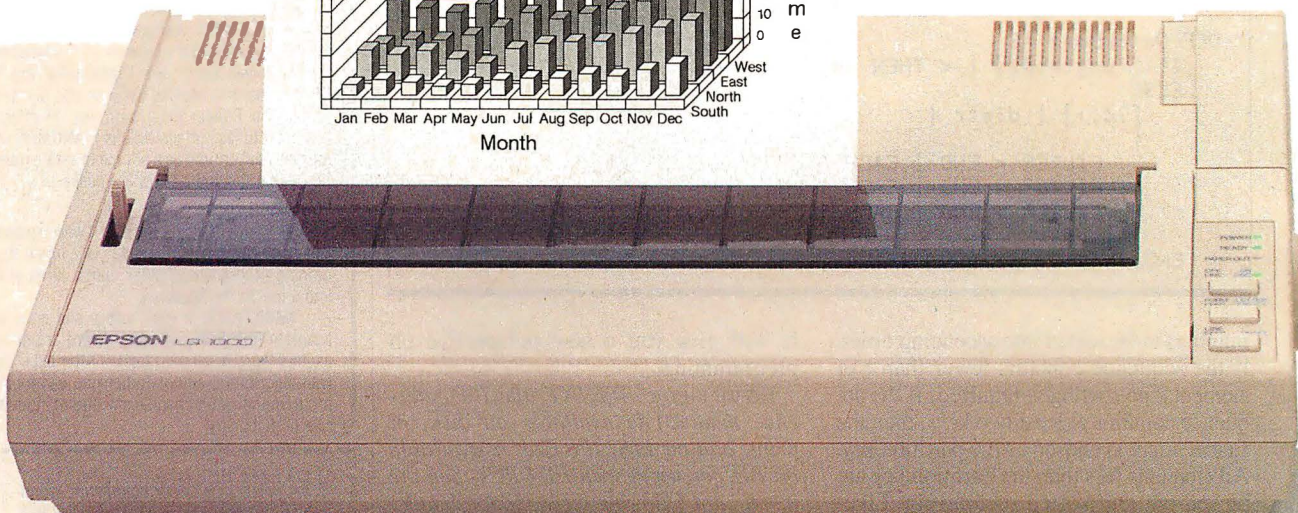
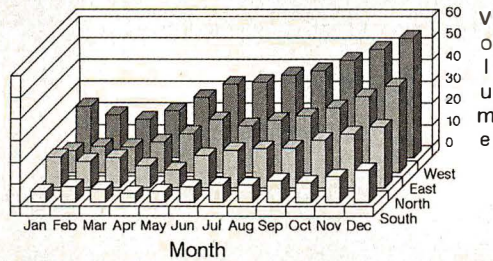

The small printer on the left seems positively unexciting next to the new ALPS ALQ300.

And it's not just because of our colorful personality.

You see, the ALQ300 is a lot faster. It handles bidirectional graphics with flying colors. And for black and white work—spreadsheets, letters, you name it—the ALQ300

zips along as fast as 240 cps.

It can do more things. It has snap in/out 24- or 18-pin print heads. Multiple font cartridges. Paper handling extras like auto-

matic single sheet feed and bottom feed. And of course, it runs with all the most popular PCs and software.

It's much easier to use, too. Because you do everything

Both offer the same great features as the first dot matrix printers with resolution quality. They quietly print at speeds you're versatile. A full range of models, transparencies, multiple-part files, pitches and fonts.

*The ALQ300 prints everything from the letter quality text you see here, to high resolution graphics in seven colors.*



# Y COMPARISON.

## SHIPMENTS BY MONTH

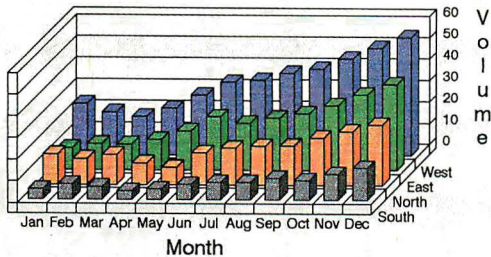

ALPS ALQ300

on the front panel. Change type styles and print modes. Load paper. Even override your software. All without software commands or DIP switches.

You may have also noticed that the ALQ300 looks more substantial. It is. Treat it right and it'll run over five years without a breakdown.

You may also expect that the ALQ300 is more expensive. It isn't. Our 24-pin version has a suggested retail price of just \$995.

And our 18-pin model is \$100 less.

Now it's time to make your own comparison. Call us for a free demo or more information at **(800) 828-ALPS**. In California, (800) 257-7872.

And you'll find there really isn't any comparison to make.

**ALPS**  
AMERICA

**IT'S TIME YOU SAW THE ALPS.**



# 1/2 Size, 1/2 Cost & Not A Clone! Monochrome Graphics 1/2 Card — \$139 v.s. \$295\*

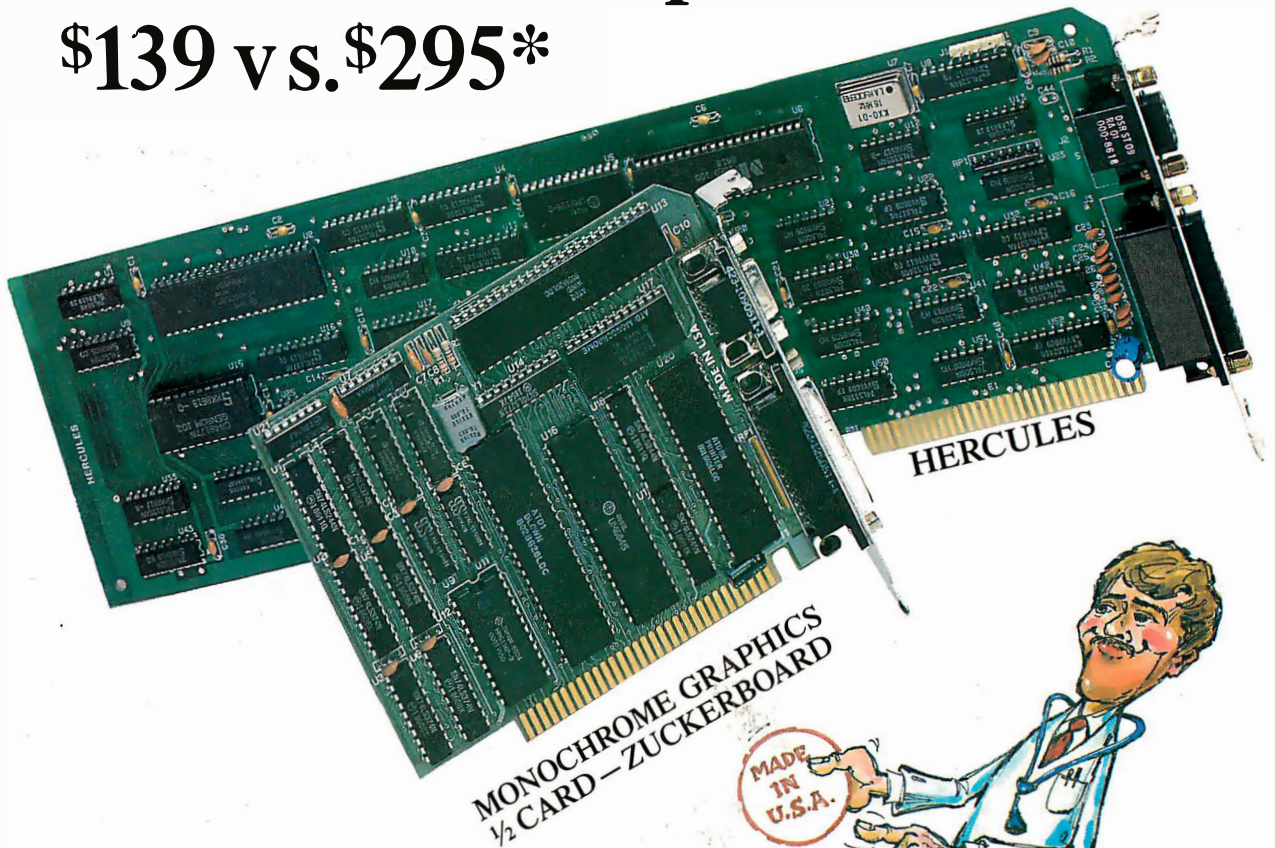

In California Call:  
In Colorado Call:  
In Florida Call:  
  
In Georgia Call:  
  
In Illinois Call:  
  
In Massachusetts Call:  
In New York Call:

Kenfit Software @ 800-662-0505  
Micro Data Products @ 303-360-6200  
First Source @ 305-648-0501  
O'Toole Interprises @ 800-558-9379  
P.C. Distributors @ 800-428-1888  
Majors Distributing @ 404-454-8281  
Ashford International @ 404-939-7533  
Comark, U.S.A. Flex @ 800-323-6135  
P.C. Distributing @ 312-298-1400  
State Wide @ 312-932-0890  
J.H. Lawrence @ 800-221-3328  
Great Lakes Distributing @ 716-691-8981  
KBL Marketing @ 516-434-9010  
Manchester Equipment @ 516-435-1199  
Micro-Buy @ 516-420-1633

In Ohio Call:  
In Connecticut Call:  
In Tennessee Call:  
In Texas Call:  
  
In Virginia Call:  
In Canada Call:  
In Pennsylvania Call:

Infotel @ 513-663-5488  
Amdex Computer Inc. @ 716-586-5910  
P.C. Distributing @ 800-626-0012  
Multi Computer Products @ 800-648-4419  
Compu D Distributors @ 214-264-2626  
Hiltz Computer Products @ 800-433-1007  
Video Electronics, Inc. @ 800-527-8731  
TCS Supply Distributors @ 703-591-5054  
JB Marketing @ 613-938-3333  
People & Technology @ 800-247-5494

Dr. Dr. Zucker

## It's another ZUCKERBOARD



235 Santa Ana Court • Sunnyvale, CA 94086  
(408) 720-1942 • 1-800-458-6200 CA • 1-800-624-4920 US

Hercules is a trademark of Hercules Computer Technology, Inc.  
\* Average price of 400 dealers according to June 1986, survey by Stone Board Inc., Dallas, Texas  
ZUCKERBOARD is a registered trademark of Advanced Transducer Devices, Inc.

Inquiry 327



Richard F. Retter and Andrew N. Morelli Jr.

# Build Your Own 256K Amiga Expansion RAM

*Assembling this module can save you over a hundred dollars*

**T**he Amiga comes with the standard 256K bytes of RAM. The optional 256K expansion cartridge retails for \$195, but you can build it for about \$50.

The first step is to gather all the parts. Most can be purchased from stores such as Radio Shack, and the dynamic RAM chips can be obtained from suppliers such as Microprocessors Unlimited. Another good source of parts is Jameco Electronics. Here's what you'll need:

- One Radio Shack Memory IC PC Board, Cat. No. 276-184
- Eight 18-pin, solder-tail, low-profile IC sockets
- Eight 0.01-microfarad, monolithic tantalum capacitors
- Fourteen 39-ohm, 0.25-watt carbon resistors
- One 28/56- or 30/60-contact PC card edge connector, PC mount short-pin type, with 0.156-inch spacing
- Eight 64K by 4-bit dynamic RAMs, 150 ns (Hitachi HM50464P-15)
- Miscellaneous 28-gauge wire-wrap wire

## Construction

Assemble the module by following these nine steps:

1. Prepare PC board. Remove the four long ground strips on the Radio Shack board with a razor and pliers. Using a small drill or an X-acto knife, cut all traces marked with an X in figure 1.
2. Drill 16 holes for the eight capacitors. (Each RAM chip has one capacitor positioned above it.)
3. Depending on the connector obtained, drill either 56 or 60 holes for the connector. The connector (and thus the holes you drill) must be as close to the edge of the PC board as possible, otherwise you will

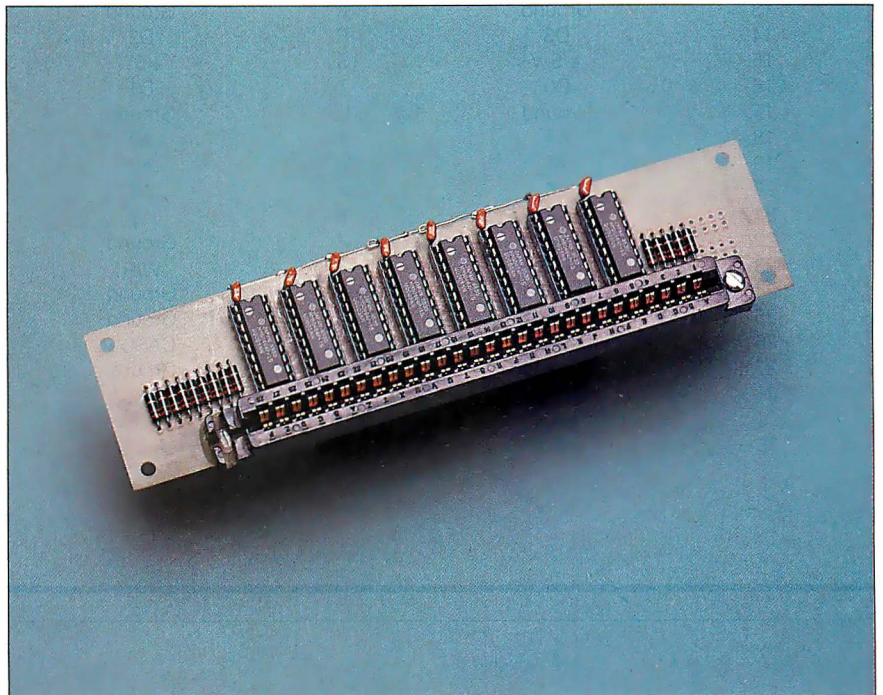

not be able to insert the RAM chips into their sockets. (See table 1 for connector pin-out.)

4. Prepare the connector (28/56-contact users only). In order to fit the 28/56-contact connector onto the 30/60-finger Amiga bus you will have to cut a groove in the end of the 28/56 connector. The correct end to groove is the high-numbered end—the end closest to contacts 28/FF. A good tool to use for this operation is a Dremel tool. Note the use of a nonconductive nylon screw in the slot cut in the end of the connector. The head of the screw must be filed to fit into the slot cut in the connector. (See the component side of the PC board in the photo.)

Note also that 30/60-contact connectors of the proper type are extremely rare, if

not impossible to find. Thus the references to the readily available 28/56-contact connector. Use low-profile sockets and PC mount, short-pin type connector only, to

*continued*

*Richard F. Retter holds a B.A. in chemistry from Western Connecticut State College. He is pursuing a master's degree in computer science and is involved in research on zinc bromide batteries. He can be contacted at 14 Myrtle Ave., Danbury, CT 06810.*

*Andrew N. Morelli Jr. holds a B.S.E.E. from Florida Institute of Technology. He is a manager and design engineer in the field of processor control equipment. He can be contacted at 23 Smith St., Danbury, CT 06810.*



**Table 1:** List of connector pins and signals.

CONNECTOR PIN-OUT			
Connector Pin#	Description	Connector Pin#	Description
1	Ground	A	Ground
2	D15	B	D14
3	+5 V	C	+5 V
4	D14	D	D13
5	Ground	E	Ground
6	D11	F	D10
7	+5 V	H	+5 V
8	D8	J	D9
9	Ground	K	Ground
10	D7	L	D6
11	+5 V	M	+5 V
12	D4	N	D5
13	Ground	P	Ground
14	D3	R	D2
15	+5 V	S	+5 V
16	D0	T	D1
17	Ground	U	Ground
18	A4	V	A3
19	A5	W	A2
20	A6	X	A1
21	A7	Y	A0
22	Ground	Z	Ground
23	RAS	AA	W/R
24	Ground	BB	Ground
25	Ground	CC	Ground
26	CASU0	DD	CASU1
27	Ground	EE	Ground
28	CASL0	FF	CASL1
29	+5 V	HH	+5 V
30	+5 V	JJ	+5 V

keep the depth of the board to a minimum. 5. Use epoxy to glue the connector to the PC board. Keep epoxy away from the connector leads. Correct orientation is shown in figure 1.

6. Solder the sockets to the PC board. Bend and tack-solder resistors to the board, referring to figure 1 for the proper resistor locations.

7. Place capacitors into board and hold them in place with epoxy or tape. At this point cut all leads to the same length as the RAM socket leads. If this isn't done, the board will stick out too far and the snap-on cover will not fit over the board.

The colored outlines in figure 1 indicate the locations of RAM chips, resistors, and capacitors. The Xs indicate etch cuts: Note that one lead of each bypass capacitor is inserted into a hole in the PC board. The other lead is soldered, daisy-chain fashion, to the exposed lead of the adjacent capacitor until the last capacitor is encountered. The exposed lead of the last capacitor (at the end of the daisy-chain) is soldered to +5 volts. Note: If the tantalum capacitors you use are polarized (have a + on one lead), this must be the lead that gets daisy-chained and tied to +5 V. See photo.

8. Solder all wires according to the information given in table 2. Keep all wires short, neatly routed, and as close to the circuit board as possible to reduce crosstalk and noise.

9. Carefully insert the eight RAM chips. Use caution, as 64K by 4-bit dynamic RAMs are extremely sensitive to static.

**Installation Notes**

Once the board has been completely wired, double-check the wiring using  
*continued*

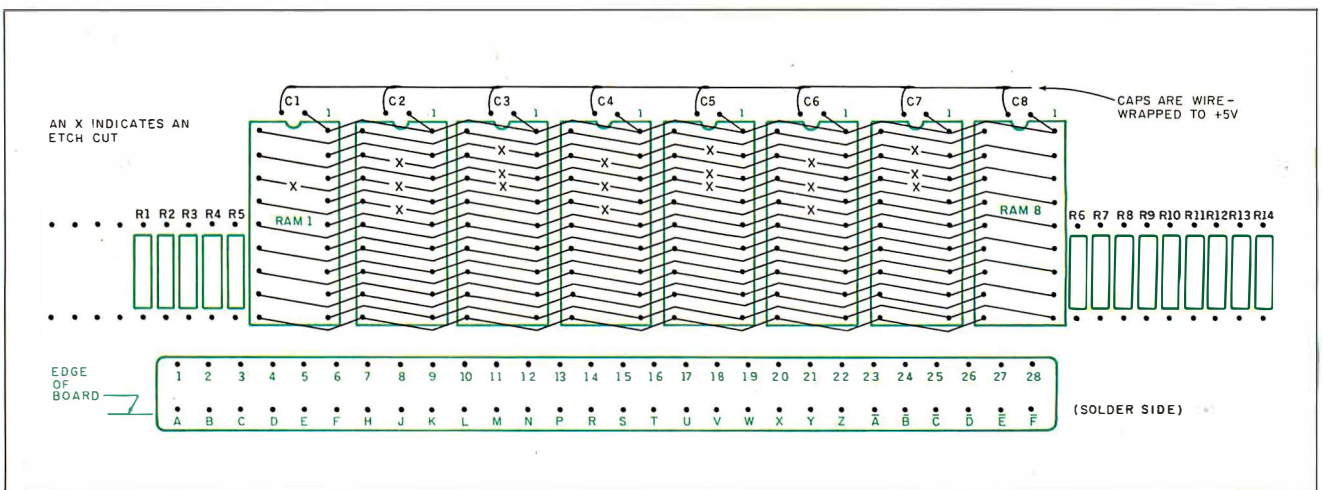

**Figure 1:** The printed circuit side of the 256K Amiga expansion RAM board. Colored outlines show the position of RAM chips, resistors, and bypass capacitors. The Xs indicate etch cuts. Note the line at the left of the connector, indicating the correct position of the connector with respect to the edge of the circuit board. This spacing is critical if the board is to plug into the Amiga correctly.



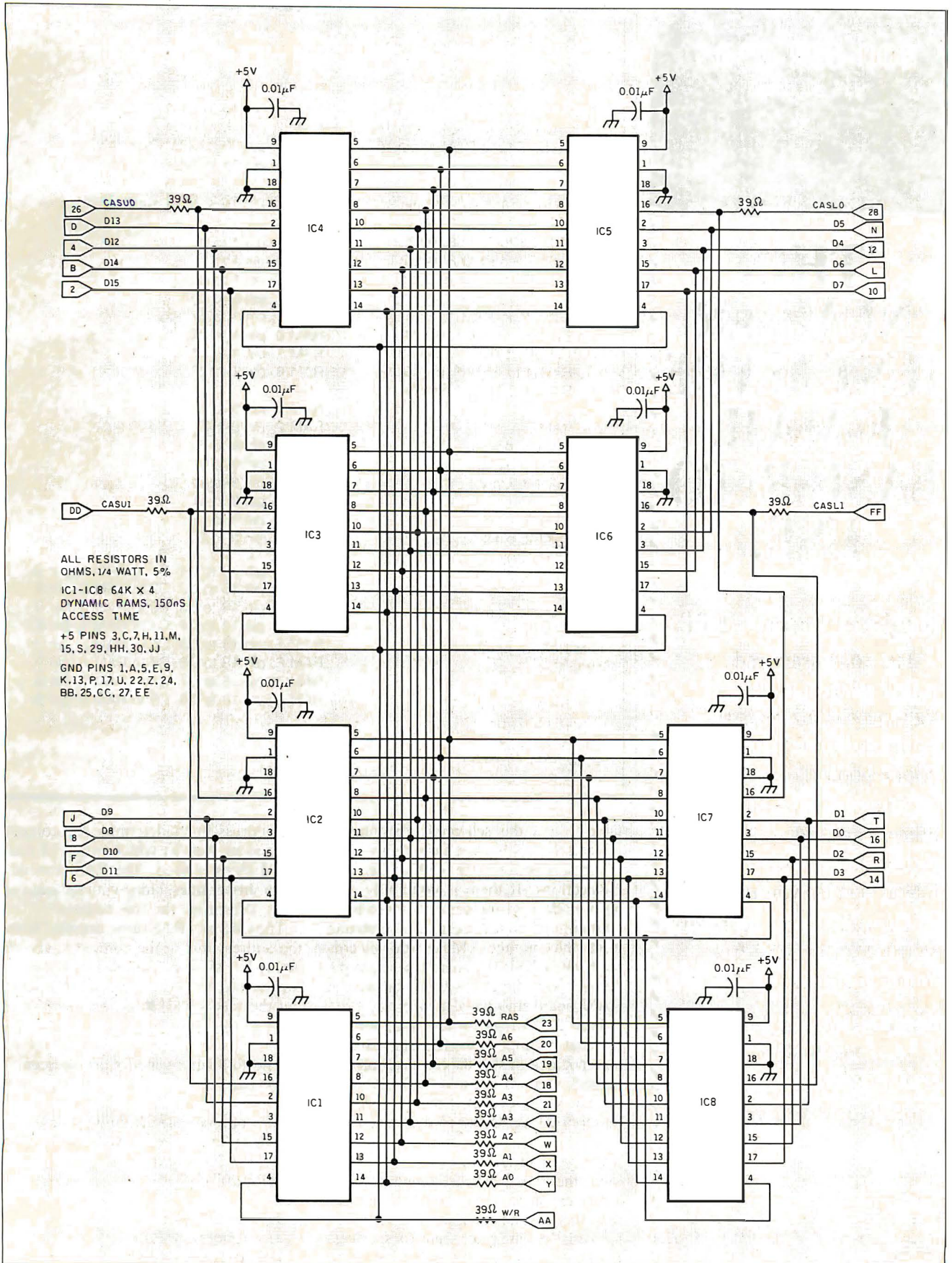

Figure 2: Schematic diagram for the 256K Amiga expansion RAM board.



**800-622-0505**  
VIA MODEM

# THIS NUMBER JUST MADE E-MAIL EASIER TO USE.

## Register today FREE.

List your preferred E-Mail address in the National E-Mail Registry™—the online E-Mail phone book.

When you are listed, others can find you—even if they don't know which E-Mail service you use.

The call is free. Act before March 1 and get 50 free online searches.

**Call 800-622-0505**  
via modem.

300/1200/2400 Baud. 7 Bit Word. Even Parity. 1 Stop Bit.

N A T I O N A L  
**E-Mail**  
R E G I S T R Y

**Table 2: Wire-wrap/solder list.**

FF to R14. R14 to RAM 8, pin 16.	RAM 1, pin 16 to RAM 3, pin 16.
28 to R13. R13 to RAM 7, pin 16.	RAM 2, pin 16 to RAM 4, pin 16.
26 to R12. R12 to RAM 4, pin 16.	RAM 5, pin 16 to RAM 7, pin 16.
DD to R11. R11 to RAM 3, pin 16.	RAM 6, pin 16 to RAM 8, pin 16.
18 to R10. R10 to RAM 8, pin 8.	RAM 5, pin 18 to RAM 4, pin 1.
19 to R9. R9 to RAM 8, pin 7.	
20 to R8. R8 to RAM 8, pin 6.	RAM 1, pin 1 to 5.
23 to R7. R7 to RAM 8, pin 5.	RAM 2, pin 1 to 9.
AA to R6. R6 to RAM 8, pin 4.	RAM 3, pin 1 to K.
	RAM 4, pin 1 to 13.
21 to R1. R1 to RAM 1, pin 10.	RAM 5, pin 1 to 17.
V to R2. R2 to RAM 1, pin 11.	RAM 6, pin 1 to 22.
W to R3. R3 to RAM 1, pin 12.	RAM 7, pin 1 to 24.
X to R4. R4 to RAM 1, pin 13.	RAM 8, pin 1 to 27.
Y to R5. R5 to RAM 1, pin 14.	
	RAM 1, pin 9 to 3.
2 to RAM 3, pin 17.	RAM 2, pin 9 to C.
B to RAM 3, pin 15.	RAM 3, pin 9 to 7.
4 to RAM 3, pin 3.	RAM 4, pin 9 to H.
D to RAM 3, pin 2.	RAM 5, pin 9 to 11.
	RAM 6, pin 9 to M.
F to RAM 2, pin 15.	RAM 7, pin 9 to 15.
6 to RAM 2, pin 17.	RAM 8, pin 9 to S.
J to RAM 1, pin 2.	
8 to RAM 1, pin 3.	RAM 1, pin 18 to C1. C1 to RAM 1, pin 9.
	RAM 2, pin 18 to C2. C2 to RAM 2, pin 9.
10 to RAM 5, pin 17.	RAM 3, pin 18 to C3. C3 to RAM 3, pin 9.
L to RAM 5, pin 15.	RAM 4, pin 18 to C4. C4 to RAM 4, pin 9.
N to RAM 6, pin 2.	RAM 5, pin 18 to C5. C5 to RAM 5, pin 9.
12 to RAM 6, pin 3.	RAM 6, pin 18 to C6. C6 to RAM 6, pin 9.
	RAM 7, pin 18 to C7. C7 to RAM 7, pin 9.
R to RAM 7, pin 15.	RAM 8, pin 18 to C8. C8 to RAM 8, pin 9.
14 to RAM 7, pin 17.	
T to RAM 7, pin 2.	
16 to RAM 7, pin 3.	

table 2 and the schematic diagram in figure 2. If possible, use a continuity tester to measure between the +5-V and ground connections. If there is continuity, you have made a wiring error. If there is no continuity, then test the unit by inserting it into the computer. (Make sure you correctly align the RAM board contacts to the Amiga bus fingers *before* seating the RAM board into the Amiga.)

Turn the Amiga on and wait for the Kickstart prompt. If the Kickstart prompt does not appear, shut the computer off and recheck your work. From the Workbench display, your new RAM memory should be reported at the top of the screen.

### Theory of Operation

Since the lines from the computer to the RAM expansion connector are already fully decoded, all connections are straightforward. The computer sends (or receives) 16 data bits at a time. These bits are stored into four of the RAM chips. The CAS (column address strobe) lines, along with

the address lines, determine the column address as well as which group of four RAM chips is used. The RAS (row address strobe) lines, along with the address lines, determine the row address.

The CAS and RAS lines, decoded from the address bus in the computer, are all active-low signals. The read/write line is low during the write cycle and high during the read cycle. ■

The following vendors are sources for parts:

Microprocessors Unlimited Inc.  
24000 South Peoria Ave.  
Beggs, OK 74421  
(918) 267-4961

Jameco Electronics  
1355 Shoreway Rd.  
Belmont, CA 94002  
(415) 592-8097





## O/S ARCHITECTURE: sink with UNIX or soar with QNX.

If the sheer weight of UNIX brings the PC to its knees, all applications running under it will suffer. Conceived more than a decade and a half ago, UNIX is today the result of modifications, additions and patches by hundreds of programmers. It needs the resources of at least an AT.

Compare this to the QNX O/S, designed by a dedicated team with a common purpose and complete understanding of both the software and the environment in which it must run. Having elegantly solved the problem of inter-task communications, QNX is more than capable of both networking and real time performance – the superior choice for process control and office automation systems.

Quick and efficient on a PC, QNX soars on an AT. QNX occupies 70K (stand-alone version) to 104K (network version) of system memory and allows 40 tasks (programs) and up to 10 terminals per computer.

QNX modular architecture facilitates easy adaptation and extensions by software developers for specific requirements. In addition, PC-DOS runs as a single-tasking

guest operating system under QNX. With the DOS Development System, DOS EXE files can be developed in shorter time than under DOS itself.

Communication among all tasks is via "message-passing." Tasks anywhere on a network of up to 255 computers communicate rapidly and transparently with each other.

With the true distributed processing and resource sharing of QNX, all the resources on the network are available to any user. Application programs and data can be distributed over the network without having to go through a central file server.

Network growth is fast and simple. If your disk becomes a bottleneck, add a disk anywhere on the network. If your needs outgrow your present configuration, just add terminals and/or computers as required, without having to re-write programs and without system degradation.

If you would like to know the secret of the QNX architecture, please give us a call. We invite End Users, VAR's, OEM's and Software Developers to discover a whole new world of computing capabilities.

Over 25,000 systems have been installed worldwide since 1982.

<b>Multi-User</b>	10 serial terminals per PC, AT.	<b>C Compiler</b>	Standard Kernighan and Ritchie.
<b>Multi-Tasking</b>	40 (64) tasks per PC (AT).	<b>Flexibility</b>	Single PC, networked PC's, Single PC with terminals, Networked PC's with terminals.
<b>Networking</b>	25 Megabit token ring. 255 PC's and/or AT's per network. 10,000 tasks per network. Thousands of users per network.	<b>PC-DOS</b>	PC-DOS runs as a QNX task.
<b>RealTime</b>	2,800 task switches/sec (AT).	<b>Cost</b>	From US \$450. Runtime pricing available.
<b>Message Passing</b>	Fast intertask communication between tasks on any machine.		

For further information or a free demonstration diskette, please telephone (613) 726-1893.

The only multi-user, multi-tasking, networking, real-time operating system

**QNX** for the IBM PC, AT and compatibles.  
By Quantum Software.

Unix is a registered trademark of AT & T Bell Labs. IBM PC, AT, XT and PC DOS are trademarks of IBM Corp.

Quantum Software Systems Ltd., Moodie Drive High Tech Park, 215 Stafford Road, Ottawa, Ontario, Canada K2H 9C1



# RADICAL

There's never been a desktop printer like this before.



**The Shape.** Sharp. Sleek. And amazingly adaptable. The Genicom 1000 Series Desktop Printers. Ready for anything from business forms to spreadsheets; word processing to heavy-duty data processing. With letter quality printing at 100 cps. And data processing printing at 200 cps. Open the clamshell casing and look inside. Discover just how simple the future can be.

**The Personality.** IBM,<sup>®</sup> Epson,<sup>®</sup> Diablo<sup>®</sup>—the Genicom 1000 can be all of these printers and more. Because we've built their personalities into plug-in cartridges. Changing personalities is as easy as changing your mind. Simply plug in the personality cartridge of your choice, and your Genicom 1000 is off and running. Working with almost any PC or software program you care to mention. Effortlessly.



Express your personality. With font cartridges that plug right into the front of the printer. Pick your type; you've got hundreds of fonts to choose from. Insert up to three cartridges at once, and vary type styles within the same document.

**The Design.** The Genicom 1000 is the first desktop printer designed with common sense, right down to its built-in printer stand.

The unique design also makes paper loading faster and easier than ever before. Feed tractor paper straight through the bottom. Or from the rear. With Genicom's automatic, zero tear-off bar, no matter how you feed it, you'll never waste a piece of paper again.

When you want to print on letterhead, just feed single sheets of paper, typewriter style. You don't even have to remove the tractor paper.

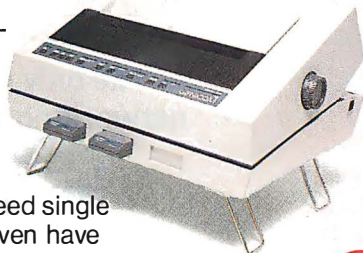

But the 1000 Series was designed for more than ease of use. It was also designed for performance. Its 18-wire printhead delivers high resolution graphics and word processing printing that can only be called letter quality.

**The Controls.** Easy to adapt. Easy to use. And easy to control. With the Genicom 1000's front panel, total command is at your fingertips. Choose fonts, character spacing, line spacing, form length and print quality with the push of a button. No dipswitches. And no fumbling inside the printer.

**The Track Record.** When it comes to reliability, Genicom stands by its record. We've created a full line of printers: from desktop models to machines that print 800 lines per minute. Our printers have proven their rugged dependability performing for some of the world's largest corporations. Now we're ready to prove it to you.

So stop by your authorized Genicom dealer today and ask for a demonstration of the new 1000 Series; the 1025 and the 1020 for wide column printing. We think you'll agree, these printers are a radical departure from the crowd.

For the Genicom dealer nearest you, call 1-800-437-7468. In Virginia, call 1-703-949-1170.

## GENICOM<sup>®</sup>

The Printers That Mean Business.

One Genicom Drive, Waynesboro, VA 22980

Inquiry 346



Rene Stolk and George Ettershank

# Calculating the Area of an Irregular Shape

*An explanation of the algorithm and a demonstration program in BASIC*

**T**he need to calculate the area of an irregular shape arises often in technical fields. Examples include the area of a lake for a geographer and the area of a cell for a biologist.

The first step in determining the area is to represent the object with a map, photograph, projected image, or other form. Using a graphics tablet or other digitizing device, you then trace a stylus or cursor over the perimeter of the shape, generating a stream of Cartesian coordinates.

The computer's job is to calculate an estimate of the area enclosed by the sample points. The accuracy of the estimate

depends on the density of the sample points with respect to the overall raggedness of the curve; the more irregular the curve is, the more points are needed for a good estimate.

I'll present an algorithm for calculating areas of simple closed curves similar to figures 1a, 1b, and 1c. The algorithm will not, however, measure the area of curves having a crossover as in figure 1d. Such shapes must be broken up into their constituent simple closed curves and analyzed piece by piece.

## The Algorithm

Consider the triangle *OAB* in Cartesian space as shown in figure 2a. By inspection, we see that the area of *OAB* equals

$$\begin{aligned} \text{Area}(OCB) + \text{Area}(ABCD) - \text{Area}(ODA) \\ = x_2y_2/2 + (x_1 - x_2)(y_1 + y_2)/2 - x_1y_1/2 \\ = 1/2(x_2y_2 + x_1y_1 + x_1y_2 - x_2y_1 - x_2y_2 - x_1y_1) \\ = 1/2(x_1y_2 - x_2y_1). \end{aligned}$$

Substitute actual numbers into this formula and you'll find that a triangle traversed in one direction gives a positive result while a triangle traversed in the opposite direction gives a negative result. So to be sure we have a positive area, it is necessary to take the absolute value of the result.

Now look at the more complex shape *ABCD* in figure 2b. Again we see by inspection that the area is the sum of the areas of triangles *OAB*, *OBC*, and *OCD*, minus the area of *ODA*. We can apply the previous formula to each of these triangles, making sure always to move in the same direction, clockwise or counterclockwise. If we do so, the component areas will all be positive or all be negative, allowing us to add them and take the absolute value of the sum.

To illustrate the application of this equation, let's calculate the area of *ABCD* using the numbers shown in figure 2b: *A* = (1,4), *B* = (3,4), *C* = (4,3), and *D* = (4,1). Substituting into the equation, we know that  $\text{Area}(OAB)$  equals

$$\begin{aligned} 1/2 \times |1 \times 4 - 4 \times 3 + 3 \times 3 - 4 \times 4 \\ + 4 \times 1 - 3 \times 4 + 4 \times 4 - 1 \times 1| \\ = 0.5 \times |-8| \\ = 4.0. \end{aligned}$$

Calculating the area of any arbitrary shape (simple closed curves only) is just

*continued*

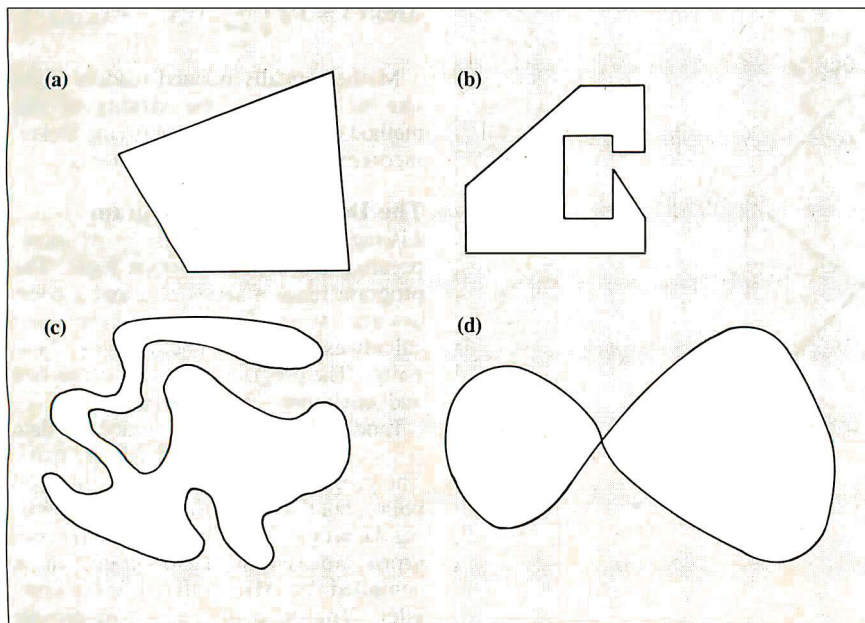

**Figure 1:** The algorithm can calculate the area of shapes like these, given a sufficient collection of sample points (shape d must be treated as two separate curves).

*Rene Stolk is a systems engineer and George Ettershank is a research biologist. They can be contacted at the Department of Zoology, Monash University, Clayton, Victoria 3168, Australia.*



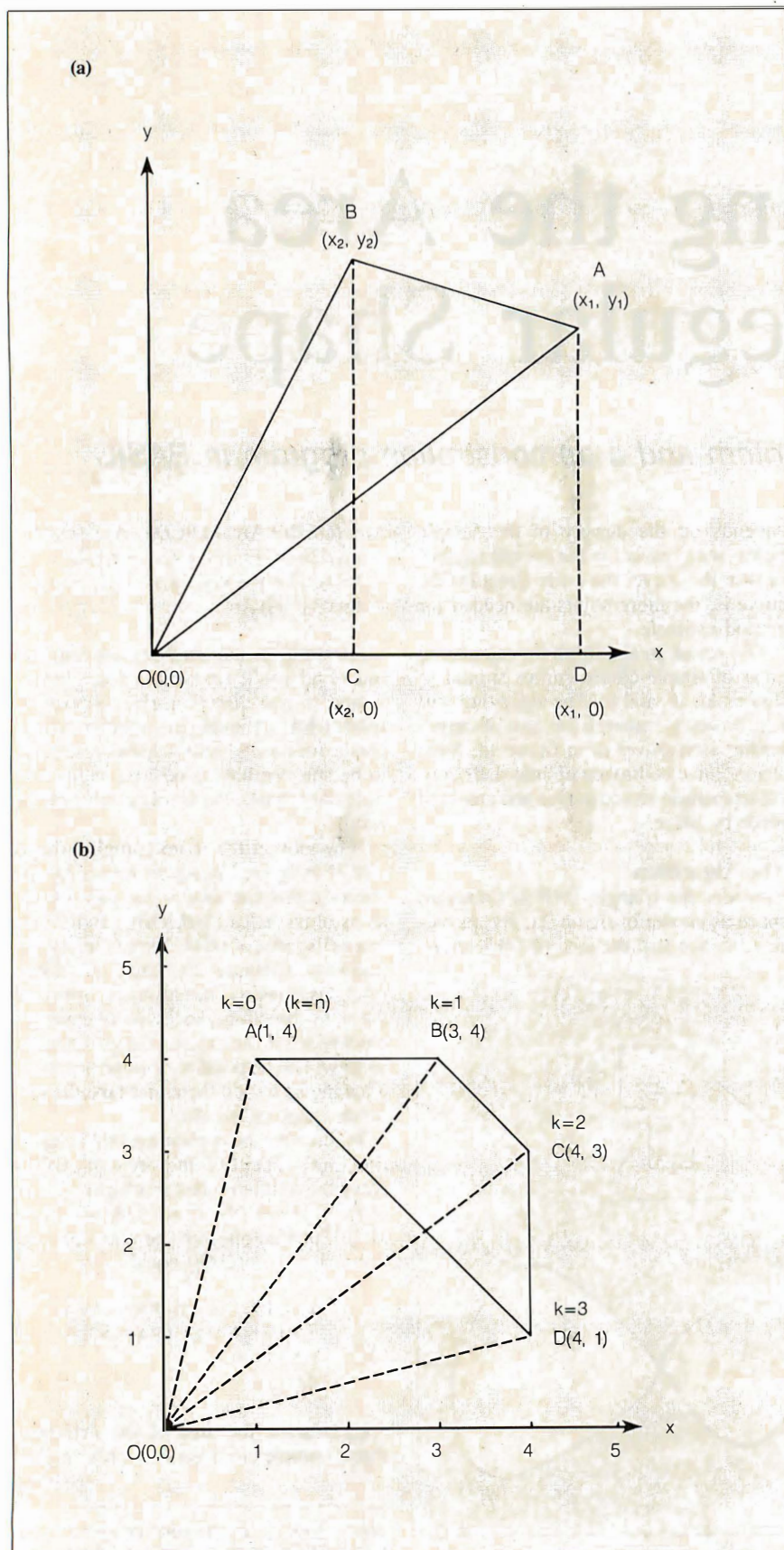

Figure 2: The area of an irregular polygon can be expressed in terms of triangles and trapezoids whose base and height are known.

Listing 1: A BASIC program to calculate the area of an irregular shape, defined by the coordinate pairs given in the DATA statements.

```

10 DIM X(50),Y(50)
20 READ N
30 FOR K=1 TO N
40 READ X(K),Y(K)
50 NEXT K
60 X(0)=X(N)
70 Y(0)=Y(N)
80 AREA=0
90 FOR K=0 TO N-1
100 AREA=AREA + X(K) *
      Y(K+1) - X(K+1) *
      Y(K)
110 NEXT K
120 AREA = .5 *
      ABS(AREA)
130 PRINT "Enclosed area
      is "; AREA
140 END
150 DATA 4
160 DATA 4,3,4,1,1,4,3,4
    
```

a matter of generalizing our previous formula. If the coordinates of the successive points are taken close together, the shape is split into a series of very narrow triangles, so that even an area bounded by a curved line can be approximated to a high degree of accuracy.

Let  $\langle x,y \rangle$  be a sequence of  $n$  points tracing the outline of a simple closed curve  $C$ . Define the starting point  $(x_0,y_0)$  to be the same as the ending point  $(x_n,y_n)$ . Then

$$\text{Area}(C) = 1/2 \left| \sum_{k=0}^{n-1} (x_k y_{k+1} - x_{k+1} y_k) \right|$$

Mathematically minded readers might like to know that the validity of this method can be proved by applying Stokes' theorem to a standard line integral.

**The Demonstration Program**

Listing 1 is a BASIC program incorporating the area-calculation logic. The program reads a series of  $x$  and  $y$  coordinates from DATA statements and calculates the area enclosed by those points. The program assumes that the first and last points are connected.

Line 150 specifies the number of data points, and line 160 contains the  $x,y$  pairs. The program is set up to handle up to 50 points, but that can be increased by changing the array sizes in line 10. (Nondynamic arrays are used so the program can be compiled by Microsoft's BASIC compiler.) The program is set up to provide single-precision results. For maximum accuracy in the program's result, you can change variables  $X$ ,  $Y$ , and  $AREA$  to double precision. ■



Robert J. Sciamanda

# Another Approach to Data Compression

Use these BASIC programs to explore the Nyquist sampling theorem

**S**uppose you have a large quantity of data obtained by hardware measurements, software simulation, or any other method. The numbers may correspond to physical measurements or to values of a known or unknown mathematical function. Do you need to keep all this data? Or can you keep only samples of it and later reconstruct the original data set to within a specified accuracy, using the samples?

I've written a set of BASIC programs that answer these questions by using the Nyquist sampling theorem to find the lowest sampling rate that can be used to reconstruct the original data to a preset degree of accuracy.

The Nyquist sampling theorem says that a finite-bandwidth function can be reconstructed exactly from a set of sampled values:

$$f(n\tau), n = -\infty, \dots, -1, 0, +1, \dots, +\infty$$

so long as the sampling frequency,  $1/\tau$ , is greater than twice the highest frequency present in the Fourier spectrum of  $f(t)$ .

The reconstruction algorithm is given by the "Nyquist sum":

$$f(t) = \sum_{n=-\infty}^{+\infty} \frac{f(n\tau) \sin[(\pi/\tau)(t - n\tau)]}{(\pi/\tau)(t - n\tau)}$$

Hardware implementations of Nyquist sampling and reconstruction are familiar; the hardware embodiment of the equation above is in fact the low-pass smoothing filter used in digital-to-analog conversion hardware.

In the case at hand, the frequency content of the original function is unknown. However, you can use the Nyquist sum equation to find a suitable value of  $\tau$  (the sampling interval) through a trial-and-

error approach, trying larger and larger values of  $\tau$  until the observed error of the Nyquist sum exceeds a preset limit.

## The BASIC Programs

There are five programs in all. Initially you must run them in sequence.

Listing 1 generates a file named DATA, which contains values from a typical function. The original data values are preceded by count N.

The program in listing 2 reads N+1 values from the file into the array A(). The program then asks you to specify the accuracy to which this data must be reconstructed.

The software sampling interval L is then set equal to 2, and the Nyquist sum equation is used to reconstruct A() from the subset consisting of every Lth item in A(). If this reconstruction is successful to within the specified accuracy, L is incremented by 1 and the reconstruction process is repeated.

With each iteration of this process, reconstruction is attempted from a subset of fewer data samples until the accuracy requirement fails. The original data count N, the largest successful L value, and the compressed data (every Lth item in A()) are then written into the disk file CDATA.

Listing 3 reverses the process of listing 2, reconstructing the original data set to within the specified accuracy from the compressed data file CDATA.

The original data count, the sampling interval, and the compressed data are input from CDATA as N, L, and the array B(), respectively. The Nyquist sum equation is then applied to reconstruct the original data set, which is written into the disk file RDATA.

RDATA is identical in format to the original data file DATA; that is, the first entry is the data count N, followed by the N+1 reconstructed data values.

Listing 4 provides an explicit check of the compression-reconstruction process. After running the reconstruction program (listing 3), run listing 4 to see a side-by-side comparison of the original and reconstructed data sets.

[Editor's note: *BYTE* added listing 5, which plots the points from DATA and RDATA on the screen. The listing requires an IBM PC or compatible machine with BASICA and high-resolution graphics.]

All listings (except 5) were written in Microsoft GW-BASIC for a Zenith Z-150. They should run without modification on IBM PC compatibles and with only minor changes on other computers equipped with BASIC and a disk drive.

Using the test data generated by listing 1 and electing an accuracy of 0.005, listing 2 (the compression algorithm) ran in 45 seconds on a Z-150 and found the largest successful sampling interval to be  $L = 3$ .

## Will It Work with Real Data?

How much your real data can be compressed by this method—or whether it can be compressed at all—is a function both of your required accuracy and of the frequency content of the data. The more erratic the data variations, the higher the component frequencies and the higher the required sampling frequency.

An important factor contributing to the frequency content of the original data is the smoothness of the transitions to and from the value 0 at the beginning and end of the data domain. The value 0 is pre-

*continued*

Robert J. Sciamanda is a physicist at American Sterilizer Co. (2424 West 23rd St., AMSCO 620, Erie, PA 16514). Previously he taught physics at Gannon University and designed automated inspection systems for EG&G at the Idaho National Engineering Laboratory.



# PROM PROGRAMMING?

From \$250.00

Finding a Low-Cost PROM or PAL\* programmer is only half of the battle. Finding a company that won't desert you when you need support or service is the other half.

Logical Devices Products **cost** you **less** because we offer the best price performance ratio in the market, **and** because once you buy our products you will experience less down time and **more reliable** operation than most other units. In addition you get features that were evolved from our years of experience of serving people who program chips.

We offer a wide range of products from dedicated programmers to universal software driven models.

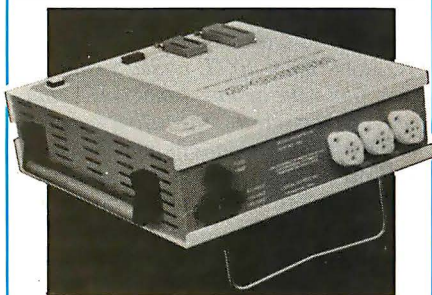

**GANGPRO-8** production programmer. 8 EPROMs to 27512 with RS-232 option.

**PROMPRO-8X** universal portable. RS-232. Programs PROMs/PAL\*s/Micros

**PALPRO-2X** Low Cost PAL\* only programmer. Dedicated, RS-232 unit.

**SHOOTER** Low cost EPROM only programmer. RS-232, Stand-Alone.

**PC-PRO** IBM PC plug-in EPROM card 2716-27512

**ALLPRO** pin driven software based universal unit, programs every imaginable fuse programmable IC.

**CAST** boolean software/silicon compiler for PLDs. JEDEC output

**UV ERASERS FROM \$49.95**

All products carry 90 day Warranty & 14 day Money Back Guarantee

**CALL 1-800-331-7766**  
**LOGICAL DEVICES INC.**

USA	305-974-0967
ENGLAND	44 272 277323
AUSTRALIA	03560-1011

\*PAL IS A REGISTERED TRADEMARK OF MONOLITHIC MEMORIES INC.

## DATA COMPRESSION

**Listing 1:** A program to generate a data file for testing the Nyquist compression technique. The program evaluates the Gaussian function

$$10e^{-(5-D*I)^2}, \quad i = 0 \text{ to } 50.$$

```

10 OPEN "O",#1,"DATA" :REM Make a test data file by taking
20 PRINT#1,50          :REM 51 samples from a Gaussian
30 D=.2                :REM curve centered at i=25.
40 FOR I=0 TO 50
50 A=10*EXP(-(5-D*I)^2)
60 PRINT#1,A
70 NEXT I
80 CLOSE

```

**Listing 2:** This program reads the sample data file called DATA, prompts the user for the required accuracy, and then determines whether the data can be compressed and reconstructed using the Nyquist sampling theorem. If possible, the compressed data is written to a file called CDATA.

```

10 OPEN "I",#1,"DATA"
20 INPUT#1,N           :REM Get data count.
30 DIM A(N)
40 FOR I=0 TO N       :REM Get original data set.
50 INPUT#1,A(I)
60 NEXT I
70 CLOSE
80 INPUT "Enter desired accuracy ";E
90 FOR L=2 TO INT(N/2-.5)
100 W=3.141593/L
110 FOR I=1 TO N      :REM Reconstruct missing values.
120 IF I MOD L=0 THEN 190 :REM Branch at sampled values.
130 G=0
140 FOR J=0 TO N STEP L :REM The Nyquist sum.
150 M=W*(I-J)
160 G=G+A(J)*SIN(M)/M
170 NEXT J
180 IF ABS(G-A(I))>E THEN 210 :REM Sum done; test
    accuracy.
190 NEXT I           :REM If ok, reconstruct next value.
200 NEXT L          :REM Increment sampling interval.
210 L=L-1           :REM Highest successful sampling interval.
220 IF L>1 THEN 260 :REM L=1 means no compression
    possible.
230 PRINT "For an accuracy of +/-";E;"all of this data
    must be kept."
240 PRINT "No compressed data file (CDATA) will be
    generated."
250 END
260 OPEN "O",#1,"CDATA" :REM Create compressed data file.
270 PRINT#1,N,L :REM Write data count, sampling interval.
280 FOR J=0 TO N STEP L :REM Write compressed data set.
290 PRINT#1,A(J)
300 NEXT J
310 CLOSE
320 L$="th"
330 IF L=2 THEN L$="nd"
340 IF L=3 THEN L$="rd"
350 PRINT "Every ";L;L$;" data value has been kept in the
    compressed data file (CDATA)."
```

```

360 PRINT "The original data set can be reconstructed to
    an accuracy of +/-";E

```



**ORDER LINE**  
**800-354-7330**

# LOWEST PRICES NO SURCHARGE ON BANK CARDS SILICON SPECIALTIES

**ZENITH COMPUTERS**  
Always the lowest prices.  
Call us for a quote.

**PRINTERS**

Alps 2000	\$715
2100	\$1145
Brother All Models	Save
Citizen MSP-10	\$260
MSP-15	\$379
MSP-20	\$319
MSP-25	\$475
Premier 35	\$475
Diablo D-25	\$469
635	\$765

**EPSON**

All Printer Models	Save
IBM Printer	\$399
NEC	
3510, 3550	\$729
8810, 8850	\$1045
P5	\$959
P6	\$429
P7	\$609

**OKIDATA**

All Printer Models	Save
Panasonic 1080 I	\$195
1091 I	\$259
1092	\$295
1592	\$409
3131	\$245
3151	\$385

**STAR MICRONICS**

All Printer Models	Save
KEYBOARDS	
Keytronics 5151	\$159

**Toshiba**

321 Parallel & Serial	\$455
341E Parallel	\$669
351 Model II	\$1045
P351 Parallel & Serial	\$929
Loser Printer	Save

**DISKETTES**

Maxell M2S (Qty 100)	\$ 85
Sony MD/2 (Qty 100)	\$ 85

**MONITORS**

Amdex All Monitors	Save
NEC Multisync	\$575
MultisyncXL	Save
MultisyncPlus	Save
Multisync Monochrome	Save
Multisync Graphic Board	Save
Princeton Graphics	Save
Zenith All Models	Save

**VIDEO TERMINALS**

Qume QVT Green 101	\$299
QVT Amber 101	\$314
Wyse 30	\$295
50	\$369
75	\$559
Wyse 85	\$439
Wyse 350	\$859
enith All Monitors	Save

**DISK DRIVES**

Omega Bernoulli 10 meg	\$1195
Bernoulli 20 meg	\$1595
Bernoulli 40 meg	\$2325

**SEAGATE**

20 meg	
w/Western I/O	\$385

**HARDWARE**

**MODEMS**

Anchor Automation	
Signalman Express	\$185
Practical Peripherals	
Practical 1200 Baud	\$124

**HAYES**

All Modems	Save
Prometheus All Models	Save
US Robotics Courier 2400	\$349
P/sword 1200	\$165
Microlink 2400	\$349

**BOARDS**

AST All Models	Save
Hercules Color Card	\$149
Graphic Card	\$179
Intel Above Board PS/PC (1110)	\$239
Above Board AT (2010)	\$329
Above Board PS/AT (2110)	\$369
NEC Multisync Graphic Board	Save
Orchid Tiny Turbo 286	\$415
Turbo EGA	\$565
Paradise Five Pak	\$99
EGA Autoswitch	\$575
Plus Development	
Plus Hard Card 20 Megabyte	\$609
Quadram Tiny Turbo 286	\$355
Quad EGA+	\$359
Tec Mar Graphics Master	\$439
Captain No Memory	\$109
EGA Master	\$239

Video 7 Vega Enhanced Graphics Adapt	\$279
Vega Deluxe	\$335

**SOFTWARE**

**IBM PC AND 100% Compatibles**

**INTEGRATIVE SOFTWARE**

Enable 1.1	\$319
Framework II	Save
Smart Software System	\$389
Symphony	Save
Ability	\$55

**GRAPHICS**

Chartmaster	Save
Diagram Master	Save
Energraphics 2.0	\$269
In-A-Vision	\$249
Microsoft Buss Mouse 6.0	\$106
Microsoft Chart	\$164
Microsoft Serial Mouse 6.0	\$119
Newsroom	\$31
PC Buss Plus Mouse	
w/Point Plus	\$115
Click Art Personal Publisher	\$99
PC Mouse w/Dr. Halo II	\$99
PC Point w/Mouse	\$115
Printmaster	\$29
Sigmaster	Save
Turbo Graphix Tool Box	\$38

**MONEY MANAGEMENT**

Dollars & Sense w/Farcast	\$94
Tobias Managing Your Money	Save

**DATA BASE MANAGEMENT**

Clipper	\$329
Cornerstone	\$55
dBase II	Save
dBase III Plus	Save
Extended Report Writer	Save
KnowledgeMan II	\$249
PFS: Professional File	Save
Quickcode	\$138
QuickReport	\$138
Reflex	\$82
Think Tank	\$91

R:Base 5000	
System V	\$355

**SPREADSHEETS**

Lotus 1-2-3	Save
Multiplan	\$108
Spreadsheet Auditor 3.0	\$82
VP Planner	\$47
Supercalc 4	Save

**COMPUTERS**

**IBM**

PC 1 Drive 256K	\$1199
XT 1 Drive 256K	\$1729
XT 1 Drive 20 Meg 640K	\$2169
AT/68	\$2849
AT/339	\$4449

**COMPAQ**

Portable II-2 Drive	\$1649
---------------------	--------

**PANASONIC**

Business Partner Dual Drive	\$979
Sr. Partner Dual Drive	\$1169
Exec. Partner Dual Drive	\$1699
Other models	Save

**TOSHIBA**

T-1100	\$1299
T-1100 Plus	Save
T-3100	Save

**Zenith Computer Products**  
**SAVE up to 50%**  
All Models Save

**PLOTTERS**

Epson Hi-80	Save
-------------	------

**UTILITIES**

MS Wind ws	\$55
Copy II PC	\$19
1 DIR	\$46
Fastback	\$84
Norton Utilities 3.1	\$48
Printworks	\$36
Sidekick	\$30
Sidekick (Unprotected)	\$47
Travelling Sidekick	\$39
Sideways 3.1	\$34
Superkey	\$39
Xtree	\$25

**WORD PROCESSORS**

Leading Edge Word Processor	\$42
Leading Edge W/P w/Spell & Mail	\$72
Lightening	\$55
Microsoft Word 3.1	\$249
Multimate Advantage	Save
Wordstar w/Tutor	\$162
Wordstar Pro Pack	\$233
PFS: Professional Write	Save

Word Perfect (Ver.4.2) \$199  
Wordstar 2000 + 2.0 \$278

Many other titles available.



**FCC APPROVED**

**mi SYSTEMS**  
**Turbo PC/XT \$429**

256 Memory, One 360K Brand Name + Floppy Drive  
135 Watt Power Supply, Slide Case, AT Style Keyboard  
8 MHz Clock Speed, (Keyboard Selectable), 8 Expansion Slots

**SPECIAL**  
Over \$200 worth of  
Paperback Software Programs  
**\$39** with each system

Turbo PC/XT w/256K & 1 Drive	\$449
Turbo PC/XT w/640K & 1 Drive	\$499
Turbo PC/XT w/640K & 2 Drives	\$599
Turbo PC/XT w/640K, 1 Drive & 20MG	\$929
MS DOS 3.2 w/GW Basic	\$ 75
MonGraphics Card with Software and Parallel Printer Port	\$ 75
Color Card with Parallel Print Port	\$ 69
Multifunction Card w/Software	\$ 79
Amber Monitor (TTL)	\$ 95
Amber Monitor w/Swivel Tilt	\$105
Color Monitor (RGB)	\$289
Sega Enhanced Graphics Card	\$235
I/O Card (Serial/Parallel)	\$ 39
I/O Card (Serial/Clock Calendar)	\$ 41
5151 Clone Keyboard	\$ 79



**SILICON SPECIALTIES**  
2034 WEST SOUTHERN  
MESA, ARIZONA 85202  
602-969-0909

CVS-108

Product shipped in factory cartons with manufacturer's warranty. Please add \$10.00 per order for UPS shipping. Prices & availability subject to change without notice. Send cashier's check or money order... all other checks will delay shipping two weeks.

Inquiry 259 for MS DOS Products. Inquiry 260 for all others.



## QSP SUPER MICRO

**286  
AT™**



- ZERO WAIT STATE
- 1 MB high speed (120NS) DRam on board
- 6/8 MHz (10 MHz opt.)
- Licensed Phoenix BIOS
- Built-in 2 serials & 1 parallel port
- Reset button & turbo mode LED
- Hold up to 5½ht drive
- Clock/calendar w/battery backup & rechargeable AA battery set mounted
- 200 Watt power supply
- Setup software
- Hard cover User's Manual

ALL FOLLOWING MODELS WITH AN  
IBM® COMPATIBLE ENHANCED

KEYBOARD

CALL FOR BEST PRICES ON OUR  
ADD-ON CARDS

**MODEL 1 \$1395.00**

- Above configuration +
- 1.2 MB floppy drive
  - WD H/F disk controller

**MODEL 2 \$1499.00**

- MODEL 1 +
- Hercules compatible monographic w/printer port
  - Mono monitor

**MODEL 3 \$1994.00**

- MODEL 1 +
- EGA card (16 colors, 640 x 350 Res.)
  - EGA monitor

**MODEL 4 \$2099.00**

- MODEL 2 +
- Seagate 30MB high speed hard disk (39MS)

**TURBO XT™ \$389.00**

- w/256K, 1FD + CTL, K.B.,  
150 WATT P.S.



**SALES: (408) 435-8222**

Technical Support (415)657-1410  
780 Montague Expy., Ste. 207  
San Jose, CA 95131

No surcharge for MasterCard or VISA. Fortune  
1000 Purchase Order welcome. Dealer and  
Corporate inquiries welcome. IBM, Intel, Hayes  
and Hercules are registered trademarks of their  
respective companies. PC, AT, PC-XT, PC-AT are  
trademarks of IBM Corporation.

## DATA COMPRESSION

**Listing 3:** This program reads compressed data from CDATA and uses it to reconstruct the original data by applying the Nyquist sampling theorem.

```

10 OPEN "I",#1,"CDATA" :REM Compressed data.
20 INPUT#1,N,L :REM Get count, sampling interval.
30 K=INT(N/L):DIM B(K)
40 FOR I=0 TO K :REM Get compressed data.
50 INPUT#1,B(I)
60 NEXT I
70 CLOSE
80 OPEN "O",#1,"RDATA" :REM Create reconstructed data.
90 PRINT#1,N :REM Write data count.
100 W=3.141593/L
110 FOR I=0 TO N :REM Reconstruction
120 IF I MOD L = 0 GOTO 190 :REM Branch at sampled values.
130 G=0
140 FOR J=0 TO K :REM The Nyquist sum.
150 M=W*(I-J*L)
160 G=G+B(J)*SIN(M)/M
170 NEXT J
180 GOTO 200 :REM Sum done; store this value.
190 G=B(I/L)
200 PRINT#1,G :REM Write reconstructed value to file.
210 NEXT I :REM Go reconstruct next value.
220 CLOSE :REM Done
230 PRINT "The reconstructed data file is RDATA"
    
```

**Listing 4:** This program displays data from the original and reconstructed data files.

```

10 OPEN "I",#1,"DATA" :REM Original data file.
20 OPEN "I",#2,"RDATA" :REM Reconstructed data file.
30 PRINT " DATA RDATA Error"
40 IF EOF(1) THEN CLOSE: END
50 INPUT#1,A :REM Get original data value.
60 INPUT#2,B :REM Get reconstructed value.
70 ER=ABS(B-A) :REM Calculate error.
80 PRINT USING "#.#####^^^ #.#####^^^ #.#####";A,B,ER
90 GOTO 40
    
```

**Listing 5:** This program plots the data from DATA and RDATA on the screen (high-resolution capability required). Note that the scale and offsets may differ for the two plots.

```

10 SCREEN 0,0,0 :REM Text screen
20 SZ=4-INT(-(640+7)*200/32) :REM Size of graphics array.
30 DIM SC(SZ) :REM To hold graphics screen.
40 VRES=200: HRES=640
50 REM
60 YES=(1=1)
70 NO=(1=0)
80 SS=NO : REM Screen not saved yet
90 FILES
100 LINE INPUT "Name the input file ";FI$
110 IF FI$=NU$ THEN END
120 OPEN FI$ FOR INPUT AS 1
130 INPUT #1,N
140 PRINT FI$; " contains ";N+1; "values"
150 INPUT #1,Y
160 MINY=Y: MAXY=Y
170 FOR K=1 TO N
180 INPUT #1,Y
190 IF Y>MAXY THEN MAXY=Y
    
```

continued



# BOOKMARK™



## BOOKMARK™ Data Protection Software

**Automatically marks your place so you can resume where you left off.**

Runs with most software so if you decide to call it a day you can power down, and upon restart BOOKMARK will bring you back where you left off...it's like having a BOOKMARK in your computer!

Stop wasting time navigating through menus . . . or teaching novices.

**Easy to use.** You choose how often work is saved, by number of keystrokes or length of time.

**Work in progress can be resumed within seconds after system crash, power failure, accidental reset or power down.**

Costly battery backup systems are no longer needed when work in progress is already saved to the point of the previous BOOKMARK placement.

**BOOKMARK is a memory-resident utility that automatically and periodically saves work in progress to a reserved area of the hard disk.**

Suggested Retail Price **\$69.95**

**Requirements:**

IBM PC/XT/AT or 100% Compatible

64k to 640k

IBM DOS 2.1 or Higher

1 Floppy Disk Drive • Hard Disk Drive (10 Megbytes Minimum) • Video Display Adapter, IBM (Monochrome, Color, Enhanced Color), Hercules, AST  
(BOOKMARK occupies an equivalent space on hard disk as in system RAM plus video RAM)

To Order, Call INTELLISOFT International or Ask Your Dealer for BOOKMARK

# INTELLISOFT™



**INTERNATIONAL**

Call Toll Free (800) 544-MARK • In California Call Toll Free (800) 543-MARK  
70 Digital Drive • P.O. Box 1972 • Novato, California 94948 • (415) 883-1188

BOOKMARK™ is a trademark of INTELLISOFT International. Copyright © 1986 by INTELLISOFT International. All rights reserved.  
IBM PC/XT/AT are registered trademarks of International Business Machines Corporation. Hercules is a trademark of Hercules Computer Technology.  
AST is a registered trademark of AST Research, Inc.



**Best Prices  
Best Service**

**HARDWARE  
COMPUTERS**

**IBM COMPATIBLES** w/Turbo, 256K Ram, Keyboard, w/1 Floppy... 509 Plus 20MB Hard Disk... 899

**PANASONIC** Business & Executive Partners... CALL

**ATARI ST COMPUTERS**... CALL

**MODEMS, BOARDS, DRIVES**

Evercom 1200 Internal... 119	SixPakPlus 384K... 209
Hayes Modems... CALL	SixPak Premium... 249
Practical Modem 1200... 135	Intel Above Board PC... 225
Genoa Spectrum... 185	Above Board AT... 355
Hercules Graphics +... 189	Tollfree J-Rom 3... 189
Aufa Switch EGA... 389	J-Rom 3AT... 249
EGA Wonder... 255	J-Laser +... 459
Tecmar EGA Master... 285	Microsoft Mach 10... 265
Video 7 Vega Deluxe... 385	Seagate 20MB Kit... 389
384K RAM Card... 99	Seagate 30MB Kit... 459
Captain 384K... 165	Filecard 20MB... 679
Advantage Premium... 439	Filecard 30MB... 679
Rampage/EGA AT... 759	Hardcard 20MB... 679

**OTHER HARDWARE**

EPSON-All Models... BEST	Sweet 1600... 749
LX/FX/LQ... PRICES	Roland DXY-800 Platter... 409
Citizen 1200... 189	Houston Inst DMP-29... 1799
Panasonic 1080 I... 209	Amdek 722... 509
Panasonic 1091 I... 269	NEC 1401 Multi-Sync... 639
Panasonic 1092... 315	SonyKV1311 RGB/TV... CALL
Panasonic P3131... 265	Sony 1302 Multi-Sync... CALL
Summasketch 1201... 379	Thompson 36432 RGB... 329

**SOFTWARE**

**WORD PROCESSING — ACCOUNTING —**

First Impression... 389	BPI Enterprise/Mod... 429
Manuscript... 339	Complete Bus. Actng... 159
Microsoft Word 3... 249	DAC EZ Accounting... 42
Word Perfect 4.1... 209	Open Systems V3/Mod... 429
PFS: First Choice... 89	Real World... CALL
PFS: Pro Write... 115	Tax Preparer... 195
Reference Set... 53	

**— SPREADSHEETS —**

Lotus/Symphony... CALL	HAL... 103
Framework II... 399	Open Access II... 289
Ability... 61	Mosaic Twin... 57
PFS: Pro Plan... 145	

**— DATABASE —**

dBase III Plus... 399	Framework II... 399
Rapid File... 259	Open Access II... 289
Paradox... 449	Ability... 61
Powerbase... 199	Mosaic Twin... 57
R Base System V... 349	PFS: Pro Plan... 145
Reflex... 83	
Revelation... 529	
PFS: Pro File... 145	
Q & A... 239	

**— GRAPHICS —**

Click Art Pers. Pub... 109	Alice Pascal... 59
Fantasy... 43	Microsoft C... 269
Freelance Plus... 339	Quick Basic... 60
Harvard Pres. Graphics... 229	Turbo Pascal Ver3... 59
Generic Cod... 69	Turbo Pralog... 59
In "A" Vision... 255	Desqview... 59
Newsroom Pro... 79	Windows... 59
Printmaster Plus... 36	Carbon Copy... 117
ProDesign II... 169	Fastback... 95
Show Partner... 48	Norton Utilities... 55
Dr. Halo II w/Mouse... 109	Pop-Up Deskset... 43
	HOT... 45
	Disk Optimizer... 32
	SQZ... 56
	Xtree... 31
	Statgraphics... 449
	Total Project Manager... 289

**800-662-2686 orders only**  
for Ca. Orders, Tech Support, 415-668-9350  
Call or Write for Free Catalog

**PAYMENT:** (No Fee For Credit Cards) Visa, MasterCard, Cashier's Checks, Personal Checks with 2 week hold. Qualified P.O.'s. California residents add sales tax.  
**SHIPPING:** UPS ground-2% per order, \$5 min. FREE for SW orders over \$1000, UPS Blue-3% per order, \$7 min. FREE for SW orders over \$1500. Printers, Monitors, Disk Drives, Computers — Call for charges.

All Products New with full warranties.  
Price & availability subject to change without notice.



584 CASTRO ST., SUITE 487 SAN FRANCISCO, CA 94114  
a division of MCSS, Inc. Computer & Software specialists since 1981

**DATA COMPRESSION**

```

200 IF Y<MINY THEN MINY=Y
210 NEXT K
220 CLOSE
230 PRINT "Values range from ";MINY;" to ";MAXY
240 PRINT "Press any key to continue";
250 WHILE INKEY$=NU$: WEND
260 YSCALE=(VRES-1)/ABS(MAXY-MINY)
270 XSCALE=(HRES-1)/N
280 CLS
290 SCREEN 2 :REM Graphics screen
300 IF SS THEN PUT (0,0),SC :REM Restore screen if it has
    been saved previously.
310 REM
320 OPEN FI$ FOR INPUT AS I
330 INPUT #1,N
340 INPUT #1,Y
350 PSET (0,VRES-1-(Y-MINY)*YSCALE) :REM Plot 1st point.
360 FOR X=1 TO N
370 INPUT #1,Y
380 LINE -(X*XSCALE,VRES-1-(Y-MINY)*YSCALE) :REM Connect.
390 NEXT X
400 CLOSE
410 GET (0,0)-(639,199),SC
420 WHILE INKEY$=NU$: WEND :REM Hold til key pressed.
430 SS=YES :REM Screen has been saved.
440 SCREEN 0,0,0 :REM Go back to text screen.
450 GOTO 90
    
```

sumed for values "before" and "after" the N+1 data values. This is because in the reconstruction of each function value, the Nyquist sum equation requires the use of sampled values over the complete domain of the function, that is, from  $n = -\infty$  to  $n = +\infty$ . When the series is truncated, as it must be in any practical implementation, the algorithm operates as if all the truncated sample values are 0.

In both hardware and software implementations, it is common practice to preprocess the data, using filtering and windowing techniques to limit the high-frequency content. Filtering eliminates or smooths out exceptional fluctuations or discontinuities in the data, while windowing techniques modulate the truncation of the data domain, providing smooth transitions to and from the value 0. Such techniques allow sampling at a lower frequency, but at the risk of doing violence to the data. The trade-off must be made on a case-by-case basis, assessing the extent to which the high-frequency content is artificial, that is, due to noise or introduced by truncation of the data domain.

**For the Curious**

It is instructive to use the algorithm of the Nyquist sum equation to reconstruct typical functions (truncated sinusoids, Gaussians, etc.) from sample sets extracted at a variety of sampling frequencies to exhibit the so-called aliasing effects of undersampling. These effects are best studied by comparing plots of the original and reconstructed functions.

To create data from a particular function, change listing 1. Note that the first

value written to the file must be a count that is one less than the number of data values to follow. For instance, if the file contains 10 values, the count should be 9.

To control the sampling frequency without regard to Nyquist accuracy limitations, change listing 2, lines 80-100, to

```

80 PRINT "Sampling rate (2 to ";
    INT(N/2-.5); ")";
90 INPUT L: IF L < 2 OR L >
    INT(N / 2-.5) THEN 80
100 OPEN "O", #1, "CDATA"
    
```

and delete lines 110 through 260 and line 360.

Run the modified program to generate the sampled data file CDATA, then run listing 3 to attempt a reconstruction of the original data. Use listings 4 and 5 to compare the original and the reconstructed data.

Intellectually, the theory behind the Nyquist theorem is intriguing and elegant, and it requires only a knowledge of Fourier transform theory. Carson Chen's "An Introduction to the Sampling Theorem" (National Semiconductor Application Note 236) is a concise and readily available synopsis of Nyquist theory and includes an excellent bibliography. Chen's explanation is included in the *National Semiconductor Data Conversion/Acquisition Databook* (Santa Clara, CA: National Semiconductor Corp., 1984, page 12.46).

On the practical side, the Nyquist technique deserves more attention and development as a software calculation tool, alongside traditional numerical interpolation. ■



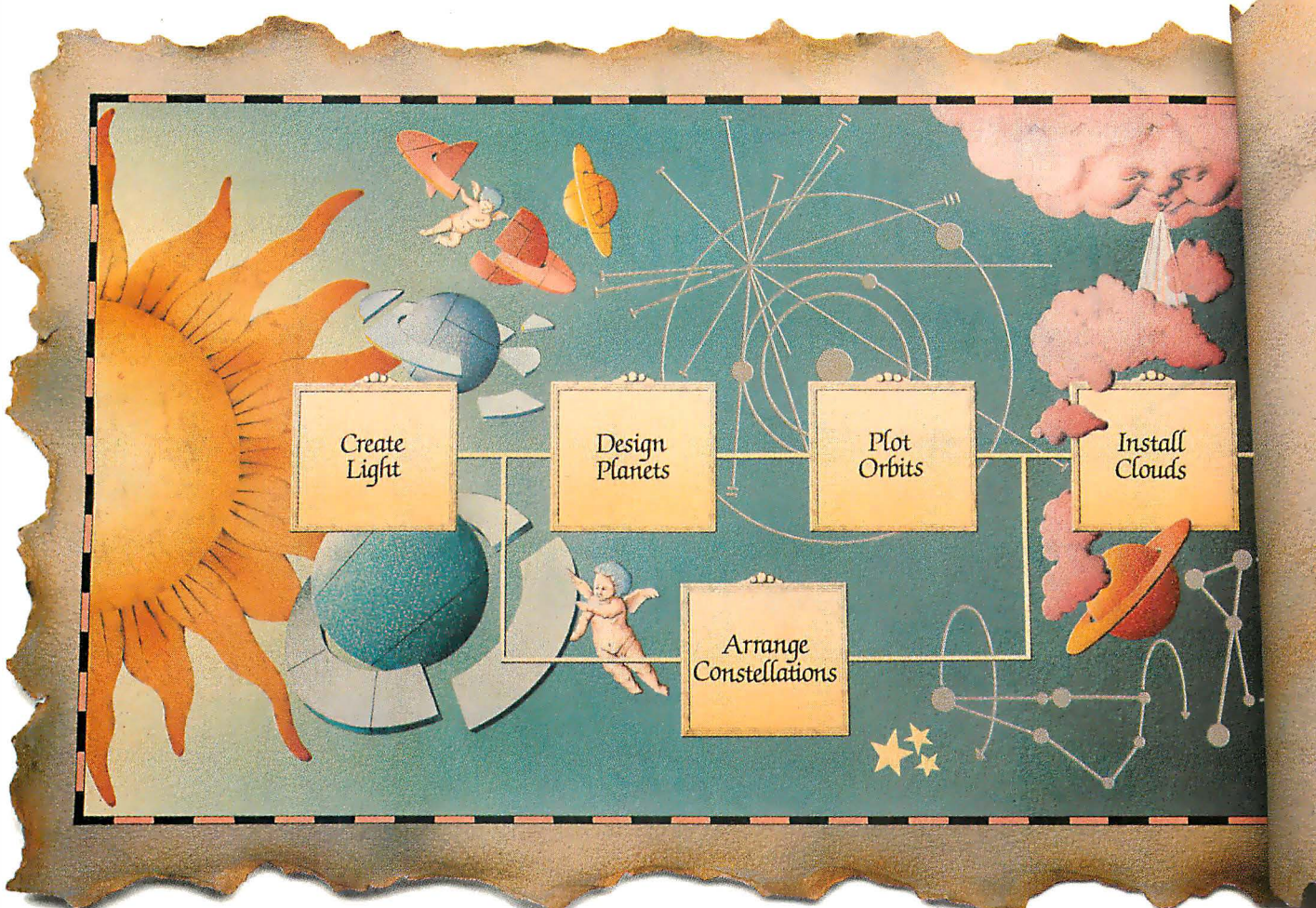

# NOW IT'S EASIER TO MOVE HEAVEN & EARTH.

## Introducing Harvard Total Project Manager II

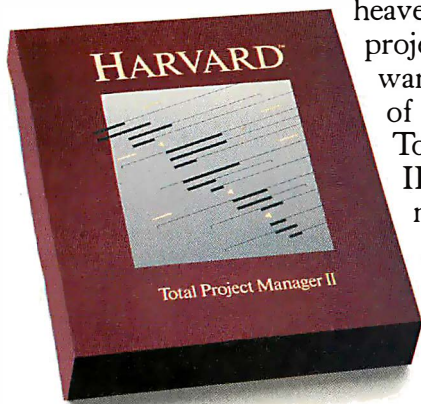

If you have to move heaven and earth, the best project management software can make a world of difference. Harvard Total Project Manager II (HTPM II) lets you manage important projects faster and easier, with earth-shaking new features.

Finally you can plan your project directly on the computer.

HTPM II's unique graphic Work Breakdown Structure lets you identify all your project's tasks entirely on-screen. From there, it's easy to optimize your project's plan through a program-generated PERT chart.

Or, if you prefer, you can create or manage your project in the PERT chart, Gantt chart or HTPM II's own Task List format.

With HTPM II, managing resources has never been easier. When you're juggling several projects, you can track allocations across all jobs and be instantly alerted to over-commitments. Automatic resource leveling easily resolves complex conflicts, too.

HTPM II also clearly displays actual vs. planned and baseline information on-screen, to help evaluate costs and scheduling.

And, for presentation-quality reports, HTPM II supports an expanded list of peripherals, including the HP Laserjet and many plotters.

So for better planning, scheduling, controlling and reporting, choose HTPM II. Because with Harvard Total Project Manager, the sky's the limit!

**For a free trial size diskette call 1-408-848-4391.  
For upgrade information call 1-800-255-5550.**

## GRADUATE TO HARVARD TOTAL PROJECT MANAGER II.

Runs on IBM XT with hard drive and MS DOS compatibles. Software Publishing Corporation, P.O. Box 7210, Mt. View, CA 94039-7210.



1-2-3  
More than the best  
selling PC software

1982  
1-2-3 → intro

1984  
1-2-3 → The Standard

1986/87  
1-2-3 → A System

New Lotus  
products -  
Lotus HAL,  
Freelance Plus, etc.

independent  
software  
developers



1-2-3® is more than just the best selling PC software package in the world. It's a system. A system that includes a wide range of Lotus® products that work with 1-2-3. Including Lotus HAL™—for easier and faster use of 1-2-3. 1-2-3 Report Writer™—for reports, forms and mailing labels. And Freelance® Plus— for business graphics.

It's also more than 1000 specialized applications designed by independent software developers to work with 1-2-3.

It's outstanding support and service backed by a free telephone hotline and Lotus PROMPT™, a new comprehensive user support program.

But most important, it's a guarantee that the 1-2-3 software you buy today will become more valuable and more useful to you in the years ahead.

# Lotus 1-2-3

*Business software integrating spreadsheet, graphics and database.*

© 1987 Lotus Development Corporation. Lotus, 1-2-3 and Freelance are registered trademarks of Lotus Development Corporation. 1-2-3 Report Writer, Lotus HAL and Lotus PROMPT are trademarks of Lotus Development Corporation. Lotus HAL is distinguished from HAL, which is a trademark of Qantel for its Hotel and Leisure Software.

*new Support/Service  
training centers  
800 #*

**A secret weapon  
for 1-2-3 and Symphony users.**

**TOP SECRET**

The Cambridge Spreadsheet Analyst can win you the best...

**SEND US \$79.95,  
AND NO ONE WILL EVER  
QUESTION YOUR FIGURES AGAIN.**

**AS MANY  
ON A DISK. \$79.95.**

**What If?**

...I wouldn't want a  
move without it

PC

**MAKING**

FOR

...I wouldn't want a move without it

PC

**Note-1  
THE 1-2-3 DOG**

**HOW TO ORDER:**

Return Mail Publishing  
**1-800-556-1234 x525**  
(In CA 800-441-2345 x525)

**Lotus users prefer SIDEWAYS  
by a very wide margin.**

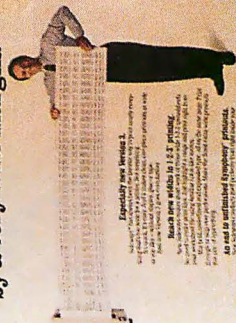

**SPREADS**





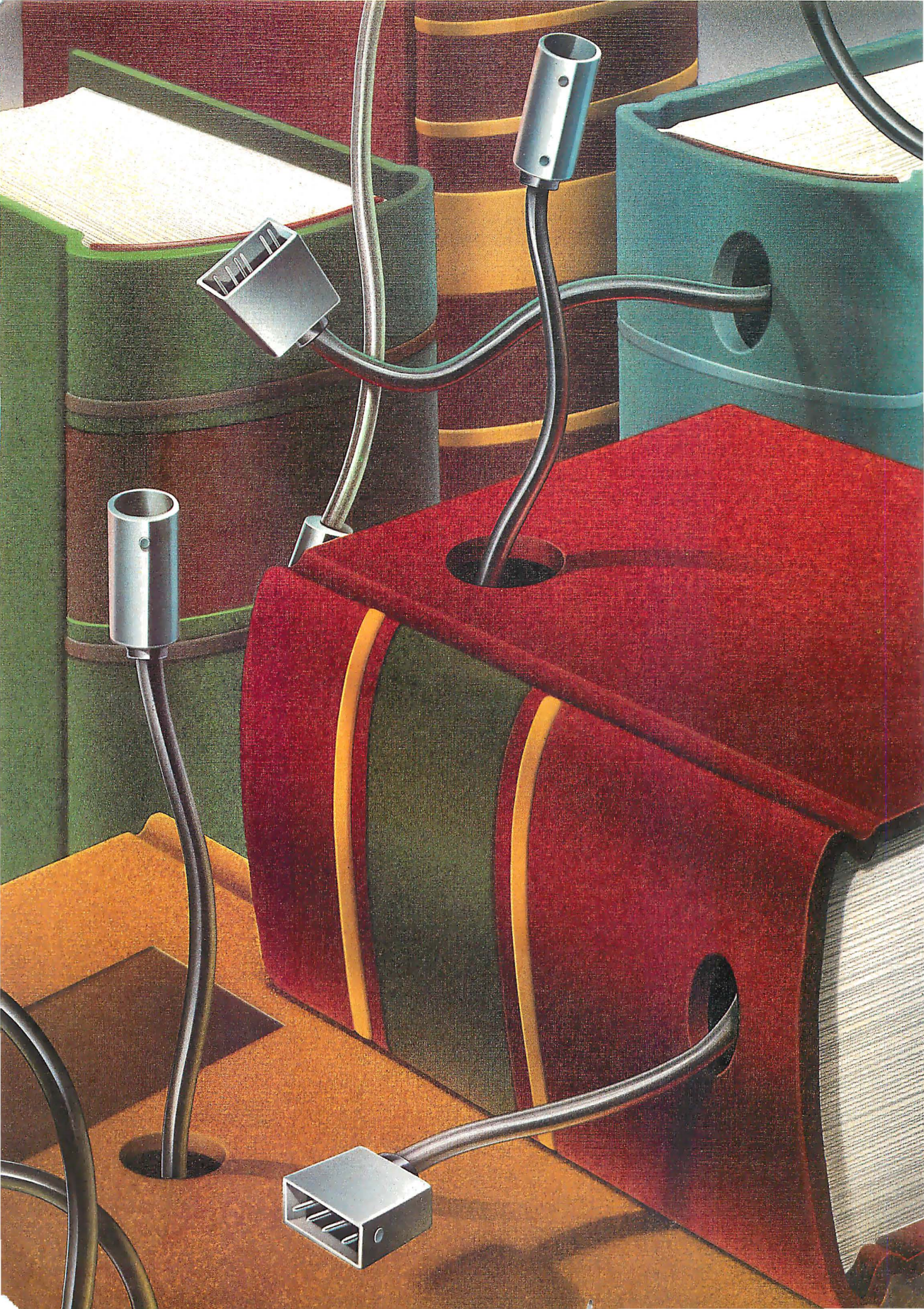



# *Educational Computing*

---

**Using Computers for Instruction**  
*by Henry Jay Becker* ..... 149

**The Difference in Higher Education**  
*by Donna Osgood* ..... 165

**The Quiet Revolution**  
*by Brock N. Meeks* ..... 183

**A Hard Look at Educational Software**  
*by Adeline Naiman* ..... 193

**The Potential for Interactive Technology**  
*by Alfred Bork* ..... 201

---

IN THIS COLLECTION of articles exploring various aspects of educational computing, you'll find, as we did, that while some authors call for revamping the entire educational process, other authors survey the successes in the field. One thing is certain, no two agree or share the same visions, causes, or needs in applying computer technology to education.

We begin with "Using Computers for Instruction," which presents some unofficial results of the Second National Survey of Instructional Uses of School Computers, commissioned by the U.S. Department of Education in 1985 and conducted that spring. According to Henry Jay Becker, a research scientist from Johns Hopkins University in Baltimore, while successes have been recorded, unexpected trends may unwittingly shape the future unless they are corrected.

Following the survey, BYTE's Donna Osgood focuses on major accomplishments of a sampling of colleges—Reed College, Stanford University, Carnegie Mellon, Drexel University, and Brown University—and shows the different ways these five colleges have used computers. She includes screen shots of programs developed by both faculty and students that are available to all colleges through the Academic Courseware Exchange, explained in an accompanying text box. From these examples, it is evident that educators and students are gaining proficiency in using new techniques to computerize academics.

To further electronic access to post-secondary education, Brock N. Meeks, a teacher in an on-line alternative education program, discusses the real advantages of receiving graduate credit for courses offered on-line in "The Quiet Revolution." This is followed by comments from readers affiliated with universities who responded to the editorial in the September 1986 issue of BYTE, which was a call for improved on-line education.

Shifting focus from college to elementary and secondary educational concerns, "A Hard Look at Educational Software" by Adeline Naiman, director of an educational software firm, charts the reluctance of investors in developing innovative software. She ascertains it is the publishers who have leaped in to fill this void. In the end, Ms. Naiman heralds the birth of a third generation of software applicable to the classroom.

With an eye to the future, we close our presentation with a theoretical viewpoint by Alfred Bork, long known for his work with computers in education. His concerns mirror many of the findings from Becker's survey, bringing our discussion full circle. In "The Potential for Interactive Technology," Bork critiques the current problems found in education, emphasizes a few workable programs, but goes on from there to encapsulate visions for combating the problems he so carefully outlines. Further, Bork calculates the expense of his program and its multinational possibilities.

The conclusions you draw from these readings will undoubtedly reflect your particular interest in the field, whether you attend school, have children in school, or are a teacher, administrator, or a concerned member of the computing community. Perhaps the issues raised here, in conjunction with the successes, will contribute to the pursuit of equality on all fronts in academic computing.

—Margaret Cook Gurney, Associate Technical Editor



# Get a new handle on your business with SBT.

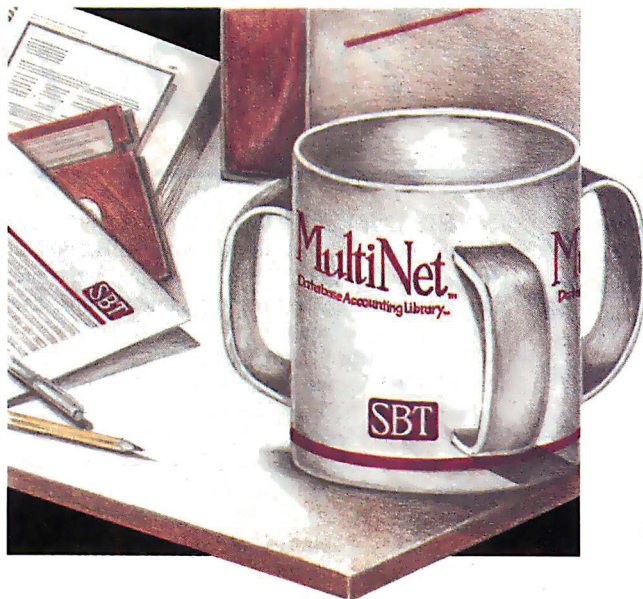

Now you can handle up to 254 users, all working in the same data files, with the SBT MultiNet Database Accounting Library. The accounting software written in dBASE III PLUS.

So whether your business is large or small, you can grow to the limits of the most advanced PC networks available.

When you want that special report, or your business needs something we didn't think of, you can quickly and easily modify our programs to meet your needs exactly (because our dBASE source code is included **absolutely free**).

And if you don't have time to make the changes yourself, there's a nearby consultant who can make them for you.

So if your company has two users or two hundred and fifty, you can add customers, update records, and have as many people enter orders as it takes to keep your business growing.

Isn't it nice to know there's software you can't outgrow? The SBT MultiNet Database Accounting Library.

Now you can get a new handle on your business.

Call today for our demo disk and brochure.

#### THE SBT DATABASE ACCOUNTING LIBRARY.

dProfessional	Time & Billing	\$395
dOrder	Sales Order Processing	\$295
dInvoice	Billing/Inventory Control	\$295
dStatement	Accounts Receivable	\$100
dPurchase	Purchase Order	\$295
dPayable	Accounts Payable	\$395
dPayroll	Payroll/Labor	\$395
dLedger	General Ledger/Finance	\$395
dAssets	Asset/Depreciation	\$295
dProject	Project/Job Accounting	\$395
dProperty	Tenant/Unit Management	\$395
dBackup	Menu/Backup	\$ 65

MultiNet versions \$200 additional per module

Call today for the name of the SBT consultant in your area.

ThreeHarbor Drive  
Sausalito, CA 94965  
(415) 331-9900





# Using Computers for Instruction

*The results and implications of a national survey may surprise you*

Henry Jay Becker

IN 1985 THE SECOND National Survey of Instructional Uses of School Computers was commissioned by the United States Department of Education. The 2331 schools that were included in the study were selected from a sample of elementary and secondary schools, public and private. Schools with higher grade levels and schools that were expected to have more computers were oversampled in order to provide the most detail possible about schools making varied and extensive uses of computers. The raw results were reweighted so that the data shown could be interpreted as coming from a representative sample.

Data analysis for the survey is still in progress and is supported by the Department of Education's Office of Educational Research and Improvement and by a grant from the National Science Foundation. Any opinions expressed in this article are my own and do not reflect the policy of these agencies; no official endorsement should be inferred. The study was conducted in the spring of 1985, and data should be viewed in that context. (For further information, see reference 1.)

## Achieving a Desirable Ratio

In the last five years, most schools have begun using computers in their instructional programs. Seven years ago, half of all high schools had no computer at all; and only four years ago, fewer than half of elementary schools had any. However, currently, 90 percent of all U.S. schoolchildren attend a school with at least one computer. The typical high school has

more than 20 computers, and the typical elementary school has 6. But these numbers are far short of the resources needed if schools are to provide all their students with a substantial degree of computer-based experience.

Under the right conditions, a typical high school student could use computers to write compositions, memorize facts and vocabulary, understand relationships and concepts in mathematics and science, and write computer programs. Each of these separate uses might occupy from 30 minutes to three hours of computer time per week. Thus, a high school student could profitably use computers for as much as an hour or two per day.

But very few schools have the computer resources to give that much computer time to each student. To provide only 30 minutes of computer time daily to each student, a school would need one computer for every 12 students—assuming constant use of the computers for six hours per day, with no time lost to transitions, scheduling foul-ups, or other interruptions. Such a favorable ratio is available at only 7 percent of high schools and 2 or 3 percent of elementary and middle schools. Most schools can provide a substantial computer experience to some students only by limiting the number of students who have access to computers.

## Student Computer Use

Nearly half of elementary and middle school pupils and about one-third of high school students make some use of computers at school. However, many of these

computer uses are casual and of short duration. Overall, a typical elementary school student using computers in a particular week uses them for 35 minutes that week, either all on one day or in 10- or 15-minute sessions on different days. During most weeks the student may not use computers at all because elementary schools generally rotate computer exposure among as many students as possible. The typical middle school student using computers has a little more than one hour per week, while the typical high school computer user has nearly two hours. While fewer students use computers in the higher grades, they do so much more intensively.

Figure 1 shows how school computer time and student users are divided among the grade levels from kindergarten through twelfth grade. In elementary schools, both the number of student users and the total amount of use increase every grade from kindergarten to fifth grade. At the middle school level, fewer students use computers, but the total computer time goes up sharply between the sixth and seventh grades. At the high school level, both measures shift sharply. In the ninth grade,

*continued*

*Henry Jay Becker is a research scientist at the Center for Social Organization of Schools at Johns Hopkins University (3505 North Charles St., Baltimore, MD 21218). He conducts research on the use and effectiveness of computers for instruction and learning in school. He has a Ph.D. in sociology from Johns Hopkins.*



substantially fewer students spend substantially less time using computers than in the eighth grade. (About the same number of ninth-grade students use computers as kindergarteners.) High school computer use is clearly dominated by juniors and seniors, who make up 60 percent of the high school users and nearly 67 percent of the instructional time available on high school computers.

Comparing these survey findings to a similar survey conducted in 1983, a typical student computer user in 1985 gets about twice as much computer time as a student user did two years earlier, and the number of students using computers at each school has also about doubled. These increases

are possible because the number of computers in schools has quadrupled during the two-year period, and each computer is now in use for more hours per week.

**Teacher Use**

One-fourth of the teachers use computers regularly with students. A much higher proportion of elementary school teachers do so (37 percent in the K-6 schools) than do secondary school teachers (15 percent). However, because schools with older students tend to be larger, roughly the same number of teachers (five per school) use computers regularly during the year at the typical elementary school and at the typical high school.

On the other hand, high school teachers who use computers are much more computer-knowledgeable than their elementary school counterparts. For each school, the survey obtained an estimate of the number of computer-using teachers who are considered expert in each of four aspects of using computers—using some instructional programs, knowing about a wide variety of programs, using word processing or other professional tools, and writing computer programs. Averaging across these four areas of computer-related knowledge, 27 percent of the computer-using teachers from the high schools and 21 percent of those from the middle schools are considered expert, while only 10 percent of those from the elementary schools are.

**Major Instructional Uses**

The ways in which students use computers differ sharply by grade level, as you would expect. More than 50 percent of the computer time for students in elementary schools involves computer-assisted instruction (CAI) with drill-and-practice or tutorial programs, and only about 12 percent of the time is spent writing computer programs. High school students, on the other hand, spend only 16 percent of their computer time on CAI but fully 50 percent in programming. On the average, across all school levels, student time averages out and divides evenly among CAI, programming, and other academic work (including “discovery learning” and word processing).

How central a role do computers play in instruction at different grade levels? Teachers were asked about their use of computers for one (randomly sampled) class or subject—whether computers are used in that particular class as a regular part of instruction, primarily for enrichment, or primarily for remediation. Figure 2 shows how the responses differ by grade level.

From kindergarten through the eighth grade, computers are used primarily for enrichment. They also play a remediation role from the first through the seventh grades, but remediation is never much more than 33 percent of all computer use. In the secondary grades, computers become integral to class instruction, especially in the eleventh and twelfth grades.

Thus, while more students use computers at the lower grades, those high school students who use them do so more intensively and more often as a regular part of class instruction. However, regular use in high school classes generally involves the computer as the *subject* of instruction rather than as an instructional

*continued*

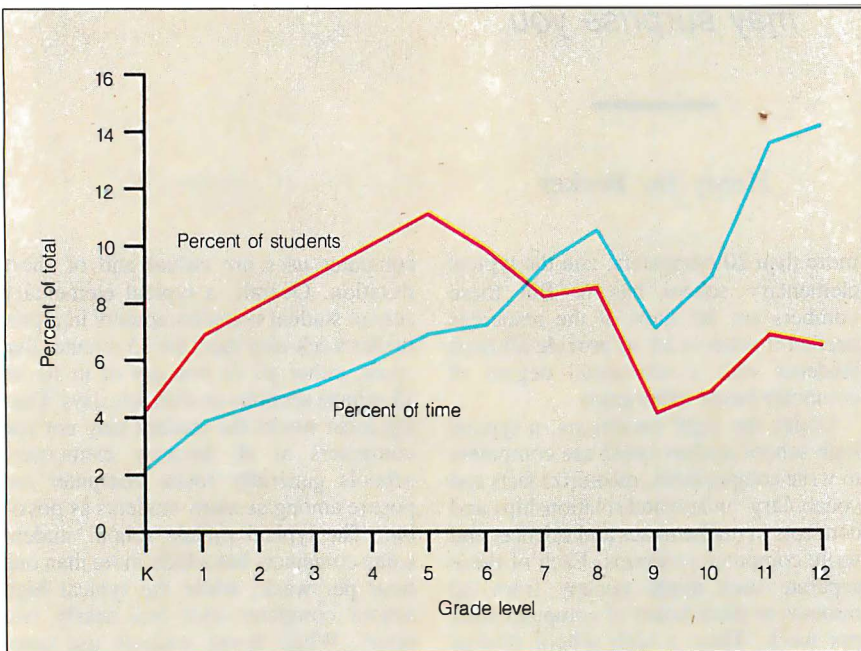

**Figure 1:** Distribution of student computer users and computer time use by grade level.

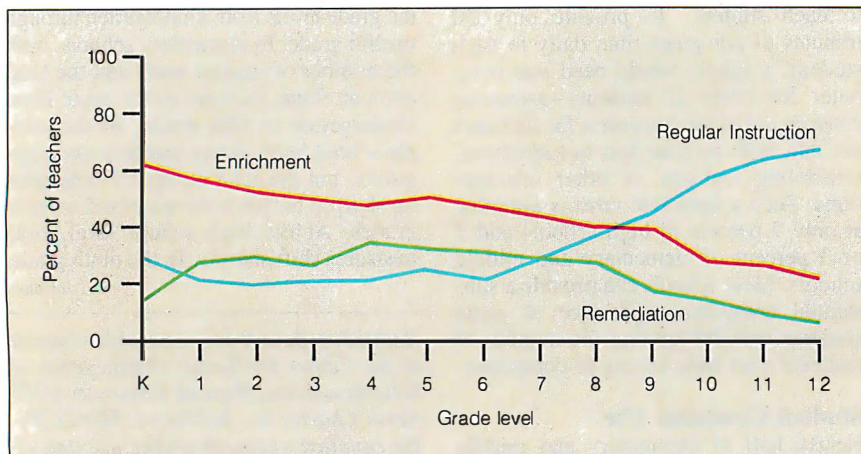

**Figure 2:** Function of computer activity for teachers—enrichment, remediation, or regular instruction—by grade level. (Percents may total more than 100 percent because of multiple answers.)



# Attention Lotus users: Write easier, write faster. Right in 1-2-3.

Lotus users must be the most loyal, most patient people in the world . . . so many of you continue to use 1-2-3 for writing memos and reports. You tap the / Range Justify command to rearrange text. Your [F2] edit key is worn an eighth of an inch shorter than the rest. It's not pretty, but it works. Well, your patience just paid off. Introducing 4WORD, The Add-In Word Processor™ for 1-2-3. If you've ever written a memo using Lotus, you're going to love it.

## Complete Word Processing. Built-In.

4WORD is unlike anything you've seen. It's not a macro. It's not even a stand-alone Lotus add-on. 4WORD is full-featured word processing software that integrates into 1-2-3 itself. It's one of the first products available that uses the new Advanced Add-In technology from Lotus. So it actually functions as part of 1-2-3 (the way word processing works inside Symphony). That means when you want to write a memo, just shift into 4WORD with a single keystroke. Right in the middle of your spreadsheet. You never have to stop, store and exit 1-2-3 again.

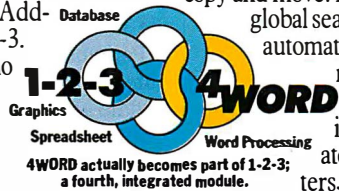

4WORD, just move the cursor to an unused column, press a key and you're there. Now you can type away. With features of the most powerful word processors.

## Better letters. On-screen.

4WORD gives you automatic word wrap with on-screen justification. Block copy and move. Bold, italics, underline, global search and replace, tabs, automatic re-align, margins, and more. All right on your screen. All without leaving 1-2-3. You can even create sophisticated form letters, and merge them with the spreadsheet's database. Automatically. Then print with the 1-2-3 /Print command. And, the whole process can be controlled by a 1-2-3 macro.

Now let's talk integration. Imagine the memo again. And imagine this: To demonstrate your solution, you need to include spreadsheet numbers. Can 4WORD do that? You bet. Just tap / Integrate (that's a new 4WORD command), move the cursor across the range of numbers and zap. Your memo is connected to your spreadsheet. And the numbers appear in the memo right where you want them. If you change numbers in the spreadsheet, the memo changes too. We call this "hotlinks." And the first time you write a report with tables, exhibits and appendices linked to 1-2-3 spreadsheets, you'll understand why.

Think of 4WORD as a easy-to-use companion to 1-2-3. It's the kind of product you've come to expect from Turner Hall, publishers of Note-It and SQZ!. 4WORD won't replace your stand-alone word processor . . . it's really not meant to. But for only \$99.95, it's one heck of a spreadsheet addition.

### Specifications:

- Not copy-protected.
- Requires PC/MS-DOS 2.0 or later and an IBM PC version of Lotus 1-2-3 Release 2.0 or later.
- Compatible with EMS boards and programs like Sidekick, SQZ!, Note-It® and HAL.
- Uses only 50K of additional memory.
- Complete on-line, Lotus-like help system.
- Can be controlled by 1-2-3 macros.

## The Write Guarantee.

We're so sure you'll love 4WORD, we'll give you this guarantee: try 4WORD for 30 days and if you're not completely satisfied for any reason we'll take it back and send back your money. No questions asked. Call today. Or better yet, right now.

**1-800-556-1234 x528**  
**(In CA 800-441-2345 x528)**

# 4WORD

## THE ADD-IN WORD PROCESSOR™ FOR 1-2-3

Only  
**\$99.95**

Available at better  
dealers everywhere

Inquiry 302

**Turner Hall Publishing**

A division of Symantec

10201 Torre Ave., Cupertino, CA 95014 • (408) 253-9607

SQZ! and 4WORD The Add-In Word Processor are trademarks and Note-It is a registered trademark of Turner Hall Publishing. Lotus, Symphony, HAL and 1-2-3 are registered trademarks or Lotus Development Corp. Other brand and product names are trademarks of their respective holders.

Please send me \_\_\_\_\_ copies of 4WORD for \$99.95, plus \$2.00 per unit shipping. (\$12 per unit outside USA). CA residents add \$7.00 sales tax per unit.

I enclose \$ \_\_\_\_\_  
 VISA  MasterCard  AMEX  Diners Club

Card # \_\_\_\_\_ Exp. Date \_\_\_\_\_

Name \_\_\_\_\_

Company \_\_\_\_\_

Address \_\_\_\_\_

City/State/Zip \_\_\_\_\_

Phone ( \_\_\_\_\_ ) \_\_\_\_\_ BY2/87

Developed by  
**LeBlond Software**  
The Add-In Experts



## Boys outnumber girls in using computers before or after school.

medium or a productivity tool. So, regardless of grade level, only a small fraction of the time is the computer used as a *regular* part of instruction in traditional academic subjects.

Table 1 presents the distribution of com-

puter uses across school subjects for the following three grade groups: early elementary (K-3), late elementary and middle (4-8), and high school (9-12). The teachers were asked which computer activity their students most recently engaged in. The results are weighted according to how much that class used computers during the year, so percentages give the approximate proportion of total use.

In grades K-3, whole-number arithmetic and language arts, including spelling and reading, constitute 77 percent of computer use, which includes the time spent in

computer-literacy units where students are engaged in math or language drills. General instruction about computers, programming, problem solving, and writing altogether come to only about 20 percent of the time spent. In contrast, in grades 9 through 12, 50 percent of all computer activity is concentrated in computer programming and computer-literacy courses and topics, while only 13 percent is divided between math and language arts.

More time (18 percent) is spent in business typing and word processing courses at the high school level. Counting only regular computer use in a subject, computers appear to play an even greater role in industrial arts and business education courses than they do in any of the traditional high school academic areas, with the possible exception of science.

Perhaps the most diverse use of computers appears in the late elementary and middle grades. There is substantial use in math and language arts (48 percent), as well as significant use where the computer is the *object* of instruction (41 percent). Middle school once again proves its name as a transition between elementary and high school.

### Differences by Sex

Boys use school computers more than girls do, although not everywhere and not in all respects. The survey assessed the proportion of student computer users who are girls for the following kinds of use: before or after school, word processing, elective computer programming classes, computer-game playing, and overall use. Girls constitute roughly half of students using computers for word processing and roughly half of students using computers overall. This parity stretched across all three school levels. In addition, playing computer games involved as many girls as boys in elementary school, but not in middle or high school.

Enrollments in elective programming classes in the middle and high schools were also roughly evenly split between male and female students, with the typical school reporting that programming classes are about 45 percent female. An even higher percentage of girls were in those programming classes that require algebra or higher math as a prerequisite.

Where computers are used either before or after school, boys outnumber girls 3 to 1. At the typical middle school, only 15 percent of the before- or after-school users are girls. Boys also dominate elective programming activities in elementary school and game playing in middle and high school. Girls dominate in high school word processing, most of which occurs in business education courses where girls

*continued*

## The Advantage Is...



## Upgradeability

At a fraction of the cost of the leading modem, the Messenger 1200™ is a brilliant investment in your computer system's future. Its many advanced features are highlighted by easy upgradeability to 2400 baud transmission (if your communication requirements increase). The Messenger 1200,™ it's got all the advantages.

- Upgradeable to 2400 Baud
- 100% Hayes Compatible— Full Hayes 'AT' Command Set
- Asynchronous and Synchronous Data Formats
- 300/1200 Baud Rates and Auto Dial/Auto Answer
- External RS-232 or Internal Halfcard Models
- FREE Powerful Communications Software and Extras
- Single Modem Chip Technology
- One Year Warranty

Dealer inquiries welcome—for orders or literature call:  
Toll free (800) 334-5255 Inside CA (818) 709-6581



Aicon Systems, Inc. 8968 Fullbright Ave., Chatsworth, CA 91311-6158



# IT'S HERE

**re:Source**—Software that rewrites the script for online computing. If you own an IBM PC or compatible, re:Source is a combination of communications and script development software that not only supercharges The Source®, but makes it much easier to use.

re:Source is a specially developed "front end" system that speeds up file transfers, automates frequent command sequences, and integrates database information for The Source.

Now you can develop and customize your own online scripts. And take advantage of re:Source's advanced offline editing features to save on connect charges. And re:Source can be customized to

use with other online services.

Other communications software only lets your PC respond to an online service. re:Source controls both your PC and the online service itself.

After all, you paid a lot for your PC. It shouldn't act like a dumb terminal.

**re:Source. The Source created it. The Source supports it.** And we're backing re:Source with an online Special Interest Group.\* Get quick responses to questions about script development, exchange scripts with other users, download new versions directly from The Source and more.

Buy re:Source now at the special introductory price of \$89.00. It includes a free membership to

The Source\*\*, a carefully developed blend of useful information and sophisticated communications tools for the at home/at work user.

If you want to see what online services will look like tomorrow, call this toll-free number, today. And give the operator this claim number 9R02432.

**1-800-336-3366 (1-703-821-6666 in Virginia and outside the continental U.S.)**

## re:Source

from The Source, 1616 Anderson Road, McLean, VA 22102

\*Online rates as low as 10¢ a minute.  
\*\*A \$10 monthly minimum applies.



**Table 1:** *Distribution of computer use by subject and grade level. (Sum of individual entries may not equal subtotal entry because of rounding. Similarly, subtotals may not sum to grand total.) All numbers are percentages.*

Subject (from course title, activity, and software in use)	Grade Levels of Students in Class		
	K-3	4-8	9-12
<b>Mathematics*</b>			
Topics below algebra or unspecified math	42	27	5
Algebra, geometry	0	1	1
Trigonometry, advanced math	0	0	1
Subtotal: traditional math subjects	42	28	7
<b>English</b>			
Language arts and spelling	18	12	4
Reading	17	8	2
Subtotal: language arts	35	20	6
Writing	2	2	3
Word processing in English class	3	3	2
Subtotal: writing	5	5	5
<b>Computers and problem solving</b>			
Math topics: problem solving, Logo, programming activities	3	6	2
Programming** as specific topic or course	2	13	42
Logo as specific topic***	4	5	1
Computer literacy as specific topic or course	6	10	5
Subtotal: computers and problem solving	14	34	50
<b>Business and word processing</b>			
Business, accounting, secretarial, other than word processing	0	0	6
Word processing, not in English class	1	2	12
Subtotal: business	1	2	18
<b>Other subjects</b>			
Science and nutrition	1	3	7
Social studies	1	4	1
Industrial arts and agriculture	0	1	5
Others	2	2	2
Subtotal: other subjects	4	11	15
<b>Total for all subjects</b>	100	100	100

\* See also first entry under Computers and problem solving.  
 \*\* Excluding specific mentions of Logo.  
 \*\*\* Including some general problem solving not classified elsewhere.

make up most of the enrollment. Individual computer-using teachers were asked to indicate the sex of the three students most affected by their experience with computers in school. About 62 percent of the students identified by elementary school teachers were boys; at the secondary school level, about 67 percent of those mentioned were boys. Moreover, the first person named by each teacher was overwhelmingly likely to be a boy—74

percent of the first mentioned at the elementary level and 78 percent at the secondary level. However, when asked how computers have affected these students, elementary and middle grade teachers who had named a girl were more likely to say that computers have helped her academically. Male elementary and middle grade nominees were more likely to be affected in terms of behavior and attitudes—such as im-

provements in self-confidence, self-discipline, or motivation.

**Differences by Ability**

Higher-ability students are much more apt to use computers. At all school levels, students from the top third of their class are disproportionately included among the most active computer users. Students from the bottom third of their class are well

*continued*



**CM-1376**

PGA compatible 13" RGB Analog Super High Resolution monitor. 4,096 color display with 640 x 480 lines of resolution.

**CM-1370**

Persyst "BOB"™ or Sigma 400L™ card compatible 13" RGBI Super High Resolution monitor. 16 color display with 800x400 lines of resolution.

**CM-1370A**

AT&T 6300™ and 6300 Plus™ compatible 13" RGBI Super High Resolution monitor. 16 color display with 800 x 400 lines of resolution.

**CM-1365**

CGA compatible 13" RGBI High Resolution monitor. 16 color display with 640 x 200 lines of resolution. Five position color display switch.

**CM-1360**

CGA compatible 13" RGBI High Resolution monitor. 16 color display with 640 x 200 lines of resolution. Three position color display switch.

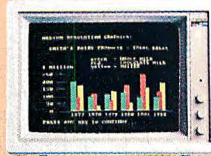
**MM-1422G/A**

MDA or Compaq™ compatible 14" High Quality Monochrome monitor. Amber or green display with 800 x 350 lines of resolution.

**MM-1225G/A**

Apple™, Atari™, or Commodore™ compatible 12" High Quality Monochrome monitor. Amber or green display with 800 x 350 lines of resolution.

**MM-1222G/A**

MDA compatible 12" High Quality Monochrome monitor. Amber or green display with 800 x 350 lines of resolution.

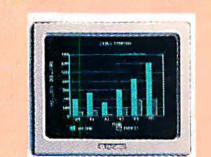

**CM-1380F**  
EGA compatible 13" RrGgBb Super High Resolution monitor. 64 color display with 640 x 350 lines of resolution.

# TATUNG MONITORS.

## We want to be number 1.

### That means we have to have a better product.

**We do.** Better, brighter image quality. Compatibility. The best value you'll find. A guarantee you'll never have to use. And choice...the chance to choose the monitor that meets your needs precisely. That's what it takes to be Number 1. That's just what Tatung offers.

No one gives you a wider range of monitors to choose from. No one offers more quality, more value, and service. That's

**Tatung Quality Monitor Peripherals & Accessories:** TEGA-22 Card, Cable-70, 12"MB-12 and 13"MB-13 tilt & swivel bases.

why more and more computer systems show their stuff on Tatung Monitors. For complete details and specifications, simply send us your business card, or call Angela Liu toll free: 1-800-421-2929 (Outside CA) (213) 979-7055 (In CA).

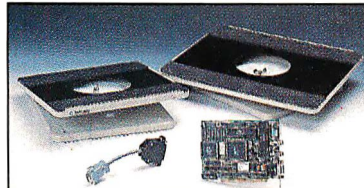

Persyst "BOB" is a registered trademark of Persyst, Personal Systems Technology, Inc. Sigma 400L is a registered trademark of Sigma Designs, Inc. AT&T 6300 & 6300 Plus are registered trademarks of AT&T Information Systems. Compaq is a registered trademark of Compaq Computer Corporation. Apple is a registered trademark of Apple Computer, Inc. Atari is a registered trademark of Atari Corporation. Commodore is a registered trademark of Commodore Business Machines, Inc.



# TATUNG

Inquiry 343 for End-Users.  
Inquiry 344 for DEALERS ONLY.

Tatung Company of America, Inc. 2850 El Presidio St., Long Beach, CA 90810  
In Northern California Call: Tatung Science and Technology, Inc., 780 Charcot Ave., San Jose, CA 95131 (408) 435-0140



*The effect of computers on lower-ability students is improved behavior and attitude.*

represented in elementary school, but not in high school.

Compared to those in the middle third of their class, top-third students use computers more overall, before and after school, and in word processing, and much more in elective programming. Only in playing computer games are the high achievers not dominant.

School computers affect higher- and lower-ability students differently. By far the most frequently reported effect on lower-ability students is improved motivation, self-confidence, and self-discipline.

These behavioral and attitudinal consequences are mentioned much less often for higher-ability students, particularly at the high school level. Lower-ability students also receive academic help primarily in developing basic skills in mathematics, reading, and language. In contrast, teachers reported that computers help higher-ability students primarily with higher-order thinking skills, programming skills, writing, science projects, out-of-school activities, career preparation, real-world experience, and other activities—in other words, “high-ability academic direction” (see figure 3).

Computers may affect students of different academic abilities differently in part because such students use computers in different ways and for different school subjects. The pattern of computer use in low-ability classes in grades 4–8 strongly resembles the overall pattern shown in table 1 for all classes in K–3 (see table 2). Three-quarters of computer activity in

these classes emphasizes basic math and language arts skills. These classes do not share the emphasis on computer-specific and higher-order skills found at the same school level in mixed-ability classes and even more so in high-ability classes.

Computer programming stands out as the most substantial aspect of computer use by high-ability classes in the middle grades. Programming, computer literacy, and problem-solving activities account for 60 percent of the computer time in these classes. Altogether, two-thirds of the class computer time is devoted to higher-order thinking, writing, and programming activities for high-ability groups. In contrast, these uses take up only about 40 percent of the computer time for mixed-ability classes and less than 20 percent for low-ability classes.

Mixed-ability computer-using classes in the middle grades suffer from a poorer ratio of students to computers than do

*continued*

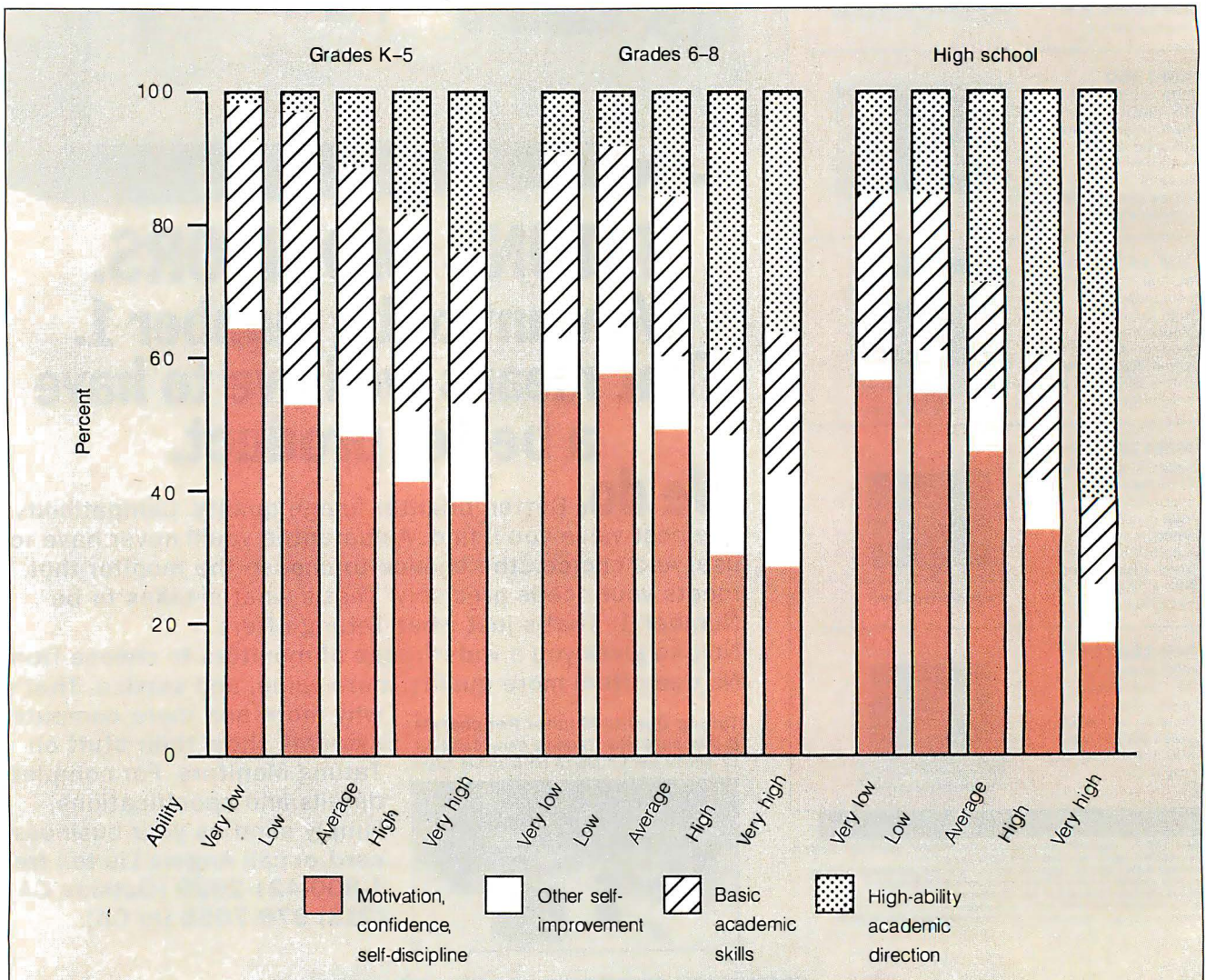

Figure 3: How the most affected students were helped, by grade level and ability.



# WE JUST GOT MORE SOPHISTICATED SO YOU CAN GET MORE BASIC.

**W**e invented BASIC over 20 years ago. Later, we re-invented it for micros as the True BASIC™ structured-programming language.

And the idea was: To make programming as easy and natural as possible. So you could concentrate on what to program. Not how.

Now there's True BASIC Version 2.0 for the IBM® PC and compatibles. Faster, more powerful and sophisticated than the original.

## **MORE GRAPHICS.**

Right from the start, True Basic gave you terrific device-independent graphics. Built-in 2-D transforms. And support for multiple windows.

Now we've added more graphics and full mouse support.

So for the first time, you can create one program that will do superb graphics on CGA, EGA or Hercules displays. Without worrying about additional drivers or overlays. And on the EGA, you can SET COLOR MIX to define your own colors. Use four shades of blue if you want (and make our competitors green with envy).

## **MORE CONTROL.**

We always supported you with recursion, local and global variables and separately compiled libraries.

Now you can have *modules*, too, the industrial-strength tool for building large applications.

Using modules makes it easier for you to share data between routines. Build data structures. Then, if you want, hide them from other parts of the program. So you can always be free to focus on the task at-hand.

Modules have their own initialization sections, so you can set up global variables or turn on instrumentation.

And, like other procedures in True

BASIC, modules can be compiled separately and stored in a library where they can be shared by several applications. Or they can be loaded directly into the True BASIC environment as part of your customized workspace. So when you use True BASIC interactively, the modules look like built-in functions.

Modules made Modula-2 the successor to Pascal. Now they've put True BASIC one-up on all other BASICs.

## **MORE SPEED.**

2.0 is 20 to 200 percent faster than True BASIC Version 1.0. Both compile times and execution speeds. And on some real-world benchmarks, we're faster than many native-code compilers.

## **MORE POWER.**

Start with a complete matrix algebra package.

Then, since we support the use of 640K for both code and data, add arrays as large as you want.

Our compiled code is more compact than what other compilers generate, so there's more memory left for your application.

We've enhanced our dynamic array redimensioning and improved our built-in 8087/80287 support, making True BASIC the most powerful number-crunching BASIC around.

And if it's strings you crunch, we've added new string functions and raised the limit. So strings can be up to 64K characters long.

## **MORE DEBUGGING.**

We pioneered breakpoints and immediate-mode capability in a compiled BASIC environment.

Now we've added utilities that allow you to visually TRACE through your program, and check the values of selected variables. Or print a cross-referenced listing.

And new compiler options like NO LET and NO TYPO let you decide how strictly you want your variable names checked.

## **MORE INNOVATION.**

True BASIC has always had features like full-screen, scrollable editing, Block copy and block moves. And global search and replace.

Now, 2.0 keeps you on the leading edge of editing and file-management technology. With SCRIPT, to write the True BASIC equivalent of a DOS batch file. ECHO, to transfer your output to disk or printer. And ALIAS, to give you and your programs a better roadmap to your subdirectories.

There's also Version 2.0 of the Developer's Toolkit. With support for DOS interrupts. Pop-up menus. Even designer fonts.

And remember: your programs are portable to the other machines we support: the Apple Macintosh™ and Commodore Amiga®.

## **MORE SUPPORT.**

Call your local dealer. Call us TOLL-FREE at 1-800-TR-BASIC. Or write to: True BASIC, Inc., 39 South Main Street, Hanover, NH 03755. We'll send you more information. Including a free demo disk.

See for yourself. That we're still true to our basic idea.

*True*  
**BASIC™** inc.

True BASIC Language System is a trademark of True Basic, Inc. Macintosh is a trademark licensed to Apple Computer Inc. Amiga is a registered trademark of Commodore-Amiga, Inc. IBM is a registered trademark of International Business Machines.



**Table 2:** Distribution of computer use by subject and ability level. (Sum of individual entries may not equal subtotal entry because of rounding. Similarly, subtotals may not sum to grand total.) All numbers are percentages.

Subject (from course title, activity, and software in use)	Grade and Ability Levels of Students in Class					
	Grades 4-8			Grades 9-12		
	Low (29%)	Mixed (59%)	High (12%)	Low (13%)	Mixed (78%)	High (9%)
<b>Mathematics*</b>						
Topics below algebra or unspecified math	36	27	9	32	1	0
Algebra, geometry	2	1	3	1	1	2
Trigonometry, advanced math	0	0	0	0	1	3
Subtotal: traditional math subjects	38	28	12	32	3	5
<b>English</b>						
Language arts and spelling	20	10	4	16	2	1
Reading	19	5	2	13	0	2
Subtotal: language arts	39	15	6	29	2	3
Writing	5	1	6	4	2	9
Word processing in English class	1	3	4	5	1	5
Subtotal: writing	6	4	10	9	3	14
<b>Computers and problem solving</b>						
Math topics: problem solving, Logo, programming activities	4	6	10	3	1	2
Programming** as specific topic or course	2	14	25	4	50	32
Logo as specific topic***	3	6	8	2	1	1
Computer literacy as specific topic or course	4	12	18	6	5	4
Subtotal: computers and problem solving	13	38	61	15	57	40
<b>Business and word processing</b>						
Business, accounting, secretarial, other than word processing	0	1	0	0	7	2
Word processing, not in English class	2	1	2	6	13	11
Subtotal: business	2	2	2	6	20	13
<b>Other subjects</b>						
Science and nutrition	1	5	2	2	6	18
Social studies	0	6	6	3	1	3
Industrial arts and agriculture	0	1	0	2	7	0
Others	2	3	3	3	2	3
Subtotal: other subjects	3	14	10	9	15	24
<b>Total for all subjects</b>	100	100	100	100	100	100

\* See also first entry under Computers and problem solving.

\*\* Excluding specific mentions of Logo.

\*\*\* Including some general problem solving not classified elsewhere.

either low- or high-ability classes. The mixed-ability classes tend to be somewhat larger than the gifted classes and much larger than the special-education classes. And they are allotted fewer computers. About 60 percent of the classes in the middle grades use computers in the classroom rather than in a computer lab, and there they have a 20-to-1 ratio of students per computer. So they typically have only one or two computers in their classroom. High-ability classes using computers in

the classroom have a median 10-to-1 ratio, and low-ability classes typically have an even better 5-to-1 ratio. In addition, high-ability classes are more likely than either of the other types to use computers outside of the classroom, in a laboratory or library, where the student-to-computer ratio is typically 1 to 1.





Students in high-ability classes, along with their teachers, are more likely to have a computer at their own home than are other middle grade computer-using

students and their teachers. Among teachers of the high-ability classes, 47 percent have a home computer compared to 28 percent of the other computer-using teachers. In more than 90 percent of the high-ability classes, at least three students have a home computer. This compares to about 60 percent for the mixed-ability classes and only 20 percent for the low-ability classes (which, however, have fewer students). On the other hand,

*continued*

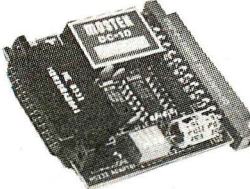

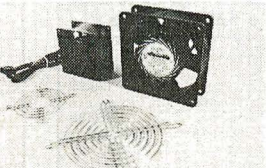
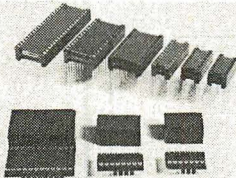
## One-Stop Component Center

<p><b>JE232CM RS232 Interface</b> (Commodore™ VIC-20 &amp; C-64)</p> 	<p><b>National/TI/Motorola/Intel/SAMS Data Books</b></p>  	<p><b>Fans, Finger Guards and Plug Cords</b></p> 	<p><b>Integrated Circuits (E)EPROMs, RAMs, MPUs, etc.</b></p> 
<p><b>Linear Taper Potentiometers</b></p> 	<p><b>Wire Wrap Sockets/ Header Plugs/Covers</b></p> 	<p><b>RS232 25 Contact D-Subminiature Connectors</b></p> 	<p><b>JE215 Adjustable Power Supply Kit</b></p> 

### YOUR NEIGHBORHOOD JIM-PAK AUTHORIZED DISTRIBUTOR

<p><b>ALABAMA</b> Birmingham: J.L.S. Electronics Huntsville: W&amp;S Electronics Mobile: ATM Electronics Montgomery: Handley's Elect. Center</p>	<p><b>COLORADO</b> Colorado Springs: Centennial Electronics Denver: <b>Fistel's Microelectronics</b></p>	<p><b>LOUISIANA (Continued)</b> Houma: Pelican Electronics Lake Charles: Wholesale Radio &amp; Equip. Metairie: Pelican Electronic Supply Shreveport: Electronic Supply of Shreveport Shreveport: Industrial Electronic Supply Shreveport: Southern Electronics</p>	<p><b>NEW JERSEY</b> Camden: General Radio Fairlawn: Heath/Zenith Mantua: Electronic World Ocean: Heath/Zenith Trenton: Laraco Radio Vineland: Laraco/Vineland</p>
<p><b>ALASKA</b> Anchorage: Electronic Supply Center Homer: A-COM of Alaska</p>	<p><b>CONNECTICUT</b> Wallingford: Iron Town USA</p>	<p><b>NEW MEXICO</b> Albuquerque: Electronic City</p>	<p><b>TEXAS</b> Brownsville: George's Electronic Mart Dallas: Heath/Zenith Harlingen: George's Electronic Mart Houston: Angie Electronics McAllen: George's Electronic Mart McAllen: Valley Wide Electronics Odessa: Whitlock Instrument Richardson: Martin Wholesale Electronics</p>
<p><b>ARIZONA</b> Sierra Vista: B&amp;S Electronics Tucson: Electronic City Yuma: Yuma Electronics</p>	<p><b>DELAWARE</b> Newark: Computerland Wilmington: Wholesale Electronics</p>	<p><b>NEW YORK</b> Amherst: Audio Center Amherst: Heath/Zenith Bethpage: Electronic No. 24 Inc. Buffalo: Radio Equipment Corp. Commack: Spartan Electronics Jamestown: Warren Radio Johnston City: Unicorn Electronics Kingston: Greylock Electronics Middleton: Greylock Electronics Newburgh: Action Audio Inc. New York: T&amp;T Electronics New York: Heath/Zenith Plattsburgh: Champlain Electronics Roughkeepsie: Greylock Electronics Rochester: Heath/Zenith Troj: Trojan Electronic Supply Ulster: Central Electronics</p>	<p><b>UTAH</b> Cedar City: I &amp; C Electronics Midvale: Heath/Zenith Ogden: Carter Supply Co. Salt Lake City: Kimball Electronics</p>
<p><b>ARKANSAS</b> Little Rock: Arkansas Electronic Supply</p>	<p><b>FLORIDA</b> Clearwater: Amateur Electronic Supply Daytona Beach: C&amp;S Electronics Del Ray Beach: Electronic Parts Outlet Fort Walton Beach: Palm Electronics Gainesville: Skipper Electronics Hialeah: Heath/Zenith Miami: Oharamdas Sons Oakland Park: Lafayette Radio Orlando: C&amp;S Electronics Pensacola: Pensacola Electronics Tampa: Leader Electronics</p>	<p><b>MARYLAND</b> Aberdeen: Harco Electronics Baltimore: BCT Electronics Beltsville: Mark Electronics College Park: Electronics Plus Glen Burnie: Revaco of Maryland Laurel: Maryland Radio Center Lavage: J&amp;M Electronics Towson: <b>Baynesville Electronics</b></p>	<p><b>VERMONT</b> Burlington: Greylock Electronics</p>
<p><b>CALIFORNIA</b> Anaheim: R.F. Electronics Atascadero: Coast Electronics <b>Berkeley: Al Lasher's Electronics</b> Carpinteria: Electronic Resources Chico: Playless Wholesale Chico: The Electronics Warehouse Chula Vista: Lion Electronics Concord: Pacific/Valley Electronics Costa Mesa: Mar-Vac Electronics Covina: G&amp;H/AMCO Elect. Supply Cucamonga: Abletronics Dublin: Pacific/Valley Electronics Eureka: Redwood Electronics Fontana: Fontana Electronics Fresno: Sparky Electronics Fresno: Whitcom Electronics Glendale: Eagle Electronics Goleta: Bill's Stereo Half Moon Bay: Strawflower Elec./Radio Shack Harbor City: Bull's Electronics Hawaiian Gardens: Carson Electronics Hollywood: Pacific Radio Exchange Inglewood: Inglewood Elect. Lompoc: L&amp;H Electronic Emporium Los Osos: Coast Electronics Merced: Rick's Electronics Modesto: Inland Electronics Monterey: Zackit Morro Bay: Coast Electronics National City: Willy's Electronics Oakland: Brill Electronics Oakland: Pacific/Valley Electronics Oceanside: Wenger Electronics Oceanside: Electronic Center Orange: Chuck Hurley's Electronics Sacramento: Industrial MRO Electronics Sacramento: MarVac's Call Radio Electronics <b>Sacramento: Zack/Sacramento</b> San Carlos: J&amp;H Outlet <b>San Francisco: Zack Electronics</b> San Jose: Schad Electronics San Jose: United Radio and TV San Luis Obispo: Coast Electronics San Luis Obispo: Mid-State Electronics San Rafael: Electronics Plus San Ysidro: Electronics Central Santa Cruz: Santa Cruz Electronics Santa Maria: Electronic Parts Supermart Santa Rosa: Pacific/Valley Electronics Scotts Valley: Santa Cruz Electronics #2 Stockton: Cal-Centron Electronics Stockton: Raeburn Electronics Torrance: Signal Electronics Torrance: Torrance Electronics *Vallejo: Zackit Westminster: JK Electronics *Willits: COBCO Electronics</p>	<p><b>GEORGIA</b> Atlanta: A.C.M. Computer Mart Oakland Park: A.C.M. Computer Mart Stone Mountain: Coleman's Electronics</p>	<p><b>MASSACHUSETTS</b> Pittsfield: Pittsfield Radio Equipment Springfield: Sydele Electronic Supply</p>	<p><b>VIRGINIA</b> Annandale: Arcade Electronics Arlington: Arlington Electronic Wholesalers Blacksburg: Scotly's Radio &amp; TV Bristol: Shield's Electronic Supply Charlottesville: E.I.R. Electronics Charlottesville: Grave's Electronics Hampton: Cain Electronics Lynchburg: Electronic Service Co. Norfolk: A-Vec Electronics Norfolk: Cain Electronics Norfolk: Priest Electronics Norfolk: Radio Parts Dist. <b>Richmond: A-Vec Electronics</b> Roanoke: A-Vec Electronics Roanoke: People's Electronics Springfield: ABB&amp;S Corp. Vienna: Electronic Equipment Bank Virginia Beach: Cain Electronics Winchester: Stinson Electronics Inc. Woodbridge: E.G.E.</p>
<p><b>ILLINOIS</b> Addison: Digital World Berwyn: B.B. &amp; W. Electronics Carbondale: Pick's Electronics Downers Grove: Suburban Electronics <b>Mount Prospect: Tri-State Elect.</b> Niles: Joseph Electronic Peoria: Warren Radio Co. South Holland: Union Electronic Dist.</p>	<p><b>HAWAII</b> Honolulu: Industrial Electronics Honolulu: Integrated Circuit Supply</p>	<p><b>MICHIGAN</b> Adrian: Wedemeyer Elect. Supply <b>Ann Arbor: Wedemeyer Elect. Supply</b> Bay City: Kinde Distributing Detroit: Electronic Parts Co. East Detroit: Heath/Zenith Fenton: Tri County Electronics Flint: Shand Electronics Grand Rapids: Radio Parts Inc. Grand Rapids: T&amp;W Electronics Grand Rapids: Warren Radio Jackson: Fulton Radio Supply Lansing: Fulton Radio Supply Lansing: Wedemeyer Elect. Supply Livonia: Northwest Electronics Madison Heights: Warren Radio Niles: Niles Radio Supply Saginaw: Shand Electronics Saint Clair Shores: Bell Electronics Co. Taylor: Tel Van Electronic Supply Traverse City: Traverse City Elect. Supply Warren: K-40 Electronics Westland: The Electronic Connection</p>	<p><b>NORTH CAROLINA</b> Greensboro: Heath/Zenith</p>
<p><b>INDIANA</b> Angola: Lakeland Electronics Bloomington: Stansler Radio Cherferton: Chesleron Electronics Evansville: Hutch &amp; Son Gary: Calumet Electronics Indianapolis: Warren Radio Co.</p>	<p><b>IDAHO</b> Boise: Kimball Electronics Boise: R.J.M. Electronics Pocatello: Kimball Electronics</p>	<p><b>MINNESOTA</b> Duluth: Northwest Radio of Duluth <b>Minneapolis: Acme Electronics</b></p>	<p><b>NORTH DAKOTA</b> Bismarck: Holden Electronics Fargo: Digital Hospital Fargo: S/S Electronics Mandan: John Iverson Company</p>
<p><b>INDIANA (Continued)</b> Bloomington: Stansler Radio Cherferton: Chesleron Electronics Evansville: Hutch &amp; Son Gary: Calumet Electronics Indianapolis: Warren Radio Co.</p>	<p><b>IOWA</b> Ames: Electronic Supply, Inc. Clinton: R.J.S. Electronics Davenport: Union Supply Co. Davenport: Warren Radio Des Moines: Radio Trade Supply Iowa City: Union Supply Co.</p>	<p><b>MISSISSIPPI</b> Bitou: Hooper Electronic Supply Jackson: Ellington Electronic Supply Pascagoula: Hooper Electronic Supply</p>	<p><b>NORTH CAROLINA (Continued)</b> Bismarck: Holden Electronics Fargo: Digital Hospital Fargo: S/S Electronics Mandan: John Iverson Company</p>
<p><b>KANSAS</b> Overland Park: Burstein &amp; Assoc. Salina: Electronics Inc. Wichita: Amateur Radio Equipment Wichita: Lloyd's Radio &amp; Elec. Wichita: R.S.C. Electronics</p>	<p><b>KENTUCKY</b> Lexington: Radio Electronic Equip. Co. Louisville: Peerless Electronic Equip. Co. Paducah: Warren Radio Co.</p>	<p><b>MISSOURI</b> Cape Girardeau: Show Me Electronics Flat River: Show Me Electronics Jefferson City: Central Missouri Dist. Co. Jefferson City: Show Me Electronics Kansas City: Electronic Supply Co. Inc. Rolla: Eagle Electronic Dist. Rolla: Show Me Electronics Sedalia: Show Me Electronics Springfield: Show Me Electronics St. Louis: Show Me Electronics</p>	<p><b>OHIO</b> Akron: Warren Radio Bryan: Berne's Electric Canton: Electronic Center Inc. Cleveland: Heath/Zenith Lancaster: Electronic Supply Co. Parma: Superior Electronics Toledo: Heath/Zenith Toledo: Warren Radio Wickliffe: Amateur Electronic Supply Youngstown: Ross Radio Co.</p>
<p><b>KANSAS (Continued)</b> Overland Park: Burstein &amp; Assoc. Salina: Electronics Inc. Wichita: Amateur Radio Equipment Wichita: Lloyd's Radio &amp; Elec. Wichita: R.S.C. Electronics</p>	<p><b>LOUISIANA</b> Baton Rouge: Industrial Elect. Supply Baton Rouge: Menard Electronics Broussard: Menard Electronics Gretna: Pelican Electronics</p>	<p><b>MONTANA</b> Bozeman: Electronic Service &amp; Dist. Great Falls: Electric City Radio</p>	<p><b>OKLAHOMA</b> Bartlesville: All-State Electronics Oklahoma City: Radio Supply Oklahoma City: Trice Electronics Tulsa: Trice Electronics</p>
<p><b>NEBRASKA</b> Lincoln: G.I. Electronics <b>Lincoln: Scott Electronic Supply</b> Omaha: Scott Electronics</p>	<p><b>NEVADA</b> Las Vegas: Century 23 Sparks: Computer House</p>	<p><b>NEW YORK (Continued)</b> Amherst: Audio Center Amherst: Heath/Zenith Bethpage: Electronic No. 24 Inc. Buffalo: Radio Equipment Corp. Commack: Spartan Electronics Jamestown: Warren Radio Johnston City: Unicorn Electronics Kingston: Greylock Electronics Middleton: Greylock Electronics Newburgh: Action Audio Inc. New York: T&amp;T Electronics New York: Heath/Zenith Plattsburgh: Champlain Electronics Roughkeepsie: Greylock Electronics Rochester: Heath/Zenith Troj: Trojan Electronic Supply Ulster: Central Electronics</p>	<p><b>OREGON</b> Beaverton: Norvac Electronics Corvallis: Zero One Electronics Eugene: Norvac Electronics Portland: Portland Radio Supply</p>



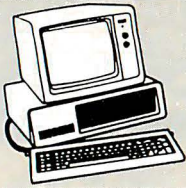

# FOCUS Computers

WE HAVE THE LOWEST PRICES ON ALL COMPUTERS, PRINTERS, FLOPPY DISKS, SOFTWARE, HARD DRIVES, TALLGRASS, BERNOULLI, AND LASER JET PRINTERS

## COMPUTERS

### COMPAQ

COMPAQ PORTABLE II WITH 640K 360K DISK DRIVE 30 MEG HARD DRIVE 9" HIGH RESOLUTION MONITOR  
**"CALL FOR NEW LOW PRICE"**

SPERRY IT ..... CALL  
SPERRY MICRO IT ..... CALL

XT & AT PACKAGES  
**CALL FOR THE LOWEST PRICES IN THE COUNTRY!!!**

## LAP TOP COMPUTERS

### TOSHIBA

T1100 PLUS ..... NEW LOW  
T1100 PLUS (640K) ..... CALL  
T3100 AT COMPAT ..... CALL

### SHARP

PC 7000 DESKTOP YET LIGHTWEIGHT AND TRANSPORTABLE  
**\$ WE HAVE THE ABSOLUTE LOWEST PRICE \$**

### Bondwell

XT COMPATIBLE WITH 640K TWO 360K DISK DRIVES KEYBOARD MONO BOARD, HI RES. MONITOR, GW BASIC & DOS ..... \$869

## MODEMS

Hayes Smartmodem 1200B/IBM ..... 299.95  
Hayes Smartmodem 300 ..... 129.95  
Hayes Smartmodem 2400/RS 232 ..... 569.95  
Hayes Micromodem IIe/Smartcom ..... 129.95  
Hayes Smartmodem IIc (Apple) with Smartmodem software ..... 149.95  
Amazing Modems 1200 Baud internal with software ..... 98.45  
Amazing Modems 2400 Baud internal with software ..... 196.95

## MONITORS

Magnavox RGB Ultra hi res 640 x 240 with green text switch IBM Compat. .... 268.50  
Amdek color 730 RGB/Analog/Extra hi res. PGA Compat. .... 749.95  
Can't mention the name 13" RGB hi res. mfg by Hitachi. List. 699.95 ..... **Now only 279.95**  
NEC multi sync everything all in one monitor EGA/PGA/CGA/ NEW LOW  
Xtron hi res T.T.L. monitor white base ..... 4109.95  
Princeton Graphics HX12 hi res color RGB ..... 398.95

## PRINTERS

PANASONIC (2 year warranty)  
KXP 1080 NLO faster (120 cps) 188.50  
KXP 1091 top rated (160 cps) 239.50  
KXP 1092 super fast (240 cps) 299.50  
KXP 1595 15" carr (240 cps) 529.95  
EPSON  
LX86 New (120 cps) 232.50  
FX286 New ..... **NEW LOW PRICE**  
NEC  
3550 Spinwriter LO ..... 789.95  
OKIDATA  
OKI 182P 120 cps (80 column) 199.95  
OKI 292 200 cps NLO ..... **LOW PRICE**  
TOSHIBA  
TOSHIBA P321 ..... 348.50  
TOSHIBA P341 ..... 572.50

## NEW - NEW - NEW - NEW

### ZENITH data systems

ZFL 18192 SUPER LIGHTWEIGHT PORTABLE STANDARD 640K MEMORY STATE OF THE ART 3 1/2" POP UP DRIVES IBM SOFTWARE COMPATIBLE 25 x 80 BACKLIT LCD DISPLAY CALENDAR CLOCK PARALLEL & SERIAL PORT  
**LOW LOW PRICE**  
Z171 LIGHTWEIGHT PORTABLE WITH TWO 5 1/4" DRIVES 256K RAM INCLUDING BATTERY BACKLIT LCD DISPLAY WAS **1999.50** NOW ONLY **1299.50**

Focus Computers, 1303 46th St., Brooklyn, N.Y. Tel. (718) 871-7600. Open Mon.-Thurs. 10-7, Sun. 10-6, Fri. 10-3. Most orders shipped within 24 hours. Master Card, VISA, American Express gladly accepted. All prices in this ad reflect cash discount. New York State orders must add local sales tax. All merchandise available while supplies last. Price guaranteed subject to verifiable suppliers increases. Money back guarantee if returned within 14 days in mint condition with all papers and packing material intact. No returns accepted on open software.

Call Toll Free  
**1-800-223-3411**

## COMPUTERS FOR INSTRUCTION

substantial experience in formal teacher training does not markedly distinguish computer-using teachers of the high-ability classes from those of mixed- or low-ability classes. They are only modestly more likely to have had 50 hours or more of training in using computers for instruction (32 percent vs. 25 percent).

In high school, low-ability classes continue to use computers primarily for pre-algebra mathematics and language arts skills. The average or mixed-ability classes are heavily concentrated in computer programming, business, and word processing. A much higher proportion of the computer work of the average classes is in programming activities than in high-ability high school classes (50 percent vs. 32 percent). Most of the programming classes in high school are composed of students typically above average in ability, but only a very small minority are composed primarily of very-high-ability students.

Science and writing are two areas where high-ability high school classes use computers more than do average or low-ability classes. Together, science and writing constitute 32 percent of the computer work of high-ability high school classes. Relatively little computer work (5 percent) goes on in advanced mathematics courses outside of programming.

That students in different academic ability groups use computers so differently is not surprising. It reflects the great variety of instructional applications and the different educational needs of students. But certain uses of computers require students to solve operational problems and make decisions without close adult supervision. The less sophisticated the instructional software, the more necessary independent student activity is. To extend computer opportunities that emphasize higher-order thinking and problem solving to less able students requires software that is comprehensive, easy to use, and that fits into what students can do away from the computer while waiting their turn.

However, there are some surprises. The survey found very little use of computers in mathematics classes beginning with algebra and even less in the highest-level mathematics courses. There is neither substantial use of prepackaged or teacher-written software, nor is there much evidence of student programming projects aimed at understanding traditional topics in these mathematics courses. The use of computers in secondary science and social studies courses is mainly limited to advanced high school science courses and middle school social studies courses.

Extension of computer use to greater numbers of higher mathematics, science

*continued*

## The Real World Runs on Real Time.



Modern intelligent systems require real time response and high efficiency. That's why OS-9/68000 has been the designer's choice in thousands of the most demanding real-life applications.

OS-9 is very compact, highly adaptable, and fully ROMable. It's C source code compatible with Unix, and it's supported by a wide range of outstanding software tools, including graphics and networking options.

Many leading suppliers of 68000 and 68020 based systems offer ready-to-run OS-9 packages for their products. Or you can use a Microware PortPak to install OS-9 on your own custom hardware.

When microseconds count, you can count on OS-9.

**OS-9/68000™ — The Emerging Standard.**

*microware*

Microware Systems Corporation  
1866 N.W. 114th Street • Des Moines, Iowa 50322  
Phone 515-224-1929 • Telex 910-520-2535



# RUN, RUN, RUN.

## ...RUN Z-80

Now any IBM PC, XT, AT, or compatible can run CP/M for only \$199. You'll get our half size Z-80 card which is based on the new Hitachi HD64180 chip and our RUN/CPM emulation software. Just plug the card into your PC and you'll be running the most popular and powerful CP/M software available, including the most popular assemblers, compilers, word processors, spreadsheets and other applications. Your PC will be capable of running software written for popular CP/M computers such as Osborne, Morrow, Kaypro, etc. Your PC will even run CP/M programs up to 300% faster, with full color. RUN/CPM gives your PC's floppy drives the ability to directly read, write, and format over 180 different CP/M formats. So all you do is read that CP/M disk right into your PC.

Give Your PC The Power To Run CP/M

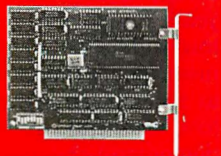

Plus you can run CP/M programs directly from your PC's hard disk, or from a RAM disk. RUN/CPM will even let you run MS DOS background programs such as Borland's Sidekick on top of your CP/M programs.

RUN/CPM is also available for the NEC V-20/30 microprocessor which supports the 8080 instruction set for only \$99.95.

CIRCLE READER NO. 331 FOR MORE INFO.

## ...RUN INTEL

With our Hitachi HD64180 based half size board and Micrun emulation software, you can transform any IBM PC, XT, AT, or compatible into an Intel Micro Development System capable of running 8 bit ISIS-II software. Our ISIS-III interface lets you run 16 bit Intel software without any additional hardware. Your PC will remain 100% DOS compatible while running Intel software.

### Micrun 80

ASM80
PLM80
PLM51
CREDIT
PASCAL
ASM48
AEDIT

### Micrun 86

ASM86
PLM86
PLM96
AEDIT
PASC86
C-86
FORT86

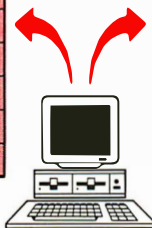

**Micrun 80** our 8 bit ISIS-II interface is priced at \$495 and includes all software and our 64180 half size card. **Micrun 86** is priced at \$450 and includes all software required to run 16 bit ISIS-III software.

## AND A 64180 DEVELOPMENT SYSTEM

By combining available 64180 development software with our card, you will have an affordable PC based development station for your 64180 applications.

CIRCLE READER NO. 332 FOR MORE INFO.

## ...RUN 80386 IN CIRCUIT EMULATION

With the Microtek 80386 32 bit emulator, you can get an 80386 in circuit emulator for a fraction of the cost you'd expect to pay. With features like real time emulation to 32 MHz, and 256K of soft mapped emulation memory, this is simply the best buy in emulators today. It even gives you a powerful symbolic debugger with user definable procedures under MS DOS, VMS, and ULTRIX. Use with any IBM PC, XT, AT or compatible, or stand-alone with a terminal.



**Other Processors supported include:** 80286, 80186, 80188, 8086, 8088, 68000, 68010, 68008, Z80, NSC800, 8085, 6809, 6809E, 6502 (40 and 28 PIN) 8032, 8051, 8031, 8344, 8048, 8049, 8050, Z8, and SUPER 8. Prices start at \$4300.

CIRCLE READER NO. 333 FOR MORE INFO.

CALL TOLL FREE  
**1-800-637-7226**

European distributor for Intel and CP/M line:

**ISOCOM GmbH**

Max-Planck-Strasse 6, 8000 Munich 80  
West Germany Tel. (089) 470-1094

## MICRO/INTERFACES

6824 Northwest 169 Street, Miami, Florida 33015 (305) 823-8088  
Telex 5106004680 MICRO INTER CO.

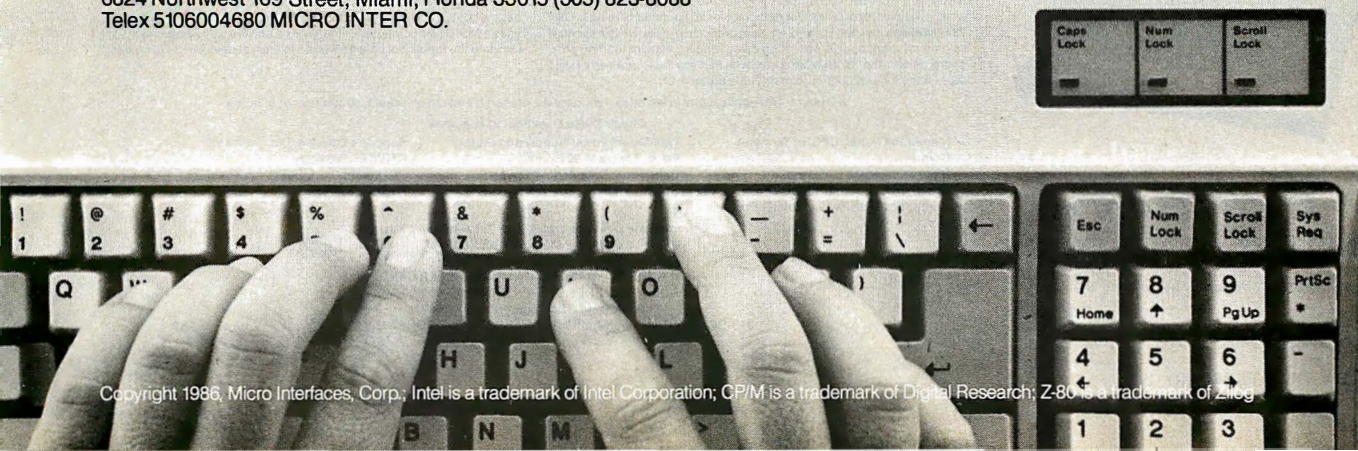



## So far, computers have had a limited impact on learning.

and social studies classes awaits the creation of a greater variety of instructional software for these subjects, materials to integrate software with existing curricular goals, clear demonstration to teachers of the advantages of using computers for these applications, and a larger supply of computers accessible to classes in these subjects.

### The Impact of Computers

This study systematically surveyed the entire range of schools and classrooms across the country, looking at major patterns. In terms of statistical patterns, computers so far have had only a limited impact on children's learning in school. Without a doubt, school instruction about computers has substantially increased the number of high-ability high school students who reach an introductory level of computer programming competence before entering college. But whether those programming skills provide college-bound students with opportunities that they would otherwise not obtain is a question that this survey does not explore.

Other major academic consequences at the high school level are harder to identify. Certainly, word processing has become a larger component of the high school business education program. But word processing has not yet become the routine means by which students write English compositions. In high school, computers are not yet major tools in mathematics, science, or social studies classes, although their use in science classes is not unusual.

Despite the dominance of drill and prac-

tice in the lower grades, computers have not markedly affected most student learning and practice in language arts and arithmetic. This is due to the limited amount of computer equipment in the schools, the relatively brief experience provided to individual students, and the generally unsystematic use of software at the lower grades. For elementary schools, the actual function of computers is primarily to acquaint students and teachers with a new cultural object. No evidence was found to indicate that school-wide student test scores have been affected by the kind and intensity of CAI that occurs in most elementary school settings.

The ways that students in the middle grades use computers depends a lot on their level of academic performance. Better students in the middle school have opportunities for independent exploration that include programming, problem solving, and some word processing, in addition to the more traditional CAI. The eventual impact of computer-based creative exploration and problem solving among high-ability and average middle grade students is unclear but promising.

### From Hacker to Classroom

The modern world has dozens of subcultures, each with enthusiastic devotees to a particular viewpoint. Among computerists, it seems natural to use computers to assist in educating our youth. But social institutions like mass education have their own peculiar "laws" or driving forces. To have a major impact on education, computerists must understand the conditions for successfully intervening into the schooling order. Dealing with schools as they are and not as we might wish them to be is a necessary first step to changing them.

For schools to use the power of electronic information and communication to substantially alter how students learn will

require hurdling important political, economic, and social barriers. Reform must overcome the ways that schools provide instruction, the economic realities of school budgets, the magnitude of the effort required, and the need for private-sector suppliers to make a profit.

Funding for school computers and related materials will continue to come from the small proportion of school budgets that is independent of personnel costs and other necessities. Computer-related expenditures already constitute a major portion of the discretionary spending by school systems. Increases in investment in educational technology by schools can occur only if our society is willing to allocate a larger portion of national income to education.

If computer-based activities—whether word processing, spelling drills, algebra tutorials, social studies simulations, or industrial arts applications—are to improve the academic productivity of most young people, these activities will have to take into account the complexities of instructing a heterogeneous mixture of young people in large group settings.

The belief that computers *can* provide benefits and the optimistic expectation that they *are* supplying these benefits have fueled a tremendous growth in the use of computers in schools over the past several years. But in the long run, educators will lose faith in the value of computer-based instruction if objective evaluations begin to accumulate evidence that computers have made little difference in the education of most children and adolescents. ■

### REFERENCE

1. Becker, Henry Jay. *Instructional Uses of School Computers*. Center for Social Organization of Schools, Johns Hopkins University, No. 1, June 1986, and No. 2, August 1986. Subscription (6 issues) available from Johns Hopkins University for \$7.50.



**TECHTRAN INC.**

200 COMMERCE DRIVE / ROCHESTER, NEW YORK 14623  
TEL.: (716) 334-9640 FAX (716) 359-3990 TWX: 510-253-3246

Data Storage Solutions Since 1971

## Invest in Improved PC Data Handling . . . . the TECHTRAN 787 Bytebank

If you're a PC user, you know that there are times that all you do is wait . . . wait for reports, wait for data, wait for any number of things. The 787 Bytebank can free your PC for more productive tasks, while it spends its time printing reports, collecting data, sending data, or loading programs. In fact, the 787 Bytebank can even perform these tasks as a portable, since it has a built-in rechargeable battery.

A "natural" for applications in factories, laboratories, research and development, your office, or at home.

#### Check These Outstanding Features:

- ✓ Membrane Panel, CPU, or Terminal Controllable
- ✓ Binary and ASCII File Handling
- ✓ Two (2) Independent RS232C Ports
- ✓ Centronics 8-Bit Parallel Printer Port
- ✓ Wall-Mount Power Supply and Battery Power For Up to 30 Hours
- ✓ Concurrent Data Acquisition and Transmission in "Polled Mode"
- ✓ Supports Xmodem, Xon/Xoff and RTS/CTS Protocols
- ✓ Programmable Input/Output Interface
- ✓ Memory Storage Up To 2 meg

The 787 Bytebank is a microprocessor-based battery operated digital data recorder, and data communications terminal. The 787 Bytebank uses a MS-DOS™ compatible file structure and file name conventions to facilitate the transfer of data between systems, at rates up to 19,200 bps.

For Immediate Delivery, Order Your 787 Bytebank Today!!!

256K to 2 Meg from \$995.00

CHECK MONEY ORDER

IN A HURRY? USE YOUR VISA or MASTER CARD

ORDER TOLL FREE BY CALLING 1-800-832-0044

Dealer and OEM Inquiries Welcome

MS-DOS is a Registered Trademark of MICROSOFT CORPORATION®



Order Status,  
Technical & Other  
Info. (602) 246-2222



**SPECIAL**  
WORD PERFECT  
**\$195**

Call for programs  
not listed

# TOLL-FREE ORDER LINE 1-800-421-3135

## FREE SOFTWARE! FREE SOFTWARE! FREE SOFTWARE!

Purchase over \$100 and receive one of these disks absolutely FREE! Purchases over \$250 get two free disks, over \$400 get three, or get all four disks when your purchase is over \$500! **1) MIXED BAG** — A great assortment of utilities and games all packed on one disk. **2) PC-WRITE** — Try this famous feature packed word processor. It's a winner! **3) FONT-SET** — Lets you set popular fonts like bold, underline, etc. on most late model printers from Citizen, Epson, NEC, Okidata, Panasonic, Star, Toshiba, etc. You can even use your printer like a typewriter! **4) ABC-LIST** — Great mailing list program! Sort on any field, do qualified searches, print reports and mailing labels, and more!

<p><b>DATA BASE MANAGERS</b></p> <p>Clipper ..... \$329 Clout 2 ..... Call Condor III ..... 310 Knowledgeman II ..... Call Powerbase 2.2 ..... 212 Q&amp;A ..... Call Quickcode ..... 138 Quickreport ..... 138 Revelation ..... 469 R: Base System V ..... 365</p> <p><b>WORD-PROCESSING</b></p> <p>Easy Extra ..... 88 Microsoft Word ..... 252 Multimate Advantage ..... Call Peachtext 5000 ..... 145 Volkswriter 3 ..... 139 Webster Spellcheck ..... 37 Wordstar ..... 162 Wordstar Propac ..... 233 Wordstar 2000 ..... 233 Wordstar 2000+ ..... 278</p> <p><b>SPREADSHEET</b></p> <p>Microsoft Multiplan ..... 108 Spreadsheet Auditor 3.0 ..... 82 Supercalc 4 ..... Call VP Planner ..... 49</p> <p><b>ACCOUNTING</b></p> <p>BPI AP, AR, PR, GA ..... 299 ea. Cyma ..... Call Dac Easy Accounting ..... 39 Dollars &amp; Sense ..... 94 Managing Your Money 3.0 ..... 108</p> <p><b>INTEGRATED</b></p> <p>Ability ..... 59 Enable ..... 312 Smart Software ..... Call</p> <p><b>COMMUNICATION PROGRAMS</b></p> <p>Carbon Copy ..... 115 Crosstalk ..... 89 Remote ..... 89 Smartcom II ..... 83</p> <p><b>GRAPHICS</b></p> <p>Chartmaster ..... 199 Energraphics 2.0 ..... 269 In-A-Vision ..... 249 Microsoft Bus Mouse ..... 106 Microsoft Chart ..... 164 Microsoft Serial Mouse ..... 119 Newsroom ..... 31 PC Mouse W/DR Halo II ..... 106 Printshop ..... 33 Signmaster ..... 132</p> <p><b>PROJECT MANAGER</b></p> <p>Harvard Total Project ..... 262 Microsoft Project ..... 219 Super Project Plus ..... Call Timeline 2.0 ..... 209</p>	<p><b>EDUCATIONAL</b></p> <p>Flight Simulator ..... \$28 Turbo Tutor II ..... 25 Typing Tutor III ..... Call</p> <p><b>LANGUAGES</b></p> <p>Lattice C Compiler ..... 242 Microsoft C Compiler ..... 249 Microsoft Fortran ..... 195 Microsoft Macro Assembler ..... 84 Microsoft Pascal Compiler ..... 166 Microsoft Quick Basic ..... 55 Ryan McFarlan Fortran ..... 305 Ryan McFarlan Cobol ..... 479 Turbo Pascal w/8087 + BCD ..... 55</p> <p><b>UTILITIES</b></p> <p>Copy II PC ..... 19 Copywrite ..... 39 Desqview ..... 55 Double Dos ..... 27 Fastback ..... 85 Homebase ..... 39 Microsoft Windows ..... 55 Norton Utilities 3.1 ..... 48 Prokey 4.0 ..... 70 Sidekick (unprotected) ..... 47 Sideway 3.1 ..... 36 Superkey ..... 39 Traveling Sidekick ..... 39 XTree ..... 27</p> <p><b>ACCESSORIES</b></p> <p>Copy II PC Board ..... 75 135 watt power supply ..... 59 Mini Micro Parallel Print Buffer ..... 69 Masterpiece ..... 88 Masterpiece Plus ..... 113</p>	<p><b>KEYBOARDS</b></p> <p>Keytronics 5151 ..... \$162 Keytronics 5153 ..... 269</p> <p><b>PRINTERS</b></p> <p><b>CANON LASER</b> ..... 1939 <b>CITIZEN</b> MSP-10 ..... 279 MSP-15 ..... 379 MSP-20 ..... 315 Premiere 35 Daisywheel ..... 469 <b>EPSON</b> - Call on all models <b>FUJITSU</b> DX2100 Parallel ..... Call DL2400 Ser/Par ..... Call <b>LASER IMAGE 2000</b> ..... Call <b>NEC</b> NEC P5XLP ..... 1126 NEC P7 Parallel ..... 635 NEC 8850 ..... 1098 NEC P6 Parallel ..... 455 <b>OKIDATA</b> - Call on all models <b>PANASONIC</b> 1091-I ..... 259 1092 ..... 299 1592 ..... 425 KXP3151 ..... 399 <b>STAR MICRONICS</b> LV1210 ..... 179 NB15 ..... 975 NX10 ..... 232 SG15 ..... 365 SR15 ..... 585 <b>TOSHIBA</b> P351 ..... 969 P341 ..... 768 P321 ..... Call</p> <p><b>MONITORS</b></p> <p>AMDEK 310A ..... 142 AMDEK 600 ..... 395 Magnovox Color RGB ..... Call Multitech Color RGB ..... 259 Princeton Max 12 ..... 159 Samsung TTL Amber ..... 72 Samsung TTL Green ..... 70</p> <p><b>EGA MONITORS</b></p> <p>AMDEK 722 ..... 502 NEC Multisync ..... Call Packard Bell EGA ..... 450</p> <p><b>EGA BOARDS</b></p> <p>Everex Enhancer EGA ..... 235 Paradise Auto Switch EGA Card ..... 359 Quad EGA Plus ..... 349 STB EGA Plus ..... Call Vega Deluxe ..... Call Vega Video ..... 299</p> <p><b>RAM</b></p> <p>64K 150NS (set of 9) ..... 10.50 256K 150NS (set of 9) ..... 27 256K 120NS (set of 9) ..... Call</p> <p><b>MODEMS</b></p> <p>Everex 300/1200 ..... 120 Hayes 1200 ..... Call</p>	<p>Hayes 1200B ..... Call U.S. Robotics Courier 2400 ..... 349 U.S. Robotics Passwd. 1200 ..... 180</p> <p><b>BOARDS</b></p> <p>AST Advantage Premium ..... Call AST Premium ..... 359 AST Sixpac (384K) ..... Call Hercules Color Card ..... 145 Hercules Graphics + ..... 182 Intel Above Boards ..... Call J Lazer (Tall Tree) ..... Call J Ram III (Tall Tree) ..... 159 J Ram III AT (Tall Tree) ..... 199</p> <p><b>COMPUTERS</b></p> <p><b>AZ TURBO PC</b> IBM Compatible Computer, 4.77 or 7.47 key selectable, AT style keyboard, 640K, dual drive, 135 watt power supply ..... 620 or with 20 MB Seagate Harddrive ..... Call 6 month limited warranty</p> <p>Corona PC ..... Call</p> <p><b>Multitech 900 Accel</b> IBM AT Compatible, 512K, expandable to 1 MB on the mother board, one 1.2 MB drive, 195 watt power supply, MS/DOS 3.1, clock, 6 or 10 MHz key selectable, soft white monitor, AT style keyboard, 1 year TRW warranty ..... Call</p> <p><b>Multitech Turbo</b> IBM Compatible Computer, 256K, dual drives, 8 MHz, ports-parallel-serial-clock, 5151 type keyboard, graphics board (similar to Hercules), mono monitor DOS 3.1, 6 month national warranty ..... Call</p> <p><b>Packard Bell VT286</b> IBM AT Compatible, 640K, expandable to 1 MB on the mother board, one 1.2 MB drive, 210 watt power supply, MS/DOS 3.1, clock, 6 or 8 MHz, AT style keyboard, 1 year warranty ..... 1600</p> <p>Sharp Portable ..... 999</p>
---	---	--	--

**INCREDIBLE VALUES**

Nationally advertised boards for IBM PC and most compatibles at give away prices.

Keyboards (similar to 5151) ..... \$79

Monochrome Board w/printer port (similar to Hercules Graphics) ..... \$79

Expansion Board 0 to 576K ..... \$42

Multifunction Board w/game port (similar to AST six pack) ..... \$79

Four Drive Floppy Controller ..... \$39

Color Card w/o printer port ..... \$69

Color card w/printer port ..... \$79

**AZ TURBO PC**  
IBM Compatible Computer, 4.77 or 7.47 key selectable, AT style keyboard, 640K, dual drive, 135 watt power supply ..... 620  
or with 20 MB Seagate Harddrive ..... Call  
6 month limited warranty

**Multitech 900 Accel**  
IBM AT Compatible, 512K, expandable to 1 MB on the mother board, one 1.2 MB drive, 195 watt power supply, MS/DOS 3.1, clock, 6 or 10 MHz key selectable, soft white monitor, AT style keyboard, 1 year TRW warranty ..... Call

**Multitech Turbo**  
IBM Compatible Computer, 256K, dual drives, 8 MHz, ports-parallel-serial-clock, 5151 type keyboard, graphics board (similar to Hercules), mono monitor DOS 3.1, 6 month national warranty ..... Call

**Packard Bell VT286**  
IBM AT Compatible, 640K, expandable to 1 MB on the mother board, one 1.2 MB drive, 210 watt power supply, MS/DOS 3.1, clock, 6 or 8 MHz, AT style keyboard, 1 year warranty ..... 1600

**TERMS:** Add 3% for C.O.D. orders. Shipping on most software is \$5.00. AZ orders +6.7% sales tax. Personal check - allow fourteen (14) days to clear. We accept purchase orders from authorized institutions for 1.5%. All returns are subject to our approval. There will be a 20% restock fee. Minimum phone order \$50. All prices are subject to change.

No Charge for Master Card or Visa



**TOLL-FREE ORDER LINE 1-800-421-3135**  
**WAREHOUSE DATA PRODUCTS**  
2701 West Glendale Ave. • Phoenix, AZ 85051

Phone Hours: Monday, Wednesday & Thursday  
7 am-9 pm; Tuesday & Friday 7 am-5:30 pm;  
Saturday 9 am-5 pm; Sunday 10 am-2 pm. MST.



CompuPro Presents

# The Swap Meet for the Rest of You

About three times a year, the gang at CompuPro cleans out the back room of stuff we can't sell as new and hauls it down to a traditional Silicon Valley event called Computer Swap America. In fact, there's one coming up on January 24th, and if you live in the area, you should attend. The bargains there are fantastic, and the highlight of the day is when Bill Godbout (our illustrious leader) gets up on a makeshift stage and holds a crazy auction. The deals are so great, that people have flown in from as far away as the East Coast, and more than covered the cost of their travel expense with the money they've saved.

This time, our back room walls are bulging—mainly because we changed 3rd party service organizations to Sperry CUSTOMCARE and

we got back all the service spares from the previous firm. So we decided that we'd bring some of the swap meet bargains to those of you that can't make it to the actual event. The items listed below are tested and functional, but may be discontinued models, returned service spares, used, cosmetic rejects, obsolete revisions, have wires, or anything else that prevents us from offering them as new or current. They are sold on an "as-is" basis. Quantities on these items are limited, subject to prior sale, and no rainchecks will be issued. Where possible, we will try to include a technical manual, but we make no guarantees as quantities are limited. **These products are for experienced hackers only! These items are not new and are not intended for use in commercial service!**

## S-100 CPU Boards

CPU 286 (8 MHz 3 cycle)	\$249
CPU 8086 (8 MHz)	\$109
CPU 8086 (10 MHz)	\$139
CPU 8085/88 (6/8 MHz)	\$129
CPUZ (8 MHz)	\$119
CPU 68K (10 MHz)	\$139
68451-L8 MMU CHIP (8 MHz)	\$ 29
CPU 32016 (6 MHz w/ICU)	\$ 99
SPUZ 256K (8 MHz Z80 slave proc.)	\$179
SPUZ 64K (8 MHz Z80 slave proc.)	\$149

## S-100 Static RAM and MDRIVE/H Boards

RAM 23 (64K-8/16 bit xfers)	\$109
RAM 21 (128K-8/16 bit xfers)	\$159
RAM 22 (256K-8/16 bit xfers)	\$269
MDRIVE/H (512K RAM Disk/Cache)	\$319
MDRIVE/H (2 Meg RAM Disk/Cache)	\$499

## S-100 Disk Controller Boards

DISK 1 (8" floppy controller)	\$ 99
DISK 1A (5.25" and 8" floppies)	\$169
DISK 2/SELECTOR CHANNEL (SA4000)	\$129
DISK 3 (ST506)	\$199

## S-100 I/O and Miscellaneous Boards

System Support 1 (w/battery)	\$139
PC VIDEO (with free SuperCalc 3!!)	\$249
NET PC (Arcnet for PCs, w/CPLINK)	\$189
NET 100A (S-100 Arcnet LAN)	\$189
INTERFACER 3 (8 serial ports)	\$169
INTERFACER 4 (3 serial, 1 Centr.)	\$139
CABLE 4	\$ 25
Special 50 pin to 3 DB-25 cable for I3 (2 reqd.) and I4 (1 reqd.).	

## Enclosures and Motherboards

12 Slot Motherboard with Card Cage and DC cable	\$139
20 Slot S-100 Motherboard	\$ 99
6 Slot S-100 Motherboard	\$ 59
Enclosure 2-20 Slot MB w/PS	\$399

## STD Bus Products

STD Bus Motherboard 16 slot	\$ 35
STD Bus 16K Static RAM	Set of 4/\$100

**CP/M 80 2.2 or CP/M 816(86) no DRI docs. \$60.00 each or both for \$99.00**

**How to Order:** These products may be ordered through participating CompuPro dealers, or you may order directly from us. Send check or money order (do not send cash) to: **CompuPro-Swap, 26538 Dantl Ct., Hayward, CA 94545-3999**

Be sure to enclose the description and quantity of the items desired, your UPS shipping address (no P.O. Boxes, please!) and a daytime phone number. Also enclose \$5.00 shipping and handling, California residents enclose 6.5% sales tax. Remember, these items are sold on an as-is (no warranty) basis. All sales are final. All items are subject to prior sale and are first-come-first-served, so get your orders in quickly. If an item is out-of-stock, your money will be refunded, or we may substitute a functionally equivalent or better product. Please allow 6 to 8 weeks for delivery. **Note: Credit Card and Phone Orders will not be accepted. We cannot answer questions about these products on the phone either. If you don't know what they are or how to use them, you shouldn't buy them.**

Subject to prior sale, these items and more may be available for purchase in person at Computer Swap America, January 24th and March 28th, 1987, Santa Clara County Fairgrounds, Tully Road, San Jose, California. Mark your calendars!

For an up-to-date list of what's still available and other special offers, join [compupro.ad](http://compupro.ad) on BIX. Check any recent issue of BYTE Magazine for instructions on how to log onto BIX.

**CompuPro™**



# The Difference in Higher Education

*Five colleges meeting the challenge*

Donna Osgood

EARLY IN 1984, I wrote an article surveying the status of the microcomputer in colleges around the country (see "A Computer on Every Desk," June 1984 BYTE). I was looking for schools that were getting computers into students' hands in large numbers, outside of computer science and engineering departments. A few pages on each of 15 schools covered the subject thoroughly.

*The color version of a program called MirrorBalls designed by Reed student Peter Shirley is a Rascal program that calculates and colors the reflection of the grid on the polished balls.*

In the past few years, the situation has changed dramatically. To survey all the schools that have put micros on students' desks, and to cover the software developed at those schools, I would have had to preempt this entire issue of BYTE. The pioneering schools I wrote about before have expanded their own involvement with microcomputers and have paved the way for other institutions. Software develop-

ment has burgeoned. This is not surprising when you consider that some of our best thinkers have gotten their hands on some of our best thinking tools. Here is only a brief sample of what is going on in colleges today.

Each of the five schools profiled here differs markedly from the others in size and academic focus, as well as in approach to computing. They all share a commitment, however, to the idea that putting powerful tools in the hands of students and faculty can make a difference in higher education.

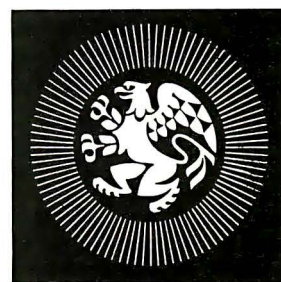
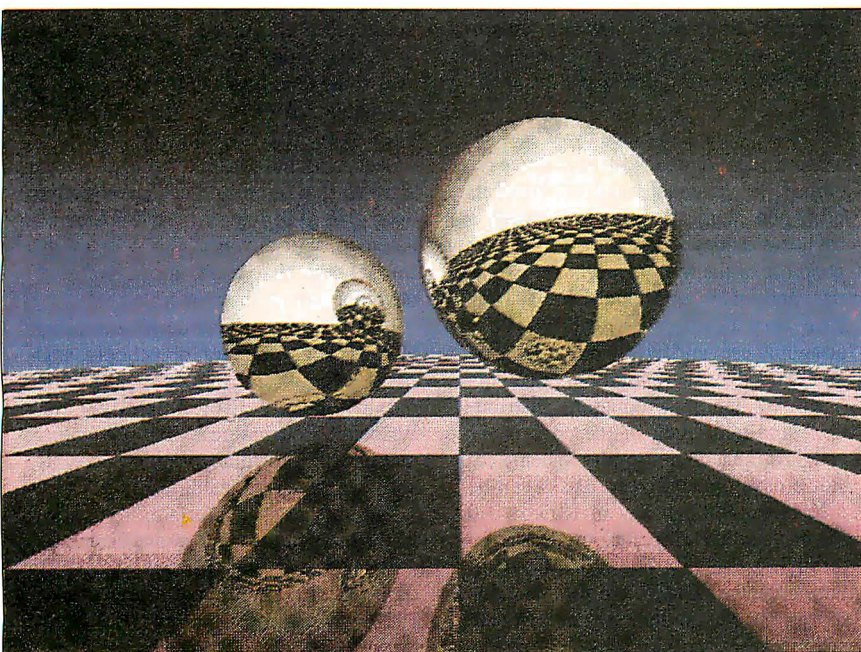

## REED COLLEGE

*Portland, Oregon*

Watchwords for Reed College's Master Plan for Computing Resources are open access, enhancement of curriculum, and unification of resources. Though Macintoshes are scattered across the campus,

*continued*

*Donna Osgood is associate editor of BIX and can be reached at BYTE/McGraw-Hill, 425 Battery St., San Francisco, CA 94111, or on BIX as dosgood.*



on faculty desks, in departmental offices, and in public clusters, no one has to buy a computer. No one is required to take a computer course or demonstrate technological literacy, either. Reed administrators believe that open access, making the resources readily available and

obviously useful, is the best approach to integrating the computer into the curriculum.

Open access means "virtually unrestricted and uncharged resource use," according to Richard Crandall, Reed's technology plan director. Macintoshes are

available without cost to any faculty member. Students can use computers in the seven Information Resource Centers, open 24 hours a day, or they can apply for one of the college's machines, loaned at no cost for a semester to small groups of students chosen by a lottery. Every academic office is also equipped, many with LaserWriters and AppleTalk networks. Typewriters at Reed are an endangered species.

How can a small liberal arts college afford to supply their entire academic population with free access to computer resources? With a lot of help from their friends. Corporations and charitable trusts have contributed money, equipment, and time. These contributions are supplemented and stimulated by software and hardware development at Reed, which provide both income and visibility.

### Software Development

Reed's Development Laboratory has produced Macintosh software for laboratory interfacing, graphics, and terminal emulation, as well as games that serve both educational and recreational functions. Central to Reed's development effort, however, is Rascal (for real-time Pascal), a hybrid of Pascal and C optimized for the Macintosh. The Rascal Compiler/Development System project has spawned other

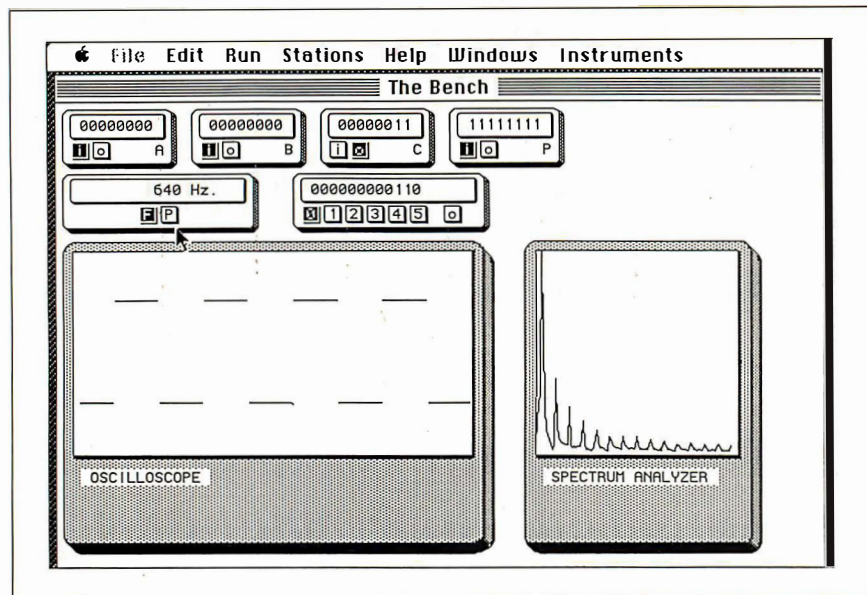

Figure 1: BenchLab—iconic instrumentation has replaced some physical instrumentation in labs at Reed College in Portland, Oregon.

## Kinko's Academic Courseware Exchange

With the great influx of Apple Macintoshes on college campuses in the past few years has come an outpouring of creative software development. The Mac's graphics and user interface offer a simple and effective way to deliver information. Consequently, faculty in many fields have sought ways to use it to best advantage in their classes.

Software development is expensive, however, and some schools invest a great deal of money, faculty time, and programmer time in producing programs for specific courses. A program developed for Organic Chemistry 101 at one college is likely to be useful in many schools, and the professor who authored the program will be eager to share it with colleagues. If you've found a better way to teach a subject, why not spread it around?

The Apple University Consortium and Kinko's, a national chain of photocopy centers, have established the Academic Courseware Exchange (ACE) to promote this kind of sharing. Courseware developed at colleges and universities across the country is described in the ACE catalog. Programs in biology, chemistry,

computer science, engineering, general science, geography, history and politics, humanities, math and statistics, music, philosophy, physics, and sociology are available, along with authoring tools in several subjects. Prices are comparable to textbook costs—between \$7 and \$13 per disk.

The software distributed by ACE is not a drab collection of drill-and-practice exercises. Each school has contributed its best, and many of the programs are a tribute to academic ingenuity. Most make good use of the Mac's graphics capabilities, and many use sound as well. They have been developed by educators for academic use, and most have been tested and refined in the classroom.

Kinko's handles production, distribution, and marketing of the courseware and pays the author a royalty to help subsidize development costs. Disks can be distributed through any of Kinko's 310 stores, mailed directly, or delivered through a campus bookstore or computing center. Kinko's employs campus representatives to demonstrate software and to let professors know what programs

are available that may meet their needs.

The ACE catalog, published in the fall of 1986, lists 56 programs for the Macintosh and 9 for the Apple II. Many were developed at Dartmouth, Drexel, or Stanford, but schools like Franklin and Marshall College in Lancaster, Pennsylvania, and University of the Pacific in San Francisco have also contributed. ACE provides a national forum for these smaller schools that would otherwise not have been able to distribute their software so extensively. It also provides courseware for schools that can't afford software development of their own.

"A computer on every desk" is a reality at a growing number of schools, and many others see microcomputer use mushrooming. Programs like the Academic Courseware Exchange will fuel that growth, providing essential academic software at a reasonable cost.

For a catalog or information, contact Kinko's Academic Courseware Exchange, 4141 State St., Santa Barbara, CA 93110, (800) 235-6919; in California, (800) 292-6640. From outside the U.S., call (805) 967-0192.



languages, like the Problem Solving Interpreter (PSI) and Solver for Implicit Equations (SIMPLE).

Rascal was developed because scientists at Reed needed a real-time language to communicate with laboratory devices. Thus it lends itself to scientific calculations, statistics, and data analysis software as well as data acquisition, display, and laboratory-interfacing real-time applications. Three-dimensional graphics applications and animation models can also be developed using Rascal.

PSI is "a structured syntax, declarationless language, suitable for isolated calculation." It was designed for people who need to solve computation problems common in research and academic work, without spending a lot of time learning to program a computer. It is, according to its documentation, "a good language for the academic worker who must, from time to time, solve isolated problems or verify numerically new conjectures." It is optimized from the user's point of view, not the machine's, trading off machine speed and code efficiency for ease in setting up a problem.

### The Computerized Laboratory

Both hardware and software development at Reed have gone into iconic instrumentation, which Crandall refers to as "a new concept in laboratory computing." Data is acquired via The BenchTop Instrument, a laboratory interface device for data acquisition and apparatus control that runs off the Macintosh serial port or any RS-232C port. Results are displayed on the Macintosh, using iconic instruments.

A Rascal application, BenchLab, creates laboratory instruments on the screen, including an oscilloscope, spectrum analyzer, frequency counter, A/D converter, D/A converter, and four I/O ports (see figure 1). The student or scientist can select an instrument from a menu or run all of them at once.

Researchers at Reed have used the BenchTop system in a variety of projects. A chemistry student developed a system to run, display, and store NMR (nuclear magnetic resonance) spectra from a spectrometer. It will print spectra or store them as MacPaint documents. Reed's psychology department uses BenchTop applications for a variety of tests, including reaction-time studies, personality and mood tests, and a Skinner box for experiments in operant psychology. One psychology student has created a psychophysiology laboratory system that records electroencephalogram and heart-rate data.

The college itself uses BenchTop to monitor and analyze energy use in the 24 buildings on campus. An "energy map"

displays heat and electric parameters for physical plant personnel.

### Picturesque Applications

Rascal's graphics capabilities have been put to good use in a number of applications. MirrorBalls, for example, was originally written in Macintosh Pascal by Reed student Peter Shirley, as part of a thesis on optical ray tracing and the optical nature of surfaces.

In its original form, the program, which calculates the status of every pixel, took 24 hours to run. The Rascal version of the same program takes about 5 minutes. The difference, Crandall says, lies in the fact that "Rascal is a true compiler which generates machine code. So now we have many students doing spectacular programs with Rascal, for tasks that were heretofore impossible or at best time-consuming."

Billiard Parlor, a pool-table simulation, is a popular public domain program that was developed at Reed. Billiard Parlor simulates everything but the smoke in the room and the chalk on your fingers. You can choose your game (pool, billiards, eight ball, snooker, etc.), place balls on the table by hand, choose the direction and force of your shot, and hear the balls click as they strike each other. But don't hit the cue ball too hard or it will hop.

Billiard Parlor is distributed on a disk with a number of other useful and interesting applications, like a MacWrite rescue utility, the Sieve of Eratosthenes, and a speech synthesizer. The disk is available through the Academic Courseware Exchange (see the text box "Kinko's Academic Courseware Exchange" at left).

Not content with the graphics capabilities of an unaided Macintosh, Reed developers have added a color system: SuperChroma. This is a color image processor (Vectrix VX384), a high-resolution RGB monitor connected through the modem port, and software called ColorPaint and OmniPaint. You draw on the color monitor with the mouse as if you were using a MacPaint with 16 million colors.

### Beyond the Ivy-covered Walls

The Macintosh has meant more to Reed College than convenient computing power. It has opened the gates of the ivory tower as well. Students and faculty have been involved in the efforts to raise funding for the computing project.

Reed's software and hardware products are distributed commercially and in academic circles. The college is also involved in community computing; for example, every high school in Portland, Oregon, now has a Macintosh, through a joint project in which Apple provided the equipment and Reed provided the staff and the software.



### STANFORD UNIVERSITY

*Palo Alto, California*

As microcomputers began to proliferate on the Stanford campus a few years ago, it was clear that no single standard could be imposed on the diverse population of a major university. Rather than trying to force faculty, students, and staff to adopt a particular computer, Stanford has relied on a sort of guided evolution—encouraging flexible but focused growth. As Michael Carter, director of Instruction and Research Information Systems (IRIS) put it, "What we're trying to do is enhance academic achievement by applying computer technology. Our best bet is to try to focus it a little here, nudge it a little there, lead a little bit over here. With so many really smart faculty members out there, I want to give them enough devices so that they know exactly what they want to do, and then follow them, rather than to control the way they use computers. The trick really is to remove the obstacles so that those people can lead the way."

This strategy has been successful, producing an impressive body of faculty-developed software, stimulating rather than repressing creativity. Microcomputers are available to the Stanford community in large numbers, and an ever-increasing number of faculty are taking advantage of them in presenting information to their students.

Students who need to use a microcomputer in their course work can use any of several public facilities. One cluster of Macintoshes in a library, for example, is available for walk-in users, though students in selected courses get priority. Another cluster, in the student union building, offers terminals connected to the timesharing system, through the university's Ethernet network, SUNet. This cluster also provides DEC Rainbow 100s for word processing, spreadsheets, and programming and IBM PC ATs for graduate student thesis preparation. The Engineering Microcomputer Cluster (called E=MC<sup>2</sup>) contains Macintoshes and IBM microcomputers.

Stanford also has "interactive classrooms." One has a network of Macintosh Plus computers, with an image-switching system to allow instructor previewing and

*continued*



common viewing of Macintosh display screens. Another classroom provides IBM PCs with videodisk capabilities, access to SUNet, and local area file service.

Anyone who wants his or her own microcomputer at Stanford can rent one from the Workstation Support Center or buy one at a considerable discount through Microdisc (microcomputer discount), part of the Stanford Bookstore. Microdisc offers hardware and software from Apple, Hewlett-Packard, and IBM,

as well as a demonstration area, consulting staff, and a service and repair center. They have sold several thousand computers in the past few years.

### The Faculty Author Development Program

Faculty software development for microcomputers has been supported since the fall of 1984 through the Faculty Author Development (FAD) program. IRIS provided equipment, design, and program-

ming help to faculty members, who have completed 36 software projects in a broad range of fields. FAD projects include work in economics, engineering, humanities, library science, mathematics and computer science, medicine, life science, and physical science.

An example of FAD software is The TheaterGame, designed by Professor Larry Friedlander of Stanford's English department. Theater students use it as a sort of "sketch pad," placing and moving characters on the screen to simulate stage blocking, using an interactive animation editor (see figure 2). The animated scene can be recorded and synchronized with a tape recording of the spoken text. The TheaterGame is available through the Academic Course Exchange at Kinko's copy centers nationwide.

The TheaterGame accompanies a videodisk-based interactive instructional system that delivers an archive of theater-history slides, film clips, and tutorials. The videodisk instruction is designed to let the student think like an actor, director, and producer, comparing and analyzing different versions of the same scene, and eventually designing his or her own.

Another program designed through FAD has been popular in the Apple/Kinko's Academic Courseware Exchange. The program, called The Would-Be Gentleman and written by Carolyn Lougee, models the economic and social life of a French bourgeois during the reign of Louis XIV (see figure 3). The player absorbs a history lesson while making economic and social decisions, forging alliances, and managing property, attempting to maximize wealth and prestige over two generations.

A program of interest to mathematics and computer science students, called Turing's World (see figure 4), was designed by two logicians, Professors Jon Barwise and John Etchemendy, in Stanford's department of philosophy.

"Imagine trying to teach Pascal without a computer," says Etchemendy. "Students would write programs, and have to think them through to see whether they would work. Impossible, of course, since many bugs show up only when the program runs. Logicians in computability theory have been in the same situation, trying to teach about Turing machines."

Turing's World (also available through the Academic Courseware Exchange) is used in a second-quarter logic course for students in computer science, math, philosophy, and linguistics. Students are asked to build a Turing machine to compute a certain function or solve a particular problem. Using the mouse and a menu of options presented by the pro-

*continued*

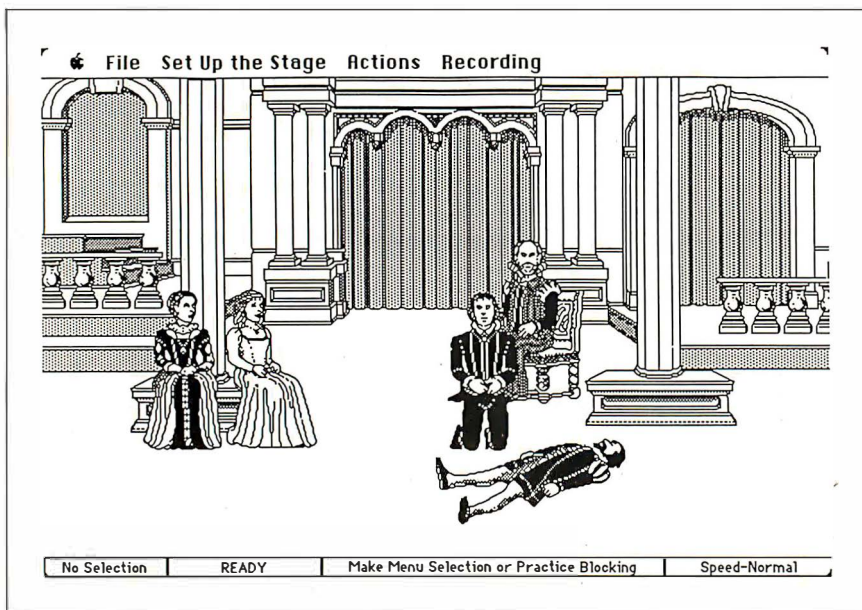

**Figure 2:** *The TheaterGame* by Stanford's Larry Friedlander is a "play processor." By pointing and dragging the mouse you move the characters around on the stage. Their movements can be recorded and played back, synchronized with a voice recording.

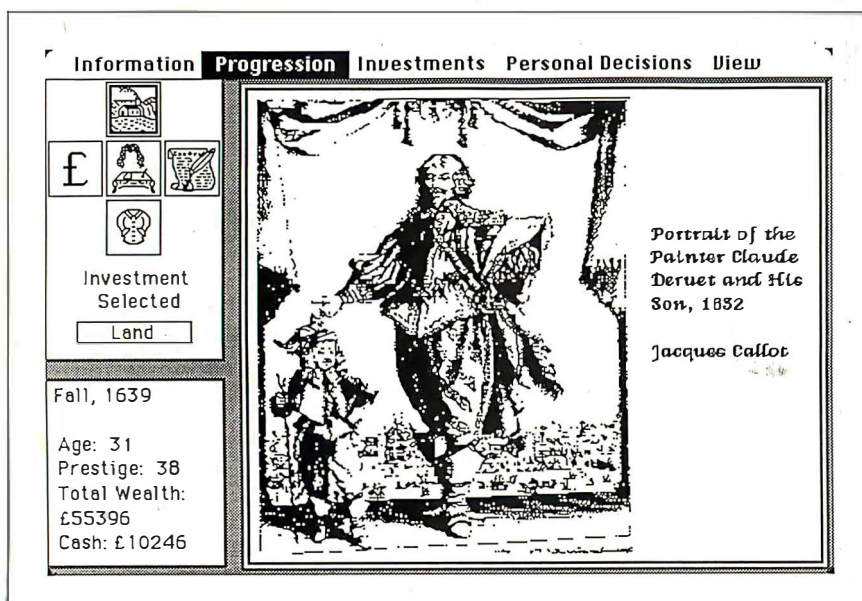

**Figure 3:** *The Would-Be Gentleman* by Carolyn Lougee of Stanford simulates the economic and social life of a Frenchman during the reign of Louis XIV.



# E=M

# AZTEC

Our thanks to NASA for supplying this computer enhanced ultraviolet photo taken by Skylab IV of a solar prominence reaching out 350,000 miles above the sun's surface

## Genius Begins With A Great Idea ...

### But The Idea Is Just The Beginning

What follows is the time consuming task of giving form and function to the idea.

That's why we concentrate on building into our software development systems functions and features that help you develop your software ideas in less time and with less effort.

We've started 1987 by releasing new versions of our MS-DOS, Macintosh, Amiga, ROM, and Apple II C development systems. Each system is packed with new features, impressive performance, and a little bit more genius.

### Aztec C86 4.1

New PC/MS-DOS • CP/M-86 • ROM

Superior performance, a powerful new array of features and utilities, and pricing that is unmatched make the new Aztec C86 the first choice of serious software developers.

### Aztec C86-p Professional System . . . \$199

• optimized C with near, far, huge, small, and large memory + Inline assembler + Inline 8087/80287 + ANSI support + Fast Float (32 bit) + optimization options • Manx Aztec 8086/80x86 macro assembler • Aztec overlay linker (large/small model) • source level debugger • object librarian • 3.x file sharing & locking • comprehensive libraries of UNIX, DOS, Screen, Graphics, and special run time routines.

### Aztec C86-d Developer System . . . \$299

• includes all of Aztec C86-p • Unix utilities make, diff, grep • vi editor • 6+ memory models • Profiler.

### Aztec C86-c Commercial System . . . \$499

• includes all of Aztec C86-d • Source for library routines • ROM Support • CP/M-86 support • One year of updates.

### Aztec C86 Third Party Software

A large array of support software is available for Aztec C86. Call or write for information. The following is a list of the most requested products: Essential Graphics • C Essentials • C Utility Library • Greenleaf Com. • Greenleaf General • Halo • Panel • PC-lint • PforCe • Pre-C • Windows for C • Windows for Data C-terp • db Vista • Phact • Plink86Plus • C-tree.

### CP/M • TRS-80 • 8080/Z80 ROM

C compiler, 8080/Z80 assembler, linker, librarian, UNIX libraries, and specialized utilities.

### Aztec C II-c (CP/M-80 & ROM) . . . \$349

### Aztec C II-d (CP/M-80) . . . \$199

### Aztec C80 (TRS-80 3&4) . . . \$199

### Aztec C68k/Am 3.4

New Amiga Release

Amiga user groups across the USA voted Aztec C68k/Am release 3.4 the best Software Development System for the Amiga. Release 3.4 is more impressive.

### Aztec C68k/Am-p Professional . . . \$199

A price/feature/performance miracle. System includes: optimized C • 68000/680x0 assembler • 68881 support • overlay linker • UNIX and Amiga libraries • examples.

### Aztec C68k/Am-d Developer . . . \$299

The best of Manx, Amiga, and UNIX. System includes: all of Aztec C68k/Am-p • the Unix utilities make, diff, grep and vi.

### Aztec C68k/Am-c Commercial . . . \$499

Aztec C68k/Am-d plus source for the libraries and one year of updates.

### Aztec C68k/Mac 3.4

New Macintosh Release

For code quality, reliability, and solid professional features, Aztec C for the Macintosh is unbeatable. This new release includes features and functions not found in any other Macintosh C development system.

### Aztec C68k/Mac-p Professional . . . \$199

• optimized C • 68000/680x0 assembler • 68881 support • overlay linker • UNIX and Macintosh libraries • examples.

### Aztec C68k/Mac-d Developer . . . \$299

The best of Manx, Macintosh, and UNIX. System includes: all of Aztec C68k/Am-p • the Unix utilities make, diff, grep • vi editor.

### Aztec C68k/Mac-c Commercial . . . \$499

Aztec C68k/Am-d plus source for the libraries and one year of updates.

### Aztec C65

New ProDOS Release

Aztec C65 is the only commercial quality C compiler for the Apple II. Aztec C65 includes C compiler, 6502/65C02 assembler, linker, library utility, UNIX libraries, special purpose libraries, shell development environment, and more. An impressive system.

### Aztec C65-c Commercial . . . \$299

• runs under ProDOS • code for ProDOS or DOS 3.3

### Aztec C65-d Developer . . . \$199

• runs under DOS 3.3 • code for DOS 3.3

### Aztec ROM Systems

6502/65C02 • 8080/Z80 • 8086/80x86 • 680x0

An IBM or Macintosh is not only a less expensive way to develop RCM code, it's better. Targets include the 6502/65C02, 8080/Z80, 8086/80x86, and 680x0.

Aztec C has an excellent reputation for producing compact high performance code. Our systems for under \$1,000 outperform systems priced at over \$10,000.

### Initial Host Plus Target . . . \$750

### Additional Targets . . . \$500

### ROM Support Package . . . \$500

### Vax, Sun, PDP-11 ROM HOSTS

Call for information on Vax, PDP-11, Sun and other host environments.

### C' Prime

PC/MS-DOS • Macintosh

Apple II • TRS-80 • CP/M

These C development systems are unbeatable for the price. They are earlier versions of Aztec C that originally sold for as much as \$500. Each system includes C compiler, assembler, linker, librarian, UNIX routines, and more. Special discounts are available for use as course material.

### C' Prime . . . \$75

### Aztec Cross Development Systems

Most Aztec C systems are available as cross development systems. Hosts include: PC/MS-DOS, Macintosh, CP/M, Vax, PDP-11, Sun, and others. Call for information and pricing.

### How To Become An Aztec C User

To become a user call 800-221-0440. From NJ or international locations call 201-542-2121. Telex: 4995812 or FAX: 201-542-8386. C.O.D., VISA, MasterCard, American Express, wire (domestic and international), and terms are available. One and two day delivery available for all domestic and most international destinations.

Aztec C is available directly from Manx and from technically oriented computer and software stores. Aztec Systems bought directly from Manx have a 30 day satisfaction guarantee.

Most systems are upgradable by paying the difference in price plus \$10. Site licenses, OEM, educational, and multiple copy discounts are available.

To order or for more information call today.

# 1-800-221-0440

In NJ or international call (201) 542-2121 • TELEX: 4995812

# MANX

Inquiry 156

Manx Software Systems

1 Industrial Way, Eatontown, NJ 07724

MS is a registered TM of Microsoft, Inc. • CP/M TM DRI. HALO TM Media Cybernetics, PANEL TM Roundhill Computer Systems, Ltd. PHACT TM PHACT Assoc. PRE-C, Plink-86, Plink-86 + P-Force TM Phoenix, db Vista TM Frame Corp. C-terp, PC-lint, TM General Software, C-tree TM Farcom, Inc., Windows for C, Windows for DATA TM Creative Solutions, Apple II, Macintosh TM Apple, Inc. TRS-80 TM Radio Shack, Amiga TM Commodore Int'l. Unix TM AT&T, Vax TM DEC, Aztec TM Manx Software Systems



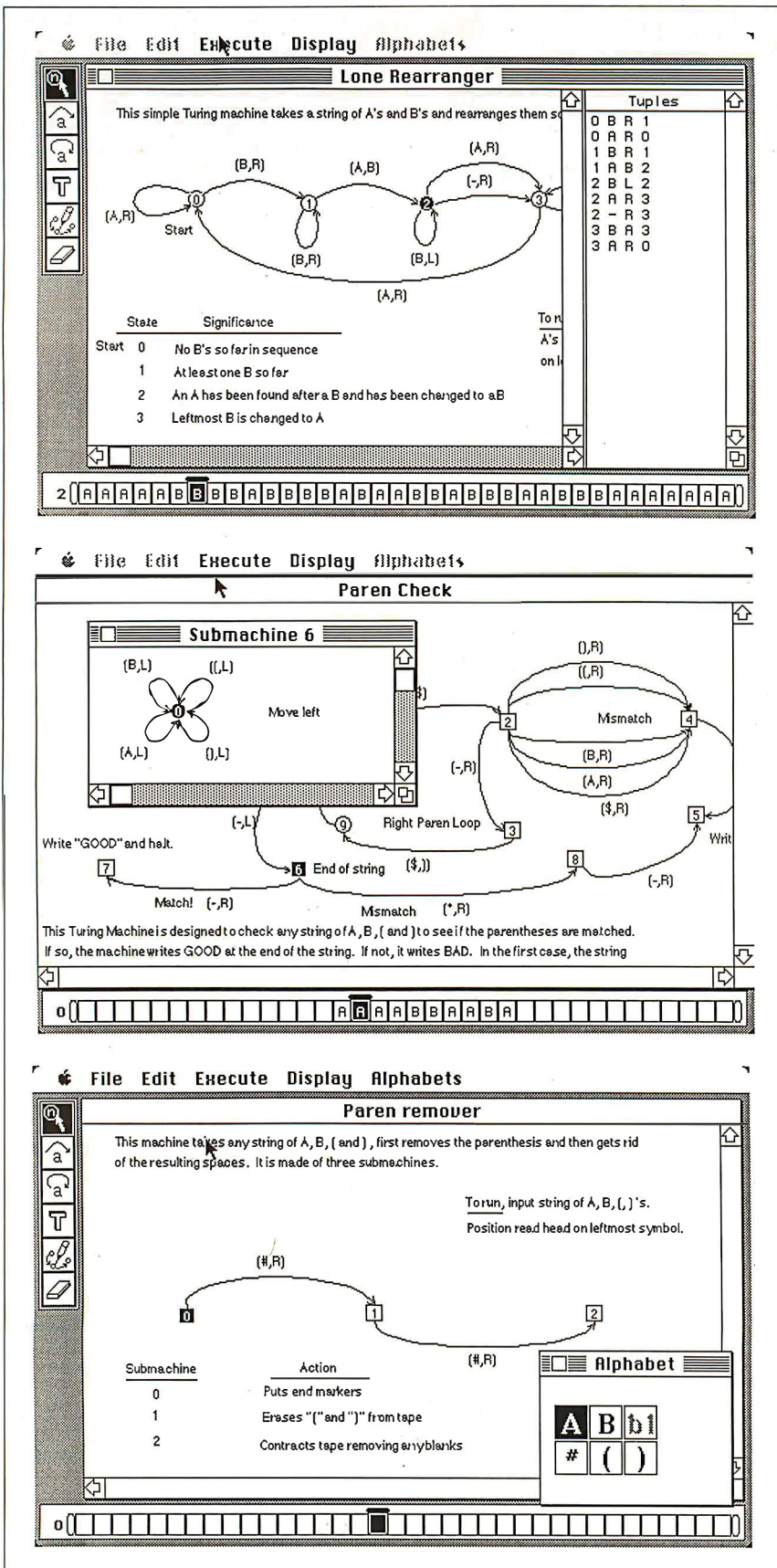

Figure 4: Turing's World by Jon Barwise and John Etchemendy of Stanford gives users a graphical environment in which to build, debug, and run Turing machines.

gram, the student draws a flowchart of a machine that will solve the problem. Once it is turned on, the program converts the flowchart into a Turing machine that carries out the appropriate actions, so that the student can see whether it works as intended. If the problem is complex, the student can construct a Turing machine, shrink it, and make it a node in a larger Turing machine. The nesting can go on as long as the Macintosh has memory to support it.

This process of moving from the abstraction to a physical device that embodies the abstract machine makes life much easier for both the student and the instructor. Using Stanford's interactive classrooms, the instructor can display students' work on a screen and then compare different approaches to the same problem.

**The Courseware Authoring Tools Project**

An approach described by Michael Carter, to remove obstacles so that faculty members can control their use of computers, is being carried a step further with the Courseware Authoring Tools (CAT) project. "Our goal," says Carter, "is a set of tools as easy to use as MacWrite and as immediate as Pinball Construction Set." Rather than working with faculty to develop specific applications for particular courses, they are working to develop tools that are broadly applicable.

Carter believes that "authoring systems in general tend to have a great number of the pedagogic decisions already made." The environment designed through the CAT project should be flexible enough to allow real freedom in courseware design, with 90 percent of the work done by the professor and only 10 percent by a programmer. It will be implemented on machines on the order of Sun workstations or the IBM RT PC.

Stanford's population is so diverse and the needs of faculty members so broad-ranging that no single system will satisfy everyone. According to Barbara Jasinski, manager of the CAT project, "Given our time and resources, we can't develop all the courseware to be used on the Stanford campus. We are trying to pull together a set of hardware and software tools that will help our faculty implement courseware."

The CAT environment may be gathered from several sources—other universities (e.g., Carnegie Mellon's Andrew, MIT's Athena, or Brown's Intermedia), from vendors, and software written at Stanford. "We aren't limiting ourselves to what we could develop here, since our faculty's needs are so varied," says Stanford's Jasinski.

*continued*



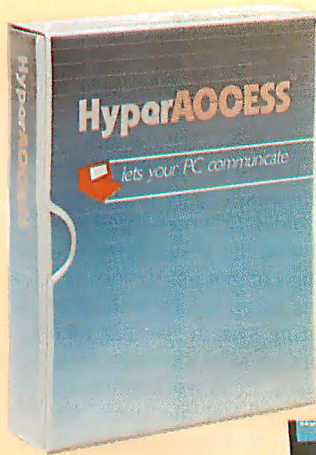

# HyperACCESS™

## Top Rated Communications Software

### Editor's Choice PC MAGAZINE

October 28, 1986

**"An excellent program with many advanced features, including a comprehensive language, unattended host and file transfer capabilities."**

### Rated #1 by Software Digest RATINGS NEWSLETTER September, 1986

**"The consistent combination of power/usability ratings put HyperACCESS at the top..."**

### Rated by InfoWorld July 14, 1986

**"It's a snap to start using the program immediately... you can be communicating in a matter of minutes."**

Whether you're just beginning to use your PC for communications or you've been frustrated by limitations of another program, HyperACCESS is the answer. Simple for novices. Exhilarating for experts. Ideal for businesses.

There's no initial hurdle. HyperACCESS **adapts itself** to your computer and modem (it dials, redials, and answers more than 40 models). You can use it just by looking at your screen. The manual is crystal clear. A detailed training program is included.

It comes ready to call CompuServe, Dow Jones, EasyLink, MCI Mail, NewsNet, The Source, and others (trial subscriptions included). Learns your passwords the first time you call and enters them for you from then on. You can list more than 100 computers (or people) for instant calling. HyperACCESS logs every call.

**Astonishing versatility!** Lets you link with systems that defy others. With mainframes, minis, micros, or RS-232C devices. It emulates VT52, VT100/102, TeleVideo 925/950, H19, TTY, Wang, IBM 3101, and IBM 3278 asynchronous terminals. It supports up to 19,200 baud and transfers files **FAST** using Kermit, Xmodem (CRC or Checksum), and ASCII Protocols.

HyperACCESS is an outstanding host, too. Even when you're not there, your PC can be accessed by callers who have passwords you've defined. You set whether each caller can read or type messages, transfer files, run programs\*, or use your PC without restrictions.

HyperACCESS has the clearest, most complete script language, so you can create custom functions and menus, or automate any portion of a call. And we give you powerful scripts — transfer files between unattended PC's — pick up electronic mail at 2 am — act as a high-security dialback host, and more.

\*Certain programs are incompatible with remote use.

HyperACCESS, trademark of Hilgraeve; IBM, PC, XT, AT, TopView, trademarks of International Business Machines; MS, Windows, trademarks of Microsoft; Software Digest, Ratings Newsletter, trademarks of NSTL, Inc.; InfoWorld, publication of CW Communications, Inc.

Even in the midst of communications, HyperACCESS lets you run your other DOS software or use your computer's DOS commands. And HyperACCESS is so well-behaved, it can also run under Windows, TopView, DESQview or DoubleDOS, concurrently with other programs.

**Call or Write Today!**  
**800-826-2760 or (313) 243-0576**

- Send HyperACCESS on 5¼" disks for \$149
- Send HyperACCESS on 3½" disks for \$149
- Send HyperACCESS on 5¼" and 3½" disks for \$169
- Send me a demo disk for \$5 (specify 5¼" or 3½")

**30-Day Money-Back Guarantee**

Name: \_\_\_\_\_

Company Name: \_\_\_\_\_

Shipping Address: \_\_\_\_\_

City: \_\_\_\_\_

State: \_\_\_\_\_ Zip: \_\_\_\_\_

Payment:  Check  VISA  MC Card Exp. Date: \_\_\_\_\_

Credit Card #: \_\_\_\_\_

\$149 per copy plus \$5 shipping, \$20 overseas; Mich. residents \$6 sales tax. System Requirements: IBM PC, XT, AT, or compatibles, 192K RAM min. PC-DOS 2.0 or greater. (Separate Z-100 version.) **Not copy protected.**

**Also available on 3½" disks. Includes PC-to-Laptop utilities.**

**Hilgraeve Inc.**  
P.O. Box 941, Monroe, MI 48161  
Communications Software Since 1981.



# Carnegie Mellon

## CARNEGIE MELLON

Pittsburgh, Pennsylvania

The Andrew Project (named for Andrew Carnegie and Andrew Mellon) has been the nexus of a great deal of cooperative effort at Carnegie Mellon University (CMU). The Information Technology Center is charged with designing and developing the workstation environment and the communication system. It is a joint effort of CMU and IBM, with IBM providing staff members as well as money and equipment.

CMU's Computation Center has been responsible for deploying and maintaining the communication system, and the Center for Development of Educational Computing has developed course-related software. In addition, the initial networking effort was an ingenious patching together of several existing technologies, and involved the voluntary cooperation of many departments and university centers, to link 2000 machines in a short time.

According to Andrew's designers, James H. Morris et al., in a March 1986 *Communications of the ACM* article, "The computing paradigm envisioned in Andrew is a marriage between personal computing and timesharing. It incorporates the flexibility and visually rich user-machine interface made possible by the former, with the ease of communication and information-sharing characteristics of the latter." This is accomplished with a Vast Integrated Communications Environment (VICE) campuswide file system that is designed to expand gracefully to network several thousand workstations called VIRTUEs (Virtue Is Reached Through UNIX and EMACS).

However strained the acronym, a VIRTUE workstation is a powerful tool—an IBM RT PC, Sun, or MicroVAX with a couple megabytes of memory, a 1000-by-800-pixel screen, and processing power of 2 to 4 million instructions per second. VIRTUE software includes a window manager with subroutine libraries for text, graphics, and data manipulation; a database subroutine manager; and applications for electronic mail and bulletin boards. (For a technical discussion on Andrew, see "Data Structures in a Bit-Mapped Text Editor" by Wilfred J. Hansen, January.)

In selecting an operating system,

Andrew's developers chose Berkeley UNIX for its portability, advanced features, and well-defined standard. Any workstation that supports UNIX will run VIRTUE. UNIX machines are still costly, however; the powerful workstation that a student can afford to buy is yet to come.

### The Network

Carnegie Mellon is completing the installation of an 11,000-plug IBM cabling

system on which most of the IBM equipment communicates using Token-Ring adapters. The older Ethernet-based network is joined with the Token-Ring Network by routing computers.

File sharing is set up to look to the user like a timesharing system, so that each workstation appears to be sharing a large central file system. Each workstation has a small amount of local file space, but most files are shared. When called for by



Figure 5: The Great American History Machine by David Miller of Carnegie Mellon displays census and election data graphically in detailed maps, which can then be manipulated to reveal demographic trends. Shown here are Arkansas, Louisiana, and Mississippi.



an application program, a file is cached at the workstation. Changes are made to the cached copy locally, and an updated copy transmitted to the appropriate file server only when the file is closed. Presently, 14 file servers, each with a gigabyte of storage, serve a registered user population of about 3100.

Electronic mail and bulletin boards are a natural outgrowth of a campuswide network. In fact, about 300 bulletin boards are available to the CMU population, including Arpanet, USEnet, and lots of local boards. That's a good bit more information than anyone can absorb. "Most of us have thrown up our hands and tried to limit the number of these bulletin boards we see," says James Morris, head of the Andrew project. "We have newspapers and magazines which deal every day with deciding what's worth reading and what's not. That kind of intelligence needs to be added here." Several researchers at CMU are investigating the problem of information overload.

### CMU Tutor

To use Andrew's capabilities in their courses, instructors need to develop software in their fields of study. Some faculty members have designed courseware, had it implemented in C, and have used it in their courses. Not many, however, can program in C themselves. Many useful and interesting C programs are left as orphans when the student programmer who wrote the code graduates, and the professor finds that the program needs to be updated.

Building on their experience with Plato, Bruce and Judy Sherwood have developed CMU Tutor, an authoring environment for creating interactive courseware with sophisticated graphics. CMU Tutor makes it easy for an instructor with little prior programming experience to exploit the power of the workstations. CMU Tutor programs can also be compiled and run on IBM PCs and will eventually be available for Macintosh as well.

In a series of one-week workshops at Carnegie Mellon, educators from around the country got a chance to use CMU Tutor and assess its value for their own institutions. Participants were given an orientation on Monday morning and began learning to use CMU Tutor Monday afternoon. By Friday morning, in a show-and-tell session, many had developed significant, graphics-oriented courseware packages.

### The Great American History Machine

One application now in use in the history department at Carnegie Mellon takes full advantage of the graphics and processing

power that Andrew provides. As shown in figure 5, The Great American History Machine takes U.S. census and election data and displays it on maps that can be manipulated by the user. The program, according to its designer, history professor David Miller, allows historians and students "to take a body of data that has been sitting around in machine-readable form for years, and lets them find patterns in it and develop hypotheses."

For example, a historian working with the 1850 census might examine a variable like illiteracy—that is, the illiteracy rate in the nonslave population. A national map would show, predictably, high literacy rates in the Northeast and a great deal of illiteracy in more rural areas like Arkansas. The deep South, however, shows a very mixed pattern. A historian interested in this point might then compare this map with another that illustrates a different measure of affluence—slaveholding, for instance. The second map appears in a window next to the first.

The match is not too good in this case—the second map distinguishes between counties with slave populations of less than 6 percent, 6 percent to 28 percent, and over 28 percent.

At this point, the power of the program becomes apparent. With a few clicks of the mouse, the user can change the cut points, displaying counties with slave populations of over 50 percent. The maps of the two variables, literacy and slave ownership, now match much more closely. This ability to discern patterns in a body of data is vital to historians and sociologists.

Also crucial is the ability to give students a set of information and a way to look at it and let them construct their own hypotheses. A professor using The Great American History Machine can decide how much preprocessing to do on the data before the students see it. In some classes, it might be appropriate to offer data and analysis, with the conclusions already drawn. More advanced students might deal with the data in its raw form and make their own decisions. Says Miller, "This tool can really bring the computer into the historical profession."

### On-Line Grant Proposals

The National Science Foundation has contracted with the Information Technology Center to build an electronic mail system through which researchers will be able to submit their grant proposals. This involves text editors that can handle mathematical formulas, graphics capabilities, and the ability to transfer files from one system to another. The system can extend far beyond grant proposal submissions—it may evolve into a medium in which scien-

tists can exchange information easily, circumventing the slow, cumbersome publishing process.



### DREXEL UNIVERSITY

*Philadelphia, Pennsylvania*

Early in 1984, Drexel University started a massive deployment of Macintoshes to its students. Freshmen that year were required to have access to one, and most of them bought Macintoshes from Drexel, at less than half the retail price. Student response was enthusiastic, and the program has continued with each incoming freshman class. There are about 10,000 Macintoshes on campus now, and by 1988 there will be nearly 12,000.

Students matriculating this year bought a Macintosh Plus and received essential software with it: MacWrite, MacPaint, Excel, MacPascal, MS BASIC, and FileMaker. A terminal emulation package is also available to all students. Anyone who needs help with the Macintosh can call a telephone hotline, use the walk-in consulting service, check with the student-run users group, or simply hang around the public computer cluster and ask.

The open-access public cluster has nearly 100 Macintoshes, supplemented by 15 departmental clusters. All major lecture halls on campus have built-in Macintosh projection units. Two classrooms are set up with 25 to 30 Macintoshes and wall-mounted 24-inch monitors. Professors who want to use the computers for class demonstrations are not limited to these two rooms, however—they can request a mobile Mac-monitor unit.

Distributing course-related software at the beginning of each semester was a problem until recently. Last fall, a file-server system was in place, consisting of a Macintosh Plus with 40 megabytes of disk storage, connected to four 512K-byte Macs with AppleTalk. Students simply find the folder for the appropriate course number and download the files.

### Software Development

Drexel's Software Development Group employs a staff of about 40 programmers, both professionals and students, to help faculty members create courseware. So far, about 90 programs developed at

*continued*



Drexel are in use all across the curriculum. Some of these are also distributed nationally, through the Academic Courseware Exchange.

Allan Smith of Drexel's chemistry department, for example, developed the Molecular Editor with which you can build complex molecules on the screen using 100 or more atoms of any element in the periodic table (see figure 6). Beginning with a collection of basic structures and functional groups, the user can cut, copy, and paste in three dimensions to construct the molecule, and then can rescale it, rotate it on three axes, rotate part

of a molecule with respect to another part, or rescale the atoms while leaving the bonds unchanged.

Students can also analyze the molecule, measuring the distance between atoms, the angle between bonds attached to the same atom, or the torsional angle about a bond. Twenty files can be open at once, and the display can flip from one to another. On a 512K Macintosh, this provides an animation feature, running quickly through a sequence of open files. The disk includes an animation of a chemical reaction in three dimensions, as well as sample files of organic molecules, functional groups,

inorganic molecules, and crystals.

The Macintosh has made some converts among the faculty at Drexel. Eric Brose of the history and politics department was sure he would have no use for the computer in his classes. Now, his Treaty of Versailles program is used at Drexel and distributed through ACE. Treaty of Versailles puts students in the role of the diplomats who reshaped Europe at the end of World War I. Students answer questions about the terms of important treaties, use national, ethnic, and historical information to redraw Europe's map, and participate in a simulation of a meeting at the Versailles Conference. The student diplomats must come to an agreement determining Europe's new national boundaries and must marshal arguments to support their positions, using maps they produce (see figure 7).

Instructors in engineering, who have been accustomed to thinking of microcomputers as toys, are also among the converts. A third of the Macintosh programs developed at Drexel are for engineering classes. Signal Operations by Banu Onaral, for example, is part of a package of programs that offer students an interactive environment for investigating theories and concepts in discrete signals and systems. The computer handles routine display and computation tasks, freeing the student for more thought-provoking exploration.

Students using Signal Operations first generate signals (either point by point or using predefined signals like impulse, step, ramp, exponential, sinusoid, or rectangular pulse). These signals can then be subjected to mathematical operations and algorithms such as time shifting, time and amplitude scaling, rotation about the  $x$  or  $y$  axis, logarithm, convolution, correlation, and so on, to create new signals. Students can edit and compare signals and store them to be used with other programs in the package (see figure 8).

### The Students

How are students reacting to the ubiquitous Macintosh on the Drexel campus? According to John Gregory of the Office of Computing Services, after the initial excitement subsides, they take it all in stride. "It has become such a standard part of the operation that no one notices it anymore, any more than when they buy new notebooks," says Gregory, a little wistfully.

However disappointing it may be when the program Drexel has worked so hard to implement gets a "but, of course" reaction from the students, Gregory recognizes it as a measure of success. He warns that expectations can escalate rapidly—this year's juniors, who were thrilled with their Macintoshes three years ago, see this

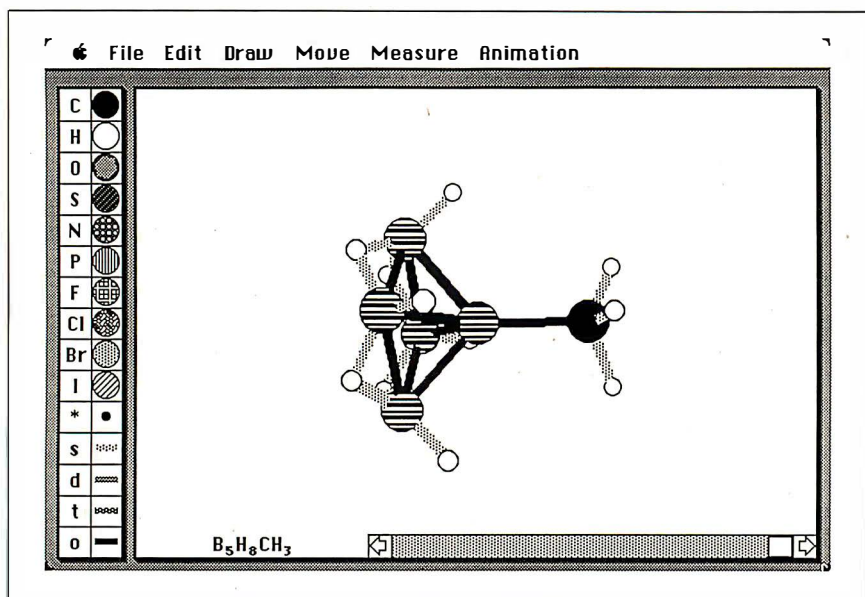

Figure 6: *Molecular Editor*, by Allan Smith of Drexel University, allows the user to build and rotate three-dimensional molecules on-screen.

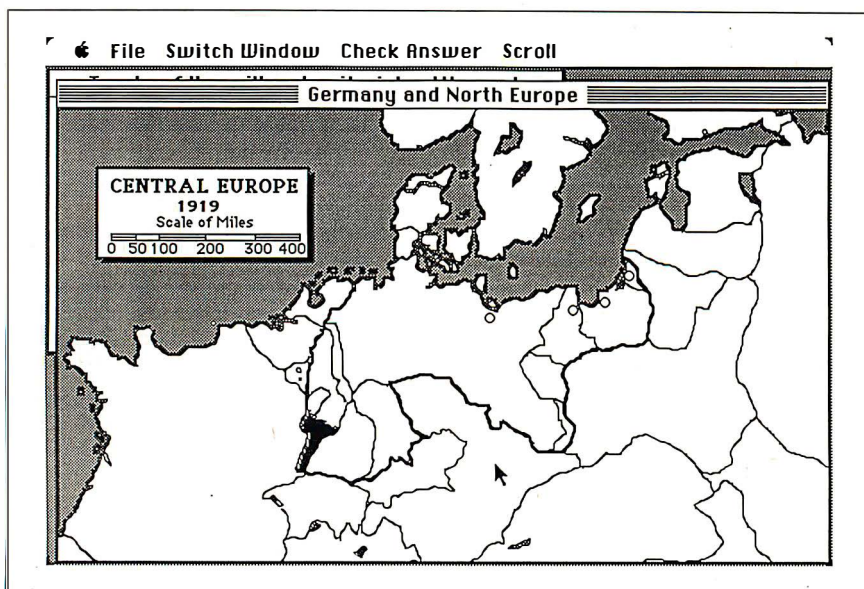

Figure 7: *Treaty of Versailles*, by Drexel's Eric Brose, lets students take on diplomats' roles in reshaping Europe after World War I.



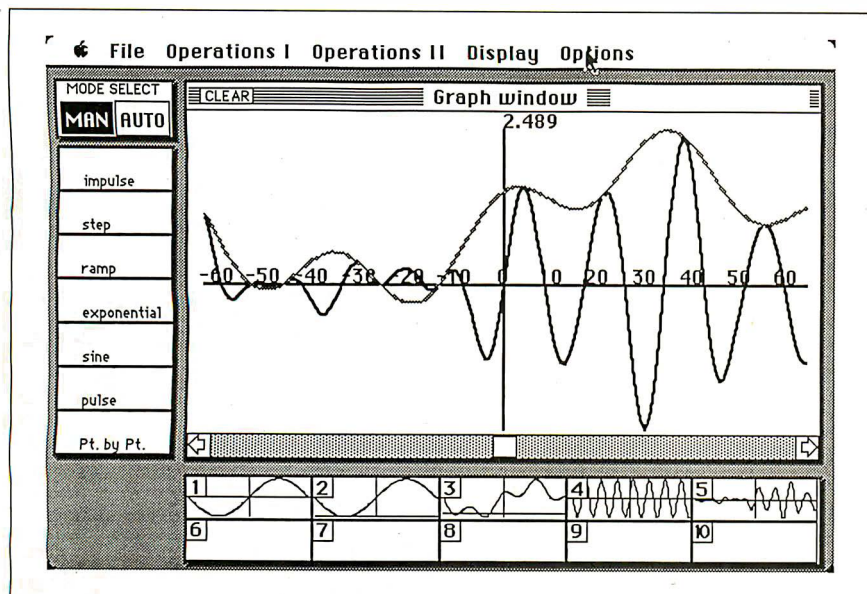
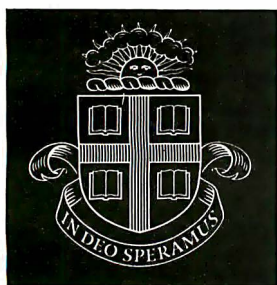

Figure 8: *Signal Operations* by Banu Onaral of Drexel lets engineering students create and manipulate signals.

year's crop of freshmen getting the Macintosh Plus and want a piece of the action. "Institutions saturated with computers need to be prepared for this," he says.



### BROWN UNIVERSITY Providence, Rhode Island

Brown University is in the midst of a 10-year project to design and implement the Scholar's Workstation—"a campuswide network of high-powered, graphics-based workstations for use in research and teaching in the sciences and liberal arts." One stage in this development is represented by the Intermedia Project.

#### Intermedia

Norman Meyrowitz, head of the Intermedia Project, calls it "a large-scale, object-oriented hypertext/hypermedia system" in a paper presented at OOPSLA '86 (and published under the title "Intermedia: The Architecture and Construction of an Object-Oriented Hypermedia System and Applications Framework" in the OOPSLA '86 Conference Proceedings [New York: Association for Computing Machinery, 1986]). OOPSLA stands for "object-oriented programming systems,

languages, and applications."

"Hypertext" is a term coined by Ted Nelson in the early 1960s to connote a nonlinear body of information with "links" between documents that guide readers from one to another. "Hypermedia" is the logical extension of hypertext, encompassing graphics, animation, video, sound, and so on. Blocks, or pieces of documents, can be linked to form multimedia webs of information. The same documents may be linked by different webs.

For example, Shakespeare's works might make up the body of information. An English student might use a web of links from the text of a play to a glossary, to pictures of historical figures, and to explanatory background material. A theater student might access the same body of information through a web linking the text to video clips of a performance, pictures of costumes, and critics' reviews.

According to Meyrowitz, Intermedia is a modeless environment, "a framework for a collection of tools that allow authors to create and link documents from a variety of applications." There are presently five applications available within this framework: a text editor, a graphics editor, a scanned-image viewer, a three-dimensional object viewer, and a timeline editor. (A music editor, a video clip editor, and access to CD-ROM data are in planning.) The user interface is as consistent as possible across applications so that a user has no trouble going from one to another.

Intermedia was developed under the UNIX 4.2 operating system and runs on the Sun workstation and on the IBM RT

PC. In the previously mentioned article, Meyrowitz describes the hardware: "The RT PC contains a RISC (reduced instruction set computer) microprocessor rated at over 2 MIPS and a companion memory management unit that handles a 40-bit virtual address space.

"The configurations we use have 3 to 4 megabytes of physical memory, a 100 by 768, 97 pixels per inch, monochrome bit-mapped display, an Ethernet connection to a local area network, and a two-button mechanical mouse. The systems can each support a number of internal hard disks, though for the most part, individual workstations each have a 40-megabyte hard disk to contain only the operating system files. Each LAN has one or more central server machines that contain larger disks and more memory; the Intermedia system code, user documents, and webs are typically stored on the server's hard disk."

#### System Development

In choosing an operating system, Intermedia's developers looked for features they considered necessary for the next generation of workstations, including support for virtual memory, multitasking, and networking. They chose Berkeley UNIX 4.2, enhanced with Sun's Network File System, that would run on the Suns and the RTs.

Next, Intermedia's developers chose a user interface toolbox and an applications framework. They needed low-level mouse and keyboard handlers, fast graphics, window and menu managers, and so forth. They did not want to design a new applications framework, so they looked for one that would provide a generic application from which a developer could build software. The toolbox and applications framework that met their criteria were Apple's Macintosh Toolbox and MacApp. Meyrowitz points out the obvious problem: "... neither the Mac Toolbox nor MacApp ran on an RT PC."

One puzzle piece was supplied by Cadmus Computer Systems (Lowell, Massachusetts), who had CadMac Toolbox implemented in C on a UNIX base. Brown obtained a license to port CadMac to the RT and found an added advantage in the fact that CadMac supported multiple processes. Through special agreements with Apple and Bolt Beranek and Newman (BBN) (Cambridge, Massachusetts), MacApp was ported from Object Pascal to an object-oriented, preprocessed version of C. Using a BBN class compiler, Brown got MacApp running on the RT PC. Intermedia was built on top of CadMac and MacApp.

Materials are now available on the In-

*continued*



termedia workstations for two experimental classes, one in English and one in biology, and the system is being used on a smaller scale in several other courses. In these early stages of the project, a professor and his assistants put material on the system "by hand," document by document, using Intermedia's text editor, drawing program, etc. Before the text editor was available, they created documents using MacWrite and technicians ported them to Intermedia.

The instructor or user marks blocks within the document that serve as anchor points, then creates links from point to point. The links do not become part of the document but are stored separately, in webs. Several webs may overlay one set of material. Thus, users following one set of links through a body of information need not see the links other people are using.

For instance, a student taking English 32, a survey of English literature, could explore a corpus of material called "Context 32: A Web of English Literature." The student would first see a screen of icons representing individual text, picture, graphic, or timeline documents. Rather than open a particular document, however, the student will click on the icon representing the web, or set of links among the documents. In this case, Browning Web links documents that illuminate the life and works of Robert Browning. A "global map" opens, giving a visual representation of the web (see figure 9).

Users of early hypertext systems often

found themselves lost and confused in a maze of documents and links. However, Intermedia's Macintosh-like interface prevents this problem, since users can always find their location on a map, either global or local.

Studying the global map, it is clear that the document representing Browning's literary relations contains the most links to other documents and might be a good place to start. Double-clicking on the icon opens the document and reveals a picture of Browning, with icons representing links. To follow a link, the student can click on the icon and choose "Follow" from the Intermedia menu or simply double-click on the icon.

Choosing the "Biography" icon would display a dialog box explaining that there are two links anchored at that point—a biography and a timeline of the important events of Browning's life. Selecting one of the links opens the document and highlights the portion of the document to which the link refers. Rather than linking an entire document to another document, any selectable portions of the documents can serve as anchor points. Thus, in a text file, a link may be made to an insertion point, a sentence, or any piece of text the link creator chooses.

Creating a link is nearly as easy as following one. You simply define a block to serve as an anchor, choose "Start Link" from the Intermedia menu, open the document to which the link will be made, select a destination block, and choose

*continued*

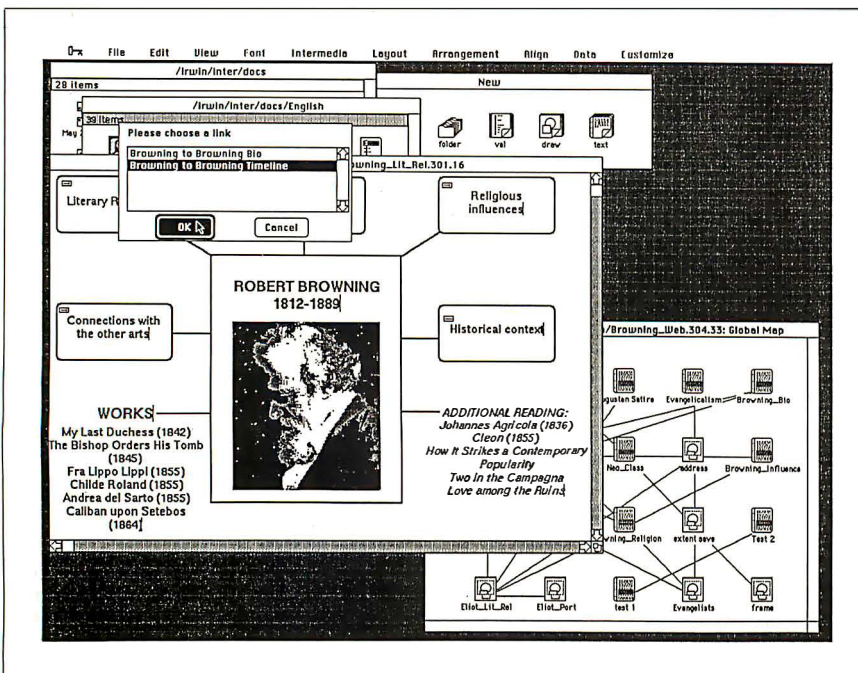

Figure 9: Students in an English literature survey class at Brown can explore a corpus of information by following links from one document to another.

## All this—and only 15 pounds!

### Power for performance:

- IBM PC AT compatible
- 80286 processor, running at 8MHz
- MS-DOS™ 2.11\* operating system, BASIC

### More storage for more applications:

- 640KB RAM, extendable to 2.6MB
- Built-in 10MB hard disk
- Built-in 720KB 3½" diskette drive

### The display with clear advantages:

- High-resolution gas plasma display
- IBM Color Graphics Adapter (CGA) compatible
- 80 x 25 character display
- 640 x 400 bit-mapped graphics display

### Interfaces to make connections a snap:

- RGB color monitor port
- Parallel printer port
- RS-232C serial port

### Built-in convenience:

- Full-sized 81-key keyboard
- 110/220 VAC switch-selectable power supply
- Only 12.2" W x 3.1" H x 14.2" D

### Important extras included:

- SideKick® and SuperKey® software
- Attractive carrying case

### "Big" system expansion options:

- Internal 300/1200 bps Hayes®-compatible modem
- Internal 2MB extended memory card
- 15-key numeric keypad
- External 5¼" 360KB diskette drive
- Floppy Link to desktop 5¼" diskette drive
- Expansion chassis with five IBM-compatible slots

The T3100. So powerful—and so portable—it's like being able to take your whole office wherever you work.

\*MS-DOS 3.2 operating system available soon.

# TOSHIBA



# 14" x 12" x 10MB x 80286\*



## AT Power, Toshiba-Style.

Until now, working away from your office meant having to settle for lesser computers—or no computer at all.

Toshiba ends that compromise. The T3100 delivers the power of an IBM® PC AT™ in a lean, 15-pound computer that you can take with you. With a full-sized keyboard and advanced gas plasma display that give you equal comfort and clarity on your desk—or on the road.

### Don't let its size fool you.

Though the T3100 is no bigger than many laptop computers, it offers the power of a full-function IBM compatible desktop AT system. You get the speed and ease of a built-in hard

disk, communications and expansion options, and more—including dual-voltage power that lets you plug in and go to work just about anywhere in the world.

\*Okay, we exaggerated. It's actually 14.2" x 12.2". But you really get a 10.6MB built-in hard disk.

See the system that has all of the industry experts so excited. Call: **1-800-457-7777** for your nearest Toshiba computer and printer dealer.

In Touch with Tomorrow

## TOSHIBA

TOSHIBA AMERICA, INC., Information Systems Division

Trademarks: PC AT—International Business Machines Corporation; MS-DOS—Microsoft Corporation. Registered Trademarks: IBM—International Business Machines Corporation; Hayes—Hayes Microcomputer Products, Inc.; SideKick, SuperKey—Borland International, Inc.





"Complete Relation" from the menu. The technique is consistent across applications and is intuitively obvious to anyone familiar with a Macintosh-like interface. To prevent the anarchy that would result if many people were creating links in the same body of material, users are assigned privilege levels, with read-only, write, and annotate privileges.

Traversing the web in an English course, a student can see the connections between a literary work and the context in which it was written. He or she may see essays, short informational pieces on

the author, time lines of the author's life, pictures, and drawings. The student can get a feel for the artistic, religious, and philosophical background of the author and the times.

"The professor who teaches the English course using Intermedia is concerned that students just read books in a vacuum," says Meyrowitz. "Literature is multi-causal, and we want students to become critical thinkers, to understand there are a lot of connections that can't be ignored."

One of Intermedia's great strengths is its flexibility as a pedagogic tool. "We are

not designing special-purpose programs that teach a specific subject," says Nicole Yankelovich, who has been instrumental in the development of Intermedia. "We provide tools that can be used in many ways. We've been impressed with the creativity of the faculty in using Intermedia. They have come up with ways of using it that we never considered."

### Graphics Capabilities

The biology course makes extensive use of Intermedia's graphics capabilities. Students (and professional biologists) have had difficulty visualizing a three-dimensional object, such as a cell, based on two-dimensional drawings. A student who can call up a digitized electron micrograph of the cell in question, with 3-D models that can rotate and change scale and with links to 2-D drawings, has a better chance of forming an accurate mental picture of the cell. In addition, after following links back and forth between 2-D and 3-D representations, the student is better able to analyze the 2-D drawings in texts or journals and has a better feel for how they would look in three dimensions.

Access to powerful graphics is not the only fundamental change in the biology course, however. Students can also write and store their papers on-line, making links to material stored there to support their arguments. The professor can examine their work at several stages and make suggestions in the outline or the draft phase. This puts the professor more in the role of a collaborator than an instructor, closely simulating the way that professional biologists might work together.

Intermedia's linking system is in itself a pedagogic tool. In one experimental religious studies class, students are submitting their papers on-line. The instructor links his comments to them and creates links among the students' papers, pointing out different approaches to the same argument. An anthropology professor whose students study historical ethnography presents all his students with the same set of documents and asks them each to create a web of links to present a case for their arguments.

"The role of the computer is changing," says Meyrowitz. "It can be your depository, your library, your shoebox full of card files, with an all-encompassing framework in which to organize the information. It used to be that the computer would dictate how information could go in and how it could come out—like a Model T, you could have any color, as long as it was black. Intermedia represents a way for people to harness the power of the computer, rather than letting the computer harness them." ■

## Do You Ever Get the Feeling That No One Speaks Your Language?

### Arity/Prolog. The Language That Spans the Generation Gap.



Arity listens to what you ask for. You want a serious, versatile language that will go the distance for you. There are two very good reasons for you to use Prolog—to do your work smarter and faster. That's exactly what the Arity/Prolog development environment will help you do. Our powerful tools, based on the general purpose programming language Prolog, will significantly reduce your development time and allow you to solve a wide range of application problems.

**No translation required.** Our development environment for the IBM PC family and all MS-DOS compatibles includes the Arity/Prolog Compiler and Interpreter, the Arity/Expert System, and Arity/SQL. And you can tie them all together. You can interface with several other programming languages and build extensions to your existing applications. You'll be truly multilingual—what better way to span the generation gap?

**It can take you to new places.** You'll discover amazing speed, power, and flexibility using the Arity/Prolog programming environment, with its one gigabyte of virtual memory and fast, compact compiled code, for conventional applications. And if you're working in new territories, like expert systems or sophisticated database management systems, you'll be speaking the native tongue.

**Speak it freely.** Our products are not copy protected and we charge no royalties, so you can use them in as many end-user applications as you'd like. Why keep the language of solutions all to yourself?

Join the thousands of assembly and C programmers who already use Arity/Prolog—the language of solutions.

**Call 1-800-PC-ARITY Today.**

Massachusetts residents call 617-371-1243.

Software that roars.

ARITY CORPORATION

30 Domino Drive, Concord, MA 01742 U.S.A.

1-800-722-7489 or in Massachusetts call 617-371-1243



# 80386 ST \$3195.

## ST/286-12™ MOTHER BOARD

ST for Superior Technology

**\$1295.** 12 MHz  
One Year  
Warranty Against  
Manufacturers Defects

- Standard with Intel 80286
- Optional Upgrade to Intel 80386
- Up to 640K Ram on Board
- Clock/Calendar with Battery Back-up
- Complete with Enhanced Set-up Software
- Documentation Included
- Fits XT and AT Cases
- Supports AT and XT Boards
- Runs All Major Software Written For the IBM PC, PC/XT and PC/AT
- Available for Immediate Delivery
- Made in the U.S.A.

**80386  
UPGRADE  
only \$800**

## CCI ST/286-12™



**\$2395.**

One Year  
Warranty Against  
Manufacturers Defects

**12 MHz  
STANDARD**

**80386 UPGRADE  
only \$800**

**INCLUDES:** ST/286-12™ Mother Board, 640K of Ram, 1.2 Meg Floppy Drive, Western Digital Combined Floppy and Hard Disk Controller Card, AT Keyboard, 192 Watt Power Supply, Clock/Calendar with Battery Back-up, Intel 80286 Processor, Diagnostic and Enhanced Set-up Software, Documentation.

## HARD DISKS

<b>20 MEG SEAGATE KIT for XT</b> Western Dig. Controller, Cables, Software, Mounting Hardware	<b>\$445</b>
<b>30 MEG SEAGATE KIT for XT</b> Adaptec Controller, cables, Software, Mounting Hardware	<b>\$505</b>
<b>20 MEG SEAGATE for AT</b> 40 MS Voice Coil, Cables and Rails	<b>\$569</b>
<b>30 MEG SEAGATE for AT</b> 40 MS Voice Coil, Cables and Rails	<b>\$675</b>
<b>40 MEG SEAGATE for AT</b> 40 MS Voice Coil, Cables and Rails	<b>\$799</b>
<b>60 MEG PRIAM for AT</b> 28 MS Voice Coil, Cables and Rails	<b>\$1475</b>
<b>86 MEG TOSHIBA for AT</b> 23 MS Voice Coil, Cables and Rails	<b>\$1695</b>

10 MHz

## CCI ST/286™

ST for Superior Technology



**\$1495.**

One Year  
Warranty Against  
Manufacturers Defects

**INCLUDES:** ST/286™ Mother Board, 1 Meg of Ram, 1.2 Meg Floppy Drive, Western Digital Combined Floppy and Hard Disk Controller Card, AT Keyboard, 220 Watt Power Supply, Clock/Calendar with Battery Back-up, 80286 Processor, Documentation, Phoenix BIOS and Phoenix SETUP Software.

No charge for UPS ground shipping. No surcharge for MasterCard or Visa. Add 5% sales tax if a Florida resident.

Warranty work requires proof of purchase and return authorization number. Merchandise returned for credits subject to a 15% restocking fee.

## COMPUTER CLASSIFIEDS, INC.



Sales Calls Outside Florida **1-800-331-5150**  
17830 State Road 9 • Miami, Florida 33162



Sales Calls From Anywhere in Country **(305) 651-5853**  
Technical Support Calls **(305) 651-0073 - Telex 510-600-7725**

Intel, Hercules, Atronic, Western Digital, Seagate, Priam and Toshiba are trademarks of their respective companies. IBM, PC, IBM XT, IBM AT are trademarks of IBM Corporation. Some quantities may be limited. Computer classifieds reserves the right to substitute equivalent items. All prices are subject to change without notice.



Share  
Info.

MFG.



Spreadsheet  
database  
communications

Acctg/Finance



Spreadsheet  
graphics  
comm.

Sales/ Mkty

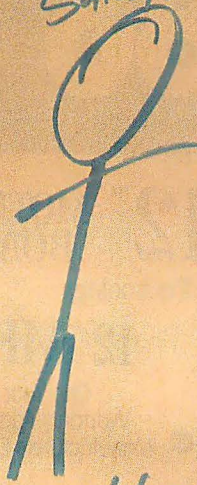

Spreadsheet  
graphics  
wd. process  
comm.

personnel



wd. process  
graphics

Symphony  
works  
For Everyone





R+D  
Spreadsheet  
database



you can't  
outgrow  
it

Symphony® is the one software product no business person can afford to be without. Based on the 1-2-3® spreadsheet technology, Symphony pulls together five key functions in one program. Functions that help a marketing manager work smarter. Give a financial analyst a clearer picture. Run an entire company more effectively.

Symphony is designed to stay ahead of your expanding needs. Its five functions can handle a wide range of business requirements. But should you have more specialized needs, you can incorporate Lotus® add-in products, or any of the more than 250 applications created by independent software developers.

Symphony. Business software you'll never outgrow.

## Lotus Symphony

*A complete general-purpose software tool built around the world's leading spreadsheet technology.*

© 1986 Lotus Development Corporation. Lotus, 1-2-3 and Symphony are registered trademarks of Lotus Development Corporation.



# Why RamFont™ is so essential to your software.

Until now, most programs could only display 256 pre-programmed characters.

Just enough for the regular alphabet, some numbers and a few special symbols.

Enter the Hercules™ Graphics Card Plus.

Its extraordinary new RamFont mode can store up to 3072 programmable characters, and display them at lightning-fast speed.

And RamFont is so flexible, you can even mix graphics on the same screen as text.

A whole new generation of software is available now, taking advantage of RamFont's unique capabilities to give you more power and speed than ever before.

## Lotus® 1-2-3®

By using RamFont to display smaller-than-standard characters, 1-2-3 Release 2 gives you a spreadsheet that shows almost twice as much data as before.

And, RamFont makes scrolling instantaneous and smooth, rather than painfully slow and jerky.

You can even view a graph in a pop-up window—another RamFont first.

## Microsoft® Word 3.

Word 3 was the first PC word processor that let you see boldface, italics, subscripts and superscripts mixed with regular text.

But it was slow.

Not anymore.

With RamFont, Word 3 runs almost four times faster.

## Lotus Manuscript.™

Manuscript is Lotus' new technical word processor, written to run optimally on the Hercules Graphics Card Plus.

It uses the RamFont mode for fast, multiple-font text editing.

Then it switches to graphics mode to format a page for printing, showing proportionally spaced equations.

## Even more goodies.

Besides these dramatic improvements, RamFont also dramatically improves the scrolling speeds of Symphony® 1.1 and Framework II.™

For WordStar®, there's a RamFont add-on that lets you use multiple fonts.

There's even a new word processor that lets you write in Greek, Russian and Hebrew, *on the same screen.*

And there's more incredible RamFont software right around the corner.

## And now, the really good part.

RamFont is only one of the Hercules Graphics Card Plus' major advantages.

You also get our famous high resolution graphics, to run programs like AutoCAD® and Pagemaker.™

And our high resolution text mode that runs thousands more programs.

And a parallel printer port that can be "unplugged" for greater flexibility.

## Here are a few of the programs taking advantage of RamFont.

Lotus 1-2-3 Release 2  
(and later)

Lotus Symphony Version 1.1

Lotus Manuscript

Microsoft 3.1

(includes mouse support)

Ashton-Tate Framework II

Nota Bene™

PS™

Computer Linguist

For a complete list, contact Hercules.

All for the astonishingly low suggested list price of \$299.

Which, on top of the Plus' performance, has caused a few people in the industry to get unusually excited:

**\$299**

Suggested Retail Price.

"If you intend to buy an IBM PC or clone and want to run a monochrome system, this is the card to get. I wouldn't even think of anything else."

John C. Dvorak,

PC Magazine columnist.

Neither would we.

Call 1-800-532-0600 ext. 212 for the name of an Authorized Hercules Dealer near you and we'll rush you our free info kit.

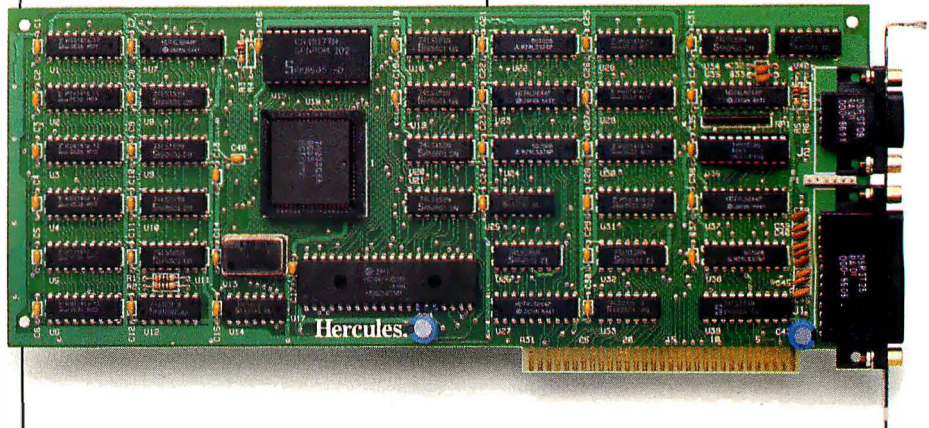

## The Hercules Graphics Card Plus with RamFont.

Address: Hercules, 2550 Ninth Street, Berkeley, CA 94710. Ph: 415 540-6000. Telex: 754063. Trademarks/Owners: Hercules, RamFont/Hercules; Lotus, 1-2-3, Manuscript, Symphony/Lotus; Microsoft/Microsoft; Framework/Ashton-Tate; WordStar/MicroPro; AutoCAD/AutoCAD; Pagemaker/Aldus; Note Bene, Dragonfly: PS/Scroll Systems.



# The Quiet Revolution

*On-line education becomes  
a real alternative*

Brock N. Meeks

A QUIET REVOLUTION is taking place. It is a revolution of phosphor, integrated circuits, and carrier tones, and it is occurring within the framework of American education. It is fueled by computer conferencing systems, modems, and on-line databases—the counterparts of yesterday's chalkboards, lecture halls, and libraries. Its participants speak in code, using terms like "telelearning," "electronic university," and "virtual classroom." The ultimate goal of this revolution is a simple one: getting an education without setting foot inside a classroom.

Education outside the classroom is not a new concept. We've all seen the correspondence courses offered on matchbook covers. However, such courses suffer a high attrition rate (better known around correspondence schools as the body count). Academic studies show that 70 percent dropout rates are not uncommon. The major problem is a lack of communication with the instructor and other students. Without this vital motivation, only the most dedicated students complete a traditional correspondence course.

## Hallowed Halls of Phosphor

An electronic university exists within the confines of a mainframe computer and is managed by either electronic mail, a computer conferencing system, or both. (For an overview of computer conferencing, see the Theme section of the December 1985 issue of BYTE.) A student attending an electronic university interacts with instructors and other members of the class by using a computer and a modem.

Electronic mail and computer conferencing allow an on-line course to duplicate many of the dynamics found in a traditional classroom. However, on-line courses carry a tremendous advantage: You don't have to be in the same place at the same time. The instructor and students can be in several different states and time zones and "attend" class at any time. International students can also participate in such courses because these electronic classrooms are hooked to packet-switched carrier networks, making them accessible from almost anywhere in the world.

## On-line Mentors

TeleLearning Systems of San Francisco operates the Electronic University Network (EUN). During its four-year history, TeleLearning Systems has delivered college-level courses electronically, using telecommunications as the link between instructor and student. However, EUN recently underwent a radical restructuring of its on-line program.

In the old system, courses were delivered on disk, with associated hard-copy reading and study materials. The course disk contained a fixed set of assignments and projects for the student to complete and upload to the instructor. It was classic computer-assisted instruction, with an element of telecommunications thrown in to make the process more convenient. EUN's new structure, 180 degrees from the old system, is aptly called Protege. (Protege refers to both the new program and the software that drives it.)

"The essential idea of the program is to connect protégés with mentors," says James Milokovic, vice president of research and development at EUN and designer of the Protege software. The concept of the Protege program is analogous to a Copernican revolution, says Milokovic. "Instead of the student having to revolve around the instructor being in a certain building at a certain time on a certain day, now the entire program, including the instructor, revolves around the student."

The Protege software is the heart of EUN's new program. It's completely menu-driven and operates on one-key commands. All assignments are completed using the Protege disk. On disk are knowledge templates for performing all course requirements. For example, if you want to send your on-line mentor a question or pose a problem, you simply compose your query in the electronic mail template. To send the note to your instructor, you turn on the modem, hit one key, and your message is automatically delivered. You never enter another keystroke.

Course assignments are now uploaded to the student one at a time. This way the instructor stays in personal contact with

*continued*

*Brock N. Meeks (5830 Bari Ct., Suite B, La Mesa, CA 92041) is a freelance journalist who writes about high technology for several publications. He is also a teacher in Connected Education's Media Studies program.*



## *Besides individual classes, EUN also offers degree programs.*

the student. "It is of significant interest to the instructor to know [whether] you work for [a particular company] or are a minister," says Milokovic. This type of personal contact lets the instructor customize the course to the workaday world of the student. For example, besides teaching you the basics of marketing, the instructor may have you apply your textbook learning to how your company really designs its marketing strategy.

Currently, 200 colleges and universities participate in the program that forms EUN and provide EUN with more than 200 on-line courses. Each university or college develops its own course for inclusion in the EUN course catalog. Credit is granted from the institution that developed the course. If you've taken a course in economics from a professor at Harvard University, then Harvard grants you the credit, not EUN. EUN is simply the link between you and your mentor. If someone looks at your college transcript, there is no difference between a class taken on campus or over the modem. (For more information, see "The Electronic University Network" by Donna Osgood, March 1986 BYTE.)

Besides the individual classes, EUN also offers degree programs: three different M.B.A. degrees from City University of Bellevue, Washington, and four undergraduate degrees from Edison State College in New Jersey.

All courses offered by EUN meet or exceed standard College Level Examination Program (CLEP) requirements. This means your accumulated credit can be transferred to more than 1700 colleges and universities that accept CLEP-level courses. Costs begin at \$215 for an average three-credit course and include connect time. The price goes up another \$25 to \$50 depending on your choice of books.

### **Teleconferencing**

The New York Institute of Technology (NYIT) has established the fully accredited American Open University (AOU) on a VAX-11/730 using the Participate (PARTI) computer conferencing software. Currently, AOU offers 130 on-line courses and three B.S. degrees in business administration, general studies, and behavioral science. Each degree program requires 120 credits for completion, exactly the same as NYIT's on-campus degree programs require. "These aren't

special programs for on-line students," says Ward Deutschman, dean of NYIT's Center for Adult and Professional Education. "Because of accrediting requirements they have to be the same courses offered on campus."

AOU emulates a traditional classroom using teleconferencing. When a course is in session, all interaction among the students and instructors takes place in a course conference. Here, students ask questions and discuss the assignments prepared by the instructor. They can also reply to the comments of other students.

Subconferences, or branches off the main course conference, are also possible. For instance, you might use a sub-conference when students are working in teams on a particular assignment. "Students often form 'study group' conferences as well," Deutschman said. These on-line study groups allow students to share notes or compare personal observations about the class.

When starting at AOU, you work with a special advisor to develop a background portfolio. This portfolio takes into account any previous college credit, military and corporate training, and life experience. "We don't want to take your time or money for things you've already learned," says Deutschman. After your portfolio is complete, your advisor will work out a degree map that allows you to chart a course of study to complete your degree. If you just want to bone up on a subject or two while accumulating some extra college credits, you can take individual courses.

When you sign up for a class, you receive a course learning package containing a textbook, an extensive (100- to 150-page) course outline, sample tests, quizzes, course objectives, and instructor background information. Once on-line (AOU is on the Telenet packet-switched network), you will find all the support typically available to on-campus students.

For example, AOU students can access the on-line librarian for reference materials. The AOU librarians will look up your request and send you a message explaining where, in your local area, that information is available. If you happen to live in a remote area where extensive library support is unavailable, the AOU librarians can arrange for an interlibrary loan. Students can also talk to counselors and advisors on-line and send private correspondence to the instructor or to other students.

Costs are \$85 per credit—which is less than an on-campus course—and most courses are for three credits. "On-line students don't tax our overhead and don't use buildings or electricity," said Deutschman, "so we don't have to charge them as

much." Your course fees include six hours of on-line time. If you happen to use more than six hours, you are billed on a pro-rata basis. "But for what it's worth, [so far] we've never charged anyone for extra time on-line," said Deutschman adding that AOU is more concerned with having students interact on-line—not watching the clock.

### **Classroom for the World**

"We want to be a university to the world," says Connected Education's director Paul Levinson. "Our philosophy is that education shouldn't be tied to a classroom or geographic region," a heady claim for a program that saw its first on-line semester open in September 1985. However, more than a year later, Connected Education has both the statistics and the enrollment to back up that claim. It has already drawn a fair contingent of international students. Last semester Connected Education had students enrolled from Japan, Singapore, and Columbia.

In conjunction with the New York-based New School of Social Research, Connected Education offers graduate and undergraduate courses in the New School's Media Studies program. Levinson says a Ph.D. program is well into the development stage.

Each course offered by Connected Education brings together an expert in a particular field of study and students needing graduate-level course work. All the courses are taught via the New Jersey Institute of Technology's Electronic Information Exchange System (EIES). All courses run on the semester system and are two months long, during which time the students and the instructor discuss various issues relevant to the course topic. An interested student can obtain a detailed course outline and a required reading list before committing to taking a specific course.

Unlike the structured courses taught at AOU, Connected Education courses are propelled by the give and take of daily on-line dialogue. Although instructors follow a prearranged course outline, they're flexible enough to change the direction of the course according to the needs of the class.

During the course the instructor assigns various projects and reading assignments that the students are required to complete and comment on. Daily participation in the course is encouraged. To obtain a passing grade, each student is required to input at least two messages per week. In reality, students often upload several messages a day—message traffic in Connected Education's courses runs extremely high. Students must also take a midterm and final exam. These exams are in essay

*continued*



# TABLE OF BENCHMARK RESULTS

This table shows the results of the processor/ coprocessor speed tests using the April 1986 release of PC Magazine's 'PC Labs Benchmark Tests'. These are public domain programs, and are available on diskette from PC Magazine, or via the PC Magazine bulletin board. These results were obtained by us at PCSG, and are not yet official

published PC Magazine figures.

The last line in the table, the Norton System Information Test, is not from PC Magazine, but is part of the popular 'Norton Utilities'. The version we used was 3.1, which is the latest version but may not give identical results to older versions.

	IBM PC	IBM AT	BREAKTHRU 286
Clock speed in MHz (IBM PC is 4.77)	4.77	6	8
Empty Loop	1	1.99	3.34
Integer add from memory	1	3.35	4.41
Integer multiply from memory	1	6.06	6.55
Floating point without coprocessor	1	3.33	4.42
Floating point w/8MHz coprocessor	n/a	n/a	1.82
Prime number test	1	1.95	2.85
Lotus 123 macro (64OK)	1	2.64	3.69
Lotus 123 macro (256K)	1	1.77	3.54
Norton System Information Test	1	5.73	7.34

In every case but clock speed the numbers indicate how many times faster a test is performed than on a regular IBM PC.

RAE0032 / B



**Personal Computer Support Group**

**ORDER CARD**

## Breakthru: 286 Speed-up Board

Remember, NO SOFTWARE is needed. But as a special Bonus, our \$89.95 Lightning Disk Speed-up Program is included at no extra charge.

Mail this card TODAY or call

**214/351-0564**

*Introductory Offer!!*

*\$395.00*

Date \_\_\_\_\_

Quantity \_\_\_\_\_ x \$395.00 \_\_\_\_\_

Ship to:

Add shipping fees \_\_\_\_\_

Name \_\_\_\_\_

2nd Day \$6.50

Next Day \$15.00

Company \_\_\_\_\_

Total \_\_\_\_\_

Address \_\_\_\_\_

City / State / Zip \_\_\_\_\_

Billing Instructions:

MC  Visa  Check  AmEx  COD

Phone \_\_\_\_\_

Card # \_\_\_\_\_ Exp. Date \_\_\_\_\_



*Introductory Offer \$395.00!!*

# BREAKTHRU 286 SPEEDUP BOARD-

**IT'S SIMPLY THE BEST!**

*60 Day Money Back Guarantee  
If Not Delighted!*

---

---

---



NO POSTAGE  
NECESSARY  
IF MAILED  
IN THE  
UNITED STATES



**BUSINESS REPLY MAIL**  
FIRST CLASS      PERMIT NO. 779      DALLAS, TEXAS

POSTAGE WILL BE PAID BY ADDRESSEE

**Personal Computer Support Group**  
11035 HARRY HINES BLVD., #207  
DALLAS, TEXAS 75229-9990





# MAKE YOUR IBM PC FASTER THAN AN AT.

IN JUST 5 MINUTES!

Introductory  
Offer —  
~~\$395.00~~

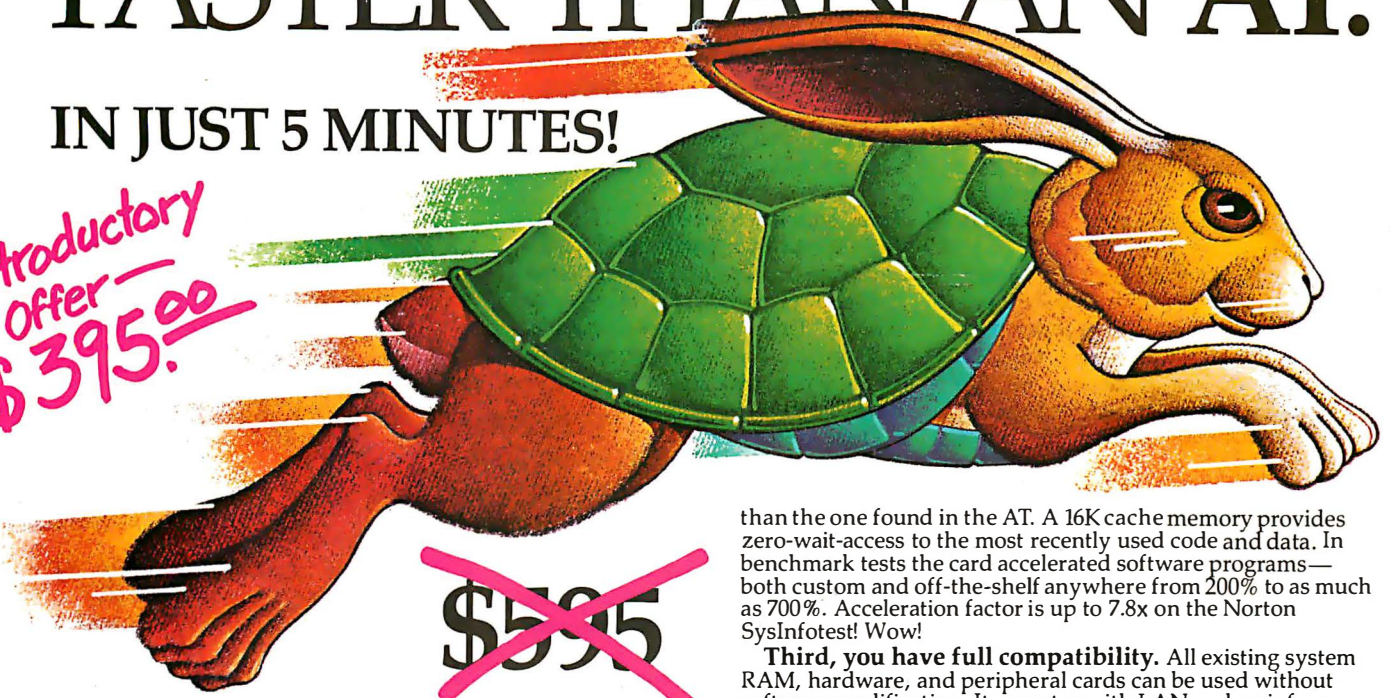

**DON'T TAKE OUR WORD FOR IT.  
USE THE BREAKTHRU 286 SPEEDUP  
BOARD FOR 60 DAYS. IF YOU ARE NOT  
TOTALLY SATISFIED RETURN IT FOR A  
FULL REFUND.**

It sounds great; the idea of a speedup board that you can just plug right in as easily as putting bread in a toaster. How wonderful to be able to convert a PC or XT to a \$4000 AT without the expense. But even when you get ready to spend \$595.00 you want to be sure your choice is the very best.

Here at PCSG we sell our IBM PC disk access speedup software by the thousands. But software doesn't do anything about speeding up the microprocessor (or CPU) speed. As you know the microprocessor is the brain of the computer that controls all the operations like screen updates and calculations like a spreadsheet makes.

***Faster and smarter than an AT —  
PCSG guarantees it.***

We wanted to offer a speedup card that would be the complement to our disk speedup software, (incidentally included at no extra charge.) We wanted it to be literally the most advanced, compatible and feature rich board available today. We could only be satisfied with a board that was the finest example of the engineering art.

There is no question we have met our every objective by developing and manufacturing the *BREAKTHRU 286* card. This is the best designed and most functional speed up card available today. We guarantee it.

**HERE IS WHAT MAKES IT SO SPECIAL.**

**First, it installs so easily.** It is a half slot card, only five inches in length. You don't even have to give up a full slot. What's more, unlike competing products it works in the Compaq and most clones. The instructions are so simple we considered showing a picture of a child putting it in. Easy diagrams show how you just place the card in an open slot, remove the original processor and connect a single cable. There is no software required. From that moment you are running faster than an AT.

**Second, it is advanced.** The *BREAKTHRU 286* replaces the CPU of the PC or XT with an 80286 microprocessor that is faster

than the one found in the AT. A 16K cache memory provides zero-wait-access to the most recently used code and data. In benchmark tests the card accelerated software programs—both custom and off-the-shelf anywhere from 200% to as much as 700%. Acceleration factor is up to 7.8x on the Norton SysInfotest! Wow!

**Third, you have full compatibility.** All existing system RAM, hardware, and peripheral cards can be used without software modification. It operates with LAN and mainframe communication products and conforms to the Lotus/Intel/Microsoft Expanded Memory Specification (EMS). Software compatibility is virtually universal.

**Fourth, it is the best there is.** There are several other boards on the market. Some are priced about the same as the *BREAKTHRU 286* and some are cheaper. We at PCSG have compared them all, but there simply was no comparison. What we discovered is that many cards being sold offer only a marginal speed up in spite of their claims. We found some to be merely versions of the obsolete 8088 or 8086, and others to be just poorly engineered. The 8MHz *BREAKTHRU 286* is unequivocally the best executed and most completely reliable speedup board manufactured today.

PCSG has since early 1983 dominated the lap portable market with ROM software such a Lucid spreadsheet and Write ROM that reviewers rated as excellent. We were proud to successfully enter the IBM PC market last year with disk access speedup software. Now we are so pleased with the *BREAKTHRU* speedup card. We use them on our own PC's to make them faster than AT's. We are really excited about this product.

PCSG makes the unabashed statement that the *BREAKTHRU 286* card represents more advanced technology than boards by Orchid, Quadram, Victor, Mountain, P.C. Technologies, Phoenix... we could go on.

But an ad can't let you experience it for yourself. That's why we sell the *BREAKTHRU 286* on a 60 day trial. If you aren't completely satisfied return it within 60 days for a full refund. It is priced at \$395. Call today with your MasterCard, Visa, American Express or COD instructions and we will ship your card the very next day.

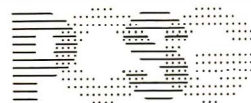

**PERSONAL COMPUTER SUPPORT GROUP**

11035 Harry Hines Blvd. #207 • Dallas, Texas 75229

**214-351-0564**





## Face-to-Face or Not to Face

In response to an editorial by our editor in chief, Phil Lemmons, concerning the use of computer conferencing in education in the September 1986 BYTE, we received some interesting letters from readers. They raise some important questions on both sides of this issue.

Various comments from these letters are presented here along with some pertinent excerpts from the two papers listed in the bibliography. Please note that these persons are not necessarily spokespersons for their particular universities; their affiliations, however, are given in table A.

### What is education?

"Education is about understanding, not information transferral."

—William Kemp

"Education is essentially the conveyance of ideas and information among students and faculty, and there's no reason that many of the courses now taught in traditional place-based institutions cannot be taught effectively via on-line conferencing."

—Paul Levinson

"It is this concept of communications being the fundamental benefit of the class-

room environment that underlies the premise . . . that computerized conferencing provides one of the first opportunities to create a true 'virtual classroom'."

—Starr Roxanne Hiltz and Murray Turoff

### Does education need the face-to-face encounter?

Computer conferencing lacks the "effective feedback provided in live conversation by facial expressions, posture, gestures, etc. That sort of information is what a good teacher uses to monitor how a class is reacting to what [is being said]."

"Face-to-face encounters are very rich in feedback through nonauditory information channels, while all telecommunications systems, from the lowly telegraph to the latest two-way video, are weak in providing [such] feedback. Inexperienced users . . . find sustaining engagement in [such] conversations quite difficult."

This form of education also lacks the "immediacy which being in a live classroom provides. (Immediacy here means information carried by the nonverbal information channels which surround and enrich human speech.) Worst of all, the teacher in a computer conference has no live students providing the constant feedback [that] good teaching requires."

—William Kemp

"Certainly for the technical disciplines, face-to-face contact is unnecessary, perhaps even distracting, and often effectively unavailable in any case in auditorium-sized classes."

—Daniel Mocsny

"Many educators believe strongly that this technology is the wave of the future for remote classroom delivery and an important augmentation of the traditional classroom. [Only] a quarter to a third of the students would prefer the face-to-face environment rather than courses taught or augmented via computerized conferencing" [see figure A].

—Hiltz and Turoff

### Aren't graphics necessary?

"Walk into any science or engineering course lecture and observe the chalkboard. Less than half the scribbles can be represented directly by ASCII characters. Instead, one sees a freewheeling set of sketches, graphs, equations, symbols, arrows, etc. The skilled instructor throws it all up there with no apparent effort while conducting a [class]. . ."

—Daniel Mocsny

"Probably one of the single biggest shortcomings of the current EIES system and other computerized conferencing systems now being used for education is the lack of graphics. It is currently difficult to deal with equations and diagrams in these text-oriented systems."

—Hiltz and Turoff

### Who finds this method of education useful?

"Even people in urban areas face an analogous problem [to that of those in remote areas]: the two-hour drive in city traffic to reach a one-hour class isn't very practical."

—William Kemp

"Not only can students electronically take part in classes from virtually anywhere in the world, but they can take part at times of their choosing—anytime night or day, seven days per week. This results in people participating at their best, and the consequence is a very rich intellectual experience."

"Issues which might otherwise be neglected or forgotten in an in-person classroom—questions that may occur to students after class hours—are preserved

**Table A:** *Affiliations of the various contributors to the text box.*

Starr Roxanne Hiltz and Murray Turoff  
Computerized Conferencing and  
Communications Center  
New Jersey Institute of Technology  
Newark, NJ 07102

Drew Hopkins  
Director, Management Information  
Systems  
Thomas A. Edison State College  
101 West State St.  
CN 545  
Trenton, NJ 08625

William Kemp  
Assistant Dean for Programs and  
Projects  
Mary Washington College  
Office of Graduate and Extended  
Studies  
1301 College Ave.  
Fredericksburg, VA 22401-5358

Paul Levinson, Ph.D.  
Director, Connected Education Inc.  
92 Van Cortlandt Park S, #6F  
Bronx, NY 10463

Daniel Mocsny, Ph.D.  
Postdoctoral Assistant  
University of Cincinnati  
Department of Chemical and Nuclear  
Engineering

Mail Location #171  
Cincinnati, OH 45221  
[Editor's note: *Neither this department  
nor Mary Washington College  
currently offer courses via computer  
conferencing.*]

Jane Robinett  
Polytechnic University  
Department of Humanities and  
Communications  
333 Jay St.  
Brooklyn, NY 11201

John A. Scigliano  
Director, Center for Computer-Based  
Learning  
Department of Computer Science  
3301 College Ave.  
Fort Lauderdale, FL 33314



and woven into the computer conference.”

—Paul Levinson

“This application of telematics has many potential advantages compared to other modes of educational delivery, including more active participation by students, convenient access to the electronic classroom at the times and places that can best fit in with the student’s work obligations, and increased motivation to work hard on assignments because they will be viewable by other students as well as by the instructor(s).”

“[Students] can take courses from teachers and institutions located far away, which may not be offered by institutions within commuting distance. There are [also] many potential [students] for whom it is difficult or very expensive to become a resident student on a college campus and/or to participate in classes held at fixed times.”

“The new technologies are already eroding the geographical monopoly held by many institutions of high education.”

—Hiltz and Turoff

**What problems exist in learning to use the system?**

“Seasoned users of on-line computer conferencing have learned to adapt their behavior as senders and receivers of information to the low content density of the medium—just as almost everyone has adapted to transferring information over the telephone. But using either medium successfully is definitely an acquired skill.”

—William Kemp

“Until course conferencing software is as easy to use and as versatile as a simple piece of chalk and blackboard, the resistance of faculty will be great.”

“Conferencing will bring about a restructuring of jurisdictions. First the students [will] stay home, then the faculty.”

—Daniel Mocsny

“More than 80 percent of the students enter five or more spontaneous comments during the semester in addition to formal assignments. This represent[s] a level of equality of participation far in excess of normal face-to-face courses.”

“There is no doubt that the additional student-instructor interaction of computer

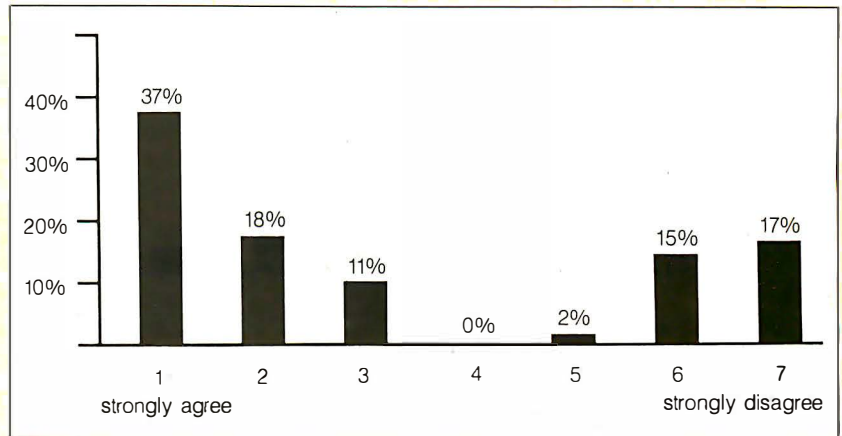

**Figure A:** Distribution of responses from students on EIES to the statement: “I would be willing to take courses taught only through EIES with no face-to-face lecture if I had adequate access to terminal equipment at home and/or work.”

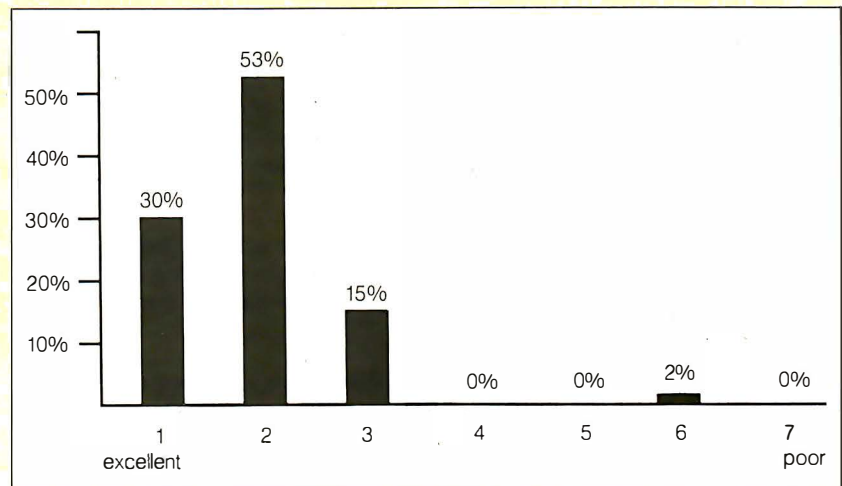

**Figure B:** Distribution of responses from students on EIES to the overall performance of their instructors.

conferencing generates more work and time involvement for each instructor on a per-student basis.”

—Hiltz and Turoff

**Benefits of computer conferencing in education**

Through computer conferencing, we can finally obtain “a truly universal university.”

—Paul Levinson

“Among the advantages cited by students are increased convenience, more contact with the professors, increased motivation to do a good job on assignments because their peers will see their contributions, and more opportunity to participate in discussions. Instructors cite the ease with which it is possible to team-

teach a course or to include ‘visiting lecturers’ with industrial experience, and the high quality of student contributions, which are generally well thought out before they are entered” [see figure B].

“It has not worked to try to keep an on-line class moving together in lock-step at the same rate through the material in a course, given the asynchronous nature of this medium and the fact that students tend to participate a lot when they have time but only a little when there are other pressing work obligations.”

“With this technology, colleges and universities can offer their most outstanding professional talent to students anywhere in the country. What choice

*continued*



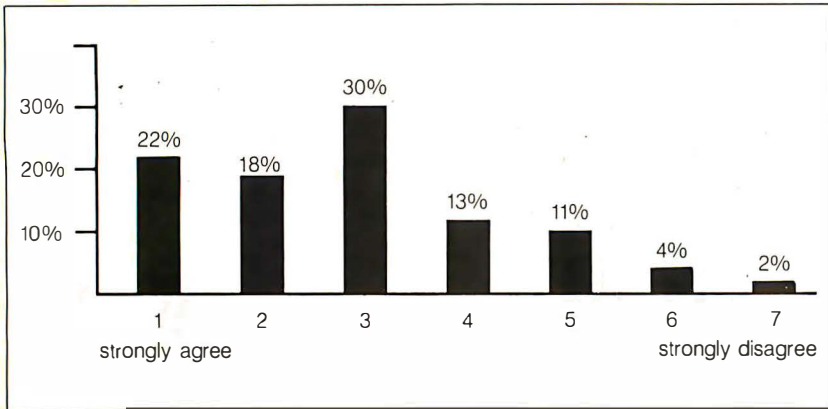

**Figure C:** Distribution of responses from students on EIES to the statement: "I learned a great deal more because of the use of EIES."

will a talented student make: an average professor at a college within physical commute distance, or the same course from a Nobel prize winner at a university 1000 miles away which can offer the course remotely?"

"EIES offers some special features that helped facilitate the educational process. The 'question' feature allowed the instructors to enter questions on-line which required an essay response. Students could not see each others' answers until they had supplied their own answers. Thus the instructors could ask questions

that produced overlapping answers, without losing a later student's participation because earlier students had already said part of what a later student had to say [see figure C]. In the face-to-face environment, by contrast, only the first student to answer a question gets to express a given view. EIES also allows the use of 'pen names' so students can make anonymous comments."

—Hiltz and Turoff

**Some other schools involved**

Nova University has "been offering on-line degree programs for over three years

and [has] over 500 students enrolled in this format."

—John A. Scigliano

At the Polytechnic University, "we have found our students enthusiastic about on-line courses and hope to expand our course offerings in the coming semesters. Computer conferencing is an exciting and powerful educational tool and I sincerely hope that it will be put to wider use in the near future."

—Jane Robinett

"The simulated classroom project [at Thomas A. Edison State College] will eventually allow Edison students throughout the country to earn college credits through the use of the college's existing guided independent-study program. We are adding a computer conferencing mode to facilitate the courses. Edison students, regardless of time and location, will be able to interact with faculty and students, submit projects, review and participate in on-line topics discussion utilizing the conferencing component."

—Drew Hopkins

"Both the University of Michigan and the University of Wisconsin have used conference packages to augment regular courses for a number of years."

—Hiltz and Turoff

form and are uploaded to the instructor.

Connected Education's first semester offered courses such as "Teleworld," an analysis of the social impacts of new media; "Artificial Intelligence and Real Life," which discussed topics such as "Is protein necessary for intelligence?"; and "Propaganda: The Literary Science." Other courses offered range from "Telelaw" to "Politics of the Information Age."

Each course costs \$795 and earns three graduate-level credit hours. All on-line connect charges are included, and students receive unlimited time on the conferencing system for class participation. Students have electronic mail and real-time conferencing capabilities as well. Levinson says transfer of Connected Education's credits to other institutions is possible but at the discretion of the receiving school.

**On-line Brain Trust**

Western Behavioral Sciences Institute (WBSI), a 27-year-old "think tank," offers a unique program designed to help executives and government officials further their management and communications skills in several different areas. "We've developed a program that alerts today's

decision makers to the new requirements of leadership," says WBSI president, Dr. Richard Farson. The on-line structure of WBSI's program offers the opportunity for people in leadership to learn from each other, says Farson.

Participants in WBSI's School of Management and Strategic Studies (SMSS), as the program is called, include college presidents, corporate CEOs, national and foreign government officials, military and CIA personnel, best-selling authors, and former astronauts, among others. The program lasts for two years and is divided into four modules of six courses each. Each course is a month long.

Course instructors are drawn from the nation's top experts. For example, Harland Cleveland, dean of the Hubert H. Humphrey Institute of Public Affairs, teaches a course called "The Knowledge Dynamic in a Global Society." Another instructor is Herbert York, director of the Institute for the Study of Global Conflict and Cooperation and U.S. ambassador to the Comprehensive Test Ban negotiations from 1979 to 1981. Combine experts like these with some of the nation's most influential citizens and you have an on-line brain trust that has no equal.

The SMSS program operates much like the Connected Education program. Participants interact with the instructor and others in the course via the EIES conferencing system. The advantage of such a program is that it doesn't take the participant away from the work environment as do some of the high-powered management schools where participants are isolated from their jobs for up to 13 weeks.

Uncommon in the world of electronic learning, WBSI holds a week of face-to-face meetings before each module begins. This allows participants to meet each other and the instructors. This has the particular advantage of building up a strong on-line community that keeps participant motivation high. It also gives new participants a chance to get some individual hands-on training in the workings of the somewhat eclectic EIES conferencing system. This semiannual meeting is so successful at developing relationships among participants that alumni continue to participate in the courses and often act as freelance advisors to "undergraduates."

There is a small catch: the price tag. A two-year stint at SMSS runs \$25,000. This is usually paid for by the participant's

*continued*



# Why Are So Many People Switching to Smalltalk/V?

Why are scientists, engineers, and professionals switching to Smalltalk/V? Because it lets them do amazing things on their PCs, with a Mac-like interface and an easy-to-use object-oriented language. And with Smalltalk/V you get an unsurpassed array of problem-solving tools. You can even personalize the entire system to suit your needs.

Smalltalk/V is the programmable environment that gives you total control of your computer and makes it what it was meant to be, a truly personal tool for your mind.

**"This is the real thing, folks. A super Smalltalk like this turns your PC into a hot workstation. It's fantastic . . . Highly recommended."**

*John C. Dvorak,  
Contributing Editor, PC Magazine*

**"My background is in physical chemistry, not in programming. I like Smalltalk/V because I can use objects in the computer to represent objects in the physical world."**

*Dr. Paul Soper, Senior Specialist  
E. I. du Pont de Nemours & Co.*

**"Smalltalk/V is a productive programming environment that allows us to quickly develop sophisticated medical applications."**

*Dr. Mike McCoy,  
Dean for Instructional Computing  
UCLA School of Medicine*



**"Smalltalk/V is the highest performance object-oriented programming system available for PCs."**

*Dr. Piero Scaruffi,  
Chief Scientist, Olivetti  
Artificial Intelligence Center*

**"Smalltalk/V is an excellent buy and makes a good alternative to other programming languages for the development of complex applications."**

*Bill Wong, Director, PC Labs  
PC Magazine*

**\$99.00**

## Other Smalltalk/V Features

- Object-oriented Prolog integrated with the Smalltalk environment
- Supports exploratory programming and prototyping
- Class hierarchy with inheritance creates highly re-useable source code
- Smalltalk source code included, with browser windows for easy access and modification
- Object-swapping creates a virtual memory on hard or RAM disk
- Bit-mapped graphics with bit and form editors
- A sophisticated source-level debugger
- Automatic change log for easy recovery from errors
- Powerful directory/file browser system for organizing DOS files
- Access to other languages and DOS functions
- 500 page manual with comprehensive tutorial and reference sections
- Optional add-on modules
  - RS-232 communications interface with UNIX™ and TTY windows
  - EGA color graphics
  - "Goodies" diskette, including multiprocessing, music, zoom, object loader, and more

Inquiry 83

## Smalltalk/V The Programmable Environment

**"Smalltalk/V, with its visual interface and class structure, is a perfect way to simulate the complex interactions of natural systems."**

*Lee A. Graham, Research Assistant  
Institute of Ecology, University of Georgia*

**"I solve problems quickly using Smalltalk/V because its classes and objects help me organize my thinking. And besides, it's fun to use."**

*Dr. Barry Fishman, Sr. Project Engineer  
Hughes Aircraft Company*

BYTE and BX are trademarks of McGraw-Hill, Inc. IBM, IBM-PC, and IBM PC-AT are trademarks of International Business Machines Corporation. Unix is a trademark of Bell Laboratories.

**Yes!** I want to turn my PC into a hot workstation! Send me . . .

- Smalltalk/V-The Programmable Environment . . . . . \$99
- Communications Option . . . . . \$49
- EGA Color Option . . . . . \$49
- "Goodies" diskette . . . . . \$49
- Shipping and Handling . . . . . \$ \_\_\_\_\_
- CA residents add applicable sales tax . . . . . \$ \_\_\_\_\_
- TOTAL . . . . . \$ \_\_\_\_\_
- Shipping and Handling**
- U.S., Canada, Mexico . . . . . \$ 5.00
- Elsewhere . . . . . \$15.00

I enclose  Check  Money Order

Credit card information  MC  VISA

Number: \_\_\_\_\_

Expiration: \_\_\_\_\_

Signature: \_\_\_\_\_

Name: \_\_\_\_\_

Street Address: \_\_\_\_\_

City/State/Zip: \_\_\_\_\_

Phone: \_\_\_\_\_

NOT COPY PROTECTED, 60-DAY MONEY-BACK GUARANTEE  
ON-LINE USER-SUPPORT CONFERENCE ON BYTE'S BIX™

Smalltalk/V requires DOS and 512K RAM on IBM PCs (including AT) or "compatibles," and a CGA, EGA, Toshiba T3100, Hercules, or AT&T 6300 graphic controller. A Microsoft or compatible mouse is recommended.



5200 West Century Boulevard  
Los Angeles, CA 90045 (213) 645-1082



employer. Although the cost is high, it includes all a participant's on-line time for the life of the course. WBSI will even provide you with the computer setup of your choice if you don't already own one. To make class participation easier, WBSI has developed its own communications software specifically designed around the EIES system.

In a review of the nation's leading business management schools, done by the *Harvard Business Review*, SMSS placed in the top five. The review claimed that other management programs should

take a close look at SMSS and follow the program, both in "form and content."

**On-line Advantage**

On-line education holds a decided advantage over traditional on-campus education for several segments of the population. The disabled community benefits from the built-in ambiguity of the medium; when participating in an on-line class, it doesn't matter how long it takes to answer a question or type at a keyboard. Such a class meets on the disabled person's own timetable. Professionals who have little time

to attend evening classes but seek to upgrade their education can dictate the time and place as well as learn from an acknowledged expert in the field.

But how credible is this type of education? While opinions differ (see the text box "Face-to-Face or Not to Face" on page 186), tests show that a higher degree of achievement and retention from distance learning courses is possible.

Is on-line education for everyone? AOU's Deutschman sums it up this way, "If a person asked me whether he or she should enroll as an on-campus student or go on-line, I wouldn't hesitate to recommend the on-campus environment. The people we are interested in addressing are those whose schedules, locations, or physical handicaps make it impossible to obtain a conventional college education."

While it is unlikely that this quiet revolution will replace its traditional counterpart, one thing is certain: Computer conferencing will have a penetrating effect on the established system and force it to take a closer look at the goals, methods, and purposes of on-line education. ■

**BIBLIOGRAPHY**

Hiltz, Starr Roxanne, and Murray Turoff. *Tools for the Enhancement and Evaluation of a Virtual Classroom*. Proposal for a joint study between IBM and NJIT.  
 Turoff, Murray, and Starr Roxanne Hiltz. *Remote Learning: Technologies and Opportunities*. Invited paper for the World Conference on Continuing Engineering Education, May 7-9, Lake Buena Vista, Florida.

**FOR FURTHER INFORMATION**

**American Open University**  
 New York Institute of Technology  
 Central Islip, NY 11722  
 (516) 348-3300, New York residents only  
 (800) 222-6948, all others

**Connected Education Inc.**  
 92 Van Cortlandt Park S, #6F  
 Bronx, NY 10463  
 (212) 548-0435

**Electronic University Network**  
 TeleLearning Systems Inc.  
 505 Beach St.  
 San Francisco, CA 94133  
 (800) 225-3276

**Western Behavioral Sciences Institute**  
 School of Management and Strategic Studies  
 1150 Silverado St.  
 P.O. Box 2029  
 La Jolla, CA 92038-2029  
 (619) 459-3811

**New from Lifeboat:**



**ADVANTAGE C++**  
**Brings the power of C++ to your PC.**

- Opens the door to object-oriented programming
- Allows programs with greater resilience, fewer bugs
- Fully compatible with existing C programs
- All the benefits of C without its limitations

**ADVANTAGE Link**  
**Everything you've always wanted in a PC-DOS linker.**

- The fastest, most powerful PC-DOS linker available
- The first linker to take full advantage of extended memory
- Accepts Microsoft and Phoenix command files
- Supports up to 53 commands—more than any other linker
- Compatible with Microsoft CodeView

**ADVANTAGE LIBRARY SERIES**  
**TimeSlicer**  
**Multi-tasking library streamlines C programming.**

- Perform concurrent tasks and real-time event processing
- Includes header files for both C and assembly language and example programs with source code
- Compatible with C++ and object-oriented programming
- Critical resource management assured

To order or to obtain complete specification sheets, call:  
**1-800-847-7078 In NY: 914-332-1875**  
 55 South Broadway  
 Tarrytown, NY 10591

**LIFEBOAT**  
**LIFEBOAT**  
 The Full-Service Source for Programming Software.



**It used to take up to \$15,000  
and a video technician to  
project real-time PC images.  
Now anybody can do it  
in five minutes for \$1270.\***

1.  
Plug the unit into your PC.
2.  
Place it on your overhead projector.
3.  
Begin your real-time presentation.

### **New KODAK DATASHOW System**

Just think of all the applications.

Call for details:

**1 800 44KODAK, Ext 865**

(1 800 445-6325, Ext 865)

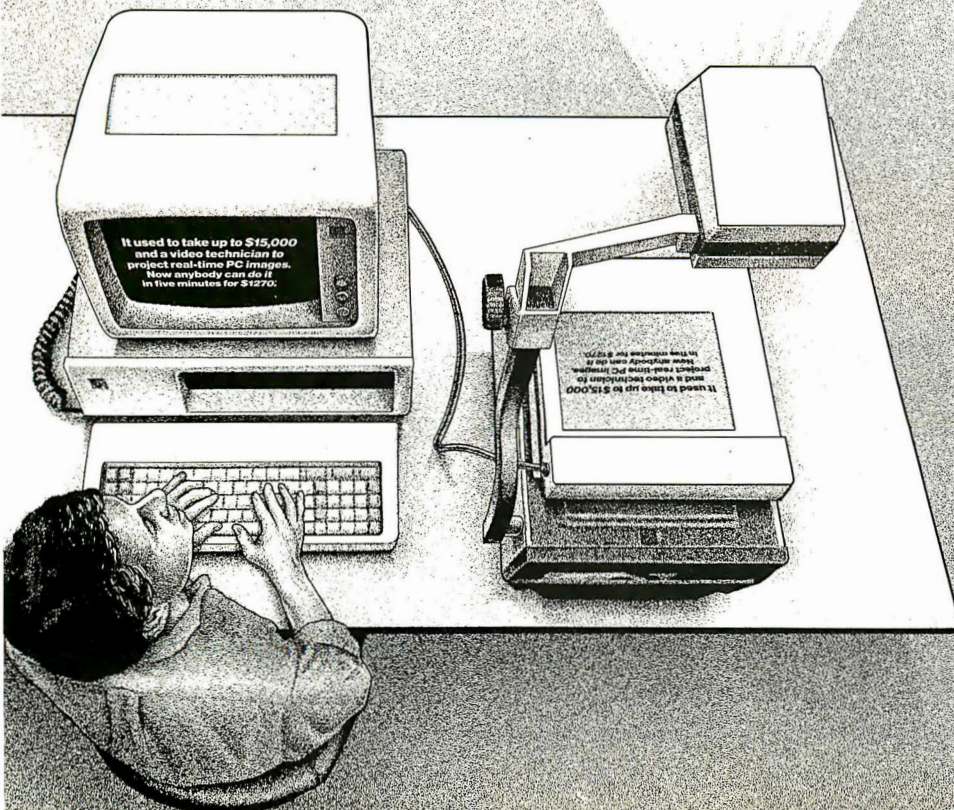

The DATASHOW System is used with an IBM PC or 100% compatible computer.

\*Price shown is Kodak's suggested price only. Actual selling price is determined by dealer.



Eastman Kodak Company  
Motion Picture and  
Audiovisual Products Division



# The new angle in plotters.

- 4-model lineup of A/B (ANSI), A4/A3 (ISO) format plotters to meet your specific requirements.
  - Flat-bed configuration with high-resolution graphic drawing capability.
    - Designed for space-saving 60° tilt angle installation.
  - Total reliability from the plotter specialists—Roland DG.

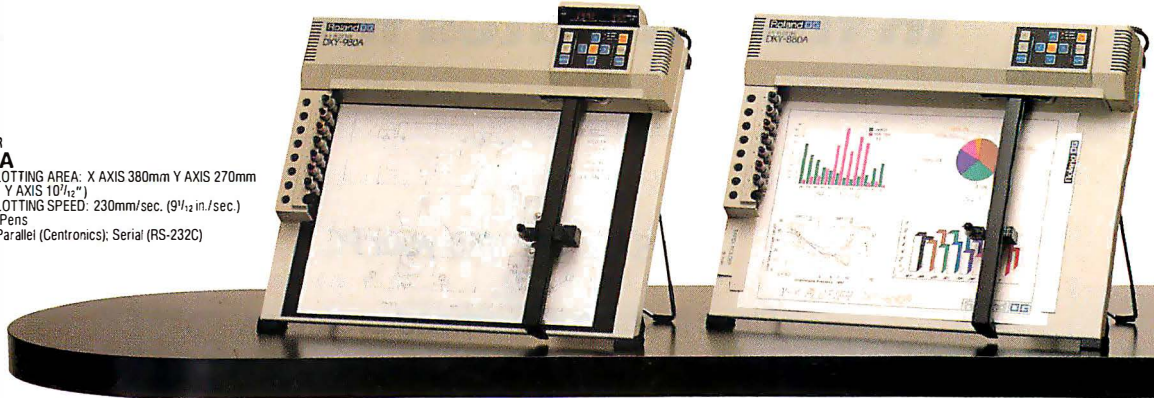

XY PLOTTER  
**DXY-980A**

- MAXIMUM PLOTTING AREA: X AXIS 380mm Y AXIS 270mm (X AXIS 14<sup>7</sup>/<sub>16</sub>" Y AXIS 10<sup>7</sup>/<sub>16</sub>" )
- MAXIMUM PLOTTING SPEED: 230mm/sec. (9<sup>1</sup>/<sub>16</sub> in./sec.)
- PEN USED: 8 Pens
- INTERFACE: Parallel (Centronics); Serial (RS-232C)

XY PLOTTER  
**DXY-880A**

- MAXIMUM PLOTTING AREA: X AXIS 380mm Y AXIS 270mm (X AXIS 14<sup>7</sup>/<sub>16</sub>" Y AXIS 10<sup>7</sup>/<sub>16</sub>" )
- MAXIMUM PLOTTING SPEED: 200mm/sec. (7<sup>11</sup>/<sub>16</sub> in./sec.)
- PEN USED: 8 Pens
- INTERFACE: Parallel (Centronics); Serial (RS-232C)

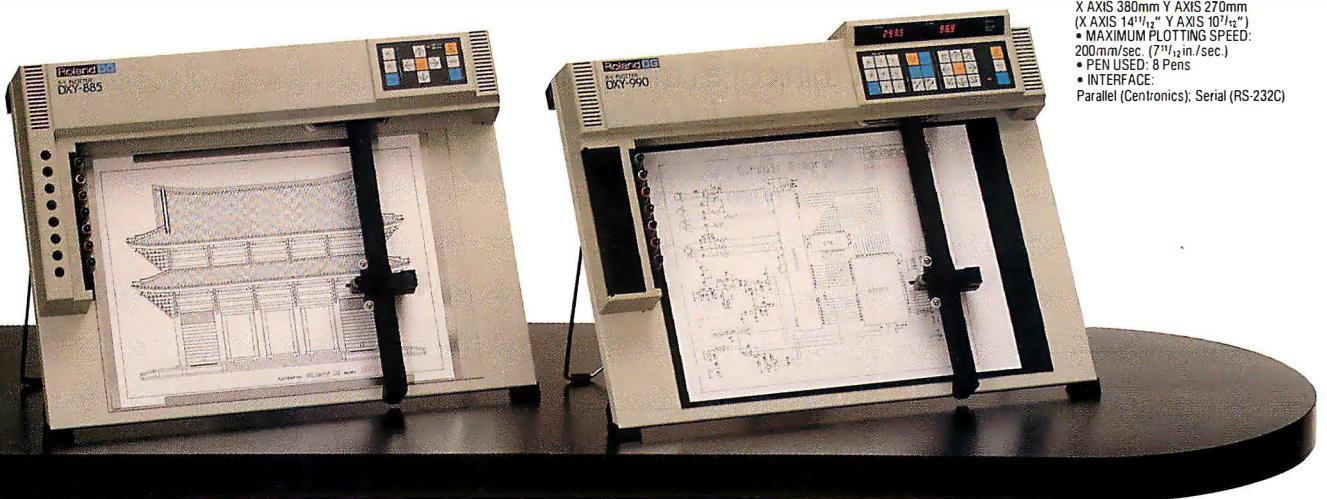

XY PLOTTER  
**DXY-885**

- MAXIMUM PLOTTING AREA: X AXIS 416mm Y AXIS 276mm (X AXIS 16<sup>3</sup>/<sub>16</sub>" Y AXIS 10<sup>7</sup>/<sub>16</sub>" )
- MAXIMUM PLOTTING SPEED: 300mm/sec. (11<sup>5</sup>/<sub>16</sub> in./sec.)
- PEN USED: 8 Pens
- INTERFACE: Parallel (Centronics); Serial (RS-232C)

XY PLOTTER  
**DXY-990**

- MAXIMUM PLOTTING AREA: X AXIS 416mm Y AXIS 276mm (X AXIS 16<sup>3</sup>/<sub>16</sub>" Y AXIS 10<sup>7</sup>/<sub>16</sub>" )
- MAXIMUM PLOTTING SPEED: 300mm/sec. (11<sup>5</sup>/<sub>16</sub> in./sec.)
- PEN USED: 8 Pens
- INTERFACE: Parallel (Centronics); Serial (RS-232C)

# Roland DG

## ROLAND DG CORPORATION

1006-14 Takaoka-cho, Hamamatsu-shi, Shizuoka-ken 433, Japan  
Phone: (0534) 36-8700 Fax: (0534) 37-8271 Telex: 4225070 AMDROL J

Inquiry 248

### INTERNATIONAL DISTRIBUTER

**U.S.A.**  
Roland Corp US  
Phone: (213) 685-5141 Telex: 0674489 RCUS LSA

**CANADA**  
Roland DG Canada Inc.  
Phone: (604) 273-4453 Telex: 4357819 ROL/AMD VCR

**AUSTRALIA**  
Roland Corporation Australia Pty. Ltd.  
Phone: (02) 982 8266 Telex: 27769 ROLAUS AA

**EUROPE**  
Roland DG Europe N.V.  
Phone: (014) 58 45 35 Telex: 71046 R0BNLB

**ENGLAND**  
Roland (U.K.) Ltd.  
Phone: (01) 568 4578 Telex: 934470 ROLAND G

**SCANDINAVIA**  
Roland Scandinavia A/S  
Phone: (01) 32 47 22 Telex: 19720 ROLAND DK

**NEW ZEALAND**  
Roland Corporation (NZ) LTD  
Phone: (09) 398-715 Fax: (09) 391-065

■ If the above doesn't cover your inquiries, please contact Roland DG Corporation, Japan.



# A Hard Look at Educational Software

*In the rush to equip schools with computers,  
we risk ignoring some important issues*

---

Adeline Naiman

WELL OVER A MILLION and a half microcomputers are in use today in public and private elementary and secondary schools in the U.S. Within five years, the student-to-microcomputer ratio is expected to be 14 to 1. The implications for instructional change are profound.

## A Brief History

In 1977 we entered the mass computer age, though few in education seem to have noticed. Those who did notice were teachers of science, math, computer science, and technical education who already liked hardware. They recognized that the microcomputer's educational possibilities were revolutionary.

By 1980 school principals were wondering how to procure the funds for computers, which ones they should invest in, and where to place them strategically for the benefit of all.

By 1983 these administrators were using microcomputers for their own management tasks: updating student records, planning bus routes, paying teacher salaries, keeping attendance, maintaining inventories, and making announcements. Also, surveys showed that nearly every student in America had access to a computer for instructional use.

Now almost everyone uses a word processor. Teachers plan new curricula to take advantage of word processors, spreadsheets, databases, and file managers.

## How Far We've Come

It is indeed good news that acceptance of computers and enthusiasm for using them

in instruction have grown so fast. Schools are institutionalizing and consolidating their purchases. Those that have multiple computers are learning where to station them for maximum effect. Many educational systems have assigned someone to act as computer coordinator. These individuals serve as trainers and troubleshooters within the system and know whom to contact for outside help. They have formed regional networks for mutual support and quick exchange of ideas, resources, and teaching practices. Even maintenance and repair are being systematized so as to be more easily and quickly available and less costly.

## Where We Have Yet to Go

Several issues need to be dealt with before the widespread use of computers in the classroom is fully efficient.

First, the state of the art in education hardly reflects the technological advances available. The industry simply doesn't remain static long enough for schools to catch on. Moreover, schools remain conservative about investing in expensive hardware. Once having bought computers, they expect them to last forever. Schools write bidding specifications, entertain proposals, buy all the same machines (often on the basis of lowest price, not the most appropriate functions), contract for maintenance as part of the deal, bolt the computers down to prevent theft, lock on the covers (which makes adding boards very difficult), and only then think about how they're going to use the investment. They've often left no money for software

or teacher training, let alone upgrades or replacements.

Second, teacher training lags far behind need. Rarely is it adequate or sustained, nor do all schools have support systems in place. In-service training is usually too little. Where teachers have been told they must use computers, they are often too resentful or intimidated to make much headway without lots of help.

Third, budgets for software are woefully inadequate, so computers find limited applications. Teachers, even when told not to, often copy software illegally, so as to have enough for classroom use. Swapping is common but doesn't necessarily match the teachers' needs or preferences. Some districts have elaborate sharing systems or centralized software libraries. A few use networking within the district or school.

Fourth, computer-based instruction is still viewed as a squashed-in addendum to the ongoing syllabus. There is a need for a whole revamping of the curriculum in many subject areas so as to take advantage of what the computer can offer.

Fifth, there are still not enough computers in schools to provide more than a lab to which teachers can bring their students. Only experimental classrooms show a computer for every child or small group in the room. Moreover, inequity is rife. Computers are bunched in wealthy

*continued*

---

*Adeline Naiman is director of software for HRM Software. She can be reached at 1696 Massachusetts Ave., Cambridge, MA 02138.*



suburbs or in large cities with sizable appropriations for computer-based instruction. Small towns and rural districts, as well as low-income cities, lag behind, except where a state has promoted and supported a computer initiative. More boys than girls are encouraged to take up computer use, except in the lower grades. Minorities are inadequately represented in advanced computer science courses.

Sixth, software is still driven by what most educational publishers have reluctantly had to buy or develop to supplement their textbooks to meet adoption re-

quirements. These multimillion-dollar businesses control the market and determine what children learn. Being businesses, they cannot afford to take risks, so few of them publish innovative educational software.

So what have schools been using on the reported figure of 1.6 million computers in the schools? More precisely, what and how have they been teaching with them?

**Help Wanted**

In the initial onslaught of the software shortage, a few aficionados wrote their

own instructional software. A teacher who could see how to make a computer do something more easily might design a simple program for local use or might collaborate with a programmer or engineer friend. If a colleague wanted to try out the product, so much the better. A few small publishers polished such programs up and offered them inexpensively. Sometimes the programs were full of bugs. Generally, they looked primitive. A great many single-concept science programs began this way.

Other programmers took the educational software and ideas that had already been developed for timesharing systems and rewrote them for micros. Very few of these early programs offered more than a textbook or a workbook, but they fit right into the curriculum and gave the computer something to do that didn't strain its powers.

After a while, complaints began to emerge about the rough quality of the available educational software. As computers gained more memory capacity, authors began to write more polished programs. Many of these were so formulaic that authoring systems were published that allowed teachers to develop their own drills or branching multiple-choice programs. Even when such programs are professionally prepared and are supplied with ornamental graphics and sound, they are what teachers and students have come to describe as dull, at best.

Only when educational software began to look like a commercially worthwhile field did graphics designers, software engineers, and teachers come out of hiding. Conventions evolved about what an ideal program should look like and contain.

**Hands-off or Hands-on**

When "computer literacy" entered the curriculum, it focused on hardware, not software. It meant courses on "How the Computer Works," "Inside the Computer," "The Impact of Computers on Our Society," or "Our Friend, the Computer." Children were given paper-and-pencil tests on what they learned about computers. We all know youngsters who had to draw the CPU, memory banks, input, output, and keyboard. Step-by-step lesson plans were designed by curriculum developers. It is little wonder that many high schoolers now hate computer courses.

Apparently, however, educators thought that was the way to incorporate computer consciousness into the curriculum. But awareness is only a first step in literacy. People don't learn to drive a car by reading a manual.

Practice is the best teacher. We learn  
*continued*



**THE 375 - A SOFTWARE DEVELOPER'S DREAM**



**THE BEAUTY AND THE BSD**

**\$4,995\***

**OVER 1,000 PROGRAMS, 3,000 FILES !**

<p><b>Full 4.2BSD UNIX™</b></p> <p>Each 375 comes standard with a complete configurable 4.2BSD UNIX system. We don't skimp on software. And we can even give you EMACS, INGRES, TEX and SPICE for those special applications.</p> <p style="text-align: center; color: red;"><b>Loaded With Standard Features</b></p> <ul style="list-style-type: none"> <li>★ 50MB Winchester Disc Drive</li> <li>★ 1MB 5¼" Floppy</li> <li>★ 2MB RAM (8MB optional)</li> <li>★ Integral SCSI &amp; ST506 Interfaces</li> </ul>	<p><b>Loaded With Languages</b></p> <p>Turn on your 375 and start developing your own applications. It's that easy. C, FORTRAN, PASCAL, BASIC, APL, Assembler, LISP and PROLOG: they all come standard on every 375.</p> <ul style="list-style-type: none"> <li>★ 4 RS232 Ports (up to 36 optional!)</li> <li>★ Parallel Printer Port</li> <li>★ External Winchester and Floppy Ports</li> <li>★ Series 32000, 10MHz, VM, FPU</li> </ul>
--	--

Also Available: 10 Mb ETHERNET, up to 280MB disk memory, streaming tape, and more !

**A Portable Computer for the Serious User**

At last, a powerful, portable (22lbs) scientific computer for all your serious work. The 375 combines the advantages of a VAX™ with the size, versatility, and price of a micro. All the software tools are there. It's even small enough to leave on your desktop or take wherever you need it. **And it's available direct to you right now !**

**CALL US TODAY (408) 279-0700**

SYMMETRIC COMPUTER SYSTEMS - 1620 Oakland Rd. Suite D200 - San Jose, CA 95131

\* Prepaid. Sales tax and Shipping Costs not included.  
UNIX is a registered trademark of AT&T Bell Labs.  
VAX is a trademark of Digital Equipment Series 32000 is a trademark of National Semiconductor Corp.



## TAPE BACKUP

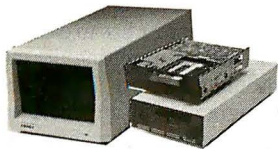

- External **\$879**
- Internal **\$794**
- 20MB Cassette Tape backup **\$699** **\$599**
- Backup 20MB in less than 5 minutes
- Image/file-by-file backup and restore
- Menu driven software
- Interchangeable DMA, port address and interrupt

## MODEM

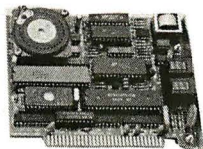

**\$128**  
**EVEREX**  
**EVERCOM**

- Comes with Bit-Com Software
- 1/2 size 300/1200 Baud Modem
- Fully Hayes, Bell 103 & 212 compatible
- Supports Com 1, 2, 3, & 4
- External 300, 1200 Baud **\$189**
- 1200/2400 Baud internal 1/2 size modem **\$289**
- Modem, multifunction card **\$289**

## HARD DISK

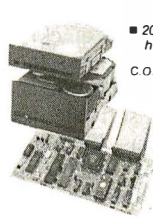

20 MB Seagate 1/2Ht. hard disk (with controller)  
C.O.D. vISA MC only **\$359**

Company Terms **\$429**

- 30MB seagate 1/2Ht. hard disk (65 Ms) with controller **\$499**
- 20MB Seagate full Ht. hard disk (40 Ms) **\$528**
- 30MB Seagate full Ht. hard disk (40 Ms) **\$628**
- 40MB Seagate full Ht. hard disk (40 Ms) **\$759**

## TURBO XT

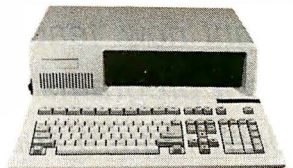

- 8088 CPU (4.77 and 8 MHz keyboard switchable) **\$659**
  - 8 Expansion slots
  - 640K Memory on Motherboard
  - 360K Drive with controller
  - 150 W power supply
  - Keytronic 5151-compatible keyboard
  - Socket for 8087 Math Co-processor
- FCC Class 'B'

## ACCELERATOR 80286 TURBO BOARD



- Runs with IBM PC, XT and compatibles **FCC Class 'B' Made in USA**
  - With the Turbo card, your PC will run 7 times faster than IBM, PC, XT or 33% faster than 6 MHz IBM AT
  - 16 bit 80286 design
  - Accepts optional 80287 Math Co-processor
- \$379**

## AT MULTIFUNCTION



- QIC multifunction AT (OK) **\$179**
- Hold up to 2 MB (64K or 256K) **Made in USA**
- 1 parallel, 2 serial and 1 game port
- Come with chip tester, RAM disk and spooler program **FCC Class 'B'**

## PC/XT MULTIFUNCTION



- Serial port
  - Software
  - Game port
  - Expandable to 384K
  - Clock/Calendar
  - Parallel port
- \$85**

**QIC RESEARCH INCORPORATED**

**QIC-286-QT**

**INCREDIBLE MACHINE**

**INCREDIBLE PRICE**

Thousands of systems installed proven reliable

Made in the U.S.A. **\$1075**

Quality is what we stand for.

Special dealer and corporate discount.

- Fully IBM AT compatible, runs all major software
- 80286 CPU, 6/8 MHz clock/calendar
- 512K RAM on mother board, expandable to 1024K
- 1.2MB or 360K floppy disk drive
- Combined floppy/hard disk controller
- AT style keyboard
- 192W power supply
- 8 Expansion slots
- Clock/calendar with battery backup
- Documentation and setup program
- FCC Class 'B' approved**

## EXPANSION CHASSIS



- Compatible with AT, XT and PC
  - 0 wait state, work with any video display card and multifunction card
  - 3 sizes
  - Power supply
  - Full size, 8 slots 130W
  - 1/2 size, 4 slots 75W
  - slimline, 3 long and 1 short slots 70W
- \$429**
- FCC Class 'B' Made in USA

## QIC MONOGRAPHIC



- 720 x 348 Resolution
  - Hercules compatible
  - Runs Lotus 123 Graphics
  - Printer Port
- \$95**

## QIC COLOR CARD



- IBM Color Card compatible
  - 16 colors, 640 x 200 resolution
  - RGB and composite output
  - Parallel Printer Port
- \$95**

## HD/FLOPPYCONTROLLER



- FCC Class 'B' Made in USA
- AT Version (16 bit) **\$169**
- XT size format XT Version (8 bit) **\$149**
- Western Digital Chipset
- Control 2 hard disks and 2 floppy drives

## FLOPPY DRIVE



- Teac/Fujitsu/Toshiba 1.2 MB **\$135**
- 1/2 Ht. size
- High Reliability
- Low Power Consumption 360K **\$95**

## CHIPS



- 256K RAM (150 ns) **\$27**
- 64K RAM (150 ns) **\$9**

## KEYBOARD

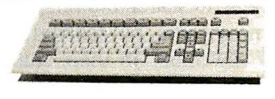

- Keytronic 5151 style keyboard
- IBM PC/XT, AT compatible **\$88**
- 95 keys keyboard • LED lights

## QIC EGA



- IBM EGA compatible
  - 640 x 350, 16 colors
  - 720 x 348 mono
  - 640 x 200 color
- \$249**

## EMS BOARD



- Expandable up 2MB
  - Compatible with IBM, PC/XT
  - Fully socketed with parity check
  - Lotus/Intel/Microsoft compatible
- \$139**

## MONO & I/O CARD



- Hercules compatible graphics
  - Monochrome high resolution 720 x 348
  - Parallel printer port
  - Game port
  - Serial communication port
- \$139**

## POWER SUPPLY



- PC, XT compatible 135W **\$79**
- 4 Power leads for drives 150W **\$89**
- Reliable

**QIC RESEARCH INCORPORATED**  
753 Ames Ave.  
Milpitas CA 95035

800-843-0806 (Sales)  
(408) 942-8086 (CA)  
Tech support (408) 942-0856  
Dealer and Quantity discount are available

QIC Research of Chicago  
1926 Waukegan Rd., Suite 3A  
Glenview IL 60025  
(312) 998-8903

Seagate, Tandon, Hercules, Hayes, Bell, IBM are trademarks of their respective companies

**Policy:**  
Returned items must be as-new, not modified or damaged, with all warranty cards, manuals and packaging intact. Returned items must be shipped prepaid and insured, and must bear a QIC return Authorization (RA) on the shipping label. Call QIC Customer Support Department for RA. No credit issued after 30 days from date of shipment



*Right now, teachers want programs that don't require substantial changes in the way they teach.*

early that the best way to master a new skill is to have someone show you how to do it and then go off by yourself and plug away until you've got it. (As for motivation and persistence, watch the kids in the video arcades.)

Once teachers began using computers to teach actual subjects, they quickly realized that students loved doing things on the computer, even tedious drills on arithmetic or spelling. In the teachernet, the word got out that the computer was a big motivator, even for the previously unteachable. Of course, a big part of that motivation may have been getting away from the syllabus and letting the students push the keys for themselves.

### Software Developers Join Up

While much of the early software did not move far from conventional teaching, its success moved developers to test their creative powers. In this, they were helped by the expanding base of computers in schools and the growing confidence and discernment of teachers.

A whole cadre of elementary teachers, especially those who read *Mindstorms: Children, Computers, & Powerful Ideas* by MIT's Seymour Papert (New York: Basic Books, 1982, softcover), fell in love with Logo. In some school districts, all primary classes featured Logo programming. There were even a couple of Logo schools. Research did not show significant learning gains, but teachers reported that they saw these in their students.

### A Second Generation Emerges

Gradually, a second generation of software made its way among the by-now standardized drills. It was designed, often by a team of educators and programmers and graphic artists, to take advantage of the rapid development of professional programmers' tricks and utilities. It brought techniques down from the mainframe and the military. It learned from the insidious addiction of the arcade game and made for snazzier programs.

Much of this gussying up of the old electronic workbook took place because publishers were suddenly enchanted by a newly envisioned home market. Even the textbook publishers who had resisted the

new medium hopped on board. They learned quickly from one another and from successful independent developers what software should look like. Commercial software has established its own formulas. Elementary programs look much alike, whether they deal with alphabets, syllables, words, or sentences, or with counting, addition, simple subtraction, or easy multiplication. They resemble one another ("Sesame Street" and "The Electric Company"). All educational software programs are currently designed to conform to educational precepts about how children are known to learn and what they should be taught. While they may seem dull to adults, as any parent knows, children's books written to formula and word list can hold children rapt through countless repetitions.

### Starting Early

Where such second-generation programs have made a difference is in preschool. Between television and computer, it would be hard for a toddler to avoid letters and numbers. Kindergarten now has a curriculum, complete with goals and objectives.

But when you start using Logo in kindergarten, what do you do in first grade? More important, what do you do in the fifth grade after five years of turtle geometry and sprites? Logo is a powerful language, designed originally for artificial intelligence purposes, but few teachers take it beyond its openers. Only a few schools keep it going beyond the early grades, so the possibilities for learning to write substantial programs, plan ahead, and debug routines are interrupted. (One Massachusetts system has pulled Logo from its elementary schools and requires it for all middle school students.) Then, when students get into high school, the programming language they learn is BASIC or Pascal.

A hopeful sign is that districts are beginning to spend staff time and budget dollars on creating computer plans for the long haul. This means that they are likely to introduce some continuity in their computer-based programs and a better integration of computing in the K-12 curriculum.

### Closing the Gap

For older children, the second-generation software offers ingenious construction sets, problem-solving challenges, a raft of simulations, real-time lab science, and other substantial tools for learning. Some of this is stand-alone software, not tied to an existing syllabus or textbook. It is meant to be used as "enrichment" rather than as a substitute for some portion of traditional instruction. It seems that as the

computer finds its own voice, the software that best uses the computer has to ease into the classroom without upsetting the curriculum or unsettling teachers. As teachers get used to programs that are more interesting and that teach better than conventional instructional media, they should begin to teach in different ways.

But right now, teachers want programs that don't require substantial changes in the way they teach. They feel they know how to teach their subjects. They spend their days running the classroom, their nights correcting papers or preparing lesson plans, and their summers working in special programs. Even if revising the curriculum appeals to them, they understandably lack time and energy to tackle such massive change. Nor can schools assign dollars and staff to reexamine their whole curriculum or retrain teachers so as to take full advantage of the new opportunities the computer affords.

So a tension has come to exist between the desire to expand the new technology and the realities, economic and social, of teachers and schools. That tension creates a void in redesigning education. In our free-enterprise economy, you can count on someone leaping to fill any dollar-fringed void. In the computer arena, the leaper is the publishing establishment.

### How the Publishers Respond

The leading textbook publishers did not start out wildly enthusiastic about the prospect of publishing software. The reasons are many.

First, their marketing system is already in place and serves a different product well. The salesperson does not need to carry hardware or be sure a working demo computer is available, learn how to use the software and anticipate problems, answer technical questions, and show the teacher how this program fits into the existing subject syllabus. In other words, the seller does not have to educate the buyer.

Second, teachers know how to select textbooks, but criteria for selecting educational software vary. Different arbiters proclaim different standards. Some evaluation guidelines favor teacher-proof automatic programs. Others want open-ended programs that allow the teachers, or even the student, to determine what is taught. Between these two poles is a range of "political" and pedagogical values, and alongside those run the technical criteria that many teachers and school software purchasers don't yet feel qualified to judge.

Third, teachers know how to teach from a textbook. They may follow it exactly or use it as a stimulus and reference for their own teaching plan. Students know how to

*continued*



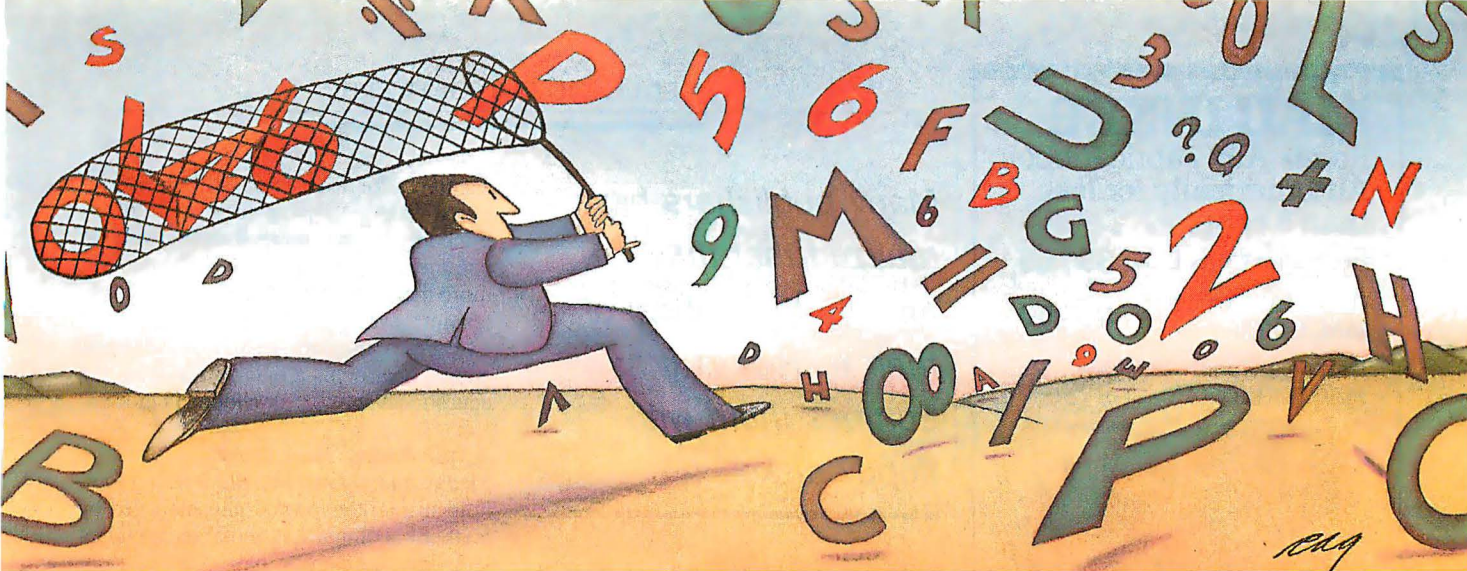

**PROBLEM:** The more experience your hard disk has, the harder it has to work.

**THE SOFTLOGIC SOLUTION:** Disk Optimizer™

**NOW FASTER,  
MORE POWERFUL  
AND NOT COPY  
PROTECTED!**

**Your hard disk will run faster when it's not chasing around after files.**

Remember the old days when your hard drive was new? Remember that smooth, fast, slick performance? Those quick retrievals, rapid saves, lightning-like database sorts?

Well ever since, DOS has been doing its best to slow your hard drive down. Not by slowing down the motor, but by breaking your files up into pieces. Storing different chunks in different places. Data files, programs, overlays and batches that started out in one seamless piece are now scattered all over.

Loading is slower.

Sorting is slower.

Retrieving, backing-up.

Everything takes longer because your disk has to work harder.

Problem is, it's something that happens so gradually you may not notice the difference. At least, not until you see the dramatic improvement after using Disk Optimizer.

**File fragmentation—It's a problem you can see.**

Watch your hard drive the next time it reads or writes a file. Each "blip" of the LED means the drive-head is moving to another place on the disk—either to pick up or lay down another chunk of data.

And the truth is, head movement takes time. Far more time than actual reading and writing. What's worse, all this head movement causes extra wear and tear that can shorten the life of your drive.

**Disk Optimizer—Tunes up your disk by cleaning up your files.**

Disk Optimizer works by finding all the scattered pieces of your files and putting them

back together where they belong. Next time your drive reads it, there's just one place to look.

And the results are often dramatic. Reading and writing times may be cut by as much as two thirds. Database sorts that used to take hundreds of head moves now proceed quickly and efficiently. And since head movement is now at an absolute minimum, your disk drive will lead a longer, more productive life.

**Analyze, scrutinize, optimize.**

Before you optimize, you'll probably want to analyze. So Disk Optimizer shows you, in percentages, how much

fragmentation has taken place—on the

entire disk, in individual directories, or for groups of files you specify using global or wildcard names.

Plus, there's built-in data security that lets you assign passwords to as many files or file groups as you want.

And the File Peeker gives you an inside look at the structure of files. It's a great way for non-programmers to learn more about computers, and a powerful tool for professionals who want to analyze the contents of their disks.

**Get your hard disk back in shape—with new improved Version 2.0**

Hard to believe, but new Disk Optimizer Version 2.0 is

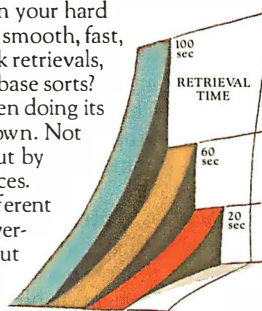

The more fragmented your files get, the longer they take to retrieve.

**Disk Optimizer \$59.95\***

YES! I want to put the zip back in my hard disk. Send me \_\_\_\_\_ copies of Disk Optimizer right away.

Name \_\_\_\_\_

Company \_\_\_\_\_

Address \_\_\_\_\_

City \_\_\_\_\_ State/Zip \_\_\_\_\_

Check Enclosed  VISA  MC  AMEX

Card # \_\_\_\_\_ Exp. Date \_\_\_\_\_

Signature \_\_\_\_\_

SoftLogic Solutions, Inc.  
530 Chestnut Street  
Manchester, NH 03101  
800-272-9900  
(603-627-9900 in NH)

**SOFTLOGIC  
SOLUTIONS**

**Call today: 800-272-9900**

\*plus \$5.00 shipping and handling.



# MAC INKER™

Re-ink Any Fabric Ribbon  
Automatically for less  
than 5 cents.

Dedicated Units Start at **\$54.95**

Universal Cartridge  
MAC INKER **\$68.50**

Universal Spool  
MAC INKER **\$66.95**

shipping \$3.00

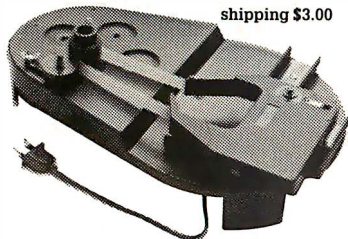

Lubricated, Dot Matrix Ink \$3.00, bottle available in black/brown/red/green/yellow/purple/orange/gold and silver.

Over 50,000 MAC INKER(s) in the field.

Over 7500 printers supported.

## MERCURY MODEM

Really 100% Hayes\* Compatible.

- 300/1200 baud.
- audio monitor/front panel lights.
- 18 months warranty.

Shipping \$4.00

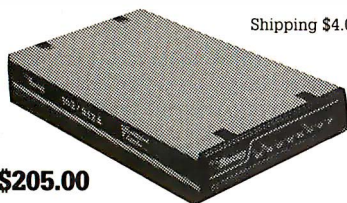

**\$205.00**

\*Hayes is a trademark of Hayes Microproducts.

## DATA SWITCHES

All types, all lines switched, all metal, heavy duty switch, elegant design, best value for money.

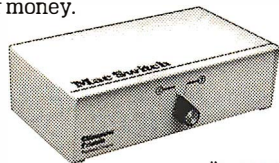

2 Ports Parallel or Serial **\$ 7500**

4 Ports Parallel or Serial **\$15000**

2 Computers/2 Printers  
Parallel or Serial **\$15000**

We have cables too. Please inquire or specify at time of order.

Order Toll Free.

Call or write for free brochure.

**1-800-547-3303**

In Oregon 503-626-2291 (24 hours line)

# Computer Friends®

14250 NW Science Park Dr., Portland, OR 97229,  
telex 4949559

Dealer inquiries welcome.

*Many publishers have realized that they amplify the appeal of their textbooks if they buttress them with floppy disks.*

learn from (or bypass) a textbook. Textbooks are a firm medium; software simply is not.

Fourth, good software is expensive to make, is rarely produced on schedule, is never completely debugged before it goes to market, and represents an investment risk. Stand-alone programs are particularly risky, since it is unlikely that teachers will forgo part of their required teaching to make room for a program that doesn't teach the same unit of subject matter better and more efficiently. Add-ons require reshuffling of time slots in the class periods, enough available computers so that students can tackle the same topic within a brief time range, and faith in the product. Monitoring student performance and meeting test requirements are much harder to accomplish with nontraditional material.

So why have publishers bothered to entangle themselves in a web they never made? There are several answers. A few publishers have become enthusiastic about the medium and its teaching potential. Others have been dragged kicking and screaming into the fray as school boards and central administrations increasingly require a computer component for all textbook adoptions. Many publishers have realized that they amplify the appeal of their textbooks if they buttress them with floppy disks.

Keeping the textbook at the core, then, is how publishers have chosen to respond to the challenge. Following the successful textbook-development model, they employ editorial and design teams that work with consultant teachers to produce modest computer programs integrated into their textbooks or series. The software tends to be of the drill-and-practice kind, with some tutorials and occasionally a simulation or a game. More recently, publishers have seen the advantage of incorporating student-management utilities to drum up teacher support.

Yet, except where a federal agency has provided seed money to spur innovative software development for publishers to pick up on, few programs even begin to use the power of the computer. Moreover,

standards for what is possible in educational program design seem to be determined by the latest introduction from the commercial hardware manufacturers—more memory, faster speed, better graphics, improved sound output, more attractive appearance or type. It is clear that educational goals alone do not drive the educational-software development process.

### Applications Take Hold

Meanwhile, unable to build a strong foothold in markets owned and managed by textbook companies, most independent software companies have gone out of business, or at least out of education. Left in the arena are the handful of independent publishers who did not lose their shirts in the home-market fiasco, who have a good track record among educators, and who can weather the seasonal cash flow associated with selling to schools. Many of their products are the most interesting around. Increasingly, the larger textbook companies are adopting ideas and models these small spearhead companies have pioneered.

There is also now a prevalent belief that school software is not only a worthy market by itself but also will be what the next wave of home software buyers will want for their kids. So investors are creeping into the educational software field. This will undoubtedly affect the design of programs intended for both school and home.

### A Third Generation Is Born

What may forge the link is a third generation of educational software that could not have been predicted half a decade ago. This is the adaptation of business utilities to serve educational purposes. The way personal computers got into many homes and small businesses was as word processors. As the computer came home from the office, spreadsheets took hold, databases solved limited recall, and other such improved efficiency beckoned.

No wonder these commercial boons became incorporated into classroom applications. Academic tools took on the style and ingenuity of office tools. Word processing looks to be the biggest change in the teaching of writing, not to mention spelling, grammar, punctuation, reading, and the whole gamut of language arts.

Database programs now come with templates in social studies up and down the grade levels. Spreadsheets are being applied to the teaching of mathematics. Fast graphing routines have revitalized algebra, and computer graphics support both Euclid and transformational geometry. Lab science can be done the way scientists do it—by recording, analyzing, and

*continued*



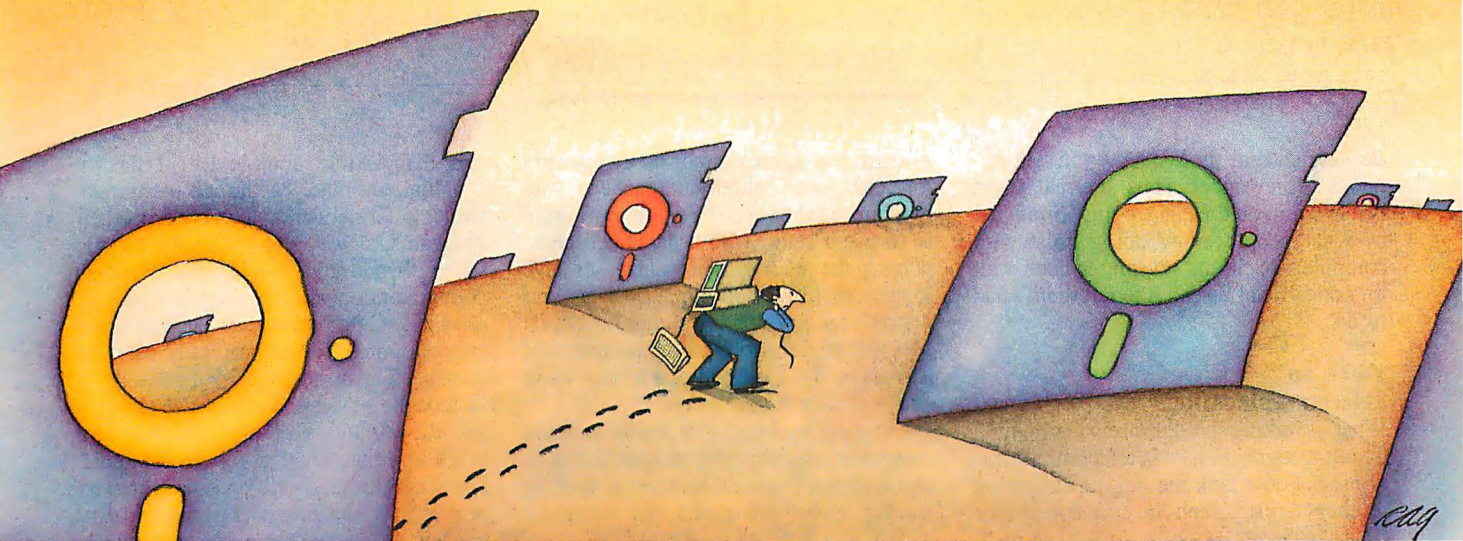

# PROBLEM: There's just no easy way to move from one software program to another.

**NOW FASTER,  
AND NOT COPY  
PROTECTED!**

## THE SOFTLOGIC SOLUTION: Software Carousel

**Now you can keep up to 10 programs loaded and ready to run.**

Hard to believe, but some people are happy with just one kind of PC software. Well, this is not a product for them.

But if you're someone who depends on many packages, all the time—someone who'd use several programs at once if you could, well now you can. With Software Carousel.

### Why call it "Software Carousel"?

In some ways, Software Carousel works like the slide projector you're used to. You load a handful of pictures, view one at a time, then quickly switch to another. A simple idea, with powerful possibilities for computing.

Here's how it works. When you start Software Carousel, just tell it how much memory you have, load your software and go to work.

Need to crunch numbers? Switch to your spreadsheet. Need your word processor? Don't bother saving your spreadsheet file. Just whip over to your document and do your work. Snap back to your spreadsheet, and it's just like you left it.

With up to ten different programs at your fingertips, you'll have instant access to your database, communications, spelling checker, spreadsheet, word processor, RAM resident utilities, languages, anything you like.

### Reach deep into expanded memory.

This could be the best reason ever for owning an expanded memory card, like the Intel Above Board, ASTRAMpage, or any

card compatible with the L/1/M Extended Memory Standard.

Software Carousel puts programs into this "high-end" memory for temporary storage when they're not in use. And

switches them back out when you want them. It's fast, efficient, and easy.

If you want, Software Carousel will even use your hard drive for swapping. Just allocate a portion for storage, and go to work.

### Sidekick, Superkey and Ready. All at the same time.

You know what happens if

you try loading two or more RAM resident utilities at once. You get crashed keyboards, frozen screens, all kinds of interference between programs fighting for control.

With Software Carousel, you can have as many accessories and utilities on-tap as you want. Just load different ones in different Carousel partitions. Since they can't see each other, they can't fight.

### The easy way to maximize PC power.

With all this power, you might think Software Carousel is complicated and difficult to use. Not so. Particularly when you compare it to other programs

like Windows and TopView.

Set it up once and Software Carousel remembers forever. Better still, Carousel will often look for the programs you use most and optimize them for the quickest access.

And when you use Software Carousel with our newest product, Shear Power, you'll have at your command the most powerful integrated software environment available on PC's today.

The way we see it, there are certain things you have a right to expect from your computer. Access to your software is one of them. At just \$59.95\* a copy, Software Carousel is the best way to get it.

See Software Carousel at better computer dealers everywhere. Or order today by calling 800-272-9900 (603-627-9900 in NH), or mail the coupon below.

	4X	8X	12X	16X
Word Star	Green	Green		
1-2-3	Yellow	Yellow	Yellow	Yellow
BPI	Red	Red	Red	Red

With Software Carousel running in RAM, you can load a program and retrieve a file up to 15 times faster. Test conducted on an IBM XT

## Software Carousel \$59.95\*

YES! Send me \_\_\_\_\_ copies of Software Carousel at the special introductory price of just \$ 59.95\*

Name \_\_\_\_\_

Company \_\_\_\_\_

Address \_\_\_\_\_

City \_\_\_\_\_ State/Zip \_\_\_\_\_

Check Enclosed  VISA  MC  AMEX

Card # \_\_\_\_\_ Exp. Date \_\_\_\_\_

Signature \_\_\_\_\_

SoftLogic Solutions, Inc.  
530 Chestnut Street  
Manchester, NH 03101  
800-272-9900  
(603-627-9900 in NH)

**SOFTLOGIC  
SOLUTIONS**

**Call today: 800-272-9900**

\*plus \$5.00 shipping and handling.



displaying real-time data from experiments as they occur. Thus, the real world is moving in on the classroom, stimulated by what people enjoy doing most with computers. Schools no longer need wait for educational research to tell them what to do.

**Work on Telecommunicating**

What is taking hold more slowly than pundits prognosticated is telecommunications. Schools lack the habit of allowing teachers to use telephone connections for

instructional purposes, nor do they budget for classroom phones. Teachers find modems hard to use. They are more likely to use a setup with a dedicated computer in the media center—databases have long been library resources. States and districts are pushing telecommunications as a way of networking practitioners and resources. This is a top-down innovation and will take time.

Even networking, that much vaunted cost-saver, appeals more to administrators and computer specialists than it does to teachers, who now prefer the autonomy

and manageable complexity of the individual computer. Although many publishers offer networkable versions of their programs, as well as multipacks, they do so to discourage the inevitable illegal copying of copyrighted materials, as well as to cut school costs. Site licenses seem uneconomical for school publishers to manage. The disadvantages of networking include the suggestion of lockstep teaching and the exclusion of much of the most original educational software available. For example, science lab kits that require probes for recording data as experiments happen don't lend themselves to networking. Downloading conventional software may not yet justify the installation costs and cumbersome structure of networks.

**Special Education**

There is one area in which few teacher holdouts exist and in which the use of the computer for instruction is unquestioned, and that is special education. While little software has been created expressly for use with special-needs children, much of the existing software—including the most innovative—lends itself to use in remedial work, in individualized learning plans, and in one-on-one teaching of mainstreamed children working outside of class with a specialist. This phenomenon cannot begin to touch on the use of computer-controlled devices for children and young adults who are seriously impaired in motor capacity, hearing, sight, or speech. The miracles wrought by such devices, especially for those who have been unable to communicate without them, justify the cost of their development.

It is with those youngsters who could not succeed in learning through conventional means that the computer excels. It provides alternate routes to mastery of essential skills and to self-esteem. It also serves well the children classified under special needs as "gifted and talented." Until recently, the use of computers was greatest among the brightest kids and the learning impaired. For both groups, it has proved a godsend.

When we stop seeing the computer as a new and special introduction into the classroom, most of the doubts and anxieties that still hang on will have disappeared. We must yet help to break down gender barriers as young women move with greater confidence and in increasing numbers into computer-based courses and careers. Eventually, everybody will become computer literate just as we are now "telephone and automobile literate." We learn the fundamentals of our society quickly when they surround us from infancy. And by the time children born today begin school, computers will be a constant presence in their lives. ■

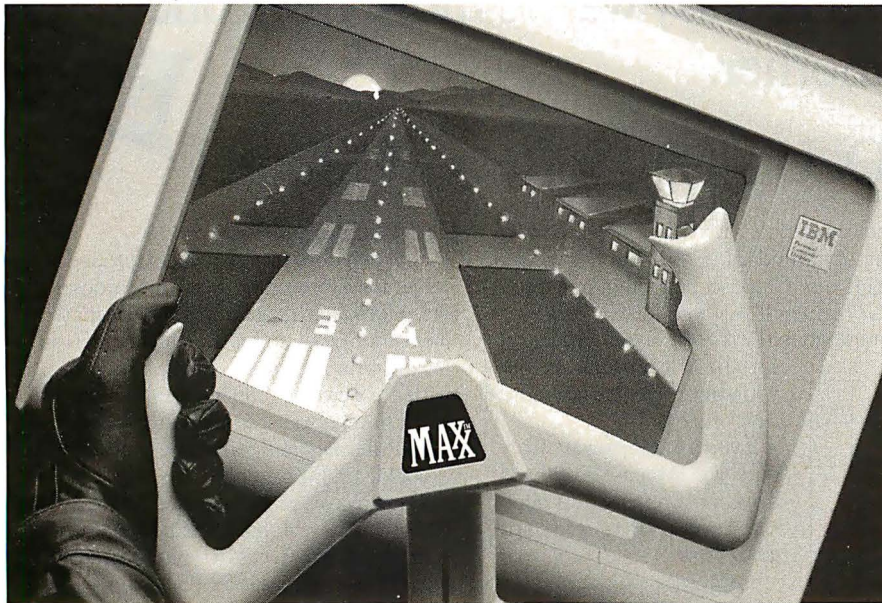

**Achieve the next dimension in computer excellence. Experience MAXX™**

Imagine sitting in the cockpit. Hands on the yoke. Diving. Spinning. You pull out. Bank to the left and slide across the screen. The control tower passes on the right.

Maxx™ lets you experience the thrill of flight. At home. Or in the office. Wherever you decide. Icon is pleased to announce

Maxx™. The fit in a series of Computer Interface Peripherals (CIPs). CIPs bring real-time cockpit simulation to the computer.



Maxx™ is positioned front & center and allows easy keyboard access.

**First, the keyboard.**

Whether your interest is in F-16 jets, Cessnas, auto racing, tank operations or



A control handle provides the "feel" of a real yoke.

space flight, Maxx™ excels.

Maxx™ is currently compatible with IBM's PC, XT and AT models through the fifteen-pin game port. And with Apple

Computer's IIc, IIe and II GS series through the nine-pin game port.

**Then, the mouse.**

Designed to the specifications of the traditional aircraft control yoke, Maxx™ looks, feels and performs realistically.

Strategically placed buttons are located atop each arm of the yoke. And a centrally located slide throttle controls airspeed.

Maxx™ is easy to use. Boot-up the selected software disk, calibrate Maxx™

to the system and experience desk-bound reality.

Maxx™ comes fully assembled, ready to use. A true plug-and-play Computer Interface Peripheral (CIP).

**And now, MAXX™.**

Flight maneuvers are a breeze with the "feather-touch" of Maxx™. Action buttons are strategically placed.

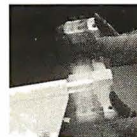

For more information, or to order, call 1-(206) 431-9082 or mail \$129.99 plus \$3.00 for shipping and handling to Icon Incorporated, 1611-116th Avenue NE, Bellevue, Washington 98004.



Copyright 1986, Icon Incorporated. Maxx™ is a trademark of Icon Incorporated. Apple is a trademark of Apple Incorporated. IBM is a trademark of IBM Incorporated.



# dBase, dPen.\*

When the ball point pen was introduced, it immediately became indispensable. Never again would you have to struggle with leaky, messy fountain pens. The same is true for database management software. From its inception, it has become a necessary part of the business mainstream. At least that's what anyone who's ever used one will say.

But, the most indispensable database of all is dBase,<sup>®</sup> outselling all other databases combined. And with good reason. dBase is more powerful, more flexible, has more features and is easier to use. And now it's easier to learn and more powerful than ever thanks to its newest version, dBase III PLUS. But that's not all.

In honor of the dBase's one millionth sale, and for a limited time, when you purchase dBase III PLUS from Logisoft we'll include another indispensable tool, the world famous Cross<sup>®</sup> pen. A free gift from Logisoft, the world's largest direct distributor of computer products. Logisoft offers version guarantees on all software, free overnight delivery, corporate volume discounts and custom leasing programs making us dStandard of the industry. In fact, some people think we're as indispensable as the products we sell. Or give away.

**\* With Every dBase III Plus,  
Get a Cross Writing Instrument  
FREE!  
Quantities Limited**



**The Largest Direct Distributor  
of Software and Hardware Products  
...in the World.**

**LOGISOFT<sup>®</sup>**

**1-800-645-3491**

NY STATE: 1-800-235-6442 (516) 249-8440

Customer Service: 1-800-431-9037 NYS: 516-249-8440

110 Bi-County Blvd., Farmingdale, NY 11735

Logisoft Europe BV: Baarsjesweg 224, Amsterdam Holland

EUROPE: 020-83-4864 FAX #516-249-5289

Logisoft is a Distributor for Over 250 Leading Manufacturers and Publishers of Computer Products Including: Ashton Tate • AST • Compaq • Epson • Hayes • IBM • Leading Edge • Lotus • Microsoft • Okidata • Seagate • Word Perfect



# Free on-site service and



## New IBM AT-30 Mb

- 8 MHz • 512K • 30 Mb IBM Hard Drive (Full Height, w/controller) • 1.2 Mb Half/Height Floppy • Eight Expansion Slots • IBM Enhanced PC Keyboard • Serial/Parallel Adapter • Free 90-day, On-Site Service Contract • Color or Monochrome Monitor Available as Option.

• Purchase Price: \$4,195

Lease For **\$165** per month



## New IBM XT 286-20 Mb

- 6 MHz • 80286 Based CPU • Zero Wait States • 640K • 1.2 Mb Half/Height Floppy • 20 Mb Full/Height Hard Drive • Serial/Parallel Adapter • Eight Expansion Slots-(5) 16-Bit, (3) 8-Bit • IBM PC Enhanced Keyboard • Free 90-Day, On-Site Contract • Color or Monochrome Monitor Available as Option.

• Purchase Price: \$3,199

Lease For **\$126** per month



## IBM XT-20 Mb

- 512K • 20 Mb IBM Full Height Hard Drive • 360K Floppy Drive Half/Height • Eight Expansion Slots • IBM Enhanced PC Keyboard • Asynchronous Communications Adapter • Free 90-day, On-Site Service Contract • Color or Monochrome Monitor Available as Option.

• Purchase Price: \$2,299

Lease For **\$98** per month



## AT&T 6300

- 640K RAM Memory • One 360K Floppy Drive • Seven Expansion Slots • AT&T Keyboard • High-Resolution Monochrome Graphics Card • High-Resolution Monochrome Graphics Monitor • Serial & Parallel Ports • GW Basic and MS. DOS. Free 90-Day, On-Site Service Contract. Color Monitor Optional.

• Purchase Price: \$1,699

Lease For **\$73** per month

### FREE ON-SITE SERVICE—

You receive 90 days of free service at your facility on any purchase or lease of a system. Over 96 authorized service centers to serve you throughout the U.S. with an average 4 hour response time.



### LOWEST PRICE

### COMMITMENT—

Because we are the largest direct distributor, our buying power allows us to offer the lowest possible prices on our wide range of products.



### FREE OVERNIGHT DELIVERY—

Buy it today, use it tomorrow on orders totaling over \$100. Due to certain restrictions, some bulk items and orders under \$100 are shipped UPS FREE (within Cont. U.S.).



## LOGICSOFT CUSTOMER SERVICES

### TOLL-FREE CUSTOMER SERVICE—

On-line computer system allows instant access to customer information. Call 1-800-431-9037.



### LOGICLEASE—

Allows affordable low monthly payments, helps eliminate equipment obsolescence, offers outstanding flexibility plus possible tax benefits. 24 hr. lease approval by phone (on orders over \$1000).



### SYSTEM CUSTOMIZATION—

Your system customized to your needs plus Free 48 hour configuration, testing and burn-in service so your system is ready to run upon delivery.



• No surcharge for MasterCard, VISA, American Express, C.O.D., money order, check or PO's (please call for price verification) • No sales tax on orders shipped outside N. Y. State • Please add 2% for insurance and handling (\$3.00 minimum) (int'l orders add'l) • We do not bill until we ship. All products covered by mfg's warranty. Defective merchandise may be returned for repair or exchange only. We do not guarantee compatibility. Any goods returned for credit are subject to a 10% restocking charge. All prices and policies subject to change without notice.



# and overnight delivery



## New Compaq Deskpro 286-40 Mb

• 16, 8 & 4 MHz Clock Speeds • 1 Mb Ram Memory • 80386 Based CPU • One 40 Mb Hard Drive (w/controller) • One 1.2 Mb Half/Height Floppy Drive • Three Expansion Slots • Compaq 101 Key Enhanced Keyboard • One Serial One Parallel • Color or Monochrome available as Option.  
**Purchase Price: \$5,349**

Lease For **\$203** per month



## Compaq Deskpro 286-30 Mb

• 640K RAM Memory • 80286 Based CPU • One 30 Mb Hard Drive (w/controller) • One 1.2 Mb Half/Height Floppy Drive • Seven Expansion Slots • Compaq Keyboard • Graphics Card • One Parallel Port • Free 90-Day, On-Site Service Contract • Color or Monochrome Available as Option.  
**Purchase Price: \$3,799**

Lease For **\$150** per month



## NEC APC IV W 40 Mb

• 80286 Based CPU • 640K RAM Memory • 6 + 8 MHz Clock Speed • 1.2 Mb Floppy Drive • 40 Mb Hard Drive • NEC MultiSync Monitor • EGA Display Card • 8 Expansion Slots • (2) Serial and (1) Parallel Port • 213 Watt Power Supply • MS DOS and GW Basic Included • 1 Year Warranty  
**Purchase Price: \$3,695**

Lease For **\$145** per month



## Enhanced Leading Edge Model D

• 512K RAM Memory • 1200B Internal Modem • Two 360K Half/Height Floppy Drives • Four Expansion Slots • Keyboard • Text Display Card • Monochrome Monitor • One Serial and Parallel Port • Software Bundle • Color Monitor Option Available.  
**Purchase Price: \$1,375**

Lease For **\$59** per month



## Blue Chip/ by Hyundai IBM PC/XT Compatible

• 512K Ram Memory • 4.77 MHz • One 360K Half/Height Floppy Drive • Six Expansion Slots • Low Profile Keyboard • Serial/Parallel Ports • 130 Watt Power Supply • High Resolution Monochrome and RGB Display Card Standard.  
**Purchase Price: \$649**

### Blue Chip Options:

MS DOS & GW Basic	.....	\$79.00
Blue Chip Amber Monochrome Monitor	.....	\$85.00
Blue Chip Green Monochrome Monitor	.....	\$75.00
Additional 360K Half/Height Floppy Drive	.....	\$99.00
10 Mb Hard Drive Option	.....	\$389.00
20 Mb Hard Drive Option	.....	\$449.00

### 100% Burn-In and Testing.

All systems undergo a 48-hour configuration, testing and burn-in period. We will configure system boards, set DIP switches, format hard drives, perform memory diagnostics and check system with monitor.



## Toshiba Laptop T-1100 Plus (Dual Floppy)

• 640K RAM Memory • CMOS 80C86 Running at 7.1 MHz • Two 720K 3.5" Floppy Drives • One Expansion Slot • TOSHIBA Keyboard • LCD Display • Color Graphics/Monochrome Composite Card • One Parallel and Serial Port • Clock Calendar • External Floppy Drives Optional.  
**Purchase Price: \$1,799**

Lease For only **\$76** per month



## Toshiba 3100 Laptop

• AT Power in a Compact Size • Gas Plasma Screen • 8 MHz • 640K Ram Memory • One 3.5 720K Floppy Drive • 10 Mb Hard Drive • Parallel/Serial Port.  
**Purchase Price: \$3,599**

Lease For **\$142** per month

## Zenith Z-181 Laptop

• Supertwisted Backlit LCD Screen • 4.77 MHz • 640K Ram Memory • Two 3.5" 720K Floppy Drives • Parallel/Serial Ports.  
**Purchase Price: 1,899**

Lease for **\$81** per month

# LOGICSOFT®

10 Bi-County Blvd., Dept. 543  
 Farmingdale, NY 11735  
 Domestic/Int'l Telex  
 36905 SoftUR  
 FAX #516-249-5289

To order, call our National Hotline:

## 1-800-645-3491

NY STATE: 1-800-235-6442 (516) 249-8440

To Receive Technical Assistance, call: (516) 249-8440  
 Customer Service: 1-800-431-9037 NYS: (516) 249-8440

EUROPE: 020-83 48 64  
 Telex: 10759 Logic NL  
 Mail orders to:  
 LOGICSOFT EUROPE BV  
 Baarsjesweg 224 Amsterdam,  
 Holland



# Largest selection of peripherals Free overnight delivery!

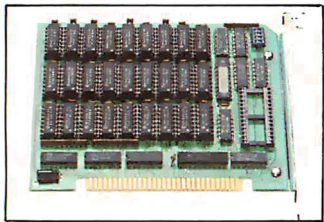

w/0K ..... 59  
w/384K ..... 119  
w/576K ..... 139  
Logic (AST Comp) I/O  
Mini Half Card ..... 105

**EVEREX**  
Magic Card II w/384K ..... 199  
**TECMAR**  
Captain (384K) ..... 199  
**QUADRAM**  
Quadboard (384K) ..... 155  
Silverboard ..... 155  
Ems w/256K ..... 349  
Liberty (AT) 128K (6-8 MHz) . 315

**INTEL**  
Above Board (PS/AT)  
w/128K ..... **Low Price Call!**  
(PC) w/64K ..... **Low Price Call!**  
(AT) w/128K ..... **Low Price Call!**  
(PS) 64K ..... **Low Price Call!**  
(PS) 256K ..... **Low Price Call!**  
8087-2 Math Co-Processor . 179  
8087-3 Math Co-Processor . 139  
80287 Math Co-Processor . 199

**GRAPHICS BOARDS**  
**AST**  
Preview ..... \$239  
**EVEREX**  
The Edge ..... 239  
Evergraphics ..... 106  
**HERCULES**  
Monochrome Graphics  
Card ..... 199  
Color Card ..... 155  
Graphics Card Plus ..... 209  
**LOGICSOFT**  
Logic (Hercules Comp.)  
Color Graphics Board . . . 89



Logic (IBM Comp.)  
Enhanced Graphics  
Adapter (EGA) ..... 249

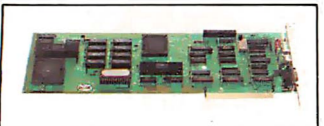

Logic (Hercules Comp.)  
Monographics Board . . . 99  
**PARADISE SYSTEMS**  
Auto Switch EGA Card . . . 359

Modular Graphics Card . . . 249  
Color/Mono ..... 139  
**QUADRAM**  
EGA Plus Graphics ..... 369  
**VIDEO 7**  
VEGA (1/2 Card) ..... 339  
VEGA Deluxe (1/2 Card) . . . 395  
**STB**  
Chauffeur ..... 209  
EGA Plus ..... 309  
**TECMAR**  
Graphics Master ..... 475  
EGA Master ..... 275

**COMMUNICATIONS BOARDS**  
**AST**  
5251-11 Plus ..... \$655  
5251-11 ..... 609  
**DCA**  
IRMA Board ..... 779

**MODEMS**  
**AST**  
Reach 1200 Half Card . . . \$225  
**EVEREX**  
Evercom II ..... 149  
**HAYES**  
Smartmodem 1200 ..... 389  
Smartmodem 1200B  
w/Smartcom II ..... 359



Smartmodem 2400 ..... 599  
Smartmodem 2400B  
w/Smartcom II ..... 549

**LOGICSOFT**  
Logic (Hayes Comp.) 1200  
Baud External Modems . 179  
Logic (Hayes Comp.) 2400  
Baud External Modem . . 309

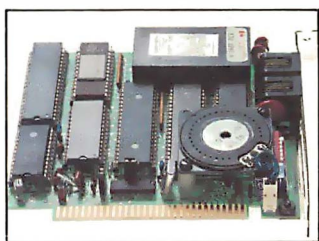

Logic (Hayes Comp.) 1200B  
Internal Modem with  
Mirror (Crosstalk Clone)  
Software ..... 129  
Logic 2400B Internal Modem  
2400B w/Software ..... 299  
**PROMETHEUS**  
Pro-modem 1200 ..... 279  
Pro-modem 1200B  
w/software ..... 239  
**TOSHIBA**  
1200B Laptop Modem  
(T1100 Plus) ..... 329

**VENT-TEL**  
PC Modem 1200 Half Card . 359  
1200 Plus ..... 329  
PC Modem 2400 Half Card . 469

**MOUSE INPUT DEVICES**  
**MOUSE SYSTEMS**  
PC Mouse w/DR Halo 2 . . **Special**  
**MICROSOFT**  
Microsoft Mouse (Serial) . . \$135  
Microsoft Mouse (Buss) . . . 125

**SURGE PROTECTORS**  
**KENSINGTON MICROWARE**



Masterpiece Plus ..... \$119  
**CURTIS**  
Diamond ..... 39  
Emerald ..... 36  
Ruby ..... 59

**KEYBOARDS**  
**KEYTRONIC**  
5151 (Deluxe) ..... \$169  
5153 (w/touch Pad) ..... 279  
3270 PC ..... 235  
5151 (AT&T) ..... 189  
Keytronic Jr. 5151 ..... 169

**MEMORY STORAGE**  
**IOMEGA**  
Bernoulli Box (10 + 10) . . \$1999



Bernoulli Box (20 Mb) . . . 1899  
Bernoulli Box (20 + 20) . . 2499  
Bernoulli Box Plus ..... 4199

**HARD DISK DRIVES**  
**MOUNTAIN COMPUTER**  
Hard Drive Card (20 Mb)  
or (30 Mb) . . . **Low Price Call!**  
**PRIAM CORP**  
60 Mb Internal Hard Drive  
..... 1389  
Innerspace ID 40 Mb ..... 1349  
**PLUS +**  
Hard Card 10 Mb ..... 399

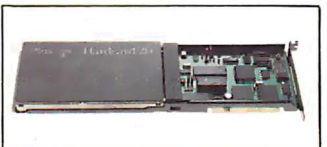

Hard Card 20 Mb ..... 675  
**SEAGATE**  
10 Mb 1/2 Ht Int ..... 465

20 Mb 1/2 Ht Int ..... 48  
30 Mb 1/2 Ht Int ..... 53  
20 Mb Full Ht (AT) ..... 59  
30 Mb Full Ht (AT) ..... 74  
40 Mb Full Ht (AT) ..... 87  
80 Mb Full Ht (AT) ..... 134  
**CORE**  
20 Mb Int (AT) . . . **Low Price Call!**  
30 Mb Int (AT) . . . **Low Price Call!**  
40 Mb Int (AT) . . . **Low Price Call!**  
72 Mb Int (AT) . . . **Low Price Call!**

**CARTRIDGE TAPE BACK-UP**  
**EVEREX**  
Excel Stream 20 Mb Int . . . \$63  
Excel Stream 60 Mb Int . . . 79  
Excel Stream 60 Mb Ext . . . 89  
**IRWIN**  
Irwin 110 10 Mb Int ..... 49  
20 Mb Int ..... 58  
20 MB 325 (AT) Ext. D ..... 77  
**LOGICSOFT**



Logic 60 Mb Internal Cartridge  
Tape Backup Kit ..... 72  
Logic 25 Mb Internal Cartridge  
Tape Backup Kit ..... 56

**SYSGEN**  
Image Tape Backup  
10 Mb Int ..... 78  
Image Tape Backup  
20 Mb Int ..... 59  
Image Tape Backup  
20 Mb Ext ..... 64

**TECMAR**  
QIC 60 AT ..... 123  
QIC 60 Ext Tape Backup . . 157  
**CORE**  
60 Mb Ext ..... 159

**FLOPPY DISK DRIVES**  
Panasonic 360 K 1/2 Ht. . . \$11  
Tandon TM-100 360 K F/Ht. . 12  
Tandon TM-100 360 K 1/2 Ht. 10  
Toshiba 360 K 1/2 Ht. . . . 11

**BACK UP POWER SUPPLIES**  
**DATA SHIELD**  
200 Wt (PC) ..... \$24  
300 Wt (XT) ..... 35



500 Wt (AT) ..... 56  
800 Wt (AT) ..... 63

\*Due to weight restrictions, Printers and Monitors and some misc. bulk items are shipped UPS—free. All prices and policies subject to change without notice.



## 5 YEAR WARRANTY

Look for the items printed in **red** to identify Logisoft's own line of computer hardware products. They are fully compatible with, but priced well below, the major manufacturers. You save—not by our use of inexpensive labor and parts—but through state-of-the-art technology.

**Each product carries our 5 year unconditional replace or repair warranty.**

## Sale! Save \$50



### NEC MULTISYNC MONITOR WITH SWIVEL BASE

The resolution solution. This state of the art color monitor scans all frequencies between 15.75 KHz and 35 KHz allowing compatibility with all current color graphics boards. The last color monitor you'll ever need.

Our regular low price **\$599**



### VIDEO-7 VEGA BOARD

Take full advantage of the NEC multisync monitor color capabilities. The Vega 1/2 card supports resolution up to 640 x 350. Includes Monochrome Graphics, Color Graphics, Hercules Graphics and Enhanced Graphics. High technology at a low price.

Our regular low price **\$339**

If purchased separately. **\$938**  
Buy both and save \$50 **\$888**

Hurry—sale ends February 28, 1987

### PRINTERS\*

#### EPSON

- EX 800 (80 column, 300 cps) ..... **Low Price Call!**
- EX 1000 (136 column, 300 cps) ..... **Low Price Call!**
- FX-85 (80 column) **Low Price Call!**

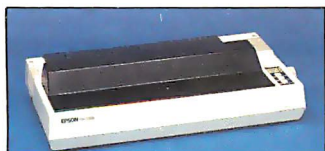

- FX-286 (136 column) ..... **Low Price Call!**

- LQ 1000 (136 column) ..... **Low Price Call!**
- LQ 2500 (136 column, 324 cps) ..... **Low Price Call!**

#### NEC

- Pinwriter P-5 Series ..... **Low Price Call!**
- Pinwriter P-6 ..... 489
- Pinwriter P-7 ..... 669
- P6 Color Printer ..... 599
- P7 Color Printer ..... 799

#### OKIDATA

- 182 Plug & Play ..... 223
- 192 Plus (IBM) ..... 379
- 193 Plus (IBM) ..... 558
- 290 Series ..... **Low Price Call!**
- 2410 P Plug & Play ..... 1759

#### PANASONIC

- KX1091 I ..... 299
- KX 1080 I ..... 219
- KX 1595 ..... 599

#### TOSHIBA

- P/S 321 (IBM) ..... 489
- P 341 ..... 695
- P/S 351 (IBM) ..... 999

#### CITIZEN

- MSP10 ..... 289
- MSP15 ..... 379
- MSP20 ..... 339
- MSP25 ..... 499
- Premier 35 ..... 509

### LASER PRINTERS\*

#### CANON

- Laser Printer LBP8A1 ..... \$1985
- Laser Printer LBP8A2 ..... 3089

#### HEWLETT PACKARD

- Laser Printer ..... 2489
- Laser Printer Plus ..... 3199
- Laser Jet 500 (+) ..... 4299

### PLOTTERS\*

#### FACIT

- 4550 (6 Pen Plotter) ..... 395

#### HEWLETT PACKARD

- 7475A ..... 1629
- 7550 ..... 3349

#### HOUSTON INSTRUMENTS

- DMP 40 ..... 899
- DMP 41 ..... 2549
- DMP 42 ..... 2549
- DMP 51 ..... 3849
- DMP 52 ..... 3849
- DMP 52 MP ..... 4889

### PRINTER BUFFERS

#### QUADRAM

- Microfazer Series ..... **Low Price Call!**

### MONITORS\*

#### AMDEK

- Color 600 RGB ..... \$ 389
- Color 722 (EGA Comp.) ..... 499
- Color 725 ..... 559
- 12" Amber 310A ..... 149

#### IBM

- Color Monitor ..... 545
- Monochrome Monitor ..... 225
- Enhanced Color Display ..... 679

### NEC



- Multi-sync color w/swivel base ..... 599

### PRINCETON GRAPHICS

- RGB HX-12 (690X240) ..... 449
- RGB HX-12E (EGA Comp.) ..... 535
- RGB SR-12 ..... 569
- RGB SR-12P ..... 689
- Amber Max 12 ..... 159

### QUADRAM

- Amberchrome 12" ..... 145
- Enhanced Graphics Monitor w/swivel ..... 525

### TAXAN

- 660 12" EGA ..... **Low Price Call!**
- 720 14" CGA ..... **Low Price Call!**
- 118 12" Green ..... **Low Price Call!**

### MULTI-FUNCTION BOARDS

#### AST RESEARCH

- Six Pack Premium ..... \$309
- Six Pack Plus (384K) ..... 229
- Rampage w/256K ..... 249
- Rampage (AT) w/512K ..... 449
- Advantage (128K) ..... 359
- I/O Mini Half Card ..... 119
- I/O Plus II ..... 125

### LOGISOFT

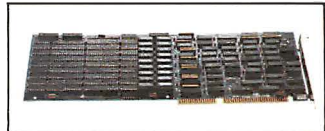

- Logic Board (Lotus/Intel/Microsoft Expanded memory specification) ..... 189

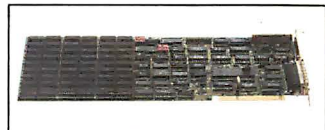

- Logic (AST Compatible) Multi-function Board w/OK ..... 99
- w/384K ..... 155



- Logic (AST Compatible) AT Multifunction Board w/128K (Expandable to 2.0 Mb) ..... 199

- Logic (AST Compatible) 576K Ram Board 1/2 Card

Circle #400 on reader service card.



# Free overnight delivery on software for all your IBM PC applications!

## Special !!!

### MANAGING YOUR MONEY

#1

Personal Finance Package  
by Andrew Tobias

NOW ONLY **\$115.00**

### LOTUS HAL

Use English-like commands for easier use of 1-2-3.

NOW ONLY **\$115.00**

### PC MOUSE WITH DR. HALO II

Movement at your fingertips. The #1 selling optical mouse complete with pad and software.

NOW ONLY **\$119.00**

#### WORD PROCESSING

Display Write IV	\$359
Easy Writer II	209
Microsoft Word 3	279
Multimate	259
Multimate Advantage	309
Office Writer	245
PFS Professional Write	115
Volkswriter 3	147
Word Perfect	209
Wordstar	179
Wordstar Pro Pak	239
Wordstar 2000	245
Wordstar 2000 Plus	295
XY Write III	219

#### WORD PROCESSING ADD-ONS

Fancy Font	\$139
------------	-------

Punctuation & Style	75
Turbo Lightning	59
Word Finder	55
Word Perfect Library	69

#### DATABASE MGMT.

Cornerstone	\$ 69
d Base III Plus	419
d Base III Lan Pak	629
Knowledgeman/2	309
PFS Professional File	145
Paradox	449
Powerbase	185
Q & A	245
R: Base 5000	265
R: Base System V	359
Reflex	95
Revelation	519

#### DATABASE MGMT. ADD-ONS

Clipper	\$349
Clout 2	139
dGraph III	149
Ext Report Writer	99
Genifer	229
Quickcode III	149
Quick Report	149
Quicksilver	459

#### SPREADSHEET/INTEGRATED

Ability	\$ 69
Enable	349
First Choice	95
Framework II	419
Lotus 1-2-3	317

Microsoft Multiplan	119
Smart Integrated	475
Supercalc IV (NEW)	285
Symphony	449

#### SPREADSHEET ADD-ONS

Cambridge Spreadsheet Analyst	\$ 65
HAL	<b>Special</b>
Lotus Report Writer	99
Note It	49
Quickcode for 1-2-3	85
Sideways	45
Smart Notes	49
Spreadsheet Auditor	99
SQZ	65

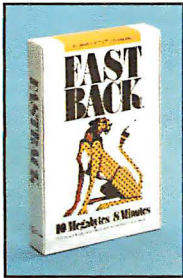

#### FASTBACK—

A low cost alternative to tape backup hardware. Back up 10 Mb in less than 8 minutes using 5 1/4" diskettes.

only **\$95**

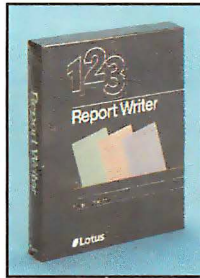

#### LOTUS REPORT WRITER-

The next step for the Power User! Format your own reports, forms and mailings using 1-2-3 files.

only **\$99**



#### SIDEWAYS—

Now you can create extra wide printouts of your spreadsheets without the mess of staples, glue or tape.

only **\$45**

#### DESKTOP PUBLISHING

Click Art Personal Publisher	\$115
ScLaser Plus	349
Spellbinder Desktop Publisher	349

#### GRAPHICS

Chartmaster	\$215
Diagram Master	195
Energraphics (New)	309
Freelance	199
Graphwriter Combo	305
Harvard Presentation	249
Map Master	229
Microsoft Chart	179
Sign Master	149

#### CAD/CAM

Auto CAD 2.5	\$2249
Auto CAD Basic	247
Drafix 1	239
Generic CAD	119
Pro Design II	179

#### LANGUAGES

BASIC Compiler (MS)	\$245
C Compiler (MS) (4.0)	279
COBOL Compiler (MS)	425
FORTAN Compiler (MS)	217
Lattice C Compiler	259
Macro Assembler (MS)	97
Pascal Compiler (MS)	183
Quick Basic (MS)	67
True Basic	119
Turbo Pascal (plus BCD & 8087)	65

#### PROJECT MANAGEMENT

Harvard Total	\$285
Microsoft Project	237
Super Project Plus	295
Timeline	235

#### FINANCIAL

Managing Your Money	<b>Special</b>
Dollars N' Sense	\$107

#### ACCOUNTING

BPI Entry	\$309
Computer Associates (formerly IUS)	349
Dac Easy	49
Great Plains	447
Open Systems (3.0)	417
Real World 4.0 (New)	379

#### MISC/UTILITIES

Carbon Copy	\$139
Concurrent PC DOS	179
Copy II PC	35
Crosstalk XVI	99
Dan Bricklin's Demo	65
Disk Optimizer	35
Fastback	95
Homebase	45
Microsoft Windows	67
Norton Commander	49
Norton Utilities	55
PC DOS 3.2	85
Prokey4.0	79
Remote	99
Sidekick	47
Superkey	45
Traveling Sidekick	55
XTREE	39

**2 NEW FREE CATALOGS.**

**CALL TODAY!**

**1-800-645-3491**

• Brand new **Programmer's Language and Utilities Guide** • A convenient and valuable listing of timesaving tools for the programming professional • Complete with product description.

• Brand new **Productivity Guide** • Full line catalog of software enhancements for the business professional • Full descriptions of templates, memory management, menu management, backup software, training, and much more.

Circle #400 on reader service card.



# The Potential for Interactive Technology

*The future for learning and using technology requires vision and facts*

---

Alfred Bork

COMPUTERS AND ASSOCIATED technology (the videodisk, the compact disk, and sound) can stimulate major changes in our educational system. In the last few years, schools and universities in many parts of the world have acquired large numbers of computers. It is time to assess the situation.

The main advantage of the computer as a way of learning is that it allows us to make learning interactive for all students. We can then pay attention to the needs of each student by individualizing the learning experience.

But the results of computers in learning are disappointing; studies might even show that computers are doing more harm than good. Effective use of computers in learning will not occur automatically. A reasonable chance exists that it will not occur at all unless we readjust our current directions. Just because computers and other modern technology are widely present in schools is no guarantee that this equipment will be wisely employed.

I divide the topic of computers in learning into four major areas. First, I consider several serious problems facing our educational system today. Oddly, they receive little attention in discussions about the role of computers in learning. I will then cover the recent use of computers, visions of future developments in education, and proposals to attain those goals.

## Current Problems in Schools

Dozens of reports over the last 25 years have discussed major problems of education. Perhaps the best known, prepared in

April 1983 for the Secretary of Education, is *A Nation at Risk: The Imperative for Educational Reform*. This report emphasizes the serious consequences to the country of a poor educational system, as reflected by its title. I will not summarize these reports but rather mention a few critical factors about the current state of classroom education in the United States.

## Typical Classes

Most students today do not succeed at the learning task. It has been estimated that in a typical class, only about one-third of the students learn the material well. In a class with 20 or 30 students—common in education in the U.S.—it is almost impossible to give individual attention to the learning needs of each student. The two primary learning modes provided, the textbook and the lecture, do not create active learning possibilities for most students and offer the same learning experience to all students regardless of background, learning style, learning speed, or goals in life.

## Poor Results

Declining scores on national and international tests are another measure. For example, recent international mathematics testing shows that U.S. students are far from the top, at all age levels and in all areas of mathematics. Almost all the developed countries rank above us in these tests. Further, illiteracy has now become a serious problem in the U.S., greater than in most developed countries. The in-

dicators in such testing are mostly negative; the problems are increasing.

## Decreasing Democracy

The decline in scores becomes even more frightening when we consider the uneven distribution of the quality of education in the U.S. Minority, poor, and rural individuals receive poorer educations than do students from affluent areas. In most states, school districts in wealthy areas spend far more per student than poorer districts. This inequality of opportunity is more likely to be a problem in the U.S. than elsewhere, given local control of school budgets, but it is a worldwide problem. Children may be created equal, but the educational system quickly changes that. We seem to be moving back to a time when education was the privilege of only a few.

## Lack of Teachers

Over the next ten years the shortage of good teachers will continue to grow. This decline may well be the dominant visible problem of education during this period. There are several causes. First, we pay teachers very little compared to professions requiring similar education. The average salary of a teacher in the U.S. in 1985, according to the National Educa-

*continued*

---

*Alfred Bork, developer of highly interactive computer-based material, is professor of computer science and director of the Educational Technology Center at the University at California at Irvine.*



*It is estimated that about half of the teachers currently in schools will be retiring during the next ten years.*

tional Association, was about \$25,000. Second, teaching is no longer considered a desirable profession by many people in this country. Third, we train few teachers now. Only about one-fifth of the number of math teachers graduate today as compared to ten years ago. Fourth, our schools of education are, on the average, weak. Fifth, the students currently entering teaching have low test scores on such exams as the SAT. Sixth, it is estimated that about half of the teachers currently in schools will be retiring during the next ten years, primarily because they have reached retirement age.

Hence, we can expect an increasing shortage of qualified teachers in the next few years. Simple solutions will not be adequate for this problem. Educational planning, with or without computers, must pay attention to this decline in both quantity and quality of teachers.

### **Negative Attitudes**

The attitude toward teachers and the teaching profession just mentioned is paralleled by a decline in interest in education in this country. We see many unsuccessful attempts to increase taxes to pay for adequate education.

Of even more concern is the attitude of most students toward learning. Our schools seem to make people less interested in learning. Young children entering school are bright and curious, enjoying much of what they do. A few years later many of them view schools as a type of prison, convinced that the failure to learn is their own problem.

If we are to improve education, we must consider new directions. These directions must recognize that we will soon have far fewer teachers than we currently have. Modern technology, particularly the computer, provides us with the possibility of meeting these problems.

### **How Computers Are Used Today**

To support the belief that computers can lead to an improved educational system, I discuss four examples of existing computer-based learning material: the logic course at Stanford developed by

Patrick Suppes, the physics course at the University of California at Irvine, the Writing to Read course, and the Scientific Reasoning Series. These four projects show the role of interaction. Two of them, the courses at Stanford and Irvine, are more than ten years old. The examples use sizable amounts of computer material, mostly with support from print and other media.

The heart of the logic course at Stanford, and of the set theory course that may follow it, is the interactive proofs. Like other good courses of this type, the focus is on getting college students to prove increasingly difficult theorems.

The interactive theorem-provers that support the computer-based course allow students to develop their own proofs, which can then be checked by the computer. Both formal and informal proofs are possible. The detailed feedback to the student is far superior to that provided in most lecture-based logic courses. The expository material is less interactive (not surprising given the ten-year age of this course) but does reflect interesting early use of digitally stored speech. The course has been transported to other locations. Throughout much of its history at Stanford, it has been the only logic course available to students.

At the University of California at Irvine, a physics course was organized around a set of on-line exams, with each exam uniquely generated by the computer. As with most physics courses, the exams are primarily problem-based, but considerable conceptual knowledge is also required. Students stay with an exam until they perform it almost perfectly, in the tradition of mastery learning.

The exams contain most of the learning material of the course. As soon as a student has trouble with a problem on the exam, a detailed learning aid is interactively presented to the student. Often this material is closely related to the difficulty the student is experiencing. A variety of other learning modes are available, but it is possible to learn the material from the exams alone.

Students are also offered a choice of content; two different courses, mostly with different quizzes, are available. Students can choose a conventional course, but three-quarters select the computer course.

A central problem of education for young children is reading and writing. The Writing to Read course, developed by John Henry Martin, is directed at five- and six-year-old children. It is a multimedia course, with extensive use of materials other than the computer.

The course is based on a phonetic system. Children learn to write (i.e., type)

the words they can say, and then they can read the words that they type. (Unlike the Initial Teaching Alphabet approach, it has been found that students quickly move to ordinary spelling.)

Writing to Read has had a full summative evaluation, conducted by the Educational Testing Service in Princeton, New Jersey. The results are favorable compared to other ways of teaching reading and writing. Even to the casual observer, the performance of the children at the end of the year is almost amazing; children are typing coherent compositions. The series is available from IBM.

The Scientific Reasoning Series is a collection of ten programs, directed to students of junior high school age and up. Bright elementary students will also be able to use many of them. The aim of this series is to bring students to an understanding of the nature of science.

The tactic is to place students in interactive environments in which they will behave like scientists in developing and testing concepts and theories. These environments are student-supportive, offering aid to students who are progressing slowly. The programs are self-contained, not requiring reading material, teachers, or other programs. The flavor is conversational, with the student playing an active role in the learning process. This series is also available from IBM.

The four projects just discussed illustrate what is possible with sizable developments. They suggest the computer's potential to improve education. But we need to consider further the structure of future educational systems.

### **Two Positive Visions**

We can conceive of computer-based systems of the future that will provide a much better education for all students than our current system does. To follow are two models for future educational systems: mastery learning and the proposals of George Leonard.

Given that future educational systems should perform better than current systems, we should work toward the goal of everyone learning everything well, the goal of mastery learning. This does not imply any reduction of the level of education.

The notion of mastery learning, as promoted by Benjamin Bloom of the University of Chicago and others, has a variety of components. But these are not all possible at the same time in most current educational situations without skilled individual tutors. A student is kept with a given topic until mastery is demonstrated. This demonstration is typically through some type of exam, with the student be-

*continued*



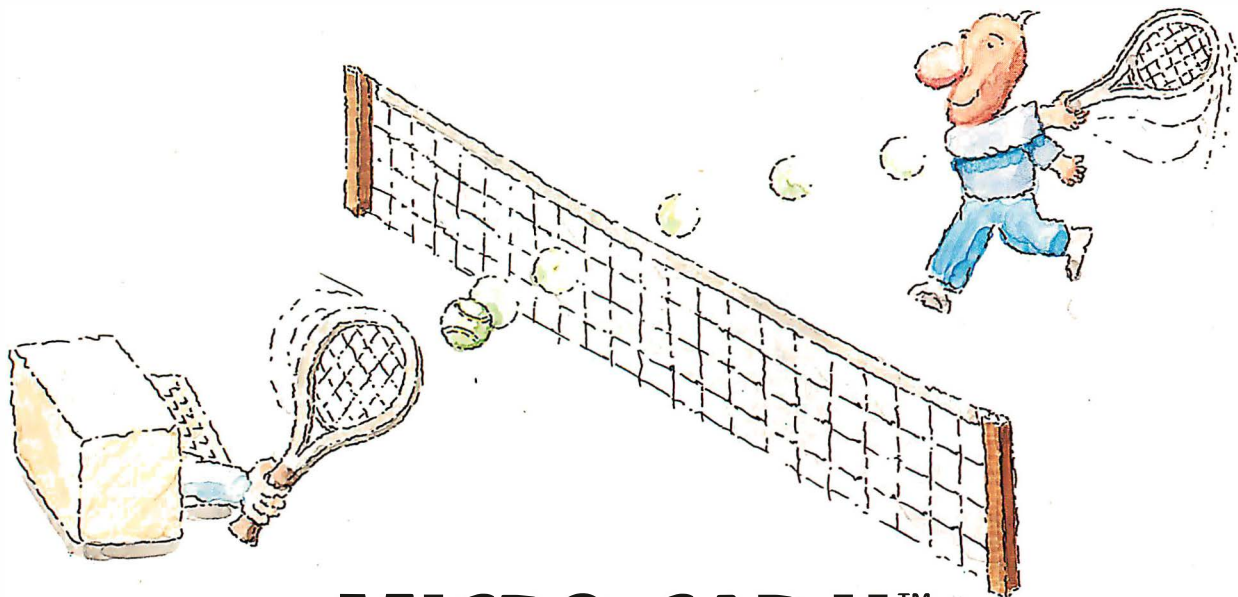

# MICRO-CAP II.™

## The CAE tool with fully interactive analog simulation for your PC.

Spectrum Software's MICRO-CAP II® is fast, powerful, and feature rich. This fully interactive, advanced electronic circuit analysis program helps engineers speed through analog problems right at their own PCs.

MICRO-CAP II, which is based on our original MICRO-CAP software, is a field-proven, second-generation program. But it's dramatically improved.

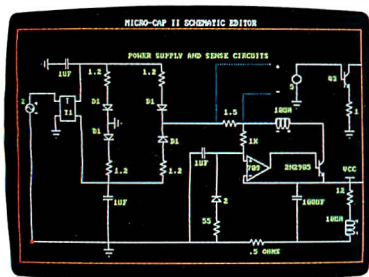

Schematic Editor

MICRO-CAP II has faster analysis routines. Better resolution and color. Larger libraries. All add up to a powerful, cost-effective CAE tool for your PC.

The program has a sophisticated integrated schematic editor with a pan capability. Just sketch and analyze. You can step

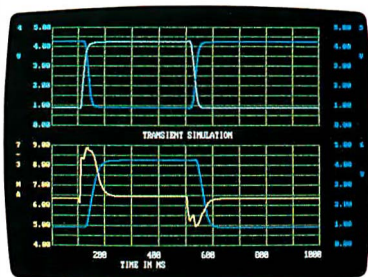

Transient Analysis

component values, and run worst-case scenarios—all interactively. And a 500-type\* library of standard parts is at your fingertips for added flexibility.

MICRO-CAP II is available for IBM® PCs and Macintosh.™ The IBM version is CGA, EGA, and Hercules® compatible and costs only \$895 complete. An evaluation version is available for \$100. Call or write today for our free brochure and demo disk. We'd like to tell you more about analog solutions in the fast lane.

- Integrated schematic editor
- Fast analysis routines
- High-resolution graphic output
- Standard parts library of 500\* types

\*IBM versions only.

- Transient, AC, DC, and FFT routines
- Op-amp and switch models
- Spec-sheet-to model converter\*
- Printer and plotter\* hard copy

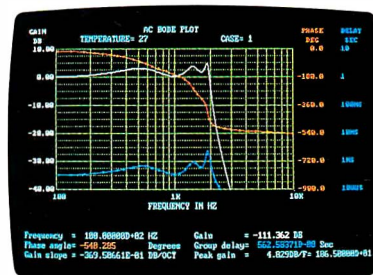

AC Analysis



1021 S. Wolfe Road, Dept. E  
Sunnyvale, CA 94087  
(408) 738-4387

MICRO-CAP II is a registered trademark of Spectrum Software.

Macintosh is a trademark of McIntosh Laboratory, Inc. and is being used with express permission of its owner.

Hercules is a registered trademark of Hercules Computer Technology

IBM is a registered trademark of International Business Machines, Inc.



ing required to perform almost perfectly on the exam. A student who does not show mastery continues to study the unit, with a variety of learning material provided by the instructor. Several approaches to learning the topic may be required, perhaps reflecting different pedagogical approaches and different media. Students are thus encouraged to learn at their own rate and ability.

In a sense, mastery learning is the application of democracy to education. Not only are people created equal, but we ensure equal education for all. Experience

suggests that mastery learning is possible with the use of modern technology.

But mastery learning does not completely specify the structure of schools. In thinking about future educational structures, certain questions must be answered. How many teachers will we have? What are the roles for the teachers? Will schools continue to exist or will part of education move to other learning environments, such as the home or public library? How do we accomplish the nonlearning aspects of schools, such as child care? How do we develop the necessary curriculum

material? How do we implement and disseminate desirable changes? What does the daily life of a technology-based school look like?

Few people have developed visions of future schools. But without such visions, meaningful planning to improve education is difficult. Consider George Leonard's approach.

A few speculative views of schools 20 or so years from now have been developed. George Leonard has developed two of these. One is described in his book *Education and Ecstasy* (Dell Publishing, 1968) and the other in an article entitled "The Great School Reform Hoax" (*Esquire*, April 1984). Both of these schools are fully consistent with the goal of mastery learning; both make extensive use of the new interactive technologies; both individualize the learning process and make it interactive for all students. Both are practical visions of an educational system heavily dependent on modern interactive technology.

In *Education and Ecstasy*, Leonard divides the school into two segments, one for acquiring knowledge and one for affective behavior. In the knowledge dome, students work at large three-dimensional displays. The computer has a complete management system; as a student begins to work, the experiences are directly relevant to that student's needs. Brain waves are analyzed to reflect understanding, or lack thereof, in addition to the technical details already in use today. In the socialization component of the school, children work in small groups, with teachers, using encounter-group approaches.

Later, in the *Esquire* article, the two functions of the school are combined into a single program. A greater variety of instructional modes are used. And a major new ingredient is added: Students start each day by planning their schedules for the day, usually in an interaction with the computer.

#### How To Attain Such Schools

This last section proposes a set of steps that could lead to a future educational system that would be, for most students, far superior to our current one. Although the problems discussed in the first section refer partially to the U.S., the approach suggested could work all over the world, including the developing countries.

To implement the models of George Leonard, the creation of many courses is a critical step in developing a new educational system. Our current courses are inadequate; they were developed before the modern learning technologies were available, they are not interactive and in-

*continued*

## YOUR COMPUTER WAS MADE TO BE SEEN AND HEARD

### BUT HOW IT SPEAKS IS AS IMPORTANT AS WHAT IT HAS TO SAY

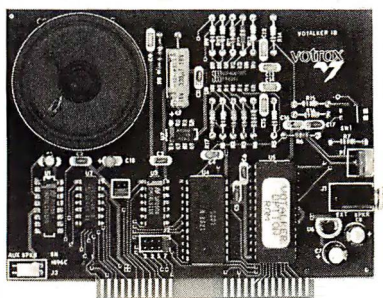

Why bother giving your IBM® computer the power of speech if the core of the synthesizer has limited capabilities? The **Votalker-IB** uses the new SC-02 Speech Chip combined with a superb text-to-speech algorithm to enhance your educational, business, and other computer applications with voice versatility and voice clarity. With the Votalker-IB your IBM\* computer acquires unlimited vocabulary with 32 inflections and 4,100 pitch settings. The Votalker-IB also simulates song in five octaves, and generates sound effects in 16 amplitudes. It's all the flexibility you need in speech synthesis, and more. Because with Votalker-IB you get advanced voice technology **and** a surprisingly low price.

Contact Votrax today for all the flexibility you need at a price you can afford. **Call 1-800-521-1350.**

**FOR A DEMONSTRATION CALL: (313) 588-2926**

IBM® is a registered trademark of International Business Machines, Inc.  
\*IBM PC, XT, AT AND COMPATIBLES



**VOTRAX INTERNATIONAL, INC.**  
1394 Rankin  
Troy, Michigan 48083-4074  
(313) 588-2050 TWX-8102324140  
Votrax-TRMI

*"Technology that Talks"*



# AT performance at an XT price. Any way you look at it.



## The TeleCAT-286™ \$2995. Complete.    The TeleCAT-286 EGA™ \$3595. Complete.

If you're looking for a quality AT-compatible computer, TeleVideo® offers you not one, but two. With the TeleCAT-286. And now, the new TeleCAT-286 EGA.

Both of these compact computers give you a complete set of features. Like 512K RAM. A 1.2MB floppy. A 20MB hard disk. And a high-resolution monitor.

There's even a free 90-day nationwide on-site service agreement.

And if you want full EGA color, take a look at the new TeleCAT-286 EGA. With its

high-resolution 13-inch EGA color monitor, you get a full spectrum of brilliant displays. Its low-glare, high-contrast dark screen makes it easy on the eyes, too. You can even change this screen to green monochrome, with the flick of a switch.

What's more, the new TeleCAT-286 EGA comes with an EGA card that's fully IBM compatible, so you can run any full-color AT graphics software packages. And they'll never look better. Because this EGA card features 256KB of display RAM, and 640 X 350

graphics resolution, for bright colors and sharp text.

The result? A clear, crisp image that no CGA color monitor can ever live up to.

The TeleCAT-286, and the new TeleCAT-286 EGA. Find out more about them. Call 1-800-TELECAT (835-3228), Dept. 355, for the name of your nearest TeleVideo dealer.

And see for yourself why TeleCAT computers are definitely worth looking into.

 **TeleVideo®**  
Settle for more.

TeleVideo Systems, Inc., 1170 Morse Avenue, P.O. Box 3568, Sunnyvale, CA 94088-3568 • (408) 745-7760

IBM and AT are trademarks of International Business Machines, Inc.

©1986 TeleVideo Systems, Inc.



## CP/M Emulation on PC

Run CP/M software with our Z80 and HD64180 coprocessor cards. Super-speed version runs at an incredible 12.5 mhz. No wait states! Blue Thunder 6 mhz coprocessor \$249.95. ZSIM Software/V20 emulator \$99.95.

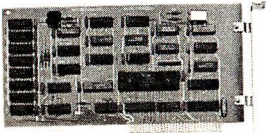

BLUE THUNDER

## DEVELOPERS!

Our Z80 and HD64180 plug-in PC coprocessors give you the hardware and software basis for the best Z80 family development systems. For example, you can run the *SLR Systems Superfast* assembler, which runs 10-20 times faster than Avocet or 2500AD cross assemblers. Our DSD80 remote debugger eliminates the need for an in-circuit emulator.

**RUN ISIS**  
Very Fast

Plug in one of our co-processors, running at a clock speed up to 12.5 mhz. Then run your Intel development tools on your PC as much as 20 times faster. Runs ASM51, ASM80, CREDIT, etc. \$395.00 and up.

### HD64180 SHORT CARD

Our newest co-processor has 2 serial ports and runs at 6.144 mhz. \$295.00. 9.216 mhz available.

### HD64180 PC Satellite Real Time Coprocessor

Our D64180 coprocessor has Hitachi's newest Z80 compatible micro-processor. You get serial ports, counter timers, DMA and a well-documented interface to your PC. *This unit accepts Intel standard iSBX bus piggy-back boards.* You can add any of over 100 peripheral cards from dozens of manufacturers. Use it to unload real time control or communications from the host PC. Also serves as an HD64180 development system.



D64180 Co-processor

We cater to professional software developers. Examine our quality and performance.

Z-World  
2065 Martin Ave. #110  
Santa Clara, CA 95050  
(408) 980-1678



## INTERACTIVE TECHNOLOGY

*Current courses are inadequate. They were developed before modern learning technologies were available and do not aim at mastery learning.*

dividualized, and they do not aim at mastery learning.

But two factors, and perhaps others, make it difficult to move to extensive immediate curriculum development. First, it is questionable whether we have enough practical experience with computers in learning, particularly with full courses, to jump directly to remaking all courses. The second factor is the difficulty of starting a project of this magnitude directly. Not everyone is convinced that a computer-based educational system is possible and reasonable.

To overcome these problems, and to proceed rationally, I suggest a two-stage approach. We should conduct a trial period to examine the concept of technology-based courses, followed by full development.

### The Experiment

The purpose of this experiment is to study the effective use of the computer in education, in a focused way, to furnish information for later development. I propose the development, use, and summative evaluation of about 20 full courses that utilize the computer and associated technology, along with older learning media.

These courses should be diverse in all senses. They should be flexible enough to reflect different approaches to learning, different subject areas, and students of different ages. Courses should use a variety of production systems in the process of development. Their structure should be modular so that students can choose from several levels. All courses should be funded at levels that might lead to high-quality courses.

We already have a reasonable understanding of the process needed to develop high-quality material, so the focus should be on highly skilled teachers as the heart of the pedagogical design team. These teachers should be given maximum freedom to make the best possible decisions to aid student learning. Further, most or all teacher training materials should be considered as an essential part of the course development itself. The pro-

cess of implementing each course in the schools should be studied.

The most important part of the experiment will be the extensive evaluation of these courses with typical students, both in the formative sense, during development, and in the summative sense. Summative evaluation should be conducted with at least tens of thousands of students, in a variety of types of schools, comparing these courses in detail with the existing courses in the areas involved. This full evaluation should not be done by individuals associated with the development; competent professional evaluators should plan and manage the evaluation.

Based on our studies at the University of California at Irvine, I estimate that this experiment in the full use of the computer in education will cost about \$200 million and will require about five years to complete. After such an experiment, we will have the information we need to remake our educational system and begin its full development.

### International Ramifications

An intriguing possibility to consider is multinational development. Joint activities at the University of California at Irvine and the University of Geneva in Switzerland have demonstrated that it is possible to structure computer-based learning material so that it is relatively easy to convert to a new language. Cultural differences may be present, but most of these can be taken care of in the translation process. Some areas may not lend themselves to such development, but in many areas, such as science and mathematics, courses can only benefit from international development. This approach should be particularly important for the developing countries, given their difficulties in developing full-scale educational systems.

Several of us worked at estimating the cost of full curriculum development. Conservatively, we should expect to spend about \$10 billion, perhaps over a period of about six to eight years. Another way of viewing this is that we would need to invest 1 percent of our educational costs each year in such development.

If we were to place education's cost as one of national value, the cost is about one-third of that of putting a person on the moon and is about one or two days of the military budget each year. These figures assume only one language; conversion to other languages would be a modest increase.

Education worldwide has major and increasing problems. We have the capability, using the new interactive technology, to ameliorate these problems. But this will only happen if we learn from the past to plan for the future. ■



# THE BAD NEWS ISN'T THE PRICE.

Okay, you could have saved thousands with Ability,<sup>™</sup> the \$99 integrated program that does everything your armload of programs does.

But maybe even more importantly, you could have saved tons of time and hassle.

Because we've combined six high-powered PC productivity tools into a single, simple package.

You get full-featured wordprocessing with no exotic codes to learn, and what-you-see-is-what-you-get formatting.

Spreadsheets larger than Symphony, with all the powerful math and business functions you need and the ability to import Lotus 1-2-3 files (and formulas where possible).

A forms-oriented database that's easier to use than pfs:file.

Professional business graphics from your spreadsheets and databases with just a few keystrokes.

**Ability: \$99.**

Menu-driven, Migent Pocket Modem<sup>™</sup> and Hayes-compatible communications.

Even "slide shows" with sound on your PC!

And smooth, seamless integration like nothing you've ever seen before.



Because with Ability, the table and graph you see in the letter aren't just copies pasted in—they're live.

So if you change the table in the letter, the changes are made in the linked spreadsheet or database that contains the underlying data. Or change the spreadsheet and the letter is updated at the same time. And the graph is automatically redrawn to reflect the changes, either way. (Perfect for those weekly and monthly reports.)

And anybody can do it with no programming at all, because Ability is menu-driven and uses the same instructions in all six applications.

At just \$99, Ability could even pay for your PC if you don't already have one.

Check it out at your local computer store or contact: Migent, Inc., P.O. Box 6062, Incline Village, NV 89450. (702) 832-3700.

**MIGENT<sup>™</sup>**

©Migent, Inc. 1986 Ability and Pocket Modem are trademarks of Migent, Inc. Other names and products trademarked by others.

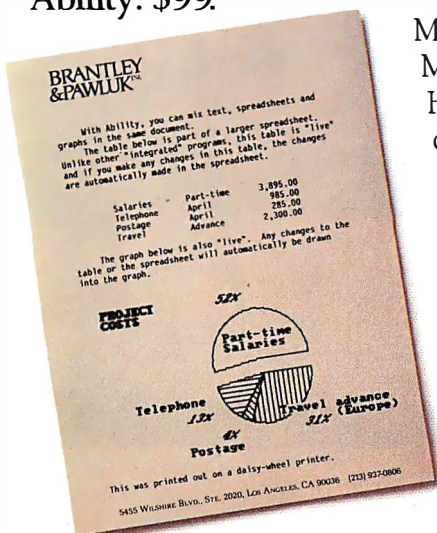



# Finally, a language worth

For years BASIC has been everyone's first language. And for almost as long, they've been tempted by other languages. Lured by promises of more speed, more power.

We have a solution. A new language that's a substantial improvement over BASICA. Faster. More structured. Finally, a compelling reason to leave BASIC.

Introducing Microsoft's QuickBASIC Compiler, Version 2.0.

At last, you can have the latest programming techniques, combined with the solid foundation of BASIC. Our new compiler is as compatible with BASICA as you can get. At the same time it offers the extra speed and power you've been looking for.

## Run faster with compiled code.

If there's one thing you've asked for, it's speed. And Microsoft® QuickBASIC simply blazes. Old BASICA programs will run up to ten times quicker once they've been compiled. Sometimes even faster.

## Everything you need. Built-in.

Making programs run faster is only part of the story, though. The new Microsoft QuickBASIC Compiler includes a full-screen editor, built-in. So now you can make the jump from writing to RUNning in no time flat. Edit your program, compile it, and run it. Faster than any other BASIC compiler around. All without leaving our on-line help and prompts.

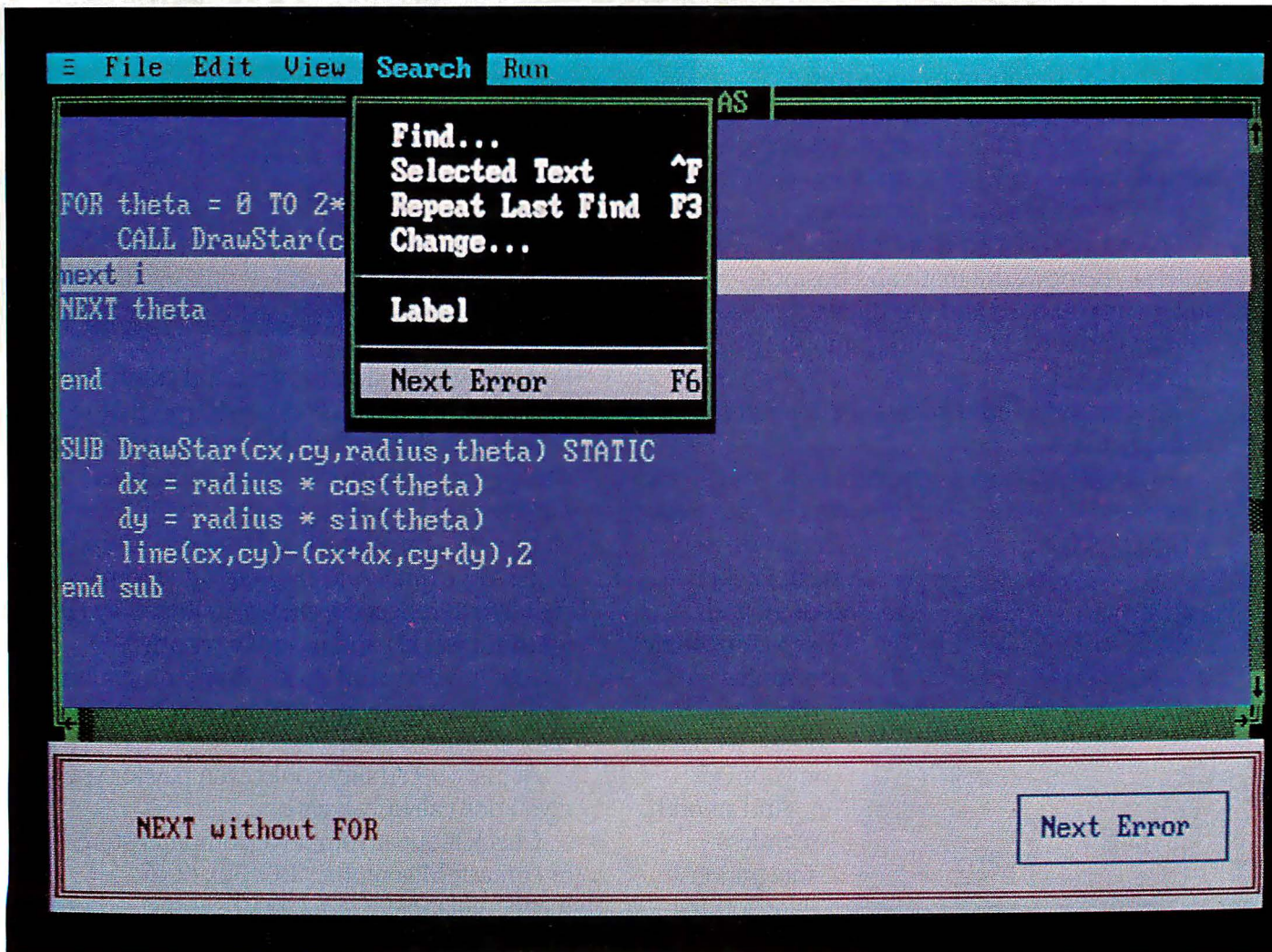



# leaving BASIC for.

On the rare chance your program doesn't run 100% the first time out, we've got another surprise for you. The Microsoft QuickBASIC debugger. Our full-screen tracing lets you debug your programs while watching the source code execute. A line at a time, or with breakpoints. As easy as can be.



Our compiler is also smart enough to save you time. First, by finding any errors in one pass. Second, by putting your editor's cursor on the problem. Automatically. So you don't have to get lost in a maze of error codes and line-numbers.

## The BASIC virtues. And more.

Speaking of line numbers, let's not. Because line numbers are strictly optional. And Microsoft QuickBASIC lets you use alphanumeric labels as well. Now you can GOTO *ErrorCheck* instead of line number 6815.

Or you could stop using GOTOs altogether. There are a variety of options that could make the GOTO an endangered species. Features like multi-line IF-THEN blocks. And named subprograms. Now your BASIC programs can be as structured and organized as you want.

We've only just begun to talk about the virtues of Microsoft QuickBASIC. There are dozens of enhancements to your favorite language. Things like larger arrays. Local and global variables. Reusable modules that let you create libraries of your most often-used routines. All explained in a revised manual that includes a complete language reference.

## Making your quick escape.

If all these features follow your BASIC instincts, then zip on down to your nearest Microsoft dealer. That's where you'll discover the best surprise of all. The price. Only \$99 for the best reason to leave BASIC.

For the name of your nearest Microsoft dealer, call (800) 426-9400. In Washington State and Alaska, (206) 882-8088. In Canada, call (416) 673-7638.

### Microsoft QuickBASIC Compiler Version 2.0 for IBM® PC and Compatible Computers.

#### BASICA Compatibility

- Sound statements including SOUND and PLAY.
- Graphics statements including WINDOW, VIEW, DRAW, GET, PUT, LINE, CIRCLE, LOCATE and SCREEN.
- Support of EGA extended graphics modes. NEW!
- BASICA structures are supported including WHILE/WEND, IF/THEN/ELSE, FOR/NEXT, GOSUB/RETURN, and event handling.

Results of Sieve Benchmark	BASICA 3.1	Microsoft QuickBASIC 2.0
Seconds per iteration	78	0.52

#### Complete Programming Environment

- Built-in Editor that places the cursor on found errors automatically. NEW!
- Compile entirely in memory at speeds up to 6000 lines per minute. NEW!
- Link routines once when starting a programming session and no need to link again when changing programs. NEW!
- Built-in debugger with single-step, animate, and trace modes. NEW!
- Create stand-alone programs.

#### Alphanumeric Labels

- Can be used to make your programs more readable. Line numbers are not required but are supported for BASICA compatibility.

#### Structured Programming Support

- Block IF/THEN/ELSE/END IF eliminates the need for GOTO statements. NEW!
- Subprograms can be called by name and passed parameters. Both local and global variables are supported.

#### Modular Programming Support

- Separate compilation allows you to create compiled BASIC libraries to use and re-use your programs.
- A library of routines to access DOS and BIOS interrupts is supplied. NEW!

#### Large Program Support

- Code can use up to available memory.
- Numeric arrays, each up to 64K bytes, can use up to available memory. NEW!

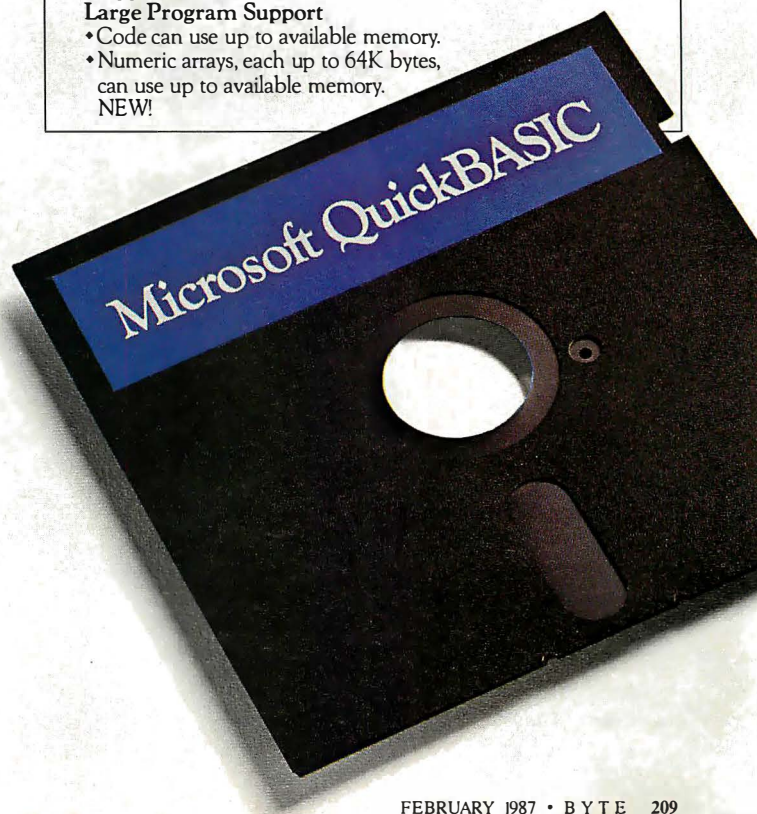

Microsoft® QuickBASIC  
The High Performance Software™

Inquiry 329



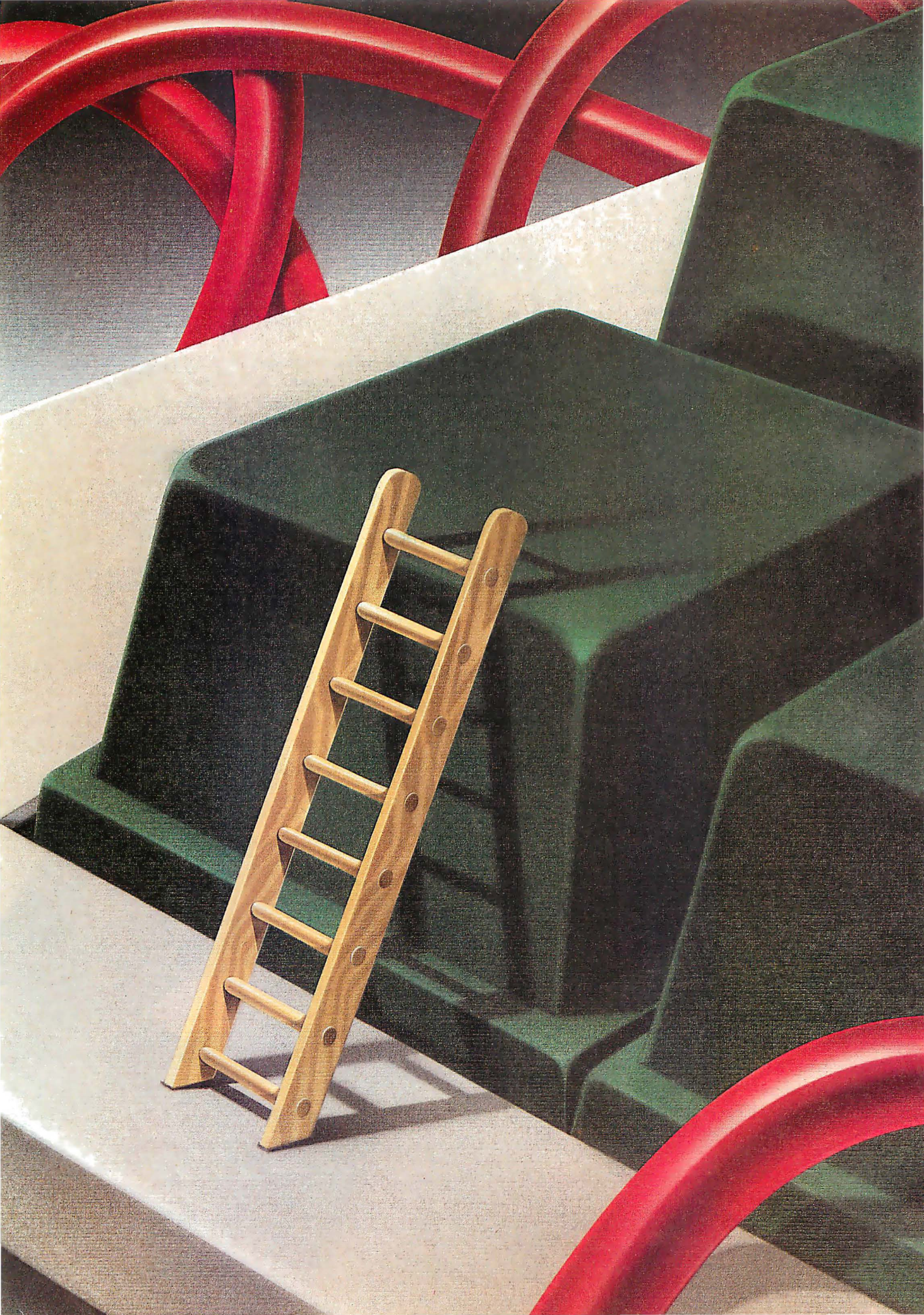



# Reviews

---

<b>Reviewer's Notebook</b> <i>by Jon Edwards</i> .....	213
<b>The ALR Access 386 and the Compaq Deskpro 386</b> <i>by Stanley J. Wszola and Curtis Franklin Jr.</i> .....	215
<b>Four Portable Computers</b> <i>by John D. Unger</i> .....	221
<b>The Atari 1040ST</b> <i>by Dave Menconi</i> .....	231
<b>Four Ink-Jet Printers</b> <i>by Robert D. Swearingin</i> .....	239
<b>Microsoft QuickBASIC 2.0</b> <i>by Dennis Dykstra</i> .....	247
<b>Forecast Master</b> <i>by Lowell Rosen</i> .....	255
<b>Public Domain Software for the Amiga</b> <i>by Warren Block</i> .....	256
<b>Review Feedback</b> .....	261

---

TWO OF THE FIRST available systems running on Intel's 80386 microprocessor are the Advanced Logic Research Access 386 and the Compaq Deskpro 386. BYTE's Stan Wszola and Curt Franklin find that both 16-MHz systems achieve a dramatically high level of performance, though each uses a slightly different design to do so. Both systems, our editors report, make other computers seem impossibly slow in comparison.

For those looking for portability rather than speed, John D. Unger examines four portable computers: the Toshiba T1100 Plus, the Zenith Z-181, the Bondwell 8, and the IBM PC Convertible. Although all four operate as well as full-fledged desktop IBM PC compatibles do, the T1100 Plus has the edge in performance and the Z-181 has the most readable screen.

On the 68000 front, Dave Menconi looks at the Atari 1040ST. Compared with the 520ST, the 1040ST has more memory, a built-in 3½-inch floppy disk drive and power supply, and the TOS desktop in ROM rather than on disk. The 1040ST, Menconi concludes, offers good value despite a few flaws. He also compares two 20-megabyte hard disk drives from Atari and Supra that complement the 1040ST's power.

In a review of ink-jet printers, Robert D. Swearingin examines four units ranging widely in capabilities, size, and price: the Diconix 150, the Quadram Quadjet, the Xerox Model 4020, and the Tektronix 4696. None had problems with clogged ink nozzles or reliability, as was common in earlier ink-jet printers. None was especially fast, but all provide quiet operation and good print quality.

High quality is the hallmark of Microsoft QuickBASIC 2.0, which reviewer Dennis Dykstra finds to be much more powerful than version 1.0. According to Dykstra, version 2.0 offers many of the advantages of an interpreter without sacrificing the speed of a compiler. These features, combined with its full-screen editor and other enhancements, make QuickBASIC 2.0 suitable for serious software developers.

For serious statisticians is Forecast Master, reviewed by Lowell Rosen. A time-analysis package with sophisticated forecasting techniques, Forecast Master is not for beginners, in part because of its inadequate documentation. Technical experts, though, will appreciate its many features, which include state-space and other univariate and multivariate procedures.

Finally, Warren Block surveys public domain programs for the Amiga, which fill the void caused by the relatively small number of commercial programs available for this machine. Block covers UNIX-like utilities and filters, a memory-display program, a presentation graphics program, and word processing and telecommunications software. All are available for a reasonable fee or for free, and all provide useful functions for Amiga owners.



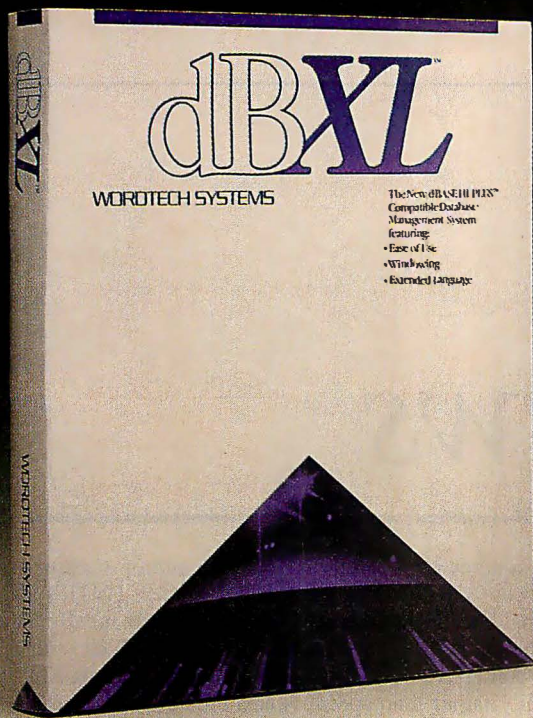

# Depending on which package you buy it in, dBASE® power will cost you \$169 or \$695.

Introducing dBase XL™  
The dBASE III Plus™ "Superclone"  
At just \$169, it makes paying  
for a name pretty pricey.

Just as you can buy two versions or more of programs like BASIC, you can now buy two versions of dBASE power. Depending on which version you buy, you'll get more or less the same performance for \$169 or \$695.

Get a lot more  
for a lot less with dBase XL.

With dBase XL, both files and syntax are compatible with dBASE III Plus. You can interchange databases, indexes, and other files between the two products. And if you've used dBASE, you'll only need to learn the commands we've added (yes added) to make the dBASE III language more powerful. They run the same. But with dBase XL you'll have more to run with.

If you're new to dBASE, dBase XL INTRO lets you run the program with menu choices. A "tutor" line simply shows you which dBASE III Plus command you're creating with the menu. If you goof, error messages are simple and easy-to-understand and two levels of *Help* are just a function key away. Even our documentation is easier. (Since it's written better, there's less of it. Look at the photo above.)

For you power users, we've included special features like access to DOS services, up to 99 windows without any other software, and automatic memory variable management. Whether you're programming for yourself or others, dBase XL is the ultimate development tool.

Unlike dBASE III Plus, dBase XL runs on PC-DOS or MS-DOS, so you can run it on the HP-150™, the TI Professional™, and the Apricot™, to name a few.

dBase XL. It's more power than the name brand without paying for the name.

## INTRODUCING dBase XL

WORDTECH SYSTEMS

P.O. Box 1747, Orinda, California 94563, (415) 254-0900, TELEX 503599

Not copy protected. dBase XL is a trademark of WordTech Systems. dBase III Plus and dBase are trademarks of the Ashton-Tate Corp. MS-DOS is a trademark of Microsoft Corp. PC-DOS is a trademark of IBM Corp. HP-150 is a trademark of Hewlett-Packard Corp. TI Professional is a trademark of Texas Instruments. Apricot F1 is a trademark of Apricot Corp.



# REVIEWER'S NOTEBOOK

Ah, COMDEX. Finally a show that deserved attention. There were 80386 systems, motherboards, and turbo boards in abundance, and I was very impressed watching CAD packages change perspectives almost instantaneously. More than 30 systems and boards, ranging substantially in capabilities and price, were displayed by Intel, Compaq, Zenith, and many other companies. Among them were American Computer and Peripheral, Kaypro, Convergent Technologies, Goldstar Semiconductor, Orchid, Quadram, ATronics, Computer Dynamics, Multitech Electronics, PC's Limited, Cheetah International, and Applied Reasoning. Judging from the demos, there is no doubt at all that the 80386's performance will make a substantial difference for software development.

If I had to sum up the show in only a few words (and I do), I'd say that this year the incremental advances in technology that always surface at COMDEX provided us with the clear promise of both more processing power per dollar and of brighter times ahead. The 80386 systems and boards were not the only signs of faster processing. Definioncon (31324 Via Colinas #108, Westlake Village, CA 91362, (818) 889-1646) released its new DSI-785 coprocessor system, which holds 16 megabytes of memory and runs at speeds up to 25 MHz. The microprocessor, a Motorola 68020, uses MS-DOS and supports real-time and multitasking operations. The DSI-785 can write to main memory using zero wait states at 16.67 and 20 MHz; it requires one wait state at 25 MHz. The board installs in any IBM PC XT or PC AT.

In Datavue Technical Systems' booth, I saw an IBM PC-compatible system that the company says has an average execution speed of 10 million instructions per second, equivalent to an Intel 8086 running at 150 MHz. Its top speed is 22 MIPS. The system, called the Advanced Personal Computer System, consists of the company's IBM PC compatible hooked to a black box that does all the processing except I/O. The box holds its own power supply and two Datavue boards that plug together and work as an 8086 emulator. The boards are based on the Datavue 86150 microprocessor, compatible with the 8086 instruction set. A company spokesman said that you can't hook the

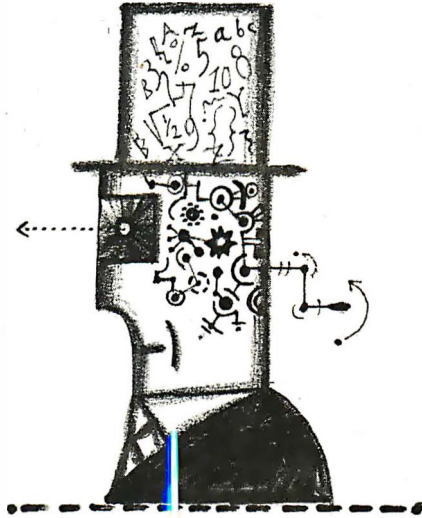

black box to any PC compatible, but the firm hopes to link it to IBM PC XTs and PC ATs soon. The box alone costs \$10,995. Packaged with Datavue's PC-compatible system, prices range from \$11,500 to \$15,000, depending on configuration. Datavue (4355 International Blvd., P.O. Box 2687, Norcross, GA 30093, (404) 564-5780) plans to ship the system sometime during the first quarter of this year.

Back in the office, there was the usual load of interesting things—perhaps less flashy than the high-powered machines at COMDEX, but useful nonetheless. Merak Industries' Addcard (8704 Edna Dr., Warren, MI 48093, (800) 231-4310) adds four short slots to your IBM PC or compatible for only \$79. The card plugs into the fifth expansion slot on an IBM PC and takes advantage of the space between the left disk drive, the power supply, and the fifth slot.

Caucus is an electronic conferencing system from Camber-Roth (243 Hoosick St., Troy, NY 12180, (518) 273-0983). With this software you can set up a conferencing system similar to BIX on your own IBM PC. The conferencing syntax is somewhat different from BIX's, but I was nonetheless impressed with the package's ease of installation and use.

Springboard Software Inc. (7808 Creekridge Circle, Minneapolis, MN 55435, (612) 944-3915) has introduced The Newsroom Pro for the IBM PC and compatibles with 512K bytes of RAM and a color graphics adapter. It lets you create newsletters and distinctive two-column

reports quickly and easily. Text automatically formats around graphics and repositions itself when you move the graphics. The package includes more than 2000 predrawn images and effective drawing and editing options.

Another interesting item for the IBM PC is Stay-Res from MicroHelp Inc. (2220 Carlyle Dr., Marietta, GA 30062, (404) 973-9272). A programming tool for BASIC development, Stay-Res allows you to easily make compiled programs memory-resident. Each memory-resident program requires only 7K bytes of DOS memory. At the moment, Stay-Res supports Microsoft QuickBASIC (version 1.0 or 2.0), the IBM BASIC compiler (version 1 or 2), and the Microsoft BASIC compiler (version 5.36). Programs compiled with QuickBASIC version 2.0 will require DOS 3.0 or higher.

I've also been trying Super PC-Kwik, a disk accelerator from Multisoft Corp. (18220 Southwest Monte Verdi Blvd., Beaverton, OR 97007, (503) 642-7108) that provides a flexible disk cache. I tried it for more than a week and noticed some small speed improvement in disk access, though the gain would undoubtedly have been far greater if I had a floppy-based system or had I given the cache more than the 60K bytes I could afford. If you have a Macintosh that you want to speed up, I recommend that you try TurboCharger from Nevins Microsystems (P.O. Box 1249, Capitola, CA 95010, (408) 479-0860). One of our technical editors, Tom Thompson, swears by this disk cache.

For the Amiga there is Impact!, a presentation graphics application from Aegis Development (2210 Wilshire Blvd., Suite 277, Santa Monica, CA 90403, (213) 306-0735). With this package, Aegis has once again tapped the Amiga's graphics abilities. The program's number of features is legion; in addition to the usual ones, you can assemble a slide show with preset pauses.

Finally, some personal news: I am moving on to an exciting new job at Princeton University. There is no joy in leaving BYTE and its top-notch staff, but I have no doubt that the magazine and staff will continue to prosper—my very best to them and to you all.

—Jon Edwards  
Senior Technical Editor, Reviews



# INTRODUCING POWER MOUSE™

COMPACT REMOTE POWER CONTROLLER WITH SURGE/MODEM PROTECTION

Finally—a remote power control unit for computer systems, work stations, and electronic equipment that fits in the palm of your hand. And provides comprehensive surge and spike protection for every unit it controls—including modems. It's called POWER MOUSE™—and it's only from Networx.®

With POWER MOUSE you give customers the ability to power-up an entire system—up to five components—at the touch of a single master switch. Or to control each unit individually with convenient push-push switches from a single, central controller.

Competitive power control units can occupy several times as much workstation space. And force customers to change the configuration of a system. Even alter its ergonomics.

With POWER MOUSE, only the compact "mouse" takes up any valuable workstation area. The separate remote power module mounts unobtrusively under the desktop, or in any convenient location. And provides the finest surge protection available, in a fraction of the usual workstation space.

Don't wait. Sell the first truly compact power control/surge suppression unit available—POWER MOUSE. And watch your customers come out of the woodwork.

Suggested list price \$199.95

- Meets IEEE 587 category A and B standards
- EMI and RFI filter
- Static protection
- LCD clock
- Five year warranty
- Made in U.S.A.

Call Networx toll-free, 1-800-522-2222.



Computer and Electronic Accessories  
203 Harrison Place, Brooklyn, NY 11237-1587



Hideaway remote power module protects entire system, even modems.





# The ALR Access 386 and the Compaq Deskpro 386

Stanley J. Wszola and Curtis Franklin Jr.

The Advanced Logic Research Access 386 (left) and the Compaq Deskpro 386 (right) are two of the first microcomputers available that use Intel's 80386 microprocessor. While still compatible with older software and hardware for the IBM PC XT and PC AT, both computers offer dramatically increased performance.

The Compaq Deskpro 386 was previewed by Tom Thompson and Dennis Allen in the November 1986 BYTE. The ALR Access 386 is newly released. Both computers use the 80386 microprocessor, but each uses a slightly different design to achieve high performance.

## Description

The ALR Access 386 is available in three basic configurations. All come with 512K bytes of RAM, a 1.2-megabyte floppy disk drive, one serial and one parallel port, an old-style PC AT-compatible keyboard (see photo 1), and eight expansion slots. The enhanced monochrome version adds a multifunction board with 512K bytes of RAM, an additional serial and parallel port, a 30-megabyte hard disk drive, a Hercules-compatible monochrome graphics card, and a high-resolution (720 by 300 pixels) monochrome monitor. The enhanced color version adds a multifunction board with 2 megabytes of RAM, an additional serial and parallel port, a 30-megabyte hard disk drive, an ALR EGA-compatible video card, and a 14-inch EGA/CGA color monitor. The machine that we reviewed was an enhanced color version that varied from the company's description by having only 512K bytes of RAM on the multi-function board.

The Access 386 is housed in a PC AT-style case that measures 21 by 17 by 6½ inches. The system unit weighs 42

*Two machines  
that offer high performance  
and compatibility*



pounds, making system relocation a proposition to be taken seriously. The Access 386 contains space for five half-height devices. The unit that we reviewed had three spaces occupied, two by a Seagate 4038 hard disk and one by a 1.2-megabyte floppy disk drive.

The Compaq Deskpro 386 comes in two different configurations. The Model 40 features 1 megabyte of RAM, a 1.2-megabyte floppy disk drive, and a 40-megabyte hard disk drive. The Model 130 has 1 megabyte of RAM, a 1.2-megabyte floppy disk drive, and a 130-megabyte hard disk drive. The system memory board for both models can be upgraded for a maximum of 10 megabytes. You can add extra memory boards for a total system maximum of 14 megabytes. Two keyboards are available. You can choose either the IBM PC-style 84-key keyboard

with a separate numeric keypad and 10 function keys or the IBM RT PC-style 101-key keyboard with a separate numeric keypad and cursor keys and 12 function keys. The unit measures 20 by 16½ by 6½ inches.

Compaq offers two optional monitor/video board combinations. The Compaq enhanced color graphics board and Compaq color monitor combination gives you a screen with 640- by 350-pixel resolution and 16 simultaneous colors out of a palette of 64. This board is compatible with the IBM Enhanced Graphics Adapter. The other combination is the Compaq dual-mode monochrome monitor with an amber or green screen and the Compaq video display controller board. This board is compatible with the IBM Color Graphics Adapter and provides composite and RGB output. The Deskpro 386 also has an I/O card for parallel and serial output.

The Deskpro 386 maintains the same case style as previous Deskpro models. The front panel holds the keyboard connector and security lock and has space for up to four half-height 5¼-inch floppy disk drives. The rear panel includes connections for composite and RGB video output, a serial port (male DB-9 connector), a parallel connector (female DB-25), and a DIN connector for the monitor power interface for a monochrome monitor. The model we reviewed had 1 megabyte of RAM on the system memory board, an 80287 math coprocessor chip, one 1.2-megabyte floppy disk

*continued*

*Stanley J. Wszola, a BYTE technical editor, and Curtis Franklin Jr., an associate technical editor, can be reached at BYTE, One Phoenix Mill Lane, Peterborough, NH 03458.*



drive, one 360K-byte floppy disk drive, a 40-megabyte hard disk drive, and a 40-megabyte tape-cartridge backup unit. The Model 40 weighs 42 pounds.

### Under the Hood

When we removed the case from the ALR Access 386, two things initially caught our attention: the two 32-bit bus slots and the section of blue jumper wires snaking across the motherboard. At first glance, the 32-bit slots appear as though they were based on the PC AT slots and use a double-length extender section (see photo 2). According to ALR, this is a proprietary design with no attempt made to conform to any of the preliminary 32-bit bus standards. ALR says that it will offer memory-expansion cards for this bus but has no information on other companies' products that might work in the slots. The jumper wires are a disconcerting touch in a production machine.

The Access 386 has eight expansion slots (two 8-bit IBM PC-compatible, four 16-bit PC AT-compatible, and two 32-bit), of which five are available to the user. Two of the PC AT-compatible slots are filled with a disk controller and a multifunction card. One of the PC-compatible slots holds the display adapter. Since the 32-bit slots are located near the disk drive enclosures, anyone using these slots will face routing disk controller cables either over or under the 32-bit cards.

The Compaq Deskpro 386 is also a unique machine internally. At first glance,

the most striking feature is the location and configuration of the system memory board. In contrast to the other 8- and 16-bit slots located toward the rear of the motherboard, the memory board's 32-bit slot is positioned on the right side of the motherboard toward the front of the computer (see photo 3). The power and ground connection slot for the memory board is located at the rear of the motherboard. This places it out of the way of any other board slots. At the time of this review we didn't have any of the piggy-back memory boards, so we don't know how wide a fully loaded system memory board is. This 32-bit slot is also a proprietary design without any support from other board manufacturers.

The Deskpro 386 has eight slots: three 8-bit IBM PC-compatible, four 16-bit PC AT-compatible, and one 32-bit. On the machine we reviewed, the hard disk/floppy disk controller card used one 16-bit slot, the parallel/serial card used one 16-bit slot, and the enhanced color graphics board used one 8-bit slot.

### Data Storage

Putting a slow hard disk drive on an 80386-based computer is like never taking an exotic racing car out of second gear. Both ALR and Compaq have tried to get around this performance bottleneck by using fast-access drives.

The Access 386 uses the Seagate ST4038, a 30-megabyte hard disk. Using the CORE International Coretest Disk

Performance Program to evaluate disk performance, we recorded a data-transfer rate of 165K bytes per second, an average seek time of 36.5 milliseconds, and a track-to-track seek time of 9.9 ms. These are good results for a hard disk. This can be attributed to the hard disk and the Western Digital WD1003-WA2 floppy/hard disk controller board. This is a 16-bit board with a 765 controller chip and other Western Digital chips.

The Deskpro 386 takes hard disk performance a step further. The computer uses the Control Data Model 94208-51 hard disk, a 40-megabyte drive configured as two drives: C and D. Using the same Coretest Disk Performance Program, we recorded a data-transfer rate of 200K bytes per second, an average seek time of 25.7 ms, and a track-to-track seek time of 4.0 ms. This improved performance is due in part to the Compaq Multipurpose Fixed Disk Controller card. This 16-bit board is a combination serial, parallel, floppy, and hard disk controller card. This card has the 765 disk controller chip, but it also has custom LSI chips that handle some drive-control functions and perform address decoding for the hard disk, thereby increasing the speed for data access.

The above times are averages taken from several tests and are only meant to show relative performance. The ALR Access 386 is a good performer, but it is clear that the Compaq Deskpro 386 has a hard disk system that better matches the 80386 in performance.

The Deskpro 386 also includes a 40-megabyte tape cartridge unit. This unit, an Irwin Magnetic Systems Model 145, can store an entire 40 megabytes on one DC 2000 tape cartridge. It can also read a DC 1000 tape cartridge, the type used on previous models of Compaq computers.

### Expandability

Both computers are capable of significant memory and storage expansion because of their mix of 8-, 16-, and 32-bit sockets for expansion boards.

The Access 386's power supply is rated at 200 watts, sufficient power for almost any expansion. The motherboard has a socket for the addition of an (as yet unreleased) 80387 numeric coprocessor chip. If you need a numeric coprocessor before the 80387 becomes available, ALR offers a small board that contains a high-speed 80287 and plugs into the 80387 socket. Unfortunately, you must remove the hard disk drive to gain access to the 80387 socket.

The Deskpro 386 is equally blessed with room for expansion. Its power supply is also rated at 200 watts. The motherboard has a socket for an 80287 numeric



Photo 1: The ALR Access 386 keyboard.



## REVIEW: ALR ACCESS 386 AND COMPAQ DESKPRO 386

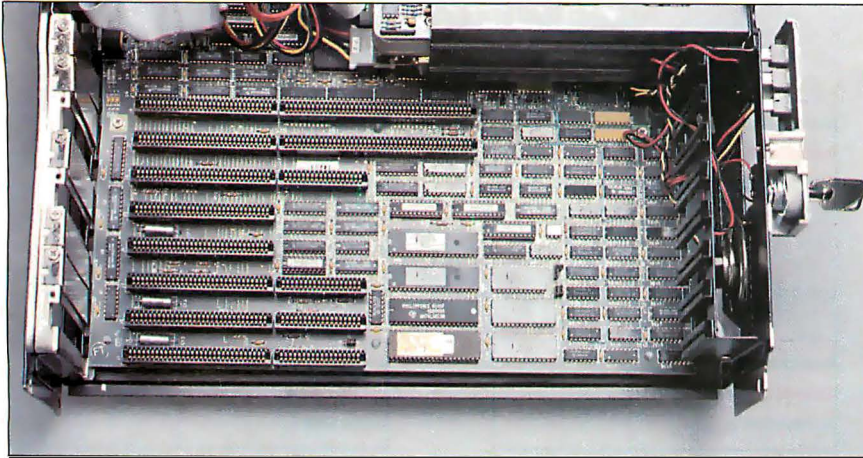

**Photo 2:** Motherboard for the ALR Access 386. Note the 32-bit bus connectors on the upper left side near the power supply and the jumpers on the upper right side of the board.

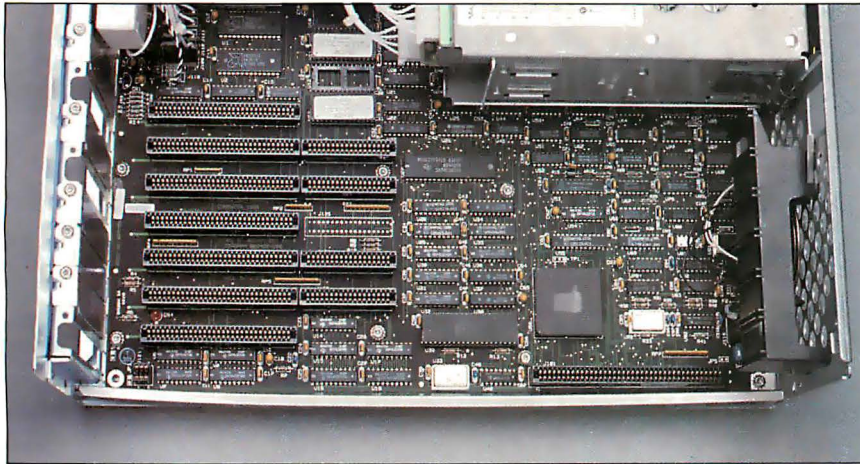

**Photo 3:** Motherboard for the Compaq Deskpro 386. The 32-bit bus connector for the system memory board is located in the lower right corner, while the power and ground connectors are in the lower left corner.

coprocessor chip. The socket is located near the system memory board slot and is easily accessible.

### Software

The only software that came with the Access 386 was a setup disk containing programs to set system parameters and the time and date on the internal clock/calendar. We used PC-DOS 3.2 as the operating system and experienced no compatibility problems. ALR will bundle Quarterdeck Office Systems' DESQview 1.3 and an expanded memory manager with the machine.

The Deskpro 386 comes with MS-DOS 3.1, Compaq BASIC 3, and the Compaq Expanded Memory Manager (CEMM). CEMM is a software driver that allows programs to use memory beyond the 640K-byte limit imposed by MS-DOS. CEMM is compatible with the Lotus/Intel/Microsoft Expanded Memory

Specification. You can configure the driver to use up to 8 megabytes.

We used several software packages with both computers, including The Norton Utilities, Norton Commander, XyWrite III, Lotus 1-2-3, and Microsoft Multiplan. All the programs operated correctly, and their speeds were significantly improved when running at 16 MHz.

Unlike the ALR Access 386, the Deskpro 386's running speed can be altered to allow you to run software that is timing-critical. The Compaq DOS includes a MODE SPEED command for changing the speed of the microprocessor. The default parameter is Auto, which will automatically switch the speed as required by certain programs. For maximum speed you can set the speed to High, which is 16 MHz. If a program has difficulty running, you can use the Fast mode to reduce the speed to 8 MHz. For even more com-

*continued*

# DRIVE INN

Enclosures  
& power  
supplies for  
**FLOPPY,  
WINCHESTER,  
TAPE DRIVES,  
SINGLE  
BOARD  
COMPUTERS  
&  
S-100  
SYSTEMS.**

8 inch  
5 inch  
3 inch

**CUSTOMIZING  
AVAILABLE**

Call or write  
for free  
catalogs  
and  
application  
assistance.

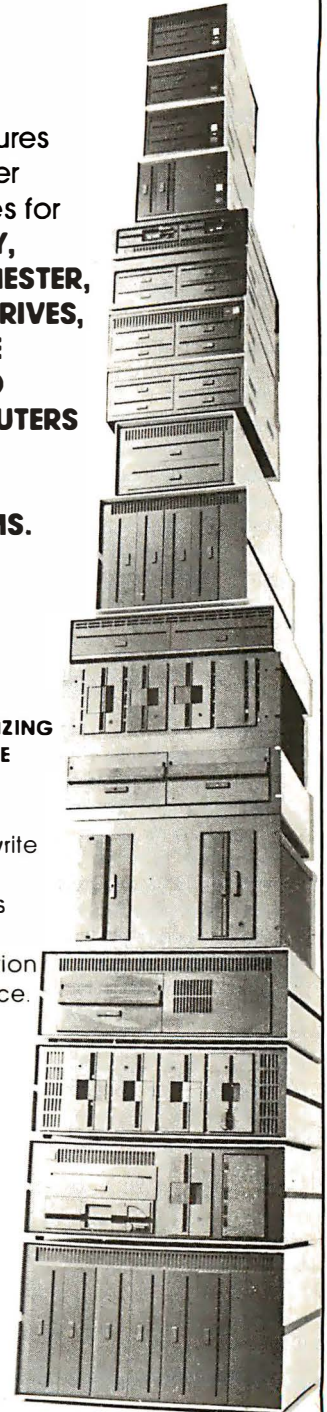

## INTEGRAND

RESEARCH CORPORATION  
8620 Roosevelt Ave. • Visalia, CA 93291  
209/651-1203

TELEX 5106012830 (INTEGRAND UD)  
EZLINK 62926572

We accept BankAmericard/VISA  
and MasterCard



**ALR Access 386**

**Company**

Advanced Logic Research Inc.  
10 Chrysler Ave.  
Irvine, CA 92718  
(714) 581-6770

**Size**

21 by 17 by 6½ inches; 42 pounds

**Components**

**Processor:** 16-MHz 32-bit Intel 80386; socket for optional Intel 80387 numeric coprocessor operating at 16 MHz or 80287 numeric coprocessor module operating at 10 MHz

**Memory:** 512K bytes of 32-bit interleaved RAM; 32K bytes of Phoenix BIOS ROM

**Mass storage:** 1.2-megabyte floppy disk drive; 30-megabyte hard disk drive with 40-ms access time

**Keyboard:** 84-key PC AT-style keyboard with separate numeric keypad

**I/O interfaces:** RS-232C serial port with male DB-25 connector; parallel port with female DB-25 connector

**Documentation**

Access 386 user's manual

**Price**

Basic system with 512K bytes of RAM, 1.2-megabyte floppy disk drive, and one serial and one parallel port: \$3990

Enhanced monochrome system with 1 megabyte of RAM, 1.2-megabyte floppy disk drive, 30-megabyte hard disk drive, two serial and two parallel ports, Hercules-compatible monochrome graphics card, and high-resolution monochrome monitor: \$5890

Enhanced color system with 2.5 megabytes of RAM, 1.2-megabyte floppy disk drive, 30-megabyte hard disk drive, three serial and three parallel ports, ALR EGA-compatible video card, and EGA/CGA color monitor: \$6949

**SYSTEM FEATURES**

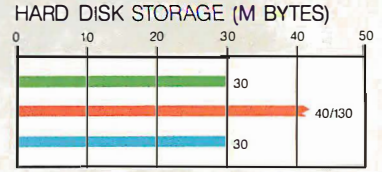

**DISK ACCESS IN BASIC (IN SECONDS)**

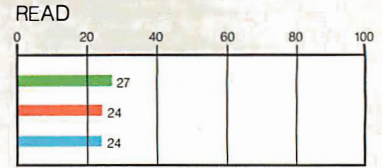
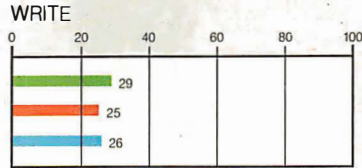

**BASIC PERFORMANCE (IN SECONDS)**

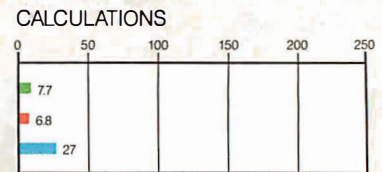
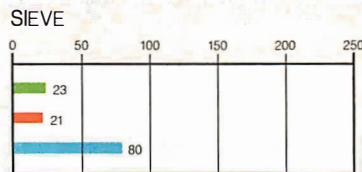

**SYSTEM UTILITIES (IN SECONDS)**

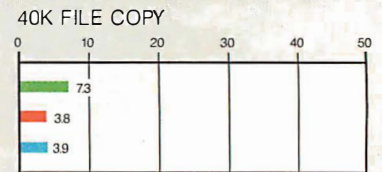
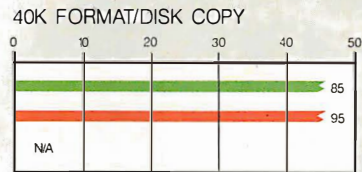

**SPREADSHEET (IN SECONDS)**

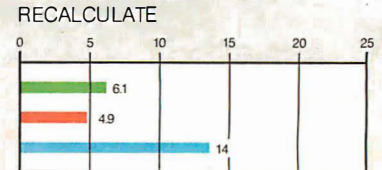

■ ALR ACCESS 386 ■ COMPAQ 386 ■ IBM PC AT

The Memory Size graph shows the standard and optional memory available for the computers under comparison. The Hard Disk Storage graph shows the highest capacity of a single hard disk drive. The graphs for Disk Access in BASIC show how long it takes to write and then read a 64K-byte sequential text file to a blank 1.2-megabyte floppy disk. (For the program listings, see BYTE's *Inside the IBM PCs*, Fall 1985, page 195.) The Sieve graph shows how long it takes to run one iteration of the Sieve of Eratosthenes prime-number benchmark. The Calculations graph shows how long it takes to do 10,000 multiplication and 10,000 division operations using single-precision

numbers. The System Utilities graphs show how long it takes to format and copy a 40K-byte file using the system utilities. The Spreadsheet graphs show how long it takes to load and recalculate a 25-by-125-cell spreadsheet in which each cell equals 1.001 times the cell to its left.

The spreadsheet used was Microsoft's Multiplan version 1.06. Tests on the ALR Access 386 computer were done using PC-DOS 3.2 and GW-BASIC 3.11. The Compaq Deskpro 386 used Compaq DOS 3.1 and Compaq BASIC 3.11. The IBM PC AT used PC-DOS 3.2 and BASICA 3.2 running at 6 MHz.



**Compaq Deskpro 386****Company**

Compaq Computer Corp.  
20555 FM 149  
Houston, TX 77070  
(713) 370-0670

**Size**

20 by 16½ by 6½ inches; 42 pounds

**Components**

Processor: 16-MHz 32-bit Intel 80386; socket for optional Intel 80287 16-bit coprocessor operating at 8 MHz

Memory: 1 megabyte of 32-bit 100-ns memory on system memory board; 128K bytes of BIOS ROM

Mass storage: 1.2-megabyte 5¼-inch floppy disk drive; 40-megabyte hard disk drive with 30-ms access time

Keyboard: 84-key IBM PC-style keyboard with separate numeric keypad and 10 function keys; 101-key IBM RT PC-style keyboard with separate numeric keypad, cursor keys, and 12 function keys

IO interfaces: RS-232C serial port with male DB-9 connector; parallel port with female DB-25 connector

**Options**

XENIX System V/286 base operating system:	\$599
Software development system:	\$599
Text processing system:	\$199
Compaq color monitor:	\$799
Compaq dual-mode monochrome monitor:	\$255
Enhanced color graphics board:	\$599
Video display controller board:	\$199
40-megabyte tape cartridge backup unit:	\$799
Additional 1 megabyte of RAM for system memory board:	\$549
2-megabyte piggyback board with 1 megabyte of RAM:	\$849
2-megabyte piggyback board with 2 megabytes of RAM:	\$1398
8-megabyte piggyback board with 4 megabytes of RAM:	\$2999
Additional 4 megabytes of RAM for 8-megabyte piggyback board:	\$2699
360K-byte 5¼-inch floppy drive:	\$225

**Documentation**

Operations guide; MS-DOS reference guide; BASIC reference guide. Optional: two-volume technical reference guide; color graphics board installation and operations guide; maintenance and service guide.

**Price**

Model 40 with 1 megabyte of RAM, 1.2-megabyte floppy disk drive, and 40-megabyte hard disk drive:	\$6499
Model 130 with 1 megabyte of RAM, 1.2-megabyte floppy disk drive, and 130-megabyte hard disk drive:	\$8799

patibility, you can set the mode to Common, which reduces the speed to 6 MHz. No matter what speed you set the microprocessor at, the bus will remain at 8 MHz. The speed you select remains in effect until you turn the computer off.

Both computers failed one favorite test of compatibility: They wouldn't run Microsoft's Flight Simulator. Both computers attempted to boot the program but then locked up, and we had to turn them off before we could restart them. We weren't too disappointed; these computers are definitely not game machines.

The future of software for the 80386 looks bright. Already software developers have written development software such as 386/ASM and 386/LINK, an 80386 assembler and linker package from Phar Lap Software (60 Aberdeen Ave., Cambridge, MA 02138, (617) 661-1510). DESQview version 1.3 supports both computers' virtual machine architecture and allows you to run up to nine programs concurrently with multiple windows.

**Benchmark Results**

There is a danger in using computers such as the Access 386 and the Deskpro 386; most other personal computers seem hopelessly slow in comparison. Judged by most standards of microcomputer performance, the Access 386 and Deskpro 386 fairly fly. They are fast enough to require a reworking of one of the BYTE benchmarks. The 25- by 25-cell spreadsheet loaded so quickly (considerably less than 1 second) that human reaction time became a major variable in timing. To compensate, we used a 25- by 125-cell spreadsheet and still had impressive results.

In a side-by-side comparison of the benchmark results, the Deskpro 386 came out as the faster computer, but not by much. In most tests, the timing difference was only seconds. These differences can be attributed to variations in the hardware design, ROM BIOS, and DOS. For most practical applications, the Deskpro 386 and Access 386 are comparable.

**Documentation**

The user's manual that comes with the Access 386 is not a glossy color affair, but the production values are not what makes it an unsatisfactory document. Its first major drawback is the lack of an index. Some areas, such as the setting of switches and jumpers, are well covered but difficult to find without an index. Another major drawback is in the emphasis of the documentation. It is very curious that, in a manual for a computer of this type, the keyboard receives more pages than any other topic. The manual does not mention the 32-bit bus, but it does explain the function of the space bar. Another draw-

back of the documentation is the lack of illustrations. Of the illustrations provided, 28 are of the keyboard, and all are of poor quality.

The beginning of the manual refers the reader to several component manuals for "detailed information on the various sub-assemblies," but this does not take away the requirement for comprehensive, well-organized documentation covering the computer as a whole. Another flaw is the reference to the use of IBM's BASICA on the Access 386. BASICA will run only on true IBM PC-compatible computers. This is a glaring error that detracts from the quality of the computer.

In contrast, the Deskpro 386 comes with a wealth of information. Standard manuals included with the computer are an operations guide, an MS-DOS reference guide, and a BASIC reference guide. Optional manuals available are a two-volume technical reference guide, a color graphics board installation and operations guide, and a maintenance and service guide. All the manuals are well written, indexed, and thoroughly illustrated. They cover every feature of the computer, operating system, and software.

**Summary**

There has been a lot of discussion about who needs an 80386 computer. The 80386 systems are ideal for software developers, heavy-duty database users, and computer users who do intense number crunching. They would all benefit from the increased speed and performance. However, the real motivation for buying an 80386-based system is speed. No user likes to wait for a computer.

The ALR Access 386 is a computer that is high-performance in nearly every sense of the word. As one of the first in a new generation of small computers, it shows impressive performance gains while providing compatibility with old, familiar software. With a base price of \$3990, the Access 386 would be a true bargain except for two problems: Soldered jumper wires on the motherboard of a computer of this sophistication are of great concern to us, and the poor quality of the documentation is inexcusable. If these two problems are of little concern to you, then the ALR Access 386 offers high-speed microcomputing at a very reasonable cost.

The Compaq Deskpro 386 excels in nearly every capacity. It has a solid design with outstanding performance, and it is backed by the proven support of Compaq. However, all this excellence comes at a high price. The basic Model 40 lists for \$6499. A Model 40 comparably equipped to an ALR Access 386 enhanced color system would cost over \$8700. You pay for the Compaq quality. ■



# IS GETTING THE ANSWER TO SOFTWARE PROBLEMS A BIGGER PROBLEM THAN THE PROBLEM?

**Don't stay on hold when there's help online from CompuServe® Software Forums.**



The new upgraded version of your software locks up. And every time you reboot, you get stuck in the same place in the program.

You've chucked the manual, because you've done exactly what it tells you to do six times already. So you call the software company.

Now you spend half a day beating your head against a brick wall of busy signals, ranting at recorded messages, hanging around on hold. And you still don't get the solution to your problem.

Meanwhile, progress is stopped and your profits are dribbling away. But wait. There's help...

Several prominent, progressive software publishers recognize this problem, and working with CompuServe, have developed a solution—CompuServe Software Forums.

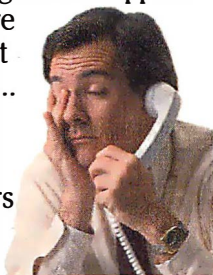

Now you can go online with experts from the companies that produced your software and get

prompt, written answers to your specific problems. You can even talk with the actual software developers.

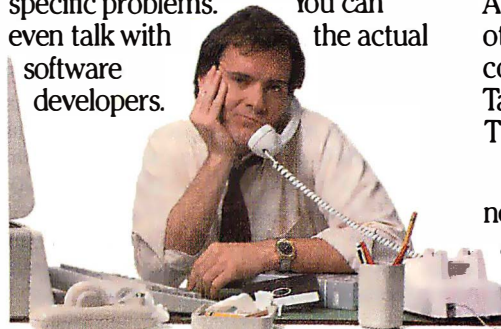

Aldus®, Ashton-Tate®, Autodesk®, Borland International®, Creative Solutions®, Digital Research®, Living Videotext®, Lotus® Inc., Microsoft®, MicroPro®, Misosys Inc.® and Software Publishing® all have CompuServe Software Forums. And we keep adding more.

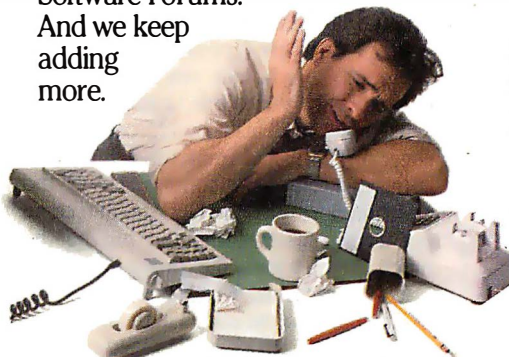

CompuServe's large subscriber base also puts you in touch with thousands of other, often more experienced, users of the same software. You'll find they can give you lots of creative ways to get the most out of your software.

And software forums are the best way to learn about product updates, new product announcements, new ways to expand the uses of your software, and offer free uploads of your own programs.

Our online electronic magazines

frequently publish software reviews. And you can find help for many other software products in our other computer-related forums for IBM®, Tandy®, Atari®, Apple®, Commodore®, TI® and others.

The last thing you need when you've got a software problem is a bigger problem getting answers. So, from now on, get prompt, informed answers on CompuServe Software Forums.

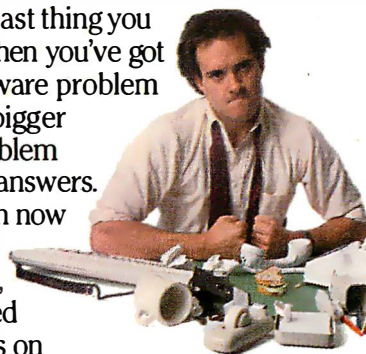

To buy your CompuServe Subscription Kit, see your nearest computer dealer. Suggested retail price is \$39.95.

To order direct or for more information, call 800-848-8199 (in Ohio, 614-457-0802).

If you're already a CompuServe subscriber, just type GO SOFTWARE at any ! prompt.

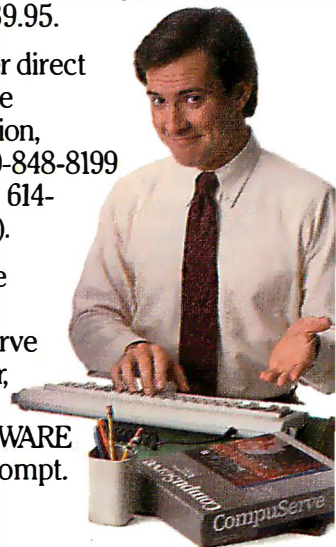

## CompuServe®

Information Services, P.O. Box 20212  
5000 Arlington Centre Blvd., Columbus, OH 43220

An H&R Block Company





# Four Portable Computers

John D. Unger

## *IBM PC-compatible offerings from Toshiba, Zenith, Bondwell, and IBM*

In this review, I'll compare four IBM PC-compatible portable computers: the Toshiba T1100 Plus (lower right), the Zenith Z-181 (upper left), the Bondwell 8 (lower left), and the IBM PC Convertible (upper right). Perhaps because of their small size, I found these computers to be much more "personal" than the many desktop machines I have used and reviewed over the years. All four use double-sided 3½-inch disk drives that store 720K bytes, and all but the Bondwell come equipped with dual drives. All but the IBM Convertible come with MS-DOS 2.11 and GW-BASIC.

The Toshiba T1100 Plus's standard configuration (\$1999) is impressive. It includes 256K bytes of RAM, parallel and serial ports, RGB and composite video ports, an LCD screen, a connector for an external disk drive, and Borland's SideKick program. The unit I reviewed also had an optional internal 1200-bps modem and 640K bytes of RAM (the 640K-byte model costs \$2399). The T1100 Plus stands out from the pack in processing speed: It has an 80C86 microprocessor that you can switch between 4.77 MHz and 7.16 MHz.

The Zenith Z-181 (\$2399) includes 640K bytes of RAM and the same standard features as the T1100 Plus. The Z-181 also has a backlit display with an aspect ratio like that of a standard CRT display. In addition, the Z-181 includes a ROM-based program called MPM-180, which contains advanced hardware diagnostics, a debugging facility similar to Microsoft's Debug, and other useful system-related utilities.

Unlike the other units reviewed here, the Bondwell 8 (\$1295) has only one internal 3½-inch disk drive; a second external drive is available as an option. The system comes equipped with 512K bytes

of RAM, which cannot be expanded, and an internal 300-bps modem. The Bondwell 8 also has a communications program called MODEM8 for use with its internal modem. Like the Z-181, the Bondwell 8 uses a backlit LCD.

The IBM PC Convertible (\$1995) comes with the least number of standard features. It has only 256K bytes of RAM, which you can upgrade to a maximum of 512K, and it has no I/O ports on its main board. You can add options to the PC Convertible by connecting "slices" of hardware onto the rear of the machine via a proprietary bus. Each slice has an input and an output connector, which allows you to stack slices one behind the other on the back of the machine. Even without any slices added, the IBM is a full two or more inches deeper than the other systems. You should expect to add about

\$1000 to the base price for extras, including an operating system (\$95), to make the PC Convertible comparable to the T1100 Plus or the Z-181 system.

The PC Convertible includes, however, an LCD screen and an icon-based set of programs called Application Selector, which is actually a shell that sits on top of the operating system. The Application Selector provides access to a disk-based series of programs that includes a simple word processor, an appointment calendar, a phone directory and auto-dialer, and a calculator.

### Portable Hardware

As befits a true portable computer, three of the machines have a handle for easy carrying; only the Z-181 lacks this convenience. The handles on the T1100 Plus and Bondwell 8 fold out of the front and rear of the case, respectively, and the PC Convertible's handle slides out of the front just beneath the keyboard and doubles as a comfortable wrist rest for typing on a tabletop.

Each machine is a self-contained unit capable of operating continuously for at least five hours on a single charge of its internal nickel-cadmium batteries. However, each laptop uses a different battery configuration. The T1100 Plus has a 9-volt system, the PC Convertible's has 15 volts, the Bondwell 8's has 13.8 volts, and the Z-181's has 18 volts. You can plug or unplug the AC adapter/chargers for the Z-181, the T1100 Plus, and the PC Convertible from their respective computers

*continued*

*John D. Unger (P.O. Box 95, Hamilton, VA 22068) is a geophysicist for the U.S. government who writes graphics software and uses computers to study the structure of the earth's crust.*





**T1100 Plus**

**Company**

Toshiba America Inc.  
Information Systems Division  
2441 Michelle Dr.  
Tustin, CA 92680  
(714) 730-5000

**Size**

12 by 12 by 2½ inches; screen size: 9 by 4 inches; weight: 10 pounds

**Components**

**Processor:** 80C86, keyboard-switchable from 4.77 to 7.16 MHz

**Memory:** 256K bytes of RAM (standard); expandable to 640K bytes on system board as option; 640K-byte model available

**Mass storage:** Two 720K-byte double-sided, double-density 3½-inch floppy disk drives

**Display:** 80-column by 25-row LCD; emulates IBM Color Graphics Adapter in black and white to give 320- by 200-pixel or 640- by 200-pixel monochrome graphics

**Keyboard:** 81 keys, including 10 function keys; special editing key cluster; numeric keypad selectable on ASCII keyboard

**Battery power:** 9-volt nicad rechargeable; approximate lifetime: 8 to 10 hours

**Expansion:** Optional expansion chassis with five IBM PC-compatible slots

**I/O interfaces:** RS-232C serial port, 9-pin male D-shell; Centronics-compatible parallel port for printer or optional external disk drive, 25-pin female D-shell; IBM PC-compatible RGB video port; composite video port with phono jack; IBM PC-compatible I/O bus

**Software**

MS-DOS 2.11; SideKick; GW-BASIC

**Options**

External 5¼-inch disk drive; internal 300/1200-bps Hayes-compatible modem; floppy link card for IBM PC-compatible desktop computer; 384K-byte memory expansion board; five-slot expansion chassis; automotive power adapter

**Documentation**

User's manual; MS-DOS manual; SideKick manual

**Price**

256K-byte model: \$1999  
640K-byte model: \$2399

**Z-181**

**Company**

Zenith Data Systems  
1000 Milwaukee Ave.  
Glenview, IL 60025  
(312) 391-8860

**Size**

11½ by 13½ by 3 inches; screen size: 8½ by 6½ inches; weight: 12 pounds

**Components**

**Processor:** 80C88 at 4.77 MHz; socket for 8087 coprocessor

**Memory:** 640K bytes of RAM (standard)

**Mass storage:** Two 720K-byte double-sided, double-density 3½-inch floppy disk drives

**Display:** 80-column by 25-row LCD; emulates IBM Color Graphics Adapter in gray tones to give 320- by 200-pixel or 640- by 200-pixel monochrome graphics; uses electroluminescent backlighting

**Keyboard:** 75 keys, including 10 function keys; special editing key cluster; numeric keypad selectable on ASCII keyboard

**Battery power:** 18-volt nicad rechargeable; approximate lifetime: 5 to 7 hours

**Expansion:** None

**I/O interfaces:** RS-232C serial port, 25-pin male D-shell; Centronics-compatible parallel port for printer; port for optional external disk drive, 25-pin female D-shell; IBM PC-compatible RGB video port

**Software**

MS-DOS 2.11; GW-BASIC; MPM-180

**Options**

External 5¼-inch disk drive; internal 300/1200-bps Hayes-compatible modem; 8087 coprocessor

**Documentation**

User's manual

**Price**

\$2399

**Bondwell 8**

**Company**

Bondwell Inc.  
3300 Seldon Court  
Suite 10  
Fremont, CA 94539  
(415) 490-4300

**Size**

12¼ by 11¼ by 3 inches; screen size: 9 by 3 inches; weight: 11½ pounds

**Components**

**Processor:** 80C88 at 4.77 MHz

**Memory:** 512K bytes of RAM (standard)

**Mass storage:** One internal 720K-byte double-sided, double-density 3½-inch floppy disk drive

**Display:** 80-column by 25-row LCD with electroluminescent backlighting; emulates IBM Color Graphics Adapter in shades of gray to give 320- by 200-pixel color graphics or 640- by 200-pixel monochrome graphics

**Keyboard:** 76 keys, including 10 function keys; special editing key cluster; numeric keypad selectable on ASCII keyboard

**Battery power:** 13.8-volt nicad rechargeable; approximate lifetime: 4 to 6 hours

**Expansion:** None

**I/O interfaces:** RS-232C serial port, 9-pin female D-shell; Centronics-compatible parallel port, 15-pin female D-shell; external floppy disk drive port for optional disk drive; IBM PC-compatible RGB video port; composite video port with phono jack; standard telephone jack for internal 300-bps modem

**Software**

MS-DOS 2.11; GW-BASIC 2.02; MODEM8 communications software

**Options**

External 3½-inch disk drive; external 5¼-inch disk drive; serial and parallel cables

**Documentation**

User's manual; MS-DOS and GW-BASIC user's guides

**Price**

\$1295



**IBM PC Convertible**

**Company**

IBM Corp.  
11400 Burnet Rd.  
Austin, TX 78758  
(512) 838-3300

**Size**

14¼ by 12 by 3 inches; screen size: 10¼ by 3½ inches; weight: 12½ pounds

**Components**

**Processor:** 80C88 at 4.77 MHz

**Memory:** 256K bytes of RAM (standard); expandable to 512K bytes on system board as option

**Mass storage:** Two 720K-byte double-sided, double-density 3½-inch floppy disk drives

**Display:** 80-column by 25-row LCD; emulates IBM Color Graphics Adapter in black and white to give 320- by 200-pixel or 640- by 200-pixel monochrome graphics

**Keyboard:** 78 keys, including 10 function keys; special editing key cluster; numeric keypad selectable on ASCII keyboard

**Battery power:** 15-volt nicad rechargeable; approximate lifetime: 9 to 11 hours

**Expansion:** Accepts two optional additional 128K-byte memory boards and an internal modem

**I/O interfaces:** IBM 72-pin proprietary expansion bus; plug for external power supply/battery charger

**Software**

IBM Application Selector software

**Options**

PC-DOS 3.2; internal 300/1200-bps modem; dot-matrix printer; serial/parallel adapter; CRT display adapter; monochrome display; color display; automobile power adapter; 128K-byte memory board

**Documentation**

User's guide; PC-DOS user's guide (optional)

**Price**

\$1995

**SYSTEM FEATURES**

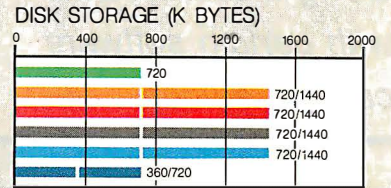
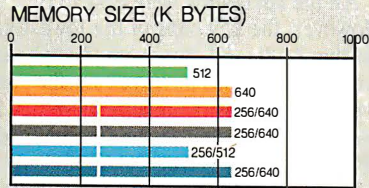

**DISK ACCESS IN BASIC (IN SECONDS)**

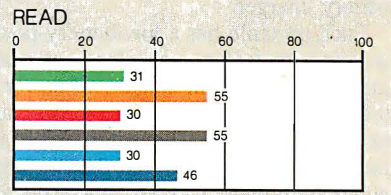
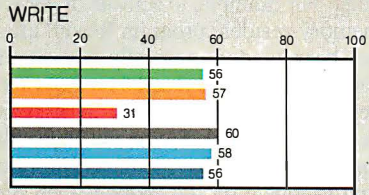

**BASIC PERFORMANCE (IN SECONDS)**

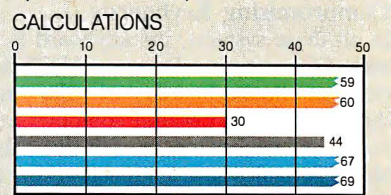
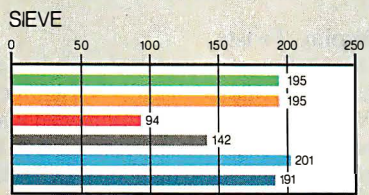

**SYSTEM UTILITIES (IN SECONDS)**

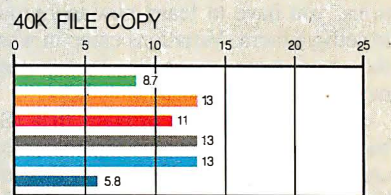
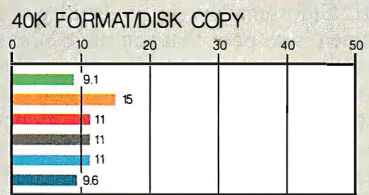

**SPREADSHEET (IN SECONDS)**

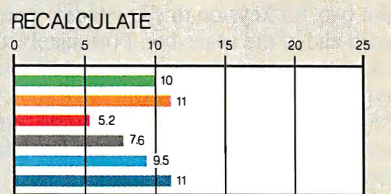
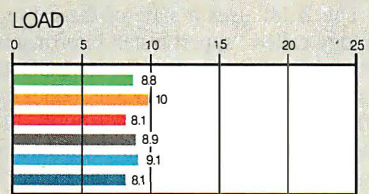

■ BONDWELL 8   
 ■ TOSHIBA T1100 PLUS (7.16 MHz)   
 ■ IBM PC CONVERTIBLE  
■ ZENITH Z-181   
 ■ TOSHIBA T1100 PLUS (4.77 MHz)   
 ■ IBM PC

The Memory Size graph shows the standard and optional memory available for the computers under comparison. The Disk Storage graph shows the highest capacity of a single floppy disk drive and the maximum standard capacity for each system. The graphs for Disk Access in BASIC show how long it takes to write and then read a 64K-byte sequential text file to a blank floppy disk. (For the program listings, see BYTE's *Inside the IBM PCs*, Fall 1985, page 195.) The Sieve graph shows how long it takes to run one iteration of the Sieve of Eratosthenes prime-number benchmark. The Calculations graph shows how long it takes to do 10,000 multiplication and 10,000

division operations using single-precision numbers. The System Utilities graphs show how long it takes to format and copy a 40K-byte file using the system utilities. The Spreadsheet graphs show how long it takes to load and recalculate a 25- by 25-cell spreadsheet in which each cell equals 1.001 times the cell to its left. The spreadsheet used was Microsoft's Multiplan 1.06. GW-BASIC 2.02 was used for the Bondwell 8, Z-181, and T1100 Plus BASIC benchmarks. IBM BASICA 3.2 was used for the PC Convertible BASIC benchmarks. The system utilities were run using MS-DOS 2.11 or PC-DOS 3.2 as supplied by each company.



## Using these systems with certain software can be tedious.

without interrupting normal operations. However, you must switch off the Bondwell 8 before connecting or removing its battery charger.

Each portable has a low-battery-power indicator that gives you plenty of warning when you are running out of power so that you can save your data to disk and turn off the system. The battery life of the individual units varies, but the two computers with backlit LCDs, the Z-181 and Bondwell 8, have the shortest battery life.

### Compromising Keyboards

In all these systems, the keyboard is an area of compromise. The main ASCII portions of the keyboards have the same dimensions as a desktop computer keyboard, and the key tops are full-size. Also, all the portables have ten function keys arranged horizontally above the number keys. However, even though the keyboards have all the standard IBM PC key functions, you have to learn new techniques to activate them. Variations creep in where the manufacturers have incorporated numeric keypad and editing keys.

And just when you thought that IBM had its keyboard layout act together, along comes the PC Convertible. On this keyboard the Ctrl key is just below the left Shift key (where the Alt key usually resides) and, for some reason, IBM has put two Alt keys on this keyboard, one at each end of the space bar. Fortunately, the other three manufacturers stuck to a more typical arrangement of the Ctrl and Alt keys. However, just to keep things interesting, Zenith squeezes the Caps Lock key between the A key and the Ctrl key.

The TI100 Plus has separate arrow, Home, End, PgUp, and PgDn keys for editing and, like the other systems, several of the letter and number keys on the main keyboard double as numeric keypad keys. The PC Convertible also has separate arrow keys for editing, but you have to use a key labeled Fn to shift the arrow keys to get Home, End, PgUp, and PgDn functions. Except for the PC Convertible's Ctrl and Alt keys mentioned earlier, the Z-181's keyboard otherwise resembles that of the PC Convertible—including the addition of an Fn key. The Bondwell 8 has a special cluster of editing keys in the top right corner that are easy to learn but awkward to reach. Some of the Bondwell 8's keys have as many as four different functions, depending on the Num (number lock) tog-

gle and use of the Shift and Alt keys.

All the keyboards were easy to type on. However, the key caps of the lowest keys on the Z-181 and Bondwell 8 keyboards are more than two inches above the tabletop; I found this arrangement somewhat awkward compared to the one-inch-high keyboard on my AT&T PC 6300 desktop.

Moreover, using any of these systems with certain software can be somewhat tedious compared to using a desktop computer. For example, to activate or leave the memory-resident program Ready! after it has been loaded, normally you simultaneously press the Ctrl and 5 on the numeric keypad—a fast operation on a typical desktop keyboard. But on the TI100 Plus, for example, you have to press Num Lock first to toggle on the keypad, then press Ctrl and 5, and then remember to toggle the Num Lock key back off again.

### Display Twists

The quality of a portable's display can make or break the machine's usefulness. Two of the portables, the Bondwell 8 and the Z-181, have backlit screens, while the other two have more traditional LCDs that depend on incident lighting.

To conserve battery power, the Bondwell 8 has a switch to turn its backlighting off. Unfortunately, the readability of the screen is so poor that you must have the backlighting on most of the time. Even with the backlighting on, the gray characters are washed out on the greenish background. Outdoors on a bright day, the Bondwell 8 display is almost as good as the other portables' displays when they are used under the poorest lighting. I was not impressed with the Bondwell 8's screen.

The Z-181 uses a state-of-the-art technology called "supertwisted birefringent," or simply "supertwist," in its LCD that provides bright blue characters on a light gray, almost white, background. The supertwist LCD gives the Z-181 two important improvements over the other displays: increased contrast of the "on" pixels with the background, or "off," pixels, and legibility of the screen from wider viewing angles.

Nothing comes for free. Part of the price you pay for the Z-181's display quality is in decreased battery life. Even though built-in software turns off the backlighting after about two minutes of keyboard inactivity, the Z-181's average battery life is less than that of the other portables. When the computer temporarily turns off the backlighting, the screen is still legible. You simply hit any key to bring the backlighting up to its previous level.

The Z-181 emulates the IBM PC's Color Graphics Adapter display but does only a fair job of reproducing colors as shades of blue and a peculiar blue-brown. The

color rendition is very sensitive to the amount of contrast, and the entire range of shades is impossible to achieve at any one setting. The Bondwell 8 is also compatible with the CGA display and, like the Z-181, attempts to emulate colors (with shades of gray), but achieves even less of a range with its display than the Z-181.

The displays on the TI100 Plus and PC Convertible are very similar, with the TI100 Plus having the edge in contrast and low-light legibility. Both display easily read characters as dark gray on a light gray background. Their screens produce good contrast under normal to poor indoor lighting conditions, but I had to turn up the PC Convertible's contrast control to its highest setting much of the time. The character set on the PC Convertible is particularly well designed; it is not up to par with IBM's Monochrome Display Adapter characters because of the LCD's reduced resolution, but it is better than the standard CGA-based character set used by the other portables.

Neither the TI100 Plus nor the PC Convertible attempt to discern shades of gray other than black and white (which they show as dark gray and light gray). This is fine for character displays but makes viewing programs that use color graphics difficult. Both of these portables display 320- by 200-pixel and 640- by 200-pixel graphics, but their character displays also support monochrome attributes such as blinking, high intensity, and reverse video. The TI100 Plus has a memory-resident utility program that allows you to change the screen's display attributes to best suit certain software.

Of the four portables, the Z-181 has the best aspect ratio. The screens on the other portables have aspect ratios (width to height) that range from 2.3 to 1 for the TI100 Plus to 3.1 to 1 for the Bondwell 8 compared to 1.3 to 1 for the Z-181. This means that the Z-181's screen displays graphic shapes virtually the same as a normal CRT, while circles appear as ovals on the TI100 Plus, Bondwell 8, and PC Convertible displays.

You can continuously adjust the TI100 Plus and Bondwell 8 screens from 0 degrees (just barely opened) to about 180 degrees (staring up at the ceiling). The Z-181 opened up to about 150 degrees, but I could tilt the PC Convertible's display only to about 120 degrees, or just beyond vertical. There were situations where I wished I could have tilted the display on the PC Convertible further to improve the legibility and contrast.

### Disk Storage and I/O

All four of the portables use double-sided 3½-inch drives and can store up to 720K

*continued*



# THE POWER OF POSITIVE SYNCING.

## THE ONE COLOR MONITOR WITH COMPATIBILITY ACROSS THE BOARD.

The NEC MultiSync™ is the most popular color monitor in its class today. In fact, it's in a class by itself. It's the first color monitor compatible with all three PC graphics boards made by IBM®—PGA, EGA and CGA.

Dollar for dollar, it delivers the best color resolution as well. With clarity and detail limited only by the board in your machine.



### THE INTELLIGENT MONITOR.

NEC technology gives MultiSync circuitry that automatically scans incoming frequencies, then adjusts to anything from 15.75 KHz to 35 KHz. No switches to switch, no instructions from the keyboard. The monitor does it. Automatically.

MultiSync functions in TTL and analog modes. Delivers 7 switchable colors. And its resolution climbs as high as 800 horizontal dots and 560 vertical lines on a 14 inch screen.

**C&C** Computers and Communications

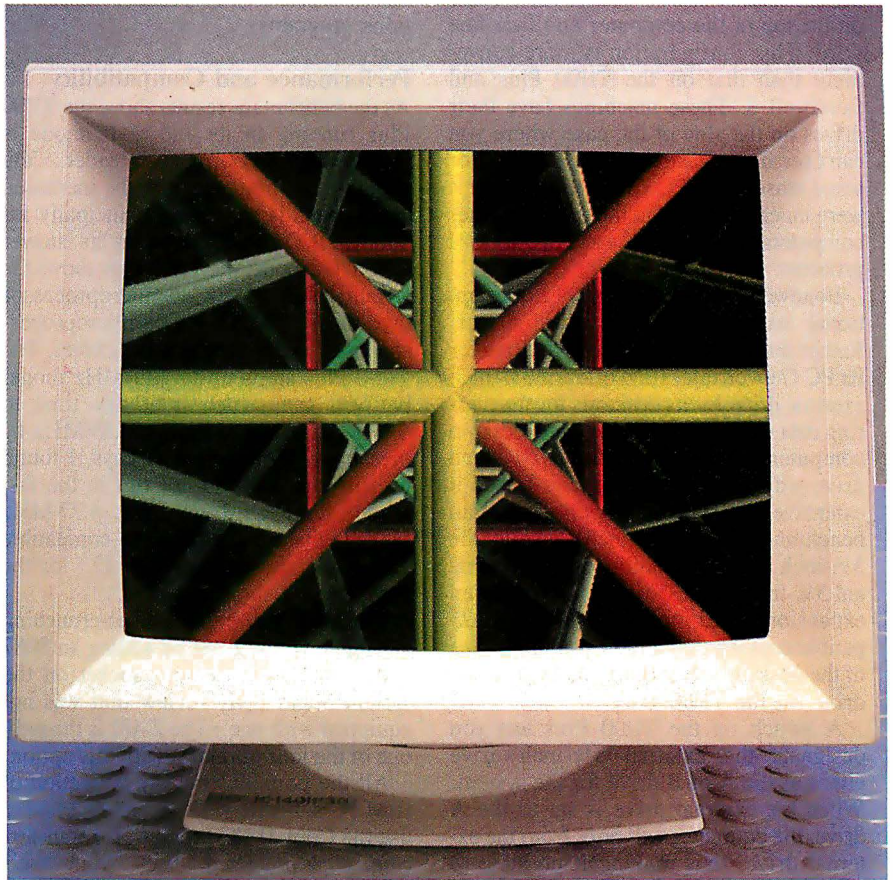

## MULTISYNC™

### THE INTELLIGENT CHOICE.

MultiSync is the first monitor you should consider, because it's good enough to be the last monitor you'll ever need.

So whether you're buying your first system, upgrading to color, or moving into professional business graphics, desktop publishing or CAD/CAM, visit your nearest dealer.

See a demonstration of the power of positive syncing. It will give you something great to think about.

For product information and sales assistance, call 1-800-447-4700.

For technical assistance and information, call 1-800-NEC-SOFT.

NEC Home Electronics (U.S.A.) Inc.  
Computer Products Division  
1255 Michael Drive  
Wood Dale, Illinois 60191.

# NEC



## *The biggest source of incompatibility was the displays.*

bytes on a single disk. The disk drives on the Z-181 and PC Convertible are located on the top of the computer and face forward. This configuration is more convenient than that on the T1100 Plus and Bondwell 8. These machines have their drives on the side of the case where you can't see if you have a disk in a drive. For some reason, the PC Convertible's drives were much noisier than those on the other computers, but the noise was not a serious problem.

Bondwell, Zenith, and Toshiba offer optional external 5¼-inch disk drives. Rather than providing a 5¼-inch drive for its PC Convertible, IBM offers a 3½-inch external drive for its desktops for transferring data to and from portable and desktop computers. Toshiba included its 5¼-inch drive with my review unit, and I used it extensively to transfer test programs and benchmarks from 5¼-inch disks to the 3½-inch format. In addition to the external 5¼-inch drive, Toshiba also offers an expansion board for your IBM PC-compatible desktop that allows you to use one of the desktop's disk drives as an external drive for the T1100 Plus.

A switch on the T1100 Plus lets you designate the external 5¼-inch drive either as the A or B drive for the system. When the external drive is set as the A drive, the computer will boot from the external drive, thus making it possible to load and run copy-protected 5¼-inch disks. Regardless of the switch setting, you can have only two functional disk drives active on the system at any one time (either the two internal 3½-inch drives or the external 5¼-inch drive and one internal drive).

All the portables except the PC Convertible include serial and parallel ports, but the type of connector used for these ports varies from machine to machine (see pages 222 and 223). The parallel printer port on the T1100 Plus doubles as the port for an external disk drive. A three-position switch on the side of the computer determines whether the parallel port is set up for a printer or for using the external drive as the A or B drive.

All the machines except the PC Convertible have standard RGB ports to attach a color monitor; the T1100 Plus and the Bondwell 8 also have a phono jack with composite video output to connect to an external monochrome monitor. This combination produces shades of gray in color

graphics display mode.

Finally, all the portables have provisions for an internal modem. The Bondwell 8 comes equipped with a 300-bps modem, and 1200-bps modems are offered by the other three manufacturers as options. The PC Convertible's optional modem, however, is not compatible with the popular Hayes modem protocol and therefore will not work properly with some communications programs.

### **Performance and Compatibility**

As the benchmark results show, the T1100 Plus running in its 7.16-MHz mode is clearly the performance leader. You should note, however, that the increased clock speed is significant principally for nondisk I/O tasks. Even in its slower 4.77-MHz mode, the T1100 Plus shows the advantage of its 80C86 microprocessor over the 4.77-MHz 80C88 microprocessors used in the other three machines. The T1100 Plus starts up in 7.16-MHz mode, but you can switch it at any time to 4.77-MHz mode or back to 7.16 MHz by pressing a combination of keys. I found no software that did not run in the fast mode; however, I used the 4.77-MHz mode to make some IBM PC-compatible games run slower. See page 223 for the complete benchmark results.

You can improve the number-crunching capability of the Z-181 by adding an 8087 coprocessor to an empty socket on the system board. (My review unit was not equipped with one.) The Z-181 is the only one of the four portables with this option.

All the portables ran my collection of IBM PC software well. However, I had to use the Copy II PC program for transferring copy-protected disks from their 5¼-inch format to the 3½-inch format. The only problem was that Copy II PC formats the 3½-inch disks for only 360K bytes, the same as the source disk's capacity.

The biggest source of incompatibility with IBM PC software was with the portables' displays. Even the most compatible display, the Z-181's, cannot rigorously mimic the IBM CGA, and the PC Convertible and T1100 Plus displays compromise by using monochrome attributes for colors. In addition, the LCDs give a reverse-video effect—dark characters on a light background—that causes Flight Simulator on the T1100 Plus or PC Convertible to look like you are flying at night.

### **Interesting Options**

The PC Convertible has many options available for it, mainly because it comes with so few standard features in its normal configuration. Two options, the 128K-byte memory board (\$195) and the 300/1200-bps modem (\$450), go inside the unit; all the other options (several can be

piggybacked) attach to a connector on the rear of the computer. As mentioned earlier, each slice makes the already large portable deeper and deeper. The most interesting slice for the PC Convertible is a dot-matrix printer (\$295) that is only about 4½ inches deep. It operates off of the internal battery pack and provides good-looking hard copy. The printer uses a ribbon to print on standard bond paper, or it can print on special thermal paper without a ribbon installed.

Toshiba has an intriguing option that may appeal to someone who wants to use the T1100 Plus as a double-duty machine—on the desktop and on the road. This option is a self-powered expansion chassis that can accommodate up to five full-length IBM PC-compatible expansion cards. The chassis connects to the T1100 Plus via a special expansion bus. This option is expensive (\$999) but is one that might prove practical in some situations.

But the most important option is yours—which should you buy? All four of these portables are real IBM PC-compatible computers. Overall they perform as well as, or better than, their full-size desktop counterparts. In every case, however, the keyboards are awkward for tasks that call for numeric keypad functions or some editing key functions. The keyboards can also be frustrating to use when you have to frequently switch from a desktop keyboard. However, these portable-keyboard compromises are not too difficult to live with.

Either the Z-181 or T1100 Plus would be a good choice, although both would be superior portables if each had the best feature of the other: the Z-181 with a faster processor and the T1100 Plus with a supertwist backlit LCD. If performance is important to your application, then the T1100 Plus would be your best choice. Its 80C86 running at 7.16 MHz makes this machine a clear winner in the benchmark tests.

Only the Z-181 has a display that rivals a desktop's CRT display. Although the PC Convertible and T1100 Plus have about the best nonbacklit LCDs that I have seen, they pale in comparison to the Z-181's supertwist backlit LCD. The Bondwell 8's display is barely adequate and makes an otherwise good portable wearisome to use.

Neither the PC Convertible nor the Bondwell 8 should be considered a great buy. The PC Convertible has no special advantages that offset its larger size and lack of standard features, and although it has no serious shortcomings, you will have to spend almost \$1000 over the base price to get the features that come standard on the other machines. The Bondwell 8 would be a bargain were it not for its relatively poor display. ■



# SYNC TWICE.

## MULTISYNC™ SETS ANOTHER INDUSTRY STANDARD WITH A GRAPHICS BOARD THAT OFFERS PGA RESOLUTION AT AN EGA PRICE.

Another standard from MultiSync™. First, the MultiSync monitor, the original color monitor compatible with CGA, EGA, and PGA graphics adapters.

Now, the new MultiSync GB-1 graphics board.

With a MultiSync monitor, the GB-1 actually takes EGA all the way to PGA resolution — 640 X 480!

Compatibility is no problem. The GB-1 syncs with EGA and CGA color text and graphics, and with MDA and Hercules™ monochrome.

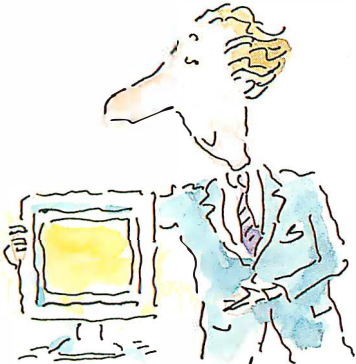

Built-in screen drivers ready for 1-2-3™, Windows™, AUTOCAD™, Dr. Halo II™.

So you're ready for the top spreadsheet, window and CAD/CAM programs in ultra high resolution, without investing in more boards. Even a parallel printer port is included.

### Free Dr. Halo II software.

This powerful program provides dramatic color for business graphics. With smoother scrolling, Hardware Zoom. Hardware Viewport. And pixel panning.

### Desktop publishing comes true.

When you create graphics for business presentations, your free Dr. Halo II software works like a paint brush. Just pick your palette, and work in the clearest colors. It accommodates a wide assortment of type fonts, too.

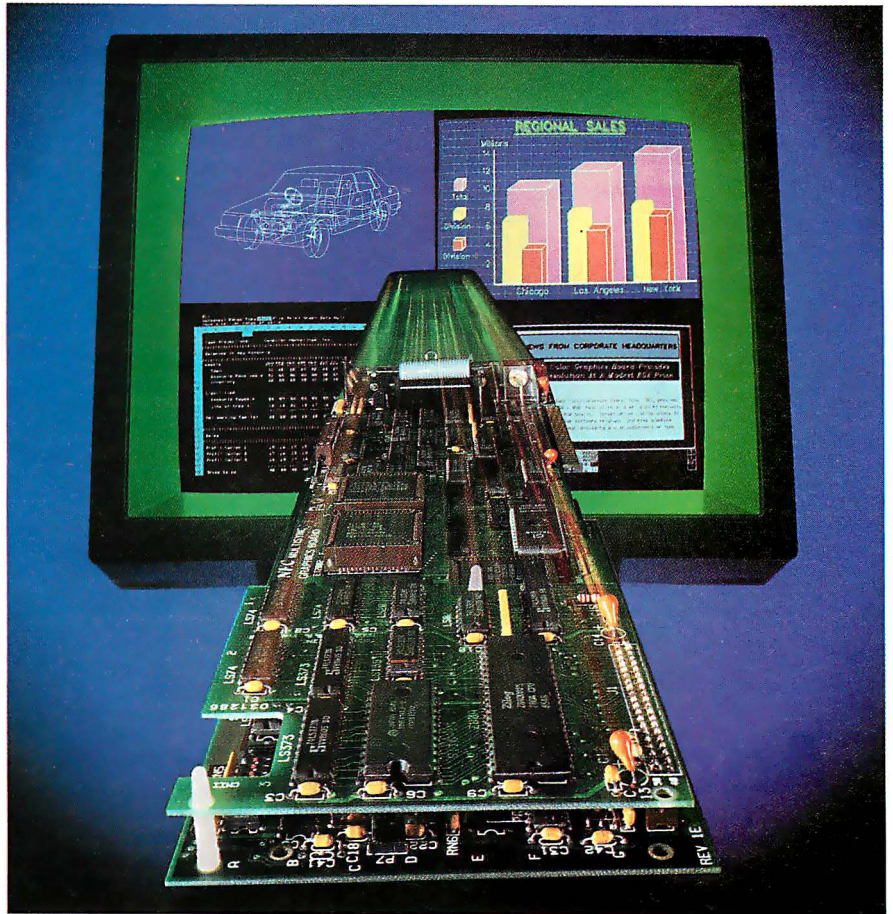

## MULTISYNC™ COLOR GRAPHICS BOARD

### 132 column spreadsheets.

You can display up to 132 columns by 44 lines. With text, your screen will show nearly a full page.

### \$50 Rebate!

Purchase a MultiSync Color Graphics Board and you'll find a \$50 rebate coupon inside the carton. You can apply it to the price of the MultiSync Color Graphics board or the 14" MultiSync Color Monitor.

See your MultiSync dealer. He has the graphics board and the monitor that will open your eyes. Your computer's too.

**For product information and sales assistance, call 1-800-447-4700.**

**For technical assistance and information, call 1-800-NEC-SOFT.**

**NEC Home Electronics (U.S.A.) Inc.  
Computer Products Division  
1255 Michael Drive  
Wood Dale, Illinois 60191.**

# NEC

**C&C Computers and Communications**

MultiSync is a registered trademark of NEC Home Electronics (U.S.A.) Inc. 1-2-3 is a registered trademark of Lotus Development Corp. Windows is a registered trademark of Microsoft Corporation. AUTOCAD is a registered trademark of Autodesk, Inc. Hercules is a registered trademark of Hercules Computer Technologies. Dr. Halo II is a registered trademark of Media Cybernetics, Inc.



# PRINCETON. The in



## And much more:

**Full EGA and CGA support.** Princeton EGA monitors bring you 64 brilliant colors and bright sharp images in enhanced graphics mode, with 640 x 350 resolution. Your EGA software never looked better. Plus our HX-12E and HX-9E automatically switch from EGA to CGA mode, when needed.

**Compatibility.** Princeton monitors are 100% compatible with leading personal computers like IBM®, Compaq®, and more. No matter what system you have, there's a Princeton monitor that's right for you.

**Quality Image.** A .28mm dot pitch (the finest dot pitch of all leading EGA displays), bright colors, and sharp resolution give Princeton monitors a quality image that cannot be beat.

**Easy Viewing and Ergonomic Design.** Princeton monitors are designed for easy use, too. You get easy viewing with the HX-12E's black matrix tube and etched

nonglare screen. The lines are crisp, the characters sharp, and the colors even, so you're more productive. Controls are located on the front, where you can reach them.

**Reliability.** Princeton monitors are designed and manufactured to meet your most demanding needs. Only the finest components are used. The result: dependable performance day in and day out.

**Value.** No other monitor gives you more for the money than Princeton. Compare for yourself. Feature for feature there's not a better value around.

**Availability.** Princeton monitors are as easy to get your hands on as they are easy to use. You can find them at computer stores around the world.

**Reputation.** More and more, people are making Princeton Graphic Systems their number one choice in personal computer displays. Because people know Princeton delivers the ultimate in compatibility, reliability, and performance.

\*Dot pitch is the measure of the distance between phosphors of like color (dots) on the display screen. The smaller the dot pitch, the closer the dots are to each other. Thus, there are more picture elements which can be displayed on the screen which results in a higher resolution.

IBM is a trademark of International Business Machine, Inc. Compaq is a trademark of Compaq Computer Corp. Wall Street Journal is a registered trademark of Dow Jones, Inc.



# finest dot pitch\* EGA monitors.

*And the finer the dot pitch,  
the sharper the image.*

For the no-compromise enhanced graphics monitors, look for the Princeton Graphic Systems name. Princeton delivers everything you need in a quality EGA display, from crisp, clear, full EGA support to rugged reliability. When you choose Princeton you choose the best.

**HX-9E.** The first IBM compatible 9" high resolution color monitor to support EGA. Has a .28mm dot pitch black matrix tube and etched nonglare screen for sharp, crisp displays and features a built-in tilt/swivel stand and green/amber switch.

**HX-12E.** The first IBM compatible high resolution color monitor to support EGA with a .28mm dot pitch. The HX-12E builds on the award winning features of the HX-12 and features 640 x 350 resolution for sharp, crisp text and colorful graphics.



**PRINCETON®**  
GRAPHIC SYSTEMS  
AN INTELLIGENT SYSTEMS COMPANY

601 Ewing Street, Bldg. A Princeton, NJ 08540, Telex: 821402 PGSPRIN, (609) 683-1660, (800) 221-1490, Ext. 1804





# The 3-in-1 applications development tool for every Tom, Dick and Harriett.

Presenting the first database applications development tool that delivers the promises of 4th-generation languages on the micro-computer.

It's SIMPLE Software.

SIMPLE stands for **SYSTEM IMPLEMENTATION by EXAMPLE™**, and it delivers the absolute best balance of power and ease-of-use.

## **SIMPLER THAN EVER BEFORE.**

SIMPLE lets you jump in at any level of experience and unleash the full processing power of the PC. It has a totally non-procedural way of doing things that flattens-out the learning curve. You can automate everyday business tasks or prototype new applications without ever having to write a single line of procedural code.

SIMPLE enables experienced programmers to achieve higher levels of productivity. And for developing mainframe applications, SIMPLE is the perfect prototyping tool—combining ease-of-use, speed, and high-quality system documentation.

## **YOU GET 3-IN-1.**

### **1. IT'S A DESIGN TOOL.**

SIMPLE allows you to quickly prototype applications on the micro-computer—sit right down and draw, edit, and specify processing logic with a few keystrokes. SIMPLE aids in the process of structured design by organizing development efforts in a building-block fashion. Experienced developers move quickly and easily from task to task. Less experienced users are literally guided through the entire applications development process.

### **2. IT'S A RELATIONAL DATABASE MANAGER.**

SIMPLE offers exceptional speed performance. It is written in Assembler and incorporates a highly optimized

B-tree data access method that eliminates record sorting. SIMPLE also uses a dynamic single-record index. You can have an unlimited number of indices in any record. Each index may be either a single or concatenated key. SIMPLE's relational joins are easy to construct and more efficient to process. Joins are accomplished dynamically at time of processing and support one-to-many and many-to-many relationships.

### **3. IT'S AN APPLICATIONS GENERATOR.**

It is the most practically functional applications generator on the market today. SIMPLE is completely non-procedural, never forcing you back to procedural methods, letting you accomplish even the most complex databased applications in the most easy-to-use-and-understand fashion.

## **A SINGLE, VISUAL 4GL LANGUAGE.**

Uniquely, every step in program development from input screens, to reports, to complex processing logic is accomplished in SIMPLE's all-visual worksheets. It is fully non-procedural and totally picture-oriented. Design right on the screen, and SIMPLE's built-in pattern-recognition logic automatically generates all the application code for you. You never have to leave SIMPLE's 4GL non-procedural technique.

## **POWERFUL WORKSHEETS.**

SIMPLE provides three powerful, yet easy-to-learn worksheets—a File Worksheet, Specify Worksheet and Design Worksheet. You need only to define a file, then SIMPLE creates the basic program for you. Enhancements are done on SIMPLE's Design and Specify Worksheets.

In the Design Worksheet, you simply paint or draw an example of the input screen or report you want.



**Company Managers like Tom** easily develop customized applications like this **Branch Reporting System** which reports information from support service calls. Tom now has a system which validates certain information and provides a customer history to improve the branch's support capabilities. With SIMPLE's Specify Worksheet on screen, Tom simply joins data from four different files and establishes their relationship.



**Information Center Staff Members like Dick** easily create new microcomputer applications systems like this **Lead-Tracking System**. Dick is able to sit down with the Director of Marketing and review the main entry screen developed on SIMPLE which shows the prospect demographic information, the media source and date from which each lead was generated, and the fulfillment literature to be sent.



**System Analysts/Programmers like Harriett** easily prototype design changes while interacting with Department Heads. Harriett has prototyped some requested changes in a **Mainframe Payables System**. With the help of SIMPLE, she has built a test database with data imported from the mainframe and is able to review the check-ledger report, in the Controller's office on her portable computer.

The Design screen may be painted exactly as you want using SIMPLE's built-in, full-screen editor which offers a wide range of capabilities to aid you—including the ability to delete or insert a character or an entire line, move or copy blocks of information, lasso text or variables, and window to other worksheets in one or two keystrokes. Powerful specification macros are invoked providing application users the ability to pop-up a window and browse through another file, interrupt data entry to perform another program, provide context-sensitive help, and perform conditional processing based on the user's input.

In the Specify Worksheet, you implement your processing logic. You never have to fall back to procedural programming to get the processing power you need. Range checking and data validation are easily implemented, visually. Conditional processing statements are quickly set up. Arithmetic operators, date operators, and a full set of string functions are available. You specify an example of how you want your data processed, and SIMPLE creates the program.

## **A POWERFUL MENU GENERATOR.**

SIMPLE's power gives you the easy flexibility to generate unlimited levels of user-guidance menus, as your applications require. There are limitless design options for effective "point-and-shoot" menu creation. And you have total freedom to build menus before, during or after development, unmatched in other systems.

## **SIMPLE, SIMPLER, SIMPLEST.**

Ask for SIMPLE at your computer dealer. Or call us direct for the dealer nearest you and a full-functioning SIMPLE demo package with a Quick-Start manual for only \$9.95\*.

\*Includes shipping and handling. California residents add sales tax. SYSTEM IMPLEMENTATION BY EXAMPLE is a registered trademark of Accuphase, Ltd. IBM PC is a trademark of International Business Machines Corp.

**SIMPLE**  
SYSTEM IMPLEMENTATION BY EXAMPLE™

Published by Software Merchants Unlimited  
Software Merchants Unlimited  
2252 Fillmore Street, Suite 401  
San Francisco, California 94115  
415-567-5071

**CALL 800-8 SIMPLE**





# The Atari 1040ST

Dave Menconi

*This system is  
an excellent value with only  
a few faults*

The Atari 1040ST, like the 520ST, has a powerful 68000 microprocessor, high-resolution color or monochrome graphics, and the TOS desktop for easy handling of programs and files. The 1040ST also has twice the memory (1024K bytes rather than 512K), a 3½-inch floppy disk drive and a power supply that are built in, and the TOS desktop in ROM rather than loaded from disk. [Editor's note: See the product preview of the 1040ST by Phillip Robinson and Jon R. Edwards in the March 1986 BYTE for more introductory information.]

The 1040ST does not, as Atari earlier stated it would, come with an RF modulator (a device that would allow you to use the 1040ST with a standard television set) or a graphics co-processor (a so-called blitter chip). For color graphics you will need the color monitor, for a total system cost of \$1199.99. The monochrome 1040ST system costs \$999.99.

## On the Outside

The 1040ST has three screen resolutions. Low resolution requires a color monitor, allows 16 colors (which you can select from a palette of 512 colors), and has 320 by 200 pixels. Medium resolution also requires a color monitor, allows 4 colors, and has 640 by 200 pixels. High resolution requires a monochrome monitor and has 640 by 400 pixels. There is no overlap between the monitors and the resolutions—the monochrome monitor can't do low or medium resolution, and the color monitor can't do high resolution. Furthermore, if you switch monitors while the system is on, the 1040ST does a warm restart, just as if you had pressed the reset button. Even switching between low and medium resolution has its problems, which I'll discuss later.



The 1040ST keyboard is somewhat spongier than most keyboards with which I am familiar, but I had little trouble adjusting. The keyboard is complete, including a numeric keypad, a set of cursor-control keys, Help and Undo keys, 10 function keys, an Esc key, and a Control key. The layout of the keyboard is quite convenient, especially the cursor-control keys, the Help and Undo keys, and the extra-large Return and Backspace keys. The designers of the 1040ST keyboard, while keeping user-friendliness in mind, also accommodated the more experienced users.

Among the benefits of the full keyboard are the special key combinations that perform useful functions. For example, pressing the Alternate key and the cursor keys allows you to move the cursor around the screen without using the mouse, and

pressing the Alternate key and the Insert key has the same effect as pressing the mouse button. This feature lets you use the cursor-control keys even when the program is not designed for that.

The desktop does not take full advantage of several keyboard features. For example, it does not use the function keys, the Help key, or the Undo key. Similarly, the mouse has two buttons, but the desktop uses only the left one. This does, however, leave these unused features available for use by programmers; if the desktop had used them, designers would be stuck using them in the same way or else being inconsistent.

The 1040ST's 720K-byte double-density drive can read, write, and format single-sided and double-sided disks. Surprisingly, all the double-sided modes are slightly slower than their single-sided counterparts.

When the built-in drive turns on, the external drive also turns on, and vice versa. Also, for some reason, my external single-sided drive turned on for a second about once a minute even when the computer was off. Since this doesn't happen when the drive is connected to the 520ST or is disconnected entirely, it must be caused by the 1040ST.

The 1040ST's built-in power supply causes the top of the computer to get a little warm, but the chips inside seem adequately cooled. I left the system on for days at a time with no problems.

## Under the Hood

Inside the case, the 1040ST is completely shielded to prevent RF interference.

*continued*

Dave Menconi (5333 Betsy Ross Dr., Santa Clara, CA 95052) is a software engineer for Computer Resources Inc.



**Atari 1040ST**

**Company**

Atari Corp.  
1196 Borregas Ave.  
Sunnyvale, CA 94086  
(408) 745-2000

**Size**

18½ by 11½ by 2¾ inches

**Components**

**Processor:** Motorola 68000 with an 8-MHz clock

**Memory:** 1 megabyte of dynamic RAM; 192K-byte TOS in ROM, not including optional desk accessories

**Mass storage:** Internal 720K-byte double-sided, double-density 3½-inch drive; system supports a maximum of two floppy disk drives

**Display:** 12-inch monochrome or color monitor; three modes: 640- by 400-pixel monochrome, 320- by 200-pixel with 16 colors, and 640- by 200-pixel with 4 colors

**Keyboard:** 94-key IBM Selectric-style QWERTY keyboard with numeric keypad, cursor controls, and rhomboid function keys

**Sound:** Three independent sound channels from 30 Hz to 125 Hz

**I/O interfaces:** MIDI-in and MIDI-out ports  
Centronics parallel printer port (supports Epson-compatible printers)

RS-232C serial port

Floppy disk port

Hard disk port (10-megabit-per-second DMA transfer rate)

128K-byte ROM cartridge

Ports for mouse and joystick or two joysticks

**Software**

Atari Logo, Atari ST BASIC, 1st Word word processor, NEOchrome graphics editor

**Options**

SF354 single-sided drive: \$199.99  
SF314 double-sided drive: \$299.95

**Price**

Monochrome system: \$999.99  
Color system: \$1199.99

**SYSTEM FEATURES**

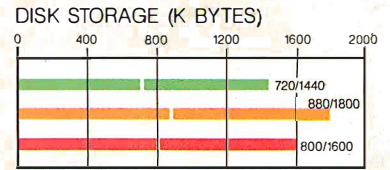

**DISK ACCESS IN BASIC (IN SECONDS)**

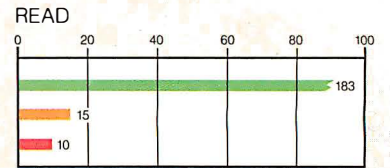
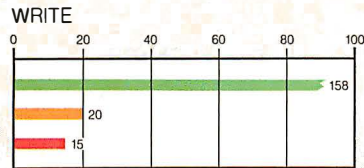

**BASIC PERFORMANCE (IN SECONDS)**

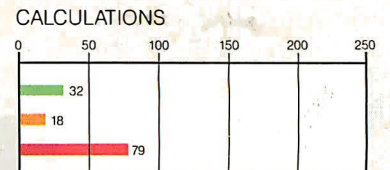
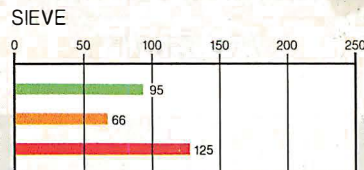

**SYSTEM UTILITIES (IN SECONDS)**

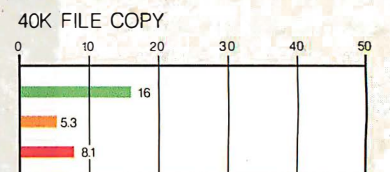
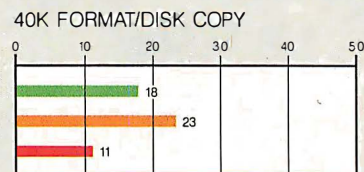

**SPREADSHEET (IN SECONDS)**

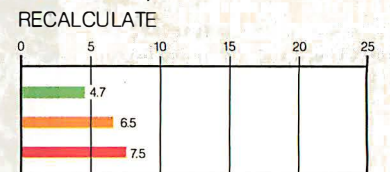
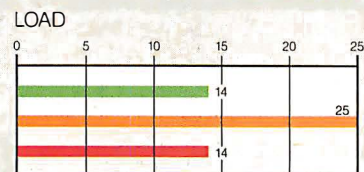

■ ATARI 1040ST ■ AMIGA ■ MAC PLUS

The Memory Size graph shows the standard and optional memory available for the computers under comparison. The Disk Storage graph shows the highest capacity for a single floppy disk drive and the maximum standard capacity for each system. The graphs for Disk Access in BASIC show how long it takes to write and then read a 64K-byte sequential text file to a blank floppy disk. (For the program listings, see BYTE's *Inside the IBM PCs*, Fall 1985, page 195.) The Sieve graph shows how long it takes to run one iteration of the Sieve of Eratosthenes prime-number benchmark. The Calculations graph shows how long it takes to do 10,000 multiplication and 10,000 division operations using single-precision numbers. The System

Utilities graphs show how long it takes to format and copy a 40K-byte file using the system utilities. The Spreadsheet graph shows how long it takes to load and recalculate a 25- by 25-cell spreadsheet in which each cell equals 1,001 times the cell to its left. The Atari 1040ST tests were performed using TOS (in ROM), Atari ST BASIC, and Acalc spreadsheet. The Amiga tests were performed using the Workbench, Amiga BASIC, and the Lattice Unicalc spreadsheet. (Amiga BASIC requires a CLEAR ,30000, 30000 command for the Sieve to run.) The Macintosh tests were performed using the Macintosh System and Finder, Microsoft BASIC, and Microsoft's Multiplan.



The power supply and the built-in disk drive are on separate boards that sit atop the main motherboard. The designers put the ROM chips under the power supply board where they can be easily upgraded. Going in deeper than that is a nuisance because of the shield that covers most of the motherboard.

Under the shield are the same parts that the 520ST has, but they are rearranged on a two-inch longer (from front to back) board to make room for another 16 RAM chips and the other components that are built in. The mouse and joystick plug into the keyboard through a hole in the bottom of the case, which makes the mouse harder to take off and replace than that on the 520ST. Despite early plans for an RF modulator, the 1040ST has only a blank space on the board where the modulator belongs.

## TOS

The 1040ST's operating system (TOS) desktop lets you run programs, copy files, format disks, and perform all the other essential tasks of using a computer by clicking, dragging, and double-clicking icons with the mouse.

Until just before the release of the 1040ST, TOS was on disk and you had to load it into the system (a process that took half a minute or more) before you could do anything with the machine. Now the entire operating system is in ROM, allowing the computer to boot in 5 seconds (more if there are desk accessories on your initial program disk) and freeing up 200K bytes of RAM for your programs' use.

The desktop allows you to manipulate documents (data files), applications (programs), and folders (directories). Each folder is, in effect, like a separate subdisk drive. Thus, if the folder MAILLST (for your mailing list) on drive A is open, you cannot access any of the other files on drive A. This lets you break up the files into separate directories. Dealing with just the MAILLST files is easier than sorting through all the files on the disk.

Folders are especially useful on a hard disk. Within each segment, the folders break up the files into general categories. Within each folder, subfolders break up the files into smaller categories until the total number of items in a folder is manageable. This organization is one of the major reasons for buying a hard disk.

You can nest folders within folders up to eight deep, although I have never seen directories nested more than six deep, even on a minicomputer. You are limited to 40 folders on a floppy disk. Unfortunately, the system does not tell you when you have exceeded the 40-folder limit. At some point after you exceed the limit,

strange things may start to happen to your disk—you may be unable to delete some files, the system may reset when you try to get information about the disk, or some other nasty quirk may develop. In practice, however, this is not much of a problem because you are unlikely to want more than 40 folders on a single floppy disk.

Another quirk is that copying a file to itself damages the directory of the disk. This can happen if you are copying files and you accidentally let go of the mouse button in the same window. The desktop will warn you about the conflict, but if you press Return or click on the OK icon, it will go ahead and possibly ruin the disk. Once again, this is not something that will happen often, but if it happens, the consequences are dire.

Another quirk occurs if you use programs that are in different screen resolutions. Once the system is initialized, you cannot change the resolution. This means that if an application is designed to run in medium-resolution mode and you enter it in low resolution, the application can't correct the problem and switch modes—the best it can do is to give you a message that says, "Please switch to medium resolution," and terminate.

TOS handles this to some degree by remembering the resolution you were in the last time you saved your desktop and initializing the system to that resolution. The only problem with this is that when you are in high resolution using a monochrome monitor and switch to a color monitor, the system switches to low resolution. The difference between low and high resolutions is great enough that they are likely to look very different on your screen, and any applications you run are going to be different, too.

The routines that make the desktop menus, windows, icons, and dialog boxes are easily accessible to programmers. These features can greatly enhance an application's ease of use by putting control in the hands of the user.

## TOS vs. the Macintosh Finder

The TOS desktop is very similar to the Finder in the Apple Macintosh but with a few significant differences.

The Macintosh keeps track of what disk is in each drive and keeps strict control over when a disk can be ejected, while the 1040ST has ejection buttons. When you change disks on the 1040ST, you must press the Esc key to update the screen.

The Macintosh lets you move icons around the window at will and view the files in one window as icons while viewing those in another as text. On the 1040ST the icons are arranged for you, and all windows have to be either textual or iconic.

On the 1040ST, the menus pop down whenever the pointer passes over them, and the menu stays down until you click the mouse either in the menu or elsewhere on the screen. In comparison, on the Macintosh you must click on a menu for it to come down.

Another difference is the pause that the 1040ST requires between when you click on something and when you are able to move it. On the Macintosh, you can click on an icon and start dragging immediately; under TOS, you must pause for an instant before moving the mouse.

Taken singly, these differences aren't terribly significant. But as a whole, they show a trend: The Macintosh Finder is intended to be a perfect user interface, while the TOS desktop is designed to be a simple, easy-to-use workhorse.

## Software

Unfortunately, relatively little software is available that really makes use of the windows, menus, and icons so characteristic of TOS. Each developer creates his or her own user interface from scratch, and every program will come up with a different way of handling similar tasks.

For example, 1st Word, a TOS-based word processor that comes with the 1040ST, provides two ways for exiting a document: QUIT, which throws away your work (after warning you), and SAVE, which closes your document after saving it. You cannot save the document without closing it. Power failures do happen, and most computer users learn to save their work often, a task made very inconvenient by this program.

Aside from this problem, 1st Word has a full range of features. It supports a large number of printers, several font styles (including bold, italic, and underlined), cutting and pasting, and "what-you-see-is-what-you-get" screen editing.

Unfortunately, the latter feature makes the program somewhat slow. When I conducted the word processor benchmark tests on two hard disks (see the text box "The Atari SH204 and SupraDrive Hard Disk Drives" on page 234), 1st Word was slower than ST Writer (an old-style word processor that uses embedded control characters).

The 1040ST also comes with Atari ST BASIC, Atari Logo, and NEOchrome, a paint program. Atari ST BASIC has some nice features. It starts up with four windows: one for editing, one for listing programs, one for output to the screen, and one for commands. Each of these windows can be resized, moved, activated, or closed by using the mouse. This is a good deal more flexible than the approach taken by other BASICs.

*continued*



# The Atari SH204 and SupraDrive Hard Disk Drives

The extra power and memory of the Atari 1040ST makes the addition of a hard disk drive appropriate. I used the 1040ST that I reviewed with the Atari SH204 hard disk and the SupraDrive from Supra Corporation.

Both the SH204 and the SupraDrive are 20-megabyte drives. Unlike Supra, which makes a 30-megabyte drive, the largest drive Atari makes is the SH204 (it also makes a 10-megabyte drive). But Atari has made provisions for having multiple drives on one system. The drives can be numbered from 0 to 7, so theoretically you can have up to 1600 megabytes of storage on-line at one time. However, the manual is not clear about how you hook two hard disks up, since both the computer and the hard disk have only one plug. In spite of that, the SH204 manual is better than the SupraDrive's, but the latter still has all the information you need.

Neither the SH204 nor the SupraDrive can have partitions larger than 16 megabytes, so the 20-megabyte disk drives must be segmented into two or more logical drives, none of which can hold more than 16 megabytes.

The SupraDrive is 11 inches long and 5½ inches wide, but it needs extra space all the way around to provide for cooling. An annoying trait of the drive is its noise. While the drive is on, it produces a persistent low hum that can be heard for some distance.

The SH204 is 15 inches long and about 8 inches wide—much larger than the SupraDrive. It is also considerably noisier—you can't hear the SupraDrive if the Atari drive is on.

Although the 1040ST's ROMs allow for only 40 folders on a disk, the SupraDrive's boot software installs a patch that allows up to 70 folders. Care should be taken, however, not to exceed this 70-folder limit. If you do exceed it, the disk directory is likely to become very sick and ruin part or all of the hard disk. However, the documentation gives no warning of this danger.

I found both hard disk drives to be well worth their price tags. The increased access speed and expanded storage augment the 1040ST's power considerably. [Editor's note: For the benchmark results, see table A.]

## Atari SH204

### Type

20-megabyte hard disk

### Company

Atari Corp.  
1196 Borregas Ave.  
Sunnyvale, CA 94086  
(408) 745-2000

### Size

15 by 8 by 4 inches; 9 pounds

### Features

Chaining of multiple drives

### Software

Boot software; format and utilities software

### Options

10-megabyte hard disk (SH104) also available

### Documentation

User's manual

### Price

\$799.95

## SupraDrive

### Type

20-megabyte hard disk

### Company

Supra Corp.  
1133 Commercial Way  
Albany, OR 97321  
(503) 967-9075

### Size

11 by 5½ by 3¾ inches; 5 pounds

### Features

5¼-inch drive with Rodime controller

### Software

Boot software; format and utilities software

### Options

Also available in 30-, 45-, and 60-megabyte sizes

### Documentation

User's manual

### Price

\$799

**Table A:** Comparison of the BYTE benchmarks on the Atari SH204 and SupraDrive 20-megabyte hard disk drives. All times are in seconds.

	Atari SH204	SupraDrive
Write 64K-byte file (BASIC)	82.00	83.30
Read 64K-byte file (BASIC)	177.00	172.70
Copy 40K-byte file	2.63	3.20
Load spreadsheet (ACalc)	8.89	9.99
Document load		
ST Writer	5.86	5.94
1st Word	9.33	9.88
Document save		
ST Writer	4.67	2.03
1st Word	10.11	7.99



However, ST BASIC's I/O capabilities are limited. As the benchmarks show (see page 232), reading and writing from BASIC, even with a hard disk (see times at left), is very slow.

The Atari Logo program is a simple-looking dialect of LISP and is powerful for all its apparent simplicity. The major feature of Atari Logo is its use of turtle graphics; graphics commands are given from the cursor's point of view, thus greatly simplifying programming.

NEOchrome is a beautiful graphics editor. It is almost worth getting a color monitor just to see the pictures that come with this program. NEOchrome doesn't work with a monochrome monitor. An especially clever feature of the program is the ability to roll selected colors through the color registers, thus giving still pictures the illusion of motion.

**1040ST vs. 520ST?**

Why buy an Atari 1040ST instead of a 520ST? To begin with, the 1040ST has fewer power cords. A comparable 520ST has two power supply boxes (one for the computer and one for the disk drive) and three power cords (one for each power supply and one for the monitor). The 1040ST has no power boxes and only two

power cords. This may not seem like much, but all those cords become tangled very easily, and any decrease helps.

The major reason to get a 1040ST, however, is the extra memory. While the 520ST can, in theory, handle as much memory as a 1040ST (both use the same memory management chip, which can handle 4 megabytes of RAM), the board in the 520ST has no space to hold the extra chips. A number of schemes have been devised for adding chips to the 520ST, either to the top of the existing chips or to the bottom of the board. Unfortunately, soldering that number of chips onto a board with such close tolerances is apparently extremely difficult—even experts have ruined computers. Lately, upgrades that consist of a board that plugs into existing sockets have become available. These look promising, but they are still too new to be sure of. If you want a megabyte of memory in your computer, you are definitely better off buying a 1040ST than trying to add chips to a 520ST.

What would you do with a megabyte of memory if you had it? The simplest use for a large piece of memory is a RAM disk, which makes some of your RAM act like a very fast disk drive and makes almost any program run faster.

Beyond that, most common applications such as word processors, spreadsheets, and database managers should be able to make use of all that extra memory directly, even without the use of a RAM disk. A smart database manager, for instance, would allow you to edit and sort records in memory and would be much faster for databases that fit completely in RAM. A megabyte of memory would also allow you to put a very large database on your computer and manipulate it solely in memory and very rapidly.

Finally, you can do some powerful graphics and voice-synthesis tricks with a megabyte of RAM. For instance, an animation program could buffer the frames that are coming up and thus achieve very good, fast animation.

**Conclusion**

The Atari 1040ST is an excellent value with just a few problems that mar an otherwise ideal product. These include the lack of an RF modulator that would allow you to use it with a television set, the possibility of damaging disks if you exceed the desktop limit on folders or try to copy a file to itself, and a shortage of software that makes use of the desktop interface. ■

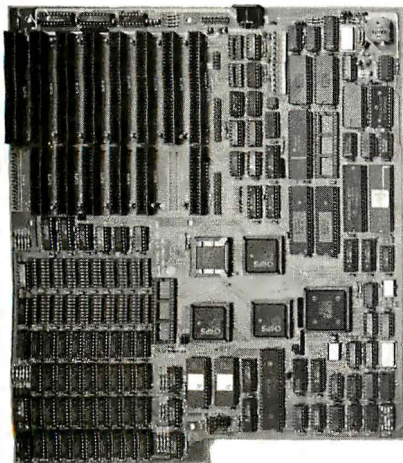

**TURBO AT SYSTEM**

Features:

- 80286 — 10 CPU
- Case and 220 Watts Power Supply
- 6/10 MHz Clock Selectable (Soft Switch Control)
- 1.2 M Floppy Disk Drive
- Hard Disk/Floppy Disk Controller
- 640 K RAM On Board, Expandable to 1MGB
- VLSI Chip Technology
- Professional "AT" Style Keyboard

**TURBO AT — 3MF MOTHERBOARD**

Features:

- 0 or 1 Wait State at 6 MHz
- On Board Rechargeable Battery
- 80287 Socket Ready
- Serial/Parallel Port on Board
- 80286 CPU
- 6MHz, 8MHz, 10MHz, or 12MHz
- Chips Technology (Lower Heat, Higher Quality)
- 3 MB on Board
- XT Size, jr AT Motherboard Available



**WiseTEK INT'L, INC.**  
 513 Valley Way  
 Milpitas, CA 95035  
 TEL: (408) 263-1237  
 FAX: (408) 263-1870

**Distributors, Dealers,  
 OEM Welcome**

**MICRONIC INT'L, CORP.**  
 108 E. 16th Street  
 New York, NY 10003  
 TEL: (212) 529-4699  
 FAX: (212) 529-9926



# Lotus HAL Lets You Do More With (And Get More From) 1-2-3 Than Ever Before.

Lotus HAL™ is a memory resident companion product for Lotus 1-2-3® that enhances the full range of 1-2-3's capabilities—and adds new ones.

It increases 1-2-3's power and flexibility, so you can work more efficiently and become more productive than ever before.

## Benefits For All 1-2-3 Users

Lotus HAL works by giving you easier access to all of 1-2-3's numerous capabilities. And it's extremely useful for 1-2-3 users of all levels.

If you're new to 1-2-3, Lotus HAL will let you use it with greater confidence and speed.

If you're familiar with 1-2-3, Lotus HAL will make it easier for you to access additional power and capabilities.

And if you're an advanced 1-2-3 user, Lotus HAL will show you new features and functions that will add extra flexibility to the power of 1-2-3 you've already tapped.

How does Lotus HAL do all this—for all users?

## Easier Commands

Lotus HAL makes executing 1-2-3 procedures even easier than before. Because it accepts phrases like "total sales," "graph Jan to Mar," or "copy this to A10," etc. In fact, Lotus HAL's vocabulary includes English words and phrases. So you can customize a command dictionary of your own—with the words and operations you're most used to and most comfortable using.

Since Lotus HAL makes 1-2-3 more accessible for all users, you'll learn more—in less time—about all the capabilities of 1-2-3.

For instance, if you're presently using only the spreadsheet, Lotus HAL will show you how to create graphs and do database functions—far more simply than ever before.

## Time-Saving Shortcuts, Easy-To-Crete Macros

With Lotus HAL, you'll take shortcuts and accomplish multi-step tasks quickly and easily. So you'll greatly reduce errors—and save time.

And, with a simple "undo" command, Lotus HAL even lets you recover from errors you've already made. So if you're a novice user, you'll learn faster and with greater confidence. And if you're an experienced user, you can experiment more freely and do "what ifs"—without fear of having a mistake destroy hours of work.

Lotus HAL also makes developing macros simpler than ever—so simple, in fact, that even novice users can create 1-2-3 macros with Lotus HAL. And no matter how familiar with 1-2-3 you are, you'll benefit from being able to write and test macros to make sure they do what you had in mind.

## New Power

Lotus HAL will let you take 1-2-3 as far as you need. And if you've been taking it far already, Lotus HAL offers you new commands that will further enhance your productivity.

For example, Lotus HAL lets you replace items anywhere in the worksheet (even within formulas), and create a dynamic link between cells in multiple worksheets. It also lets you audit your worksheet—so you can find mistakes without having to review the entire sheet "manually."

Best of all, while Lotus HAL greatly enhances 1-2-3's commands, it doesn't change either 1-2-3 or the worksheet. It's always available, but it never gets in your way. And you can share data as freely when you're using Lotus HAL as you did when you were using 1-2-3 alone.

In fact, you can do everything you've ever done with 1-2-3 even better... plus a great deal more.

And since Lotus HAL is part of the 1-2-3 system—and the Lotus family—you get an unparalleled commitment to customer service and support that will keep you up and running.

© 1987 Lotus Development Corporation.

Lotus and 1-2-3 are registered trademarks of Lotus Development Corporation. Lotus HAL and 1-2-3 Companion are trademarks of Lotus Development Corporation.

Lotus HAL is distinguished from HAL, which is a trademark of Qantel for its Hotel and Leisure Software.

### System Requirements.

Lotus HAL requires 1-2-3 Release 1A, Release 2 or Release 2.01 for personal computers from IBM, COMPAQ, and AT&T, plus 1-2-3 Certified Compatibles; DOS 2.0 or higher. Please refer to your 1-2-3 package or 1-2-3 documentation for appropriate hardware configurations and DOS requirements or consult your dealer.

Lotus HAL resides in memory with 1-2-3 and operates with it; a minimum system configuration of 512K is required.

\*Lotus HAL does not operate with 1-2-3 for the IBM PCjr (ROM version), IBM PC Convertible or Release 1A for the IBM 3270 PC.

THE

1-2-3



1-2-3

GREAT







# NewViews™ Accounting

## The Visual Approach at Last.

### YOUR SEARCH IS OVER

Finally, you have accounting created more for the sensibilities of business than the requirements of systems designers. Drive windows over your books, editing as you go. NewViews is "WYSIWYG" at its best.

### IT'S MULTI-DIMENSIONAL

NewViews documents expand and contract for more detail. To add reports, accounts and transactions just add lines to documents. The rules of double entry accounting are strictly enforced with complete security and audit trails. But for the first time, you can see what you're doing.

### FORGET ABOUT MENUS

Issue commands from easy pull-downs with full context sensitive help. Your hand is held every step of the way.

### FORGET ABOUT MODULES

NewViews unifies all accounting functions in a single consistent approach. It completely redefines integration because there is no such thing as a separate "module". With one program, one manual, at one price, you can manage:

- General Ledger
- Financial Statements
- Accounts Receivable
- Accounts Payable
- ATF Payroll
- Time & Billing
- Sales & Over Entry
- Client Write-Up
- Financial Inventory
- Manufacturing
- Job Costing
- Consolidations
- Departments & Branches
- and so on...

### FORGET ABOUT BATCHES

All documents are related in real-time. Your accounts and reports change on a transaction by transaction basis.

### SYSTEM REQUIREMENTS

NewViews runs on IBM and compatible personal computers and local area networks. You need a hard disk, 256K RAM, any monitor, and DOS 2.0 or later. Information can be imported and exported to other popular software packages.

Companies, reports, accounts, transactions, branches, departments, etc., are limited only by your disk. NewViews is not copy-protected.

### ORDER NEWVIEWS

C.O.D., MasterCard, American Express, check or money order are accepted. Phone support is provided at no charge. Training workshops are available.

### FREE SEMINARS

See NewViews in action at a seminar in your city. They are ideal for evaluation, orientation and training.

CALL (416) 923-4567 FOR RESERVATIONS.

Anaheim	Jan-21	Columbus	Mar-06	Los Angeles	Jan-20	Ottawa	Jan-22	San Jose	Jan-16
Atlanta	Jan-07	Dallas	Jan-21	Los Angeles	Feb-23	Ottawa	Feb-17	San Jose	Jan-28
Atlanta	Jan-26	Dallas	Mar-02	Los Angeles	Mar-02	Philadelphia	Jan-16	San Jose	Feb-20
Atlanta	Feb-25	Detroit	Jan-06	Memphis	Jan-23	Philadelphia	Feb-27	San Jose	Mar-05
Atlanta	Mar-16	Detroit	Feb-17	Memphis	Feb-27	Phoenix	Feb-27	Seattle	Jan-07
Baltimore	Jan-21	Fort Worth	Jan-20	Miami	Jan-30	Pittsburgh	Jan-26	Seattle	Mar-11
Baltimore	Mar-03	Fort Worth	Mar-03	Miami	Feb-20	Pittsburgh	Mar-09	St. Louis	Jan-20
Birmingham	Jan-09	Fresno	Jan-28	Milwaukee	Feb-20	Portland	Jan-09	St. Louis	Feb-27
Birmingham	Mar-13	Fresno	Mar-04	Minneapolis	Jan-12	Portland	Mar-09	Tampa	Feb-02
Boston	Jan-06	Hartford	Jan-28	Minneapolis	Feb-23	Providence	Jan-08	Tampa	Feb-18
Boston	Jan-29	Hartford	Feb-20	Montreal	Jan-20	Providence	Feb-18	Toronto	Jan-15
Boston	Feb-17	Hartford	Mar-11	Montreal	Feb-16	Sacramento	Jan-13	Toronto	Feb-05
Boston	Mar-12	Houston	Jan-14	Montreal	Jan-12	Sacramento	Feb-17	Toronto	Feb-19
Buffalo	Jan-26	Houston	Mar-09	New Orleans	Jan-11	San Antonio	Jan-16	Toronto	Mar-05
Buffalo	Mar-12	Indianapolis	Jan-22	New Orleans	Jan-11	San Antonio	Jan-16	Toronto	Mar-19
Chicago	Jan-08	Indianapolis	Mar-02	New York	Jan-13	San Diego	Jan-07	Toronto	Jan-05
Chicago	Feb-19	Jacksonville	Jan-28	New York	Feb-24	San Diego	Jan-26	Vancouver	Jan-13
Cincinnati	Jan-23	Jacksonville	Feb-23	New York	Mar-09	San Francisco	Jan-15	Vancouver	Mar-13
Cincinnati	Mar-04	Kansas City	Jan-15	Newark	Jan-14	San Francisco	Jan-29	Washington	Jan-20
Cleveland	Jan-28	Kansas City	Feb-25	Newark	Jan-23	San Francisco	Feb-18	Washington	Mar-02
Cleveland	Mar-10	Long Island	Mar-05	Newark	Feb-25	San Francisco	Mar-06		

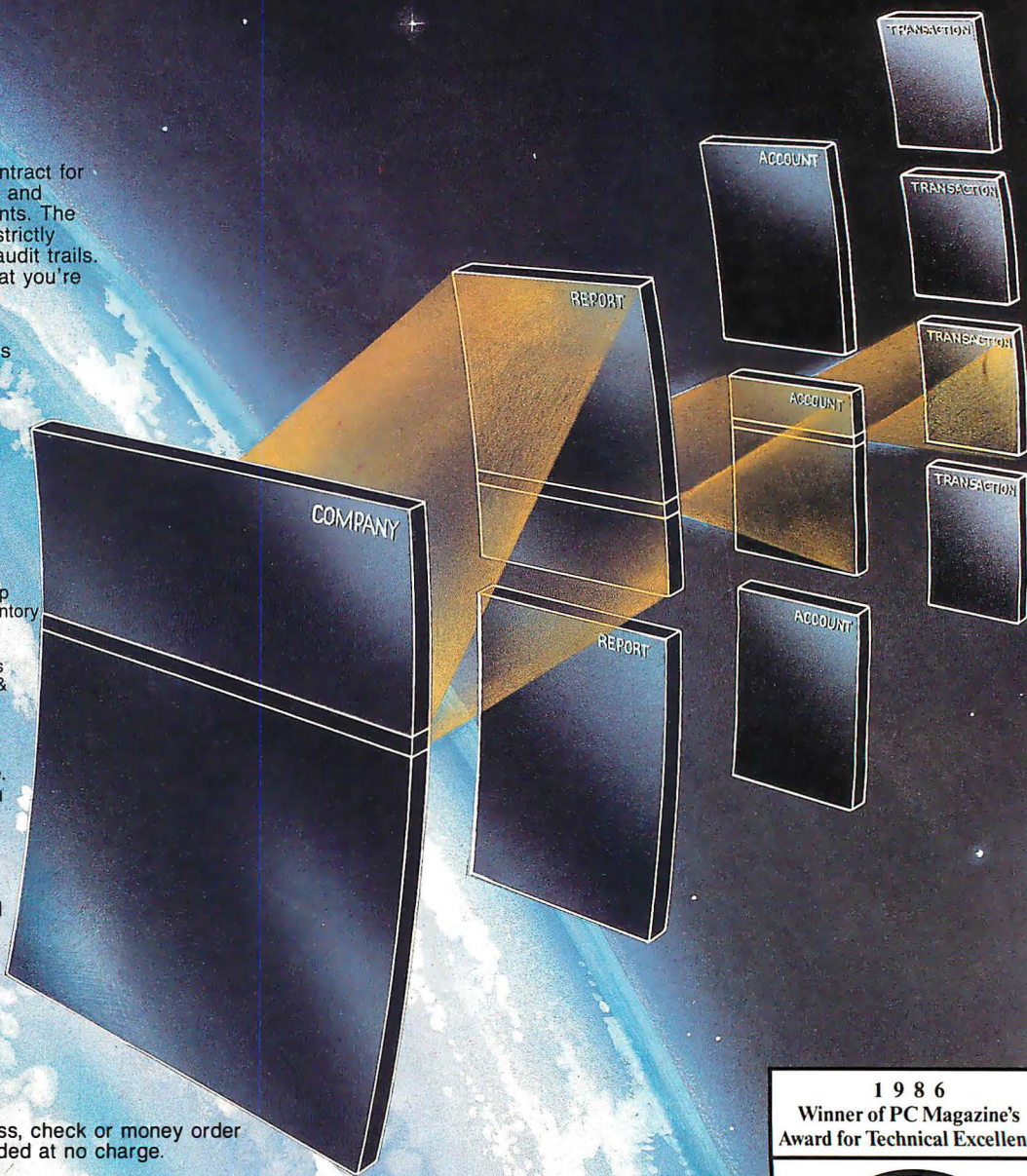

1986  
Winner of PC Magazine's  
Award for Technical Excellence



NewViews  
Complete Financial  
Accounting  
\$695.00 U.S.  
\$895.00 CDN.  
Q.W. Page Associates Inc.  
(416) 923-4567





# Four Ink-Jet Printers

Robert D. Swearingin

*A look at units ranging  
from black-and-white portable  
to full-size color*

After several weeks of producing text and graphics with four ink-jet printers that varied widely in price and features, I was favorably impressed with the overall quiet operation and output quality. I experienced no problems with reliability or the clogged nozzles associated with this technology in the past. The four printers that I reviewed are the Diconix 150 (lower left), the Quadram Quadjet (lower right), the Xerox Model 4020 (upper right), and the Tektronix 4696 (upper left).

## The Diconix 150 Portable

At \$479, the Diconix 150 is more expensive than some other portable printers. But at 3¾ pounds, including five C-size nickel-cadmium batteries that fit inside the platen, it contains more features than many desktop printers—all inside a case that is only 11 by 6½ by 2 inches. In addition to draft, near-letter-quality (NLQ), and script text, it prints italic, emphasized, enlarged, condensed, superscript, subscript, and underlined text, as well as graphics at 1133 dots per line.

A tractor feed is standard, and the printer also accepts single sheets, envelopes, and transparencies through the paper slot in the rear of the machine. The unit comes with a combination AC adapter/charger, and it will produce 150 pages of text on a full charge. Diconix promises to offer an optional serial port. The control panel on top of the unit contains LEDs for power, paper-empty, and on-line status and push buttons for on-line, linefeed, and formfeed functions. By pressing different combinations you can select draft, NLQ, script, envelope mode, battery charging, a self-test, and reverse linefeed. DIP switches under the cover let you set carriage return and linefeed, skip perforation, fonts, IBM/Epson emulation, and inter-



national character sets.

To avoid the complicated nozzle-cleaning circuitry found in many ink-jet printers, Diconix used some interesting engineering on this printer. The 12-nozzle print head and the ink supply are combined in a small \$9.95 cartridge that snaps onto the carriage. It prints about 500 pages of text; then you simply throw the cartridge away and snap in a new one. This cartridge works very well and eliminates another restraint: Many ink-jet printers require a level surface, and the inkwells must be capped when the unit is moved. This isn't practical for a portable, and the Diconix 150 has no such requirements. As the unit was printing, I picked it up and turned it upside down. No problems occurred, and the print quality remained constant.

The specifications for the Diconix 150

list printing speeds of 150 characters per second for draft and 50 cps for NLQ. Using a BYTE benchmark that printed 50 lines of 60 As, I clocked the printer at 82 cps for draft and 30 cps for NLQ. Otherwise, it performed as advertised.

The printing quality of text is better than the average portable; the draftmode is not very dense, but the printer overcomes this deficiency somewhat with an attractive serif typeface. The NLQ and script modes are quite nice, and the Diconix 150 does excellent graphics with clean lines and good density, although my first bar graph was a surprise. The 12-nozzle Diconix 150 is programmed to accept image data files for 9-pin printers without conversion. As a result, it prints graphics in three-quarter size. Thus, if you want to print a 3- by 6-inch image, you must program it for a 4- by 8-inch image.

The operator's manual is one of the best I've encountered.

Sections on setup, operation, commands, and maintenance and the appendix are tabbed for quick reference. The commands section, unlike many, is thorough and easy to understand. Control codes are spelled out in keystrokes and in BASIC.

The Diconix 150 is an extremely versatile printer without the trade-offs normally associated with portables. I couldn't find much to complain about. The printer produced spotty copy initially because I failed to snap the carriage latch completely into place after installing the ink cartridge. After I discovered my mistake and ad-

*continued*

*Robert D. Swearingin (Department of Journalism and Printing, P.O. Box 1930, Arkansas State University, State University, AR 72467) is an instructor of journalism and a freelance writer.*



**Diconix 150**

**Type**  
Portable ink-jet printer

**Company**  
Diconix Inc.  
P.O. Box 3100  
Dayton, OH 45420  
(513) 259-3100

**Size**  
11 by 6½ by 2 inches; 3¾ pounds

**Features**  
Draft, near-letter-quality, script, italic, bold, enlarged, condensed, superscript, subscript, and underlined text  
1133 dots-per-line graphics resolution  
Tractor feed  
Envelope mode  
Transparencies  
IBM/Epson emulation  
120-volt AC adapter/recharger  
2K-byte buffer  
Parallel interface

**Documentation**  
91-page operator's manual

**Price**  
\$479

**Xerox Model 4020**

**Type**  
Color ink-jet printer

**Company**  
Xerox Corp.  
475 Oakmead Parkway  
Sunnyvale, CA 94086  
(408) 737-7900

**Size**  
22 by 13½ by 6 inches; 28½ pounds

**Features**  
Draft, near-letter-quality, italic, enlarged, superscript, subscript, and underlined text  
7 colors  
240 dots-per-inch enhanced graphics resolution  
Transparencies  
2K-byte input buffer  
4.4K-byte image data buffer  
Parallel interface

**Options**  
RS-232C interface: \$100

**Documentation**  
80-page operator's guide

**Price**  
\$1495

**Quadram Quadjet**

**Type**  
Color ink-jet printer

**Company**  
Quadram Corp.  
One Quad Way  
Norcross, GA 30093  
(404) 923-6666

**Size**  
15¾ by 11½ by 4¼ inches; 12½ pounds

**Features**  
Draft, bold, and enlarged text  
7 colors  
640 dots-per-line graphics resolution  
Transparencies  
One-line buffer  
Quadjet driver software  
Parallel interface  
IBM screen-dump software

**Documentation**  
38-page operator's manual  
19-page software manual

**Price**  
\$495

**Tektronix 4696**

**Type**  
Color ink-jet printer

**Company**  
Tektronix Inc.  
P.O. Box 500  
Station Y3-314  
Beaverton, OR 97077  
(503) 627-7111

**Size**  
20 by 13½ by 6 inches; 29 pounds

**Features**  
Draft and underlined text  
7 colors  
120 dots-per-inch graphics resolution  
Transparencies  
Additional colors and features with Tektronix terminals  
Parallel interface

**Options**  
IBM screen-dump software

**Documentation**  
153-page user's manual

**Price**  
\$1795

justed to loading paper from a slot in the rear, the printer was a pleasure to use.

**The Quadram Quadjet**

A minimum-frills color printer, the \$495 Quadram Quadjet produces graphics and text in seven colors. It weighs only 12½ pounds and has a relatively small footprint: 15¾ by 11½ by 4¼ inches. The control panel has buttons for on-line, linefeed, and formfeed control. Two LEDs signal power and on-line status; a third LED signals when you're out of paper, and it blinks during the printer's reinking operation.

The ink is supplied by two cartridges—one for black (\$10) and another for yellow, magenta, and cyan (\$17). They print 4 million characters and simply plug in under a front panel with no need to worry about spilled ink. A carriage lock on top of the printer caps the four ink nozzles during shipping or long periods of nonuse. When unlocked, it uncaps the nozzles and performs a 10-second reinking operation. You can reink any time that printing quality deteriorates, a feature I did not use because the output remained consistently good. The Quadjet accepts single sheets, transparencies, and rolled paper that fits in a holder under the top cover.

For text, the Quadjet prints average draft-quality, bold, and enlarged type in black. The colors are bright and consistent, and the ones that require more than one jet—red, green, and violet—are considerably denser than the draft copy in black. Quadram rates the printer at 37 cps for draft and 17 cps for bold. My times were 24 and 14 cps, respectively. Color text printed at the same speed as black. The printer does good-quality color graphics at 640 dots per line and is extremely versatile because of the Quadjet driver software that comes with the unit. It programs the printer for a software-independent screen dump from the IBM PC (it's also available for Apple computers and the PCjr), for IDS Prism emulation, and for printing advanced screen modes with the Quadcolor II graphics card. You can also change screen colors for the printout. This is a useful feature if you want to print graphics from a variety of software without worrying about the printer driver. As a nitty-gritty color printer, the Quadjet performs very well in its price class.

**The Xerox Model 4020**

The \$1495 Xerox Model 4020 is larger, heavier, more sophisticated, and offers more features than the two units reviewed thus far. It measures 22 by 13½ by 6 inches, weighs 28½ pounds, and inks with 20 nozzles. The yellow, cyan, and magenta inks use four nozzles each; the black ink

*continued*



# THE ONLY DRIVE WORTH ASKING FOR BY NAME.



We'll let you in on a secret. If the small computer you're using has a hard disc drive memory, chances are that drive was made by Seagate.

There's a reason for this—actually over 4 million reasons. (That's the number of hard disc drives Seagate has shipped to quality-conscious customers throughout the world.)

Why are we telling you this?

So you can be sure you get Seagate quality in your new computer, disc memory upgrade or add-on.

The name on the outside may be different, but now that you know the difference, make certain that the name on the inside is SEAGATE.

Seagate Technology, 920 Disc Drive,  
Scotts Valley, CA 95066. 800-468-DISC  
(800-468-DISK in California)

 **Seagate**

Inquiry 257 for End-Users. Inquiry 258 for DEALERS ONLY.



uses four nozzles for graphics and four more for text. A maintenance cartridge fits under a door on the printer front; fluid from this automatically cleans the nozzle system. When you turn the printer on, you hear about half a minute of muted clicks and buzzes as this process proceeds before the Ready light turns on. When you turn the printer off, the cleaning takes about a minute. A button on the back panel initiates a four-minute recovery cycle that flushes the nozzles thoroughly and removes air bubbles from the system if you're having problems with print quality. I performed this recovery cycle at setup and didn't need to use it again.

The Model 4020 accepts sheets, transparencies, and rolled paper that fits on a spindle that attaches to the back. The four ink reservoirs are inside the top cover. To replenish a color, you simply plug a cylindrical cartridge into the proper reservoir (they are keyed to avoid mistakes), push down until the seal punctures, wait a few seconds for the ink to drain, and throw away the empty cartridge. This is more trouble than a single multicolor cartridge, but more economical; you don't have to throw away the rest of your magenta and cyan because you're out of yellow. The cartridges come in sets of four and last for about 180,000 characters or 120 pages of graphics with 15 percent coverage.

The front panel contains LEDs for the four ink colors and on-line and power status. Three membrane buttons control on-line, linefeed, and formfeed functions. A small rear panel houses the parallel interface, switches for self-test, recovery, and bidirectional print adjust, and DIP switches. The DIP switches set international characters, draft or NLQ, enhanced graphics mode for Diablo C150 software, margins, print direction, carriage return, linefeed, and fonts. If you select the optional \$100 RS-232C interface, an additional DIP switch sets the protocol and data rate.

For text, the Model 4020 prints 10-pitch Gothic and italic, 12-pitch Gothic, and 12-pitch roman, selectable by DIP switch or software, and 17-pitch Gothic, selectable by software only. It also prints expanded, superscript, subscript, and underlined printing. Specifications are 80 cps for draft and 40 cps for NLQ; my times were 58 and 30 cps, respectively. Unlike the other color machines I evaluated, the Xerox Model 4020 slows down to print color; it printed red at 40 cps in its default color text mode (see example at right). It is worth the wait, however. The Model 4020's color text has excellent density and brilliance. For black text, I'd rate the draft quality slightly better than average and the NLQ as outstanding. The 12-pitch roman is an attractive and readable face, although

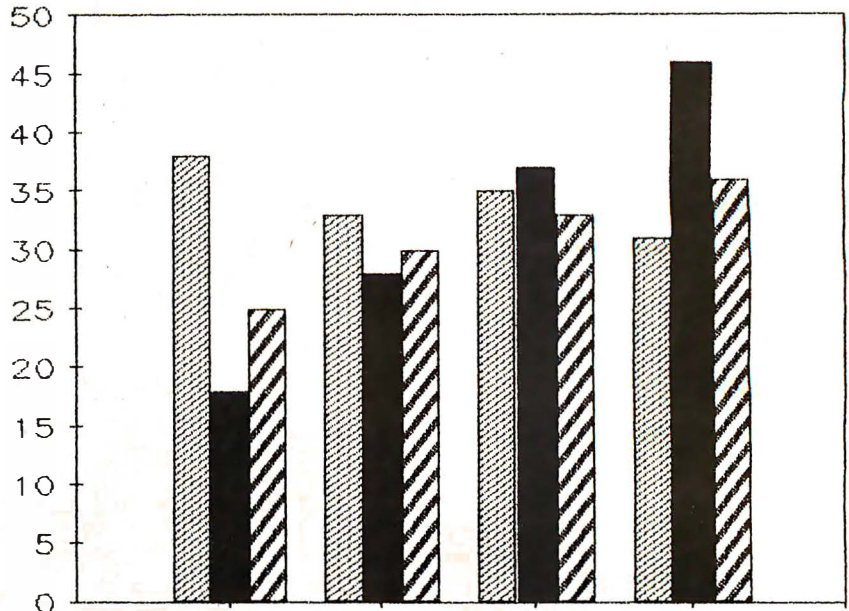

This is the Diconix 150 portable, Draft Quality.  
 This is the Diconix 150 portable, NLQ.  
 This is the Diconix 150 portable, Italic NLQ.  
 This is the Diconix 150 portable, emphasized NLQ.  
 This is the Diconix 150 portable, Script.

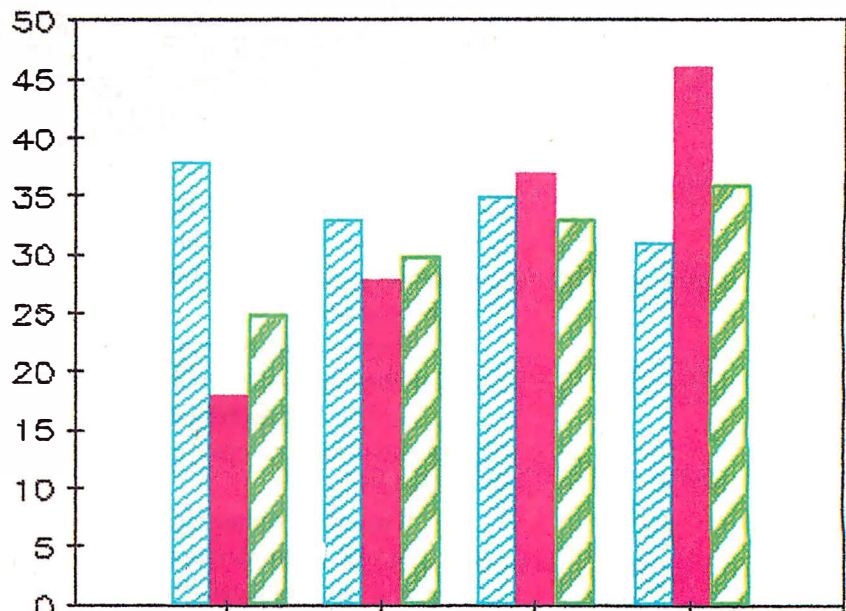

This is the Quadram Quadjet, Draft.  
 This is the Quadram Quadjet, Bold.  
 This is the Quadram Quadjet, Enlarged.  
 This is the Quadram Quadjet, Red.  
 This is the Quadram Quadjet, Green.  
 This is the Quadram Quadjet, Violet.

Print samples from the four ink-jet printers. The bar chart was generated with Chart-Master on an IBM PC-compatible computer.



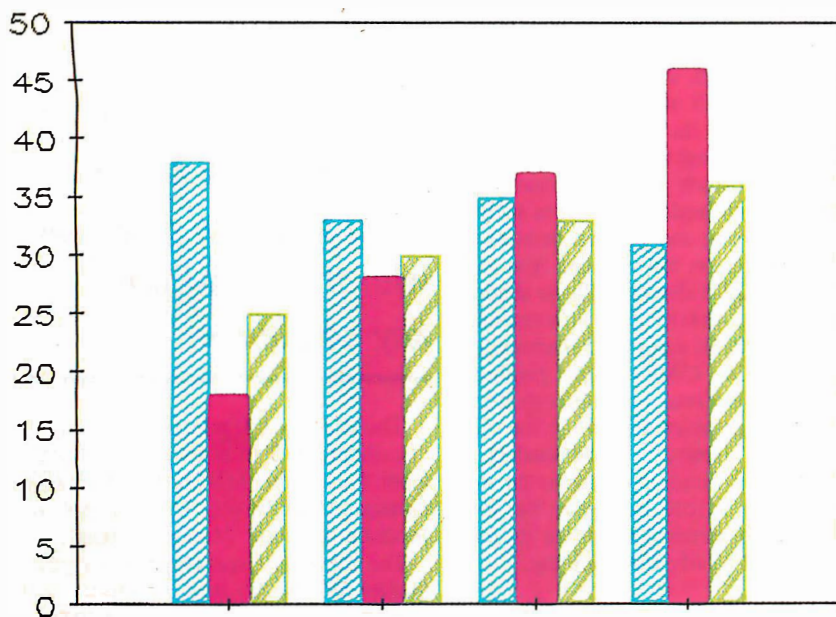

This is the Xerox 4020, Draft.  
 This is the Xerox 4020, NLQ.  
 This is the Xerox 4020, *Italic NLQ*.  
 This is the Xerox 4020, 12-Pitch Roman.  
 This is the Xerox 4020, Red.  
 This is the Xerox 4020, Green.  
 This is the Xerox 4020, Violet.

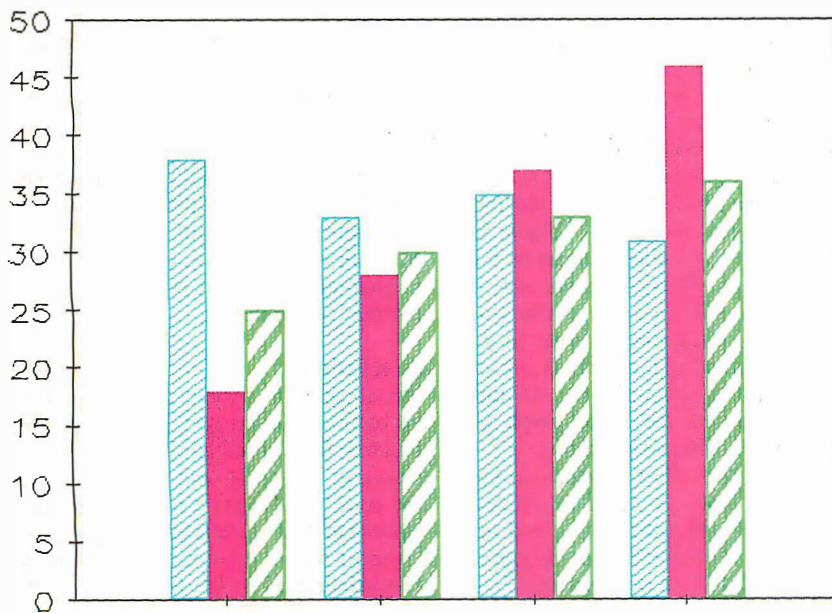

This is the Tektronix 4696.  
 This is the Tektronix 4696, Underlined.  
 This is the Tektronix 4696, Red.  
 This is the Tektronix 4696, Green.  
 This is the Tektronix 4696, Violet.

not particularly dense. The graphic quality is excellent, with clean lines and bright colors at resolutions of 120 dots per inch in draft and 240 dots per inch in enhanced mode. The printer accepts the Diablo C150 driver; Xerox publishes a list of more than 50 compatible packages for the IBM PC and compatibles and several more for the Amiga and the Apple II family.

**The Tektronix 4696**

It's hard to resist the temptation to compare the Tektronix 4696 with the Xerox Model 4020 because both machines obviously came from the same manufacturer. They're similar in size, weight, and appearance, even when you peek beneath the top cover. But they were designed for different applications. Specifically, if your application involves only IBM PCs, this printer is probably not for you, even though it is compatible. It provides fewer features than the Model 4020 at a higher price: \$1795. The manual and specification sheet mention only Tektronix 4100-series display terminals and 4400, 4110, and 4120 workstations. A company spokesman confirmed that this is the primary market. If you use Tektronix terminals or a combination of these and IBM PCs, the Tektronix 4696 is worth a closer look.

The maintenance fluid and ink cartridges are similar to the Model 4020's, but I couldn't verify whether the contents are the same. Ink cartridges, good for about 100 pages of graphics, cost \$18 for a set of four. The nozzle-servicing sequence was a few seconds shorter on power-up and a few seconds longer on power-down than that on the Model 4020. The front panel contains LEDs for the four ink colors, on-line, and power status, along with membrane buttons for on-line and linefeed functions. Although the printer has no formfeed button, there is one labeled "Media" that lights an LED indicating the printer is in a special mode for transparencies. The back panel contains switches for self-test, recovery, and bidirectional print adjustment. Two DIP switches set the margins and carriage return; two others are for service diagnostics and don't function during normal operation.

The only options for text are draft, underlined, and color, although one of the character sets includes room for a downloadable face. The specifications list the printer speed at 35 cps. I timed it at 29 cps for black and color. The type is an attractive dot-matrix face that is a bit too thin for my taste. The printer accepts the Tektronix 4695 driver and produces excellent color graphics at 120 dots per inch.

*continued*



## THE COST OF QUALITY XTURBO COMPUTING JUST HIT ROCK BOTTOM!

**NOW! FULLY FUNCTIONAL  
XTURBO SYSTEMS  
ALL COMPLETE WITH  
HARD DRIVE AND  
TTL AMBER MONITOR**

FULL SYSTEM PRICE ONLY

**10MB \$845**  
**20MB \$985**  
**30MB \$1049**

**No Hidden Costs, No Gimmicks  
A True IBM Compatible at  
Hundreds Below Competition  
LOOK AT THESE FEATURES:**

### IBM COMPATIBLE XTURBO SYSTEM, 4.77/8 MHZ WITH 16-BIT 8086-2 PROCESSOR

1. Dual Speed—Keyboard Switchable
2. 640K RAM, 256K On Board
3. 8087 Socket
4. Eight Expansion Slots
5. 135 Watt Power Supply with Built-in Filters And Spike Protection
6. Front Panel Turbo Indicator
7. Can Boot-Up in Turbo Mode
8. Handsome, Heavy-Duty AT Style Cabinet
9. Built-in Speaker
10. Illustrated Operations Manual
11. Runs all MS-DOS programs including 1-2-3, Flight Simulator, etc. and GWBASIC
12. Brand New (Not Refurbished) Hard Drive & Controller
13. System Boots From Hard Drive
14. 360K Direct Drive (Not Belt Driven) Floppy Drive
15. Four-drive (Not 2-Drive) Floppy Controller
16. AT-Style Keyboard, 84 Keys, LED Indicators and Large Return Key
17. Monographics (Hercules Compat.) Card W/Prtr Port
18. High Resolution TTL Amber Screen Monitor
19. One-Full-Year Limited Warranty
20. 30-Day Return for Refund Policy

CALL NOW **415 527-5834**  
VISA • MASTER • COD



**OLLA COMPUTER  
SYSTEMS, INC.**

1224 TENTH STREET BERKELEY, CA 94710

## FOUR INK-JET PRINTERS

Printouts of two complicated color graphs included on the optional IBM screen-dump software are impressive. As with the Quadram Quadjet, the screen-dump software is a plus. It allows you to change colors as well as the size of the printout.

With a Tektronix terminal you can dump 8- by 6-inch portrait formats and 10½- by 8-inch landscape formats with a keyboard button, and you can print continuous images on rolled paper. You can print up to 125 different halftone shades with Tektronix 4100 terminal firmware and more than 130,000 colors and shades with the Tektronix 4510A color graphics rasterizer. The printer will also copy from a terminal's graphics area while the terminal works elsewhere. Unfortunately, I could not run these applications on my micro. Again, I liked the printer, but you really need a terminal to utilize its full potential and justify the price tag.

### Graphics

Comparing these printers is difficult, but the ink jets, at least, are a common denominator. I ran the same clustered bar chart, designed with Chart-Master, on all four units. The four-color chart, with three variables and four observations, was 6½ inches wide by 5 inches high—the largest I could get with my 384K-byte memory.

Print quality of the graph was good with all the printers (see the print samples on pages 242 and 243). The Diconix 150 printed a crisp black-and-white version in 3 minutes and 21 seconds. Times for the color printers were 7:01 for the Quadram Quadjet, 3:24 for the Xerox Model 4020, and 2:36 for the Tektronix 4696. On color brilliance, the Model 4020 and the Tektronix 4696 were exceptional—I'd give the Model 4020 a slight edge, at least on this particular graph. The Quadjet was noticeably paler but still quite acceptable with good color. Considering the price of the Quadjet, it compares favorably if you are on a budget and not in a hurry. All four printers produced the same graph on transparencies with no problems.

Software-independent screen dumps were another story. None of the printers had problems with text, but I could not get the Xerox Model 4020 to dump graphics with the Shift-Print key sequence. First I tried a black-and-white chessboard with players on the squares. The Model 4020 made a rough outline of the board, about 4 inches square, using repeated bracket signs. Results weren't any better with a color Monopoly board. The printer dumped an 8- by 3½-inch version, reproducing the color text in black and with no graphics. Nonetheless, the Model 4020 performed nicely when driven with graphics software.

*None of the printers had problems with text, but I could not get the Xerox Model 4020 to dump graphics with the Shift-Print key sequence.*

The Diconix 150 printed a 4- by 6-inch chessboard in 2 minutes and 44 seconds after I used the MS-DOS GRAPHICS command. However, I could not reproduce the color Monopoly board.

The Quadram Quadjet dumped a good-quality 5½- by 7½-inch chessboard in 6 minutes and 17 seconds. The Tektronix 4696 reproduced a denser version, about the same size, in 1 minute and 27 seconds. The Quadjet printed a 3½- by 5½-inch color game board in 2 minutes with good reproduction. The Tektronix 4696 printed a slightly smaller version, 3 by 5¼ inches, in 44 seconds with brighter colors and better graphics. The printers took longer on the black-and-white image, but the chessboard is quite dense—probably in the neighborhood of 50 percent. The Monopoly game board, with its text and smaller symbols, is probably at or below the 15 percent density average for business graphics.

Generic screen dumps of graphics are questionable. If that's a requirement for your application, you'll want to be sure that appropriate software is available for the printer you choose, and even that is no guarantee when you try to dump from assorted programs.

### Conclusions

I encountered no serious constraints with any of the ink-jet printers. They're not particularly fast, although the Diconix 150 compares favorably with other portables I've used. Ink-jet printers are more susceptible to dust and altitude changes, and I suspect they are not the best choice if your printer will be idle for long periods. Finally, ink-jet printers are paper-sensitive; there was a noticeable difference in image quality when I tried one printer's paper in another printer. Furthermore, the paper is treated on one side; if you put it in backward when inserting single sheets, the image quality is terrible.

If these factors don't affect your application and you need a quiet, quality dot-matrix printer, any of these printers are well worth considering. ■



# Don't Buy From A Stranger

**QUBIE' ... To over 80,000 satisfied customers, Qubie' is no stranger.**

Qubie' delivers the finest peripherals available in terms of features, reliability, price and performance, with service and support unparalleled in the micro-computer industry.

At Qubie', customer satisfaction is one of the cornerstones of our philosophy. Our professional Sales/Customer Service staff can answer any questions before you buy. Our excellent Technical Support staff (with hours **M - F, 8am - 5pm PTZ and Sat. 8 - 11am PTZ**) are as close as a phone call away should you require assistance. With our quality products, your satisfaction is assured. Qubie' offers a **One Year Warranty, 48-hour turnaround and Federal Express** service on warranty repairs. At Qubie', your satisfaction is our top priority, but if for any reason you are not completely satisfied with your purchase, with our exclusive **30-Day No Risk Guarantee**, you may return your purchase for a complete refund, including the cost to send it back. Ask your friends, business associates and colleagues about Qubie' -- chances are they are one of the 80,000 satisfied customers.

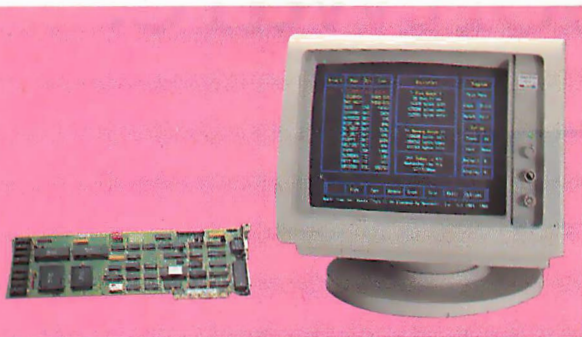

A fully compatible 256K EGA Card with a parallel port for only **\$219!** It features 16 simultaneous colors displayed from a palette of 64 colors, and crisp, clear text on both monochrome and enhanced color displays -- options that are not available on some EGA cards.

Qubie' also offers a special "Display Deal" - the EGA card plus a Basic Time HR31-350 monitor for just **\$649!**

Expanding your PC to include a 20 megabyte hard drive has never been simpler with a Qubie' internal drive.

The PC20 is an internal hard disk subsystem mounted like your floppy, for an incredible **\$369**. The PC20 is a standard mounting drive (like a floppy), so that you can see the read/write light. The drive boots directly from the hard disk, and requires no software patches. Our format software allows changeable interleaving that gives you noticeable speed improvement over the standard XT drive.

Qubie' also includes software that truly enhances the use of your hard disk -- 1dir, the hard disk organizer that makes DOS a snap, and the special Qubie' version of **ZyINDEX**, the super searcher.

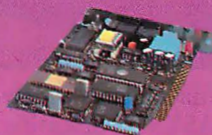
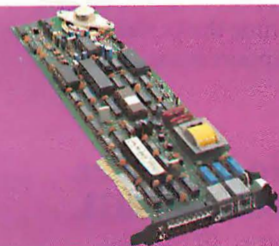
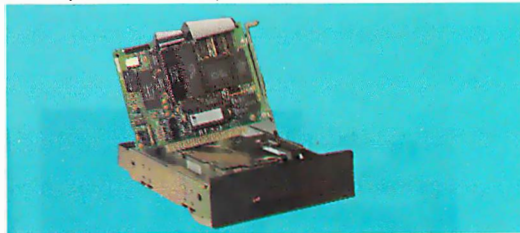

Choose from a family of four modems -- the 1200 baud modems at **\$119**, and the 2400 baud modems at **\$229**, that offer unbelievably great performances!

You can be sure that the Qubie' family of modems are of good stock. Qubie' offers both 1200 and 2400 baud modems. Our modems are fully compatible with all Hayes software commands. Software packages such as Crosstalk, ProComm, and Sidekick, will work flawlessly.

The 2400 internal and external state-of-the-art modems are equipped with Automatic Adaptive Equalization, CCITT V.22/V.22 bis, Bell 212A compatible, and 2400/1200/600/300/110 bps.

The 1200 baud modems are Bell 103/212A 300/1200 baud, include a modular phone cord, and PC-TALK III software.

At **\$119**, and **\$229**, these are the best price, performance modems for your communication needs.

# QUBIE'

Department B  
507 Calle San Pablo  
Camarillo, CA 93010  
Inquiry 240

Inside California  
**805-987-9741**

Outside California  
**800-821-4479**

London (01) 223-4569 Paris (01) 321-5316 Sydney (02) 579-3322 Canada (403) 434-9444



# Still the only integrated scientific analysis, graphics, and data acquisition software.

## ASYST™

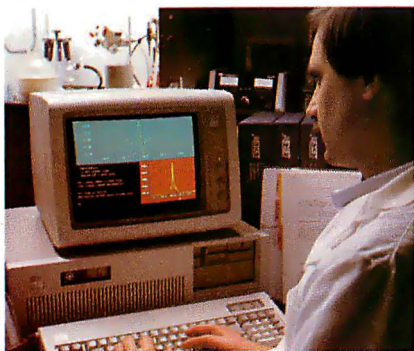

Macmillan's widely-acclaimed ASYST™ Scientific Software still offers more built-in capabilities than any other PC software. Its unique interactive programming environment includes such functions as FFT, smoothing, integration, differentiation, curve fitting, statistics, differential equations, and matrix and polynomial operations. And all functions are supported by sophisticated graphics, such as error bars, scatter plots, and axonometric plotting.

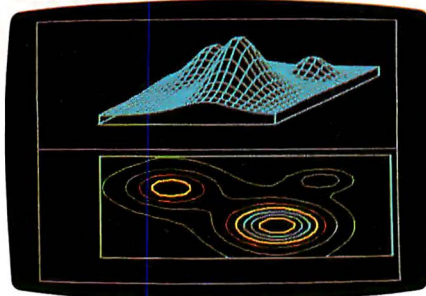
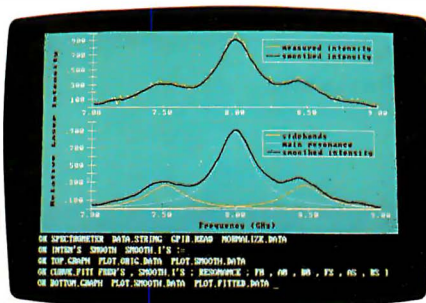

ASYST's extensive function set provides the building-blocks that let you assemble scientific applications—fast. RS-232 and optional A/D and

GPIB/IEEE-488 support offer interface versatility you just can't get from other products. And all hardware support integrates seamlessly with the full range of ASYST capabilities.

**Free technical support.** 60 days of free technical support help you design, set up, and fine-tune the perfect system. Ongoing support is available at a nominal cost.

**30-Day No-Risk Offer.  
CALL 1-800-348-0033.**

In New York state, (212) 702-3241.  
Ask for technical literature, including performance benchmarks.

### Macmillan Software Co.

An affiliate of Macmillan Publishing Company  
630 Third Avenue, New York, NY 10017





# Microsoft QuickBASIC 2.0

Dennis Dykstra

## *An integrated programming environment with powerful features*

QuickBASIC is a program that compiles BASIC source files into machine code. In describing version 1.0 of Microsoft's QuickBASIC, you could pretty much have stopped with that statement. But version 2.0 is much, much more. It is an integrated programming environment that provides many of the advantages of an interpreter without requiring you to give up the execution speed of a compiler. It includes a full-screen editor, a debugger with single-step, animate, and trace modes, a library manager that lets you prepare libraries of compiled routines that you can call from your QuickBASIC programs, and a highly structured language that just might make you forget you ever heard the word GOTO.

Although most QuickBASIC users will probably use the built-in full-screen editor to write source programs, you can actually use any text editor that will produce ASCII files. This includes the editor in your BASIC interpreter, although you must remember to save programs with the .A option to put them in ASCII format; QuickBASIC doesn't know about tokenized BASIC files.

### Comparisons with BASICA

Because Microsoft's BASIC is bundled with most PC-DOS and MS-DOS computers, you might expect that QuickBASIC would be able to compile your BASICA programs unchanged. This is partially true. Most QuickBASIC statements use exactly the same syntax and work exactly the way they do in BASICA. Others, though, have somewhat different syntax or work a bit differently, and a few BASICA features aren't recognized by QuickBASIC at all. On the other hand, QuickBASIC includes certain enhancements that provide much better capabilities for developing structured programs than those provided by BASICA.

QuickBASIC supports both dynamic and static arrays, with static arrays being the default. Storage for dynamic arrays is

allocated at run time; for static arrays, it is allocated at compile time. Static arrays require slightly less storage space and can be accessed faster. Dynamic arrays are more flexible because you can redimension them with REDIM or deallocate them with ERASE. Furthermore, QuickBASIC 2.0 allows each dynamic array to use as much as 64K bytes of memory space, with the number of these large arrays in any program being limited only by available memory. This gives your programs access to a lot of in-memory data.

Strings in QuickBASIC can be up to 32,767 characters in length, as opposed to 255 in BASICA. All the BASICA string functions are fully supported. In addition, a new function, SADD, returns the memory address of a string.

You can use the CHAIN statement to transfer control from the currently operating program to another QuickBASIC program, although the ALL, MERGE, DELETE, and line-number CHAIN options available in BASICA are not supported. You can also pass control to any .EXE file by using RUN *filename* (*filename* is a string expression). To execute .COM or .BAT files or a built-in DOS command such as DIR or TYPE, you have to use SHELL *command* (*command* is a string expression), which works the same as it does in BASICA.

Most of the BASICA commands not recognized by QuickBASIC are those that would normally be executed in the interpreter's direct mode, such as LIST and RENUM. Several statements have slightly different syntax in QuickBASIC than in BASICA. In particular, programs that use DRAW, PLAY, and RESUME will probably require some modification before they will compile correctly. DEFUSR and USR are not supported at all by

QuickBASIC. COMMON, DEFtype, and DIM statements declaring static arrays must appear at the beginning of QuickBASIC programs. Also, if your program does error trapping with ON ERROR GOTO or event trapping with ON *event* GOSUB, you will have to notify the compiler of this at compile time. Several other BASICA defaults are optional in QuickBASIC so that your executable files can be smaller if you don't need those capabilities. This includes the ability to exit an infinite loop by pressing Control-Break.

All the BASICA graphics statements have been ported over to QuickBASIC. With the exception of DRAW, all are syntactically the same as in BASICA. An enhancement in version 2.0 that will be of major interest to users of enhanced graphics adapters is that QuickBASIC now supports all EGA modes as well as monochrome and color graphics adapter modes. In addition to the new EGA screen modes, QuickBASIC 2.0 provides a PALETTE statement that lets EGA users change the set of colors being displayed.

Several statements are new in QuickBASIC. One useful addition is COMMAND\$, which returns a string containing the command line used to invoke the program. You can use this string to determine any parameters that the user may have set when the program was started. LBOUND and UBOUND return the lower and upper bounds of an array; this can be useful when dynamic arrays are passed to subroutines. LOCK and UNLOCK allow users with DOS 3.0 or later to control access to all or part of an opened file. This may be essential in a net-

*continued*

*Dennis Dykstra (Northern Arizona University, P.O. Box 4098, Flagstaff, AZ 86011) is a professor and does software consulting and freelance writing. His latest book is Mathematical Programming for Natural Resource Management (McGraw-Hill, 1984).*



**QuickBASIC 2.0****Type**

Extended programming language, BASIC compiler, and programming environment based on IBM BASICA and Microsoft GW-BASIC

**Company**

Microsoft Corp.  
16011 Northeast 36th Way  
PO. Box 97017  
Redmond, WA 98073-9717  
(800) 426-9400

**Format**

5¼-inch MS-DOS floppy disks

**Computer**

IBM PC, PC XT, PC AT, and close compatibles with at least 256K bytes of memory, DOS 2.0 or later, and one double-sided disk drive; can be used with or without a hard disk; not copy-protected

**Documentation**

600-page user's manual; README.DOC and UPDATE.DOC files on disk

**Price**

\$99

work environment where several processes might use the same file simultaneously.

Line numbers are optional in QuickBASIC, and I find that programs are a lot more readable without them. If you need a target for a GOTO or GOSUB statement, you can use an alphanumeric label that can be up to 40 characters long. But you may find that you can live perfectly well without ever using another GOTO. QuickBASIC has structures that let you avoid them altogether, thus allowing you to develop truly modular programs in the tradition of Pascal and C.

**Mandate for Modularity**

QuickBASIC facilitates modularity through its support of multiline functions, true multiline IF...THEN...ELSE blocks, named subroutines, local variables, separate compilation of program modules, and a facility for developing user libraries.

One of the limitations of BASICA is that it supports only single-line user-defined functions. QuickBASIC gives you both single- and multiline functions. Any user-defined function is globally available within the module in which the function is defined. Microsoft refers to a module as a single disk file containing a main program, one or more subroutines, or both.

A function definition must reside physically above the first program line that invokes it. Thus, you cannot place function definitions at the back of the file, as you can with FORTRAN, for example. Nor can you compile user-defined functions by themselves and then link them with a main program. However, you can put one or more function definitions in a separate file and merge them with the source file at compile time. This is done by placing a compiler metacommand, \$INCLUDE, in the source file at the point where the function definitions are to be merged. \$INCLUDE is also convenient for merging blocks of statements that will be used in more than one module, such as COMMON statements.

QuickBASIC 2.0 supports true IF...THEN...ELSE blocks, with no limit on the number of physical lines that these blocks can occupy. Multiple ELSEIF statements give you the capability provided by CASE constructs in Pascal and C.

In BASICA, the CALL *name* statement is used to transfer program control to an assembly language subroutine stored at the address pointed to by a variable named *name*. This address is an offset into BASICA's code segment. The syntax of the CALL statement in QuickBASIC looks the same but is actually quite different. In QuickBASIC, *name* refers to a subroutine name, not a variable. This subroutine might reside in the same module as the calling program (in which case *name* is considered an internal reference), or it might reside in a separate module (an external reference). It can be either a QuickBASIC subroutine or an assembly language subroutine. In BASICA the programmer has to worry about initializing *name* so that it points to the correct address. In QuickBASIC that is the job of the compiler (for internal references) or the linker (for external references).

A named QuickBASIC subroutine (as opposed to a conventional GOSUB) is a contiguous block of code that is normally positioned after the END statement of the main program. The first statement in this block of code must be SUB *name* (*parameter list*) STATIC, and the last statement of the block must be END SUB. Parameters are optional and can be simple variables or arrays; the corresponding arguments of the CALL statement can be simple variables, arrays, or expressions and must agree in type with the parameters. The keyword STATIC is mandatory and indicates that the subroutine is non-recursive. Recursive subroutines are not supported in QuickBASIC 2.0.

Variables used in a QuickBASIC program are not available to the named subroutines called by that program unless specifically passed to them. Identical

variable names in a main program and in a named subroutine refer to different memory locations unless the variable is specifically declared to be shared between the main program and the named subroutine. This applies only to named subroutines, however; any variables used within a multiline user-defined function, except those passed as arguments, are by default global variables. However, you can force such variables to be local to the function by including the statement STATIC *variable list* just below the DEF FN statement. This can cure many debugging headaches.

Variables can be passed to named subroutines in several ways. They can be passed as arguments to the CALL statement or they can be named in a SHARED or COMMON statement. The SHARED statement lists main-program variables that are to be made available to all subroutines residing in the same module as the main program. The COMMON statement is used when the main program and subroutine reside in different modules. COMMON is also used to pass variables to another main program invoked by the CHAIN statement.

When you link separately compiled modules together, exactly one module must contain a main program; other modules can contain named subroutines. Each module is compiled separately using QuickBASIC. This produces an object file for each module with the extension .OBJ. The separately compiled modules can then be linked with Microsoft's Link program (Overlay Linker version 3.06 comes with QuickBASIC) to produce an executable program file with the extension .EXE.

QuickBASIC 2.0 provides a library management capability through a program called BUILDLIB.EXE. Software developers familiar with Microsoft's LIB.EXE will find BUILDLIB.EXE inconvenient because you cannot add or delete individual modules from the library; you simply create the library all at once from the collection of .OBJ files. If you want to add a new module, you recreate the library with both the old and new .OBJ files. To me this is awkward, but users not already familiar with object libraries may find it easier than working with a more flexible, but also more complex, library management system.

**More Memory to Manage**

One of the limitations that almost every BASICA programmer confronts sooner or later is that both the BASIC source code and all the data have to fit within a single 64K-byte segment. By adopting this limit, BASICA conforms to what Intel refers to as its "small memory model." QuickBASIC 2.0 gives you a "medium memory model" in which 64K bytes are allocated



to data alone, and up to 64K of code space is allocated to each source module. Although each module is limited to 64K bytes of code space, you can link separately compiled modules together to form large programs that are limited in size only by available memory. All such modules have access to the single data segment, but only variables declared in COMMON statements or passed as subroutine arguments preserve their values across module boundaries.

Version 2.0 of QuickBASIC provides another improvement that will interest software developers. Dynamic arrays are now stored separately from the 64K data segment. Each dynamic array can occupy up to 64K by itself. Dynamic arrays can be referenced in COMMON statements, and the number of such arrays that you can use in a program is limited only by available memory. This capability will help elevate QuickBASIC to the category of serious development languages.

**The Assembly Connection**

QuickBASIC 2.0 makes it possible to use assembly language subroutines even if you don't have Microsoft's Macro Assembler. (However, for the greatest speed and flexibility or very large assembly language routines, you will still need the Macro Assembler.) QuickBASIC lets you POKE machine language subroutines into memory and then branch to them by using a CALL ABSOLUTE (*argument list*) statement, where the last argument in *argument list* is an integer variable specifying the offset into the current data segment where the machine language subroutine begins. Version 2.0 also supports BSAVE and BLOAD, so you can quickly save and load large machine language routines and, perhaps more importantly, you can quickly save and load graphics screens directly to and from screen memory.

You can even invoke BIOS and DOS interrupts from within a QuickBASIC program using INT86 and INT86X. These are nearly identical to the interrupt interfaces provided with Microsoft Pascal and C. INT86X lets you change the values of the DS and ES registers; INT86 does not. The format of both interfaces is

```
CALL INT86(X)(interrupt,VARPTR
(regs1(0)), VARPTR(regs2(0)))
```

where *interrupt* is the number of the interrupt being invoked, *regs1* is an array of register values to be used as input by the interrupt routine, and *regs2* is an array in which register values output by the interrupt routine will be returned. To print the current screen, for instance, you can invoke BIOS interrupt 5 (the PrintScreen service) via

```
CALL INT86(5,VARPTR
(REGS1(0)),VARPTR(REGS2(0)))
```

with all elements of REGS1 initialized to zero.

**The Integrated Environment**

In preparing version 2.0 of QuickBASIC, Microsoft clearly paid attention to the enormous success of Borland's Turbo Pascal. QuickBASIC now sports a built-in full-screen editor from which you can compile, run, and debug programs, all without ever leaving the editor. This makes program development very much like using an interpreter, except that the editor is a lot better; through drop-down

menus it features commands like Search, Cut, Paste, and the all-important Undo, which are missing from the BASICA editor. The QuickBASIC editor also supports a mouse if you like that kind of interface. On a color monitor, the editor comes up in white text on a blue background, but Microsoft has thoughtfully provided a way for you to change the colors to suit your own taste.

After you have fully debugged a program, you can convert it to executable code (an .EXE file), either from within the editor or from a DOS command line. Doing this from within the editor is much faster, since everything required is already

*continued*

**Table 1: Results for the standard BYTE benchmarks (see BYTE's Inside the IBM PCs, Fall 1985, page 195). Two separate compile times are shown.**

"In memory" refers to compiling from the editor and includes the time required to write an executable file to disk (for QuickBASIC this is not, however, a stand-alone executable file as is produced by ZBasic—the BRUN20 run-time environment must be loaded before it can execute). "Command line" refers to compiling and linking of QuickBASIC programs from the DOS command line to generate stand-alone executable files. "Disk storage" refers to the total space required for the ASCII source file plus the executable file. The Write program measures the time required to write a 64K-byte sequential file onto a blank disk, 128 bytes at a time; Read measures the time required to read this file into memory, 128 bytes at a time. Calc determines how long it takes to do 10,000 multiplication and 10,000 division operations; Calc.INT does the test with integer variables, and Calc.FP does it with single-precision floating-point variables. Sieve measures the time required to execute one iteration of the Sieve of Eratosthenes program to determine all prime numbers up to 13,999. Sieve.INT does the test with integer variables, and Sieve.FP uses single-precision variables. All tests were done on a Tandy 1000 with 384K bytes of memory and two double-sided disk drives running MS-DOS 2.11. All times are in seconds; file sizes are in bytes.

Language	Test	Run time	Compile times		
			In memory	Command line	Disk storage
QuickBASIC	Write	58.7	5.4	121	33,344
ZBasic	Write	57.7	9.4	—	13,952
GW-BASIC	Write	58.9	—	—	308
QuickBASIC	Read	30.5	5.1	122	33,234
ZBasic	Read	30.5	9.8	—	13,824
GW-BASIC	Read	55.9	—	—	248
QuickBASIC	Calc.INT	1.1	5.3	123	28,698
	Calc.FP	11.1	5.4	123	28,874
ZBasic	Calc.INT	1.1	9.6	—	13,952
	Calc.FP	102.0	9.6	—	14,080
GW-BASIC	Calc.INT	61.8	—	—	384
	Calc.FP	63.0	—	—	307
QuickBASIC	Sieve.INT	1.4	5.9	124	28,794
	Sieve.FP	19.4	5.9	127	29,492
ZBasic	Sieve.INT	1.4	9.5	—	14,208
	Sieve.FP	63.2	10.4	—	14,336
GW-BASIC	Sieve.INT	181.0	—	—	488
	Sieve.FP	205.0	—	—	448



in memory and no link step is needed. But if you are developing a program that will comprise several separate modules, you'll have to compile them independently and then invoke the linker from the DOS command line. People who have used other compilers will have no difficulty with this, but it may be a new experience to BASIC programmers.

**Triple Threat**

QuickBASIC 2.0 actually provides three run-time systems. One of these is invoked from the built-in editor and, with a compilation speed of up to 6000 lines per minute, is by far the fastest way to compile programs. Programs executed from within the editor run more slowly than those executed from the DOS command line, however; BYTE's Sieve of Eratosthenes benchmark runs only about one-twelfth as fast from within the editor as from the DOS command line. This is still 10 times faster than in BASICA, but you would normally be willing to give up that extra speed only during program development when the interpreter-like environment is helpful.

Aside from the QuickBASIC editor, there are two run-time systems from which to choose, depending on the kind of executable file you want to produce. If you choose to link with BCOM20.LIB, QuickBASIC produces a stand-alone executable file. If you link with BRUN20.LIB, an .EXE file is produced that is substantially smaller (e.g., 2K bytes instead of 28K for the Sieve of Eratosthenes program), but it cannot run by itself. When you invoke the program, it first loads BRUN20.EXE, a run-time environment; BRUN20 then actually supervises the execution of your program.

Both of these systems have their advantages (e.g., CHAINing with COMMON is supported only by BRUN20), and it was thoughtful of Microsoft to provide a choice. All the execution-time results in tables 1 and 2 were obtained by linking with BCOM20.LIB. Linking with

BRUN20.LIB would have reduced both disk storage space and link times substantially, but it would have increased run times by 15 to 20 percent. Also, BRUN20.EXE must then reside on your disk, and it occupies 68,396 bytes.

**How Quick?**

QuickBASIC is well named. Compared with Zedcor's ZBasic, which lists for about the same price and is probably its chief competition, QuickBASIC requires more time to convert a source program into stand-alone executable code. But at run time, QuickBASIC really goes flat out (see table 1). For some benchmark tests it was a dead heat, but for others QuickBASIC was a clear winner.

Both QuickBASIC and ZBasic write to disk at about the same speed as interpreted BASIC, but they read from disk almost twice as fast. For integer runs of the Calc and Sieve benchmarks, QuickBASIC and ZBasic both turned in times as fast as previously reported for Turbo Pascal 3.0 (see the review by Mark Bridger in the February 1986 BYTE) and considerably faster than True BASIC or BetterBASIC (see the ZBasic review by TJ Byers in the May 1986 BYTE). For the Calc.INT benchmark, though, I had to use C=C \ A with QuickBASIC to force integer division; otherwise it ran much slower at floating-point speed. This is something to keep in mind if you need to speed up an integer-intensive routine. When the Calc and Sieve benchmarks were run with floating-point variables, both QuickBASIC and ZBasic slowed down considerably, but QuickBASIC was the clear winner. In the Calc.FP benchmark, in fact, QuickBASIC was nine times as fast as ZBasic, and in the Sieve, three times as fast. Compiled ZBasic was even slower than interpreted GW-BASIC in the Calc.FP benchmark.

[Editor's note: Execution times for QuickBASIC were made with the error handler (Debug option) turned off. Under that condition, there is no checking for

out-of-bound array references, arithmetic overflow, and other errors that may occur at run time. When the error handler is enabled, QuickBASIC execution times are significantly longer.]

While running QuickBASIC through its paces, I also found that when large arrays are passed from the main program to a subroutine, the subroutine will execute much faster if the arrays are passed in COMMON or SHARED statements than if they are passed as arguments in the CALL statement. A Quicksort subroutine required about 50 percent more time to sort an array of 500 integers when the array to be sorted was passed as an argument.

One set of commands that I expected to execute about as fast in interpreted BASIC as in QuickBASIC is the set of graphics primitives that make the various implementations of Microsoft BASIC such a pleasure to use. Since these commands require relatively little work by the interpreter, I assumed that they would already be pretty much up to speed.

However, I was wrong. All the graphics commands I tested work faster, some of them much faster, in QuickBASIC than in GW-BASIC. To illustrate the typical speedup, table 2 summarizes the results of three simple tests. The first two are tests of full-screen GET and PUT statements, and the third measures the time required to draw a circle in the center of the screen and fill it with a solid color. QuickBASIC executed these commands 3 to 15 times faster than GW-BASIC. The speed improvements, particularly those with GET and PUT, make QuickBASIC a realistic development language for programs that use graphic window overlays.

**More Than Competent**

Although I've never thought of BASIC as a serious development language, I now have to admit that I like QuickBASIC. Microsoft brought BASIC to microcomputers with Altair BASIC, and QuickBASIC represents the company's latest contribution to the evolution of this language. Version 1.0 went far enough that you could see the promise of great things, but not far enough to be really satisfying. Version 2.0 lives up to that promise.

QuickBASIC is now more than just a competent language. It represents an outstanding contribution to the microcomputer world. The documentation is attractively presented and about as comprehensive and utilitarian as any language documentation you'll find. The price is competitive with any full-fledged BASIC compiler for the IBM PC that I know about, and well below most of them. If you like BASIC, you'll like QuickBASIC. If you don't like BASIC, QuickBASIC just might change your mind. ■

**Table 2: Time required to execute representative graphics commands in QuickBASIC and in interpreted GW-BASIC on a Tandy 1000. All times are in seconds.**

Test description	Execution time	
	QuickBASIC	GW-BASIC
DIM A%(8001) GET(0,0)-(199,319),A%	0.49	6.09
PUT(0,0),A%,PSET	0.77	4.05
CIRCLE(160,100),90,1: PAINT(160,100),2,1	0.89	3.11



# EGAWONDER™

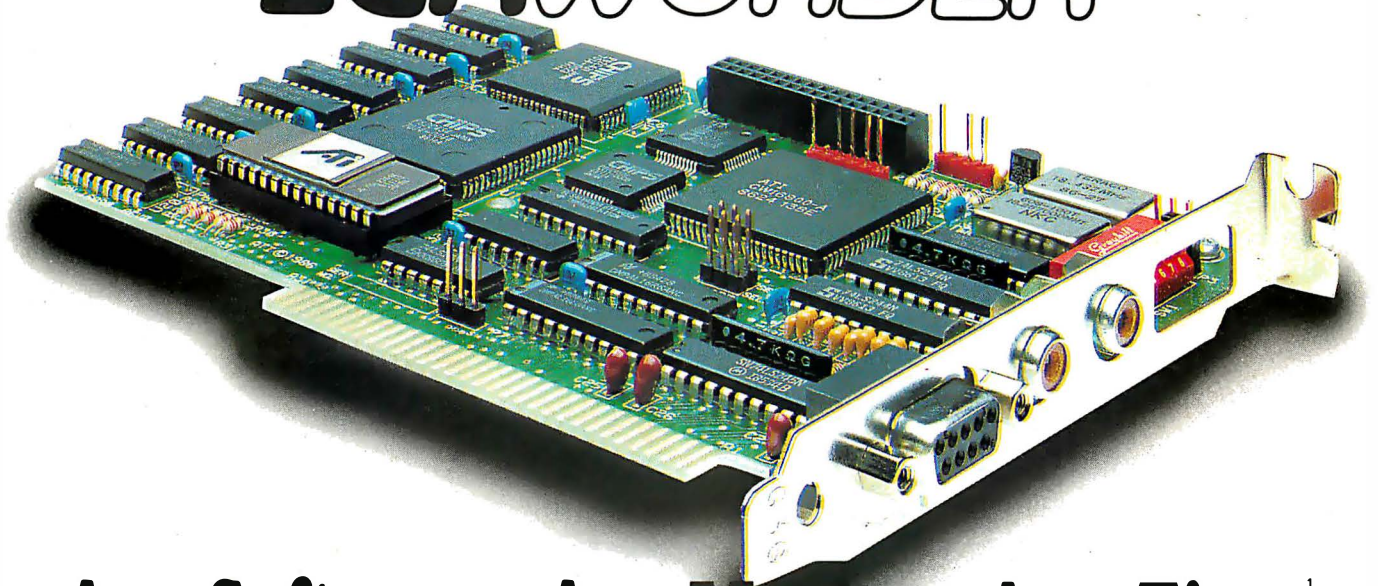

## Any Software. Any Monitor. Any Time.

### EGA Monitor

### TTL Monochrome Monitor and Compaq PC Portable<sup>2</sup>

### RGB, Composite Monitors, and the IBM Portable PC

**EGA Software**      **Hercules Software**

**ATI Technologies Inc.**

you just bought as an EGA monitor. In the past, most video card buyers have been disappointed. However, starting with the ATI Wonder of monitors. The ATI EGA Wonder brings the same philosophy of the

to be disappointed in that it runs all 4 of the most software standard star types - an Enhanced Graphics Display, RGB Color/Graphics Display

**It also runs 132 columns**

ensures a monitor's display quality. When running CG software on a color monitor, double scanned for a high quality image. When running CG software on an RGB monitor, colors are converted into shades, making running CG software on an RGB monitor a waste of 64 colors in 640 x 480 resolution graphics display of an EGA monitor.

**CGA Software**      **132 Column Software**

**EGA Software**      **Hercules Software**

**ATI Technologies Inc.**

you just bought as an EGA monitor. In the past, most video card buyers have been disappointed. However, starting with the ATI Wonder of monitors. The ATI EGA Wonder brings the same philosophy of the

to be disappointed in that it runs all 4 of the most software standard star types - an Enhanced Graphics Display, RGB Color/Graphics Display

**It also runs 132 columns**

ensures a monitor's display quality. When running CG software on a color monitor, double scanned for a high quality image. When running CG software on an RGB monitor, colors are converted into shades, making running CG software on an RGB monitor a waste of 64 colors in 640 x 480 resolution graphics display of an EGA monitor.

**CGA Software**      **132 Column Software**

**EGA Software**      **Hercules Software**

**ATI Technologies Inc.**

you just bought as an EGA monitor. In the past, most video card buyers have been disappointed. However, starting with the ATI Wonder of monitors. The ATI EGA Wonder brings the same philosophy of the

to be disappointed in that it runs all 4 of the most software standard star types - an Enhanced Graphics Display, RGB Color/Graphics Display

**It also runs 132 columns**

ensures a monitor's display quality. When running CG software on a color monitor, double scanned for a high quality image. When running CG software on an RGB monitor, colors are converted into shades, making running CG software on an RGB monitor a waste of 64 colors in 640 x 480 resolution graphics display of an EGA monitor.

**CGA Software**      **132 Column Software**

EGA Wonder runs EGA, CGA, MDA, Hercules and 132 Columns on an Enhanced Graphics Display. CGA text is improved to 8 x 14 and graphics are double scanned for a high quality display.

EGA Wonder runs EGA, CGA, MDA, Hercules and 132 Columns on a TTL Monochrome Monitor and Compaq PC Portable<sup>2</sup>. Colors of EGA and CGA are converted into shades, graphics are full screen and no pre-boot drivers are required.

EGA Wonder also runs EGA, CGA, MDA, Hercules and 132 Columns on an RGB Monitor, Composite Monitor, and the IBM Portable PC in 64 colors (shades). EGA and Hercules software are interlaced for high resolution text and graphics.<sup>3</sup>

Composite monitor and PC Portable display not shown.

Features	ATI EGA Wonder	Paradise Auto Switch	Quadram and Video 7
Compatible to EGA, CGA, MDA, Hercules	✓	✓	✓
256K Video Memory	✓	✓	✓
Automatic Switching Between EGA and CGA Color Modes and Among EGA, MDA, and Hercules Modes	✓	✓	
Runs EGA, CGA, MDA, Hercules and 132 Columns on an EGA Monitor	✓		
Runs EGA, CGA, MDA, Hercules and 132 Columns on an RGB Color Monitor	✓		
Runs EGA, CGA, MDA, Hercules and 132 Columns on a TTL Monochrome Monitor	✓		
Runs EGA, CGA, MDA, Hercules and 132 Columns on a Composite Monitor	✓		
Runs EGA, CGA, MDA, Hercules and 132 Columns on an IBM Portable P.C.	✓		
Warranty	2 Yrs	1 Yr	1 Yr
Suggested List Price	\$399	\$595	\$599

\*Trademarks: Paradise Auto Switch - Paradise Systems Inc; Quad EGA+ is a trademark of Quadram Corp; Video-7 - Video-7, Incorporated; IBM PC Portable - IBM - International Business Machines; Compaq - Compaq, Inc

1. "Any Software, Any Monitor, Any Time" applies to IBM graphics, standards, monitors, software.  
 2. Optional Compaq Expansion Module (no 132 Columns) suggested list price \$99.  
 3. Flickering effect of interlacing reduced with purchase of anti-glare screen filter.

### Upgrade to EGA Without An EGA Monitor

The ATI EGA Wonder goes far beyond software compatibility. It is the result of intensive development by one of the most revolutionary technology companies today — ATI Technologies Inc.

The ATI EGA Wonder is not just better technology. It is the solution for upgrading to EGA without an EGA monitor.

Only the ATI EGA Wonder displays EGA, CGA, MDA, Hercules and 132 column software on an Enhanced Graphics Monitor, an RGB Color/Graphics Monitor, a TTL Monochrome Monitor, a Composite Monitor, or the internal monitor of the PC Portable.

Only the ATI EGA Wonder provides upward compatibility to EGA and downward compatibility to CGA, MDA, and Hercules on your present monitor — EGA, RGB, TTL, Composite or PC Portable.

At ATI we have developed a better graphics card for you. Call us today at (416) 477-8804 for more information.

450 Esna Park Dr. Markham, Ontario  
 Canada L3R 1H5 TLX. 06-966640



**Technology you can Trust.**



# Think Fast.



Now think Toshiba T1100 PLUS. The IBM<sup>1</sup>-compatible portable PC that puts full desktop PC power in a package small enough to fit in a desk drawer. And light enough to make an office out of any place there's a seat.

## SPEED IS OF THE ESSENCE.

Computers can compute many times faster than our brain. But with many portable PCs, you can go out of your mind waiting for them to load a program, move around blocks of text, search through a database or recalculate a spreadsheet.

Not so with the T1100 PLUS. Our 80C86 16-bit processor has 16-bit data paths and runs at 7.16 MHz. Combined with our 640KB of maximum memory capacity, it runs up to twice as fast. And that means you can get through your work faster. Whatever kind of work you do.

## HOW SMALL IS IT?

Putting all this speed and power in a package only 12.1" W x 2.6" H x 12"D and weighing under 10 pounds was no small feat. We did it by using our unique gate array technology to reduce the number of ICs. Which gives you exceptional reliability as well as incredible portability.

## IT BENDS OVER BACKWARDS.

O.K., it's fast, small and light. Which is enough in itself. But what else does the T1100 PLUS portable computer have going for it, you ask. Plenty, we say.

Ever had to squint or scrunch down to see what's going on with other portable PCs' screens? Our screen is a high-contrast, high-resolution LCD that shows 25 lines by 80 characters of text with 640 x 200 resolution. And it will even bend over backwards to



# Now Think Small.

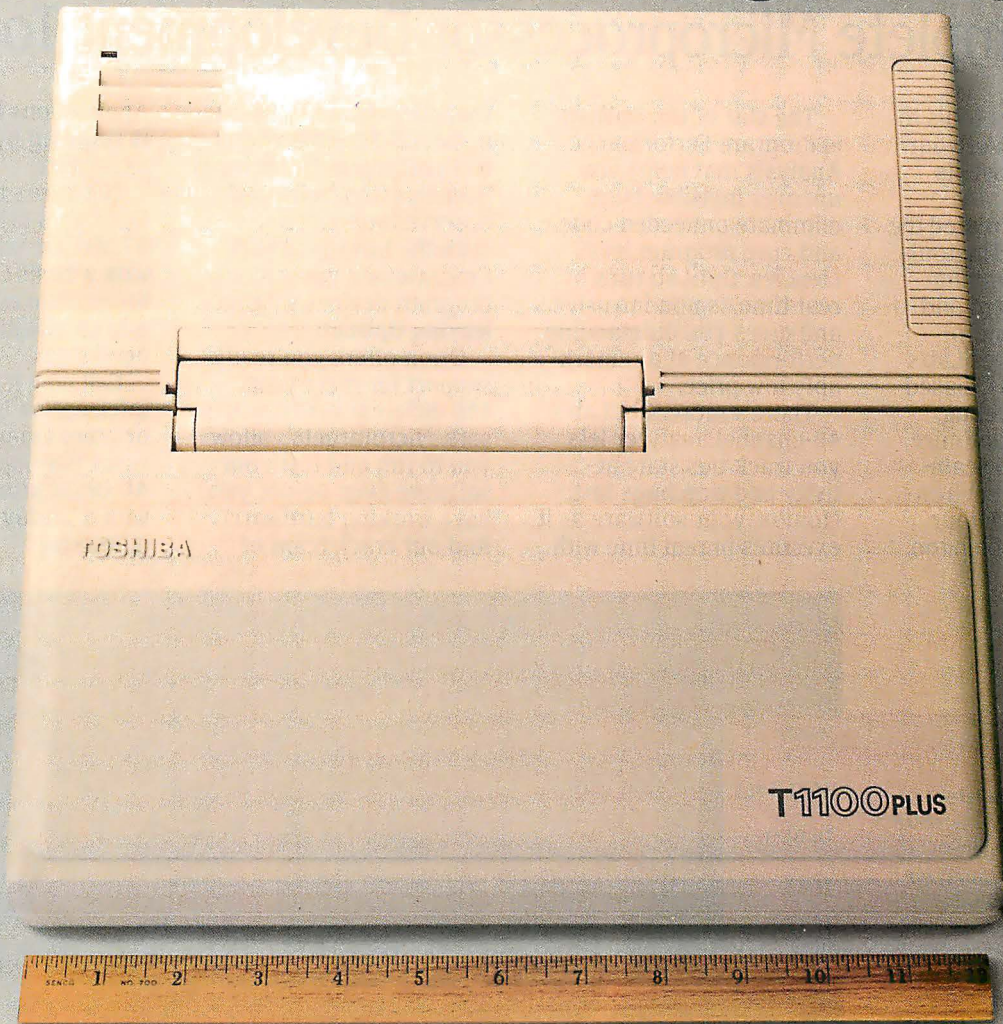

accommodate you by tilting a full 90 degrees. **STANDARDS THAT SET THE STANDARD.**

The T1100 PLUS comes with a long list of standards including dual 720KB 3.5" disk drives, MS-DOS<sup>2</sup>, serial, parallel and CRT ports, an IBM-compatible keyboard with 81 full-size keys, rechargeable NiCad batteries that last up to eight hours per charge, AC adapter, user's manual, MS-DOS manual and soft carrying case.

Also standard is SideKick<sup>3</sup>, the best-selling utility program that includes a notepad, calculator, autodialer, calendar and appointment scheduler. And our exclusive "Exceptional Care" Program. In the unlikely event

that anything goes wrong with your T1100 PLUS, we guarantee you prompt delivery of a replacement while yours is being fixed.\*

Options for the T1100 PLUS include 300/1200 bps Hayes<sup>4</sup>-compatible internal modem, external 5.25" disk drive, Floppy Link to a desktop PC's 5.25" drive, IBM-compatible five-slot expansion chassis and automobile power adapter.

Is there anything we left out? Oh yes, the phone number for your nearest Toshiba computer and printer dealer. It's 1-800-457-7777. Please call to let us know you're thinking of us.

1. IBM is a registered trademark of International Business Machines Corp. 2. MS-DOS is a registered trademark of Microsoft Corp. 3. SideKick is a registered trademark of Borland Int'l, Inc. 4. Hayes is a registered trademark of Hayes Corp. \*Requires no-cost enrollment in "Exceptional Care" Program.

In Touch with Tomorrow

## TOSHIBA

Toshiba America, Inc., Information Systems Division



# Introducing OptiLab™

## The Complete Microprocessor Development Toolbox.

You need the right tools to speed completion of your project and improve its quality.

That's why we created the OptiLab toolbox. The tools you want for beginning-to-end development and optimization of microprocessor code. OptiLab's fully-integrated, PC-based system lets you debug, analyze, modify, optimize, and test code in a seamlessly integrated environment. You can add your own cross-assembler, too.

The star of the OptiLab is Program Performance Analysis that helps you uncover invisible bugs, eliminate unneeded code, and cure program inefficiencies. OptiLab runs in real-time, is non-intrusive, and gives you outstanding performance at a remarkably low price.

There's more. OptiLab's 48-channel analyzer lets you track bus state activity and trap bugs fast. Monitor your software as it executes in real time with

the full-featured 8/16-bit In-Circuit Emulator. Send test patterns with the Input Stimulus Generator and observe their effects. With the built-in EPROM Programmer, you can program devices without leaving OptiLab.

Orion offers you ready support for more than 150 different microprocessors. MicroTargets™ allow you to run and test your software even before you have working hardware. And our crack team of

Applications Engineers is standing by if you need assistance.

But here's the real news. OptiLab is priced under \$7,000. Or, you can start with a basic Orion system for as little as \$2,995 and add capabilities as you need them.

Call now for complete information on OptiLab or other Orion microprocessor development tools. All Orion products are sold with a 15-day money-back guarantee.

	WRITE	
Analyzer	OptiLab™	
In-Circuit Emulator		
Line-by-Line Assembler		
Debug Package		
Performance Analyzer		
Stimulus Generator		
EPROM Programmer		
		ASSEMBLE
		DEBUG
		TEST
	OPTIMIZE	
	SHIP	

Everything from assembly to final optimization of your software can be done with the OptiLab toolbox.

OptiLab presents a graphical display of actual program performance.



**ORION**  
INSTRUMENTS, INC.

**Call Toll Free: 1-800-245-8500**  
In California: (415) 361-8883

Orion Instruments, Inc., 702 Marshall Street, Redwood City, California 94063, U.S.A. Telex: 530942

Inquiry 194



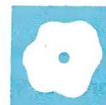

# Forecast Master

Lowell Rosen

## *A state-of-the-art statistical package with lots of power and some flaws*

Forecast Master, from Scientific Systems and the Electric Power Research Institute, is a powerful and sophisticated package with many state-of-the-art methods that you will not find in most statistical packages. Some of the techniques are hot out of the math journals.

Forecast Master is not a general-purpose statistical package. If all you care about are means, standard deviations, simple linear trend fitting, and very-near-term ballpark forecasting, then look elsewhere. This program is not for beginners. The reference manual to Forecast Master claims that its methods are "readily accessible to the user who is not also a specialist in statistical forecasting." At best, I think that this statement is wishful thinking. One cannot leap into this program and expect to get the most benefit from it without the prerequisite statistics training and some prior forecasting experience.

Forecast Master is a menu-driven collection of up-to-date and high-tech statistical procedures for performing univariate and multivariate time-series forecasting. This means that you can forecast a company's earnings from its own past history and also make use of other economic indicators such as the consumer price index or the prime interest rate. Good multivariate forecasting capability gives you the same power tools used by the banking houses, Dow Jones, and the U.S. Department of Labor. It gives you firsthand experience with the input-output output theory of economics.

### **A Plethora of Techniques**

Forecast Master is clearly designed for experts in technical analysis who have had prior forecasting experience and a more-than-passing interest in the mathematics of matrix analysis and multivariate data analysis. Its separate procedures include

- multivariate state-space forecasting with up to 10 variables (exogenous and endogenous)

- univariate Box-Jenkins for ARMA (autoregressive moving average) models
- multivariate Bayesian vector autoregression for up to five variables
- univariate exponential smoothing including adaptive time weights and compensation for trends and seasonal effects
- AUTOPRO regression
- multivariate variable parameter regression for time-varying regression coefficients
- econometric analysis using the XII method including trend, seasonal, cyclical, and erratic decomposition
- simple curve fitting including linear, exponential, quadratic, hyperbolic, log, and power curves

Among its preprocessing data transformations are differencing and log transforms to improve statistical stationarity, and it has an excellent capability to define new variables as functions of old ones. All the methods are carefully designed to let you develop your own models, change parameters, explore variations, and finally compare and graph the results of what you did. This is indeed what a professional wants to do, but it can also become a confusing jungle of multiple choices to the uninitiated.

### **No Roadmap**

It is in this jungle of high-tech forecasting techniques that Forecast Master's documentation exhibits its major deficiency. It covers at length the fine points of the math analysis of the different algorithms, but it fails to provide any cross-index of all the methods. Needed are summaries and comparisons in terms of input data requirements, their good and bad points, criteria for use, forecast accuracy, size of the forecast horizon, and basic philosophy

of the method. In addition, the documentation fails to give any substantial roadmap to the first-time but intelligent user who has the simple but urgent question, "Which method should I use and trust?"

It is one thing to press computer keys and get a screenful of numbers such as a Durbin-Watson statistic, Ljung-Box test score, or AIC error statistic (which you may or may not have seen in a statistics course) and another thing entirely to understand the meaning and utility of state-space transition and error matrices and how canonical correlations between past and future can be used for model order determination and more accurate forecasting. The help screens in Forecast Master should have been more useful in this context.

### **Powerful Forecasting**

Econometric analysis of a time series with its seasonal, cyclical, and trend components is the basis of economic time-series forecasting. Likewise, regression techniques have been around for many years, but state-space forecasting is not as widely used, if only because it is so new. Yet it has the capability to be the most accurate of all the techniques. Historically, it is a direct application of the Kalman filtering methods used in engineering and science. The same methods in state-space forecasting can be used for predicting the daily, weekly, or monthly movements in the stock market or the national debt or world trade balances. The Kalman methods are basically iterative, least-squares estimation techniques that constantly adapt to the changing patterns of

*continued*

*Lowell Rosen (7941 Paseo Del Ocaso, La Jolla, CA 92037) is a professor of graduate statistics and management science at National University in San Diego, California. He is also an aerospace scientist with General Dynamics in the Space Systems Division.*



**Forecast Master****Type**

Time-series forecasting statistical package

**Company**

Scientific Systems  
One Alewife Place  
Cambridge, MA 02140  
(617) 661-6364

**Format**

Three 5¼-inch floppy disks; not copy-protected

**Computer**

IBM PC or compatible with 512K bytes of memory and one floppy disk drive (640K and two floppy drives are suggested); IBM-compatible graphics monitor and printer (with graphics capability); MS-DOS

**Features**

Multivariate and univariate time-series forecasting; menu-operated with graphing

**Documentation**

142-page reference manual

**Price**

\$795

a time series by continuously monitoring the forecasting errors being made. They can potentially provide the largest forecasting horizons of all the methods.

**Data Handling and Display**

Forecast Master comes with a collection of data files with which you can start playing the forecast game. They are simple ASCII files representing such things as the quarterly unemployment rate, the M1 money supply, and the quarterly savings rate. They also have associated key files that list the start date and sampling period (e.g., monthly, quarterly) of the data. Any other data that you wish to enter into the program must be on your DOS disk as an ASCII data file.

Once in the program, you must then exercise the menu option to create a key file for the data. You cannot enter, change, modify, list, combine, compare, or delete data from within Forecast Master. There is no data management capability within the program. Instead, the Edit Data File menu option merely bumps you out of the program into a text editor of your choice where you can make changes. This lack of a fast, basic data manager (usually the hallmark of good statistical packages) is a serious deficiency in the program.

The graphics-plotting routines within Forecast Master also offer a strange

paradox. On one hand, they are fast and easy to use, but on the other hand they fail to annotate key time information on the graphs. Data is segmented into pages according to the resolution you request and then plotted on the screen of your graphics monitor. You have the capability to move to the next page or back to a previous one. A convenient feature lets you do log, difference, and ARMA deseasonalization transforms on the data before it is plotted. On-screen information includes the name of the data, the scale factors, vertical numbering, and the start and end dates of the data. The horizontal axis, however, shows no dates, just tick marks. If you want to determine the date of a particular plotted point, you have to count possibly hundreds of tick marks.

**Accuracy**

Once you get used to the menu operation and the data-selection techniques, the program runs quite quickly. Both data selections and forecasts are conveniently remembered from run to run so that comparisons are easy to make. A built-in graphics screen dump to an Epson printer worked fast and flawlessly, providing a hard-copy output similar to the IBM graphics screen dump, but with an apparent higher resolution.

To test the routines, I divided the built-in data files such as the unemployment rates in half, with the first half functioning as the historical set. I could then compare the forecasts with the remaining data.

All the forecasting methods yielded excellent short-term forecasts of three to five periods. My particular interest was in how well they would do with extended forecasts beyond one and one and a half years. When using 12-period forecasts on the quarterly unemployment rates, I found that at about the halfway point in the data both Box-Jenkins and the simpler three-parameter exponential smoothing model predicted exponential growth patterns over a three-year period, while the state-space methods predicted first an upswing of four points and then a downswing of the same amount two years later. Of the three methods, the state-space method predicted the correct pattern but led it by one year.

**Summary**

Forecast Master is a powerful state-of-the-art forecasting package for time-series analysis. It is primarily for technical experts who can best appreciate and use its many features. I like its particular use of state-space technology and the ability to compare forecasts among all the methods. But I don't like the absence of lots of well-documented application examples showing this power, nor its high price. The menus are a bit of a hindrance, but quick nevertheless. The program would greatly benefit from a high-level macro command capability. The deficiencies in the documentation, data management, and graphing are serious though not fatal. I hope a future revision will resolve these matters. ■

# Public Domain Software for the Amiga

Warren Block

Public domain software for the Amiga is very important. The number of commercial programs available for the Amiga is relatively small (at least thus far) and, in many cases, this has caused programmers to write programs for specific needs of their own. Many of these programs have made their way into the public domain, and in this review I will describe some of the best. This is by no means a comprehensive list; more public domain material is becoming available every week.

**Utilities**

The AmigaDOS environment is similar in many ways to UNIX, so it is not surprising that many of the utilities released into

the public domain resemble those on minicomputer and mainframe UNIX systems. The majority of these programs are used with the CLI (command-line interface) provided in AmigaDOS, bypassing the icon-oriented Workbench. Take, for example, the SQ and USQ utilities. SQ (squeeze) simply compresses a file, generally resulting in a 20 to 40 percent savings in space. USQ (unsqueeze) reconverts the squeezed file to its original state. The Amiga is first and foremost a graphics machine, and bit-mapped pictures take a lot of disk space. Using SQ and USQ, you can minimize the bites that large files take out of your disks or the time it takes to transfer files by modem.



Another useful utility is WLC (word/line count). WLC counts the words and lines contained in an input file. This is similar to the UNIX `wc` utility. WLC works equally well with plain text or program source code, and if the text file is in RAM: (the AmigaDOS RAM disk device), it is quite fast.

Filters (programs that take a file and modify it in some way) are common in the current public domain library. Two good examples are CRS, a filter that allows you to add or remove carriage returns from its input file, and Strip, a general-purpose filter that removes control characters of all types from the file that you feed to it. Both are extremely useful when you are attempting to use files downloaded from an on-line service or bulletin board system. Strip also works well to remove control characters from a word processor file if a plain text version of it is needed. These two programs are not flashy, but when you need them, they are welcome aids.

GfxMem is a memory-display program that opens a window on the Workbench screen. This window shows graphically how much memory is being used in both chip memory (the first 512K bytes of RAM) and fast memory (anything above 512K). It can be quite educational to run GfxMem on the Workbench screen together with a drawing program. When you pull down the screen used by the drawing program so the GfxMem window shows, you can see how memory is eaten up during a graphic fill of a shape (the more complex the shape, the more memory is used) and then returned afterward. It is also very handy if you are attempting to multitask several programs at the same time and wish to keep a safe distance below the limit of memory.

Another available utility is MyCLI. This is a program that creates a new CLI window with features not shared by ordinary AmigaDOS CLIs. MyCLI features intrinsic commands; that is, they are always in memory as a part of the MyCLI program itself. You need the Run and Execute commands in the current `c` directory, but with them in RAM:, there is no need for the Workbench disk at all. MyCLI can also send and receive files over the serial port, lets you define the function keys, and allows MS-DOS-style batch files. Overall, MyCLI is an excellent replacement for the standard CLI program, and author Mike Schwartz invites correspondence on the program's performance, so it will most likely improve even more.

### Demonstration Software

Quite a few of the public domain programs developed for the Amiga have been, not surprisingly, for the purpose of demon-

strating the computer's features. Programs of this type are not very useful except for two things: demonstrating how to write a program for the Amiga (source code is usually provided along with object code), or simply showing what the machine can do. Some are impressive enough to justify their inclusion here, however.

People who doubt the Amiga's animation capabilities are usually convinced by seeing 3DRotate. It draws a three-dimensional wire-frame arrow on the screen and rotates it in three dimensions. The rotation is unbelievably smooth and fast, and the program runs in the 640- by 400-pixel high-resolution mode, so "jaggies" are almost undetectable.

Skewb is another demonstration program, although it has a different twist: It draws one of the Cube puzzles on the screen and then rotates sections of it. Skewb lets you increase the number of small cubes that the large cube contains, up to the point where the cube shown on the screen is made up of 12 small cubes per side, although the program starts to slow down drastically long before that happens.

### Flashy Program

Paul Biondo's DPSSlide takes a practical approach to graphics. DPSSlide displays standard Amiga IFF (Interchange File Format) graphic pictures (like those created by Aegis Development's Images or Electronic Arts' Deluxe Paint programs) in a slide-show-type presentation. The actual pictures to be displayed are determined by a text file that contains information on how long each "slide" is to be shown and what method should be used to bring it onto the display—Pop Up, where the picture just appears; Fade In or Fade Out/Fade In; or Scroll Up, in which the new picture scrolls up the screen, covering the previous one. It is an easy task to create the text file with ED, the AmigaDOS screen editor. You can easily create a professional-looking presentation complete with a feature to pause the display during the show. DPSSlide works extremely well, and it is an invaluable addition to any Amiga owner's software library.

### Something More Practical

Two types of programs should always be available for a new computer very soon after its release: word processing and telecommunications programs. In the case of the Amiga, Commodore's Textcraft was available quickly to address the need for word processing, but there was no equivalent commercial terminal program. This prompted the creation of several public domain programs. Commercial ones are now available, but the public domain ver-

## Public Domain Software Contacts

### Users Groups:

AMICUS Disks  
PiM Publications Inc.  
P.O. Box 869  
Fall River, MA 02722

Send a SASE and \$1 for a listing of current disks available.

AURA (Amiga Users-Raleigh Area)  
c/o Ray Cook  
1114 Wildwood Rd.  
Durham, NC 27704

Request a list of currently available disks.

### Other:

Fred Fish  
1346 West Tenth Place  
Tempe, AZ 85281

Send a mailing label with your address and three first-class stamps for a list of currently available disks. At last count, he had forty disks, most of which were completely full.

sions have been evolving and getting better in the interim.

One such program, StarTerm, is an excellent example. StarTerm has an impressive list of features, including the ability to communicate at rates of 300 to 9600 bits per second, window or full-screen display, and multiple upload/download options. The program also has function-key definitions, a phone directory, and a start-up preferences file. These are all loaded from disk upon program execution. StarTerm supports auto-dialing with modems that are capable of it and has a well-polished user interface with custom gadgets and requesters. Some unusual capabilities include the ability to automatically adjust files downloaded with the XMODEM protocol to the correct length (thus making "chop" programs unnecessary) and the ability to switch between smooth and normal screen scrolling.

StarTerm can transfer data as plain ASCII text or via the XMODEM text or binary protocols. If you wish to use an Amiga for telecommunications, I strongly suggest you get StarTerm. It is far less expensive than any commercial program

*continued*



*DeciGEL allows the use of an MC68010 in place of the MC68000, increasing the speed of math computations and looping.*

and just as capable as many. Your conscience may bother you, though, if you

use it without sending \$15 to the authors (Jim Nangano and Steve Plegge) as they request.

Many people who purchase Amigas are programmers who wish to take advantage of its processor power and speed. Getting program source code into the computer requires a text editor of some sort, but the AmigaDOS ED editor falls far short of most users' expectations, ignoring the Amiga's mouse and menu system and using non-mnemonic control commands.

Now there is a version of MicroEMACS for the Amiga, called MEMACS, which

takes full advantage of the Amiga's user interface to provide an excellent programming editor. MEMACS has such useful features as a split-screen display to show different parts of the same program or to allow editing of two or more files at the same time and automatic indentation that greatly simplifies programming in languages like C and Modula-2, as well as keyboard shortcuts that make the use of menus optional.

Other features included in the program are adjustable margins, automatic word wrap that can be disabled, block cut and paste, and search-and-replace features that effectively make MEMACS capable of being used as a word processing program. It wasn't really meant for this purpose, but it works very well for letters and simple documents requiring little text formatting. The implementors of this version of MicroEMACS are Andy Poggio and Rick Wirch, who have given the Amiga programming community this commercial-quality text editor for free.

A small assembly language program called DeciGEL is of note to those Amiga owners who wish to squeeze even more performance out of their machines. It allows the use of an MC68010 in place of the MC68000 microprocessor, increasing the speed of math computations and looping by as much as 50 percent. Along with the DeciGEL source and object code is a text file describing the installation processes for both hardware and software. DeciGEL was written by Scott Turner, and the installation file is by Thad Floryan.

#### Availability

The first place you should try to obtain these public domain programs is from your local users group. Many groups are out there, and if you live in a relatively populated area there is very likely one near you that has most of the programs I have described.

The rural Nebraska area I live in, unfortunately, has nothing at all in the way of Amiga users groups, so I had to locate some by mail. Addresses for them are listed on page 257 along with instructions for obtaining listings of the software they have available. When contacting any of these people, keep in mind that they are doing this out of sheer kindness and are not making any real profit out of it. Whenever I contact one of these people, I send them some mailing labels with my address preprinted on them to make their lives easier. ■

*Warren Block (645 King St., Chadron, NE 69337) currently comprises the entire computer repair department of Chadron State College.*

## "Watson keeps our top clients happy and brought us 16 new accounts the first month."

Hank Gillespie, Manager  
Robert Thomas Securities  
Ingleside, Texas

At Robert Thomas Securities, Watson lets clients place orders and get personalized market information around the clock from any pushbutton phone. The service is so popular it brought the firm 16 new referral clients the first month! And at a very reasonable cost: Watson, a multi-purpose voice processing option for IBM PC, XT, AT, and compatibles, has a base price of only \$498.

For an ear-opening demo on how Watson can help you manage business communications better, call 1-800-6-WATSON. In Mass., (617) 651-2186.

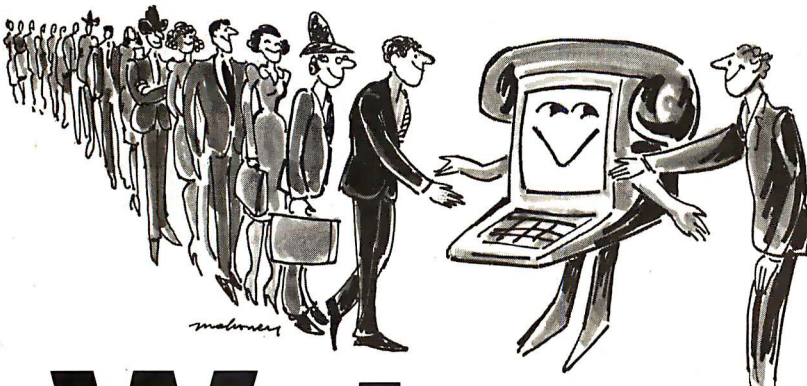

# Watson™

Natural MicroSystems Corporation

Watson is a trademark of Natural MicroSystems Corp. IBM PC, XT and AT are trademarks of International Business Machines Corp.



We used to be PC 1  
We're still your #1 Choice!

5830 E. Washington Blvd.,  
City of Commerce, CA 90040

# Technoland™

**5 Days Guaranteed Shipping**  
**Next Day Delivery Available**  
**Free UPS (G) Shipping**  
30 Days Money-back Satisfaction Guarantee  
California Residents —  
We'll Pay Your Sales Tax!

## Technoland PC/XT™

**\$595**



Includes 8088-2 Dual Speed (4.7MHZ-7.4MHZ) unit, 640K RAM, 360K Floppy Drive W/Controller, AT™ Style Keyboard, 135W Power Supply, MS-DOS 3.1 W/Manual, System Manuals, Full 18 Months Warranty, Run all major software for IBM-PC™ and PC/XT™.

## YOUR #1 CHOICE

## Technoland AT™

**\$1,159**



Includes 80286-Based 8MHZ unit, AMI BIOS, 512K on 1 MB Monther Board, 1.2 MB Floppy Drive, W.D. Hard/Floppy Controller, Clock/Calendar W/Battery Back Up, AT Style Keyboard, 200-W Power Supply, MS DOS3.1 W/Manual, System Manuals, Full 18 Months Warranty, Run all major software for IBM-PC/AT™

### Monochrome System

Basic System Plus...  
● Monochrome Graphics Adapter XT™ \$ 795  
● 12" TTL Monochrome Monitor AT™ \$1,359

### Color System

Basic System Plus...  
● Color Graphics Adapter XT™ \$ 995  
● 13" RGB Color Monitor (640 x 200) AT™ \$1,559

### EGA System

Basic System Plus...  
● Enhanced Graphics Adapter XT™ \$1,275  
● 13" High-Res RGB Color Monitor (640 x 350) AT™ \$1,839

### Seagate Hard Disk



#### Hard Disk Kit \$389

- 20 MB Half Ht. ST225
- Western Digital Controller
- Boots From Hard Disk
- 65 MS Access Time

20 MB 4026 \$549  
30 MB 4038 \$629  
40 MB 4051 \$759

- 39 MS Access Time
- Linear Voice Coil Activator
- Boots From Hard Disk
- Auto Head Parking

Fully DOS compatible Each system comes complete with Ready-to-Install Hard Disk, Cables, Controller, Manual, Software, and Mounting Hardware. Add \$150 for External Case.

### "IBM's Brother" Monochrome Monitor

- IBM Lookalike \$119
- 12" Screen
- Amber or Green



### High Resolution RGB Color Monitor

- 13" Screen \$339
- 640 x 200 Resolution
- RGB — 16 Colors



### EGA Compatible Color Monitor

- 34" mm Dot Pitch
- 13" Screen \$449
- 640 x 350 Resolution
- RGB — 16 Colors



### AT™ Multifunction Card \$189

- Expandable to 3 MB (OK)
- Parallel, Serial and Game Ports

### XT™ Multifunction Card \$105

- Clock/Calendar, FDC
- Parallel, Serial and Game Ports
- RAM Disk & Printer Spooler (Software)

### Mini I/O Card \$ 89

- Parallel, Serial and Game Ports

### Mono-Graphics Adapter \$ 99

### Color Graphics Adapter \$ 89

### EGA Card-Short Card \$259

- EGA, CGA, MDA & Hercules Compatible

### Tiny Turbo Card \$449

- High-Speed Accelerator for PC and PC/XT™
- Replaces 8088 with 80286
- Socket for 80287 on Board
- Short Card

### New! High Speed 250 Printer \$479

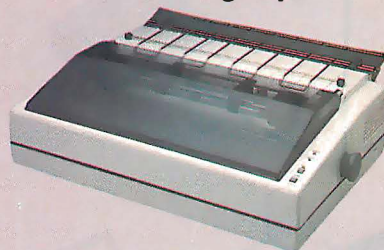

554.x380x178 (LxDxH) 33 lbs Weight

- Clear Printing at 250 cps.
- Double-Size and Double Strike Printing
- 136 Columns
- 9x9 dot Composition
- Underlining Capability
- Professional Office Equipment

### Citizen Printer

MSP-20 ( 80 Column) \$329

MSP-25 (136 Column) \$489

- 200 cps Draft/50 cps NLQ
- IBM, Epson Compatible
- Parallel Interface

### Floppy Disk Drive \$ 90

- Half-Height
- DS/DD-360K
- Name Brands-TEAC, Panasonic, Mitsubishi

### 1.2 MB Floppy Disk Drive \$125

### Hard Disk Card-20MB \$408

- 3½ Hard Card
- Boots from Hard Disk
- IBM XT™ Compatible

### Hayes Compatible Modem \$139

- 300 & 1200 BPS
- Short Card
- Fully Hayes Compatible

### Enhanced Keyboard (5339) \$ 79

- Separate Cursor & Numeric Pads
- Keys in Standard Locations
- LED Status Indicators
- 12 Function Keys

### 135W Power Supply \$ 79

### 200W Power Supply \$119

## Technoland's Policy:

We accept Master Card and VISA (no surcharge), money order, cashier's check, personal check (please allow 10 days to clear), company / institutional PO's and wire transfers. We pay shipping (UPS ground — faster shipping available at additional charge) in continental US. We pay applicable sales tax.

Any item bought from Technoland (including software if unopened) may be returned for a full refund within 30 days of the date it was shipped if for any reason you are not 100% satisfied. All Technoland products carry Technoland's one year limited warranty; some products also carry manufacturer's warranty. Selected Technoland products may carry additional warranties. Warranty policy requires that you submit proof of purchase and obtain an RMA number from us by telephone.

IBM, Hercules, Compaq, ATT, Panasonic, TEAC, Mitsubishi, ARC, Sanyo, Western Digital and Seagate are trademarks of their respective companies. MS-DOS is a trademark of Microsoft Corporation. IBM PC, IBM XT and IBM AT are trademarks of IBM Corporation.

Quantity Discount Available!

**Order Toll Free:**  
**(800) 222-3978**

In California: (213) 724-2781  
Technical Support: (213) 724-1684  
Customer Service: (213) 724-1685  
Mon. — Sat. 8:00 a.m. to 5:00 p.m.



Now Available!

FIVE NEW MODELS

# SHARE PRINTERS AND BUFFER PRINT JOBS WITH ONE VERSATILE UNIT

Print Master from BayTech is an intelligent printer controller that connects between your computers and printers. It allows you to share one printer automatically, contend for multiple printers automatically, or switch between several printers by sending a simple code, not by changing cables. Plus, Print Master's generous built-in buffer spools data until your printers can receive it.

Because Print Master is a very flexible device, you can set it up to fit your application, even if your application changes.

## YOU SET UP THE IN-OUT PORTS

You configure Print Master's ports for any combination of printers and computers by answering questions from easy-to-follow menus. For example, with the ten port Print Master, nine computers can share one printer, eight computers can share two printers, seven computers can share three printers, and so on, to one computer which can share nine printers. You can also menu-select the disconnect time-out, form feeds, etc. and on serial models, the configuration of individual ports to translate for printers and computers using different configurations.

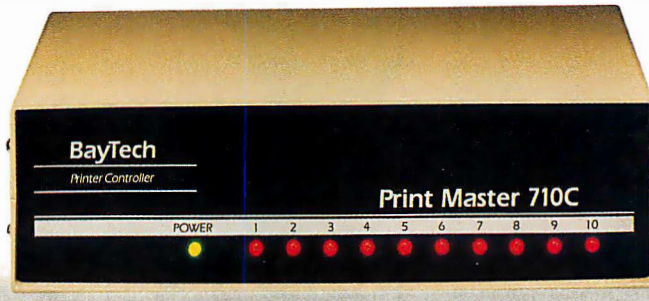

## 512K OR ONE MEGABYTE BUFFER KEEPS YOU WORKING INSTEAD OF WAITING

Since Print Master can accept data faster than your printer (up to 19.2KB serial or 5,000 characters per second parallel), you can send a print job to Print Master's standard 512K buffer and then go on to another project. All users connected to Print Master can send data to this common pool buffer, and they can be doing it simultaneously, even if no printer is available. Data is stored in the buffer until it can

be sent on a first-job-in first-job-out basis to the selected printer. If you need more memory than 512K, Print Master is optionally available with one megabyte buffer.

If several users are sharing one printer, printer sharing via Print Master is completely automatic. There are no codes to send. You simply perform your normal print operation. If you are sharing several identical printers, connection is also

automatic. Again, you perform your normal print operation and are connected to the next available printer on a first-come-first-serve basis. Print Master will send data to all printers simultaneously to keep your printers running at full capacity.

If you are sharing several different printers, such as a laser-jet, a dot matrix and a plotter, and you wish to select a specific printer, you do your normal print routine and also send a printer select code (which you can define yourself) before the first characters of your data. The data is then routed to the selected printer. It's that easy.

## PARALLEL, RS-232C OR RS-422A MODELS

706A (6 parallel ports), \$795  
706C (6 serial ports), \$795  
708C (8 serial ports), \$895  
710C (10 serial ports), \$995  
706D (4 parallel/2 serial), \$795  
708D (6 parallel/2 serial), \$895  
706E (4 serial/2 parallel), \$795  
708E (6 serial/2 parallel), \$895  
710E (8 serial/2 parallel), \$995  
708F (4 serial/4 parallel), \$895  
710F (6 serial/4 parallel), \$995  
All above models have standard 512K buffers.  
Additional 500K buffer, \$249  
RS422A for distances up to 4,000 feet now available on some models.

## WANT DETAILS?

Call or write BayTech at P.O. Box 387, Highway 603, Bay Saint Louis, Mississippi 39520, USA. Telex 910-333-1618. Phone 601-467-8231 or

**800-523-2702**

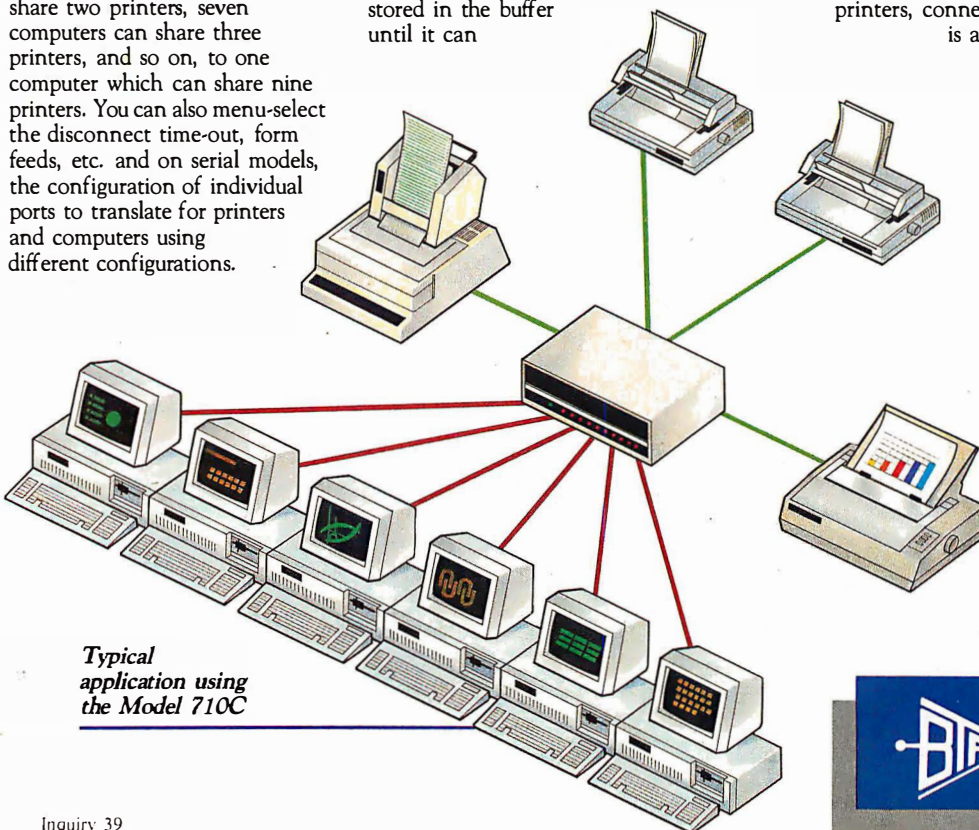

Typical application using the Model 710C



BAY TECHNICAL ASSOCIATES, INC.  
DATA COMMUNICATIONS PRODUCTS



# REVIEW FEEDBACK

## Three IBM Clones

I read John D. Unger's review entitled "Three IBM Clones" (November 1986 BYTE), which compared the Kaypro PC, the Epson Equity I, and the Multitech MPF-PC/700 D1, with interest, since I bought a Kaypro PC in June. There are, however, either some errors in the article or differences between the machine that was reviewed and mine.

My Kaypro PC came with MS-DOS 3.2, GW-BASIC 3.1, Mite 4.09, WordStar 3.3, and CorrectStar 3.31a, not the 2.11 versions.

My multivideo board is half-length (in a full-length slot next to the processor board), despite what the manual shows, and there is a switch for two speeds on the rear of the machine below the reset switch. Nothing is mentioned in my user's manual (dated "Preliminary," 10/25/85) about the speeds, but the local dealer said that the switch is for selecting between 4.77 and 8 MHz. The computer seems to run faster with the switch in the Up position, but I have not been able to time it. One game will not load in the Up position, however.

I am very pleased with my choice and use it daily.

W. Kimball Downey  
Lynchburg, VA

## Quarter-inch Tape Backup Units

I disagree with a few points in Malcolm C. Rubel's assessment of Alpha Microsystems' Videotrax in his review entitled "Four ¼-inch Tape Backup Units" (October 1986).

While admittedly slower than traditional tape backup units, the amount of time that it takes to perform a Videotrax backup could be considered rhetorical. I know people who start a backup procedure just prior to leaving the office for the evening. The next morning they can remove a completely verified backup tape from the machine. The Videotrax system was designed with this unattended operation in mind.

Mr. Rubel neglected to mention that an image backup of a complete 10-megabyte disk using the Videotrax unit takes about 15 minutes. (For that matter, image-mode backup times were not mentioned for any of the reviewed units.) Image-mode backups have been, in my experience, problematic with several ¼-inch systems but work well with Videotrax.

Mr. Rubel seems to favor the concept of the backup device/media as an extension of

the system's file structure. While I concede that a serial storage medium can be of value in some applications, I would be quick to point out the conceptual differences between a working tape and a backup tape. Once written, there are only two reasons that you should place backup media in the machine. The first is to perform a restore, and the second is to rewrite the media because all the information on it has become dated. At all other times, the media should be stored in a safe place away from the computer.

Backups should extend over several generations, and the Videotrax unit allows you to do this on an inexpensive and widely available medium. The "no update" capability of the Videotrax tends to force backups into conformity with this philosophy. The idea of the backup software allowing the previous version to be overwritten (as with the Tallgrass TG-4060) gives me the heebie-jeebies.

Creed A. Erickson  
Lititz, PA

I read with interest Malcolm C. Rubel's review of ¼-inch tape backup units. I have been using a Tecmar QIC-60 unit for almost two years now and have found Mr. Rubel's assessment to be correct. He states that if you stop a backup in progress, you have to erase the entire tape before you can back up additional data. This is also the case if the backup is interrupted because of some problem. In my application I collect about 5 megabytes of data on a hard disk, which I then add to files already on a ¼-inch tape. However, I don't usually find that I can fill a tape before an error stops the backup and thus prevents additional data from being added to the tape. It is not practical to erase the tape and repeat the process.

One way around this problem is to first copy the data to a "scratch" tape, and if the whole 5 megabytes is successfully transferred, it can be successfully transferred to a permanent tape. It should not be difficult for Tecmar to add a feature to the QIC-60 software to allow the user to erase the last volume on a tape.

N. Kouwen  
Waterloo, Ontario, Canada

## Turbo Prolog

My initial impression of Turbo Prolog was one of extreme enthusiasm. When I read Namir Clement Shammas's review of Turbo Prolog (September 1986), I read it with keen

interest. While parts of his review echoed my enthusiasm, his concluding remarks cast a cloud of doubt over the ultimate utility of the product. He said that because of its nonstandard nature, "Turbo Paslog," as he called it, could not be recommended for the seriously Prolog-minded.

This negative statement unjustly labels Turbo Prolog as a curiosity rather than a real programming tool. Turbo Prolog has its salient points as well as its shortcomings; however, I feel that its strengths far outweigh its weaknesses. There are a few features about Turbo Prolog that I find annoying. The rigid data typing that is required for, I assume, compilation purposes can be a real thorn in the side to a first-time user. And to the seasoned Prolog programmer who is used to an interpretive environment, the quasi-Pascal structure of the data typing, which is not found in standard Prolog, may seem to be a quirky formality. However, what little bit Turbo Prolog gives up in flexibility, it more than compensates in speed and elegance.

I agree with Mr. Shammas that Turbo Prolog's claim to be a superset of the Clocksin and Mellish standard is somewhat of a misnomer. While Turbo Prolog lacks some standard predicates, such a deficiency does not truly reflect Turbo Prolog's ability to tackle respectable Prolog tasks. True, there are several syntactic variations between Turbo and standard Prolog. However, in many cases, I have been able to augment my Prolog library straight from Clocksin and Mellish with little or no modification at all. While Mr. Shammas assails Turbo Prolog's nonstandard nature, he fails to point out that it is many of these nonstandard features that give Turbo Prolog its creative flavor. I agree that if its departure from standardization prevents functionality, then innovation becomes an impairment. But I think that the serious Turbo Prolog programmer can become quite proficient. When coupled with some creativity, the powerful high-level programming features found in Turbo Prolog have the makings for some fine applications.

Marcel G. Davidson  
Salt Lake City, UT ■

REVIEW FEEDBACK is a column of readers' letters. We welcome responses that support or challenge BYTE reviews. Send letters to Review Feedback, BYTE, One Phoenix Mill Lane, Peterborough, NH 03458. Name and address must be on all letters.



# Now There's A Management Tool That Lets You Work More Efficiently... Without Changing The Way You Work. Lotus Metro.

Lotus® Metro™ is a memory-resident program that combines the powerful efficiency of 12 business management tools with the time-saving convenience of macros.

Metro gives you more ways to get your work done. Metro has the same command and menu structures as 1-2-3® or Symphony® so you already know how to use it. And since it's from Lotus, you can count on its high quality and reliability to let you start working more efficiently—and in complete confidence—right away.

In fact, when you consider everything Metro can do, you won't believe its low price—just \$85.

## The Most Comprehensive Product Of Its Kind.

Metro lets you handle daily tasks on your PC more quickly and easily than ever before. You'll simplify routine—and complicated—jobs. Handle workflow interruptions more effectively. Organize your day.

In short, you'll become more productive by minimizing the time you waste.

## Bring All Your Work Together.

You can customize Metro to your needs by choosing any of the following management tools:

- *Clipboard* lets you easily move data and text between 1-2-3, Symphony or other software products—as well as between the Metro management tools themselves.
- *Appointment book* keeps track of your schedule.
- *Phone book* compiles names, addresses and phone numbers—and can even dial your phone.
- *Calculator* includes memory and financial functions.

- *Notepad* lets you jot down quick ideas and memory-joggers you can retrieve at the touch of a button.
- *Editor* creates business letters and spreadsheet reports, and allows you to view and edit existing files.
- *List manager* orders daily tasks, and effectively segments/tracks 'to do' lists.
- *Watch* helps you keep records of time spent on as many as 100 different projects.
- *DOS file manager* executes DOS commands from within applications.
- *Kaleidoscope* specifies colors on your screen, *Configuration* lets you build the product that best fits the way you work, *Special characters* contain a full 256 character IBM extended ASCII table.
- And *Macros* let you turn even your most complicated multi-step tasks into one-step commands.

## High Quality... Total Compatibility.

Metro is built to the high quality standards of 1-2-3 and Symphony—so it won't endanger your data. Metro is unprotected, so it's easy to install and easy to use. And it can be easily removed from memory whenever you need more room for your spreadsheet or other functions.

As a member of the Lotus family, Metro is the management program best suited—and designed—to work with other Lotus products. And it comes complete with Lotus' unparalleled commitment to customer service, reliability and support.

© 1987 Lotus Development Corporation. Lotus, 1-2-3 and Symphony are registered trademarks of Lotus Development Corporation. Metro is a trademark of Lotus Development Corporation.

System Requirements:

IBM® PC, XT, Portable, AT, COMPAQ® Portable, PLUS, DESKPRO. Two 5.25" double-sided disk drives (hard disk recommended for optimal performance). Minimum of 80K required for RAM-resident portion of Metro. DOS 2.0 or higher. Metro is unprotected and can be removed from memory.

Lotus Metro runs with a wide variety of software programs, including 1-2-3® Symphony®, Symphony Spelling Checker, Symphony Text Outliner, 1-2-3 Report Writer,™ and Signa!™

THE

STUFF  
DONE

\$ 85



SHORTEST DISTANCE  
BETWEEN 9 & 5

LOTUS  
METRO

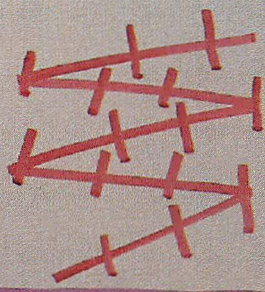
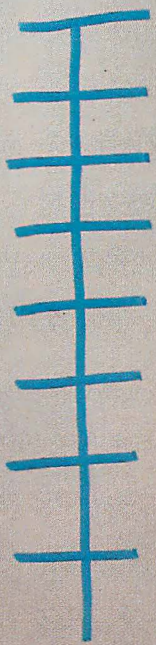

WITH  
METRO

WITHOUT  
METRO



# Try Lotus Metro Today.

No other "desktop" product offers you the power and efficiency of Metro...

The unique combination of comprehensive management tools and macros that allows you to manage your PC... organize your workday... and increase your productivity.

And, at only \$85, no other product even comes close to its value. (Especially since Metro will quickly pay for itself again and again.)

Which is why you should visit your nearest Lotus dealer to sample Metro.

Or, if you're already convinced, simply use the coupon below to order Metro directly from Lotus.

Or order Metro (Product No. YF-1690) by calling Lotus, toll free,

1-800-345-1043

Lotus Metro

*The memory-resident desktop manager combining twelve accessories and a powerful macros program.*

Complete and return to: Lotus Development Corporation, 90 Annex, Atlanta, Georgia, 30390-0370 or call 1-800-345-1043.

- Yes. I'd like to try Lotus Metro for 30 days without obligation. (YF-1690)
- Please send more information about Lotus Metro. (YF-2821)

Send me \_\_\_\_\_ unit(s) of Metro @ \$85 each \_\_\_\_\_

Sales Tax\*\* \_\_\_\_\_

Total \_\_\_\_\_

I've enclosed my check or money order made payable to: Lotus Development Corporation.

Please charge my:  VISA  MasterCard

Card No. | | | | | | | | | | | | | | | | | | | | | |

Expiration Date \_\_\_\_\_ / \_\_\_\_\_

Signature \_\_\_\_\_

Name \_\_\_\_\_

Company \_\_\_\_\_

Address \_\_\_\_\_

City \_\_\_\_\_ State \_\_\_\_\_ Zip \_\_\_\_\_

Telephone ( \_\_\_\_\_ ) \_\_\_\_\_

\*\*Residents of the following states apply applicable sales tax: CA, DE, FL, GA, IL, MA, MD, MI, MN, MO, NJ, NY, OH, TX, VA, WA. Offer good in U.S.A. and Canada only. In Canada make payment by credit card or International Postal Money Order. CODs and purchase orders will not be accepted.

When you purchase Metro directly from Lotus, take your first 30 days to try it out. If, at the end of your first month, Metro does not perform as described and you've purchased it directly from Lotus, we'll gladly give you a full refund.



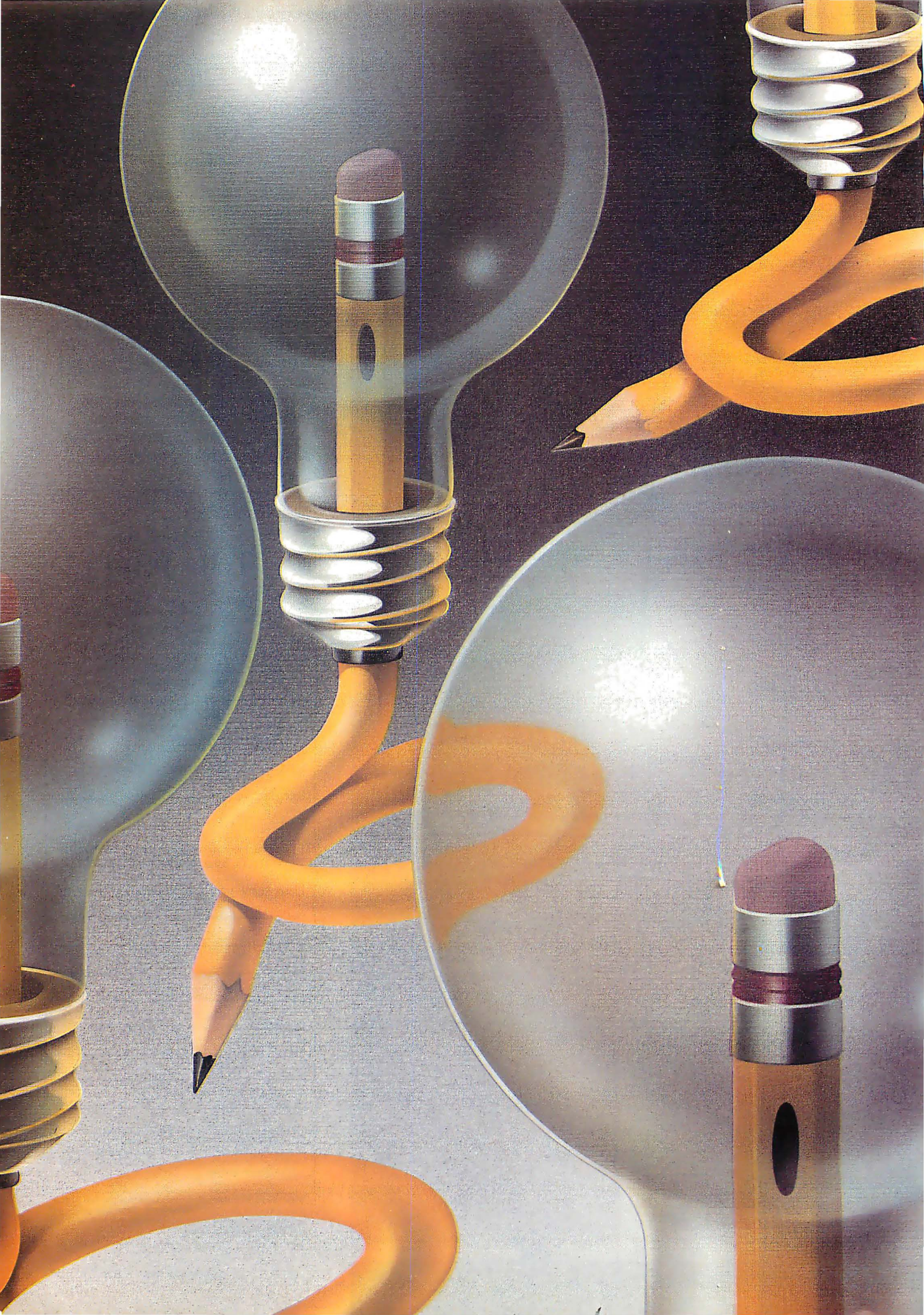



# Kernel

---

**Computing at Chaos Manor:  
A Confederation of Hackers**  
by *Jerry Pournelle* ..... 267

**BYTE U.K.: And More Clones**  
by *Dick Pountain* ..... 287

**Applications Only: Miscellany**  
by *Ezra Shapiro* ..... 295

**According to Webster: Journeys**  
by *Bruce Webster* ..... 303

**Mathematical Recreations:  
A Ternary State of Affairs**  
by *Robert T. Kurosaka* ..... 319

---

AS THE TITLE OF HIS COLUMN indicates, Jerry Pournelle attended the second edition of the Hackers' Conference this month. Held in an inspiring location and blessed with good weather, the conference—attended by most of the giants of the hacker community—was a good experience for Jerry. And he will happily go to the next one. Other happenings this month found Jerry acquiring an Okidata Okimate 20, which is pretty close to a printer for all seasons. Because the Golem is being updated, Jerry did the column using WordPerfect on Big Kat. Jerry gives his views on WordPerfect and also looks at the new version of Q&A.

Dick Pountain recounts some recent developments in the British personal computer industry. After a period where four major companies were producing machines of incompatible proprietary designs by the hundreds of thousands, there are now two major companies pinning their futures on selling IBM clones. In the space of a month in 1986, Apricot and Amstrad both launched IBM-compatible computers. Dick first looks at the Amstrad PC1512 series, which contains possibly the cheapest IBM PC clones in the world. He then evaluates the Apricot Xen-i, which may be the highest-performance and highest-quality PC AT clone in the world.

Ezra Shapiro is starting to experience one of the problems Jerry has found at Chaos Manor—software is chewing up floor space at an alarming rate. In the past month, he has received more than 30 products. This gigantic backlog has caused Ezra to have a significant guilt complex. He thus has decided to deal with several products in a shorter format. The lucky ones this month are Volkswriter Deluxe Plus, GraphicWorks, Highways and Byways, SuperPaint, Puppy Love, and Acta. Try to guess which one Ezra finds to be a real dog.

After having stayed around home for the past few months, Bruce Webster finds himself in the middle of a series of trips. One event he went to was the Apple IIGS Developers Conference. As a result of learning more about how the IIGS works and seeing more of what it can do, Bruce thinks more of this machine than he did a month ago. He is also impressed with the job Apple is doing in general. Bruce's product of the month is MacFORTH Plus from Creative Solutions Inc. He considers it one of the finest FORTH development environments on any system. Bruce also looks at MultiFORTH, Weinberg, and Editing Tools; gives some updates; talks briefly about MIDI; and recommends some books.

It's time for Mathematical Recreations once again. This time around, Bob Kurosaka looks at the base-3 number system, which offers an automatic solution to a classic puzzle. The puzzle involves the mathematics of balance scales.



# ARE YOUR DOCUMENTS ALIEN?

If capturing text or images from paper documents is alien to you, our **SCANNING CONNECTION** is your best plan of attack.

In less than one minute, an image of your document can be read, stored, retrieved, processed, and output to a laser printer.

A version of Halo DPE® is provided for processing images. Photographs, books, articles, and drawings can be scanned and saved in compressed form.

The saved images can be combined with text in a wide variety of fonts and sizes. The completed document can be reproduced on a laser printer.

Images can be processed with our OCR software to produce text documents. Enhanced matrix matching is used for accurate character recognition. After the system is trained for each new typestyle, the matrix pattern is saved and reused.

A text editor is used to locate and correct scanning errors. The final document is stored in IBM DCA format with tabs, margins, indents, and line ends. The IBM DCA format can be read by most popular word processing programs.

We specialize in conversion systems and can transport your documents or images to most computer, typesetting, or word processing systems.



With our **DISKETTE CONNECTION** system you can read and write most 8", 5¼", and 3½" diskettes using a PC. We support systems from CPT, LANIER, NBI, WANG, XEROX, HONEYWELL, DG, DEC, and IBM.

Our **TAPE CONNECTION** system can read and write most 9-Track magnetic tapes using your PC. We can supply tape drives in several models at 800, 1600, or 6250 BPI. Tapes can be labeled and multivolume.

The price for a Canon IX-12 scanner, controller card, cable, and image software is **\$1195**. The optional OCR software is **\$595**. The price for an IBM 3117 flat bed scanner, controller card, and image software is **\$1395**. The price for an 8" diskette drive, controller card, cable, and utility software is **\$1195**. The optional software for word processing conversion is **\$695**. The price for a 9-Track 1600 BPI tape drive, controller card, cable, and software is **\$3495**.

*Since 1982, we have installed thousands of diskette and tape conversion systems at customer locations around the world. We have written hundreds of software programs and designed dozens of hardware products to meet our customer's conversion requirements. We support our products because we developed them. Call us today for help in solving your conversion problems.*

## Flagstaff Engineering

1120 W. Kaibab • Flagstaff, AZ  
86001 • 602-779-3341 • telex 705609

In Europe contact Compusol  
12 Rue Rosenwald • 75015 Paris  
tel 530.07.37 • telex 205431F





# A Confederation of Hackers

Jerry Pournelle

*Jerry goes back  
to camp and compares notes  
with classic hackers*

Last weekend I went to Hackers 2.0, the second edition of the Hackers' Conference. The first one was held in 1984 up near the Golden Gate; we had this one in a retreat camp not far from Saratoga, which is a town at the far edge of Silicon Valley. It turned out to be an inspiring location among redwood forests, and to add to the mood the weather was magnificent.

Most of the giants of the hacker community were there: so many that it's impossible to name them all, and insulting to name a few as representative. There were hackers from every era, from the early days at MIT and Stanford to newcomers who work with Apples, PClones, the Atari ST, and the Amiga.

Some incidents: the Long March Beer Run. A companion and I set out for Saratoga (four miles away) for beer. There was an overturned bus on the two-lane highway, making it impossible for us to get past; so, we thought, we'll go the other way, uphill. Twenty-two very twisty miles and 45 minutes later we ended up on Page Mill Road in Palo Alto.

Bill Atkinson and Steve Capps, authors of QuickDraw, came up to me in the dinner line. "Do you think the Macintosh will survive?" they demanded, thus continuing a conversation started two years ago at the first Hackers' Conference.

"With a new keyboard, more memory, faster disk access, and a way to communicate with other machines—why shouldn't it?" was my only possible reply.

They also explained why they used the single-button mouse. "If it has more than one button, people look at the mouse rather than the screen," Atkinson said. "We didn't want them to look at the mouse. Besides, there's nothing you can do with several buttons you can't do with a single-button mouse if the software's designed right." That makes so much sense I want to think about it awhile.

On the first night, someone short-sheeted my bed. On the second, they'd wired a Radio Shack buzzer to scream at

me when I, full of good cheer and Philippe Kahn's donated champagne (he paid for the masquerade party), tried to go to bed. Fortunately, I had brought my great double-bladed axe—at the masquerade it was my double-sided double-density hacker's tool—and it was no great problem to disconnect the buzzer.

I also met the original Amiga designers and saw what may be the best educational tools ever invented, namely, a series of animations, narrations, and illustrations that do a better job of teaching physics than anything I've ever seen before. This was developed largely at JPL (NASA's Jet Propulsion Laboratory) and has been on PBS. If I'd had something like this to study in high school and early college, I'd know a lot more about physics now. The computer revolution affects more than just computing.

There were the usual conferences and discussions of copy protection. We're all agreed that information piracy is a growing problem, and there appears to be no ready solution for it. I admit to being a bit scared, since I make my living from intellectual property, and that's becoming hard to impossible to protect. In a very real sense, we're all going to have to depend on ethics—and the last I heard, that isn't even being taught in the schools any longer.

It was an exhausting conference, with all the usual discussions of the future of computing and hacking and society and how hackers can change the world. Impossible to summarize, but more than worthwhile. A good conference. I'll be happy to go to the next one.

## More Atari ST

A number of people brought machines to the conference. One of the most

popular was an Atari ST brought by Alex Leavens. Alex, incidentally, is working with Mrs. Roberta Pournelle to program her reading instruction program for the ST. He's done about half of it, and I must say it really

looks great. Roberta can hardly wait until he finishes, and I must confess mild anxiety myself.

The program incorporates most of what she learned in more than 20 years of teaching reading to illiterates of every age and with every disability. We have every reason to believe it will work: with luck and skill that program could change the world.

The first version requires that someone who can read work with someone who can't: the lessons come up on the screen, the "instructor" pronounces the words in the lesson, and the student follows along. The computer keeps track of lessons and progress and when the student gets things right puts on a light or a music show as a reward.

The next version will, we hope, just about eliminate the instructor. The Atari ST has good enough speech-synthesis hardware to do that. Alas, the speech-synthesis *software* that comes with the ST isn't so hot, and I don't know of anyone with plans to rewrite it. Maybe, though, by the time the first version of the reading instruction program is out something will be done.

The most popular Atari ST software at the conference was a game, StarGlider, which I confess is pretty addicting. It comes with a science fiction novella that's a little overwritten in places, but it reads well enough—and sure sets things up for the game. I've had a bit of trouble learning to use a mouse to control a fighter

*continued*

*Jerry Pournelle holds a doctorate in psychology and is a science fiction writer who also earns a comfortable living writing about computers present and future.*



# Maximum Memory at the Lowest Price

INTRODUCTORY OFFER—Prices Good Until March 15, 1987

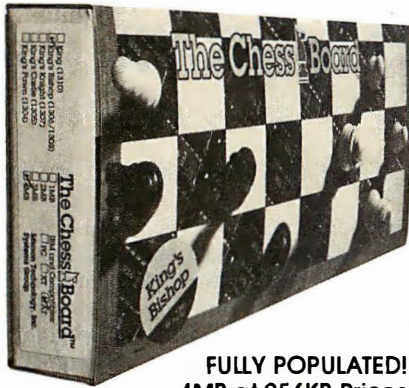

FULLY POPULATED!  
4MB at 256KB Prices

## The King's Bishop™ . . . \$595

- 4 Megabytes of dynamic RAM for your AT, XT-286, or compatibles—FULLY POPULATED!
- Runs at 6 MHz with Zero Wait-state; 8, 10, 12 and 16 MHz with One Wait-state
- Accesses 16-bit words
- Completes conventional memory (backfills) to 640K
- Fully supports Extended and Expanded (LIM/EMS) operation
- Ram Diagnostics and Print Spooler software included
- Two-year Limited Warranty for registered users
- 8 MHz Zero Wait-state version—\$695  
10 MHz Zero Wait-state version—\$795



## The Queen's Castle™ . . . \$295

- 2 Megabytes of dynamic RAM for your PC/XT or compatible—FULLY POPULATED!
- Runs at 4.77 and 8 MHz
- Completes conventional memory (backfills) to 640K
- EMS Software for expanded (LIM/EMS) memory operation, RAM Disk, RAM Diagnostics, and Print Spooler
- Two-year Limited Warranty for registered users



Dealer and O.E.M. Inquiries Invited

# MICRON

TECHNOLOGY, INC.

Systems Group  
2805 East Columbia Road  
Boise, Idaho 83706



We're building our reputation on innovation.

IBM PC/XT/AT are trademarks of IBM Corporation

For Orders and Information:

# 1-800-642-7661

For Technical Service and in Idaho: (208) 386-3800

plane—I'd have thought a joystick would be better—but people more expert with arcade games than I am say they actually begin to prefer the mouse when they get used to it. One thing I did learn from StarGlider was why the U.S. Navy prefers two-seater fighter planes. It's hard to fly that thin and still go kill targets, especially if you have to guide missiles until they lock on. Anyway, if you like arcade games, you'll love this one.

Incidentally, StarGlider was developed with HiSoft's DevpacST (available from Apex Resources), an assembly language development system Bruce Webster recommends highly (see the November 1986 BYTE). I confess that I've never written a program in 68000 assembly language. Since my publishers are seriously discussing putting out contracts on me if I don't turn in some novels, it's not likely that I will for a while. Those who do write assembly language programs for the ST seem to like HiSoft's package a lot.

Atari had also finally released the ST version of the old 8-bit Star Raiders. This is a pure shoot-'em-up with only the most rudimentary strategic decisions, but it has absolutely gorgeous graphics. I notice on BIX that even those who hate the program seem to spend a lot of time playing it.

Finally, I have the Epyx version of Rogue for the Atari ST. It has a number of refinements: great graphics, an on-screen inventory visible at all times, graphic representation of strength and hit points, and a whole bunch of other stuff. It's estimated that since Michael Toy first wrote Rogue for UNIX systems the game has cost more than a billion dollars in machine and programmer time wasted. If you like Rogue for any machine, you'll love it for the Atari ST.

### Flash

I don't often play Star Raiders, or Rogue, or StarGlider for that matter, mainly because Mrs. Pournelle is using the Atari ST for BIXing. Like most recent converts to BIX she's become an addict, and it's nearly impossible to get her away from the silly machine.

What she's using is a Volks VM 520 modem from Anchor Automation connected to the Atari 1040ST. This is a slim little thing with only one control and no blinking lights, sort of the bare essence of a modem, and it works fine with the Atari ST. The communications software is Flash from Antic Software.

Flash is one of those products I call infuriatingly excellent. Excellent in that it does the job and has just a lot of desirable features. Among other things, it automatically captures everything you've sent and received (at least as much as there's memory for, which in a 1040ST is a lot);

a click on the right-hand mouse button and you can go back and review whatever you got off BIX, and if you've got a printer hooked up, you can print all or part of it, too.

Another Flash feature is a rather nice little full-screen editor you can use to compose messages and send them. Actually, the editor is part of the capture buffer: you can compose a message in there, mark it, and send it—Flash sends marked blocks of text. Naturally, you can do the same thing with text you've already received, meaning that it's a lot easier to edit BIX messages in Flash than it is to use the primitive BIX line editor.

Flash can upload and download using Ward Christensen's XMODEM protocols. It has a translation table, meaning that as you send or capture text you can change anything to anything else: very useful if you have a computer with weird internal symbols, such as an Atari XE, which uses ASCII character 155 instead of a carriage return—the translation table can change incoming CRs to the 155 character and vice versa. Flash has a script capability: you can set up a series of commands and events and make them all happen when you log in.

In other words, Flash has plenty of nifty features, so why do I call it infuriating? As usual, it's the documents. If you want to use Flash, you'd better be prepared to read the entire 50-page book not once, but at least twice: unless you're more familiar with these things than I am, you won't understand on the first pass through. And since there's neither index nor analytical table of contents, you've got to read it all to find out what features are available, much less how to use them.

Flash doesn't have terminal emulation (or if it does, I haven't found that out) and lacks a few of the other features of really advanced communications programs; the documents aren't at all clear and in some cases are downright misleading on the more advanced features; but the bottom line is that it took no more than five minutes to set up the Atari ST with the Volks modem and Flash, and Roberta has had no trouble using it. The price is good, too. Recommended, provided you're willing to read the documents twice.

### Monochrome

I've always had the Atari ST monochrome monitor, but for one reason or another I never used it; but when Alex Leavens came to visit he brought a copy of Magic Sac, the cartridge that plugs into the side of your Atari 1040ST and lets it run Macintosh programs. Magic Sac requires monochrome, so I fished the monitor out of the back room and plugged it in.

continued



# THE PROGRAMMER'S SHOP

helps save time, money and cut frustrations. Compare, evaluate, and find products.

## RECENT DISCOVERY

**PolyBoost** - Run 2 to 10 times faster with software accelerator. Speeds disk access, screen display, keyboard input. PC \$ 69

## AI-Expert System Dev't

Arity System-incorporate w/C. MS \$ 259  
 Experteach-Improved, samples PC \$ 399  
 EXSYS PC \$ 339  
 Texas Instruments:  
 PC Easy PC \$ 439  
 Personal Consultant Plus PC \$2599

## AI-Lisp

Microsoft MuLisp 85 MS \$ 199  
 PC Scheme LISP - by TI. SCHEME has simple, "orthogonal" syntax. PC \$ 85  
 TLCLISP - classes, compiler. MS \$ 225  
 TransLISP - Good for learning MS \$ 85  
 Others: IQLISP (\$155), UNX LISP (\$59), IQLISP (\$269), WALTZ LISP (\$139)

## AI-Prolog

APT - Active Prolog Tutor - build applications interactively PC \$ 65  
 ARITY Standard - full, 4 Meg  
 Interpreter - debug, C, ASM PC \$ 319  
 COMPILER/Interpreter-EXE PC \$ 699  
 With Exp Sys, Screen - KIT PC \$1129  
 LPA MacProlog - Complete incremental compiler and an interpreter MAC \$ 295  
 LPA MicroProlog - intro MS \$ 85  
 LPA MicroProlog Prof. - full memory MS \$ 349  
 Prolog-86 - Learn Fast MS \$ 89  
 Prolog-86 Plus - Develop MS \$ 229  
 TURBO PROLOG by Borland PC \$ 69

## Editors for Programming

BRIEF Programmer's Editor - undo, windows, reconfigure PC Call  
 EMACS by UniPress - powerful, multifile, MLISP. Source: \$929 \$ 299  
 Epsilon - like EMACS PC \$ 155  
 Kedit - like XEDIT PC \$ 105  
 Lattice Screen Editor-multiwindow multi-tasking Amiga \$ 89 MS \$ 109  
 PC/VI - Custom Software MS \$ 109  
 Personal REXX PC \$ 109  
 PMATE - power, multitask PC \$ 109  
 SPF/PC - fast, virtual memory PC \$ 139  
 XTC - multitasking PC \$ 79

## FEATURES

**dBXL** by Word Tech - complete interpreter clone. Adds windowing, Quicksilver, LAN support. Non-copy protected. PC \$ 129

**TransLISP PLUS** - with C INTERFACE, 400+ COMMON LISP functions  
 Optional UNLIMITED Runtime \$ 150  
 PLUS FOR MSDOS \$ 179

## 700+ Programmer's Products

The Programmer's Shop carries every programmer's software product for MSDOS, PC DOS, CPM, Macintosh, Atari, and Amiga systems. We help you choose the best tools for you. Most popular products are in stock, available for quick delivery. We will gladly special order a product for you at no charge — just allow a few extra days for delivery.

Need Cross Compilers, Translators, or the right Fortran compiler? Ask us.

### Our Services:

- Programmer's Referral List
- Compare Products
- Help find a Publisher
- Evaluation Literature FREE
- BBS - 7 PM to 7 AM 617-826-4086 National Accounts Center
- Dealers Inquire
- Newsletter
- Rush Order
- Over 700 products

## C Support-Systems

Basic-C Library by C Source MS \$139  
 CSharp - well supported, Source, realtime, tasks PC \$600  
 CToolSet - DIFF, xref, source MS \$ 95  
 The HAMMER by OES Systems PC \$159  
 Lattice Text Utilities PC \$ 95  
 Multi-C - multitasking PC \$149  
 PC LINT-checker. Amiga \$89, MS \$107  
 SECURITY LIB - add encrypt to MSC. C86 programs. Source \$229 PC \$115  
 Quickshell - script compiler PC \$349

## Fortran & Supporting

Forlib + by Alpha - graph, comm. \$ 59  
 MACFortran by Microsoft - full '77 \$229  
 MS Fortran link to C \$209  
 No Limit - Fortran Scientific \$119  
 RM Fortran - enhanced "IBM Ftn" \$389  
 Scientific Subroutines - Matrix \$149

## MultiLanguage Support

BTRIEVE ISAM MS \$199  
 BTRIEVE/N - multiuser MS \$469  
 CODESIFTER - Execution PRO-FILER. Spot bottlenecks. MS \$ 99  
 Dan Bricklin's Demo Program PC \$ 65  
 HALO Graphics - 115+ device interfaces, rich, printer. Specify language interface PC \$209  
 Microsoft Windows Software Development Kit PC \$349  
 PANEL - data validation, no royalties Xenix \$539, MS \$219  
 Pfinish Performance Analyzer MS \$249  
 PLINK-86 - a program-independent overlay linker to 32 levels. MS \$249  
 PLINK-86 PLUS - incremental MS \$369  
 PolyLibrarian MS \$ 85  
 PVCS Version Control MS \$329  
 Screen Sculptor - slick, thorough PC \$ 99  
 ZAP Communications - VT 100, TEK 4010 emulation, file xfer. PC \$ 89

## Atari ST & Amiga

We carry full lines of Manx, Lattice, & Metacomco.

Call for a catalog, literature and solid value

**800-421-8006**

**THE PROGRAMMER'S SHOP™**

128-B Rockland Street, Hanover, MA 02339

Mass: 800-442-8070 or 617-826-7531 12/86

## RECENT DISCOVERY

**Uniware Cross Development Tools** - include 68000 C compiler. Development Package with compiler, assembler, link editor, and utilities, 17 cross assemblers for Intel, TI, Motorola, Zilog, etc. - relocatable, macros. MS \$ Call

## C Language-Compilers

AZTEC C86 - Commercial PC \$ 499  
 C86 by CI - 8087, reliable MS \$ 299  
 Datalight C - fast compile, good code, 4 models, Lattice compatible, Lib source. Dev'rs Kit PC \$ 77  
 HOT C - new, intriguing PC \$ 85  
 Lattice C - from Lattice MS \$ 299  
 Mark Williams - w/debugger MS \$ 369  
 Microsoft C 4.0 - CodeView MS \$ 279  
 Wizard C - full, fast. MS \$ 359

## C Language-Interpreters

C-terp by Gimpel - full K & R MS \$ 229  
 C Trainer by Catalytix PC \$ 89  
 INSTANT C - Source debug, Edit to Run-3 seconds, .OBJS MS \$ 379  
 Interactive C - interpreter, editor PC \$ 225  
 Introducing C - learn C quickly PC \$ 105  
 Run/C Professional - MS \$ 179  
 Run/C Lite - improved MS \$ 97

## C Libraries-General

Blackstar C Function Library PC \$ 79  
 C Essentials by Essential PC \$ 83  
 C Food by Lattice-ask for source MS \$ 109  
 C Scientific Subroutines-Peerless MS \$ 135  
 C Tools Plus (1&2) PC \$ 135  
 C Utilities by Essential - Comprehensive screen graphics, strings. Source. PC \$ 137  
 C Worthy Library MS \$ 269  
 Entelekon C Function Library PC \$ 119  
 Greenleaf Functions-portable, ASM \$ 139  
 PforCe by Phoenix - objects PC \$ 249

## C Libraries-Files

FILES: C Index by Trio - full B + Tree, vary length field, multi compiler  
 /File is object only MS \$ 89  
 /Plus is full source MS \$ 349  
 CBTREE-Source, no royalties MS \$ 99  
 CTree by Faircom-no royalties MS \$ 319  
 dbQUERY-ad Loc, sQL - based MS \$ 159  
 dbVISTA - full indexing, plus optional record types, pointers, Network.  
 Object only - MS C, LAT, C86 \$ 159  
 Source - Single user MS \$ 429  
 Source - Multiuser MS \$ 849  
 dBASE Tools for C PC \$ 65  
 dbc Isam by Lattice MS \$ 199  
 dBx - translator MS \$ 319  
 w/source MS \$ 519

## FEATURE

**Insight 2+** - Flexible expert systems shell has intrinsic dBASE operators, forward and backward chaining, transparent view of reasoning process. MS \$ 389

Note: All prices subject to change without notice.

Mention this ad. Some prices are specials. Ask about COD and POs. Formats: 3" laptop now available, plus 200 others. UPS surface shipping add \$3/item.



## ENCLOSURE PRODUCTS

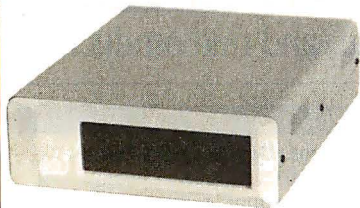

- Tape and Hard Disk Drives Enclosures for all Major Micros.
- Single Board Computer Packages
- Custom Design Available
- Class 'B' Certification Support Can Be Provided
- Call For Pricing and Catalog

**Microware Inc.**

41711 Joy Road • Canton, MI 48187  
(313) 459-3557

Inquiry 171

### 3D INTERACTIVE GRAPHICS CGS-3 Library for CGA Card

2D and 3D drawing, rotation, scaling, real-time animation Merge/Copy/Edit images, display images in real-time Construct/View/Store/Retrieve images. Selective screen filling/scrolling in any direction. Keyboard support. Read/Check keystrokes while program keeps running. Sound/Musical effects. And much more.

Required IBM PC/Compatible/CGA/DOS 2 X 3 X. Support 8087/80287 Callible from MS/IBM Fortran/BASIC/Pascal/Profort/Assembler CGS-3 Library + 2D/3D Tutor + 100-page manual **\$26.95**

### EGS-3 Library for EGA/Hercules Card

Includes all functions for CGS-3 Library plus: Screen page control. Programmable color palette. Display/Remove text with down-loadable fonts. Draw/Fill with Patterns sized up to 64K64 color pixels. Graphics screen dump.

Required IBM PC/Compatible. 256K E. A or compatible or Hercules Card. Support 8087/80287. Callible from MS/IBM Fortran/BASIC/Pascal/Profort/Assembler. EGS-3 Library + 2D/3D Tutor + 150-page manual **\$39.95**

### LITE-3 Interpreter for EGA/Hercules Card

Interactive Graphics Command Interpreter includes all abilities of EGS-3 Library. Compiling/Linking not required. Single-step graphic command facilities.

Required IBM PC/Compatible. 256K EGA or compatible or Hercules Card. Support 8087/80287. BASIC/Turbo Pascal. MS/IBM Fortran/BASIC/Pascal/Profort/Assembler. LITE-3 Interpreter + 2D/3D Tutor + 150-page manual **\$49.95**

### Both EGS-3 and LITE-3

**\$59.95**

Demo (applied toward purchase) \$5.00  
Please add \$3 S/H. TX residents please add 6.125% tax.

**Filtrex Research, Inc.** (713) 556-5747  
P.O. Box 820425  
Houston, Texas 77282 MC/VISA/CHECK/MO

Inquiry 94



**Sure  
it's insured?**

SAFWARE® Insurance provides full replacement of hardware, media and purchased software. As little as \$39/yr. covers:

- Fire • Theft • Power Surges
- Earthquake • Water Damage • Auto Accident

For information or immediate coverage call:  
**1-800-848-3469**

In Ohio call 1-614-262-0559



SAFWARE, The Insurance Agency Inc.

Inquiry 253

## CHAOS MANOR

Incidentally, if you have both color and monochrome for the Atari ST, you want to be careful how you change from one to the other. The safest way, of course, is to turn the computer off while making the switch. You can also disconnect one monitor, reboot while no monitor is connected, and plug in the other one. The reason for this is that the Atari checks on boot-up to see whether you're using monochrome or color, and it sends out voltages sufficient to ruin one monitor if it thinks it's sending to the other.

I understand there's a company making a cable switch device just for the Atari; it will automatically reset the machine if you throw the switch to change from one monitor to the other. I sure wish I had one.

Anyway, we hooked up the monochrome monitor. We in this context are Alex Leavens and I. Alex is the moderator of a couple of Atari-related conferences on BIX, and he knows more about the Atari ST than any Atari employee I ever met. When we got the monochrome display hooked up, I could see why everyone is impressed with it; but, alas, it was too small for me to see very well.

No problem, said Alex; whereupon he proceeded to open up the monitor and tweak the vertical and horizontal amplification until the image filled the entire screen. The result is letters about 10 percent larger, which is to say large enough for me to see. You do pay a penalty, in that screen images are not precisely square any longer. You have to be careful with CAD stuff. For me, though, that larger image far outweighs the shape distortion, which is really so mild I have to look close to notice it.

A lot of Atari ST software will run on both color and monochrome. That includes games like StarGlider, and indeed many StarGlider addicts prefer the monochrome version because it's supposed to give more precise control. Alas, Time Bandit and Star Raiders require color.

The Atari ST with monochrome looks as good as the Macintosh to me, and certainly the image is larger. Quite impressive, especially considering what it costs. More and more Mac software gets ported from Macintosh to Atari ST with Magic Sac; ST owners who don't have monochrome and Magic Sac should seriously consider getting both.

### Okidata Okimate 20

This is pretty close to a printer for all seasons. The Okimate 20 is a small—I mean really small, about the size of an Atari ST—dot-matrix printer that can take any of a number of “plug and print” modules to adapt it to your particular com-

puter. Mine came with a module for the Atari ST; but Okidata is sending me modules to let me use it on an Amiga, IBM PC, and Apple IIe.

Each module comes with an instruction book, programs, and cable, all—including instructions—keyed to the particular computer you'll be using it with.

We had the Okimate 20 hooked up to the Atari ST in about 20 minutes. Fifteen were spent getting the paper into the machine. As with a lot of those small dot-matrix jobs, feeding in the paper is a black art. I suppose it gets easier with practice. Meanwhile, I keep eyeing the paper supply, hoping it will last long enough that my blood pressure will be lower when I have to put in new paper. Of course, I had even worse problems with the Epson printer. The only small printer I know that's easy to get paper into is the one from MPI.

Aside from getting the paper in, the Okimate 20 works great. The instructions are incredibly clear, with good illustrations. Some real editorial work went into producing this instruction book. (I have only the one for the Atari ST, but since the printer has been out longer than that computer, I'll assume they've done a good job with the other machines, too.)

Once you get the Okimate 20 hooked up, you're in for a treat. It's quiet. Not as quiet as a laser printer—what is?—but quiet enough that you can be in the same room with it and not go mad.

It also does *great* print quality in document mode. I often get letters from readers asking if editors will read manuscripts printed in dot matrix. I generally say it depends on the manuscript: editors will tackle anything if it's good enough, but the harder it is to read, the better the submission had better be. With the Okimate 20 you needn't worry: I, at least, can't tell its document mode from a Diablo daisy-wheel printer's output. The Okimate has a Courier—more or less—type font, and the letters are black and filled in. The lowercase descenders like j and g really descend below the line, and, in a word, the output is indistinguishable from impact printers.

It does this by a thermal-transfer process. That doesn't mean you need “thermal paper,” although in fact the Okimate will print on thermal paper provided you remove the ribbon. (You can even use rolls of thermal paper if you want to.) Thermal transfer means that the 24 dot elements are heated and melt wax off the Okidata ribbon onto the paper. It stands to reason then that the paper has to be smooth, meaning that you can't use high rag-content bond. On the other hand, copier paper works fine, and so does the “computer paper”

*continued*

Inquiry 54 →



# The American Success Story:

Once upon a time, America lead the world in innovation, quality, engineering, and manufacturing with names like Edison, Ford, and Bell...

Once again America returns:

**\$755**

Basic system



Basic system 8 MHZ CPU with Option A \$1075  
Basic system 10 MHZ CPU with Option A \$1125

... "Low price and blazing speed"...

Joe Desposito  
PC Magazine

## FEATURES:

- \* Maxi switch keyboard
- \* 6/8/10 MHz selectable, depends on model
- \* 1MB of inboard memory (with 512K standard)
- \* 8 I/O expansion slots
- \* 195 watt power supply, 110V/220V switchable
- \* Fully compatible BIOS (written in U.S.A.)
- \* Full documentation, operation manual with binder
- \* Full one year warranty



**FREE:**

Fully configured and tested for your system requirements

## RUNS:

NOVELL DBASE  
AUTO CAD LOTUS  
XENIX SIDEKICK

"If imitation is the sincerest form of flattery, the CLUB AT pays the IBM AT a heartfelt compliment. The only failing of the (CLUB AT) is that it imitates the IBM machine too accurately...and you can't beat that..."

Karl Koessel PC World December 1986

## EVEREX EVERCOM

"Fully Hayes™ Compatible"

300/1200 BAUD

1200/2400 BAUD

\$128

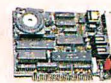

\$249



300/1200 BAUD, half size/half power, excellent for long distance calls, free BitCom communications software

## Option A: 1.2MB Floppy Drive WD HD/Floppy Controller

**CLUB 286 Mono system \$1311**

**\$1311**

**CLUB 286 Color system \$1508**

**\$1508**

\* Complete system as described above plus mono display card and IBM quality mono monitor

\* High quality

\* Complete system as above

\* Plus color display card and color monitor

**CLUB 286 Color EGA system \$1742**

**\$1742**

\* Complete system with EGA card & monitor

\* Fully assembled and tested, no installation required

## GRAPHICS BOARDS

## MULTIFUNCTION CARD

## HARD DISKS TAPE BACKUP SUBSYSTEMS

## OTHERS



A. \$228



G. \$179



B. \$238



H. \$75



C. \$99

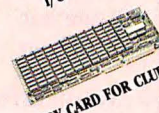

I. \$155

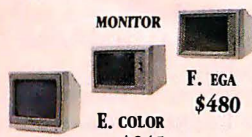

F. EGA \$480



J. \$55



D. MONO \$138

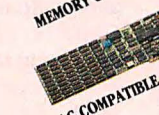

K. \$88



CALL

## L. FAST HARD DISK FOR AT



20 MB 4026 \$528

30 MB 4038 \$628

40 MB 4051 \$699

72 MB (23 MS) \$1195

80MB 4096 \$1295

## M. FOR PC UPGRADE TO XT



INTERNAL

20 MB \$375

30 MB \$475

## EXTERNAL TAPE BACKUP SOFTWARE INCLUDED



INT EXT

20 MB \$580 \$680

## N.



60 MB \$747 \$827

## HARD DISK CONTROLLER

\* Data Switch Box \$88

\* PC/XT controller \$90

\* Floppy controller \$49

\* 25 Pin Serial Cable \$18

\* Split Power Y-cable \$8

\* IBM Type Printer Cable \$15

\* IBM AT Bus Extended Card (good for test & debug) \$30

\* AT HD/Floppy Controller \$170

\* Compaq 286 HD Controller \$188

\* PC/XT/HD Floppy Controller \$140

\* Mouse \$75

## WEEKLY SPECIALS Qty. of 2

Toshiba 72 MB \$1099

Teac Floppy 360K \$85

Seagate 4051 \$638

## SOFTWARE

Graphics DR. HALO \$49

Communications

BIT-COM \$49

## ADD ON

\* Kits for Mini I/O.

2nd Serial Port \$25

\* Kits for CLUB 2000.

2nd Serial Port \$25

## CHIPS

64K DRAM



150 ns (9 pcs.) \$9

120 ns (9 pcs.) \$12

256K DRAM



150 ns (9 pcs.) \$27

120 ns (9 pcs.) \$36

100 ns (9 pcs.) \$45

## CLUB AT INC.

46707 Fremont Boulevard, Fremont CA 94539

Quality and volume is Our Business

All Sales Call (415) 490-2201

FAX No. 415-490-2687



Now open 7:30-6:30 for your convenience

University P.O.'s are welcome Quantity Discounts are Available  
Corporate Buyer call for Neil Mehta Dealers are Welcome

ORDER BY MAIL: Check or Money Order, California add 6.5% tax  
ORDER BY PHONE: C.O.D., Cashier Check, VISA (3%),  
American Express (4%) or Approved Company P.O.  
TERMS: All prices are subject to changes and quantity may be limited and we  
reserve the Right to Substitute Equivalent Items. Unauthorized Returns are  
subject to 10% Restocking Fee. Call for RMA Numbers for Returns and Repairs.  
IBM, Hercules, Bitcom, Xenix are trademarks of the Respective Companies.  
Limited Warranty, 1 year parts and 6 months Labor.

A. Parallel port, 256K Video memory, runs color/mono display, 16 colors, 640 x 350 resolution.

B. Same as A, no parallel port, short card, and with Hercules emulation.

C. Printer port, monochrome graphics, runs Lotus 123/graphics, 132 x 44 column display.

D. Nonglare, 12" screen, 800 x 350 resolution.

E. 640 x 200 resolution, IBM quality.

F. 640 x 350, 640 x 200, EGA and CGA.

G. Game port, parallel port, 0-2MB memory, runs at 12 MHz, 2 serial ports (2nd optional)

H. Parallel port, real time clock/calendar, 2 serial ports (2nd optional).

I. Club 3000 No piggy back, 0-3 MB capacity, 64K/256K RAM chips.

J. Club 576 (for PC Portable) software, short card, 0-576K memory, supports 64K/256K DRAM.

K. Club 384 Serial port, parallel port, 0-384K memory, clock/calendar, game port and software.

L. 39 ms access time, auto head parking, linear voice coil activator, one year limited warranty, cables, AT sliding rail and software included.

M. 65 ms access time, boots from hard disk, Western Digital controller, manual, cables, hardware and software included. 20/30MB Seagate Hard Disk.

N. 20 or 60MB backup, menu driven software, backup 5MB per minute, image & file-by-file backup.



# BRIEF is "Recommended."

— Jerry Pournelle  
Byte Magazine, 12/86

*"If you need a general purpose PC programming editor,  
look no further."* Jerry Pournelle, Byte, 12/86.

- A high-level, readable Macro Programming Language - allows customization for programming languages . . . Complete, unlimited variables, etc.
- Edit multiple files of unlimited size (2 Meg is OK)
- Multiple Windows on screen with different or same file, fragments, etc.
- A bona-fide UNDO stack (up to 300) of all operations; deletions, reading files, search, translate, more.
- Reconfigurable keyboard
- Full "regular expression search" - wild cards, complex patterns
- Adjustable line length - up to 512.
- Keystroke macros - for common typing sequences
- Suspend BRIEF to execute, *exit to DOS* - run another program (like a compiler, dir, XREF, DIFF, or DEBUG) then resume BRIEF session
- Compiler-specific support like auto indent, syntax check, compile with-in BRIEF

Only \$195  
Call 800-821-2492

**Solution  
Systems**

335-B Washington St.  
Norwell, MA 02061  
617-659-1571

Full Refund  
if not satisfied  
in 30 days.

### Survey Data

88% of survey respondents were more productive with BRIEF than other editors.  
50% were more productive with BRIEF than their previous editor in 5 hours or less.  
72% were performing all operations in 2 hours.

For PC, AT, & compatibles.

# A CROSSTALK<sup>®</sup> SuperKlone<sup>™</sup>



FEATURING  
Foreground/Background Communications

MIRROR<sup>™</sup> provides:

- Crosstalk XVI compatibility
- Background communications
- Built-in text editor
- Learn-mode for automatic script file generation
- Transaction log

AND MUCH MORE...

MIRROR<sup>™</sup>  
**\$69.95**

Site Licensing Available  
60-Day Money-back Guarantee  
Not Copy Protected

MIRROR is available for the IBM PC/XT/AT and compatibles running MS-DOS 2.0 or higher. MIRROR<sup>™</sup>, SuperKlone, KloneWare and SoftKlone are trademarks of SoftKlone Distributing Corporation. Crosstalk XVI and Microstuf are registered trademarks of Microstuf, Inc.



1210 E. Park Ave. • Tallahassee, FL 32301  
For information call 1-904-878-8564  
TLX: 6714280 KLON

The Age of KloneWare Has Arrived

Shipping/handling ..... 5.00  
(COD orders add \$3.00)  
International shipping/handling ..... 18.00  
Florida residents must add 5% sales tax



To Order Call **(904) 878-8564**

Distributed in Canada by:  
Saratoga Software Distributors  
Telephone: (416) 923-1500

Distributed in the UK by:  
Management Data Processing Ltd.  
Telephone: (0225) 60491  
Trisoll Ltd. Telephone: (0629) 3021

Distributed in Scandinavia by:  
UNC, (Norway)  
Telephone: 02 38 39 10

Distributed in Australia by:  
Delta Computer Systems Pty. Ltd.  
Telephone: (02) 633-4055  
P.C. Extras Pty. Ltd.  
Telephone: (02) 319-2155

I bought at my local paper wholesale house. (If you live in Los Angeles and aren't familiar with Kelly Self-Help Paper Company, you're spending too much money on paper.)

The color quality of the Okimate 20 is pretty good, too; better than you'd expect. It takes forever to do a color print, but for making charts and briefing aids this thing is more than good enough. I don't really have much call for color printouts, but back in my business presentation days, I would have paid a lot for the capability.

There's one real drawback to this machine. The ribbons are expensive. Okidata wants \$4.99, and according to the manual you'll get only about 75 pages from that. The color ribbons are worse: \$5.49 for about 15 color screen pictures—not quite as expensive as a Polaroid color print, but getting there. For that matter, black and white works out to seven cents a page for ribbons alone; add paper and you're up to a dime. Draft quality costs less, of course, but still, it's not all that cheap if you do much printing. These are the ribbon prices given on the order sheet Okidata sends with the machine. I'd suppose that you can find better prices from discount supply houses. Of course, by the nature of the thermal-transfer process you can use the ribbon only once.

On the other hand, if you have a source of thermal paper, you don't need ribbons at all. Moreover, the printer itself sells for \$268 not discounted, including one plug-and-print module. You can buy more modules if you want to use the Okimate with other machines. I intend to test it with a whole bunch of different computers; more next time. Meanwhile, I'm really rather fond of the little beast, but I sure hope I can find a cheaper source of ribbons.

### WordPerfect

I'm writing this with WordPerfect on Big Kat, the Kaypro 286i AT work-alike. A story goes with that.

A while ago I went up to Silicon Valley, and while there I dropped in to see Bill Godbout, chairman of Viasyn. We got to discussing machines, and it turned out my Golem, the big CompuPro boat-anchor machine that does yeoman service here, was pretty obsolete compared to what they're doing at CompuPro now. Not only that, but there's new stuff coming. I've always been a sort of test station for CompuPro's latest stuff. If I can't make it crash, my son Alex can; and if he can't, it's probably pretty bulletproof.

Consequently, when I drove up to Octocon—a science fiction convention held in Santa Rosa, alas, too infrequently, since it's nearly every writer's favorite

*continued*



**Borland's Turbo Lightning FREE**

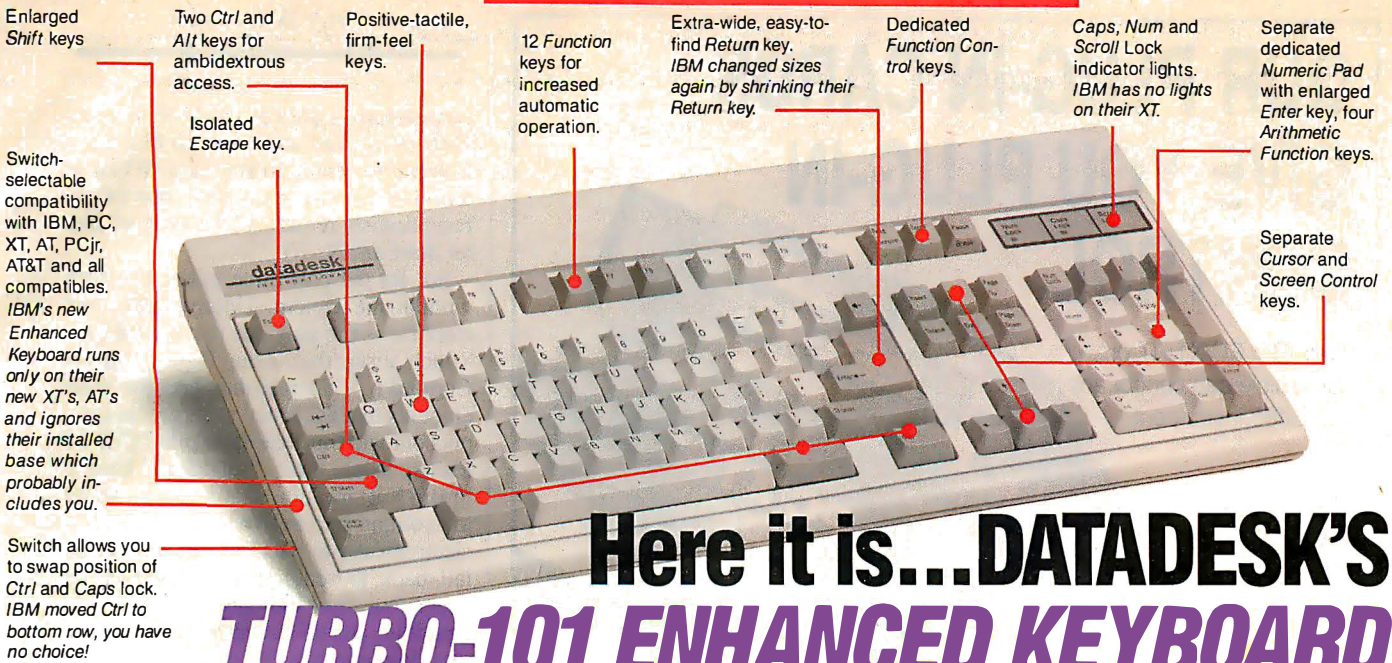

# Here it is...DATADESK'S TURBO-101 ENHANCED KEYBOARD for the 10 million PC users IBM just ignored!

IBM just announced their new redesigned "standard" keyboard for personal computers. There's only one problem: it won't work on your IBM computer if it was purchased prior to June 1986 or on any PC compatible purchased at any time!

Not to worry. Our new Turbo-101 Enhanced Keyboard gives you the layout and enhancements of the IBM with some logical improvements (see above photo). And it works on your existing PC, XT, AT, PCjr, AT&T, Epson and virtually all compatibles!

### Get Borland's Turbo Lightning™ For FREE!

To really turbocharge your productivity, we are including, free-of-charge, Borland's red-hot Turbo Lightning software with each keyboard. Now, when using SideKick, WordPerfect, Microsoft Word, 1-2-3 or most popular programs, our Turbo-101 Keyboard will check your spelling as you type, gives you instant access to Random House's 80,000-word Concise Dictionary and 60,000-word Thesaurus and much, much more!

"Lightning's good enough to make programmers and users cheer, executives of other software companies weep," says Jim Seymour of PC Week. Sold separately, Turbo Lightning retails for \$99.95!

The Only Alternative  
**datadesk**  
INTERNATIONAL

7650 Haskell Avenue  
Van Nuys, California 91406 (818) 780-1673

Turbo-101 is a trademark of DataDesk International. Turbo Lightning is a trademark of Borland International. IBM and IBM AT are registered trademarks of International Business Machines, Inc.

Inquiry 81 for End-Users.  
Inquiry 82 for DEALERS ONLY.

### The Turbo-101 is the best data entry tool since the pencil!

For users of spreadsheets like 1-2-3, the Turbo-101's separate cursor controls and numeric keypad makes entering numeric data into cells and moving from cell to cell as natural as moving your fingers. And for word-processing, the 'Selectric' typewriter layout makes the Turbo-101 as easy to use as a pencil; and with the extra large Enter, Shift & Control Keys, you'll make so few mistakes, you won't even need an eraser!

### SPECIAL OFFER!

ONLY \$149.95\* FOR BOTH  
KEYBOARD & SOFTWARE

Includes 30-day money back  
guarantee and 2 year full warranty.

To prove that we don't ignore you or your pocketbook, you get our Turbo-101 Enhanced Keyboard and Borland's Turbo Lightning for an astounding \$149.95.\* No, you didn't read it wrong. During this amazing **Introductory Offer** you get both keyboard and software for less than most software programs by themselves! Now, if you're still feeling ignored, you can always do what you-know-who wants you to do...and buy a new computer to get their keyboard!

credit card orders call  
**(800) 826-5398**  
in CA call  
(800) 592-9602

\*Price does not include adaptor cables required by certain compatibles \* A Limited offer—price subject to change without notification.



Up to now, DataDesk International may be one of the best kept secrets, but here's what's being said about our first end-user Keyboard/Borland software bundle:

"Who Can Pass Up a Deal? Department. Talk about an aggressive product!"  
John C. Dvorak,  
InfoWorld Mar 86

"It solves all of the problems exhibited by their regular PC/XT keyboard...it's a great bargain!"  
PC Productivity Digest  
May 86

"DataDesk Intl. has designed a sturdy and handsome keyboard that has tactile response...is the hardware bargain of the year" says Charles Humble, Oregonian Jan 86

"The best part of the keyboard is the way it feels. It's ideal! And fast. I've never worked on a keyboard with a nicer touch."  
Business Computer Digest  
Aug 86

"It's a good keyboard. Good feel: the keys have tactile feedback. No mush at all. This is about as good a keyboard deal as you're likely to find...I have absolutely no hesitation in recommending the Model PC8700."  
Jerry Pournelle,  
Byte Magazine Sept. 86

"This keyboard is neat to type on and feels solid. It has tactile feedback keys...I can type much faster on it."  
Test Drive Scorecard:  
DataDesk-10 Key Tronics-9  
Teleconnect Magazine  
May 86

BOTH TURBO-101 ENHANCED™  
KEYBOARD AND BORLAND'S TURBO  
LIGHTNING™ SOFTWARE FOR ONLY:

**\$149.95\*** LIMITED  
OFFER

\*Plus \$10 Shipping & Handling.  
California Residents  
Add \$9.75 Per Unit Sales Tax

NO. UNITS: \_\_\_\_\_  
PAYMENT:  VISA  MC  CHECK  
AMOUNT ENCLOSED: \$ \_\_\_\_\_

**Enter** ←  
NAME: \_\_\_\_\_  
ADDRESS: \_\_\_\_\_  
CITY: \_\_\_\_\_  
PHONE: \_\_\_\_\_  
CC NO.: \_\_\_\_\_

STATE: \_\_\_\_\_ ZIP: \_\_\_\_\_  
COMPUTER TYPE: \_\_\_\_\_  
EXP: \_\_\_\_\_



# OUR PLUG-IN CARDS GIVE YOU PLUG-IN CONTROL.

Your IBM PC/XT/AT or compatible can control any IEEE-488 instrument.

You can:

- Plug-in to BASIC, C, FORTRAN, or Pascal.
- Use HP-IB plotters, printers, and instruments.
- Spend less time programming.
- Call (617) 273-1818 and put us to the test.

Complete hardware and software solutions for just \$395.



Capital Equipment Corp.  
99 South Bedford Street  
Burlington, MA. 01803



## CHAOS MANOR

convention—I packed the Golem in the back of my car and dropped him off at CompuPro central in Hayward. When we wheeled him in on a cart, one of the receptionists remarked, “Maybe we better start an IV. . .”

So: for the past three weeks I’ve been without the Golem. Unfortunately, that machine is the only one that can take the 8-inch disks that Zeke II—my *ancient* CompuPro Z80 who has become what amounts to a dedicated word processor—puts out and translate them into PC-DOS format. Alas, the only modem I have is in Big Kat: meaning that unless I can get my column into PC-DOS, I can’t send it electronically to BYTE. I suppose I could fall back to sending the column in on paper, but then someone would have to type it in, and no one really and truly enjoys doing things like that.

The bottom line was that I had to write this column, and some other stuff that had to be turned in electronically, on Big Kat. That’s all right because I’ve been meaning to test out some text editors, and there’s no better test than to *use* the darned things for practical work.

I’d heard a lot of good things about WordPerfect, so I decided to start with it.

First thing was to install it. That turned out to be harder than I’d thought. The WP documents are a bit confusing. Actually, they’re a *lot* confusing. One problem is that there’s this little errata sheet inserted into the package, but it’s not easy to find, and it corrects a serious omission in the very first thing you do, namely, install your printer. The instruction book looks to be very complete, and it shows you what you should do and what you should see—but when you do that, you don’t see what the book shows, because the book omits to say you have to do a “page down” to get the screen pictured in the manual. The errata sheet corrects that, but I didn’t find the errata sheet in time; as a consequence, I ceased to trust the installation book.

There were some other misunderstandings: what I was doing didn’t seem to be what the book said would happen. Eventually I called WordPerfect Corporation (formerly SSI), WP’s publisher. They have an 800 number, but that was busy, so I called the pay number. That turned out to be a mistake: no one I could get on that phone knew anything about my problem. You *have* to use the 800 number and talk to the “technicians.” You’d better be determined if you’re going to do that.

It’s OK: I have the new Zenith Zoom modem, and that has a built-in demon dialer that will keep calling until it gets an answer. That got me past the busy signal. Even then, of course, I got a

*continued*

Bus Specific Networks

# IN HALF A SLOT

Interconnect Novell, Vianet, TurboDOS, and other ARCnet networks with our new half-size LANPC card.

Only from InterContinental Microsystems, now in a new half-slot size card, you can convert hard-working PCs to even harder-working LAN Intelligent Workstations, Diskless Workstations and File Processors. You get IBM PC bus-standard compliance, built-in complete controller for ARCnet modified token passing networks. And you can have a fiber-optic option. All with FCC approval. So you can have ARCnet capabilities in less space than ever before—in only half a PC slot. Just imagine the things you can do with the other half.

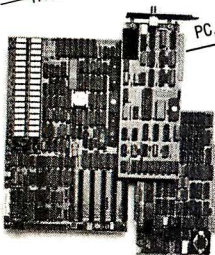

PC, ARCNET, AND S-100 APPLICATIONS.



**ICM**

TOMORROW'S BREAKTHROUGHS TODAY

InterContinental Microsystems  
4015 Leaverton Ct., Anaheim, CA 92807  
Phone: (714) 630-0964  
Telex: 821375 SUPPORT UD  
Easylink 62562040 BBS (714) 632-8750



# GET SERIOUS



**...ABOUT ANALYZING YOUR DATA.** You might be spreading your spreadsheet a little too thin. Or maybe you're starting from scratch. But if you're serious about data analysis, you're ready for SPSS/PC+™ – a full software family that brings you six high-powered ways to complete any data analysis task.

*Enter it.* SPSS/PC+ Data Entry™ takes the effort out of entering and correcting data.

*Analyze it.* The SPSS/PC+ Base Package provides a powerful array of statistical and reporting procedures.

*Examine it.* SPSS/PC+ Advanced Statistics™ lets you get more serious with your data.

*Table it.* SPSS/PC+ Tables™ produces presentation-ready tables instantly.

*Chart it.* SPSS/PC+ Graphics™ featuring Microsoft® Chart creates show-stopping graphs and charts.

*Map it.* SPSS/PC+ Mapping™ featuring MAP-MASTER™ – our latest option – creates maps where vast amounts of data can be summarized and presented in one, simple picture.

SPSS/PC+ products are being put to productive use by serious fact finders in business, government and education. For countless purposes such as market research. Wage and salary studies. Survey analysis. And quality control. Plus each product is superbly documented and supported by SPSS Inc., a leader in statistical software for nearly 20 years.

So if you're serious about data analysis, step up to SPSS/PC+. For details, contact our Marketing Department.

**CALL 1/312/329-3630**

**SPSS inc.**

SPSS Inc. • 444 North Michigan Avenue, Suite 3000 • Chicago, Illinois 60611

In Europe: SPSS Europe BV. • P.O. Box 115 • 4200 AC Gorinchem, The Netherlands • Telephone: +31183036711 • TWX: 21019

SPSS/PC+ runs on IBM PC/XT/AT's with hard disk. Contact SPSS Inc. for compatible microcomputers. SPSS/PC+, SPSS/PC+ Data Entry, SPSS/PC+ Advanced Statistics, SPSS/PC+ Tables, SPSS/PC+ Graphics and SPSS/PC+ Mapping are trademarks of SPSS Inc. for its proprietary computer software. Chart and Microsoft are trademarks of Microsoft Corporation. MAP-MASTER is a trademark of Decision Resources.



NEW

TOPS IN ITS CLASS.  
PROVIDES A NEW LEVEL  
OF CONVENIENCE FOR  
MS-DOS USERS.

InfoWorld

# Point. Shoot. Take Command.

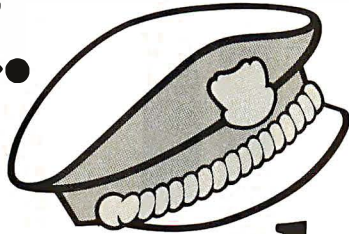

Rip full throttle through your data with this time-saving control program from Peter Norton. The Norton Commander™ software gives you a fast, powerful *point and shoot* method to perform your computer operations. Point to a directory and The Commander jumps to it. Point to your data file and The Commander runs your data with its matching program. Speed through listings, update files like lightning. Delete. Copy.

Built-in sweep functions manage your disk. Add your own user menus for one-key operation. *And it doesn't eat up your screen while it's doing it.* Easy to use with keyboard or mouse. The Norton Commander. The quickest way to enhance your PC, and *take command.*

The Norton Commander. Designed for the IBM® PC, PC-AT, and DOS compatibles. At your software dealer or order direct for \$75\* from Peter Norton Computing, Inc., 2210 Wilshire Boulevard, #186, Santa Monica, CA 90403. 213-453-2361. Visa and Mastercard welcome.

\*Subject to shipping and handling charges.

## THE NORTON COMMANDER™



THE QUICK AND EASY  
HARD DISK MANAGER

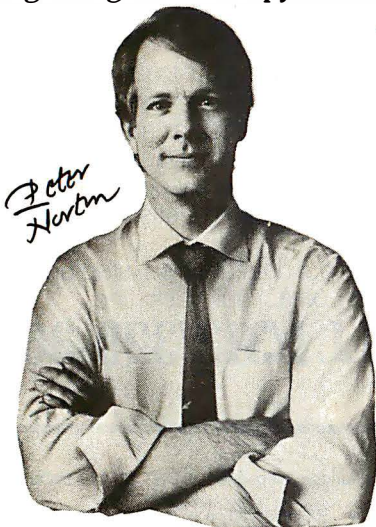

The Norton Commander™ is a trademark of Peter Norton Computing, Inc. © 1986 Peter Norton Computing. IBM® is a registered trademark of International Business Machines Corporation.

recording, but after about four minutes on hold I had a technician, who was able to take care of my original problems, largely by referring me to the errata sheet. Then I asked how to read in an ASCII file.

She didn't know what an ASCII file was.

Time to read the manual, so I did, to discover that WordPerfect's index is *awful*, and the table of contents no better; but if you are determined, you can find out that WP calls an ASCII file a "text file," and it does—more or less—have a way to read one in. Once you've read it in you need to remove the "hard carriage return" from the end of each line. First, of course, you have to see what *is* at the end of each line, and what WP *calls* that: WordPerfect doesn't use any kind of standard terminology.

Worse, when WordPerfect reads in an ASCII file, it reads a carriage return/line-feed pair as carriage return plus a *space*, meaning that paragraphs separated by two CRs are now separated by CR space CR, meaning that if you're trying to write a search-and-replace macro to convert your ASCII file into a WP file, you'll play the very devil doing it until you discover that.

Eventually I managed. That is: I told WP to search my file (it came off BIX) for "CR space CR" (actually, I told it to search for "[HRt] space [HRt]" since WP thinks a standard ASCII CR is a "hard carriage return," i.e., "[HRt]"). Each time WP found that, it was to substitute the English word PARA; I then went through and told it to change *all* CRs to spaces; and then change all instances of the word PARA to two CRs. The result was a file with the ends of paragraphs marked by CRs and the ends of lines marked not at all. That is a standard WP file, and now I could edit my BIX file.

I was also rather piqued with WP.

However, after that I found WP rather easy to use. It has a number of my favorite features, such as reformatting on the fly when you insert and delete text. Alas, it doesn't do it quite the way WRITE, the CP/M editor I use on Zeke, does it. WRITE simply reformats; WP shoves the right end of the line off the screen and won't reformat the paragraph until the cursor leaves the line you're working on. Ah well, that's sort of good enough.

I thought at first that WP didn't have "delete next word," but that turns out to be another document defect; in fact, Control-Backspace does that nicely, if the cursor is at the beginning of or inside the word. That takes a bit of getting used to, but surely no more than WordStar's Control-T, which does the same thing. WRITE's "delete next word" is more convenient in that it also takes out interven-

*continued*



**Limited time offer!**  
Trade up to TAS-Books and save \$10!

# TAS-Books VS. Dac-Easy



	DAC	TAS-Books
Full price including Payroll, G/L, A/R, A/P, Sales order/Invoicing/P/O/Inventory & Tutorial	\$159.75	<b>\$99</b>
Written using 4th generation language	NO	<b>YES</b>
Source code included/modifiable	NO	<b>YES</b>
Easy-to-change file structures	NO	<b>YES</b>
Report generator	NO	<b>YES</b>
Multi-user option available	NO	<b>YES</b>
On-line help messages	NO	<b>YES</b>
3-yrs. GL data by month	NO	<b>YES</b>
Create mail/merge files	NO	<b>YES</b>

**Feature for feature, dollar for dollar, TAS-Books wins, hands down!**

### TAS-Books gives you more for your money.

Before you buy DAC Easy accounting software (or if you already have), you should know what you could have instead.

You could have software that changes — easily — to fit your accounting system, instead of the other way around. You could have a program that includes payroll and a full-featured data base at no extra charge.

If you've already bought Dac-Easy, you can still trade up to TAS-Books, and get an additional \$10 off the price!

### TAS-Books adapts to fit your business.

Accounting systems are not all alike. That's why TAS-Books is written using the popular TAS-Plus 4th generation language/relational data base, with source code included. So you can easily customize TAS-Books to fit your business.

### TAS-Books does so much, so easily.

TAS-Books gives you full audit trails and integrated modules, with sales and purchase histories updated automatically. You can review up to 3 years of GL data by month. Plus all the usual accounting functions. And you get a tutorial, and on-line help messages in each field.

### Here's what TAS-Books offers you:

- General Ledger**
  - 3 years of data by month
  - Full audit trails
  - Post to previous periods and reclose
  - Budgeting by month
  - Flexible financial statement setup/printing
- Accounts Receivable**
  - Open item
  - Mailing labels and rolodex cards
  - Detailed history of sales, costs, and net
  - Statements
  - Ageings
- Accounts Payable**
  - Easy to enter invoices/vouchers
  - Enter checks written by hand and/or print out checks automatically
  - Mailing labels and rolodex cards
  - History of purchases
- Payroll**
  - Easy to run
  - Produces all necessary information
  - Prints W-2 forms
  - Allows for employee reimbursement without tax
- Inventory**
  - Averages cost and records last cost
  - Adjusts physical quantity
  - Uses fractional quantity
  - Keeps track of non-inventoried items
  - History of sales, cost, and net
  - Adjust cost
  - Each item can have its own SALES and COGS GL account
- Invoicing/sales order**
  - 99 items per order
  - Description lines added easily
  - Credits may be mixed on same order
  - Discount for any line
  - Ship to may be loaded from customer file
- Purchase order**
  - 99 items per order
  - Description lines added easily
  - Credits may be mixed on same order
  - Discount for any line
  - May order non-inventoried items
- Plus many reports and other features too numerous to mention!**

### Full-featured database gives you real versatility.

No need to buy an expensive data base to interface with TAS-Books: it's included at no extra charge! So you can easily generate customized reports and create mail-merge files. No need to preallocate files. TAS-Plus does all the hard work for you! And if you're already using DAC Easy, TAS-Books will translate your current files.

**Order today 1-800-648-6258.**

Call our Toll-Free Hotline. Use your VISA, MasterCard or American Express to order today. For information or Washington residents call 1-206-644-2015.

TAS-Books is available for the IBM PC/XT/AT and fully compatible computers.

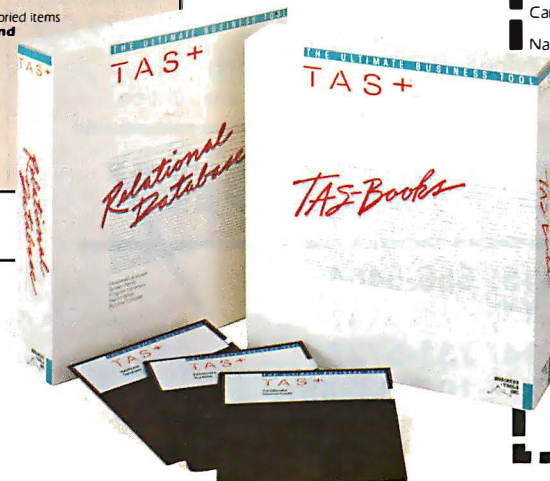

## Money-back guarantee!

Try TAS-Books for 30 days. If it's not exactly what you've been looking for in accounting software, just send it back. You'll get a full refund (less \$15 handling fee).

## TAS+™

NOT COPY-PROTECTED

### Trade up to TAS-Books.

Send us the title page from your Dac-Easy manual. We'll send you TAS-Books at an additional \$10 off its money-saving price. Limit one discount copy per customer. Offer ends March 31, 1987.

**YES!** I want powerful, user-friendly accounting software, with easy-to-customize coding and its own full-featured data base. And I want to save money over programs that offer me a lot less. Rush me TAS-Books now!

Quantity _____	Subtotal _____
_____ @ \$99 ea.	_____
Shipping: \$8 U.S., \$25 outside U.S.A.	_____
Trading in DAC? Subtract \$30!	_____
WA residents add 8.1% sales tax.	_____
TOTAL _____	_____
(U.S. funds only)	_____
Name: _____	_____
Shipping address: _____	_____
City: _____	_____
State: _____ Zip: _____	_____
Telephone: _____	_____
Payment (circle one): VISA MC AMX Check	_____
Credit Card Expiration Date: _____	_____
Card Number: _____	_____
Name on Card: _____	_____

**BUSINESS TOOLS INC.**



4038-B 128th Ave. S.E.  
Suite 266  
Bellevue, Washington 98006  
(206) 644-2015



The following are registered trademarks of these companies: TAS-Plus, The Accounting Solution, TAS-Books, Business Tools, Inc., IBM PC/XT/AT, International Business Machines Corp., Dac-Easy, Dac Software, Inc.

© 1986 Business Tools, Inc.



# LAP TOP PC

**\$999**  
(LTD.  
QUANTITY)



512K MEMORY  
FLOPPY CONTROLLER  
DISK DRIVE, SERIAL  
PORT, PARALLEL  
PORT, RUNS DOS,  
LOTUS, WORDSTAR  
AND MORE.

## TOSHIBA LAP TOP 1100 PLUS \$1599

Turbo XT Clone 8/4.77 MHZ Switchable 64K Memory Expandable to 640K Power Supply, Keyboard, FDC, 360KB Disk Drive Chassis, Fully Tested.

**\$399** (Qty. 3 Minimum)

**AT CLONE 6/12 MHZ** Switchable Clock 1 MB Memory, Atronics Motherboard, Power Supply, Keyboard, Chassis, Fully Tested.

**\$1299**

**AT CLONE 6/10 MHZ** Switchable.

**\$999**

## SPECIAL OF THE MONTH

2400 BAUD MODEM .....	<b>\$179</b> Qty.
1200 BAUD MODEM .....	<b>\$ 85</b> Qty.

AT Controller Hard & Floppy .....	<b>\$145.</b> Qty.
XT Hard Disk Controller .....	<b>\$ 69.</b> Qty.
Power Supply XT .....	<b>\$ 46.</b> Qty.
Power Supply AT .....	<b>\$ 89.</b> Qty.
EGA Card .....	<b>\$199.</b> Qty.
Printer Cables .....	<b>\$3.99</b> Qty.
Hard Disk Cables .....	<b>\$2.99</b> Qty.
256K RAM's (120 NS) .....	<b>\$2.50</b> Qty.
64K RAM's (120 NS) .....	<b>\$ .79</b> Qty.

All of above prices are C.O.D. cash only.  
Prices and availability subject to change without notice.

# CLONE FACTORY

(415) 656-5404  
(213) 477-0447  
(714) 731-5727  
TWX: 5106003265

ing spaces and puts the word after the one deleted where you have the cursor; much easier editing that way. Oh, well.

They aren't everything I want, but in fact WordPerfect has a lot of the features I want in a text editor, and a built-in macro generator capability that would let you build more. It has one other good feature: there isn't much on the screen that I didn't put there. True, there's a kind of status line at the bottom that I don't seem to be able to get rid of, but it's not very obtrusive. (And, of course, I have my Perma Power Color Commander, which can change colors of stuff on-screen; if the status line bothers me enough, I can turn it off by changing the status line display color to the background color.)

The bottom line is that I've tried three other famous IBM PC text editors, and I've come back to WordPerfect to write this column; and I have to admit that while it's not WRITE, I could, without a great deal of trouble, use this thing to write books with. It's good enough, and maybe more than good enough.

There are some serious problems, though. First, WP uses hidden codes to format text. There's a command that lets you "reveal" those codes, provided that you can read them; but I for one would greatly prefer the WordStar variety of "dot" commands, so that you can see the darned things. I'd far rather, for instance, do .ce3 to tell the program to center the next three lines, than do Shift-F6, type text, and do that again, and again.

On the other hand, WP is a WYSIWYG (what you see is what you get) editor and attempts to show you on screen exactly what you will get when you print. It apes a sheet of paper rather well, and for people who have no experience in using word processors and computers, it may well be easier to learn than something like WordStar or WRITE. Naturally, dot commands would mess up the WYSIWYG feature, since they take up space on the screen but won't print on paper.

Whether or not you'll like WordPerfect depends in part on how much time you want to spend learning about an editor. WP has a "learn" program. I confess I didn't go through it; the tutorial would have taken all day. Of course, if you're only starting to write with computers, taking all day for a tutorial is a good idea.

Another problem with WordPerfect is the sheer number of commands available. Every function key does *four* different things, depending on whether you press the function key, Alt+function key, Shift+function key, or Control+function key. There's a little template WP provides and heaven help you if you ever lose it. They've tried to do some logical group-

*continued*



# Aztec C ... The Best C

## Frees the genius in you

You've got a great idea . . .  
 . . . you're ready to write your programs.

You don't want to be sidetracked by all the paperwork. With Manx Aztec C and the ingenious **make** function, your creative processes won't get bogged down in program administration and housekeeping. Manx Aztec C has the most sophisticated, hardworking program administrator available to you. Once you've described your project, adding new features or enhancements is simple. You never have to concern yourself with the repetitive, tedious task of rebuilding your systems.

The development process moves quickly. Compiles, assemblies, link edits . . . all finish in record time.

Manx Aztec C is the fastest, most efficient C development system in the industry. Benchmarks show it . . . reviews commend it . . . users praise it.

You're ready to test the program. You're ahead of schedule. The Manx Aztec C Source Level Debugger shows you the exact C language statement giving you a problem. You fix the problem quickly . . . you're still ahead of schedule.

You've got some time for fine tuning. The Manx Aztec C Profiler examines your program, tells you where the slow spots are and validates your test procedure. A few changes and it's exactly what you wanted.

You've made it!

**Aztec C is available for MS-DOS/PC DOS. Call for details on Macintosh, Amiga, Apple II, CP/M-80, CP/M-86, TRS-80, ROM and others.**

To order, or, for information

**Call Today**

**1-800-221-0440**

In NJ or outside the USA call  
 (201) 542-2121

30-day satisfaction guarantee. Special Discounts are available to professors, students, independent developers, and on a "trade-in" basis. Site licenses.

**MANX**

Manx Software Systems  
 One Industrial Way  
 Eatontown, NJ 07724

" . . . a superb linker, a profiler, an assembler, and a set of development utilities are only the beginning of this package . . . performed admirably on the benchmarks, with short compile times and the best link times in this review . . . includes the most professional make utility . . . documentation is clear and complete. There is no doubt that this is a valuable and powerful programming environment." **Computer Languages Feb. '86**

" . . . execution times are very good, close to the best on most tests . . ." **PC Tech Journal Jan. '86**

" Easily one of the fastest compilers overall . . . library provides a lot of flexibility . . . generates small .EXE files." **Dr. Dobbs Journal Aug. '85**

<b>C'Prime (Compiler, Assembler, Linker)</b>	<b>\$ 99.</b>
<b>Aztec C 86-d Developer's System</b>	<b>\$299.</b>
<b>Aztec C 86-c Commercial System</b>	<b>\$499.</b>
<b>PC ROM (8086, 68000, 8080, or 6502)</b>	<b>\$750.</b>

Third Party Software for Aztec C: HALO, PHACT, C-tree, PRE-C, Windows for C, PC-lint, PANEL, Greenleaf, db Vista, C-terp, Plink-86, FirsTime, C Util Lib, and others.

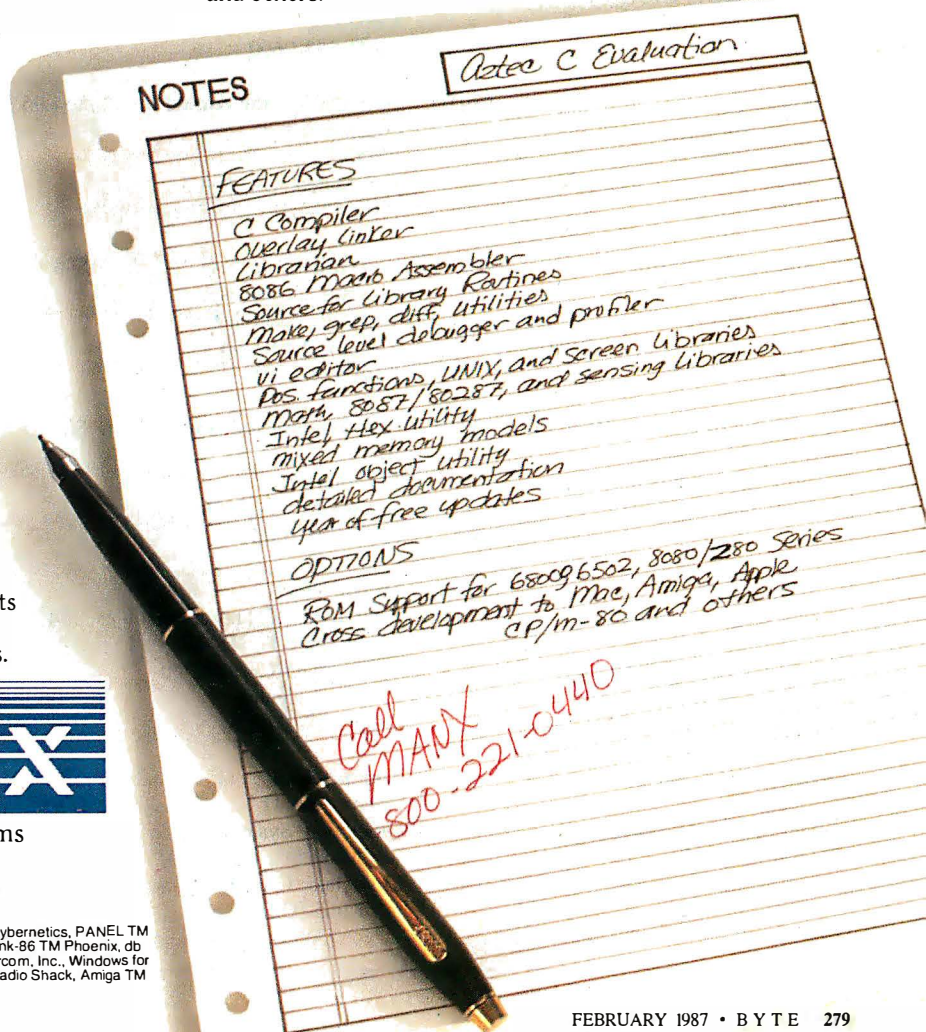

MS is a registered TM of Microsoft, Inc., CP/M TM DRI, HALO TM Media Cybernetics, PANEL TM Roundhill Computer Systems, Ltd., PHACT TM PHACT Assoc., PRE-C, Plink-86 TM Phoenix, db Vista TM Raima Corp., C-terp, PC-lint, TM Gimpel Software, C-tree TM Faircom, Inc., Windows for C TM Creative Solutions, Apple II, Macintosh TM Apple, Inc., TRS-80 TM Radio Shack, Amiga TM Commodore Int'l.



ing, but it hasn't always worked: the F3 key does "help," "reveal codes," "switch" (to another document; you can work on two at a time with WP), and "screen," which does a bunch of things, including changing screen colors.

This wouldn't be so bad if the WP documents were well organized, but in fact they're wretched. They're divided into a number of sections, and the index, which is rather poor, doesn't make it anything like clear which reference in which section you ought to look at to find out what a command does.

On the other hand, the on-screen help capability is as good as anything I've seen except maybe for EMACS, and indeed WP seems to have borrowed some of its help notions from that programmer's delight. It has one of the nicest spelling checkers I have ever seen; you don't need any instructions to use it. Alas, it seems to put all your additions into one update

dictionary, which is going to make it hard for me to use since my novels have alien character names and other stuff that I sure don't need to be in my main dictionary; but it may also be that I simply haven't plowed through the formidable WP documents at sufficient length.

Oof: I just looked at the Spell document and discovered that there seems to be no special dictionary; and it takes about 20 minutes to eliminate words from the dictionary once added. (Not 20 minutes a word, but 20 minutes no matter how many words.) This is not the world's nicest feature.

WordPerfect also has a thesaurus. I can't tell how complete it is, but in trying things at random, I was more than satisfied with it. Neither the thesaurus nor the spelling checker can compete with Word Finder's stuff, but then nothing does, and you can always use Word Finder with WordPerfect provided you've got a

fast machine and lots of memory.

WordPerfect has lots of special features like merge and footnotes, none of which I know how to use yet because I haven't needed them; but it's nice to know they're in there, and, given patience to fight my way through the instructions, I make no doubt I'll figure out how to do the job when I have to. Incidentally, I'm not being sarcastic when I say that: the documents are complete, just badly organized; and the technician may not have known what an ASCII file was, but she sure knew WordPerfect. If you've enough patience to get to the company's help service, you'll get help.

On balance, I like WordPerfect better than most other text editors I've tried for the PC. I'm using it, and I'll probably go on using it for a while.

### Q&A

When I was last in Silicon Valley, Barbara Clifford and I visited Symantec, which is the company that publishes Q&A. Symantec is run by Gordon Eubanks, one of the old-line hackers from the early days of this industry. Gordon wrote CBASIC, which is still one of the better languages to use. Now he's big business with dozens of employees.

Q&A is an integrated word processor and database program that comes with a file manager and a program you might call "artificially intelligent" called the Intelligent Assistant. I was impressed with Q&A when it first came out. I'm even more impressed with the new version, which has a spelling checker that works as nicely as WordPerfect's and lets you incorporate special dictionaries.

The word processor in Q&A is modeled to a great extent on PFS:Write and somewhat on the IBM Displaywriter. This makes it easy to learn for those who already know those programs and confusing for the rest of us. However, it's no harder to learn than any other, and of course there's a tutorial.

I don't mean to put down the Q&A editor. It has a lot of good features, most more oriented toward business use than text creation; and it's probably good enough that if I were used to it I'd be able to write books with it, and as a matter of fact there's a very strong probability that in future I'll do precisely that. However, the editor isn't really Q&A's strongest feature.

Where Q&A shines is the database management. This program makes it child's play to design a database, and if after you've used the database for a while you discover you didn't have enough categories and need a lot of modifications, that's easy with Q&A, too. And once

*continued*

## Items Discussed

<b>DevpacST</b> .....\$79.95 Apex Resources 17 St. Marys Court Brookline, MA 02146 (617) 876-2505	<b>Q&amp;A</b> .....\$349 Symantec 10201 Torre Ave. Cupertino, CA 95014 (408) 253-9600
<b>Flash</b> .....\$39.95 Antic Software 524 Second St. San Francisco, CA 94107 (415) 957-0886	<b>Star Fleet I for Amiga</b> .....\$54.95 Electronic Arts 2755 Campus Dr. San Mateo, CA 94403 (415) 571-7171
<b>Fontasy version 2</b> .....\$69.95 Prosoft 7248 Bellaire Ave., P.O. Box 560 North Hollywood, CA 91603 (800) 824-7888	<b>StarGlider</b> .....\$44.95 Firebird Licensees Inc. 74 North Central Ave. Ramsey, NJ 07446 (201) 444-5700
<b>FTL Modula-2 for IBM PC</b> ..\$49.95 Workman and Associates 1925 East Mountain St. Pasadena, CA 91104 (818) 791-7979	<b>Star Raiders for Atari ST</b> ...\$29.95 Atari P.O. Box 61657 Sunnyvale, CA 94089 (408) 745-2000
<b>Okimate 20</b> .....\$268 Okidata Corporation 532 Fellowship Rd. Mt. Laurel, NJ 08054 (800) 654-3282	<b>WordPerfect</b> for IBM PC and compatibles ..\$495 for Apple II, IIC, IIGS .....\$179 WordPerfect Corporation 266 West Center Orem, UT 84057
<b>Print Shop</b> .....\$44.95-\$59.95 Broderbund Software 17 Paul Dr. San Rafael, CA 94903 (415) 479-1170	<b>Zoomracks I</b> .....\$79.95 <b>Zoomracks II</b> .....\$119.95 Quickview Systems 146 Main St., Suite 404 Los Altos, CA 94022 (415) 965-0327



# Contemporary Electronics Series

## Trial Examination Order Form

YES! I'm interested in learning contemporary electronics and would like to examine the first module in the series. If I decide to keep it, I will pay just \$19.95 plus \$2.25 shipping and handling. I will then receive future modules automatically, one every 4 to 6 weeks. Each of the 15 modules in the series is \$19.95 plus \$2.25 shipping and handling and comes on the same 15-day Free Examination basis. There is no minimum number of modules that I must buy and I may cancel at any time simply by notifying you.

If I do not choose to keep the first module, I will return all materials in good condition and pay nothing. Future modules will be canceled and I will be under no further obligation.

Name \_\_\_\_\_

Please Print

Street \_\_\_\_\_

City/State/Zip \_\_\_\_\_

Phone Number (       ) \_\_\_\_\_

All orders subject to approval and payable in U.S. funds only. Available in U.S. and Canada only. **Add stamp and mail today!**

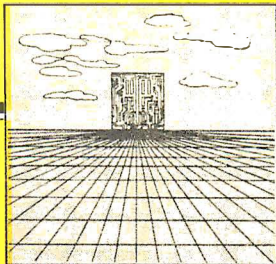

## Covers every subject of modern electronics

- Digital logic
- Digital gates (TTL, CMOS, MOS)
- Flip flops
- Counters and registers
- Op-amps and applications
- Combinational logic circuits (ROM, PLA, decoder)
- Amplifier fundamentals
- Transistors (bipolar and FET), diodes and thyristors
- Linear and digital integrated circuits
- Microprocessors
- Oscillators
- Optoelectronics
- Fiber optics
- Robotics

2080-027





Post Office  
Will Not  
Deliver Without  
First Class  
Stamp



**McGraw-Hill Continuing Education Center**

3939 Wisconsin Avenue

Washington, D.C. 20016-9265





MASTER THE NEW ELECTRONICS WITH MCGRAW-HILL'S

# Contemporary Electronics Series

The fast, easy and low cost way to meet the challenges of today's electronic innovations. A unique learning series that's as innovative as the circuitry it explains, as fascinating as the experiments you build and explore.

From digital logic to the latest 32-bit microprocessor, the McGraw-Hill Contemporary Electronics Series puts you into the electronic picture one easy step at a time. Fifteen unique Concept Modules, sent to you one every 4-6 weeks, give you a handle on subjects like optoelectronics, robotics, integrated circuits, lasers, fiber optics and more.

Each Concept Module goes right to the heart of the matter. You waste no time on extraneous material or outdated history. It's a fast, efficient, and lively learning experience... a non-traditional approach to the most modern of subject matter.

### Unique Interactive Instruction

With each module, you receive a McGraw-Hill Action Audio Cassette. Each tape is a dynamic discussion that drives home the key facts about the subject. Your learning

With your first module, you get this solderless breadboarding system. You'll use it throughout the series to build electronic circuits and bring concepts to life.

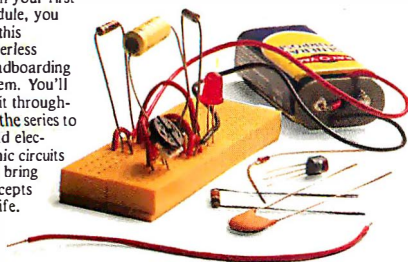

experience is reinforced through interaction with vividly illustrated text, audio cassettes, and actual electronic experiments. Indexed binders preserve backup material, notes, and tapes for convenient referral.

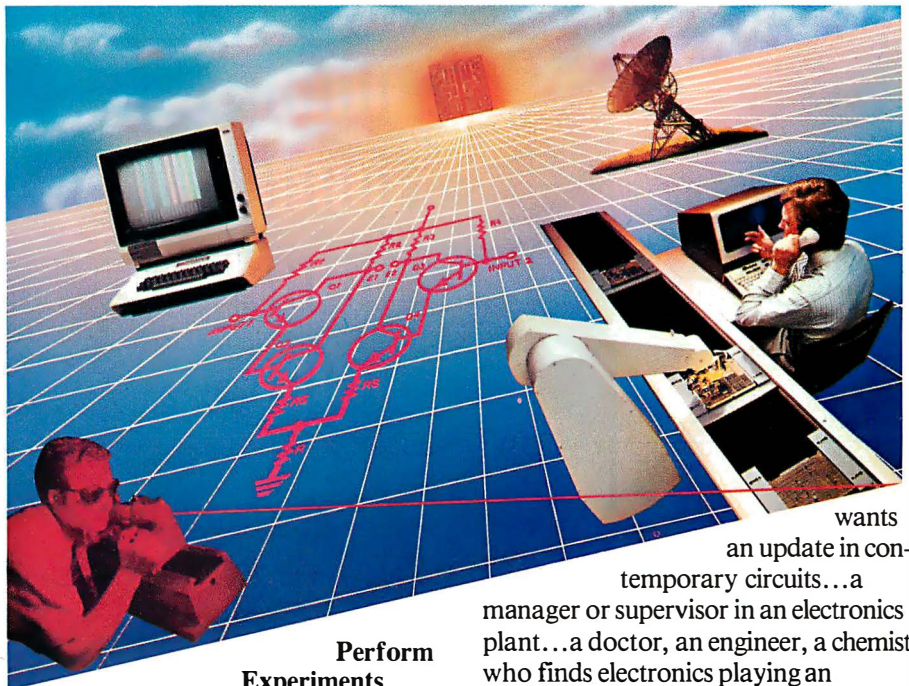

### Perform Experiments in Contemporary Electronics

Throughout your series, laboratory experiments reinforce every significant point. This essential experience

...dynamic, hands-on demonstrations of theory in practice... will help you master principles that apply all the way up to tomorrow's latest VLSI (Very Large Scale Integrated) circuitry.

In your very first module, you'll use integrated circuits to build a digital oscillator, verifying its operation with a light emitting diode (LED). You'll learn to identify passive and active components, understand concepts common to all electronic circuits.

### For Anyone Interested in Electronics

The Contemporary Electronics Series is designed for anyone from hobbyist to professional. It's for you if you're looking for new fields of interest... if you're a teacher who

wants an update in contemporary circuits... a manager or supervisor in an electronics plant... a doctor, an engineer, a chemist who finds electronics playing an increasingly important role in your work. It's even for electronics engineers or technicians who feel their training needs freshening up. It's the quickest, most convenient, probably least expensive way to do it. And the only one that gives you hands-on experience.



### 15-Day No-Risk Trial

To order your first module without risk, send the card today. Examine it for 15 days under the terms of the order form and see how the Contemporary Electronics Series gets you into today's electronics. If card has been used, write us for ordering information.



McGraw-Hill  
Continuing Education Center  
3939 Wisconsin Ave.  
Washington, D.C. 20016



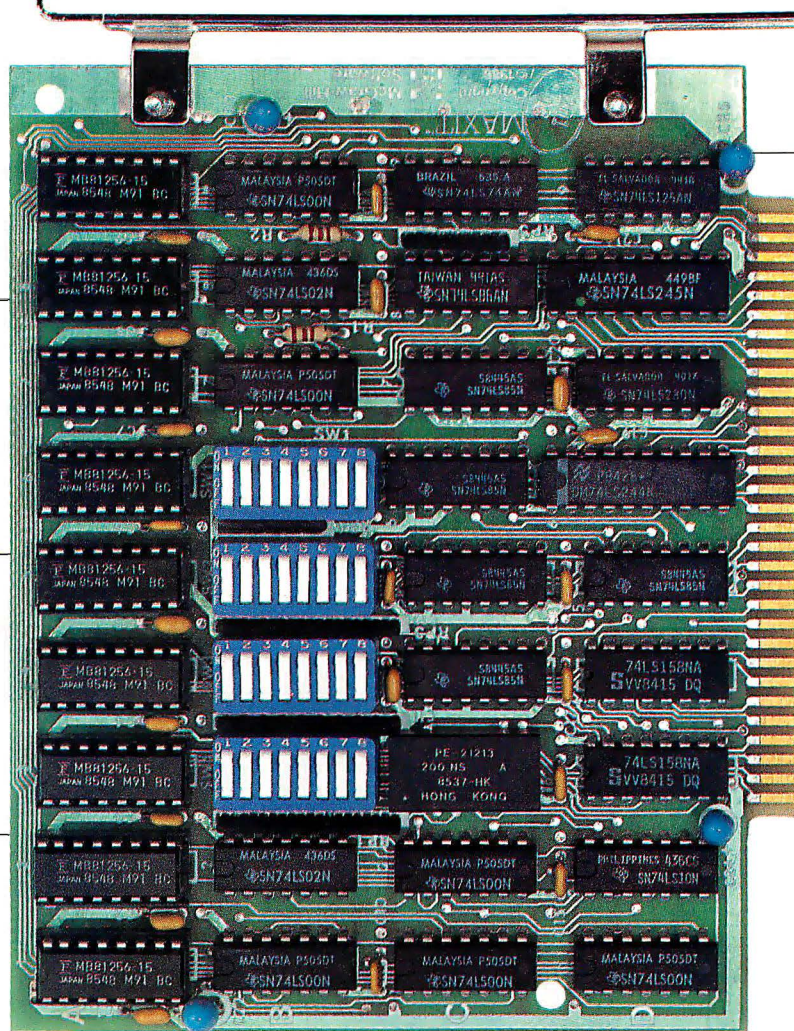

Add up to 96K above 640K to all programs, including PARADOX and 1-2-3.

Parity-checked 256K with a one-year warranty.

Run custom software or the 3270 PC Control Program above 640K.

Run resident programs like Sidekick above 640K.

Top off a 512K IBM AT's memory to 640K and add another 128K beyond that.

Short card works in the IBM PC, XT, AT, and compatibles.

Add expanded memory to programs supporting the Lotus/Intel/Microsoft specification 32.

## MAXIT™ memory works above 640K for only \$195.

### Break through the 640K barrier.

MAXIT increases your PC's available memory beyond 640K. And it does it for only \$195.

MAXIT includes a 256K half-size memory card that works above 640K. MAXIT will:

- Add up to 96K above 640K to all programs.
- Run memory resident programs above 640K.
- Top off an IBM AT's memory from 512K to 640K.
- Expand 1-2-3 Release 1A or 2.0 worksheet memory by up to 256K.
- Add expanded memory above 640K to programs like Symphony 1.1.

### Big gain — no pain.

Extend the productive life of your IBM PC, XT, AT or compatible. Build more complex spreadsheets and databases without upgrading your present software.

### Installation is a snap.

MAXIT works automatically. You don't have to learn a single new command.

If you have questions, our customer support people will answer them, fast. MAXIT is backed by a one-year warranty and a 30-day money-back guarantee.

### Order toll free 1-800-227-0900.

MAXIT is just \$195 plus \$4 shipping, and applicable state sales tax. Buy MAXIT today and solve your PC's memory crisis. Call Toll free 1-800-227-0900 (In California 800-772-2531).

We accept VISA, MC, AE, and DC.



**Osborne McGraw-Hill**

2600 Tenth Street, Berkeley, California 94710

Inquiry 195



you've entered your data, it's even simpler to generate special reports.

Indeed, Q&A incorporates notebook and telephone dialer features, so that it can replace much of SideKick.

I just got my latest edition of Q&A, so most of what I know of it comes from watching it demonstrated at Symantec headquarters. What I saw, though, makes me quite eager to get this installed: I intend once and for all to get all of the software and hardware in Chaos Manor entered into a database, and Q&A is the first one of those things I've seen that tempt me to use it.

More on Q&A in the next few months. Meanwhile, I already recommended the original, and the new version has significant improvements. One warning: Q&A eats memory like mad. (When I asked Gordon Eubanks if the new version of Q&A used less memory than the original, he said, "Well, it doesn't use any more...") If you buy Q&A you get a special offer for a 256K-byte memory board for only \$50; that's the best deal in town. You will need that memory. Provided that you have a full-up PC XT or AT, though, Q&A could well be the most valuable program you'll ever own for it.

**Short Shrift**

It's time for my traditional grab bag of programs I don't really have room to discuss but which shouldn't be ignored.

Broderbund's Print Shop series continues to produce a cornucopia of accessories and utilities to aid microcomputer owners in desktop publishing. So does Fontasy. Prosoft has sent me no fewer than nine volumes of ready-made logos, clip art, illustrations for advertisements, divertissements, and plain fun. Anyone involved in newsletters, whether for social, business, or organization purposes now has no excuse for dull and boring mailers. It's just too easy and cheap to make exciting fliers. All you need is a PC or clone, Epson printer or LaserJet, and some of these programs.

Paul Heckel was at Hackers 2.0, where he gave me a version of his Zoomracks for the Atari ST, which I had seen at an Atari Faire. Zoomracks isn't as fast as it might be on a PC (it's good enough on an AT), but it seems better on the Atari ST. The new version has some additional sort and organize features. It's not an expensive program, it's real easy to learn, and it's pretty useful. I'm having all my Atari ST program collection organized in Zoomracks files. Saves no end of searching for things.

The Zenith Z-181 continues to win favor. It was a sensation at Hackers 2.0. Actually it wasn't: everyone was impressed with the readability of the screen, and the fact

that you can have a portable that's a full PC-DOS machine, but most hackers aren't fond of PC-DOS in the first place. Those who do like PC-DOS were pretty excited about the Z-181, and indeed I've noticed I find Zebediah coming with me to more and more places. I've installed Word-Perfect, which works quite well. There's supposed to be a simple way to transfer files from Zeb to machines without 3 1/2-inch drives, but I confess I haven't done that yet. Real Soon Now. Meanwhile, if you want a full-function PC-DOS machine you can carry around with you;

if you've an urge to run MultiMate, WordStar, or Lotus 1-2-3 on trips; if you want a full database capability on the road; and your arms just aren't strong enough to lug around a Compaq, look into the Z-181. It's quite the most elegant laptop/portable I've ever worked with, and I suspect Zeb will become a permanent fixture here at Chaos Manor.

**Winding Down**

The game of the month is the Amiga version of Star Fleet I. I only regret that I've

*continued*

**When You're Looking for Answers, Come to the Library**

**10 MHz AT Compatible System**

**Complete Monographic System with Monitor and Display card**

- Mono Monitor
- Hercules compatible card
- 67% faster than IBM AT
- 8/10 MHz switchable
- 512KB memory
- W.D. HD floppy controller
- 1.2MB TEAC floppy drive
- Fully IBM compatible BIOS
- CMOS clock/calendar
- 200 watt power supply
- AT style keyboard
- Operation Manual
- Set up Utility Software
- SI Rating 10.3

Designed, Manufactured, and serviced in U.S.A.  
FCC Class 'B' approved  
One Year Limited Warranty

Free Starter's Kit:  
■ DOS 3.1  
■ 3 Diskettes  
■ Diskette case

**\$1375**

Runs Xenix™ Auto Cad Novell Network

**EGA System**  
with EGA monitor and EGA card  
**\$1875**

**Basic System**  
without Mono monitor and Video card  
**\$1129**



---

**8 MHz Turbo XT System**

- Fully IBM compatible
- 8088-2 8 MHz CPU
- 4.77 & 8 MHz keyboard selectable
- 360K floppy drive
- Floppy drive controller
- 256K memory expandable to 640K
- Option Math Co-processor
- 150W power supply
- Keyboard

FCC Class 'B' approved  
One Year Warranty

**\$475**



Monitor not included

**Seagate 20MB Subsystem**

- ST-225 Drive
- Controller
- Cable and hardware
- Software and Manual

20MB ST-4028 \$539  
30MB ST-4038 \$639  
40MB ST-4051 \$695  
80MB ST-4096 CALL

- Cable, rails
- Software and manual

**\$365**

---

**AT Multifunction**



**\$175**

- Up to 2MB memory
- Selectable memory addressing
- Serial/Parallel/ Game ports
- Software

**Everex Modem**



**\$128**

- Half-size
- 300/1200 BAUD
- Fully Hayes comp.
- BIT/COM communications software
- 2400 BAUD CALL

**EGA Card**



**\$228**

- Fully IBM EGA comp.
- Color/Mono display
- 16 colors from a palette of 64
- 640 x 350 high resolution graphics
- 256K Display memory

**Mini I/O Card**



**\$59**

- Parallel/Serial
- Clock/calendar
- Half-size card
- Cables
- With Game port \$68

**Wangtek 60MB Tape Backup**



**\$727 \$827**

- Backup 5MB in 1 minute
- Image/file by file
- Mounting hardware
- Software and Tape

**COMPUTER LIBRARY**

Sales (415) 659-8784  
Tech Support (415) 659-8849

5349 Randall Place  
Fremont, CA 94538

Quantity Discounts Available

**Others:**  
 ■ AT Multifunction \$175  
 ■ AT 3MB Memory Expansion card \$150  
 ■ AT HD/Floppy controller \$165  
 ■ PC Multifunction \$394  
 ■ Multifunction/Mono card \$139  
 ■ Expansion chassis \$428  
 ■ Floppy controller \$33  
 ■ DVEREX Edge \$229  
 ■ DOS 3.1 \$69  
 ■ 150 W power supply \$79  
 ■ Keyboard AT/XT \$75  
 ■ Mono/Color/EGA monitor CALL  
 ■ TEAC 20MB Tape backup \$580  
 ■ Hercules compatible \$98

Terms: We accept MasterCard, VISA (3% surcharge), COD's (Certified Funds) and Company/Institutional P.O.'s. California residents add 6.5% sales tax. For returns and repairs, call for RMA number. 15% restocking fee charged on unauthorized returns. Prices are subject to change without notice. BIT/COM, Hayes, Hercules, and IBM are registered trademarks of their respective companies.



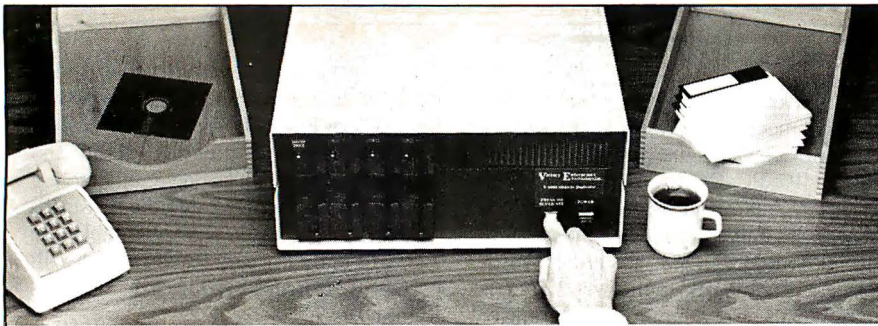

## Copying diskettes will never be easier than pushing one button.

While your computer is busy doing other things, your Victory Duplicator can be making as many as eight copies of a diskette at once—producing up to 400 copies in an hour. DualMaster™ models can even make multiple copies of two different diskettes simultaneously. Just insert the diskettes and press one button.

### Copy different formats, flawlessly.

An automatic format analysis program makes it possible for the Victory Duplicator to

copy virtually any 5¼, 3½ or 8-inch diskette. The system tests for quality and accuracy at every stage of the process.

### It practically services itself.

Each drive has a separate controller to maximize uptime. Simple diagnostics to verify drive alignment and industry standard drives allow you to maintain your system without waiting for outside service.

### All at an attractive price.

Victory Duplicators offer fast copying, serialization,

copy protection, a communications port, a four-month warranty and much more—all for one low price.

### Call 1-800-421-0103.

Call today for more information. (In Texas, call 512-450-0801.)



8910 Research Blvd., Suite B2  
Austin, Texas 78758

## Verbatim Datalife

Preserving your data is vitally important. Lose it and you've lost both time and money. That's why Verbatim Datalife Diskettes have 6 data-shielding improvements for greater disk durability and longer life. They come standard with a lifetime warranty that establishes the industry standard—it guarantees trouble-free recording, storage, and retrieval. And to help introduce you to the Verbatim quality standard we're running a special offer on many of their products, including—Datalife Diskettes, Cleaning Kits, and Disk Drive Analyzers.

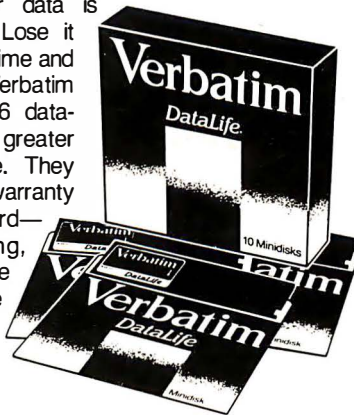

What separates us from our competition? Simply a combination of the best service in the industry, highly competitive pricing, and an ever widening range of products. Above all we care about our reputation and we are willing to work on a lower margin while delivering what others only claim—and we do it all on a day-in day-out basis.

Every subscriber to **Byte** will receive our New 96-Page Winter Spring 1986/87 Catalog over the next few months. We hope to be your source for computer supplies & accessories. **Now with 15 pages of consumer/industrial products.**

## Lyben Computer Systems

**WATCH FOR OUR NEW 1986/87 CATALOG**

1050 E. MAPLE RD. • TROY, MI 48083  
(313) 589-3440

## If you like games of the Star Trek variety, you'll love Star Fleet I for the Amiga.

had to start all over as a midshipman; there's no way to transfer my admiral status from the PC version to the Amiga. Incidentally, this is a new version of the game, with a much better player interface. If you like games of the Star Trek variety, you'll love this. I've had some problems with the Amiga version crashing the system, but that started alarm bells at Electronic Arts, and I make no doubt they'll fix things by the time you read this. There's also an Atari ST version.

The book of the month is Kenneth Macksey's *Technology in War* (Prentice-Hall, 1986), only it isn't really; that is, with Barbara Clifford's help I'm just about done revising my own *The Strategy of Technology*, which with any luck we'll be able to turn in before the end of the year. *Strategy* was a textbook at the Air Force Academy and the Air War College for a number of years; some of the professors had it as students and want a new edition, so I've been grinding on it.

The program of the month is FTL Modula-2 for the IBM PC. This thing compiles like lightning, and, better yet, you get the source code to a pretty nifty text editor. I know of at least two hackers who intend to take the FTL editor and modify it to have all my favorite features. They don't think they'll have much trouble, either. Much more on this next month.

I'm out of space, and also just about out of time. Fall COMDEX is next week, and after that I'm on a speaking tour in France and England. Meanwhile, *Storms of Victory: Janissaries Volume III* is about 80 percent completed, and I'm supposed to have it out the door before COMDEX. That's definitely going to take a lot of luck. Things continue to *flow* at Chaos Manor, and I guess I wouldn't have it any other way. ■

*Jerry Pournelle welcomes readers' comments and opinions. Send a self-addressed, stamped envelope to Jerry Pournelle, c/o BYTE, One Phoenix Mill Lane, Peterborough, NH 03458. Please put your address on the letter as well as on the envelope. Due to the high volume of letters, Jerry cannot guarantee a personal reply.*



# Programming Ease for Scientific & Engineering Applications

No matter what your level of programming expertise, if you write your own programs for engineering, science, or statistics applications, Wiley Professional Software's technical programming tools enable you to save programming time and development costs. These tools allow you to generate dependable, accurate and error free code, quickly and easily.

## New! Statistics Subroutine Libraries

STATLIB series, developed by PSI/Systems, is a one stop source for Time Series and Graphics data analysis. These two new subroutine libraries are ready to address your statistics programming problems. STATLIB.TSF covers routines in forecasting and analysis of

time based data. Generalized linear regression models, ARIMA models, survival analysis, econometric forecasting, exponential forecasting, and spectral analysis are just a few of the routines which will prove invaluable to statisticians and to programmers, engineers, and scientists who use statistics.

STATLIB.GL is a statistical *graphics* library with subroutines for Box-Jenkins identification, scatter graphs, curve-fit graphs, contour maps, axonometric plots and much more, including a library of GKS device drivers.

Economists and marketing and financial forecasting professionals will find these routines invaluable in their day to day work. And they are a must for every scientist and engineer who programs in FORTRAN.

These subroutine libraries give you all the benefits of a complete package and the added advantages of allowing you to quickly and easily customize *your* program for *your* needs.

SOURCE CODE INCLUDED.

**Statlib.TSF: Time Series Analysis & Forecasting Subroutine Library** ..... \$295

**Statlib.GL: Statistical Graphics Subroutine Library** ..... \$295

Microsoft and IBM Professional FORTRAN versions available

## New! 50 More FORTRAN Library

The *50 MORE FORTRAN* Library, developed by Peerless Engineering Service, offers a collection of subroutines and utilities previously unavailable in our FORTRAN Library. Included are pre-tested and precompiled subroutines covering such areas as Matrices, Polynomials,

Differential Equations, and Numerical Analysis (including FFTs), plus utilities for more effective screen handling. SOURCE CODE INCLUDED.

**MICROSOFT FORTRAN or IBM Professional FORTRAN version** ..... \$125

## The Classic Subroutine Library for BASIC, FORTRAN, and C Programmers

**MICROSOFT FORTRAN Library** ..... \$175

**C Language Library** ..... \$175

**BASICA Library** ..... \$125

**IBM Professional FORTRAN Library** ..... \$175

To order any of Wiley's scientific and engineering programming tools, call: **212-850-6788**

Or write:



Wiley Professional Software  
John Wiley & Sons, Inc.  
Attn: D. West  
605 Third Avenue  
New York, NY 10158  
Dealer Inquiries Invited

**wiley**<sup>™</sup>  
PROFESSIONAL  
SOFTWARE

THE TECHNICAL SOFTWARE SOURCE.



It's been 3,000 years since anything as enlightening as our 3-Book Set on Image Processing, Array

## Processing and Data Acquisition was written.



Fred Molinari, President

And you won't have to cross a desert, part the Red Sea, or pay money to get it. Data Translation's 3-Book Set is free.

First, there's "The Book": our 656-page Catalog featuring unabridged descriptions, specifications, and operating principles on Data Translation's entire product line.

Second is "The Booklet": our 1987 Product Summary Price List. It contains product overviews and comprehensive tables summarizing product features and compatible software and accessories.

Finally, there's "The How-To Book." With this Applications Handbook, you'll learn the fundamentals of Image Processing, Array Processing, and Data Acquisition through real-life examples.

For your free copy of our 3-Book Set,

**CALL (617) 481-3700.**

Alright, maybe our volumes aren't as important as Moses'. But he had help writing his!



To learn more, see us in Gold Book 1987, or call to receive our first-ever 1987 3-Book Set, including 1987 Catalog, Product Summary Price List, and Applications Handbook.

Data Translation is a registered trademark of Data Translation, Inc.

# DATA TRANSLATION

**World Headquarters:** Data Translation, Inc., 100 Locke Dr., Marlboro, MA 01752 (617) 481-3700 Tlx 951 646

**European Headquarters:** Data Translation, Ltd., 13 The Business Centre, Molly Millars Lane, Wokingham Berks, RG112QZ, England Tlx 851849862 (#D)

**International Sales Offices:** Australia (61) 2-6635289; Belgium (32) 2-7352135; Canada (416) 625-1907; Chile (2) 2-253689; China (408) 727-8222; Denmark (45) (02) 187188; England (44) 734-79383; Finland (358) 90-372144; France (33) 146306839; Greece (30) 951-4944; Hong Kong (852) 3-318585; India (91) 2-231040; Israel (972) 3-324298; Italy (39) 2-81821; Japan (81) 3-502-5550, (81) 3-375-1551; Korea (82) 778-0721-5; Malaysia (60) 3-36299; Morocco (21) 9-30-6949; Netherlands (31) 70996360; New Zealand (61) 2-663-5289; Norway (47) (02) 559050; Peru (51) (14) 31-8060; Philippines (63) 818-0103; Portugal (351) 1545313; Singapore (65) 271-3163; South Africa (27) 12469221; Spain (34) 14558112; Sweden (46) 8-7617820; Switzerland (41) 17231410, (41) 22360830; Taiwan (86) 2-709-1394; (86) 2-531-2434; West Germany (49) 89809020.





# And More Clones

Dick Pountain

## *Amstrad and Apricot are pinning their futures on IBM look-alikes*

I find it increasingly hard to remember that only two years ago Great Britain had four major personal computer manufacturers, all producing machines of incompatible proprietary designs by the hundreds of thousands. Now we have only two major native manufacturers (not counting the Italian-based Olivetti), and they are both pinning their futures on selling IBM clones. The 68000-based alternatives from Apple, Atari, and Commodore have some presence here but haven't sold as well as they have in the U.S. (even in proportion to the population). The truth appears to be that in the U.K. we buy for price and utility rather than for technical innovation.

The two major companies, Amstrad (Brentwood House, 169 Kings Rd., Brentwood, Essex CM14 4EF, U.K.) and Apricot (U.S. address: 47173 Benicia St., Fremont, CA 94538), could hardly be more different in approach, and their respective IBM-compatible machines typify the differences. Amstrad's base is in budget consumer electronics and hi-fi. The firm entered the home computer market with great success in 1985 by offering good value rather than innovation (see my columns in the January 1985 and March 1986 BYTES) and eventually swallowed the home market leader, Sinclair Research.

Apricot, on the other hand, started out supplying business computers. In 1985 it decided to move down in price, entering the educational market with a range of sub-£1000 machines that flopped badly. After reaching the very brink of disaster in 1986, Apricot has announced that it is going back to high-price, high-margin products with full professional support. It is trying to return to the "systems-house" approach of selling complete solutions and service rather than commodity personal computers.

In the space of a month in 1986, Apricot and Amstrad both launched IBM-compatible machines. The Amstrad PC1512 series contains possibly the cheapest IBM PC

clones in the world—I say possibly because the pricing policy of Taiwanese clone makers exhibits a certain "flexibility." The Apricot Xen-i, on the other hand, may be the highest-performance and highest-quality PC AT clone in the world.

### **Amstrad PC1512**

The PC1512 range includes options of one or two floppy disk drives, 10- or 20-megabyte hard disks, and monochrome or color monitors, with a price range running from £449 and up for one floppy disk drive and a monochrome monitor to £1069 for a 20-megabyte hard disk with a color display. The low price has been achieved in typical Amstrad fashion, meticulously saving costs in design and production engineering, rather than by skimping on quality of materials or essential features.

My first impressions on viewing the machine were wholly favorable. It's housed in a custom injection-molded ABS case, rather than the bent tin favored in Taiwan. Its footprint, at 15 inches square, is considerably smaller than the IBM PC, and it comes with a tilt-and-swivel monitor that encloses the power supply, allowing the whole unit to be supplied from a single power outlet plug (a feature that consumer-conscious Amstrad has insisted on from its first design).

The two alternative monitors differ in price by £150. The color monitor supports the IBM CGA (Color Graphics Adapter) standard, while the monochrome monitor is unusual in also supporting the CGA standard, in tones of gray, rather than the IBM monochrome standard. The color graphics hardware is integrated onto the motherboard, not on a separate card. The unit I tested came with twin floppy disk drives and a monochrome monitor. It was a considerable boon to be able to port my

IBM color software directly without worrying about the colors being translated into inappropriate monochrome "attributes"; the tones of gray are all clearly distinguishable. Compatibility with IBM regrettably also extends to the annoying flicker when scrolling.

Text quality on the monochrome screen is merely adequate. A pleasing thin sans serif typeface is used, and sharpness is better than on the IBM color monitor, although well short of the Macintosh or the Apricot Xen "paper-white" monitor quality.

Input is via a "real" keyboard that uses switches, springs, and removable key caps rather than the polymer-bubble technology used on Amstrad's home machines. In feel it's closer to a Key Tronic KB 5151 than to an IBM keyboard, a plus in my book. The keyboard's layout is not up to the latest standards, modeled as it is on the original flawed IBM PC keyboard. It has a few eccentric alterations of Amstrad's own, which do little to enhance it. For example, the Alt and Ctrl keys are placed side by side above the left Shift key, while PrtSc has inexplicably migrated to the main QWERTY area. There is no separate cursor keypad, and the Return and Shift keys have nasty small key tops. One useful innovation is the provision of twin Del > and < Del keys in place of Backspace; the Del > key can be soft-programmed to perform delete-right in your favorite text editor. Num Lock, Scroll Lock, and Caps Lock bear red LED indicators. One weakness, seldom seen nowadays, is that the keyboard appeared to lack full *n*-key rollover; depressing the QWE, ASD, or ZXC combinations simultaneously produces spurious characters.

*continued*

*Dick Pountain is a technical author and software consultant living in London, England. He can be contacted c/o BYTE, One Phoenix Mill Lane, Peterborough, NH 03458.*



ters (although this would cause problems only if you are ham-fisted or a super-sonically fast typist).

All PC1512 models come with a built-in Microsoft-compatible mouse. The hardware itself differs from the Microsoft unit, being of all plastic construction with a rubber ball, but the driver software is Microsoft version 5.0 and is 100 percent compatible. Inside the case of the PC1512, the motherboard tells the whole story. It's a single board, occupying only half the case floor area, and it contains fewer than 50 chips, including memory; three large 64-pin gate arrays, made in Italy and bearing the Amstrad name, do the work of most of an IBM PC. Standard memory is 512K bytes in 256K-bit chips; sockets exist to expand the memory to 640K bytes. The CPU is an 8086-2 running at 8 megahertz, which makes the machine more nearly equivalent in speed to an Olivetti M24 (known as the AT&T PC 6300 in the U.S.). A socket for an 8087 math coprocessor board is also provided.

Three full-length expansion slots are arranged side by side at the back of the case, with the connectors emerging from a hatch on the right of the case. No fan is provided since the power supply is in the monitor case. I had no problems with

overheating; the main case never became more than lukewarm. Since some scare stories were spread (reputedly by a rival manufacturer) that a PC1512 melted its case when fitted with a token-ring card, Amstrad has announced that all future production of the machines will be fitted with a fan; boss Alan Sugar says this has been done to quell the stories rather than as an admission that there was a problem. There is in any case little incentive to add many cards since the PC1512 already has all the "standard" IBM options built in. Serial port, parallel printer port, clock/calendar, mouse controller, and CGA are all on the motherboard. The EGA is not a likely addition, as it will work only in its lowest-resolution mode on the PC1512 due to the architecture. An internal modem card and extended memory are more likely additions. A shortage of hard disk PC1512s has led some people to add hard cards, but at present prices this is not an attractive option.

The PC1512 contains a nonvolatile RAM (NVR) backed by four pen-cell-type batteries that are contained in an open slot under the monitor base and that last about one year. The NVR stores information like the date and time, RS-232C port parameters, and other setup options.

When you boot the machine, it tells you when it was last used. You can alter the parameters by running a program called NVR.EXE, through which you can set the key codes produced by the Del > key, the mouse buttons, and the mouse scaling, among others. This is the only way you can program the mouse, as Amstrad does not supply Microsoft's Mouse Menu software system; it works fine on the PC1512, however, if you have a copy of it. NVR.EXE also sets the size of a RAM disk configured at boot time and permits the choice of foreground and background colors (or gray shades) for the screen. I could easily set up the black on gray that I prefer, without having to mess with ANSI escape sequences.

Amstrad bundles three operating systems with the PC1512: MS-DOS version 3.2, Digital Research's DOS Plus, and the GEM desktop. (It's really more like two and a half operating systems since GEM runs on top of DOS Plus.) DOS Plus can run both CP/M-86 and many MS-DOS programs and can read both disk formats. It permits up to three CP/M-86 programs to run concurrently in the background as long as they don't do screen I/O or share files; this effectively limits the choice to print spooling and some prewritten utili-

**6.0 Now Released!**  
 • Larger Variables  
 • Added Features

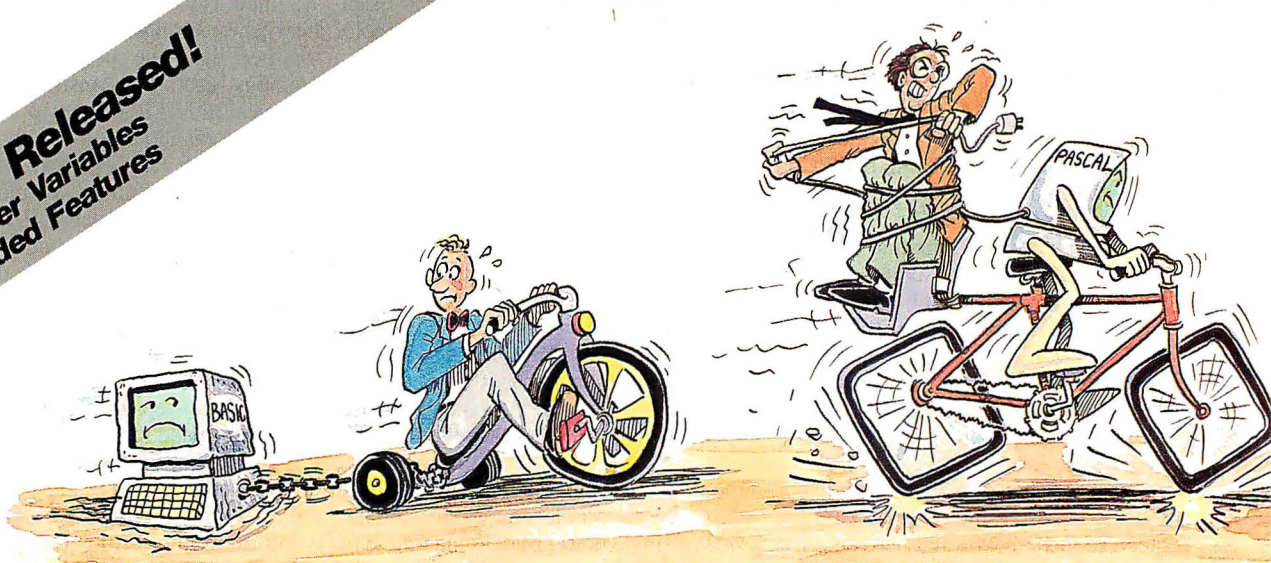

## A Personal Language

When it comes to problem solving, the APL\*PLUS System is the undisputed leader.

That's because the APL\*PLUS System works with you. It goes far beyond what application software like Lotus® or dBASE® could possibly ever offer. And, it won't tie you down with the details of standard programming languages.

The APL\*PLUS System is a personal language, with productivity features that help you concentrate on getting answers,

rather than struggle with intricate calculations and modeling.

With it you can manipulate tables of numbers as easily as single numbers and get quick results from your computer using short, simple statements.

When you've reached the limits of other packages, move up to the APL\*PLUS System. It's a powerful and flexible tool that grows with you as your needs become more sophisticated. With over 200 built-in

applications—like graphics, report formatting and communications—you have all the tools at your fingertips to quickly and easily solve those seemingly impossible problems.

Best of all, the APL\*PLUS System interfaces well with software packages you're already using—like databases, spreadsheets, and graphics packages. The APL\*PLUS System also makes it easy to link those packages that aren't



ties like an alarm timer. The only application bundled with the PC1512 is a simple-minded GEM drawing program called Doodle.

Programming capability is provided by Locomotive Software's excellent BASIC 2, which runs under GEM and fully supports the windows, menus, and bit-mapped graphics of that interface. In addition, BASIC 2 supports keyed sequential-access files, which makes it highly suitable for writing business programs, and it's very fast.

**Apricot Xen-i**

It's word-eating time for Pountain. Last April I faithfully relayed Apricot senior management's claim that they would implement IBM compatibility only through a SoftClone software-patching scheme. Even as they were telling me this little white lie, the Xen-i must have been under preparation. Shame!

The Xen-i looks externally just like the Xen that I reviewed last April, so I shall only describe the differences. It uses the same attractively styled case, except that in place of the 3½-inch microfloppy is an IBM PC AT-compatible 5¼-inch drive. Xen-i will normally be supplied with an IBM-compatible monochrome or color

monitor, although you can use Apricot's old higher-resolution monitors via a separate video outlet; however, the Xen's excellent paper-white monitor requires an expansion card. Hercules standard (720 by 350) monochrome text and graphics are supported on the motherboard without an adapter. The Xen's fine keyboard, complete with its LCD microscreen, is retained.

Internally, the Xen-i keeps the 1 megabyte of fast 120-nanosecond RAM from the Xen but now drives the 80286 CPU at 10 MHz with one wait state, making it a very fast clone indeed. You can use only 640K bytes of the RAM directly from MS-DOS, but the rest (and any expansion up to 11 megabytes) is available via a built-in page mapper that works to the Lotus/Intel/Microsoft Above Board standard. Lotus 1-2-3, for example, will use the whole megabyte.

Expansion is limited compared to a PC AT's; the Xen-i can accommodate three short cards: two PC AT-type 16-bit cards and one PC-type 8-bit card. These cards lie horizontally in a cage at the rear right (due to the low-profile case) and are the devil's own job to insert. Don't even think about any cards with large protruding devices, as they just won't fit. You can add

three full-size IBM PC or PC AT cards, however, if you use an external expansion box.

As with the Amstrad, many of IBM's options already exist on the motherboard of the Xen-i. Clock/calendar, monochrome graphics, serial and parallel ports, disk controllers, and mouse controller—albeit the quirky Apricot trackball/mouse—are standard fixtures. These functions are provided by four huge custom integrated circuits—bearing the increasingly famous CHIPS logo—on the motherboard.

Mass storage is provided by one 360K-byte or 1.2-megabyte floppy disk drive and either a 20-megabyte (HD model) or 50-megabyte (XD model) internal hard disk. The respective prices are £2998 and £3998.

The HD model that I tested came fitted with a Quadram EGA card and Apricot's own EGA monitor—my first serious encounter with an EGA system. This Quadram card has DIP switches to select between monochrome, CGA40, CGA80, EGA1, and EGA2 modes. EGA2 offered the finest resolution with a special, very sharp character set. Unfortunately, it seems you can't select a border color other

*continued*

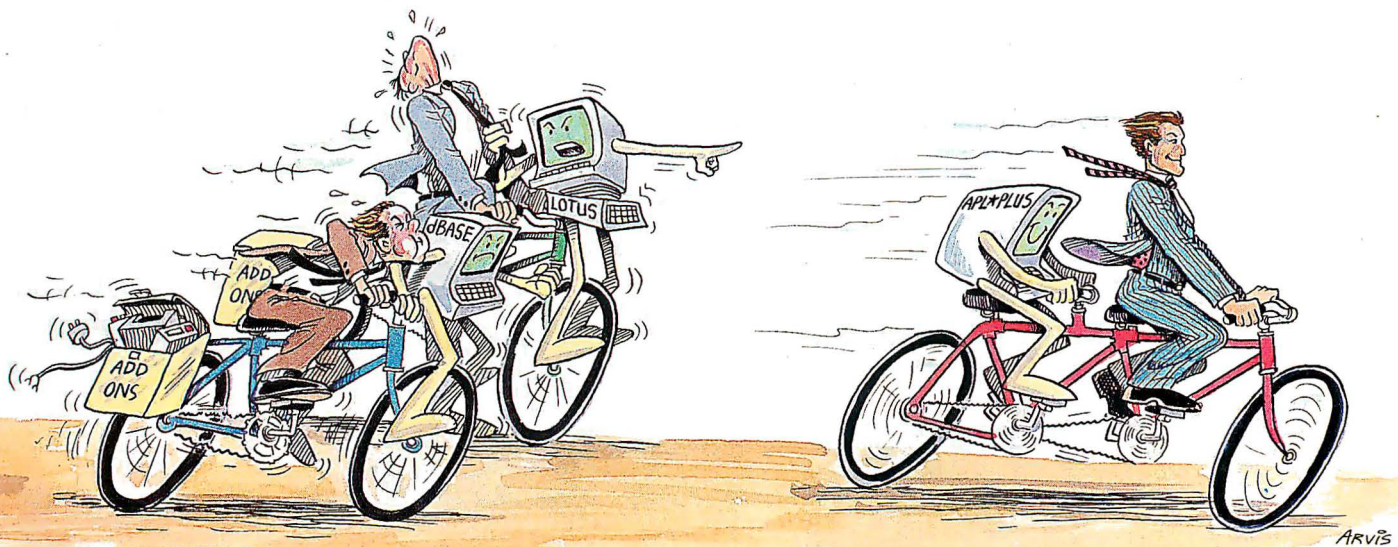

**The APL★PLUS® System and You.**

currently talking with each other.

With all this problem-solving power, it's no wonder STSC's APL★PLUS System is the personal choice of so many business professionals—financial planners, business analysts, actuaries, scientists, mathematicians, engineers, statisticians, and consultants. Especially since the APL★PLUS System is available on a full range of computers from desktops to mainframes.

Put the power, speed, and flexibility of the APL★PLUS System to work for you. See your local dealer today to get your APL★PLUS System. If they don't have it, refer them to STSC or call STSC toll-free, **(800) 592-0050**. In Maryland or Canada, **(301) 984-5123**.

Available nationally through Softsel, Micro Central, and distributors worldwide. Dealer inquiries welcome.

**Problem-Solving at the Speed of Thought**

**STSC** STSC, Inc.  
2115 East Jefferson St.  
Rockville, MD 20852

APL★PLUS is a service mark and trademark of STSC, Inc. PLUS★WARE is a trademark of STSC, Inc. Lotus and dBASE are registered trademarks of Lotus Development Corporation and Ashton-Tate, respectively.

**A PLUS★WARE™ PRODUCT**



# Packed and ready to go.

The WYSEpc+. Complete with everything that makes all others incomplete.

Now you can have a pc that's *twice* as fast as an IBM PC XT, yet fully compatible. Plus more memory,

extra ports and a built-in graphics adapter.

Because on the WYSEpc+, all the most-wanted upgrades are standard.

And even while raising the standards, the WYSEpc+ still gives you two full-size expansion slots for

your special applications. Plus your choice of an IBM PC AT-style or Enhanced-style PC keyboard.

All this, at Wyse prices. From the company offering a full line of display products.

Take a look at the chart and you'll see why the WYSEpc+ is sending the others packing.

Write Wyse Technology, Attn: Marcom Dept. pc+, 3571 N. First Street, San Jose, CA 95134. Or call toll-free, today, for more information.

Call 1-800-GET-WYSE

## WYSE

INQUIRY 324

YOU NEVER REGRET A WYSE DECISION.

	WYSE WYSEpc+	ATT PC 6300	COMPAQ DESKPRO	EPSON EQUITY I	LEADING EDGE MODEL D	ZENITH Z-158
CPU	8088	8086	8086	8088	8088	8088
Maximum CPU Speed	9.54MHz	8MHz	7.14MHz	4.77MHz	4.77MHz	8MHz
Selectable 4.77MHz Mode	Yes	No	Yes	—	—	Yes
Standard Memory	640KB	640KB	256KB	640KB	512KB	256KB
Standard Ports	2S, P	S, P	P	S, P	S, P	S, P
Monochrome/Color Graphics Adapter	Yes	Yes	Mono only	Optional	Yes	Optional
Accessory Slots After Configuration*	2	5	1	3	3	2
MS-DOS Included	3.1	2.11	Optional	2.11	3.1	Optional
Choice of Keyboard	AT, ENHANCED	PC XT	PC XT	PC, AT	PC XT	PC XT

Comparative specifications as of 8/85. \*Configuration includes 640KB memory, display adapter and hard disk controller.

WYSE is a registered trademark of Wyse Technology. WYSEpc+ is a trademark of Wyse Technology. IBM and Personal Computer AT are trademarks of International Business Machines Corporation. MS-DOS is a trademark of Microsoft Corporation. © 1986 Wyse Technology.





than black in EGA2, which makes working with a reversed screen quite impractical (black characters at the left margin lose their uprights). I tried writing bytes to the CGA border-control port (3D9 hexadecimal) with no success. EGA1 uses a character set indistinguishable from that of CGA mode but still much superior to the IBM's CGA. I found that this mode suited me nicely, providing better color saturation than EGA2 and permitting a colored border.

The Xen-i comes with PC-DOS version 3.2, Microsoft Windows, and GEM. Windows is intended to be the principal operating environment, and it includes the Windows Write and Windows Paint programs. Regrettably, I'm becoming a middle-aged, crusty reactionary and find that I prefer my customized DOS/SideKick/SmartKey/PC-Write/Procomm combination to any windowing environment I've yet tried. My environment worked just fine on the Xen-i, which was unbelievably snappy after my IBM PC.

I played briefly with Xen-Tel, Apricot's telephone management system, which consists of a stylish telephone receiver shaped to fit closely against the Xen-i keyboard and a software package that runs under Windows. Using an Apricot internal modem card (Xen-Tel is not Hayes-compatible), the software allows you to maintain a card index of phone numbers for auto-dialing and also to pull phone numbers out of files created with dBASE III, accounting packages, and other applications. You can create a queue of calls you want to make; Xen-Tel will try them and record which ones succeeded and which ones need to be retried.

**Compatibility**

Both the Amstrad PC1512 and the Apricot Xen-i showed a high degree of IBM compatibility. The PC1512 balked at only one of the dozens of programs I tried, namely, LMI's PC/FORTH, which is pretty badly behaved; the PC1512 just spat it out and returned to the DOS prompt. It ran plain SideKick, even though it isn't supposed to (there is a special Amstrad version). The only problem I found was that the Notepad's top line didn't clear when I typed in a new filename. The PC1512 ran the IBM version of Turbo Pascal and the Sublogic Jet flight simulator without a hiccup.

The Xen-i ran PC/FORTH perfectly but refused the flight simulator (I believe it doesn't run on the AT either). The only other minor quirk I found was with the resident utility DOSEDIT, which ran but wouldn't allow insertion when editing a command line.

Knowing that communications provides a stern test of compatibility (and neither

of these machines has a switchable CPU rate), I swapped my modem cable from my IBM PC to the PC1512 and ran Procomm. To my astonishment, it worked the first time and logged on to BIX perfectly. A similar experiment on the Xen-i failed; Procomm ran all right and appeared to talk to the modem but wouldn't log on to PSS (Packet SwitchStream) despite much fiddling with parameters. This was more in keeping with my expectations about compatibility in communications.

Both the PC1512 and the Xen-i refused to read DOS 2.1 disks from my IBM PC on one or two occasions (the Amstrad issuing a nonchalant "General failure error reading drive b:"). Inspection of the disks revealed nothing out of the ordinary, and my IBM PC continued to read them without a hitch.

The Xen-i uses the highly rated Phoenix BIOS, while the PC1512's BIOS bears an Amstrad copyright notice.

**Performance**

Since there is so little to say about the software for IBM clones, I devoted longer than usual to benchmarking the two machines. Assuming good compatibility, performance is one of the few distinguishing features of a clone.

As well as running the BYTE BASIC benchmarks in GW-BASIC on the Xen-i

and in BASIC 2 on the PC1512, I ran some Turbo Pascal benchmarks that test disk, text screen, and graphics speed. The reasoning was this: Locomotive's BASIC 2 is so much faster than GW-BASIC that those tests mostly compare the speed of the BASIC interpreters. It was thus essential to run some identical programs to detect real differences in the hardware.

The results of the BASIC tests are in table 1. The conclusions you could draw from these figures illustrate the dangers inherent in benchmarking. It would appear that the PC1512 is faster than the Xen-i at running the Sieve and almost as quick doing calculations, also that the PC1512 accesses its floppy disk drives faster than the IBM PC does its hard disk. The real message is that Locomotive's BASIC 2 is more than twice as efficient as GW-BASIC and BASICA.

Running the same .COM file compiled from Turbo Pascal on the various machines shows the hardware performance ratios more clearly (see table 2). These benchmarks, developed for the U.K. magazine *Personal Computer World*, are TrigLog, 1000 repetitions of evaluating  $\cos(\sin(\arctan(\log(x))))$ ; TextScrn, writing and scrolling 1000 20-character strings; GrafScrn, plotting 10,000 points; and Store, storing 1000 20-character records.

*continued*

**Table 1: The results of the BASIC tests (times in seconds).**

	Apricot Xen-i/GW-BASIC	Amstrad PC1512/BASIC 2	IBM PC/BASICA
Disk Write			
floppy disk	29.3	36.3	56.8
hard disk	9.9	—	41.8
Disk Read			
floppy disk	29.6	31.9	53.6
hard disk	7.1	—	29.1
Calculations	12.5	14.9	70.8
Sieve	45.0	36.9	217.6

**Table 2: Running the same .COM file (compiled from Turbo Pascal) on the different machines shows the hardware performance ratios more clearly (times in seconds).**

	Apricot Xen-i	Amstrad PC1512	IBM PC
TrigLog	12.6	23.4	56.5
TextScrn	33.2	50.6	76.4
GrafScrn	2.0	2.2	5.0
Store			
floppy disk	8.2	10.3	9.5
hard disk	1.4	—	4.7



# P.C. Computer Brokers Inc.

BYTE U.K.

**PCCB** Has Super Values Overnight Delivery Available

Call in your Toll Free Order TODAY **1-800-245-4122**



**Epson**  
RGB Color  
Monitor  
**\$359<sup>95</sup>**

**Epson**  
Monochrome  
Monitors.  
Call TODAY  
for LOW

**PCCB**  
Prices

Call PCCB TODAY For SUPER VALUE  
Price on NEW Epson Laser Jet Printer

Just Released Epson Scanner **\$299<sup>95</sup>**

**The Most ESSENTIAL CARD  
For The EQUITY I**

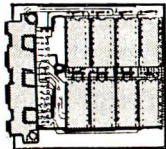

- Able To Bring The Mother Board to 512K
- 1/2 The Size of Other Cards
- 3 Year Warranty
- Save Up to \$70.00

**\$99<sup>95</sup>**

Prices Subject to Change Without Notice

Add 2.9% For Use of Visa, M/C & Choice & Discover Add 5% For Use of Amer. Exp

**LX-86**

List \$349<sup>00</sup>  
**\$229<sup>95</sup>**



**FX-85**

List \$599<sup>00</sup>  
**\$369<sup>95</sup>**

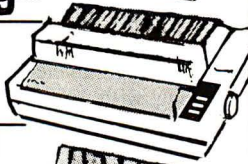

**LQ-800**

List \$799<sup>00</sup>  
**\$499<sup>95</sup>**

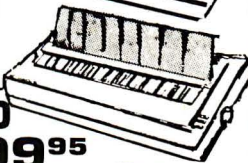

**LQ-1000**

List \$1095<sup>00</sup>  
**\$699<sup>95</sup>**



**EX-1000**

List \$995<sup>00</sup>  
**\$599<sup>95</sup>**

**EX-800**

List \$799<sup>00</sup>  
**\$499<sup>95</sup>**

**LQ-2500 \$1089<sup>95</sup>**

Restocking fee: 20% of mdse. cost

**P.C. Computer Brokers Inc.**

**3879 East 120th Ave. Thornton, Co. 80233**

**(303) 450-6727**

**1-800-245-4122**

# DOUBLE YOUR STORAGE CAPACITY

The new PERSTOR 200 Series Double Capacity Controllers increase the storage capacity of your ST506/412 Winchester hard disks by 90% or more. Advanced RLL encoding technology is used to increase data transfer rate to 9 and 10 megabits per second, and a 56

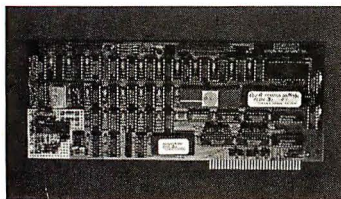

bit error correction code is used to assure data integrity. What's more, it works with both RLL and MFM drives with plated or oxide media.\*

To place an order or become a dealer call (602) 948-7313.

## PERSTOR

Sensible solutions for your hard disk problems.

**Systems and Software, Inc.**  
7825 East Redfield Road  
Scottsdale, Arizona 85260

\*call for specific drives.

It seems that for compute-bound tasks the machines perform roughly as 4.5 to 2 to 1 (Apricot to Amstrad to IBM), while on floppy disk-bound tasks they are about equal. On text-screen scrolling, they are all shamefully slow (the Apple IIGS executes TextScr in 16 seconds). And on graphics, surprisingly, the PC1512 plots points as fast as the Xen-i.

Out of curiosity, I also ran Peter Norton's SysInfo utility on all three machines and received the answers 10.3, 1.8, and 1 for performance ratings of the Xen-i and the PC1512, respectively, relative to the IBM PC. This clearly supports the point made by Stephen S. Fried's article "IBM PC Accelerators" in BYTE's 1986 *Inside the IBM PCs* that SysInfo exaggerates the speed of 80286 machines by about 100 percent.

Subjectively, the Xen-i feels much, much faster than the other two machines; when you load PC-Write on the Xen-i, you're into the editor before your finger leaves the Return key. This appears to be due to the seek time for the hard disk. The Xen-i's Microscribe hard disk finds and transfers data at least three times faster than my modest external hard disk drive; timing the loading of the benchmark TrigLog confirmed that while my disk took 1 second, the Xen-i was too quick to time. The PC1512's floppy disk drive took 4.6 seconds to load TrigLog. Don't scoff at such subjective factors; in my experience they are at least as important as benchmarks. Ergonomic research by IBM has shown that users of interactive computers become frustrated or anxious when system response time exceeds 4 seconds without an explanation; a fourfold speed advantage can make all the subjective difference in the world.

### Conclusions

Both these computers are excellent substitutes for an IBM PC. The £449 Amstrad PC1512 is an extraordinary value for the money, and not surprisingly its introduction has thrown the U.K. personal computer market into a turmoil, with crashing software prices and dire predictions of mass bankruptcy among computer dealers. In fact, orders for the PC1512 are so heavy that Amstrad boss Alan Sugar has confirmed that supply will not keep pace with demand until at least spring of 1987. The £2998 Apricot Xen-i, while more than three times as expensive as the Amstrad, is a BMW among clones; it's fast, compact, pretty, supports lots of memory, and should receive a high standard of after-sales service from Apricot. After "mine" was returned to Birmingham, I harbored brutally unkind thoughts toward my poor faithful old IBM PC for several weeks. ■

Inquiry 284 for End-Users.  
Inquiry 285 for DEALERS ONLY.



# The new Rackmount 30.<sup>TM</sup> Sometimes a little more flexibility will put you over the top.

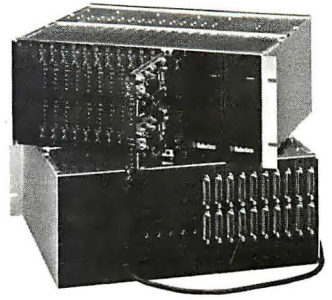

**USRobotics modular system gives you more modems and more automatic features. For more applications.**

**Start with full-featured modems:** 15 dual modem boards, each with 2 auto-dial, auto-answer, 2400/1200/300-bps asynchronous modems, for a maximum of 30 modems per rack chassis. LED indicators on each modem give you continuous diagnostics. Use the Rackmount 30 as an auto-answer system for the asynch ports of your main-frame or mini. Use Rackmount 30 as an auto-dial modem pool for a cluster of PCs or data terminals. Or use auto-dialing to automate central site polling of remote PCs.

**Add a modular chassis design:** At the back of the 19-inch-wide chassis, each modem board couples to a matching dual interface board containing cabling interfaces for telephone and computer. You can remove or install modem boards through the front of the rack without ever disturbing any cable connections or interrupting power to other modems. Choose your RS-232 cabling interface—either DB-25 or modular 8-pin style. Redundant power supplies assure you uninterrupted operation.

**DuPont, Digital Equipment, Boeing, the U. of California—all have chosen USRobotics Rackmount 30. For flexibility now and expandability tomorrow. Learn how the Rackmount 30 can push your business over the top.**

**Call 1-800-DIAL-USR  
In Illinois (312) 982-5001**

Yes, please send me your free 6-page brochure on the new Rackmount 30, and how rack modems can benefit my operation.

Name \_\_\_\_\_

Title \_\_\_\_\_

Company \_\_\_\_\_

Address \_\_\_\_\_

City \_\_\_\_\_ State \_\_\_\_\_ Zip \_\_\_\_\_

Business Phone ( ) \_\_\_\_\_

2/87-BY-30

**USRobotics<sup>TM</sup>**

The Intelligent Choice in Data Communications.  
8100 McCormick Blvd., Skokie, Illinois 60076.

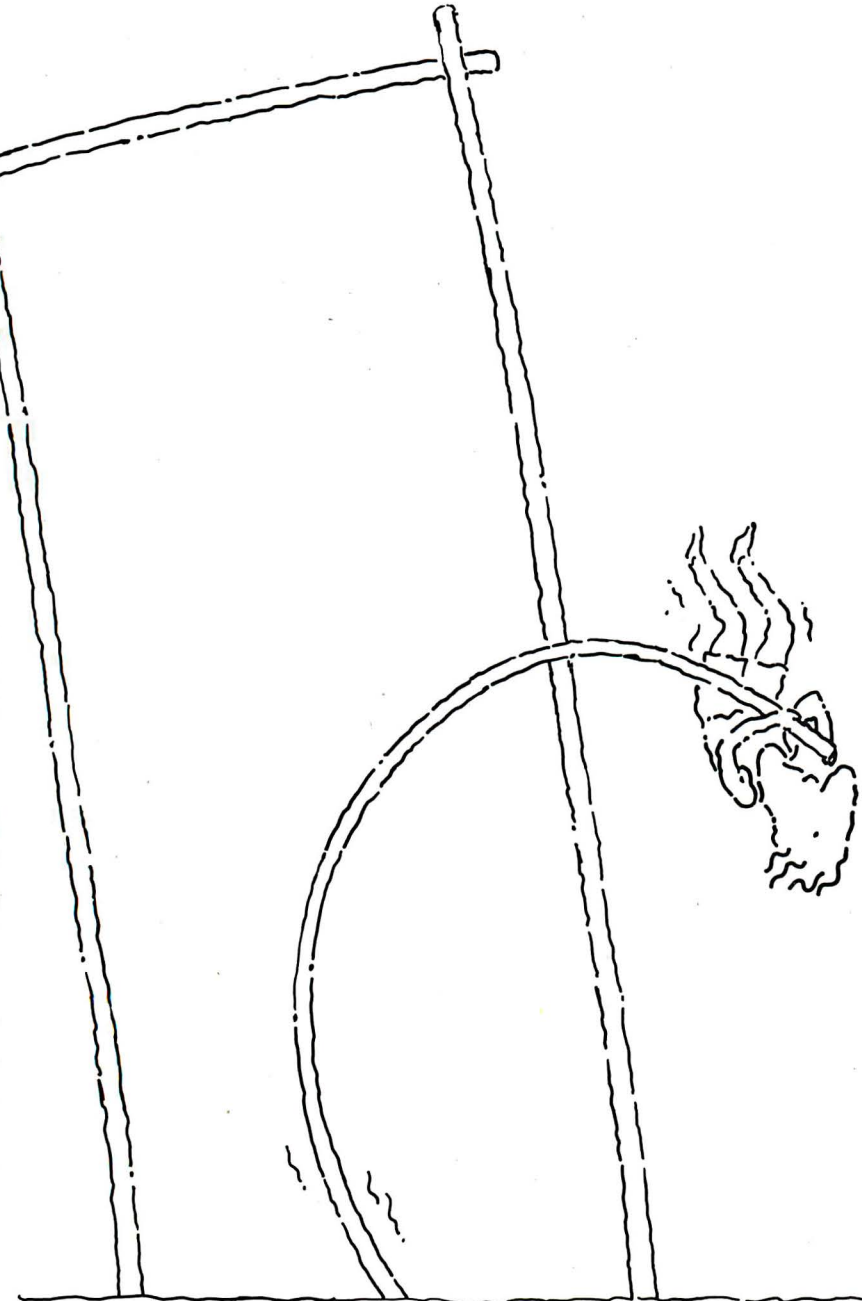



# MASS STORAGE ..... 1987

AND MULTIFUNCTION CONTROLLERS

**\$10,900 = 510 MegaBytes**

**For All AT, RT, XT, PC and COMPAQ 386 Applications**



Optional integrated  
60MB tape back-up  
**\$1,495**

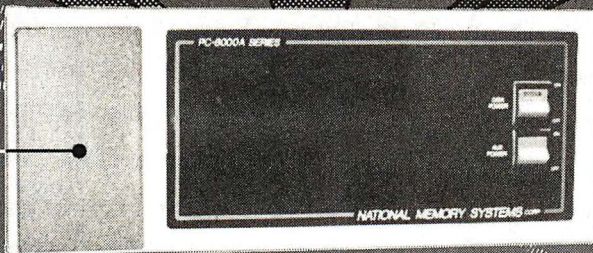

- Data rate to 2.4MB/Sec.
- Average access times as fast as 15 milliseconds
- Breaks DOS 32MB limit

8000 Series 8 inch Winchester technologies  
intelligently interfaced to microcomputers

### 8000A Series

**Mainframe:** NMS Disk/Tape systems and controllers provide economical, compact, and high performance mass storage that can be formatted as one volume. When you need performance and/or storage on your PC, XT, AT and RT, you need the industry standard NMS 8000 series with Multifunction Controller. The SMD-SCSI single board controller you've been waiting for is available now... The NMS 8000A.

**Tape Back-Up:** NMS provides ANSI-IBM format 1/2 inch tape systems and 60mb of file-by-file/streamer 1/4 inch cartridge tape systems. (NMS 9000 and PC .25 series).

**Laser Optical:** Complete, 12 inch media, 1000MB memory systems that support DOS applications and format as one volume.

**Warranty:** 12 months (RTV).

### 8100 Series

**Selection:** Only NMS provides selection of 8 inch and 5.25 inch technologies. Where speed, power and networking are important... NMS is there.

**Tape Back-Up:** An option you control... file by file and streamer backups. 60 megabytes per cartridge. Fast, reliable, and easy to use. One half inch ASCII/EBCDIC tape systems are available too.

**DOS Limits:** They don't exist with NMS memory systems. We were the first to break the barriers for you!

**Call us today!**



355 Earhart Way  
Livermore, CA 94550

**(415) 443-1669**

**TELEX 821892 NMSUD**

**PRICES VALID THROUGH 5/01/87**

- Published prices assume C.O.D. or C.I.A. —
- Compatible with all popular networks —
- One year RTV warranty —

► Ask about our family of  
**ESDI, SMD, and SCSI Controllers**

Inquiry 180

► DOS, XENIX, AIX Compatible





# Miscellany

Ezra Shapiro

## *New products are winning the battle for space; time to attack*

This business is riskier than I would have guessed when I started writing this column a year ago. In the past month alone, I've received more than 30 software products, which are chewing up floor space at an alarming rate. The result is I'm building up a gigantic backlog, and a significant guilt complex about it. There are just *scads* of new products worth writing about. So forgive me if I shorten the format this month, and maybe next, to try to cram a few more items into print.

### Old Favorite

Nice things to say about **Volkswriter Deluxe Plus** (Lifetree, \$99). Once considered one of the top MS-DOS word processors, Volkswriter Deluxe went off into marketing limbo when Lifetree introduced its successor, Volkswriter 3, about a year ago. Which was sad because Deluxe was a good product—clean, fast, and capable. I'm pleased to report that Lifetree has taken Deluxe out of mothballs, added a nice spelling checker and automatic reformatting, and chopped the price to \$99, which now makes Deluxe one of the best bargains in the business. Of course, you don't get all of 3's power: multiple style sheets, automatic hyphenation, scientific character sets, math functions, sorting, decimal tabs, and so on. And I'm not crazy about the way either product maps all 40 function-key combinations without allowing you to reconfigure. But Deluxe is a solid product that drives about 400 printers, coexists contentedly with most memory-resident programs, and does *almost* all you'd ever want to do with a word processor. Recommended.

### Why Bother?

I liked ComicWorks on the Mac when I wrote about it last December. I still like it; what troubles me, mildly, is the collateral material that comes with its fraternal twin, **GraphicWorks** (Mindscape, \$79.95). The two programs are almost identical, but ComicWorks gives you sam-

ple disks of spaceships and monsters, and GraphicWorks has examples of purchase orders and letterheads. If you bought ComicWorks because of the layout capabilities, the object editing, or the wonderful adjustable airbrush tool, you're probably wondering whether to purchase the GraphicWorks artwork disk (\$19.95) for your more serious side.

Don't do it unless you're either completely lacking in imagination or extremely lazy. Aside from a nice collection of borders (which you can use as clip art) and blank templates for a newsletter and TV storyboards, most of the GraphicWorks examples are just that—examples—and pretty yucky ones to boot. I wish they'd distributed more *blank* templates. You already get a storyboard and a newsletter with ComicWorks; you don't really need this new assortment.

If you're trying to choose between the two programs, either one is excellent, but GraphicWorks offers a few minor improvements: direct import of MacPaint files, automatic rescaling of bit maps when using a laser printer (so art and text line up properly), and marginally increased speed. As for the art disks, I've always had a soft spot for spaceships and monsters, but I suspect "GraphicWorks" looks better to the bean-counters when you're trying to sneak it through on a corporate purchase requisition.

### Getting There

Every now and then I get a program that does something new and unexpected and does it so well that I don't have much to say aside from, "This is fantastic." **Highways and Byways** (New Directions) is such a product, or rather, set of products. It's an automobile routing program for MS-DOS machines; you feed it your

starting point and destination, and it calculates the shortest and fastest way to get there, optimized for either speed or distance. The resulting report is a list of major intersections or cities along your route, with mileage and time between them. You can create the equivalent of batch files for routes with multiple stops, and you can generate thorough expense reports based on mileage, lodging, meals, and so on.

It works best on estimating trips of more than 50 miles (a sprawling city is defined as its downtown hub, which can be misleading), but I was amazed at its success in picking out better, faster routes for shorter intervals. In the first five minutes I used the program, it generated a surprising new route between San Francisco and San Jose that cuts three miles off my old method. If you do a lot of driving, the savings could really add up.

I never had to look at the manual (on disk) to run the program; it's intelligently organized and simple to operate. I did look at the documentation when preparing a list of features the program lacked and discovered that New Directions was already planning to cover them. I wanted routes through urban areas, like Los Angeles, and the ability to block off sections of highway that are badly congested. That's coming in the next release.

New Directions sells Highways and Byways either as a full national map for \$129.95 or as Western, Central, and Eastern regions at \$49.95 each (any two or all three of these can be combined). The total database is a bit more than a megabyte and includes all cities with a population of more than 6000, plus quite a few smaller locations. An annual subscription for updates to the map files costs

*continued*

*Ezra Shapiro is a consulting editor for BYTE. Contact him at P.O. Box 170040, San Francisco, CA 94117. Because of the volume of mail he receives, Ezra, regretfully, cannot respond to each inquiry.*



# Professional Programming Tools

For Programmers Compiling in

**BASIC • C • COBOL • FORTRAN • PASCAL • dBASE™**

## WINDOWS LIBRARY

- Saves hundreds of man hours in programming and debug time
- Window editor included to allow windows to be created easily
- Pop-up windows, menus, help screens
- Print variables directly to the windows
- Written in Assembly for compactness
- Full color control
- Set cursor location or obtain position
- Exploding borders selectable

## WINDOWS with DATA ENTRY

- Requires WINDOWS.LIB
- Productivity enhancement for WINDOWS.LIB
- MENU items return strings & integers when selected
- Several keyboard input routines provide a user friendly professional interface
- Several field data types supported PICTURED Strings, Date, Time, Integers (Signed/Unsigned)
- Window Librarian included to allow several screens in one file

**\$9900 NO ROYALTIES \$9900**

For more information please call.

**GLENCO ENGINEERING INC.**  
SERVING THE SOFTWARE INDUSTRY



- IBM™
- Summit Software™
- MicroSoft™
- Lattice™
- Computer Innovations™
- Ryan McFarland™
- Realia™
- Nantucket™
- and More

3920 Ridge, Arlington Hts., IL 60004 (312) 392-2492 Telex 493-7109

## APPLICATIONS ONLY

\$29.95. I had thought this sort of program was restricted to mainframes or at least minicomputers; not so. I like this product.

### Another Paint Program

Ever since Apple decided to stop giving away MacPaint with every Macintosh, the action has been hot and heavy. Now we've got **SuperPaint** (Silicon Beach, \$99), which obsoletes both MacPaint and MacDraw, and it throws in a bunch of nifty additional features. It also soundly trounces FullPaint (which I loved in the September 1986 column).

SuperPaint gives you two editing layers, a Paint layer and a Draw layer, with an appropriate set of tools for each. The Paint layer works like MacPaint, the Draw layer like MacDraw (obvious, isn't it?). Clicking an icon shifts between them.

The Paint layer offers the standard toolkit for creating bit-mapped graphics, plus free rotation, skew, perspective, and distort. For close work, you get three levels of enlargement, 2X, 4X, and 8X (pixel-by-pixel FatBits). The Draw layer lets you create discrete objects that retain characteristics for easy repositioning and automatic scaling.

In both layers, you can set line width and line height (makes drawing fancy boxes a snap). You can zoom an image and hide the palettes for unencumbered full-screen editing. Circles, rectangles, and other shapes can be drawn either by choosing corner points or by starting from a center point and selecting a radius. If you want to work larger than screen size, all tools scroll the image automatically. Filling a hollow area with a pattern is now limited only by your selection, not by the boundaries of the screen. Finally, for precise control, you can "nudge" an image one screen dot at a time in any direction. You can print either layer independently or print both simultaneously after choosing which layer should appear "on top."

The hottest new feature of SuperPaint is called LaserBits, which lets you edit an image at the 300-dots-per-inch resolution of standard laser printers rather than the Mac's 72-dpi FatBits resolution. LaserBits images are stored as separate files that are incorporated into your artwork at output time.

Reactions? As I've mentioned, this product blows away MacPaint, MacDraw, and FullPaint, and does it for a reasonable price. It does *not* threaten ComicWorks; there are just too many things in that product that SuperPaint isn't intended to do. ComicWorks has layout and object-editing tools outside the scope of SuperPaint, but it's a tougher program to learn and use.

*continued*

For IBM® PC's, XT's, AT's and other DOS machines. This is the one you've heard so much about — with faster compile times than many COBOL compilers costing hundreds of dollars more! It's based upon ANSI-74 standards. Now comes standard with source code programs demonstrating full screen, cursor control, color, reverse video, etc., another program shows how to even reprogram your keyboard and much more.

Don't let our mail order prices fool ya! This is a new improved version of our best selling COBOL compiler previously offered at \$300.00 a copy. Look at the December 1979 issue of Byte Magazine for one of our first COBOL ads!

Other outstanding values at \$39.95 are: Utah FORTRAN, Utah BASIC, Utah PASCAL, Utah PILOT and Utah EDIT. Used by 50,000 professionals, students, and teachers in 40 countries.

To order:  
(702) 827-3030

IBM is a registered trademark of International Business Machines.

SINCE 1977  
ELLIS COMPUTING™

Ellis Computing, Inc. • 5655 Riggins Court, Suite 10 • Reno, Nevada 89502



# Attention Lotus users: This \$79.95 reducing program can save you a ton.

We hate fat files. Specifically, those little porkers from Lotus 1-2-3, Symphony and V.P. Planner. That's why Synex Systems developed SQZ!™ for us. It squeezes the daylight out of your spreadsheet files. By up to 95%. That means you can get up to 95% of your used disk space back. And save 95% on communications. Right now.

With SQZ!, a 360K floppy can hold 3 megabytes of worksheets. A 10 megabyte hard disk turns into 100 megs. Now you can say goodbye to floppy bills and inconvenience. Not to mention floppy wait (SQZ! can speed up spreadsheet loading from floppies by as much as 50%). And, you can forget spending all that money on a higher capacity hard drive. You save time, space and trouble. For only \$79.95. Sound too good to be true? Read on.

## Picture the Technology.

The secret to SQZ! is an amazing data compaction technology that was originally used for image processing. That's the high tech word for looking at an entire picture and breaking it down into like components to make it smaller and easier to handle. Anyway, think of a spreadsheet as a picture, group the blanks and characters together and voila.

*"SQZ!: Soon to be essential . . . SQZ! looks like it will become an indispensable utility every serious spreadsheet user will want."*

—Business Software, June 1986

*"SQZ! does a marvelous job of making a Lotus user's available disk space appear to grow."*

—PC Week, June 1986

*Nominated for the 1986 PC Magazine award for technical excellence.*

Available at better dealers everywhere



**Turner Hall Publishing**

Inquiry 303

A division of Symantec

10201 Torre Avenue • Cupertino, CA 95014

SQZ! is a trademark and Note-It is a registered trademark of Turner Hall Publishing. Lotus, Symphony and 1-2-3 are registered trademarks of Lotus Development Corp. Other brand and product names are trademarks of their respective holders.

Your data just got skinny. Image processing has proven the technique to be extremely reliable (remember the clarity of Jupiter pictures sent millions of miles by the Voyager spacecraft?). Now, SQZ! brings this maximum compaction and reliability to Lotus users. It's actually quite simple. And devastatingly effective.

What wasn't quite as simple was hiding it from you . . . that is, making SQZ! squeeze and unsqueeze files without any action from the user. But we did it. So when you load SQZ!, Lotus loads right

along with it (taking up only 30K more memory space). Then, when you call up a worksheet, SQZ!

unsqueezes it from the disk and pulls it into memory as usual. When you save it, the file's squeezed automatically. Now exit Lotus, and SQZ! goes away too. And you get 30K of memory back. That's all there is to it. It's like getting another hard disk. For \$79.95.

If this sounds similar to what some other software

companies are telling you about their squeezers, don't be fooled. The most they can reduce a 1-2-3 file is 20%. At best. Compare that with our 95%. There's really no comparison.

## Squeeze Your Phone Bill.

And there's more. SQZ! has a communications option that actually reformats spreadsheets so they can be sent through electronic mail services that don't support binary file transfer. And because these files are squeezed, they take less time to send. 80%-90% less. So a spreadsheet that might normally take 20 minutes (and cost \$20) now goes in less than three. For only three bucks.

## Your Main SQZ!.

Call us today. We'll zip you out a copy of SQZ! right away. Then, if for any reason you're not happy with it or us, send SQZ! back. We'll refund your money. No questions asked.

**1-800-556-1234 x527**  
**(In CA 800-441-2345 x527)**

# SQZ!™

**The Data Squeezer for Lotus**

Please send me \_\_\_\_\_ copies of SQZ! at \$79.95, plus \$2.00 shipping. (\$12 outside USA). CA residents add \$5.60 sales tax.  I enclose  
 VISA  MasterCard  AMEX  Diners Club

Card # \_\_\_\_\_ Exp. Date \_\_\_\_\_

Name \_\_\_\_\_

Company \_\_\_\_\_

Address \_\_\_\_\_

City/State/Zip \_\_\_\_\_

Phone ( ) \_\_\_\_\_



**SUNDAY 10-5**

**PROMPT DELIVERY**

**COMPUTERS, PRINTERS, DISK DRIVES, MODEMS, MONITORS, ACCESSORIES, FURNITURE & EXPERIENCE**

**GUARANTEED LOWEST PRICES**

**COMPUTER: 1-800-874-1235**

**VIDEO: 1-800-223-6779**

**COMPUTER: 1-800-2828**

**VIDEO: (718) 237-2828**

**S'nW ELECTRONICS & APPLIANCES**

**633 Bedford Ave, Bklyn, NY 11211**

**HOURS: Mon-Thurs 9-6**

**Fri 9-2, Sun 10-5, Sat. Closed**

**TOLL FREE OUT OF N.Y.**

**IN N.Y. CALL (718) 237-2828**

**C.O.D. Accepted**

**Credit Card Accounts charged at time of order**

**• Add shipping hand. ins. • Prices subject to change without notice**

**• Qty limited • Not responsible for typographical errors**

APPLICATIONS ONLY

*I find myself doing my final tweaking with SuperPaint.*

What I find myself doing is using ComicWorks to create complex paintings, saving them in MacPaint format, and then doing my final tweaking with SuperPaint. The LaserBits option makes this diddling all worthwhile; I've used it to prepare a couple of pieces that I've dumped out to a QMS PS-800 printer, and the results have been spectacular.

**A Real Dog**

Supposedly an educational game for the Mac, **Puppy Love** (Addison-Wesley, \$19.95) purports to teach structured programming techniques by using the analogy of training a dog. You wait until an animated puppy performs a maneuver on the screen, hit the space bar, and type in a name for the trick. Then you type the name again, and if the dog repeats the trick, you click a bone-shaped icon—he's learned it. The program keeps track of the tricks by listing them in a "journal." How does this teach programming? Well, you can build complex tricks by writing them into the journal, for example, "a double whammy is two backflips followed by a pirouette." You can even use conditional branching and Boolean logic: "IF the squirrel is on the screen DO pirouettes UNTIL it leaves, ELSE do somersaults." When you've taught the dog five tricks, you go to the dog show and try to win prizes; that's the game aspect. Once the mongrel has mastered a routine and won a ribbon, he starts displaying new maneuvers, which you can add to his little performances. The idea is to make the "programs" more complex as you advance from one level to the next.

To be blunt, I think **Puppy Love** is insipid, boring, badly designed, and not particularly educational. It is impossible to tell what age group the program is aimed at; there is no recommendation on the package or in the manual. I'd guess at early elementary school from the content, but the manual is printed in teeny type and uses words like "choreography."

Operations are not intuitive (Why do you use the space bar rather than the mouse to signal that you want to name a trick?), and you *must* read the manual to get the hang of it because there is no on-line help. The documentation is a flimsy pamphlet printed on cheap newsprint paper, easy to lose and not very kidproof; one spilled glass of fruit juice and the

*continued*

**Choose Power Commander II<sup>®</sup> Computer Power Control Center for appearance, convenience, and, above all, protection.**



Tele-Line™ protection for modems, answering machines, etc.

Anti-Static Touchplate grounds hazardous static

Power Minder™ warning light for momentary sags and surges

Automatic Over-voltage Protection against damaging high line voltage

Overcurrent protection with resettable circuit breaker

- Simplifies on/off operations of computer and four peripherals, individually with 5 lighted switches, or all together with a master switch; ends power cord confusion and tangles
- Protects your equipment from data disturbances and damage from transient surges caused by lightning and utility switching; unique hybrid filtering circuit responds to clamp spikes in 5 picoseconds, 1000 times faster than typical surge suppressors!
- Low let-through voltage—less than 300 V.
- Reduces EMI/RFI noise from power lines and power supply cords
- Patented failsafe Automatic Shutdown protection cuts off all power if the

protective filtering circuit wears out or burns out, so your computer is never vulnerable to unprotected operation\*.

- Five outlets, 15 Amp total. 12-foot power cord. Attractive putty color case. Five-year warranty.

Insist on complete protection... with the Number One rated Perma Power Power Commander II<sup>®</sup>, at computer stores and office supply dealers nationwide.

\*Patent No. 4,577,578

**PERMA POWER<sup>®</sup> Electronics Inc.**

5601 West Howard Avenue • Chicago, Illinois 60648  
Telephone (312) 647-9414 Telex: 4948559 PRMPWR



# Exercise Your Subroutines On Our Simulator.

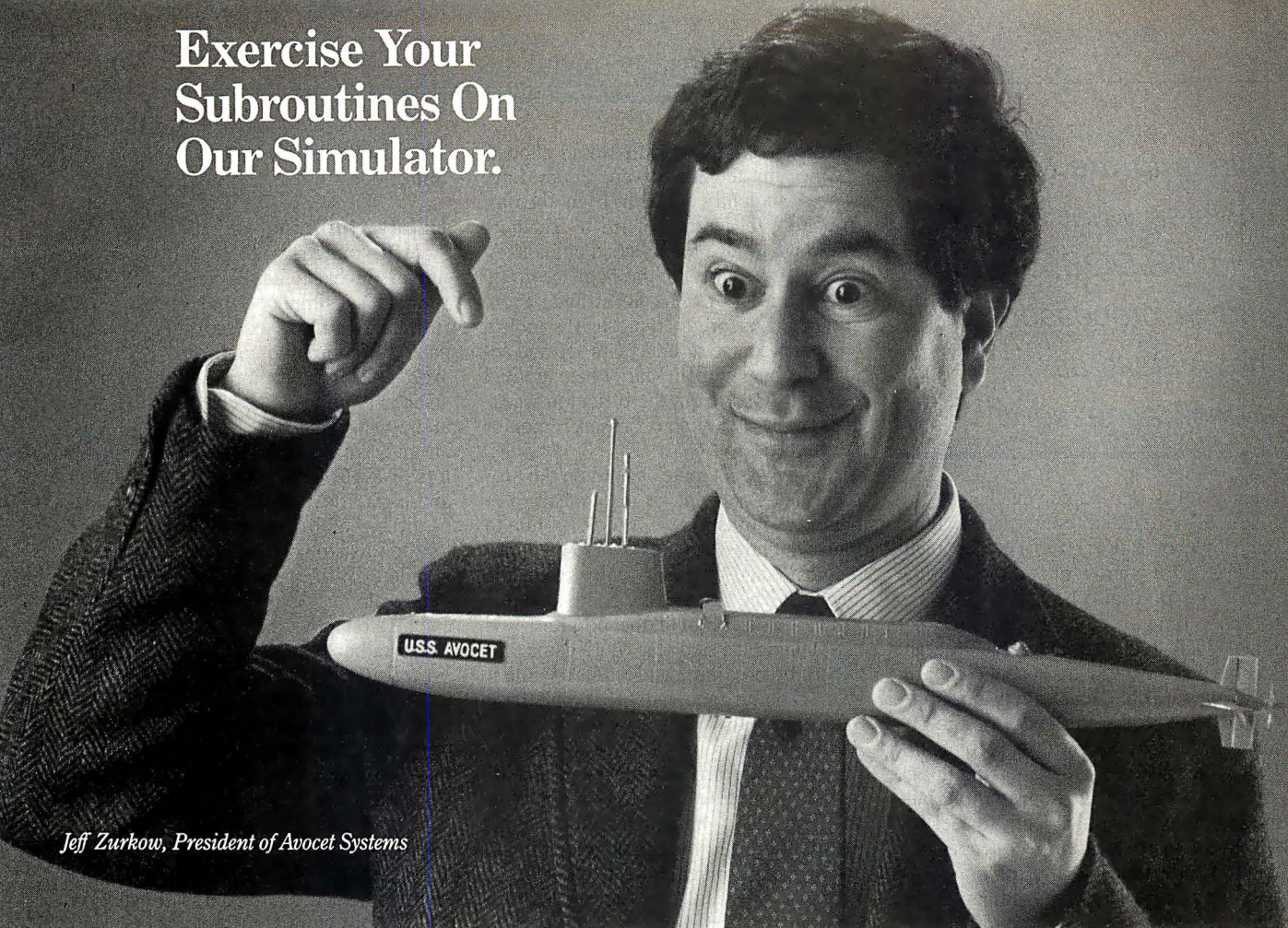

Jeff Zurkow, President of Avocet Systems



Avocet offers an entire line of low-cost microprocessor development tools.

### Target Microprocessor Families Supported

1802/1805	68000/68010	COP400
6502/65C02	68020	HD64180
6801/6301	8048/8041	NEC 7500
6804	8051	TMS-32010
6805/6305	8085	TMS-32020
6809	8096	Z8
68HC11	F8/3870	Z80

### Host Operating Systems

CP/M DOS VAX Unix VAX VMS

### AVMAC Macro

Assemblers .....from \$349

AVSIM Simulator/

Debuggers .....from \$299

Other Development

tools .....Call for full catalog

### AVSIM eliminates bugs without sinking a big investment.

Stop blasting EPROMS just to see if your code is debugged. Avocet has the best way to test microprocessor code on your PC or VAX. We call it AVSIM, the simulator/debugger. Each AVSIM package provides detailed software simulation of a family of CPU's. Check the chart—the one you need is probably just a phone call away.

### Fully interactive, so you'll never crash beneath the surface.

All code generated by Avocet's assemblers can be loaded and exercised interactively, with all the features you need to catch bugs. And you won't have to worry about crashing AVSIM with a program fault. Whether it's a jump to non-existent memory, a stack overflow or an unexpected interrupt, AVSIM traps them all. And then it lets you undo instructions until you find what went wrong.

Call **800-448-8500** or 207-236-9055. TELEX 467210 AVOCET CI. FAX 207-236-6713.

Avocet Systems Inc., 120 Union St.  
P.O. Box 490, Rockport, ME 04856

### From the best family of PC tools for microprocessor development.

We've been developing software for PC's since before there *were* PC's. Avocet has developed a reputation for technical excellence and great service. From assemblers to EPROM programmers to debugging tools, we've been expanding your development capabilities without torpedoing your budget.

### Try before you buy. And we'll ship in less than 48 hours.

You probably need your AVSIM simulator/debugger right away. And that's when you'll get it. When you order it, we'll also send you a complete demonstration kit for the simulator and our AVMAC macro assembler. Try the demo for thirty days—if you aren't completely satisfied, we'll refund your purchase price, less \$35.00 for the demo disk. That's yours to keep, which is a good deal by itself!

So come aboard with Avocet. Our crew is experienced, knowledgeable and helpful. After all, you know the old saying, "Accept no sub-stitutes."

# AVOCET

SYSTEMS, INC.



**Acta is to the Mac  
universe what Ready!  
is to MS-DOS: a simple  
outline processor  
that installs as  
a desk accessory.**

manual turns into papier-mâché.

I'm also irritated by the underlying philosophy of Puppy Love. The documentation explains that while you're training your dog, you'll also be learning how to do "cool computer stuff" (their words, not mine). Well, if the authors of the program assume that kids want to do cool computer stuff, why not just teach them programming? I fail to see the need for this intermediate step, and we've all seen the PBS specials showing the amazing things kids can do with real programming languages. Why do adults seem to feel it's necessary to oversimplify concepts that children are quite capable of grasping? And what about creativity, imagination, the thrill of inventing something that's *yours*, and all those good things? No room for them here; all you get to do is organize events into sequences. The dog can't do anything that isn't preordained.

Finally, what kid with normal drives and interests is going to sit there trying to make this animated mutt do stupid tricks when he or she could be playing a video game or watching *The A-Team* on

the tube? I know which *I* would choose.

Since my feelings toward Puppy Love were so violently negative, I sent the program off to Jeremy Stein, a friend in Washington, DC, for a second opinion. At 14, Jeremy is closer to the right age group than I am, and I think his attitude about computers is pretty typical. He took a computer course several years ago and enjoys playing with a Mac when his dad brings it home from the office on weekends, but he's not an obsessed computer nerd.

Jeremy wasn't quite as hard on the program as I was, but he also wasn't particularly enthusiastic. "It took a while to figure out how to make it work," he commented, "and it didn't really teach me anything. The graphics are good, though." When I asked him if the program was entertaining, he said that "it's a game, not a learning program" and "after a while it gets a little bit annoying." He didn't think that many kids would ever want to play the program through to the end. Jeremy was also concerned with the issues of utility and portability. "You can't use it to do anything else," he complained. "With BASIC and Logo you can do more things, and on many computers." He guessed that Puppy Love would be acceptable for children between 6 and 8; beyond that, kids would either find the program "too young" or they'd be too advanced for it.

So Puppy Love gets real low marks. I actively dislike the product; Jeremy merely wouldn't waste his time playing the game. When I voiced my opinion to Lynne Bolduc at Addison-Wesley, she told me the product had been selling like wildfire and that A-W's booth at computer shows had

been swamped by *adults*. Makes you think, doesn't it?

### Handy Outlining

**Acta** (Symmetry, \$79.95) is to the Mac universe what Ready! is to the MS-DOS scene. It's a simple outline processor that installs as a desk accessory. As such, it can't be compared to More, Microsoft Word 3.0, or ThinkTank 512; it's just too small and limited to be classed with stand-alone programs. But it's handy to have around, particularly if you're chewing up lots of RAM with your main application and can't afford to use Switcher and one of the big outliners. Acta is just fine for "to do" lists or document annotations or simple card filing, and it will hold MacPaint graphics as well as text. File export can be a bit annoying; if you use the clipboard rather than the full "Save as MacWrite," you'll lose type attributes, though you will retain outline indentations. Formatting options are limited, and you'll probably want to massage your output with a word processor. But all in all, it's a decent implementation of the concept.

### Treasure Trove

If you use either Microsoft Excel or Works on the Mac, you should get your hands on the catalogs from Heizer Software (5120 Coral Court, Concord, CA 94521, (415) 827-9013). The company sells a huge assortment of effective, low-cost templates and macros for Excel, ranging from biorhythm calculators to statistical analysis macros to full payroll and accounting systems. Most items are between \$5 and \$20; the most expensive offering is a collection of personal finance tools at \$96, and the payroll package is a whopping \$67. Nothing here is especially miraculous, but it sure beats having to build this stuff on your own.

The Works templates are sold as four volumes of 12 items at \$50 per set, grouped as Tutorial, Small Business, Utility, and Personal Productivity.

Ray Heizer runs his business as an exchange or clearinghouse. Let's say you've written a macro that calculates missile trajectories. You think your product would be useful for others, but you're hesitant to become a part-time software publisher. Ray checks out your work, then you and he set a price for it and it goes into a catalog. Heizer Software takes care of marketing and distribution, and the two of you split the take. It's a nice alternative to shareware, and judging by the scope and size of the catalogs, it works.

I've seen two disks' worth of samples, and I'm impressed. Ray Heizer is obviously a perfectionist; everything is polished and professional. Get copies of the catalogs and see what you think. ■

## Items Discussed

<b>Acta</b> .....\$79.95 Symmetry Corporation 761 East University Dr. Mesa, AZ 85203 (602) 844-2199	<b>Puppy Love</b> .....\$19.95 Addison-Wesley Inc. Route 128 Reading, MA 01867 (617) 944-3700
<b>GraphicWorks</b> .....\$79.95 artwork disk only .....\$19.95 Mindscape Inc. 3444 Dundee Rd. Northbrook, IL 60062 (312) 480-7667	<b>SuperPaint</b> .....\$99 Silicon Beach Software Inc. 9580 Black Mountain Rd., Suite E San Diego, CA 92126 (619) 695-6956
<b>Highways and Byways</b> .....\$49.95 three-region set .....\$129.95 New Directions Software 5259 Sepulveda Blvd., #9 Van Nuys, CA 91411 (818) 784-9354	<b>Volkswriter Deluxe Plus</b> .....\$99 Lifetree Software Inc. 411 Pacific St. Monterey, CA 93940 (408) 373-4718



# We've taken the work out of doing Windows.

Microsoft® Windows is becoming the most popular operating environment for PC systems.

It's not surprising. Windows provides the foundation for an exciting new generation of applications that users are demanding. In addition, Windows handles many of the details involved in a software project allowing you to spend more time enhancing your application. That's why a growing number of corporate and independent software developers are building Windows applications.

The Microsoft Windows Software Development Kit is your key to this extraordinary new environment. It's packed with full reference documentation, libraries, utilities and sample programs. Together with our C Compiler or Macro Assembler, it's a comprehensive package that lets you make the most of your application.

## Software with a new view.

Giving your applications the Windows treatment begins with a new look. The rich graphical environment allows you to rethink how you want your program to be presented on screen. It lets you mix text and graphics. You can incorporate multiple fonts in a variety of sizes, faces and styles. And it provides the basic building blocks that make it easy to create drop-down menus, dialog boxes, scroll bars, icons and more.

These features not only simplify your application design, but also provide the familiar interface that makes your software easier to learn and use.

## Easing the data shuffle.

Of course, there's more to Windows than just looks. Now, different applications can work together. In concert.

The Windows Clipboard provides support for users to cut and paste information between your applications and others. Or you can use messages to establish "hot links" to transfer data automatically.

## Upgrading made easy.

Windows' device independent design allows you to build your application today and take advantage of new technology as it becomes available. When new graphics cards, printers and pointing devices appear they can be used with your software, without modifying your code. Simply by installing the new driver.

## Your window of opportunity.

The Microsoft Windows Software Development Kit is your fastest route to better applications. And with it, we also offer DIAL, our on-line technical support service to help you with the tough questions, and development courses that cover everything from using the dialog editor to memory management.

Find out how you can get your Microsoft Windows Software Development Kit. Pick up the phone and call (800) 426-9400. In Washington State and Alaska, call (206) 882-8088. In Canada, call (416) 673-7638. And we'll open the door to Windows.

### The Microsoft Windows Software Development Kit includes:

- ♦ Dialog editor.
- ♦ Icon editor.
- ♦ Font editor.
- ♦ Resource compiler.
- ♦ Linker.
- ♦ MAKE (program maintenance utility).
- ♦ Symbolic debugger.
- ♦ Heap analysis utility.
- ♦ Sample programs.
- ♦ Windows libraries.
- ♦ Programmer's reference.
- ♦ Programmer's utility guide.

### System requirements:

- ♦ 512K memory, DOS 2.0 or higher.
- ♦ Two double sided disk drives.\*
- ♦ Graphics adapter card.

\*hard disk recommended

# Microsoft® Windows Software Development Kit

The High Performance Software.

Microsoft is a registered trademark of Microsoft Corporation.



# The Amazing A-BUS

**NEW**

## Plug into the future

With the A-BUS you can plug your PC (IBM, Apple, TRS-80) into a future of exciting new applications in the fields of control, monitoring, automation, sensing, robotics, etc.

Alpha's modular A-BUS offers a proven method to build your "custom" system today. Tomorrow, when you are ready to take another step, you will be able to add more functions. This is ideal for first time experimenting and teaching.

A-BUS control can be entirely done in simple BASIC or Pascal, and no knowledge of electronics is required!

An A-BUS system consists of the A-BUS adapter plugged into your computer and a cable to connect the Adapter to 1 or 2 A-BUS cards. The same cable will also fit an A-BUS Motherboard for expansion up to 25 cards in any combination.

The A-BUS is backed by Alpha's continuing support (our 11th year, 50000 customers in over 60 countries).

The complete set of A-BUS User's Manuals is available for \$10.

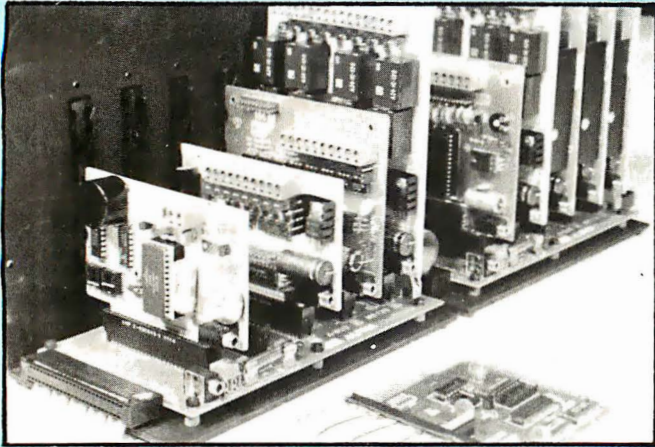

An A-BUS system with two Motherboards  
A-BUS adapter (IBM) In foreground

### About the A-BUS:

- All the A-BUS cards are very easy to use with any language that can read or write to a Port or Memory. In BASIC, use INP and OUT (or PEEK and POKE with Apples and Tandy Color Computers)
- They are all compatible with each other. You can mix and match up to 25 cards to fit your application. Card addresses are easily set with jumpers.
- A-BUS cards are shipped with power supplies (except PD-123) and detailed manuals (including schematics and programming examples).

#### Relay Card

RE-140: \$129

Includes eight industrial relays, (3 amp contacts, SPST) individually controlled and latched. 8 LED's show status. Easy to use (OUT or POKE in BASIC). Card address is jumper selectable.

#### Reed Relay Card

RE-156: \$99

Same features as above, but uses 8 Reed Relays to switch low level signals (20mA max). Use as a channel selector, solid state relay driver, etc.

#### Analog Input Card

AD-142: \$129

Eight analog inputs. 0 to +5V range can be expanded to 100V by adding a resistor. 8 bit resolution (20mV). Conversion time 120us. Perfect to measure voltage, temperature, light levels, pressure, etc. Very easy to use.

#### 12 Bit A/D Converter

AN-146: \$139

This analog to digital converter is accurate to .025%. Input range is -4V to +4V. Resolution: 1 millivolt. The on board amplifier boosts signals up to 25 times to read microvolts. Conversion time is 130ms. Ideal for thermocouple, strain gauge, etc. 1 channel. (Expand to 8 channels using the RE-156 card).

#### Digital Input Card

IN-141: \$59

The eight inputs are optically isolated, so it's safe and easy to connect any "on/off" devices, such as switches, thermostats, alarm loops, etc. to your computer. To read the eight inputs, simply use BASIC INP (or PEEK).

#### 24 Line TTL I/O

DG-148: \$65

Connect 24 input or output signals (switches or any TTL device) to your computer. The card can be set for: input, latched output, strobed output, strobed input, and/or bidirectional strobed I/O. Uses the 8255 A chip.

#### Clock with Alarm

CL-144: \$89

Powerful clock/calendar with: battery backup for Time, Date and Alarm setting (time and date); built in alarm relay, led and buzzer; timing to 1/100 second. Easy to use decimal format. Lithium battery included.

#### Touch Tone® Decoder

PH-145: \$79

Each tone is converted into a number which is stored on the board. Simply read the number with INP or POKE. Use for remote control projects, etc.

#### A-BUS Prototyping Card

PR-152: \$15

3½ by 4½ in. with power and ground bus. Fits up to 10 I.C.s

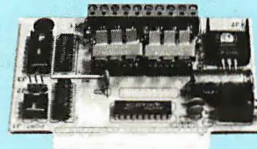

ST-143

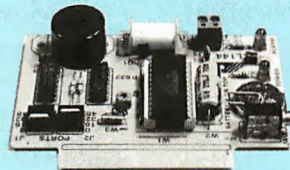

CL-144

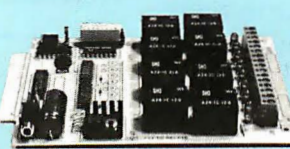

RE-140

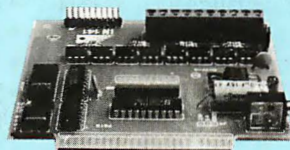

IN-141

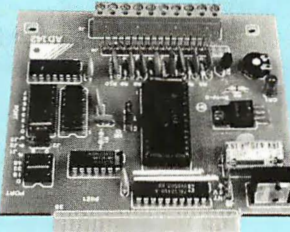

AD-142

### Smart Stepper Controller SC-149: \$299

World's finest stepper controller. On board microprocessor controls 4 motors simultaneously. Incredibly, it accepts plain English commands like "Move arm 10.2 inches left". Many complex sequences can be defined as "macros" and stored in the on board memory. For each axis, you can control: coordinate (relative or absolute), ramping, speed, step type (half, full, wave), scale factor, units, holding power, etc. Many inputs: 8 limit & "wait until" switches, panic button, etc. On the fly reporting of position, speed, etc. On board drivers (350mA) for small steppers (MO-103). Send for SC-149 flyer.

#### Remote Control Keypad Option RC-121: \$49

To control the 4 motors directly, and "teach" sequences of motions.

#### Power Driver Board Option PD-123: \$89

Boost controller drive to 5 amps per phase. For two motors (eight drivers).

#### Breakout Board Option BB-122: \$19

For easy connection of 2 motors. 3 ft. cable ends with screw terminal board.

### Stepper Motor Driver ST-143: \$79

Stepper motors are the ultimate in motion control. The special package (below) includes everything you need to get familiar with them. Each card drives two stepper motors (12V, bidirectional, 4 phase, 350mA per phase). **Special Package: 2 motors (MO-103) + ST-143: PA-181: \$99**

### Stepper Motors MO-103: \$15 or 4 for \$39

Pancake type, 2¼" dia, ¼" shaft, 7.5°/step, 4 phase bidirectional, 300 step/sec. 12V, 36 ohm, bipolar, 5 oz-in torque, same as Airpax K82701-P2.

### Current Developments

Intelligent Voice Synthesizer, 14 Bit Analog to Digital converter, 4 Channel Digital to Analog converter, Counter Timer, Voice Recognition.

### A-BUS Adapters for:

IBM PC, XT, AT and compatibles. Uses one short slot	AR-133...\$69
Tandy 1000, 1000 EX & SX, 1200, 3000. Uses one short slot	AR-133...\$69
Apple II, II+, IIe. Uses any slot	AR-134...\$49
TRS-80 Model 102, 200. Plugs into 40 pin "system bus"	AR-136...\$69
Model 100. Uses 40 pin socket. (Socket is duplicated on adapter)	AR-135...\$69
TRS-80 Mod 3,4,4 D. Fits 50 pin bus. (With hard disk, use Y-cable)	AR-132...\$49
TRS-80 Model 4P. Includes extra cable. (50 pin bus is recessed)	AR-137...\$62
TRS-80 Model I. Plugs into 40 pin I/O bus on K8 or E/I.	AR-131...\$39
Color Computers (Tandy). Fits ROM slot, Multopak, or Y-cable.	AR-138...\$49

### A-BUS Cable (3 ft, 50 pin cond.) CA-163: \$24

Connects the A-BUS adapter to one A-BUS card or to first Motherboard.

### Special cable for two A-BUS cards: CA-162: \$34

### A-BUS Motherboard MB-120: \$99

Each Motherboard holds five A-BUS cards. A sixth connector allows a second Motherboard to be added to the first (with connecting cable CA-161: \$12). Up to five Motherboards can be joined this way to a single A-BUS adapter. Sturdy aluminum frame and card guides included.

Add \$3.00 per order for shipping.  
Visa, MC, checks, M.O. welcome.  
NY residents add sales tax.  
C.O.D. add \$3.00 extra.  
Canada: shipping is \$5  
Overseas add 10%



**ALPHA Products**  
a division of Sigma Industries, Inc.  
7904-B Jamaica Avenue, Woodhaven, NY 11421

Technical info: (203) 656-1806  
Orders only: 800 221-0916  
Except in NY  
New York orders: (718) 296-5916  
All lines open weekdays 9 to 5 Eastern time



# Journeys

Bruce Webster

*A further look  
at the Apple IIGS, FORTH tools,  
and updates*

It's early November as I write this . . . and I'm glad that I can sit here and do just that. When I came downstairs a while ago to continue working on this column, I discovered that my office door was locked and shut. Un-

fortunately, the key to that door is missing, and the only other entrance—a window—can't be opened from the outside. It took me 25 minutes and an assortment of tools to get in. Actually, all I needed was a screwdriver and a hammer, but I didn't discover that until some 22 minutes into my efforts. Reminds me of the time I borrowed my parents' car to drive from San Diego to Los Angeles to visit Herr Doktor Pournelle. I was low on gas when I got to L.A. and pulled into a gas station, only to discover that the gas cap had a lock and I had no key for it. But that's another story.

After having stayed around home for the last few months, I'm in the middle of a series of trips. Last week I attended the Apple IIGS Developers Conference in San Jose, followed by the Hackers' Conference in the mountains west of Saratoga. Tomorrow I leave for the Amiga Developers Conference in Monterey, and the week after that is COMDEX in Las Vegas. I'm not complaining, mind you—just a bit harried in trying to take care of other matters between trips.

## Apple IIGS Revisited

As mentioned, I attended the IIGS Developers Conference, learned more about how the IIGS works, and saw more of what it can do. Result: I think more of the machine than I did a month ago. I have been concerned that the lack of page flipping or relocation for the super hi-res modes would be a hindrance to high-performance graphics, and there's no question (even by the designers) that the IIGS would have been better off with at least a second super hi-res graphics page. Even so, I saw some impressive graphics demonstrations that reassured me that the IIGS was not as handicapped as I thought. Also, I learned that the IIGS upgrade for the Apple IIe is just a motherboard swap: For \$500, you get a brand-new off-the-shelf IIGS motherboard, as well as a new metal pan with the appropriate ports in the back. Since there are a million or two IIe machines out there, I suspect Apple is going to sell a lot of those upgrades.

I directly questioned a number of the engineers about certain design decisions. Three major answers tended to surface: lack of time, lack of margin, and lack of foresight. As happens in just about any design project, many ideas were brought up and discussed, but the production schedule was too tight to allow implementation. Others were discarded because of added cost to the base unit. And some came up too late in the design cycle to be incorporated. The IIGS did not start out as the IIGS; it started out as a smaller and somewhat enhanced IIe, and some

aspects (such as the super hi-res mode) were almost afterthoughts. It was only later that the emphasis on high-quality graphics came into play, and by then other design constraints limited what changes the engi-

neers could make to the machine.

The conference itself was well organized, well attended, and well worth the time and money. Sessions were held discussing each of the major aspects of the IIGS: hardware, ROM routines, operating system, development software, marketing, and so on. Handouts galore were given, and some 11 (yes, 11) volumes of technical documentation are being sent to each attendee. Apple's propensity for homemade videos (usually slick slide-based presentations, with some adapted rock song for background) manifested itself in no fewer than five different videos; they also presented the current flock of Apple II and Macintosh commercials.

One particular high point of the conference was the after-lunch talk by Jean-Louis Gasee, Apple's vice president of marketing. Gasee is a candid, entertaining speaker who enjoys throwing out one-liners and highly quotable statements. He spoke freely not only of the IIGS but also of the Macintosh and of the directions in which both were going. His most memorable quote (which may have come from someone else; he gave no attribution): "Work at some level must be a celebration of the human spirit."

That comment summarizes Apple's apparent efforts and direction. I came away from the conference extremely impressed at how well organized and directed Apple is on just about every level. The folks at Apple have a clear idea of what markets they want to go after, what products they will go there with, and just how they will get there. The TV advertisements (by Apple's new ad agency, BBDO) were impressive and effective; I wouldn't be surprised to see a few Clio winners in the bunch. The best word to summarize my impressions of Apple is "professional," in its most positive sense. And they seem to be having a lot of fun doing what they're doing.

If I sound effusive, it's because seeing a company that has its collective act this much together is rare in this industry, and a bit intoxicating. This, of course, could just be a front and Apple might be falling apart internally, but I don't really think so. I think they have learned from past mistakes and are doing a lot of things right. Of course, I still think the IIGS is terribly overpriced, but I suspect market conditions will adjust that, just as they have for the IIe, the Macintosh, the LaserWriter, and so

*continued*

*Bruce Webster, a consulting editor for BYTE, can be reached via BYTE, P.O. Box 1910, Orem, UT 85057, or on BIX as bwebster.*



# FEATURES STANDARD WITH US, OTHERS DON'T EVEN OFFER AS OPTIONS.

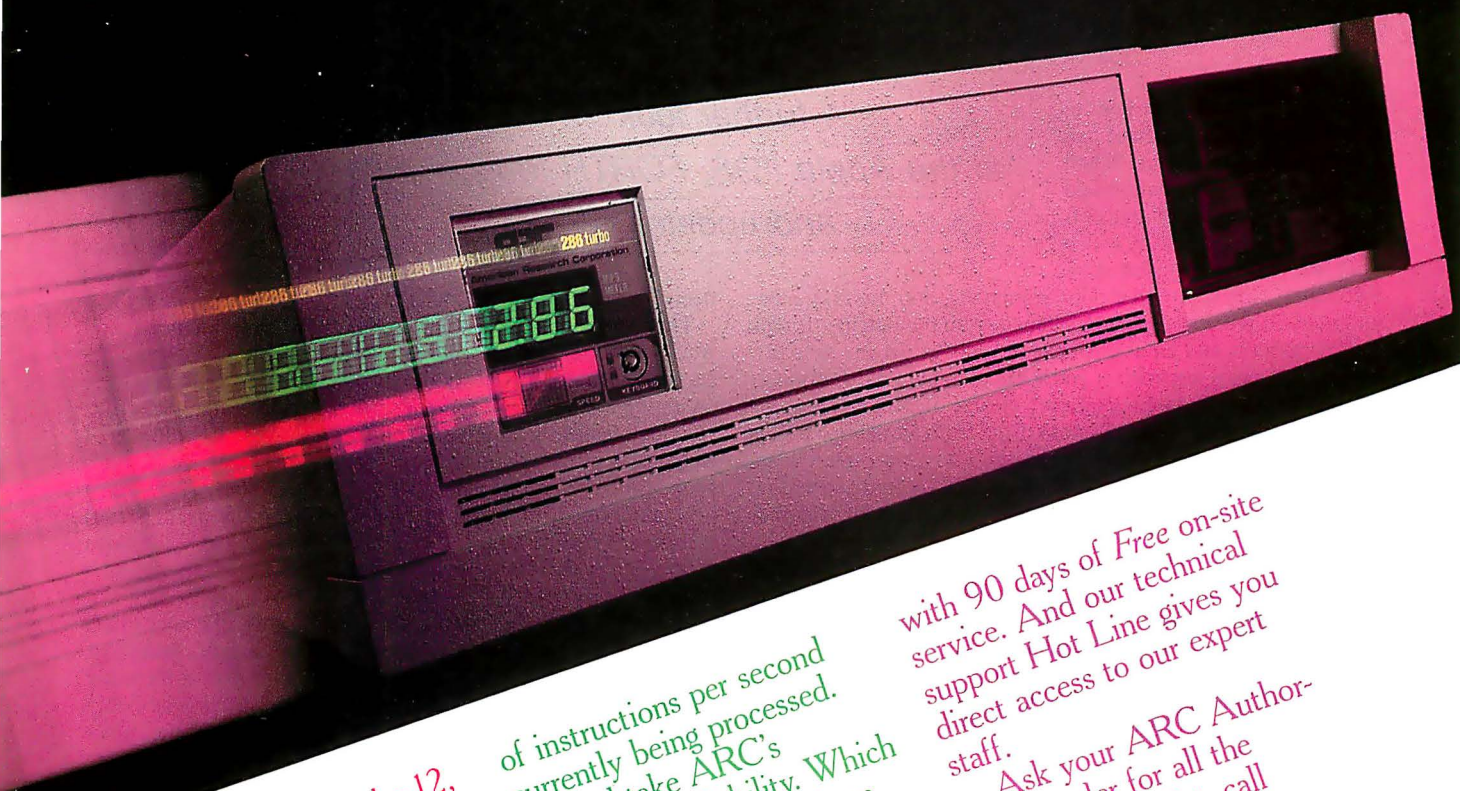

Take our ARC Turbo 12,  
for example.

Take its speed. The fastest  
off-the-shelf AT™ compati-  
ble you can buy. (12.5 MHz,  
50% faster than IBM.™)

Take the ARC Turbo 12's  
exclusive MIPS Meter,  
which gives you a digital  
read out of the actual  
number of millions

of instructions per second  
currently being processed.

And take ARC's  
unmatched reliability. Which  
is what you'd expect from  
one of the fastest growing  
computer manufacturers.

We back our equipment  
with a two-year limited  
warranty, the longest in the  
industry. Each  
unit also comes

with 90 days of Free on-site  
service. And our technical  
support Hot Line gives you  
direct access to our expert  
staff.

Ask your ARC Author-  
ized Dealer for all the  
details. (For a list, call  
800-654-6151.)

It's a fast world. With  
ARC, it won't pass you by.



**ARC** American  
Research  
Corporation



ACCORDING TO WEBSTER

on. I think Apple will do very well indeed for the next year or two.

**IIGS Technical Note: Dithering**

As has been mentioned before, the IIGS in its highest-resolution mode (640 by 200) has 4 to 16 colors available. In that mode, each byte represents four pixels; each pixel comprises 2 bits. Those 2 bits yield a value from 0 to 3, which is used to look up the color (a 12-bit value) in the current palette. But the palette actually has 16 entries, in order to deal with 320 by 200 mode. So some clever engineer at Apple, not wanting the other 12 locations in the palette to go to waste, designed things so that the first pixel in a byte (highest 2 bits) indexes locations 0 through 3 in the palette; the next pixel (next 2 bits) indexes locations 4 through 7; the next, locations 8 through 11; and the last, locations 12 through 15. The first pixel of the next byte then indexes back to locations 0 through 3 again. Each group of four colors is called a minipalettes.

Well, some of the engineers at Apple—most notably Arthur W. Cabral—discovered that if you used one set of colors for the minipalettes of the even pixels and another set for the minipalettes of the odd colors, you ended up with a consistent mix of 16 colors in super hi-res (640 by 200) mode. This is because of a technique known as dithering. It works because of the combination of side-by-side colors in even and odd pixels.

You might think that the effective horizontal resolution is back down to 320 pixels, since it takes two pixels to make each color. That's right in part, but since text is in black and white, your horizontal resolution for text is only one dot per pixel, and you can get more than 80 columns of text on the screen. The result is that you can have a 16-color display mixed with 80-column text.

What should the minipalettes be? The even ones (0-3, 8-11) should be black, red, green, and white; the odd ones (4-7, 12-15) should be black, blue, yellow, and white. The values of those colors in the palette are (in hexadecimal) black 0000, blue 000F, green 00F0, yellow 0FF0, red 0F00, and white 0FFF.

You can, of course, adjust those shades to come up with different palettes. Also, you can switch to different palettes for different scan lines. I'd be interested to see what you would get if you used different palettes on alternating scan lines.

**IIGS Development Tools**

I was happy to see representatives from several firms that produce compilers and the like at the IIGS Conference. I have yet to get my hands on any development tools for the IIGS, but I thought I could at least point those of you with interests to the appropriate firms.

First, you should be aware that Apple is developing an Apple IIGS Programmers Workshop (APW) as a parallel to the Mac Programmers Workshop (MPW). APW defines link and object code formats, standard libraries, and so on. It currently includes an assembler (ORCA-16) and a C compiler (from Megamax); a Pascal compiler is planned, but it is uncertain as to who will produce it. Since APW has set some standards, the different compilers and assemblers should produce relatively compatible code.

Bill and Ann Duvall (as well as Jay Friedman) of Consulair Corporation were there. Consulair already has a Mac-to-IIGS assembler/linker that allows you to write and assemble your 65816 programs on a Mac, then transfer the object code over to the IIGS. The price is \$195, and it comes with no licensing fees. Since the IIGS is currently hard to come by (and more expensive than a comparably equipped Mac Plus), a product like this makes sense. This way, a development house can get by with just one IIGS as long as it has sufficient Macintoshes for the

*continued*

# VP-Planner®

- ❖ A spreadsheet that's keystroke, file, and macro compatible with 1-2-3® Rel. 1A.
- ❖ Exclusive Multi-dimensional Database.
- ❖ Includes 40 new commands and functions not found in 1-2-3.
- ❖ Autokey captures keystrokes and turns them into macros.
- ❖ Smooth and flexible interface to dBASE II® and III® files.
- ❖ Sparse matrix memory management for larger worksheets in less RAM.
- ❖ Non-copy-protected backup disk available.

## A GREAT DEAL more.

For the 256K IBM® PC and compatibles.

Only **\$99<sup>95</sup>**

**Paperback Software® International**

2830 Ninth Street  
Berkeley, CA 94710  
(415) 644-2116

VP-Planner and Paperback Software International are registered trademarks of Paperback Software International. 1-2-3 is a registered trademark of Lotus Development Corporation. dBASE II and dBASE III are registered trademarks of Ashton-Tate. IBM is a registered trademark of International Business Machines Corp.

# SOFTWARE SENTINEL™

**MUCH MORE THAN JUST PROTECTION**

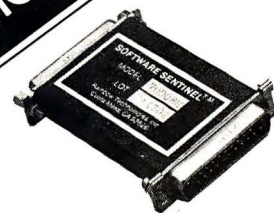

Stop unauthorized use of software...and keep your customers happy at the same time. The no-interference hardware keys from the industry's leading supplier put money in your pocket and save you from angry customer complaints. Our product line includes devices for either parallel or serial port. The latest addition allows you to **cover multiple programs with one device and/or customize as needed.** Call for new low prices.

**SOFTWARE DEVELOPER BENEFITS**

- Prohibits unauthorized use of software
- No need for copy protection
- Algorithm technique (never a fixed response)
- Virtually unbreakable
- Higher level language interfaces included
- 100 times faster (1ms) than fixed response devices
- Minimal implementation effort
- Runs under DOS and Xenix, on IBM PC, AT, XT & compatibles

**SOFTWARE USER BENEFITS**

- Unlimited backup copies
- No floppy required with hard disk
- Pocketsize
- Transparent
- Transportable

**EVALUATION KIT AVAILABLE**



17971 SKYPARK CIRCLE SUITE E, IRVINE, CA 92714 (714)261-0228  
Telex 386078



# Six great reasons to join **BIX** today

- **Over 140 microcomputer-related conferences:**

Join only those subjects that interest you and change selections at any time. Take part when it's convenient for you. Share information, opinions and ideas in focused discussions with other BIX users who share your interests. Easy commands and conference digests help you quickly locate important information.

- **Monthly conference specials:**

BIX specials connect you with invited experts in leading-edge topics—CD-ROM, MIDI, OS-9 and more. They're all part of your BIX membership.

- **Microbytes daily:**

Get up-to-the-minute industry news and new product information by joining Microbytes Daily and What's New Hardware and Software.

- **Public domain software:**

Yours for the downloading, including programs from BYTE articles and a growing library of PD listings.

- **Electronic mail:**

Exchange private messages with BYTE editors and authors and other BIX users.

- **Vendor support:**

A growing number of microcomputer manufacturers use BIX to answer your questions about their products and how to use them for peak performance.

## What BIX Costs . . . How You Pay

ONE-TIME REGISTRATION FEE: \$25

Hourly Charges: (Your Time of Access)	Off-Peak 6PM-7AM Weekdays Plus Weekends & Holidays	Peak 7AM-6PM Weekdays
BIX	\$9	\$12
Tymnet*	\$2	\$6
<b>TOTAL</b>	<b>\$11/hr.</b>	<b>\$18/hr.**</b>

\* Continental U.S. BIX is accessible via Tymnet from throughout the U.S. at charges much less than regular long distance. Call the BIX helpline number listed below for the Tymnet number near you or Tymnet at 1-800-336-0149

\*\* User is billed for time on system (i.e., 1/2 Hr. Off-Peak w/Tymnet = \$5.50 charge)

BIX and Tymnet charges billed by Visa or Mastercard only.

## BIX HELPLINE

(8:30 AM-11:30 PM Eastern Weekdays)

U.S. (except NH)—1-800-227-BYTE

Elsewhere (603) 924-7681

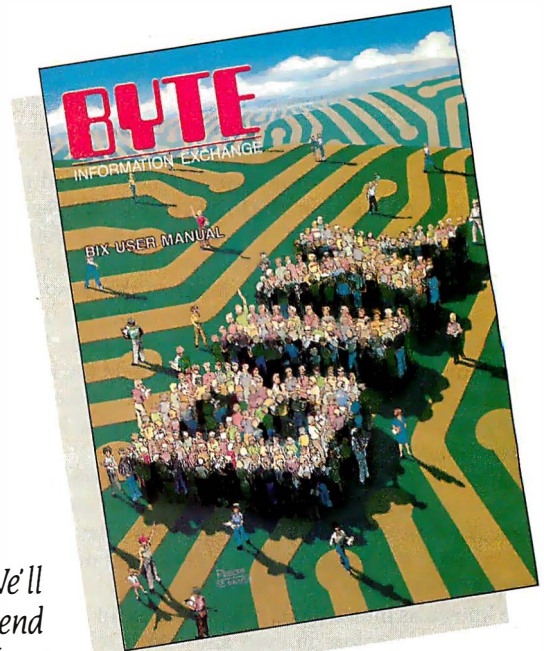

We'll  
Send  
You a

BIX User's Manual and Subscriber Agreement  
as Soon as We've Processed Your Registration.

JOIN THE EXCITING WORLD  
OF BIX TODAY!

## JOIN BIX RIGHT NOW:

Set your computer's telecommunications program for full duplex, 8-bit characters, no parity, 1 stop bit OR 7-bit characters, even parity, 1 stop using 300 or 1200 baud.

Call your local Tymnet\* number and respond as follows:

### Tymnet Prompt

Garble or "terminal identifier"  
login:  
BIX Logo—Name:

### You Enter

a  
bix <CR>  
new <CR>

After you register on-line, you're immediately taken to the BIX learn conference and can start using the system right away.

## FOREIGN ACCESS:

To access BIX from foreign countries, you must have an account with your local Postal Telephone & Telegraph (PTT) company. From your PTT enter 310600157878. Then enter bix <CR> and new <CR> at the prompts. Call or write us for PTT contact information.

# BIX

ONE PHOENIX MILL LANE  
PETERBOROUGH, NH 03458  
(603) 924-9281



ACCORDING TO WEBSTER

programmers. Consulair is working on a Mac-to-IIGS C compiler, possibly with dual-machine debugging via the serial ports. Look for a full report when I get my hands on something.

Megamax was also represented, and it announced two Mac-to-IIGS compilers, C and Pascal, for \$500 each. The spec sheet says that both will support disassembly, in-line assembly, and dual-machine debugging. Requirements are a 512K-byte Mac with two floppies and a IIGS with one (3½-inch) floppy. Again, more info as products come in.

Tom Leonard of TML Systems showed up, announcing TML Pascal for the IIGS. Unlike the other firms' products, his compiler runs directly on the IIGS. It requires 512K bytes of RAM and a 3½-inch (800K-byte) floppy and is APW-compatible. The cost is only \$125. Tom claims a high degree of compatibility with TML Pascal for the Mac, which could make ports moderately painless. Inspired by the competition, TML is considering releasing a Mac-to-IIGS cross-development version as well.

Lastly, H.A.L. Labs announced Lisa 816, a native IIGS assembler. The specification sheet was a little sparse on details, but it did indicate full 65816 support, with APW compatibility "to be implemented." The cost is nice at \$50.

**Product of the Month: MacFORTH Plus**

Because of the popularity of the three major 68000-based systems (Macintosh, Atari ST, Amiga) among hackers and developers, many firms that produce compilers and interpreters are working to bring out their products on all three machines... a welcome trend for programmers who have to port programs from one machine to another. Some have parallel development systems for MS-DOS computers, and (as mentioned above) a few are expanding to cover the Apple IIGS. I'll be covering those firms and their products, and I'll start this month with Creative Solutions Inc., owned by Don and Christine Colburn.

MacFORTH was the second programming language (and first true development system) available on the Macintosh. It was mentioned in my BYTE review of the Macintosh (August 1984), and my first programming article for BYTE was a go board written in MacFORTH (November 1984). Given how long it took for other native development systems to emerge on the Mac, MacFORTH might have become widely used, but for a few problems. First, FORTH is an arcane language, revered by those who use it and shunned by just about everyone else; the standard line is, "FORTH isn't a language—it's a religion!" On top of that, CSI was requiring stiff licensing fees. In short, developers were asked to pay a lot to use a language they didn't understand. CSI eventually dropped the licensing fee, but by then several C compilers had been released (few of which required fees), and C became the dominant native development language on the Mac. Of course, it would have anyway, but MacFORTH might have had a larger share.

Despite the miscues, CSI is still here and is going strong. Don Colburn, who is chief programmer at CSI, has continued to improve MacFORTH while developing FORTH systems for the Atari ST and the Commodore Amiga. The result is a trio of products: MacFORTH Plus, MultiFORTH for the ST, and MultiFORTH for the Amiga. The continuity of design is evident in the documentation and in the products themselves.

MacFORTH Plus is the latest revision of MacFORTH, which has gone through three levels (I, II, and III) and several versions. It replaces all previous versions and levels and has extensions and performance improvements over all of them. The environment is like a Mac: mice, menus, multiple windows. A built-in Mac-style editor produces regular text files, unlike the traditional block-oriented FORTH files (though you can produce those instead, if you really insist). One window is your regular FORTH command-line window; you can open up to three other

*continued*

# VP-Info™

- ◆ Fully relational database with record locking for multi-user applications.
- ◆ Compatible with dBASE II® and III® data files.
- ◆ Built-in compiler for fast execution.
- ◆ Versatile report and screen generator.
- ◆ 93 commands and functions not found in dBASE III.
- ◆ Non-copy-protected backup disk and low-cost run-time available.
- ◆ 107 commands and functions not found in dBASE II.

## A GREAT DEAL more.

For the 256K IBM® PC and compatibles.

Only **\$9995**

**Paperback Software® International**

2830 Ninth Street  
Berkeley, CA 94710  
(415) 644-2116

VP-Info is a trademark and Paperback Software is a registered trademark of Paperback Software International. dBASE II and dBASE III are registered trademarks of Ashton-Tate. IBM is a registered trademark of International Business Machines Corp.

## Expansion Chassis/Tape Back-up

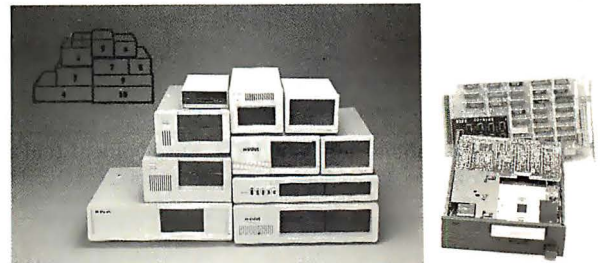

### Specification

Model No.	No. of Slot	Space for ½ Height Drive	Power Supply (Watts)	Dimension D×W×H(cm)	Price
M-1*	0	1	50	30×15×6.5	\$139
M-2	3	3	100	42×25×16	\$299
M-3	5	3	100	39×30×15	\$239
M-4	12	2	100	40×49×14	\$299
M-5	0	2	45	39×18×15	\$149
M-6	0	1	50	26.5×18×13.5	\$169
M-7	5	2	100	38.5×30×13.5	\$299
M-8	0	2	45	39.5×18×13.5	\$149
M-9	0	2	60	38.5×49×9	\$249
M-10	8	4	135	43×49×14	\$239

\* Extra space for a stand alone controller

EXT and RCV Adapters (Interfacing Computer & Chassis With Slots)...\$149

Tape Back-up (With Controller & Cable)...\$499

**ORDER TOLL FREE: (800) 826-0267**  
**In California Call (408) 434-0877**  
**SOURCE ELECTRONICS CORP.**

2380 Qume Drive, Suite E  
San Jose, CA 95131

Telex: 279366

Fax: (408) 434-0539



# FORTRAN PROGRAMMERS

LCS ANNOUNCES F77L LAHEY FORTRAN VERSION 2.20  
WE JUST MADE OUR TOP RATED FORTRAN LANGUAGE SYSTEM BETTER.

*"Lahey's F77L FORTRAN is the compiler of choice. It's definitely a 'Programmer's FORTRAN,' with features to aid both the casual and the professional programmer . . . F77L compiled the five files in a total of 12 minutes, which was 4 times as fast as MS FORTRAN and an astounding 6 times as fast as Pro FORTRAN..."*

—Editor's Choice PC Magazine

## HERE ARE JUST A FEW OF THE REASONS WHY F77L IS THE COMPILER OF CHOICE:

- Full Implementation of the ANSI 77 Standard
- Fast Compilation—outruns everything on the market
- Powerful Multi-Featured Source On-Line Debugger
- Popular Extensions for easy porting of mainframe and mini computer programs (Including NAMELIST)
- Recursion—allocates local variables on the stack
- Arrays and COMMONS greater than 64K
- Clear and Precise English Diagnostics
- Long Variable Names—Up to 31 Characters
- COMPLEX\*16, LOGICAL\*1 and INTEGER\*2
- IEEE Standard Floating Point
- Compatibility with popular third party software
- Unmatched Technical Support with an on-line bulletin board

## NEW FEATURES WITH VERSION 2.20:

- Cross reference and source listings
- Allocation maps of COMMON variables and arrays
- In-line comments
- IMPLICIT NONE compiler option
- Faster Execution
- Source On-Line Debugger (SOLD) includes:  
Trace Execution; No Relinking required;  
On-screen Listing; No effect on code size

Call about our New F77L development tools:  
Lahey Profiler Mathematical Functions Library Overlay Linker

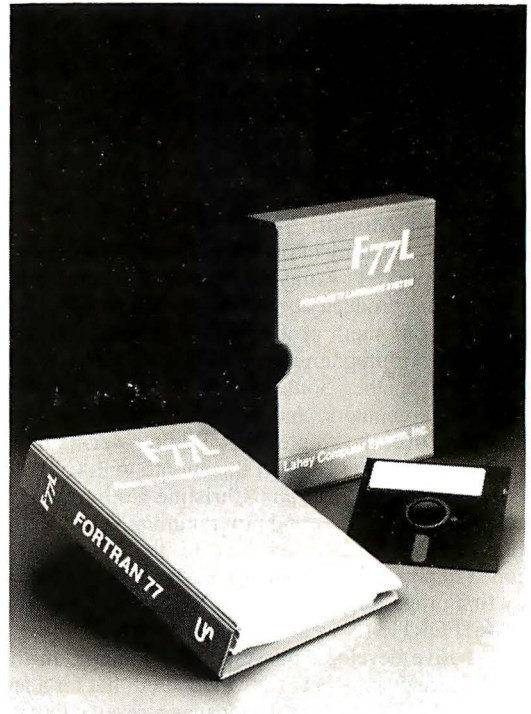

It is more than just features that make F77L an outstanding product; it is the years of experience behind the software. At Lahey Computer Systems, we have been developing FORTRAN compilers since 1967 and we are committed to keeping F77L the industry leader.

When *PC Magazine* selected our version 1.35 as the Editor's Choice among PC FORTRANs, we were pleased but not completely satisfied—we knew we could improve the product. F77L Version 2.20 increases our lead over the competition. F77L's precise diagnostics, advanced debug package, helpful user screens and comprehensive manual make it a complete and easy to use high productivity tool.

When evaluating any software package, an important factor to consider is the value of your time. F77L saves you time and

money the moment you start using it. Our FORTRAN Language System has the key features you need to increase productivity and get the job done. Other PC FORTRANs may be cheaper than F77L, but none are less expensive to use.

## F77L—THE PROGRAMMER'S FORTRAN

Price: \$477.00 Includes Free UPS 2nd Day shipping.  
System Requirements: MS-DOS or PC-DOS (2.0 or greater).  
256K. math coprocessor (8087-80287)

TO ORDER OR FOR MORE INFORMATION:  
**702-831-2500**



**Lahey Computer Systems, Inc.**  
P.O. Box 6091, Incline Village, NV 89450  
Telex: 9102401256

## International Representatives:

Canada: Barry Mooney & Assoc., Tel. (902)6652941 • England: Grey Matter Ltd. Tel. (0364)53499 • Switzerland: DST Comp. Services, Tel. (022)989188  
Denmark: Ravenholm Computing, Tel. (02)887249 • Australia: Comp. Transitions, Tel. (03)5372786 • Japan: Microsoft Inc., Tel. (03)8138222

MS-DOS & MS FORTRAN are trademarks of Microsoft Corporation. Pro FORTRAN refers to IBM PC Professional FORTRAN by Ryan McFarland



ACCORDING TO WEBSTER

windows for editing source files. The most useful menu command is Save and Include, which saves the contents of the current editing window out to disk, then compiles that file into MacFORTH Plus so you can test it. If you want to compile just a portion of the file, you can select the code, then press the Enter key. Incidentally, the source code of the editor (which was written by David Sibley using MacFORTH Plus) is included, so you can modify and extend it yourself.

MacFORTH Plus gives you access to the Mac Toolbox and operating system, but it hides a lot of the overhead from you. Event handling, menus, windows, graphics, and other aspects have been simplified through some high-level routines that do a lot of the grunt work for you. For example, listing 1 shows a complete program. It defines and creates a new window (named SHEET). The routine TRACE.FINGER (known in FORTH parlance as a word) draws dots as you hold down the button and move the mouse around. The word FINGER.PAINT does all the event handling needed. The final command (SHEET ON.ACTIVATE FINGER.PAINT) associates the routine FINGER.PAINT with the window SHEET, so that FINGER.PAINT will be executed whenever you click on SHEET. Those of you who have programmed the Mac in other languages will appreciate just how much is being done for you here.

Don Colburn has added some extensions to his FORTH implementation to aid the programmer. You can define local variables within a word's definition. These variables pull their values off the stack as they are referenced. This not only reduces the headache of keeping the stack straight during execution, it actually improves performance and reduces code size in many cases. You can easily declare data structures (equivalent to records or structs) thanks to a number of predefined words. You can even declare multiform structures, which are similar to Pascal's variant records or C's unions.

A 68000 assembler is also part of the package. This is not an assembler in the traditional sense. Instead, it is a set of MacFORTH commands that allow you to directly compile 68000 instructions into your program, using a reverse Polish notation (RPN) syntax, mnemonics, and special key words.

True floating-point numbers are implemented, using the Standard Apple Numeric Environment (SANE) routines on the Mac. You can toggle between having integers (32-bit fixed point) or floating-point values on the stack.

If you've been wondering, yes, you can create stand-alone (turnkey) applications using MacFORTH Plus. The result is an executable file that can be run without MacFORTH Plus. You can also snapshot your working environment, so that you can avoid having to pull in and compile the same language extensions each time you go into MacFORTH.

Another feature of MacFORTH Plus is that it offers multitasking. This was possible (with some hacking) in earlier versions; here, it's fully documented and supported. The demo program, for example, loads in and runs several other programs, each as a separate task within its own window. All are active simultaneously; you can drag the windows around or resize them, and the tasks continue to run.

Perhaps the best feature of MacFORTH Plus is the manual. It is large (450 pages), softbound, and highly readable. It is well written and takes a tutorial approach, with a light sense of humor and lots of short sample programs. It devotes eight chapters to teaching you how to use the Mac Toolbox routines from within MacFORTH Plus and (wisely) does not assume that you own and understand *Inside Macintosh*. I have only two complaints with the manual, both minor. First, it's hard to get it to lie flat without using heavy objects to weigh down one side or the other. Second, as often happens with FORTH-related works, it gets a bit zealous at times about the virtues of FORTH, while gloss-

continued

# VP Expert™

- ◆ Rule-based Expert System Development Tool.
- ◆ Inductive Front End for fast and easy prototyping.
- ◆ Intelligent access to worksheets and database files.
- ◆ Backward and forward chaining with confidence factors.
- ◆ Run other programs from within expert systems.
- ◆ Text and graphic tracing for easy development.
- ◆ Non-copy-protected backup and run-time disks available.

## A GREAT DEAL more.

For the 256K IBM® PC and compatibles.

Only **\$9995**

**Paperback Software® International**

2830 Ninth Street  
Berkeley, CA 94710  
(415) 644-2116

VP-Expert is a trademark and Paperback Software is a registered trademark of Paperback Software International. IBM is a registered trademark of International Business Machines Corp.

## Little Board™/186 High Performance, Low Cost PC-DOS Engine

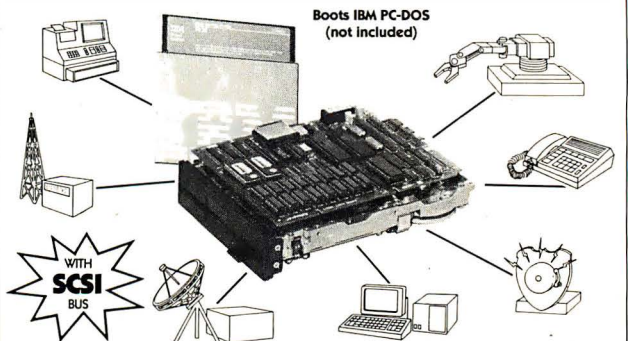

- Three times the COMPUTING POWER of a PC
- Data and File Compatible with IBM PC, runs "MS-DOS generic" programs
- 8 MHz 80186 CPU, DMA, Counter/Timers, 128/512K RAM, zero wait states, 16-128K EPROM
- Mini/Micro Floppy Controller (1-4 Drives, Single/Double Density, 1-2 sided, 40/80 track)
- 2 RS232C Serial Ports (50-38, 400 baud), 1 Centronics Printer Port
- Only 5.75 x 7.75 inches, mounts directly to a 5-1/4" disk drive
- Power Requirement: +5VDC at 1.25A; +12VDC at .05A; On board -12V converter
- SCSI/PLUS™ multi-master I/O expansion bus
- Software Included:
  - PC-DOS compatible ROM-BIOS boots DOS 2.x and 3.x
  - Hard Disk support
- OPTIONS:
  - Expansion board with:
    - 128 or 512K additional RAM
    - 2 Sync/Async RS232/422 serial ports
    - Battery backed Real Time Clock
    - 8087 Math Co-Processor
    - Buffered I/O Bus
    - STD Bus Adapter
    - Utilities source code
    - TurboDOS / Networking

**AMPRO**  
COMPUTERS, INCORPORATED

IBM®, IBM Corp.; 80186®, Intel, Corp.; Turbo DOS®, Software 2000, Inc.

67 East Evelyn Ave. • Mountain View, CA 94041 • (415) 962-0230 • TELEX 4940302



ing over some of the drawbacks. Even so, this manual is among the best I've seen (and I've had to wade through quite a few).

MacFORTH Plus lists at \$299, but there is an upgrade policy for any registered owners of the original MacFORTH versions. Level I owners can upgrade for \$129, Level II owners for \$49, and Level III owners for \$35. The software is unprotected, and there are no licensing fees for commercial products. Instead, CSI makes the standard request that you acknowledge in the program and the documentation that your program was written using MacFORTH Plus. Technical support is provided via newsletters, telephone, and a CSI/FORTH conference on CompuServe (type "GO FORTH" to get there).

MacFORTH Plus has come a long way since the original product I received back in April 1984. I am no FORTH expert, but I suspect it represents one of the finest FORTH development environments on any system. The price is probably too high to encourage casual investigation by purchasers, who might want to look at Mach II FORTH (which costs around \$100). Those of you who can afford it, though, would probably be best off going with MacFORTH Plus.

### MultiFORTH

MultiFORTH for the Amiga uses the same basic kernel as MacFORTH Plus, but it (obviously) has different extensions to let you use system and ROM routines. The user interface is more along the lines of the traditional FORTH; pull-down menus are not used, though the FORTH environment is within a window that you can resize and drag around the screen. For that matter, the multitasking nature of the Amiga operating system allows you to launch MultiFORTH as a separate task (run MultiFORTH). You can then switch back and forth between MultiFORTH and the regular Amiga command-line interface (CLI). However, since MultiFORTH allows you to directly execute any CLI command with the sequence `CLI command`, and since common CLI commands (such as `DIR` and `CD`) are directly implemented, you may not need a separate CLI window.

Like MacFORTH Plus, MultiFORTH/Amiga is set up to work

with regular text files (though it, too, can use traditional FORTH block files). The system disk comes with ED, Amiga's standard screen-oriented editor. You might want to consider replacing it with something else; I use TxEd from MicroSmiths Inc. Once I invoke TxEd (using the command `cli run e`), I resize it to the upper half of the screen—since TxEd does use menus—and resize the MultiFORTH command window to the lower half. I can then edit a source file in the TxEd window, save it out to disk, click in the MultiFORTH window, load the source code into MultiFORTH, and test it. Since TxEd can spawn additional tasks of itself, I can have multiple source files open at the same time, switching between each and MultiFORTH by moving the mouse to that window and clicking. That way, I can build an environment similar to, though not quite as convenient as, MacFORTH Plus.

MultiFORTH/Amiga has the same basic extensions as MacFORTH Plus: locals, structures, assembler, snapshots, turnkey applications, and so on. Floating-point capabilities are implemented by an extension file that makes use of the fast floating-point (FFP) library on the Amiga. Multitasking is supported via the Amiga operating system rather than through MultiFORTH itself.

MultiFORTH/Amiga doesn't have the powerful housekeeping routines for the Amiga to parallel those offered by MacFORTH for the Macintosh Toolbox and OS. In fact, not all library calls are specifically implemented. For many library calls, you must use a generic "call library routine" word, passing values to and from it via the 68000 registers.

MultiFORTH for the ST was implemented by Greg Guerin. It is similar to the Amiga version in many respects but is even less Mac-like. It has no menus or windows and is completely command-line-oriented. The editor it comes with—MicroEMACS—is screen-oriented and makes no use of the mouse. It has all the features and extensions of MultiFORTH/Amiga (locals, structures, etc.), and it has the same types of limitations on calls to GEM routines: not all are directly implemented, but

*continued*

**Listing 1:** A sample program in MacFORTH Plus. (This program is based on a listing appearing in the MacFORTH Plus manual and is used here with permission.)

```

NEW.WINDOW SHEET                                \ define new window
" Finger Paint Window" SHEET W.TITLE           \ set title
40 40 200 200 SHEET W.BOUNDS                  \ set bounds
CLOSE.BOX SIZE.BOX + SHEET W.ATTRIBUTES      \ set attributes
SHEET ADD.WINDOW                               \ create the window

: TRACE.FINGER ( -- ) \ define routine; nothing expected on stack
  HIDE.CURSOR                                  \ turn off the cursor
  BEGIN STILL.DOWN WHILE                      \ while button is down...
    @MOUSEXY DOT                              \ draw a dot where mouse is
  REPEAT                                       \ end of loop
  SHOW.CURSOR ;                               \ turn cursor back on

: FINGER.PAINT ( activate flag ) \ define routine; flag on stack
  IF BEGIN                                     \ if activated, do loop
    DO.EVENTS                                 \ get event code
    CASE                                       \ handle events
      MOUSE.DOWN OF TRACE.FINGER ENDOF        \ draw if mouse down
      IN.SIZE.BOX OF ." Resized!" ENDOF      \ write message if resized
      IN.CLOSE.BOX OF 7 SYSBEEP ENDOF        \ beep if window closed
    ENDCASE                                   \ end case statement
  AGAIN                                       \ end loop
  ELSE ." Window deactivated!" THEN ;        \ if deactivated, write msg

SHEET ON.ACTIVATE FINGER.PAINT                \ pass activate flag to F.P

```



# THE DIRECT APPROACH ALWAYS PAYS OFF.



**\$1089**

**BASIC CD/286™** → Runs at 6/10MHz  
This basic system gives you the power-user speed of 10MHz plus 512K RAM, a 1.2 meg floppy drive, an AT-style keyboard, a full 192-watt power supply, a combined floppy/hard disk controller card, an 80287 math coprocessor socket, and a complete operations manual.

**\$1589**  
**COMPLETE MONOCHROME SYSTEM WITH 20 MEG**

This system adds a quality monochrome monitor, a Hercules compatible video card, and a 20 meg hard drive to the basic CD/286 system for a low total package price.



**\$2129**  
**COMPLETE EGA COMPATIBLE SYSTEM WITH 20 MEG**

This 10 MHz power-user package replaces the monochrome display with a superb high-resolution EGA-style monitor and a high-resolution EGA compatible video card (complete with 256K of video RAM)—the ultimate power user parlay.

**Multifunction Card**



- OK expandable to 384K
- Parallel port
- Serial port
- Clock/calendar

**\$99**

**20 MB Hard Disk Drive on a Card**



- Low power consumption
- 3½" hard disk
- Western Digital controller
- Easily installs in minutes

**\$395**

**EGA Card**



- 640x350, 16 colors
- 100% compatible with IBM EGA™ Card

**\$195**

**Intel Math Co-Processors**



- 8087-3 ..... **\$119**
- 8087-2 ..... **\$149**
- 80287-6 ..... **\$179**

**I/O Card**

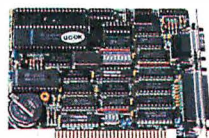

- Game port
- Parallel port
- Serial port (2nd optional)
- Clock/calendar

**\$75**



- EGA Monitor
- EGA Card
- 640x350, 16 colors
- 100% compatible with IBM EGA Card

**\$599**

Mitsubishi EGA Monitor ..... **\$449**

**Internal Modem**

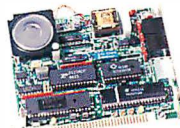

- 300/1200 Baud
- Fully Hayes compatible
- Built-in speaker

**\$119**

**External Modem \$119**



**IBM PC-AT \$2489**

- 256K RAM
- One 1.2 Meg floppy drive
- Dual floppy/hard drive controller

**IBM PC-XT \$1695**

- 256K RAM
- 1/360K floppy drive



**COMPAQ Portable \$1995**

- 20 Meg Hard Disk

**SPARE PARTS CORNER**

- 135W Power Supply ..... **\$65**
- XT Turbo Motherboard w/OK and Turbo Case ..... **\$99**
- Microsoft GW Basic™ 3.2 ..... **\$89**

**MonoGraphics Card**



- 720 x 348 resolution
- Hercules compatible
- Parallel port
- Serial port available as an option

**\$89**



→ 5160 AT Style Keyboard  
→ Made in USA **\$59**

**HERCULES™**

- Color Graphics Card w/parallel port ..... **\$155**
- Monochrome Graphics Card ..... **\$195**

**Floppy Disk Drive**

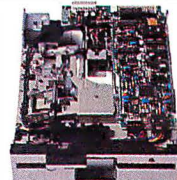

- Half Height
- DS/DD
- Black or AT gray **\$85**

**HARD DISK KITS**

- For IBM PC™**
- Half height hard disk
  - Western Digital controller
  - Cables and instruction manual
  - Boots from hard disk

- 20 Meg ..... **\$375**
- 10 Meg ..... **\$249**

**For IBM AT™**

- 40ms access time
- Full height hard disk
- Cables, mounting rails, and manual
- Boots from hard disk
- Uses AT controller (not included)

30 Meg Seagate for AT ..... **\$629**

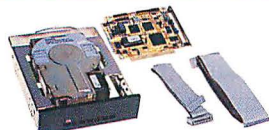

**For IBM PC™ \$459**

- Half height hard disk
- 30 Meg w/RLL controller

**For Compaq Portable**

- Cables
- Instruction Manual
- Software
- 3½" Shock Mounted Winchester Hard Disk
- Hard Disk Controller
- 20 Meg **\$389**



- LQ-800 ..... **\$609**
- LQ-1000 ..... **\$759**
- FX-85 ..... **\$395**



- AST Advantage!™ w/128K ..... **\$395**
- AST RAMPage!™ w/256K ..... **\$259**
- AST Six!ak™ w/384K ..... **\$189**

Computer Direct is committed to maintaining a very high level of customer satisfaction. Our sales representatives are available to answer any questions, provide advice or technical information, and arrange to deliver your computer equipment in a timely fashion.

**OUR POLICY**  
No minimum order. We accept VISA and MasterCard (no surcharge). Mail in money orders, certified checks, and personal checks (allow 10 days to clear); wire transfers, approved company/institutional purchase orders (Per Upon Receipt); C.O.D. (\$5.00 surcharge + cashier's check). All Continental U.S. orders are shipped UPS, ground at no charge. Shipments are fully insured. Next Day Air is available. Texas residents must add 6.125% sales tax. All products carry a One Year Limited Warranty on parts and labor. All returned merchandise must have a return authorization number. Prices are subject to change without notice. Call for latest price. A copy of our limited warranty is available upon request.

One year limited warranty. Visa and MasterCard accepted. UPS ground shipment prepaid in USA only. All brands are registered trademarks of their respective companies.

7801 North Lamar, Suite E-216, Austin, Texas 78752  
(512) 459-4199  
TOLL-FREE SALES CALLS, 1-800-225-5655  
FAX (512) 454-0986



Inquiry 63



# Announcing BYTE's New Subscriber Benefits Program

Your BYTE subscription brings you a complete diet of the latest in microcomputer technology every 30 days. The kind of broad-based objective coverage you read in every issue. *In addition*, your subscription carries a wealth of other benefits. Check the check list:

## DISCOUNTS

- ✓ 13 issues instead of 12 if you send payment with subscription order.
- ✓ One-year subscription at \$22 (\$20 off cover price).
- ✓ Two-year subscription at \$40
- ✓ Three-year subscription at \$58
- ✓ One-year GROUP subscription for ten or more at \$17.50 each. (Call or write for details.)

## SERVICES

- ✓ **BIX:** BYTE's Information Exchange puts you on-line 24 hours a day with your peers via computer conferencing and electronic mail. All you need to sign up is a microcomputer, a modem, and telecomm software. For further information call 1-800-227-BYTE.
- ✓ **Reader Service:** For information on products advertised in BYTE, circle the numbers on the Reader Service card enclosed in each issue that correspond to the numbers for the advertisers you select. Drop it in the mail and we'll get your inquiries to the advertisers.
- ✓ **TIPS:** BYTE's Telephone Inquiry System is available to

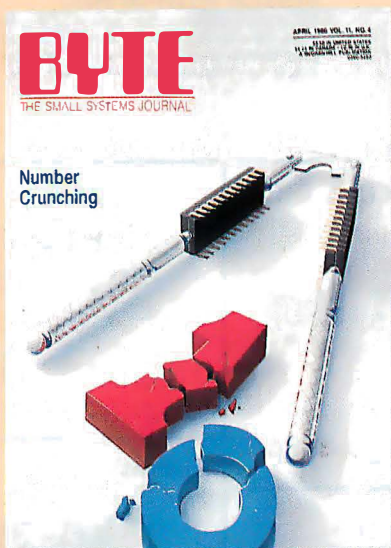

subscribers who need *fast response*. After obtaining your Subscriber I.D. Card, dial TIPS and enter your inquiries. You'll save as much as ten days over the response to Reader Service cards.

- ✓ **Program Listings:** Listings of programs that accompany BYTE articles are now available on BIX, on disks or in quarterly printed supplements (see reply cards in this issue), or call 1-800-258-5485.
- ✓ **Microform:** BYTE is available in microform from University Microfilm International in the U.S. and Europe.
- ✓ **BYTE's BOMB:** BYTE's Ongoing Monitor Box is your direct line to the editor's desk. Each month, you can rate the articles via the Reader Service card. Your feedback helps us keep up to date on your information needs.

- ✓ **Subscription Service:** If you have a problem with, or a question about, your subscription, you may phone us during regular business hours (Eastern time) at our toll-free number: 1-800-423-8912 (in N.J., 201-981-1963). You can also use Subscription Service to obtain back issues and editorial indexes.

## BONUSES

- ✓ **Annual Separate Issues:** In addition to BYTE's 12 monthly issues, subscribers also receive our annual IBM PC issue free of charge, as well as any other annual issues BYTE may produce.
- ✓ **BYTE Deck:** Subscribers receive five BYTE postcard deck mailings each year—a direct response system for you to obtain information on advertised products through return mail.

## TOLL-FREE NUMBERS FOR YOUR CONVENIENCE:

**Subscriptions & Back Issues:**  
1-800-423-8912  
(in N.J., 201-981-1963)

**BIX:** 1-800-227-BYTE

**Program Listings Orders:**  
1-800-258-5485

*And . . . welcome to  
BYTE country!*

**BYTE**  
THE SMALL SYSTEMS JOURNAL





Make a  
career move  
today...  
Subscribe to  
**BYTE** and  
stay on the  
leading edge  
of micro-  
computing  
technology.



For direct ordering  
call toll free weekdays  
9:00am-5:00pm  
E.S.T.:

**800-423-8912**

(in New Jersey:  
201-981-1963)

**OR**

Complete adjacent  
postcard and mail.

Note our special offer:  
*Send cash with your order  
and receive 13 issues at  
the price of 12 for each  
year you subscribe (North  
America only).*



**YES! I want to subscribe to **BYTE**  
and save \$20 off\* the cover price.**

U.S.  \$22.00 (1 yr.) \*Basic subscription rate  \$40.00 (2 yrs.)  \$58.00 (3 yrs.)  
 Canada/Mexico  Europe-Air Delivery  Worldwide-Surface Delivery  
 \$25.00 U.S. (1 yr.) \$69.00 U.S. (1 yr.) \$37.00 U.S. (1 yr.)

Enclose payment (check or credit card information) and get one extra issue for each year you subscribe (North America only).

- Bill me (North America only)  
 Payment enclosed (U.S. funds drawn on a U.S. bank only)  
 Charge to my  VISA  MasterCard



472TSX

Card # \_\_\_\_\_ Expires \_\_\_\_\_ Signature \_\_\_\_\_

Name \_\_\_\_\_

Address \_\_\_\_\_

City/State \_\_\_\_\_ Country \_\_\_\_\_ Code \_\_\_\_\_

Please allow 6-8 weeks for processing your subscription



**YES! I want to subscribe to **BYTE**  
and save \$20 off\* the cover price.**

U.S.  \$22.00 (1 yr.) \*Basic subscription rate  \$40.00 (2 yrs.)  \$58.00 (3 yrs.)  
 Canada/Mexico  Europe-Air Delivery  Worldwide-Surface Delivery  
 \$25.00 U.S. (1 yr.) \$69.00 U.S. (1 yr.) \$37.00 U.S. (1 yr.)

Enclose payment (check or credit card information) and get one extra issue for each year you subscribe (North America only).

- Bill me (North America only)  
 Payment enclosed (U.S. funds drawn on a U.S. bank only)  
 Charge to my  VISA  MasterCard



472TSX

Card # \_\_\_\_\_ Expires \_\_\_\_\_ Signature \_\_\_\_\_

Name \_\_\_\_\_

Address \_\_\_\_\_

City/State \_\_\_\_\_ Country \_\_\_\_\_ Code \_\_\_\_\_

Please allow 6-8 weeks for processing your subscription



**YES! I want to subscribe to **BYTE**  
and save \$20 off\* the cover price.**

U.S.  \$22.00 (1 yr.) \*Basic subscription rate  \$40.00 (2 yrs.)  \$58.00 (3 yrs.)  
 Canada/Mexico  Europe-Air Delivery  Worldwide-Surface Delivery  
 \$25.00 U.S. (1 yr.) \$69.00 U.S. (1 yr.) \$37.00 U.S. (1 yr.)

Enclose payment (check or credit card information) and get one extra issue for each year you subscribe (North America only).

- Bill me (North America only)  
 Payment enclosed (U.S. funds drawn on a U.S. bank only)  
 Charge to my  VISA  MasterCard



472TSX

Card # \_\_\_\_\_ Expires \_\_\_\_\_ Signature \_\_\_\_\_

Name \_\_\_\_\_

Address \_\_\_\_\_

City/State \_\_\_\_\_ Country \_\_\_\_\_ Code \_\_\_\_\_

Please allow 6-8 weeks for processing your subscription





NO POSTAGE  
NECESSARY  
IF MAILED  
IN THE  
UNITED STATES



**BUSINESS REPLY MAIL**

FIRST CLASS MAIL PERMIT NO. 39 MARTINSVILLE, NJ

POSTAGE WILL BE PAID BY ADDRESSEE

**BYTE** Subscriptions

PO Box 597  
Martinsville, NJ 08836-9956



NO POSTAGE  
NECESSARY  
IF MAILED  
IN THE  
UNITED STATES



**BUSINESS REPLY MAIL**

FIRST CLASS MAIL PERMIT NO. 39 MARTINSVILLE, NJ

POSTAGE WILL BE PAID BY ADDRESSEE

**BYTE** Subscriptions

PO Box 597  
Martinsville, NJ 08836-9956



NO POSTAGE  
NECESSARY  
IF MAILED  
IN THE  
UNITED STATES



**BUSINESS REPLY MAIL**

FIRST CLASS MAIL PERMIT NO. 39 MARTINSVILLE, NJ

POSTAGE WILL BE PAID BY ADDRESSEE

**BYTE** Subscriptions

PO Box 597  
Martinsville, NJ 08836-9956



Make a  
career move  
today. . .  
Subscribe to  
**BYTE** and  
stay on the  
leading edge  
of micro-  
computing  
technology.



For direct ordering  
call toll free weekdays  
9:00am-5:00pm  
E.S.T.:

**800-423-8912**

(in New Jersey:  
**201-981-1963**)

**OR**

**Complete adjacent  
postcard and mail.**

Note our special offer:  
*Send cash with your order  
and receive 13 issues at  
the price of 12 for each  
year you subscribe (North  
America only).*



you can build your own as needed. Floating-point numbers are not implemented in MultiFORTH/ST as of this writing; however, a new version is coming out that may include them.

The manuals for both the Amiga and ST versions are well written and extensive—typically more than 300 pages long. They are in three-ring loose-leaf binders that sit flat and are easy to update. Both use many of the same chapters, notably those that offer a simple tutorial on FORTH and those dealing with MultiFORTH features (chapters 4 through 12). Each manual has sections specific to each machine, listing the calls you can make, but little information is given on how to use them; instead, you are referred to the sample programs and the appropriate technical documentation for each machine. This is probably the single biggest difference between MacFORTH Plus and the MultiFORTH implementations.

Speaking of the manuals, I do find amusing the occasional attempts in the manuals to gloss over some of FORTH's drawbacks, or to even make them appear to be positive points ("That's not a bug, it's a feature!"). At one point, the manual strongly encourages comments and meaningful identifier names, noting how quickly poorly documented code becomes difficult to follow. It then states: "This is a problem characteristic of all programming languages." Maybe so, but most languages I've worked with have an intelligibility half-life measured in months or years, while that of FORTH is often measured in weeks. I have five-year-old undocumented Pascal listings that I can pick up and readily follow. By contrast, when I converted my go board program from MacFORTH to Pascal, I had a difficult time figuring out just what I had been doing, even though I had heavily commented the source and it had been only a few months since I had written it. I should point out that I had previously spent a year or so programming in FORTH for a former employer; I was (and am) not a FORTH expert, but neither was I a novice.

Don Colburn and the others at CSI have worked hard to make MultiFORTH more accessible to those not familiar with block-oriented text files and RPN calculators. They wisely point out FORTH's greatest strengths: the ability to rapidly prototype programs and to extend the language itself. They've created a development environment that makes it easy to switch from the Mac to the Amiga to the ST. And soon you'll be able to switch to the Apple IIGS as well, with a version of MultiFORTH that will be compatible with MacFORTH Plus because of the similarity in ROM routines.

MultiFORTH/ST costs \$149, while MultiFORTH/Amiga costs \$179; the reasons for the difference in price are unclear. Both versions are unprotected, and there are no licensing fees for commercial products; again, the request is made that you acknowledge the use of MultiFORTH in your program and documentation.

These are both well-done products, but they are not yet up to the standards of MacFORTH Plus. Because of that, I can't give them the same hearty endorsement. However, they are worth considering if you are looking for a tool to explore how the system and graphics routines work on either machine. I recommend that you take a good look at the product and documentation before deciding to buy it.

### The Hackers Corner

Some interesting products have come in the mail lately. Allan Bonadio, who has a degree in physics, sent me an equation editor for the Macintosh. The program is called Weinberg (after physicist and Nobel laureate Steven Weinberg), and it allows you to compose rather complex equations far more easily than you could using Word or MacPaint, with special help for representing integrals, summations, fractions, roots and powers, matrices, and tensors. There are actually two programs: a stand-alone ap-

*continued*

## A MESSAGE TO OUR SUBSCRIBERS

FROM TIME TO TIME WE MAKE THE BYTE subscriber list available to other companies who wish to send our subscribers material about their products. We take great care to screen these companies, choosing only those who are reputable, and whose products, services, or information we feel would be of interest to you. Direct mail is an efficient medium for presenting the latest personal computer goods and services to our subscribers.

Many BYTE subscribers appreciate this controlled use of our mailing list, and look forward to finding information of interest to them in the mail. Used are our subscribers' names and addresses only (no other information we may have is ever given).

While we believe the distribution of this information is of benefit to our subscribers, we firmly respect the wishes of any subscriber who does not want to receive such promotional literature. Should you wish to restrict the use of your name, simply send your request to the following address.

### BYTE MAGAZINE

ATTN: SUBSCRIBER SERVICE  
P.O. Box 6821  
PISCATAWAY, NJ 08854



## Special Advertising Offers on BIX —Tell Us What You Think—

During January and February, several BYTE advertisers will have special ad conference areas on BIX (in addition to their regular ads in BYTE) where you can learn more about their products, and get late breaking news on special product and pricing offers not found in the magazine and available only to BIX users. Their messages will be brief... no lengthy screens or menus to wade through to get the important information and find the bargains. The participating companies and their conference areas on BIX are:

Alps Printers (alps.ad), CompuPro (compupro.ad), Fortron Corporation (fortron.ad), Jameco Electronics (jameco.ad), JDR Micro-devices (jdr.ad), and PC-SIG (pcsig.ad).

If you want to check a company's BYTE ad in this issue before logging on to BIX you'll find them as follows: Alps/pg. 126-127, CompuPro/164, Fortron/330, Jameco/372-373, JDR/381-385, PC-SIG/125.

We encourage your feedback to participating companies and to us. Do you like user-selectable advertising areas on BIX? What do you like or dislike about the way in which advertising appears on BIX during this test? What would you like to see changed that would improve this service for you as a user if it were continued? Each advertiser's BIX advertising conference will tell you how to contact any of them, and you can send BIXmail with comments to Doug Webster (dweb), Director of Business & Marketing for BIX.

These special advertising areas will open on BIX at the beginning of January and run through February.

**BIX**

ONE PHOENIX MILL LANE  
PETERBOROUGH, NH 03458



**• Z Best Sellers •**

**Z80 Turbo Modula-2 (1 disk) \$69.95**

The best high-level language development system for your Z80-compatible computer. Created by Borland International. High performance, with many advanced features; includes editor, compiler, linker, 552 page manual, and more.

**Z-COM (5 disks) \$119.00**

Easy auto-installation complete Z-System for virtually any Z80 computer presently running CP/M 2.2. In minutes you can be running ZCPR3 and ZRDOS on your machine, enjoying the vast benefits. Includes 80+ utility programs and ZCPR3: The Manual.

**Z-Tools (4 disks) \$150.00**

A bundle of software tools individually priced at \$260 total. Includes the ZAS Macro Assembler, ZDM debuggers, REVAS4 disassembler, and ITOZ/ZTOI source code converters. HD64180 support.

**PUBLIC ZRDOS (1 disk) \$59.50**

If you have acquired ZCPR3 for your Z80-compatible system and want to upgrade to full Z-System, all you need is ZRDOS. ZRDOS features elimination of control-C after disk change, public directories, faster execution than CP/M, archive status for easy backup, and more!

**DSD (1 disk) \$129.95**

The premier debugger for your 8080, Z80, or HD64180 systems. Full screen, with windows for RAM, code listing, registers, and stack. We feature ZCPR3 versions of this professional debugger.

**Quick Task (3 disks) \$249.00**

Z80/HD64180 multitasking realtime executive for embedded computer applications. Full source code, no run-time fees, site license for development. Comparable to systems from \$2000 to \$40,000! Request our free Q-T Demonstration Program.



**Echelon, Inc.**

Z-System OEM Inquiries Invited.  
 Visa/Mastercard accepted. Add \$4.00  
 shipping/handling in North America, actual  
 cost elsewhere. Specify disk format.

885 N. San Antonio Road • Los Altos, CA 94022  
 415/948-3820 (Order line and tech support) Telex 4931646

**First in a New Series**

**The Implementation of the Icon Programming Language**

Ralph E. Griswold and  
 Madge T. Griswold

Icon is a new general-purpose, high-level programming language that lends itself to processing textual material (strings of characters) and other non-numeric data. The language has applications that include rapid prototyping, linguistic analysis, and artificial intelligence. Icon supports a wide variety of data types and sophisticated structures.

Ralph and Madge Griswold describe how this unique programming language is actually implemented, including details of the organization of the implementation, its internal data structures, its virtual machine, and its interpreter. 100 illustrations. \$39.50

At your bookstore or

**Princeton University Press**

41 William Street, Princeton, NJ 08540

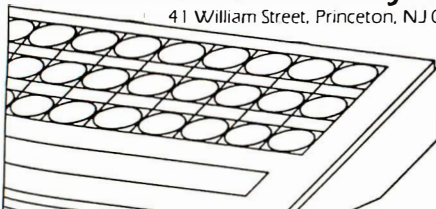

*Editing Tools is a combined editor and DOS shell for MS-DOS systems that is written in Turbo Pascal. The editor can have multiple files opened.*

plication with full menus and help and a desk accessory, so that you can call it up from within your word processor or paint program. Weinberg produces a standard PICT image, so you can paste it into documents, pictures, and similar structures. It is oriented toward the Symbol (Greek) font, though you can get by with others. Allan sent me version 0.90 (beta), which he is selling for \$54.95; it isn't clear if that includes an automatic upgrade. The documentation (which comes on the disk) includes an interesting discussion on the inconsistency of notation in scientific and mathematical circles.

I also received a product called Editing Tools (version 2.0), written by Jiann Jou. The program is a combined editor and DOS shell for MS-DOS systems. The editor can have multiple files opened and maintains a "trash file" where all deletions go, so that you can recover deleted text. The program is written in Turbo Pascal; most routines have been optimized using in-line assembly code, but the original Pascal for each routine remains there in comments. For just \$10, you get the program and a 36-page manual; for \$25 more, you get all the source code.

**Updates**

Some months back I wrote about Pascal Extender from Invention Software Corporation. Pascal Extender is a collection of library routines designed to take much of the work and hassle out of programming on the Macintosh. Two versions were then available, one for TML Pascal and one for MacPascal. ISC has now released a version for Lightspeed Pascal, in which its routines are implemented as several units that can be used by your projects. Since source code is included, you can modify these routines to do what you want to. They've also added a number of new routines to all their versions for manipulation of pictures (load, grab, save), printing, zooming windows, and other such items. They also have offered C Extender, an equivalent package for different C compilers. If you're not up to speed on Macintosh programming (and maybe even if you are), you'll find these packages will help you write working Mac-style applications quickly. Pascal Extender costs \$89.95; C Extender costs \$129.95. They are not copy-protected, source code is included, and there are no licensing fees.

Remember the Alegria memory-expansion box I reviewed back in December? Well, I couldn't bear to send it back, so I bought it. My next hardware investment will be for a set of 1-megabit RAM chips, which will boost my Amiga up to 2.5 megabytes of RAM! More RAM! Now if I could just get a hard disk.

**More on MIDI**

I am running across additional resources in my quest to become MIDI-literate. For those of you who don't know, MIDI stands for "musical instrument digital interface," and it represents a hardware-and-software standard to allow computers and electronic musical instruments (like synthesizers) to talk with one another. MIDI ports are built into the Atari 520ST and 1040ST, and hardware adapters are available for the Macintosh, Amiga, IBM PC (and clones), Apple II, Commodore 64, and several

*continued*



# Introducing PC performance at a terminal price.



## The versatile PC Station™. From TeleVideo®.

With all the power an AT offers, it's no wonder more people are using it to drive multi-user systems.

And when it comes to using all this power, only one workstation gives you so many features for so little money: the TeleVideo PC Station.



As you can see, the back panel of the PC Station is exactly the same as the IBM PC's, with fully IBM-compatible ports for hooking up industry-standard peripherals.

This ASCII terminal has the precise look and feel of a PC. But that's just the beginning. It also has a back panel that's

identical to the IBM PC's, with a parallel printer port. A serial port. And two host ports, so it can be simultaneously connected to an ASCII mainframe host and an AT host. There's no loss of memory when changing hosts, because the PC Station holds a page of memory from each at the same time.

And the PC Station gives you even more. Like a 132-column display, for spreadsheets. Programmable function keys, for customization. For better readability, there's a green, non-glare 14" screen,

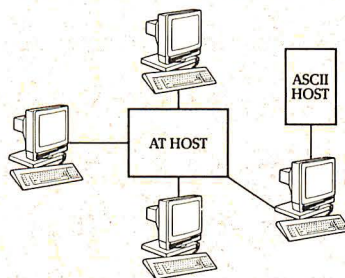

*The PC Station is the only terminal of its kind with dual-host capability, which allows it to be connected to a mainframe host and an AT host simultaneously.*

with IBM-style character fonts. Plus a smooth, quiet AT-style keyboard, with keytop LEDs. All included in the low \$629 list price.

The TeleVideo PC Station. For a free solutions guide, and the name of your

nearest TeleVideo dealer, call 1-800-835-3228, Dept. 271.

And check out the workstation that offers you all the benefits of a PC—without a PC price.

 **TeleVideo®**  
Settle for more.

TeleVideo Systems, Inc., 1170 Morse Avenue, P.O. Box 3568, Sunnyvale, CA 94088-3568 • (408) 745-7760

IBM and AT are trademarks of International Business Machines, Inc. ©1986 TeleVideo Systems, Inc.



other families of computers (including some that are made specifically for use with MIDI systems).

I have found (and subscribed to) another excellent periodical: *Keyboard* magazine. *Keyboard* isn't devoted entirely to electronic instruments—it does cover pianos, organs, and music in general—but it's a great source for reviews, ads, and informative articles. Subscriptions cost \$19.95 a year (P.O. Box 2110, Cupertino, CA 95015, (408) 446-1105); single issues can be found in most large bookstores.

## Items Discussed

<b>Editing Tools</b> .....	\$10
Dr. Jiann Jou P.O. Box 460969 Garland, TX 75046 (214) 495-8862	
<b>Lisa 816 Assembler</b> .....	\$50
H.A.L. Labs 18942 Dallas Ave. Perris, CA 92730	
<b>Mac-to-IIGS Assembler</b> .....	\$195
Consulair Corporation 140 Campo Dr. Portola Valley, CA 94025 (415) 851-3272	
<b>Mac-to-IIGS C Compiler</b> .....	\$500
<b>Mac-to-IIGS Pascal Compiler</b> .....	\$500
Megamax Inc. P.O. Box 851521 Richardson, TX 75085 (214) 987-4931	
<b>MacFORTH Plus</b> .....	\$299
<b>MultiFORTH for the Amiga</b> .....	\$179
<b>MultiFORTH for the Atari ST</b> .....	\$149
Creative Solutions Inc. 4701 Randolph Rd., Suite 12 Rockville, MD 20852 (301) 984-0262	
<b>Pascal Extender</b> .....	\$89.95
<b>C Extender</b> .....	\$129.95
Invention Software Corporation P.O. Box 3168 Ann Arbor, MI 48106 (313) 996-8108	
<b>TML Pascal for the IIGS</b> .....	\$125
TML Systems 4241 Baymeadows Rd., Suite 23 Jacksonville, FL 32217 (904) 636-8592	
<b>Weinberg</b> .....	\$54.95
Allan Bonadio Associates 1579 Dolores St. San Francisco, CA 94110-4928 (415) 282-5864	

The best book on the subject that I've found so far is *MIDI for Musicians*, written by Craig Anderton (editor of *Electronic Musician* magazine). The book is published by AnSCO Publications and costs \$14.95. It's a large softbound book that aims to explain computers, electronic instruments, and the MIDI standard to musicians. It's readable, has lots of diagrams, and is stuffed with bits of information that you would probably have to dig through many different sources to find for yourself. It also includes the official MIDI standard document.

### Books

When I discussed 8086 assembly language programming a few months ago, I had praise for Bob Lafore's *Assembly Language Primer for the IBM PC & XT*. I mentioned, though, that the book was just that—a primer—and I was in the market for a good follow-up text. Well, I've found one: *IBM PC & XT Assembly Language: A Guide for Programmers* (2nd ed.) by Leo J. Scanlon (Brady Communications, 1985). It fills the gap nicely between Lafore's book and a reference manual, taking a tutorial approach but going into more depth. The book is \$21.95 and contains an order form for a disk with source and object code of most of the example programs in the book; said disk costs \$30.

In my spare time, I teach at the Brigham Young University computer science department. One of the classes I'm teaching this semester deals with data structures—stacks, queues, lists, trees, sets, graphs—and methods of sorting and searching them. The textbook I'm using is not only an excellent treatment of the subject, it's one of the best textbooks I've ever seen, period. It's well written, logically organized, and ideal for self-study on the subject. It uses an abstract data type approach, with implementations done in Pascal. The title is *Data Structures with Pascal and Abstract Data Types*, it's written by Daniel F. Stubbs and Neil W. Webre, and it was published by Brooks-Cole Publishing Company in 1985. The list price is \$25.

### Hackers Conference

Since Hackers 2.0 (the second Hackers' Conference) has been given a lot of coverage elsewhere, and since nothing really momentous happened there, I don't see much point in going into too much detail here. I do want to acknowledge and thank Glenn Tenney, Brett Glass, and Bob Bickford. Those three put in many hours and much effort, and the result was a great weekend.

Hackers 2.0 was more laid-back than Hackers 1.0—perhaps too much so, but I'm not sure anyone felt like being terribly intense. I did see a few interesting programs demonstrated. Andy Hertzfeld showed me version 0.84 of Servant, his extension on the Mac user interface. He should be done with it by the time you read this. After that, he's thinking of developing for some machine other than the Macintosh. Steve Jasik (author of Mac-Nosy) demonstrated his interactive window-based debugger for the Macintosh; had he sent me a copy a month earlier, he would have beaten out Metascope for best utility of 1986. Look for a review here if and when I get a copy.

My personal highlight of the conference? Probably the four or five hours I spent playing MazeWar+ on a network of seven Macintoshes. I know that sounds a bit frivolous, but it gave me a taste of what's in store some years down the road as networked systems become more prevalent.

### In the Queue

Well, the sun is doing its best to rise over the mountains east of me, and I've got to be on campus in a few hours, so it's time to wrap this up. Next month, look for coverage of the Amiga Developers Conference and COMDEX, as well as more multi-system language reviews. With luck, I might have my hands on an 80386-based system by then and give some feedback there. Until then, I'll see you on the bit stream. ■



# "First-Class"

—Computerworld

# "IMPRESSIVE"

—Personal Computing

# "Faster"

—InfoWorld

# "MUSCULAR"

—PC Magazine

# "A Screamer"

—PC World

## THE MOST RESPECTED NAMES IN THE INDUSTRY HAVE SOME POWERFUL WORDS FOR OUR APC IV.

When we asked our advertising agency to help us introduce our Advanced Personal Computer IV several months ago, they came up with some pretty strong ads.

But now the trade press has helped us come up with an even stronger one.

*PC World*, for example, says, "The APC IV is an AT-compatible, 80286-based screamer." *PC Magazine* adds, "It is muscular, stylish, very classy... everything an AT-class machine should be and then some." And in the opinion of *Personal Computing*, "The APC IV is an impressive-looking computer... with powerful expansion capabilities and a monitor you won't want to take your eyes off."

So don't just take our word for it. Get the full story—along with reprints of the articles quoted above—by calling NEC at 1-800-343-4419 (in MA 617-264-8635). Or write to NEC Information Systems, Inc., Dept. 1610, 1414 Massachusetts Avenue, Boxborough, MA 01719.

*Take it to the limit.*

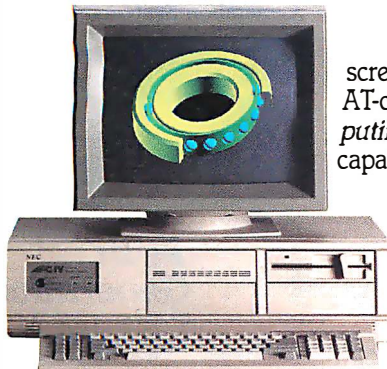

**C&C** Computers and Communications



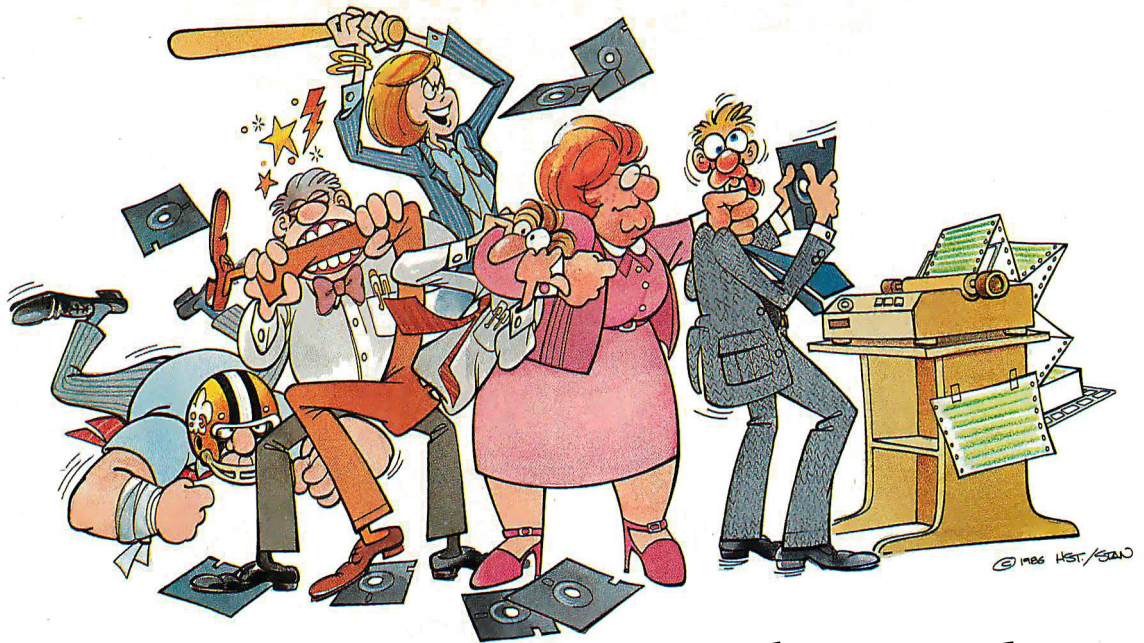

# For People Who'd Rather Switch than Fight!

The ultimate printer-sharing switch has arrived...

## Here's the Logical Connection™!

It happens all the time: your entire office staff is having a "get-together" by the printer. And if you haven't found the solution to this bottleneck yet, it's time you got the connection: The Logical Connection.™

## No more slow-downs.

The Logical Connection™ is the ultimate printer-sharing switch because it lets *everyone* share the same printers (or other peripherals), at the same time! With no downloading, disk-shuffling, cable-swapping, switch-flipping or any of the other thousand natural shocks that sharing's heir to. The Logical Connection™'s big, smart buffer (256K, 512K model also available) will spool each document for sequential printing, so your computers can keep right on working. But wait, there's more . . .

## Long-distance switching.

What if your printers and computers are strung out all over the building? No problem, because you can "daisy-chain" up to 45 Logical Connections™ together. Over a single twisted-pair wire like telephone wire (which, by the way,

you probably already have *wired* all over the building). And each computer can choose which printer it wants to use, simply by issuing a pre-defined 8 character "selection string." Need more? Just hook a couple of Logical Connections™ up to a pair of cheap

problem. And if two devices have different handshaking, baud rates, word lengths, or parities, The Logical Connection™ will do all the conversions for you *automatically*, whenever they're needed. And it will never forget your configurations, because its memory is in battery-powered RAM.

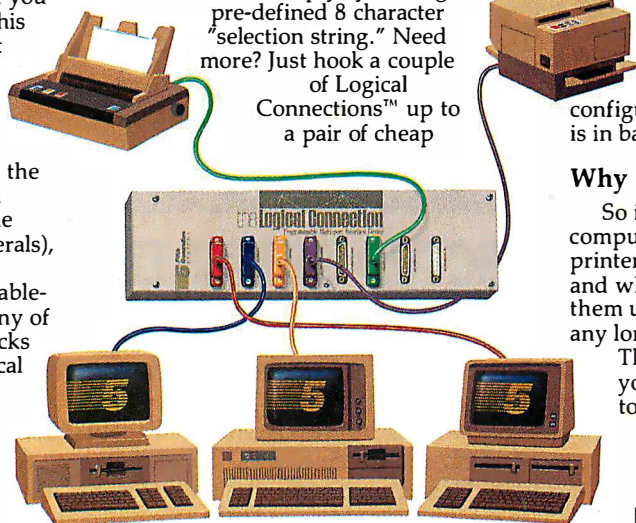

modems and let a roomful of computers talk to a roomful of printers across the country . . . or across the world.

## Automatic Data Conversion

If you want to run a parallel daisy-wheel *and* a serial laser printer from the same computer port, no

## Why fight it?

So if you'd like to give *all* your computers instant access to *all* your printers (and plotters and modems and whatever else you'd like to hook them up to), *all* the time, why fight it any longer? Make the switch. Get The Logical Connection™ at your leading computer dealer today, or order direct from Fifth Generation Systems.

the Logical Connection  
Programmable Multi-port Interface Device

**\$495**  
Suggested retail price

**Fifth Generation**  
SYSTEMS  
Innovative Products Using Today's Technology





# A Ternary State of Affairs

Robert T. Kurosaka

## *The base-3 system offers an automatic solution to a classic puzzle*

This month we'll investigate the mathematics of balance scales. Our study begins with the natural language of computers, binary arithmetic, but soon moves on to the more exotic ternary or base-3 system. Even there, we'll find that computers come in handy. Consider the balance scale and measuring weights shown in figure 1. We intend to weigh some commodity (say, coffee) to the nearest ounce. The coffee goes in the right pan, and we add sufficient weights to the left pan until the scales balance, giving us the weight of the coffee.

What would be the minimum set of measuring weights needed to weigh at least 30 ounces of coffee? Before proceeding, you are urged to try and solve this warm-up question.

Thinking in familiar decimal terms, our first guess might be a set of eight weights: 10, 10, 5, 1, 1, 1, and 1 oz., respectively. An obvious refinement gives six weights: 10, 10, 5, 2, 2, and 1. However, further experimentation leads to the ideal solution of five weights: 16, 8, 4, 2, and 1, with which we can actually measure any amount up to 31 oz.

### First There Were Two

If you're thinking that the last sequence is composed of powers of 2, and thus suggests that the problem is binary in nature, you're right. To see why, look at the binary representation of our 31-oz. maximum weight:  $11111_2$ , which represents the number  $1 \times 2^4 + 1 \times 2^3 + 1 \times 2^2 + 1 \times 2^1 + 1 \times 2^0$ . Each of the binary digits in the number corresponds to one of our weights. Smaller amounts are weighed by removing one or more of the binary counterweights.

We now have an automatic method for determining which weights are needed to offset a given amount: First convert the amount into binary notation, and then read off the digits. For each 1 digit, we take the correspondingly marked weight. For instance,  $28 = 11100_2$ , meaning that we use only the 16-, 8-, and 4-oz. counterweights

to offset a 28-oz. portion of coffee.

Our binary analysis also gives us the useful information that with  $n$  weights valued at 1, 2, 4, . . . ,  $2^{n-1}$ , we can counterbalance any amount up to  $2^n - 1$ .

Now we'll alter the weighing method to allow weights to be placed in either pan. For instance, to weigh out 3 oz. of coffee, we place the 4-oz. counterweight in the left pan and the 1-oz. counterweight in the right pan, plus enough coffee to balance the scale. The mathematical expression of this is  $4 = 1 + c$ , with  $c$  being the amount of coffee.

What's the minimum set of weights using this "bilateral" weighing method? Experiment with this one and come up with your own guess. (Hint: We can get by with fewer weights than with the "unilateral" system.)

### And Then There Were Three

Let's apply a little computer logic to the question. In the unilateral system, a weight could have two possible "states": on the scale or off the scale; that's why our binary model works so well. But in the new system, a weight can have three possible states: in the right pan, in the left pan, or off the scale. This leads us to try a ternary model for the counterweight values: 1, 3, 9, and so forth. By trial and error, we find that using just the weights 1, 3, 9, and 27, we can counterbalance any weight up to 40.

Can we apply the automatic method again for determining which weights will be needed to counterbalance a given amount? Let's try to weigh out 22 oz. of coffee. First convert 22 to ternary notation:  $22 = 2 \times 3^2 + 1 \times 3^1 + 1 \times 3^0 = 211_3$ . So we place two 9-oz. weights, one 3-oz. weight, and one 1-oz. weight in the left pan, and we place sufficient coffee in

the right pan to balance the scale. The corresponding equation is  $9+9+3+1=c$ .

But there's a problem—we don't have two 9-oz. weights. Furthermore, we're supposed to be placing some of the weights in the right pan; that's the bilateral method.

We don't give up, though. Instead, we mentally add another 9-oz. weight to each pan (even though we really don't have any more 9-oz. weights). The scales still balance, and the equation is  $9+9+9+3+1=c+9$ . But the left side can be rewritten as  $27+3+1$ , and it suggests a real solution to the problem: On the left scale, place 27-, 3-, and 1-oz. weights; on the right scale, place a 9-oz. weight and the coffee to be weighed.

Fortunately, it is not necessary to perform this mental juggling act every time with the bilateral method. Ternary notation gives us another automatic process for figuring out which weights to use.

First convert the number (the amount to be weighed out) to ternary. For example,  $22 = 211_3$ .

Examine the digits of the ternary number from right to left. Each time we encounter a 2, change it to a  $-1$  and add 1 to the next digit on the left. Continue moving to the left until no more 2s remain. In our example, we'll use delimiters to separate each of the individual digits:  $211_3 = (1) (-1) (1) (1)_3$ .

The resulting modified ternary "number" is a sequence of 1s, 0s, and  $-1$ s. For each 1, place the corresponding weight on the left pan. For each  $-1$ , place the corresponding weight on the right pan. Now add enough coffee to the right pan until the scale is balanced.

For practice, apply this automatic

*continued*

*Robert T. Kurosaka teaches mathematics in the Massachusetts State College system. He can be reached c/o BYTE, One Phoenix Mill Lane, Peterborough, NH 03458.*



**MAKE YOUR PC  
SEEM LIKE AN AT!**

**MAKE YOUR AT  
SEEM LIKE A  
DREAM MACHINE!**

**ANSI-<sup>tm</sup>  
CONSOLE**

*The Integrated Console Utility™*  
**FAST, POWERFUL  
ANSI.SYS REPLACEMENT**

For the IBM-PC, AT, and clones

New Version 2.00 is MUCH FASTER!  
Now blink free scrolling on CGA!

Now uses EMS/EEMS for Scroll Recall  
New Menu Program for Changing Options

**GET A BOX FULL OF UTILITIES!  
MAKE LIFE EASIER FOR ONLY \$75!**

- Speed up your screenwriting 2-6x
- Extend your ANSI.SYS to full VT100
- Add many more escape sequences
- Scroll lines back onto screen
- Save scrolled lines into a file
- Add zip to your cursor keys
- Free your eyes from scroll blinking
- Easy installation
- Get a 43 line screen w/EGA
- Get a 50 line screen w/CGA
- No more annoying typeahead beep
- Prevent screen phospher burnin
- Control many programs' use of color
- Generate breakpts from keyboard
- Shorten that annoying bell
- Over 50 other useful options

*"The psychological difference is  
astounding"*  
—Lotus June 85 pg 8.

*"So many handy functions rolled into  
one unobtrusive package"*  
—PC-World Feb 86 pg 282.

*"The support provided by the  
publishers is extraordinary"*  
—Capital PC Monitor May 86 pg 25.

*"... the best choice for improving your  
console..."*  
—Capital PC Monitor June 86 pg 26.

460p Manual (w/slip case) & disks \$75.

**Satisfaction Guaranteed!  
Order Yours Today!**

**HERSEY MICRO CONSULTING**  
Box 8276, Ann Arbor, MI 48107  
(313) 994-3259 VISA/MC/Amex

**DEALER INQUIRIES INVITED**

Fast ANSI Console Driver

method to the number 46. (Hint: You should end up using a bilateral combination of 81, 27, 9, and 1.)

In general, given  $n$  weights valued at 1, 3, 9, ...,  $3^{n-1}$ , the bilateral weighing method will handle any weight up to  $(3^n - 1)/2$ .

The program in listing 1 incorporates this ternary arithmetic to "weigh" any amount up to  $(3^{12} - 1)/2$ .

With this warm-up completed, we're ready to take on a classic puzzle using a computer-aided approach.

**The Counterfeit Coin**

We have a set of apparently identical coins containing one counterfeit. The counterfeit is off-weight (either light or heavy). We are to identify the bad coin in

*continued*

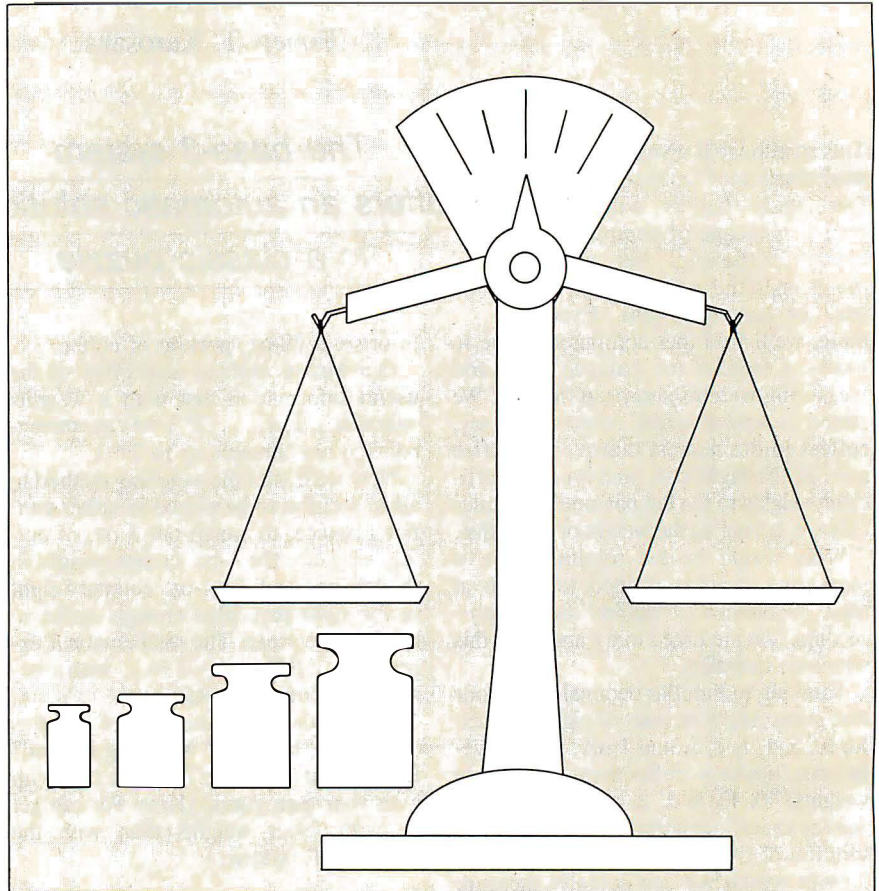

**Figure 1:** A set of balance scales with standard counterweights.

**Listing 1a:** BASIC program to verify a weight using ternary-power counterweights. A sample run is also shown.

```

10 DIM A(12),P(12),N(12)
20 N=12
30 CLS
40 PRINT "We have 12 weights, valued as follows..."
50 FOR W=0 TO N-1
60 PRINT 3^W;
70 NEXT W
80 LARGEST=INT((3^N-1)/2)
90 PRINT "Enter the weight to be verified ( 1 -"; LARGEST;
  " )"
100 INPUT W: W=INT(W)
110 IF W<1 OR W>LARGEST THEN 90
120 SW=W
130 FOR D=N TO 1 STEP -1
140 Q=INT(W/3)
    
```

*continued*



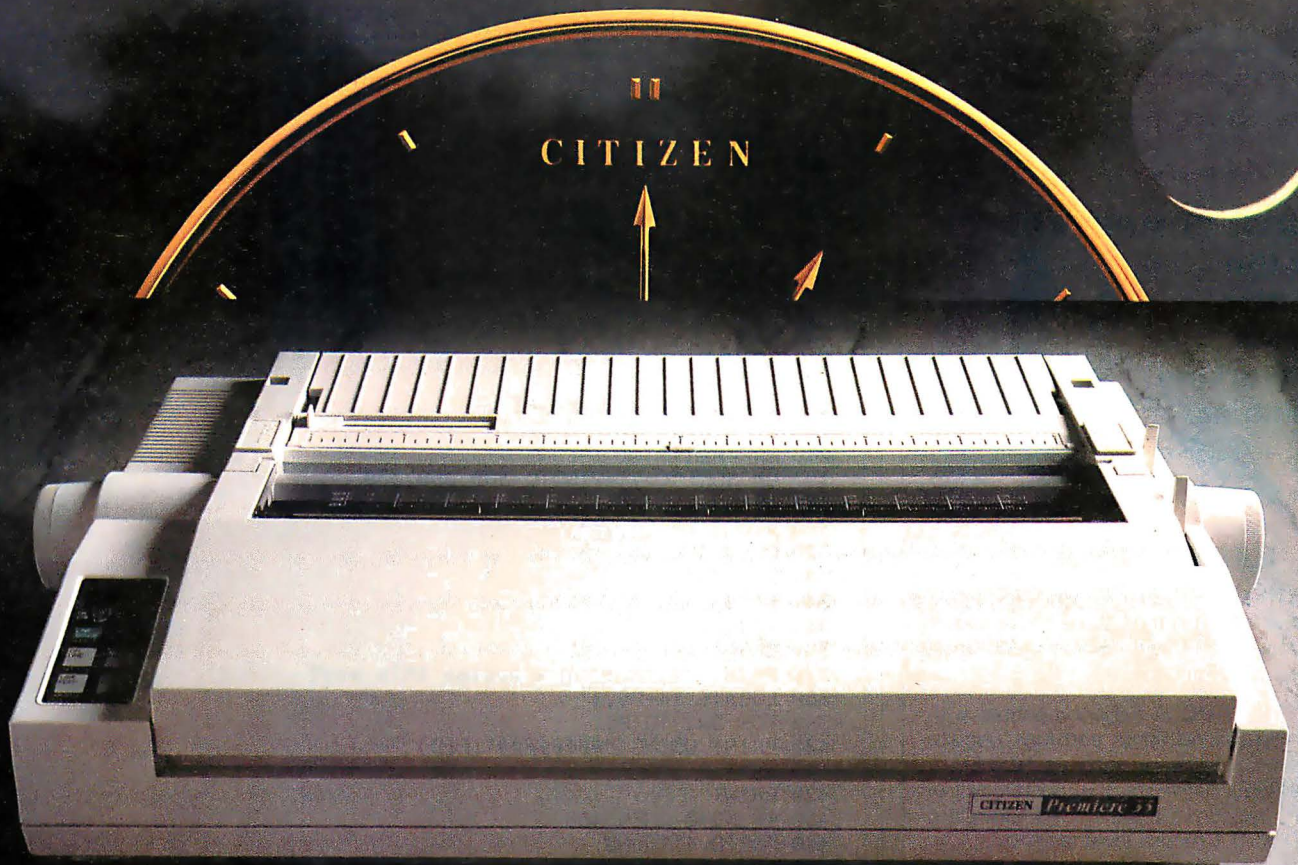

# FINALLY, A DAISYWHEEL PRINTER THAT'S RIGHT ON THE MONEY.

The Citizen™ Premier™ 35 gives you all the features of a high-end daisywheel printer, without the high-end price. For hundreds of dollars less, you get all the speed and features you'd expect from other quality 35 cps daisywheel printers, plus something no one else can give you. The same precision and engineering that go into our timepieces.

If your software is compatible with a Diablo® 630, the NEC 3550, or the Qume® Sprint® 11+, it's already set up to drive a Premier 35 without a bit of problem.

The Premier 35's LCD display spells out operations and errors in plain English. Its unique paper loading system makes work easy. And its built-in, variable-width tractor is a feature you'd normally have to pay extra for. More than enough reasons to make your buying decision split-second.

For more precise information, call 1-800-556-1234 Ext. 34. Or, in California, 1-800-441-2345 Ext. 34.

The Premier 35. A value that will lead you to only one conclusion. It's about time.

©1986 Citizen America Corporation. Citizen, the Citizen logo, and Premier 35 are trademarks of Citizen Watch Co., Ltd. Diablo is a registered trademark of Xerox Corporation. Qume and Sprint 11+ are registered trademarks of Qume Corporation, a subsidiary of ITT.

 **CITIZEN™**  
Printers that run like clockwork.

Inquiry 52



# LOOKING FOR "NET" RESULTS?

**EARTH COMPUTERS**  
 has the  
 solution  
 to your  
 Networking  
 problems.



## EARTHNET-PC.™

EARTHNET-PC is the most flexible networking card on the market. It has been designed for high performance and maximum functionality.

EARTHNET-PC is fully compatible with SMC networking cards and runs popular networking software such as NOVELL's NETWARE, ViaNet, and TurboDOS, all of which support the new LAN Standard and DOS 3.1 record locking.

EARTHNET-PC's 5-1/2 inch card fits in any short slot of an IBM-PC/XT or compatible system and uses advanced Token-Passing technology. Data transfers are made at 2.5 Megabytes per second.



YOU CAN STOP SEARCHING...EARTH-NET-PC IS THE SOLUTION TO YOUR NETWORKING PROBLEMS! Order your EARTH-NET-PC today! Call EARTH COMPUTERS, the company that's setting the standard for LAN standards.

**ATTENTION DEALERS!** If you've been searching for ways to increase your NETworking profits, call EARTH COMPUTERS and find out about our attractive, profit-generating dealer program.

EARTHNET-PC is a trademark of EARTH COMPUTERS  
 NETWARE is a trademark of Novell  
 ViaNet is a trademark of Vianetix, Inc.  
 TurboDOS is a trademark of Software 2000  
 IBM-PC/XT is a trademark of International Business Machines, Inc.



EARTH COMPUTERS

P.O. Box 8067, Fountain Valley, CA 92728  
 TELEX: 910 997 6120 EARTH FV

**(714) 964-5784**

Ask about EARTH COMPUTERS' other fine PC and S-100 compatible products.

```

150 A(D)=W-3*Q
160 W=Q
170 NEXT D
180 FOR D=N TO 1 STEP -1
190 IF A(D)<2 THEN 220
200 A(D)=A(D)-3
210 A(D-1)=A(D-1)+1
220 NEXT D
230 NG=0
240 PS=0
250 PWR=1
260 FOR D=N TO 1 STEP -1
270 A(D)=A(D)*PWR
280 PWR=PWR*3
290 ON SGN(A(D))+2 GOTO 300,350,330
300 NG=NG+1
310 N(NG)=ABS(A(D))
320 GOTO 350
330 PS=PS+1
340 P(PS)=A(D)
350 NEXT D
360 CLS
370 PRINT "Balance the scales this way"
380 LOCATE 14-PS,1
390 FOR D=1 TO PS
400 PRINT USING "#####";P(D)
410 NEXT D
420 PRINT
430 IF NG=0 THEN 480
440 FOR D=1 TO NG
450 LOCATE 12-NG+D,18
460 PRINT USING "#####";N(D)
470 NEXT D
480 LOCATE 13,18
490 COLOR 0,7
500 PRINT USING "##### ";SW
510 COLOR 7,0
520 PRINT "-----"
530 PRINT " |-----| "
540 PRINT "          ^"
    
```

We have 12 weights, valued as follows...

1 3 9 27 81 243 729 2187 6561 19683 59049  
 177147

Enter the weight to be verified ( 1 - 265720 )  
 ? 301

Balance the scales this way

```

          1
          3
          81                27
         243                301
-----
|-----|
          ^
    
```

Ok

*Listing 1b: Alternate lines with simplified I/O for BASICs without the LOCATE feature.*

```

380 PRINT "Left side: ";
400 PRINT P(D),
430 PRINT "Right side: ";
450 REM line deleted
460 PRINT N(D),
480 REM line deleted
490 REM line deleted
500 PRINT "??";SW;"??"
510 REM line deleted
520 REM line deleted
530 REM line deleted
540 REM line deleted
    
```



Creating With  
Pictures  
Just Got Easier!

# Professional Image Board

The new Professional Image Board is a PC board which allows an ordinary home video camera (color or black-and-white) to be plugged into an IBM personal computer or IBM compatible. Now, live, fast action scenes can be instantly captured in full color and frozen. The frozen pictures can be computer enhanced feature by feature and stored on a floppy or hard disk. The frozen pictures can also be transmitted to any remote computer in the world via modem. The Professional Image Board also allows you to perform cut and paste operations with most popular software.

## SPECIFICATIONS

- Works with IBM PC/XT/AT or compatible
- Capture one picture in 1/60 second from standard NTSC signal source (Regular video camera, VCR, etc., or RGB camera)
- Shows picture on analog monitor or TV
- Resolution 512 x 256 capable of 32K different colors
- Adding text on the captured picture
- Mixing external image with internal image in live mode
- Image captured by PIB can be displayed on EGA monitor
- Adapter available for European standard TV



Unretouched frozen video image in full color. Captured with ATronics' Professional Image Board.



**ATronics  
International Inc.**  
*We Deliver Advanced Technology*

1830 McCandless Dr. Milpitas CA 95035  
(408) 943-6629



a specified maximum number of weighings on a balance scale. No standard weights are available; the coins are to be weighed against each other. We are not allowed to add or remove coins during a weighing.

The simplest version of this problem involves eight coins, of which one is known to be heavy. In only two weighings, find the bad coin. Trying to solve this one will give you a greater understanding and appreciation of what follows.

Now for the big one, involving 12 coins, of which one is light or heavy (we don't know which in advance). Using three weighings, we are to find the bad coin and state whether it is light or heavy. Again, you are urged to give this one a try.

Start by numbering the coins from 1 to 12 for reference. Suppose we express those 12 reference numbers in ternary. Further

suppose that the result of each weighing (left pan down, right pan down, no difference) could give a new ternary digit, so that after three weighings we are left with a ternary number identifying the bad coin. That would be too easy!

In fact, the method we've sketched out does work, but it's not easy. The preparation is quite complicated (enter the computer to help out).

**Preparation Phase**

First, for each numbered coin, we need the ternary equivalent and the two's complement (also in ternary). To get the two's complement, subtract each digit from 2. (Equivalently, change each 0 to a 2, each 2 to a 0, and leave 1s unchanged.) For instance, coin #1 is 001<sub>3</sub>, which has a two's-complement representation of 221<sub>3</sub>. Table 1 lists the ternary and two's-complement

representations for all 12 coins.

The next step is to classify each of our ternary and two's-complement numbers as either "clockwise" or "counterclockwise." To do so, we read a number's digits from left to right and note the first change of digits. If the change is 0 to 1, 1 to 2, or 2 to 0, the number is clockwise. Otherwise, it is counterclockwise. The "clocks" in figure 2 should clarify these directions. In table 1, clockwise numbers are marked with an asterisk.

*continued*

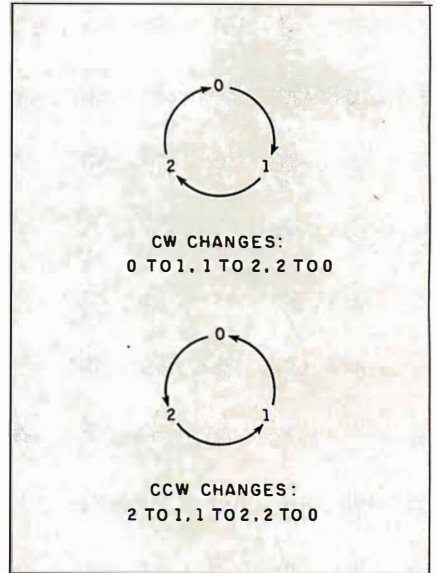

**Figure 2:** Illustration of clockwise and counterclockwise digit changes, for use in classifying numbers. A number is clockwise if its first digit change (starting at the left) is clockwise; otherwise, it is counterclockwise.

**Table 1:** In preparation for solving the counterfeit-coin problem, the coins are numbered in decimal, ternary, and two's-complement ternary. ("Clockwise" coins are marked with an asterisk.)

Decimal	Ternary	Two's complement
1	*001	221
2	002	*220
3	*010	212
4	*011	211
5	*012	210
6	020	*202
7	021	*201
8	022	*200
9	100	*122
10	101	*121
11	102	*120
12	110	*112

# DataSaver® Standby UPS

**90 Watt.** The original micro-UPS that brought standby AC power to Apple users in 1980. Still the POWER SOLUTION for serious applications of the MAC, small micros, and portables. Model 9012060 \$350. FCC(15A&B).

**400 Watt.** Now, POWER PROTECTION and MASTER CONTROL for full-size micros. Filters electrical noise/spikes and provides up to 10 minutes of AC power for the AT and supermicros. Model 40012060 \$695. UL-E101268.

**200 Watt.** This DataSaver standby UPS offers compact, cool and quiet line conditioning and backup power to PC, XT, and COMPAQ markets. Data and hardware are protected. Model 20012060 \$495.CSA-LR51253.



**Cuesta Systems Corporation**  
3440 Roberto Court  
San Luis Obispo, California 93401

© 1986. Made with pride in the U.S.A.  
805/541-4160 TLX:4949381 CUESTA  
Dealer, VAR, & OEM inquiries invited.



# Osborne/McGraw-Hill Computer Books For IBM® PC Productivity

## Using dBASE III PLUS™

by Edward Jones

You'll be in full command of all the new features of this powerful database software with Jones' expertise. Design, create, and display a dBASE III PLUS database; generate reports; use Query files; and plug into networking. A practical handbook for beginners and experienced users.

\$18.95, Order #0-07-881252-6, 516 pp.  
7½ x 9¼

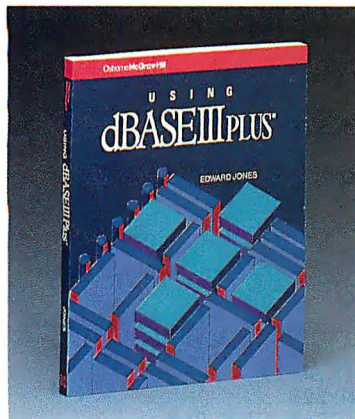

## PC-DOS Tips & Traps

by Dick Andersen, Janice M. Gessin, Fred Warren, and Jack Rodgers

Here's an invaluable collection of helpful tips and clever solutions to troublesome traps for everyone using PC-DOS 2.1 or MS-DOS® 2.11. From initializing your system and formatting disks, to controlling peripherals and managing the DOS environment, you'll find an array of tricks and secrets.

\$16.95, Order #0-07-881194-5, 218 pp.  
7¾ x 9¼

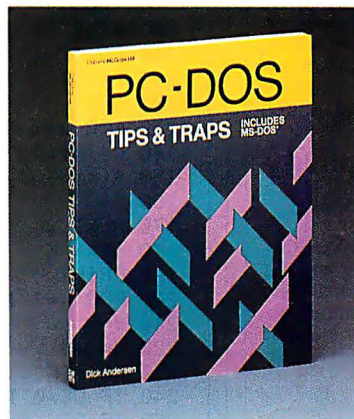

## Advanced WordPerfect®: Features & Techniques

by Eric Alderman and Lawrence J. Magid

The source for ambitious users. Provides tools and concepts that you can use to take advantage of macros, paragraph numbering and outlining, indexing, and WordPerfect's mathematical capabilities. Covers WordPerfect integration with Lotus® 1-2-3®, dBASE III®, Sidekick®, and ProKey™.

\$16.95, Order #0-07-881239-9, 310 pp.  
7¾ x 9¼

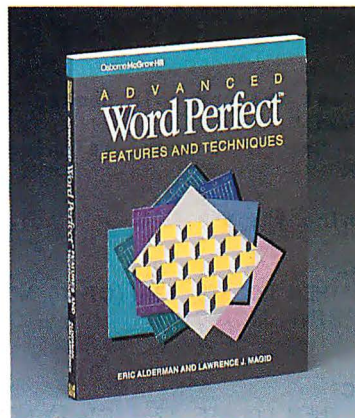

## The Osborne/McGraw-Hill Guide to Using Lotus® 1-2-3; Second Edition

by Edward M. Baras

Master Lotus 1-2-3 upgrade, Release 2, with this comprehensive guide. Provides detailed descriptions of worksheet, database, and graphics functions for fundamental through advanced applications. Includes ready-to-use models.

\$18.95, Order #0-07-881230-5, 412 pp.  
7¾ x 9¼

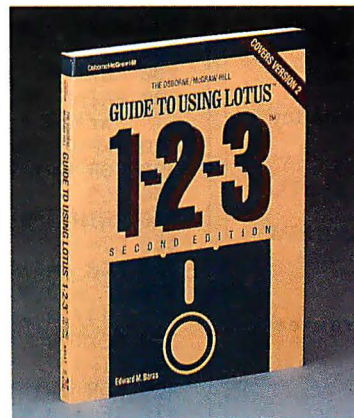

- ◆ Osborne/McGraw-Hill books are available at bookstores and computer stores everywhere.
- ◆ To order by mail, complete the coupon and send it to: Osborne/McGraw-Hill  
P. O. Box 400  
Hightstown, NJ 08520
- ◆ All orders must be prepaid and should include local tax.
- ◆ Checks, money orders, VISA and MasterCard are acceptable for payment. No postage or handling charges are required.
- ◆ Books will be shipped via UPS. Allow 4-6 weeks for delivery. Books will not be delivered to post office boxes.

This order is subject to acceptance by McGraw-Hill. Offer is good only in the U.S.A.

**Osborne McGraw-Hill**

Copyright ©1986 by McGraw-Hill, Inc.

NAME _____	
ADDRESS (No PO Box) _____	
CITY _____	
STATE _____	ZIP _____
INDICATE METHOD OF PAYMENT <input type="checkbox"/> CHECK/MONEY ORDER	
<input type="checkbox"/> VISA/EXP. DATE _____	<input type="checkbox"/> MASTERCARD/EXP. DATE _____
CARD # _____	
SIGNATURE _____	
QTY _____	ORDER # _____ PRICE _____
_____	
_____	
<b>Osborne/McGraw-Hill</b>	SUBTOTAL _____
PO Box 400, Hightstown, NJ 08520	TAX _____
Clip and send.	TOTAL _____
42-Q-015-7000-1	



# C Programmers!

**db\_VISTA<sup>®</sup>: high-speed DBMS  
written exclusively for C  
NOW offers SQL-based query**

High-Speed data retrieval and access... just two benefits of using Raima's network model DBMS, db\_VISTA. Combine these design benefits with those of C—speed, portability, efficiency, and you begin to understand db\_VISTA's real measure... performance.

**Says, Dave Schmitt,  
President of Lattice, Inc.**

"If you are looking for a sophisticated C programmer's database, db\_VISTA is it. It lets you easily build complex databases with many interconnected record types. Raima's customer support and documentation is excellent. Source code availability and a royalty-free run-time is a big plus."

**db\_QUERY<sup>™</sup>: new simplicity  
retains performance!**

db\_QUERY, our new C-linkable, SQL-based, ad-hoc query and report writing facility... provides a simple, relational view of db\_VISTA's complex network database. No longer will you give up performance for simplicity... combine db\_QUERY with db\_VISTA... you have both!

- **Written in C**
- **Royalty-Free**
- **Source Code Available**
- **Multi-user and LAN capability**
- **Fast B-tree indexing method**
- **Transaction processing**
- **Faster without Data Redundancy**
- **Complete Documentation**
- **Operating systems:** MS-DOS, PC-DOS, UNIX, XENIX, SCO XENIX, UNOS, ULTRIX, VMS
- **C compilers:** Lattice, Microsoft, IBM, DeSmet, Aztec, Computer Innovations, XENIX and UNIX

**30-day Money-Back Guarantee**

**Royalty Free  
Price Schedule**

	db_VISTA	db_QUERY
Single-user	\$ 195	\$ 195
Single-user w/Source	\$ 495	\$ 495
Multi-user	\$ 495	\$ 495
Multi-user w/Source	\$ 990	\$ 990
<b>NEW:</b>		
VAX Multi-user	\$ 990	\$ 990
VAX Multi-user w/Source	\$1980	\$1980

**FREE Technical Support  
For 60 days**

**Call Toll-Free Today!**

**Order Line . . . . 1-800-327-2462  
Information Line 1-206-828-4636**



**RAIMA<sup>™</sup>**  
CORPORATION

High-Speed Programming Tools,  
Designed for Portability

3055-112 N.E., Bellevue, WA 98004 USA  
(206) 828-4636 Telex: 6503018237 MCI UW

0287B

## MATHEMATICAL RECREATIONS

**Listing 2a: BASIC program to find a single off-weight coin using a balance scale with no standard weights.**

```

10 DIM A(120,5),R(5)
20 REM
30 REM
40 CLS: PRINT "Bad Coin Finder"
50 INPUT "How many weighings are to be allowed (2 TO 5)";N
60 IF N<2 OR N>5 THEN 50
70 C=INT((3*N-3)/2)
80 PRINT "Out of "; C; "coins, exactly 1 is bad (light or
   heavy). I'll find it."
90 PRINT "Numbering the coins";
100 FOR K=1 TO C
110 PRINT ".";
120 D=K
130 FOR J=N TO 1 STEP -1
140 Q=INT(D/3)
150 A(K,J)=D-3*Q
160 D=Q
170 NEXT J
180 NEXT K
190 PRINT
200 FOR K=1 TO C
210 J=0
220 J=J+1
230 DF=A(K,J)-A(K,J+1)
240 IF DF=0 THEN 220
250 IF DF=-1 OR DF=2 THEN 290
260 FOR L=1 TO N
270 A(K,L)=2-A(K,L)
280 NEXT L
290 NEXT K
300 PRINT "Pick out the bad coin number ( 1 to"; C; ") and
   write it down."
310 INPUT "Press Return to start weighing";RT$
320 FOR W=1 TO N
330 CLS
340 PRINT "Weighing #"; W
350 CI=1
360 FOR J=1 TO C
370 IF A(J,W)=0 THEN LOCATE 12-((CI-1) MOD 10), 1+INT((CI-
   1)/10)*8: PRINT J:CI=CI+1
380 NEXT J
390 CI=1
400 FOR J=1 TO C
410 IF A(J,W)=2 THEN LOCATE 12-((CI-1) MOD 10),41+INT((CI-
   1)/10)*8: PRINT J:CI=CI+1
420 NEXT J
430 LOCATE 13,1
440 PRINT "-----" TAB(40)
   "-----"
450 PRINT TAB(16) "|" TAB(56) "|"
460 PRINT TAB(16)
   "-----"
470 PRINT TAB(36);"^"
480 LOCATE 18,1
490 PRINT"Which side is heavier? L=left, R=right,
   N=neither: ";
500 WH$=INPUT$(1)
510 PRINT WH$;
520 V=INT((INSTR(1,"LlNnRr",WH$)+1)/2)
530 IF V=0 THEN 480 ELSE R(W)=V-1
540 NEXT W
550 COIN=0
560 FOR K=1 TO N
570 COIN=3*COIN+R(K)
580 NEXT K

```

continued



# smARTWORK<sup>®</sup> Keeps Getting Smarter

## Smarter Artwork

Three years ago, Wintek engineers created smARTWORK to reduce the time and tedium of laying out their own printed-circuit boards. Thousands of engineers have since discovered the ease of use and sophistication that makes smARTWORK the most popular PCB CAD software available. And thanks to them, smARTWORK keeps getting better.



smARTWORK transforms your IBM PC into a PCB CAD system

Interactive routing, continual design-rule checking, pad shaving, and production-quality 2X artwork have always been a part of smARTWORK. And now that many customer suggestions have become a part of the software, smARTWORK is an even better value. *That's why we offer it with a thirty-day money-back no-nonsense guarantee.*

Using an Epson or IBM dot-matrix printer, you can create 2X artwork and 1X or 2X checkplots in a fraction of the time hand-taping requires

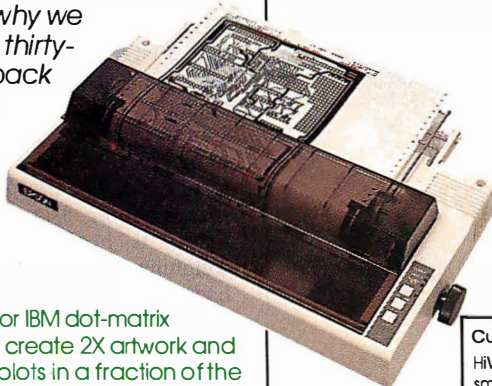

## New smARTWORK Features

- Silkscreen layer for component placement and identification
- Text capabilities for all three layers
- Selectable trace widths and pad shapes and sizes
- User-definable library
- Ground planes created with a single command
- Solder-mask and padmaster plots generated automatically
- Quick printer 2X checkplots
- Additional drivers for printers and plotters
  - Optional drill-tape and Gerber photoplotter utilities
  - AutoCAD<sup>®</sup> .DXF file output
  - Completely updated manual
  - 800 number for free technical assistance

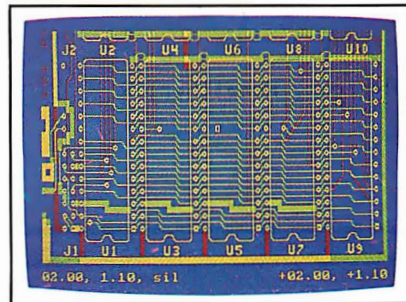

2" by 4" section of a 10" by 16" double-sided board with silkscreen layer

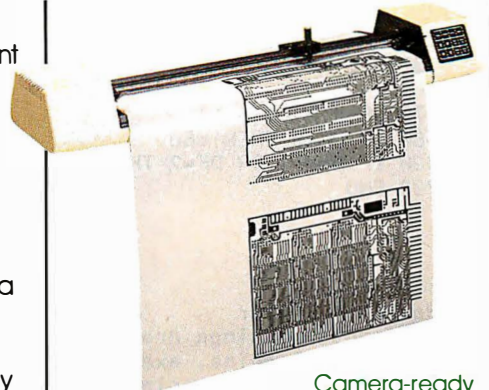

Camera-ready 2X artwork from an HI or HP pen plotter

## The Smart Buy. Guaranteed.

Still priced at \$895, smARTWORK is proven, convenient, and fast. Our money-back guarantee lets you try smARTWORK for 30 days at absolutely no risk. Call toll free (800) 742-6809 today and put smARTWORK to work for you tomorrow. That's smart work.

## System Requirements

- IBM PC, PC XT, or PC AT with 384K RAM, and DOS V2.0 or later
- IBM Color/Graphics Adapter with RGB color or B&W monitor
- IBM Graphics Printer or Epson FX/MX/RX-series printer, and/or
- Houston Instrument DMP-40, 41, 42, 51, 52, or Hewlett-Packard 7470, 7475, 7550, 7580, 7585, 7586 pen plotter
- Optional Microsoft Mouse

Wintek Corporation  
1801 South St.  
Lafayette, IN 47904  
Telephone: (800) 742-6809  
In Indiana: (317) 742-8428  
Telex: 70-9079 WINTEK CORP UD



"smARTWORK", "Wintek", and the Wintek logo are registered trademarks of Wintek Corporation. "AutoCAD" is a registered trademark of Autodesk, Inc.

Current Versions	
HiWIRE	V1.0r0
smARTWORK	V1.2r6



```

590 LOCATE 18,1
600 PRINT STRING$(80,32)
610 LOCATE 18,1
620 IF COIN>C THEN COIN=INT(3^N-1-COIN)
630 IF COIN<1 OR COIN>C THEN PRINT"Impossible! Please try
      again.": END
640 PRINT "Coin "; COIN; "is ";
650 D=0
660 D=D+1
670 DF=R(D)-R(D+1)
680 IF DF=0 THEN 660
690 IF DF=-1 OR DF=2 THEN PRINT "HEAVY" ELSE PRINT "LIGHT"
700 END
    
```

**Bad Coin Finder**

How many weighings are to be allowed (2 TO 5)? 5  
 Out of 120 coins, exactly 1 is bad (light or heavy).  
 I'll find it. Numbering the coins.....

Pick out the bad coin number ( 1 to 120 ) and  
 write it down. Press Return to start weighing?

**Weighing # 1**

14	33	43	53	23	60	70	80
13	32	42	52	22	59	69	79
12	31	41	51	21	58	68	78
11	30	40	50	20	57	67	77
10	29	39	49	19	56	66	76
9	28	38	48	18	55	65	75
5	27	37	47	8	54	64	74
4	17	36	46	7	26	63	73
3	16	35	45	6	25	62	72
1	15	34	44	2	24	61	71

Which side is heavier? L=left, R=right, N=neither: R

*Listing 2b: Alternate lines with simplified I/O for BASICS without the LOCATE feature.*

```

350 PRINT: PRINT"Left side: ";
370 IF A(J,W)=0 THEN PRINT J;
390 PRINT: PRINT "Right side: ";
410 IF A(J,W)=2 THEN PRINT J;
430 PRINT
440 REM Line deleted
450 REM Line deleted
460 REM Line deleted
470 REM Line deleted
480 PRINT
510 REM Line deleted
590 PRINT
600 REM Line deleted
610 REM Line deleted
    
```

The complicated preparation is over, and we are ready to perform some ternary magic.

**The Weighing-in**

For the first weighing, we place in the left pan every coin whose first (leftmost) digit is 0. In the right pan we place every coin whose first digit is 2. If the left pan goes down (is heavy), we write a 0. If the pans balance, we write a 1. If the right pan goes down, we write a 2.

The second weighing is similar, except we look at each coin's second digit. Into the left pan go the coins whose second digit is 0; into the right pan go the coins whose second digit is 2. After checking the balance, we write down a 0 (left pan down), 1 (balanced), or 2 (right pan down), as before.

For the third weighing, coins whose third (rightmost) digit is 0 go in the left pan; coins whose third digit is 2 go in the right pan. Write down a 0, 1, or 2, as before.

We have now generated a three-digit ternary number. We find the number in table 1 and read off the corresponding coin number from column 1. That's our bad coin. If the ternary number is clockwise, the coin is heavy; if the ternary number is counterclockwise, the coin is light.

Simple? Not at all. But the method works, and it can be generalized to handle problems allowing  $n$  weighings of  $(3^n - 3)/2$  coins.

For instance, if seven weighings are allowed, we can find the one bad coin among 1092 coins. But applying the method manually would be virtually impossible because of the paperwork involved. Which explains why you won't find reference to a 1092-coin problem in any puzzle book.

Nevertheless, the program in listing 2 brings computer power to the task, and it lets us handle any arbitrary number of weighings. The program sets an upper limit of 5 to allow simulation of a scale on the screen.

To raise the limit, replace the value 5 with a larger number in lines 10, 50, and 60. In this case, you will also need to include the alternate lines in listing 2b.

In the program, the computer asks you to pick out the bad coin and write down its number. The computer then simulates each weighing, asking you to tell it which "pan" is heavier. At the end of  $n$  weighings, the computer will identify the bad coin by number and specify whether it is light or heavy.

I would appreciate hearing from readers who have comments on these ternary puzzles or can suggest other mathematical recreations involving alternate number systems. ■



# LISTINGS YOUR WAY!

It's easy. Now there are three ways to get source-code listings that go with BYTE articles—on disk, in print or on line.

## ORDER BYTE LISTINGS ON DISK!

These magnetic disks contain listings of source code described in the issues of BYTE. Disks are available by annual subscription or as individual orders and in 11 popular disk formats. Order today!



**FOR DIRECT ORDERING CALL TOLL FREE: 800-258-5485**

**Call: M-F, 8:30 a.m. to 4:30 p.m. Eastern Time**

**(603-924-9281 for New Hampshire residents)**

**For credit card orders only.**

## ORDER BYTE LISTINGS IN PRINT!

BYTE is now offering a supplement in print. In this supplement, you can now get printed versions of all source-code listings that go with BYTE articles.

### LISTINGS ON DISK

BYTE listings on disk are right for you if you want to compile or run programs quickly. Disks are now available by annual subscription as well as individual orders. BYTE offers listings in 11 popular disk formats. See the order card below.

### LISTINGS IN PRINT

This print supplement contains source-code listings described in the issues of BYTE. See order card below.

### LISTINGS FROM BIX

(BYTE Information Exchange) By joining BIX, you can download BYTE source-code listings at standard BIX rates. See BIX informational ad listed in Reader Service index in this issue.

## BYTE LISTINGS ON DISK

IN USA:	Single Month Subscription (one disk)	Annual Subscription (13 disks)
<b>5¼ inch:</b>	<input type="checkbox"/> \$8.95	<input type="checkbox"/> \$69.95 (Save \$46.40)
<input type="checkbox"/> IBM PC		
<input type="checkbox"/> Apple II		
<input type="checkbox"/> Kaypro 2 CP/M		
<input type="checkbox"/> Tandy Mod 4		
<input type="checkbox"/> MS-DOS 8 Sector		<input type="checkbox"/> TI Professional
<b>3½ inch:</b>	<input type="checkbox"/> \$9.95	<input type="checkbox"/> \$79.95 (Save \$49.40)
<input type="checkbox"/> Apple Macintosh		
<input type="checkbox"/> Atari ST		
<input type="checkbox"/> Amiga		
<input type="checkbox"/> HP 150		
<b>8 inch:</b>	<input type="checkbox"/> \$9.95	<input type="checkbox"/> \$79.95 (Save \$49.40)
<input type="checkbox"/> CP/M		

OUTSIDE USA:	Single Month Subscription (one disk)	Annual Subscription (13 disks)
<b>5¼ inch:</b>	<input type="checkbox"/> \$10.95	<input type="checkbox"/> \$89.95 (Save \$52.40)
<input type="checkbox"/> IBM PC		
<input type="checkbox"/> Apple II		
<input type="checkbox"/> Kaypro 2 CP/M		
<input type="checkbox"/> Tandy Mod 4		
<input type="checkbox"/> MS-DOS 8 Sector		<input type="checkbox"/> TI Professional
<b>3½ inch:</b>	<input type="checkbox"/> \$11.95	<input type="checkbox"/> \$99.95 (Save \$55.40)
<input type="checkbox"/> Apple Macintosh		
<input type="checkbox"/> Atari ST		
<input type="checkbox"/> Amiga		
<input type="checkbox"/> HP 150		
<b>8 inch:</b>	<input type="checkbox"/> \$11.95	<input type="checkbox"/> \$99.95 (Save \$55.40)
<input type="checkbox"/> CP/M		

**Please send me single disks in the format checked above for the following 1986 issues:**

- |                                   |                                       |
|-----------------------------------|---------------------------------------|
| <input type="checkbox"/> January  | <input type="checkbox"/> August       |
| <input type="checkbox"/> February | <input type="checkbox"/> September    |
| <input type="checkbox"/> March    | <input type="checkbox"/> October      |
| <input type="checkbox"/> April    | <input type="checkbox"/> November     |
| <input type="checkbox"/> May      | <input type="checkbox"/> December     |
| <input type="checkbox"/> June     | <input type="checkbox"/> IBM PC Issue |
| <input type="checkbox"/> July     |                                       |

Name \_\_\_\_\_

Address \_\_\_\_\_

City \_\_\_\_\_ State \_\_\_\_\_ Zip \_\_\_\_\_

County or Parish \_\_\_\_\_ Country \_\_\_\_\_

Check enclosed     MasterCard     VISA

Credit Card \_\_\_\_\_

Exp. Date \_\_\_\_\_ Signature \_\_\_\_\_ Date \_\_\_\_\_

U.S. Funds enclosed (If ordering from outside the U.S. please remit in U.S. funds drawn on a U.S. bank. Thank you.)

**FEBRUARY**

## BYTE LISTINGS IN PRINT

- IN USA:**
- January through June 1986 for only \$8.95.
- July through September 1986 for only \$6.95.
- October through December 1986 (available in November) for only \$6.95.
- 1986 Annual Subscription for only \$18.00 (Save \$4.85).

- OUTSIDE USA:**
- January through June for only \$9.95.
- June through September for only \$7.95.
- October through December for only \$7.95.
- 1986 Annual Subscription for only \$21.00 (Save \$4.85).

The print listings come in one convenient package. The first issue of the listings supplement includes listings for the first half of 1986. Thereafter,

the listings supplements are quarterly. Sign up now for an annual subscription and avoid the need to order every quarter.

Name \_\_\_\_\_

Address \_\_\_\_\_

City \_\_\_\_\_ State \_\_\_\_\_ Zip \_\_\_\_\_

County or Parish \_\_\_\_\_ Country \_\_\_\_\_

Check enclosed     MasterCard     VISA

Credit Card \_\_\_\_\_

Exp. Date \_\_\_\_\_ Signature \_\_\_\_\_ Date \_\_\_\_\_

U.S. Funds enclosed (If ordering from outside the U.S. please remit in U.S. funds drawn on a U.S. bank. Thank you.)

**FEBRUARY**



# LISTINGS YOUR WAY!

It's easy. Now there are three ways to get source-code listings that go with BYTE articles—on disk, in print or on line.

## LISTINGS ON DISK

BYTE listings on disk are right for you if you want to compile or run programs quickly. Disks are now available by annual subscription as well as individual orders. BYTE offers listings in 11 popular disk formats. See the order card below.

## LISTINGS IN PRINT

This print supplement contains source-code listings described in the issues of BYTE. See order card below.

## LISTINGS FROM BIX

(BYTE Information Exchange) By joining BIX, you can download BYTE source-code listings at standard BIX rates. See BIX informational ad listed in Reader Service index in this issue.

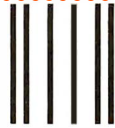

NO POSTAGE  
NECESSARY  
IF MAILED  
IN THE  
UNITED STATES

### BUSINESS REPLY MAIL

FIRST CLASS MAIL PERMIT NO. 10 PETERBOROUGH, NH

POSTAGE WILL BE PAID BY ADDRESSEE

## BYTE Listings

One Phoenix Mill Lane  
Peterborough, NH 03458-9990



NO POSTAGE  
NECESSARY  
IF MAILED  
IN THE  
UNITED STATES

### BUSINESS REPLY MAIL

FIRST CLASS MAIL PERMIT NO. 10 PETERBOROUGH, NH

POSTAGE WILL BE PAID BY ADDRESSEE

## BYTE Listings

One Phoenix Mill Lane  
Peterborough, NH 03458-9990



**FOR DIRECT  
ORDERING CALL  
TOLL FREE:  
800-258-5485**

**Call: M-F, 8:30 a.m. to  
4:30 p.m. Eastern Time**

**(603-924-9281 for New  
Hampshire residents)**

**For credit card  
orders only.**



# CHAOS MANOR MAIL

Conducted by Jerry Pournelle

## Tight Squeeze for Tiny Turbo

Dear Jerry,

I recently purchased an Orchid Tiny Turbo after noting your remarks about Orchid Technology. The Tiny Turbo and a 20-megabyte HardCard gave my Compaq portable the facelift it needed.

A few comments on the Tiny Turbo. Documentation for the installation in a PC is okay, but it is almost nonexistent for Compaqs. Slot configuration and processor location on the portable make installation of the unit akin to putting 10 ounces of turbo in a 9-ounce can. I even scored the connector ribbon during installation as a result of the extremely tight fit.

The Tiny Turbo works as advertised. I'm very happy with the performance, but very distressed about the installation. Knowing this, I would probably not buy it again.

Steve Boesch  
Mountain Home, ID

*Hadn't tried an Orchid product with a Compaq; I'm not surprised it was a tight fit, and, indeed, I'm amazed you could do it at all. Thanks for writing.*—Jerry

## Henry's Inspiration

Dear Jerry,

Your description of Little Computer People (November 1986), and the BYTE staff's treatment of Henry, made me think of a short story that might well have been the inspiration for this program.

It was published in a large book of short stories called *Alfred Hitchcock's Ghostly Gallery*. It involved two people who take a job housesitting for a man who is going out of town for a few weeks. Before leaving, he warns them to stay away from a mysterious covered birdcage in his room.

However, the housesitters became curious and find inside the birdcage a scene much like the one described: a small house like a doll's house, with a newspaper on the front porch written in an unintelligible language. There also seems to be someone living in the house.

For some reason, much like the BYTE staff, the housesitters eventually begin treating the residents of the house in an unkind way. Eventually they move out, I think to be replaced by some noisy and messy tenants. The man who owns the house eventually returns and becomes angry at the housesitters; the tenants of the doll's house in the birdcage, he says, are

"The Little People" who brought him good luck, and whom he had spent many years convincing to live in the house.

Since the book was widely available at a time and targeted for an age group that would have exposed it to many of the people who are now programmers, I wonder whether this story had some direct or indirect influence on the creation of the program? In any case, it was a very good short story.

Eric Roskos  
Bellevue, WA

*That's a famous story, and I've been trying to remember who wrote it; either Robert Bloch or Ted Sturgeon, I'm sure.*

*As I recall, the newspaper was in English, but the headlines were unintelligible. "Fotspath Marches on Feswick," or something. Alas, my Little Computer People don't do anything so interesting. In fact, we've turned them off...*—Jerry

## Double Rainbow

Dear Jerry,

In your discussion of NEC's V20 chip (June 1986), which enables PCs to run CP/M as well as the conventional MS-DOS, you mention that replacing the 8088 with the V20 doesn't work with "partial clones" like the DEC Rainbow. I'm sure that's true, but, of course, the DEC Rainbow comes equipped with *both* the 8088 and the Z80, and so it happily runs both MS-DOS and CP/M.

Thanks for the tip about the Workman and Associates catalog. Having access to both CP/M and MS-DOS is a good deal.

Robert Leopold  
Livingston, NJ

*Right; I'd forgotten that. The Rainbow had the potential to be quite a machine in its day, but DEC determined on a marketing philosophy that utterly doomed it. From what I hear, they didn't really learn their lesson, either.*

*Barry Workman assures me that CP/M is not at all dead. For that matter, I'm writing this on a Z80 CP/M 2.2 machine.*—Jerry

## OS-9

Dear Jerry,

I was surprised to read in your usually civil column that BIX has an OS-9 conference moderated by a fanatic determined

to tell you more than he knows about the operating system. I have not had the pleasure of meeting Jim Omura in person, but judging by his postings to USENET's net.micro, 6809, net.micro.68k, and mod.os.os9, he appears to be reasonably knowledgeable.

Concerning the price of OS-9 for the Atari ST, it is *not* Microware that determines the price, but TLM Systems, the company that did the port and that is selling it. If messages on CompuServe's OS-9 SIG are to be believed, Microware thinks TLM is charging too much, too. So do I, but I don't have much control over things of that sort.

James Jones  
West Des Moines, IA

*I've already apologized to Jim Omura; my remark was intended to be funny, but it was a bit heavy-handed. Omura is an enthusiast and will tell you a lot...*

*When OS-9 licensing fees get somewhere reasonable, we may see it more widespread.*—Jerry

## Spreadsheet for Sundog

Dear Jerry,

In the May 1986 BYTE, you said: "I swear I was tempted to set up a SuperCalc spreadsheet on Big Kat and record the Sundog information on that, until sanity prevailed." I guess I am insane, because I did just that on Appleworks. It was easier to read than my handwritten notes.

By the way, I was one of the beta testers for Universe II (Apple version). On the Apple, it uses the mouse and the Apple Pascal 1.3 desktop library. It's a little slow and there are a lot of disk accesses, but it looks nice, and the game plays well.

Harry Erwin  
Shelton, CT

*I've got Universe II for the Atari ST and I've been afraid to play it; I fear I may become addicted, and I'm out of time just now. I also have an IBM PC copy. Universe I on the PC almost drove me crazy until I discovered the trick of using SuperKey to create a whole bunch of macros; then I could set up my travel orders and go out for coffee while the machine flew me around.*

*I may yet do a spreadsheet for Sundog. Incidentally, there are some really nifty Sundog tips on BIX.*—Jerry ■



**FORTRON CORPORATION**  
 3225 Seldon Court  
 Fremont, CA 94538

Information & CA Res. (415) 490-8171  
 Technical Support (415) 490-8403  
**Orders Only (800) 821-9771**

## FORTRON PRESENTS THE DEPENDABLE ONES

While some power supply importers reduce their selling prices by using cheaper and fewer materials, we at Fortron do not jeopardize our discriminating customer's faith in our standards of quality by such compromises.

Here are some visible differences Fortron uses:

- **Burndy (U.S. made) connectors** which provide error-free connections from power supply to CPU board and peripherals.
- **A shielded power cord** insures minimum AC line interference.
- **Built-in EMI filter** maintains a conductive emissions level specification to greater than 6 dB/uV below **FCC Class B**.
- **All U.L. recognized materials and circuit layout** to ensure complete safety.

In addition to our high quality materials, our testing facility in the U.S. and our technical support from five full time power supply and system application engineers has made Fortron's PC/XT and AT power supplies tops in their field.

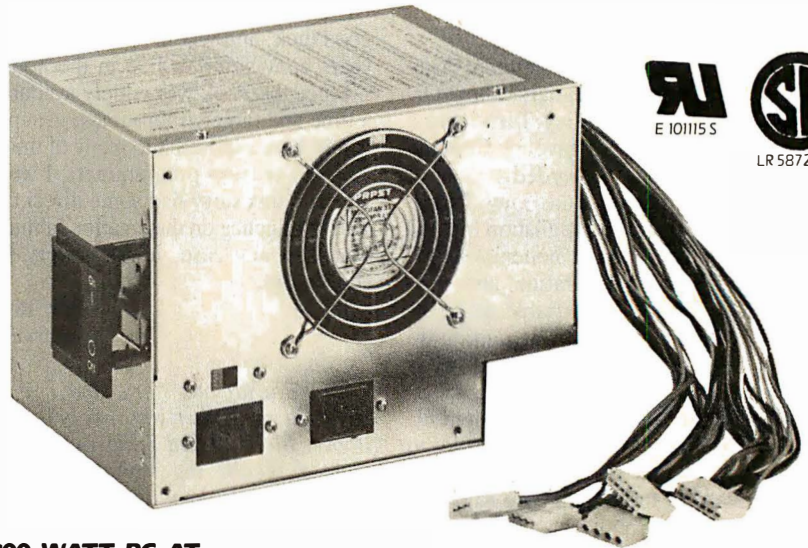

### 200 WATT PC AT

- U.L. recognized, certified
- OVP, OCP, short circuit protection
- Meets European safety requirements
- MTBF 34,000 hours
- Four drive connectors
- One full year warranty



### 150 WATT PC XT

Direct Replacement for IBM® PC XT Power Supply

## REVOLUTIONARY PRICED Hercules® compatible Monochrome Graphics/Controller

### -Compatibility-

For PC, XT, AT. 6, 8, 10, 12 Mhz.

- IBM® Monochrome/Printer adapter compatible
- Hercules® Graphics Adapter compatible
- Runs directly Lotus® 1-2-3 AutoCad®, Symphone®, Basic

### -Outstanding Features-

- 80 X 25 text mode
- 64K bytes graphics display memory
- 720 X 348 pixel resolution
- Printer interface

### -Short Card, easy installation-

### -Reliability-

- Custom-built chip, ICT tested, producing a nearly zero defect rate.
- lower signal to noise ratio
- one full year warranty

### -FCC Class B Certified-

starting at . . . **43<sup>00</sup>** ea.

(Dealer's quantity price)

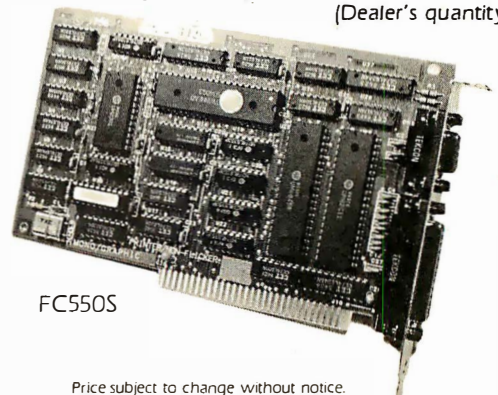

FC550S

Price subject to change without notice.



The Best of BIX is a look at a few of the thousands of messages posted on BIX each month. Excerpts this month are taken from the Amiga, Atari ST, IBM PC, Telecomm.Tech, Apple, Macintosh, BASIC, C.Language, and Pascal conferences. For more information on joining BIX, turn to the advertisement on page 306.

## AMIGA

Both discussions in the Amiga window feature software. In the first, low-level control of the parallel port is the subject of debate. In the second, the ever-popular question of implementing data structures in assembler is addressed.

### PARALLEL TIMING

amiga/tech.talk #749, from cllirakis (Christopher Lirakis), Sun Nov 2 12:49:23 1986.

Hello. I am interfacing some stuff to the parallel port and I find that I have problems reading information using the ROM kernel routines. I currently have an ADC hooked up. As I understand it, my device is supposed to generate ACK and the Amiga will respond with DRDY. I find that I get DRDY pulses at any old time after I give my ACK. What is the scoop here? Does anyone know? Is it due to the multitasking?

I would also like to know if you can set the bits POUT, BUSY, and INT. I see a routine to read their status, but it would also be nice to set them. Thanks, Chris.

amiga/tech.talk #752, from jdow (Joanne Dow), Mon Nov 3 00:37:56 1986. A comment to message 749.

On INPUT from the peripheral device to the Amiga, pin 10 acts as DRDY and pin 1 acts as ACK. That is, you signal pin 1 and read pin 10 for the handshake return. You must open the parallel port in your program for output before this has a prayer of working, as you're likely set up in printer device mode, output. And until you issue the turnaround by opening the port for write, you can forget about using it for input mode. <@\_@>

amiga/tech.talk #756, from cllirakis, Mon Nov 3 19:52:32 1986. A comment to message 752.

What you are telling me sounds like it is the total opposite of what I read. Open the port for write? I want to read data. Does the Amiga look for a pulse on pin 1? ACK is attached to the F input of the 6522 VIA. This input is used to interrupt. I assume that the driver is meant to respond to that. I am confused? Chris

amiga/tech.talk #757, from jdow, Mon Nov 3 22:18:48 1986. A comment to message 756.

The pin functions are labeled for a standard Centronics parallel port write-only function. The ACK and DRDY functions reverse for a read. You must open the parallel port for a read from your device. Then the pin functions should be reversed by control software for the port. It sounds like you are trying to short-circuit the OS for this function. This likely has left DRDY in a low-impedance driver mode and ACK in a high-impedance receive mode. As you are trying to drive DRDY and monitor ACK, your circuit would not work.

This would lead to stray pulses on ACK and strangeness on DRDY. DRDY might do funny things as the serial port functions. <^\_^>

amiga/tech.talk #760, from laars (Dean Kriellaars), Wed Nov 5 08:28:10 1986. A comment to message 756.

Don't even open the parallel port. It's just too much trouble! Go right to the 8250's. Specifically, address 0xBF01. All you do is hook up the A/D and this function:

```
#include <exec/types.h>
#include <exec/tasks.h>

extern APTR MemPtr; /*Pointer to start of Allocated
Memory*/

extern int CurMem; /* Size of Allocated Memory */

Get_Par_Data()
{
    register int x,Smax;
    register short a,b;
    register unsigned char *Inptr;
    register unsigned char *Mptr;

    Inptr=0xBF01; /* Look in Hardware Manual under
CIAA                Address Map */

    Mptr=MemPtr; /* Assign to Start of Allocated
Memory */
    Disable();
    Smax=CurMem; /* Memory Size */
    for(x=0;x<Smax;x++)
    {
        *Mptr=*Inptr;
        for(a=0;a<b;a++,a--,a++); /* Wasting Time
Loop*/
        ++Mptr;
    }
    Enable();
}
```

And that's it!

amiga/tech.talk #759, from cllirakis, Tue Nov 4 18:43:16 1986. A comment to message 757.

Excuse my denseness. I am still confused. Thank you for your patience. 1) I open the parallel port for read. 2) I pulse the ACK line low when my data is ready to be read. 3) I await Amiga response on DRDY. You suggest: 1) Open the parallel port for read. 2) Pulse DRDY low when data is ready to be read. 3) Wait for acknowledgment on ACK. If this is true, then the hardware manual speaks falsely in its timing diagrams. Chris

amiga/tech.talk #765, from jdow, Thu Nov 6 21:49:30 1986. A comment to message 759.

When the Amiga is writing, the Amiga pulses DRDY. Then the peripheral pulses ACK. When you open the port for read, then the peripheral should signal ACK from the peripheral and the Amiga should reply on DRDY. This will not be set up unless you use the AmigaDOS open for read. (It should be then; that port is the one Carl Sassenrath is using for MAS-20 disk.) <@\_@>

amiga/tech.talk #767, from cllirakis, Sun Nov 9 11:15:54 1986. A comment to message 765.

Hello again. I have been experimenting. During the last week I have read some conflicting data. I now believe I have it right. In the programs I have been using, I have always opened the parallel port using the proper calls, based on C and the chapter in the RKM on parallel port. Once opening the parallel port and trying to do reads I find that the data in the hardware manual is correct. The object to be read must generate

*continued*



a low pulse on ACK to tell the Amiga it is ready to transfer data. The Amiga responds on DRDY. Although this does work, there are some random pulses generated on DRDY also; this I can see on a scope. It seems that the Amiga does reads, or at least tries to do something with the data direction register associated with the parallel port. Why do I believe all this? I have tried to do the reverse (i.e., pulse DRDY and look at ACK). This did not work for me. I also find it unusual that anyone should suggest this. According to the hardware manual, the ACK pin is attached to the F input of the 6526 chip. This is the input that will FLAG the interrupt flag in interrupt/mask register of the 6526. This may be set to do a hardware interrupt, if desired. I believe that this is how the kernel uses the flag. The DRDY is said to be attached to the PC on the same chip. This goes low after any port B, which is the parallel port access, either read or write. As I read it, this is only an output, not an input, so, unless either of these pins is tied to something else that goes the reverse direction internally, then the system is set up only for DRDY out and ACK in.

So, I still don't know why I get other random pulses on DRDY. I assume it has to do with the driver under v1.1 DOS. I guess I wait for v1.2 since I am not a software jock. Does what I have stated make sense?  
Chris

amiga/tech.talk #769, from jdow, Mon Nov 10 03:11:53 1986. A comment to message 767.

Ah, 1.1 is the problem indeed. I bet that the times it pulses are when the serial port is in use. They interact under 1.1. This is fixed under 1.2 and is why Redmond's parallel-port-driven MAS-20 is not yet in release. As soon as 1.2 is public, look for that drive to appear. <@\_@>

amiga/tech.talk #766, from jdow, Thu Nov 6 21:50:17 1986. A comment to message 760.

And if you do that, there are NO GUARANTEES that your code will work on future machines. If that is no problem, fire away! <@\_@>

amiga/tech.talk #771, from tholloway (Tim Holloway), Sat Nov 22 14:43:22 1986. A comment to message 760.

... And it will serve you right if the port is at a different address in the Amiga 500 and 2500 machines.

[Editor's note: References in this section to AmigaDOS use version 1.1. Version 1.2, which corrects many of the problems mentioned, has since been released.]

## I/O REQUEST STRUCTURES IN ASSEMBLER

amiga/amiga68000 #88, from cheath (Charlie Heath, MicroSmiths Inc.), Sun Oct 12 23:43:42 1986.

How do you reference the substructure fields in assembler? For instance, for a C statement like

```
tr->tr_time.tv_secs = 1;
```

What is the equivalent assembler statement? The statement

```
move.l #1,TV_SECS(A0)
```

creates only the substructure offset (in this case, 0 instead of 32).

Thanks-- ...cheath

amiga/amiga68000 #90, from ksalmon (Ken Salmon), Mon Oct 13 01:34:31 1986. A comment to message 88.

Charlie, having already covered this ground using the timer in assembler, here goes:

The devices/timer.i Include file shows

```
STRUCTURE TIMEREQUEST,IO_SIZE
STRUCT IOTV_TIME,TV_SIZE
LABEL IOTV_SIZE
```

The second argument of the STRUCTURE macro (as in exec/types.i) gives an initial offset. In this case, IO\_SIZE is the size of the I/O structure from exec/io.i. The STRUCT after TIMEREQUEST defines an occurrence of TIMEVAL. So, you calculate the proper offset at assembly time like this:

```
move.l #1,IOTV_TIME+TV_SECS(a0)
```

assuming that a0 points to your timer request. Ken

amiga/amiga68000 #91, from cheath, Mon Oct 13 01:39:05 1986. A comment to message 90.

Thanks to ya. Was that intuition, brute force, luck, or example?

**2 Mb EMS RAM / CLOCK FOR IBM PC/XT and COMPATIBLES WITH LIFETIME WARRANTY**



**LIMBO \$199.00 WITH 64K OF RAM**

**FEATURES —**

- Supports Lotus/Intel/Microsoft Expanded Memory Specifications (EMS)
- Uses either 64K or 256K DRAM chips
- User upgradeable
- Can fill system memory to 640K, allowing remaining memory to be used for EMS
- Includes Clock/Calendar function
- EMS memory manager software included
- EMS compatible RAM Disk software included
- EMS compatible Print Spooler software included

**ADDITIONAL PRODUCTS —**

- CLOCK/CALENDAR CARD
- PROM BLASTER (24 or 28 pin)
- COMBO II CARD
- 256K RAM CARD
- 512K RAM CARD
- EXTERNAL HARD DISK
- INTERNAL HARD DISK
- XT HARD DISK UPGRADE
- SHORT SLOT PAR/SERCARD FOR PPC AT
- 384K RAM CARD FOR PPC
- ADD-ON DISK DRIVES
- AT RAM CARD
- AT COMBOCARD
- CABLES

**Apparat, Inc.**  
6801 South Dayton — Englewood, Colorado 80112  
(303) 799-0819 — TOLL FREE 800/525-7674

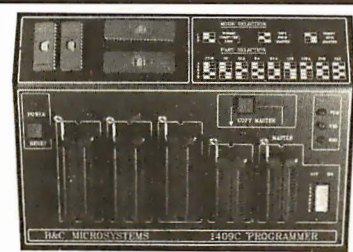

**UNIVERSAL EPROM PROGRAMMER \$599!!**

- Built in timer erase option; foam pad area
- Menu selection; No modules or adapters
- User friendly software; Complete help menu
- Direct tech. support; Full 1 yr. warranty
- Stand alone duplication & verify;
- Quick pulse algorithm: 27256 under 60 sec
- All 24/28 pins to 27011 & CMJUS E(E)PROMS
- Micros: 8741, 2, 4, 8, 9, 51, 52, 55, 9761 & CMOS
- Auto baud RS232 to 19.2k; Free PC drivers
- Offset/split Hex, Binary, Intel & Motorola 8, 16 & 32 bit files; Kits from \$99!

**B&C Microsystems**  
6322 Mojave Dr., San Jose, CA 95120  
Ph (408) 997-7685 Tx 4995363 Visa & MC

**AC/FORTRAN™ AMIGA**

Mainframe quality, full feature **ANSI FORTRAN 77** compiler includes **Debugger**, Linker, Library Manager, Runtime Library, **IEEE** math, and C interface. Supports **Complex numbers**, **Virtual arrays**, **Overlays** and Dynamic Linking. Not copy protected. Available now \$295. Turbo Amiga version also available.

**AC/BASIC™**

From the authors of **Microsoft BASIC** compiler for Macintosh, comes AC BASIC for the Amiga. Companion compiler to the **Amiga BASIC** interpreter. Has more features and includes a **Debugger**, includes **BLOCK IF**, **CASE** statement, and **STATIC** keyword extensions and executes up to **50x** faster. AC BASIC is the new BASIC reference for MS68000 based personal computers. Not copy protected. \$295.

Telephone orders welcome

**abssoft**

Scientific Engineering Software  
4268 N. Woodward, Royal Oak, MI 48072 (313) 549-7111  
Amiga trademark of Commodore Amiga  
Microsoft trademark of Microsoft Corp.



amiga/amiga68000 #92, from ksalmon, Mon Oct 13 01:41:47 1986. A comment to message 91.

In my case, that was just having been there before, and spending some time staring at the Include files. So, I know from practical experience that it works. Ken

amiga/amiga68000 #93, from cheath, Mon Oct 13 01:47:36 1986. A comment to message 92.

I stared, too, and didn't see anything obvious. Guess I'm not familiar with the structure definitions in Metacomco format - are they documented anywhere? Also, is there any relationship between the structure names in the ".h" files and the offsets in ".i" files?

amiga/amiga68000 #94, from jdow, Mon Oct 13 01:51:39 1986. A comment to message 93.

Yes, indeedy. Count out the bytes offset from beginning of the structure. They SHOULD be the same. I remember trying it some longish time ago last year just after getting the assembler and C compiler and trying to fathom fonts. <^\_^>

amiga/amiga68000 #95, from ksalmon, Mon Oct 13 01:56:14 1986. A comment to message 93.

I figured it out a while ago by just sitting down with the macro definitions in exec/types.i and seeing how they were used in other Include files. Those macros aren't commented, but they are pretty simple. Most of the field names with .i structures have the same names as the .h fields, with a 3-character prefix (structure initials and \_). But there's a lot of inconsistency, and the cases don't always match. It generally means you have to study each one individually to get the right name. I usually use a hard-copy listing of the .h version side by side with the .i version in RKM 1 & 2 (boy, I sure wish they had left all the Include files together like in the old RKM, instead of splitting across volumes). Ken

amiga/amiga68000 #96, from ksalmon, Mon Oct 13 01:58:28 1986. A comment to message 94.

I started out counting byte offsets just to assure myself everything was in order. Then I realized it's a \*lot\* simpler just to compare the .h and .i versions side by side. Things fall into place much quicker that way. Ken

amiga/amiga68000 #98, from cheath, Mon Oct 13 02:03:39 1986. A comment to message 95.

I'd figured out the xx\_ stuff, but not the substructure offsets; the names for substructures don't seem to have any relation to the ".h" equivalents. Am I missing something?

amiga/amiga68000 #99, from jdow, Mon Oct 13 02:08:39 1986. A comment to message 98.

They seemed to with the fonts stuff. It took some serious digging 'til I got the flavor of how the cumulative offsets worked in there. Then I seem to have clicked a translator in my head for the assembly STRUCTURE declarations comparing to C "struct" declarations. Once that worked, it was obvious. Now, the reason I am a wizardess and not a guruess is I can work the magic but not adequately explain it. <SIGH>

Remember to note exactly what size an object in a C language declaration really is. Many times, you find a structure included in full rather than as a pointer in a C declaration. Then, the offsets simply add. Otherwise, if only a pointer is included, the offset simply adds four bytes. I seem to remember that there was a different name for assembly pointers, sizes, and actual objects. Had to do with the prefix, I think. --- so long ago. I'm getting old and forgetting stuff only a year old already! <^\_^>

amiga/amiga68000 #101, from ksalmon, Mon Oct 13 02:22:15 1986. A comment to message 99.

It really turns out to be quite simple:

A STRUCTURE macro defines a new structure, just like a struct in C; if the second parameter is non-zero, it defines the size of what would be the first embedded substructure. The symbol SOFFSET is used to keep a running offset for locations within the structure.

A STRUCT macro defines an occurrence of some other structure, as a substructure to the current STRUCTURE. The first argument is equated to the substructure name, then SOFFSET is advanced by the amount of the second argument (mostly, this will be xx\_SIZEOF, but sometimes they fool you and use lowercase).

BYTE, UBYTE, WORD, UWORD, APTR, BPTR, and the rest simply equate the first argument (actually the only one) as a label, to the current SOFFSET, then advance it by the appropriate number of bytes.

LABEL is generally used at the end of a STRUCTURE list, to assign a label to the current value of SOFFSET. That label is the one used in other STRUCT occurrences, to "reserve space" for that many bytes in the SOFFSET counter.

It really isn't necessary to add up the offsets in your head. Just use those symbols and let the assembler worry about it. The key thing is to remember that a STRUCT is just like a subordinate struct in C. I understand the complaint that there is not always a one-to-one match with the actual names used in the C header files. That's why I recommend a side-by-side comparison. Works every time or your money cheerfully refunded. Ken

## ATARI ST

The questions in the Atari section this month are all solved using the tools within C. In the first, the problem is C; or more specifically, the way C handles (or doesn't handle) data structures. In the second, the details of high-speed, low-level control of the MIDI port are discussed.

### STRUCTURES IN C

atari.st/c.language #384, from cmarrlott (Chris Marriott), Fri Oct 24 07:39:11 1986.

There seems to be a bug in code generation with the Megamax C compiler. Recently, I've written a routine to print disk directories, which uses the following structure for a disk transfer address block:

```
struct {
    char ssystem[20];
    unsigned char attribute;
    unsigned int time;
    unsigned int date;
    long size;
    char name[13];
} dta;
```

The problem is that all the information is getting passed into the structure OK, \*except\* that references to the characters at the start of the structure are out by one, for example, to get at the attribute byte, I cannot use dta.attribute, I have to say dta.system[21], which \*should\* refer to the first byte of the time field. The time and all later fields are OK, though, so it seems like Megamax is referencing all the character offsets as one too great.

Can anybody see if I'm missing something here, because this looks like a bug to me. +++ Chris M +++

atari.st/c.language #385, from comeau (Greg Comeau), Fri Oct 24 08:30:16 1986. A comment to message 384.

*continued*



Try changing "unsigned char" to just plain "char". Of course, this may require that you change some of your logic also. Or are you saying that the system also starts at system[1] and not system[0]?

atari.st/c.language #386, from sprung (Ron Sprunger), Fri Oct 24 12:06:37 1986. A comment to message 384.

Your system variable is one too short - use bytes 0 through 20.

atari.st/c.language #387, from mmallett (Mark E. Mallett), Fri Oct 24 13:40:48 1986. A comment to message 386.

Right. Just to be more explicit, dta.system[21] accesses TWO past the end of the system element, since declaring system[20] defines the array from 0 to 19. mm-

atari.st/c.language #388, from jim\_kent (Jim Kent, Dancing Flame), Fri Oct 24 15:20:27 1986. A comment to message 387.

Also, many compilers will pad structure elements (especially ints) to be on even (WORD) addresses. This isn't a bug but in fact makes the 68000 go faster.

atari.st/c.language #389, from sprung, Fri Oct 24 15:31:43 1986. A comment to message 388.

It may not be a bug, but it sure could foul up some re-mapping that the less-disciplined of us (read sprung) do occasionally.

atari.st/c.language #390, from comeau, Fri Oct 24 22:33:09 1986. A comment to message 388.

Even further... some will align the beginning of the structure itself on a word (or some multiple thereof) boundary.

atari.st/c.language #391, from sprung, Sat Oct 25 02:24:39 1986. A comment to message 390.

That could be interesting if you allocate a bunch of them in sequence and try to access them absolutely as an array.

atari.st/c.language #392, from jim\_kent, Sat Oct 25 03:50:20 1986. A comment to message 391.

Oh, but the same compilers will most likely pad the length of the array (the returned value of the sizeof() compile-time function) to be even as well.

atari.st/c.language #393, from heller (Robert Heller), Sat Oct 25 12:58:41 1986. A comment to message 388.

It is also REQUIRED in the 68000 - you can't fetch a word or long from an "odd" address - causes an alignment error trap (exception #3: Address Error). So... malloc and friends on a 68000 system should (had better!) return even addresses, and C compilers generally always give an even number for sizeof (some struct type) and will pad structure elements in structs to make ints and floats come out on even offsets. It is generally considered a compiler bug if the compiler will let you declare something like

```
struct x { char name[33]; int z; } ;
```

and really only reserve 33 bytes for field name. Most proper C compilers will actually pretend that you said

```
struct x { char name[34]; int z; } ;
```

(The same will (should?) happen for Pascal and Modula record types.) Note that this is a sticky portability problem, but only if you need to transfer data packed into binary files (i.e., ARC files - the MS-DOS version does fwrite/fread with an odd-sized struct - the headers in ARC files are 29 bytes! Of course, the (long) ints are byte-swapped, too (low byte first, the 68000 wants high byte first...)). Robert

atari.st/c.language #394, from jim\_kent, Sat Oct 25 13:33:12 1986. A comment to message 393.

Actually, I believe the Green Hills compiler will let you start an int on an odd address, and then fetch it a byte at a time. Maybe I'm wrong, I didn't look at the assembly, but there were things I thought would cause an exception #3 in some early Amiga IFF routines that didn't when compiled under Green Hills or Lattice, but certainly did under Aztec.

## LOW-LEVEL READING OF SERIAL PORTS

atari.st/c.language #401, from hsoroka (Howard Soroka), Sun Oct 26 02:06:55 1986.

I need to read the MIDI-in port of the ST VERY QUICKLY! The BIOS/XBIOS calls to read and write these ports seem to work OK, but they're extremely slow, or so I think. I say this because my attempts to read and store data dumps from various Yamaha MIDI devices only work if the devices are sending very small dumps (< 255 chars). It seems that, with more information coming in, a buffer is being overrun in the ST, as the BIOS read calls don't empty it out fast enough. This poor little buffer is being blasted with 8K or 9K bytes at maximum speed (31.25 Kbaud is the MIDI rate; pretty snappy).

The solution (I suspect) is to read the ports in an assembly routine called from C (MWC, of course). Why then does the system politely BUS-ERROR every time I try to read from 0xffff04 or 0xffff06 (the MIDI ACIA ports)? Same thing with the other ACIA (at 0xffff00 and 0xffff02). I think it's a bus error anyway (2 cherry bombs, non-fatal). For now, I'd be happy to just read one byte, let alone the whole mess. I know some may think this question belongs in the MIDI department, but it's really a question about ST internals more than MIDI itself.

Here's the code I use (from MWC). I also tried setting the status register to 0x2700, but that made no difference. This code does work consistently with any address between 0x1000 and the top of RAM, but how on earth do you read a device port at a low level? The BIOS appears to do the same kind of thing as I'm trying (according to the Abacus books). Why does it work for the BIOS and not for me? HELP!

```
.shri
.globl atest_ atest_
link a6, $0x0
clr.l d0
movea.l 0x8(a6), a0
move.b 0(a0), d0
unlk a6
rts
```

The variable passed in on the stack is the address we want to read, of course, using a0 to do so. ARRGGGHH. MFFTTSSFFTT... BZZZZTT. BZTZTZTZ.  
(Sound of programmer imploding, much gore, tears shed, etc.)  
Beggingly,  
howard

atari.st/c.language #407, from jim\_kent, Sun Oct 26 15:01:09 1986. A comment to message 401.

Looks real simple to me, Howard; you just need to pass the address of your routine to the OS to execute in supervisor state with a Super call. It's in osbind.h somewhere...

atari.st/c.language #408, from jtittsler (Jim Tittsler), Sun Oct 26 16:31:51 1986. A comment to message 401.

The MIDI input is being received by an interrupt service routine and stored in a small circular buffer by the BIOS. If your program cannot take it out of the buffer fast enough to keep it from overflowing, I think

*continued*





“Microport is  
the *fastest* path  
between  
*real* UNIX<sup>®</sup>  
System V  
and you.”

Dimitri Rotow runs a company on the go. He has little time for hardware or software that doesn't do the ultimate job for his company's customers.

Two months ago he assessed three readily-available UNIX (and UNIX-like) operating systems. After evaluating pricing, packaging, documentation, quality, service, manufacturer's support, compatibility, third-party support, features, conformity and performance, he and his VP of engineering came to one conclusion: "To praise Microport is to praise the AT&T/Intel joint venture, because Microport's version of UNIX System V is virtually *identical*. However, more *value* is received since more middlemen are removed—that's much closer to buying direct and selling direct."

Bell Technologies' customers appreciate real value plus real System V. If you're an OEM, a reseller, an end-user or simply curious about our product—call us today and see what all the endorsements are about.

**Microport Systems, Inc.**

10 Victor Square  
Scotts Valley, CA 95066

408/438-UNIX (438-8649, local)  
800/822-UNIX (Inside California)  
800/722-UNIX (Outside California)  
FAX: 408/438-2511  
Telex: 249554



**Team Use for The AT.**

See us at UNIFORM;  
Washington, D.C.;  
January 20-23; Booth 1021

Dimitri Rotow, President  
BELL TECHNOLOGIES



there are a couple of better solutions than directly reading the UART at task time. 1) Increase the size of the buffer. XBIOS call 14 (iorec) returns a pointer to a structure that contains a pointer to the buffer to be used, as well as the size of the buffer (and other things). 2) Write your own interrupt service routine to buffer the bytes at interrupt time. XBIOS call 34 (kdbvbase) gives you a pointer to a structure that includes a pointer to the MIDI input interrupt service routine that will be entered with the MIDI byte in D0.b.

atarl.st/c.language #410, from tjeffries (Tom Jeffries), Tue Oct 28 04:33:42 1986. A comment to message 401.

If I remember correctly, you can change the size and/or location of the MIDI buffer without having to write your own routine with one of the XBIOS routines. If you do want to read the port directly, jim\_kent is correct that you need to be in supervisor mode to read those memory locations. Supexec() in the XBIOS is another function to get you in that mode. I'm curious about details of the data loss you are experiencing. I've hit the MIDI-in pretty hard and have still been able to get everything out with Bconstat(). What are you reading, patch data? And do you miss chunks of bytes or a bit here and there?

atarl.st/c.language #411, from hsoroka, Tue Oct 28 12:03:21 1986. A comment to message 410.

Jtittler suggested a couple things, one of which was manipulating the size and location of the MIDI buffer with XBIOS function 14 (iorec). Jim\_kent mentioned the Super() call for reading the port directly from assembly language. You're all correct. All of your (the three of you collectively) suggestions work!

The most robust approach, however, is definitely to change the size of the buffer (why go low-level when it's not necessary?). This worked the first time. I simply declare a large global array of chars in my program and, using iorec(2) to find the address of the MIDI buffer, I replace the contents of that iorec struct with the relevant information of my own. I flush out the "real" MIDI buffer before doing this, although I'm not sure that that's necessary. When I'm through, I replace the old buffer's iorec using a struct assignment, but this requires the Super() call, as the iorec lives in protected memory (I think. Am I right about this, guys?).

This works like a champ, and no assembler required. Many thanks to you folks for your kind help; you've improved the quality of life on Earth.

As for the actual MIDI data, I was trying to store data dumps from a DX-7, RX-11, and QX-7 sequencer. Since all MIDI system-exclusive messages end with EOX (0xf7), my code waits for that character to terminate its read loop. The RX-11, for example, blasts out about 8K bytes at maximum speed when told to dump. The MIDI buffer being circular, all that data just kept overwriting the buffer (which I think is only 128 bytes) so often that the 0xf7 just got lost along with loads of other stuff. In addition to not gathering the correct data, my program would usually hang, because it never found an 0xf7 anywhere. The f7 was probably somewhere in the buffer, but lost between the head and tail pointers, and therefore never recovered. I was losing whole chunks of many bytes, in answer to your question, not merely a bit or two here and there.

Ugh, what a mess. However, all is hunky-dory now. Have you had success using the BIOS/XBIOS calls for large data dumps without changing the buffer? If so, I'd love to know how. Thanks...  
howard

atarl.st/c.language #412, from dsmall (David Small), Tue Oct 28 16:47:54 1986. A comment to message 411.

I had to increase the buffer size in the MacCart as well to handle input blocks of 5120 bytes (decimal) coming in at 9600 baud, so I believe that MIDI might drop bytes at 31 Kbaud.

atarl.st/c.language #413, from tjeffries, Wed Oct 29 03:44:48 1986. A comment to message 411.

Howard, I wrote a patch editor for the Casio CZ series (CZ PATCH, published by Dr. T's Music Software) that just grabs the sys ex data as it comes in and sticks in my own buffer area, so I didn't have to rely on the ST's buffer at all. Easier than changing the buffer, but then, I always know how many bytes are coming in. Actually, I've been quite pleased with what I've seen of the XBIOS MIDI calls. I'd sort of expected to have to write my own low-level stuff but Atari's stuff has been robust enough (as long as I didn't rely on the size of their buffer) that I haven't had to. I've had a lot more trouble with different Casios operating/responding at different speeds than I've had with the ST.

# GREATER PERFORMANCE... AT HALF THE COST!

## DATA I/O 29B™ COMPATIBILITY-UNDER \$1,500 GANG & SET UNIVERSAL EPROM PROGRAMMER

### BYTEK — THE #1 CHOICE

- GANG EPROM Programmer: Support for MOS/CMOS EPROM/EEPROMs.
- SET EPROM Programmer: 16, 32 and optional 64-Bit Words
- UNIVERSAL Programming Options: Bipolar PROMs, Logic Array Devices, 40 pin Micro Computer Devices, 3 Voltage Devices, 8 and 16 Bit Emulation, and GANG adapter with additional 8 ZIF sockets.
- RAM: 64K BYTES expandable to 1MBYTE
- 3-Way device type selection: Manually, Auto ID or from Menu
- Stand Alone Operation (includes EDITing)
- 25 Keys, 32 Character LCD Display
- RS232 PC Interface for Terminal Mode
- Parallel Printer Port
- Computer Remote Control Data I/O compatible

Data I/O is a trademark of Data I/O Inc.

ORDER TODAY:

800-523-1565

In FL: 305-994-3520

In CA: 415-487-4694

Telex: 4998369 BYTEK

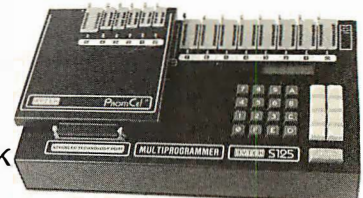

**\$1,495**

Model: S125-GL

Shown with optional PROMCel.

MADE IN THE U.S.A.  
DISTRIBUTOR INQUIRIES  
WELCOME



Mastercard or Visa Welcome



Instrument Systems Division • 1021 South Rogers Circle • Boca Raton, Florida 33431



atarl.st/c.language #418, from jtittsler, Wed Oct 29 22:53:44 1986. A comment to message 413.

The only word of warning about the MIDI OUTPUT routines provided in the standard TOS is that it's done by polling the UART rather than by interrupts. This has the advantage that you can know within a character time when that byte is being sent, and the disadvantage that if the UART is busy outputting the last character, you will wait for it (so, in some applications you might want to check the output status before calling the output function). Just a "user note."

atarl.st/c.language #419, from dsmall, Thu Oct 30 02:49:30 1986. A comment to message 418.

Also, look out for the IPL=7 bug. If you kick up the IPL when data is coming in, you can get into a deadlock situation with the MFP and UART. Essentially, the UART gets 2 chars in the non-services time (while IPL=7). The IPL is then restored. MFP processes first interrupt. However, 2nd character is never "seen" by MFP because the UART holds the IRQ line low (asking for service) -- and the MFP is edge-triggered. This locks your keyboard/mouse, if done to that UART, and should hang the MIDI as well, because it's the same line. Moral: Watch the IPL critical code stuff during I/O.

-- Sadder and wiser, Dave

## IBM PC and Compatibles

The threads in the IBM PC section serve to illustrate how discussions flow in BIX. In the first, a question on reentrant code is answered and is promptly followed by a longer discussion on DOS return codes. In the second, a question in the IBM PC conference is ultimately answered in the Telecomm.Tech conference, with pointers showing the connection between the two conferences.

### REENTRANCY IN MS-DOS

ibm.pc/programming #546, from damoore (Dave Moore), Mon Oct 13 07:08:25 1986.

I have been trying to write a "HOT KEY" routine that would allow you to reenter a program when a key was struck (as opposed to when it is read by a program/MS-DOS - slightly different). To overcome the problems with MSDOS/BIOS not being reentrant, I captured all the relevant interrupts and set up a semaphore so that I only switch tasks when the BIOS/DOS is not being accessed (i.e., I treat it like a critical region). The trouble is, once I take the interrupts, my program goes wild. I am almost certain that my capture code contains no obvious bugs. I am simulating an INT by pushing the flags saved from the real INT and then doing a long call. When I get back, I update the real flags. The only other things I do are increment/decrement the semaphore and check if a "HOT KEY" request is pending. WHATS HAPPENING? WHY DON'T IT WORK?

By the way, I am plugging the interrupts direct, not asking DOS nicely for them. Also, I wondered if perhaps something in the BIOS 'backs up' over its interrupt for any reason. Otherwise, what's the difference between a real interrupt and PUSHF/CLI/CALL FAR?

ibm.pc/programming #549, from gperfect (George Perfect), Wed Oct 15 02:50:32 1986. A comment to message 546.

Be careful how and when you perform the inc/dec on return from the original int handler. Inc/dec affect the flags, so you MUST save the flags before decrementing your flag. The following code works:

```
pushf          ;Simulate an interrupt
call far ptr oldint
; Now decrement flag and return correct results
```

```
;
;Save flags to be returned
dec word ptr MYFLAG
popf           ;Restore flags after change by DEC
iret          ;Return to interrupted process
```

I assume you have already incremented your flag prior to above code (actually, I just forgot it!).

ibm.pc/programming #550, from skluger (Sigl Kluger, Definicon Systems), Wed Oct 15 13:25:44 1986.

I have a program that uses the DOS EXEC function (4Bh) to execute another program. After the call returns, I use function 4BDh to get the return code and I always get 0 back. Why?

ibm.pc/programming #551, from mws (Mark Shurtleff), Wed Oct 15 15:02:43 1986. A comment to message 550.

What program are you EXECing? If it is a standard DOS utility, only BACKUP and RESTORE ever return a valid code, all others give you a 0. If it's a program of your own, does it terminate using Fn 77 (4Ch) with the return code in AL? More info, please.

M S  
W

ibm.pc/programming #555, from skluger, Thu Oct 16 01:06:19 1986. A comment to message 551.

Any program I EXEC, including a test program that only consists of a MOV AX,4C55h followed by INT 21h, returns 0. I do the exec, immediately followed by INT21/4D, and get zero. Every time. All the time.

ibm.pc/programming #556, from dmick (Dan Mick), Thu Oct 16 01:10:53 1986. A comment to message 555.

Um...bug? I've never tried it, but I will. It should be pretty easy to trace the 4Dh call, as it doesn't seem to do much.

ibm.pc/programming #560, from mws, Thu Oct 16 16:39:02 1986. A comment to message 555.

Every time. Can I ask a very dumb question? Are you testing \*AL\* for the return code? \*AH\* indicates the program termination using Fn 77 (4Ch), and will return the following codes:

```
AH = 0 --> Normal Exit
    = 1 --> Exit by Ctrl/Break or Ctrl/C
    = 2 --> Exit by Critical Error
    = 3 --> Exit by TSR
```

Does this help, or do I reiterate something already known?

M S  
W

ibm.pc/programming #561, from skluger, Thu Oct 16 17:10:41 1986. A comment to message 560.

Since I'm "really" interested in the return code I'm, of course, examining AX.

ibm.pc/programming #563, from geary (Michael Geary), Fri Oct 17 07:21:17 1986. A comment to message 561.

Here's a little test of EXECing a child process and checking its return code.

This is test1.com, it EXECs test2.com and then breaks at 0129 with the return code in AX, or at 012A if there were any errors. (Only run this under Debug, because of the INT 3s!)

```
-u 100 12a
2394:0100 BC0002      MOV     SP,0200
2394:0103 BB2000      MOV     BX,0020
2394:0106 B44A        MOV     AH,4A          ;"J"
2394:0108 CD21        INT     21
2394:010A 8C0E4401     MOV     [0144],CS
```

continued



```

2394:010E 8C0E4801      MOV    [0148],CS
2394:0112 8C0E4A01      MOV    [014A],CS
2394:0116 BB4001        MOV    BX,0140
2394:0119 BA5001        MOV    DX,0150
2394:011C B8004B        MOV    AX,4B00
2394:011F CD21          INT    21
2394:0121 7207          JB     012A
2394:0123 B44D          MOV    AH,4D          ;"M"
2394:0125 CD21          INT    21
2394:0127 7201          JB     012A
2394:0129 CC           INT    3
2394:012A CC           INT    3
-d 140 l e

```

```

2394:0140 00 00 60 01 00 00 5C 00-00 00 6C 00 00 00
..'....\...l...
-d 150 l a

```

```

2394:0150 74 65 73 74 32 2E 63 6F-6D 00
test2.com.
-d 160 l 2

```

```

2394:0160 00 0D

```

And this is test2.com, which just exits with a return code of 77h:

```
-u 100 104
```

```

2394:0100 B077          MOV    AL,77          ;"w"
2394:0102 B44C          MOV    AH,4C          ;"L"
2394:0104 CD21          INT    21

```

IBM.pc/programming #564, from skluger, Fri Oct 17 09:44:19 1986. A comment to message 563.

Just like my code (which doesn't work). I don't use call 4A though since I've butchered my .EXE file so that it only takes up 12K.

## SETTING A HIGH BAUD RATE

IBM.pc/hardware #1687, from tjeffries (Tom Jeffries), Thu Nov 20 23:40:45 1986.

Is it possible to set the serial port UART to a higher baud rate than 9600? My super-cheap multi I/O card uses an 8250 UART, which is supposed to be capable of rates up to 56 Kbaud, but I don't have a spec sheet and the "documentation" that came with my card doesn't tell me much. Is the 8250 the standard UART on serial cards? And how do I access it to set baud rate and send data?

IBM.pc/hardware #1688, from sparks (Dave Sparks), Fri Nov 21 00:42:17 1986. A comment to message 1687.

<flip> <flip> According to the documentation I have on the IBM async card, the baud rate generator in the 8250 is capable of only 3.1 MHz, which means the effective bit rate is 193.75 Kbaud. However, in the next sentence, it states that the data rate should be no greater than 9600 baud. I would tend to believe that the data rate is dependent on the chip designation (e.g., 8250A, versus 8250). If you want to experiment, the theoretical clock setting for 19.2 Kbaud is 0006h, 38.4 Kbaud is 0003h. Since the accuracy of the clock is purely dependent on the crystal, there should be no problems, other than that caused by the ability of the chip to operate at that rate. :- ) dave

IBM.pc/hardware #1700, from barryn (Barry Nance), Fri Nov 21 08:11:34 1986. A comment to message 1687.

I think the answers to your questions are over in telecomm.tech/example.code, which contains a rather thorough discussion on communications programming.

IBM.pc/hardware #1693, from geary, Fri Nov 21 02:33:40 1986. A comment to message 1688.

The 8250 works fine at 19.2 Kbaud using the divisor of 6; I've run them that way with no problems. You do start to run out of compute horsepower in a 4.77-MHz PC around that rate, though. Haven't tried 38.4 Kbaud.

IBM.pc/hardware #1699, from proman (Peter Romanchuck), Fri Nov 21 05:12:59 1986. A comment to message 1688.

We have a program that uses the standard COM port at 115 Kbaud with no problem. Alas, I do not know HOW this is set, but it works.

IBM.pc/hardware #1696, from tjeffries, Fri Nov 21 03:31:38 1986. A comment to message 1693.

How do you set it to the higher rate? The only references I have found so far just explain how to set the baud with a BIOS function that only recognizes speeds up to 9600.

IBM.pc/hardware #1698, from geary, Fri Nov 21 03:37:21 1986. A comment to message 1696.

You have to program the chip yourself. I could give you some sample code but it's complex. (The routine I have handles interrupts, etc.) Or you could look at "async.drv" in listings (IBM area) for some sample code.

telecomm.tech/example.code #68, from cdanderson (C. David Anderson), Fri Nov 21 22:51:56 1986.

After some searching around in here, based on a pointer in IBM.pc/hardware re the possibility of setting my serial port to 19,200 rather than being limited to 9600, I confess that I am over my head. Does anyone know of a commercially available program that will give me 19,600 baud for a normal serial port, so that I can run my HP laser at 19,200 (which it has switch settings for, and which Lotus will support) so that I can also run my word processor at 19,200 (not just Lotus)? Thanks.

telecomm.tech/example.code #69, from barryn, Fri Nov 21 23:05:08 1986. A comment to message 68.

You're not looking for a way to program it, but a program that sets the baud rate for subsequent COM port usage? Sort of a souped-up MODE command?

telecomm.tech/example.code #70, from petewhite (Pete White), Sat Nov 22 00:22:33 1986. A comment to message 68.

I thought PC-Talk was capable of 19,200 transfers; we use it at that speed to transfer files to a typesetter (unless my memory has gone west). I'll take a look . . .

telecomm.tech/example.code #71, from geary, Sat Nov 22 06:36:55 1986. A comment to message 68.

Here is a little program to set a comm port's baud rate to 19,200. To create the program, enter the program below and name the file 19200.DBG. Then, enter the command

```
C>debug <19200.dbg
```

This will create a program called 19,200.COM. This program sets the baud rate only; it does not affect the other communications parameters (parity, data bits, stop bits). So you should first use the MODE command to set the other parameters. Then give the command:

```
C>19200 {port#}
```

where {port#} is 1, 2, 3, or 4.

So, for example, to set up a serial printer on COM2 that uses 8 bits and no parity, you might say

```

C>mode com2:9600,n,8,1,p
C>mode lpt1:=com2
C>19,200 2

```

File 19,200.DBG follows...



```

a
CLD
MOV SI,0081
LODSB
CMP AL,0D
JZ 0140
CMP AL,31
JB 0104
CMP AL,34
JA 0104
SUB AL,31
XOR AH,AH
MOV BX,AX
XOR AX,AX
MOV ES,AX
ES:
MOV DX,[BX+0400]
TEST DX,DX
JZ 0140
ADD DX,03
IN AL,DX
JMP 012A
MOV BL,AL
OR AL,80
OUT DX,AL
JMP 0131
SUB DX,03
MOV AX,0006
OUT DX,AX
JMP 013A
ADD DX,03
MOV AL,BL
OUT DX,AL
INT 20

```

n 19,200.com  
r cx  
42  
w  
q

## APPLE II/MACINTOSH

The Apple II section centers on a discussion of how to alter the system speed of the IIGS in order to maintain compatibility with existing speed-sensitive peripherals. The Macintosh thread discusses some of the pleasures and frustrations of working with MacApp (the "official" Macintosh software development tool).

### SPEED CONTROL

apple/gs.other #334, from delton (Don Elton), Tue Nov 18 23:26:23 1986.

Is there a simple way, from software, to alter the speed of the IIGS long enough to standardize timing loops, etc., across the various Apple machines? For example, my terminal program turns off an Accelerator IIe or Transwarp card during all timing loops via a couple of byte stores, so the timing-sensitive parts of the program run correctly regardless of the machine. I'd be interested in being able to do the same on a IIGS, given the info on what to poke or read and where to do it.

apple/gs.other #335, from mdavls (Morgan Davis), Wed Nov 19 00:46:15 1986. A comment to message 334.

You can kludge it somewhat by accessing the slot that gets slowed down from inside your timing loop. Most of the speed-up cards will slow down for a few hundred milliseconds after they've been told to do so. You'd probably want to use a bit instruction to access any slot address, and so you'd have to take into account the cycles involved in your bit absolute (or indexed) instruction.

Of course, this is all dependent on your card being able to slow down (as per DIP switch settings) when a certain slot is accessed.

This would also be pretty generic between speed-up cards, since it doesn't involve any knowledge of slow-down/speed-up register locations.

apple/gs.other #337, from delton, Wed Nov 19 18:35:50 1986. A comment to message 335.

I wonder how many cards on a IIGS will need slowing down, and does the IIGS slow down for slot access? The problem isn't with accelerator cards; it's with running an emulation mode program on the IIGS, and being able to slow it down momentarily from time to time in case the IIGS is running at the 2.8 speed instead of the 1.0 speed.

apple/gs.other #338, from gs.softteam (Apple Computer Inc.), Wed Nov 19 19:29:46 1986. A comment to message 337.

Yes, the IIGS does slow down for slot access. Any access to \$CnXX will slow to 1 MHz, but (and I mean BUT) any internal operations to the 65816 during execution of code residing in a slot in fast mode will not necessarily occur in slow speed. The fetching of Op-Codes, reading, and writing from a slot will occur at 1 MHz while internal operations will occur at fast speed if the system is set to the fast speed. The result is that timing loops executed from a card that were written based on 1-MHz timing actually run faster when the IIGS is running fast. Slots 4, 5, 6, and 7 have the ability to force system speed to slow mode when a disk interface card is installed in the slot. The firmware configures a softswitch that enables motor on detection for these slots. If a motor on address is accessed (as in diskII), then the system will automatically slow down to 1 MHz. System speed will be restored when the motor-off switch is accessed.  
Ray Montagne (IIGS Software Team)

apple/gs.other #340, from delton, Wed Nov 19 20:36:39 1986. A comment to message 338.

Nice to know that slots can slow down. So, how specifically does one, from a user program, change the system speed to 1-MHz operation, and then how does one change the system speed back to 2.8-MHz operation? The obvious solution for a timing-sensitive piece of code would be to get the machine running at a standard speed (across the IIe and IIGS, for example) for the duration of the execution of that code. Is there a softswitch or something you hit to get slow speed or fast speed? If so, what code is needed specifically to do the trick? Thanks.

apple/gs.other #347, from mdavls, Thu Nov 20 15:01:18 1986. A comment to message 338.

Ray, when a slot is accessed for a brief moment, how long is the slow window in effect? When you "hit" an Apple II speed-up card for slowing down, it will last for approximately 300 milliseconds \*after\* access to a slot has stopped. Does the GS do this, too?

apple/gs.other #349, from larryt (Larry Thompson, Apple Computer Inc.), Thu Nov 20 23:32:16 1986. A comment to message 347.

The GS does not have the 300-millisecond time lag after a slowed cycle. After a slow read or write cycle, the GS will speed up right away if the machine is configured to run fast.  
Larry Thompson

apple/gs.other #353, from mafischer (Michael Fischer, Apple Computer Inc.), Sat Nov 22 02:53:31 1986.

In regard to the question about how to set system speed from an application, the following code example is taken from my book -- The Apple IIGS Technical Reference (due in early January from Osborne/McGraw-Hill). It sets speed to fast, saving the original setting. It could just as easily set speed to normal.

*continued*



Note that the code is written for the APW Assembler using the macros available on that system.

```

Pushword #$0000 ;Result space
Pushword #$0020 ;Want system speed
                ;parameter
_ReadBParam    ;Get speed setting
PLA             ;from top of stack
AND #$00FF     ;Mask off high byte
STA OldSpeed   ;and save it
BNE ItsFast    ;Skip rest if already fast
                ;speed
Pushword #$0001 ;Set fast speed
Pushword #$0020 ;System speed parameter
_WriteBParam   ;and change it ItsFast
. . .
    
```

\*Rest of program that needs this speed goes here  
 \*At end of this part of program, reset speed as follows:

```

LDA OldSpeed    ;Find old speed
BNE Done        ;Old speed was fast, don't
                ;reset
PHA             ;Normal speed value
Pushword #$0020 ;System speed parameter
_WriteBParam   ;Reset to old value Done
. . .           ;Rest of program goes here
    
```

apple/gs.other #354, from delton, Sat Nov 22 22:52:04 1986. A comment to message 353.

It looks like this code changes battery RAM. Does it actually change the speed setting immediately or only after a reboot? I'll need to change the speed instantaneously, more or less. Thanks.

apple/gs.other #363, from gs.softteam, Wed Nov 26 16:54:43 1986. A comment to message 353.

This is not the proper way to set system speed. What you have done here is change the system default speed so that the next time the system is reset, the system speed will be set according to the parameter written in battery RAM. Writing to the battery RAM has no immediate effect on the system. You must also set the appropriate hardware register to get the system environment set as you wish. In order to set the system speed, the most significant bit of the speed register (\$C036) must be set to a 1 for fast or 0 for slow. Remember that this must be done in 8-bit mode. The hardware register should probably be accessed in bank \$E0, in case I/O shadowing has been turned off (this assures access to the register). Only the bit being modified should be accessed. Other bits in this register are set by the firmware on system initialization and could have disastrous results if set to the wrong state by an application. Here is an example of setting fast speed:

```

sep   #$20    ; 8 bit "m"
longa off
lda   #$80    ; bit 7 is fast speed
phb
pea   $E0E0   ; set data bank for switch access
plb
plb
tsb   $C036   ; set fast speed
plb
    
```

To set slow speed, replace the "tsb" with a "trb" instruction. Another method might be

```

lda   >$E0C036 ; read register
ora   #$80     ; and set fast speed
sta   >$E0C036
    
```

Either of these methods has an immediate effect on system speed while not destroying the state of other bits in the register. If your program needs to restore the system speed, then there are two methods available. First, your program can save the system speed by reading the register and pushing on the stack prior to setting the new speed. In this case, you just pull the saved speed off the stack and write it to the register.

The second method is to read the battery RAM and set the hardware register based on the value read from the battery RAM. Your application should never write the battery RAM unless it intends to alter the system default. A control panel-type desk accessory is the only application likely to do this. We sure would like to have reviewed any material being published by anyone to assure that no technical problems arise.  
 Ray Montagne (IIGS Software Team)

## CREATING DIALOG BOXES WITH MACAPP

macintosh/macapp #40, from chn (Carl Nelson), Wed Sep 17 04:02:59 1986.

In creating a dialog the other night, I wanted to add a single text item on the end of a dialog, and I was surprised to find that someone didn't put in what I would call an obvious (trivial) method in TDialogView called "DefineText". It seems almost too trivial to put in, but basic in that it would be a method someone would want to override for some exotic text field input. Anyone else miss this one or any other like it?

BTW, the Define Radio cluster is NICE! It only took 2 hours to get a new kind of TRadioCluster (TADrsCluster) running. I use it to read part of my SCSI disk boot blocks, then show it to me in the other parts of the dialog. (Real EASY, the hard part was convincing my SCSI drive to give it to me.)  
 ....Carl

macintosh/macapp #49, from scotty (Barry Wilson), Thu Nov 20 02:59:05 1986. A comment to message 40.

I am new to BIX but have been using MacApp now for about three months. I was as surprised as you are when it took more lines to create a Check Box than a radio cluster! After one or two dialog boxes done that way I finally added a new dialog unit to my library, inheriting all the features of UDialog and defining my own convenience functions DefineText, DefineCheckBox and DefineScrollList. I have a wish list of more features I would like to add, including using Icons and Picts as Buttons.

macintosh/macapp #50, from kschmucker (Kurt Schmucker), Thu Nov 20 22:44:33 1986. A comment to message 49.

How about sharing with us some more of the details (and the code) for your improvements to UDialog, and your wish list for other stuff?

macintosh/macapp #51, from demars (Dennis DeMars), Sun Nov 23 19:42:11 1986. A comment to message 49.

MacApp is obviously in a less developed state than other elements of MPW, and one of the most obviously uncompleted portions in UDialog. The documentation on this unit is so skimpy as to be almost useless, and the whole dialog implementation appears to me to be rather kludgy. I assume that the final product will contain more substantial documentation for UDialog (actually, the documentation for the entire MacApp package needs to be expanded), and I hope that UDialog will be honed up to contain support for check boxes, user items, and so forth.

macintosh/macapp #53, from kschmucker, Tue Nov 25 09:03:45 1986. A comment to message 51.

I agree that UDialog needs more documentation, but the sample programs demonstrate a lot of stuff that is not explicitly expressed in the documentation.

Historically, MacApp is in a MORE developed state than the rest of MPW. MPW's slow schedule and many postponements slowed down the release of MacApp.

macintosh/macapp #54, from dgoldsmith (Dennis Goldsmith, Apple Computer Inc.), Wed Nov 26 12:48:34 1986. A comment to message 51.



It's certainly true that UDialog doesn't have all the features it could, but we just haven't had time to put in some of the things that would have been nice. It's not at all hard to add these features yourself. It's also not necessary to use UDialog at all for dialogs; if you find that it's not doing what you need, you can either just use the dialog manager directly (for modal dialogs) or use an ordinary window with controls in it. UDialog is one of the areas in MacApp that we are planning to examine carefully for future releases. I wouldn't say that MacApp in general is less finished than MPW (or rather, was at the time of the 1.0 Beta2 releases). We've certainly tightened up the error handling since then, but the architecture hasn't changed. You also don't get to look at the source code for MPW. Working on MacApp is sort of like living in a glass house; everyone gets to see your dirty laundry. Part of the reason MPW 1.0 is finished but MacApp 1.0 isn't is that we are trying to be extremely careful. A bug in MPW can be worked around, but a bug in MacApp is a bug in every program built with MacApp. We are currently sweating out the last week or two of testing and we're hoping we'll be ready to go soon.

---

macintosh/macapp #59, from demars, Mon Dec 1 00:51:51 1986. A comment to message 54.

When I said MacApp appeared to be in a less developed state, I was thinking mainly about the documentation rather than the MacApp program itself (I haven't seen anything in the program I would call incomplete except for UDialog, which I've already commented on).

Of course, there is the problem that any new user is going to have using a complex new system, but even after immersing myself in the system for several weeks, I have found that the documentation, as extensive as it is, is still too terse in many areas (UDialog is one example; the info on implementing the Clipboard is perhaps a more important example).

Actually, documenting something like MacApp is pretty tough because it is impossible to provide enough information to accommodate every way that a programmer may want to customize various methods short of describing the entire MacApp program in detail from top to bottom...and the source code itself fulfills that function.

It is my feeling, though, that a programmer should only be forced to peruse the source code in extraordinary circumstances. Currently, you have to look at the MacApp source to figure out what it's doing even to do some fairly simple things. For instance, I needed to create a window with two subframes inside the window, both containing text edit regions, and one of them with a vertical scroll bar (the scroll bar belonging to the subframe, not the parent window). I had a heck of a time figuring out how to do this. How to switch the active target between the two frames was the main problem, and it is pretty simple to do, once you know how. But I couldn't figure it out from the MacApp manual alone.

Don't get me wrong; programming with MacApp is both easier AND less error-prone (once you get accustomed to the system) than without MacApp. I just think the documentation needs some work. And after all, isn't this what beta versions are for - to find weaknesses in the package? And this is, perhaps, a weakness that is hard to detect by the people who are close to the project, since they already know how things work and it may not be obvious to them what needs to be made explicit. Also, MacApp is pretty unique and presents some new problems (I tend to think that some parts of MacApp will look different in the future as people think of more flexible ways of doing things). -Dennis D.

---

macintosh/macapp #61, from scotty, Mon Dec 1 03:30:10 1986. A comment to message 59.

I certainly hope that MacApp will be a teensy bit more programmer-friendly in future releases. I started out

by trying NOT to read the source but quickly learned the hard way.

The FilterEvent method of dialog items has been on my mind today. (DoFilterEvent? or something like that.) I tried to override it for a custom item I had in mind and spent a lot of time wondering what was going on until I looked at the Dialog View and found out that the method was only getting passed along to KeyHandlers. Now, I could make my custom item a descendant of KeyHandler, but I want to retain the currently selected KeyHandler while this item operates.

Another possible solution is a new dialog view with a different DoFilterEvent, but I am unsure if this will work. Mainly, I am trying to reimplement a Scrolling List using the List Manager package. (My first version was more along the lines of what Kurt Schmucker did in his book.) I want to call the LClick and LUpdate routines and DoFilterEvent seems like the right place. Anyone have any ideas? If I get it worked out I'll let everyone know how it works.

It seems to me that if you declare a FilterEvent, then that is what it should do, and referring back to the implementation shouldn't be needed. On the other hand, I can see that it would be a waste to do an EachChild(DoFilterEvent), or some such, when probably very few dialog items need to do this.

Another thing I realized when doing this was that if an item needs to filter events in a modal dialog, then it probably needs the same treatment in a modalless dialog, as well. Oh well.

This is not to say that I dislike MacApp. I think it's great, and it can do things that I only dreamed of on my Apple III (on which I'm writing this), but because I'm relatively new to MacApp and Mac programming in general, and haven't used the List Manager outside of the MacApp environment, I am a little surprised at how difficult it is to merge the two. (I know a simple view would be easier!)

On the other hand, I have been writing Pascal code since I got my first Apple II and would be glad to help anyone new to Pascal. But I am as green on objects as the next guy.

---

macintosh/macapp #63, from demars, Mon Dec 1 23:11:33 1986. A comment to message 61.

I experienced periodic frustrations while learning MacApp, and one of them was discovering that the List Manager (which I had planned to use) was none too compatible with the "view" concept. Of course, the MacApp mavens might say that nothing prevents you from using the List Manager (you don't HAVE to use views), but, of course, quite a bit in MacApp revolves around views, so you just about have to use them.

On the plus side, when I decided to forgo the List Manager and simply write a view to do what I wanted, it turned out to be very simple to do in the MacApp framework, and actually closer to what I visualized the interface to be than what the List Manager would have given me. Anyway, it's a trade-off, like most things, between flexibility and convenience. -Dennis D.

## BASIC

New versions of BASIC generate considerable discussion in the BASIC conference. Why BASIC is best is another subject of interest.

## MEMORY-RESIDENT PROGRAMS AND QUICKBASIC

---

basic/newbaslcs #351, from pwashburn (Peter Washburn), Tue Nov 25 00:42:32 1986.

*continued*



Does anyone have an easy way of making the QuickBASIC 2.0 editor and SideKick compatible with each other? I had already discovered that you couldn't paste from SideKick into the QuickBASIC editor, but I was really disappointed to find that when I use the Debug section of QuickBASIC, the computer locked up the first time the program encountered TRON. The only way to get out was to shut the machine off. My best guess is that the two programs are fighting for control of the keyboard.

I've become really dependent on having SideKick available while programming. I know that there is no love lost between Borland and Microsoft, but does anyone have a way to make these two programs work together? Or know of another resident editor that is compatible with QuickBASIC 2.0?

---

basic/newbasics #352, from btonkin (Bruce Tonkin), Tue Nov 25 22:24:27 1986. A comment to message 351.

QB takes the keyboard, and I doubt very much it will like \*any\* memory-resident editor. In fact, MS has told me several times that they don't guarantee QB will run with \*any\* TSR.

But why would you want to use the SideKick editor? Seems to me that QB has a better editor already. Different, surely, but better. I've never had any problems, but then I don't have any TSR programs and wouldn't use any if I had them. I need all the memory I can get and can't afford glitches caused by someone grabbing the KB vector and changing it. Think about it: Is that a bug in the compiler, a bug in the source code, a conflict between the TSR and the compiler, a conflict between the TSR and DOS, or a conflict between this TSR and one of the others? Or is it some combination? Without TSRs, life gets a lot easier while writing software. A lot of the possible problems are eliminated.

---

basic/newbasics #353, from dmick (Dan Mick), Tue Nov 25 23:45:28 1986. A comment to message 352.

Well, I don't like the QB editor better than SK's except for the limited file length. Oh, and the fact that the error indication and in-memory compile text go to and come from the editor (not SK's, no way). That's why I haven't bitched too much...it gains you that tied-in editing. I'd like it much better if it were like Turbo's editor, though (WS, in essence).

## BUSINESS BASIC I/O

---

basic/newbasics #354, from mmr (Micro Matic), Wed Nov 26 12:23:02 1986.

This is coming from across the Atlantic (Belgium). We are trying to access a device driver using the OPEN, INPUT#, and OUTPUT# commands of BBASIC. The program runs successfully on the normal GW-BASIC, but BBASIC seems to require an input \_before\_ any INPUT# is done. At this point, no input is ready! Anyone know any fixes?

---

basic/newbasics #355, from btonkin, Wed Nov 26 18:29:34 1986. A comment to message 354.

Have you tried using LOC and LOF on the file to check the size? It may well be that BB is treating the input as an INKEY\$; if so, using a WHILE/WEND loop would collect the input. Are the drivers attached to COM ports, or are they returning their input elsewhere? If to COM ports, then you may need to link the communications library when you link the .OBJ files. Please let us know more details.

---

basic/newbasics #367, from mmr, Tue Dec 2 12:03:48 1986. A comment to message 355.

Sorry at being a little slow in responding to your suggestions. I haven't tried linking the communications library. I assume you mean BASCOMB.LIB? (I have 2

libraries: basrunb.lib & bascomb.lib.) Checking LOC and LOF will only be possible if the resulting program is completely compatible with GW-BASIC.

---

basic/newbasics #368, from btonkin, Tue Dec 2 20:22:53 1986. A comment to message 367.

No; the library used for communications is called something else, and it is an .OBJ file that must be linked with your programs. It has different names, depending on the version of the compiler you're using. Please look at the files on your original distribution disk for one with a name that looks like it might refer to communications. The manual will also usually have references in it to "communications software," too. For QuickBASIC, the library is called "GWCOM.OBJ," and it's mentioned in the manual on page 376 (among other places). Other versions usually have names that are variants of this. As far as \*completely\* compatible with GW-BASIC, I don't know. I suspect there is little chance that any communications software you write will be generically compatible with MS-DOS machines; even the IBM BASIC compiler version 1.0 would create programs that had problems on quite a few not-very-compatible machines, and QB is a lot more demanding. Communications programs usually need to know where the ports are if they're going to use anything more than 300 baud. With QB, the 1.0 IBM compiler, and most other versions, \*you\* don't have to know where the ports are; but the compiler run-time had better be able to find them where they ought to be. If not - you'll get errors like "device not available," "bad file mode," and "device fault."

---

basic/newbasics #369, from mmr, Thu Dec 4 11:49:47 1986. A comment to message 368.

After a little more experimenting, it becomes clear that the fault lies with the handling of device drivers by BBASIC. Try compiling and running the following program both with GW-BASIC and BBASIC (install ANSI.SYS first):

```
10 open "I",1,"CON" ' the console
20 print "prompt:"
30 input #1, a$
40 print a$
```

With GW-BASIC, as is expected, the message "prompt:" is displayed, after which BASIC waits for input (processing the input #1 statement). BBASIC waits until you type a return, THEN displays the "prompt:" and THEN displays what you have typed in before the return! Imagine what happens when you try to access a peripheral which has to be started up by BASIC in some way or another (I need to do a print#) before it sends anything. The problem is not limited to the console (replacement) driver but occurs with any character device driver, even those that do not use the comm ports.

Next, I'll get a copy of QB and try with that. More news later.

## WHY BASIC IS BEST

---

basic/misc #207, from cable (Robert Cable), Sun Nov 9 20:28:52 1986.

Wishing to restart an old argument many (Pascal, C, Ada, etc.) programmers seem to think long dead, I'd like to make my statement on the subject of computer languages. They don't know it, but BASIC is not only far from dead, far from out of use, and far from what the current market needs in a programming language, it offers power that not many programmers can handle. Think I am kidding? I can prove it.

Believe it or not, the fastest spreadsheet currently running on a micro was written on an IBM PC in Microsoft BASIC and compiled. Not C, not Pascal, not FORTH, just BASIC. How do I know this? I have seen it



through my very own spectacles. Not advertising a product, but I'll happily prove it to the satisfaction of the worst skeptics.

The program, by the way, depends on new programming techniques and is just being released into the market. Why BASIC? According to the author, BASIC has the power without external libraries. Since the program depends on the actual compiler that created it much more than it does on the language itself, and since C lacks power in its kernel, as does Pascal, BASIC is the language of choice.

The same problem of depending heavily on the libraries rather than the language (or, as the author puts it, having a program that looks up at the language just as the user looks down at it) means that it cannot be portable the way C and Pascal programmers claim their code is. The program is married, as it were, not just to the language, but to the compiler that created it. The spreadsheet is built around a central math engine that compiles user input strings into native code subroutines which are linked to the main program so that (1) it can call them, and (2) they can call the routines in the main program's internal libraries. Running on an IBM PC with an 8087 at 4.77 MHz, this wondrous contraption processes 1500+ cells of exponentiation or 6400+ cells of square roots in ONE second. And that ain't C.

---

basic/misc #208, from btonkin, Sun Nov 9 20:39:02 1986.  
A comment to message 207.

I agree wholeheartedly. I'd like to see some of the routines from this package myself. Does the author have a BIX account? Might he like to talk about the techniques he used (either specifically or generally)? (The "he" is meant generically; the author might well be "she.")

---

basic/misc #209, from cable, Mon Nov 10 20:15:06

The author of the Amy math engine, which is used by the Indy spreadsheet I mentioned, is George Harvey, who lives in New Hampshire but works in New York and New Jersey. He may or may not have a BIX account, though he does subscribe to BYTE and surely knows of BIX.

He is not particularly bashful about his work, and I am quite sure of this because he has given talks on the subject to both the Monadnock Users Group and the New York chapter of the Independent Computer Consultants Association. (You guessed right, I have known him for several years.) I am sure he would like to join the BASIC language discussions on BIX. I'll ask him.

---

basic/misc #212, from cable, Mon Nov 24 18:38:39 1986.

I got the following from George Harvey.

Thank you for your recent message. I think I can answer your question as to why Indy87 and Indy88 were written in BASIC without getting too technical. They are the first demonstrations of the Amy math engines. There are Amy engines to support three particular compilers as of now, the IBM BASIC compiler, version 1, the Microway 87BASIC compiler, and the Microway 87BASIC/Inline compiler. The Amy engines are designed to support BASIC compilers for one reason: I believe BASIC is the best language for this application.

In order to understand my reasoning behind this, you have to understand the functioning of the Amy engines. In brief, they compile user input strings into callable native code subroutines, linking them on the fly to the currently running program, of which the Amy engines are modules. In order to save memory, they access the internal library structures of the main program to do their heavy work. In this way, a subroutine to raise a variable to the power of another variable is typically less than 20 bytes. Compiled BASIC can run through a lot of such subroutines in a second, and, using some

looping tricks, the Indy spreadsheet can process over 1500 cells of 8087 exponentiation in a second on your 4.77-MHz PC. This is why the Indy spreadsheets are so fast compared to any others on the market.

The Amy engines work by producing code that functionally copies that of the compiler for which it is designed. The code uses the same processor registers in the same ways to do the same things. This is one of the keys to how Amy engines operate. The differences that do exist are mainly due to the fact that special programming techniques are employed to find the library routines after they have been loaded.

You might say that Amy operates by looking up at the language with which it functions from underneath. Amy does not particularly care about the specifics of the commands, the language, or how modular the program is, or whether the language is structured or has recursion. Amy is quite concerned about how the language uses the registers in the processors and whether it accesses interrupts and how it stores results of calculations, because Amy has to act the same way as the host language.

Amy sits at a level below the language and has a good deal more room in which to work when the language was designed to operate at a high level. When a language is built to function at a low level, the programming techniques in Amy become more difficult and less useful.

Amy engines cannot be made portable with any of the current languages, and the issue of portability is irrelevant. Amy engines do not benefit from elimination of the GOTO or from the ability to pass parameters to subroutines. Amy engines do benefit from the kind of power associated with a language that is not afraid to be machine-specific and has a robust core library. The library of a good modern BASIC compiler has considerable power, far more than than the core libraries of Pascal or C. It is especially important that BASIC has such good string-handling functions, because the Amy routines must be, at least for part of their lives, data strings.

The truth is, if you want to get the most out of a machine, there is no getting around learning to use the insides of the operating system, ROM BIOS, and assembly language. Once you have done that, you can do anything the machine is capable of doing as long as the language you are working in has good hooks to system level. It is important to let the language do as much as it can, keeping the low-level programming to a minimum. BASIC has the hooks and the power.

You might tell people that if they want a free demo, AMY-DE.ARC (which requires a color graphics adapter but not an 8087) is in the CompuServe Access Area and on at least a few BBS systems.

And now you know as much as I do. ghh

---

basic/misc #213, from btonkin, Mon Nov 24 18:48:54 1986. A comment to message 212.

Sounds like an interesting technique. I hadn't thought of doing things that way myself, but it sure seems like it ought to work nicely. Has anyone else done anything like this? The closest I can think of as an equivalent in C or Pascal is the ability to pass a pointer to a function; as was mentioned, that method suffers somewhat in languages that don't have the core routines written in assembler already in the library. Neither C nor Pascal commonly have floating-point transcendentals written in assembler and available in their libraries, though such libraries can sometimes be purchased (depending on language, version, etc.).

*continued*



# C

The C conference excerpts include discussions of how compilers handle certain cases and tips on optimization of programs.

## IMPROPER STRUCTURE HANDLING

c.language/compilers #725, from erael (Ernie Rael), Fri Nov 7 05:02:12 1986.

I tried the following two programs. Only one got an error during the compilation phase.

```
struct a {int a,b,c;}*a;
m(){
    if(*a) a->a++;
}
```

The above passed the compiler.

```
struct a {int a,b,c;}a;
m(){
    if(a) a.a++;
}
```

It seems that neither is correct, and both should be equivalent. -err-

c.language/compilers #726, from geary (Michael Geary), Fri Nov 7 05:15:13 1986. A comment to message 725.

They certainly are both illegal, and Microsoft C 4.0 complains about both with "struct/union comparison illegal." In both cases, you are trying to compare an entire structure with zero. Not kosher. But, maybe not surprisingly, the first one slips past some compilers. Would be \*very\* interesting to see what kind of code it generated for that!

## OPTIMIZATION

c.language/tips #646, from geary, Sat Nov 8 01:52:52

Here's a trick for speeding up simple assembler functions called from Microsoft C. It works only for near functions (small model) and is easiest when there are only a few parameters. Basically, the trick is to pop the parameters (and return address) off the stack instead of setting up a frame pointer. As an example, here is a function to output a byte to a port:

```
; void near pascal Out( port, val )
;     int port;
;     char val;

OUT    proc    near

        pop    bx                ; return
addr

        pop    ax                ; val
        pop    dx                ; port

        out    dx, al

        jmp    bx                ; return

OUT    endp
```

This works best with the Pascal calling sequence, but can be used with the traditional C calling sequence as well. In the example above, you would reverse the "pop ax" and "pop dx" and insert a "sub sp, 4" right before the "jmp bx".

By way of contrast, here is the same function, coded with the conventional technique of setting up a frame pointer in BP:

```
OUT    proc    near
```

```
push    bp
mov     bp, sp

mov     dx, [bp].6
mov     ax, [bp].4

out     dx, al

pop     bp
ret     4
```

OUT endp

As you can see, the first method only saves a few instructions, but in a really time-critical situation it may be worth it.

# PASCAL

The excerpt from the Pascal conference discusses the use of the communications port from Turbo Pascal.

pascal/turbo #2227, from bernie.g (Bernie Gallagher), Sun Nov 30 13:17:33 1986.

I just bought Borland's Turbo Pascal to write a communications program. My first Pascal program is a translation of a BASIC program, which came with my modem, that "talks" directly with the modem. However, the Pascal version locks up whenever I call EOF(AUX) or EOLN(AUX). It seems that BASIC's EOF function is designed to work on both true disk files as well as logical devices such as the COM ports, but Pascal's only works with true disk files.

I've tried tricking Pascal by opening the COM port as a file, but Pascal won't let me write to it when I open it using ASSIGN/RESET (as would be expected), and it won't let me read from it when I open it using ASSIGN/REWRITE (only this time EOF and EOLN don't hang, they just fall through even if the buffer's empty, causing the READ error). If anyone else has had this problem, please clue me in to what I'm doing wrong.

pascal/turbo #2228, from jimkeo (Jim Keohane), Sun Nov 30 13:51:50 1986. A comment to message 2227.

Bernie, try using 2 files, one for input and one for output, with both assigned to "COM1" or whatever. Also, do yourself a favor and check out the PC.BIX conference. That conference contains the full working source to a turbo communications program for BIX communications. There's a "BIXCOMM.INC" file that has \*everything\* you might want in the way of full comm support. - Jim

PS - Another choice would be to install an async driver under DOS. You can then handle COM as if it were a file but still retain full interrupt handling. Look for ASYNC.DRV in the IBM area of Listings for full 8086 source.

pascal/turbo #2229, from jimkeo, Sun Nov 30 14:03:21 1986. A comment to message 2227.

Bernie, it's hard to imagine where BASIC (or any language) could correctly determine end of line or end of file on a comm port. These are usually things that a communications package lets you control. For example, is a CR end of line, or must it be CRLF, or LFCR, or just LF? It's even more true for EOF. Would EOF be a Ctrl-Z, or a NULL, or loss of carrier?

For a comm program you're writing, you're better off being in control fully and BarryN's PC.BIX turbo software is an excellent model to use. Aside from the fact that use of PC.BIX could save you money on BIX connect time.

Just do a "join pc.bix" and look for a "readme" topic or similar name. - Jim ■



# THE BUYER'S MART

## A Directory of Products and Services

THE BUYER'S MART is a monthly advertising section which enables readers to easily locate suppliers by product category. As a unique feature, each BUYER'S MART ad includes a Reader Service number to assist interested readers in requesting information from participating advertisers.

**RATES:** 1x—\$475 3x—\$450 6x—\$425 12x—\$375

Prepayment must accompany each insertion. VISA/MC Accepted.

**AD FORMAT:** Each ad will be designed and typeset by BYTE. Advertisers must

furnish typewritten copy. Ads can include headline (23 characters maximum), descriptive text (250 characters maximum), plus company name, address and telephone number. Do not send logos or camera-ready artwork.

**DEADLINE:** Ad copy is due 2 months prior to issue date. For example: October issue closes on August 1. Send your copy and payment to THE BUYER'S MART, BYTE magazine, 70 Main Street, Peterborough, NH 03458. For more information call Karen Burgess at BYTE 603-924-3754.

### ACCESSORIES

#### CARTRIDGES & MORE!

Nylon or multistrike cartridges in limited quantities for COLECO ADAM, \$19.50/dz. & \$2.50 ship. in CA 6% sales tax. Free 62 page catalog with 1,000's of cartridges & other accessories for all computers.

**Allied Business Machines, Dept. B**  
9281 Earl, La Mesa, CA 92042

Inquiry 677.

### ACCESSORIES

#### • RIBBONS • — OVER 300 AVAILABLE —

	BLACK	COLORS
APPLE IMAGEWRITER	\$2.25	\$2.75
DIABLO HT 2 m/s	2.40	n/a
EPSON MX-RX 70/80	2.25	2.75
OKIDATA 80-82-92	.85	1.25

Nationwide 1-800-331-6841

In Ohio 1-513-865-0947

M/CVISA/AMEX DEALER SUPPLIES

Inquiry 682.

### BAR CODE

#### PRINT LABELS READABLE AT 50 FT.

Print Labels with Large Text and/or bar codes on PC with Epson/Okidata/IBM printers. Text to 1"x1" reads at 50 ft. Bar codes 39, 1 2of5, UPC/EAN, MSI, DOD-LOGMARS, AIAG. Menu driven \$49-299. OR print from any program (i.e., dBase, Lotus, Wordstar) \$179; \$239 large text. Subtrns too for BASIC, Turbo, C.

#### Worthington Data Solutions

130 Crespi Court, Santa Cruz, CA 95060  
(408) 458-9938

Inquiry 323.

#### DATA CABLES & PARTS

EIA RS232-C Data Cables - standard, extended distance, Teflon Assemblies. Also Centronics (parallel), Coaxial (RG59U, RG62A/U, Dual Wang, Twin-axial), Ethernet, Ribbon, IBM, DEC Compatible cables, AB switches, connector parts, bulk cable, tools & hardware (wall plates). Send for Catalog.

**Communication Cable Co.**  
POB 600-B, Wayne, PA 19087  
215-644-1900

Inquiry 725.

#### ...SOFTWARE PUBLISHING...

GDS offers a wide variety of services that will help get your software to the market. Address your needs with GDS.

- IBM style cloth/vinyl 3-ring binders/slips
- Labels, sleeves, disk pages, bulk diskettes...
- Disk duplication with 100% verification.
- Shrink wrapping and product assembly.
- Quick turn-around.

A well packaged product can make the difference in making a sale. Call us now! VISA/MC.

**GLENCO DEVELOPMENT SYSTEMS(312) 392-2492**  
3920 Ridge Ave., Arlington Hts., IL 60004

Inquiry 682.

#### DATA INPUT DEVICES

Bar Code & Magnetic Stripe Readers for microcomputers & terminals, including IBM, DEC, AT&T, CT, Wyse, Wang. All readers connect on the keyboard cable & are transparent to all software. Low cost bar code print programs & magnetic encoders are also available.

#### TPS Electronics

4047 Transport, Palo Alto, CA 94303

415-856-6833 Telex 371-9097 TPS PLA

Inquiry 766.

#### Self-Inking Printer Ribbon

For users of Okidata and other open spool ribbon printers. Controlled Printout Devices are a new kind of printing ribbon that re-ink themselves, and will last 15 times longer than the ribbon you are now using. For further information please call or write.

**CONTROLLED PRINTOUT DEVICES, INC.**  
POB 869, Baldwin Rd., Arden, NC 28704  
(704) 684-9044

Inquiry 704.

#### IBM PC ACCESSORIES!

Our NEW Catalog includes every Accessory ANY IBM PC USER might want! PC Stands/Pedestals, Travel Cases/Dust Covers, Switches/Cables, Buffers/Converters, Surge Protectors, Floppys/Ribbons, PC Toolkits and MORE! Low Direct Prices, Same Day Shipping and Satisfaction Guaranteed! Simply call/write for a FREE COPY of our LATEST CATALOG today.

**Tipz Direct, Inc.** Simply Call 1-800-FOR-TIPZ  
P.O. Box 690, San Francisco, CA 94101-0690  
1-800-367-8479 or 415-567-4067

Inquiry 660.

#### BAR CODE READERS

Read Bar codes into any program with program-transparent, keyboard interface Bar Code Reader for IBM PC, AT and compatibles-\$385. Minis/CRTs/micros RS-232 Reader-\$399. All metal construction, auto-discrimination of 9 bar codes. Portable Readers for physical inventories-\$650.

#### Worthington Data Solutions

130 Crespi Court, Santa Cruz, CA 95060  
(408) 458-9938

Inquiry 323.

#### LOWEST PRICES ON DISKETTES

5 1/4" DSDD 39c, High Density, \$1.25.  
3 1/2" SSHD \$1.35, DSHD \$1.45.

- Lifetime warranty
- 100% error free
- Finest quality
- Boxed Products
- Includes tyvek sleeves
- Reinforced hub ring
- Labels & write protect tabs
- Same day shipping

Add 300 shipping per 100. Minimum 100 diskettes. Send check or call. CA residents add 6 1/2% sales tax.

**Data Bureau Inc.** 213-479-0345  
1633 Westwood Blvd., Ste. 120, Los Angeles, CA 90024

Inquiry 739.

#### COMPUTER PROTECTION

- UPS • LINE CONDITIONERS • ISOLATORS
- MODEM PROTECTORS
- AC POWER INTERRUPTERS

— HUNDREDS OF HINTS & PRODUCTS —

FREE CATALOG 1-800-225-4876

#### ELECTRONIC SPECIALISTS, INC.

171 So. Main St., POB 389, Natick, Mass 01760  
1-800-225-4876

Inquiry 773.

### BUSINESS OPPORTUNITIES

#### THE GUIDE TO HIGH-TECH CONSULTING AND CONTRACTING

New step-by-step, how-to information book: Getting started, career building, hardware & software job sources, part/fulltime, career change, moonlight. Contracts, taxes, client/job shop/recruiter negotiation techniques. Business/finance, engineering, scientific. Author strategies raises wages! \$16.95 + \$3 postage.

#### Madden Associates

Dept. B, 2039-F Civic Center Drive  
North Las Vegas, NV 89030

Inquiry 686.

### ASSEMBLY LANGUAGE

#### FREE 8088 TUTOR Monitor

Learn 8088 assembly language using the new book, *IBM PC-8088 Assembly Language Programming*, by Richard E. Haskell. Order the book for \$25 plus \$3 S/H and get the powerful TUTOR monitor software free. Load and examine any disk file, disassemble any 8088 code, debug EXE files. Satisfaction guaranteed.

#### REHI Books

54 N. Adams, Suite 130-Y, Rochester Hills, MI 48063  
(313) 853-1941

Inquiry 691.

### COMMUNICATION

#### ASYNCR MANAGER & TUTORIAL

Interrupt driven transmit & receive \* Buffered I/O to 64K \* XON/XOFF \* Modem controls \* XMODEM \* Use two comm ports simultaneously \* Written in assembler \* HLL calls for C and Pascal \* Complete with object libraries, documented source code, sample programs, and a comprehensive manual.  
\$69 + \$3 S/H. (CA 6%) Cash/CK/MO only

#### CIRRUS SOFTWARE

P.O. Box 51924, Palo Alto, CA 94303  
(415) 949-4254

Inquiry 749.

#### FREE CATALOG

Thousands of parts and new surplus electronic parts at super low prices. FAST ORDER PROCESSING AND SHIPPING (95% of all orders shipped within 48 hours).

CALL OR WRITE FOR A FREE CATALOG. . .

#### ALL ELECTRONICS CORPORATION

POB 20406, Los Angeles, CA 90006-0406

1-800-826-5432

Inquiry 705.



# THE BUYER'S MART

## COMMUNICATION

### MULTI-USER BBS (PC AT)

TEAMate—a mainframe quality BBS. A mini COMPUTE-SERVE. Full screen cursor-controlled interface, topic outline structure, public and private topics, audit trails, XMODEM, integrated mail, content retrieval and more. Requires XENIX. From \$495. MS-DOS Demo \$29.95

**MMB Development Corporation**  
753 Deep Valley Drive, Rolling Hills Estates, CA 90274  
**212-541-4504**

Inquiry 690.

## COMPUTER DIGITIZERS

### VIDEO IMAGE PROCESSING

- STORE VIDEO PICTURES ON DISK
- CAPTURE & PRINT REAL-WORLD IMAGES
- Custom Applications Include:
  - Video Databases
  - Desktop Publishing
  - PC Based Video Telephones
  - Color/B&W T-Shirt Systems
- Digitizers (Computer Eye, Chorus, etc.)
- Video Toolkits for DBASE III, LOTUS 123, etc.

See HAL SYSTEMS below

Inquiry 711.

### HAL SYSTEMS

*Image Processing Specialists*

674 Route 202-206N  
Bridgewater, NJ 08807

**1-800-227-0158**

(in NJ 201-218-1818)

201-469-0049 (24 hr. BBS/Modem)

"A picture is worth a thousand words"

Inquiry 711.

## COMPUTER FURNITURE

### MOBILE PC WORKSTATIONS

The new *Mobile-Station* series of computer workstations add wheels to your computer system. Position it next to your desk like a typewriter or take it from room to room. Several models in wood or laminates. Call or write for catalog and more information.

**MicroLand Furniture Co., Inc.**

11 Madrone Ave. — San Anselmo, CA 94960  
**415-485-9758**

Inquiry 746.

## COMPUTER INSURANCE

### COMPUTER OWNERS INSURANCE

Call toll free for coverages and premiums

- COMPUTERS OVERSEAS
- COMPUTERS YOU LEASE
- COMPUTERS YOU LEASE TO OTHERS

### SAFEWARE

**The Insurance Agency Inc.**

**1-800-848-3469**

IN OHIO (614) 262-0559

Inquiry 772.

## CROSS ASSEMBLERS

### ASSEMBLERS & TRANSLATORS

Over 20 high quality, full function, fast relocatable and absolute macro assemblers are available immediately. Source language translators help you change microcomputers. Call for info about MS/DOS, CPM80, ISIS versions.

### RELMS™

PO. Box 6719  
San Jose, California 95150  
(408) 265-5411  
TWX 910-379-0014

Inquiry 696.

## DATA/DISK CONVERSION

### Disk/Disk + Tape/Disk

Over 600 formats! 3½, 5¼, or 8 inch disks; 9 track mag tape; 10 MB Bernoulli cartridge. Data base and word processor translation specialists.

### Computer Conversions, Inc.

9580 Black Mountain Rd., Ste J  
San Diego, CA 92126  
**(619) 693-1697**

Inquiry 652.

### DISK AND TAPE CONVERSIONS

High quality conversion services for Dedicated Word Processors, Mini and Microcomputers. Over 600 3½", 5¼", and 8" formats. Also 800-1600BPI tape. Included: Wang, NBI, CPT, DEC, Vydec, Lanier, OS/6, Xerox, IBM Sys/34/36/38/5520, Mac, Victor, TRS, Apple, NSTAR, IBM PC/AT, HP, and most of the other microcomputers. We can convert directly into word processing software such as: DW3, WP, MS/WRD, WS, Samna, MM, PFS, and many others.

**DATA FORMATS, INC. (408) 972-1830**

Inquiry 654.

### CONVERSION SERVICES

Convert any 9 track magnetic tape to or from over 700 formats including 3½", 5¼", 8" disk formats & word processors. Disk to disk conversions also available. Call for more info. Introducing OCR Scanning Services.

### Pivar Computing Services, Inc.

165 Arlington Hgts. Rd., Dept. #B  
Buffalo Grove, IL 60089 **(312) 459-6010**

Inquiry 753.

## DIRECTORIES

**Over 1,000 toll free phone numbers for computer products & support**

**Precision Computers**  
845 Cornell, Albany, CA 94706

Software Publishers Hardware Mfg., & more. Save money for years to come. Save time by finding numbers fast. One call could pay for this book. \$9.95 plus \$3 s/h to:

Inquiry 699.

## DOCUMENTATION

### COMPUTER ASSEMBLY MANUALS

**BIG BLUE SEED for IBM™ BUILDERS:** Parts list, placement diagrams, instructions for assembling 75 bare cards. Now includes 640K, Turbo & AT MthBds. \$17.95.  
**APPLE™ BUILDERS NEED APPLE SEED:** Instructions for assembling 85 Apple-compatible bare cards including the popular 6502 II+ and IIe MthBds. \$14.95. Both for \$30. Bare cards available. Check/MD/VISA/MC.

**NuScope Associates\***, Dept. B  
P.O. Box 790 • Lewiston New York • 14092  
\*A Division of Kosmic Microtech Inc.

Inquiry 758.

## DUPLICATING SERVICES

### BLANKET SERVICES

Diskette duplication • Packaging • Stocking/Drop shipping • 48 hour delivery • SUPERLOK copy protection • No mastering fee • No charge for standard labels •

### Star-Byte, Inc.

2564 Industry Lane, Norristown, PA 19403  
**215-539-4300 800-243-1515**

Inquiry 684.

## DUPLICATING SERVICES

### FULL SERVICE DUPLICATION

Speed, Quality, Value, Security, Support,

**800-222-0490**  
**(201) 462-7628 (In NJ)**

SATISFACTION GUARANTEED

### MegaSoft, Inc.

P.O. Box 710, Freehold, NJ 07728

## EDUCATION

### COMPUTER FACT BOOK

- LEARN about Computers the Easy way.
- Written in Clear, Easy to understand English.
- Facts, Short Cuts, a Wealth of information, Hundreds of ways to Improve your skills.
- When You Need reliable Information Fast turn to the COMPUTER FACT BOOK for FREE Information write to:  
**COMPUTER & ARTS Publications**  
Suite 472-G, 5580 La Jolla Blvd.  
La Jolla, CA 92037

Inquiry 708.

## EDUCATION/GRAPHICS

### INTRODUCING MICRO TYPER

Imagine being able to create custom overheads, worksheets or modify Printshop or Newsroom! **Anything is possible with the magic of Micro Typer.** Micro Typer allows you to add creative text in different colors, sizes or languages to any Apple Graphics program. \$50.00 MC/VISA. To order call or write:

### COMPTECH SYSTEMS DESIGN

P.O. Box 516, Hastings, MN 55033

**(612) 437-1350**

Inquiry 656.

## FLOW CHARTS

### FLOW CHARTING II+ HELPS YOU!

Precise flowcharting is fast and simple with Flow Charting II+. Draw, edit and print perfect charts: bold and normal fonts, 24 shapes—95 sizes; fast entry of words, bypasses & connectors; Fast Insert Line; shrink screen displays 200-column chart; 40 column edit screen for detail work, much more!

### PATTON & PATTON

81 Great Oaks Blvd., San Jose, CA 95119

**1-800/672-3470, ext. 897 (CA residents)**

**1-800/538-8157, ext. 897 (Outside CA)**

**408/629-5044 (Outside the U.S.A.)**

Inquiry 692.

## HARDWARE

### 68020 COMPUTERS

Up to 14.5 Mbyte RAM, 258K ROM, 30 users, DMA floppy and SASI (SCSI), calendar/dock w/bat backup, timer, real time multi-tasking, multi-user op. sys., basic, assembler, screen editors, spreadsheet. Fits PC type cabinet. Mem. Prot. option, more.

From **\$2195.00.**

Other 68XXX computer systems from **\$995.00.**

### AAA Chicago Computer Center

120 Chestnut Lane - Wheeling, IL 60090  
**(312) 459-0450**

Inquiry 762.

### SAVE Direct Manufacturer XT/AT Compatible Wholesaler

XT Clone Bare Bone (case, 150WPS640K)	\$295
XT Complete System (above + (2) Fujitsu Drives	\$695
Hi-res Monitor, Mono Graphic Card, Keyboard, 2pp. 1sp, RTC	
AT Clone Bare Bone (case, 200WPS, 512K, Phoenix Bios, 80286 610 MHz)	\$695
AT Complete System (above+1.2MB, FID Controller, Hi-res Monitor, Mono Graphic Card, Keyboard, 2pp. 1sp, RTC)	\$1195

Dealer Inquiries Invited Complete Computer Accessories/Peripherals  
**DAR HAN CORP.** Visa/MC/AE Accepted  
908 E. Main St., Alhambra, CA 91801  
**(818) 570-0396 or 284-2142**  
G/Net Advanced Netware Available

Inquiry 748.



# THE BUYER'S MART

## HARDWARE

### USED APPLES & IBM's

Macintosh 512K — \$1150.00  
 Apple II+ and IIe — call  
 Imagewriter I — \$275.00  
 Motherboards & accessories — call  
 We buy, sell, & horsetrade — Apple, IBM, & CBM.

**SHREVE SYSTEMS**  
 845 Lark Ave., Shreveport, LA 71105  
**318-865-6743 4-9 p.m. C.S.T. VISA/MC**

Inquiry 737.

## HARDWARE

### EPROM/EEPROM PROG. \$250

Programs 2716-27512, 25xx and 68764/66 eproms via RS-232. Also 874x micros and 28xxA & 52Bxx EEPROMS. Automatic baud rates select, built in help menus, no personality modules!

**16 BIT I/O MODULE \$75**  
 Low cost control via RS-232. Expands to 512!

**INTELLITRONICS**  
 P.O. Box 3263, Tustin, CA 92680  
**(714) 669-0614**

Inquiry 700.

## HARDWARE/COPROCESSORS

### HARDWARE/COPROCESSOR

PC COPROCESSOR/MEMORY CARD  
 Turn Your PC into a Mini!  
 The PC 4000 plug-in card for PC and compatibles uses the high speed Novix Forth CPU that executes Forth in silicon — no assembler! At 4 MIPS, 100+ times faster than the PC PC4000 and PC run in parallel and share up to 512K on-card memory. Forth software included. C also available.

**Software Composers**  
 210 California Avenue, Suite I  
 Palo Alto, CA 94306  
**(415) 322-8763**

Inquiry 707.

## HARDWARE ADD-ONS

### APPLE COMPATIBLE PRODUCTS

16 RAM/80 Column Boards, 64K \$39, 256K \$109, 512K \$139, 1.0MEG \$238, 256K-1.0MEG includes XMe PLUSWORKS Strw. II+ 80 Col Bd \$49, Iie Keypad w/16 Keys \$39, II+ /e Cooling Fan w/surge protect \$29.95. Add \$3 Shipping. Write for complete list.

**NEXO DISTRIBUTION**  
 914 East 8th St., Ste. 109, National City, CA 92050  
**(619) 474-3328**

Inquiry 726.

## HARDWARE/GRAPHICS

### Video Animation

Would you like to do real animation on video tape? The Pico Systems Video Animation Controller and an editing video recorder are all you need. Any computer with a spare RS-232 serial port can run this controller. No special software, just simple words and numbers command the controller to insert n frames of video from your screen to an exact location on the tape, with absolute frame accuracy guaranteed.

### Pico Systems

819 Marshall Ave., Webster Groves, MO 63119  
**(314) 962-6103**

Inquiry 713.

### Cleans up your line power!

Isobar protects computer from damage caused by high voltage spikes and AC line noise. It prevents errors, malfunctions, false computer printouts and disk skips, plus audio and video hash. Isolated filter banks isolate the outlets to prevent equipment interaction! 3-way spike protection! Free catalog.

### Indus-Tool

730 W. Lake St., Chicago, IL 60606  
**Phone 312-648-2191**

Inquiry 703.

### MEGABYTES OF MEMORY

Lowest Prices Guaranteed in US. Dealer Inq. Invited  
 Fully Populated 2MB Memory Boards  
**TALLTREE SYSTEMS — JRAM BOARDS**

JRAM 2	\$134	OPEN 7
JRAM 3 Aboveboard	183	DAYS A WEEK
JRAM AT	183	M-F 9-8
JRAM AT Aboveboard	239	S-S 9-6
JDISKETTE	135	VISA, MC, AE, CHOICE
JLASER I	275	<b>703-847-4740</b>
JMODULES	CALL	<b>800-642-2395</b>

**Information and Technology Services, Inc.**

Inquiry 688

### PC I/O BOARDS

• Four Port RS-232 w/software	\$349.00
• RS-422/485 Serial	\$149.00
• RS-232/422 with 24 Parallel I/O	\$199.00
• RS-422 Synchronous	\$299.00
• EPROM/RAM	\$199.00
• A/D & Digital I/O	\$299.00

Call About Custom Designed Boards

**Sealevel Systems Inc.**  
 P.O. Box 1808, Easley, SC 29641  
**(803) 855-1581**

Inquiry 655.

### HOUSTON INSTRUMENTS PLOTTERS

Houston DMP-40/4&42: A-B/C-D-size	\$966/\$2577
loine LP3700 A-E size, 1 pen	\$3364

### DIGITIZERS

Summagraphics MM1201, pow. cable	\$374
GTCC MD7-1212 complete	\$516
Hitachi HDG-1111B Tiger II w/stylus	\$735

### GRAPHICS BOARD/MONITOR COMBOS

Orchid TurboEGA & NEC Multisync	\$1099
Artist 1 & Mitsubishi 19" monitor (C6922/PAG)	\$3418

Large corp. & institutional PO's accepted OAC.  
**ARDEN SYSTEMS, INC. (213) 479-6707 ext. 29**  
 12335 Santa Monica Bl. #240, Los Angeles, CA 90025

Inquiry 650.

### LOAD CELL INPUT & CONTROL

Local/remote control of plant processes via multi-drop bus from single serial port; compatible with all computers. Basic software included.

- Load cell input • 8 channel AC output •
- 24 channels AC/DC I/O •
- Count up/down/dispense •

### SCALE-TRON INC.

P.O. Box 424, Lachine, Quebec, H8S4C2 Canada  
**(514) 634-7083**

Inquiry 675.

### MORE THAN A MIDI INTERFACE

• Use MIDI software for scoring, sequencing, interactive music training, etc. *with your own musical instrument* or MIDI input • Drive MIDI synthesizers, effects, recorders, drum machines etc. from any acoustic instrument. Avail. for Commodore 64, Apple II, Mac, Atari, Amiga, & more \$189.00 U.S. (plus \$10.00 S&H) • Money Back Guarantee Payment by money order, VISA or Mastercard.

### PITCHRIDER™ by IVL

IVL Technologies Ltd.  
 3318 Oak St., Victoria, B.C. Canada, V8X 1R2  
**(604) 383-4320**

Inquiry 728.

## HWRE/POWER PROTECTION

### POWERLINE GREMLINS?? POWER FAILURES??

The MEIRICK STANDBY POWER SYSTEM is the TOTAL SOLUTION to your powerline problems.

240 watt system - \$365; 400 watt system - \$495;  
 800 watt system - \$795

### MEIRICK Inc., POWER SYSTEMS DIV.

Box 298, Frisco, CO 80443 303-668-3251

## LANGUAGE/TRANSLATION

### INTERCHANGE HEWLETT PACKARD FILES ON IBM PC

LIF Utility for the IBM PC allows IBM PC's and compatibles to read and write files written by Hewlett Packard series 70, 80, 200, 300, 1000, 9000 computers. Call for data sheets, config diagram, pricing. Oswego Software Inc. specializes in HP disk file copying, program translators.

### Oswego Software Inc.

507 North Adams Street, Oswego, Illinois 60543 USA  
**(312) 554-3567 TELEX 858757**

Inquiry 733.

### SANYO 550/555 USERS

TURBO BOARD-7.2 MHZ	\$ 95.00
20 MEG EXTERNAL HARD DISK SYSTEM	\$749.95
SANYO VIDEO BOARD (ORIGINAL)	\$174.95
RS-232 BD.	\$ 49.95
HARD DISK CONT W/CABLES & SOFT (ST-506)	\$249.95
768K MEM. CLK. & EXPANSION BD.	
(FREE RAMDISK, SPOOLER, & SOFTVIDEO-RUNS IBM PROGRAMS)	\$199.95

### TAMPA BAY DIGITAL

1807 Gulf-to-Bay Blvd., Clearwater, FL 33575  
**813-443-7049**

Inquiry 734.

### Z80™ / HD64180/CP/M™ CO-PROCESSORS

Plug-in co-processors for PC, PC/AT.

### Blue Thunder Z80 co-processors

6-mhz	\$249.95	10-mhz	\$399.95
	12.5-mhz		\$599.95

**HD64180 co-processors \$295** and up  
 All co-processors with CP/M emulator. Software only emulator ZSIM only \$99.95.

**Z-WORLD 408-980-1678**  
 2065 Martin Ave. #110, Santa Clara, CA 95050  
*See Ad Page 205.*

Inquiry 717.

### KING OF MICROCONTROLLERS

- 4000 Microcontroller Boards & Kits for 8035/8039/8040/8048/8049/8050/8031/8032/8051/8052/8751/6511/7001/7809 from \$19.95
- 4008 Mini RS232 Terminal Kit, Full Keyboard, LCD Display \$159.95
- 4015 8052 Basic System, EPROM Programming, RAMs & I/O \$299.95

### TECH STAR LABORATORY

Suite 709 R&B Corp. Park, 1701 N. Greenville Ave. Richardson, Texas 75081

Inquiry 709

### Motherboard Clock \$59

SideClock does not use an expansion slot! The Innovations' Clock/Calendar, installs in seconds: Just open the computer cover and snap it into place. Never enter the time and date again, SideClock does it for you. Replaceable battery & software included. 30 day \$\$ back gtd. 2 year limited warranty. \$59 +\$3 s/h. Site discounts. Dealers welcome.

### ARISTO

16811 El Camino #213-D, Houston, TX 77058  
**713/480-6288 800/3ARISTO**

Inquiry 752.

## LAPTOP COMPUTERS

### IBM & MACINTOSH \$799 SIX LB. LAPTOP COMPUTER

Choose the new Tandy 102 or NEC 8201 portable computers & combine it with our battery-operated 3 1/2" disk drive, integrated ROM software (the Ultimate ROM II), carrying bag, & either our IBM "LAPDOS" or Macintosh "MACDOS" disk sharing software. Just plug our portable disk directly into your IBM or Macintosh serial port for complete data compatibility with your favorite software. For FREE laptop catalog 1-800-343-8080.

### Traveling Software, Inc.

19310 North Creek Parkway, Bothell, WA 98011  
**(206) 483-8088**

Inquiry 779.



# THE BUYER'S MART

## MAILING LISTS

### Professional List Management

ArclList — mainframe mailing list management for the PC/XT/AT. Capacity 20 million names, automatic zip and state verification, print any label, custom charts and reports, merge-purge with excellent near-dupe recognition, match codes, postal presorting, Nih sampling, much more. \$595. Demo disk available. Take control of your list. Call for free brochure.

#### Arc Tangent, Inc.

923 Olive St., POB 2009, Santa Barbara, CA 93120  
800-843-5928 (in CA. 805-965-7277)

Inquiry 714.

## MODEMS

### MODEMS — AS LOW AS \$119

300/1200 Baud, external. 2 year warranty — free compuserve time. Toll-free customer service number. Hayes Compatible AT Command set, Auto Answer/Autodial RS232C Connector — 8 led status lights. We will beat any advertised price. Compatible with most computers and terminals.

We accept Visa/MC

#### JEMCO SYSTEMS

POB 511263, Salt Lake City, UT 84151-1263  
800-433-4606 (In Utah) 298-1661

Inquiry 759.

## PUBLIC DOMAIN

### → PUBLIC DOMAIN SOFTWARE ←

50 AMIGA DISKETTES — \$8.50 each. 25 ATARI-ST DISKETTES — \$8.50 each. 490 IBM DISKETTES — \$4.25 each. 60 SANYO 550/555 DISKETTES — \$4.25 each. SAMPLE DISKETTE & CATALOG: AMIGA or ATARI-ST \$8 ppd. IBM or SANYO \$5 ppd. All prices include FREE SHIPPING! Visa/MC - No Extra Charge! 48 hr. Turnaround! Phone Orders Welcome! Quality Media Used!

#### Computer Solutions

P.O. Box 354 - Dept. B, Mason, Michigan 48854  
1-800-874-9375 (M-F 10-5 EST) 1-517-628-2943

Inquiry 760.

### THE BEST OF THE BEST!

Public Domain & User Supported Software for IBM PC or compatible. Word Processing, Database, Spreadsheets, Utilities, Games, Accounting, etc! 50 disk package \$205.00, or rent 2 wks. \$75.00. Info & Super Sampler Disk \$6.50, Deluxe Word Processor \$6.50, both \$12.00. MC/VISA

#### BLUE CIRCLE GROUP, INC.

Box 23502, Minneapolis, MN 55423

(612) 823-4111

Inquiry 679.

### IBM, CP/M, MAC SOFTWARE

Over 2500 disks covering IBM/PCDOS/MSDOS, CP/M and Macintosh. All major public domain user groups represented. Priced from \$6 (US) disk (even lower in quantity). Fast service, shipped around the world. Call or circle inquiry #653 for our FREE 32 page minicatalog of highlights.

#### CANADA REMOTE SYSTEMS LIMITED

(1-800-387-1901) (1-416-231-2383)

Inquiry 653.

## SALES/MARKETING TOOLS

### Telemarketing Software \$95

TeleMAGIC is the #1 package for people who do business by phone. Super fast auto dialer, instant retrieval by several keys. Huge notepad. Makes "quickie" lists, reports, labels, letters. Utterly simple to use. Incredibly powerful. No copy protection. Interface with YOUR word processor. One billion records. DOS windows. Import-export-mailmerge. 30 day money back guarantee. Corporate license available. Network option. Now used by AT&T, GE, Bell, Sears, hundreds of others. VISA, MC, AX, C.O.D.

#### Remote Control

1320 Ocean Ave., Suite E, Del Mar, CA 92014  
800-922-9952 In Cal. 800-922-5228

Inquiry 777.

## SOFTWARE ACCOUNTING

### TAX PAK

Schedules A B C D E F G R SE W Forms 1040, 1040A, 2106, 2119, 2441, 2468, 3903, 4562, 4684, 5261. Not copy protected — For IBM-PC, 8"CPM (Z80) 8"CPM86 Kaypro IV Morrow MD3. Personal \$37. Professional \$185 Yearly update \$27 & \$125. Professional includes: IRS Approved forms, multiple clients, alphanumeric input.

#### CANDELARIA WORKS

3955 Club Dr., Atlanta, GA 30319  
(404) 266-2420

Inquiry 751.

### CUSTOM PAYROLL

All systems have multiple pay categories, calculation of all taxes, user defined deductions, 401(k) handling, many reports, paychecks, W-2 forms, and much more. Custom features are available. Prices start at \$695 for system, manual, and PC Basic source code.

#### Datasmith, Inc.

Box 8036, Shawnee Mission, KS 66208  
(913) 381-9118

Inquiry 761.

### DBASE BUSINESS TOOLS

- \* General Ledger
- \* Accounts Recvbl.
- \* Order Entry
- \* Sales Analysis
- \* Purch Ord/Inventory
- \* Accounts Payable
- \* Job Costing
- \* Job Estimating

\$99 EA. + s&h w/dBASE 2, 3 or 3+ SOURCE CODE

#### DATAMAR SYSTEMS™ Cred. Card-Check-COD

6809-B Convoy Court, San Diego, CA 92111  
800-223-9963/CA 800-221-9964/(619) 278-8222

Inquiry 680.

### 1986 INCOME TAX PROGRAM

PC-TAX-MASTER, the complete 1986 Federal Income Tax preparation program for IBM-PC, XT, AT, PCjr and compatibles for only \$95. Form 1040 with 22 schedules and forms. Menu driven, fast, integrated, easy to use. Prints forms. Free telephone support. Yearly updates, and 15 day money back guarantee. Free pop-up scientific calculator with order.

VISA, M.C., C.O.D. call: 1-800-628-2828 Ext 820

Questions and info call: 1-718-417-0165

#### DATAx

1923 Linden Street, Ridgewood, NY 11385

Inquiry 740.

### INCOME TAX SOFTWARE

TAXWORKS® software to enter, calculate, and print Federal Form 1040 and 17 supporting schedules. 1986 marks 4th year of production. Free telephone support. For IBM, MS-DOS, CPM-80. Federal \$400. California \$100.

#### TAXWORKS™

881 Alma Real Dr., Suite T-2  
Pacific Palisades, CA 90272

(213) 459-2746, In Calif. (800) 232-11040"

Inquiry 765.

### CPA's CLIENT WRITE-UP \$250

Now a low cost, proven system featuring complete general ledger with flexible report formats, statement of change, job cost and optional Lotus/dBase interface. After-the-fact payroll provides earnings records, state ulc, 941's, W-2's and 1099's. Runs on all IBM PC/XT/AT and compatibles with 256K \$250 complete-including printed manual. MC/VISA. 14 Day Free Trial.

#### HOWELL ASSOCIATES 713-661-6652

4545 Bissonnet Suite 280, Bellaire, TX 77401

Inquiry 723.

## SOFTWARE ACCOUNTING

### INCOME TAX SOFTWARE

LOTUS 123, APPLEWORKS, EXCEL spreadsheet templates to calculate your 1986 Federal Income Tax plus a look at 1987 & 1988 tax changes. Lots of Forms and Schedules. IRS accepted printout. \$50.00. Quick Delivery. VISA/MC. Orders: (800) 826-7146 UG/Dealer discounts.

#### ISLAND COMPUTER SERVICES

3501 E. Yacht Dr., Long Beach, N.C. 28461  
(919) 278-9483

Inquiry 689

### ALL FORMS TAX SOFTWARE

- \* Individual Federal Income Tax Software
- \* Schedules A-E, G, R, SE, W
- \* Forms 1040, 1116, 2106, 2119, 2210, 2441, 3468, 3903F, 4136, 4562, 4686, 5695, 6251
- \* Prints on IRS forms or acceptable format
- \* BASIC source, IBM PC, XT, AT or Compatibles
- \* Demo disks \$10.00 + 2.50 Shipping

Prices starting at \$39.95

#### Unique Computer Systems

140 E. Commonwealth Ave. #208, Fullerton, CA 92632  
In CA 1-800-331-5088 (714) 525-7118

Inquiry 722.

### TIME & BILLING

400 clients/20 partners/80 job & 40 out of pocket categories/20 areas of practice/fixd fee or hourly/more! Prints billing/statements/aged rec's/more! Free phone support. \$149 (VISA/MC/AMEX). MS-DOS/CPM-80. Other original software.

FREE catalogue.

#### MICRO-ART PROGRAMMERS

614 Alameda Padre Serra, Santa Barbara, CA 93103  
(805) 962-0922 (24 hours)

Inquiry 667.

## SOFTWARE/BASIC

### FINALLY! MODULES

Add class to your compiled BASIC programs with FINALLY! MODULES. Use pull-down WINDOWS, horizontal menus, pop-up help screens, input screen and directory managers. For use with FINALLY! library and QuickBASIC 2.0 or IBM Compiler 2.0. 30 Day Money-Back Guarantee. VISA/MC/Check/MO

FINALLY! MODULES is \$99.00 + \$4.00 S&H

#### KOMPUTERWERK, INC.

851 Parkview Blvd., Pittsburgh, PA 15215  
(412) 782-0384

Inquiry 719.

## SOFTWARE BUSINESS

### Service Plus—Delivery Rating

Complete set of programs for delivery services. Rates bill using your rates, zones, wt. breaks, etc. from simple rating to multiple zones, types. Reports include invoicing, driver pay, sales by customer tonnage reports, aged receivables, statements, custom labels and more. Demos \$19.95 Full System \$495.00

#### SRI CORP.

P.O. Box 70012, Houston, TX 77270  
(713) 864-5285

Inquiry 731.

### PC-Write™ Shareware Ver. 2.7

Fast, powerful word processor/text editor for IBM PC. Spelling checker, screen clip, mailmerge, split screen, ASCII files, macros. Supports proportional printing, laserJet, 300+ printers. \$16 for all software, tutorial/guide on diskette. OK to copy. Register for manual/support, \$89. Full 90-day guarantee.

Quicksoft (206) 282-0452 Visa/MC  
219 First N. #224J, Seattle, WA 98109

Inquiry 756.



# THE BUYER'S MART

## SOFTWARE/BUSINESS

### OFFICE AUTOMATION SOFTWARE

Order Entry, Inventory \$19.95 each. Independent or interactive. Fast, accurate. Database sizes: 150 to 3000. Monitor up to 15 whse. Other configs avail. Order acknowledgment forms, inventory listings, & reorder level listings printed. Min. req: IBM PC or compatible, 1 DSDD 360K drive, 128K RAM memory, DOS 2.10 or later. MCV/ISA, free shipping in continental U.S.

**FutureSoft (216) 753-1336**  
P.O. Box 23005, Cuyahoga Falls, OH 44223-1100

Inquiry 697.

## SOFTWARE/BUSINESS

### PC-Type +

The ultimate tool for writing! PC-Type+ comes equipped with the essentials, PLUS many advanced features—Mail Merge, 100,000 word spelling checker, & a Labels program. Works hand in hand with PC-File and PC-File. Open up to 10 files simultaneously! \$69.95 + \$5 s/h. For IBM PC.

**ButtonWare, Inc.**  
P.O. Box 5786, Bellevue, WA 98006  
**1-800-J-BUTTON**

Inquiry 672.

## SOFTWARE/BUSINESS

### SAVE LEGAL FEES

157 time tested legal forms on disk, complete with menu driven system and editing and printing capability. Free copy of PC-Write word processor included. Forms written by a noted attorney and applicable nation-wide. \$129.95 plus \$7.50 shipping and handling.

**LegalEase™ HDG Software, Inc.**  
54 Whitney St., Sherborn, MA 01770  
**617-651-1881**  
**800-628-2828 x 706** for credit card orders

Inquiry 669.

### PC-File/R™

All the power of PC-File III plus: Relational link to other databases, integrated letter writing & mail-merge, context sensitive pop-up help windows. New binary search retrieves data hundreds of times faster. \$149.95 + \$5 s/h.

**ButtonWare, Inc.**  
P.O. Box 5786, Bellevue, WA 98006  
**1-800-J-BUTTON**

Inquiry 673.

### PROFIT PLANNER™ \$89

Menu-driven financial software for budgets, projects, products, acquisitions & forecasting. Provides P&L, balance sheet, cash flow, ratios, net present value, internal rate & graphs. Requires Lotus 123 or clone: Symphony, too. Visa/MC/Amex. Brochure.

**Suntex National**  
P.O. Box 772868 • Houston, TX 77215  
**(800) 643-9039 ext 303 • (800) 392-6273 in Texas**

Inquiry 661.

## SOFTWARE/CHURCH

### ROMAR CHURCH SYSTEMS™

Membership-61 fields plus alternate address; labels, letters, reports any field(s). Offering-256 funds; optional pledge; statements; post to 255 x/year. Finance-G/L with budget; up to 500 sub-totals & 99 depts: month & YTD reports anytime for any month. Size 2000 people/floppy; 25000/10 meg. Ad too short! Write!

**Romar Church Systems, Attn: BMB**  
P.O. Box 4211, Elkhart, IN 46514  
**(219) 262-2188**

Inquiry 657.

## DATA ENTRY SYSTEM

Heads-down data entry with two-pass verification for the PC/XT/AT & compatibles. Loaded with features like: Auto dup & skip, verify bypass, range checks, & table lookups. Fully menu driven only \$395. Call for free 30 day trial period.

**COMPUTER KEYS**  
21929 Makah Rd., Woodway, WA 98020  
**(206) 776-6443**

Inquiry 693.

### TPRO88 - ROUTE FINDER

A powerful interactive system for finding routes on transportation networks w/up to 512 nodes and 16K links. TPRO88 can find the shortest path between two nodes, sequence up to 50 stops, compute minimum spanning trees and times/distances between all points. Req. IBM PC, 192K, graphics adapter. \$99 w/8087 support, user's guide, sample U.S. Highway network. VISA/MC.

**EASTERN SOFTWARE PRODUCTS, INC.**  
POB 15328, Alexandria, VA 22309  
**(703) 549-5469**

Inquiry 693.

### Church Package

Parishioner Time, Talent and Treasure System program is written in modifiable dBASE source code.

- Contributions • Disbursements • Ledger
- Names with mailing labels
- Personal information database.

Requires dBASE II or III. PC-DOS/CPM-80 \$200.

**Feller Associates**  
550 CR PPA, Route 3, Ishpeming, MI 49849  
**(906) 486-6024**

Inquiry 743.

### Service Plus Inventory II

Inventory location & control for warehouse & distribution centers. Fast, comprehensive & guaranteed to increase productivity. Handles 1000s of product codes (SKUs) each having as many locations as needed. Many reports including full activity by product codes, pick sheets by FIFO, lot #, serial #, or expir. dates. Demos available \$19.95 Full system \$695.00 Add'l modules available. Requires Harddisk IBM XT, AT or compatible multiuser or single user available.

**SRI CORP.**  
P.O. Box 70012, Houston, TX 77270  
**(713) 864-5285**

Inquiry 732.

### dFELLER Inventory

Business inventory programs written in modifiable dBASE source code.

dFELLER Inventory \$150.00  
Requires dBASE II or III, PC-DOS/CPM  
dFELLER Plus \$200.00  
with History and Purchase Orders  
Requires dBASE III or dBASE III Plus (For Stockrooms)

**Feller Associates**  
550 CR PPA, Route 3, Ishpeming, MI 49849  
**(906) 486-6024**

Inquiry 742.

## SFTWR/COMMUNICATIONS

### EasyComm™

Modern communications too cumbersome? Thousands have switched to EasyComm™. Full featured, 300/1200 baud, VERY EASY TO USE, users love it! For IBM/Hayes compatibles. Reg. \$49.95 MCV/ISA.

**1 YEAR ANNIVERSARY CELEBRATION SPECIAL**  
5000 copies only \$9.95 ea. incl. user manual + \$2.25 S/H

**CalSOFT Software**  
3609 Thous. Oaks Blvd., Suite 121, Westlake Village, CA 91362  
**(805) 497-8054**

Inquiry 776.

### PC-File III™ Version 4

Search, sort, browse, global changes, mailing labels, format reports with selection & calculations, sub-totals, totals, averages, encryption. Exchange data with 1-2-3, WORD, WordStar. Over 190,000 users. \$59.95 + \$5 s/h. For IBM PC.

**ButtonWare, Inc.**  
P.O. Box 5786, Bellevue, WA 98006  
**1-800-J-BUTTON**

Inquiry 671.

### IBM/APPLE/MAC SOFTWARE \$10/DISK

2,500 Top Titles in Word Processing, Spreadsheet, Graphics, Database, Integrated, etc. Instant Access!

24 hr. **800-663-8844** Call  
Hot Line **604-732-7508 in Canada Toll Free**

to place your order. Super fast 2-day Air Courier Delivery anywhere in North America. Don't Miss Our Limited Time Special: Order 10 Disks, Get 5 FREE! Call now for FREE giant catalog. M/C, VISA, AE, COD  
**SOFTWARE**

Inquiry 740.

## SOFTWARE/ENGINEERING

### ELECTRONIC CIRCUIT ANALYSIS

ECA-2 is a PC based high performance analog circuit simulator w/AC, DC, Transient, Fourier, Worst-Case and Monte-Carlo analysis. ECA-2 will handle circuits of approx. 500 nodes and 2500 components. In addition to value and tolerance, the component parameters include Bandwidth, Temperature Coefficient, Delay, Phase Angle and continuous or piecewise non-linearities. Includes component sweeping for optimization. Demo disk \$15. ECA-2 \$675. One year update service \$120.

**TATUM LABS**  
POB 698, Sandy Hook, CT 06482  
**(203) 264-3755**

Inquiry 659.

### PC-CHECKBOOK

Total checking at your fingertips! Quick & easy to use. Version 3.0 include: Auto Filing, 1000 Entries/Checkbook, File protection, Check Editing, Sorting by Date & Check No., Analysis Report, Screen Print, Sequential & by Category, POP-UP Prompts & Full Screen Help Menus. May be used as a Budget Manager. \$39.95 chk/MC/ISA.

**DEB/SOFT APPLICATIONS**  
P.O. Box 35398, Houston, TX 77235  
**(713) 729-2362**

Inquiry 774.

### CASH PLUS

A complete set of programs to help small business people track sales and receivables efficiently. Reports include: Aged Receivables, Statements, Cash Due today or future date, Sales by category, customer, YTD, custom labels, and much more. Add on modules available.

Demos \$10.95 Full System \$89.95  
**SRI CORP.**  
P.O. Box 70012, Houston, TX 77270  
**(713) 864-5285**

Inquiry 730.

### ENGINEER'S AIDE

**Integrated Process Engineering Software**

- Pipeline/Ductwork Sizing
- Office/Control Valve Sizing
- Pump/Fan/Compr. Sizing
- Project Financial Analysis
- Heat Exchanger Sizing
- Conversions/Specifications

**Pull-down menus, pop-up help, money back guarantee. All for \$395 (IBM & Macintosh).**  
**Engineering Programming Concepts**  
P.O. Box 925, Camarillo, CA 93011,  
**805-484-5381**

Inquiry 685.



# THE BUYER'S MART

## SOFTWARE/ENGINEERING

### ENGINEERING SOFTWARE

CAD • TECHNICAL WORD PROCESSING • GRAPHICS  
PROJECT MANAGEMENT • MAINT & INSPECTION  
ENG CALCULATOR • STATISTICAL ANALYSIS  
FORECASTING • FINITE ELE • EQUATION SOLVER  
SPACE PLANNING • BILL-OF-MATL TAKE-OFF  
ENG PUB • ELECT & LIGHTING • FREE CATALOG

**American Hytech Corporation**  
416 Ocean Ave., Marblehead, MA 01945  
Tel (617) 639-2625

Inquiry 702.

## SOFTWARE/GENERAL

### SongWright III

**Music Processor for IBM Compatibles**  
Prints quality lead sheets, songs, scores with text and symbols, multiple staves; transposes to any key; plays tunes. Screen graphics editor; IBM/Epson/Star printers. Send \$49.95, \$2 s&h or write for free sample output.

### SongWright Software

Route 1, Box 83, Lovettsville, VA 22080  
(703) 822-9068

Inquiry 681.

### NEW INTEGRATED ENVIRONMENT AI FOR THE IBM PC

**TOPSI IS A FULL VERSION OF OPSS WHICH RUNS UNDER MS-DOS, UNIX OR CP/M. A FAST, EFFICIENT EXPERT SYSTEM DEVELOPMENT TOOL.**  
PROTOTYPING: \$125 PRODUCTION: \$250  
PROFESSIONAL: \$375 SHIPPING, ADD \$5

### DYNAMIC MASTER SYSTEMS

POB 566456, Atlanta, GA 30356  
(404) 565-0771 Telex #282923

Inquiry 695.

INDEX TO BYTE MAGAZINE  
JANUARY 1981 TO PRESENT  
\* KEY WORD / TITLE SEARCH \*  
MS/DOS FORMAT  
PAPER LISTING \$10.00  
MS/DOS \$25.00  
UPDATES WITH ORIGINAL DISC \$10.00  
NOT COPY PROTECTED  
SEND CHECK / MONEY ORDER  
TO: JWT / PAT  
1024 Beso Court, St. Louis, MO 63026

Inquiry 712.

### GREAT SOFTWARE, CHEAP!

Absolutely Smashing User Supported Software \$4.95 per disk. PC-Outline, PC-Write, DOSamatic, Commercial Unprotect, File Express, Cheap Assembler, Chess, utilities galore, many more. Money-back guarantee. IBM PC, PC Jr, or compatibles. **FREE CATALOG.**

### Shareware Express

31877 Del Obispo, Ste. 102M  
San Juan Capistrano, CA 92675

Inquiry 664.

## SOFTWARE/GRAPHICS

### GRAPHICS PRINTER SUPPORT

**AT LAST! Use the PrtSc key to make quality scaled B&W or color reproductions of your display on any dot matrix, inkjet, or laser printer. GRAFPLUS supports all versions of PC or MS-DOS with IBM (incl. EGA), Tecmar, and Hercules graphics boards. \$59.95.**

### Jewell Technologies, Inc.

4302 SW Alaska St., Suite 207, Seattle, WA 98116  
(206) 937-1081

Inquiry 676.

## SOFTWARE/GRAPHICS

► **4D Graphics Lab** could change the way you think about space itself. Now you can take total control over the real-time rotational motion of the hypercube and other 4D shapes. You can define your own shapes too, and control the color and exact placement of each line in the x, y, z, and w axes. Play with hypercube, and other interesting 4D shapes. Order today for \$44.44 plus \$4 S&H, CA add 2.89 tax. For Compaq, IBM PC, compatibles w/DOS 2 or 3, CGA.

### 4D GRAPHICS LAB

Suite 537, 12021 Wilshire Blvd., Los Angeles, CA 90025  
(213) 479-4792

Inquiry 776.

### FORTRAN PROGRAMMER?

Now you can call 2-D and 3-D graphics routines within your FORTRAN program.

**GRAFMA TIC:** 75 callable routines for screen output. \$135.  
**PLOTMA TIC:** Pen plotter driver. \$135.  
For the IBM PC, XT, AT and compatibles. We support a variety of compilers, graphics boards and plotters.

### MICROCOMPATIBLES

301 Prelude Drive, Dept. B  
Silver Spring, MD 20901  
(301) 593-0683

Inquiry 727.

### TI PRO + TURBO + GRAPHICS

**TIGrafix** = graphics, turtlegraphics, music, scand curs controls, + more. Use basic pics w/o reprog Source & doc included. **TIGrafix \$89.95, + TURBO w/8087 & BCD - \$169.95.** NEW—**TURBOFIX** patches IBM TURBO 3.01A to run on Ti, windows, plot & draw: \$39.95 or with TIGrafix or TURBO \$30.00. Specify IBM or MS DOS TURBO.

### ProWARE, Inc.

P.O. Box 15272, Portland, OR 97215  
VISA/MC/CHECK 7AM-7PM MON-FRI  
(503) 233-4465

Inquiry 662.

### SOFTWARE/GRAPHICS LAND SURVEYS

**L-PLOT...** A Metes & Bounds program to plot/print plats of Any scale— Any description—use Any measurement Calc. areas, error of closure, plots multi tracts. IBM/compat with monographics, CGA or EGA capability. \$190. 30-day FREE trial. Visa/MC/chk.

### LAN/SCAN, INC.

P.O. Box 6863, Abilene, TX 79608  
(214) 824-6419

Inquiry 694.

### SCIENTIFIC GRAPHS

**SCI-GRAF** produces high-res graphs (1680 x 1712 pixels) on Epson or IBM graphics printers. Supports log/linear scales, error bars, overlays, batch-mode operation. Very flexible data ent y from disk or keyboard. User customizable. Requires DOS 2 or 3, 256K.  
**\$99.95** (Sorry, no credit cards)

### Microcomputer Systems Consultants

32 West Anapamu, Suite 190, Santa Barbara, CA 93101  
(805) 963-3412

Inquiry 757.

## SOFTWARE/LANGUAGES

### Minnesota SNOBOL4 Language

Powerful string & data handling facilities. Interpreter compatible with mainframe SNOBOL4. 32K strings, 32 bit integers, 8087 for float & large memory model. Sample pgms include ELIZA. For >128K IBM PC & DOS or equivalent. Definitive "green" book by Griswold et al available.  
Guide + 5 1/4" SSD diskette ..... \$44.95  
Guide + diskette + "green" book ..... \$59.95  
"Green" book only ..... \$26.95

Postpaid in USA. In NY add tax. VISA/MC (914) 271-5855  
**BERTST INTERNATIONAL**  
POB 441, Millwood, NY 10546

Inquiry 724.

## SOFTWARE/LANGUAGES

### MasterFORTH

**MasterFORTH** is a complete programming environment for the IBM PC family, the Apple II family, the Macintosh & others. It includes a macro-assembler, full file interface, string package, & resident debugger. Programs can also be optimized with the optional target compiler. \$100-125.

### MicroMotion

(213) 821-4340

8726 S. Sepulveda Blvd. #A171, Los Angeles, CA 90045

Inquiry 688.

### BLACKSTAR SERIES/NO ROYALTY FEE

\* **C FUNCTION LIBRARY.** 283 functions. Includes source for all C & assembler routines. \* 350 page manual for Lattrace 3.0 & Microsoft 3.0 & 4.0 \$175.

\* **BASIC DEVELOPMENT TOOLS.** Includes B + Tree • Screenbuilder • Help Message System • Pop up Window Manager. For IBM Basic, Microsoft, Quick Basic \$99.

### STERLING CASTLE SOFTWARE

702 Washington Street, Suite 174, Marina Del Ray, CA 90292  
(in CA) 213-30 -3020 (outside CA) (800) 7-Castle

Inquiry 755.

### PASCAL-to-C TRANSLATOR

Industrial strength conversion from Turbo, Microsoft, UCSD, MT +, Apollo, Macintosh, and other Pascals to K&R C. Handles nested procedures, intrinsic functions, separately compiled units and modules, all data types including long integers. Requires 512K IBM PC/XT/AT. Send up to 500 lines of Pascal and we will convert it for FREE. Site licensing from \$5,000. Conversions 50 cents/line.

### TGL Inc.

27096 Forest Springs Ln., Co vallis, OR 97330  
(503) 745-7476

Inquiry 718.

### SCREEN PROGRAM GENERATOR

**SPG I** creates BASIC program code quickly and easily. Design your screen directly and SPG I will generate the BASIC program code to handle the display and input of data. Controls use of color, editing, graphics, cursor movement and function keys. Generated code easy to modify / merge / compile. IBM PC & compatibles 128K.  
**\$49.95 + \$3 S&H (CA + tax)**

### Treebeard Software

5901 Warner Avenue, Suite 428, Huntington Beach, CA 92649  
(714) 840-6939

Inquiry 701.

### HYPER C COMPILERS/TOOLS

Apple II ProDos Professional compiler, CDOS compiler, ProDos entry level compiler, 65C02 Assembly Language Dev. System, Macintosh compiler, full source code for both Apple II and Macintosh programming tools.

For further information/catalog contact:

**WSM GROUP, INC. (602) 298-7910**  
P.O. Box 32005, TUCSON, AZ 85751

Inquiry 771.

## SOFTWARE/LEGAL

### DESIGNED FOR LEGAL WORK

True professionalism requires specialization. This word, document processing, and case management software is designed for legal work only. It makes legal documents, court pleadings, and captions automatically. **SoftWars® \$200.**

### TSC The Software Company

P.O. Box 872687, Wasilla, AK 99687  
MCA/VISA 907-745-6267

Inquiry 781.



# THE BUYER'S MART

## SOFTWARE/SCIENTIFIC

### MATH TOOLBOX SERIES

Numerical and Graphical analysis of scientific data w/o programming; vectors, matrices, complex, roots, systems, integration, ODE, PDE, curve fit, stats, 2D-3D graphics + more! Also: Waveform processing, numerical modeling subs. Wide range of Scientific-Engineering applications.

#### ALPHA Applied Research

2355 McLean Blvd., Eugene OR 97405  
(503) 485-6841

Inquiry 721.

### DATA ACQUISITION AND ANALYSIS ON PC'S

• MEASURE for Data Acquisition directly to Lotus 123 • FOURIER PERSPECTIVE II advanced Digital Signal Analysis • LOTUS MANUSCRIPT Technical Document Preparation System, Combines Text and Graphics • PRIME FAC-TOR FFT Subroutine Library Call from Turbo Pascal, C, Fortran, Basic. Up to 65,520 Data Points, 2D available. • TURBO PASCAL from Botland. • TELEVISION for Image Communications • 8087 Coprocessors, all varieties. • DASH-16 A/D Converter Board from Metrabyte.

FREE Customer Service - Satisfaction GUARANTEED

#### ALLIGATOR TECHNOLOGIES

P.O. Box 11386, Costa Mesa, CA 92627  
(714) 662-0660

Inquiry 706

### CROSS ASSEMBLERS for VAX VMS and PC/MS DOS New Low Prices

Relocatable Macro Cross Assemblers, Linkers, Librarians Targeted to almost all Microprocessors

#### ENERTEC, INC.

BOX 1312, Lansdale, PA 19446  
215-362-0966 MC/VISA

Inquiry 744

### Classical Controls Analysis Program

Powerful, sophisticated stability analysis tool for XT, AT and Compatibles. S-plane, Z-plane, W-plane. High Resolution Bode, Nichols, Nyquist, Root Locus and time response plots. Solve block diagrams. Automatic SISO generation from transfer function databases. Interactive, menu-driven, easy-to-learn user interface. Solves up to 50 equations. Analyze 60th order transfer functions. Mainframe power at PC price. Write to:

#### Lewis Engineering Software

4911 Hampton Rd., La Canada, CA 91011  
(818) 790-4801

Inquiry 716

### TURN WordPerfect™ INTO A SCIENTIFIC WORD PROCESSOR ONLY \$75

Display & print complete math & Greek symbol sets. Includes display chip, printer downloading program, & free custom printer drivers & macros with proof of purchase of WordPerfect. Call for flyer, list of supported hardware, & ordering info.

#### SCIENTIFIC WORD PROCESSING ENHANCEMENTS

8320 N. Lockwood Ave., Skokie, IL 60077  
(312) 677-4270

Inquiry 763.

### forMath® text-formatter

- Equations, matrices, ratios, integrals, diagrams
- Macros, fonts, Greek/math symbols
- Hyphenation, secn/eqn/ref numbering
- Indexes, table of contents, footnotes
- Dot-matrix, daisywheel, laser printers, all monitors \$400. \$50 for demo

#### SHANTHA SOFTWARE INC.

50 West 97th St. Room 11N, New York City 10025  
(212) 222-SNIP  
Touchtone toll free: 950-1088-walt-FORMATH

Inquiry 666.

## SOFTWARE/SCIENTIFIC

### MATRIX CALCULATOR v.2.0

Matrix manipulations, Linear Programming, System of Eqns, Multilin Regr., Diff Eqns. Spread Sheet-like Editor/Printer. Free DSIKUTIL software, 160+ pg. manual. \$59.95 Turbo Pascal Source code Opt at \$60 include Free Turbo Pascal Linker program.

#### SoftTech Inc.

14640 LaBelle, Oak Park, IL 82327  
1-313-544-8544

Inquiry 683.

### ► MATRIX 100 ◀

Perform multiple regression, solve simultaneous equations, invert matrices, etc. in BASIC or Fortran. "... very sound numerically ... very powerful and very easy to use" — ORMS Today 2/85 "Stanford Business Software deserves congratulations" — PC Mag, 5/14/85. Price \$80; 8087 support \$125; compiler support \$250; Fortran library \$175. (\$4 s&h).

#### STANFORD BUSINESS SOFTWARE, INC.

2672 Bayshore Parkway, Ste. 304  
Mountain View, CA 94043  
To Order Call (415) 424-9499

Inquiry 747.

## SOFTWARE/SORT

### OPT-TECH SORT/MERGE

Extremely fast Sort/Merge/Select utility. Run as an MS-DOS command or CALL as a subroutine. Supports most languages and filetypes including Btrieve and dBASE. Unlimited filesizes, multiple keys and much more! MS-DOS \$149. XENIX \$249.

(702) 588-3737

#### Opt-Tech Data Processing

P.O. Box 678 - Zephyr Cove, NV 89448

Inquiry 770.

## SOFTWARE/TOOLS

### Modula-2

REPertoire is the fastest selling M2 toolkit. New release includes DBMS, screen system, editor, & 250+ routines. \$19 for all LNKs & SYMs; \$89 with full (560K) source and 300pg printed manual. MC/VISA/AMEX/COD/PO. Call for free demo & manual on disk. Logitech & other versions.

**PMI** 4536 SE 50th, Portland, OR 97206  
(503) 777-8844; BIX: pmi

Inquiry 663.

### dBDOCGEN™

#### dBASE™ DOCUMENTATION GENERATOR

dBASE owners easily document your dBASE applications. Documents .DBF (with structure and field names), .NDX (with index), .CMD, .FRM, and .FMT files. Only \$99.50 + \$4 UPS Gnd or + \$6 Blue S&H VISA/MC

CALL TODAY (503) 233-8676

#### TOP PRIORITY Data Products, Inc.

1731 S.E. 55th Ave., Portland, OR 97215-3396

Inquiry 667.

## STATISTICS

### STATISTICS CATALOG!

If you need statistics for IBM PC or Apple II, call us and let our technical advisors help you find the statistics programs you need. Write or call now to get a FREE catalog of statistics and quality control software.

#### HUMAN SYSTEMS DYNAMICS

9010 Reseda Blvd., Ste. 222  
Northridge, CA 91324

(800) 451-3030 (818) 993-8536 (CA)

Inquiry 754.

## STATISTICS

### The Statistician

includes: Multiple Regression (Stepwise, ridge, all subsets, backward elimination)  
• Time series analysis • descriptive statistics • transformations • survey research • nonparametrics • X-Y plots • ANOVA • random samples • data base • data editor • search & sort • hypothesis tests  
For IBM, MS-DOS, XENIX, CPM, TRS-DOS.

#### QUANT SYSTEMS

Box 628, Charleston, SC 29402 1-800-334-0854  
803-571-2825 (Ext. 814)

Inquiry 658.

### STATISTIX™

\$75 - Satisfaction guaranteed

A comprehensive, powerful, yet easy-to-use statistical analysis system for IBM PC/XT/AT's, Apple II's, and MS DOS machines. Clear 200p manual. Write for information.

#### NH ANALYTICAL SOFTWARE

801 West Iowa Ave., St. Paul, MN 55117  
(612) 488-4436

Inquiry 738.

### NUMBER CRUNCHER STAT SYS

Menu-driven. Multiple & stepwise regression, ANOVA, time series, discriminant cluster and factor analysis, principal components, scatter plots, histograms, t-tests, contingency tables, non-parametrics. Import export data. Spreadsheet, sort, join, merge. \$79. IBM PC/Macintosh. Quantity discount.

#### NCSS-B

865 East 400 North, Kaysville, UT 84037  
801-546-0445

Inquiry 729.

### RATS! Version 2.0

RATS, the best selling Econometric software package, now includes daily and weekly data, a new easier to use 500 page manual, and many advanced features. Use RATS for time-series and cross-section regression, including OLS, ARIMA, VAR, logit, and probit. IBM PC or compatible. \$200. MC/VISA. Call for brochure.

#### VAR Econometrics, Inc.

P.O. Box 1818, Evanston, IL 60204-1818  
(312) 864-1910

Inquiry 710.

### SL-MICRO

Tabulate survey results or analyze experimental data using SL-MICRO. It has Frequencies with statistics, Crosstabs, Anova, Multiple Regression & Correlation. Data Editor & Data Transformations.

Only \$250 for PC-DOS, MS-DOS or CP/M

#### QSC, Box 778, East Lansing, MI 48823

(517) 641-4428

Inquiry 782.

### P-STAT®

Full mainframe package for PC/XT/AT & compatibles. Statistics, data & file management, data display, report writing and survey analysis all in one. 4GL programming language, online HELP & EDITOR, command or menu driven. \$95 demo and site license available.

#### P-STAT, Inc. (609) 924-9100

471 Wall Street, P.O. Box AH, Princeton, NJ 08542  
Telex: 466452

Inquiry 764.



# THE BUYER'S MART

## TYPESETTING

### DESKTOP PUBLISHING

Laser Printer composition software to drive Cordata L300 with 100 PS Ints \$495. With add 14 PS Lndscp fonts \$695. For Canon LBP-8 A2. NCR. HP LaserJet+ or Ricoh 6000 with 71 PS Pnt or Lndscp Ints \$495. H & J, merge graphics, mix face & pt. size anywhere on any line, mult tab & col justification. Boxes & Rules.

#### Micro Print-X, Inc.

P.O. Box 581, Ballinger, TX 76821  
(915) 365-2343

Inquiry 720.

## UTILITIES

### PADLOCK/PADLOCK II DISKS

PADLOCK furnishes the user with a method for providing protection against unauthorized duplication from DOS commands \$99. PADLOCK II disks come preformatted with finger-print and serialization. PADLOCK II disks offer superior protection. Ask about our HARD DISK protection with uninstall capability. MC/VISA.

#### GLENCO ENGINEERING

3920 Ridge Ave., Arlington Hts., IL 60004  
(312) 392-2492

Inquiry 769.

### FILE GENIE™

File Genie™ is a file conversion system which gives you the necessary tools to easily analyse and convert any file to a new structure. Ideal for re-structuring unusable data or word processing files. Search and replace in multiple files using "wild card" file descriptions. MS/PC-DOS. \$69.95 M/C VISA

#### TEAM AUSTIN, INC.

6809 Convooy Ct., San Diego, CA 92111  
USA 800-822-0852 (in CA) 800-822-0853

Inquiry 775.

### ATTENTION WORDSTAR USERS

Non-resident utility supplies missing path support. Run wordstar, spellstar etc. from any directory. Edit, read, write, print files in any directory. No more subst commands. enter path when entering file name. Change current directory. IBM & compatibles DOS 2.x-3.x \$30 incl. s/h (MA + 5%).

#### BASEMENT SOFTWARE

6 Woodbine Circle, Needham, MA 02194  
(617) 449-5299

Inquiry 715.

### CONCURRENT DOS BACKUP

BackPack™ runs like BACKUP/RESTORE and supports DOS and CP/M media as well as users. Backs up and restores up to 1000K/min. on an AT and 360K/min. on an XT. Supports release 4.1. Also available on CP/M-80 and CP/M plus. \$150.

#### Bright Light, Inc.

520 Fellowship Rd. #C301, Mt. Laurel, NJ 08054  
(609) 778-0772

Inquiry 670.

## UTILITIES

### SOURCE CODE LIBRARIAN & REVISION CONTROL SYSTEM

TLIB™ keeps ALL versions of your program in ONE compact library file, even with hundreds of revisions.  
• 5 times faster than SCCS • LAN compatible  
• Free public domain MAKE (with source) by L. Dyer MS/PC-DOS 2.x & 3.x. \$99.95 + \$3 S&H. VISA/MC

#### BURTON SYSTEMS SOFTWARE

POB 4156, Cary, NC 27511  
(919) 469-3068

Inquiry 651.

### EditingTools

A superb text editor with an intelligent DOS interface. Load multiple directories as menus in table format. Edit multiple files. Move text between files. Incredible value at \$30. Add \$25 for well-written source code in Turbo Pascal. Add \$2 for s/h.

#### Dr. Jiann Jou

P.O. Box 460969, Garland, TX 75046  
214-495-8862

Inquiry 698.

### IBM PC, DOS 2/3 70 KB

We print pictures (300 + pic. maker enclosed) mixed with multifonts on Toshiba, Epson, etc. OR run our mem. resident calendar, calculator, DOS services etc or even YOUR own codes.

What can't it do? at \$45 US?

#### LCS

(514) 279-5678

P.O. Box 956, Outremont, Quebec  
Canada, H2V 4R8

Inquiry 678.

### AT'S DON'T NEED 360KB DRIVES

The 1.2mB drive has long been known to READ but NOT reliably WRITE on 360KB floppies. With "CPYAT2PC"™ 1.2mB drives CAN reliably WRITE 360KB floppies saving a slot for a second hard disk or backup tape. "CPYAT2PC" (Not Copy Protected) offers "the preferable SOFTWARE SOLUTION. ONLY \$79 + \$4 S/H VISA/MC/COD UPS B/R

#### MICROBRIDGE COMPUTERS

655 Skyway, San Carlos, CA 94070  
Order toll free 1-800-621-0851 x777  
415-593-8777 (CA) 212-334-1858 (NY)  
TELEX EZLNK 62873089 Dealer inquiries invited

Inquiry 750.

### PAL FOR SIDEKICK!

Personal Appointment Locator automatically shows coming appointments, searches your file, maintains to-do list, automatically repeats appointments, examines multiple files. Resident alarm too! Only \$49.95. Cheap at twice the price!

#### PAL SOFTWARE

Ste. 12B 110 Green St., New York, NY 10012  
212-334-9172 1-800-541-0900  
(In CA.) 1-800-334-3030

Inquiry 767.

## UTILITIES

### Protect your hard disk data!

Second Chance protects hard disk data files by making fast reliable backups. Second Chance is from Quaid Software, the makers of CopyWrite, so you can count on the same reliability speed and ease of operation you're used to with CopyWrite. MS-DOS \$75 U.S. Check/Credit card.

#### QUAID SOFTWARE LIMITED

45 Charles St. E. 3rd Fl.  
Toronto, Ontario, Canada M4Y 1S2  
(416) 961-8243

Inquiry 665.

### Recover deleted files fast!

Disk Explorer now includes automatic file recovery. You type in the deleted file's name, Disk Explorer finds and restores it. Disk Explorer also shows what's really on disk, view, change or create formats, change a file's status, change data in any sector. MS-DOS \$75 U.S. Check/Credit card welcome.

#### QUAID SOFTWARE LIMITED

45 Charles St. E. 3rd Fl.  
Toronto, Ontario, Canada M4Y 1S2  
(416) 961-8243

Inquiry 736.

### PRINTER! CACHE! RAMDISK!

PRINT-matic (\$9.95) sends any of 16 user predefined control codes to any printer from within applications. WARP-TEN (\$16) is a programmable disk cache that speeds up your PC disk accesses. RAMbak (\$16) automates the saving of new or changed RAM disk files to floppy disks and/or hard disk subdirectories. PC, XT, AT, compatibles with 256K DOS 2.0+. (MN Res. + 6%). NCP

#### Software Brewing Company

P.O. Box 12094, St. Paul, MN 55112  
612-636-2727 Visa/MC/CHK

Inquiry 736.

### HANDS OFF™ PC SECURITY

- Locks Hard Disk. - Restricts Floppy Use.
- Protects Subdirectories.
- Normal Use of DOS Commands and Application Software.
- IBM PC, XT, AT and True Compatibles.
- DOS V2.0 and Higher. Hard Disk System.
- Keep Other Peoples HANDS OFF Your System
- \$89.95 VISA/MC

#### SYSTEM CONSULTING, INC.

314 Canterbury Dr., Pittsburgh, PA 15238  
(412) 963-1624

Inquiry 735.

## WORD PROCESSING

### HEBREW / ENGLISH / GREEK

Arabic, Russian and European Languages. Full featured, multi-language word processor supports on-screen foreign characters with no hardware modifications, and prints on most dot matrix printers. \$350 + \$5 s/h. Or send \$15 + \$4 s/h for demo. Req. 384K.

#### Gamma Productions, Inc.

710 Wilshire Blvd., Suite 609, Santa Monica CA 90401  
(213) 394-8622

Inquiry 665.

Advertise your computer products for  
as little as \$375 in THE BUYER'S MART.  
For more information call  
Karen Burgess at BYTE 603-924-3754.



# Compu\$ave

Call Toll Free: 1-800-624-8949

A DIVISION OF ADLANKO CORPORATION

### PRINTERS

Canon LBP-A1 . . . 1935	Alps P2000 . . . 709
CIE Triprinter . . . 1395	CIE LIPS-10 . . . 2345
Citizen MSP10 . . . 269	Citizen 120D . . . 175
Citizen MSP20 . . . 309	Fujitsu 2100 . . . 369
<b>Toshiba 351C . . . 1165</b>	Fujitsu 2600 . . . 1255
Toshiba Laser . . . 2499	<b>NEC P6 . . . 428</b>
Panasonic 1080i . . . 195	NEC P7 . . . 599
Panasonic 1091i . . . 258	NEC CP6 . . . 545
Panasonic 1092 . . . 295	NEC CP7 . . . 729
Panasonic 1595 . . . 565	Okidata 192+ . . . 362
<b>Star NB15 . . . 925</b>	Okidata 294 . . . 1089
Diconix: 150 cps/ Portable/ 4 Lbs . . . 329	
<b>Laser Printer Headquarters . . . SAVE</b>	
Data Prod./Data South/Diablo/Epson . . . CALL	
Genicom/Juki/Qume/Televideo/TI . . . CALL	
Buffers/Cables/Sheet Feeders . . . SAVE	
Stands/ Switch Boxes/ Tractors . . . SAVE	

### MONITORS

Aydin 19" EGA . . . 1995	Amdek 730 . . . 599
Mitsubishi 6922 . . . 1995	Amdek 310A . . . 143
Mitsubishi 8918 . . . 2895	Goldstar RGB . . . 259
NEC Multisynch . . . 559	PGS MAX12 . . . 154
Thomson Ultra . . . CALL	Samsung TTL . . . 82
Pack. Bell EGA . . . 455	Taxan 770 . . . CALL
Wyse 700 & Card . . . 699	Taxan 840 . . . CALL
Hitachi/Panasonic/Tatung/Teco . . . CALL	

### COMPUTERS

AT&T 6300: 640K/ 1 Drive . . . 1295
<b>Cordata PC: Port. &amp; Desk/ 2 Drives . . . 899</b>
Cordata AT: Port./ 1.2M Drive . . . 1595
Laser 128: Apple IIE Compatible . . . 382
Packard Bell AT: 640K/ 44M Drive . . . 2199
Packard Bell AT: 640K/72M Drive . . . 2599
Panasonic Bus. Partner: 2 Drives . . . 965
Panasonic Senior Partner: 1 Drive . . . 1065
Panasonic Exec. Partner: 2 Drives . . . 1599
<b>Sharp PC7000: Port./ 2 Drives . . . 985</b>
<b>Sperry IT: 1M/44M Drive . . . 2799</b>
Toshiba 1100 + & 3100 Portables . . . CALL
Wyse + Turbo: 640K/ 2 Drives . . . 1025
Wyse + Turbo: 640K/ 20M Drive . . . 1475
Wyse 286: 10 MHz/ 640K/ 1.2M Drive . . . 1795
Wyse 286: 10 MHz/ 640K/ 20M Drive . . . 2149
Zenith 181: Portable/ 2 Drives . . . 1675
Altos/Corvus/ITT/NEC/Televideo . . . CALL

### TERMINALS

Adds Viewpoint + . . . 439	Altos V . . . CALL
IBM 3164 Color . . . 899	Ampex 232 . . . 485
<b>Kimtron KT7 . . . 435</b>	<b>Wyse 30 . . . 289</b>
Televideo 905 . . . 289	Wyse 50 . . . 369
Televideo 955 . . . 399	Wyse 60 . . . 425
Televideo 9220 . . . 452	Wyse 85G . . . 432
Hazeltine/Liberty/Link/Visual/Zenith . . . CALL	

### PLOTTERS

Houston 41/42 . . . 2325	Houston 56A . . . 4195
Houston 51/52 . . . 3295	Ioline 4000 . . . CALL
Houston 51.52MP . . . 3695	Roland 800 . . . 375
Hewlett 7475 . . . 1575	Roland 880 . . . 879
Hewlett 7570 . . . 4475	Roland 980 . . . 1165
Calcomp/Gould/Taxan/Other Models . . . CALL	

### DIGITIZERS

Kurta Penmouse . . . 185	Kurta 8.5x11 . . . 299
Houston TG1005 . . . 275	Kurta 12x17 . . . 549
Houston TG1011 . . . 489	Hitachi 11x11 . . . 589
Houston TG1017 . . . 585	GTCO: All . . . CALL
Houston TG8036 . . . 2799	Summa 12x12 . . . 379
Summa Mac 12 . . . 389	Summa 12x18 . . . 659
<b>MS BUS Mouse . . . 109</b>	<b>Summa Mouse . . . 79</b>
Mouse Systems PC Mouse BUS + . . . 122	
Many Other Brands And Models . . . CALL	

### MODEMS

Anchor Volksmodem 12 . . . 118
Anchor Lighting 2400 . . . 295
<b>AT&amp;T 4024 . . . 475</b>
Hayes Smartmodem 1200 . . . 365
Hayes 2400B: W/Software . . . 535
Incomm 2400: Upgradeable 4800 + . . . 295
Prometheus Promodem 1200 . . . 272
<b>Prometheus Promodem 2400G . . . 285</b>
Racal-Vadic 2400 V & PC . . . 399
US Robotics Courier 2400 . . . 378
Ven-Tel 2400 Plus . . . 375
Codex/Novation/Rixon/UDS/Zoom . . . CALL

### BOARDS

Artist I: 1024x768 (Interlaced) . . . 1495
Artist 10: 1024x1024 (Interlaced) . . . 2195
AST Rampage: PC-XT/ 256K . . . 275
<b>ATI EGA Wonder Card . . . 272</b>
AT Multifunction: OK (Expands 1.5M) . . . 219
NEC Multisynch Graphics Card . . . 389
Orange Grappler + : Apple . . . 69
<b>Orchid Turbo PGA . . . 1025</b>
PC Monochrome Graphics Card . . . 82
PC Multifunction & Controller Card . . . 99
<b>Taxan Gold Card . . . 319</b>
Taxan 560 EGA Auto Switch . . . 319
Tecmar EGA: Graphics . . . 265
<b>Video 7 Vega Deluxe . . . 365</b>
Genoa/Hercules/Intel/Persyst . . . CALL
Quadram/STB/Tseng/Verticom/Vutek . . . CALL

WE ALSO CARRY MANY OTHER PRODUCT LINES & MODELS. CABLES, SOFTWARE CHIPS, KEYBOARDS, POWER DEVICES

### DISK DRIVES

Seagate 20M Kit . . . 369	Priam ID-40 . . . 915
Seagate 30M Kit . . . 449	Toshiba 3.5" . . . 119
Apple & IBM Compatible Drives . . . SAVE	

### OTHER FLOPPY AND HARD DRIVES

Alloy • CDC • CMS • Corvus • Fujitsu
Genoa • IOMEGA • Irwin • Mitsubishi
Maynard • Miniscribe • Mountain • Teac
Peachtree • Maxtor • Tandon • Titan
Talgrass • Tecmar • Western Digital

**HOURS: MON - FRI 7AM - 6PM / SAT 9AM - 2PM  
IN ARIZONA CALL (602) 437-4855**

CompuSave: 4207 S. 37th St., Phoenix, AZ 85040/Prices Reflect Cash Discounts And Subject To Change Without Notice. Major Credit Cards And Selected PO's Are Accepted. We Cannot Guarantee Compatibility.

# Soft \*Rite >> LANbasic!

Soft \*Rite announces a Superior three-part programmer's tool. Microsoft BASIC™ compatible in every place that counts. \*

LANscreen	LANbasic	LANdbase
<p>LANscreen makes the burden of defining your database record structures one that you will look forward to instead of dread. Standard fields and types such as "Money", "Telephone" and "Date" are one keystroke to generate. As many as 255 database structures can be related to a single screen! Segmented data input can be done automatically by editing the field display. Part numbers with spaces or dashes and slashes are automatically parsed down to the essential raw data. Definable Upper and Lower limits for numeric inputs along with ACCEPT/EXCEPT input filters are standard features. Screen Mask generation is done with a "freestroke" approach. You may put mask elements and data input/output cells wherever you wish. COLOR them too! EGA support too!</p> <p>*Drivers Installed for IBM PC-NET/MS-NET</p>	<p>LANbasic is your own personal solution to powerful data manipulation. How many times have you got excited over some new "total" database package only to find out (after spending a fair amount of time and money) that you were stuck in some corner, unable to do some function that has become standard in "In Business for Money's" Basic? The manual is 400 pages long, so we cannot fully describe all the features, but here are a few in ADDITION to the ones you are now used to:</p> <p>★ COMDATA\$ 14 common areas ALWAYS available to inside or outside, chained or linked programs ★ Re-assignable printer ports LPT1-LPT4 ★ Generic filename use that allows file and database locations to be re-defined outside of basic in a user-created REDIRECTOR file, to ease multi-user system configuration ★ USESCREEN, &lt;1-16&gt; ★ SCREENINPUT, &lt;anyfield&gt; ★ SCREENOUT.PUT, &lt;anyfield&gt; ★ OPENDB, &lt;remote or local database manager&gt; ★ DBGET, &lt;variable from DBM, automatically defines and dimensions in LAN basic&gt; ★ DBPUT, &lt;same&gt;</p>	<p>LANdbase is the home for your data. LANbasic calls are coupled to LANdbase via network communications (PCnet or ?). A single keyvalue and function number will return a record. Multiuser record locking is handled by simply putting an 'X' after the read call. (i.e. RDDBEQUX, &lt;argument&gt;. Automatic "health checking" to warn you of poor hardware performance and lost or fragmented data. "Paranoid" mode of operation where files not accessed for some time will be closed and reopened to flush buffers and insure integrity. Password, Userlevel and Data encryption functions. Several DBM's can be installed in the network system to improve performance and reliability. Toggle mode screen (printer) reporting to record log-on or other access activities. Bill Fairman's tried and proven true C-Tree(c) data management product.</p>

**Soft \*Rite Multi-User Programming Tools**  
**15381 Chemical Lane, Huntington Beach, CA. 92649**  
**(714) 898-0525**



# "Double Strength" Solution delivers a high performance computer *and* power graphics!

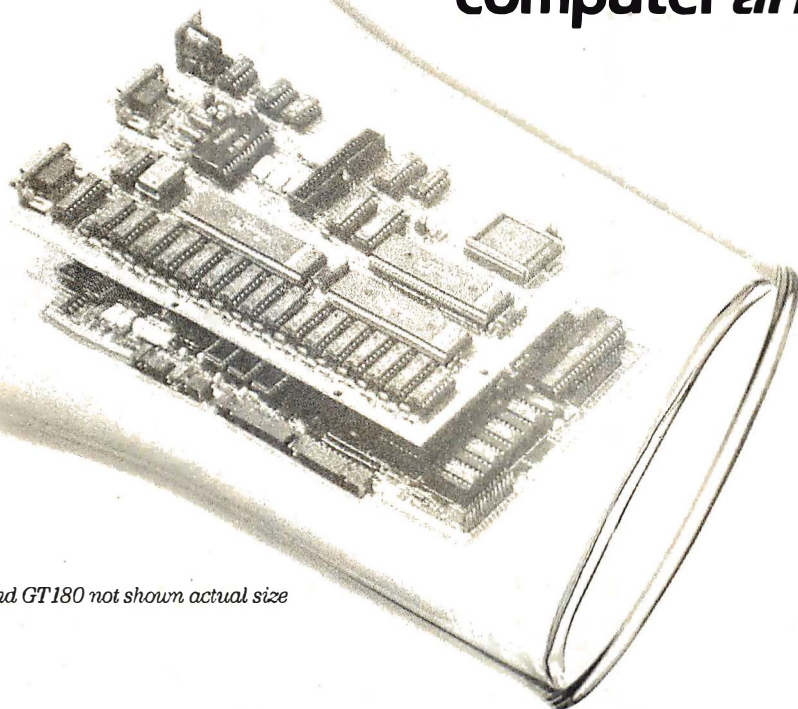

SB180FX and GT180 not shown actual size

**Y**ou've needed a computer that's smaller, faster and packs more memory. And you've wanted the best of today's graphics. Well, now you can have both affordably. Micromint brings you its newest single board computer, the SB180FX and its piggy-back color graphics board the GT180. Now with this "double strength" combination you can take industry standard Z-80 compatible software and add colossal graphics like the ones you see on this page. That's right—*graphics like these with your Z-80 software!*

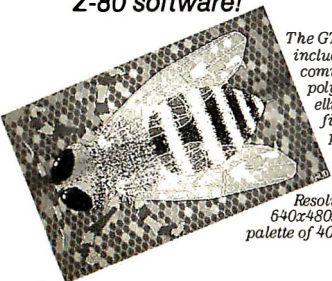

The GT180 has 38 commands including 23 graphics drawing commands: line, rectangle, polyline, polygon, circle, ellipse, arc, ellipse arc, filled rectangle, paint, pattern and copy.

Resolution of the GT180's 640x480x16 colors with a palette of 4096.

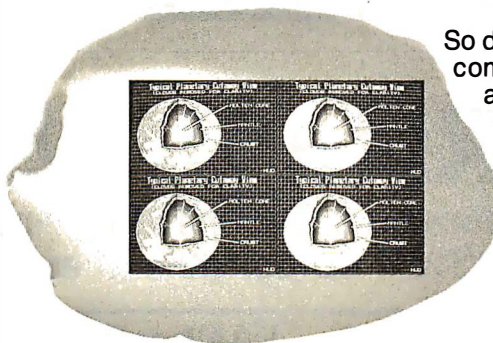

Three horizontal split screens and one window screen. Size and position fully programmable.

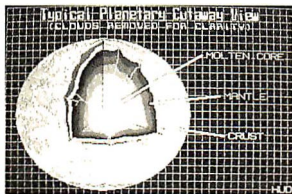

Software: Modula 2 by Borland International including SB180/GT180 Graftx Toolbox.

port, a peripheral expansion bus, three bi-directional parallel ports and an industry standard 765A-compatible disk controller for up to four disk drives (any combination of 3 1/2", 5 1/4" or 8" drives). An on-board SCSI expansion bus lets you connect directly to a hard disk drive or additional computers.

So don't wait any longer for the computer size, speed, memory and graphics you've been waiting for. The SB180FX and GT180 team not only gives you the latest features you're looking for, you can have them for a great low price.

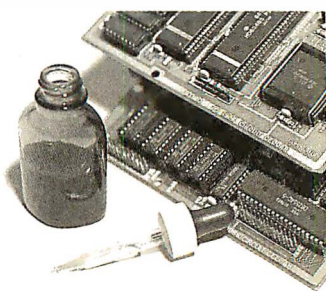

**SB180FX\* . . . starting at \$409.00**  
**GT180 . . . . . \$395.00**  
**Borland International**  
 Turbo Modula 2 . . . . . \$69.00  
 Modula 2 Graftx Toolbox . \$89.00

\* minimum configuration: 256K bytes of RAM and ROM monitor.

TO ORDER CALL

**1-800-635-3355**

for technical information or In Connecticut call: 1-203-871-6170

**Micromint, Inc.** 4 Park Street Vernon, Connecticut 06066 TELEX: 643331





## XEROX® COMPUTER FOR BUSINESS, AND PERSONAL USE!

### XEROX®... The Name You Can Trust!

Since 1906 Xerox® has been the world leader in office automation and copying equipment. They have set standards that others can only imitate. The Xerox® 6064 Personal Computer was designed to meet the demands of business, professional, and personal computing today, and into the future! We are proud to offer this complete Xerox® System at a remarkably **LOW price**. Compare for yourself... then buy your Xerox® 6064 from C.O.M.B.!

**Get the Xerox® Advantage!** The Xerox® PC offers you the advantage of running IBM™ compatible MS™-DOS, so you can run the hundreds of business and professional software programs available today! And the Xerox® PC is easy to use! It's designed to get you up and running as quickly as possible with computer-aided instruction and superior documentation covering all aspects of personal computing.

**Xerox®...Service You Can Count On!** If you're considering an IBM™-compatible, don't be misled by price alone! The system we are offering is a **complete system**...very easy to hook up and use...and very affordable. But more than that, each system we sell is backed by Xerox® service and support. When you buy this system, your name and computer's serial number is automatically registered with Xerox®. Should you need service or advice, a network of over 150 service centers stands ready to help you. Before you buy...compare! Xerox® is your best value! Check all these features:

- IBM™-PC Compatibility.
- Standard 83-Key PC Keyboard with Mouse Interface (Mouse Not Included.)
- High-Resolution Monochrome Monitor, with 10" Diagonal Non-Glare Screen, Swivel and Tilt Housing.
- Two 5¼" Floppy Disk Drives.
- 256KB Memory. 8MHz Intel 8086-2 Microprocessor for Faster Speed, Less Waiting Time.
- Seven Expansion Slots, Serial Port for Communications or Printer, and Parallel Printer Port.
- Comes with ScreenMate™, a User Friendly Guide to the Functions of the MS™-DOS Operating System.
- Menu Driven...No Need to Remember Complicated Commands! ScreenMate™



Lets You Select from a Menu and Provides Clear On-Line Instructions If You're Confused About Your Next Step.

### Complete Tutorial Software and Manuals Included:

- "Getting Started" Booklet.

- Four Reference Guides.
- Four Software Programs: Two X-Cel™ Training Disks, Two Diagnostic Disks, GW™-BASIC Interpreter, and MS™-DOS/ScreenMate™ Operator's Guide.
- Twenty Blank Disks.

Over 150 Service Centers Nationally.

Manufacturer's Limited 90-Day Warranty on Parts/Labor.

List Price ..... **\$2764.80**

**\$999**

Liquidation Priced At Only ..... **Item H-2101-7118-557 Shipped Frt. Collect Ship. Wt.: 79 lbs.**

Xerox® and the identifying numbers herein are trademarks of XEROX® CORPORATION.

**Credit Card Customers Can Order  
By Phone 24 hrs. a Day 7 Days a Week**

**TOLL FREE:  
1-800-328-0609**



SEND TO: Item H-2101  
C.O.M.B. Direct Marketing Corp.  
1405 Xenium Lane N/Minneapolis, MN 55441-4494  
Please Send \_\_\_ Xerox® Personal Computer(s) Item H-2101-7118-557 at \$999 each.  
(Item shipped freight collect). (Minnesota residents add 6% sales tax.) Sorry, no C.O.D.

My check or money order is enclosed. (No delays in processing orders paid by check.)  
Charge:  VISA®  MasterCard®  Discover<sup>SM</sup>  American Express®

Acct. No. \_\_\_\_\_ Exp. / \_\_\_\_\_  
PLEASE PRINT CLEARLY  
Name \_\_\_\_\_  
Address \_\_\_\_\_  
City \_\_\_\_\_  
State \_\_\_\_\_ ZIP \_\_\_\_\_  
Phone (\_\_\_\_) \_\_\_\_\_  
Sign Here: \_\_\_\_\_





**DESK-ADAPTOR™**  
CONVERT YOUR DESK  
TO A COMPUTER WORK STATION

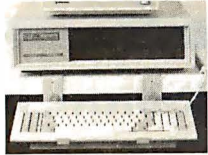

Why buy expensive computer furniture for home or office?

- Convert any desk or table into a computer work station.
  - The Desk-Adaptor™ keyboard holder lowers keyboard height to optimum keying height for maximum comfort and productivity.
  - Installed and removed in seconds without tools. Easily stored when not in use.
  - Padded clamps won't mar desk or table surfaces.
  - Accommodates all keyboards up to 9.5 inches deep.
- \$27 plus \$3 shipping. MN residents add 6% sales tax.

Appro-Tech, Inc.  
4201 Brookside Avenue  
St. Louis Park, MN 55416

Inquiry 27

**DYNAMIC RAMS**

1Mbit	100ns	\$38.00
41256	100ns	\$ 3.60
41256	120ns	\$ 2.60
✓41256	150ns	◀ \$ 2.20
4464	150ns	\$ 3.25
✓4164	150ns	◀ \$ 1.00

■ PROCESSORS			■ E PROMS		
8087-2	8mhz	\$149.00	27512	250ns	\$18.50
8087	5mhz	\$109.00	27C256	250ns	\$ 5.50
80287-6	6mhz	\$169.00	27256	250ns	\$ 4.95
80287-8	8mhz	\$265.00	27128	250ns	\$ 3.75
V-20	8mhz	\$12.75	27C64	200ns	\$ 4.50
V-30	8mhz	\$14.00	2764	250ns	\$ 3.25
■ STATIC RAMS			2732A	250ns	\$ 4.25
6264LP-15	150ns	\$ 2.95	■ 800's (Parts in stock)		

**I.C. EXPRESS**

15358 Valley Blvd., City of Industry, CA 91746  
Phone: 818-369-2688 (Mon-Fri 8-5)  
ORDER TOLL FREE  
**(800) 892-8889 • (800) 882-8181**  
Outside California Inside California  
CALL FOR CURRENT PRICES & VOLUME DISCOUNTS.  
Price Shown for Cash • MasterCard/VISA add 3% more.  
Prices are subject to change. Minimum order \$10.00.  
California residents must add 6.5% sales tax.  
Shipping & Handling: UPS Ground \$5.00, UPS Air \$7.00 (under 1 lb.)  
ALL MERCHANDISE IS 100% GUARANTEED.

Inquiry 121

**EASY TESTING & REWIRING  
OF RS-232 INTERFACES!**

**B & B ELECTRONICS "BUDGET  
BREAK-OUT BOX"**

- opens signal lines
- monitors RS-232 signals
- re-wires lines

**\$49.95**

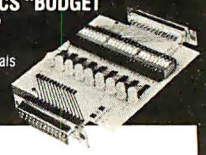

Ideal for troubleshooting, Break-out Box Model 232MAB incorporates nine 2-color LED's for monitoring TD, RD, RTS, CTS, DSR, CD, and DTR, plus 2 spare LED's.

Includes one male and one female RS-232 connector; requires no AC power or batteries. Also includes 24-page instruction manual.

Order direct from Manufacturer TODAY and SAVE!  
**SAME-DAY SHIPMENT! MONEY-BACK GUARANTEE!**

Request your FREE B & B ELECTRONICS Catalog, with a complete line of RS-232C interface and monitoring equipment.

\*Terms: Visa, MC, cash orders postpaid; P.O.'s from qualified rated firms accepted. IL residents add 6 1/4% sales tax.

**B & B electronics**  
MANUFACTURING COMPANY

ORDER TODAY!

1502B Boyce Memorial Drive • Ottawa, IL 61350  
Phone: 815-434-0846

Inquiry 36



**REAL WORLD I/O**  
Affordable Access To The  
Real World For PC/XT/ATs

**AD500** • 8-channel, 12-bit analog input board. Software programmable gains of 1, 10, 100. Utilizes a highly stable A/D converter. Excellent accuracy and high noise immunity. 7 digital I/O lines. Ideal for lab/industrial automation. **\$239**

**AD100** • Single channel version of AD500 with 10 digital I/O lines. Same programmable gain and high noise immunity. Useful for transducers, ATE, education. **\$149**

**DG24** • Digital I/O board with 24 TTL I/O lines configurable in software. 8255 PPI based. **\$95**

**XB40** • Extender board and cable for above boards. Includes easy connect terminal strip and prototype area. **\$49**

Software examples in Pascal, BASIC, Forth and Assembly.  
Complete documentation and money back guarantee.

Real Time Devices, Inc.

**rttd** 1930 PARK FOREST AVENUE  
P O BOX 306  
STATE COLLEGE, PENNSYLVANIA 16804

(814) 234-8087

Inquiry 246

**American Semiconductor**

**THE BARE XT TURBO SYSTEM**  
**\$399**

\*Looks, tests, and acts like an IBM, AND IT'S 100% compatible.

8087	\$119.00	BABY AT	\$499.00
80287-3	175.00	AT	1100
80287-8	239.00	V-20	14.00
64K	.99	FLOPPY DD/DS	.75.00
41256K-150	2.39		
41256K-200	1.99		

XT & AT ADD ON CARDS  
For AT, XT, Compaq, & Corona:  
30MB Hi-Speed RLL KIT **\$499**

20MB Hard Drive **\$299**

**TO ORDER TOLL FREE CALL  
1-800-237-5758, EXT. 819**

Inside Florida Technical Line  
813-961-9444 1-813-961-5584

16520 N. Florida Ave., Lutz, Florida 33549  
Add 3.2% for VISA/MC purchases.

Inquiry 345

**CIRCUIT SIMULATION from \$95.00**

SPICE, the most powerful analog circuit simulation program of the 80's now runs on the IBM PC as IS\_SPICE for only \$95.00. Performs AC, DC and Transient analysis.

Improvements are made using a pre processing compiler, PRE\_SPICE for \$125.00 and a graphics waveform display and measurement program, Intu\_Scope for \$250.00.

Our unique approach to improving SPICE allows complete mainframe compatibility and adds features that include: Monte Carlo Analysis, Macro models with parameters, parts libraries, automatic data measurements, bi-directional Fast Fourier Transforms, Polynomial Regression and much more.

Now supporting 3 popular graphics adapters; EGA, CGA and Hercules with dot matrix and plotter outputs. The full system is \$470.00 and requires 640K RAM, 8087 or 80287, fixed disk and graphics adapter.

Programs are not copy protected, come with a 30 day money back guarantee and Newsletter subscription. Shipping via UPS surface is included in the U.S.A., foreign add \$20.00 for air mail. In California, add 6.5% sales tax.

For information, write or call intusoft, PO Box 6607, San Pedro, CA 90734-6607, Tele: (213) 833-0710.

Inquiry 129

**FORMATTED DISKS**

"Ready to use in your  
IBM PC or compatible."



**Nashua**

58¢  
**3M**  
69¢

ALF formats brand-name factory certified disks, and double-checks them for defects. You save the time and hassle of formatting disks yourself, and pay no more than for ordinary blank disks!

CALL TODAY TOLL-FREE

**1-800-321-4668**

in Colorado, 303-234-0871

**ALF** 1315-F Nelson St. Denver, CO 80215

Inquiry 10

**\$79 HARD DISK CONT.**

**Computer Surplus Store**

**New Shugart Model 1610 5-1/4" Hard Disk Controllers**

**Emulates:**

- Xebec S1410 (1610-3)
- DTC 510 (1610-1)
- SCSI (1610-4)

**Works with:**

- Micromint COM 180, SB180
- Wavemat Bullet
- AMPRO All Boards
- Macintosh
- Apple IIe
- ACS 1000

**Full 90 Day Guarantee**

**Manual & Schematic Only \$8**

Xebec S1410 HDC .....\$95  
**IBM PC Controllers**

- Adaptec 2010A .....\$150
- Adaptec 2070 (RLL 2-7) .....\$175

(Shipping & Handling \$5.00)

222 Phelan Ave. • San Jose, CA 95112  
**408-280-1740**

Inquiry 68

**UNDERSTAND**

Feeds and refolds paper in the same space you use for your printer! Swing paper receiving tray down and bottom shelf becomes a storage for paper. Only **\$44.95**.

Other stands and trays available from **\$19.95**.

**CALL TOLL FREE**

**1-800-344-6934**

**Grand Union Micro Systems**  
2222 Gumtree Lane, Fallbrook, CA 92028  
For Customer Service Call (619) 723-0862

Inquiry 107



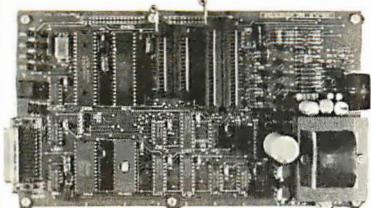

**UNIVERSAL EPROM PROGRAMMER KIT \$99!!**

- On board power supply, 110/220 VAC;
- Menu selection; No personality modules;
- Built in monitor for easy I/O debugging;
- User friendly softw; Full tech. support
- Detailed 50 page manual with schematics;
- Quick pulse algorithm: 27256 under 60 sec
- All 24/28 pins to 27011 & CMOS E(EP)ROMS
- Micros: 8741, 2, 4, 8, 9, 51, 52, 55, 9761 & CMOS
- Auto baud RS232 to 19.2k; Free PC drivers
- Offset/split Hex. Binary, intel & Motorola
- 8, 16 & 32 bit files; Cased 1409C-34 599!

**B&C Microsystems**

6322 Mojave Dr., San Jose, CA 95120

\* Ph (408) 997-7685 Tx 4995363 Visa & MC

**The best diskettes at the best prices!**

Don't waste your money on inferior products!

SuperStar™ diskettes are:  
 HIGH CLIP (65%+)...not A SI (40%)!  
 American made...not cheap imports!  
 Backed by a real LIFETIME WARRANTY!  
 Yes, you can buy a cheaper diskette...but that's exactly what you'll be getting!

**5.25" DISKETTES:**

SSDD	.29 ea.
DSDD	.33 ea.
SSDD-96TPI	.38 ea.
DSDD-96TPI	.46 ea.
DSDD-HD	1.06 ea.

**3.5" DISKETTES:**

SSDD	1.06 ea.
DSDD	1.25 ea.

Order in multiples of 50 only. \$35.00 min.

1-800-621-6827

(In Illinois, 1-312-256-7140)

VISA/MASTERCARD ACCEPTED.

**DISK WORLD!, Inc.**

Inquiry 85

**SAVE MONEY EPROM PROGRAMMER**



APROTEK 1000 ONLY

**\$265.00**

COMPLETE WITH PERSONALITY MODULE

117 AC POWER-RS-232 CONNECT -6 BAUD RATES - HANDSHAKE TO HOST **ALLOWS READ, WRITE, VERIFY & COPY**

Comes complete with IBM-PC, Apple, or CPM (Specify Computer) Driver Program on Disc.

Programs the following 5 Volt 24 or 28 pin devices: 2716 series through 27512, 25xx series, 68764 plus others. Please Specify Personality Module desired with order. Additional Personality Modules only \$15.00 ea. Full 1 year warranty.

TO ORDER: CALL 1-800/962-5800 OR WRITE

APROTEK

1071 A AVENIDA ACASO

Add

CAMARILLO, CA 93010 \$4.00 Shipping USA

Info: (805) 987 2454

VISA or MC Add 3%

We Accept Govt., School & Large Corp. P.O.s

Inquiry 28

**DATAFLEX™**

- Multi-user Database!
- Powerful!
- Multiple Operating System Compatibility!
- Attractive Dealer Pricing!
- Full Dealer Support!

Dataflex is a trademark of Data Access  
 Dealer Inquiries Invited

**COGITATE**

24000 Telegraph Road  
 Southfield, Michigan 48034 USA  
 (313) 352-2345

Inquiry 55

**Incredible!**  
**64K Printer Buffer with cable**  
 Plus \$3 shipping & handling  
**\$69**  
 30-day money back guarantee plus 1-year warranty  
 Limited Offer-Order Today

Works with any standard Centronics parallel interface • Reset button • Multiple copy repeat function • Auto diagnostics • Self-test

Order by Check/MO or VISA/MC/AX



Call Toll Free

USA: 800-533-8049

CA: 800-624-5628

330 Central Avenue • Fillmore, CA 93015

Inquiry 51

**PC/XT USERS!**

- COGTREE Utilities by Cogitate ..... \$129.95
- LYNC by Norton-Lamber.... \$199.95
- DATAFLEX by Data Access...Varies
- RM/COBOL by Ryan/McFarland.....Varies
- Universe by Omnitrend.....\$ 98.50
- Blue MacI by Cogitate.....\$599.00
- CadPower+ by Trilex.....\$995.00
- Softext Teaching Aids.....\$ 95.00
- PrintSet by Cogitate.....\$ 79.95
- CogITAPE by Cogitate.....CALL!!
- Anti-Static Products.....Varies
- Uninterruptible Power Backups.....Varies
- TeleVideo Software.....CALL!!

**COGITATE**

"A Higher Form of Software"

24000 Telegraph Road  
 Southfield, MI 48034  
 (313) 352-2345/Telex 386581

VISA/MASTERCARD ACCEPTED  
 Dealer Inquiries Welcomed

Inquiry 56

**SUN-ST 8MHz TURBO**



- Fully IBM XT Compatible
- Two 360KB Disk Drives
- 640K RAM
- Hercules Compatible Mono Graphic Card (720x348)
- 12" High-Res TTL Mono Monitor
- AT Style Keyboard
- 150W Heavy Duty Power Supply
- Keyboard Switchable to 4.77MHz
- Parallel Print Port
- FCC Approved
- ASSEMBLED & TESTED
- 1 Year Limited Warranty

LOW AS

**\$795**

PLEASE CALL FOR OTHER CONFIGURATIONS

**SUN-286 SYSTEM**

- 6/8MHz 80 286 CPU
- 640K
- 200W Power Supply
- New Enhanced Keyboard
- 1.2MB FDD w/Controller

Assembled & Tested **\$1295**

ORDERS ONLY - TOLL FREE

**1-800-421-5775**

(213) 644-1140 CALIFORNIA

TERMS: VISA, MasterCard (No Surcharge), CDD, Cash or Certified Check (VISA or MC Ref. Required), School & Gov. Contractor P.O. accepted. Shipping & H.C. \$4.00 for 3 lbs. plus \$6.00 for each additional lb. CA residents add CA Sales Tax. \$10.00 Minimum Order.  
 WARRANTY: 90 Days Warranty Labor, Parts Replacement Only. IBM is a registered trademark of International Business Machines Corp.



**SUNTRONICS, INC.**

12603 Crenshaw Blvd., Hawthorne, CA 90250



## DiskMASTER<sup>®</sup>

The Ultimate Diskette Value ...



Discover The Difference ...

**2 FOR 1 LIFETIME WARRANTY**

- Performance exceeds ANSI specifications by 62.5%
- Each diskette 100% tested and certified error free
- 65% clipping level • Over 10 million passes per track
- Reinforced Hubs (DS-DD only) • Tyvek<sup>®</sup> sleeves
- W/P tabs and ID labels

<b>.49</b>	<b>1.19</b>
5 1/4" - 48 TPI DS-DD	DS-HD 96 TPI IBM-AT Compatible

Simply top Brand-Name Quality, made in the U.S.A. by a leading manufacturer. Factory polybagged in lots of 25 (min order 50)

## YCENTECH<sup>®</sup>

America's Premium Quality Color Diskettes

**TIMELESS WARRANTY**

- ✓ Performance exceeds A.N.S.I. specifications by 88%
- ✓ Each disk 100% tested and certified
- ✓ 14 COLORS for data organization
- ✓ Pkgs. of 10, tyvek sleeves, w/p tabs, and ID labels

SS-DD	QTY. 10 BOXES OR 100 DISKETTES	DS-DD
<b>.74</b>	5 1/4" Color, BOXED, 48 TPI	<b>.98</b>
<b>1.39</b>	3.5" Color, BOXED	<b>1.95</b>
<b>.64</b>	5 1/4" Color, BULK, 48 TPI	<b>.88</b>
<b>1.30</b>	3.5" Color, BULK	<b>1.92</b>

High Density, Color, 1.6mb, IBM AT Compatible ..... **1.95**

Includes Tyvek sleeves, w/p tabs, and ID labels. FREE Financial Calculator Software. Call for details.



America's No. 1 Name-Brand Diskettes

- ✓ LIFETIME WARRANTY
- ✓ High quality and consistently reliable
- ✓ More rigid jackets than ever before

SS-DD	QTY. 5 BOXES	DS-DD
<b>.74</b>	5.25, 48 TPI	<b>.97</b>
<b>1.35</b>	3.5, 135 TPI	<b>1.90</b>

DS-HD 96 TPI, IBM AT Compatible ..... **1.95**

Call for best 3M prices on head cleaning and data cartridges.

## Nashua<sup>™</sup>

Affordable Quality Incredible Value Best Prices Ever!

- ✓ LIFETIME WARRANTY
- ✓ Factory Fresh in BOXES of 10 with sleeves, w/p tab, ID labels

SS-DD	QTY. 10 BOXES	DS-DD
<b>.54</b>	5.25, 48 TPI, box of 10	<b>.57</b>
<b>1.12</b>	3.5", 135 TPI	<b>1.46</b>

High Density, IBM PC-AT Compatible ..... **1.50**

## BULK SPECIAL OF THE MONTH

Made in U.S.A.

- ✓ LIFETIME WARRANTY
- ✓ Exceeds ANSI specifications
- ✓ Includes Tyvek sleeves and w/p tab
- ✓ Hub Rings
- ✓ 100% tested and certified
- ✓ Made in USA

**5 1/4" DS-DD MULTIPLES OF 100**

# 35¢

### ORDERING INFORMATION

TERMS: Free use of VISA, Mastercard, and American Express. P.O. orders accepted from recognized corporations rated 3A2 or better, government and schools on net 30. SHIPPING: Add \$3.00 per 100 diskettes or fraction thereof, add \$5.00 for COD orders.

PRICE PROMISE: We will better any lower delivered price on the same products and quantities advertised nationally.

Toll Free Order Line: **1-800-233-2477** Information Line: **1-801-561-0092**

Computer Affairs, inc. 199 Cottage Avenue Salt Lake City, Utah 84070 Hours: 8am to 5pm (mtn. time)

# RS-422

## Communications Board

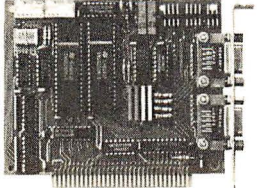

- For IBM-PC/AT/XT and compatibles
- Dual RS-422/RS-485 interface
- Differential drivers to 4000 ft.

**Fast Delivery**

## QUA TECH, INC.

478 E. Exchange St. Akron OH 44304 (216) 434-3154 TLX: 5101012726

Inquiry 232

## MODULAR DATA ACQUISITION



- For IBM & Compatibles
- Flexible and Inexpensive
- Money Back Guarantee
- Free Technical Support

**Fast Delivery**

## QUA TECH, INC.

478 E. Exchange St. Akron OH 44304 (216) 434-3154 TLX: 5101012726

Inquiry 234

## WAVEFORM SYNTHESIZER

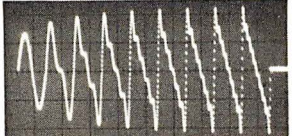
- For IBM-PC/XT/AT and compatibles
- Generates user-definable signal
- Up to 2000 points per envelope

**\$795.00**

## QUA TECH, INC.

478 E. Exchange St. Akron OH 44304 (216) 434-3154 TLX: 5101012726

Inquiry 236

# 72 Digital I/O

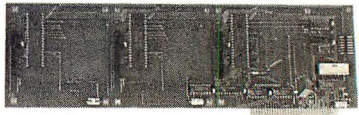

## PXB-721

### Parallel Expansion Board

- For IBM-PC & Compatibles
- 72 Digital I/O Lines
- Simple Programming
- Uses One Expansion Slot
- Fast Delivery

# \$195

## QUA TECH, INC.

478 E. Exchange St. Akron OH 44304 (216) 434-3154 TLX: 5101012726

Inquiry 233

## Power Control

110/220 AC by your IBM-PC



The boards allow you to Control/Monitor high voltage AC/DC power lines with your IBM-PC/XT/AT or compatible while providing optical isolation.

## QUA TECH, INC.

478 E. Exchange St. Akron OH 44304 (216) 434-3154 TLX: 5101012726

Inquiry 235

# RS-232

## Communications Board

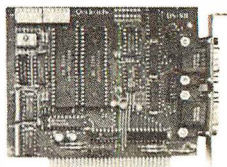

- For IBM-PC/XT/AT & comp.
- Dual RS-232C interface
- Optional software supports COM1, COM2, COM3, COM4
- Jumper selectable interrupts

**Fast Delivery**

## QUA TECH, INC.

478 E. Exchange St. Akron OH 44304 (216) 434-3154 TLX: 5101012726

Inquiry 237





# pinecom™

# ..... IBM Compatibles

## 2 SPEEDS TURBO SYSTEM FULLY IBM PC/XT COMPATIBLE 4.77/8MHZ

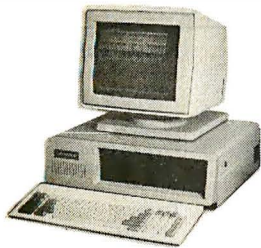

- 640K on Board RAM
- 2 Floppy Disk Drives
- Disk Controller Card
- 150W Power Supply
- FCC Type Slide Case
- 'AT' Style Keyboard
- 8 IBM I/O Slots
- 8088-2 Micro Processor
- 8087 Co-Processor Socket
- 4.77 MHZ/8MHZ Clock Selectable
- Monitor and Display Card Not Included

Fully Assembled and Tested ..... **\$595<sup>00</sup>**  
 (Other Options and Configurations Available, Please Call.)

## PINECOM AT SYSTEM FULLY IBM AT COMPATIBLE



- 8/6 MHZ Clock Selectable
- 80286 CPU
- 1.2 MGB Floppy Drive
- 200 Watts Power Supply
- Hard Disk/Floppy Disk Controller
- 512K RAM Expandable to 1 MGB
- Clock Calender w/Battery Backup
- 'AT' Style Keyboard

Fully Assembled and Tested ..... **\$1229<sup>00</sup>**  
 30 MGB (ST-4308) Hard Disk ..... \$620  
 Other Options, See Below

## Turns Your 'XT' Into an 'AT' PCI-286 SPEEDCARD For IBM PC/XT Compatibles

- 80286/8088 Microprocessor Switch Selectable
- 7.2MHz Clock Speed
- 8K Cache Memory
- 7.5 Times Faster Than PC/XT
- Math Co-Processor 80287 (5/8MHz) Optional
- Fully DMA Compatible
- Runs All AT/XT Software
- Easy To Install, No Soldering Required

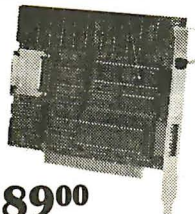

**\$389<sup>00</sup>**

## SALES ITEMS

- 20 MGB Hard Disk (Seagate ST-225) (79 MS) ..... **\$290<sup>00</sup>**
- Western Digital Hard Disk Controller Card WX-2 ..... **\$100<sup>00</sup>**
- 30 MGB Hard Disk For 'AT' (ST 4038) (39 MS) ..... **\$620<sup>00</sup>**
- Half Size Modem Card 300/1200 BPS Hays Compatible (Logitech) ..... **\$125<sup>00</sup>**
- 3 Button Mouse System with Software (Serial) ..... **\$85<sup>00</sup>**
- TTX 1411 RGB Monitor 14" 0.39 Dot 640 X 250 ..... **\$330<sup>00</sup>**
- Samsung 12" Monochrome TTL Monitor, Amber or Green .. **\$89<sup>00</sup>**
- Samsung 12" Monochrome Composit Monitor, Amber ..... **\$75<sup>00</sup>**
- Monochrome Graphic Adapter with Printer Port ..... **\$85<sup>00</sup>**
- Color Graphic Adapter with 2 Composit Output ..... **\$70<sup>00</sup>**
- 0/576 K Max. RAM Expansion Card For PC/XT ..... **\$45<sup>00</sup>**
- Fujitsu 360K Half Height Floppy Disk Drive ..... **\$88<sup>00</sup>**
- Joystick with 2 Fire Buttons For IBM ..... **\$18<sup>00</sup>**
- 6 Outlets Power Strip with Surge Suppressor and Main Sw. . **\$18<sup>00</sup>**
- 8087-3 Co-Processor Chip For XT (4.77 MHZ) ..... **\$115<sup>00</sup>**
- 8087-2 Co-Processor Chip For XT Turbo (8 MHZ) ..... **\$168<sup>00</sup>**
- 80287-8 Co-Processor Chip For AT (8 MHZ) ..... **\$299<sup>00</sup>**
- NEC V-20 Processor (Replace 8088) 40% Faster ..... **\$13<sup>00</sup>**
- NEC V-20 Processor (Replace 8088-2) 150% Faster ..... **\$18<sup>00</sup>**

## TURBO SYSTEM

- 640K RAM on Board 4-77/8MHz Motherboard
- 360K Floppy Disk Drive w/Controller
- 20 MGB Hard Disk w/Controller
- 150 Watts Power Supply
- Mini 'AT' Style Case With Key Lock
- Front Panel LED for Power, Hard Disk and Turbo Mode
- Hardware Reset Button on Front Panel
- 'AT' Style Full Function Keyboard (5060)
- Monochrome Graphic Card w/Printer Port
- 12" Hi-Res Amber or Green T.T.L. Monitor
- NEC V-20-8 Processor Used (330% Faster than IBM PC)\*\*

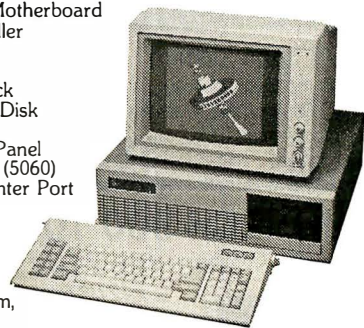

\*\*Based on Norton Utility Program,  
System Information's Result.

FULLY ASSEMBLED AND TESTED ..... **\$1132<sup>00</sup>**

## BTC 5339 (5152) 12 FUNCTION KEYS ENHANCED KEYBOARD FOR IBM PC/AT

FOR AT or XT  
BTC-5339

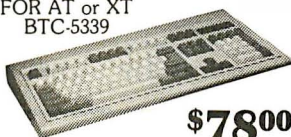

**\$78<sup>00</sup>**

- Positive Tactile Feedback
- Solid State Capacitance Low-Profile key switches
- Separate Cursor Key Pad
- Separate Numeric Key Pad
- Enlarged Return Key With LED Indicator for Shiftlock
- 12 Function Keys Supports DOS 3-2

## IMAGE ACE II VIDEO CAPTURE CARD

ACE-II



**\$275<sup>00</sup>**

Captures video from video camera or TV, transfer to your PC computer, can display on your monitor, storage on disk, or transmits it out via modem to other user. Requires color graphic card. Install to any empty slot on your computer. Software and instruction included.

## 3 MGB MULTIFUNCTION CARD FOR 'AT'

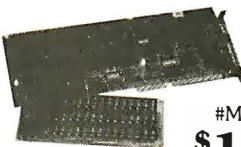

#MF-3000

**\$184<sup>00</sup>**

- User Expandable Up to 3 MGB with 128/512K Increments
- One RS-232 Serial Port (2nd Port Optional)
- One Parallel Printer Port
- One Game Port
- RAM Set (Each 1MB) ..... **\$108<sup>00</sup>**
- 2nd Serial Port I.C. Set ..... **\$26<sup>00</sup>**
- Shipped With Zero K RAM

## 2 MGB RAM EXPANSION CARD FOR 'AT/XT'



**\$147<sup>00</sup>**

#MEMO-2000-XT  
#RAM-310-AT

- Confirms to Lotus/Intel Expanded Memory Spect. (EMS)
- Up to 2048K Bytes of Expansion Memory
- Uses 64K or 256K RAM Chips
- Software and Instruction Manual Included
- Memory Set (Each 1MB) ..... **\$108<sup>00</sup>**
- Shipped with Zero K RAM

## 4 SERIAL PORTS (RS-232) ADAPTER



MS-400-XT

**\$92<sup>00</sup>**

MS-400-AT

**\$125<sup>00</sup>**

- 4 Serial Ports COM-1, COM-2, COM-3, COM-4
- Custom Fully Molded Serial Cabling and Mountings
- Short Card Design, Available For 'AT' or 'XT'

## COPY II PC OPTION BOARD

"Copies Virtually All Protected Software"

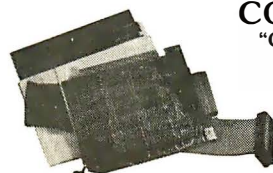

For IBM XT/AT, Comes with Disk Back Up Utility, Copy II PC Board, Cable and Instruction

**\$99<sup>00</sup>**

# PINE COMPUTER INC.

9690 Telstar Ave., Suite 204  
El Monte, CA 91731

Phone: (818) 575-1882

Telex: 5106017376 PINECOM

TERMS: COD accepted on cashiers check or cash. Visa or Master Charge accepted with 3% surcharge. Shipping charges for COD orders = 5% of total purchase, 2% for prepaid orders, minimum charge applied.

\*IBM is registered trade mark of IBM Corp.



# YES, YOU CAN!

PC AMERICAN MAKES IT POSSIBLE FOR YOU!

## 20MB Turbo System

(4.77/8MHz XT Compatible)  
640K, 1 Floppy, 20MB, AT Style KBD,  
One Year Warranty,  
FCC Approved ..... **\$895**

## 30MB Turbo System

(4.88/8MHz XT Compatible)  
640K, 1 Floppy, 30MB, AT Style KBD,  
One Year Warranty,  
FCC Approved ..... **\$955**

## MULTITECH 900 10/6 MHz \$1500

Compatible Computer

- 10 or 6 MHz
- 1.2 MB Floppy
- Keyboard
- MS DOS 3.1
- 5 Half-Height internal Drive slots
- One Year Warranty
- Serviced Nationwide by TRW
- 512K on motherboard expandable to 1 MB

### Multitech Options

- Softwhite monitor and monochrome graphics card **\$219**
- Color monitor and color graphic card **\$359**
- EGA monitor and EGA card **\$659**
- Multitech multifunction plus EMS, 0 to 1.5 MB **\$219**
- Daughterboard to expand to 3 MB **\$128**

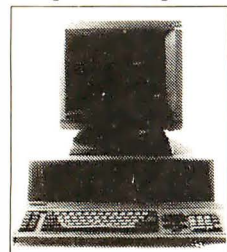

## HARDWARE

### Desktop Computer

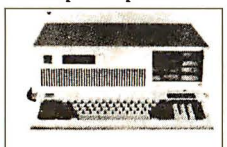

IBM PC AT 512K 2495  
Compaq Deskpro 386 4995  
IBM PC XT 640K 1 Floppy 1689  
IBM PC 256K 1089

### Lap-Size Computer



NEC Multispeed (4.77/9.54 MHz) 1595  
Toshiba 11100+ CALL  
Toshiba T3100 CALL

### Floppy Disk Drive

Fujitsu 360K 85  
Teac 555V 360K 99  
Teac FG 1.2MB 149  
Toshiba 360K 149  
Toshiba 3 1/2" 720K 139  
Toshiba 1.2 139

### Hard Disk Drive

Seagate ST225, 20MB KIT 379  
Seagate ST238, 30MB KIT 479  
Seagate ST4026, 20MB 529  
Seagate ST4038, 30MB 629  
Rohde 203E, 30 MB 498  
Seagate ST4051, 40 MB 729  
CDC 9415-86, 80MB 1295  
Western Digital 1002 125  
Western Digital WA2 239  
Western Digital WAH 189  
Disk Manager Software 99

### Alternative Mass Storage

Everex Stream 60 ext 819  
Archive 60 internal 695  
Irwin 10MB internal 389

### Diskettes and Tapes

3M DC-600A cartridge 26  
3M DC-1000 cartridge 19  
Bernoulli 20MB cartridge 72  
Maxell MD2-DM 10 disks 19  
Maxell MD2-HD 10 disks 35

### Color Monitor

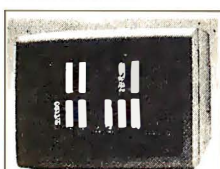

Princeton SR-14 770 x 400 495  
Thompson color RGB 269  
Taxan 630 450  
Taxan 640 515

### EGA Color Monitor

NEC Multisync 569  
Princeton HX-12 E 539  
Multitech EGA 419  
Sony Multisync 599

### Monochrome Monitor

Samsung amber/green/TTL 85  
Amdex 310A TTL amber 159  
Princeton MAX 12 amber 155  
Multitech soft white TTL 119

### Printer-Dot Matrix Near Letter Quality



Epson IQ-1000 830  
IBM Proprinter 415  
IBM Proprinter XL 629  
Citizen 1200 120 CPS 190  
Citizen MSP 15 160 CPS 414  
Citizen MSP 15 160 CPS 249  
Okidata 182 120 CPS 270  
Panasonic KXP 1091 120 348  
Panasonic KXP 1092 180 1053  
NEC P5 290 CPS 1192  
NEC P5 XL 290 CPS 475  
NEC P7 216 CPS 865  
Toshiba P-321 216 CPS 442  
Toshiba P-341 216 CPS 699  
Toshiba P-351 288 CPS 949  
Toshiba P-351 288 CPS 1135

### Printer-Letter Quality

Citizen Premier 35 CPS 517  
IBM Quietwriter 1215  
Brother M1509 180cps 399

### Printer-Laser

H P LaserJet 500 3850  
H P LaserJet Prot 2350  
H P LaserJet Plus 3000  
Toshiba Laser call

### Plotter

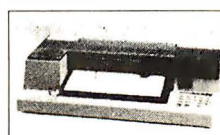

HP 7475 A Plotter 1744  
Houston Ins. DPM 56 5169  
Roland 880 8 pen 966

### Input Device

Microsoft Mouse 119  
Mouse System Mouse 139  
Logic Mouse 79  
PC Optical Mouse w/Dr. Halo 135

### Graphics Board, Monochrome

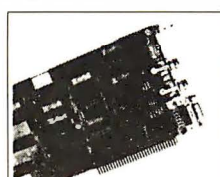

Hercules Graphics Plus (New!) 194  
Everex Edge Mono/RGB/32col. 239  
ATI Mono/Color/high/res 239  
Cione monochrome graphic 95  
Persyst Bob/MG mono/RGB 171

### Graphics Board Color

Paradise Mod. Graphics 249  
Hercules Color Graphics (New!) 149  
Cione Color Graphics 85

### Graphics Board EGA

ATI Wonder 299  
Paradise EGA/Auto Switch 359  
Video 7 Deluxe/Auto 389  
Multitech EGA 239  
NEC EGA for Multisync 495

### I/O Board

2 Floppies P/S/C/I/ AT 10 P/S 89

### Modem



US Robotics Direct 1200 139  
INCOMM 2400 Baud External 299  
US Robotics 2400 PC INT 199  
Everex Evercom 1200 129

### Memory Expansion



AST Premium 256K 2 MB SixPackPlus 234  
Clone SixPack 89  
AST Rampage PC 234  
AST Rampage AT 445  
Tall Tee J-Rom 3 184

### Chips

256K 150 Nona 27  
256K 120 Nona 29  
64K 150 Nona 9  
8087 118  
8087-2 158  
80287-3 199  
80287-8 299

What You See  
Is  
What You Get!

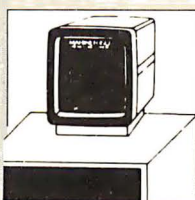

## THE GENIUS by Micro Display

is a full page, ultra high res display that reduces the time and effort to produce top-notch results with desktop publishing software.

The Genius is a vertical 8 1/2" x 11" monitor. It includes its own video display adapter board which allows a special split-screen for simultaneously displaying both text and graphics.

**\$1136**

Aldus PAGE MAKER  
desktop publishing software **\$ 495**

## SOFTWARE

### Accounting

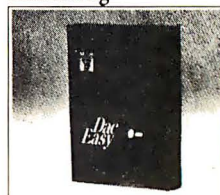

Doc-Easy Accounting 45  
Open System, Account Soft 399

### Data Management



dBASE III Plus, Ashton T 399  
R Base 5000, Micromim 308  
Reflex, Borland 66  
Paradox Ansa Software 442

### Desktop Management

Sidekick, Borland 49  
The Desk Organizer, Warn 65

### Education

Moth Blaster 25  
Early Learning Series 33  
Newsroom, Springboard 30

### Games

SceneryDisks Western US 72  
Flight Simulator, Microsoft 32  
Jet, Sublogic Communication 33  
Sargon III, Hayden Software 29  
Zork I, II, and III, Int. 29  
F-15 Strike Eagle MicroPro 29  
Temple Of Aposhi Trilogy 29  
World's Greatest Baseball 25

### Graphics-Business

Charter-Master, Decision Re 220  
Harvard Presentation Graphics 299

### Graphics-CAD

ProDesign II, American 173  
In-a-Vision, Microsoft 237  
Generic CAD, Generic 99

### Integrated



Framework II 399  
Moth Plan Word Perfect 112  
Symphony, Lotus 425  
1-2-3, Lotus 305  
Lotus HAL 112

### Investment

Andrew Tobias's MECA 115  
Dow Jones Market Manager 147  
Dollars and Sense 107  
Market Analyzer, Dow Jones 219  
Market Manager Plus, Dow Jones 158

### Project Management

Harvard Software Pub 299  
Microsoft Project 238  
Time Line, Breakthrough 235

### Tax Planning or Preparation

Tax Preparer, HowardSoft 299  
PC/TaxCut, Best Program 65

### Training

Teach You soft dBASE III 89  
PFS FirstChoiceSP 95  
Webster's New World Writer 82  
Webster's New World Thesaurus 45  
Print Shop, Bodebund 52  
Typing Tutor III, Simon & Simon 42

### Utilities

Norton Utilities, Norton 51  
Carbon Copy, Meridian 130  
PC Tool, Central Pint 39  
Copy II PC, Central Pint 39  
1 DIR+, Boubouki 53  
V Feature, Couden Bow 99  
SQZ! Turner Hall 59  
Fast Back, Fifth Generation 94  
XTrea, Executive Systems 29

### Word Processing

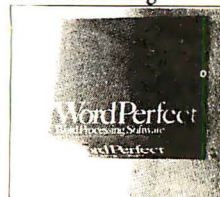

WordPerfect 4.0 219  
TheLibrary 91  
Microsoft Word, Microsoft 285  
WordStar2000, MicroPro 277  
Easy, MicroPro 75  
Multimate Advantage Ashton 317

The difference between PC American and other suppliers is our service. We guarantee low prices, carry products that are fully backed by manufacturer's warranties and offer customer service and technical support.

Yes you can! It's easy to do business with PC American. We offer terms to qualified institutions, accept major credit cards, wire transfers, checks, and cash. Yes you can! Give us a call. Let us make it possible for you.

TERMS: We accept C.O.D., cashier check, Visa, Master Card, 3% extra on American Express, wire transfers, approved P.O.s. All equipment carries new factory warranty. Prices are subject to change. Any return item must be accompanied by a return authorization number and description. IBM, Compaq, Seagate are registered trademarks of their respective companies.

**HOURS**  
MONDAY - FRIDAY  
8:30 - 5:30  
SATURDAY  
10:00 - 2:00

**pcAmerican**  
Marketing, Inc.  
17151 Newhope St., Suite 104, Fountain Valley, CA 92708

1-714-557-3903  
CUSTOMER SERVICE

1-800-654-5365  
SALES HOTLINE

1-714-557-3904  
TECHNICAL SUPPORT





# pinecom™

# ..... IBM Compatibles

## 2 SPEEDS TURBO SYSTEM FULLY IBM PC/XT COMPATIBLE 4.77/8MHZ



- 640K on Board RAM
- 2 Floppy Disk Drives
- Disk Controller Card
- 150W Power Supply
- FCC Type Slide Case
- 'AT' Style Keyboard
- 8 IBM I/O Slots
- 8088-2 Micro Processor
- 8087 Co-Processor Socket
- 4.77 MHZ/8MHZ Clock Selectable
- Monitor and Display Card Not Included

Fully Assembled and Tested ..... **\$595<sup>00</sup>**  
(Other Options and Configurations Available, Please Call.)

## PINECOM AT SYSTEM FULLY IBM AT COMPATIBLE



- 8/6 MHZ Clock Selectable
- 80286 CPU
- 1.2 MGB Floppy Drive
- 200 Watts Power Supply
- Hard Disk/Floppy Disk Controller
- 512K RAM Expandable to 1 MGB
- Clock Calender w/Battery Backup
- 'AT' Style Keyboard

Fully Assembled and Tested ..... **\$1229<sup>00</sup>**  
30 MGB (ST-4308) Hard Disk ..... **\$620**  
Other Options, See Below

## URNS YOUR 'XT' Into an 'AT' PCI-286 SPEEDCARD For IBM PC/XT Compatibles

- 80286/8088 Microprocessor Switch Selectable
- 7.2MHz Clock Speed
- 8K Cache Memory
- 7.5 Times Faster Than PC/XT
- Math Co-Processor 80287 (5/8MHz) Optional
- Fully DMA Compatible
- Runs All AT/XT Software
- Easy To Install, No Soldering Required

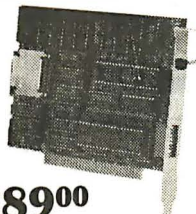

**\$389<sup>00</sup>**

## SALES ITEMS

- 20 MGB Hard Disk (Seagate ST-225) (79 MS) ..... **\$290<sup>00</sup>**
- Western Digital Hard Disk Controller Card WX-2 ..... **\$100<sup>00</sup>**
- 30 MGB Hard Disk For 'AT' (ST 4038) (39 MS) ..... **\$620<sup>00</sup>**
- Half Size Modem Card 300/1200 BPS Hays Compatible (Logitech) ..... **\$125<sup>00</sup>**
- 3 Button Mouse System with Software (Serial) ..... **\$85<sup>00</sup>**
- TTX 1411 RGB Monitor 14" 0.39 Dot 640 X 250 ..... **\$330<sup>00</sup>**
- Samsung 12" Monochrome TTL Monitor, Amber or Green .. **\$89<sup>00</sup>**
- Samsung 12" Monochrome Composit Monitor, Amber ..... **\$75<sup>00</sup>**
- Monochrome Graphic Adapter with Printer Port ..... **\$85<sup>00</sup>**
- Color Graphic Adapter with 2 Composit Output ..... **\$70<sup>00</sup>**
- 0/576 K Max. RAM Expansion Card For PC/XT ..... **\$45<sup>00</sup>**
- Fujitsu 360K Half Height Floppy Disk Drive ..... **\$88<sup>00</sup>**
- Joystick with 2 Fire Buttons For IBM ..... **\$18<sup>00</sup>**
- 6 Outlets Power Strip with Surge Suppressor and Main Sw. . **\$18<sup>00</sup>**
- 8087-3 Co-Processor Chip For XT (4.77 MHZ) ..... **\$115<sup>00</sup>**
- 8087-2 Co-Processor Chip For XT Turbo (8 MHZ) ..... **\$168<sup>00</sup>**
- 80287-8 Co-Processor Chip For AT (8 MHZ) ..... **\$299<sup>00</sup>**
- NEC V-20 Processor (Replace 8088) 40% Faster ..... **\$13<sup>00</sup>**
- NEC V-20 Processor (Replace 8088-2) 150% Faster ..... **\$18<sup>00</sup>**

## TURBO SYSTEM

- 640K RAM on Board 4-77/8MHz Motherboard
- 360K Floppy Disk Drive w/Controller
- 20 MGB Hard Disk w/Controller
- 150 Watts Power Supply
- Mini 'AT' Style Case With Key Lock
- Front Panel LED for Power, Hard Disk and Turbo Mode
- Hardware Reset Button on Front Panel
- 'AT' Style Full Function Keyboard (5060)
- Monochrome Graphic Card w/Printer Port
- 12" Hi-Res Amber or Green T.T.L. Monitor
- NEC V-20-8 Processor Used (330% Faster than IBM PC)\*\*

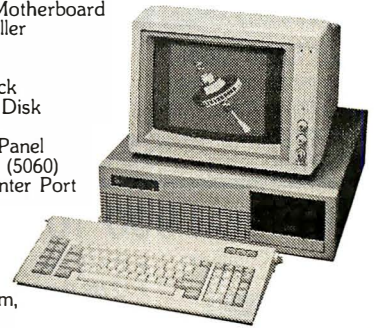

\*\*Based on Norton Utility Program, System Information's Result.

FULLY ASSEMBLED AND TESTED ..... **\$1132<sup>00</sup>**

## BTC 5339 (5152)

### 12 FUNCTION KEYS ENHANCED KEYBOARD FOR IBM PC/AT

FOR AT or XT  
BTC-5339

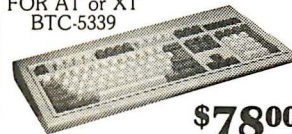

**\$78<sup>00</sup>**

- Positive Tactile Feedback
- Solid State Capacitance Low-Profile key switches
- Separate Cursor Key Pad
- Separate Numeric Key Pad
- Enlarged Return Key With LED Indicator for Shiftlock
- 12 Function Keys Supports DOS 3-2

## IMAGE ACE II VIDEO CAPTURE CARD

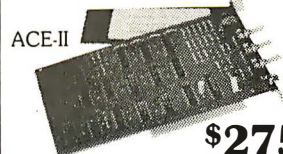

**\$275<sup>00</sup>**

Captures video from video camera or TV, transfer to your PC computer, can display on your monitor, storage on disk, or transmits it out via modem to other user. Requires color graphic card. Install to any empty slot on your computer. Software and instruction included.

## 3 MGB MULTIFUNCTION CARD FOR 'AT'



#MF-3000  
**\$184<sup>00</sup>**

- User Expandable Up to 3 MGB with 128/512K Increments
- One RS-232 Serial Port (2nd Port Optional)
- One Parallel Printer Port
- One Game Port
- RAM Set (Each 1MB) ..... **\$108<sup>00</sup>**
- 2nd Serial Port I.C. Set ..... **\$26<sup>00</sup>**
- Shipped With Zero K RAM

## 2 MGB RAM EXPANSION CARD FOR 'AT/XT'



**\$147<sup>00</sup>** #MEMO-2000-XT  
#RAM-310-AT

- Confirms to Lotus/Intel Expanded Memory Spect. (EMS)
- Up to 2048K Bytes of Expansion Memory
- Uses 64K or 256K RAM Chips
- Software and Instruction Manual Included
- Memory Set (Each 1MB) ..... **\$108<sup>00</sup>**
- Shipped with Zero K RAM

## 4 SERIAL PORTS (RS-232) ADAPTER

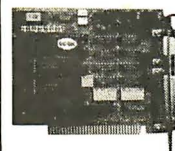

MS-400-XT  
**\$92<sup>00</sup>**

MS-400-AT  
**\$125<sup>00</sup>**

- 4 Serial Ports COM-1, COM-2, COM-3, COM-4
- Custom Fully Molded Serial Cabling and Mountings
- Short Card Design, Available For 'AT' or 'XT'

## COPY II PC OPTION BOARD

"Copies Virtually All Protected Software"

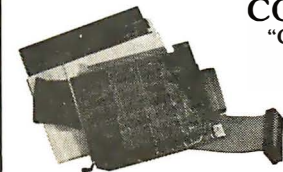

For IBM XT/AT, Comes with Disk Back Up Utility, Copy II PC Board, Cable and Instruction

**\$99<sup>00</sup>**

# PINE COMPUTER INC.

9690 Telstar Ave., Suite 204  
El Monte, CA 91731

Phone: (818) 575-1882  
Teléx: 5106017376 PINECOM

TERMS: COD accepted on cashiers check or cash. Visa or Master Charge accepted with 3% surcharge. Shipping charges for COD orders = 5% of total purchase, 2% for prepaid orders, minimum charge applied.

\*IBM is registered trade mark of IBM Corp.



# YES, YOU CAN!

PC AMERICAN MAKES IT POSSIBLE FOR YOU!

## 20MB Turbo System

(4.77/8MHz XT Compatible)  
640K, 1 Floppy, 20MB, AT Style KBD,  
One Year Warranty,  
FCC Approved ..... **\$895**

## 30MB Turbo System

(4.88/8MHz XT Compatible)  
640K, 1 Floppy, 30MB, AT Style KBD,  
One Year Warranty,  
FCC Approved ..... **\$955**

## MULTITECH 900 10/6 MHz \$1500

Compatible Computer

- 10 or 6 MHz
- 1.2 MB Floppy
- Keyboard
- MS DOS 3.1
- 5 Half-Height internal Drive slots
- One Year Warranty
- Serviced Nationwide by TRW
- 512K on motherboard expandable to 1 MB

### Multitech Options

- Softwhite monitor and monochrome graphics card **\$219**
- Color monitor and color graphic card **\$359**
- EGA monitor and EGA card **\$659**
- Multitech multifunction plus EMS, 0 to 1.5 MB **\$219**
- Daughterboard to expand to 3 MB **\$128**



## HARDWARE

### Desktop Computer

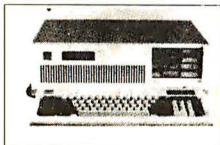

IBM PC AT 512K 2495  
Compaq Deskpro 386 4995  
IBM PC XT 640K 1 Floppy 1689  
IBM PC 256K 1089

### Lap-Size Computer



NEC Multispeed (4.77/9.54 MHz) 1595  
Toshiba T1100+ CALL  
Toshiba T3100 CALL

### Floppy Disk Drive

Fujitsu 360K 85  
Teac 555B 360K 99  
Teac FG 12MB 149  
Toshiba 360K 239  
Toshiba 3 1/2" 720K 139  
Toshiba 1.2 149

### Hard Disk Drive

Seagate ST225, 20MB Kit 379  
Seagate ST238, 30MB Kit 429  
Seagate ST4026, 20MB 579  
Seagate ST4038, 30MB 629  
Rodime 203E, 30 MB 498  
Seagate ST4051, 40 MB 729  
CDC 9415-86, 80MB 1295  
Western Digital 100Z 125  
Western Digital WA2 239  
Western Digital WAH 189  
Disk Manager Software 99

### Alternative Mass Storage

Everex Stream 60 ext 819  
Archive 60 internal 695  
Irwin 10MB internal 389

### Diskettes and Tapes

3M DC-600A cartridge 26  
3M DC-1000 cartridge 19  
Bernoulli 20MB cartridge 72  
Maxell M02-D0 disks 19  
Maxell M02-HD 10 disks 35

### Color Monitor

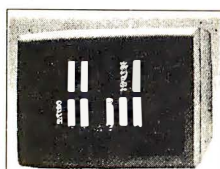

Princeton SR-14 770 x 400 495  
Thompson color RGB 269  
Taxan 830 450  
Taxan 840 515

### EGA Color Monitor

NEC Multisync 569  
Princeton HK-12 E 539  
Multitech EGA 419  
Sony Multisync 599

### Monochrome Monitor

Samsung amber / green / TTL 85  
Amdex 310A TTL amber 159  
Princeton MAX12 amber 155  
Multitech soft white TTL 119

### Printer-Dot Matrix Near Letter Quality

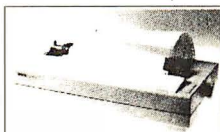

Epson LQ-1000 830  
IBM Proprietary 415  
IBM Proprietary XL 829  
Citizen 1200 120 CPS 190  
Citizen MSP 15 180 CPS 307  
Okidata 182 120 CPS 249  
Panasonic KXP 1091 120 270  
Panasonic KXP 1092 180 348  
NEC P5 290 CPS 1053  
NEC P5 XL 290 CPS 1192  
NEC P7 216 CPS 475  
NEC P7 216 CPS 665  
Yoshida P-321 216 CPS 442  
Yoshida P-341 216 CPS 899  
Yoshida P-351 288 CPS 949  
Yoshida P-351 288 CPS 1135

### Printer-Letter Quality

Citizen Premier 35 CPS 517  
IBM QueueWriter 1215  
Brother M1509 180cps 399

### Printer-Laser

H P LaserJet 500 3850  
H P LaserJet Prof 2350  
H P LaserJet Plus 3000  
Toshiba Laser coil

### Plotter

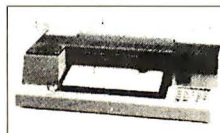

HP 7475 A Plotter 1744  
Houston Ins. OPM 56 1689  
Roland 880 B pen 966

### Input Device

Microsoft Mouse 119  
Mouse System Mouse 139  
Logic Mouse 79  
PC Optical Mouse w/Dr. Halo 135

### Graphics Board, Monochrome

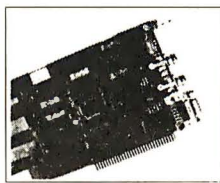

Hercules Graphics Plus (New!) 194  
Everex Edge Mono/RGB/132col. 239  
ATI Mono/Color/High/res 239  
Clone monochrome graphic 95  
Percy! Bob/MG mono/RGB 171

### Graphics Board Color

Paradise Mod. Graphics 249  
Hercules Color Graphics (New!) 149  
Clone Color Graphics 85

### Graphics Board EGA

ATI Wonder 299  
Paradise EGA/Auto Switch 359  
Video 7 08Lux/Auto 389  
Multitech EGA 239  
NEC EGA for Multisync 499

### I/O Board

2 Floppies P/S/C/G/ 89  
AT I/O P/S 89

## Modem

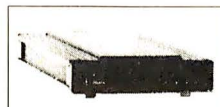

US Robotics Direct 1200 139  
INCOMM 2400 Baud External 299  
US Robotics 2400 PC INT 199  
Everex Evercom 1200 129

## Memory Expansion



AST Premium 256K 2 MB SixPakPlus 234  
Clone SixPak 89  
AST Rampage PC 234  
AST Rampage AT 144  
Tall Tree J-Ram 3 885

## Chips

256K 150 Nona 27  
256K 120 Nona 29  
64K 150 Nona 9  
8087 119  
8087-2 158  
80287-3 199  
80287-8 299

What You See  
Is  
What You Get!

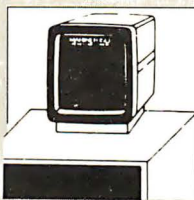

## THE GENIUS by Micro Display

is a full page, ultra high res display that reduces the time and effort to produce top-notch results with desktop publishing software.

The Genius is a vertical 8 1/2" x 11" monitor. It includes its own video display adapter board which allows a special split-screen for simultaneously displaying both text and graphics.

**\$1136**

Aldus PAGE MAKER  
desk top publishing  
software **\$ 495**

## SOFTWARE

### Accounting

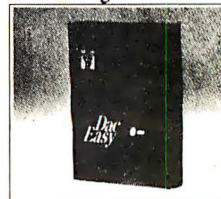

Doc-Easy Accounting 45  
Open System, Account Soft 399

### Data Management



dBASE III Plus, Ashton T 399  
R. Base 5000, Microrim 308  
Reflex, Barland 86  
Paradox Anso Software 442

### Desktop Management

Sidekick, Barland 49  
The Desk Organizer, Warn 65

### Education

Math Blosser 25  
Early Learning Series 33  
Newsroom, Springboard 30

### Games

Scenery Disks Western US 72  
Flight Simulator, Microsoft 32  
Jet, Sublogic Communication 33  
Sargon II, Hayden Software 29  
Zork I, II, and III, Inf 29  
F-15 Strike Eagle MicroPro 29  
Temple Of Aposhi, Trilogy 29  
World's Greatest Baseball 25

### Graphics-Business

Charter-Master, Decision Re 220  
Harvard Presentation Graphics 299

### Graphics-CAD

ProDesign II, American 173  
In-a-Vision, Microsoft 297  
Generac CAD, Generic 239

### Integrated



Framework II 399  
Math Plan Word Perfect 112  
Symphony, Lotus 425  
1-2-3, Lotus 305  
lotus HAL 112

### Investment

Andrew Tobias's MECA 115  
Dow Jones Market Manager 147  
Dollars and Sense 107  
Market Analyzer, Dow Jones 219  
Market Manager Plus, Dow Jones 158

### Project Management

Howard, Software Pub 299  
Microsoft Project 238  
Time Line, Breakthrough 235

### Tax Planning or Preparation

Tax Preparer, HowardSoft 299  
PC/TaxCut, Best Program 85

### Training

Teach Yourself dBASE III 89  
PFS First Choice SP 95  
Webster's New World Writer 82  
Webster's New World Thesaurus 45  
Print Shop, Boderbund 52  
Typing Tutor III, Simon & Simon 42

### Utilities

Norton Utilities, Norton 51  
Carbon Copy, Meridian 130  
PC Tool, Central Pnt 39  
Copy II PC, Central Pnt 39  
1 DIR+, Boutbaki 53  
V Feature, Golden Bow 99  
SQZ! Turner Hall 94  
Fast Back, Fifth Generation 59  
XTree, Executive Systems 29

### Word Processing



WordPerfect, 4.0 219  
The Library 91  
Microsoft Word, Microsoft 285  
Wordstar 2000, M. usePro 277  
Easy, MicroPro 15  
Multimate Advantage Ashton! 317

The difference between PC American and other suppliers is our service. We guarantee low prices, carry products that are fully backed by manufacturer's warranties and offer customer service and technical support. **Yes you can! It's easy to do business with PC American. We offer terms to qualified institutions, accept major credit cards, wire transfers, checks, and cash. Yes you can! Give us a call. Let us make it possible for you.**

TERMS: We accept VISA, cashier check, Visa, Master Card, 3% extra on American Express, wire transfers, approved PO's. All equipment carries new factory warranty. Prices are subject to change. Any return item must be accompanied by a return authorization number and description. IBM, Compaq, Seagate are registered trademarks of their respective companies.

HOURS  
MONDAY — FRIDAY  
8:30 — 5:30  
SATURDAY  
10:00 — 2:00



17151 Newhope St., Suite 104, Fountain Valley, CA 92708

1-714-557-3903  
CUSTOMER SERVICE

1-800-654-5365  
SALES HOTLINE

1-714-557-3904  
TECHNICAL SUPPORT



# HUNTING FOR A GREAT DEAL?

## HARD DISK DRIVE CARDS

Logic Array MegaCard!

21-Megabyte

**NEW!**  
**\$429**

- Hard disk drive on a plug-in card gives PC or compatible the storage capacity of an XT

- Uses NEC technology for high reliability
- Fast, easy installation

- **two year guarantee**—parts and labor

21-Megabyte ..... \$429  
30-Megabyte ..... \$479  
40-Megabyte ..... \$649  
40-Mb AT MegaCard ..... \$749

## HARD DISK DRIVE KITS

(Half height, boots from hard disk—includes controller, cables, manual)

20-Megabyte ..... \$375  
30-Megabyte ..... \$410  
40-Megabyte ..... \$555  
50-Megabyte ..... \$675  
80-Megabyte ..... \$799

(with Disk Manager software)

## FLOPPY DISK DRIVES

360-K ..... \$89

1.2 Megabyte, AT-Compatible ..... \$129

1.2 Megabyte, PC-Compatible

(enables your PC or XT to read and write AT-formatted diskettes)

was \$299—clearance price NOW ..... \$129

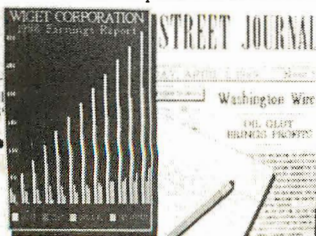

**HUNTER SALES**



18017 Skypark Circle, Suite L, Irvine, CA 92714

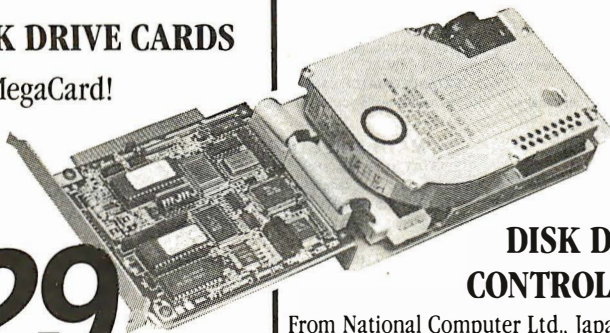

## DISK DRIVE CONTROLLERS

From National Computer Ltd., Japan's premier maker of controllers

- These compact AT-compatible controller cards are among the smallest available.
- Co-resident, IBM-COMPATIBLE

NDC 5126 AT Winchester only ..... \$179  
(a half card—so small you won't believe it's AT-compatible)

NDC 5125 AT Winchester/Floppy ... \$189

NDC 5127 XT Winchester only ..... \$79

NDC 3011 SASI Controller ..... \$91

Double your drive capacity with the LOGIC ARRAY KXP 230Z ..... \$199



## BOARD LEVEL PRODUCTS FROM MYLEX

Multifunction card

0-K ..... \$82

384-K ..... \$123

Envision I (mono/color/graphics) ..... \$147

Envision II (mono/color/graphics,

char. RAM enhanced modes) ..... \$156

Color Adapter I ..... \$77

Business Master I (mon/par adapter,

enhanced text modes) ..... \$80

Business Master II (high-res. mon graphics,

enhanced text modes) ..... \$91

Enhanced Graphics Adapter ..... \$279

(EGA, CGA, MDA, HGC compatible)

## CHIPS

256K D-RAM (set of 9) ..... \$27

64K D-RAM (set of 9) ..... \$9

V-20 (8 MHz) ..... \$10.95

## INTEL MATH CO-PROCESSORS

8087 ..... \$125

8087-2 ..... \$179

80287-6 ..... \$225

## MODEMS

1200-Baud external, Hayes-compatible, uses AT command set ..... \$99

## SOFTWARE

Rix EGA Paint ..... \$49

On Track Disk Manager ..... \$65

## HERE'S HOW TO ORDER:

We accept Visa, MasterCard and American Express (no surcharge) and Money Orders. Minimum charge card order \$25. No sales tax outside California. (CA residents add 6%.)

Personal or company checks require three weeks to clear.

We insure all orders.

Shipping and handling minimum \$5 up to 3 lbs. within continental U.S. Call for shipping info on other orders.

**Prices and availability may change.**

Returns require authorization and are subject to restocking charge.

Normal manufacturers' warranties apply.

Not responsible for typographical errors.

IBM, MultiSync, MegaCard, Mylex EGA Paint and On Track are trademarks of their respective companies.

**CALL 800-443-7355**  
**In Calif. Call 800-345-4868**  
**Tech Questions 714-250-3386**

MON-FRI 7AM-5PM Pacific Time



# FOLKS DOWN IN TEXAS DON'T LIKE PAYIN' BIG BUCKS ESPECIALLY FOR IBM-PC SOFTWARE SO WE SELL IT FOR ONLY \$6.00!

OVER 600 DISKS FULL OF IBM-PC COMPATIBLE PUBLIC DOMAIN AND USER SUPPORTED SOFTWARE.

## APPLICATIONS

- GENEALOGY ON DISPLAY (#90)**
- GENEALOGY - FT (#240)** From Pine Cone software.
- LABELMAKER (#146)** Our favorite label file and maker. Menu driven.
- FAMILY HISTORY (#361)** Family history, ancestor and descendant charts. Sample programs.
- FORM LETTERS (#388)** LOTS of samples of the most commonly used business letters. Modify!
- PC-SPRINT (#507)** Detailed instruction on how to double your computer's speed for less than \$50.00.
- MSDOS-CPM/80 INTERFACE (#561)** CPM lovers! This program allows you to transfer information between and emulate CPM and MSDOS.
- NAME GRAM/BREAK DOWN/FOREWARD (#477)** Discover the words inherent in your phone number, do great anagrams.
- THE WORLD DIGITIZED (#494, 495, 496)** A cartographer's dream. Locate and display over 100,000 locations.
- 100 LETTERS (#300)** Most commonly used from letters, and business applications at your fingertips.

## COMMUNICATIONS

- QMODEM (#310)** Without a doubt the fastest and best communications software you can buy at any price.
- PC-TALK (#16)** The classic "Freeware" communication program.
- RBSBS (#212)** Become a SYSOP and start a bulletin board.
- FIDO NET (#333)** Bulletin Board System. Perhaps the easiest to run.
- PROCOMM (#499)** Communication software that makes a hacker's dream come true.

## DATABASE

- VCR DBASE (#493)** Keep track of those favorite VCR tapes that you never can seem to find when you want them.

## DATABASE PROGRAMS

- PC-FILE (#5)** Perhaps the granddaddy of user supported database programs from Jim Button.
- NEWBASE (#238)** Menu driven database for the beginner.
- PC-DBMS (#383)** A relational database management system that provides on-line help and screen editing functions.
- CREATOR (#339)** Create, report and sort makes this a super database management system.
- MAIL MASTER (#481)** Easily sort, index, and list your multiple mailing data bases.

## EDUCATION

- EQUATOR (#249)** A teaching tool for math, science and finance.
- PC-TUTORIAL (#403)** A first course in computer usage covering various aspects of MS-DOS. Good!
- PC-PROFESSOR (#105)** Learn Basic the easy way. One of the best tutorials on BASIC.
- PC-DOS HELP (#254)** Type "help" for the DOS command you forgot.
- PC PROMPT (#558)** Fascinating on line memory resident DOS helper that also supports BASICA, ED-LIN, DEBUG, and TURBO PASCAL.
- PC-SPRINT (#507)** Tutorial on how to triple your PC's speed.

## FINANCIAL

- PC-CHECK MANAGER (#275)** Keeps multiple checkbooks in balance.
- TAX FILE DBS (#295)** Tax record keeping system that saves you money on April 15.
- PORTSWORTH PACKAGE (#101)** Evaluates your ever-changing stock portfolios.
- PC-GENERAL LEDGER (#237)** An exceptional accounting system. Used by some CPA's.
- LOAN AMORTIZATION (#399)** For output to screen or printer. Lots of on-line help.
- MR. BILL (#469, 470)** Prepare invoices, client report, audit trail, etc.
- (3) ANALYTIC CALC (#430-432)** 3 disk set. Complete spreadsheet, database, graphics, word processor - fassst!
- (2) PC ACCOUNTING SYSTEM (#559, 560)** General purpose ledger system that includes payroll, depreciation, accounts receivable/payable, inventory, processing 1099's and a good general ledger.
- PC-PAYROLL (#565)** Handle all payroll problems with this complete menu-driven payroll system. Includes taxes, reports, forms, etc.
- (2) SALESEYE (#501, 502)** Never let another prospect or lead get away! Prints memos and letters as well.

## GAMES

- TOP GAMES (#274)** The most requested arcade type games.
- ARCADE GAMES (#293)** Another goodie bag of top arcade games.
- PC JR GAMES (#354)** Games that will work only on PC JR. Combat, Dungeons and Dragons, Global Thermonuclear War.
- MISC GAMES (#390)** Good selection of educational, adventure, and arcade games.
- PINBALL RALLY (#557)** You asked for it! Here are three pinball games that vary in complexity, PINBALL, RAIN, TWILZONZ.
- DND (#567)** Dungeons and Dragons, this uses text characters instead of graphics.
- REFLEX POINT (#487)** Self styled action game similar to ROBOTTECH cartoon series.

## GRAPHICS

- PC-KEY DRAW (#344-345)** A small CAD system. Lots of demonstration files.
- PC-PICTURE GRAPHICS (#136)** Drawing package allows you to zoom, color, and store pictures.
- PC-GRAPH (#418)** Allows user to create graphics from PC-File report files.
- PRESENT (#471)** Professional slide shows are a snap with the advanced graphic features of this program. Includes a screen "capture".

## LANGUAGE

- CHASM (#10)** Cheap assembler with tutorial.
- XLISP (#148)** Lisp language interpreter.
- PROLOG & UNIFORTH (#417)** Complete with editor and documentation.
- ESIE (#398)** Build and generate an expert system in a flash.
- P-BASIC (#381)** BASICA work-a-like for clones, etc.
- TINY PASCAL COMPILER BUILDER (#540)** Learn to create your own Pascal Compiler and language compiler/includes tutorial.

- SCREENCODE (#503)** Build your screen applications and watch SCREENCODE generate the code for DBASE II and III, BASIC, and more.
- VISIBLE PASCAL COMPILER (#510)** Watch your program step through its routines as you learn to program it in PASCAL.
- EXTENDED BATCH LANGUAGE (#124)** Makes the PC do menial tasks you never thought possible.

## MATH AND STATISTICS

- EPISTAT (#88)** Statistical analysis of small to medium-sized data samples.
- STAT-TOOLS (#509)** (1 of 2) Do single size experiments, studentized ranges, calculate the size of specific sample sizes.
- STAT-TOOLS (#509)** (2 of 2) Do calculations that require the entry of original observations, exact randomization tests, mean squares, etc.

## MUSIC

- PC-MUSICIAN (#127)** Compose music on your PC, save and play again.
- PIANO MAN (#279)** Play your keyboard like a piano.

## PRINTER UTILITIES

- SIDEWAYS (#265, 411)** Prints text sideways on an Epson printer.
- SETPRTR (#79)** Sets up Epson print from a menu.
- PRINTER UTILITIES (#411)** Smorgasboard of utilities and tools.
- EPSON PRINTER UTILITIES (#326)** Spool, set up routines all designed for Epson codes.
- BANNER (#386)** Make long banners with large letters. Includes MS-FORTRAN source codes.
- WSMX80 (#526)** Allows Word Star to print more ways than you imagined on an Epson/Compatible printer. Useful for mathematical and scientific notation.

## SPREADSHEET TEMPLATES

- PC-CALC (#199)** Fabulous 123 work-a-like from the author of PC-File.
- (2) LOTUS 1-2-3 TEMPLATES AND MACROS (#406, 414)** Why spend hours writing your macros when these are ready made? Modify them yourself.

## TEXT PROCESSING TOOLS

- WORDSTAR AIDS (#375)** Collection of the most useful utilities for the Wordstar user.
- PC OUTLINE (#414)** Create and collapse and outline. Great for plans, essays, etc.
- PC-STYLE (#505)** Better than your high school English teacher! Analyzes your writing ability.
- POLYGLOT & LETTERFALL (#542)** Two educational programs to match sentences, words, and definitions. Q&A's. Typing tutor is great!
- SIDE WRITER (#523)** Print your text files sideways. Allows the 132 column barrier to be broken. Great for large spread sheets.

## UTILITIES

- GINACO (#66)** Polished routines written in basic for any beginner or expert. We love it!
- ULTRA-UTILITIES (#133, 245)** Recover lost files, modify sectors, etc. Like Nortons.

- SYSTEMU (#250)** Build a menu driven menu system. Excellent for hard disks.
- PC-DESKMATES (#405)** Better than Sidekick and all of the rest of the memory resident desktop utilities.
- ALIGN (#217)** Disk Alignment tool. Needs Cats Eye.
- TOP UTILITIES (#273)** All of the most requested utilities on one disk.
- UNPROTECT (#414)** Various routines to disconnect protection schemes.
- PATCHES (#376)** Make back up copies of some of the most popular commercial programs with this collection.
- DOSMATIC (#498)** Fabulous task-switching and menuing utility that allows several programs to run at once.
- PC-TOOLS (#536)** Lots of useful utilities with both EXE and ".C" sourcecode. BROWSE, DUMP, MERGE, WORD COUNT, ROFF, GREP, etc.
- DBS-KAT (#537)** Diskette cataloging system for archival purposes. Database can hold up to 9999 diskettes and 16,000,000 files.
- STILL RIVER SHELL (#481)** An enhancement of the PC-DOS working environment. Faster and uses Key Commands.
- PC-PROMPT (#558)** The on-line mode makes this memory resident utility tops. Great for beginners and advanced users alike.

## WORD PROCESSING

- PC-WRITE (2) (#78)** A & B Our most popular full featured word processor that is actually faster than Wordstar. Now with spelling checker.
- DICTIONARY (#378)** Dictionary type spelling checker.
- PC TYPE (#455)** Jim Button's contribution to a full fledged word processor.
- (2) NEW YORK WORD (#528, 529)** Powerful word processor that creates keystroke macros, split screen editing, mail merge and more. Watch out Micro-Soft.



Please  
Enclose  
Check  
With  
Order

TOTAL # \_\_\_\_\_ x \$6 = \_\_\_\_\_

DISK DIRECTORY \_\_\_\_\_ x \$6 = \_\_\_\_\_  
(Explanation of all files & programs)

OTHER \_\_\_\_\_

SUBTOTAL \_\_\_\_\_

TEXAS RESIDENTS ADD 6 1/2% TAX \_\_\_\_\_

SHIPPING AND HANDLING \_\_\_\_\_  
(1 @ \$1.00 and 50¢ for each additional disk)

**LONE STAR**  
SOFTWARE

No COD's or Purchase Orders • U.S. Funds Only  
Foreign Orders add \$5.00 to all Shipping/Handling  
We Warranty All Disks Against Defects In Duplication

SHIP TO: \_\_\_\_\_

CHARGE MY: \_\_\_\_\_

MASTERCARD  VISA

CARD NO. \_\_\_\_\_

EXPIRATION DATE \_\_\_\_\_

SIGNATURE \_\_\_\_\_

2100 Hwy. 360, Suite 1204, Grand Prairie, Texas 75050, (214) 647-1010 ©1987 LONE STAR SOFTWARE, INC.



**A MUST for Computers**

**VIZIFLEX SEELS**

**The Ideal Keyboard Cover!**

Protect your computer and **eliminate** downtime caused by liquid spills, contaminants, environmental hazards, etc. with VIZIFLEX SEELS - the **only** keyboard cover that:

- **Remains securely in-place** during the operation of the keyboard and will not interfere with computer performance in any way.
- **Is designed to "form-fit"** to the exact contours of the keyboard to provide superior tactile sensitivity & feel for individual keys.
- **Consists of Ultraflex™ material, a transparent, flexible "film"** which allows all "markings" to be clearly visible.

VIZIFLEX SEELS are the **only** keyboard covers for your computer!



Inquiry 310

**NEED CUSTOM HARDWARE? CALL US.**

Free quotes, affordable rates  
Rapid turnaround, in-house CAD  
Specializing in data acquisition, Interfacing, and microcontrollers for industrial and scientific needs.

**Human Devices**

46 East 91st St., NYC NY 10128  
212-996-5017

Inquiry 116

**SOFTWARE DUPLICATION SERVICES**



- World's Largest Duplicator
- Highest Quality
- Fastest Turnaround
- Attractive Cost Savings
- One-Stop shopping
- Copy Protections for all formats
- Professional Engineering Support
- Branches Nationwide
- A Division of XIDEX Corp.

**CALL 1-800-233-5099**

Inquiry 325

**SOFTPORT**

**SERIAL/PARALLEL ADAPTER WITH SOFTWARE SWITCHABLE SERIAL PORT**

- One RS232 serial port software switchable to one of four 25 pin D connectors
- One Centronics compatible parallel port
- Switching programs for command line and pop up operation
- Eliminates plug swapping and switch boxes
- Less expensive and more convenient than separate adapter and switch box
- For use with the IBM PC, XT, AT, and compatibles running PC or MS DOS
- LPT1 or 2, COM1 or 2, IRO3 or 4, and IRO5 or 7 are selectable
- By the manufacturer of ROMDISK PC
- Retail price \$195

**CURTIS, INC.** 22 Red Fox Road  
St. Paul, MN 55110  
612/484-5064

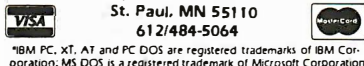

Inquiry 74

**ENCLOSURE POWER**



- \* Floppy's, Hard Disk, Optical Disk, Tape Drive, or any Combination
- \* Custom Design with Injection Molding Front
- \* Superb Quality and Pricing
- \* Prompt Delivery

**JMR ELECTRONICS, INC.**  
The Power Source Behind The Drive  
18559 1/2 Parthenia Street, Northridge, California 91324  
Outside CA (800) 635-5555  
CA (818) 993-4801

Inquiry 141

**ICs PROMPT DELIVERY!!!**  
SAME DAY SHIPPING (USUALLY)  
QUANTITY ONE PRICES SHOWN for DEC. 21, 1986

OUTSIDE OKLAHOMA - NO SALES TAX

	DYNAMIC RAM	
1Mbit	1000Kx1	100 ns \$38.50
51258	*256Kx1	100 ns 9.95
4464	64Kx4	150 ns 3.29
41256	256Kx1	100 ns 3.84
41256	256Kx1	120 ns 2.69
41256	256Kx1	150 ns 2.49
4164	64Kx1	150 ns 1.30
	EPROM	
27512	64Kx8	200 ns \$14.95
27C256	32Kx8	250 ns 5.51
27256	32Kx8	250 ns 4.96
27128	16Kx8	250 ns 3.77
27C64	8Kx8	200 ns 4.52
2764	8Kx8	250 ns 3.27
	STATIC RAM	
62256LP-	1232Kx8	120 ns \$14.95
62264LP-15	8Kx8	150 ns 2.95

640 Kbyte MOTHERBOARD KITS: Zenith 150, IBM PC/XT, Compaq Portable & Plus; hp Vectra

\* 5 MHz \$172.00  
\* 8 MHz \$270.00

OPEN 6 1/2 DAYS, 7 AM-10 PM SHIP VIA FED-EX ON SAT.  
SUNDAYS & HOLIDAYS: SHIPMENT OR DELIVERY, VIA U.S. EXPRESS MAIL.  
SAT DELIVERY INCLUDED ON FED-EX ORDERS  
RECEIVED BY: Th: Std Air \$6.14 lbs Fr: P-One \$13.2 lbs  
MasterCard/VISA or UPS CASH COD  
**Factory New, Prime Parts JIPCO**  
MICROPROCESSORS UNLIMITED, INC.  
24,000 S. Peoria Ave., (918) 267-4961  
BEGGS, OK, 74421 No minimum order  
Please call for current prices because prices are subject to change. Shipping & insurance extra. Cash discount prices shown. Orders received by 9 PM CST can usually be delivered to you the next morning, via Federal Express Standard Air = \$6.00, or Priority One = \$13.00

Inquiry 169

**VAR's OEM's RESELLER's**  
Save 20 to 40% Import Direct  
**818-889-1092**

**IBM-PC\* Logic Boards**

- XT Std. 4.7 MHz 640k Motherboard \$68 <sup>32</sup>
- SI 1.0 (Full IBM comp. w/BIOS-0k)
- XT Super Turbo 4.7-10 MHz \$105 <sup>22</sup>
- SI 3.7 (V-20, w/BIOS-0k)
- Baby 286 Turbo 6-10 MHz AT \$313 <sup>86</sup>
- SI 10.3 (fits Std. XT Box, w/BIOS-0k)
- Super Baby 286 6-12 MHz AT \$348 <sup>86</sup>
- SI 13.5 (fits Std. XT Box, w/BIOS-0k)

**IBM-PC\* Components (Partial List)**

- 80/132 M/G/P Herc. Compatible \$67 <sup>23</sup>  
(80x25, 132x25, 132x44, & 720x350)
- Color/Graphics/Printer \$49 <sup>12</sup>  
(640x200 RGB Std.)
- Multi Disk I/O \$57 <sup>23</sup>  
(Floppy Ctrl, Par, Ser, Clk, Cld)
- Amber Monitor Hi Res \$66 <sup>12</sup>  
(Tilt-swivel Base & Anti-glare Screen)
- RT/AT/XT Keyboard 5339 Style \$56 <sup>40</sup>  
(Hi-quality with great feel)
- DS/DD Floppy Drive \$59 <sup>87</sup>  
(Hi-quality w/Direct Drive motor)
- AT Mini Box w/Lock \$35 <sup>13</sup>  
(Perfect chassis for Baby 286's)
- Baby AT Power Supply \$78 <sup>22</sup>  
(180 Watts in a XT size)
- EGA Card w/Printer Port \$168 <sup>43</sup>  
(Now affordable)
- Super Modem Card \$184 <sup>64</sup>  
(300/1200/2400 Baud, Hayes Comp.)
- 2 Meg EMS Memory Card \$200 <sup>87</sup>  
(Full EMS Std. w/1 Meg RAM)
- 20 Meg Hard Disk Drive \$318 <sup>61</sup>  
(Half High, w/Ctrl)
- AT Portable Case Baby 286 \$497 <sup>22</sup>  
(AT Key, 180 Watts, Amber TTL)

ACS Imports specializes in buying custom and standard electronics components to fit your specific needs. We have years of expertise buying and importing components.

ACS Imports will solve your sourcing needs.

**Call: 818-889-1092**

**ACS Imports**

5311 Derry Ave. #A  
Agoura Hills, CA 91301  
TLX 510 601 8224  
FAX 818 889 5605

\*IBM is trademark International Business Machines  
All prices are FOB Taiwan - Import Quantities



# SAVE ON BUSINESS SYSTEMS

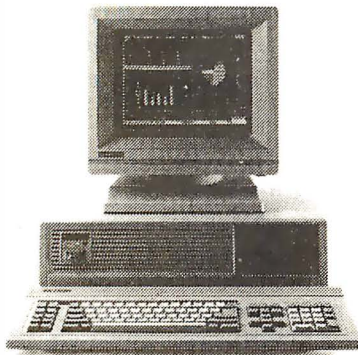

## MULTITECH ACCEL 900 6/10 MHZ Switchable speeds, AT Compatible

### INCLUDES:

- 80286 Processor
- 30MB Hard drive, 512K RAM, 1.2MB floppy
- Monochrome graphics and soft - White display
- 2 parallel & 1 serial port, clock calender
- 8 slots
- DOS 3.1
- Free Software
- FCC Class B approved

# \$2449

## 8mhz Turbo 20MB XT Compatible Computer



### INCLUDES:

- 640K Ram
- 1 floppy drive
- Ser. par. clock
- 8 slots
- Mono graphics
- Monitor
- Dos 3.2
- FCC Class B approved

# \$1,199.00

## 4.77mhz Floppy Drive System XT Compatible Computer



### INCLUDES:

- 640K Ram
- 2 floppy drive
- ser. par. clock
- 8 slots
- Mono graphics
- Monitor
- Dos 3.2
- FCC Class B approved

# \$829.00

\*Call for custom configurations on all systems

CALL FOR CATALOG • SOFTWARE • THOUSANDS OF PRODUCTS AVAILABLE • VOLUME DISCOUNTS

### SYSTEMS

IBM PC AT 6Mhz 30MB drive, 512K3,	100.00
IBM PC AT 8Mhz 30MB Drive, 512K	CALL
IBM PC XT 20MB drive, 640K	2,122.00
Sperry IT 44MB drive, 1 Meg	2,800.00
Compag Deskpro 286 30MB drive	2,999.00
Leading Edge	CALL
Multitech Plus 700 2floppydrive	775.00
Toshiba Systems	CALL

### IBM SOFTWARE

LOTUS 123	CALL
Symphony	CALL
ASHTON TATE dBASE III Plus	CALL
Q & A	CALL
REVELATION	499.00
POWERBASE	199.00
CLIPPER dBASE III Compiler	355.00
LATTICE C COMPILER	265.00
LET'S C Compiler	49.00
SUPERCALC IV	275.00
MULTIMATE ADVANTAGE	269.00
MICROSOFT Multiplan	119.00
EXCEL	245.00
Word	CALL
Windows	65.00
DOS 3.2 W/GW basic	69.00
Quick Basic	65.00
BOREALD TURBO PASCAL	42.00
Turbo Pascal W/BCD	60.00
REFLEX	CALL
LIGHTENING	59.00
Superkey	41.00
Sidekick	50.00
NORTON UTILITIES	55.00

FASTBACK	95.00
CROSSTALK XVI	99.00
MIRROR Comm Software	49.00
PEACHTREE Back to Basics	199.00
OPEN SYSTEMS	CALL
BPI General Accounting	299.00
PEACHTREE Business System	157.00
ONE-WRITE PLUS	149.00
ACCOUNTING PARTNER	199.00
MONOGRAM DOLLARS & SENSE	99.00
TOBIAS MANAGING YOUR MONEY	99.00
DAC EASY ACCOUNTING	45.00
PFS First Choice	89.00
PFS Professional Write	115.00
PFS Professional File	145.00
SATELLITE WORD PERFECT	209.00
WordStar 2000 PLUS	299.00
GENIFOR	CALL
RBASE System V	370.00
FUNK SIDEWAYS	39.00
HARVARD TTL PROJECT MNGR	285.00

### HARDWARE

AST 6 pack Plus W/384K	CALL
6 pack premium W/256K	289.00
RAMPAGE	CALL
HERCULES MONO Graphics Plus	189.00
Intel Above Board	CALL
JRAM 3	CALL
Microsoft Mouse W/Stlwr.	117.00
Mouse Systems Mouse	119.00
Orchid Tiny Turbo	449.00
Turbo 286E	749.00
Genoa spectrum	SAVE
Spectra EGA	SSAVE
Paradise Autoswitch EGA	388.00

Quadram EGA+	349.00
STB EGA+	255.00
Companion PC 0-2MB LIMS	189.00
Multifunction card 384K,S.P.Clk	139.00
AT Multifunction card 0K-3MB	175.00
Monochrome graphics card	85.00
Color graphics card	89.00

### DRIVES/TAPE DRIVES

20 MB Seagate drive	379.00
30 MB Seagate for XT	479.00
30 MB drive for AT	649.00
360 K Floppy for AT	110.00
Teac 55B	99.00
20 MB Hard Card	429.00
Plus Hard card	CALL
Mountain Hard card	CALL
10 MB Irwin	359.00
20 MB Irwin	429.00
Everex Stream 20	569.00
Everex Stream 60	899.00
Peacchtree	CALL
Franklin 20 MB	399.00
GENOA 20MB tape B/U	SAVE
GENOA 60MB tape B/U	SAVE
ALLOY	CALL

### PRINTERS

PANASONICKX-P1080i	CALL
KX-P1091i	SAVE
KX-P1092	299.00
KX-P1592	419.00
KX-P1595 240 CPS	CALL

KX-P3131 17cps Daisy	249.00
KX-P3151 22cps Daisy	385.00
Citizen MSP-10	275.00
MSP-15	389.00
EPSON FX-286	CALL
LO-1000	CALL
BROTHER-1509	369.00
M-1409 dot matrix	CALL
HR-20 Daisy wheel	369.00
OKIATA-All Models	CALL
TOSHIBA All Models	CALL
CANNON Laser Printer	1,999.00
HEWLETT PACKARD LAZER	2,199.00
HOUSTON INSTRUMENTS	CALL
CORDATA LASER	CALL

### MONITORS/MODEMS

Amdek 310 A	149.00
Color 600	389.00
Color 722 RGB 720 X 350	495.00
Princeton Graphics HX-12	399.00
HX-12E (Enhance graphics)	499.00
MAX-12	149.00
TAXAN all models	CALL
NEC Multisync	CALL
IBM Compatible Monochrome	89.00
Color RGB Monitor (640 X 200)	269.00
Anchor Lightning 2400	299.00
Volksmodem 1200 (5 yr wrnty)	139.00
Volksmodem 1200 Internal	120.00
Hayes 1200	379.00
2400	CALL
Prometheus 2400	359.00
Promodem 1200	239.00
Promodem 1200B	179.00
Promodem 1200A	189.00

# COMPUTERBANC

6951 Warner Ave., Huntington Beach, CA 92647

Customer Service Call 714-841-6160

Technical Service Call 714-847-BANC



Orders Only  
OUTSIDE CALIFORNIA

# 800/332-BANC

# 714-841-6160

Cash prices indicated. We guarantee all items for 30 days. Within this period, defective merchandise returns must be accompanied by RMA number. All other returns will be subject to a 15% restocking fee. For prepaid orders, there will be a 3% shipping charge; 5% for UPS Blue Label; \$5.00 minimum; California residents add 6% sales tax.

Prices subject to change without notice.  
©Copyright 1985 COMPUTERBANC, All Rights Reserved.



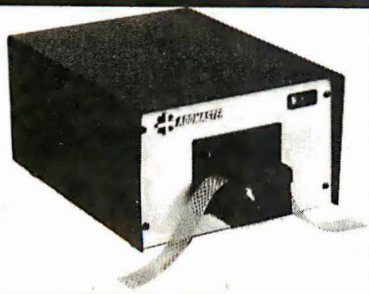

**RS232C IBM PC Compatible  
Paper Tape Transmitter/Model 612**

Stops and starts on character at all speeds, uses manual control or X-on, X-off 90-260 volt, 50-60 Hz power. 50-9600 baud, up to 150 char/sec synchronous or asynchronous; gated internal or external clock, RS 232C, current loop or parallel output, reads 5-8 level tape, 7-11 frames per character, even or odd parity. Desk top or rack mount.

Addmaster Corporation, 2000 S. Myrtle Ave., Monrovia, CA 91016, (818) 358-2395, Telex 674770 Addmaster SGAB

Inquiry 5

**EPROM  
PROGRAMMER  
\$349**



The EP-1 is a great value, here's why:

- IBM PC Software included or RS-232 to any computer
- ASCII Command driven operation. All intelligence in unit
- Reads, Programs, Copies over 150 types from 2716 to 27512
- Optional Intel microcontroller programming head
- Menu-driven Chip Selection, No Personality Modules
- Fast, Slow, Quick-Pulse Programming Algorithms
- Intel (8080 & 8086), Motorola, Tekhex, Straight Hex Files
- Splits Files by Base Address and Odd/Even (16 bit systems)
- Gold Textool ZIF IC socket
- Generate & Set Checksums
- Over-Current Protection
- 8 Baud Rates 300 to 38,400
- Full One-Year Warranty
- 5.125, 21.25V Programming
- U.V. Erasers from \$34.95
- Same Day Shipment

**BP MICROSYSTEMS**

10681 Haddington, #190 / Houston, TX 77043  
(713) 461-9430 (800) 225-2102

Inquiry 43

**When MEDIA CONVERSION Fails,  
DATA TRANSLATION Prevails!**

Use your data among mainframes, minis, micros, dedicated word processors, and typesetters! We offer translation of the logical elements of data in addition to conversion of physical parameters, NOT just dumping or ASCII transfer from one medium into another. For example:

- Translation of the control characters and formatting features of stand-alone or microcomputer-based **word processors**.
- **Database** restructuring—Even from your word processors' File and List Managers.
- **Spreadsheet** translations—formatting, cell referencing codes, and formulas.
- **State and federal** compliances—Magnetic media and file-structure conversions.

ADAPSO member

CompuData Translators, Inc. 6565 Sunset Blvd. Suite 301, Hollywood, CA 90028 (213) 462-6222

Inquiry 58

**Heritage Systems Corp**

HSC-9100  
80 By 24  
Or 25 Line  
Alpha-numeric  
Video Terminal  
Card

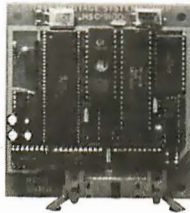

ANSI X3.64/Other Terminal Emulations  
50 To 38.4K Baud Serial Port  
RS-232 Or TTL/CMOS Versions  
IBM PC Compatible Keyboard Input  
EEPROM Based On Screen Config  
Composite or Separate Video  
100 By 100mm Card 5V Only @ 200mA  
**\$1391 TTL/CMOS \$149 RS-232**

PO Box 10588,  
Greensboro, NC 27404-0588  
(919) 274-4818  
TLX WVI 6503057397

Inquiry 113

**COLOR  
VT220 \$150**

\*plus your PC, XT, AT, or compatible

ZSTEMpc-VT220 Smart Terminal Emulator  
Double high/double wide characters  
Full line graphics. Smooth Scrolling  
2-way file transfers incl. XMODEM & KERMIT  
Full keyboard softkeys/MACROS. DOS access  
Data rates to 38.4 KB. High throughput  
CGA, Hercules, MDA, & EGA support  
8-bit mode, downloadable fonts,  
user defined keys, full national/multinational modes  
ISO and attribute mapped color  
ZSTEMpc-VT220 \$150. 4010/4014 option \$99.  
Available soon: VT220 Style replacement keyboard  
ZSTEMpc-VT100 \$99. - Choice of the U.S. A/F  
30 day money back guarantee. MC/VISA

**KEA SYSTEMS LTD.**

#412 - 2150 W. Broadway  
Vancouver, B.C. CANADA V6K 4L9  
Support (604) 732-7411  
TELEX 04-352848 VCR

Order Toll Free (800) 663-8702

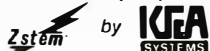

Inquiry 144

**EPROM  
PROGRAMMER  
FOR PC \$129.95**



- 2716 to 1 MEG
- Updateable to 32 MEG
- Programs 2764 A in 10 Seconds
- Menu Driven Software
- External 40 PIN ZIF (PC only)
- 90 Day Warranty
- 10 Day Money Back Guarantee
- Available for APPLE II \$92.50
- For More Information Call



NEEDHAM'S ELECTRONICS  
1121 Las Palmas, Sacramento, CA 95815  
(916) 924-8037 (M-F) 8 AM to 5 PM PST

Inquiry 187

**DISKETTES  
5 1/4" PC-Pack**

100% Tested & Certified Error Free, at "Minimum 55% Clipping Level or Higher" Lifetime Warranty? Poly-Bagged in Fifty & Made in the U.S.A. With Tabs, Labels & Tyvek Sleeves

Double Side - Double Den.

**.28¢ each** (100) **.39¢ each**  
(250) **.34¢ each**  
(1000+) (500) **.31¢ each**

Shipping Charges Vary With Quantity Call

Old Reliable Diskette Connection  
Delaware 1-800-541-1849  
Oklahoma 1-800-654-4058  
Nevada 1-800-621-6221

Minimum order 25.00 - Visa, MasterCard accepted, COD add 3.00. UPS delivery. US Mail for APO, FPO AK, HI, or PR add 5% additional for PAL.

**PRECISION**  
Manufactured by Xidex

5 1/4" S-Side D-Density | 5 1/4" D-Side D-Density  
**5.25 PER BOX** | **5.55 PER BOX**  
(MINIMUM FIVE BOXES)

**5 1/4" High Den. 13.95**

Old Reliable Diskette Connection  
Delaware 1-800-541-1849  
Oklahoma 1-800-654-4058  
Nevada 1-800-621-6221

Minimum order \$25.00 - Visa, MasterCard accepted. C.O.D orders add \$3.00 - Surface Shipping; on 3.5 or 5.25" add \$3.00 per 100 disks. \*Add \$4.00 per 100 disks. UPS delivery only. U.S. mail for APO, FPO, AK, HI or PR add an additional 5% for PAL. Prices subject to change without notice!

**3M** LIFETIME WARRANTY

Call For Quantity Discounts

5 1/4" Disks	Data Cartridges	3 1/2" Disks
S-Side	DC 100A 12.95	S-Side <b>13.95</b>
D-Den <b>7.95</b>	DC 1000 12.95	D-Side <b>19.95</b>
D-Side <b>9.95</b>	DC300A 16.60	
S-Side <b>15.75</b>	DC 300XL 19.55	8" Disks
D-Side <b>19.75</b>	DC300XLP 19.85	S-Side <b>15.40</b>
HIGH DEN. <b>21.95</b>	DC 800A 22.00	S-Side <b>18.95</b>
	HEAD CLEANERS	D-Side <b>20.95</b>
	12.75 EA.	
	30 Cleanings	

Old Reliable Diskette Connection  
Delaware 1-800-541-1849  
Oklahoma 1-800-654-4058  
Nevada 1-800-621-6221

Minimum order \$25.00 - Visa, MasterCard accepted. C.O.D orders add \$3.00 - Surface Shipping; on 3.5 or 5.25" add \$3.00 per 100 disks. \*Add \$4.00 per 100 disks. UPS delivery only. U.S. mail for APO, FPO, AK, HI or PR add an additional 5% for PAL. Prices subject to change without notice!



# California Digital

17700 Figueroa Street • Carson, California 90248



**\$59.95**

## IBM Thermal Printer

Manufactured by IBM for use with the PC/jr. This 80 column thermal printer is ideal for fast low cost drafts. The printer is capable of interfacing to any computer with an 1200 baud RS-232 serial port. Accepts either fan fold or 8 1/2" roll fed thermal paper. Will "NOT" accept standard writing paper.

Nine pin head allow the IBM thermal printer to output extended foreign character set, math symbols and bit image graphics. At \$59.95 we expect this to be a quick sell out.

## IBM 8MHz./XT Compatible



**\$579**

- DOS 3.2 & GW Basic
- Eight Expansion Slots
- 135 Watt Power Supply
- 256K Expandable to 640K on Motherboard
- Double Sided Double Density Disk Drive
- IBM/AT Type Keyboard (with LED Indicators)

The Eclipse Turbo 16/XT is an outstanding value in IBM Compatible Computers. After careful research and evaluation we found it to be the most reliable XT compatible available.

The computer includes some of the most recent features available, such as the 8 MHz. (software selectable to 4.77 MHz.) multi-layer motherboard with 256K of RAM upgradable on board to 640K. A generous eight expansion slots and 135 Watt power supply give you ample room and power for add-on boards. And our floppy controller supports up to four drives, so as many as three additional drives can be added. The units is complete with manuals, GW Basic and the new version of MicroSoft DOS 3.2 along with the AT style keyboard.

The Turbo 16/XT is FCC and Underwriters Laboratories approved. Finally, each computer is configured and fully tested before sending it to you.

**Satisfaction Guaranteed!** We're really excited about this new unit, and so sure you will be too... that you may return the Eclipse 16 for a full credit towards an IBM PC if you are not completely satisfied.

20MB Hard Drive w/Controller ....\$429	8087 Math Co Processor .....119	Summagraphics SummaMouse .....139
30 Megabyte HardCard .....459	Color Graphics Card .....79	Upgrade from Floppy Controller to Disk I/O 2 drive controller, clock/cal., software parallel, serial, & game ports 79
Additional Drive-Installed .....99	Monochrome Graphics Card.....99	1200 Internal Modem w Software 129
1rw n 10 Meg. Tape Backup up .....489	RGB Color Monitor.....199	
Upgrade from 256K to 640K RAM ...79	TTL Monochrome Monitor.....139	

## 21 Megabyte Gold Card

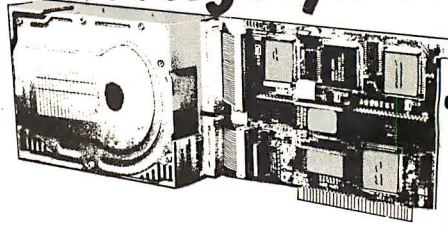

**\$479**

Also available 31 Megabyte at only \$559.

The fastest, lowest powered, longest warranted, most durable, highest capacity, most reliable, lowest priced HARD-DISK-ON-A CARD available in the world today.

- 65ms Access Time - Fastest Available
- Automatic Head Unloading
- Protects Heads and Media
- 2K Sector Buffer - Increases System Throughput
- High Reliability: 28,000 hr. MTBF
- No one else even close
- 15.5 Watt Power Consumption - Lowest Available
- 2 Year Warranty - Longest Available

## NOW YOUR COMPUTER CAN READ!!

Omni-Reader... the first optical character reader designed and priced for the small computer

**\$179**

### COPY:

- Manuscripts
- Contracts
- Articles
- Forms
- Invoices

### APPLICATIONS:

- Mailing Lists
- Editing
- Data Base Management
- Transferring information between incompatible systems

Uses a standard RS-232 serial port hookup to interface easily with your computer.

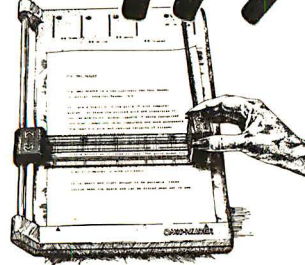

## 1200 BAUD MODEMS

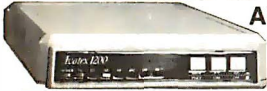

AVATEX 1200

**\$99**

This 300/1200 baud modem matches the design specs of the Bell 212A, feature by feature, bringing you reliability, impeccable transmission and easy operation.

Hayes Compatible, except for "S" register. Communication software included.

The AVATEX 1200, at \$99, is a steal!



SMARTTEAM 1200

**\$159**

The Team 212A offers all the features of the Hayes Smart Modem 1200 for a fraction of the price. Now is your opportunity to purchase a 1200 baud modem at the price of a 300 baud modem.

## U.S. Robotics 2400 Internal

**\$189**

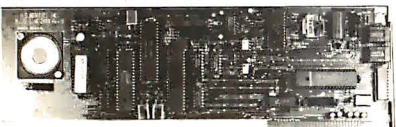

Fully Hayes 2400 baud compatible. Auto dial, auto answer, auto everything only \$189.

## ECLIPSE 2400 BAUD MODEM



**\$299**

- Hayes & Bell 212A/103 Compatible
- CCITT V.22, V.22 bis

The ECLIPSE 2400 modem is a microprocessor-based full or half-duplex modem incorporating the latest in high speed data communications capabilities. It also accommodates computers and terminals equipped with an RS-232 port allowing communication with other computers or timesharing systems either locally or remotely. Compatibility, Versatility and Performance are yours in a configuration designed to provide years of reliable operation.

## MODEMS

Eclipse 1200 100% Hayes, with status lamps.	EDP-1200	149.00
Eclipse 1200B internal with software	EDP-1200B	139.00
Eclipse 2400 External, Hayes Compatible	EDP-2400	299.00
Avatech 1200 baud external, Hayes	AVA-1200	99.00
Hayes Smartmodem 2400 baud modem	HYS-2400	599.00
Fujitsu 2400/1200 baud auto everything.	FUJ-1935D	459.00
Team 1200 Hayes Compatible, 300/1200 baud.	TEM-1200	159.00
Smarteam 1200B IBM 1200 baud card	TEM-1200B	159.00
UltraLink 1200 data and voice on same line.	UTL-1200A	99.00
CTS 212AH 1200 baud, autodial	CTS-212AH	179.00
Terminal software for CTS 212AH	CTS-212SFT	35.00
Prometheus 1200 super features	PRM-P1200	289.00
Prometheus 1200B internal PC	PRM-P1200B	279.00
Signaman Mark VI, 300 baud internal PC	SGL-MK6	49.00
Hayes Smart Modem 1200 baud, auto dial	HYS-212AD	369.00
Hayes 1200B for use with the IBM/PC, 1200 baud.	HYS-1200B	339.00
Hayes Chronograph, time & date	HYS-CHR232	199.00

## Seagate 30 MEGABYTE WINCHESTER HARD DISK KIT

**\$459**

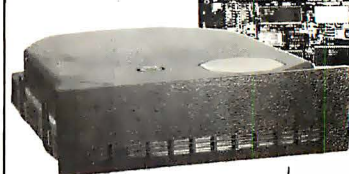

Five Inch Winchester Disk Drives

each two+

SEAGATE 225 20 Meg. 1/2 Ht.	329	299
SEAGATE 4026 26 M. 35mS.	759	729
SEAGATE 4051 51 M. 35mS.	995	959
FUJITSU 2242 55 M. 35mS.	1599	1529
FUJITSU 2243 86 M. 35mS.	2095	2019
RODIME RO-202E	27 Meg.	659 629
RODIME RO-203E	40 Meg.	995 959
RODIME RO-204E	53 Meg.	995 959
CONTROL DATA	94155-86 M.	1829 1779
MAXTOR XT1140	140 Meg.	2995 2929
HONEYWELL	85M. 27 mS.	1795 1695
TOSHIBA MK5670 M.	30mS.	1789 1729
TANDON	502 10 Meg.	419 379

- Winchester Controllers for IBM/PC
- XEBEC 1220 with floppy controller
- DTC 5150BX
- OMTI 5510 half card
- ADAPTEC 2070 RLL controller
- ADAPTEC 2010A
- WESTERN DIGITAL WD/1002
- SCSI/SASI Winchester Controllers
- XEBEC 1410A 5 1/4" foot print
- OMTI 20L

- Winchester Accessories
- Installation Kit with manual
- Winchester enclosure and supply
- Dual 20/34 cable set
- Switching power supply

TOLL FREE ORDER LINE  
**(800) 421-5041**

TECHNICAL & CALIFORNIA  
**(213) 217-0500**



# California Digital

17700 Figueroa Street • Carson, California 90248

## Bernoulli Box

was \$3540 now only

**\$1595**

The Bernoulli Box by Iomega, features 10 and 20 megabyte removable cartridges, and delivers reliability, expandability, transportability, security and speed in one versatile subsystem. It lets you transfer megabytes of information safely and swiftly for primary or backup storage. Or combine several software programs onto a single cartridge for easy switching from one to another. Reliable... the Box has incredible resistance to shock and vibration completely eliminating the possibility of head crash.

Expandable... grow at your own pace by adding inexpensive cartridges. When security is essential, don't lock up your system... just lock up the cartridges. The Bernoulli Box delivers performance that often exceeds the best of hard disk speed and the convenience of floppy disks. At these prices don't be caught wishing you had one after a loss of irreplaceable data.

	List	Our Price
10+10 Meg.	A2210H	\$3450 1595
20+20 Meg.	A2220H	4540 2095
Bootable Controller		255 159
10 Meg. Cartridge		79 49
20 Meg. Cartridge		99 65



**FOUR PEN COLOR PLOTTER \$159**

The manufacturer has asked us not to publish their name. But this four color plotter was produced by one of the World's largest makers of personal computers.

The 410 color plotter will connect to the serial port of virtually any micro-computer. Simple ASCII commands direct one of the four color pens to draw circles, arcs or ellipses on paper or transparency material up to 11 by 17 inches. The plotter is capable of producing the full upper and lower case alphabet along with seven international character sets. Text can be printed horizontal, vertical or diagonal in sizes from 1/16 to 6 inches, slanted forward or backward to 85 degrees.

Enlargements or reductions are achieved through elaborate firmware. Pen travel is four inches per second with .004" pen resolution. Standard pens are available in an assortment of 32 different colors and widths.

The ideal plotter for architecture, CAD engineering or graphic design. At \$595 it was a great buy, at \$159 its a steal. Support packages for specific computers available. Manual only \$15 refundable upon purchase or plotter.

**SONY** 53W Floppy Disk Drive  
3 1/2" New IBM portable compatible

**\$139**



**5 1/4" DISK DRIVE**

**\$65**



Quantity Two

One Two Ten

QUME 142 half height	69	65	call
TEAC FD55BV half height	109	99	89
TEAC FD55FV 96 TPI, half ht.	119	109	105
TEAC FD55GF for IBM AT	169	159	155
PANASONIC 455 Half Height	109	99	89
PANASONIC 475 1.2 Meg./96	119	115	109
MITSUBISHI new 501 halfht.	129	119	109
MITSUBISHI 504A AT comp.	169	159	155
Switching power supply			49
Installation Kit with manual			10
Dual enclosure for 5 1/4" drives			59
34 pin edge connectors			5
Scotch head cleaning kit			19
Flip & File Storage tubs			15

## Adeus Daisy Wheel

**\$159**



The Adeus CP/2000, is a 22 character per second daisywheel printer which accepts 96 character Diablo wheels and ribbons. This printer was manufactured by the Olympia Typewriter Company for Cosmo World USA. This unit will print 10, 12 and 15 characters per inch proportionally spaced with increments of 1/120". Bi-directional printing, 2 K/Byte buffer (expandable to 6K) and both serial and Centronics parallel interfacing make the Adeus CP/2000 an exceptional buy at only \$159. Original price \$595.

## Sweet P 100 Plotter

**\$159**



The Sweet "P" 100 was private labeled for the Epson corporation under the Comex Brand. This plotter makes short work of translating financial and numeric data into a graphic presentation. Many ready to run programs such as Auto/CAD, Lotus 1-2-3, and Visi-on already support this plotter.

The Sweet "P" 100 features programmable paper sizes up to 8 1/2 by 120 inches. 6 inch per second plot speed and 0.004" step size. Easy to implement Centronics interface allows the Sweet "P" 100 immediate use with the printer port of most personal computers. Also available is a support package which includes demonstration software, interface cable, a multicolor pen assortment and a variety of paper and transparency material.

## PLOTTERS

Four pen color plotter, 11 by 17 IBM/PC compatible	APL-410	\$159
Sweet "P" 100 (Comrex) 8 1/2 by 120"	COM-C1	\$159
Houston Instruments DMP29, 11 by 17	HOU-29	1779
Houston Instruments DMP40, 11 by 17, B size	HOU-40	959
Houston Inst. DMP51/52MP C/D, 14 pen plotting	HOU-41	3779
Houston Instruments DMP56, E size 34 by 44	HOU-51MP	4859
Houston Instruments PC695, 11 by 17 multi-pen	HOU-56	4795
Roland DYX-101 flat bed 11 by 17	ROL-101	419
Roland DYX-800 11 by 17 multi-pen 8 color	ROL-800	899
CalComp 1043GT plotter	CCP-1043	7999

### DIGITIZERS • MOUSE

Hitachi Tiger Tablet 11 by 11"	HIT-TT2	615
Summagraphics Summasketch 12" 4 button	SUM-SK12	399
Summagraphics SummaMouse 100 line resolution	SUM-MS	99
MicroSoft serial mouse with paint brush	MST-MS232	139
MicroSoft serial mouse card w/paint brush	MST-MSB	129

## Dragon Computer

**\$89**



Compatible with most RadioShack Color Computer software. The world famous Dragon computer is now available in the United States. Manufactured by the Tano Corp. under license of the British Broadcasting Company. The Dragon comes complete with 64K Byte of memory, serial modem port along with a Centronics printer interface. This unique microcomputer features Motorola's advanced 6809E microprocessor and comes standard with Microsoft Color Basic, data base manager, and a complete word processing package. The computer outputs color composite video along with R.F. video that allows the unit to be used in conjunction with any color television. This is the ideal low cost computer to be used with any dial up information system such as the Source, EasyLink or any other time share service.

**CP/M 2.2 \$14.95**

For years standard of the micro-computer industry. Original cost of Digital Research's CP/M 2.2 was \$189. With manuals and diskette \$14.95 or by ten at only \$9.95.



## Hi-Res RGB Monitor

**\$189**



Manufactured by Apple Computer, this high resolution monitor features a 12 inch 600 by 400 pixel screen with power tilt. Ideal for use on PC compatibles. An excellent value at \$189.

**\$39 DEC Q Buss**

The DEC H9281 backplane was manufactured by Digital Equipment for use in their PDP11/23 computer. Four slots dual height suitable for use on all kinds of Q-Buss Systems.

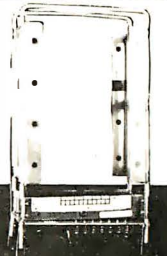

## PRINTERS

### MATRIX PRINTERS

NEC/P7 132 col. par interface	NEC-760	659 00
Star Gemini NB-15, 300cps, 136 col. 24 wire head	STR-NG15	1299 00
Star Gemini NX-10, 120 cps/30cps N.O. tractor	STR-NX10	319 00
Citizen MSP100T, 60 char/sec.	CI-MSP10	359 00
Panasonic KX10911 120 cps, draft, 29 NLO, fract & friction.	PAN-KX10911	27900
Panasonic KXP3151 132 col. 22cps NLO	PAN-KX10911	449 00
Okidata 182P/IBM parallel 9 1/2" paper	OKI-182P	239 00
Okidata 192A parallel interface, 160 char/sec.	OKI-192	379 00
Epson LX-80 10" 120 Char/sec.	EPSLX-80	279 00
Epson LQ800 near letter quality	EPSLQ800	629 00
Epson FX85 160 cps, draft 32 cps, N.O. 240 dot/inch.	EPS-FX85	439 00
Epson FX286 132 col. 200cps 29cps N.O. graphics	EPS-FX286	619 00
DataProducts B-600-3, band printer 600 LPM	DPS-B600	6985 00
Printonix P300 high speed printer 300 lines per minute.	PTX-P300	3995 00
Printonix P600 ultra high speed 600 lines per minute.	PTX-P600	5795 00

### WORD PROCESSING PRINTERS

NEC8810 55 char/second, serial interface	NEC-8810	1179 00
NEC8850 55 char/sec, par interface	NEC-8850	1179 00
NEC3550 popular printer designed for the IBM/PC	NEC-3550	819 00
Silver Re d EXP800, 25 cps, 10/12/15 pitch, serial/par.	SRD-EXP800	519 00
Silver Re d EXP800 same as 600 but 40 char/sec.	SRD-EXP800	729 00
Diablo 620, proportional spacing, horz. & vert. tab, 20 cps.	DBL-620	299 00
Juki 6100, 18 char/sec.	JUK-6100	459 00
Juki 6300, 40 char/sec.	JUK-6300	769 00

## Quick-Link 300

**\$59**



The Quick-Link 300 gives you an instant link to any dial up data base. Such as Dow Jones, Western Union or the Source. The Quick-Link has four user programmable log-on keys, allowing the operator, with only one key stroke, to dial the data base, log-in and give the password. All this information is permanently stored in non-volatile RAM.

Features include video output to television or monitor, auto dial, auto-log, full sized keyboard, 300 baud modem and 1200 baud auxiliary printer port. All this is available for only \$59.



Shipping: First five pounds \$3.00, each additional pound \$.50. Foreign orders: 10% shipping, excess will be refunded. California residents add 6 1/2% sales tax. • COD's discouraged. Open accounts extended to state supported educational institutions and companies with a strong "Dun & Bradstreet" rating.





# UNIX/PC-DOS ENGINE

XK-186, A FAST, COMPLETE SINGLE BOARD COMPUTER

\$595<sup>00</sup>

Runs PC-DOS and Unix workalikes



■ 10 MHz - no wait state, 16 Bit 80186 Processor

■ 512 KB RAM Standard - expandable to 1 MB

■ Full hard disk support

■ Includes 2 serial ports, floppy disk interface, centronics ports, expansion interface and battery-backed clock.

**RISK FREE TRIAL!**

Call and ask about our risk free evaluation.

(415) 345-4040

**CARINT** Limited

One Waters Park Drive, Suite 101 San Mateo, California 94403 USA Telex: 756224

Inquiry 50

# DATA ACQUISITION TO GO INTERFACE FOR ANY COMPUTER

## FREE IBM SOFTWARE



Connects via RS-232. Fully IBM compatible. Built-in BASIC. Stand alone capability. Expandable. Battery Option. Basic system: 16 ch. 12 bit A/D, 2 ch. D/A, 32 bit Digital I/O. Expansion boards available. Direct Bus units for many computers.

(201) 299-1615

P.O. Box 246, Morris Plains, NJ 07950

**ELEXOR**

Inquiry 89

# Get the whole story on graphics terminal emulation.



To find out more about software that lets your PC emulate TEKTRONIX™ 4105/6/7/9 and DEC VT100™ terminals, call or write:

**GRAFPOINT**

4340 Stevens Creeks Blvd., Suite 280, San Jose, CA 95129 (408) 249-7951

Inquiry 106

Expand your options!

# DISK UPGRADE BIOS for ATs

## Forget Drive Table Limits!

- Use any Compatible Drive on the AT Controller
- For DOS, UNIX, XENIX . . .
- Plug-in Installation
- Includes set-up and low-level format

## DUB-14 GOLDEN BOW SYSTEMS

\$95

\$3 shipping/handling California orders add 6%



2870 Fifth Avenue Suite 201 San Diego, CA 92103 619/298-9349

Inquiry 104

Why waste time?

# ACCELERATE with VCACHE™

## HARD DISK ACCELERATOR

- Caching eliminates repetitive disk accesses
- Use up to 15 Mb of extended/expanded or 500 Kb of standard memory

## DISKETTE ACCELERATOR SCREEN ACCELERATOR VCACHE GOLDEN BOW SYSTEMS

\$65

Add \$3 for shipping/handling California residents add 6% sales tax



2870 Fifth Avenue Suite 201 San Diego, CA 92103 619/298-9349

Inquiry 105

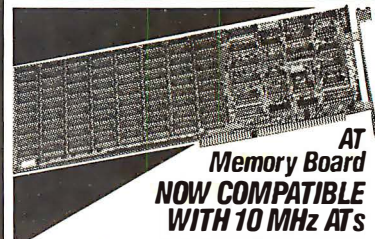

## AT Memory Board NOW COMPATIBLE WITH 10 MHz ATs

MRB 2010 memory board that expands ATs to run multiple programs for multitasking operations is now capable of running at 10 MHz. These upgraded boards enable AT systems to operate at higher speeds and are compatible with Xenix, Unix, and other multiuser systems.

- MRB 2010 features include:**
- 2 megabytes per board — use up to 3 boards
  - Compatibility with many other memory boards
  - 10 MHz operation with IBM ATs
  - Installation in less than 10 minutes

Call now for information on how the MRB 2010 can expand the multitasking options of your AT system.

**STAR GATE TECHNOLOGIES INC.**  
33800 Curtis Blvd. Eastlake, OH 44094 (216) 951-5922

Inquiry 278

# 9-TRACK MAG. TAPE SUBSYSTEM FOR THE IBM PC/XT/AT AND...



For information interchange, backup and archival storage, IBEX offers a 9-track, IBM format compatible 1/2" magnetic tape subsystem for the IBM PC, featuring:

- IBM format 1600/3200 and 800 cpi.
- Software for PC-DOS, MS-DOS.
- Also for DEC, VAX, VME, S-100, RS-232, IEEE 488.

**IBEX**

IBEX COMPUTER CORP.  
20741 Marilla St.  
Chatsworth, CA 91311  
(818) 709-8100  
TWX: 910-493-2071

Write, phone or TWX for information.

Inquiry 120

EVSAN		Order Toll Free:	
P.O. Box 2143 Daly City, CA 94017		(800) 443 - 8853 Tel. (415) 991 - 1051	
V - 20	8mhz 9.00'	V - 30	8mhz 11.00
<b>Math Co Processors</b>			
C8087	8mhz 142.00	80287	8mhz 275.00
C8087	5mhz 102.00	80287	6mhz 168.00
<b>DYNAMIC RAMS</b>			
1 NEG	150/100ns 36.00	27512	250ns 15.00
41256	100ns 4.50	27256	250ns 5.10
41256	120ns 2.85	27C256	200ns 6.90
41256	150ns 2.50	27C256	250ns 6.40
4464	120ns 4.25	27128	150ns 4.50
4464	150ns 3.78	27128	250ns 3.60
4128	150ns 3.95	2764	200ns 3.60
4164	120ns 1.20	2764	250ns 3.10
4164	150ns 0.98	2564	450ns 7.50
<b>COLOR GRAPHIC CONTROLLER</b>			
07220AD	18.50	2532	450ns 4.25
		2716	450ns 2.95
		2708	450ns 2.25
<b>STATIC RAMS</b>			
43256L	120ns 22.50	62G1L	150ns 2.85
5865PL	150ns 3.25	5564PL	150ns 5.25
6116L	150ns 1.60	6116P	150ns 1.40
4016	150ns 1.40	2016P	100ns 1.50
<b>FLOPPY DISK DRIVE:</b>			
	TEAC	5L	F0558
	FUJITSU	5L	M2551
			94.00
			82.00
<b>INTERFACE:</b>			
	0.32	1489	0.32

TERMS AND CONDITIONS: PRIME PARTS 100% GUARANTEED  
1) Prices subject to change, PLEASE CALL for CURRENT & VOLUME PRICING. MINIMUM ORDER ..... \$10.00  
2) SHIPPING & HANDLING UPS Ground ..... \$ 3.00  
ONE POUND CHARGES UPS 2nd DAY ..... \$ 4.50  
California Resident subject to sales tax.  
3) 3% SURCHARGE ON CREDIT CARD CHARGES  
OFFICE HOURS: MON to FRI 7:30AM to 5:30 PM

Inquiry 93

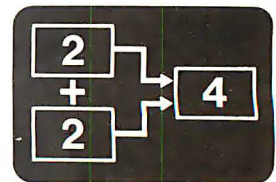

## PICTURES THAT THINK

Boxes & Arrows™ is an IBM PC-based block diagram editor and computing system. If you are looking for something more than a spreadsheet, Boxes & Arrows will let you combine computation with pictorial representation.

- Automatic box & line drawing
- Labels and algebraic formulas
- Any printer, any display
- No limit to diagram size
- Call or write for full details

**inner loop**  
software

Inner Loop Software  
5456 McConnell Avenue  
Los Angeles, CA 90066  
(213) 822-2800

Inquiry 123



# IBM SOFTWARE

OVER 10,000 IBM/COMPATIBLE PUBLIC DOMAIN PROGRAMS AVAILABLE FROM OUR

"INTERNATIONAL SOFTWARE LIBRARY"



FREE! BUY 12 DISKS — GET A DISK ORGANIZER (VALUE \$19.99)

## WORD PROCESSORS

**Letter Writer (103)** Program makes letter writing a snap. P  
**Galaxy (109)** This word processor is command compatible with WordStar, but also offers pull down menus for the forgetful or the novice. P  
**PC-Write (115-116)** With spelling checker version 2.7 (two disks). P

## GAMES

**Arcade Games (204)** Including Kong, a 3-D version of Pacman, Pango and Bricks. (Color monitor required) P  
**FlightMare (212)** Be a fighter pilot in the future (Requires color or composite monitor), and BABY (requires color). P  
**Galaxy Trek (214)** Great Star Trek type game. P  
**JumpJoe (222)** Like Donkey Kong requires color monitor w/miscellaneous utilities. P  
**Inulte (223)** Generate random insults on screen for the unsuspecting PC user. P  
**Hopper (224)** "Frogger" clone. (Requires color graphics adapter). P  
**BASIC games (233)** Pac-Man, Lunar Lander, Startrek, Jailbreak, Meteor, Fence and Breakout. P  
**Hack (237)** A display oriented Dungeon and Dragons adventure game. Works with monochrome or color monitor, and requires 256k RAM. P  
**Global Thermal Nuclear War (251)** For monochrome or color monitor. P  
**Striker (252)** Shoot the enemy targets with your helicopter, like defender (requires color graphics). P  
**Round42 (256)** Better than space invaders (requires color graphics adapter). P  
**Adventure (260)** Game with "C" source code. N

## TELECOMMUNICATIONS

**Fido bba (303-304)** One of the most used and friendliest Bulletin Board Systems around. P  
**Procomm (308-327) version 2.3** With random redial capabilities. (Two disks)U  
**No Change BBS (340-342)** Software. (Three disks). N

## HACKERS/CRACKERS/ SECURITY

**8086, 8087, 8088 (401)** Disassembler P  
**COPYPC (415)** Better than diskcopy for recovering data from disks that have bad sectors. P

## SPREADSHEETS

**PC-Calc (501)** Spreadsheet can have up to 26 columns and 255 rows. P

## SPREADSHEET TEMPLATES

**Lotus 1-2-3 (606)** Utilities disk Macros (requires Lotus 1-2-3). P  
**Lotus 1-2-3 (607)** Utilities Spreadsheet Templates (requires Lotus 1-2-3). P  
**1-2-3 Help Files (616)** Tips for the beginner (requires Lotus 1-2-3) P

## GRAPHICS

**Key Draw CAD System (703-704)** Requires color graphics adapter, (two disks). P  
**Digi-Draw (708)** Emulates paper and pencil drawing on your PC (requires color graphics). P  
**3-D (719)** Allows you to create, edit, and save 3 dimensional objects (requires color graphics adapter). P  
**Stripper (725)** Adults only! (requires color graphics adapter). P  
**Artmaster (726)** User friendly graphics program (requires color graphics). N

## ACCOUNTING/FINANCE

**The Portworth Package (801)** Monitor and evaluate your stock portfolio. P  
**Finance (802)** Determine present and compound value; perform mortgage, loan and bond analysis. P  
**PC-General Ledger (803)** Written by a financial executive with more than 25 years of experience. P  
**Stock Charting System (819)** Allows you to create and output volume high/low close charts for stocks you choose P

## DATABASE MANAGERS

**PC-File III (901)** User friendly filing system. P  
**File Express (912-913) version 3.70** Powerful and user friendly Data Base Manager (Two disks). P

**NewBase (919)** Menu driven database system. P

**Keep-in-Touch (923)** Helps you maintain information about people. N

## BASIC

**PC-Professor (1102)** Basic Tutorial. P  
**Basic program generator (1103)** Creates the source code for a data base management system. P

## "C"

**The Boss (1305)** Helps to implement Pop-up windows pull down menus, status lines and on-line help (requires lattice C, Microsoft C or Computer Innovations C186 compiler). N  
**C2dBase (1309)** For dBASE III users that like "C". N  
**YACC (1311)** Yet Another Computer Compiler. N

## ASSEMBLY LANGUAGE

**Chasm (1501)** Cheap assembler. P

## LANGUAGES: MISCELLANEOUS

**Programmers Guide (1612)** Help writing and marketing your applications. N  
**dBASE III routines (1614)** This disk has over 60 dBASE III routines (requires dBASE III). P  
**dBASE II programs (1616)** Programs for accounting, mail labels, form letters and more (requires dBASE II). N

## APPLICATIONS

**TALKDEMO.BAS (1709)** PC talks through its speaker with BASIC source code. (Requires IBM PC and BASICA, or 100% compatible and GW-BASIC). P  
**TV Schedule (1715)** Helps you create a viewing schedule of your favorite programs and video tape log. N  
**File Master (1717)** Manage your paper files. N

## DOS

**DOS help (1901)** Disk based DOS help.  
**DOS tutorial (1902)** Teaches you the powerful operating system. P  
**DOS-a-matic (1903) version 2.06** Menu driven program makes using DOS a cinch. P

## MUSIC

**PC-Musician (2401)** Develop and play back songs on your PC. P  
**Piano-Man 3.2 (2402)** Record, edit and then play back your favorite tunes. P

## EDUCATIONAL

**PC-Touch (2502)** Typing tutor compiled with BASIC source. P  
**Funnels and Buckets (2517)** This game makes learning basic math skills fun. P  
**Japanese for business and travel (2521)** Learn some vocabulary, grammar and culture about Japan. N  
**Beginning Spanish (2524)** Habla espanol? N

## TEXT PROCESSING

**EZ-Spell (2812)** This program performs spell check for you. N

## RAM DISK SOFTWARE

**ADJRAM (3003)** Lets you change RAM disk size without a reboot. N

## FILE RECOVERY/ MANIPULATION

**Hard disk backup utilities (3109)** Better safe than sorry. This has several hard disk backup programs. N  
**MasterKey (3110)** Like Norton Utilities, only better. N

## DESKTOP/ ACCESSORIES

**Hard disk utilities (3201)** Including CED, Partner 101 and POPALARM. P  
**EZ NOTE (3207)** Allows you to make notes and then print them out. N  
**PAL 1.4 (3209)** This program makes sidekick even more powerful. N

## MISCELLANEOUS UTILITIES

**Still River Shell (3408)** Run DOS commands from a menu. P  
**Z80MU 3.1 (3428)** Run Z80 programs under PC DOS. P  
**Disk drive utilities (3442)** Includes a RAM disk, a cache program, a fast format program and more. N

... and many more!

KEY  
 P = Popular  
 U = Updated N = New

### 5.25" DISKS: ( Minimum 30)

ds/dd \$ 0.49  
 ds/qd 96 tpi \$ 0.79  
 ds/hd 1.2mb for AT \$ 1.49

ALSO NEW PRODUCTS!!!  
 CABLE, PAPER AND MORE.  
 CALL FOR INFORMATION.

MINIMUM QUANTITY -- ORDER OF 5 PROGRAM DISKS. FREE CATALOG WILL BE SENT WITH YOUR ORDER OR UPON REQUEST. We accept checks (allow 10 days to clear), money orders, Mastercard, Visa, American Express, C.O.D. (add \$1.90). For information, call (619) 942-9998.

800-992-1992  
 NATIONAL

U.S./DISK, INC.

800-992-1993  
 CALIFORNIA

511-104 Encinitas Boulevard, Encinitas, California 92024

Hours: Mon.-Sat. 8:30 am - 4:30 pm Pacific Time



## Motion Control & Data Acquisition

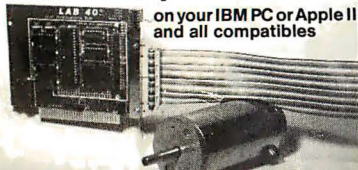

on your IBM PC or Apple II and all compatibles

**Smart 2 Axis Motion Controller:** For many types of motors & encoders. New I.C. (from HP) allows changes & monitoring on the fly. Optically isolated. W/SOFTWARE \$350.

**Four Axis Stepper Driver:** With SOFTWARE & motor for instant automation. \$95.

**Fast A/D Board:** With programmed gain, 650 KHz, 4 inputs, \$220. Complete Scope hardware & SOFTWARE \$500. Also: 12 Bit A/D, Relay Driver, Real Time Clock. Circuit developers Project Book \$25.

How do you do it? Use our Local Applications Bus, LAB 40. One host adapter (\$150) supports up to 8 boards, like those above, on a 50 ft. ribbon cable.

Please call (415) 755-1978 for free literature.

**Computer Continuum**

75 Southgate Ave., Suite 6  
Daly City, CA 94015 (415) 755-1978

## IEEE 488 (GPIB/HPIB)

- Controllers
- Buffers
- Converters
- Extenders
- Interface Boards



for PCs, Macintosh, HP plotters, instruments, printers, etc.

Call or send for your  
**FREE Technical Guide**

**IOtech** (216) 439-4091

23400 Aurora Road  
Cleveland, Ohio 44146

Inquiry 130

## IBM-PC Schematic Design

A professional package enabling you to design, edit, print & plot electronic schematics. Supports "A" — "E" size sheets, over 2000 Unique Library Parts, Auto Panning, Part Rotation, 5 Zoom Levels, Rubberbanding, Powerful Macros, Hi-Res Color & Monochrome Graphics, Much More! \$495 Includes Everything.

Call or Write for Free Demo Disk.

Or **CAD Systems Corporation**  
1049 S.W. Baseline St. Suite 500  
Hillsboro, OR 97123  
**(503) 640-5007**



## BULK DISKETTES MAXELL

5 1/4 DS/DD **59¢**

Price based on quantity of 250  
Includes sleeves, labels and tabs

Quantities Limited Call Today!

**800-222-0490**

(In N.J. 201-462-7628)

Full service duplication facility  
24 Hour Shipment

**MEGAsoft**

P.O. Box 710  
Freehold, N.J. 07728

Inquiry 161

NEW!



**SafeSkin™**  
KEYBOARD PROTECTOR

Remains in place during keyboard use. Prevents damage from liquid spills, dust, ashes, etc. Fits like a second skin, excellent feel. Available for: IBM-PC, AT, Apple (all), Compaq, Model 100, NEC 8201, C64, Zenith 150, DEC, Kaypro, KB5151, AT&T 6300, WYSE 50 and many others. Send \$29.95, check, M.O., Visa & MC include exp. date. Specify computer type. Dealer inquiries invited. Free brochure avail.

**Merritt Computer Products, Inc.**  
2925 LBJ Fwy. #180 / Dallas, Texas 75234  
(214) 339-0753

Inquiry 162

! not only a  
printer buffer !

THIS IS THE MOST SOPHISTICATED  
**PRINTER BUFFER - MULTIPLEXOR - SWITCH**

WITH TWO SEPARATE INPUTS (SERIAL AND PARALLEL) AND TWO SEPARATE OUTPUTS (SERIAL AND PARALLEL) CAN BE USED LIKE STANDARD BUFFER... WITH ANY INPUT TO ANY OUTPUT... BUT ALSO YOU CAN CONNECT 2 COMPUTERS TO 1 PRINTER, OR 1 COMPUTER TO 2 PRINTERS, OR 2 COMPUTERS AND 2 PRINTERS... AND MORE... 1 COMPUTER TO 3 PRINTERS OR 3 COMPUTERS TO 1 PRINTER.  
HIGH CAPACITY - 64 KB TO 256 KB AND - 256 KB TO 1 MB (MODELS A AND B) PAUSE, COPY AND RESET FUNCTIONS SERIAL PORTS WITH 7 OR 8 BITS WORD LENGTH, 1 OR 2 STOP BIT, PARITY, XON/XOFF, DTR, RTS

DCB-A-64K \$ 195 DCB-B-256K \$ 255 (1")

(1") Power supply and parallel cables are included

ALSO, WE HAVE THE MOST COMPLETE DATA CONVERTER UNIT CONVERTS RS232 SERIAL TO CENTRONICS PARALLEL OR VICE VERSA, JUST BY MOVING JUMPERS BAUD RATE AND PROTOCOL FULLY PROGRAMMABLE FROM 160 TO 19200 BAUDS INCLUDES: DTR, RTS, XON/XOFF, PARITY, etc

DCU \$ 80 (1")

(1") Power supply and cables NOT included



**serial < > parallel  
bi-directional converter**



**INTECTRA Inc. - Dept. 232**  
2629 TERMINAL BLVD  
MOUNTAIN VIEW - CA - 94043  
**(415) 967-8818 TX 345545**

Inquiry 124

## TIME SAVING — MONEY SAVING PRINTER BUFFER



### Printer Speeder

Works with any computer connected to a Parallel Printer ■ All models user expandable to 512K ■ Complete. Includes cable and power supply.

**PRINTER SPEEDER** is a parallel printer buffer which works with any parallel printer and frees up your computer for productive use while printing. Very high capacity (up to 512K) and full time space and null character compression means that **PRINTER SPEEDER** is ready to take on the really big jobs. A special Pause-on-Forefeed feature allows printing single sheets from the buffer. **PRINTER SPEEDER** also has Copy, Clear, and Self-Test functions built in. Supplied complete with a 5' printer cable and UL listed power supply. **PRINTER SPEEDER** is easy to install and use. All models are user expandable to 512K at any time by just plugging in standard 520K RAM chips. **PRINTER SPEEDER** is the professional's choice, for size, features, and price.

**PRICES: 128K - \$299. 256K - \$329. 512K - \$389.** Available from dealers or direct from us. We accept M/C, VISA, AMEX or COD orders. No charge for shipping or COD. 30 day trial period (no-hassle refund policy) on all products. CA residents — 6% tax.

DEALER INQUIRIES WANTED.  
O.E.M.s — Use our monthly  
our buffers to meet your  
special requirements.

**jb**  
1601 Fulton Avenue  
Sacramento, CA 95825 ■ (916) 483-0709

The Specialists with the track record in Printer Buffers

Inquiry 142



### Real-Time Multitasking Executive

- No royalties
- Source code included
- Fault free operation
- Ideal for process control
- Timing control provided
- Low interrupt overhead
- Inter-task messages
- Language Interfaces: C, Pascal, PL/M, Fortran
- DOS File Access: CP/M-80, IBMPC DOS

Options:

- Resource Manager
- Buffer Manager
- Integer Math Library

AMX for 8080 \$ 800 US  
8086 950  
6809 950  
68000 1600  
Manual (specyprocessor) 75

**KADAK Products Ltd.**

206-1847 W Broadway, Vancouver, B.C. Canada

(604) 734-2796  
Tele: 04-55670  
V6J 1Y5

Inquiry 143

## 8051 PASCAL

- \* MS-DOS Cross Compiler
- \* Generates ROMable HEX files
- \* Separate Compilation Includes Linker
- \* Two Memory Models On Chip RAM External RAM
- \* Access to BITS, PORTs, SFRs
- \* Interrupt Routines
- \* Compact Run Time Package Source Included
- \* Assembler Compatible
- \* Only \$395 Complete

**SCIENTIFIC ENGINEERING LABORATORIES**  
104 Charles Street, Suite 143  
Boston, MA 02114 Tel 617 262 3903

Inquiry 255



## Super Turbo System Complete

4.77 or 8 MHz

- 20 MEG HARD DISK
- HI-RES MONOCHROME MONITOR
- GRAPHICS MONO CARD W/PAR. PORT
- 150 Watt Power Supply ■ AT Style Keyboard
- 256K exp. to 640K ■ One 360K Half Ht. Drive

**\$949**

## Super Turbo 286 System Complete

1 Year Warranty

- 30 MEG HARD DISK
- 1.2 MEG FLOPPY
- 10 MHz
- 200 Watt Power Supply ■ AT Style Keyboard
- 512K exp. to 1Meg ■ Clk Cal/80287 Socket

Monochrome System

EGA System

**\$1762**

**\$2251**

# FEBRUARY HOTLIST

### 40 Meg Hard Disk

- 28ms Average Seek
- Micropolis 1304

\$535 or \$525 ea. for Two

### 256K Upgrade

- 150 ns ■ 9-41256

\$26 set or \$21 ea./5 sets

### Printer Switch Box

- Parallel or Serial Available
- Two Position Slimline

\$59 or \$49 ea. for Two

### Irwin Tape Back-Up

- 10 Meg Internal
- w/Software & Tape

\$319 or \$295 ea. for Two

### Tatung EGA

#### Monitor

- 640 x 350
- EGA Card included
- 256K w/Parallel Port

\$616 or \$586 ea. for Two

### CDC Floppy Drive

- 360K 1/2 Height
- IBM PC or Compatible

\$94 or \$84 ea. for Two

### Ever Com

#### 1200 Modem

- by Everex
- Internal 1200 Baud
- Hayes Compatible/Short Card

\$129 or \$119 ea. for Two

#### MONITORS

722 EGA	AMDEK	\$520
410A Mono-Amber		152
	NEC	
Multisync EGA		\$624
	PGS	
HX9E 9"		Call
HX12E		\$541
Max12E		159
	TAXAN	
No. 740, 720x400 RGB		Call
No. 760, EGA w/Paradise		
Auto Switch		699
	Call for All Taxans	
	TATUNG	
T1370, 640x400 w/AT&T Cable		\$475
T1380, 640x350 EGA		403

#### CO-PROCESSORS

8087-3, 5 MHz	\$109
8087-2, 8 MHz	154
80287-3, 5 MHz	169
80287-6, 6 MHz	175
80287-8, 8 MHz	249
80287-10, 10 MHz	339

#### PRINTERS

EPSON - Call	
OKIDATA	
ML182P Parallel 120cps	236
ML182S Serial 120cps	284
ML182IBM IBM Par. 120cps	236
ML192P Plus Parallel 200/40cps	398
ML192S Plus Serial 200/40cps	470
ML192 IBM Plus IBM Par. 200/40cps	398
ML193P Plus Parallel 200/40cps	595
ML193S Plus Serial 200/40cps	672
ML193IBM Plus IBM Par. 200/40cps	595
ML292E Modular# 240/100cps	499
ML293E Modular# 240/100cps	672
ML294 Modular# 400/100cps	1094

PLEASE CALL TOLL FREE  
(800) 654-7762

FOR PRICING ON BROTHER, NEC,  
STAR, PANASONIC, CITIZEN,  
TOSHIBA, FUJITSU

#### 5 1/4" DISKETTES

5Lifetime Guar. w/Labels & Sleeves	
Qty 100	\$59

#### EXPANSION CARDS

AST	
Sixpac +	\$124
Sixpac Premium, 256K	219
Rampage 512K for AT	469
HERCULES	
Color Card w/par cable	\$189
Graphics Card Plus w/par cable	199
MEAD	
EGA Card 640x350, 256K, w/par port	\$209
Multifunction (same as Sixpac +)	88
Color Graphics (Hercules Compatible)	78
Monographics (Hercules Compatible)	88

#### MODEMS

HAYES	
1200	\$379
2400	\$579
1200B w/smartcom II	349
2400B w/smartcom II	529
EVEREX	
EverCom 1200	\$129
EverCom 2400	249

#### SYSTEMS

IBM	
PC One, 360K, Drive 256K	\$945
PC-AT Basic, 256K, 1.2 Meg, P&S	2445
PC-XT One, 360K Drive, 256K	1645
PC-XT 286	3195
COMPAQ	
Portable II/2	\$2545
Portable II/4	3545
Portable 286/1	3395
Portable 286/2	3995
Deskpro 286/1	2545
Deskpro 386-40	6195
TOSHIBA	
Lap Top T1100 Plus, 256K	\$1685
Lap Top 3100	3595
HARD DISK DRIVES	
SEAGATE	
ST225, 20 Meg w/Cont	\$379
ST238, 30 Meg	349
MINISCRIBE (For AT)	
45MB, 28ms	\$ 995
10 Meg w/Cont Cogito	239
20 Meg w/Cont 55ms Rodime	359
30 Meg for AT, 30ms Atasi	476
40 Meg for AT 30ms Micropolis	535

# MEAD COMPUTER CORP.

1000 Nevada Hwy., Unit 101  
Boulder City, NV 89005

Call Now for LOWEST PRICES

**(800) 654-7762**

(702) 294-0204

#### Terms:

C.O.D.'s Purchase Orders,  
Cashier's Checks  
Money Orders, Personal Checks

#### Shipping:

UPS, Federal Express,  
Call for shipping prices,  
or we will ship C.O.D.



**7400**

Part No.	1-9	10+	Part No.	1-9	10+
7400	.29	.19	7485	.65	.55
7402	.29	.19	7486	.45	.35
7404	.35	.25	7489	2.05	1.95
7405	.39	.29	7490	.49	.39
7407	.39	.29	74121	.45	.35
7408	.35	.25	74123	.59	.49
7410	.35	.25	74125	.55	.45
7414	.49	.39	74126	.75	.65
7416	.45	.35	74153	4.05	3.95
7417	.45	.35	74150	1.35	1.25
7420	.35	.25	74154	1.35	1.25
7430	.35	.25	74158	1.59	1.49
7432	.39	.29	74173	.85	.75
7438	.39	.29	74174	.65	.55
7442	.55	.45	74175	.65	.55
7445	.79	.69	74176	.99	.89
7446	.89	.79	74181	1.95	1.85
7447	.89	.79	74189	2.05	1.95
7448	2.05	1.95	74193	.79	.69
7472	.75	.65	74198	1.85	1.75
7473	.45	.35	74221	.99	.89
7474	.45	.35	74222	2.05	1.95
7475	.49	.39	74365	.69	.59
7476	.45	.35	74367	.69	.59

**74LS**

Part No.	1-9	10+	Part No.	1-9	10+
74LS00	.29	.19	74LS165	.75	.65
74LS02	.29	.19	74LS166	.99	.89
74LS04	.35	.25	74LS173	.59	.49
74LS05	.35	.25	74LS174	.49	.39
74LS06	1.09	.99	74LS175	4.05	3.95
74LS07	1.09	.99	74LS184	4.59	4.49
74LS08	.29	.19	74LS191	.59	.49
74LS10	.29	.19	74LS193	.79	.69
74LS14	.49	.39	74LS221	.69	.59
74LS27	.35	.25	74LS240	.79	.69
74LS30	.29	.19	74LS243	.79	.69
74LS32	.29	.19	74LS244	.49	.39
74LS42	.49	.39	74LS245	.89	.79
74LS47	.99	.89	74LS259	.99	.89
74LS73	.39	.29	74LS273	.89	.79
74LS74	.35	.25	74LS279	.49	.39
74LS75	.39	.29	74LS322	4.05	3.95
74LS76	.55	.45	74LS363	.49	.39
74LS85	.59	.49	74LS366	.49	.39
74LS86	.35	.25	74LS367	.49	.39
74LS90	.49	.39	74LS368	.49	.39
74LS93	.49	.39	74LS373	.79	.69
74LS123	.59	.49	74LS374	.79	.69
74LS125	.49	.39	74LS383	.89	.79
74LS138	.49	.39	74LS590	6.05	5.95
74LS139	.49	.39	74LS624	2.05	1.95
74LS154	1.09	.99	74LS629	2.29	2.19
74LS157	.45	.35	74LS640	1.09	.99
74LS158	.45	.35	74LS645	1.09	.99
74LS163	.59	.49	74LS670	1.09	.99
74LS164	.59	.49	74LS688	2.05	1.95

**74S/PROMS\***

Part No.	1-9	10+	Part No.	1-9	10+
74S00	.29	.19	74S188*	1.29	1.29
74S04	.35	.25	74S189	1.69	1.69
74S08	.35	.25	74S196	2.49	2.49
74S10	.29	.19	74S240	1.49	1.49
74S32	.35	.25	74S244	1.49	1.49
74S74	.45	.35	74S253*	1.49	1.49
74S85	1.79	1.69	74S287*	1.49	1.49
74S124	2.95	2.85	74S373	1.49	1.49
74S174	.79	.69	74S374	1.49	1.49
74S175	.79	.69	74S472*	2.95	2.95

**74ALS**

Part No.	1-9	10+	Part No.	1-9	10+
74ALS00	.35	.25	74ALS138	.89	.79
74ALS02	.35	.25	74ALS174	.89	.79
74ALS04	.35	.25	74ALS175	.89	.79
74ALS08	.39	.29	74ALS240	1.49	1.39
74ALS10	.39	.29	74ALS244	1.49	1.39
74ALS27	.39	.29	74ALS245	1.49	1.39
74ALS30	.39	.29	74ALS373	1.69	1.59
74ALS32	.39	.29	74ALS374	1.69	1.59
74ALS74	.39	.29	74ALS573	1.69	1.59

**74F**

Part No.	1-9	10+	Part No.	1-9	10+
74F00	.39	.29	74F139	.89	.79
74F04	.39	.29	74F157	.95	.85
74F08	.39	.29	74F193	3.95	3.85
74F10	.39	.29	74F240	1.39	1.29
74F32	.39	.29	74F244	1.39	1.29
74F74	.49	.39	74F253	.99	.89
74F86	.59	.49	74F373	1.39	1.29
74F138	.89	.79	74F374	1.39	1.29

**CD-CMOS**

Part No.	1-9	10+	Part No.	1-9	10+
CD4001	.19	.15	CD4076	.65	.55
CD4008	.19	.15	CD4082	.25	.25
CD4011	.19	.15	CD4082	.25	.25
CD4013	.29	.25	CD4093	.35	.35
CD4016	.29	.25	CD4094	.89	.89
CD4017	.55	.55	CD40103	2.49	2.49
CD4018	.59	.59	CD40107	.69	.69
CD4020	.59	.59	CD4541	.35	.35
CD4024	.49	.49	CD4510	.69	.69
CD4027	.35	.35	CD4511	.69	.69
CD4030	.29	.29	CD4520	.75	.75
CD4040	.65	.65	CD4522	.79	.79
CD4049	.29	.29	CD4538	.79	.79
CD4050	.29	.29	CD4541	.69	.69
CD4051	.59	.59	CD4543	.79	.79
CD4052	.59	.59	CD4553	4.95	4.95
CD4053	.59	.59	CD4555	.79	.79
CD4059	3.95	3.95	CD4566	2.49	2.49
CD4063	1.95	1.95	CD4572 (MC14572)	.39	.39
CD4066	.29	.29	CD4583	.89	.89
CD4069	.25	.25	CD4584	.89	.89
CD4070	.25	.25	CD4585	.89	.89
CD4071	.25	.25	MC14411P	8.95	8.95
CD4072	.25	.25	MC14490P	4.49	4.49

**COMMODORE CHIPS**

Part No.	Price	Part No.	Price	Part No.	Price
WD1770 Disk Cont.	19.95	6545-1 CRTC.	2.49	8701 Clock Chip	9.95
SI-3052P 5V Pps. Reg. 2A	5.95	6551 ACIA	3.29	'8721 PLA	14.95
6504A CPU	1.95	6560 VIC-I	10.95	8722 MMU	9.95
6507 CPU	4.95	6567 VIC-II	14.95	*251104-04 Kernal ROM	10.95
6508 MP1 w/RAM & I/O	8.95	6569 VIC PAL	14.95	*32572-01 Logic Array	24.95
6510 CPU	1.95	6572 VIC PAL-N	14.95	*825100PLA (906114-01)	13.95
6520 PIA	9.75	6581 SD	14.95	*901225-01 Char. ROM	11.95
6522 VIA	2.95	8360 Text Editing	10.95	*901226-01 BASIC ROM	11.95
6525 IPL	9.95	8501 MP1	10.95	*901227-03 Kernal ROM	11.95
6526 CIA	14.95	8502 MPJ	7.95	*901228-05 Upgrd. ROM	15.95
6529 SPT	4.95	8563 CRT Contr.	15.95		
6532 128x8 RAM I/O Tim. & 6.49		8564 VIC	15.95		

**NEC V20 & V30 CHIPS**

Replace the 8086 or 8088 in Your IBM-PC and Increase Its Speed by up to 40%!

Part No.	Price
UPD70108-5 (5MHz) V20 Chip (Replaces the 8088)	\$ 9.95
UPD70108-8 (8MHz) V20 Chip (Replaces the 8088-2)	\$11.95
UPD70116-8 (8MHz) V30 Chip (Replaces the 8086 or 8086-2)	\$14.95
UPD70116-10 (10MHz) V30 Chip (Replaces the 8086 or 8086-2)	\$34.95

**MICROPROCESSOR COMPONENTS**

MISCELLANEOUS CHIPS		8500/8800/88000 Cont.		8000 SERIES Cont.	
Part No.	Price	Part No.	Price	Part No.	Price
D765AC	4.49	8840	3.95	8228	2.49
WD1770	19.95	8843	2.95	8237-5	4.95
CDP1802CE	4.95	8845	2.95	8243	2.25
2861-3	5.95	8850	1.49	8250A	5.45
9216	9.95	8852	3.95	8250B (For IBM)	6.95
		8875	8.95	8251A	1.75
		68000LA	11.95	8253-5	1.95
		68661PB	5.95	8254	2.95
				8255A-5	1.69
				8257-5	2.49
				8259-5	1.95
				8272	4.49
				8279-5	2.95
				8741	10.95
				8749	7.95
				8751	39.95
				8755	14.95

**DYNAMIC RAMS**

Part No.	Function	Price
4116-15	16,384 x 1 (150ns)	.89
4128-20 (Piggyback)	131,072 x 1 (200ns)	4.49
4164-150	65,536 x 1 (150ns)	1.15
4164-200	65,536 x 1 (200ns)	.95
TMS4416-12	16,384 x 4 (120ns)	4.25
8118	16,384 x 1 (150ns)	.69
41256-150	262,144 x 1 (150ns)	2.95
4064-15	65,536 x 4 (150ns) (4464) (41464)	4.79

**PROMS/EPROMS**

Part No.	Function	Price
2016-12	2048 x 8 (120ns)	1.69
2102	1024 x 1 (350ns)	.89
2102-2L	1024 x 1 (250ns) Low Power (91L02)	1.95
2114N	1024 x 4 (450ns) Low Power	1.09
2114N-2L	1024 x 4 (200ns) Low Power	1.05
21C14	1024 x 4 (200ns) (CMOS)	.49
21C19	1024 x 4 (45ns)	4.95
5101	256 x 8 (450ns) CMOS	1.95
6116L-2	2048 x 8 (150ns) Low Power CMOS	2.95
6116P-3	2048 x 8 (150ns) CMOS	1.89
6116L-3	2048 x 8 (150ns) Low Power	1.95
6264P-12	8192 x 8 (120ns) CMOS	3.89
6264P-15	8192 x 8 (120ns) Low Power CMOS	4.25
6264P-15	8192 x 8 (150ns) CMOS	3.59
6264P-15	8192 x 8 (150ns) Low Power CMOS	3.75
6514	1024 x 8 (350ns) CMOS (UPD444C)	4.49
43256-15L	32,768 x 8 (150ns) Low Power	24.95

**SATELLITE TV DESCRAMBLER CHIP**

The MM5321 is a TV camera sync generator designed to supply the basic sync functions for either color or monochrome \$25 line/60Hz interlaced and camera video recorder applications. COLOR BURST GATE & SYNC ALLOW STABLE COLOR OPERATION

**MM5321N. . . . . \$11.95**

**INTERFIL Also Available!**

**74HC HI-SPEED CMOS**

Part No.	Price	Part No.	Price
74HC00	.25	74HC175	.69
74HC02	.25	74HC221	.59
74HC04	.29	74HC240	.79
74HC08	.29	74HC244	.79
74HC10	.29	74HC245	.89
74HC14	.49	74HC253	.59
74HC30	.29	74HC259	.65
74HC32	.29	74HC273	.79
74HC74	.39	74HC374	.79
74HC76	.45	74HC393	.75
74HC85	.39	74HC595	1.19
74HC86	.79	74HC688	.79
74HC123	.89	74HC4040	.89
74HC125	.49	74HC4749	.59
74HC138	.49	74HC4050	.59
74HC139	.49	74HC4060	1.09
74HC193	.49	74HC4511	1.29
74HC154	1.19	74HC4514	1.19
74HC163	.65	74HC4538	.89
74HC174	.69	74HC4543	1.19

**74HCT -- CMOS TTL**

Part No.	Price	Part No.	Price
74HCT00	.29	74HCT139	.59
74HCT02	.29	74HCT221	.59
74HCT04	.29	74HCT1174	.69
74HCT08	.29	74HCT1175	.69



# UPDATE: Our 1987 Product Selection Guide is Here! 94 Pages of Components, Peripherals & More!

Mail Order Electronics - Worldwide  
**Jameco**  
 ELECTRONICS

## COMMODORE COMPATIBLE ACCESSORIES



### HESWARE 300 Baud Modem For VIC-20 and C-64

• Connects directly to User Port • Manual Answer/Dial • Function keys defined for convenience • Includes Midwest Micro Associates communication software.

CM-1 (For VIC-20 and C-64) . . . . . \$34.95

### RS232 INTERFACE

Allows connection of standard serial devices. JE232CM (For VIC-20, C-64 & C-128)\* \$39.95  
 \*Operation with the C-128 in 64 mode only.

External Power Supply CPS-10 (For C-64) . . . . . \$39.95

### Parallel Printer Interface

2K Buffer, Expandable to 10K!

MW-350 (For VIC-20, C-64 & C-128) . . . . . \$54.95

### Input/Output Card

16-Channel Analog Multiplexer

MW-611 (For C-64 and C-128) . . . . . \$199.95

## TRS-80/TANDY COMPATIBLE ACCESSORIES

### E-X-P-A-N-D TRS-80 MEMORY

All kits come complete with documentation

TRS-80 MODEL 4, 4P, & 4D 64K/128K EXPANSION TRS-64K-2 . . . . . \$7.95

Expands Model 4 from 16K-64K or Model 4 (Gate Array Version), 4P and 4D from 64K-128K

TRS-64K-2PAL . . . . . \$14.95

Expands Model 4 (Non-Gate Array Version) from 64K to 128K

### TRS-80 MODEL 100 8K EXPANSION

M1008K . . . . . \$19.95 ea. or 3 for \$54.95

## ZUCKERBOARD

### TANDY 1000 Expansion Memory Half Card

Expand the memory of your Tandy 1000 (128K Version) to as much as 640K. Also includes DMA controller chip.

TAN-EM256K Includes 256K RAM . . . . . \$ 99.95

TAN-EM512K Includes 512K RAM . . . . . \$129.95

### Options for TAN-EM256K/512K

TAN-C Plug-in Clock option chip (only) . . . . . \$39.95

TAN-D RAM Disk Printer Spooler Software (only) \$39.95

### TANDY 1000 Multifunction Board with Clock Calendar

Expand the memory on your Tandy 1000 (128K Version) to as much as 640K. Complete with an RS232 port, clock/calendar, RAM Disk Printer Spooler and on-board DMA controller chip.

MTAN-256K Includes 256K RAM . . . . . \$179.95

MTAN-512K Includes 512K RAM . . . . . \$209.95

## UV-EPROM ERASER

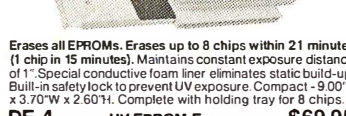

Erases all EPROMs. Erases up to 8 chips within 21 minutes (1 chip in 15 minutes). Maintains constant exposure distance of 1". Special conductive foam liner eliminates static build-up. Built-in safety lock to prevent UV exposure. Compact - 9.00" x 3.70" W x 2.60" H. Complete with holding tray for 8 chips.

DE-4 UV-EPROM Eraser . . . . . \$69.95

UVS-11EL Replacement Bulb . . . . . \$19.95

## NOW YOU CAN BUILD AN IBM PC/XT COMPATIBLE!



SALE!

### IBM Compatible Kit

- IBM-64K(2) 64K RAM Chips (18) . . . \$ 19.90
- KB83 83-Key Keyboard . . . . . \$ 29.95
- IBM-FCC Floppy Controller Card \$ 39.95
- IBM-Case Case . . . . . \$ 39.95
- IBM-MCC Monochrome Card . . . . . \$ 69.95
- IBM-PS Power Supply . . . . . \$ 69.95
- FD55B Disk Drive . . . . . \$109.95
- IBM-MON Monochrome Monitor \$ 99.95
- IBM-MB Motherboard . . . . . \$129.95

FREE! QUICKSOFT PC WRITE WORD PROCESSING SOFTWARE INCLUDED!

Regular List \$609.50

IBM-Special (Includes 9 items above) . . . . \$549.95

### ADDITIONAL ADD-ONS AVAILABLE!

- IBM-KB 83-Key Keyboard . . . . . \$ 69.95
- IBM-ENH Enhanced Keyboard . . . . . \$ 89.95
- IBM-ICB Integrated Color Board w/Printer Port . . . . . \$ 99.95
- IBM-EGA Enhanced Graphics 256K RAM . . . . . \$259.95
- IBM-MGA Monochrome Graphics Adapter . . . . . \$149.95
- IBM-MULTI Multifunction 0-384K RAM (without RAM) . . . . \$149.95
- IBM-20MBK 20MB Hard Disk Drive, Controller & Cable . . . . \$449.95
- EM-100 Expansion Memory Half Card (without RAM) . . . . \$ 59.95
- TTX-1410 14" RGB Color Monitor . . . . . \$299.95

IBM is a registered trademark of IBM Computers

## NEW PRODUCTS!



### ProModem 1200/300 Baud Half-Card Modems

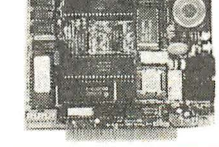

For IBM PC, XT, AT & Compatibles  
 • Auto-answer/Auto-dial • Extensive diagnostics • Built-in speaker/vol control • Auto redial on busy • Ability to access Com-port 3 • Hayes compatible • 2 yr. warranty  
 PM1200B-2 without software . . . . \$129.95  
 PM1200B-2S w/Mirror™ Software . . . \$159.95

### 2 yr. warranty! ZOOM 300 Baud Modem for Apple II, II+ and IIe



• Auto-dial/Auto-answer • Hayes compatible • Includes call progress monitor, speaker, Zoom Communications software and manual • Made in U.S.A.  
 ZM300 . . . . . \$89.95



### ProModem 1200/300 for Apple II, II+, IIe and II GS

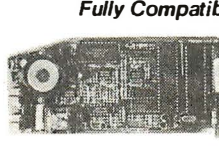

Fully Compatible with the NEW APPLE II GS!  
 • NEW, single card version • Built-in software in ROM • Comes with ProCom-A disk-based communications software • Hayes compatible • Compatible with ProDOS • Auto-dial/Auto-answer • Auto redial on busy • Built-in speaker and volume control • 2 phone jacks with exclusion switching • 2-yr warranty  
 PM1200A-2 . . . . . \$199.95



### ProModem 2400/1200/300 Baud Modems

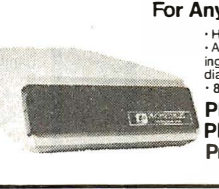

For Any Computer w/RS232 Serial Port  
 • Hayes command compatible • Call progress tone detection • Auto redial on busy • Internal power supply • Voice/data switching • Second phone jack for voice handset • Auto-answer/Auto-dial • Touch tone and pulse dialing • Speaker with volume control • 8 LED status lights • 1-yr warranty  
 PM1200G (1200/300 baud) . . . . . \$199.95  
 PM2400G (2400/1200/300 baud) . . . . \$379.95  
 ProCom-B (Communication Software) . . . \$34.95  
 For IBM PC and Compatibles

## APPLE COMPATIBLE ACCESSORIES

### Jameco Parallel Printer Card for Apple II, II+ and IIe



• Intelligent interface to most dot matrix graphics printers  
 • Centronics standard  
 • Advanced text printing

JE880 Parallel Printer Card . . . . . \$49.95  
 JE883 64K Buffer for JE880 . . . . . \$69.95

### Jameco Extended 80-Column Card for Apple IIe



• 80 Col/64K RAM • Doubles amount of data your Apple IIe can display as well as its memory capacity • Ideal for word processing • Complete with instructions

JE864 \$59.95

### Apple II, II+ and IIe Compatible Products

- APF-1 Cooling Fan . . . . . \$ 29.95
- JE860 16K RAM Card . . . . . \$ 39.95
- JE875 Disk Controller Card . . . . . \$ 49.95
- JE868\* 128K RAM Card . . . . . \$ 99.95
- JE877 Diagnostic Disk Controller Card . . . . . \$ 59.95

SMARTERM II 80-Col. Card . . . \$139.95

Big Board-256K 256K RAM Card \$199.95

Big Board-512K 512K RAM Card \$249.95

Big Board-1M 1Meg RAM Card \$299.95

\*When using CP/M, the JE868 will only function with version 2.20 or earlier: PASCAL (JE868) Version 1.1 or earlier.

### Universal 64K/256K Printer Buffer



• Four possible combinations: 1) Serial to Serial, 2) Serial to Parallel, 3) Parallel to Parallel, 4) Parallel to Serial • Cut sheet feeding • Software selectable output • Modem support • Selectable baud rates • Manual included

UB64K . . . . . \$199.95  
 UB256K . . . . . \$239.95

### IBM Compatible! DISK DRIVES

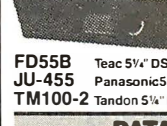

Documentation included

FD55B Teac 5 1/4" DS 1/2" Height . . . . . \$109.95  
 JU-455 Panasonic 5 1/4" DS 1/2" Height . . . . \$109.95  
 TM100-2 Tandon 5 1/4" DS Full-Height . . . . \$119.95

### DATA BOOKS

- 30003 National Linear Data Book (82) . . . . . \$14.95
- 30009 Intersil Data Book (86) . . . . . \$ 9.95
- 30013 Zilog Data Book (85) . . . . . \$14.95
- 30032 National Linear Supplement (84) . . . . . \$ 6.95
- 210830 Intel Memory Handbook (86) . . . . . \$17.95
- 230843 Intel Microsystem Hndbk. Set (86) . . . . \$24.95

### MUFFIN/SPRITE-STYLE FANS



MUF60 . . . . . \$9.95  
 Torin Industries (4.68" sq. 60 cfm)  
 SU2A1 . . . . . \$8.95  
 EG&G Rotron (3.125" square, 20 cfm)

\$20 Minimum Order - U.S. Funds Only  
 Shipping: Add 5% plus \$1.50 Insurance

California Residents: Add 6%, 6 1/2% or 7% Sales Tax

Spec. Sheets - 50¢ each  
 Prices Subject to Change

Send stamped, self-addressed envelope to receive a Quarterly Sales Flyer - FREE!  
 2/87



Send \$1.00 Postage for a FREE 1987 JAMECO CATALOG  
 ©1986 Jameco Electronics

1355 SHOREWAY ROAD, BELMONT, CA 94002 • PHONE ORDERS WELCOME 415-592-8097 Telex: 176043



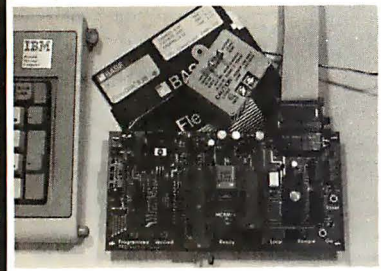

**MOTOROLA 6805 SINGLE CHIP MICROCOMPUTER DEVELOPMENT SYSTEMS**

Two systems from TEC allow the IBM PC/XT/AT to be used as a complete development system for the Motorola 6805 series single chip microcomputers. Model MCPM-1 supports the MC68705P3,P5,U3,U5, R3, & R5 chips. Model MCPM-2 supports the MC1468705F2 & G2 cmos versions. Both systems are priced at \$495 and include a cross assembler program, a Simulator/Debugger program and a programming circuit board with driver software. One serial port required.

**TEC**  
PO Box 53, West Glover, Vt. 05875  
**(802) 525-3458**

Inquiry 288

# TERMINAL EMULATIONS

**NEW SOFTERM PC, THE LEADER IN EXACT TERMINAL EMULATIONS**

\* OVER 30 EMULATIONS

- \* KEYBOARD MACROS
- \* VIRTUAL DISK CAPABLE
- \* KEYBOARD TRANSLATE
- \* CAPTURE FILES TO DISK OR PRINT
- \* FILE TRANSFERS WITH 7 PROTOCOLS (I.E. KERMIT-SERVER,HAYES,XMODEM,ETC.)
- \* CONCURRENT AND BACKGROUND COMMUNICATIONS AND MORE!!!

A COMPLETE EMULATION & COMMUNICATION PACKAGE

**OMNITRONIX**  
800/225-8590  
**CALL FOR INFORMATION**  
(303)593-9540 TELEX 450236

Inquiry 267

## Teach your PC to print perfect Bar Codes\*



\*with big characters on Epson/Okidata/IBM Printers\*

- Labels for shelves, bins, shipping, inventory, Department of Defense LOGMARS, AUTOMOBILE (AIAG) • Bar Coded catalogs
- Large text up to 1.2" tall • Codabar • Plessey, 1 2 of 5, UPC/EAN, & Code 39 • Menu driven, Subroutines, or Ram-resident
- Fast • Easy • 30 day guarantee
- Price range \$49-\$299.

**IBM PC Reader, Complete - \$385**  
Also Portables and RS-232 Readers

**WORTHINGTON DATA SOLUTIONS**  
130 Crespi Court, Santa Cruz, CA 95060  
**408/458-9938**

Inquiry 323

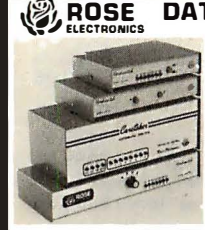

**ROSE ELECTRONICS DATA SWITCHES**

SHARE computers, printers, any parallel or serial device  
**ELIMINATE** cable swapping  
**INEXPENSIVE** way to network  
**COMPATIBLE** with all computers.

Businesses, Schools, Homes  
**WE ALSO OFFER:**  
Data Buffers, Line Drivers, Modems, Protocol Converters, Parallel - Serial Converters, Cables, Computers, Printers, Disk Drives, and more.

**AUTOMATIC - CARETAKER** is ideal for a business or school to share a printer or modem among many computers. Operation is fully automatic with no software required.  
Parallel or Serial 4 channels - \$295 8 channels - \$395

**MANUAL - HARDSWITCH** is operated with the flip of a switch. 2:2 and 2:4 models allow simultaneous communication.  
Serial 1:2 - \$59 1:4 - \$ 99 2:2 - \$109 2:4 - \$169  
Parallel 1:2 - \$79 1:4 - \$139 2:2 - \$119 2:4 - \$199  
LED and spike protection on serial models add \$20.

**CODE ACTIVATED - PORTER** connects one computer to multiple peripherals. A software code selects the peripheral.  
Parallel or Serial 4 channels - \$295 8 channels - \$395  
Buffer option 64K - \$100 256K - \$250

**REMOTE - TELEPATH** connects multiple computers to multiple peripherals. A selector at each computer or terminal chooses up to 4 peripherals and displays busy status.  
4:4 - \$495 4:8 - \$795 selector - \$39.

*Give a Rose to your computer*

**ROSE ELECTRONICS (713) 933-7673**  
P.O. BOX 742571 MC & VISA Accepted  
HOUSTON, TX 77274 Dealer Inquiries Invited  
**CALL US FOR ALL YOUR INTERFACE NEEDS**

Inquiry 294



**NEW**

## RAMJET™ Print Buffer with advanced features!

The RAMJET Print Buffer has the features you will need at a price you will like! Panel buttons allow COPY, CLEAR, BYPASS, PAUSE, RESUME. The RAMJET buffer comes with your choice of 16K, 64K, 256K. User upgradeable. Optional card expands to 512K. Special programmable features. Available with Parallel/Parallel, Serial/Serial, or Parallel/Serial ports. Parallel/Serial version can buffer either way. Serial ports independently programmable up to 19,200. Comes with rugged solid aluminum case and reliable power supply. Many more features.

**RAMJET 16K - \$169.00**      **RAMJET 256K - \$269.00**  
**RAMJET 64K - \$199.00**      **RAMJET 512K - \$399.00**

**(206) 624-4985**

**CALL TODAY!** Specify Parallel, Serial, or Parallel/Serial. Information requests welcome. Omnitronix, Inc. is an experienced custom hardware/software developer. We welcome inquiries about customized buffers or controllers. Call us about your application.

**Omnitronix, Inc.**  
760 Harrison St. - Seattle, WA 98109

Inquiry 190

## Smart Cash Register \$95

Turns MSDOS computer into complete **RETAIL POS SYSTEM**

TURBO PASCAL program 100% dBASE compatible files  
All transactions logged to disk

Transfer data to 123, dBASE, BASIC, Pascal etc.  
PLU/Inventory Table to 32000 items

4-character DEPT 5-character MFR, PROD  
Cashier security Auto/Manual discount, tax  
End-Shift summary Custom Receipts 20/40/80 col

**HARDWARE SUPPORT:** Cash Drawer BarCode Reader  
Receipt Printer Function-button Keyboard

**ORDER:**  
**915-837-7180**

Inquiry 256



## Flow Charting II+ The New Plus for Fast Flowcharting

FLOW CHARTING is new! It's now

Flow Charting II+, with more speed + more functions + more printing options;

- 10 text fonts; 26 shapes;
- Line mode can stop at a shape;
- Backspace key can erase a line to its origin;
- Free text entry anywhere, or select auto-centering;
- Vertical or horizontal printing; one chart or multiple charts.

Used by Fairchild, Bechtel and more than 500 other major corporations. Edit quickly and accurately — even major edits — with Flow Charting II+, the Specialist.

See your retail store or call:  
**PATTON & PATTON**  
Software Corporation  
800/672-3470, ext. 897 California  
800/538-8157, ext. 897 National  
408/629-5044 International)

Inquiry 202

Serial ← → Parallel



**Convert What You Have To What You Want!**

- \* RS232 Serial
- \* 8 Baud Rates
- \* Latched Outputs
- \* Centronics Parallel
- \* Handshake Signals
- \* Compact 3" x 4" x 1 1/2"

No longer will your peripheral choices be limited by the type of port you have available! Our new High Performance 700 Series Converters provide the missing link. Based on the latest in CMOS technology, these units feature full baud rate selection to 19.2K, with handshake signals to maximize transfer efficiency. Detailed documentation allows simplified installation. Order the Model 770 (Ser/Par) or Model 775 (Par/Ser) Today!

Buffer Products Coming Soon! **Tigertronics** only \$89.95  
2734-C Johnson Dr. Post Office Box 3717 Ventura, California 93008  
CALL (805) 658-7466 or 658-7467  
For FAST Delivery

Inquiry 298

## PUBLIC DOMAIN SOFTWARE

isn't copyrighted. Thousands of useful programs available for most computers from user group libraries.

User Group Libraries	Rent	Buy
IBM PC Blue 220 Disks	\$230	\$450
Capitol-IBM 45 Disks	50	105
Sanyo UG MSDOS 80 Disks	85	225
Authors Showcase (IBM)		
35 Disks	40	140
Amiga 50 Disks	65	200
Atari ST 55 Disks	75	220
Macintosh 85 Disks	90	255
CP M UG 92 Disks	45	249
SIG M UG 270 Disks	175	330
CBM 64 Gold 50 Disks	105	150
Apple DOS 120 Disks	130	200

MASTER CARD • VISA • DINERS • AMERICAN EXPRESS

Rental is for 7 days with 3 days grace for return. Use credit card, no deposit! Call for free catalog or send Disk for free Directory of programs. Specify Computer!

**PUBLIC DOMAIN SOFTWARE INTEREST GROUP INC.**  
24 HR RECORDING (702) 794-3660  
2400 Santa Rita Las Vegas, Nevada 89109  
702 732-0169 800 527-3744

BBS NUMBER (619) 749-2741

Inquiry 197



### PC COMPATIBLE SYSTEMS

## BBC "BIG BLUE CLONE"

"FCC" APPROVED & ONE YEAR LIMITED WARRANTY

BASIC CONFIGURATION: 8088-2.8 MHz CPU, 256K RAM, FLOPPY DISK CONTROLLER, 8 SLOTS, 150 WATT P/S, SLIDE CASE W/SPKR, "AT-STYLE" KEYBOARD ..... \$349

MS-DOS 2.11 ..... \$ 75  
MS-DOS 3.1 ..... \$ 95  
MS-DOS 3.2 ..... \$ 95  
GW/BASIC ..... \$ 89  
360K HH FUJITSU OR TEAC FLOPPY DRIVE ..... \$ 89  
MONOCHROME/GRAPHICS CARD W/ PRINTER ..... \$ 68  
COLOR/GRAPHICS CARD ..... \$ 60  
SIX-PAK COMPATIBLE CARD W/384K RAM ..... \$119  
TATUNG EGA MONITOR & 256K EGA ..... \$695

### TATUNG

TCS-7000 80286-10 MHz, 640K RAM, 1.2Mb FLPY DRV, 210W P/S, MS-DOS, 3.1 & DIAGNOSTICS ..... \$1,495  
TCS-7000/85 ABOVE W/85 Mb H.D. DRIVE ..... \$2,695

### cordata

PC-400 512K, 2 FLPYS, 14" 640X400 MNTR ..... \$ 939  
PC-400/20 W/20 Mb H.D. DRV ..... \$1,329  
ATD-8-Q 8 MHz 80286, 640, S.P., 1.2 FLPY ..... \$1,549  
ATP-8-Q PORTABLE VERSION OF ATD-8-Q ..... \$1,629

### SPERRY

PC/IT ENHANCED W/ 512K, 1.2 Mb FLPY & 44Mb H.D. DRVS, MS-DOS 3.1, GW/BASIC, ETC. .... \$2,629  
PC/IT EXPANDED W/85 Mb HARD DISK ..... \$3,295  
MICRO/IT W/512K, 1.2Mb FLPY, ETC. .... \$1,589

### WYSE

WYPC-286 10 MHz, 640K, S.P., CLOCK, ETC. .... \$1,698  
WYPC-286-85 W/ 85 Mb HARD DISK ..... \$2,999

### NETWORKING

CONSULTATION & INTEGRATION QUESTIONS??

CALL OUR EXPERT SALES & TECH STAFFS!!

### NOVELL

ADVANCED NETWORK STARTER KITS & SERVERS...CALL

#### 4-USER NETWORK SPECIAL

TATUNG TCS-7000/40 SERVER W/ 1.6 Mb RAM, 40 Mb (40 mSEC) HARD & 1.2 Mb FLPY DISKS, SERIAL & PARALLEL PORTS, MONO MONITOR. CACO U400-400W UNINTERRUPTABLE POWER SUPPLY.

NOVELL ADVANCED NETWORK 286/NON-DEDICATED V2.0A.

ARCNET 4-PORT PASSIVE HUB. 4 ARCNET CARDS & CABLES UP TO 100 FT. EACH. 3 WORK STATIONS "FCC" APPROVED W/4.77/8 MHz 8088 CPU, 4-LAYER MOTHER BOARD, 640K RAM, MONO/GRAPHIC/PRNT CTRL & MONITOR, "AT-STYLE" KEYBOARD, 360kb FLPY DRIVE.

TAPE BACK-UP 60Mb EXTERNAL. .... \$7,979

### ALLOY

PC-SLAVE/16 1Mb, 8MHz V20 ..... \$649  
ATNX FORMS-DOS3.1 ..... \$195  
LAN-PC ARCNET CARD ..... \$369  
HUBS: 8-ACTIVE ..... \$519  
HUBS: 4-PASSIVE ..... \$ 40

ARCNET COMPATIBLE 1/2 CARD ..... \$295  
8-PORT ACTIVE HUB ..... \$449  
4-PORT ACTIVE HUB PC/CARD ..... \$225  
4-PORT PASSIVE HUB ..... \$ 49

### STB

RIO GRANDE 128K-1.5Mb, P.S. .... \$195  
RIO PLUS II 64K, S.P., G.C. .... \$198

### TECMAR

WAVE 64 256K ..... \$ 129  
eSCAN SCANNER ..... \$1,295  
MAC-DRIVE 10 Mb CRTG ..... \$1,095  
EXP. CHAS. 11 SLOT 33/5Mb ..... \$1,295

**AST** 6-PAK PREMIUM 256K ..... \$179  
RAMPAGE-AT ..... \$395  
RAMVantage 512K-3Mb ..... \$259  
ADVANTAGE ..... \$329  
3G-PLUS 256K, HGC, CGA, EGA ..... \$335

**intel** ABOVE BOARD/PC 1110 ..... \$238  
ABOVE BOARD/AT 2110 ..... \$368  
ABOVE BOARD/AT 2010 ..... \$328  
INBOARD 386/AT 0-1Mb RAM CONVERTS YOUR EXISTING PC/AT TO A 16 MHz 80386 ..... \$1,098  
MATH 8087-2 ..... \$155/80287-8 ..... \$249

### houston instrument

DMP41 & DMP42 ..... CALL  
DMP 51 & DMP 52 ..... FOR  
DMP 56 ..... BEST  
DMP 29 ..... PRICES  
DMP 40 ..... AROUND!!

### TRUE GRID DIGITIZERS

TG1005 ..... WEWON'T  
TG1011 ..... BE  
TG1017 ..... BEAT!!

### POWER SYSTEMS & ACCESSORIES



P-15 MONITOR BASE W/5 A/C PLUGS NOISE & SURGE & MODEM PROTECTED, DISK STORAGE ..... \$ 89  
U1000 POWER SAVER 1000W U.P.S. (by TOPAZ) W/ 4 OUTLETS & TRUE SINE WAVE ..... CALL  
U400 POWERSAVER 400W ..... CALL

### TRIP/LITE

BC-425 S.P.S. 60 MIN. 1/2 LOAD ..... \$399  
BC-675 S.P.S. 70MIN. 1/2 LOAD ..... \$575  
BC-1000 S.P.S. 40MIN. 1/2 LOAD ..... \$795  
SB2000 S.P.S. UNLIMITED BASED ON BATT ..... \$745

### MONITORS & TERMINALS

**TATUNG** ONE YEAR WARRANTY & 30 DAY D.O.A. SWAP-OUT!

CM-1365 RGB 13" 5-COLORTEXT 640X200 ..... \$339  
CM-1380F EGA 13" 640X350 G/A SWITCH ..... \$450  
TEGA-22 256K EGA 1/2 CARD HGC CGA MDA ..... \$245  
MM-1222A AMB/GRN HI-RES MONO MONITOR ..... \$99  
NEC MULTISYNC MONITOR ..... \$595  
PRINCETON GRAPHICS MONITORS ALL MODELS ..... CALL  
ZENITH ZVM-1240 AMBER FLAT NON-GLARE ..... \$139

### LINK

MC-3 "AT"-K.B. GRN/AMB/WHT SCREENS ..... \$399  
PC-TERMAT-K.B. GRN/AMB SCREENS ..... \$369  
PC-TERM/GRAPHICS ..... \$489  
220 DEC EMULATION ..... \$449

### WYSE

WYSE30 ..... \$299  
WYSE50 ..... \$379  
WYSE60 ..... \$469

### PRINTERS & BUFFERS

### brother

HR-20 20 CPS DAISY WHEEL-AUTO LOAD ..... CALL  
M-1109 100/25 CPS P & S W/TRACTOR ..... \$189  
M-1509 180/45 CPS P & S W/TRACTOR ..... CALL  
M-1709 240/50 CPS P & S W/TRACTOR FX-286 & IBM PROPRINTER COMPATIBLE "PAPER PARK" ALLOWS SIMULTANEOUS LOADING OF CONTINUOUS FORM & CUT SHEET PAPER & AUTO LOADS ..... CALL

### CITIZEN™

MSP-10 ..... \$279 MSP-15 ..... \$ 369  
MSP-20 ..... \$309 MSP-25 ..... \$ 469  
120D ..... \$179 PREMIERE35 ..... \$ 459  
CORDATA LP-300 LASER PRINTER ..... \$2,099  
AST TURBOLASER (RICOH BASED) ..... CALL  
STAR MICRONICS SR-15 ..... \$ 549  
TOSHIBA ALL MODELS ..... CALL  
XEROX/DIABLO 635 W/II/F ..... \$ 769  
XERXP/DIABLO D80IF ..... \$1,295  
XEROX 4045 LASER W/COPIER & DRAM ..... \$4,498

### SCIENTIFIC/INDUSTRIAL PC BOARDS

A/C64-PC ..... \$369 D/A64-PC ..... \$439  
1018-PC 128T TL IN-PUTLINES ..... \$369  
A/C 64-100 (S-100) ..... \$225 D/A 64-100 (S-100) ..... \$298

### SCIENTIFIC SOLUTIONS

IEEE488 ..... \$239 IEEE488 SOFTWARE \$ 65  
E + EEPROM PROGRAMMER/READER ..... \$275  
LAB MASTER ..... \$859

### S-100 BUS PRODUCTS

CPRO RAM-16 64K STATIC ..... \$ 99  
BRACKETS FOR COMPUPRO DRV CABINET ..... \$ 25  
COMPUPRO SYSTEM 816/C3-40 Mb ..... \$7,449  
INTERCONTINENTAL MICRO SYSTEMS ..... CALL

### HARD DISK & TAPE DRIVES

26 Mb PC-INSIDER ..... \$ 389  
38 Mb PC-INSIDER ..... \$ 498  
51 Mb PC-INSIDER ..... \$ 888  
51 Mb AT-INSIDER ..... \$ 778  
85 Mb AT-INSIDER ..... \$1,195  
EVEREX STREAM-60-8 60 Mb EXT. TAPE ..... \$ 719  
IRWIN 20 Mb TAPE INTERNAL ..... \$ 469  
TECMAR QIC 60/AT INT 60 Mb TAPE ..... \$1,139

### BARE WINCHESTER DRIVES

SEAGATE ST-225 HH ..... \$ 309  
SEAGATE ST-4051 FH ..... \$ 775  
QUANTUM Q540 43 Mb FH ..... \$ 749  
MICROPOLIS 1325 85 Mb 28 mSEC ..... \$1,198  
MAXTOR XT-1140 140 Mb 28 mSEC ..... \$2,888  
MAXTOR XT-2190 190 Mb 28 mSEC ..... \$3,099

### FLOPPY DISK DRIVES

MITSUBISHI 2894 FH 8" ..... \$465/2896 HH 8" ..... \$425  
MITSUBISHI MF-501 48TPI ..... \$95/MF-50496TPI ..... \$129  
TEACFD-55-BV 48 TPI FLPY DRV ..... \$ 89  
FUJITSU 5.25" HH 48 TPI FLPY DRV ..... \$ 89

### SOFTWARE

WE SELL ALL WELL KNOWN BRANDS!! ORDER CORRECTLY OPENED SOFTWARE IS NOT RETURNABLE!!

NEWSTAR NEW-WORD 3 ..... \$189  
BD SOFTWARE "C" COMPILER ..... \$ 95  
MICROSOFT WORD/PC ..... \$280  
ASHTON-TATE dBASE III PLUS ..... \$461  
MICRORIM rBASE SYSTEM V ..... \$418

### MODEMS

ProModem 1200B/W/MIRROR SOFTWARE ..... \$129  
ProModem 1200 ..... \$249 ProModem 2400 ..... CALL  
ProModem 1200G ..... \$179 ProModem 2400G ..... \$339  
CTS 2424 ADH ASYNCH/SYNCH. HAYES COMP ..... \$269  
CTS 2424 AMH CLASH/MN PERROR CORRECT ..... \$349

### MultiTech

MT224EH MNPERROR CORRECTION ..... \$469  
MT224ER RACK MOUNT W/ ERROR CORECTION ..... \$465  
U.S. ROBOTICS COURIER 2400 ..... \$335  
U.S. ROBOTICS 272A "HAYES COMPATIBLE" ..... \$195

All merchandise new. Advertised prices are cash prepaid only. PO's from qualified firms & AM Express: : 95 MC & Visa: : 988 COD's (: 99 \$5 min. fee) with Cashiers Check/MO, Bank Wires & APO's accepted. Shipping minimum \$4 first 5lbs. Tax: AZ RES ONLY add 6.5% sales tax. All returns subject to 20% restocking fee or credit towards future purchases. All prices & availability subject to change without notice.



# JADE TURBO or 286

- 640K of RAM
- 7 MHz turbo mode
- 360K disk drive
- 5151-style keyboard
- 8 expansion slots



- 640K of RAM
- 8 MHz 80286
- 1.2 MB disk drive
- AT-style keyboard/case
- 8 expansion slots

**\$588**

**\$1288**

### OPTION #1

Two disk drives  
Mono graphics card  
Parallel printer port  
Amdek 310A monitor

**TURBO 286**  
**\$898 \$1598**

### OPTION #2

20 MB hard disk  
Mono graphics card  
Parallel printer port  
PGS MAX-12E monitor

**TURBO 286**  
**\$1288 \$1898**

### OPTION #3

20 MB hard disk  
Color graphics card  
Parallel printer port  
Hitachi hi-res color monitor

**TURBO 286**  
**\$1388 \$1998**

# HIGH RESOLUTION COLOR MONITOR

**\$269**

List Price \$699

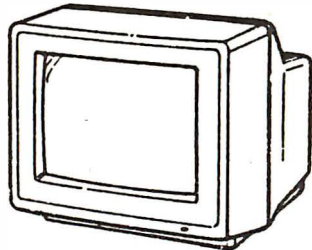

Manufactured  
by Hitachi



- High resolution 640 x 240
- Excellent dot pitch .38 mm
- 16 true colors, 2000 characters
- Accepts standard RGB input signals
- Non-glare picture tube
- Free PC RGB cable included
- Free tilt & Swivel

# EGA PACKAGE

**\$669**

List Price \$998

EGA Monitor  
Plus  
EGA Video Card

- Dual Mode Monitor
- Non Glare, .31 Dot Pitch
- 640 x 350, 640 x 200
- EGA, CGA, MDA & HGA
- 100% IBM Compatible
- 256K of Video RAM

# 3 1/2" DISK DRIVE FOR YOUR PC/XT/AT

720K Disk Drive for  
Mass Storage or for  
Down Loading to your  
Lap-Top Computer  
Requires DOS 3.20

**\$149**

# MICROSOFT. MS-DOS 3.20

Including GW-BASIC  
Supports 3 1/2" Drive

**\$88**

# 21 Megabyte Hard <sup>DISK</sup> ON A Card

**\$399**

- 21.3 MB Formatted
- Lowpower
- Head Park Zone
- Plated Media
- Light 2.4 lbs.

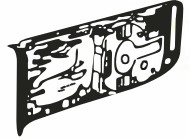

# HARD DISK DRIVE

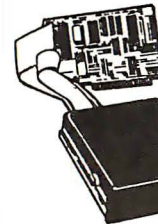

**\$299**

HARD DISK,  
CONTROLLER  
AND CABLES

10 MB Internal Kit \_\_\_\_\_ \$299  
20 MB Internal Kit \_\_\_\_\_ \$399  
30 MB Internal Kit \_\_\_\_\_ \$499

# 30 MB KIT

**\$399**

HURRY  
LIMITED  
QUANTITY

Complete kit for your PC or XT compatible.  
Includes Controller Cable, and 43 ms Full  
Height Tandon Drive.

HIGH PERFORMANCE  
**20 MB HARD  
DISK FOR YOUR AT**  
**\$299**

Includes drives, mounting rails and cables.  
30 Megabyte AT Kit \_\_\_\_\_ \$499  
40 Megabyte AT Kit \_\_\_\_\_ \$699

# MICROSPEED FAST 88 7 MHZ TURBO CARD FOR YOUR PC

**\$99**

- Top rated
- 6.14, 6.67 and 7.37 MHz
- Uses no slots
- No wait states

- External switch
- Reset switch

# STARWRITER F-10

when our 40 cps letter quality daisywheel  
from the same manufacturer is only

**\$499**

Limited  
Quantity

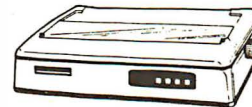

Bi-directional deluxe tractor \_\_\_\_\_ \$249 \$149  
Automatic cut sheet feeder \_\_\_\_\_ \$449 \$199  
Multi strike ribbon \_\_\_\_\_ \$9 \$5



**RGB Color Monitors**

Hitachi 640 x 240	\$269
Magnavox 640 x 240	\$319
Magnavox EGA 640 x350	\$499
Jade EGA 640 x 350	\$449
Thompson Ultra Scan 800 x 560	\$579
Quimax EGA 640 x 350	\$489
NEC Multisync 800 x 560	CALL
PGS HX-12 640 x 240	\$439
PGS HX-12E 640 x 350	\$529

**PC Mouse**

PC Mouse w/Dr. Halo II	\$119
Microsoft Mouse with software	\$129

**PC Power Supply**

135 watt power supply	\$69
150 watt power supply	\$79
200 watt power supply	\$99

**PC or AT Video Boards**

Hercules Color Graphics	\$159
Jade Color Graphics	\$89
Hercules Mono Graphics Plus	\$199
JADE Monochrome Graphics	\$99
Quad EGA+	\$359
Video 7 Vega EGA	\$339
JADE EGA+ EGA, CGA, MDA	\$239
JADE EGA+ Above Plus HGA	\$289

**High Speed APU Chips**

8087-3 5 MHz	\$119
8087-2 8 MHz	\$159
80287-3 5 MHz	\$179
80287-8 8 MHz	\$269
NEC V-20 5 MHz	\$11
NEC V-20 8 MHz	\$14
NEC V-30 8 MHz	\$16

**Monochrome Monitors**

Jade green Hi-res TTL	\$99
Jade amber Hi-res TTL	\$99
Amdek 310A amber	\$149
Magnavox green Hi-res TTL	\$119
Magnavox amber Hi-res TTL	\$119
PGS MAX 12E amber	\$159

**22 CPS DAISYWHEEL PRINTER**

**\$199**

- Diablo 630 Compatible
- Proportional spacing
- 2K Buffer
- Parallel and serial

Adjustable Tractor	\$69
Auto sheet feeder	\$159
Extra ribbon	\$5

**Modems**

**1200 BAUD MODEM**

**\$129**

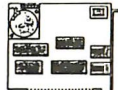

Internal 1200 baud card with software	\$129
External 1200 baud	\$139
Internal 2400 baud card with software	\$299
Hayes 1200B internal card w/o software	\$329
Hayes 1200B internal card w/Smartcom II	\$359
Hayes Smartmodem 1200	\$389
Hayes 2400B internal card w/Smartcom II	\$549
Hayes Smartmodem 2400	\$589

**NO-SLOT CLOCK**

For Your Apple, PC-XT or Clone

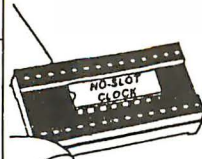

**\$49**

- Uses No Slot
- 20 Year Battery
- Includes Software

Real time clock/calendar for your IBM PC-XT, Clone Apple II+, IIe or IIc (Please Specify)

Plug-in Clock Board for PC \$49

**Iso-Bar**

These industrial quality ISO-BAR's contain surge suppression circuitry & built-in noise filters plus a 15 amp circuit breaker.

6 socket, 1 filter ISO-BAR	\$44
4 socket, 2 filter ISO-BAR	\$59
8 socket, 4 filter ISO-BAR	\$69
200W standby power supply	\$269
450W standby power supply	\$399
675W standby power supply	\$599
1000W standby power supply	\$899

**Plotters**

ROLAND DXY-800 8 COLOR

**8 PEN PLOTTER \$399**

List Price \$899

- Serial and Parallel
- A and B size Plots up to 17"x11"
- AUTOCAD compatibility
- 1% accuracy, .1mm step & .3mm repete

**PC Multifunction Cards**

384K Jade Seven Pak w/OK, p. s. c. c. g. software	\$89
384K Jade Seven Pak with 384K installed	\$139
AST Six Pak Plus 64K	\$159
AST Six Pak Plus 384K	\$229
AST Six Pak Premium 512K	\$389

**LASER PRINTERS**

6 PAGE Per Minute **\$1750**

10 PAGE Per Minute **\$1950**

CALL FOR DETAILS!

**Disk Drive For Your APPLE**



as low as **\$99**

20 MB hard disk	\$799
IIc 1/2 high disk drive	\$119
IIe 1/2 high disk drive	\$99
IIe, IIc disk drive	\$129
IIe 64K, 80 column card	\$49
IIc 80 column card	\$119
Grappler printer card	\$89
IIc 16K RAM card	\$39
1MB RAM card w/o k	\$129
IIc, IIe printer card & cable	\$49
IIc, IIe cooling fan	\$59

**Epson Printers In Stock**

**EPSON HW-10**  
100 CPS **\$189**

Including Free Interface and Cable

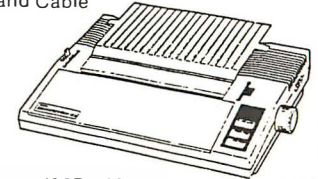

Citizen 120D 120 cps	\$198
Okidata 192 160 cps	\$339
Epson LX-86 120 cps	IN STOCK
Epson FX-85 160 cps	IN STOCK
Epson FX-286 200 cps	IN STOCK
Epson LQ-800 24 pin	IN STOCK
Epson LQ-1000 24 pin	IN STOCK
Epson EX-800 300 cps	IN STOCK
Epson EX-1000 300 cps	IN STOCK
Epson LQ-2500 324 cps	IN STOCK

**Microfazer-Buffers**

Expands to 64K (Parallel to 512K)

8K Parallel in/parallel out	\$139
64K Parallel in/parallel out	\$164
128K Parallel in/parallel out	\$269
512K Parallel in/parallel out	\$499

Your choice: serial in/serial out; parallel in/serial out; serial in/parallel out.

8K	\$169	64K	\$199
----	-------	-----	-------

**64K BUFFER FOR YOUR EPSON**

Serial or parallel input. Fits MX, RX, FX printers

Limited Quantity **\$99**

**JADE COMPUTER**

4901 W. Rosecrans Ave. Box 5046 Hawthorne, CA 90251-5046



Prices at our six store locations will be higher.

We accept cash, checks, credit cards or purchase orders from qualified firms and institutions. Minimum prepaid order \$15.00. Ca & Tx residents add 6 1/2% tax. Prices & availability subject to change without notice. Shipping & handling charges via UPS Ground 50c/lb UPS Air \$1.00/lb Minimum charge \$3.00.

**PLACE ORDERS TOLL FREE!**

**Continental U.S.A. (800)421-5500**

**Inside California (800)262-1710**



# PC + MIDI = MUSIC

It's a simple equation. To plug your PC or PC-compatible into the modern world of music-making, use the complete line of MIDI software and hardware from VOYETRA TECHNOLOGIES.

- SEQUENCER PLUS:** 65-track total MIDI recorder/editor.
- CONVERSION PLUS:** file converter for music notation programs.
- PATCH MASTER:** network organizer and sound librarian.
- OP-4001:** PC/MIDI interface card.

*"I've never seen a more powerful, easy-to-use music and recording system... bug-free."*  
(PC COMPANION)

For more information contact VOYETRA TECHNOLOGIES, Dept. PC, 426 Mt. Pleasant Avenue, Mamaroneck NY 10543, or call (914) 698-3377.

# MagicFont the \$59 Font Revolution

Design HP-compatible symbols, logos and fonts—without a color monitor or graphics card. Quick and easy!!!



CES 800 251-2223

509 Cathedral Pkwy. 10A  
New York, NY 10025  
212-222-8148

MS-DOS or CP/M

Transfer Your Data From IBM-PC/  
RS232 to Commodore Computer  
C64/128 or Vice Versa

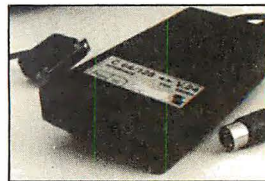

Brief Description:

- ✓ Baudrate 225 to 57600 selectable
- ✓ Hardware or XON/XOFF Handshake
- ✓ EEPROM - No Dip Switches
- ✓ Selectable Device Address
- ✓ 64 KByte Buffer Capacity

Price: Only \$149 (Part-No.98064)

(CA residents add tax 6.5% Shipping/Handling (US) add \$4 on all orders. Item subject to availability and price change without notice. Send check or money order.)

We carry interfaces and cables for most major computers and printers.

Tec Trans-Guertzen,  
6925 Rosemead Blvd.,  
San Gabriel, CA 91775  
(818)285-3121

IBM-PC/XT/AT are trademarks of International Business Machines  
C64/128 are trademarks of Commodore Business Machines

Inquiry 313

Inquiry 64

Inquiry 294

**NO SHIPPING CHARGES**  
**ORDER TOLL-FREE 800-824-3432**

In California Call (818) 341-8833

### DRIVES

1/2 Ht. IBM <sup>®</sup> Compatible	89.99
Tandon 100-2	99.99
Tandon 100-4 (96 tpi)	129.99

### SYSTEMS

PC/XT Compatible **499.99**

- 640K on Motherboard
- Slide-In Case
- 1-1/2 HT. Floppy
- 135 Watt Power Supply
- Mono Card w/Printer Port
- 5150 Type Keyboard

→ FCC APPROVED ←

CALL FOR  
CUSTOM CONFIGURATIONS  
AT COMPATIBLES — CALL!

We carry a complete line of electronic components. Call or write for our free catalog!

**NICORN ELECTRONICS**  
10010 Canoga Ave., Unit B-8 Chatsworth CA 91311

Minimum order \$10.00 — No shipping charges on prepaid orders — C.O.D. add \$3.00 — UPS Blue add \$3.00 — Calif. residents add 6 1/2% sales tax. Personal checks held for clearance. VISA, MC.

## PC-WRITER™



IBM PC GRAPHICS  
&  
LETTER QUALITY  
Enhancement for  
Okidata ML82A/83A  
Dot Matrix Printers

- Plug-in module easily installs in printer.
- Draft (120 cps) & Letter Quality (30 cps)
- Elite character pitch
- Front panel access to all features
- Emulation of IBM PC Graphics printer
- Superscripts / subscripts
- Foreign / scientific characters
- Works with print screen key in graphics and text
- Prints all 228 display screen characters and box drawing symbols exactly as they appear on display (double line as well as single line box symbols)

Ask About OK-WRITER™ Okidata graphics for \$99 with many of above features

**RAINBOW TECHNOLOGIES, INC.**

17971-E Skypark Circle, Irvine, CA 92714  
(714) 261-0228 Telex 386078  
UK Distributor: X-DATA (0753) 72331

Inquiry 243

## 9-Track Tape Subsystem



Now you can exchange data files between your IBM PC/XT/AT and any mainframe or minicomputer using IBM compatible 1600 BPI 9-Track tape. Unit can also be used for disk backup and archival storage. Transfer rate is one megabyte per minute on PCs and 100% compatibles. Subsystems include 7" or 10 1/2" streaming tape drive, tape coupler card and DOS compatible software.

Prices start at \$3,555.

**QUALSTAR®**

9015 Eton Ave., Canoga Park, CA 91304  
Telephone: (818) 882-5822

Inquiry 238

**100% ERROR FREE  
DISKETTES**

**POLY PACK 5 1/4" DOUBLE SIDE  
DOUBLE DENSITY**



(Blank Jacket)  
With Hub Rings  
Write Protect Tabs  
Tyvec Envelopes

In Factory-Sealed  
Poly Packs  
Sold in Lots of 100  
Minimum/200

**33¢  
Each**

Min. Order \$25.00. S&H: Continental USA \$4.00/100 or fewer disks. Reduced shipping charge on larger quantities. Foreign orders, APO/FPO, please call. MI residents add 4% tax. Prices subject to change without notice. Hours 8:30 AM - 7:00 PM ET.

**Precision Data Products™**

P O Box 8367, Grand Rapids, MI 49518  
Customer Service & Information  
(616) 452-3457  
Toll-Free Order Lines:  
MI 1-800-632-2468  
Outside MI 1-800-258-0028

## BAR CODES MADE EASY

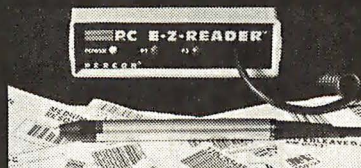

**PERCON® E-Z-READER™**  
FAST • ACCURATE • RUGGED

NO SOFTWARE CHANGES with PC/XT/AT,  
AT&T 6300/7300, TeleVideo 905/955 keyboard,  
multi-user RS 232 interfaces • Thousands in use  
• Free phone support • 2 year warranty  
• Bar code printing software available

Details or Questions? Call us.

**(503) 344-1189**

2190 W. 11th Ave., Eugene, OR 97402

A LEADER IN BAR CODE READER ENGINEERING

**PERCON®**

Inquiry 212

**DOUBLE THE OPTION CAPACITY  
OF YOUR IBM PERSONAL COMPUTER**

## PC-XTRA

- DIRECT EXTENSION OF IBM PC BUS
- NO SOFTWARE CHANGES
- NO HARDWARE MODIFICATION
- STYLING CONSISTENT WITH IBM

Add all those special options that you've been wanting without worrying about filling your plug-in and back panel space



DEALER INQUIRIES INVITED.

**\$549.00\*** F.O.B. SANTA ANA

\*CALIFORNIA RESIDENTS ADD 8% SALES TAX

**P C HORIZONS, INC.**

1701 E. Edinger, Ste. A6, Santa Ana, CA 92705  
(714) 953-5396

Inquiry 221

Inquiry 204



# ATTAK-286™ MODEL 1A

HIGH SPEED 12 MHZ OPERATION 6,8,10, and 12 MHZ! SELECTABLE TO

- FULL IBM PC-AT\* COMPATIBILITY!
- FULL MEGA-BYTE RAM CAPACITY!

100% DESIGNED, MANUFACTURED, ASSEMBLED AND TESTED IN USA!

AIT Corporation is a publicly traded company. Majority USA owned and traded on the OTC market under AITC



THOUSANDS SOLD WORLDWIDE!

Keyboard Interface same as PC-AT

FULL TIME PRODUCT SUPPORT AND SERVICE.

VOLUME DISCOUNTS AVAILABLE!

UNIQUE FEATURE!  
Complete Set-Up Software in ROM BIOS (No Disk Required for Set-Up)

Complete Documentation Package with Full Schematic Diagrams Included

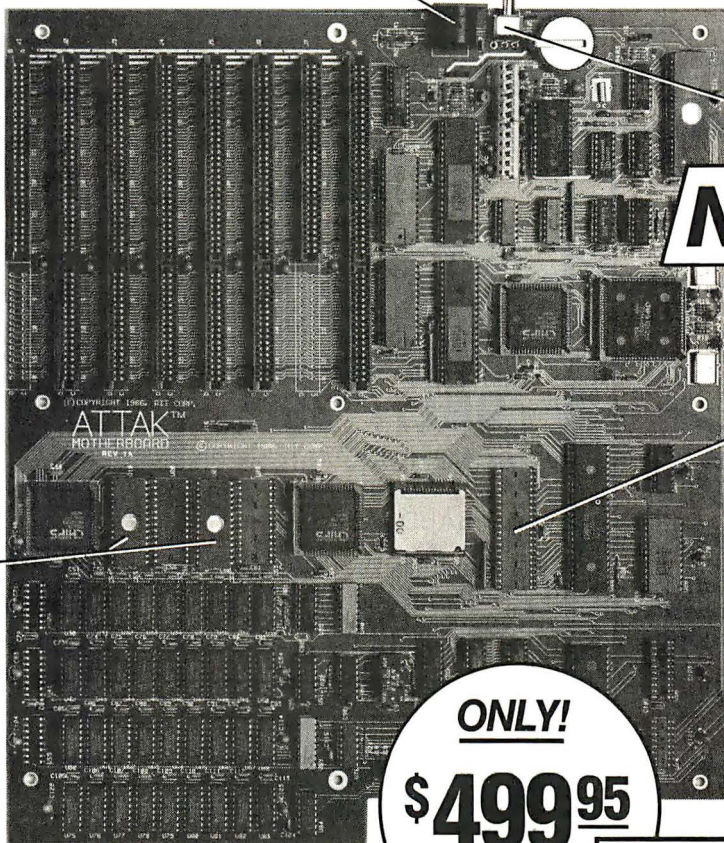

UNIQUE FEATURE!  
Hardware Reset Switch

**NEW!**

0-1 WAIT STATES!

UNIQUE FEATURE!  
Multi-Speed 80287 Numeric Processor Speed-Up Capability (Switch Selectable)

Triple Tested for 100% Quality Assurance!

Highest Quality Industrial Grade AMP Sockets!

**ONLY!**  
**\$499<sup>95</sup>**

**OEM EVALUATION BOARD**  
Completely Assembled and Tested with all IC's and Components

- ATTAK-286™ MODEL II 24MHZ ..... CALL
- ATTAK-386™ 32 BIT MICRO ..... CALL
- CASES, POWER SUPPLIES, PERIPHERALS, ETC. . . CALL
- TURBO-SCOPE™ A/D BOARD ..... \$99.95
- ATTAK-286™ MODEL 1A BARE BOARD ..... \$99.95

• OK RAM  
• 8 MHZ Version, Expansion to 12 MHZ

100% SATISFACTION GUARANTEED.  
10 DAY MONEY BACK GUARANTEE IF NOT COMPLETELY SATISFIED!



**ORDER NOW!**  
**SAME DAY SHIPMENT!**  
(FOR IN STOCK ITEMS)

**AIT CORPORATION** ADVANCED INTELLIGENCE TECHNOLOGY

4100 Spring Valley Road  
Suite 400  
Dallas, Texas 75244  
(214) 490-0344

TELEX 821379  
FAX (214) 960-1309

TERMS: We accept cash, checks, money orders and credit cards. Prices and availability subject to change without notice. Shipping and handling charges via UPS ground 50¢/lb UPS air \$1.00/lb. Minimum charge \$3.00.

\*IBM and IBM PC-AT are trademarks of International Business Machines

© 1986 AIT CORP.



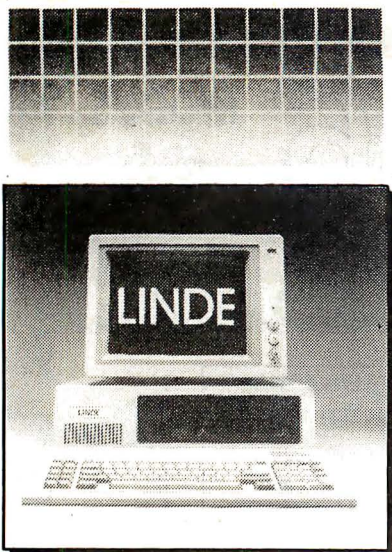

# LINDE BASIC SYSTEM

- PC/XT Compatible
- 640K on Board
- 1 DS/DD Floppy Drive
- Floppy Disk Controller
- Flip-Top Case
- Mono Graphic Card w/Printer Port or Color Graphic Card
- 150W Power Supply
- AT Style Keyboard
- FCC Approved
- 1 Year Limited Warranty

**\$575.**

Call for  
Quantity  
Discount

- Expandable to 640K RAM
- Option 4.77 MHZ/8MHZ Turbo Mother Board
- Multi Display Color Monitor
- TTL Monochrome Monitor
- 20MB Hard Disk/Controller
- Mouse w/Software
- 2nd DS/DD Floppy Drive
- Hayes Compatible Internal Modem
- Disk I/O Card
- EGA Card & Monitor
- Printer & Cable
- Joystick
- MS DOS 3.2 w/GW Basic

Ask for our AT-286 System  
**(213) 327-6431**

113 E. Savarona Way, Carson, CA 90746



## Single Board Systems

Introduces

### SBS-52 Controller

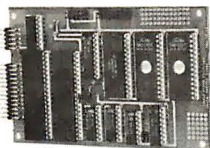

- 8052 Basic VI.I
- 32 Kx8 Ram
- 2 Real Time Clocks
- 32 I/O Lines
- Programs Eproms
- Small 3.00x5.00 Size

1-10 \$179.00

Single Board Systems  
P.O. Box 3788

Salem, Oregon 97302  
Phone (503) 581-6570

Inquiry 261

## THE PORTABLE TERMINAL



**ONLY! \$39<sup>95</sup>**

- 16K MEMORY + 5.00
- RS232 COMPATIBLE S&H
- 300 BAUD MODEM

Materials Processing  
185 LaFond Avenue  
St. Paul, MN 55103  
(612) 292-4867

Inquiry 176



## PORTABLE ADDITIONS

**DISK DRIVE** 3 1/2", 1 3/4 lbs., battery oper. or A/C adaptor (incl.), 100K storage. With TS-DOS software \$229 Drive without software \$179

**24K RAM CHIP**—Tandy 200 \$65, 2/\$59 ea.

**8K RAM CHIP**—Model-102 \$9.95  
Model-100 & NEC 8201/\$23 3/\$19 ea.

**SIDESTAR**—NEC Starlet ~~\$399~~ \$199  
128K Ram Disk Cartridge

**SIDECAR**—NEC PC-8201A \$259  
128K cartridge (four 32K banks)

**CALL TOLL FREE 1-800-732-5012**  
Calif: 805-987-4788

Canada: 604-856-8858, Australia: 02-419-8899



**PURPLE COMPUTING** VISA M/C & AMER. EXP.

420 Constitution Ave., Camarillo, CA 93010

Inquiry 228

## XT SYSTEM 3 BASIC TURBO



FCC Approved IBM® PC, XT compatible

Includes:

- XT-type case
- 150-watt power supply
- 640K turbo motherboard with 256K on board

#98999 ..... \$263<sup>00</sup>

IBM, PC, XT, AT are registered trademarks of International Business Machines.

The Wholesale Outlet

1 Interstate Avenue  
Albany, NY 12205  
Dept. BYB

**TO ORDER CALL:**  
1-518-459-7883

MC/VISA OR COD CASH

All orders shipped FOB Albany • Prices subject to change

We have Magnavox professional monitors!

Inquiry 316

## 6809 Single Board Computer

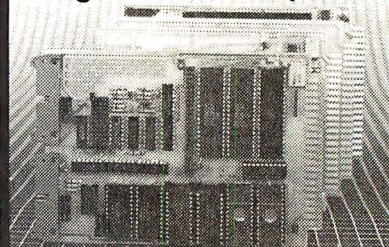

6809 MPU, 2 serial ports, 4 parallel ports, RAM, EPROM, real-time clock, watchdog timer, 44-pin 4.5" x 6.5" PCB

**EXPANSION MODULES:** RAM, EPROM, CMOS RAM/battery, analog I/O, serial I/O, parallel I/O, counter/timer, IEEE-488, EPROM programmer, floppy disks, cassette, breadboard, keyboard/display.



**WINTEK**

Wintek Corp.  
4801 South Street  
Lafayette, IN 47904  
317-742-8428

Inquiry 318

Advertise your  
computer products  
through  
**BYTE BITS**  
(2" x 3" ads)

For more information  
call Dan Harper at  
603-924-6830

BYTE  
70 Main St.  
Peterborough, NH 03458



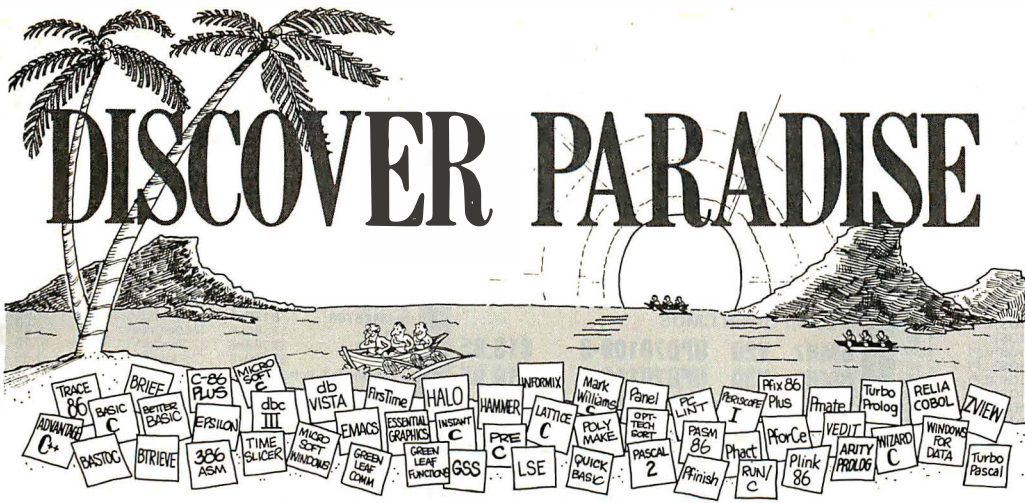

# Programmer's Paradise Gives You Superb Selection, Personal Service and Unbeatable Prices!

Welcome to Paradise. The PC/MS-DOS software source that caters to your individual programming needs. Discover the Many Advantages of Paradise...

- Lowest price guaranteed
- Latest versions
- Huge inventory, immediate shipment
- Knowledgeable sales staff
- Special orders
- 30-day money-back guarantee

## We'll Match Any Nationally Advertised Price.

	LIST OURS
C++	
ADVANTAGE C++	\$ 495 CALL
PFORCE++	395 CALL
C COMPILERS	
C-86 PLUS	497 CALL
DATALIGHT - C	60 49
DATALIGHT - C DEVELOPER'S KIT	99 79
LATTICE C 3.2	500 289
LATTICE C W/SOURCE	900 545
LET'S C	75 59
W/CSD DEBUGGER	150 109
MICROSOFT C 4.0	450 275
MARK WILLIAMS C	495 289
SUPERSOFT C	395 339
WIZARD C	450 369
C INTERPRETERS	
C-TERP	300 235
INSTANT C	500 379
INTRODUCING C	125 105
RUN/C	150 89
RUN/C PROFESSIONAL 1.1	250 169
ASSEMBLERS, LINKERS	
386ASM/LINK	495 445
ADVANTAGE LINK	395 349
MACRO-86	150 98
PASM-86	195 135
PLINK 86 PLUS	495 335
QUELO 68000 X-ASM	595 509

Polytron Specials	
POLYBOOST	80 65
POLYTRON C BEAUTIFIER	49 45
POLYTRON C LIBRARY I	99 75
POLYTRON POWERCOM	179 135
POLYLIBRARIAN	99 75
POLYLIBRARIAN II	99 75
POLYWINDOWS PRODUCTS	CALL CALL
POLYXREF	219 175
POLYXREF (One Language Only)	129 105
PVCS	395 315

GRAPHICS	
ADVANTAGE GRAPHICS	295 CALL
ESSENTIAL GRAPHICS	250 195
GSS GRAPHICS DEVELOPMENT	
TOOLKIT	495 379
GSS KERNEL SYSTEM	495 379
GSS METAFILE INTERPRETER	295 239
GSS PLOTTING SYSTEM	495 379
HALO—ONE LANGUAGE	300 209
HALO—FIVE MICROSOFT LANGUAGES	595 415
METAWINDOWS	185 115
METALINDOWS PLUS	235 189
META FONTS	80 59
META FONTS PLUS	235 189

**Terms and Policies**

- We honor MC, VISA, AMERICAN EXPRESS
- No surcharge on credit card or C.O.D. Prepayment by check. New York State residents add applicable sales tax. Shipping and handling \$3.00 per item. sent UPS ground. Rush service available, prevailing rates.
- Programmer's Paradise will match any current nationally advertised price for the products listed in this ad.
- Mention this ad when ordering—some items are specially priced.
- Prices and Policies subject to change without notice.
- Corporate and Dealer inquiries welcome.

**1-800-445-7899** In NY: 1-800-642-6471

	LIST OURS	LIST OURS
C UTILITY LIBRARIES		
ASYN MANAGER	175 135	
BASIC C	175 129	
C ESSENTIALS	100 85	
C FOOD SMORGASBORD	150 98	
W/SOURCE	300 188	
C TOOLS PLUS	175 135	
ESSENTIAL C UTILITY LIBRARY	185 135	
ESSENTIAL COMMUNICATIONS	185 135	
W/BREAKOUT DEBUGGER	250 195	
GREENLEAF FUNCTIONS	185 135	
GREENLEAF COMM	185 135	
THE HAMMER	195 175	
MULTI C	149 135	
MULTI COMM	149 135	
PFORCE	395 245	
TIMESLICER	295 265	
W/LIBRARY SOURCE	1000 CALL	
TOPVIEW TOOLBASKET	250 189	
SCREEN DISPLAY, WINDOWS FOR C		
C WORTHY	295 269	
CURSES	125 94	
W/SOURCE	250 184	
DATA WINDOWS	225 159	
W/SOURCE	450 315	
FLASH UP WINDOWS	75 68	
MICROSOFT WINDOWS		
DEVELOPMENT SYSTEM	500 329	
ON-LINE HELP	149 109	
PANEL	295 224	
SCREENPLAY (LATTICE)	150 135	
SOFTSCREEN HELP	195 175	
VIEW MANAGER	275 199	
VITAMIN C 3.0	225 199	
VC SCREEN	99 84	
WINDOWS FOR C	195 145	
WINDOWS FOR DATA	295 250	
Z VIEW	245 189	

FILE MANAGEMENT	
BTRIEVE	245 195
XTRIEVE	245 195
W/REPORT GENERATION	390 315
BTRIEVE/N	595 465
XTRIEVE/N	595 465
W/REPORT GENERATION	940 750
C TREE	395 329
R TREE	295 249
C TREE/R TREE BUNDLE	650 529
CQL	395 329
DBC III	250 189
W/SOURCE	500 379
DB VISTA	195 155
W/SOURCE	495 425
DB QUERY	195 155
W/SOURCE	495 425
FABS	150 129
FABSPLUS	195 169
INFORMIX	795 639
INFORMIX 4GL	995 799
INFORMIX SQL	795 639
PHACT	295 265

	LIST OURS	LIST OURS
SORT UTILITIES		
AUTOSORT	150 129	
M/SORT	155 139	
OPT-TECHSORT	149 115	
MAKE, LINT, PROFILE, UTILITIES		
C CROSS REFERENCE GENERATOR	50 39	
LMK	195 145	
POLYMAKE	99 75	
PMAKER	125 95	
PFINISH	395 245	
THE PROFILER	125 94	
PC LINT	139 105	
PRE-C	295 165	
TEXT MANAGEMENT UTILITIES	120 94	
DEBUGGERS		
ADVANCED TRACE 86	175 139	
BREAKOUT	125 99	
CODESMITH 86	145 108	
C SPRITE	175 138	
CI PROBE	75 59	
CSD SOURCE DEBUGGER	75 59	
PERISCOPE 1.3.0	345 293	
PERISCOPE II 3.0	175 145	
PERISCOPE II-X 3.0	145 109	
PRIX 86 PLUS	395 245	
XVIEW 86	60 49	

**February's Bundle of the Month**  
 BTRIEVE, XTRIEVE, REPORT GENERATOR  
 (formerly RTRIEVE)  
 LISTS TOGETHER \$635 OURS \$495!!!

EDITORS	
BRIEF	195 CALL
CVUE	75 59
W/SOURCE	250 195
EDIX	195 155
EMACS	295 265
ERLON	195 159
FIRSTIME (C)	295 229
KEDIT	125 105
LSE	125 95
PMATE	195 125
PC/VI	149 129
SPF/PC	195 149
VEDIT	150 109
VEDIT PLUS	185 139

ADDITIONAL PRODUCTS	
DANBRICKLIN'S DEMO PROGRAM	75 59
FASTBACK	175 149
INTERACTIVE EASYFLOW	150 129
PDISK	195 129
SOURCE PRINT	139 115
VENTURA PUBLISHER (XEROX)	895 805

LIST OURS	
PASCAL COMPILERS	
MICROSOFT PASCAL	300 189
PASCAL 2	350 329
TURBO PASCAL	100 69
OTHER BORLAND PRODUCTS	CALL CALL
TOOLS FOR TURBO PASCAL	
ALICE	95 68
FIRSTIME	75 59
FLASH UP WINDOWS	75 68
HALO	300 209
TURBO HALO	129 99
SCREENPLAY	100 89
SCREEN SCULPTOR	125 94
T-DEBUG PLUS	60 50
TURBO EXTENDER	85 65
TURBO PASCAL ASYN MGR	100 84
TURBO PROFESSIONAL	70 49
TURBO POWER TOOLS PLUS	100 83
TURBO WINDOWS	80 65
OTHER TURBO TOOLS	CALL CALL

**NEW Products**

**ADVANTAGE GRAPHICS**—Fast, powerful and extensive graphics library offering a full set of graphics primitives. No royalties, many languages! List \$295 Ours CALL

**DATAWINDOWS**—Greenleaf's latest offering includes integrated windows, transaction data entry, pop-up, pull-down, Lotus-style menu systems. And more! DataWindows is fast, writing directly to video memory.  
 List \$225 Ours \$159  
 w/Source List \$450 Ours \$315

**PASCAL 2**—Highly optimized Pascal compiler, with source level debugger, profiler.  
 List \$350 Ours \$329

**TIMESLICER**—Multitasking, linkable library supporting concurrent tasks and real-time event processing with header files provided for C++, C and assembly. Library source available!  
 List \$295 Ours \$265

**VENTURA PUBLISHER (XEROX)**—Desktop publishing software, lightning fast, loaded with features. Create professional-looking documentation at minimal cost!  
 List \$895 Ours \$905

BASIC	
BETTERBASIC	199 139
SUMMIT ADD ONS	CALL CALL
BETTER TOOLS	95 89
FINALLY	99 89
MICROSOFT QUICKBASIC	99 75
PROFESSIONAL BASIC	99 75
8087 MATH SUPPORT	50 45
PANEL-BASIC	145 115
TRUE BASIC	150 105
ADD ONS	CALL CALL
OTHER PRODUCTS AVAILABLE TO THE BASIC PROGRAMMER INCLUDE	
MULTIHALO, BTRIEVE, GSS GRAPHICS, SCREEN SCULPTOR, STRUBAS, 87 BASIC.	
<b>COBOL COMPILERS/UTILITIES</b>	
MICROSOFT COBOL	700 445
MICROSOFT COBOL TOOLS	350 205
MICROSOFT SORT	195 139
MICRO/SPF	175 CALL
OPT-TECH SORT	149 115
REALIA COBOL	995 785
SCREENPLAY	175 155
RM/COBOL	950 639
RM/COBOL 8X	1250 895
VISUAL COBOL (MBP)	1150 1015

FORTRAN COMPILERS/UTILITIES	
LAHEY FORTRAN	477 CALL
MICROSOFT FORTRAN	350 209
RM/FORTRAN	595 389
ACS TIMES SERIES	495 419
87 SFL	250 225
FOR-WINDS	90 78
FORLIB-PLUS	70 54
GRAFMATICS OR PLOTMATICS	135 119
GRAFMATICS AND PLOTMATICS	240 219
FORTRAN SCIENTIFIC	
SUBROUTINES	295 249
POLYFORTRAN TOOLS I	179 143
STRINGS AND THINGS	70 54
ALSO AVAILABLE TO THE FORTRAN PROGRAMMER: PANEL, MULTIHALO, BTRIEVE, ESSENTIAL GRAPHICS, FLASH UP WINDOWS, GSS GRAPHICS, OPT-TECH SORT.	
<b>PROLOG</b>	
ARTY PROLOG (STANDARD)	95 79
ADDIT ARTY PRODUCTS	CALL CALL
CHALCEDONY PROLOG	100 89
TURBO PROLOG	100 79
LISP, OTHER AI, CALL FOR INFORMATION, PRICING, AVAILABILITY.	

**Programmer's Paradise**  
 487 E. Main Street, Mt. Kisco, NY 10549  
 914-332-4548

**Programmer's Paradise**





# 1200 BAUD MODEM FOR IBM WITH PC TALK III SOFTWARE \$109.95

## STATIC RAMS

2101	256x4	(450ns)	1.95
5101	256x4	(450ns)(CMOS)	3.95
2102L-4	1024x1	(450ns)(LP)	.99
2112	256x4	(450ns)	2.99
2114	1024x4	(450ns)	.99
2114L-4	1024x4	(450ns)(LP)	1.09
2114L-2	1024x4	(200ns)(LP)	1.49
2114L-15	1024x4	(150ns)(LP)	1.95
TMS4044-4	4096x1	(450ns)	1.95
TMM2016-150	2048x8	(150ns)	1.95
TMM2016-100	2048x8	(100ns)	1.95
HM6116-4	2048x8	(200ns)(CMOS)	1.89
HM6116-3	2048x8	(150ns)(CMOS)	1.95
HM6116LP-4	2048x8	(200ns)(CMOS)(LP)	1.95
HM6116LP-3	2048x8	(150ns)(CMOS)(LP)	2.05
HM6116LP-2	2048x8	(120ns)(CMOS)(LP)	2.95
HM6264P-15	8192x8	(150ns)(CMOS)	3.89
HM6264LP-15	8192x8	(150ns)(CMOS)(LP)	3.95
HM6264LP-12	8192x8	(120ns)(CMOS)(LP)	4.49

LP=Low power

## DYNAMIC RAMS

4116-250	16384x1	(250ns)	.49
4116-200	16384x1	(200ns)	.89
4116-150	16384x1	(150ns)	.99
4116-120	16384x1	(120ns)	1.49
MK4332	32768x1	(200ns)	6.95
4164-200	65536x1	(200ns)(5v)	1.19
4164-150	65536x1	(150ns)(5v)	1.29
4164-120	65536x1	(120ns)(5v)	1.95
MCM6665	65536x1	(200ns)(5v)	1.95
TMS4164	65536x1	(150ns)(5v)	1.95
4164-REFRESH	65536x1	(150ns)(5v)(REFRESH)	2.95
TMS4416	16384x4	(150ns)(5v)	4.95
4112B-150	131072x1	(150ns)(5v)	5.95
TMS4464-15	65536x4	(150ns)(5v)	6.95
41256-200	262144x1	(200ns)(5v)	2.95
41256-150	262144x1	(150ns)(5v)	2.95

5v=Single 5 Volt Supply  
REFRESH=Pin 1 Refresh

## ★★★★HIGH-TECH★★★★

### NEC V20 UPD70108 \$119.95

REPLACES 8088 TO SPEED UP IBM PC 10-40%

\* HIGH-SPEED ADDRESS CALCULATION IN HARDWARE

\* PIN COMPATIBLE WITH 8088

\* SUPERSET OF 8088 INSTRUCTION SET

\* LOWPOWER CMOS

8MHZ V20 UPD70108-8 \$13.95

8MHZ V30 UPD70118-8 \$19.95

## ★★★★SPOTLIGHT★★★★

## EPROMS

2708	1024x8	(450ns)	4.95
2716	2048x8	(450ns)(5V)	3.49
2716-1	2048x8	(350ns)(5V)	3.95
TMS2532	4096x8	(450ns)(5V)	5.95
2732	4096x8	(450ns)(5V)	3.95
2732A	4096x8	(250ns)(5V)(21V PGM)	3.95
2732A-2	4096x8	(200ns)(5V)(21V PGM)	4.25
27C64	8192x8	(250ns)(5V)(CMOS)	5.95
2764	8192x8	(450ns)(5V)	3.49
2764-250	8192x8	(250ns)(5V)	3.95
2764-200	8192x8	(200ns)(5V)	4.25
MCM68766	8192x8	(350ns)(5V)(24 PIN)	17.95
27128	16384x8	(250ns)(5V)	4.25
27C256	32768x8	(250ns)(5V)(CMOS)	10.95
27256	32768x8	(250ns)(5V)	7.49

5V=Single 5 Volt Supply 21V PGM=Program at 21 Volts

## SPECTRONICS CORPORATION EPROM ERASERS



Model	Timer	Capacity Chip	Intensity (uW/Cm <sup>2</sup> )	Unit Price
PE-14	NO	9	8,000	\$83.00
PE-14T	YES	9	8,000	\$119.00
PE-24T	YES	12	9,600	\$175.00

# ORDER TOLL FREE 800-538-5000



## 8000

8035	1.49
8039	1.95
8080	2.95
8085	2.49
8087-2	169.95
8087	129.00
8088	6.95
8088-2	9.95
8155	2.49
8155-2	3.95
8748	7.95
8755	14.95
80286	129.95
80287	199.95

## 8200

8203	24.95
8205	3.29
8212	1.49
8216	1.49
8224	2.25
8237	4.95
8237-5	6.95
8250	6.95
8251	1.69
8251A	1.89
8253	1.89
8253-5	1.95
8255	1.69
8255-5	1.89
8259	1.95
8259-5	2.29
8272	4.95
8279	2.49
8279-5	2.95
8282	3.95
8284	2.95
8286	3.95
8288	4.95

## Z-80

Z80-CPU	2.5 MHz	1.69
4.0 MHz		
Z80A-CPU	1.79	
Z80A-CTC	1.89	
Z80A-DART	5.95	
Z80A-DMA	5.95	
Z80A-PIO	1.89	
Z80A-SIO/0	5.95	
Z80A-SIO/1	5.95	
Z80A-SIO/2	5.95	

## 8.0 MHz

Z80B-CPU	3.75
Z80B-CTC	4.25
Z80B-PIO	4.25
Z80B-DART	14.95
Z80B-SIO/0	12.95
Z80B-SIO/2	12.95
Z8671 ZILOG	19.95

## 6500

6502	2.69
65C02(CMOS)	12.95
6507	9.95
6520	1.95
6522	4.95
6526	26.95
6532	6.95
6545	6.95
6551	5.95
6561	19.95
6581	34.95

## 2.0 MHz

6502A	2.95
6522A	5.95
6532A	11.95
6545A	7.95
6551A	6.95

## 6800

6800	1.95
6802	4.95
6803	9.95
6809	5.95
6809E	5.95
6810	1.95
6820	2.95
6821	1.95
6840	6.95
6843	19.95
6844	12.95
6845	4.95
6847	11.95
6850	1.95
6863	22.95

## 2.0 MHz

68800	4.95
68802	5.95
68809E	6.95
68809	6.95
68821	3.95
68845	6.95
68850	2.95
68854	7.95

## CLOCK CIRCUITS

MMS369	1.95
MMS369-EST	1.95
MMS58167	12.95
MMS58174	11.95
MSM5832	2.95

## CRT CONTROLLERS

6845	4.95
68845	8.95
6847	11.95
HD46505SP	6.95
MC1372	2.95
6275	26.95
7220	19.95
CRT5027	12.95
CRT5037	9.95
TMS9918A	19.95

## DISK CONTROLLERS

1771	4.95
1791	9.95
1793	9.95
1795	12.95
1797	12.95
2791	19.95
2793	19.95
2797	29.95
6843	19.95
8272	4.95
UPD765	4.95
MB8876	12.95
MB8877	12.95
1691	6.95
2143	6.95

## BIT RATE GENERATORS

MC14411	9.95
BR1941	4.95
4702	4.95
COM8116	8.95
MMS307	4.95

## UARTS

AY5-1013	3.95
AY3-1015	4.95
TR1602	3.95
2651	4.95
IM6402	6.95
IM6403	9.95
INS8250	6.95

## SOUND CHIPS

76477	5.95
76489	8.95
SS1-263	39.95
AY3-8910	12.95
AY3-8912	12.95
SP1000	39.00

## CRYSTALS

32.768 KHz	.95
1.0 MHz	2.95
1.8432	2.95
2.0	1.95
2.097152	1.95
2.4576	1.95
3.2768	1.95
3.579545	1.95
4.0	1.95
4.032	1.95
5.0	1.95
5.0688	1.95
6.0	1.95
6.144	1.95
6.5536	1.95
8.0	1.95
10.0	1.95
10.738635	1.95
12.0	1.95
14.31818	1.95
15.0	1.95
16.0	1.95
17.430	1.95
18.0	1.95
18.432	1.95
20.0	1.95
22.1184	1.95
24.0	1.95
32.0	1.95

## CRYSTAL OSCILLATORS

1.0MHz	5.95
1.8432	5.95
2.0	5.95
2.4576	5.95
2.5	4.95
4.0	4.95
5.0688	4.95
6.0	4.95
6.144	4.95
8.0	4.95
10.0	4.95
12.0	4.95
12.480	4.95
15.0	4.95
16.0	4.95
18.432	4.95
20.0	4.95
24.0	4.95

## MISC.

TMS99531	9.95
TMS99532	19.95
ULN2003	.79
3242	7.95
3341	4.95
MC3470	1.95
MC3480	8.95
MC3487	2.95
11C90	19.95
2513-001 UP	6.95
AY5-2376	11.95
AY5-3600 PRO	11.95

## 74LS00

74LS00	16	74LS165	.65
74LS01	18	74LS166	.95
74LS02	17	74LS169	.95
74LS03	18	74LS173	.49
74LS04	16	74LS174	.39
74LS05	18	74LS175	.39
74LS08	18	74LS191	.49
74LS09	18	74LS192	.69
74LS10	16	74LS193	.69
74LS11	22	74LS194	.69
74LS12	22	74LS195	.69
74LS13	26	74LS196	.59
74LS14	39	74LS197	.59
74LS15	26	74LS221	.59
74LS20	17	74LS240	.69
74LS21	22	74LS241	.69
74LS22	22	74LS242	.69
74LS27	23	74LS243	.69
74LS28	26	74LS244	.69
74LS30	17	74LS245	.79
74LS32	18	74LS251	.49
74LS33	28	74LS253	.49
74LS37	26	74LS256	1.79
74LS38	26	74LS257	.39
74LS42	39	74LS258	.49
74LS47	75	74LS259	1.29
74LS48	85	74LS260	.49
74LS51	17	74LS266	.39
74LS73	29	74LS273	.79
74LS74	24	74LS279	.39
74LS75	29	74LS280	1.98
74LS76	29	74LS283	.59
74LS83	49	74LS290	.89
74LS85	49	74LS293	.89
74LS86	22	74LS299	1.49
74LS90	39	74LS322	3.95
74LS92	49	74LS323	2.49
74LS93	39	74LS364	1.95
74LS95	49	74LS365	.39
74LS107	34	74LS367	.39
74LS109	36	74LS368	.39
74LS112	29	74LS373	.79
74LS122	45	74LS374	.79
74LS123	49	74LS375	.95
74LS124	2.75	74LS377	.79
74LS125	39	74LS378	1.18
74LS126	39	74LS390	1.19
74LS132	39	74LS393	.79
74LS133	49	74LS441	1.49
74LS136	39	74LS624	1.95
74LS138	39	74LS640	.99
74LS139	39	74LS645	.99



# 2400 BAUD MODEM

FOR IBM WITH  
PC TALK III SOFTWARE

**\$259!**

## CMOS

4001	.19	14419	4.95
4011	.19	14433	14.95
4012	.25	4503	.49
4013	.35	4511	.69
4015	.29	4516	.79
4016	.49	4518	.85
4017	.49	4522	.79
4018	.69	4526	.79
4020	.59	4527	1.95
4021	.69	4528	.79
4024	.49	4529	2.95
4025	.25	4532	1.95
4027	.39	4538	.95
4028	.65	4541	1.29
4035	.69	4553	5.79
4040	.69	4585	.75
4041	.75	4702	12.95
4042	.59	74C00	.29
4043	.85	74C14	.59
4044	.69	74C74	.59
4045	1.98	74C83	1.95
4046	.69	74C85	1.49
4047	.69	74C95	.99
4049	.29	74C150	5.75
4050	.29	74C151	2.25
4051	.69	74C161	.99
4052	.69	74C163	.99
4053	.69	74C164	1.39
4056	2.19	74C192	1.49
4060	.69	74C193	1.49
4066	.29	74C221	2.49
4069	.19	74C240	1.89
4075	.29	74C244	1.89
4077	.29	74C374	1.99
4081	.22	74C905	10.95
4085	.79	74C911	8.95
4086	.89	74C917	12.95
4093	.49	74C922	4.49
4094	2.49	74C923	4.95
14411	9.95	74C926	7.95
14412	6.95	80C97	.95

## 7400/9000

7400	.19	74147	2.49
7402	.19	74148	1.20
7404	.19	74150	1.35
7406	.29	74151	.55
7407	.29	74153	.55
7408	.24	74154	1.49
7410	.19	74155	.75
7411	.25	74157	1.65
7414	.49	74159	.65
7416	.25	74161	.69
7417	.25	74163	.69
7420	.19	74164	.85
7423	.29	74165	.85
7430	.19	74166	1.00
7432	.29	74175	.89
7438	.29	74177	.75
7442	.49	74178	1.15
7445	.69	74181	1.95
7447	.89	74182	.75
7470	.35	74184	2.00
7473	.34	74191	1.15
7474	.33	74192	.79
7475	.45	74194	.85
7476	.35	74196	.79
7483	.59	74199	.75
7485	.59	74199	1.35
7486	.35	74221	.95
7489	2.15	74246	1.35
7490	.39	74247	1.25
7492	.50	74248	1.85
7493	.35	74249	1.95
7495	.55	74251	.75
7497	2.75	74265	1.35
74100	2.29	74273	3.15
74121	.29	74278	.65
74123	.49	74367	.65
74125	.45	74368	.65
74141	.65	9368	3.95
74143	5.95	9602	1.50
74144	2.95	9637	2.95
74145	.60	96S02	1.95

## 74S00

74S00	.29	74S163	1.29
74S02	.29	74S168	3.95
74S03	.29	74S174	.79
74S04	.29	74S175	.79
74S05	.29	74S188	1.95
74S08	.35	74S189	1.95
74S10	.29	74S195	1.49
74S15	.49	74S196	2.49
74S30	.29	74S197	2.99
74S32	.35	74S226	3.95
74S37	.69	74S240	1.49
74S38	.69	74S241	1.49
74S74	.49	74S244	1.49
74S85	.95	74S257	.79
74S86	.35	74S253	.79
74S112	.50	74S258	.95
74S124	2.75	74S280	1.95
74S138	.79	74S287	1.69
74S140	.55	74S288	1.69
74S151	.79	74S299	2.95
74S153	.79	74S373	1.69
74S157	.79	74S374	1.69
74S158	.95	74S471	4.95
74S161	1.29	74S571	2.95

## VOLTAGE REGULATORS

TO-220 CASE			
7805T	.49	7905T	.59
7808T	.49	7908T	.59
7812T	.49	7912T	.59
7815T	.49	7915T	.59
TO-3 CASE			
7805K	1.59	7905K	1.69
7812K	1.39	7912K	1.49
TO-93 CASE			
78L05	.49	79L05	.69
78L12	.49	79L12	1.49
OTHER VOLTAGE REGS			
LM323K	5V 3A	TO-3	4.79
LM338K	Adj. 5A	TO-3	6.95
78H12K	12V 5A	TO-3	8.95

## LINEAR

TL066	.99	LM733	.98
TL071	.69	LM741	.29
TL072	1.09	LM747	.29
TL074	1.95	LM748	.59
TL081	.59	MC1330	1.69
TL082	.99	MC1350	1.19
TL084	1.49	MC1372	6.95
LM301	.34	LM1414	1.59
LM309K	1.25	LM1458	.49
LM311	.59	LM1488	.49
LM311H	.89	LM1489	.49
LM317T	3.49	LM1495	.65
LM317T	.95	LM1812	8.25
LM318	1.49	ULN889	1.95
LM319	1.25	ULM2003	.79
LM320	see 7900	XR2206	3.95
LM322	1.95	XR2211	2.95
LM323K	4.79	XR2240	1.95
LM324	.49	MPQ2907	1.95
LM331	3.95	LM2917	1.95
LM334	1.19	CA3046	.89
LM335	1.79	CA3081	.99
LM336	1.75	CA3082	.99
LM337K	3.95	CA3086	.80
LM338K	6.95	CA3089	1.95
LM339	.59	CA310E	.99
LM340	see 7800	CA3146	1.29
LM350T	4.80	CA3160	1.19
LF353	.59	MC3470	1.95
LF356	.99	MC3480	2.95
LF357	.99	MC3487	2.95
LM358	.59	LM3900	.49
LM380	.89	LM3909	.98
LM383	1.95	LM3911	2.25
LM386	.89	LM3914	2.39
LM393	.45	MC4024	3.49
LM394H	5.95	MC4044	3.99
TL494	4.20	RC4136	1.25
TL497	3.25	RC4558	.69
NE555	.29	LM13600	1.49
NE556	.49	75107	1.49
NE558	1.29	75110	1.95
NE564	1.95	75150	1.95
LM566	.95	75154	1.95
LM566	1.49	75188	1.25
LM567	.79	75189	1.25
NE570	2.95	7551	.39
NE590	2.50	75452	.39
NE592	.98	75453	.39
LM710	.75	75477	1.29
LM723	.49	75492	.79
H=TO-5 CAN, K=TO-3, T=TO-220			

## DATA ACQ INTERFACE

ADC0800	15.55	8T26	1.29
ADC0804	4.89	8T28	1.29
ADC0809	4.89	8T95	.89
ADC0816	14.95	8T96	.89
ADC0817	9.95	8T97	.59
ADC0831	8.95	8T98	.89
DAC0800	4.49	DM8131	2.95
DAC0804	1.95	DP8304	2.29
DAC0808	2.95	DS8833	2.25
DAC1020	8.25	DS8835	1.99
DAC1022	5.95	DS8836	.99
MC1408L8	2.95	DS8837	1.65

## IC SOCKETS

8 PIN ST	1.99	100+
16 PIN ST	.11	.10
16 PIN ST	.12	.10
18 PIN ST	.15	.13
20 PIN ST	.18	.15
22 PIN ST	.15	.12
24 PIN ST	.20	.15
28 PIN ST	.22	.16
40 PIN ST	.30	.22
64 PIN ST	1.95	1.49
ST-SOLDER TAIL		
8 PIN WW	.59	.69
14 PIN WW	.69	.52
16 PIN WW	.69	.58
18 PIN WW	.99	.90
20 PIN WW	1.09	.98
22 PIN WW	1.39	1.28
24 PIN WW	1.49	1.35
28 PIN WW	1.69	1.49
40 PIN WW	1.99	1.80
WW-WIRE WRAP		
16 PIN ZIF	4.95	CALL
24 PIN ZIF	5.95	CALL
28 PIN ZIF	6.95	CALL
40 PIN ZIF	9.95	CALL
ZIF=TEXTUOL		
(ZERO INSERTION FORCE)		

## EDGECARD CONNECTORS

100 PIN ST	S-100	.125	3.95
100 PIN WW	S-100	.125	4.95
62 PIN ST	IBM PC	.100	1.95
50 PIN ST	APPLE	.100	2.95
44 PIN ST	STD	.156	1.95
44 PIN WW	STD	.156	4.95

## 36 PIN CENTRONICS

		MALE		
IDCN36	RIBBON CABLE			6.95
CEN36	SOLDER CUP			4.95
		FEMALE		
IDCN36/F	RIBBON CABLE			7.95
CEN36PC	RT ANGLE PC MOUNT			4.95

## INTERSIL

ICL7106	9.95
ICL7107	12.95
ICL7660	2.95
ICL8038	4.95
ICM7207A	5.95
ICM7208	15.95

## DIP CONNECTORS

DESCRIPTION	ORDER BY	CONTACTS								
		8	14	16	18	20	22	24	28	40
HIGH RELIABILITY TOOLED ST IC SOCKETS	AUGATxxST	.62	.79	.89	1.09	1.29	1.39	1.49	1.69	2.49
HIGH RELIABILITY TOOLED WW IC SOCKETS	AUGATxxWW	1.30	1.80	2.10	2.40	2.50	2.90	3.15	3.70	5.40
COMPONENT CARRIES (DIP HEADERS)	ICCxx	.49	.59	.69	.99	.99	.99	.99	1.09	1.49
RIBBON CABLE DIP PLUGS (IDC)	IDPxx	---	.95	.95	---	---	---	1.75	---	2.95

FOR ORDERING INSTRUCTIONS SEE D-SUBMINIATURE BELOW

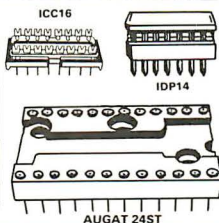

## DIODES/OPTO/TRANSISTORS

1N751	.25	4N26	.69
1N759	.25	4N27	.69
1N4148	25/1.00	4N28	.69
1N4004	10/1.00	4N33	.89
1N5402	.25	4N37	1.19
KB0P2	.55	MCT-2	.59
KB18A	.95	MCT-6	1.29
MDA890-2	.35	TIL-111	.99
N2222	.25	2N3906	.60
PN2222	.10	2N4401	.25
2N2905	.50	2N4402	.25
2N2907	.25	2N4403	.25
2N3055	.79	2N6045	1.75
2N3904	.10	TIP31	.49

## D-SUBMINIATURE

DESCRIPTION	ORDER BY	CONTACTS						
		9	15	19	25	37	50	
SOLDER CUP	MALE	DBxxP	.82	.90	1.25	1.25	1.80	3.48
	FEMALE	DBxxS	.95	1.15	1.50	1.50	2.35	4.32
RIGHT ANGLE PC SOLDER	MALE	DBxxPR	1.20	1.49	---	1.95	2.65	---
	FEMALE	DBxxSR	1.25	1.55	---	2.00	2.79	---
WIRE WRAP	MALE	DBxxPWW	1.69	2.56	---	3.89	5.60	---
	FEMALE	DBxxSww	2.76	4.27	---	6.84	9.95	---
IDC RIBBON CABLE	MALE	IDBxxP	2.70	2.95	---	3.98	5.70	---
	FEMALE	IDBxxS	2.92	3.20	---	4.33	6.76	---
HOODS	METAL	MHOODxx	1.25	1.25	1.30	1.30	---	---
	GREY	HOODxx	.65	.65	---	.65	.75	.95

ORDERING INSTRUCTIONS: INSERT THE NUMBER OF CONTACTS IN THE POSITION MARKED "xx" OF THE "ORDER BY" PART NUMBER LISTED.

EXAMPLE: A 15 PIN RIGHT ANGLE MALE PC SOLDER WOULD BE DB15PR.

**MOUNTING HARDWARE \$1.00**

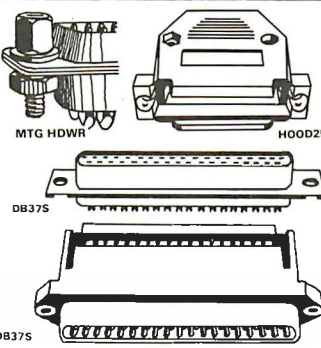

## IDC CONNECTORS

DESCRIPTION	ORDER BY	CONTACTS					
		10	20	26	34	40	50
SOLDER HEADER	IDHxxS	.82	1.2				



FOR MORE INFO & SPECIAL OFFERS  
JOIN "jdr.ad" ON BIX DURING THE MONTH OF FEBRUARY

**20 MB HD SYSTEM \$369<sup>95</sup>**

**BARGAIN HUNTERS CORNER**

**KEY TRONIC™ \$49<sup>95</sup>**

- 5150 STYLE OEM KEYBOARD**  
 \* IMPROVED KEYBOARD LAYOUT  
 \* 83 KEYS, FULLY IBM COMPATIBLE  
 \* LED INDICATORS FOR CAPS & NUMBER LOCK

**MITSUBISHI \$129<sup>95</sup>**

- HIGH DENSITY DRIVE**  
 \* IBM PC/AT COMPATIBLE  
 \* 1.2 MEGABYTE, 1/2 HEIGHT FDD  
 \* READS DS/DD OR DS/DH DISKETTES  
 \* QUIET & RELIABLE

**SPECIALS ENDS 4/30/87**

**PAGE WIRE WRAP WIRE  
PRECUT ASSORTMENT  
IN ASSORTED COLORS \$27.50**

- 100ea: 5.5", 6.0", 6.5", 7.0"  
 250ea: 2.5", 4.5", 5.0"  
 500ea: 3.0", 3.5", 4.0"

**SPOOLS**

- 100 feet \$4.30    250 feet \$7.25  
 500 feet \$13.25    1000 feet \$21.95

Please specify color:  
 Blue, Black, Yellow or Red

**EMI FILTER \$4.95**

- \* MANUFACTURED BY CORCOM  
 \* LOW COST  
 \* FITS LC-HP BELOW  
 \* 6 AMP 120/240 VOLT



**6 FOOT LINE CORDS**

- LC-2 2 CONDUCTOR .39  
 LC-3 3 CONDUCTOR .99  
 LC-HP 3 CONDUCTOR W/STD FEMALE SOCKET 1.49

**MUFFIN FANS**

- 3.15" SQ ROTRON 14.95  
 3.63" SQ ETRI 14.95  
 3.18" SQ MASUSHITA 16.95

**WIRE WRAP PROTOTYPE CARDS  
FR-4 EPOXY GLASS LAMINATE  
WITH GOLD-PLATED EDGE-CARD FINGERS**

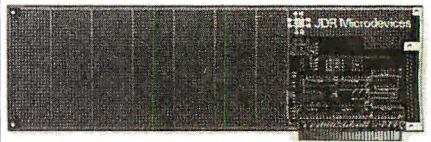

IBM-PR2

**IBM**

BOTH CARDS HAVE SILK SCREENED LEGENDS AND INCLUDES MOUNTING BRACKET

- IBM-PR1 WITH +5V AND GROUND PLANE . . . \$27.95  
 IBM-PR2 AS ABOVE WITH DECODING LAYOUT \$29.95

**S-100**

- P100-1 BARE - NO FOIL PADS . . . . . \$15.15  
 P100-2 HORIZONTAL BUS . . . . . \$21.80  
 P100-3 VERTICAL BUS . . . . . \$21.80  
 P100-4 SINGLE FOIL PADS PER HOLE . . . . . \$22.75

**APPLE**

- P500-1 BARE - NO FOIL PADS . . . . . \$15.15  
 P500-3 HORIZONTAL BUS . . . . . \$22.75  
 P500-4 SINGLE FOIL PADS PER HOLE . . . . . \$21.80  
 7060-45 FOR APPLE IIa AUX SLOT . . . . . \$30.00

**SOCKET-WRAP I.D.™**

- \* SLIPS OVER WIRE WRAP PINS  
 \* IDENTIFIES PIN NUMBERS ON WRAP SIDE OF BOARD  
 \* CAN WRITE ON PLASTIC, SUCH AS IC #

PINS	PART#	PCK. OF	PRICE
8	IDWRAP 08	10	1.95
14	IDWRAP 14	10	1.95
16	IDWRAP 16	10	1.95
18	IDWRAP 18	5	1.95
20	IDWRAP 20	5	1.95
22	IDWRAP 22	5	1.95
24	IDWRAP 24	5	1.95
28	IDWRAP 28	5	1.95
40	IDWRAP 40	5	1.95

PLEASE ORDER BY NUMBER OF PACKAGES (PCK. OF)

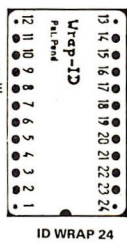

ID WRAP 24

**FRAME STYLE TRANSFORMERS**

- |             |       |       |
|-------------|-------|-------|
| 12.6V AC CT | 2 AMP | 5.95  |
| 12.6V AC CT | 4 AMP | 7.95  |
| 12.6V AC CT | 8 AMP | 10.95 |
| 25.2V AC CT | 2 AMP | 7.95  |

**25 PIN D-SUB GENDER CHANGERS \$7.95**



**SWITCHING POWER SUPPLIES**

**PS-IBM \$69.95**

- \* FOR IBM PC-XT COMPATIBLE  
 \* 135 WATTS  
 \* +5V @ 15A, +12V @ 4.2A  
 \* -5V @ 5A, -12V @ 5A  
 \* ONE YEAR WARRANTY



**PS-IBM-150 \$79.95**

- \* FOR IBM PC-XT COMPATIBLE  
 \* 150 WATTS  
 \* +12V @ 5.2A, -5V @ 16A  
 \* -12V @ 5A, -5V @ 5A  
 \* ONE YEAR WARRANTY

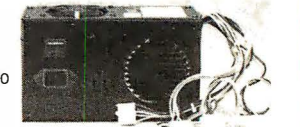

**PS-130 \$99.95**

- \* 130 WATTS  
 \* SWITCH ON REAR  
 \* FOR USE IN OTHER IBM TYPE MACHINES  
 \* 90 DAY WARRANTY



**PS-A \$49.95**

- \* USE TO POWER APPLE TYPE SYSTEMS, 79.5 WATTS  
 \* +5V @ 7A, +12V @ 3A  
 \* -5V @ 5A, -12V @ 5A  
 \* APPLE POWER CONNECTOR

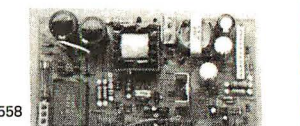

**PS-1558 \$34.95**

- \* 75 WATTS, UL APPROVED  
 \* +5V @ 7A, +12V @ 3A  
 \* -12V @ 250ma, -5V @ 300ma



**BOOKS BY STEVE GIARCIA**

- BUILD YOUR OWN Z80 COMPUTER \$19.95  
 CIRCUIT CELLAR VOL 1 \$17.95  
 CIRCUIT CELLAR VOL 2 \$18.95  
 CIRCUIT CELLAR VOL 3 \$18.95  
 CIRCUIT CELLAR VOL 4 \$18.95  
 CIRCUIT CELLAR VOL 5 \$19.95

**MICROCOMPUTER HARDWARE HANDBOOK FROM ELCOMP \$14.95**

OVER 800 PAGES OF DATA SHEETS ON THE MOST COMMONLY USED ICs. INCLUDES TTL, CMOS, 74LS00, MEMORY, CPUs, MPU SUPPORT, AND MUCH MORE!

**CAPACITORS**

**TANTALUM**

1.0µf	15V .35	.47µf	35V .45
6.8	15V .70	1.0	35V .45
10	15V .89	2.2	35V .65
22	15V 1.35	4.7	35V .85
.22	35V .40	10	35V 1.00

**DISC**

10µf	50V .05	.680	50V .05
22	50V .05	.001µf	50V .05
27	50V .05	.0022	50V .05
33	50V .05	.005	50V .05
47	50V .05	.01	50V .07
68	50V .05	.02	50V .07
100	50V .05	.05	50V .07
220	50V .05	.1	12V .10
560	50V .05	.1	50V .12

**MONOLITHIC**

.01µf	50V .14	.1µf	50V .18
.047µf	50V .15	.47µf	50V .25

**ELECTROLYTIC**

µf	25V	14	1µf	AXIAL	14
2.2	35V	15	10	50V	16
4.7	50V	15	22	16V	14
10	50V	15	47	50V	20
47	35V	18	100	35V	25
100	16V	18	220	25V	30
220	35V	20	470	50V	50
470	25V	30	1000	16V	60
2200	16V	70	2200	16V	70
4700	25V	1.45	4700	16V	1.25

**DATARASE EPROM ERASER \$34.95**

- \* ERASES 2 IN 10 MINUTES  
 \* COMPACT-NO DRAWER  
 \* THIN METAL SHUTTER PREVENTS UV LIGHT FROM ESCAPING



**1/4 WATT RESISTORS**

- 5% CARBON FILM ALL STANDARD VALUES FROM 1 OHM TO 10 MEG. OHM  
 10 PCS same value .05    100 PCS same value .02  
 50 PCS same value .025    1000 PCS same value .015

**RESISTOR NETWORKS**

SIP	10 PIN	9 RESISTOR	.69
SIP	8 PIN	7 RESISTOR	.59
DIP	16 PIN	8 RESISTOR	1.09
DIP	16 PIN	15 RESISTOR	1.09
DIP	14 PIN	7 RESISTOR	.99
DIP	14 PIN	13 RESISTOR	.99

**SPECIALS ON BYPASS CAPACITORS**

- .01 µf CERAMIC DISC 100/\$5.00  
 .01 µf MONOLITHIC 100/\$10.00  
 .1 µf CERAMIC DISC 100/\$6.50  
 .1 µf MONOLITHIC 100/\$12.50

**WISH SOLDERLESS BREADBOARDS**

PART NUMBER	DIMENSIONS	DISTRIBUTION STRIPS(S)	TIE POINTS	TERMINAL STRIPS(S)	TIE POINTS	BINDING POSTS	PRICE
WBU-D	.38 x 6.50"	1	100	---	---	---	2.95
WBU-T	1.38 x 6.50"	---	---	1	630	---	6.95
WBU-204-3	3.94 x 8.45"	1	100	2	1260	2	17.95
WBU-204	5.13 x 8.45"	4	400	2	1260	3	24.95
WBU-206	6.88 x 9.06"	5	500	3	1890	4	29.95
WBU-208	8.25 x 9.45"	7	700	4	2520	4	39.95

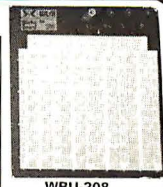

WBU-208

**LITHIUM BATTERY AS USED IN CLOCK CIRCUITS**

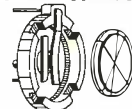

3 VOLT BATTERY \$3.95  
 BATTERY HOLDER \$1.49

**NEW EDITION!**

**1986 IC MASTER**  
 THE INDUSTRY STANDARD  
**\$129.95**



Visit our retail store located at 1256 S. Bascom Ave. in San Jose, (408) 947-8881

**JDR Microdevices**  
 110 Knowles Drive, Los Gatos, CA 95030  
 Toll Free 800-538-5000 • (408) 866-6200  
 FAX (408) 378-8927 • Telex 171-110

PLEASE USE YOUR CUSTOMER NUMBER WHEN ORDERING

TERMS: Minimum order \$10.00. For shipping and handling include \$2.50 for UPS Ground and \$3.50 for UPS Air. Orders over 1 lb. and foreign orders may require additional shipping charges - please contact our sales department for the amount. CA residents must include applicable sales tax. All merchandise is warranted for 90 days unless otherwise stated. Prices are subject to change without notice. We are not responsible for typographical errors. We reserve the right to limit quantities and to substitute manufacturer. All merchandise subject to prior sale.

© COPYRIGHT 1986 JDR MICRODEVICES

Inquiry 137

THE JDR MICRODEVICES LOGO IS A REGISTERED TRADEMARK OF JDR MICRODEVICES. JDR INSTRUMENTS AND JDR MICRODEVICES ARE TRADEMARKS OF JDR MICRODEVICES. IBM IS A TRADEMARK OF INTERNATIONAL BUSINESS MACHINES. APPLE IS A TRADEMARK OF APPLE COMPUTER.



# 2400 BAUD MODEM

FOR IBM WITH  
PC TALK III SOFTWARE

**\$259!**

## DISK DRIVES FOR APPLE COMPUTERS

**AP-150**  
**\$99.95**



- 1/2 HT, DIRECT DRIVE
- 100% APPLE COMPATIBLE
- SIX MONTH WARRANTY

**BAL-500**  
**\$129.95**

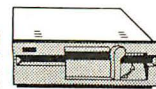

- TEAC MECHANISM-DIRECT DRIVE
- 100% APPLE COMPATIBLE
- FULL ONE YEAR WARRANTY

**AP-135**  
**\$129.95**

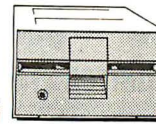

- FULL HT SHUGART MECHANISM
- DIRECT REPLACEMENT FOR APPLE DISK II
- SIX MONTH WARRANTY

**DOUBLE SIDED!**

**MAC535**  
**\$249.95**

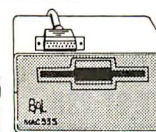

- 3.5" ADD-ON DISK DRIVE
- 100% MACINTOSH COMPATIBLE
- DOUBLE SIDED 800K BYTE STORAGE
- HIGH RELIABILITY DRIVE HAS AUTO-EJECT MECHANISM
- FULL ONE YEAR WARRANTY

**AD-3C**  
**\$139.95**

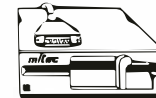

- 100% APPLE IIc COMPATIBLE, READY TO PLUG IN, W/ SHIELDED CABLE & MOLDED 15 PIN CONNECTOR
- FAST, RELIABLE SLIMLINE DIRECT DRIVE
- SIX MONTH WARRANTY

## DISK DRIVE ACCESSORIES

- FDD CONTROLLER CARD \$49.95
- IIc ADAPTOR CABLE \$19.95
- ADAPTS STANDARD APPLE DRIVES FOR USE WITH APPLE IIc

**KB-100** **\$79.95**

- CASE WITH KEYBOARD FOR APPLE TYPE MOTHERBOARD
- USER DEFINED FUNCTION KEYS
- NUMERIC KEYPAD WITH CURSOR CONTROL
- CAPS LOCK • AUTO-REPEAT

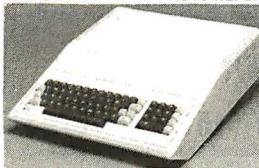

**KEYBOARD-AP** **\$49.95**

- REPLACEMENT FOR APPLE II KEYBOARD
- CAPS LOCK KEY, AUTO-REPEAT
- ONE KEY ENTRY OF BASIC OR CP/M COMMANDS

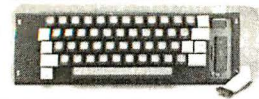

## EXTENDER CARDS

- IBM-PC \$45.00
- IBM-AT \$68.00
- APPLE II \$45.00
- APPLE IIc \$45.00
- MULTIBUS \$86.00

## APPLE COMPATIBLE INTERFACE CARDS

**EPROM PROGRAMMER \$59.95**

**MODEL RP525**

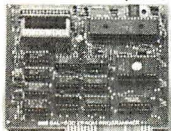

- DUPLICATE OR BURN ANY STANDARD 27xx SERIES EPROM
- EASY TO USE MENU-DRIVEN SOFTWARE IS INCLUDED
- MENU SELECTION FOR 2716, 2732, 2732A, 2764 AND 27128
- HIGH SPEED WRITE ALGORITHM
- LED INDICATORS FOR ACTIVITY
- NO EXTERNAL POWER SUPPLY NEEDED
- ONE YEAR WARRANTY

**16K RAMCARD \$39.95**



- FULL TWO YEAR WARRANTY
- EXPAND YOUR 48K APPLE TO 64K
- USE IN PLACE OF APPLE LANGUAGE CARD
- BARE PC CARD W/ INSTRUCTIONS \$9.95

**IC TEST CARD \$99.95**



- QUICKLY TESTS MANY COMMON ICs
- DISPLAYS PASS OR FAIL
- ONE YEAR WARRANTY
- TESTS: 4000 SERIES CMOS, 74HC SERIES CMOS, 7400, 74LS, 74L, 74H & 74S

**300B MODEM \$49.95**

- FOR APPLE OR IBM
- INCLUDES ASCII PRO-EZ SOFTWARE



**JOYSTICK CR-401 \$7.95**

- FOR ATARI 400, 800, 2600, VIC 20/64 AND APPLE IIc



**DISKFILE**

- HOLDS 70 5 1/4" DISKETTES



**\$895**

**3.5" DISKFILE HOLDS 40 \$995**

**POWER STRIP**

- UL APPROVED
- 15A CIRCUIT BREAKER



## 2 WAY SWITCH BOXES

- AVAILABLE IN SERIAL OR PARALLEL
- CONNECTS 2 PRINTERS TO ONE COMPUTER OR VICE VERSA
- ALL LINES SWITCHES
- PUSH-BUTTON SWITCHES MOUNTED ON PCB
- 3 FEMALE GOLD-PLATED CONNECTORS

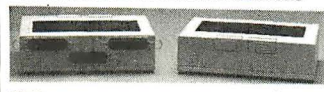

**AB-P CENTRONICS PARALLEL \$39.95**  
**AB-S RS232 SERIAL \$39.95**

## MOLDED INTERFACE CABLES

- 6 FOOT, 100% SHIELDED, MEETS FCC
- IBM PARALLEL PRINTER CABLE \$9.95
- CENTRONICS MALE TO FEMALE \$15.95
- CENTRONICS MALE TO MALE \$14.95
- MODEM CABLE FOR IBM \$7.95
- RS232 SERIAL MALE TO FEMALE \$9.95
- RS232 SERIAL MALE TO MALE \$9.95
- KEYBOARD EXTENSION (COILED) \$7.95
- APPLE II JOYSTICK EXTENSION \$4.95

## C. ITOH RITEMAN II PRINTER



- 160 CPS DRAFT MODE, 32CPS NLQ MODE
- 8 X 9 DOT MATRIX
- SUPPORTS EPSON/IBM GRAPHICS
- FRICTION AND TRACTOR FEEDS
- VARIABLE LINE SPACING AND PITCH

**\$219.95**

IBM PRINTER CABLE \$9.95  
REPLACEMENT RIBBON CARTRIDGE \$7.95

## NASHUA DISKETTES DEALS

5 1/4" SOFT SECTOR DS/DD WITH HUB RINGS

**\$990** **69c ea** **59c ea**  
BOX OF 10 BULK QTY 50 BULK QTY 250

- NASHUA DISKETTES WERE JUDGED TO HAVE THE HIGHEST POLISH AND RECORDED AMPLITUDE OF ANY DISKETTES TESTED ACCORDING TO "COMPARING FLOPPY DISKS", BYTE 9/84

## DISKETTES NASHUA 5 1/4"

N-MD2D DS/DD SOFT \$9.90  
N-MD2F DS/QUAD SOFT \$19.95  
N-MD2H DS/HD FOR AT \$24.95

**NASHUA 8"**  
N-FD1 SS/DD SOFT \$27.95  
N-FD2 DS/DD SOFT \$34.95

**NASHUA 3.5"**  
N-3.5SS 3.5" SS/DD FOR MAC \$24.95

**VERBATIM 5 1/4"**  
V-MD1D SS/DD SOFT \$16.95  
V-MD2D DS/DD SOFT \$17.95  
V-MD110D SS/DD 10 SECTOR HARD \$19.95

# BUILD STEVE GIARCIA'S INTELLIGENT EPROM PROGRAMMER

AS SEEN IN BYTE, OCT. 86

- STAND-ALONE OR RS-232 SERIAL OPERATION
- MENU SELECTABLE EPROM TYPES—NO CONFIGURATION JUMPERS
- PROGRAMS ALL 5V 27XXX EPROMS FROM 2716 TO 27512
- READ, COPY OR VERIFY EPROM
- UPLOAD/DOWNLOAD INTEL HEX FILES
- PROGRAMMER DRIVER USER MODIFIABLE

**ONLY \$199**

KIT INCLUDES PCB AND ALL COMPONENTS EXCEPT CASE AND POWER SUPPLY

## 5 1/4" FLOPPY DISK DRIVES

- TEAC FD-55B 1/2 HT DS/DD (FOR IBM) \$109.95
- TEAC FD-55F 1/2 HT DS/QUAD (FOR IBM) \$124.95
- TEAC FD-550FV 1/2 HT OS/HD (FOR IBM AT) \$154.95
- TANDON TM100-2 DS/DD (FOR IBM) \$119.00
- TANDON TM50-2 1/2 HT DS/DD (FOR IBM) \$79.95
- MPI-B52 DS/DD (FOR IBM) \$79.95

## 8" FLOPPY DISK DRIVES

- FD-100-8 SS/DD(SA/801 EQUIV) \$119.00
- FD-200-8 DS/DD (ISA/851R EQUIV) \$159.00

## DISK DRIVE ACCESSORIES

- TEAC SPECIFICATION MANUAL \$5.00
- TEAC MAINTENANCE MANUAL \$25.00
- 1/2 HT MOUNTING HARDWARE \$2.95
- MOUNTING RAILS FOR IBM AT \$4.95
- 1" POWER CABLE FOR 5 1/4" FDDs \$2.95
- 5 1/4" FDD POWER CONNECTORS \$1.19

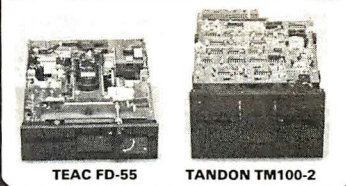

TEAC FD-55 TANDON TM100-2

## DISK DRIVE ENCLOSURES

- CAB-1FH5** \$89.95  
FULL HT 5 1/4" BEIGE CABINET W/ POWER SUPPLY
- CAB-23V5** \$49.95  
DUAL SLIMLINE 5 1/4" CABINET W/ POWER SUPPLY
- CAB-23V8** \$209.95  
DUAL SLIMLINE 8" CABINET W/ POWER SUPPLY
- CAB-2FH8** \$219.95  
HORIZONTAL DUAL FULL HT 8" CABINET W/ POWER SUPPLY

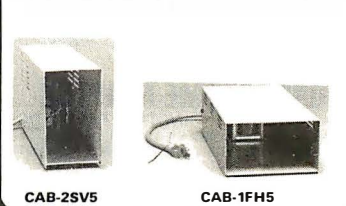

CAB-23V5 CAB-1FH5

## TEST EQUIPMENT FROM JDR INSTRUMENTS

**DIGITAL MULTIMETER PEN DPM-1000**  
AUTO RANGING, POLARITY AND DECIMAL!

**\$54.95**

- LARGE 3.5 DIGIT DISPLAY
- DATA HOLD SWITCH FREEZES READING
- FAST, AUDIBLE CONTINUITY TEST
- LOW BATTERY INDICATOR
- OVERLOAD PROTECTION



**20MHz DUAL TRACE OSCILLOSCOPE MODEL 2000 \$389.00**  
**35MHz DUAL TRACE OSCILLOSCOPE MODEL 3500 \$549.00**

FOR MORE INFORMATION ON THE OSCILLOSCOPES, CALL US FOR FREE PRODUCT BRIEFS.



# 1.2 MB MITSUBISHI DRIVE HALF HEIGHT FOR AT \$129.95

## QUALITY IBM COMPATIBLE MOTHERBOARDS

FROM MODULAR CIRCUIT TECHNOLOGY

### TURBO 4.77 / 8 MHZ \$129.95

JDR PART #: MCT-TURBO

- 4.77 OR 8 MHZ OPERATION WITH 8088-2 AND OPTIONAL 8087-2 CO-PROCESSOR
- DYNAMICALLY ADJUSTS SPEED DURING DISKETTE OPERATION FOR MAXIMUM THROUGHPUT AND RELIABILITY
- CHOICE OF NORMAL / TURBO MODE OR SOFTWARE SELECT PROCESSOR SPEED

### STANDARD 4.77 MHZ \$109.95

JDR PART #: MCT-XTMB

- 8088 CPU, OPTIONAL 8087 CO-PROCESSOR
- 8 EXPANSION SLOTS
- 0K RAM INSTALLED, EXPANDABLE TO 640K ON-BOARD MEMORY
- ALL ICs SOCKETED - HIGHEST QUALITY PCB
- ACCEPTS 2764 OR 27128 ROMS

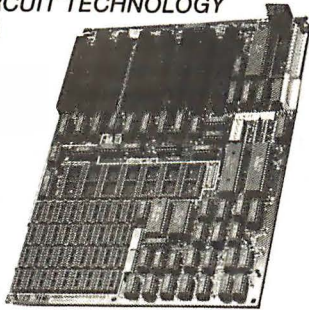

NOW WITH FREE MCT BIOS!

## IBM COMPATIBLE INTERFACE CARDS

ALL WITH A ONE YEAR WARRANTY

### MULTI I/O FLOPPY CARD

\$89.95

PERFECT FOR THE 640K MOTHERBOARD

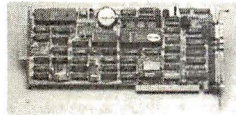

- 2 DRIVE FLOPPY DISK CONTROLLER
- 1 RS232SERIAL PORT; OPTIONAL 2nd SERIAL PORT
- PARALLEL PRINTER PORT
- GAME PORT
- CLOCK/CALENDAR
- SOFTWARE: CLOCK UTILITIES, RAMDISK, SPOOLER
- OPTIONAL SERIAL PORT \$15.95

### MULTIFUNCTION CARD

\$84.95

ALL THE FEATURES OF AST'S 6 PACK PLUS AT HALF THE PRICE

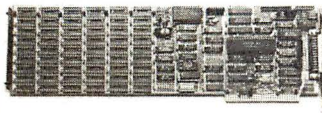

- CLOCK/CALENDAR
- 0-384K RAM
- SERIAL PORT
- PARALLEL PORT
- GAME PORT
- SOFTWARE INCLUDED
- PRINTER CABLE \$9.95
- 64K RAM UPGRADE 9/\$11.61

### COLOR GRAPHICS ADAPTOR

\$69.95

FULLY COMPATIBLE WITH IBM COLOR CARD



- 4 VIDEO INTERFACES: RGB, COMPOSITE COLOR, HI-RES COMPOSITE MONOCHROME, CONNECTOR FOR RF MODULATOR
- COLOR GRAPHICS MODE: 320 x 200
- MONO GRAPHICS MODE: 640 x 200
- LIGHT PEN INTERFACE

### MONOCHROME GRAPHICS CARD

\$79.95

FULLY COMPATIBLE W/IBM MONOCHROME ADAPTOR & HERCULES GRAPHICS



- LOTUS COMPATIBLE
- TEXT MODE: 80 x 25
- GRAPHICS MODE: 720 x 348
- PARALLEL PRINTER PORT; OPTIONAL SERIAL PORT
- STANDARD TTL COMPATIBLE OUTPUT
- OPTIONAL SERIAL PORT \$19.95

### MONOCHROME ADAPTOR

\$49.95

ANOTHER FANTASTIC VALUE FROM JDR!

- IBM COMPATIBLE TTL OUTPUT
  - 720 x 350 PIXEL DISPLAY
- PLEASE NOTE: THIS CARD WILL NOT RUN LOTUS GRAPHICS AND DOES NOT INCLUDE A PARALLEL PORT

### FLOPPY DISK DRIVE ADAPTOR

\$34.95



- INTERFACES UP TO 4 STANDARD FDDs TO IBM PC OR COMPATIBLES
- INCLUDES CABLE FOR TWO INTERNAL DRIVES
- STANDARD DB37 FOR EXTERNAL DRIVES
- RUNS QUAD DENSITY DRIVES WHEN USED WITH JFORMAT

## 1200 BAUD MODEMS BY EASYDATA

HAYES COMPATIBLE, AUTO-DIAL, AUTO-ANSWER, AUTO RE-DIAL ON BUSY, POWER-UP SELF TEST, FULL ONE YEAR WARRANTY

- |  |                         |                         |
|--|-------------------------|-------------------------|
| <b>MODEL 1200B*</b>                                    | <b>MODEL 1200H*</b>     | <b>EASYDATA-12</b>      |
| • INTERNAL DESIGN                                      | • INTERNAL DESIGN       | • EXTERNAL DESIGN       |
| • 10 INCH CARD   | • HALF LENGTH (5") CARD | • WITH POWER SUPPLY     |
| • SERIAL PORT INCLUDED                                 | • INCLUDES SPEAKER      | • LED STATUS INDICATORS |
| <b>\$119.95</b>  | <b>\$109.95</b>         | <b>\$119.95</b>         |
| *FOR IBM, INCLUDES PC TALK III COMMUNICATIONS SOFTWARE |                         |                         |

## GRT MONITORS FOR ALL APPLICATIONS



### HITACHI RGB MONITOR

MODEL 1020

- MADE FOR ERICSSON BY HITACHI
- DIGITAL RGB-IBM COMPATIBLE
- 12" SCREEN
- RESOLUTION: 640H x 200V
- 39mm DOT PITCH
- CABLE FOR IBM PC INCLUDED

\$289.95

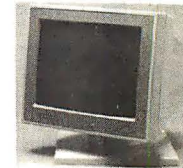

### SAMSUNG MONOCHROME

MODEL SM-12SF

- IBM COMPATIBLE TTL INPUT
- 12" NON-GLARE AMBER, LOWDISTORTION SCREEN
- RESOLUTION: 720H x 350V
- ATTRACTIVE CASE WITH SWIVEL BASE
- ONE YEAR WARRANTY

\$119.95



### CENTER SYSTEMS MONOCHROME

MODEL KLM-1211

- IBM COMPATIBLE TTL INPUT
- 12" NON-GLARE SCREEN
- VERY HIGH RESOLUTION: 1100 LINES (CENTER)
- 25 MHZ BANDWIDTH
- CABLE FOR IBM PC INCLUDED
- AMBER OR GREEN AVAILABLE

\$99.95

ATTRACTIVE TILT & SWIVEL MONITOR STAND \$129.95

## HALF HEIGHT HARD DISK SYSTEMS

Includes half height hard disk drive, hard disk drive controller, cables and instructions. All drives are pre-tested and are backed with a full one year warranty.

- |                         |                       |                 |
|-------------------------|-----------------------|-----------------|
| <b>10 MEGA BYTE HDD</b> | <b>MMI 212</b>        | <b>\$289.95</b> |
| <b>20 MEGA BYTE HDD</b> | <b>SEAGATE ST-225</b> | <b>\$369.95</b> |

## BUILD YOUR OWN 256K XT COMPATIBLE SYSTEM

- |                                      |                 |
|--------------------------------------|-----------------|
| <b>XT MOTHERBOARD</b>                | <b>\$109.95</b> |
| <b>PRO-BIOS (A \$20 VALUE) FREE!</b> |                 |
| <b>256K RAM</b>                      | <b>\$26.55</b>  |
| <b>130W POWER SUPPLY</b>             | <b>\$69.95</b>  |
| <b>FLIP-TOP CASE</b>                 | <b>\$39.95</b>  |
| <b>MCT-5150 KEYBOARD</b>             | <b>\$59.95</b>  |
| <b>1/2 HT TANDON DRIVE</b>           | <b>\$79.95</b>  |
| <b>FDD CONTROLLER</b>                | <b>\$34.95</b>  |
| <b>MONOCHROME ADAPTOR</b>            | <b>\$49.95</b>  |
| <b>CENTER MONITOR</b>                | <b>\$99.95</b>  |
| <b>TOTAL :</b>                       | <b>\$571.15</b> |

## IBM STYLE COMPUTER CASE

AN ATTRACTIVE STEEL CASE WITH A HINGED LID FITS THE POPULAR PC/XT COMPATIBLE MOTHERBOARDS



- SWITCH CUT-OUT ON SIDE FOR PC/XT STYLE POWER SUPPLY
- CUT-OUT FOR 8 EXPANSION SLOTS
- ALL HARDWARE INCLUDED

\$39.95

## IBM COMPATIBLE KEYBOARDS



### MCT-5150 \$59.95

- "5150" STYLE KEYBOARD
- FULLY IBM COMPATIBLE
- LED STATUS INDICATORS FOR CAPS & NUMBER LOCK
- LARGE, EASY TO REACH SHIFT & RETURN KEYS
- 83 KEY TYPEWRITER LAYOUT

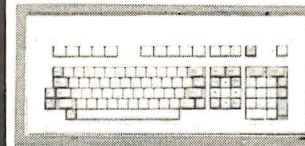

### MCT-5151 \$79.95

- REPLACEMENT FOR KEYTRONICS KB-5151™
- SEPARATE CURSOR & NUMERIC KEYPAD
- CAPS LOCK & NUMBER LOCK INDICATORS
- IMPROVED KEYBOARD LAYOUT



### MCT-5060 \$59.95

- IBM AT STYLE LAYOUT
- SOFTWARE AUTOSENSE FOR XT OR AT COMPATIBLES
- EXTRA LARGE SHIFT & RETURN KEYS
- LED INDICATORS FOR SCROLL, CAPS & NUMBER LOCK
- AUTO REPEAT FEATURE

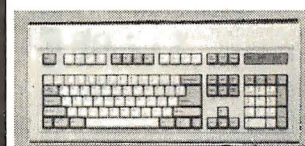

### MCT-5339 \$89.95

- IBM ENHANCED STYLE LAYOUT
- SOFTWARE AUTOSENSE FOR XT OR AT COMPATIBLES
- 12 FUNCTION KEYS
- EXTRA LARGE SHIFT & RETURN KEYS
- LED INDICATORS FOR SCROLL, CAPS & NUMBER LOCK
- AUTO REPEAT FEATURE
- SEPARATE CURSOR PAD

**JDR Microdevices**

Inquiry 138

110 Knowles Drive, Los Gatos, CA 95030

Toll Free 800-538-5000 • (408) 866-6200 • FAX (408) 378-8927 • Telex 171-110



# 1200 BAUD MODEM

FOR IBM WITH  
PC TALK III SOFTWARE

**\$1099<sup>95</sup>**

## EASYDATA 2400 BAUD INTERNAL MODEM

INCLUDES PC TALK III COMMUNICATIONS SOFTWARE!

- \* AUTO-DIAL/ANSWER/REDIAL ON BUSY
- \* TOUCH TONE OR PULSE DIAL
- \* POWER-UP SELF TEST, BUILT-IN SPEAKER
- \* HAYES COMPATIBLE "AT" COMMAND SET
- \* BELL 103, 212A, CCITT V22 AND V22BIS COMPATIBLE, FULL OR HALF DUPLEX, FOR OPERATION AT 0-300, 1200 OR 2400 BITS/SEC.
- \* SELECTABLE AS COM1 OR COM2 FROM AN EXTERNAL SWITCH
- \* ONE YEAR WARRANTY

# \$259!

## ENHANCED GRAPHICS ADAPTOR

100% IBM COMPATIBLE—PASSES IBM EGA DIAGNOSTICS

- \* COMPATIBLE WITH IBM EGA, COLOR GRAPHICS ADAPTOR AND MONOCHROME ADAPTOR
- \* DISPLAYS 16 COLORS OUT OF 64 COLORS
- \* COMES WITH 256K OF VIDEO RAM
- \* DUAL SCANNING FREQUENCIES WORKS WITH STANDARD OR EGA TYPE RGB MONITORS
- \* LIGHT PEN INTERFACE

ONLY  
**\$199.95**

## EGA MONITOR

FULL ONE YEAR WARRANTY

- \* EGA AND CGA COMPATIBLE
- \* SCANNING FREQUENCIES:  
15.75 KHz / 21.85 KHz
- \* 14" BLACK MATRIX, NON-GLARE SCREEN
- \* RESOLUTION:  
640 x 200 / 640 x 350
- \* .31 DOT, 25MHz
- \* 16 COLORS OUT OF 64

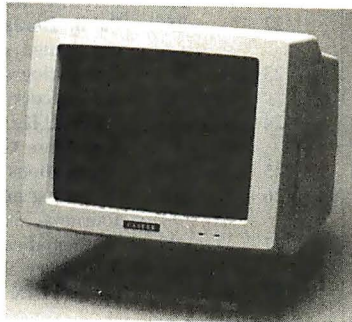

**\$479.95**

**NOW BUY BOTH FOR \$629!**

## 20 MB HARD DISK SYSTEM

INCLUDES HARD DISK CONTROLLER, CABLES AND INSTRUCTIONS. ALL DRIVES ARE PRE-TESTED AND COME WITH A 1 YEAR WARRANTY.

# \$36995

## AT MULTIFUNCTION CARD

**\$159.95**

ADDS UP TO 3 MEGABYTES OF USER EXPANDABLE MEMORY

- \* SHIPPED WITH ZERO K RAM, USER EXPANDABLE TO 1.5 MEGABYTES RAM ON BOARD, UP TO 3 MEGABYTES WITH OPTIONAL PIGGYBACK CARD
- \* USES 64K OR 256K DYNAMIC RAMS
- \* PARALLEL PORT & GAME PORT
- \* SERIAL PORT
- \* OPTIONAL SECOND SERIAL PORT

**PIGgyBACK MEMORY CARD (NO MEMORY INSTALLED) \$49.95**

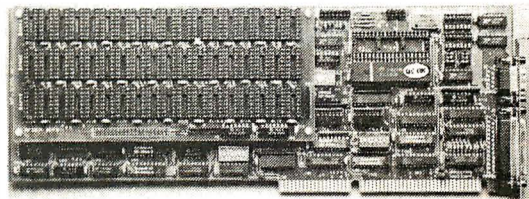

## EPROM PROGRAMMER

**\$129.95**

FOR IBM PC/XT/AT AND COMPATIBLES

- \* PROGRAMS 27xxx SERIES EPROMS UP TO 27512
- \* MENU DRIVEN SOFTWARE PROVIDED ON DISKETTE
- \* AUTOMATICALLY SETS PROGRAMMING VOLTAGE
- \* LOADS AND SAVES EPROM BUFFER TO DISK
- \* READ, WRITE, COPY, VERIFY OR CHECK BLANK
- \* DEBUG STYLE EDITOR FOR EASY MODIFICATION OF PROGRAM
- \* SPLITS OR COMBINES EPROMS OF DIFFERING SIZES
- \* INTERNAL CARD WITH EXTERNAL CABLE FOR A ZIF SOCKET

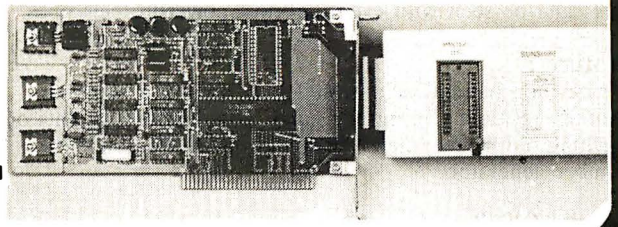

**JDR Microdevices**

110 Knowles Drive, Los Gatos, CA 95030  
Toll Free 800-538-5000 • (408) 866-6200 • FAX (408) 378-8927 • Telex 171-110

Inquiry 138

© COPYRIGHT 1986 JDR MICRODEVICES

THE JDR MICRODEVICES LOGO IS A REGISTERED TRADEMARK OF JDR MICRODEVICES. JDR INSTRUMENTS AND JDR MICRODEVICES ARE TRADEMARKS OF JDR MICRODEVICES. IBM IS A TRADEMARK OF INTERNATIONAL BUSINESS MACHINES.



# BOMB

## YOU CHOOSE THE BEST ARTICLE EACH MONTH

BYTE's ongoing monitor box (BOMB) lets you rate each article you've read in BYTE as excellent, good, fair, or poor. Each month, you can mail in the BOMB card found at the back of the issue. We tally your votes, total the points, and the two top-rated nonstaff authors are awarded \$100 and \$50,

respectively. An additional \$50 award for quality goes to the nonstaff author with the best average score (total points divided by the number of voters). If you prefer, you can use BIX as your method of voting. We welcome your participation.

ARTICLE#	PAGE	ARTICLE	AUTHOR(S)	ARTICLE#	PAGE	ARTICLE	AUTHOR(S)
1	9	Microbytes .....	staff	13	183	The Quiet Revolution .....	Meeks
2	29	What's New .....	staff	14	193	A Hard Look at Educational Software .....	Naiman
3	52	Ask BYTE/Circuit Cellar Feedback .....	Ciarcia	15	201	The Potential for Interactive Technology .....	Bork
4	67	Book Reviews .....	Wittman, Price, Olson	16	215	The ALR Access 386 and the Compaq Deskpro 386 .....	Wszola, Franklin
5	85	Workstations .....	Weston, Stewart	17	221	Four Portable Computers .....	Unger
6	101	Ciarcia's Circuit Cellar: Build an Infrared Remote Controller .....	Ciarcia	18	231	The Atari 1040ST .....	Menconi
7	114	Programming Project: Illinois Functional Programming: A Tutorial .....	Robison	19	239	Four Ink-Jet Printers .....	Swearengin
8	129	Build Your Own 256K Amiga Expansion RAM .....	Retter, Morelli	20	247	Microsoft QuickBASIC 2.0 .....	Dykstra
9	135	Programming Insight: Calculating the Area of An Irregular Shape .....	Stolk, Etershank	21	255	Forecast Master .....	Rosen
10	137	Programming Insight: Another Approach to Data Compression .....	Sciamanda	22	256	Public Domain Software for the Amiga .....	Block
11	149	Using Computers for Instruction .....	Becker	23	267	Computing at Chaos Manor: A Confederation of Hackers .....	Pournelle
12	165	The Difference in Higher Education .....	Osgood	24	287	BYTE U.K.: And More Clones .....	Pountain
				25	295	Applications Only: Miscellany .....	Shapiro
				26	303	According to Webster: Journeys .....	Webster
				27	319	Mathematical Recreations: A Ternary State of Affairs .....	Kurosaka
				28	331	Best of BIX .....	BIXen

## BOMB RESULTS

### November's Representation

Paul Walton wins \$100 for his article on "The State of Soviet Microelectronics," which placed first in November. In second is "Memory Management Units for 68000 Architectures" by Gregg Zehr, who

wins \$50. Third place is awarded to John D. Unger for his review of "Three IBM Clones." The \$50 prize for quality goes to Paul Walton for his treatise on the Soviet computer culture. Congratulations.

## COMING UP IN BYTE

### Theme:

So you thought image processing had to be either mainframe-oriented or amateurish? Take a look at some of this. The Mona Lisa is being restored through the use of a personal computer, and microcomputers are imaging stars that can't be seen with even the most powerful telescopes.

### Features:

We have on hand a feature on Turbo BASIC, a piece on memory-resident C programs, and programming insights on teaching old screens new tricks and building a random-number generator.

### Special 68000 Series:

Following this month's Amiga project, we have a hardware project for the Atari 520ST.

### Reviews:

Reviews available include a trio of inexpensive IBM PC AT clones, four laser printers, four optical readers, languages for artificial intelligence program development, Concurrent PC-DOS, and an operating system toolbox. We've also got an in-depth look at a three-dimensional CAD package.

### Circuit Cellar:

Have you seen those commercials lately where this terrific television set has a remote-control unit that will also take care of the VCR and the stereo—no matter who makes them? Steve Ciarcia is going to show you how to build one of those little hand-held controllers, so you won't have to go out and buy a new TV just to get one.



# COMPANY INDEX

Companies listed in left-hand column are referenced in sections/articles beginning on pages as numbered in right-hand column.

COMPANY	PAGE	COMPANY	PAGE	COMPANY	PAGE
ABACUS SOFTWARE	29	<i>ELECTRONIC MUSICIAN</i> MAGAZINE	303	OAK RIDGE NATIONAL LABORATORY	9
ADDISON-WESLEY INC.	295	EPOCH INTERNATIONAL	29	OKIDATA CORP.	267
ADVANCED LOGIC RESEARCH INC.	215	EPSON AMERICA	29	OLIVETTI CORP.	287
AICOM CORP.	29	EXPERTELLIGENCE	29		
ALLAN BONADIO ASSOCIATES	303	EZWARE CORP.	29	PHAR LAP SOFTWARE	215
AMERICAN ELECTRONICS ASSOCIATION	9			PHOENIX ASSOCIATES	85
AMSTRAD	287	FIREBIRD LICENSEES INC.	267	PIM PUBLICATIONS INC.	255
ANSCO PUBLICATIONS	303	FLYING MOOSE SYSTEMS & GRAPHICS CO. LTD.	29	PRINCETON GRAPHIC SYSTEMS	29
ANTIC SOFTWARE	267	FUTURE INTERNATIONAL INC.	29	PROSOFT	267
APEX RESOURCES	267				
APOLLO COMPUTER INC.	85	H.A.L. LABS	303	QMS INC.	295
APPLE COMPUTER INC.	9, 85, 165, 231, 267, 295, 303	HANSEN INSTRUMENTS	29	QUADRAM CORP.	239, 287
APPLIED BIOTECHNOLOGY LABORATORY	9	HEIZER SOFTWARE	295	QUARTERDECK OFFICE SYSTEMS	215
APRICOT COMPUTERS	287	HEWLETT-PACKARD	9	QUICKVIEW SYSTEMS	9, 267
ASHTON-TATE	9	HITACHI	9, 129		
AST RESEARCH INC.	29	HOLLINGSWORTH BUSINESS SERVICES	29	RADIX ASSOCIATES	29
AT&T INFORMATION SYSTEMS INC.	85			REALITY TECHNOLOGIES	29
ATARI CORP.	231, 267, 303	IBM CORP.	9, 85, 137, 165, 221, 267, 287		
AURA	255	IMAGEN CORP.	9	SAN DIEGO SUPERCOMPUTER CENTER	9
		INTEL	85	SCIENTIFIC SYSTEMS	255
BABY BLUE COMPUTER SYSTEMS	29	INTELLIGENT GRAPHICS CORP.	29	SEIKOSHA CO. LTD.	29
BERING INDUSTRIES	29	INVENTION SOFTWARE CORP.	303	SIDE EFFECTS INC.	29
BOLT BERANEK AND NEWMAN	165	IRWIN MAGNETIC SYSTEMS	215	SIGNETICS	9
BONDWELL INC.	221			SILICON BEACH SOFTWARE INC.	295
BORLAND INTERNATIONAL	9, 29	JAMECO ELECTRONICS	129	SPEECH SYSTEMS	9
BRODERBUND SOFTWARE INC.	29, 267			STONE & ASSOCIATES	29
BROOKS/COLE PUBLISHING CO.	303	<i>KEYBOARD</i> MAGAZINE	303	SUN GRADE INC.	29
		KINKO'S ACADEMIC COURSEWARE EXCHANGE	165	SUN MICROSYSTEMS INC.	85, 165
C LTD.	29	KURZWEIL MUSIC SYSTEMS INC.	9	SUNBURST COMMUNICATIONS INC.	29
CADMUS COMPUTER SYSTEMS	165	KYOCERA UNISON INC.	29	SUNRISE SOFTWARE INC.	29
CANON USA	29			SUPRA CORP.	231
CEIT SYSTEMS	9	LEVCO	9	SYMANTEC	267
COMMODORE BUSINESS MACHINES	129, 267, 303	LIFETREE SOFTWARE INC.	295	SYMMETRY CORP.	295
COMPAQ COMPUTER CORP.	215				
CONSULAIR CORP.	303	MACNEAL-SCHWENDLER CORP.	29	T&W SYSTEMS INC.	29
CORDATA	9, 29	MEAD DATA CENTRAL	9	TANDON CORP.	29
CRAY RESEARCH	9	MEGAMAX INC.	303	TANDY CORP.	101, 129
CREATIVE SOLUTIONS INC.	303	MICRO MAINFRAME	29	TEKTRONIX INC.	239
CYBORG CORP.	29	MICRO-LINK CORP.	29	TML SYSTEMS	303
		MICROMINT INC.	101	TOSHIBA AMERICA INC.	221
DATA FLOW IMAGING INC.	29	MICROPROCESSORS UNLIMITED INC.	129		
DATA TRANSLATION INC.	29	MICROSOFT CORP.	85, 137, 215, 221, 247, 287	U.S. VIDEO	29
DATAPAK SOFTWARE INC.	29	MICROTEK LAB INC.	29	VAMCO	29
DATAVUE CORP.	29	MINDSCAPE INC.	295	VENTURA SOFTWARE	9
DAYBREAK TECHNOLOGIES INC.	29	MITSUBISHI INTERNATIONAL CORP.	29		
DICONIX INC.	239	MONOGRAM SOFTWARE INC.	29	WESTERN DIGITAL CORP.	215
DIGITAL ELECTRONICS CORP.	9, 29	MOTOROLA INC.	29, 85, 101	WORDPERFECT CORP.	267
DIGITAL RESEARCH INC.	287	MULTITECH ELECTRONICS INC.	29		
DR. JIANN JOU	303			XCRIBE CORP.	9
		NATIONAL ASSOCIATION OF DESKTOP PUBLISHERS	9	XEROX CORP.	85, 239
ELECTRONIC ARTS	267	NATIONAL SHORTHAND REPORTERS ASSOCIATION	9	XYQUEST INC.	85, 215
ELECTRONIC INFORMATION TECHNOLOGY INC.	29	NEW DIRECTIONS SOFTWARE	295		
		NEW MICRO INC.	29	ZENITH DATA SYSTEMS	221, 137



# Subscription Problems?

**We want to help!**

*If you have a problem with your BYTE subscription, write us with the details. We'll do our best to set it right. But we **must** have the name, address, and zip of the subscription (new and old address, if it's a change of address). If the problem involves a payment, be sure to include copies of the credit card statement, or front and back of cancelled checks. Include a "business hours" phone number if possible.*

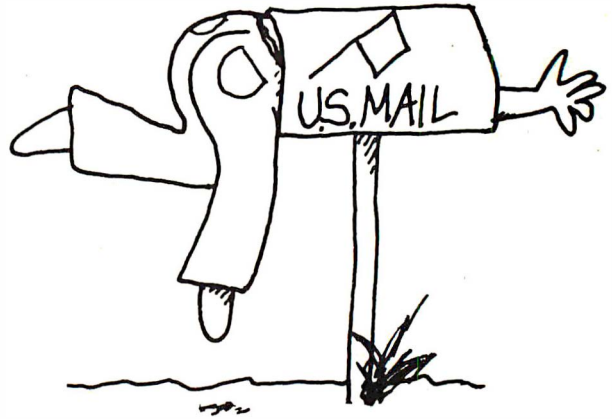

## BYTE

Subscriber Service  
P.O. Box 328  
Hancock, NH 03449

### BYTE ADVERTISING SALES STAFF:

**Dennis J. Riley, Advertising Sales Manager, One Phoenix Mill Lane, Peterborough, NH 03458, tel. (603) 924-9281**

**NEW ENGLAND**  
ME, NH, VT, MA, RI,  
ONTARIO, CANADA & EASTERN CANADA  
Paul McPherson Jr. (617) 262-1160  
McGraw-Hill Publications  
575 Boylston Street  
Boston, MA 02116

**ATLANTIC**  
NY, NYC, CT, NJ (NORTH)  
Leah G. Rabinowitz (212) 512-2096  
McGraw-Hill Publications  
1221 Avenue of the Americas—  
39th Floor  
New York, NY 10020

Dick McGurk (203) 968-7111  
McGraw-Hill Publications  
Building A—3rd Floor  
777 Long Ridge Road  
Stamford, CT 06902

**EAST**  
PA, KY, OH, NJ (SOUTH),  
MD, VA, W.VA, DE, D.C.  
Daniel Ferro (215) 496-3833  
McGraw-Hill Publications  
Three Parkway  
Philadelphia, PA 19102

**SOUTHEAST**  
NC, SC, GA, FL, AL, TN  
(404) 252-0626  
McGraw-Hill Publications  
4170 Ashford-Dunwoody Road  
Suite 420  
Atlanta, GA 30319

**MIDWEST**  
IL, MO, KS, IA, ND, SD, MN, WI,  
NB, IN, MI  
Bob Denmead (312) 751-3740  
McGraw-Hill Publications  
Blair Building  
645 North Michigan Ave.  
Chicago, IL 60611

**SOUTHWEST, ROCKY MOUNTAIN**  
UT, CO, WY, OK, TX, AR, MS, LA  
Kevin Harold (214) 458-2400  
McGraw-Hill Publications  
Prestonwood Tower—Suite 907  
5151 Bellline  
Dallas, TX 75240

**SOUTH PACIFIC**  
SOUTHERN CA, AZ, NM, LAS VEGAS  
Jack Anderson (714) 557-6292  
McGraw-Hill Publications  
3001 Red Hill Ave.  
Building #1—Suite 222  
Costa Mesa, CA 92626

Karen Niles (213) 480-5243, 487-1160  
McGraw-Hill Publications  
3333 Wilshire Boulevard #407  
Los Angeles, CA 90010

**NORTH PACIFIC**  
HI, WA, OR, ID, MT, NORTHERN CA,  
NV (except LAS VEGAS), W. CANADA  
Mike Kisseberth (415) 362-4600  
McGraw-Hill Publications  
425 Battery Street  
San Francisco, CA 94111  
Bill McAfee (415) 349-4100  
McGraw-Hill Publications  
951 Mariner's Island Blvd.—3rd Floor  
San Mateo, CA 94404

**WEST COAST SURPLUS  
AND RETAIL ACCOUNTS**  
Tom Harvey (805) 964-8577  
3463 State Street—Suite 256  
Santa Barbara, CA 93105

**The Buyer's Mart**  
Karen Burgess (603) 924-3754  
BYTE Publications  
One Phoenix Mill Lane  
Peterborough, NH 03458

**BYTE BITS (2x3)**  
Dan Harper (603) 924-6830  
BYTE Publications  
One Phoenix Mill Lane  
Peterborough, NH 03458

**Post Card Mailings  
National**  
Ed Ware (603) 924-9281  
Bradley Browne (603) 924-6166  
BYTE Publications  
One Phoenix Mill Lane  
Peterborough, NH 03458

### International Advertising Sales Staff:

Mr. Hans Csokor  
Publimedia  
Reisnerstrasse 61  
A-1037 Vienna, Austria  
222 75 76 84

Mrs. Gurit Gepner  
McGraw-Hill Publishing Co.  
PO Box 2156  
Bat Yam, 59121 Israel  
3 866 561 321 39

Mr. Fritz Krusebecker  
McGraw-Hill Publishing Co.  
Liebigstrasse 19  
D-6000 Frankfurt/Main 1  
West Germany  
69 72 01 81

Mrs. Maria Sarmiento  
Pedro Teixeira 8, Off. 320  
Iberia Mart 1  
Madrid 4, Spain  
1 45 52 891

Mr. Andrew Karnig  
McGraw-Hill Publishing Co.  
Finnbodavagen  
S-131 31 Nacka, Sweden  
8-44 0005

Mr. Alain Faure  
McGraw-Hill Publishing Co.  
128 Faubourg Saint Honore  
75008 Paris  
France  
(1) 42-89-03-81

Mr. Arthur Scheffer  
McGraw-Hill Publishing Co.  
34 Dover St.  
London W1X 3RA  
England 01 493 1451

Manuela Capuano  
McGraw-Hill Publishing Co.  
Via Flavio Baracchini 1  
20123 Milan, Italy  
02 86 90 617

Seavex Ltd.  
400 Orchard Road, #10-01  
Singapore 0923  
Republic of Singapore  
Tel: 734-9790  
Telex: RS35539 SEAVEX

Seavex Ltd.  
503 Wilson House  
19-27 Wyndham St.  
Central, Hong Kong  
Tel: 5-260149  
Telex: 60904 SEVEX HX

Hiro Morita  
McGraw-Hill Publishing Co.  
Overseas Corp.  
Room 1528  
Kasumigaseki Bldg.  
3-2-5 Kasumigaseki,  
Chiyoda-Ku  
Tokyo 100, Japan  
3 581 9811

Mr. Ernest McCrary  
Empresa Internacional de  
Comunicacoes Ltda.  
Rua da Consolacao, 222  
Conjunto 103  
01302 Sao Paulo, S.P., Brasil  
Tel: (11) 259-3811  
Telex: (100) 32122 EMBN











# BYTE READER SERVICE



Name \_\_\_\_\_ FEBRUARY 1987

472RSX

(Title) \_\_\_\_\_ (Company) \_\_\_\_\_

Address \_\_\_\_\_ Telephone \_\_\_\_\_

City \_\_\_\_\_ State \_\_\_\_\_ Zip \_\_\_\_\_

Country \_\_\_\_\_

Fill out this coupon carefully. PLEASE PRINT. Requests cannot be honored unless the zip code is included. This card is valid for 6 months from cover date.

I am requesting information for:  Business  Personal  Both

I purchased this copy by  Subscription

Newsstand, computer store, bookstore

1 23 45 67 89	111 133 155 177 199	221 243 265 287 309	331 353 375 397 419	441 463 485 507 529	551 573 595 617 639	661 683 705 727 749	771 793
2 24 46 68 90	112 134 156 178 200	222 244 266 288 310	332 354 376 398 420	442 464 486 508 530	552 574 596 618 640	662 684 706 728 750	772 794
3 25 47 69 91	113 135 157 179 201	223 245 267 289 311	333 355 377 399 421	443 465 487 509 531	553 575 597 619 641	663 685 707 729 751	773 795
4 26 48 70 92	114 136 158 180 202	224 246 268 290 312	334 356 378 400 422	444 466 488 510 532	554 576 598 620 642	664 686 708 730 752	774 796
5 27 49 71 93	115 137 159 181 203	225 247 269 291 313	335 357 379 401 423	445 467 489 511 533	555 577 599 621 643	665 687 709 731 753	775 797
6 28 50 72 94	116 138 160 182 204	226 248 270 292 314	336 358 380 402 424	446 468 490 512 534	556 578 600 622 644	666 688 710 732 754	776 798
7 29 51 73 95	117 139 161 183 205	227 249 271 293 315	337 359 381 403 425	447 469 491 513 535	557 579 601 623 645	667 689 711 733 755	777 799
8 30 52 74 96	118 140 162 184 206	228 250 272 294 316	338 360 382 404 426	448 470 492 514 536	558 580 602 624 646	668 690 712 734 756	778 800
9 31 53 75 97	119 141 163 185 207	229 251 273 295 317	339 361 383 405 427	449 471 493 515 537	559 581 603 625 647	669 691 713 735 757	779 801
10 32 54 76 98	120 142 164 186 208	230 252 274 296 318	340 362 384 406 428	450 472 494 516 538	560 582 604 626 648	670 692 714 736 758	780 802
11 33 55 77 99	121 143 165 187 209	231 253 275 297 319	341 363 385 407 429	451 473 495 517 539	561 583 605 627 649	671 693 715 737 759	781 803
12 34 56 78 100	122 144 166 188 210	232 254 276 298 320	342 364 386 408 430	452 474 496 518 540	562 584 606 628 650	672 694 716 738 760	782 804
13 35 57 79 101	123 145 167 189 211	233 255 277 299 321	343 365 387 409 431	453 475 497 519 541	563 585 607 629 651	673 695 717 739 761	783 805
14 36 58 80 102	124 146 168 190 212	234 256 278 300 322	344 366 388 410 432	454 476 498 520 542	564 586 608 630 652	674 696 718 740 762	784 806
15 37 59 81 103	125 147 169 191 213	235 257 279 301 323	345 367 389 411 433	455 477 499 521 543	565 587 609 631 653	675 697 719 741 763	785 807
16 38 60 82 104	126 148 170 192 214	236 258 280 302 324	346 368 390 412 434	456 478 500 522 544	566 588 610 632 654	676 698 720 742 764	786 808
17 39 61 83 105	127 149 171 193 215	237 259 281 303 325	347 369 391 413 435	457 479 501 523 545	567 589 611 633 655	677 699 721 743 765	787 809
18 40 62 84 106	128 150 172 194 216	238 260 282 304 326	348 370 392 414 436	458 480 502 524 546	568 590 612 634 656	678 700 722 744 766	788 810
19 41 63 85 107	129 151 173 195 217	239 261 283 305 327	349 371 393 415 437	459 481 503 525 547	569 591 613 635 657	679 701 723 745 767	789 811
20 42 64 86 108	130 152 174 196 218	240 262 284 306 328	350 372 394 416 438	460 482 504 526 548	570 592 614 636 658	680 702 724 746 768	790 812
21 43 65 87 109	131 153 175 197 219	241 263 285 307 329	351 373 395 417 439	461 483 505 527 549	571 593 615 637 659	681 703 725 747 769	791 813
22 44 66 88 110	132 154 176 198 220	242 264 286 308 330	352 374 396 418 440	462 484 506 528 550	572 594 616 638 660	682 704 726 748 770	792 814

**BYTE's BOMB** is your direct line to the editor's desk. Each month, the two top-rated authors receive bonuses based on your evaluation. First look at the list of this month's articles and corresponding article numbers (located on the page preceding the Reader Service list), then rate each article you've read as Excellent, Good, Fair, or Poor, based on your overall impression of the article, by circling the appropriate number in each column below. Your feedback helps us produce the best possible magazine each month.

Article No.	1	2	3	4	5	6	7	8	9	10	11	12	13	14	15	16	17	18	19	20	21	22	23	24	25
Excellent	1	5	9	13	17	21	25	29	33	37	41	45	49	53	57	61	65	69	73	77	81	85	89	93	97
Good	2	6	10	14	18	22	26	30	34	38	42	46	50	54	58	62	66	70	74	78	82	86	90	94	98
Fair	3	7	11	15	19	23	27	31	35	39	43	47	51	55	59	63	67	71	75	79	83	87	91	95	99
Poor	4	8	12	16	20	24	28	32	36	40	44	48	52	56	60	64	68	72	76	80	84	88	92	96	100

Article No.	26	27	28	29	30	31	32	33	34	35	36	37	38	39	40	41	42	43	44	45	46	47	48	49	50
Excellent	101	105	109	113	117	121	125	129	133	137	141	145	149	153	157	161	165	169	173	177	181	185	189	193	197
Good	102	106	110	114	118	122	126	130	134	138	142	146	150	154	158	162	166	170	174	178	182	186	190	194	198
Fair	103	107	111	115	119	123	127	131	135	139	143	147	151	155	159	163	167	171	175	179	183	187	191	195	199
Poor	104	108	112	116	120	124	128	132	136	140	144	148	152	156	160	164	168	172	176	180	184	188	192	196	200

# BYTE READER SERVICE



Name \_\_\_\_\_ FEBRUARY 1987

472RSX

(Title) \_\_\_\_\_ (Company) \_\_\_\_\_

Address \_\_\_\_\_ Telephone \_\_\_\_\_

City \_\_\_\_\_ State \_\_\_\_\_ Zip \_\_\_\_\_

Country \_\_\_\_\_

Fill out this coupon carefully. PLEASE PRINT. Requests cannot be honored unless the zip code is included. This card is valid for 6 months from cover date.

I am requesting information for:  Business  Personal  Both

I purchased this copy by  Subscription

Newsstand, computer store, bookstore

1 23 45 67 89	111 133 155 177 199	221 243 265 287 309	331 353 375 397 419	441 463 485 507 529	551 573 595 617 639	661 683 705 727 749	771 793
2 24 46 68 90	112 134 156 178 200	222 244 266 288 310	332 354 376 398 420	442 464 486 508 530	552 574 596 618 640	662 684 706 728 750	772 794
3 25 47 69 91	113 135 157 179 201	223 245 267 289 311	333 355 377 399 421	443 465 487 509 531	553 575 597 619 641	663 685 707 729 751	773 795
4 26 48 70 92	114 136 158 180 202	224 246 268 290 312	334 356 378 400 422	444 466 488 510 532	554 576 598 620 642	664 686 708 730 752	774 796
5 27 49 71 93	115 137 159 181 203	225 247 269 291 313	335 357 379 401 423	445 467 489 511 533	555 577 599 621 643	665 687 709 731 753	775 797
6 28 50 72 94	116 138 160 182 204	226 248 270 292 314	336 358 380 402 424	446 468 490 512 534	556 578 600 622 644	666 688 710 732 754	776 798
7 29 51 73 95	117 139 161 183 205	227 249 271 293 315	337 359 381 403 425	447 469 491 513 535	557 579 601 623 645	667 689 711 733 755	777 799
8 30 52 74 96	118 140 162 184 206	228 250 272 294 316	338 360 382 404 426	448 470 492 514 536	558 580 602 624 646	668 690 712 734 756	778 800
9 31 53 75 97	119 141 163 185 207	229 251 273 295 317	339 361 383 405 427	449 471 493 515 537	559 581 603 625 647	669 691 713 735 757	779 801
10 32 54 76 98	120 142 164 186 208	230 252 274 296 318	340 362 384 406 428	450 472 494 516 538	560 582 604 626 648	670 692 714 736 758	780 802
11 33 55 77 99	121 143 165 187 209	231 253 275 297 319	341 363 385 407 429	451 473 495 517 539	561 583 605 627 649	671 693 715 737 759	781 803
12 34 56 78 100	122 144 166 188 210	232 254 276 298 320	342 364 386 408 430	452 474 496 518 540	562 584 606 628 650	672 694 716 738 760	782 804
13 35 57 79 101	123 145 167 189 211	233 255 277 299 321	343 365 387 409 431	453 475 497 519 541	563 585 607 629 651	673 695 717 739 761	783 805
14 36 58 80 102	124 146 168 190 212	234 256 278 300 322	344 366 388 410 432	454 476 498 520 542	564 586 608 630 652	674 696 718 740 762	784 806
15 37 59 81 103	125 147 169 191 213	235 257 279 301 323	345 367 389 411 433	455 477 499 521 543	565 587 609 631 653	675 697 719 741 763	785 807
16 38 60 82 104	126 148 170 192 214	236 258 280 302 324	346 368 390 412 434	456 478 500 522 544	566 588 610 632 654	676 698 720 742 764	786 808
17 39 61 83 105	127 149 171 193 215	237 259 281 303 325	347 369 391 413 435	457 479 501 523 545	567 589 611 633 655	677 699 721 743 765	787 809
18 40 62 84 106	128 150 172 194 216	238 260 282 304 326	348 370 392 414 436	458 480 502 524 546	568 590 612 634 656	678 700 722 744 766	788 810
19 41 63 85 107	129 151 173 195 217	239 261 283 305 327	349 371 393 415 437	459 481 503 525 547	569 591 613 635 657	679 701 723 745 767	789 811
20 42 64 86 108	130 152 174 196 218	240 262 284 306 328	350 372 394 416 438	460 482 504 526 548	570 592 614 636 658	680 702 724 746 768	790 812
21 43 65 87 109	131 153 175 197 219	241 263 285 307 329	351 373 395 417 439	461 483 505 527 549	571 593 615 637 659	681 703 725 747 769	791 813
22 44 66 88 110	132 154 176 198 220	242 264 286 308 330	352 374 396 418 440	462 484 506 528 550	572 594 616 638 660	682 704 726 748 770	792 814

To get further information on the products advertised in BYTE, fill out the reader service card with your name and address. Then circle the appropriate numbers for the advertisers you select from the list. Add a first-class stamp to the card, then drop it in the mail. Not only do you gain information, but our advertisers are encouraged to use the marketplace provided by BYTE. This helps us bring you a bigger BYTE. The index is provided as an additional service by the publisher, who assumes no liability for errors or omissions.



PLACE  
POSTAGE  
HERE

**BYTE**

READER SERVICE  
PO BOX 298  
DALTON, MA 01227-0298  
USA

PLACE  
POSTAGE  
HERE

**BYTE**

READER SERVICE  
PO BOX 298  
DALTON, MA 01227-0298  
USA



# Make a career move!

## Get your own copy of BYTE!

Sharing is nice but not practical when you have to stay on the leading edge of microcomputer technology. From each BYTE issue theme to "MICROBYTES" and "Best of BIX", no other magazine—or group of magazines—can deliver you the vital technical information packaged in one issue of BYTE.

Don't rely on others for BYTE information—waiting on-line can be hazardous to your job. Make a career move! Have BYTE delivered to *your* door in *your* name. Use one of the adjacent cards to ensure your position in microcomputer technology.



For direct ordering call toll free weekdays 9:00am–5:00pm E.S.T.: 800-423-8912 (in New Jersey: 201-981-1963).

Welcome to BYTE Country!

## For your own subscription to complete this card and mail.

472RSX

Name \_\_\_\_\_

Address \_\_\_\_\_

City \_\_\_\_\_

State \_\_\_\_\_ Zip \_\_\_\_\_ Country \_\_\_\_\_

Bill me (U.S.A., Canada, Mexico only)

Check enclosed (All checks must be payable in U.S. funds drawn on a U.S. bank.)

Charge to my  MasterCard  VISA

Card # \_\_\_\_\_ Expiration Date \_\_\_\_\_

Signature \_\_\_\_\_

**BYTE**



### Subscription Rates

	USA	Canada /Mexico
ONE YEAR:	<input type="checkbox"/> \$22	<input type="checkbox"/> \$25
TWO YEARS:	<input type="checkbox"/> \$40	<input type="checkbox"/> \$45
THREE YEARS:	<input type="checkbox"/> \$58	<input type="checkbox"/> \$65

\$69 Europe (air delivery)  
 \$37 Europe and worldwide (surface mail)

Air mail rates outside Europe available upon request.

Please allow 6–8 weeks for processing. Thank you.



### BUSINESS REPLY MAIL

FIRST CLASS MAIL PERMIT NO. 39 MARTINSVILLE, NJ

POSTAGE WILL BE PAID BY ADDRESSEE

## BYTE Subscriptions

PO Box 597  
 Martinsville, NJ 08836-9956  
 USA

NO POSTAGE  
 NECESSARY  
 IF MAILED  
 IN THE  
 UNITED STATES

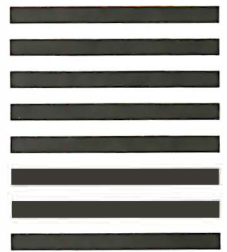

## For your own subscription to complete this card and mail.

472RSX

Name \_\_\_\_\_

Address \_\_\_\_\_

City \_\_\_\_\_

State \_\_\_\_\_ Zip \_\_\_\_\_ Country \_\_\_\_\_

Bill me (U.S.A., Canada, Mexico only)

Check enclosed (All checks must be payable in U.S. funds drawn on a U.S. bank.)

Charge to my  MasterCard  VISA

Card # \_\_\_\_\_ Expiration Date \_\_\_\_\_

Signature \_\_\_\_\_

**BYTE**



### Subscription Rates

	USA	Canada /Mexico
ONE YEAR:	<input type="checkbox"/> \$22	<input type="checkbox"/> \$25
TWO YEARS:	<input type="checkbox"/> \$40	<input type="checkbox"/> \$45
THREE YEARS:	<input type="checkbox"/> \$58	<input type="checkbox"/> \$65

\$69 Europe (air delivery)  
 \$37 Europe and worldwide (surface mail)

Air mail rates outside Europe available upon request.

Please allow 6–8 weeks for processing. Thank you.





NO POSTAGE  
NECESSARY  
IF MAILED  
IN THE  
UNITED STATES

**BUSINESS REPLY MAIL**  
FIRST CLASS MAIL PERMIT NO. 39 MARTINSVILLE, NJ

POSTAGE WILL BE PAID BY ADDRESSEE

**BYTE** Subscriptions

PO Box 597  
Martinsville, NJ 08836-9956  
USA

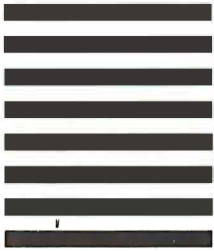

# Make a career move!

Get your *own* copy of BYTE!

Sharing is nice but not practical when you have to stay on the leading edge of microcomputer technology. From each BYTE issue theme to "MICROBYTES" and "Best of BIX", no other magazine—or group of magazines—can deliver you the vital technical information packaged in one issue of BYTE.

Don't rely on others for BYTE information—waiting on-line can be hazardous to your job. Make a career move! Have BYTE delivered to *your* door in *your* name. Use one of the adjacent cards to ensure your position in microcomputer technology.



For direct ordering call toll free weekdays 9:00am–5:00pm E.S.T.: 800-423-8912 (in New Jersey: 201-981-1963).

*Welcome to BYTE Country!*

## For your own subscription to **BYTE**, complete this card and mail.

472RSX



Name \_\_\_\_\_

Address \_\_\_\_\_

City \_\_\_\_\_

State \_\_\_\_\_ Zip \_\_\_\_\_ Country \_\_\_\_\_

- Bill me (U.S.A., Canada, Mexico only)
- Check enclosed (All checks must be payable in U.S. funds drawn on a U.S. bank.)

Charge to my  MasterCard  VISA

Card # \_\_\_\_\_ Expiration Date \_\_\_\_\_

Signature \_\_\_\_\_

**Subscription Rates**

	USA	Canada /Mexico
ONE YEAR:	<input type="checkbox"/> \$22	<input type="checkbox"/> \$25
TWO YEARS:	<input type="checkbox"/> \$40	<input type="checkbox"/> \$45
THREE YEARS:	<input type="checkbox"/> \$58	<input type="checkbox"/> \$65

\$69 Europe (air delivery)  
 \$37 Europe and worldwide (surface mail)

Air mail rates outside Europe available upon request.

Please allow 6–8 weeks for processing. Thank you.



NO POSTAGE  
NECESSARY  
IF MAILED  
IN THE  
UNITED STATES

**BUSINESS REPLY MAIL**  
FIRST CLASS MAIL PERMIT NO. 39 MARTINSVILLE, NJ

POSTAGE WILL BE PAID BY ADDRESSEE

**BYTE** Subscriptions

PO Box 597  
Martinsville, NJ 08836-9956  
USA





# WHY BUY A PRINTER THAT PRINTS ONLY ONE LETTER IN 90 SECONDS,



November 14, 1986

Mr. James Keefe  
Dunn & Johnson, Inc.  
856 Tremont Street  
Boston, MA 02116

Dear Mr. Keefe:

Thank you for your recent inquiry on the 20th Century family of energy efficient homes. There are now 21 different designs in our portfolio. Most of the plans, you will notice, combine traditional architectural forms with the most up-to-date ideas on technology and comfort. If one of your goals is low energy costs, you will be particularly interested in several designs that utilize both passive and active solar design. These houses incorporate an attached solarium, which not only serves as a solar furnace, but is also a light-filled space for eating or just being close to nature. These recent designs have proven to be extremely popular in your area.

Another series of designs range from 1400 to 2400 square feet. These plans were especially conceived to suit smaller families who require fewer rooms, yet don't want to cram their living style. If you are just beginning a family or have children who are grown, you will appreciate the spacious interior. The low maintenance and projected energy costs. Most every design in this series is adaptable to a wide variety of building sites, from flat to sloping. In fact, almost every building site can be built under part of the lot that rises steeply, and is usually considered difficult, opens up many interesting possibilities for most of the designs. For example, low cost extra space can be utilized as a separate apartment for in-laws or an office. Again, thank you for your interest. If I can answer any questions or provide further information, please don't hesitate to call me personally. We look forward to serving your housing needs.

Very Truly Yours,  
*Peter O'Connell*  
Peter O'Connell  
National Sales Director

November 14, 1986

November 14, 1986



Mr. Anthony Bennett  
Professional Interiors  
3206 Washington St.  
Newton, MA 02119

Dear Mr. Bennett:

Thank you for your recent inquiry on the 20th Century family of energy efficient homes. There are now 21 different designs in our portfolio. Most of the plans, you will notice, combine traditional architectural forms with the most up-to-date ideas on technology and comfort. If one of your goals is low energy costs, you will be particularly interested in several designs that utilize both passive and active solar design. These houses incorporate an attached solarium, which not only serves as a solar furnace, but is also a light-filled space for eating or just being close to nature. These recent designs have proven to be extremely popular in your area.

Another series of designs range from 1400 to 2400 square feet. These plans were especially conceived to suit smaller families who require fewer rooms, yet don't want to cram their living style. If you are just beginning a family or have children who are grown, you will appreciate the spacious interior. The low maintenance and projected energy costs. Most every design in this series is adaptable to a wide variety of building sites, from flat to sloping. In fact, almost every building site can be built under part of the lot that rises steeply, and is usually considered difficult, opens up many interesting possibilities for most of the designs. For example, low cost extra space can be utilized as a separate apartment for in-laws or an office. Again, thank you for your interest. If I can answer any questions or provide further information, please don't hesitate to call me personally. We look forward to serving your housing needs.

Very Truly Yours,  
*Peter O'Connell*  
Peter O'Connell  
National Sales Director

# WHEN YOU CAN BUY ONE THAT PRINTS TWO IN THE SAME TIME.

With its advanced 24-pin printhead, our Pinwriter P6 dot matrix printer prints letter-quality characters in a single pass. Conventional 9-pin printers need two passes—and twice as much time—to do the same amount of work.

But the Pinwriter P6 isn't just faster. It's better. Because even after two passes, a 9-pin printer just can't deliver the kind of sharp, dense characters you get with our Pinwriter P6 24-pin printer. Take a look at inset above and see for yourself.

So consider the speed. Compare the quality. Then add in the fact that NEC offers you the lowest noise level in the industry and more built-in fonts than anyone—and you'll see why our Pinwriter printers outclass every other printer in their price range.

Which is exactly what people have come to expect from NEC. After all, we're the world's largest manufacturer of 24-pin printers. And we offer more models. Some can even print three or more letters in 90 seconds.

For more information, call 1-800-343-4418 (in MA 617-264-8635). Or write: NEC Information Systems, Dept. 1610, 1414 Massachusetts Ave., Boxborough, MA 01719.

**NEC PRINTERS. THEY ONLY STOP WHEN YOU WANT THEM TO.**



**NEC**  
NEC Information Systems, Inc.



# Next to your computer,



## nothing beats a Tandy® printer.



**Tandy printers make fine print quality, graphics and high performance affordable.**

### **A match for your machine**

For your best value and selection in top-quality printers, shop your local Radio Shack Computer Center. We've got the printer that you need.

### **Dot-matrix power for business**

The DMP 2200 (26-1279, \$1695.00) gives you efficient, fast printing at 380 cps. It supports elongated, double high, bold, underline, super/subscripts, italics and double strike, plus bit-image graphics.

The DMP 2110 (26-2810, \$1295.00) prints at 240 cps. Use the Font Editing Packages (sold separately) to load different type styles for print quality that rivals a daisy-wheel printer!

The DMP 430 (26-1277, \$899) is a 132-column dot-matrix printer that

delivers superior correspondence characters. Plus, in the draft mode, the DMP 430 delivers a fast 180 cps.

### **Low-cost, triple-mode personal printer**

The DMP 130 (26-1280, \$349.95) lets you choose from word processing, data processing and dot-addressable graphics with four character styles.

### **Letter-quality daisy wheels**

Daisy wheel printers give you that crisp "electric typewriter" look. Our DWP 520 (26-2800, \$995.00) prints up to 500 wpm. Or try the DWP 230 (26-2812, \$399.95) for economical letter-quality and up to 200 wpm.

See the complete selection of printers and accessories at a Radio Shack or Radio Shack Computer Center today.

**Radio Shack®**  
**The Technology Store™**

A DIVISION OF TANDY CORPORATION

**Send me  
an RSC-17  
Computer Catalog.**

Mail To: Radio Shack  
Dept. 87-A-362  
300 One Tandy Center  
Fort Worth, TX 76102

Name \_\_\_\_\_  
Company \_\_\_\_\_  
Address \_\_\_\_\_  
City \_\_\_\_\_  
State \_\_\_\_\_ ZIP \_\_\_\_\_  
Phone \_\_\_\_\_

Prices apply at Radio Shack Computer Centers and at participating stores and dealers. All printers shown are IBM® compatible. The DMP 430 requires special order at some locations. IBM/Registered TM International Business Machines Corp.