

JUNE 1980 Volume 5, Number 6 \$2.50 in USA/\$2.95 in Canada

BYTE®

the small systems journal
A MCGRAW-HILL PUBLICATION

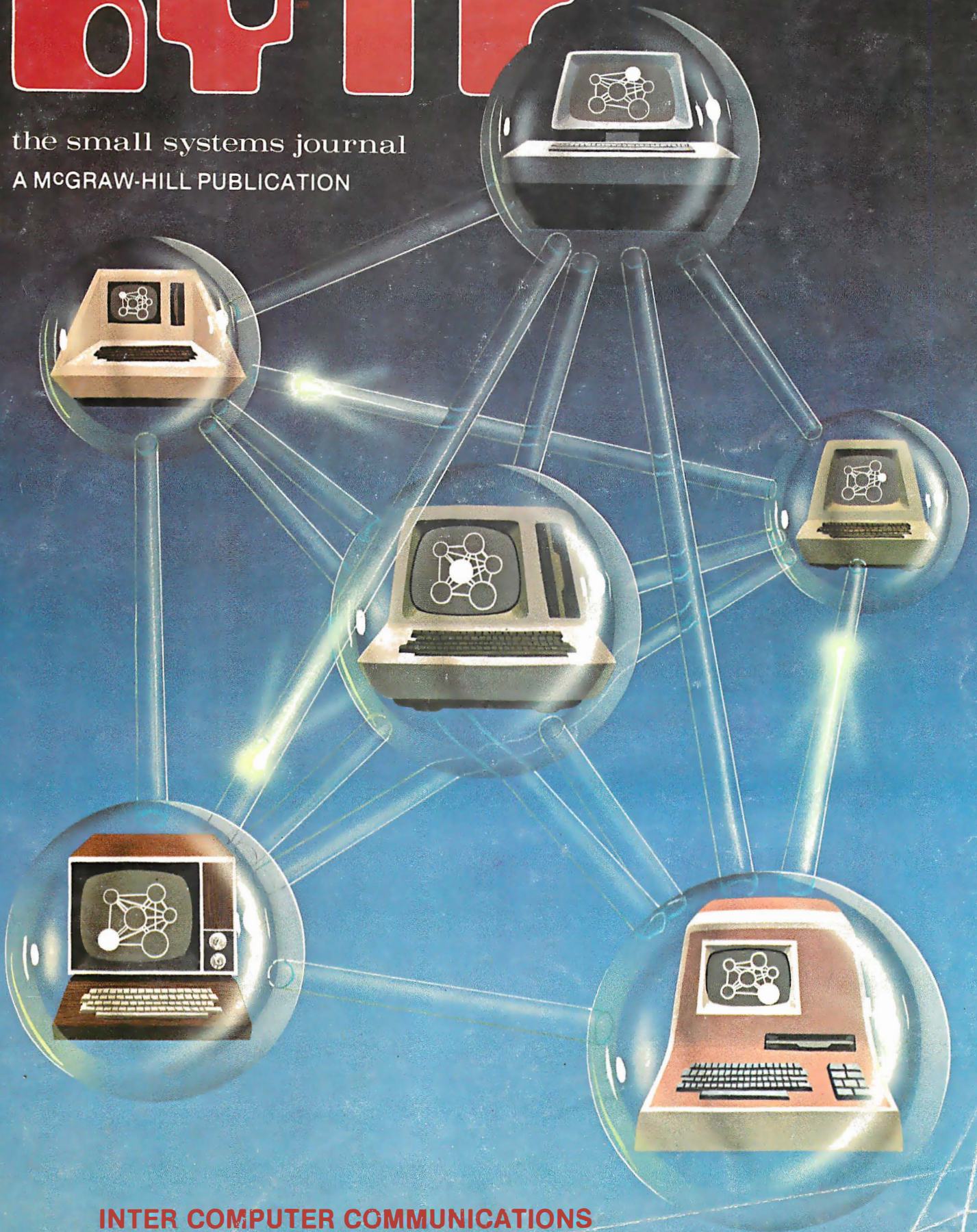

INTER COMPUTER COMMUNICATIONS



Someday all terminals will be smart.....

- ◆ 128 Functions—software controlled
- ◆ 7 x 12 matrix, upper/lower case letters
- ◆ 50 to 38,400 baud—selectable
- ◆ 82 x 16 or 92 x 22 format—plus graphics
- ◆ Printer output port
- ◆ "CHERRY" keyboard

CT-82 Intelligent Terminal, assembled and tested. \$795.00 ppd in Cont. U.S.



SOUTHWEST TECHNICAL PRODUCTS CORPORATION
 219 W. RHAPSODY
 SAN ANTONIO, TEXAS 78215

Circle 10 on inquiry card.

KOEBER



Here's the state of the art in low-cost hard-disk computers

11 MEGABYTES OF

FAST HARD-DISK STORAGE

Yes, the Cromemco Model Z-2H is in a class by itself in the computer field.

These Z-2H features tell you why:

- 11 megabytes of hard-disk storage
- 64 kilobytes of fast RAM
- Two dual-sided floppy disk drives
- Z-80A type processor
- Fast 4 MHz operation—150 nanosecond access time
- Fast hard-disk transfer rate of 5.6 megabits/second
- Low cost

And that's not all you get. Not nearly.

BROAD SOFTWARE SUPPORT

You also get Cromemco software support—the broadest software sup-

port in the microcomputer field. Software that Cromemco is known for. Like this:

- Structured BASIC
- FORTRAN IV
- RATFOR (RATional FORtran)
- COBOL
- Z-80 Macro Assembler
- Word Processing System
- Data Base Management

And more all the time.

FIELD PROVEN

The Z-2H is clearly in a class by itself. We introduced it last summer. It's field proven. It's reliable.

And it's rugged. Housed in a sturdy, all-metal cabinet.

EASILY EXPANDABLE

As always with Cromemco, you get expandability. The fast 64K RAM in this Model Z-2H can be expanded to 512 kilobytes. That amount of RAM combined with 11 megabytes of hard-disk storage gives you enormous

computer power—the equal or even beyond what much larger computers sometimes offer.

What's more, this computer gives you a 12-slot card cage. That's to plug in your special circuits as well as additional RAM and interface cards.

This expandability is supported by still more Cromemco value — the Z-2H's heavy-duty power supply that gives you 30A at 8V and 15A at $\pm 18V$ to support plug-ins.

LOW COST — SEE IT NOW

The Z-2H is real. It's been in the field for many months. It's proven itself.

You should see the Z-2H now. Contact a Cromemco representative and arrange for a demo. Learn that Cromemco is a survey-winner for reliability.

And learn that the Z-2H is under \$10K.

In the long run it always pays to get the best.



Cromemco
i n c o r p o r a t e d

280 BERNARDO AVE., MOUNTAIN VIEW, CA 94040 • (415) 964-7400
Tomorrow's computers today

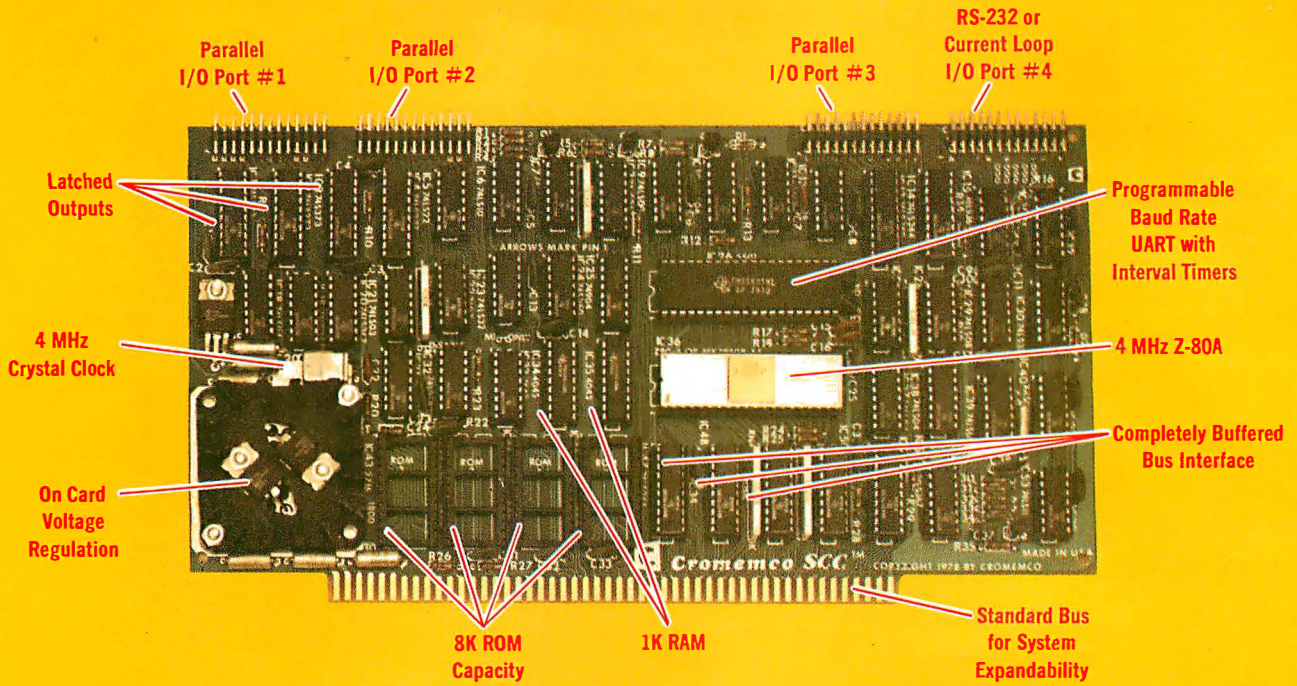

The single card computer with the features that help you in real life

COMPLETE COMPUTER

In this advanced card you get a professional quality computer that meets today's engineering needs. And it's one that's complete. It lets you be up and running fast. All you need is a power supply and your ROM software.

The computer itself is super. Fast 4 MHz operation. Capacity for 8K bytes of ROM (uses 2716 PROMs which can be programmed by our new 32K BYTESAVER® PROM card). There's also 1K of on-board static RAM. Further, you get straightforward interfacing through an RS-232 serial interface with ultra-fast speed of up to 76,800 baud — software programmable.

Other features include 24 bits of bi-directional parallel I/O and five on-board programmable timers.

Add to that vectored interrupts.

ENORMOUS EXPANDABILITY

Besides all these features the Cromemco single card computer gives you enormous expandability if you ever need it. And it's easy to expand. First, you can expand with the new Cromemco 32K BYTESAVER PROM card mentioned above. Then there's Cromemco's broad line of \$100-bus-compatible memory and I/O interface cards. Cards with features such as relay interface, analog interface, graphics interface, optoisolator input, and A/D and D/A conversion. RAM and ROM cards, too.



Card Cage

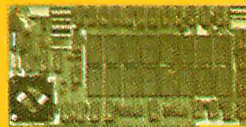

32K BYTESAVER PROM card

EASY TO USE

Another convenience that makes the Model SCC computer easy to use is our Z-80 monitor and 3K Control BASIC (in two ROMs). With this optional software you're ready to go. The monitor gives you 12 commands. The BASIC, with 36 commands/functions, will directly access I/O ports and memory locations — and call machine language subroutines.

Finally, to simplify things to the ultimate, we even have convenient card cages. Rugged card cages. They hold cards firmly. No jiggling out of sockets.

AVAILABLE NOW/LOW PRICE

The Model SCC is available now at a low price of only \$450 burned-in and tested (32K BYTESAVER only \$295).

So act today. Get this high-capability computer working for you right away.



Cromemco

incorporated

Specialists in computers and peripherals

280 BERNARDO AVE., MOUNTAIN VIEW, CA 94040 • (415) 964-7400



page 42

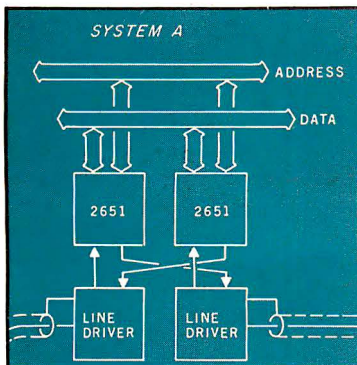

page 96

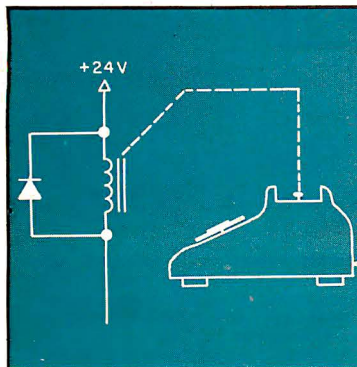

page 140

96TH CONGRESS
1ST SESSION

H. R. 3822

To amend title III of the Elementary and Secondary Education Act of 1965 to establish a National Center for Personal Computers in Education.

IN THE HOUSE OF REPRESENTATIVES

MAY 1, 1979

Mr. Downey introduced the following bill, which was referred to the Committee on Education and Labor.

A BILL

To amend title III of the Elementary and Secondary Education Act of 1965 to establish a National Center for Personal Computers in Education.

page 186

Foreground

24 AN ANSWER/ORIGINATE MODEM *by Ronald G Parsons*

Construction from precalibrated modules that eliminate the need for complicated adjustments makes this modem a practical project for the homebrewing hobbyist.

42 I/O EXPANSION FOR THE TRS-80, Part 2: Serial Ports *by Steve Ciarcia*

Along with a discussion of the theory of serial I/O ports, here's a design for an economical RS-232C interface that is compatible with standard TRS-80 software.

64 Z80 OP CODES FOR AN 8080 ASSEMBLER *by William T Powers*

Using predefined variable names, you can generate proper Z80 machine-language code.

96 COMMUNICATING IN TWO DIRECTIONS *by Mark R Tichener*

With proper transmission lines, extra terminals can make your personal computer flexible and easy to access from many locations.

122 A TIME-SHARING/MULTI-USER SUBSYSTEM FOR MICROPROCESSORS *by Don Kinzer*

This minimal hardware/software system shows that running multiple users on microcomputers is a simpler task to implement than most think.

140 A TELEPHONE-DIALING MICROCOMPUTER *by John Renbarger*

Automatic telephone dialing can be done by two diverse methods.

Background

88 MY TRS-80 TALKS TO MY CROMEMCO Z-2 *by Rod Hallen*

Peripherals that were once dedicated to a single computer can now be shared by using this communications scheme.

108 UNDERSTANDING ISAM *by Reginald D Gates*

Some microcomputers can use the indexed-sequential access method, known as ISAM, instead of random access or sequential access.

214 INTERPERSONALIZED MEDIA: WHAT'S NEWS? *by James A Levin*

Decreasing costs and increasing availability of telecommunication facilities for microcomputers imply modes of communication vastly different from the ones we use today.

230 FIFTEEN: A GAME OF STRATEGY (OR TIC-TAC-TOE REVISITED) *by John Rheinstein*

This is a Nim-like game in which players try to pick numbers that will add up to 15.

Nucleus

- | | | | |
|--------------|---|-----|--|
| 6 | Editorial: The Grass Roots Electronic Post Office... | 196 | Technical Forum: A Race-Car Monitoring Program; Computing Time Between Dates |
| 12 | Letters | 204 | Event Queue |
| 84, 212, 228 | BYTE's Bits | 210 | Clubs and Newsletters |
| 86 | Ask BYTE | 238 | Languages Forum: Comment and Correction for Mouse |
| 136 | Book Reviews: The Network Nation: Human Communications via Computer | 242 | What's New? |
| 174 | BYTELINES (formerly BYTE News) | 287 | Unclassified Ads, BOMB Results |
| 182 | BYTE's Bugs | 288 | Reader Service, BOMB |
| 186 | BYTE's Bits: Bills Introduced in Congress | | |

Publishers

Virginia Londoner, Gordon R Williamson

Associate Publisher

John E Hayes

Assistant

Cheryl A Hurd

Editorial Director

Carl T Helmers Jr

Editor-in-Chief

Christopher P Morgan

Editors

Richard S Shuford, Gregg Williams,

Curtis P Feigel

Book Editor

Bruce A Roberts

Chief Copy Editor

David William Hayward

Copy Editors

Faith Hanson, Warren Williamson,

Robin M Moss, Anthony J Lockwood

Assistant to the Editors

Faith Ferry

Assistant

Debe Wheeler

New Products Editor**Clubs, Newsletters**

Charles Freiberg

Drafting

Jon Swanson

Production Director

Nancy Estle

Assistant Production Director

Christine Dixon

Production/Advertising Coordinator

Wai Chu Li

Production Art

Holly Carmen LaBossiere, Deborah Porter

Typographers

Sherry McCarthy, Debi Fredericks,

Donna Sweeney

Advertising Director

Thomas Harvey

Assistants

Ruth M Walsh, Ms. Marion Gagnon

Special Projects Coordinator

Jill E Callihan

Assistant

Karen A Cilley

Marketing Coordinator

Laura A Hanson

Circulation Manager

Gregory Spitzfaden

Assistants

Pamela R H Spitzfaden, Agnes E Perry,

Melanie Bertoni, Barbara Varnum,

Louise Menegus

Dealer Sales

Thomas Yanni

Controller

Daniel Rodrigues

Assistant

Mary E Fluhr

Accounts Receivable Specialist

Karen Burgess

Accounts Receivable Assistant

Jeanne Cilley

Receptionist

Jacqueline Earnshaw

Traffic Department

Mark Sandagata, Rob Hannings

National Advertising Sales Representatives:

Hajar Associates Inc

East

280 Hillside Av, Needham Heights MA 02194

(617) 444-3946

521 Fifth Av, New York NY 10017

(212) 682-5844

Midwest

2405 Lawndale

Evanston IL 60201 (312) 864-3467

West, Southwest

1000 Elwell Ct, Suite 227, Palo Alto CA 94303

(415) 964-0706/(714) 540-3554



ON THE COVER

On this month's cover, Robert Tinney has created a visual fantasy on a communications theme. Imagine a network of personal computers where each person's computer is a node. Each node can display some information about the network. The fantasy cover painting shows several such personal computers in a matrix of translucent network connections. A few message packets are in transit down gossamer conduits, and each computer shows a view of the network from that node's vantage point.

As noted in this month's editorial, the real-world equivalent of this fantasy is the telephone network with low-speed modem equipment. While 300 bps is not the data communications equivalent of the bandwidth of a light beam, it is a good start which exists today. The nodes we know about via modems and telephones consist of our personalized directories of public access and private computer systems.

Officers of McGraw-Hill Publications Company: Paul F. McPherson, President; Executive Vice Presidents: James E. Boddorf, Gene W. Simpson; Group Vice President: Daniel A. McMillan; Senior Vice President-Editorial: Ralph R. Schulz; Vice Presidents: Kemp Anderson, Business Systems Development; Stephen C. Croft, Manufacturing; Robert B. Doll, Circulation; James E. Hackett, Controller; William H. Hammond, Communications; Eric B. Herr, Planning and Development; John W. Patten, Sales; Edward E. Schirmer, International.

Officers of the Corporation: Harold W. McGraw Jr, President, Chief Executive Officer and Chairman of the Board; Robert F. Landes, Senior Vice President and Secretary; Ralph J. Webb, Treasurer.

BYTE is published monthly by BYTE Publications Inc, 70 Main St, Peterborough NH 03458, a wholly-owned subsidiary of McGraw-Hill, Inc. Address all mail except subscriptions to above address: phone (603) 924-9281. Address subscriptions, change of address, USPS Form 3579, and fulfillment questions to BYTE Subscriptions, PO Box 590, Martinsville NJ 08836. Controlled circulation postage paid at Waseca, Minnesota 56093 - USPS Publication No. 528890 (ISSN 0360-5280). Canadian second class registration number 9321. Subscriptions are \$18 for one year, \$32 for two years, and \$46 for three years in the USA and its possessions. In Canada and Mexico, \$20 for one year, \$36 for two years, \$52 for three years. \$32 for one year air delivery to Europe. \$32 surface delivery elsewhere. Air delivery to selected areas at additional rates upon request. Single copy price is \$2.50 in the USA and its possessions, \$2.95 in Canada and Mexico, \$4.00 in Europe, and \$4.50 elsewhere. Foreign subscriptions and sales should be remitted in United States funds drawn on a US bank. Printed in United States of America.

Address all editorial correspondence to the editor at the above address. Unacceptable manuscripts will be returned if accompanied by sufficient first class postage. Not responsible for lost manuscripts or photos. Opinions expressed by the authors are not necessarily those of BYTE. Entire contents copyright © 1980 by BYTE Publications Inc. All rights reserved.

BYTE® is available in microform from University Microfilms International, 300 N Zeeb Rd, Dept PR, Ann Arbor MI 48106 USA or 18 Bedford Row, Dept PR, London WC1R 4EJ ENGLAND.

Subscription WATS Line: (800) 258-5485

Office hours: Mon-Thur 8:30 AM - 4:30 PM, Friday 8:30 AM - Noon, Eastern Time



- 512 x 484 resolution display supervised by its own Z80 microprocessor

- 32K bytes of dual port memory give a completely undisturbed screen image

- Resident software emulates an ASCII terminal and provides graphics routines for point, line, region, and light pen usage, and more

- Compatible with any S-100 system, yet easily interfaced to other computers

- 72 key keyboard with graphics function keys

- 15" high performance monitor

MICROANGELOTM HIGH RESOLUTION GRAPHICS SUBSYSTEM

\$1995.00

Light Pen Optional



SUBSYSTEMS

By
SCION CORP.

WORDSMITHTM VIDEO SUBSYSTEM

\$1595.00



- Wordsmith Word Processor software
- 40-line page display
- Selectric layout keyboard plus 20 Wordsmith function keys
- 15" high performance monitor
- Compatible with S-100 systems
- Complete documentation

Call or write:
SCION CORP.
8455-D Tyco Road
Vienna, Virginia 22180
(703) 827-0888

The Grass Roots Electronic Post Office

or, How Electronic (and Private) Mail Is Already Here

by Carl Helmers

How many of our readers could agree with the following propositions about ways in which they live?

I never use a telephone. Agree Disagree

I never talk with anyone. Agree Disagree

Most readers would disagree with both propositions, since they use telephones and talk to one another—as do most people in our society. One would be tempted to compare the first proposition with the second by noting that telephone use is simply talking augmented by technology. Talking does not require any technology, whereas using a telephone does. However, both are means of communication (ie: sending and receiving messages). Talking and telephone use both require what is perhaps our oldest technology: verbal reasoning within a commonly defined language.

Communications is the theme of this issue of *BYTE* and our emphasis is on extensions to the scale of this technology. We are talking about telephone networks with personal computers attached. The medium is the telephone network, and computers are the tools. We offer a number of articles this month covering areas as diverse as the technology of modems to their use in new forms of electronic-publication services for personal-computer users. In future months, readers will see more articles on communications applications of small computers.

The personal computer heralds the beginning of an age of personal data communications, encouraged by recent changes in telephone rules which allow "foreign" attachments to be connected with the telephone network. An unplanned side effect of these rule changes is that a personal computer can be one of those foreign attachments, in addition to the various forms of non-Bell domestic telephones and phone-answering machines.

We now see the ability for a personal-computer owner to send a message to another via the telephone network at any time of the day or night. The receiving computer will most likely have a floppy disk for storage and a printer for hard-copy output. If a letter takes a week to arrive at its destination or may be forever lost, why even bother with "first class" mail? A slightly more expensive electronic system already exists through data communications. These facts guarantee the existence of the completely unofficial, unplanned "Grass Roots Electronic Post Office."

For one of our readers with a personal computer to open his or her own box in the Grass Roots Electronic Post Office there is an initiation fee of sorts, namely the price of some standard or custom software and Federal Communications Commission (FCC) approved and registered modem-phone connection to the typical small computer. The auto-answer/auto-dial modem is the enabling technology for the personal computer in this application. The key to the user's mailbox is the software running in the computer. The address is provided by the telephone network as the usual phone number. A common language is provided by 8-bit asynchronous serial communications at 300 bits per second (bps).

BLACK AND WHITE BLUES GOT YOU DOWN? WANT TO ADD AT LEAST A TINT OF COLOR TO YOUR COMPUTING? WISH SOMEONE WOULD COME UP WITH AN IDEA TO IMPROVE CONTRAST, RELIEVE EYE STRAIN, AND PROVIDE A SURFACE THAT IS EASY TO CLEAN FOR YOUR MONITOR?

THE 'ORIGINAL SMOKE SCREEN' IS YOUR ANSWER! CECO HAS FOUND THE RIGHT MATERIAL THAT COMBINES THE BEST FEATURES OF DURABILITY, PERFORMANCE, AND EASE OF INSTALLATION. MADE FROM TOUGH ACRYLIC MATERIAL IT HAS SHOWN ITSELF TO BE RELIABLE, AND OPTICALLY SUPERIOR. WHILE NOT RECOMMENDED FOR COLOR MONITORS, IT IS THE PERFECT MATCH FOR YOUR 12" BLACK AND WHITE.

THE 'ORIGINAL SMOKE SCREEN' COMES READY TO INSTALL, EVERYTHING YOU NEED IS IN THE PACKAGE, NO DRILLING, SCREWS, OR OTHER DAMAGING MOUNTING IS REQUIRED. FOR AS LITTLE AS \$9.95 YOU CAN FINALLY IMPROVE THE OPTICS OF YOUR MONITOR IN ONLY SECONDS. TRULY, THIS IS A VALUABLE ADDITION TO YOUR SYSTEM.

MONO-CHROMATIC IMAGING IS THE KEY TO THE 'ORIGINAL SMOKE SCREEN' BY CECO AND IT PROVIDES AN IMAGE THAT IS EASIER TO VIEW THAN AN UNPROTECTED MONITOR. MAKES GRAPHICS LOOK MORE INTERESTING. PROVIDES A REAL IMPROVEMENT TO MONITOR PROTECTION.

PLEASE SEND 'ORIGINAL SMOKE SCREEN (S)' @ \$9.95 ea. I UNDERSTAND THAT THIS PRICE INCLUDES POSTAGE AND HANDLING AS PART OF THE INTRODUCTORY OFFER. SEND CHECK OF MONEY ORDER TO: COMPUTER ENHANCEMENTS COMPANY 18966 G. DR. N. MARSHALL, MICHIGAN 49068

NAME _____ STATE _____
ADDRESS _____ CITY _____ ZIP _____

TOTAL AMOUNT ENCLOSED: _____
ALLOW 6-8 WEEKS DELIVERY. MI. RESIDENTS ADD 4% TAX.

Dealer inquiries welcome

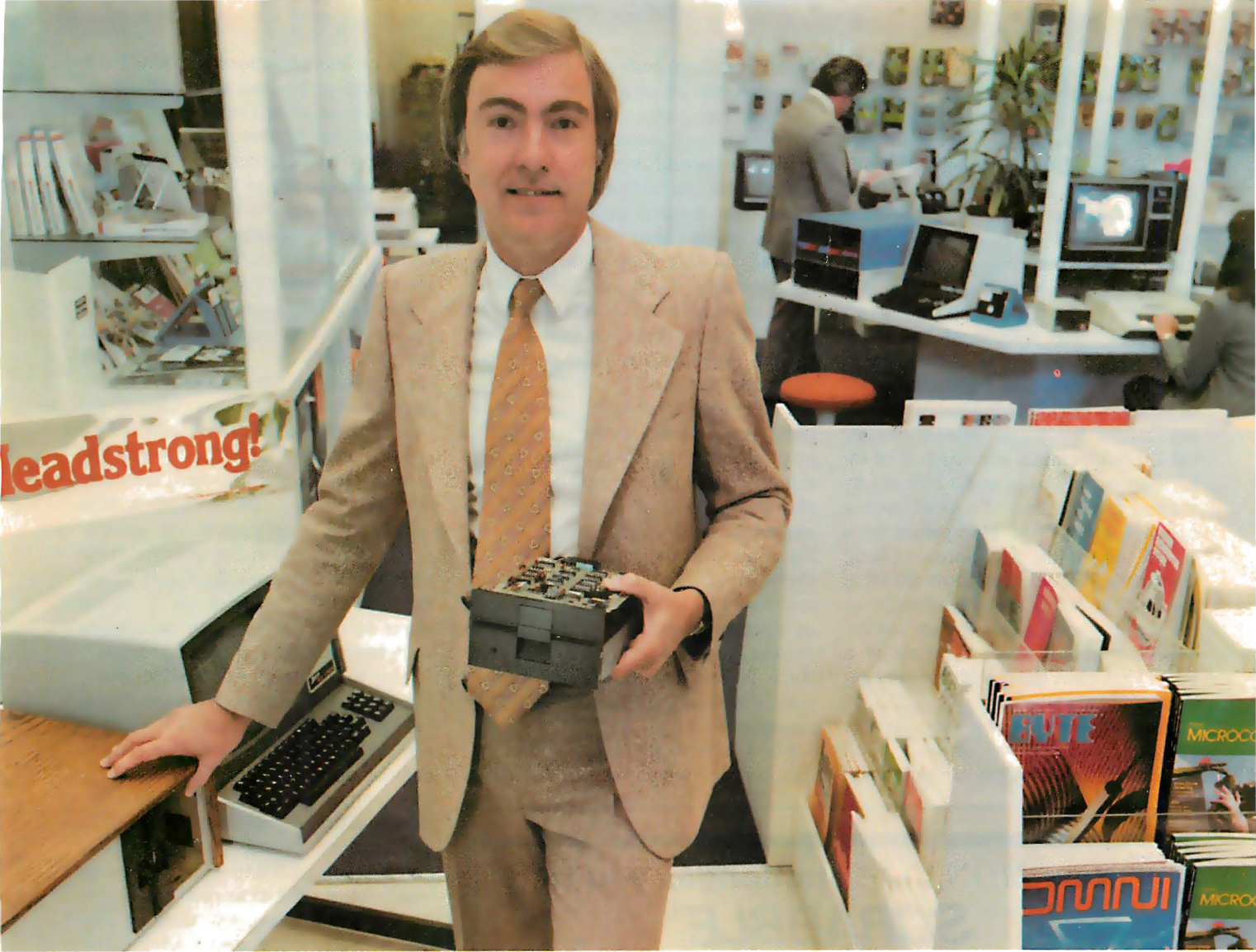

“For reliable data storage, you can’t beat Shugart’s Minifloppy.”TM

Raymond Schlitzer, Owner—
Computerland, San Francisco

“I sell systems my customers can depend on. That’s why most of the personal and small business computer systems sold here feature Minifloppy disk drives. I know from experience I can rely on the Minifloppy.”

Since 1976 Shugart’s Minifloppy has been used by more small computer system manufacturers than any other drive. In fact, more than half-a-million Minifloppys

have been installed. The Minifloppy looks small—but it stores a lot of data. 250 kilobytes on one side, or up to 500 kilobytes in the double-sided model. That’s about 50 pages of printed information on a single-sided Minidiskette, and twice that on the double-sided version. You’ll have plenty of storage capacity for your programs, letters, forms, or ledger entries. And you find your data fast, too, because the Minifloppy is a random access device

that eliminates the need to search for your data serially as you must with a tape cassette unit.

No matter what problem you’re solving with your computer system, you can rely on Shugart’s Minifloppy for data storage. We’re known as the Headstrong company for good reason. We’re Headstrong about reliability, quality, and value. Ask your dealer. He knows us.

Rely on the Headstrong Company.

 **Shugart**

TM—Minifloppy is a trademark of Shugart Associates.

475 Oakmead Parkway, Sunnyvale, California 94086

The network has existed since the phone companies made direct-dialing telephones practically universal in recent years. The telephone companies have solved all the problems of sending messages by the best routes, addressing the recipients of the messages, and running the needed lines. They provide a universally switched bandwidth adequate for 300 bps (30 characters per second) with simple Bell 103-style modems. With these specifications a three-minute phone call transmits 5400 characters of information. This is approximately equivalent to three 1920-character (24-by-80) terminal screens full of information, or a page and a half of formatted printed text. To send such a message from New Hampshire to a friend of mine in Santa Clara, California, would cost about \$0.60 at the current rates, if done at night or on the weekend. This is not an excessive premium over the cost of a \$0.15 first-class letter which might get there within a week.

Thus any two people who have a personal computer and a Bell 103-compatible modem can send elec-

tronic messages back and forth. Such messages can be on an "instant" basis with the two parties actively at a terminal. Or such messages can be sent on a "store-and-forward" basis, in which case no active human intervention is needed at either end at transmission time; messages are created as text files with addressee information. Then, at the optimal time of day from a telephone-rate point of view, these text files are sent to the appropriate recipients with similar computers.

The purposes of such communications are as varied as the purposes of any communication. The communication can be made totally private, if desired, by use of an automatic encryption technique, or the communication can be as open as the normal telephone call. As more and more people obtain this type of equipment, especially the auto-answer/auto-dial type of modem, there is the need for directories of people with active data nodes on the phone network.

Most everyone keeps a personal directory of telephone numbers in a

more or less organized fashion. With a personal computer, such a directory can be kept on a floppy disk. Using an auto-dial modem which can disconnect its carrier after dialing, automatic dialing of voice calls is possible. A natural extension is to maintain a personal directory of modem communications contacts along with the mode of operation used.

Just as a telephone-company directory goes far beyond an individual's list of friends and contacts, we may see modem manufacturers, independent publishers, or computer clubs publishing directories. Each entry would consist of the telephone number and any equipment information needed for random access. The widespread publication of general access information for private computers really defines the Grass Roots Electronic Post Office as a social phenomenon larger than its origins with individuals and small groups.

One thing we do not need as users, however, is the United States Postal Service (USPS) intervention. Today the system works through the wonders of our existing AT&T network. But then, private-letter express companies worked very well before the government postal monopoly was given legal protection in the nineteenth century. Occasional challenges of the private express statutes and USPS inefficiency are made. Companies making the challenge have shown excellent profitability prior to being closed down by the government-enforced postal monopoly. If these companies were allowed to exist and expand, we might have a little improvement (lower prices, better service) in first-class mail delivery.

In spite of heavy regulation, telephone companies work very well. After many decades of government-sanctioned limitations on competition, telephone companies are now facing new rivalries from many sources. Alternative long-distance voice and data-communications techniques now exist over microwave and satellite links. Competition is growing in alternative telephone set designs. The fact that modems can be connected to the telephone network at all is part of this recent regulatory reform.

Running counter to this liberalizing trend is the U S Postal Service's recently expressed desires to "provide" electronic mail. A political reaction from the U S Postal Service and its

Now **MONTY™** challenges you to **SCRABBLE***

MONTY™'s no ordinary Scrabble* player! He spices up his game with music and colorful graphics. And he can challenge you at any skill level—beginner to expert with tens of thousands of words. Available on disk only for Apple II, TRS-80 LEVEL II and CP/M based systems (16K required) for use with your Scrabble game. Send \$29.95 check or money order or CALL NOW Toll Free (see below) for VISA or MASTERCARD purchase. Iowans add sales tax. *MONTY™ plays Monopoly™ also available.

Another Incredible
Computer Opponent
Program



Ritam Corporation
P.O. Box 921
Fairfield, Iowa 52556

*Scrabble is a trademark of Selchow & Righter Co.
Monopoly is a trademark of Parker Bros., Inc.
Apple is a trademark of Apple Computer, Inc.
TRS-80 is a trademark of Tandy Corp.
CP/M is a trademark of Digital Research Inc.
MONTY™ is not sponsored or endorsed by
Selchow & Righter Co. or Parker Bros., Inc.
©Ritam Corp. 1980

"MONTY™ plays Scrabble"	"MONTY™ plays Monopoly™"
<input type="checkbox"/> Apple II disk \$29.95	<input type="checkbox"/> Apple II cassette \$24.95
<input type="checkbox"/> TRS-80 Level II disk 29.95	<input type="checkbox"/> Apple II disk 27.95
<input type="checkbox"/> CP/M 5" disk 29.95	<input type="checkbox"/> TRS-80 cassette 24.95
<input type="checkbox"/> CP/M 8" disk 29.95	<input type="checkbox"/> TRS-80 disk 27.95

Charge my VISA MASTERCARD Exp. Date. _____
Credit Card # _____ MC Bank # _____
Signature _____
Name _____
Address _____
City _____ State _____ Zip _____

ORDER NOW TOLL FREE • 800-624-7888 • 800-852-7777 (Calif.) • 800-824-7919 (HI & AL) Ask for Operator 975.

Z8000. You know it's better. Now, it's real.

Welcome to the next micro-computer revolution. A whole new generation of processors that bring big-machine architecture to small computers: Up to 10 times the throughput of Z80. *Eight megabytes* of directly-addressable memory. Plus, a rich, powerful set of over 400 instructions, data types and address modes.

Not a promise. A reality.

Introducing MPU-8000™ — our brand-new 16-bit CPU that makes the most of Z8000's many advantages, and then some.

With MPU-8000, you get *all* the computing power you need. And, you can have it with the low-cost Z8002, which addresses 64K, or the full eight

megabyte Z8001. There's plenty of room for expansion, too, via a top connector that makes adding an MMU or other Zbus-compatible accessories literally a snap.

Software support? Z8000 Pascal, editor, macro-assembler, operating system and more are on the way. But you don't even have to wait for them. Our new CPU is usable now in your present IEEE S-100 system, simply by slaving our MPU-8000 to your existing Z80 and cross-assembling your programs for the Z8000.

Think about it: 16-bit S-100. All the power, speed and flexibility of a mini, simply by plugging in the new MPU-8000. From Intersystems: Computer products you can rely on. And build on, too.

InterSystems™

Ithaca Intersystems Inc.,
1650 Hanshaw Road/P.O. Box 91,
Ithaca, NY 14850
607-257-0190/TWX: 510 255 4346

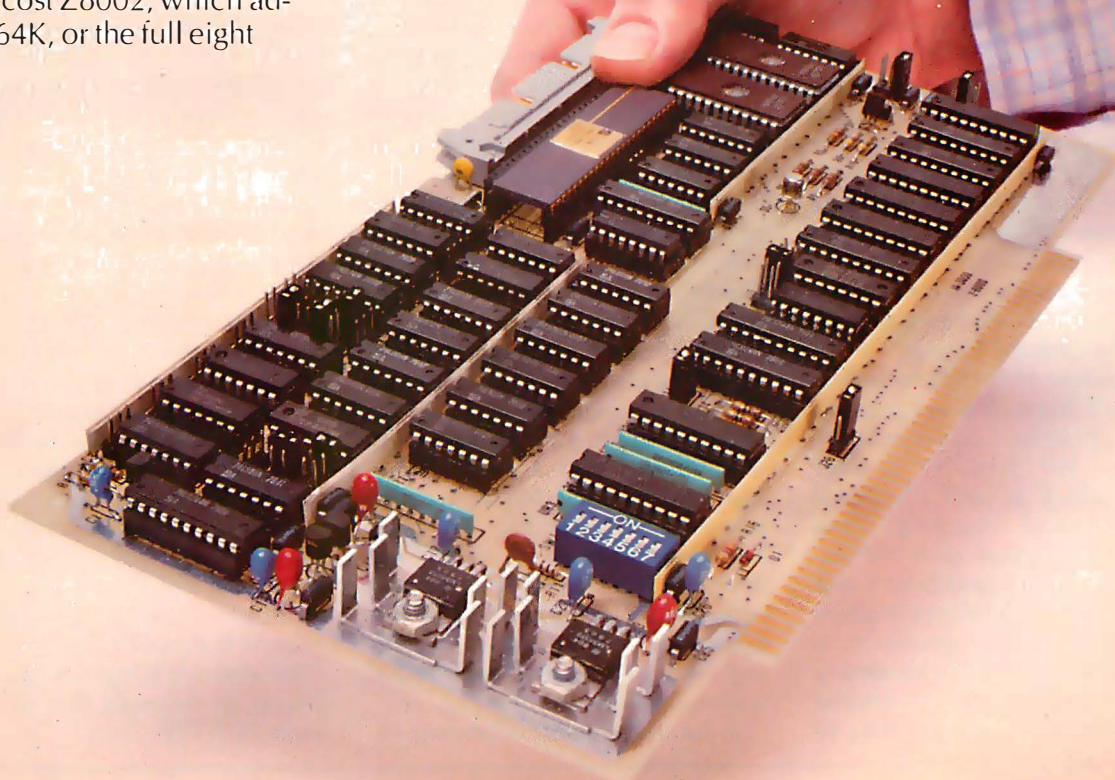

allies in Congress could adversely affect the future of a Grass Roots Electronic Post Office. Based on the past effectiveness of the Postal Service, the results could well be disastrous. In a confrontation between the FCC and the Postal Service during 1979, the FCC came out as a defender of electronic media from interference.

Assuming that political problems are not sufficient to hinder the growing private use of data-communications techniques, what technical problems might be present? The technical basis of raw communication was set many years ago with the definition of the Bell 103 modem standard. Perhaps the most significant remaining problem is the definition of "generally accepted" protocols for two-user interactions of various kinds. (Multiple-person, conference call interactions are the exception in telephone usage.)

Protocols of this sort often grow out of practice in the art. A parallel example from a related communications field is the protocol used by citizen band (CB) radio correspondents. It is derived from common usage, and has evolved in time as a subset of the English language. But it

is a protocol with defined meanings and semantics taken from common English. One fairly standard communication protocol already exists in the form of "computerized community bulletin-board systems" (CCBBS) begun by Ward Christensen and Randy Suess of the CACHE computer club in Chicago, Illinois. Many similar systems now exist as the software percolates around the country.

We can expect operating protocols for computers attached to the phone network to be as varied as the different styles of operating systems. We hope to find a generally accepted protocol for some key items. For example, the characters used to invoke a "Help" system usage aid may reduce through practice to one or more alternatives. This is somewhat akin to CB common usages like "10-4 good buddy" meaning "yes." It will be interesting to see what develops in this area.

But whatever the command practices that evolve, an underlying standard is provided by the American Standard Code for Information Interchange (ASCII) standard, as recently extended. Every personal computer made in the United States uses some

adaptation of the ASCII standard for character information. And, in ASCII, certain codes have predefined semantic meanings such as "acknowledge," "negative acknowledge," "carriage return," "line feed," etc. These predefined meanings can be used to some advantage; they represent a history of conventions that antedate widespread personal computer usage. There is no real need to reinvent a wheel which grew out of facing these problems of computer-to-computer communications.

In summary, while there are some nagging problems, the Grass Roots Electronic Post Office is alive and well. It exists in the hardware and software of personal-computer users who have modems as part of their systems. As a means of sending messages and using the telephone network more effectively by individuals or businesses, it has grown out of the simple availability of the hardware. It is not yet formally recognized enough to have its own directory publications. But wherever there exist two friends with modems there is a high likelihood of communication being used. The future for communications by personal computer looks bright. ■

Notes by Carl Helmers

Many of our readers will want to explore further this idea of personal use of data communications. An excellent source of information is found in the manuals provided by D C Hayes Associates Inc that accompany its communications products. This company markets an S-100-compatible modem and an Apple-compatible product which is called Micromodem II. These comments are based on the manual for the Micromodem II, written by Donald J Hyde.

The content of the Micromodem II Owner's Manual is an example of some of the best documentation available. We find an 81-page booklet which is well illustrated with technical drawings and examples. It begins with the expected details of installation and use of the Micromodem's built-in programs. It then progresses to a complete discussion of elementary modem programming, illustrated by examples. We find out how to

dial the telephone, hang up the telephone, answer the telephone, transmit data and receive data—all from examples given in BASIC. (D C Hayes promises to release information on use of the Micromodem with Apple Pascal, but as of this writing it has not been received. In a phone conversation in mid-March, we found that the Pascal software for Micromodem II is complete but not 100% debugged. Readers can expect to see the Pascal software available soon.)

Under other headings, we find advanced programming techniques such as manipulation of hardware defaults, turning off the carrier so that another phone on the same line can be used for voice purposes, waiting for the Nth ring, etc. Inspirational programs are provided in a chapter of that name in order to give examples of applications such as repertoire dialing, and even a computerized wakeup call-generator.

A tutorial chapter is devoted to

background information on the phone network, Bell 103 modems, data rates, ringing, and dialing. Although the source listing for the read-only memory (ROM) programs is not given in the manual (it should have been), there should be enough documentation to manipulate the hardware through these routines. And if worse came to worst, one could always disassemble the ROM programs. (Apple Pascal users should note, however, that present PROMs are useless due to references made to the Apple firmware replaced by the Pascal systems software.)

So, if readers are looking for some information on the technical details to support this concept for the Grass Roots Electronic Post Office, we highly recommend perusal of this D C Hayes manual. Another source of similar information is Ronald G Parsons' article "An Answer/Organize Modem," found on pages 24 thru 40 of this issue of BYTE.

New from SSM.



80 Character Video

With 80 characters per line our VB3 is the perfect video interface for word processing. It produces a standard 80x24 display of upper and lower case characters or as much as 80x51 for a full page of text. The matrix for graphic display goes up to 160x204. And with optional EPROM, as many as 256 user programmed characters or symbols can be produced.

VB3 is memory mapped for rapid screen updating. But it occupies memory only when activated. So one or more VB3s can be located at the same address with a full 65K of memory still available to the user.

It generates both U.S. and European TV rates and meets the new IEEE S-100 standard. Other features include keyboard input, black on white or white on black, one level of grey, underline, strike thru, blinking char., blank-out char., and programmable cursor. Software includes a CP/M compatible driver and a powerful terminal simulator.

VB3 is available in several configurations. Retail prices start at \$375 kit, \$440 assembled.



Z-80 CPU

We spent over a year designing the CB2 to assure that it will be the most fully S-100 compatible Z-80 CPU on the market.

It operates at 2MHz or 4MHz by DIP switch selection and includes two sockets for 2716/2732 EPROMs or TMS 4016 2K RAMs. Memory sockets can be disabled. Separate run/stop and single step switches allow system evaluation without the benefit of a front panel.

CB2 also features an MWRITE signal, firmware vector jump, and an output port to control 8 extended address lines (allowing use of more than 65K of memory). Jumper options generate the new IEEE S-100 signals to insure future S-100 compatibility.

Retail price—\$210 kit, \$275, assembled.

Our line. CPU, Video, I/O, RAM, EPROM, EPROM Programmer, Music, Prototyping, Terminator, Extender, and Mother boards. Available assembled or as kits.



8080 CPU

Our new CB1A is identical to our popular CB1 with the exception that the on-board RAM has been increased from 256 bytes to a full 1K.

It also features an optional 2K of 2708 EPROMs, power-on/reset vector jump, MWRITE, parallel input port with status and DIP switch addressing.

Retail price—\$159 kit, \$219 assembled.



SSM Microcomputer Products
2190 Paragon Drive
San Jose, CA 95131 (408) 946-7400

Send for our free brochure and find out why SSM has become the favorite of discerning Hobbyists and OEMs.

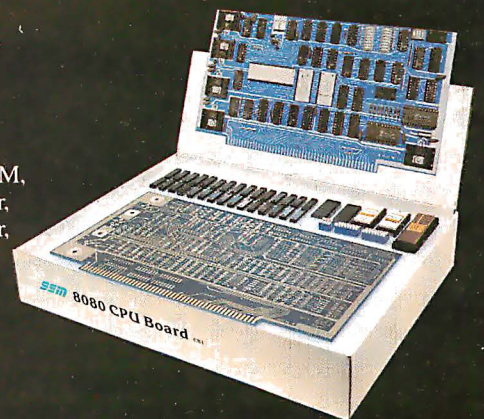

Letters

Review of Some Excellent Marketing and Pointers for Companies Marketing Computers

I read Carl Helmers' editorial in the January 1980 BYTE ("The Era of Off-the-Shelf Personal Computers Has Arrived," page 6), and I thought your readers might, in turn, be interested in my recent experience in approaching the purchase of a personal computer. First of all, let me mention that I am a consulting engineer in optics and instrumentation and must, therefore, own most of my own tools (computers). Before I give some words about my experiences in the hunt for a satisfactory personal computer, may I give some technical background about one major area of my work and the requirements I have for the personal machine?

Lenses and mirrors are part of the optics I design. The design of combinations of these to satisfy some client requirement is a complex and often laborious calculating task. Tracing a single light

ray through one lens or mirror surface in accordance with the rigorous physical-mathematical rules takes as many as 350 steps of file manipulation and arithmetic or higher mathematical calculations. To complete a design may take thousands of these ray-surface calculations. Worse yet, most optical designs are compromises against focusing errors (aberrations), and the computer must seek to improve the given lens design by reducing these errors using matrix calculations. Often, the matrices are as large as 40 by 40, or even bigger. Because matrices of this size are often not completely soluble, least-squares reduction of residual aberrations (by damping the matrix) is now the popular method of computing optimal lens designs. So, the matrix has to be resolved several times—called "iterations toward the optimum solution."

So, the outcome of all of this is my requirement that the personal computer be strongly oriented toward number crunching. Also, the matrix inversion

(solution) may depend on maintaining a large number of significant digits in each number. Thus, we arrive at one of my major complaints against personal-computer advertising: there is almost no reference to the *number of digits* available in single-precision computing. Let me now go ahead and list some of my complaints about personal-computer advertising and promotional literature from the manufacturers:

- 1) Lack of description—number of digits in single precision.
- 2) Limited number of math functions available.
- 3) Lack of description—speed of typical calculation.
- 4) Frequent absence of full list of required hardware components. What is needed to be fully up and running—controllers, interconnecting special cables, etc.
- 5) Pricing for complete package—ready to plug in and use for calculations.

As an engineer, I need to know these facts to determine if the machine is the one I should buy.

As if in answer to my questions, Hewlett-Packard (HP) recently released technical information about the HP-85 personal computer. Almost every question I might think of which bears on my decision to purchase was answered in their technical data sheet. Of course, there are some things about the HP-85 which are less than satisfactory, but, and this is very important, when I finally got to see the machine and run it for a few minutes, there were no surprises! Just about everything I expected from the brochure was found, including some of the not-so-good items. I was thus able to make up a point-score on the machine and make my decision without a lot of unknowns.

Well, where does this lead to? I suggest that the following be recommended to personal computer manufacturers:

- 1) There are many, many potential buyers who need to know things about a machine that are not now mentioned in the literature or ads.
 - a) What are the components necessary to get a ready-to-run package? What price?
 - b) How fast does the machine accomplish a typical task (some kind of benchmark test)?

TRS-80, PET, APPLE, SORCERER Ham Interface Systems



- Send & Receive RTTY / CW.
- Complete Hardware & Software Package.
- Extensive User Manuals.
- From \$129.

Write or call for complete catalog



MACROTRONICS, inc.®

1125 N. Golden State Blvd. / Suite G
Turlock, CA 95380 (A)
(209) 667-2888 / 634-8888



We are experiencing telephone difficulties,
please keep trying.

California residents add 6% tax



What kind of man owns his own computer?

Rather revolutionary, the whole idea of owning your own computer? Not if you're a diplomat, printer, scientist, inventor... or a kite designer, too. Today there's Apple Computer. It's designed to be a *personal* computer. To uncomplicate your life. And make you more effective.

It's a wise man who owns an Apple.

If your time means money, Apple can help you make more of it. In an age of specialists, the most successful specialists stay away from uncreative drudgery. That's where Apple comes in.

Apple is a real computer, right to the core. So just like big computers, it manages data, crunches numbers, keeps records, processes your information and prints reports. You concentrate on what you do best. And let Apple do the rest. Apple makes that easy with three programming languages—including Pascal—that let you be your own software expert.

Apple, the computer worth not waiting for.

Time waiting for access to your company's big mainframe is time wasted. What you need in your department —

on *your* desk — is a computer that answers only to you... Apple Computer. It's less expensive than timesharing. More dependable than distributed processing. Far more flexible than centralized EDP. And, at less than \$2500 (as shown), downright affordable.

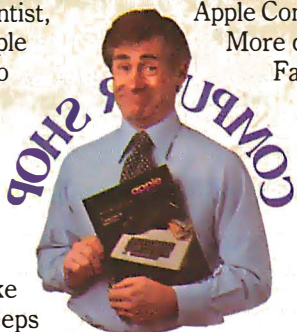

Visit your local computer store.

You can join the personal computer revolution by visiting the Apple dealer in your neighborhood. We'll give you his name when you call our toll free number (800) 538-9696. In California, (800) 662-9238.

Apple Computer, 10260 Bandle Drive, Cupertino, CA 95014.

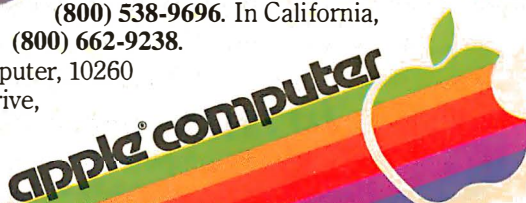

- c) What are the number of digits available in single precision? What math functions?
- 2) Take a look at the HP data sheets to see what kind of information attracts the engineers, and what is needed. Issue a similar data sheet for your machine, as a complete system ready to plug in and run.

I realize that ANSI BASIC describes pretty well a lot of the things I mentioned. However, there seems to be a wide difference between individual BASICs in important details. These should be admitted and exposed.

Many of my friends and acquaintances have purchased small personal

computers. One thing which disturbs them is the lack of a firm support commitment and a method of getting repairs and maintenance. I have heard it said more than once that the additional cost for a solid and efficient maintenance setup would not be objectionable.

Finally, there are many, too many, advertisements for peripherals that fail to mention that additional controllers or interfacing boards are needed. Sometimes, when these are mentioned, no price is given. The result: one cannot determine just what it takes to get plugged in and running. Not everyone is aware of the intricacies of interconnection and interfacing and controlling. BYTE can help here by occasionally

redefining some of the more-or-less standard terms, components, and abbreviations as related to how they combine to form a complete ready-to-run computer, even if it is a particular configuration—and by reminding advertisers to do the same.

If you suppose that we (number crunchers) are in a minority, just think of the many TI-59 and HP-67/97 users and their clubs. We'd like to move up into the bigger machines, too.

Bennett Sherman
90-59 56th Ave
Elmhurst NY 11373

Another Way to Computerize a Home

Steve Ciarcia's article "Computerize a Home" (January 1980 BYTE, page 28), which deals with utilizing the BSR X-10 Home Control System more fully by adding computer control, blazes a trail of interest to many. And his tracking of the amazing drop in system cost provided by the BSR technology is very graphic.

Readers of BYTE should be aware that some of the BSR command units do not include the microphone circuitry needed to accept the acoustic signals from the remote controller or Steve's interface. The command unit Model X10-014311, probably sold primarily as part of the \$89 starter system, does *not* have the microphone. If you plan to implement Steve's approach, you must use the Model X10-014301.

On page 34, Steve listed and evaluated the principal interface methods available between the X-10 and the computer. I think this area might deserve further review, especially in the light of the figure and caption on page 40. The principal options are:

- 1) Directly synthesize the command console waveform and impress it directly onto the AC line.
- 2) Brute-force contact closure—attaching computer-controlled relays or switches in parallel with the existing switches of the command unit.
- 3) Synthesize the waveform from the ultrasonic controller and let the computer "talk" to the command console.
- 4) In addition, synthesize an electrical waveform and inject it into the command console, bypassing the acoustic elements.

Rather than dismiss option 1 and ignore option 4, one might want to evaluate the choices on more substantive grounds, which might include the capabilities of the experimenter. Radio Shack sold a novice-level, carrier-current intercom kit for years which dealt with



**DESKTOP
MICROCOMPUTER**

Chrislin is First !!!

with deliveries of DEC's Desk Top Computers. Available with LSI 11/2 or LSI 11/23 CPU. Complete system totally enclosed within VT100 Video Terminal. Price \$4,500 with LSI 11/2 and 64K bytes or \$9,600 with LSI 11/23 and 256K bytes.

NOW Available — PDP 11/23 with 256 KB Memory \$8,900.

SPECIAL — LSI 11/2 and 32K x 16 Memory \$1,095.

10 MEGA BYTE Cartridge Disk System with Controller, RT11 compatible \$6,100.



Chrislin Industries, Inc.

Computer Products Division

31352 Via Colinas • Westlake Village, CA 91361 • 213-991-2254

Make your micro

MIGHTY!



Get the most out of your microcomputer with Graham-Dorian Business software.

At any given time, your hardware is only as useful as the software you insert in it.

So it pays to rely on Graham-Dorian, the software that gets your micro performing to its fullest — almost like a mini.

Graham-Dorian, the industry leader, offers highly detailed and well-documented programs. All pretested on the job. Each so comprehensive that it takes little time to learn to run a program — even for someone who's never operated a computer before.

Programs are compatible with most major computers using CP/M disk operating systems, and come in standard 8" or on various mini-floppy disks. Each package contains the software program in INT and BAS file form plus a user's manual and hard copy source listing. Graham-Dorian stands behind dealers with technical advice.

Yes, there's a world of difference in business software. Graham-Dorian has more per-package capabilities and more packages. (With new ones added every few months.)

The Graham-Dorian line now includes these packages:

- Medical
- Dental
- Surveying
- Inventory
- Payroll
- Apartment Management
- Construction Job Costing
- Accounts Receivable
- Accounts Payable
- General Ledger
- Cash Register
- CBASIC-2

Ask your dealer for a demonstration soon.



**Graham-Dorian
Software Systems, Inc.**

211 North Broadway / Wichita, KS 67202 / (316) 265-8633

The days of complicated, unreliable, dynamic RAM are gone:

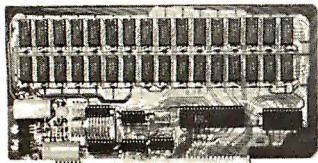

INTRODUCING JAWS

the ultrabyte memory board

\$199.95 (complete kit with 16K memory)

Netronics consistently offers innovative products at unbeatable prices. And here we go again — with JAWS, the ultrabyte 64K S100 memory board.

ONE CHIP DOES IT ALL

JAWS solves the problems of dynamic RAM with a state-of-the-art chip from Intel that does it *all*. Intel's single chip 64K dynamic RAM controller eliminates high-current logic parts . . . delay lines . . . massive heat sinks . . . unreliable trick circuits.

REMARKABLE FEATURES OF JAWS

Look what JAWS offers you: Hidden refresh . . . fast performance . . . low power consumption . . . latched data outputs . . . 200 NS 4116 RAMs . . . on-board crystal . . . 8K bank selectable . . . fully socketed . . . solder mask on both sides of board . . . designed for 8080, 8085, and Z80 bus signals . . . works in Explorer, Sol, Horizon, as well as all other well-designed S100 computers.

GIVE YOUR COMPUTER A BIG BYTE OF MEMORY POWER WITH JAWS — SAVE UP TO \$90 ON INTRODUCTORY LIMITED-OFFER SPECIAL PRICES!

UNDECIDED? TRY A WIRED 16K JAWS IN YOUR COMPUTER ON OUR 10-DAY MONEY-BACK OFFER (SPECIFY YOUR COMPUTER).

CONTINENTAL U.S.A. CREDITCARD BUYERS: OUTSIDE CONNECTICUT CALL

CALL TOLL FREE 800-243-7428

From Connecticut Or For Assistance: (203) 354-9375 Dept. B

NETRONICS RESEARCH & DEVELOPMENT LTD.
333 Litchfield Road, New Milford, CT 06776

Please send the items checked below:

- JAWS 16K RAM kit, No. 6416, \$199.95.*
- JAWS 16K RAM fully assembled, tested, burned in, No. 6416W, \$229.95.*
- JAWS 32K RAM kit, No. 6432, (reg. price \$329.95), SPECIAL PRICE \$299.95.*
- JAWS 32K RAM fully assembled, tested, burned in, No. 6432W, (reg. price \$369.95), SPECIAL PRICE \$339.95.*
- JAWS 48K RAM kit, No. 6448, (reg. price \$459.95), SPECIAL PRICE \$399.95.*
- JAWS 48K fully assembled, tested, burned in, No. 6448W, (reg. price \$509.95), SPECIAL PRICE \$449.95.*
- JAWS 64K RAM kit, No. 6464, (reg. price \$589.95), SPECIAL PRICE \$499.95.*
- JAWS 64K RAM fully assembled, tested, burned in, No. 6464W, (reg. price \$649.95), SPECIAL PRICE \$559.95.*
- Expansion kit, JAWS 16K RAM module, to expand any of the above in 16K blocks up to 64K, No. 16EXP, \$129.95.*

*All prices plus \$2 postage and handling. Connecticut residents add sales tax.

Total enclosed: \$

- Personal Check
- Money order or Cashiers Check
- VISA
- MASTERCHARGE (Bank No.)

Acct. No. _____ Exp. Date _____
Signature _____
Print Name _____
Address _____
City _____
State _____ Zip _____

Send me more information

the "hostile" 110 VAC environment Steve worries about.

I opted for option 1, for two reasons: simplicity and cost. The hardware actually requires fewer discrete parts than Steve's design and eliminates all but two integrated circuits, an opto-isolator, and a 555 timer. Even more interestingly, I used the computer, not special hardware, to generate the waveforms. For these off/on-type waveforms, the computer is in its glory. Both the actual cost of parts and the time required to implement the hardware were less than one-half of Steve's cost. Futher, I don't have to tie up or share a \$50 command console.

I didn't explore option 4, but the trade-off between the cost of the acoustic transducer and opening the command unit probably favors option 3 for a transducer costs under \$10.

In developing my software, I followed the structured programming approach because of two things I had in mind. I didn't want to dedicate a \$1200 Apple II computer to the menial task of controlling a dozen light circuits, and I didn't want to reload and reinitialize the home-control program after each time I wanted to use the machine for something else. Because of this, my program is strictly modular and can be run in two modes: the *interrupt* mode where the home-control program runs continuously in background leaving the foreground available continuously for other uses (a very elementary time-share system), or in the *alternate* mode where home-control execution can be halted temporarily to make the machine available for other uses. Following this use, the home-control program will "play catch-up" in case any event times occurred while it was off-line.

To accomplish the above, I partitioned the modules of the program into two portions: that portion required to be in the computer's memory for program operation (the event-controlling program) and that portion required to interface with the human operator and allow changes, etc (the driver program). The event-controlling program (including the machine-language waveform-generator routine) occupies less than 3 K bytes of memory and is located at the high end of memory (with HIMEM set below it). With HIMEM set below it, the computer can be used normally; the BASIC commands RUN, LOAD, SAVE, NEW, etc can be used without erasing or corrupting the event-controlling program. The driver program is loaded when necessary to make changes.

Anyone interested in more details on this approach should send a stamped, self-addressed envelope to me at the address below. I do believe implementing this approach is one step further along

the path toward an economical, utilitarian use for a home computer.

Jim Fulton
1106 Sandpiper
Corona Del Mar CA 92625

Protecting the Stack

The article by Michael McQuade in the February 1980 BYTE ("A Fast, Multibyte Binary to Binary-Coded-Decimal Conversion Routine," page 106) presents a good multiprecision binary-to-BCD routine. It presents well-structured code that also illustrates a very important subtlety; the published code will not work reliably in an interruptible operating system.

Decrementing the stack pointer is a dangerous way to maintain a "top of stack" value, because an interrupt can occur before or between the decrements and mash the contents of the stack. Pushing the data just popped is foolproof, takes 1 byte instead of 2, and one less cycle. So the two pairs of decrement-stack-pointer (DCX SP) instructions found in locations 0015 and 0016, and in locations 0023 and 0024 in listing 1 on page 110, should be changed to two single PUSH H instructions.

Thousands of programs do not maintain the integrity of the stack and so will not always work with the newer, interruptible operating systems. Unless the programmer knows what he or she is looking for, the problem can be impossible to find.

Gregg Hauser
196 Arguello Blvd
San Francisco CA 94118

A Microengine Arrives

I've bought and received a Western Digital Pascal Microengine. I had been waiting for it for a while and had enough time to fabricate the connectors necessary to interface my terminal and disk drives. So, I was prepared for the processor system when it arrived. My initial try at starting the system was both disappointing and heartening. It was disappointing because after pushing the reset button on the Microengine, I never received the greeting on the terminal that I expected. It was heartening because from the sound of the disk drive, it was likely that the processor and the disk were working correctly. I felt relief that the cabling that I'd produced and the "Shugart-compatible" drives that I'd purchased were okay.

The next day, the problem with the terminal was straightened out by a call to the terminal manufacturer. The fellow I spoke to sounded a bit chagrined when he had to admit the peculiarities of the

**There is only one
high performance
VLSI computer
solution.**

Intel delivers it.

Tools to solve the

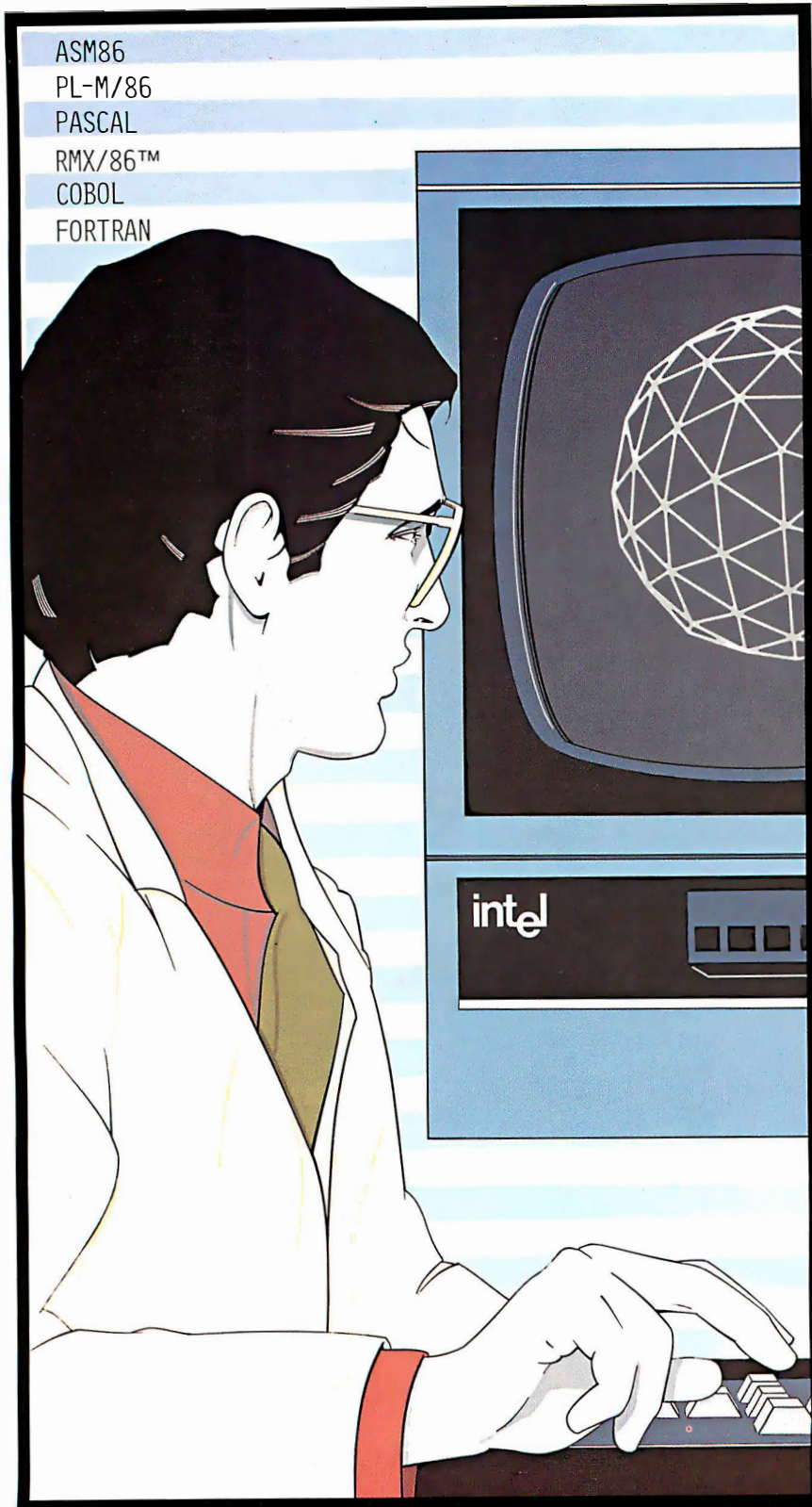

How Intel delivers the key to productivity in the '80s.

As we move into the '80s, the increasing demand for complex computer programs, the critical shortage of programmers, and the seemingly unstoppable rise in software development costs will reach crisis proportions. To understand how to bring this situation under control, we have to understand its cause.

In the 1970s, the microcomputer was used successfully to lower the cost of hardware engineering. Each new microcomputer generation integrated more and more of the system, lowering the cost of design and making it easier to put electronic intelligence anywhere and everywhere. As hardware cost dropped, rising software costs became increasingly visible.

So, today, as costs climb, management puts everyone under increasing pressure to deliver projects on time and on budget. Yet, the cost of programming is still outpacing productivity. Software development and integration still lag the system hardware. The software crisis of the '80s rages on.

Tools for structured solutions

Once a problem grows beyond a certain point, the most efficient way to solve it is with a top down approach. You break the problem into units, program and debug each one, and combine the units into a unified solution.

That's the concept. But you can't stop there. In the '80s, bridging the gap between a conceptual solution and a working one will require tools as efficient as the top down method. New tools, like a CPU with a dramatically different architecture. An architecture uniquely suited to a world of higher level languages and structured programming. Tools like a modular operating system, of a kind never before available on a 16-bit microprocessor. Tools like the

software crisis.

only complete family of programming languages, because no one language is right all the time.

Different languages have different strengths and weaknesses, and using the right language for the right job can make your programming easier. So, Intel delivers ASM86 Macro Assembly Language for space and speed sensitive modules. Our PL-M/86 systems programming language and PASCAL support structured programming at the systems and applications levels. FORTRAN and COBOL will also be available.

With Intel's relocation and linkage tools, modules written in the different languages are combined, with library utilities and operating system routines, into one, complete solution, automatically. Using this modular approach, and the right language for the right job, your finished product is clean, reliable, maintainable, and understandable.

The critical module

Since complex software requires sophisticated operating systems support, the operating system is the most critical module in your solution. It is the foundation upon which your application is built. It is also available, off the shelf, from Intel.

Today, Intel delivers the RMX/86™ operating system. RMX/86 is new, and it's the first modular, real-time, multitasking operating system for 16-bit microcomputers. File manipulation, task scheduling, and interrupt control are configured by you, according to the needs of your application. There's no unnecessary burden.

Intel's investment in the development of RMX/86 is substantial. Depending

upon the features you select, you save from two to forty man years of programming effort. That's an additional two to forty man years you can devote to your application.

Tools for realizing your solution

Of course, having the foundation and the concept of your solution doesn't help if you can't write the programs to implement it. So, Intel delivers development tools to support you through the entire development cycle. Support from source entry, with CREDIT, a CRT based text editor, through compiling and debugging, with an Intellec® development system

and ICE™ hardware/software debugging system. Intel's tools work with you. They shorten development time and support the structured approach you've taken.

But debugging software on a development system is not the same as testing it on the actual hardware. The ICE modules help here, too. During development, these tools let you trace through your software and debug it, symbolically, at the source language level. Now, these In-Circuit Emulators replace your prototype hardware's CPU to speed hardware/software integration.

If your hardware is built from components, ICE Modules will help you separate the hardware and software bugs, so you don't spend your time fixing engineering problems. If your hardware is built around an Intel iSBC 86/12A™ Single Board Computer, you'll already have a known, working hardware environment for program testing. You can use ICE Modules to concentrate your efforts on debugging your software.

Either way, the same software, operating system support and debugging tools are available to help you bring your application to life.

Synergy for high performance

In the '60s and '70s, programs were used to instruct computers. Applications of the '80s require programs to be the solutions to problems. High performance solutions will be the result of synergy between the hardware and the software.

To create this synergy today, Intel delivers the 8086 processor. The 8086 processor is unique. Instead of a linear, or flat architecture, the 8086 is the only microprocessor optimized to work with high level languages and the structured solutions they implement.

For the specialized needs of the '80s, the 8086/87 and 8086/89 co-processing systems will set the standard of performance for mathematical processing and I/O bound applications.

And Intel peripheral controllers contribute to your system throughput by freeing processors for more computation.

Your software design may be revolutionary. And with help from an architecture designed to support your structured solution, its performance can be revolutionary, too.

Intel's software tools let you concentrate your planning on the payoff—getting to market today with a superior product. To take your first step to higher productivity, fill out and mail the coupon on the other side of this page. It's a productive use of your time.

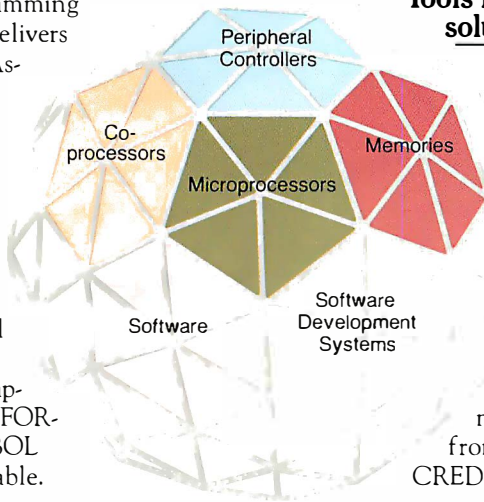

Intel Structured System

intel® delivers solutions.

Europe: Intel International, Brussels, Belgium.
Japan: Intel Japan, Tokyo. United States and Canadian distributors: Alliance, Almac/Stroum, Arrow Electronics, Avnet Electronics, Component Specialties, Hamilton/Avnet, Hamilton/Electro Sales, Harvey, Industrial Components, Pioneer, L. A. Varah, Wyle Distribution Group, Zentrionics.

Your first step toward productivity

How to get more information on solving the software crisis of the '80s.

To find out more about our solutions, fill out the informa-

tion requested below and send it to Intel Corporation, Literature Department, 3065 Bowers Avenue, Santa Clara, CA 95051. Indicate what your particular interests are, including workshops, and we'll make sure you get the appropriate material. If you don't have a pair of

scissors handy, give us a call at 408/734-8102 (Literature Department) and we'll rush the material out to you. Or call your local Intel distributor.

Intel wants to help you solve the software crisis of the '80s. It all starts right here.

Name _____
Title _____
Company _____
Division _____
Address _____
City, State, ZIP _____

I have an immediate requirement, please telephone me at (_____) _____
 I need additional information.

Please put the letter corresponding to your yearly requirements in the line to the left of those products of interest.

W for 1-10 per year
X for 11-99 per year
Y for 99-999 per year
Z for over 1,000 per year

- | | | |
|---|--|--|
| <input type="checkbox"/> A 16-bit Microprocessors | <input type="checkbox"/> F EPROMS | <input type="checkbox"/> L Macroassembler |
| <input type="checkbox"/> B 8-bit Microprocessors | <input type="checkbox"/> G Bubbles | <input type="checkbox"/> M Operating Systems (RMX/86™) |
| <input type="checkbox"/> C Single-Chip Microcontrollers | <input type="checkbox"/> H Single Board Computers | <input type="checkbox"/> N Telecom Products |
| <input type="checkbox"/> D Peripheral Controllers | <input type="checkbox"/> I Development Systems | <input type="checkbox"/> O Military Products |
| <input type="checkbox"/> E RAMS | <input type="checkbox"/> J Debug Tools | <input type="checkbox"/> P Workshops |
| | <input type="checkbox"/> K High-Level Languages
(_____) | |

Indicate languages

RS-232 interface on the terminal I was trying to use. That night, after making some changes to my cabling, I had my system up and running. I was pleased that the various parts of the system all managed to "talk" to each other with what I considered to be a relatively small amount of trouble. Perhaps there really is hope for standardization.

I would like to correspond with other users of the Microengine to exchange information on the system and its use.

Shirley Kawamoto
172 Highland Ave
Winchester MA 01890

Numerical Precision in UCSD Pascal

Since the only versions of Pascal that I have seen for garden-variety computers have six-digit (maybe seven-digit) precision, checkbook balancing with Pascal is useful only for the poor, starving computer aficionados who have at most \$9999.99. What about the rest of us who haven't bought a computer (and all those peripherals) yet?

Why are the popular Pascal compilers limited to six digits? I am *very* new to the computer field and particularly interested in Pascal. I teach mathematics, and Pascal seems to offer quite a bit. For some of my work, I like lots of digits as in Cromemco BASIC. I know that there's a trade-off between speed and significant digits, but only six digits?

Will the six-digit limitation always be present? If so, how can a business use Pascal, a language which many are claiming is the wave of the future?

Martin Berman
494 Forest Ave
Teaneck NJ 07666

The Pascal compilers in question all seem to be the ones included in the UCSD Pascal system. The definition of the pseudocode (ie: p-code) interpreter for the UCSD system is what determines the precision available. The six-digit precision is the maximum available when numbers are stored in a reasonable format in only 4 bytes. There are some nonstandard extensions in UCSD Pascal that give you up to some arbitrary number N decimal digits precision in fixed-point format; these are called long integers. I believe the maximum value of N is thirty-six digits. This particular extension was intended for use in business programs....CH

Let's Hear a Good Word for Compilers

I have read with great interest the article by Mr James Lewis comparing BASIC and assembly language speeds on

the TRS-80 ("TRS-80 Performance, Evaluation by Program Timing," March 1980 BYTE, page 84). The problem, as he clearly points out, is that it takes a large amount of human time to use assembly language efficiently.

The availability of FORTRAN for microcomputers now allows another, far superior, alternative. Since FORTRAN, like assembly language and unlike BASIC, is compiled, it should produce fast code. Assuming an inefficient compiler, producing code four times slower than that obtained by careful assembly-language coding, the program would still have run in under one and a half hours, over four times faster than the fastest BASIC run.

I strongly feel that anyone needing fast-executing code should always think of FORTRAN before rushing to assembly language.

Mohamed el Lozy MD
Harvard University
School of Public Health
Dept of Nutrition
665 Huntington Ave
Boston MA 02115

The advantages of compilation are not exclusive to FORTRAN. Any high-level language, including BASIC, may be compiled. For example, a BASIC compiler is now being sold by Microsoft for Z80 systems....RSS

\$24.95

...AND HOLDING

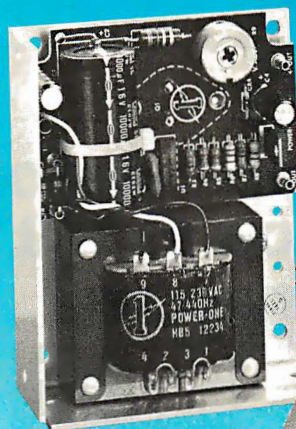

Model HB5-3/OVP

5V at 3A with Built-in OVP

PowerOne's B Case models started at \$24.95. Over 100,000 models and five years later, they're *still* only \$24.95!

- 115/230 VAC Input
- OVP Built-in
- .05% Regulation
- 2-Year Warranty
- 2-Hour Burn-in
- UL Recognized
- CSA Certified

Get all the details on our 84 standard open frames in our new 1978 catalog.

IN-STOCK NATIONWIDE... FOR IMMEDIATE DELIVERY

EASTERN REGIONAL SALES OFFICE: Schenectady, N.Y. (518) 399-9200 **ALA.:** Huntsville, Rakes Engr. & Marketing Corp. (205)883-9260 **ARIZ.:** Phoenix, PLS Assoc. (602) 279-1531 **CAL.:** Pasadena, A-F Sls. Engr. (213) 681-5631; San Diego, A-F Sls. Engr. (714) 226-8424; San Jose, Richards Assoc. (408) 246-5860 **COL.:** Denver, PLS Assoc. (303)773-1216 **CT.:** Litchfield, Digital Sls. Assoc. (203) 567-9776 **FLA.:** Orlando, OEM Marketing Corp. (305) 299-1000 **GA.:** Duluth, Rakes Engr. & Marketing Corp. (404) 476-1730 **ILL.:** Chicago, Coombs Assoc. (312) 298-4830 **IND.:** Indianapolis, Coombs Assoc. (317) 897-5424 **MD.:** Wheaton, Brimberg Sls. Assoc. (301) 946-2670; Baltimore, Brimberg Sls. Assoc. (301) 792-8661 **MASS.:** Waltham, Digital Sls. Assoc. (617) 899-4300 **MICH.:** Southfield, L.H. Dickelma Co. (313) 353-8210 **MINN.:** Minneapolis, Engr. Prod. Assoc. (612) 925-1883 **N.J.:** Whippany, Livera-Polk Assoc. (201) 377-3220; Marmora, Holdsworth (609) 398-4340 **N.M.:** Albuquerque, PLS Assoc. (505) 255-2330 **N.Y.:** Roslyn Hts., Livera-Polk Assoc. (516) 484-1276; Syracuse, C.W. Beach (315) 446-9587 **N.C.:** Charlotte, Over & Over Inc. (704) 527-3070 **OHIO:** Cleveland, Marlow Assoc. (216) 991-6500; Dayton, Marlow Assoc. (513) 434-5673 **OKLA.:** Tulsa, Advance Technical Sls. (918) 743-8517 **ORE.:** Portland, Jas. J. Backer (503) 297-3776; Salem, Jas. J. Backer (503) 362-0717 **PENN.:** Pittsburgh, Marlow Assoc. (412) 831-6113; Newtown Sq., Holdsworth & Co. (215) 356-8550 **TEX.:** Dallas, Advance Technical Sls. (214) 361-8584; Solid State Electr. (214) 352-2601; Houston, Advance Technical Sls. (713) 469-6668; Solid State Electr. (713) 772-8483 **UTAH:** Salt Lake City, PLS Assoc. (801) 466-8729 **WASH.:** Seattle, Jas. J. Backer (206) 285-1300; Radar Elec. Co. (206) 282-2511 **WIS.:** Milwaukee, Coombs Assoc. (414) 671-1945 **EUROPE:** Hanex, L.A., CA (213) 556-3807 **CANADA:** Duncan Instr., Weston, Ontario (416) 742-4448; Winnipeg, Manitoba, Cam Gard Supply Ltd. (204) 786-8481

"Think about **POWER-ONE** INC.
D.C. POWER SUPPLIES

Power One Drive • Camarillo, CA 93010 • Phone: 805/484-2806 • TWX: 910-336-1297

SEE OUR COMPLETE PRODUCT LISTING IN EEM & GOLDBOOK

Domesticating Computers: Some Wishes Expressed

The editorial in the January 1980 BYTE on the state-of-the-art home computer omits home operations and management, although four articles in the same issue illustrate the importance of this topic. To be fair, computerized home management is next year's state of the art, and I hope that my "wishes" expressed in this letter soon become reality.

Steve Ciarcia's article on adapting the BSR X-10 system ("Computerize a Home," page 28) demonstrated that it soon will be possible to control the electrical appliances and the lighting in a home. And John H Gibson's design of a computer-controlled light dimmer is, perhaps coincidentally, a homebrew design of an X-10 light switch/dimmer. Edward Joyce showed how easy it is for a computer to dial over telephone lines. I hope that someone develops a commercial product soon, based on this idea.

Taking a different view, Theron Wierenga designed a furnace watchdog to show how a computer can monitor the outside world.

To convert these homebrew ideas into off-the-shelf computer products, both

hardware and software problems must be solved. (And, as is so often the case, the hardware will be developed long before the software.)

The ideal version of the BSR X-10 would be able to *measure* the outside world, by sensors that communicate over ordinary home wiring, unlike Theron Wierenga's homebrew version. (My apologies, Theron, if I'm wrong about your design.) The sensors could be "polled," or signaled by the control unit to indicate the temperature, pressure, etc, or could initiate a signal independently (eg: in response to a change in conditions). And, of course, the sensors would be individually addressable. I doubt that BSR is working on such sensors because they would be of little use for a manually controlled system, and they have given no indication that they are working on a computerized version of the X-10.

The ideal computer will also require a programmable real-time clock. Also, if we are serious about energy conservation, we might want to shut down part or even all of the computer for a few hours of the day. Perhaps this on/off capability can be made part of the programmable timer.

Even if all this hardware were

available for our off-the-shelf computer, it would make little sense to devote a machine with considerable capacity to just one application program. Ideally, we would like to monitor and control several outside systems while still using the machine for game playing, word processing, or whatever. This requirement implies a multiprogramming operating system, a feature generally confined today to large computer systems. We would also like the real-time clock to be able to interrupt all other programs at regular intervals and initiate a polling program to sample the outside systems. Alternatively, the operating system gives every program in the system, including the polling program, a chance to execute at least once a second. So our operating system could include "time slicing." Finally, since we can never be certain of the starting address in memory of a program in a multiprogramming system, all software should be relocatable.

I think that the software requirements will prove challenging to software homebrewers, of which there aren't enough.

Philip Burton
3333 Cowper St
Palo Alto CA 94306

ASCII keyboards: parallel or serial output, as low as \$69.*



RCA VP-600 series ASCII keyboards are available in two formats. You can choose either a 58-key typewriter format. Or a 74-key version which includes an additional 16-key calculator-type keypad. Both can be ordered with parallel or serial output.

These keyboards feature modern flexible membrane key switches with contact life rated at greater than 5 million operations. Plus two key rollover circuitry. A finger positioning overlay combined with light positive activation key pressure gives good operator "feel," and an on-board tone generator gives aural key press feedback.

The unitized keyboard surface is spillproof and dustproof. This plus high noise immunity CMOS circuitry makes these boards particularly suited for use in hostile environments.

Parallel output keyboards have 7-bit buffered, TTL compatible output. Serial output keyboards have RS 232C compatible, 20 mA current loop and TTL compatible asynchronous outputs with 6 selectable baud rates. All operate from 5 V DC, excluding implementation of RS 232C.

For more information contact RCA Customer Service, New Holland Avenue, Lancaster, PA 17604.

Or call our toll-free number: 800-233-0094.

*Optional user price for VP-601. Dealer and OEM pricing available.

A Problem with Radio-Frequency Interference

We have a Nano computer and an FM radio receiver and they don't get along! When the computer is operational, it will function as a process controller for our solar-heating system. It is connected to sixteen low-voltage heat sensors located throughout the house. This wiring was positioned as the house was built and is therefore unmovable. All the wires terminate in our "computer room," which also houses the FM receiver. None of the sensor wires are closer than two feet to the FM antenna or its (coaxial) cable.

When the Nano computer is on, we get whistling, buzzing, and hissing on one station (90.9 MHz), which is 75 miles away. Putting the receiver in monophonic mode, as opposed to stereophonic, eliminates the interference, as does moving the Nano (less sensor wires) into another room. Because none of the closer stations are affected, it is clear that the strength of the FM signal is a factor. Unplugging the sensor wires from the Nano reduces the interference significantly, but not completely.

We have tried (at the suggestion of several acquaintances who are electronics/computer-engineer people) a low-frequency filter on the FM antenna, a power-line filter, switching plugs and

Mountain Hardware makes more peripherals for the Apple Computer than Anybody.

and . . .
a place to put them

INTROL X-10

Intelligent Home Controller for lights and appliances. Real-time schedules and energy conservation. Complete applications software package. Home security with random scheduler. Power usage accounting package for home energy cost control. No wiring required.

APPLE CLOCK

Real-time and date information. Interrupts permit Foreground/Background operation of two programs simultaneously. Battery back-up. Crystal-controlled for $\pm .001\%$ accuracy. Onboard ROM for easy access from BASICS. Supports PASCAL. Time from one millisecond to one year.

SUPERTALKER SD200

Input/Output Speech Digitizer. Permits talking programs. I/O capability allows interactive programs with speech-prompted inputs. Use output for speech directed activities in business systems, announcements in a control-room, or sound effects in entertainment programs. Easy to use because input as well as output is under user control with special software operating system.

ROMWRITER

Program your own EPROMs. Create your own firmware. Programs 2K, 2716 5V EPROMs. Disk software package provides easy EPROM programming. EPROMs are verified after BURN. RUN your programs from on-board socket or install them on ROMPLUS+.

ROMPLUS+

More power for your system through firmware. Six sockets accept 2716 EPROMs or ROM equivalents. Six or any combination can be used at once. Scratch-pad RAM and two TTL connectors. Special 2K ROMs available for powerful system enhancement: Keyboard Filter ROM—COPYROM—Others coming soon.

MusicSystem

Sophistication previously available only on experimental mini and mainframe computer synthesizers. Digital instrumental music synthesizer system. 16 voices in stereo. Instrument definitions simulate the sound of real instruments—and more. Fully programmable waveforms. Envelope Control. Composition system—sheet music input using standard music notation. Chords and multi-part scoring up to 16 voices. A true instrument that anyone with an Apple can play.

A/D+D/A

16 channels analog to digital input. 16 channels digital to analog output. Eight bit resolution. Super-fast 8μ sec. conversion time. Monitor and output to the real world. All on one card.



Coming in July

EXPANSION CHASSIS

By popular demand! Eight more slots for your Apple. Attractive sturdy enclosure. Its own heavy duty power supply. Easy to use. Address cards in Expansion Chassis the same way as in your Apple. Only one additional command to specify in Apple or in Expansion Chassis. Compatible with all Apple peripherals.

MOUNTAIN HARDWARE has the most comprehensive line of Apple peripherals available. Anywhere. From anybody. We know the Apple inside and out and are committed to providing the most innovative and unique products to expand and enhance its capabilities and use. After all, we were the first company to make an Apple peripheral—except Apple Computer.

The message is simple. If you have an Apple, you need to know MOUNTAIN HARDWARE.

Available at Apple Dealers worldwide.



Mountain Hardware, Inc.

Leadership in Computer Peripherals
A Division of Mountain Computer, Inc.
300 Harvey West Blvd.
Santa Cruz, CA 95060 (408) 429-8600

MORE PERIPHERALS? Send me information.

NAME _____

ADDRESS _____

CITY _____ STATE _____ ZIP _____

Apple is a trademark of Apple Computer Inc.

circuits, and grounding a wire screen and putting it between the computer and receiver. The maximum separation possible between the two is about 5 feet. None of these things have had any noticeable effect. Oddly enough, sometimes the interference all but disappears for no apparent reason.

It is imperative that this interference be permanently eliminated because we cannot relocate any of the equipment. We would appreciate any help BYTE readers can give us.

Mr and Mrs J M Johnston
1116 E Deep Run Rd
Westminster MD 21157

A North Star Alternative

I liked Carl Helmers' January 1980 editorial ("The Era of Off-the-Shelf Personal Computers Has Arrived," page 6), but I feel that it would have been better and more dramatic if he had included more examples and less emphasis on the Apple II Pascal system. I went through the same issue of BYTE and built the following system on paper:

Horizon 2-Q with 32 K user memory	
720 K bytes disk storage	
two serial input/output ports	
one parallel port	
North Star disk-operating system, monitor, and North Star BASIC	\$2560
North Star 32 K-byte memory card	\$ 520
North Star UCSD Pascal system	\$ 78
Anadex DP-8000 printer	\$ 795
Interface cables	\$ 70
CP/M operating system in North Star format	\$ 145
CBASIC-2 for North Star	\$ 110
MicroSoft MACRO-80, COBOL-80, and FORTRAN-80	\$1025
Freight	\$ 70
TOTAL	\$5373

The sources for these items include Avionics Enterprises (AEI), American Square Computer, Logon Incorporated, and LifeBoat Associates. I did not include a modem because I did not see the Hayes S-100 modem advertised this month. If I remember correctly, it sells for about \$400, bringing to \$5773 the total price of my paper system.

So, for less than \$6000 I have synthesized a hypothetical example to complement Mr Helmers' Apple II example. The Horizon 2 example will execute UCSD Pascal approximately twice as fast as the Apple II, and with the above additions provides FORTRAN, COBOL, two BASICs, two assemblers, and com-

patibility with all of the excellent software designed for use with CP/M. In addition, the Anadex printer will produce listings and output at twice the speed of the Integral Data 440 when the former is used in the bidirectional mode.

I provide this example (I have both an Apple and a North Star) to point out that some alternatives exist.

Robert Rennard
2281 Cobble Stone Ct
Dayton OH 45431

More (Transcendental) Pi in the Sky

Regarding the letter "Pi in the Sky" (February 1980 BYTE, page 16), I have found Mr Sprenkle's approximation to π of $1/(113/355)$ to be useful for the old mechanical "four-bangers" as well as the modern four-function calculators, but its accuracy generally leaves much to be desired in modern computers. My preference is the function:

$$PI = 4 * ATN(1)$$

for all scientific work. For whether you have six- or sixteen-decimal digit capability, this value of π will be accurate to the full capacity of your machine, and it is no more difficult to remember than $1/(113/355)$.

Rex H Shudde
27105 Arriba Way
Carmel CA 93923

Alas, this is not always the case. Several years ago, I was obtaining inaccurate trigonometric calculations from some FORTRAN programs that used double-precision variables. The FORTRAN compiler was the product of a prominent minicomputer manufacturer, which shall remain anonymous. After much attempted debugging, the minicomputer firm revealed that the writers of the compiler had put in an incorrect value for π , and therefore all of the double-precision trigonometric functions were inherently inaccurate. Sigh....RSS

Information Wanted

I would like contact anyone who has determined the nature of the incompatibility between the Cromemco ZPU board and the IMSAI VIO-C video interface board—when both are installed in an IMSAI I-8080 mainframe.

Also, I'm trying to locate a firm or a person who really knows how to repair an IMSAI DIO disk-interface board.

Jack Williams
902 Anderson Dr
Fredericksburg VA 22401

Industrial quality components for S-100 system builders, from California Computer Systems.

2422 Disk Controller. Single and double density controller for up to four $5\frac{1}{4}$ " or 8" single-sided drives, or two double-sided drives. Shipped with CP/M 2.0, the controller reads and writes IBM-standard single density. Automatically determines disk density—single or double. Supports PerSci auto eject, plus fast-peek for voice coil systems.

2810 Z80 CPU Board. Capable CPU for S-100 Systems operates at 2 or 4MHz, is fully Altair/Imesai compatible. Z-80 monitor is available separately. Includes auto addressing to 4K boundaries, plus a serial port for serial devices, including terminals and printers. Supports both front-panel operation and power-on memory jump, plus wait-state generation for slower memories. Compatible with proposed IEEE S-100 standards.

2032A 32K Static RAM. Fast static memory operates without wait states at a full 4MHz. Supports full and partial bank select, for expansion beyond 64K. Addressable in 8K blocks at 8K boundaries. Address and data lines are fully buffered, and there are no DMA restrictions.

2016 16K Static RAM. Fully buffered board features 2114 static RAMs for +5v operation. Bank select available by bank port or bank byte, for system expansion beyond 64K. Addressable in 4K blocks at 4K boundaries. LED indicators for board selection and bank selection. Available in 200, 300, or 450 nsec versions. All versions support 4MHz operation with no wait states.

2200A Mainframe. Rock solid, heavy gauge cabinet includes 12-slot, actively terminated S-100 motherboard, fan, and power supply. Power supply features 105, 115, or 125 volt AC input power; provides +8vDC at 20 amps, $\pm 16v$ DC at 4 amps. Available in five colors. Includes convenient, front mounted, lighted reset switch.

2501A Mother Board. 12 slots, actively terminated, with all S-100 connectors included. Distributed power line bypass, low inductance interconnect—extremely low bus noise.

Prototype Boards. Four high quality prototype boards: Solder Tail, Extender/Terminator, Wire Wrap, and Etch.

P2802AA 6502 CPU. Stand-alone CPU generates fully S-100 compatible I/O signals; executes 6502 machine language. Operates at 2MHz; capable of DMA operation.

Available nationally.

California Computer Systems industrial quality S-100 products are available at over 250 computer retailers. Volume customers should contact the marketing department at CCS.

CCS. Industrial standards.

We see the S-100 a little differently.

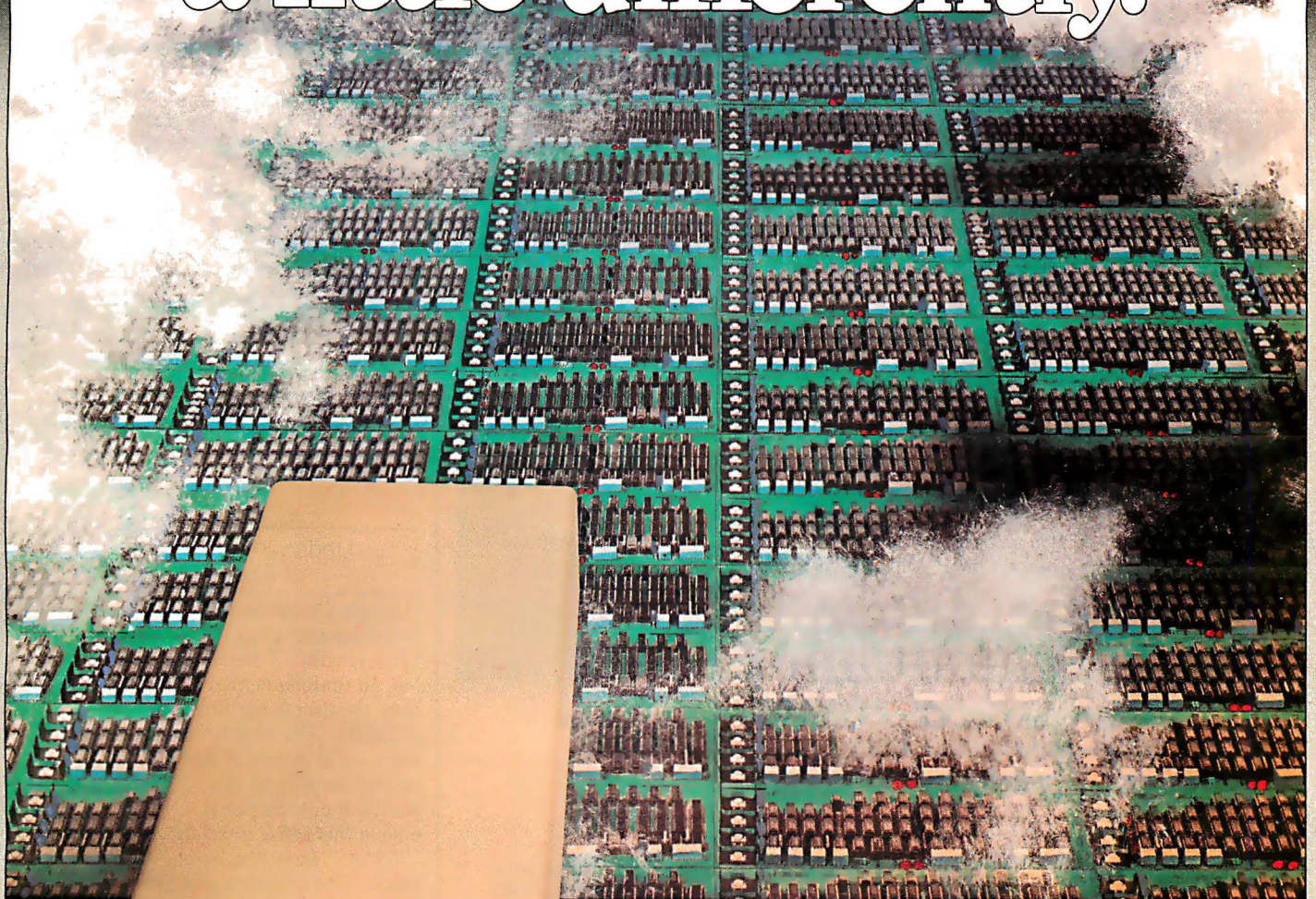

We mass-produce S-100 products to deliver industrial quality, at industrial prices.

You systems builders who need top quality, full featured, *workhorse* S-100 building blocks at the most competitive prices now have a source. California Computer Systems.

Industrial quality means top grade materials, components, and assembly, plus complete testing for absolute reliability.

Industrial quality means solid designs, a full complement of the important features you require, and a product line that delivers performance.

Industrial pricing comes from mass production. We buy at the right prices, and build *in quantity*, using state-of-the-art facilities and techniques. Including complete burn-in, for full performance right off the shelf.

Our industrial point of view means you get higher performance, greater reliability, and lower prices. If these are features you would like to see in your S-100 system, see things our way.

Because for serious users with serious uses for the S-100, these are the industrial standards.



California Computer Systems

250 Caribbean Sunnyvale, CA 94086 (408) 734-5811

UP TO 2400 MEGABYTES OF HARD DISK CONTROL FOR THE S-100 BUS

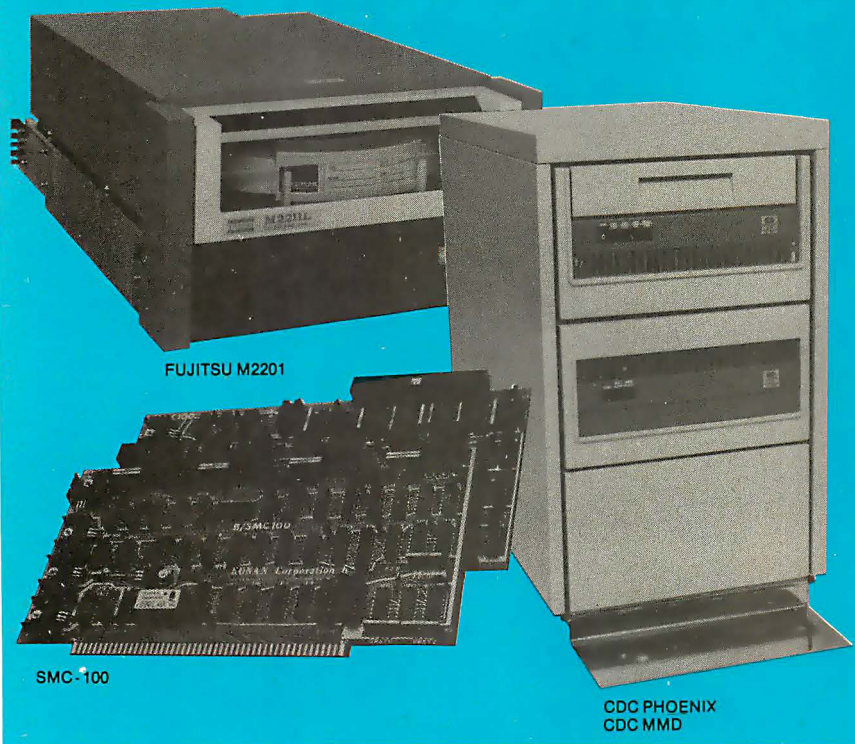

FUJITSU M2201

SMC-100

CDC PHOENIX
CDC MMD

Konan's SMC-100 is versatile, fast, cost efficient. It's the disk controller that brings S-100 bus micro computers together with large capacity hard disk drives.

Versatile

Interfaces S-100 bus micro computers with all fixed or removable media disk drives with storage module (SMD) interfaces. Each Konan SMC-100 will control up to 4 drives ranging from 8 to 600 megabytes per drive, including most "Winchester" type drives. Up to 2400 megabytes of hard disk per controller! And you can take your pick of hard disk drives: Kennedy, Control Data, Fujitsu, Calcomp, Microdata, Memorex, and Ampex, for example.

Fast

SMC-100 transfers data at fast, 6 to 10 megahertz rates, with full onboard sector buffering and sector interleaving, and a DMA that's faster than other popular S-100 DMA controllers.

Cost efficient

SMC-100 is priced right to keep your micro computer system micro-priced. It takes advantage of low-cost-per-megabyte disk drive technology to make the typical cost less than \$80 per megabyte. The OEM/Dealer single quantity price is only \$1650, with driver ROM option. Excellent quantity discounts are available.

SMC-100 availability:

Off the shelf to 30 days in small quantities. (Complete subsystems are on hand for immediated delivery.)

Konan has the answers. Talk to them today. Call direct on Konan's order number: 602-269-2649. Or write to Konan Corporation, 1448 N. 27th Avenue, Phoenix, Arizona 85009.

KONAN™

1448 N. 27th Avenue • Phoenix, Arizona 85009 • 602-269-2649

Recursive Decisions?

In his article "What Computers Cannot Do" (January 1980 BYTE, page 100), T G Lewis asserts: "If the DECIDE program *itself* is put into GR, a paradox is created for GR." Following this he shows that *if* a particular outcome (HALT NOT FOUND) results, this would lead to a contradiction and so DECIDE could not exist. His hypotheses 7 thru 10 seem to hinge on the nonexistence of a DECIDE program, which in turn depends on HALT NOT FOUND occurring on input of DECIDE into DECIDE. However, HALT NOT FOUND was only one of two possible outcomes. Finally, either I missed it or Mr Lewis did not state why HALT NOT FOUND *must* result from feeding DECIDE into DECIDE.

John S Wallingford
Chairman, Dept of Physical Science
Pembroke State University
Pembroke NC 28372

Undocumented Feature of Apple Writer

Apple Computer Company has recently introduced a text editor named Apple Writer, which I developed. Apple Writer has an undocumented feature that may save the user some time, money, and difficulty. The hidden feature is a software serial interface that connects to a printer by way of the Apple II gamepaddle input/output (I/O) socket. To enable this serial interface, the user types "SERIAL" from the Apple Writer print menu. The program will then display the hardware protocol and available data rates.

At present, this interface is one of a very few ways to use a Qume printer (among others) with the Apple II. Because only three wires are required, cost and complexity are low. However, some technical skill is required to make the electrical connections, and electrical compatibility between the printer and the Apple II must be determined. If these precautions are not taken, damage to the Apple II and/or the printer may result. It is for these reasons that Apple Computer chose not to document the feature.

I have used the serial interface on two printers (IDS and Qume) with no problems. It appears that most serial-interface-equipped printers will accept the signals available from the Apple II.

Paul Lutus
291 N Gold Canyon Dr
Kerby OR 97531 ■

6809 PROCESSING POWER!

only \$199.95

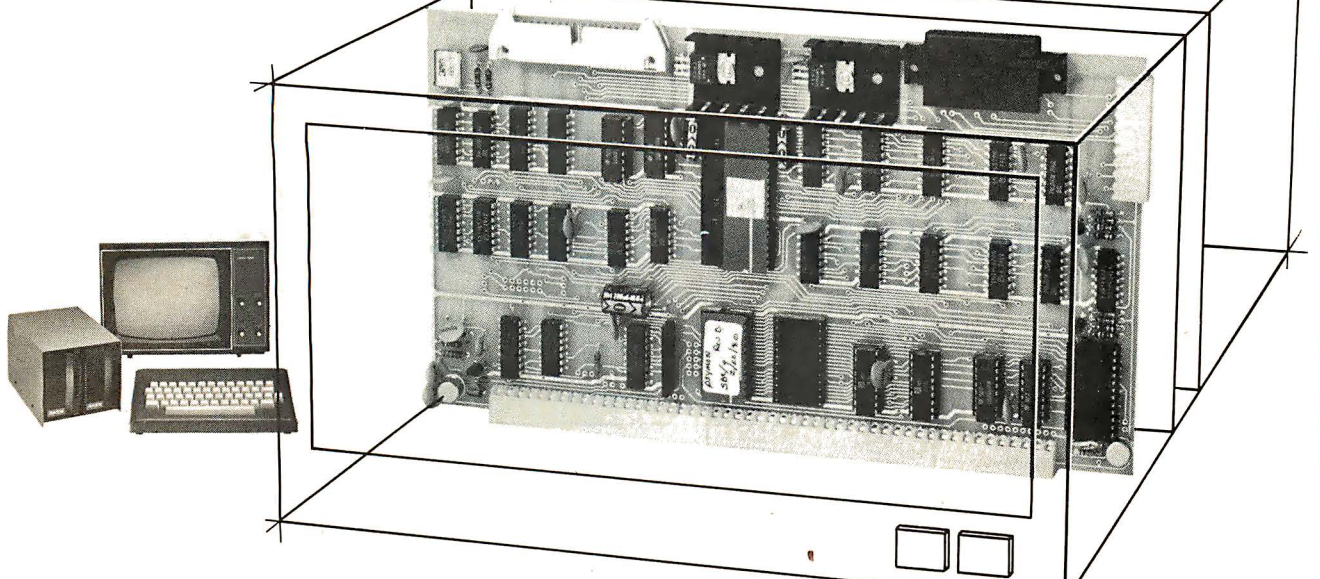

The Percom SBC/9™: A "10" By Any Measure.

Available with either the new, powerful 6809 μ P or an optional 6800-software-compatible 6802, here are 10 beautiful reasons why the Percom SBC/9™ is not just another runner-up MPU/Single-Board-Computer card.

- 1 SS-50 bus direct, plug-in-compatible upgrade MPU. Requires **no** modification of the system bus, I/O or memory.
- 2 Full-capability stand-alone single-board computer. Accommodates a 6809 microprocessor or optional 6802 microprocessor **without modification**.
- 3 On-card 1 K ROM monitor "auto-links" to optional second 1 K PROM — if installed. Second PROM may be used to easily extend or modify the primary monitor command set.
- 4 Eight-bit parallel port is multi-address extension of system bus. Accommodates an exceptional variety of peripheral devices ranging from game paddles and keyboards to memory management modules. Connector is optional.
- 5 Serial port includes a full-range selectable bit rate generator. Optional subminiature 'D' connector provides RS-232 compatibility.
- 6 Extendable addressing via SS-50 bus baud lines to 1 Mbyte. Extendable addressing to 16 Mbytes or more through the parallel "super port."
- 7 Includes 1 Kbyte of static RAM.
- 8 All on-card I/O is fully decoded so that adjacent memory space may be used.
- 9 ROM circuit may be jumper-wired for single- or triple-voltage 2716 EPROM.
- 10 On-card power regulators simplify power supply design by minimizing regulation demands.

Plug the SBC/9™ into your SS-50 system bus, and just that easily you've upgraded to the new super-fast super-powerful 6809 MPU with such programming amenities as 10 addressing modes, 16-bit instructions, auto-increment/auto-decrement and position-independent code. Plus, you now have extended addressing capability, and operation under control of PSYMON™, the most powerful and flexible 1K ROM 6809 operating system yet written.

Percom SYstem MONitor - PSYMON™ provides the usual ROM monitor functions in 1 Kbyte. It is easily extended and customized because its unique "look-ahead" program structure first searches an alternate command table. The table, if present, may be used to redefine or extend PSYMON's™ command set.

And with PSYMON™, I/O is easily directed to any peripheral device — even a disk system — through a Device Control Block table located

in memory. This allows you to leave the details of I/O software to the separate I/O device drivers.

A PSYMON™ ROM is included free with the purchase of an SBC/9™. The Users Manual includes a source listing.

The 1 Kbyte ROM monitor for the SBC/9™ 6802 option includes a primary set of typical 6800-compatible monitor commands. As for PSYMON™, the commands are easily extended or modified.

Products are available at Percom dealers nationwide. **Call toll-free, 1-800-527-1592, for the address of your nearest dealer, or to order direct.** Prices and specifications subject to change without notice.

™ trademark of Percom Data Company, Inc.

PERCOM DATA COMPANY, INC.
211 N. KIRBY GARLAND, TEXAS 75042
(214) 272-3421



An Answer/Originate Modem

Ronald G Parsons
9001 Laurel Grove Dr
Austin TX 78758

One of the few and nearly universal methods of exchanging data between diverse microprocessors is by means of data transmission over switched telephone facilities. Most other means of data exchange such as floppy disk or cassette tape are specific to one or a few microcomputers. But data transmission over phone lines is nearly independent of the microprocessors involved and the method or speed of the mass data storage used by either processor.

To transmit data at reasonable speeds over a telephone line, a *modem* is used to convert digital signals to an analog form for transmission over the telephone network. "Modem" is a hybrid of the words modulator and demodulator. A modem must be used because the telephone network was designed for analog voice transmission and not for digital data. The telephone network has an audio bandwidth of approximately 3000 Hz, so the modem must condition the signals to fit within this bandwidth.

Since communication usually involves data transmission in both directions, a convention has been established so that two sets of data traveling in opposite directions do not interfere with each other. The Bell 103 type of modem uses designated audio frequencies for binary 0 and 1. One of the pair of communicating entities is arbitrarily designated as the originating end and the other the answering end. As the words imply, the originating end usually originates

the telephone call and the answering end usually answers, but this is not necessary. All that is necessary is for one of the pair to agree to call itself the answerer and the other the originator.

The originating end transmits a binary 0 (sometimes called a space) as

The telephone network was designed for analog voice transmission, not digital data.

a tone of 1070 Hz and a binary 1 (sometimes called a mark) as a tone of 1270 Hz. The originating end also receives spaces and marks as tones of 2025 Hz and 2225 Hz, respectively. The answering end has the transmit and receive frequencies interchanged. The Bell 103 modem translates serial data from voltage levels to these audio tones capable of being transmitted over standard telephone lines at a data rate from 0 to 300 bps.

A data bit is usually translated first by a terminal or microcomputer to standard voltage levels defined by an Electronic Industries Association (EIA) standard known as RS-232C. This standard defines a space as a voltage level between +5 V and +15 V and a mark as a voltage level between -5 V and -15 V. Voltages between -5 V and +5 V have undefined meaning. These signals are capable of being transmitted over

wire cable for distances of several hundred feet at speeds up to several thousand bits per second.

The modem described in this article uses RS-232C levels between the processor or terminal and the telephone line; it connects to the telephone line through a device called a data access arrangement (DAA). This device has two common types: the CBS data coupler, which uses RS-232C levels to interface with the modem; and the simpler CBT data coupler, which uses contact closures (ie: switches or relays) for the modem interface. The CBT type is used in this design for simplicity. Motorola's *Application Note AN-747* entitled "Low-Speed-Modem System Design using the MC6860" discusses the interface to either coupler.

The most complicated and troublesome parts of a modem are usually the filters used to separate and purify the transmitted and received audio tones. It is not uncommon for filters for the transmit and receive frequencies each to contain several operational amplifiers and many precision resistors and capacitors. The filters used in this design, however, are available as "miniModem" building blocks from Cermetek Microelectronics, 660 National Ave, Mountain View CA 94043. They require no adjustments and few external components.

Two filters are used. One, the CH1262, is a switchable, dual-channel, transmit filter and line hybrid. The center frequency of the filter is

TALK TO YOUR COMPUTER FROM ANYWHERE—BY PHONE!



Nixdorf's amazing, new, portable terminal is designed for the person who needs quick, accurate communications with a computer from a variety of locations.



Ingenious microtechnology has packed all the features of a standard terminal into a battery/AC-operated unit the size of a book. With full computer telecommunications capability, it weighs just three pounds. And it's so inexpensive, you can buy one for every member of your team for far less than it would cost to lease!

The compact unit communicates via its acoustic coupler over standard telephone lines with any computer system, using standard RS 232 telecommunications (used on most mainframes). No special programming is needed.

To operate, just dial your computer or computer operator. Place your telephone handset into the acoustic coupler and you're ready to go! Just key in a line (up to 80 char-

acters), review on the 16-character display via scroll keys, then transmit. The speed of computer response is easily set for your own viewing pace.

EXECUTIVES: From home, road, or out-of-town, you can still have access to the vital information you require. Check operational data, sales figures, even pick up electronic mail. With automatic telephone pickup, you can call when it's convenient for you, regardless of time zones.



FINANCE: Dial from a client's or prospect's office to access complex programs on the spot. Enter client's data, and get results immediately. All the portability of a pocket calculator with the total capability of your home-base computer.

FIELD SERVICE: On the road, use any phone—even a paystation—to log hours, parts, with complete accuracy; then receive messages and schedule changes. Easy-to-read display eliminates handwritten or verbal errors.



SALES: Now you can check inventories from your customer's office. No need to guess on supply availability. Plus, you can place your orders directly with your central computer to speed shipment.

PROGRAMMING: You can scan or modify software from any telephone. Full-feature keyboard allows you to debug or even write short routines for fast response to urgent needs. At three pounds, you won't mind carrying it everywhere!

Rechargeable batteries give up to four hours life, charger/adaptor included. Baud rate and parity set from keyboard. 16-character LED display scrolls to show full 80-character buffer.

I would like to order the following:

Quantity	Model	Price	Total Price
_____	Nixdorf #LK3000 keyboard	\$139.95	_____
_____	Nixdorf computer module #LK2010	\$195.00	_____
_____	Nixdorf telephone coupler #LKCouplr	\$175.00	_____
_____	INS., SHIPPING And Handling Charge	\$3.50	_____
TOTAL	(Mass. Residents add 5% Sales tax.)	_____	_____

Payment: Visa MC Check Corporate P.O. No.: _____
 Card Number: _____ Expiration Date: _____
 Signature: _____

Name _____
 Company Name _____
 Address _____
 City _____ State _____ Zip Code _____

Phone No. () _____

Send all orders to our address or call

1-800-225-8493

1-800-225-8390 In Mass. 1-617-891-6495

Write to: **MARKLINE**

P.O. Box 171

Department AB

Belmont, MA 02178

chosen to be 1170 Hz or 2125 Hz by changing the DC voltage on the channel-select pins. The other, the CH1267, is a switchable, dual-channel, receive filter and limiter. It is necessary for us to be able to switch the center frequencies of the filters so the modem can be used as an originate or an answer modem.

The functions of modulation, demodulation, and control are performed by a Motorola MC6860 metal-oxide semiconductor/large-scale integration (MOS/LSI) modem chip. After conversion to transistor-

transistor logic (TTL) levels, the modulator section of the 6860 converts serial digital data into analog frequencies. It does this by digitally synthesizing a sine wave at one of the space and mark frequencies. This signal is filtered and amplified by the transmit filter. The demodulator section of the 6860 detects the presence of a mark or space frequency and presents a digital 0 or 1 output to the terminal or computer. The receive-signal input to the 6860 must be a 50% duty-cycle, TTL signal that is filtered and limited (ie: amplified and

clipped).

Several supervisory control functions are provided by the 6860. The 6860 places the modem into answer mode (if a ring indication is detected) or into originate mode (if a handset-off-hook condition is detected). If the data terminal is ready, the detection of the ring creates an answer phone signal to the DAA. A mode-signal output from the 6860 is used to control the switchable filters to ensure that the correct set of signal pairs are used. A clear-to-send (CTS) signal is also created to indicate to the terminal or computer the establishment of a communication link.

Constructing the Modem

Figure 1 shows the schematic diagram for the modem. The signals from the terminal or computer to and from the modem are first converted from RS-232C levels to TTL levels by the 1488 and 1489A integrated circuits. The request-to-send (RTS) signal is not used by the 6860, but is used by the support circuitry to control pulse dialing and setting the answer/originate mode. The 1458 dual operational amplifier is used to convert the TTL-level mode signal, as possibly modified by the test/normal switch, to a +12 V or -12 V signal sent to switch the filters between originate and answer. The 301A operational amplifier is used to limit the received signal. The 3.9 V zener diode causes the output of the operational amplifier to be TTL compatible and the TTL gate helps square up the limited signal. The 200 k-ohm variable resistor on the CH1262 is used to set the transmit level to 0 dBm (ie: 1 mW at 600 ohms or 0.7 V RMS).

If the modem is powered up with the ready-to-send line active (ie: at +5 V to +12 V), the modem is in originate mode and the answer-phone signal from the 6860 commands the DAA telephone interface to take the phone line off hook. The telephone may then be dialed by pulsing the ready-to-send line off and on under software control. An assembly-language program for an 8080 to do automatic dialing is shown in listing 1.

If the modem is powered up and the ready-to-send line is off (ie: -5 V to -12 V), the modem will wait for a ring indication from the DAA

Text continued on page 34



Eliminate The Data Comm Hassles of Outmoded "DUMB" Modems

BIZCOMP's Intelligent Modem is new. Brand new. It teams a Bell 103-type "dumb" modem with a custom BIZ-080 microcomputer in an attractive desk-top enclosure. RESULT: Incredibly simple data comm for professional users. No more mad dash to get a handset into coupler muffs before being disconnected by the remote. No more exclusion-key telephone needed to do the dialing. No more outboard coupler boxes. And for computer sites, communications software written in high level language like BASIC or COBOL. How's that for simplicity!

The 1030 gives you automatic dial, automatic answer and, unique to the industry, automatic REPEAT dial. The top-of-the-line 1031 adds command-selectable tone or dial pulse dialing for TWX net applications and self-test for ensuring full functionality. Both models are FCC registered for direct connection and feature comm rates from 110, 134.5, 150, 200 to 300 baud. BIZCOMP's innovative Code-Multiplexed Design enables complete control using a simple 3-wire RS-232 interface. Don't burden your customers with data comm hassles. Install a BIZCOMP Intelligent Modem today.

BIZCOMP Communications...
Why not start with the best?

BIZCOMP

P.O. Box 7498 • Menlo Park CA 94025 • 415/854-5434

Suggested prices from \$395.00

Patent Pending

Meet two new Printers from Anadex:

Revolutionary!

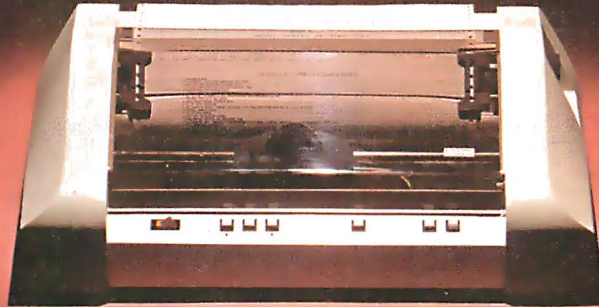

Introducing two totally new line printers from Anadex - Models DP-9500 and DP-9501 - offering 132/158/176 and 132/165/198/220 columns, respectively, and featuring true high-density graphics under direct control of the data source.

Both models employ a rugged, Anadex-built 9-wire print head life-tested to 650 million characters. Combining long life with high resolution, this new head provides dot resolutions of 72 dots/inch vertical and up to 75 dots/inch horizontal.

The full standard ASCII 96 character set, including descenders and underlining of all upper and lower case letters, is printed bi-directionally on the original and up to 5 crisp copies at speeds up to 200 CPS. Print densities are switch- or data-source selectable from 10 up to 16.7 characters/inch, and all can be printed double-width by communications command.

The three ASCII compatible interfaces (parallel, RS-232-C, and Current Loop) are standard in both models; so interfacing is usually a matter of "plug it in and print." Also standard is a sophisticated communications interface providing control of Vertical Spacing (6 or 8 lines/inch), Form Length and Width, Skip-Over Perforation, Auto Line Feed, and full point-to-point communications capability.

Other standard features are: forms width adjustment from 1.75 to 15.6 inches, shortest-distance sensing logic, self-test, quick-change ribbon cartridge with 6 million character life, and a 600 character FIFO buffer. (An additional 2048 character plug-in buffer is optional).

For complete details, quantity discounts and a demonstration, contact Anadex today.



Number	Type	+ 5 V	GND	- 12 V	+ 12 V
IC1	1488		7	1	14
IC2	1489A	14	7		
IC3	6860	12	1		
IC4	7407	14	7		
IC5	LM301			4	7
IC6	1458	14	7	4	8
IC7	7486	14	7		
IC8	7404	14	7		
IC9	7400	14			
IC10	CH1262		5	13	12
IC11	CH1267		18	9	7

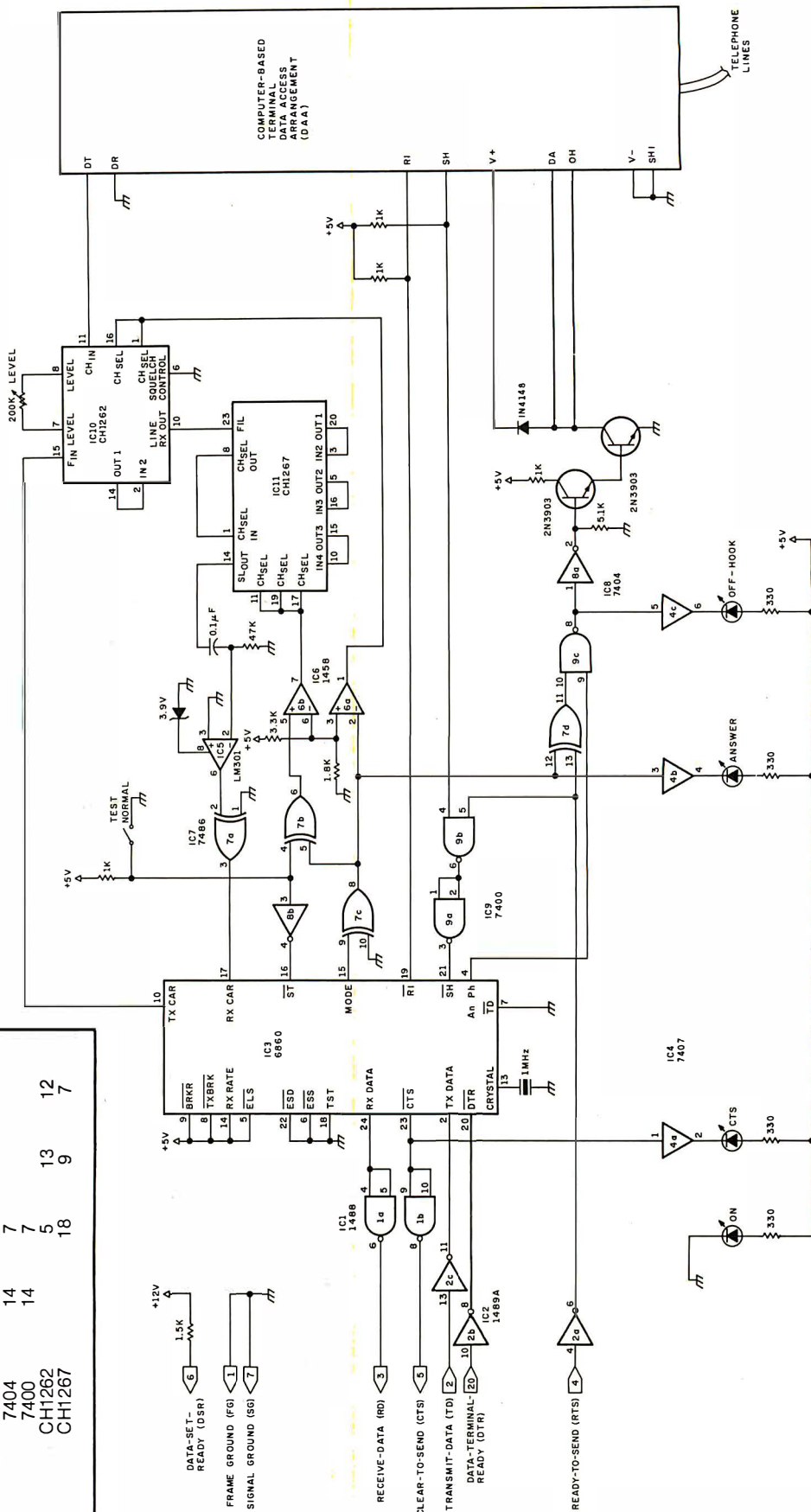

Figure 1: Schematic diagram of the answer/originate modem. IC1 and IC2 convert the modem RS-232C signal to a digital transistor-or-transistor logic (TTL) level and back. IC3 is the Motorola 6860 modem integrated circuit. IC10 and IC11 are the transmit and receive filters, respectively, used to interface the modem and the telephone line.

There are two sides to our story.

Side One

The DISCUS™ 2+2 Quad-Density Hardware

Now you can use your S-100 system to tackle big jobs. Because the DISCUS™ 2+2 Quad-Density Disk System puts 1.2 megabytes of fast-access memory on your side for just \$1545.00 complete.

With the DISCUS™ 2+2 System, complete means complete.

You get a full-size (IBM-compatible 8") double-sided/double-density disk drive,

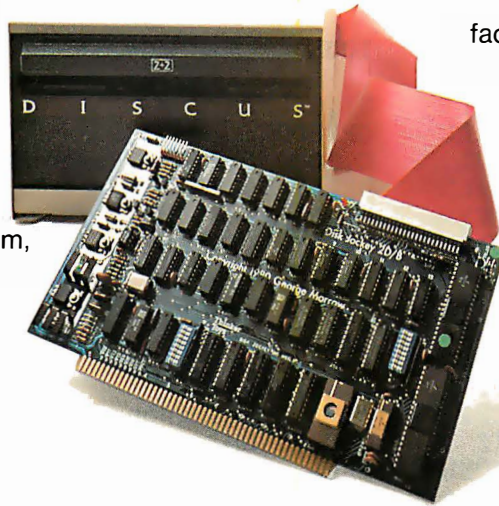

factory mounted in a cabinet with power supply, fully-buffered S-100 single-board controller, and inter-connecting cables. All fully assembled, system-tested and fully warranted.

You get the speed and efficiency of 1.2 megabyte-per-diskette memory... and you get it for 0.13¢ per byte.

Side Two

The DISCUS™ 2+2 Quad-Density Software

1.2 megabyte quad-density hardware is only one side of the story. The DISCUS™ 2+2 System price includes all the fully-interfaced, high-performance software you need to take full advantage of your quad capacity.

The system includes our exclusive BASIC-V™ virtual disk BASIC, which allows you to address your quad-density diskettes as easily as main memory. The operating system you get is the widely accepted CP/M* 2.1. And you get our powerful DISK-ATE text editor/assembler; The most advanced software



development tool available.

Micro-Soft BASIC 5.1 and Micro-Soft FORTRAN are available as options. Both run under CP/M* 2.1.

Check out the full system price of DISCUS™ 2+2 Quad against any other floppy disk system at your local computer store. At \$1545.00, we think you'll take sides with DISCUS™ 2+2.

If your dealer doesn't carry THINKER TOYS products, write MORROW DESIGNS Inc., 5221 Central, Richmond, CA 94804. Or call (415)524-2101 9-5 weekdays (Pacific Time).

MORROW DESIGNS™ / Thinker Toys™

Listing 1: DIAL routine to perform automatic dialing by the computer. This listing, which is designed to run as part of a CP/M-based 8080 or Z80 system, performs automatic dialing of a telephone number with the command DIAL <phone number>. If a modem answers, this program causes its computer to act as a "dumb" terminal for the computer connected to the answering modem.

```

; Auto-dial program
; Syntax: DIAL <phone-number>[:<signon-character>]
;   <signon-character> sent when CTS is asserted.
;
0005 =   BDOS   EQU    5      ;BDOS entry point
E00C =   TERM   EQU   0E00CH ;Terminal simulation subroutine
0020 =   SCTS   EQU    32     ;serial CTS
0010 =   SRTS   EQU    16     ;serial RTS
00F8 =   SERST  EQU   0F8H   ;serial status port
;
0100          ORG    100H
;
0100 31FFCB   START: LXI    SP,0CBFFH
0103 CDA101   CALL   OFFHOOK
0106 0E64     MVI    C,100    ;wait 2 seconds for dialtone
0108 CD5C01   CALL   DELAY
010B 0E64     MVI    C,100
010D CD5C01   CALL   DELAY
0110 218100   LXI    H,81H    ;use default buffer area
0113 7E       NEXT:  MOV    A,M      ;get digit
0114 23       INX    H
0115 B7       ORA    A
0116 CA3301   JZ     TERMINAL
0119 FE3A     CPI    ':'      ;signon-character?
011B CA2901   JZ     GETSIGNON
011E F5       PUSH  PSW
011F CD5301   CALL  SOUT    ;echo number
0122 F1       POP   PSW
0123 CD6A01   CALL  DIGIT
0126 C31301   JMP   NEXT
;
GETSIGNON:
0129 7E       MOV    A,M
012A B7       ORA    A
012B C23001   JNZ   NOTCR
012E 3E0D     MVI    A,13    ;CR if character zero
NOTCR:
0130 32AC01   STA   SIGNON
;
TERMINAL:
0133 DBF8     IN     SERST
0135 E620     ANI   SCTS
0137 C23301   JNZ   TERMINAL ;wait for clear-to-send
013A CD4A01   CALL  SETIO  ;set I/O parameters for serial port
013D 3AAC01   LDA   SIGNON
0140 B7       ORA    A
0141 C45301   CNZ   SOUT
0144 CD0CE0   TRANS: CALL  TERM
0147 C34401   JMP   TRANS
;
014A 3E01     SETIO: MVI    A,1    ;set Sol/SOLOS I/O parameters serial
C806 =       IPORT: EQU   0C806H
C807 =       OPORT: EQU   0C807H
014C 3206C8   STA   IPORT
014F 3207C8   STA   OPORT
0152 C9       RET

```

Listing 1 continued on page 32

"Our inventory is our existence. Think we'd trust it to anything less than Scotch® Brand Diskettes?"

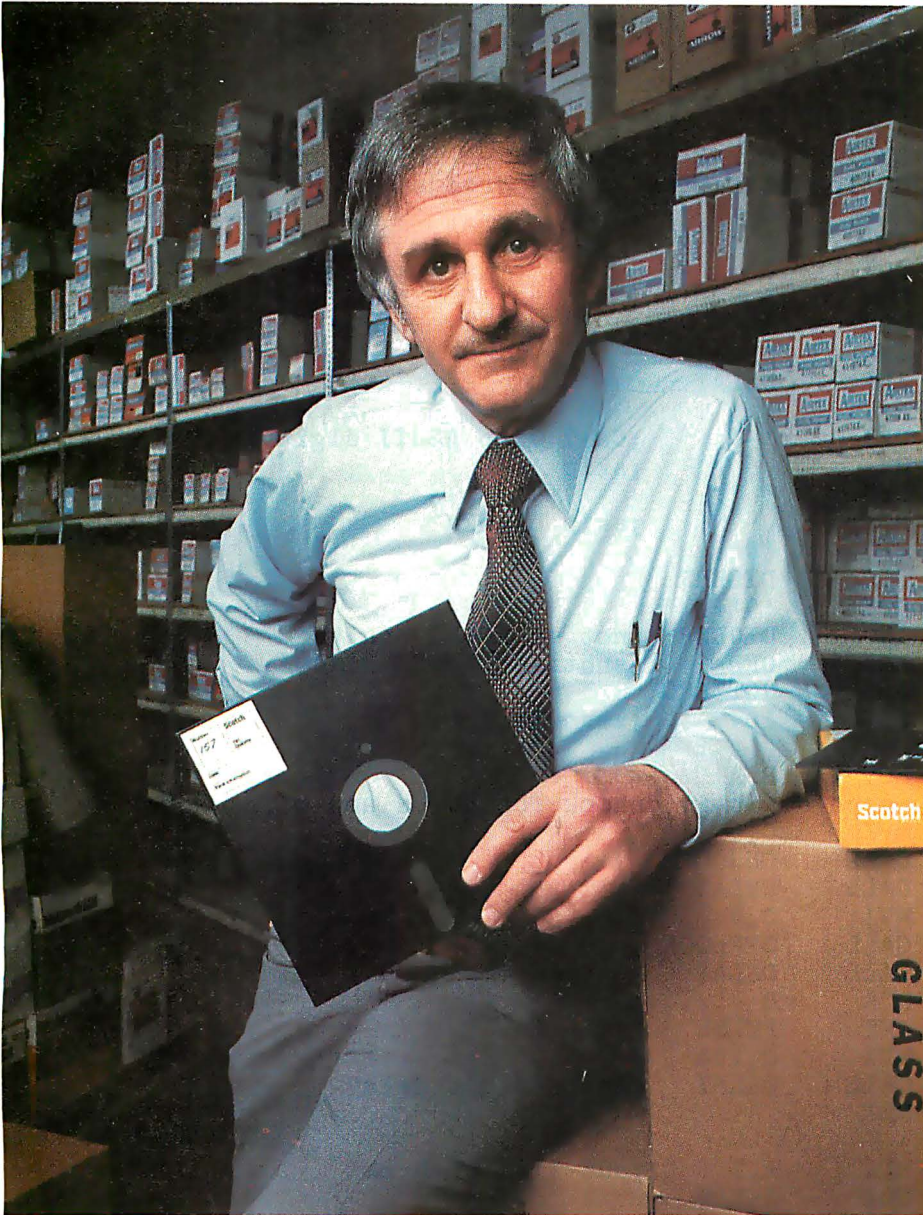

Don Stone, President,
Mass. Auto Supply Company,
Inc., Boston, Mass.

Scotch Diskettes are the diskettes you can depend upon with the information *your* business depends upon.

Each one is tested and certified error-free before it leaves our factory. Because we know nothing less than perfection is acceptable for *your* vital business data.

Scotch Diskettes are available in regular or mini sizes, compatible with almost any system.

To find out where you can purchase Scotch Diskettes, call toll free: 800-328-1300. (In Minnesota, call collect: 612-736-9625.) Ask for the Data Recording Products Division. In Canada, write 3M Canada Inc., London, Ontario, N6A 4T1.

If it's worth remembering,
it's worth Scotch
Data Recording Products.



3M

Listing 1 continued:

```

;
0153 5F      SOUT:  MOV     E,A      ;write character to console
0154 0E02    MVI     C,2
0156 E5      PUSH    H
0157 CD0500  CALL   BDOS
015A E1      POP     H
015B C9      RET

;
015C 115403  DELAY: LXI     D,852    ; .01 times (C) seconds
;Adjust DE for different clock periods
015F 0D      DCR     C
0160 F8      RM
0161 1B      DELA1: DCX     D
0162 7A      MOV     A,D
0163 B3      ORA     E
0164 C26101  JNZ    DELA1
0167 C35C01  JMP    DELAY

;
016A FE2D    DIGIT: CPI     '-'      ;Call with ASCII digit in A
016C C8      RZ          ;skip '-'
016D FE20    CPI     ' '
016F C8      RZ          ;skip blanks
0170 FE30    CPI     '0'
0172 DAA601  JC      DIGERR
0175 FE3A    CPI     '9'+1
0177 D2A601  JNC    DIGERR ;not an ASCII digit
017A E60F    ANI    OFH  ;subtract ASCII Bias
017C C28101  JNZ    NOTZERO
017F C60A    ADI    10   ;zero is ten

NOTZERO:
0181 47      MOV     B,A
PULSE: ;each digit is onhook for 60 ms and offhook for 40 ms
0182 0E06    MVI     C,6
0184 CD9C01  CALL   ONHOOK
0187 CD5C01  CALL   DELAY
018A 0E04    MVI     C,4
018C CDA101  CALL   OFFHOOK
018F CD5C01  CALL   DELAY
0192 05      DCR     B
0193 C28201  JNZ    PULSE
0196 0E64    MVI     C,100
0198 CD5C01  CALL   DELAY ;inter-digit delay
019B C9      RET

;
019C 3E00    ONHOOK: MVI     A,0      ;put line on-hook
019E D3F8    OUT    SERST
01A0 C9      RET

;
OFFHOOK: ;take line off-hook
01A1 3E10    MVI     A,SRTS
01A3 D3F8    OUT    SERST
01A5 C9      RET

;
DIGERR: ;not a digit - go on-hook and reboot
01A6 CD9C01  CALL   ONHOOK
01A9 C30000  JMP    0      ;boot

;
01AC 00      SIGNON DB     0      ;store for sign-on character

```

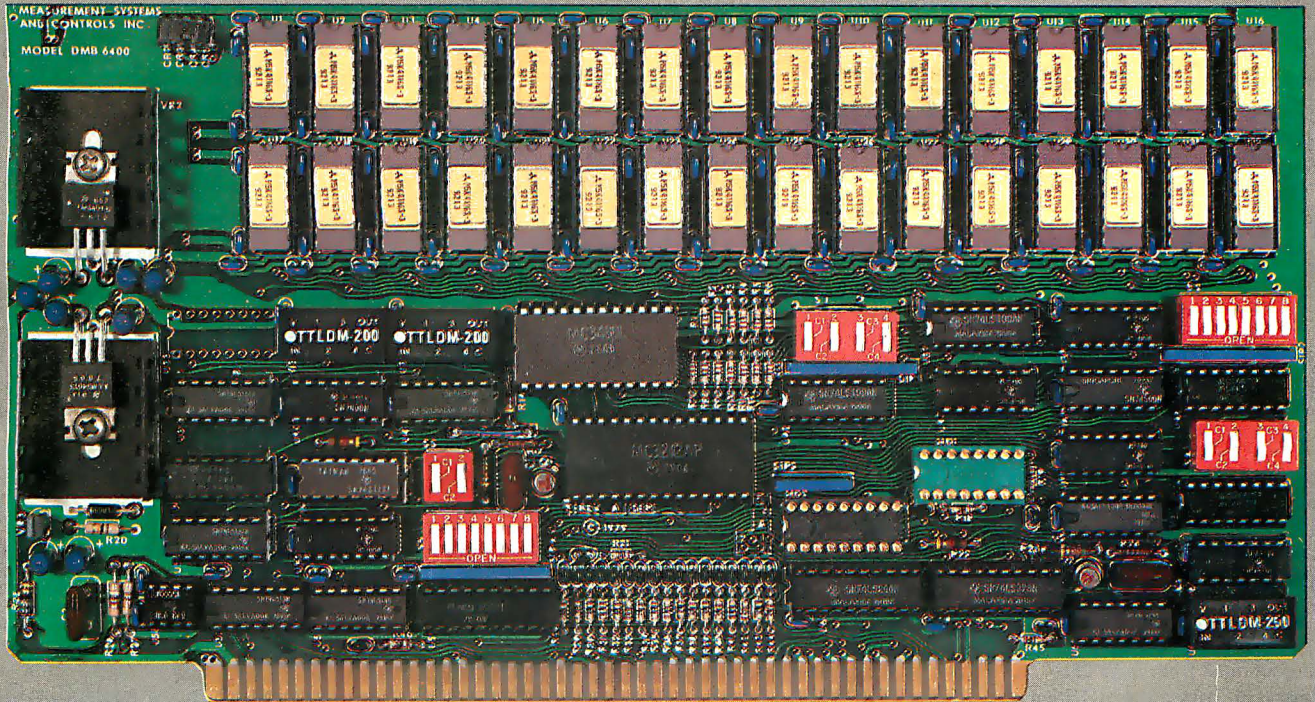

BANK SELECT — 64K BYTE EXPANDABLE MEMORY BOARD

MODEL DMB6400 SERIES
FULLY COMPATIBLE WITH:

**ALPHA MICRO
 CROMEMCO
 NORTH STAR
 MP/M**

and most other
 S-100 systems

- Four independent, 16K software selectable banks.
- Switch selectable bank sizes — from 16K to 64K in 16K increments.
- Eight banks (512K) per I/O port for each of the 256 ports.
- Z-80 4MHz operation with no wait states.
- Low power — 8 watts maximum.
- Reliable, tested and burned-in memory.
- **ONE YEAR GUARANTEE**
- IEEE S-100 compatible timing.
- Attractive Dealer & OEM Prices

MEASUREMENT
 systems & controls
 incorporated

867 North Main Street • Orange, CA 92668
 Telephone: 714/633-4460

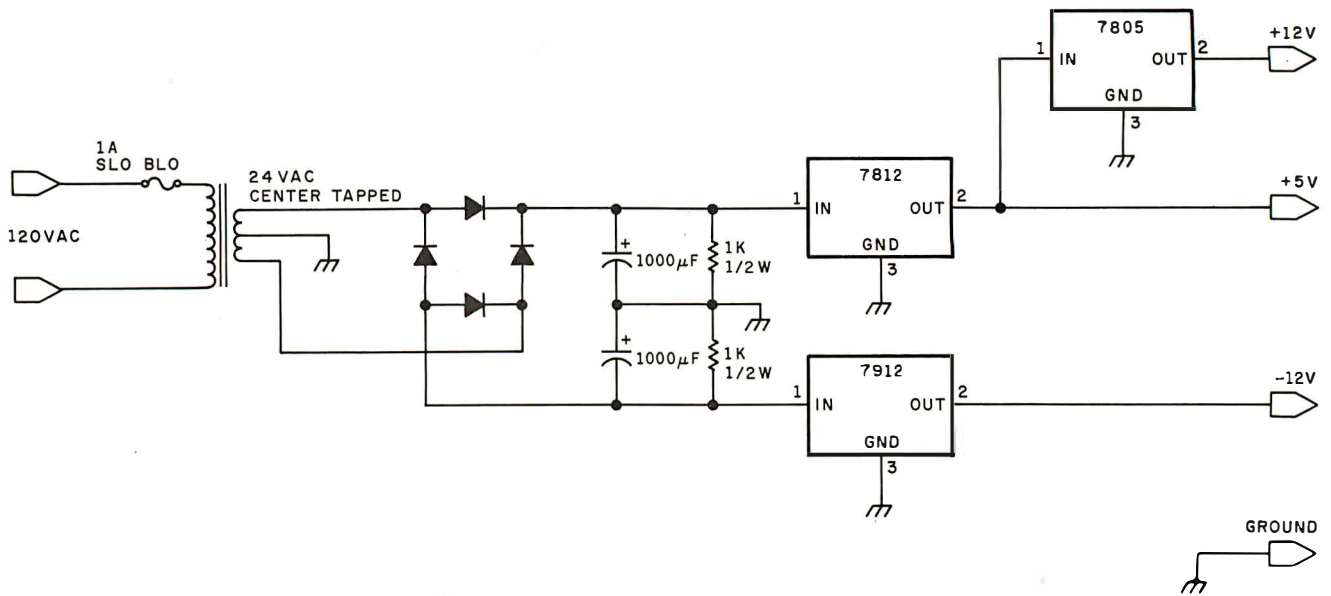

Figure 2: Schematic diagram of the optional power supply. This regulated power supply can be eliminated if the required voltages are available from a nearby computer or terminal.

Text continued from page 26:

telephone interface. On receipt of the ring, the 6860 will bring the answerphone line high and begin sending the transmit carrier, which is at 2225 Hz. If the modem on the other end of the

line responds with its carrier, which is at 1270 Hz, the 6860 will turn clear-to-send on about a half second later. The terminal or computer can detect this and initiate whatever procedure is necessary to communicate with the

originator.

Figure 1 shows four light-emitting diodes (LEDs) that can be used by the operator to monitor the operation of the modem. The functions displayed are power-on, clear-to-send, mode (with the LED on in answer mode), and off-hook.

A power-supply schematic is shown in figure 2; it supplies +5 V, +12 V, and -12 V, regulated. These voltages may be obtained from the terminal or computer if they are available. I chose to make the modem an independent device: it was wire-wrapped on a small perforated board and enclosed in a cabinet.

Modem Software

Listing 1 shows a CP/M-based, assembly-language program for an 8080 processor to perform automatic dialing to an answer modem and to initiate communication. The CP/M syntax of the program is:

```
DIAL <phone number>
```

or

```
DIAL <phone number>:
    <logon character>
```

The phone number may contain blanks and hyphens that are ignored. If an invalid character is found in the phone number, the program hangs up the telephone and reboots.

Text continued on page 40

The
Self-Indexing
Query System

WHAT'SIT?

Wow! How'd All That Stuff get In There?



**COMPUTER
HEADWARE**

BOX 14694
SAN FRANCISCO 94114

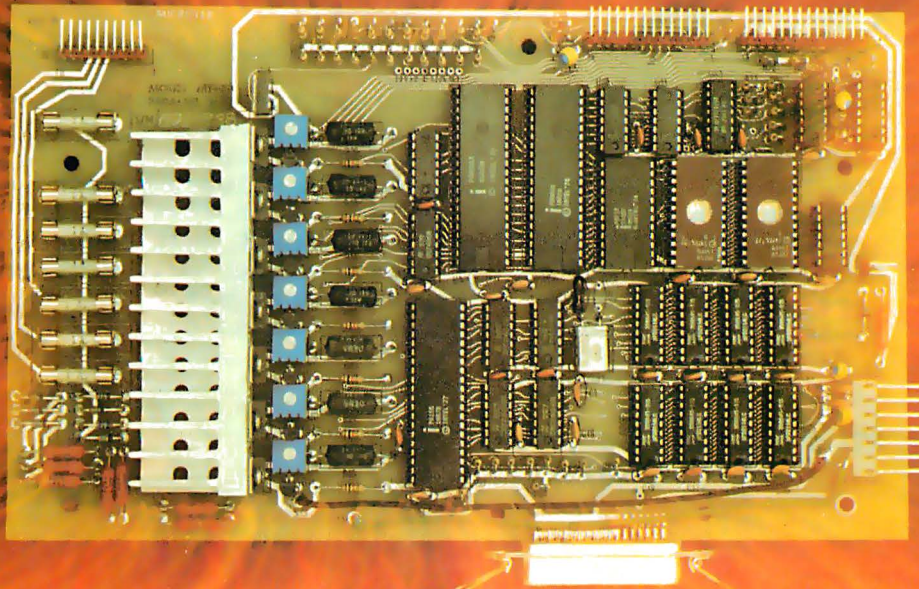

IT'S THE THOUGHT THAT COUNTS

The Microtek MT-80 *looks* like a few other alphanumeric line printers on the market today. But there *is* a difference.

Our versatile, low-cost MT-80 has been designed with a more powerful brain resulting in more advanced features and more dependable performance. We believe our printer is so reliable that we offer you an incredible 365 days warranty.

If you want dependable performance, fast factory service and a low price, look for the Microtek label. The brain behind our printer really makes the difference. It's the thought that counts.

LOADED WITH INNOVATIONS

- 40, 80 or 120 columns (software selectable)
- Non-thermal paper, pin feed
- 125 CPS, 70 lines per minute
- 9 x 7 dot matrix
- Vertical format unit
- 96-character ASCII (upper and lower case)
- Adjustable forms width to 9½"
- Parallel and serial (RS-232C) interfaces available

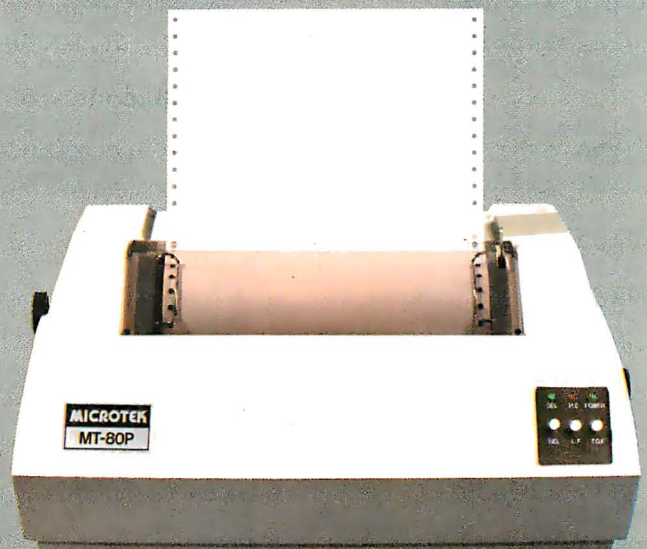

MICROTEK

For more information contact:

MICROTEK, Inc.
9514 Chesapeake Drive
San Diego, CA 92123
Tel. (714) 278-0633

Listing 2: Remote-access computer routine. This is the software needed by the computer that is connected to the answering modem of figure 1. This routine allows its computer to be controlled by a remote terminal, with the connections made by two modems and a telephone line. This routine runs on a CP/M system.

```

; Remote Access to CP/M
;   using a Sol and SOLOS
;
BFEO =      IOCODE EQU      0BFEOH ;Temporary storage for I/O code
C01C =      AOUT  EQU      0C01CH ;Write to logical output unit (A)
C022 =      AINP  EQU      0C022H ;Read logical input unit (A)
C800 =      UIPRT EQU      0C800H ;User defined input routine address
C802 =      UOPRT EQU      0C802H ;User defined output routine address
C806 =      IPORT EQU      0C806H ;Standard input unit number
C807 =      OPORT EQU      0C807H ;Standard output unit number
00F8 =      SERST EQU      0F8H   ;Serial status port
00D4 =      DCCMD EQU      0D4H   ;Tarbell command port

;
0100      ORG      100H

;
0100 31FFCB  START  LXI      SP,0CBFFH
0103 3E00      MVI      A,0
0105 D3F8      OUT      SERST ;set modem for answer - RTS off
0107 3E06      MVI      A,6   ;turn disk motor off
0109 D3D4      OUT      DCCMD
010B DBF8      NOTCTS  IN      SERST ;CTS?
010D E620      ANI      20H   ;wait for modem to answer and get response
010F C20B01    JNZ      NOTCTS ;no
0112 3E05      MVI      A,5   ;turn disk motor on
0114 D3D4      OUT      DCCMD
0116 CD4001    CALL     DELAY  ;wait one second
0119 3E03      MVI      A,3   ;set up SOLOS for
;   user defined I/O routines

011B 3206C8    STA      IPORT
011E 3207C8    STA      OPORT
0121 21E0BF    LXI      H,IOCODE ;store user defined I/O addresses
0124 2202C8    SHLD     UOPRT
0127 21EBBF    LXI      H,IOCODE+XIPRT-XOPRT
012A 2200C8    SHLD     UIPRT

; Transfer I/O code to IOCODE
012D 21E0BF    LXI      H,IOCODE
0130 0E11      MVI      C,XEND-XOPRT
0132 114A01    LXI      D,XOPRT

TRANLOOP:
0135 1A        LDAX     D
0136 77        MOV      M,A
0137 0D        DCR      C
0138 23        INX      H
0139 13        INX      D
013A C23501    JNZ      TRANLOOP
013D C30000    JMP      0 ;boot

;
0140 =        DELAY  EQU      $
0140 110000    LXI      D,0
0143 1B        DLOP1  DCX      D
0144 7A        MOV      A,D
0145 B3        ORA      E
0146 C24301    JNZ      DLOP1
0149 C9        RET

;
;Relocatable user defined I/O routines
;
;Output routine - output to serial and screen
014A 3E01      XOPRT  MVI      A,1
014C CD1CC0    CALL     AOUT  ;put on serial
014F 3E00      MVI      A,0

```

Listing 2 continued on page 38

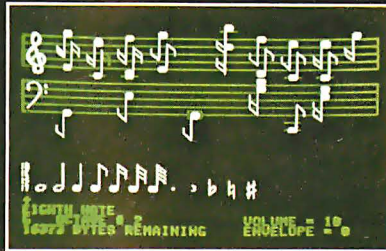
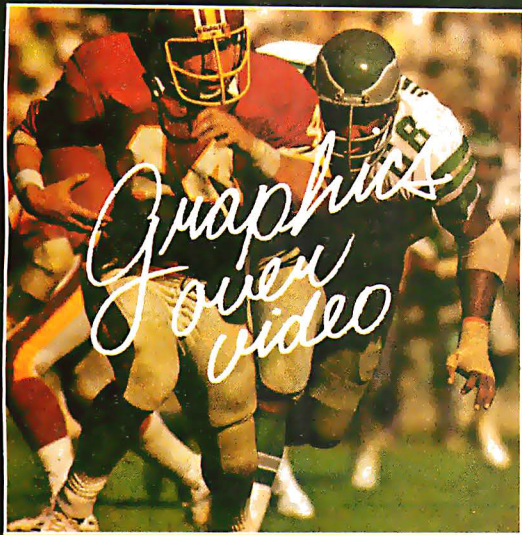

APPLE POWER

VIDEO DATA PROCESSOR

Called the VDP, comes complete with 16K memory, its own color text and graphics generator and is designed to superimpose its graphics and text over incoming video signals from video tape, video disk, TV camera, Apple Video or Broadcast • Color text and graphics on an independent screen • Video titling or video interactive training uses. It's like your own TV station, works with OUR Light Pen too! Available directly from Symtec at \$1500.00.

SPECIAL PROBLEMS

We can help. Symtec does custom engineering, fabrication, hardware and software design for microprocessor. Beginning at \$1500, these services can solve your custom application needs for industrial, scientific, medical, engineering or personal uses.

SUPER SOUND GENERATOR

Apple Music Power with a plus • 3 voices, 6 in stereo version • Noise generator • Independent control of volume, envelope and shape by channel • Full power, easy to use software to compose, edit, play in hi-res graphics, PLUS, input and output ports allow extra uses: • Printer interface • Remote ASCII or music keyboard interface • and, optional BSR X-10 Adapter is available. Suggested retail \$159.95 mono, \$259.95 stereo.

SYMTEC X-10 CONTROL

Now for the Apple II, a low cost control to link your computer to the BSR X-10 Home Control System. Control your home or office lighting and appliances • Energy management • Display lighting Security and more. Suggested retail \$49.95.

LIGHT PEN

A professional quality, full feature light pen for the Apple II Computer • Hi-resolution — draw on the screen • X, Y and sensitivity adjustments — fits any standard TV • Sync adjustment for remote video source • Touch switch sets interface flag • Rugged metal case • Recommended by Apple. Complete, ready to go, the Symtec Light Pen is provided with software and documentation in Basic, Applesoft and machine code. Muse's Pilot II Language using the Symtec Light Pen is also available. The Light Pen is useable for graphics, games, education, exhibits, freedom from the keyboard. Suggested retail \$249.95.

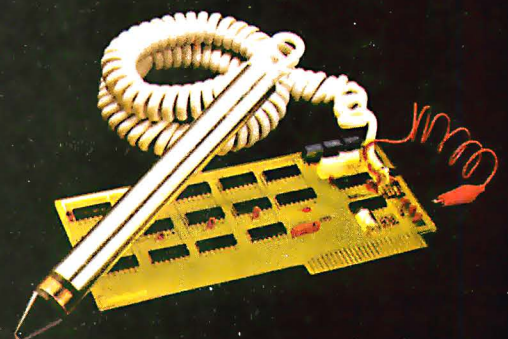

See your Apple Dealer for a demonstration of the Symtec Light Pen, Supersound Generator or Symtec Apple X-10 Control. Other products and services are available directly from Symtec. Apple is a trade mark of Apple Computer Inc. BSR System X-10 is a trade mark of BSR Ltd. Muse is the trade mark of Micro Users Software Exchange, Inc.

Listing 2 continued:

```
0151 CD1CC0          CALL    AOUT    ;put on screen
0154 C9              RET
;
;Input routine - input from serial port
0155 3E01          XIPRT  MVI     A,1
0157 CD22C0          CALL    AINP    ;get serial
015A C9              RET
;
015B 00            XEND:   DB     0
;
```

Listing 3: Remote-user routine. This routine allows a remote user to communicate with the operator of the host computer tied to the answering modem.

```
; Write to operator
;Syntax: WTO <message text>
0100                ORG     100H
0100 210000          LXI     H,0
0103 2B             BELOOP: DCX     H
0104 7D             MOV     A,L
0105 B4             ORA     H
0106 D3FC           OUT     OFCH   ;sound alarm port
0108 C20301          JNZ     BELOOP
010B C9             RET         ;return to CP/M
;
```

Listing 4: Remote-user routine. This routine allows a remote user to communicate with the host computer's operator; it also allows the operator to send a reply to the remote terminal.

```
; Write to operator with reply
;Syntax: WTOR <message text>
;
0100                ORG     100H
;
C019 =              SOUT    EQU    0C019H
C01C =              AOUT    EQU    0C01CH
C022 =              AINP    EQU    0C022H
;
0100 210000          START:  LXI     H,0
BELOOP:
0103 2B             DCX     H
0104 7D             MOV     A,L
0105 B4             ORA     H
0106 D3FC           OUT     OFCH   ;sound alarm port
0108 C20301          JNZ     BELOOP
REPLOOP:
010B 3E00           MVI     A,0
010D CD22C0          CALL    AINP    ;get keyboard character
0110 CA0B01          JZ     REPLOOP
0113 FE0D           CPI     13     ;done?
0115 C8             RZ         ;return to CP/M
0116 47             MOV     B,A
0117 CD19C0          CALL    SOUT    ;send to standard output port
; may be user defined port
; such as serial and display
011A C30B01          JMP     REPLOOP
;
```

SUPER BRAIN QD™

Once in a great while someone comes along with a simple improvement for an already great product. Take our SuperBrain, for example. Really a simple concept. A high-powered, low cost micro-computer packaged in an attractive desk top cabinet. So how do you improve on that?

WE DID IT...

It wasn't enough that our SuperBrain had such standard features as twin double density 5¼" drives with over 300,000 bytes of disk storage. A full 32K of dynamic RAM - expandable to 64K in seconds. A CP/M* Disk Operating System which assures compatibility to literally hundreds of application packages presently available. A crisp, 12" non-glare screen with a full 24 line by 80 column display. A full ASCII keyboard with a separate keypad and individual cursor control keys. Twin RS232C serial ports for fast and easy connection to a modem and/or a printer. And, dual Z80 processors which operate at 4 MHz to insure lightning-fast program execution. No, it wasn't enough. So we made it better.

ANNOUNCING SUPERBRAIN QD...

Our new QD model has all of the features of our phenomenally popular SuperBrain with the addition of double-sided disk drives and an extra 32K of dynamic RAM. So, for only a modest increase in price, you can order your next SuperBrain with more than twice the disk and memory storage capability. But, best of all, the new QD model has the same tough, rugged construction and exceptional quality that made our SuperBrain such a success.

HOW DID WE DO IT?

The secret of SuperBrain QD's incredible disk storage lies within our new double-density double-sided disk drives. A total of nearly 720,000 bytes of data are formatted on two specially designed 5¼" drives. And that's more than enough to get you started with most serious small business applications. And SuperBrain QD's standard 64K of dynamic RAM will handle even the most complicated programming tasks.

Of course, if you're into megabytes instead of kilobytes, you may think neither SuperBrain is right for you. Not so! Intertec offers 20-96 megabytes of hard-disk storage which connects in seconds to either the SuperBrain or SuperBrain QD. So, your original investment is always protected. As you grow. No matter how much you needs expand.

BUT IS IT RELIABLE?

Our best salesmen are our present users. Not only have SuperBrain users been impressed with the inherent reliability of the system, they tell us that no other microcomputer system available today offers such a unique modular design concept. Just about the only tool required to easily

maintain the system is a common screwdriver. And Intertec's total commitment to product service and customer support, with service outlets in most major cities, insures your original investment will be a valuable one for many years to come.

THE DECISION IS YOURS.

Whether your next SuperBrain is a regular model or our QD version, you will have the satisfaction of knowing you purchased what is becoming one of the world's most popular micro-computer systems. And regardless of which model you choose, you'll probably never outgrow it because you can keep expanding it.

So, call or write us today for more information. Intertec systems are distributed worldwide and may be available in your area now.

Circle 23 on inquiry card.



2300 Broad River Rd., Columbia, SC 29210
(803) 798-9100 TWX: 810-666-2115

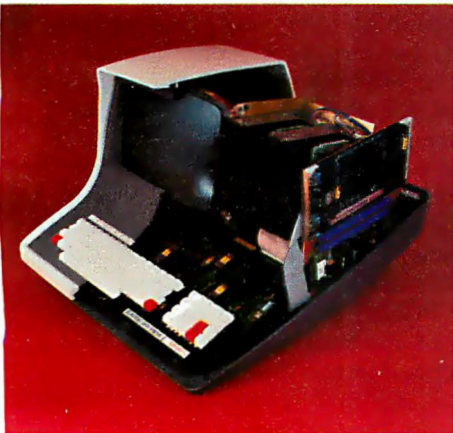

ENTREPRENEURS NEEDED

MORE THAN EVER IN THE MICRO-COMPUTER INDUSTRY.

The shortage of knowledgeable dealers/distributors is the #1 problem of microcomputer manufacturers. Over 300 new systems houses will go into business this year, but the number falls short of the 1200 needed. It is estimated that the nationwide shortage of consultants will be over 3000 by 1981. The HOW TO manuals by Essex Publishing are your best guide to start participating in the continued microcomputer boom.

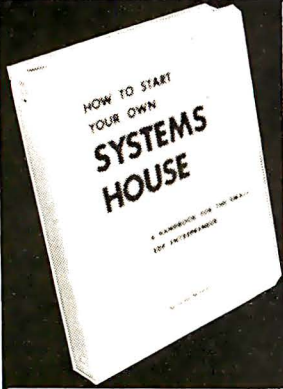

\$36. No. 10

Documentation • Solutions to the Service Problem • How to Write a Good Business Plan • Raising Capital

HOW TO START YOUR OWN SYSTEMS HOUSE

6th edition, March 1980

Written by the founder of a successful systems house, this fact-filled 220-page manual covers virtually all aspects of starting and operating a small systems company. It is abundant with useful, real-life samples: contracts, proposals, agreements and a complete business plan are included in full, and may be used immediately by the reader.

Proven, field-tested solutions to the many problems facing the small systems house are presented.

From the contents:

- New Generation of Systems Houses
- The SBC Marketplace
- Marketing Strategies
- Vertical Markets & IAPs
- Competitive Position/Plans of Major Vendors
- Market Segment Selection & Evaluation
- Selection of Equipment & Manufacturer
- Make or Buy Decision
- Becoming a Distributor
- Getting Your Advertising Dollar's Worth
- Your Salesmen: Where to Find Them
- Product Pricing
- The Selling Cycle
- Handling the 12 Most Frequent Objections Raised by Prospects
- Financing for the Customer
- Leasing
- Questions You Will Have to Answer Before the Prospect Buys
- Producing the System
- Installation, Acceptance, Collection

HOW TO BECOME A SUCCESSFUL COMPUTER CONSULTANT

by Leslie Nelson, May 1980

Independent consultants are becoming a vitally important factor in the microcomputer field, filling the gap between the computer vendors and commercial/industrial users. The rewards of the consultant can be high: freedom, more satisfying work and doubled or tripled income. **HOW TO BECOME A SUCCESSFUL COMPUTER CONSULTANT** provides comprehensive background information and step-by-step directions for those interested to explore this lucrative field:

- Established consulting markets
- How to get started
- Itemized start-up costs
- Are you qualified?
- Beginning on a part-time basis
- The Marketing Kit
- Should you advertise?
- Five marketing tips
- Getting free publicity
- How much to charge
- When do you need a contract?
- Sample proposals
- Which jobs should be declined
- Future markets
- The way to real big money
- Avoiding the legal pitfalls
- How consultants' associations can help you
- The National Register of Computer Consultants
- How others did it: real-life sample cases
- and much more.

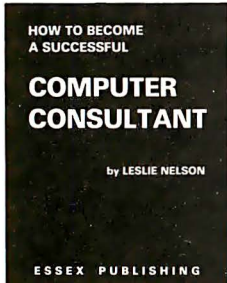

\$28. No. 16

pitfalls • How consultants' associations can help you • The National Register of Computer Consultants • How others did it: real-life sample cases • and much more.

FREE-LANCE SOFTWARE MARKETING

3rd edition, June 1980

Writing and selling computer programs as an independent is a business where • you can get started quickly, with little capital investment • you can do it full time or part time • the potential profits are almost limitless. Since the demand for computer software of all kinds is growing at an explosive rate, the conditions for the small entrepreneur are outstanding.

This manual will show you how to sell your own computer programs using these proven techniques: • direct to industries • through consulting firms • through manufacturers of computer hardware • in book form • mail order • through computer stores. It will show you how to profitably sell and license all types of software ranging from sophisticated analytical programs selling for thousands of dollars, down to simple accounting routines and games for personal computers.

The book will guide you step by step through the process of marketing, advertising, negotiating a contract, installing software, training users and providing maintenance and support. It also contains sample software contracts that have been used in actual software transactions. Also included are tips on how to negotiate with a large corporation, ways of avoiding personal liability, techniques for obtaining free computer time and hints on how to run a free-lance software business while holding a full-time job.

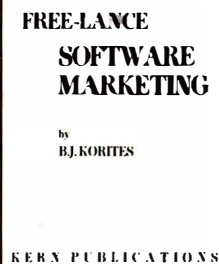

\$30. No. 32

training users and providing maintenance and support. It also contains sample software contracts that have been used in actual software transactions. Also included are tips on how to negotiate with a large corporation, ways of avoiding personal liability, techniques for obtaining free computer time and hints on how to run a free-lance software business while holding a full-time job.

ESSEX PUBLISHING CO. Dept. 2

285 Bloomfield Avenue • Caldwell, N.J. 07006

Order books by number. Send check, money order (U.S.\$), VISA or Master Charge #. Publisher pays 4th class shipping. For rush Air Mail shipping add \$2.50 per book in USA and Canada, \$5.00 in Europe, \$8.00 elsewhere. N.J. residents add 5% sales tax.

No. 10 No. 16 NO. 32 Check enclosed Credit card

Name _____

Address _____

City _____ State _____ Zip _____

Card # _____ Exp. _____

For immediate shipment on credit card orders call (201) 783-6940 between 9 and 5 Eastern time.

Text continued from page 34:

CP/M. If a colon follows the phone number, the next character is sent in ASCII form to the answering modem after the clear-to-send signal is received from the answering modem. Such a logon character is often required by timesharing services. After communication is established and any logon character is sent, the program calls a terminal-simulation subroutine (TERM) that will listen for a character which was the serial line, display it on the CP/M display, and send a character of input to the CP/M console. The serial status port and bit configuration is that of a Processor Technology Sol. The subroutine SETIO must configure CP/M to send output to the serial port and receive input from the serial port. The subroutine shown is also for the Sol.

Listing 2 shows a program that will configure the operating system to be remotely accessed. The program, after starting, will wait for the telephone to ring and the modem to answer. If the caller is an originating modem, the program will configure CP/M to use the terminal on the other end of the telephone line as the display console. All data output to the remote terminal and input to CP/M from the remote terminal is echoed to the local display.

Listings 3 and 4 show small programs that can be used by the remote user to communicate with the local operator. The programs can be used only to send a message or to send a message and get a reply from the local operator. These programs are thus named Write To Operator (WTO) and Write To Operator and Reply (WTOR).

Conclusion

Once the modem is constructed and tested, a protocol is still needed to establish two-way communications between processors. Commercial timesharing services set this protocol for their customers. Personal computer users do not have a standard file and message exchange protocol, but groups such as PCNET in the San Francisco Bay area (280 Polaris Ave, Mountain View CA 94303) are working on the problem. The PCNET protocol is based on the use of modems similar to the type described in this article. ■

New on the North Star Horizon: 18Mb Hard Disk Drive!

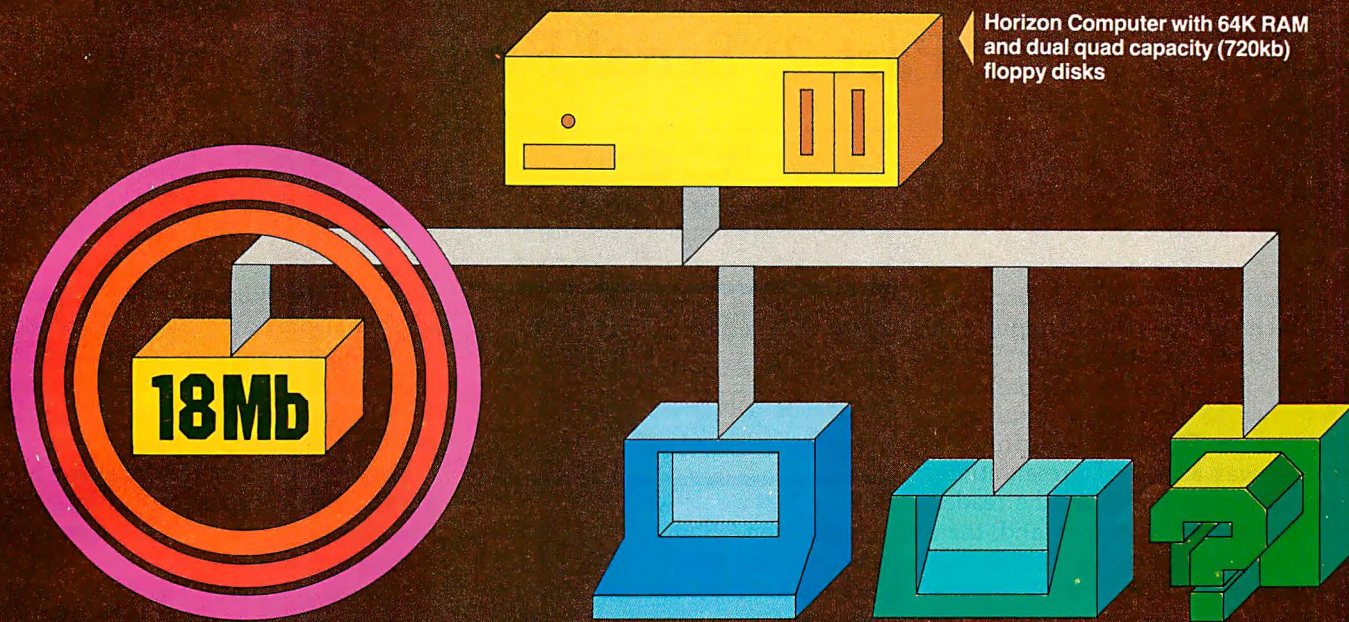

Horizon Computer with 64K RAM and dual quad capacity (720kb) floppy disks

Up to four 18Mb Winchester-type hard disk drives

Display terminal

Letter-quality or dot matrix printer

Horizon I/O flexibility allows expansion to meet your needs

Unsurpassed Performance and Capacity!

North Star now gives you hard disk capacity and processing performance never before possible at such a low price! Horizon is a proven, reliable, affordable computer system with unique hardware and software. Now the Horizon's capabilities are expanded to meet your growing system requirements. In addition to hard disk performance, the Horizon has I/O versatility and an optional hardware floating point board for high-performance number crunching. The North Star large disk is a Century Data Marksman, a Winchester-type drive that holds 18 million bytes of formatted data. The North Star controller interfaces the drive(s) to the Horizon and takes full advantage

of the high-performance characteristics of the drive. Our hard disk operating system implements a powerful file system as well as backup and recovery on floppy diskette.

Software Is The Key!

The Horizon's success to date has been built on the quality of its system software (BASIC, DOS, PASCAL) and the very broad range and availability of application software. This reputation continues with our new hard disk system. Existing software is upward compatible for use with the hard disk system. And, with the dramatic increase in on-line storage and speed, there will be a continually expanding library of readily available application software. For more information, see your North Star dealer!

NorthStar

North Star Computers, Inc.
1440 Fourth St.
Berkeley, CA 94710
(415) 527-6950 TWX/Telex 910-366-7001

HORIZON-HD-18

Horizon computer with 64K RAM, 2 quad capacity mini drives and one HDS-18 hard disk drive **\$9329**

SYS-1N

Complete Horizon HD-18 plus 80 x 24 display terminal and NEC Spinwriter printer **\$13,239**

HDS-18

Additional 18Mb hard disk drive for expansion of Horizon HD-18, or your present Horizon **\$4999**

SYS-1A

Complete Horizon HD-18 with 80 x 24 display terminal and Anadex printer **\$11,319**

I/O Expansion for the TRS-80

Part 2: Serial Ports

Steve Ciarcia
POB 582
Glastonbury CT 06033

Last month in Part 1, I discussed the attachment of parallel input and output ports to the Radio Shack TRS-80 computer. This was basically a response to the many inquiries I have had on TRS-80 interfacing. As usual, it was a general presentation, intended to first enlighten the reader with interfacing concepts and then tender a few alternative circuits for construction. While TRS-80 owners benefit most directly, many computers have similar bus structure and can just as easily accommodate parallel input/output (I/O) expansion.

The presentation this month of a serial interface for the TRS-80 required a little more thought. Parallel ports are strictly hardware devices which in their simplest form only require execution of a single assembly-language or BASIC instruction to function efficiently. A serial interface, on the other hand, needs a software program to direct its operation. The many registers and buffers involved in the serial communication process must be synchronized by the execution of a *serial-driver* routine stored in memory. Any design for a serial port has to take into account the capabilities and memory location of this routine. Even the most splendid hardware circuit would be a failure if the software driver interfered with other computer functions.

To eliminate any potential problems that might occur, I decided to make my design completely software-compatible with existing TRS-80 serial-driver routines. This does not necessarily minimize circuit complexity by any means, but it greatly enhances potential user acceptance.

I was equally concerned with the power requirements and physical

This RS-232C interface design is compatible with existing TRS-80 serial-interface control software.

configuration. Radio Shack sells a serial-interface board for the TRS-80, but it cannot be operated independently and requires integral attachment to the expansion interface

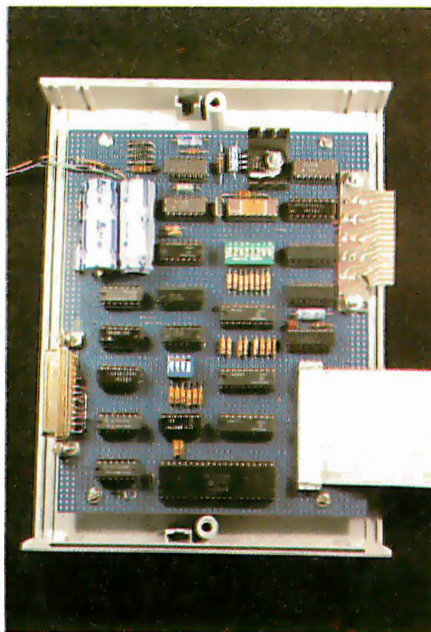

Photo 1: Prototype of the COMM-80 interface. The ribbon cable at the lower right connects to the expansion-bus port (either the expansion connector on the keyboard/processor unit or connector J2 on the expansion interface). The edge connector at the upper right is for the Centronics-compatible, parallel printer port. The RS-232C DB-25S connector is at the lower left.

module. The expansion interface and one serial port add \$400 to the cost of the basic computer. Also, with its present hardwired addressing, the TRS-80 can support only one serial port and one parallel printer port.

Depending upon the intended application, you may not need the extra functions (eg: disk controller and memory expansion) provided in the expansion interface. The \$300 outlay for the expansion interface is an extraordinary expense if you merely intend to attach a modem and use the TRS-80 as a terminal on a timesharing network, such as the Source or MicroNet. Rather than duplicate what I consider to be a restrictive hardware configuration, I have attempted to present a cost-effective communications interface that gives more flexibility in use and has a better price/performance ratio.

The COMM-80 Communications Interface

The approach I decided to take was to combine elements from Part 1 of this article with this one, and produce a stand-alone serial/parallel interface which could plug directly into the expansion-bus connector (the keyboard-unit expansion connector or connector J2 on the expansion interface). Designated the COMM-80, the unit includes a 50 to 19,200 bit per second (bps) RS-232C serial port, a full 8-bit-in/8-bit-out parallel printer port, an auxiliary expansion-port edge connector, and switch-selectable addressing which allows a single TRS-80 to simultaneously connect up to sixteen COMM-80 interfaces. A block diagram of the COMM-80 is presented in figure 1, and a picture of the prototype is in photo 1.



CM-600 Circuit Mount

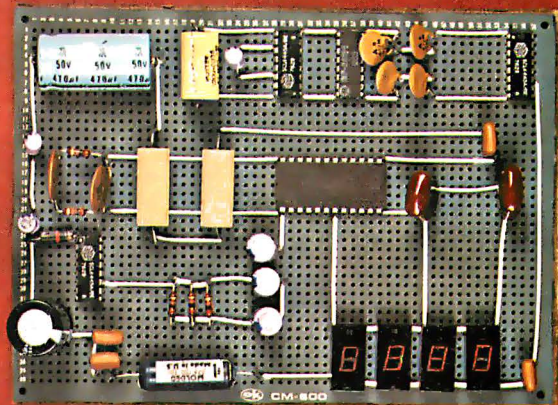
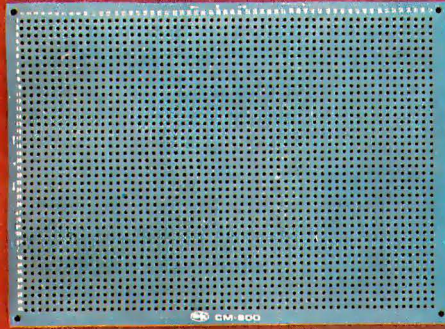

CM-600 \$6.95*
RW-50 \$2.98*

NEW CM-600 SOLDERLESS PROTOTYPE BOARD

CM-600 is a unique system for solderless construction of circuit prototypes, useful to both engineers and hobbyists. The CM-600 is a neoprene board 4½" (114mm) x 6" (152mm) with 2280 holes on .100" (2.54mm) centers. Standard components including DIP's are mounted by simply inserting leads into the holes in the long life neoprene material. Interconnections are easily made using 20 or 22 AWG (0,8 or 0,65mm) wire jumpers. Positive contact is assured by the elasticity of the hole, which compresses the leads together. To remove components or leads, simply pull out. This facilitates easy circuit changes making it ideal for breadboarding experimental circuits. CM-600 also features numbered rows and columns for easy reference.

Accessory Kit RW-50 contains 50 pcs of AWG 20 (0,8mm) insulated jumper wires of assorted lengths from ½" (13mm) to 4" (100mm). Both ends are stripped and bent 90° for easy insertion. In stock directly from

OK Machine & Tool Corporation
3455 Conner St., Bronx, N. Y. 10475 U.S.A.
Tel. (212) 994-6600 Telex 125091

*Minimum billings \$25.00, add shipping charge \$2.00
New York State residents add applicable tax

What Is a Serial Port?

Communication between computers, terminals, and other peripheral devices can be in either serial or parallel mode. In parallel mode, the entire information segment (ie: data word) is transmitted or received simultaneously in a single time frame. In serial mode, this same information is divided into its constit-

uent bits and these bits are transmitted individually over a longer period of time. In cases where high-speed data rates are involved, such as in interaction with a floppy-disk drive, the communication is usually in parallel and can involve as many as forty data and control lines. Serial mode is generally used for lower-speed exchanges.

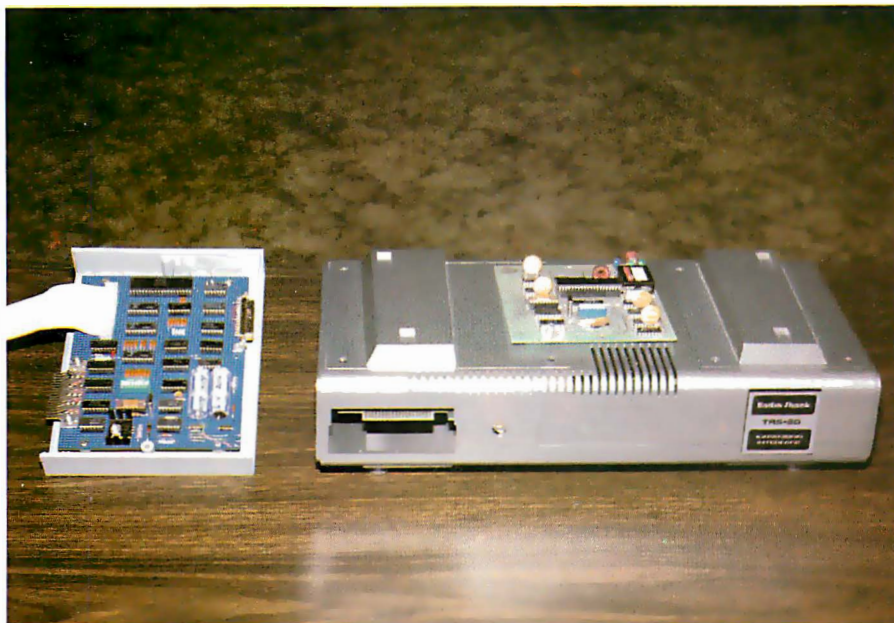

Photo 2: Here are two ways of adding RS-232 communication capability to the Radio Shack TRS-80. The COMM-80 unit is shown on the left; the combination of the Radio Shack expansion interface and serial-interface board is shown on the right.



Photo 3: A TRS-80 equipped with Level II BASIC, the COMM-80 interface, and a Novation CAT modem can be used as a remote terminal for a time-sharing service such as the Source.

An example a little closer to home is the addition of a video terminal and a printer to a computer system. Both the terminal and printer are designed to accept American Standard Code for Information Interchange (ASCII) coding, which requires only 7 bits to define a character.

The connections between the computer and the video terminal can be either serial or parallel. The choice in this case is not determined by data rate but by expense. Parallel communication is relatively easy and inexpensive for a computer. Few components are involved, and a 6-foot length of nine-conductor cable (seven lines to carry the 7-bit ASCII data, one line each for data strobe and ground) will not cost too much. Serial interfacing is another matter entirely.

Microprocessors do not naturally communicate in serial format. There are no single machine-language instructions to perform this function. To serialize data we must add a separate hardware device called a universal asynchronous receiver/transmitter (UART). It looks just like a parallel port to the processor, but internally the UART is a very complicated device.

A UART is a special large-scale integration (LSI) circuit that accepts a data byte in parallel form from the processor and converts it into a universally accepted serial format. Any two terminals set at the same data-transmission rate could conceivably be interconnected to communicate, regardless of internal operating-system differences. The expense for this flexibility is in the neighborhood of \$200 to \$500 per data channel, depending upon the computer bus configuration.

Transmitting Serial Data

Serial data can be transmitted in either *synchronous* or *asynchronous* format. I will address this discussion only to the latter format since asynchronous communication is the technique employed in the COMM-80. The asynchronous format allows unlimited time gaps to occur between transmission of characters.

The internal structure of a UART consists of a separate parallel-to-serial transmitter and a serial-to-parallel receiver joined by common programming pins. The two sections can be used independently provided

INTRODUCING HP-85.

A NEW WORLD OF PERSONAL-PROFESSIONAL COMPUTATION.

Imagine the new world that would unfold before you if you had a powerful, portable, completely integrated computer system at your personal disposal. And at an affordable price. That's exactly what Hewlett-Packard has just created.

THE HP-85: A PERSONAL COMPUTER FOR PROFESSIONALS.

At the lab, on your desk or in your study this 20-pound, self-contained system provides professional computing power when and where you need it. That means no more waiting for data to be remotely processed and returned.

A COMPLETE COMPUTER SYSTEM IN ONE SMALL PACKAGE.

You get all this in the HP-85:

Interactive graphics under keyboard control.

16K RAM Memory standard.

Standard typewriter keyboard with separate numeric key pad and eight user-definable special function keys.

High resolution CRT display with powerful editing capability.

Built-in thermal printer produces a hard copy of the display on command.

Built-in tape cartridge drive.

Each cartridge provides 217K bytes of storage capacity.

Operating system and BASIC language, permanently stored in ROM.

A SOPHISTICATED COMPUTER AT YOUR FINGERTIPS.

Hewlett-Packard has combined these sophisticated capabilities with advanced design to give you a system that is easy to use yet uncompromised in its power.

A key to this achievement is Hewlett-Packard's choice of BASIC for the HP-85's language. The



You can enhance the system's capability by adding powerful HP peripherals like a high-speed, full-width line printer, full-size plotter, or flexible disc drives.

And HP Application Pacs offer preprogrammed solutions in a wide variety of disciplines on prerecorded magnetic tape cartridges.

So, when you buy the HP-85, you're not just buying a computer system, you're buying the confidence that the Hewlett-Packard name brings and the knowledge that the HP-85 can expand with your changing needs.

For the address of your nearest HP dealer, CALL TOLL-FREE 800-547-3400 except from Hawaii or Alaska. In Oregon, call 758-1010. For details on the HP-85, send the attached coupon, or write: Hewlett-Packard, 1000 N. E. Circle Blvd., Corvallis, OR 97330, Dept. 276B.

HP-85 has more than 150 commands and statements to let you solve your problems swiftly and easily.

In addition, sixteen graphic commands have been added to the HP-85's extended BASIC to give you easy control of its amazingly versatile graphic capabilities.

DESIGNED FOR TODAY AND TOMORROW.

Whether you're in science, engineering, industry or business, the HP-85 you need today can easily be expanded or customized to meet your needs tomorrow.

You can double RAM capacity to 32K or expand ROM firmware to 80K with optional modules that plug right into the HP-85.



HEWLETT PACKARD

619/26

HEWLETT-PACKARD
Dept. 276B
1000 N.E. Circle Blvd.
Corvallis, OR 97330
Please send details on HP-85.

NAME _____

TITLE _____

COMPANY _____

ADDRESS _____

CITY _____

STATE _____ ZIP _____

they adhere to the same bit-format options. Sending a character from the processor is simply a matter of performing a parallel-output operation to the UART. The decoded-output strobe loads the UART with the data and initiates the serialization process.

Figure 2 shows a plot of logic levels versus time during the transmission of a single character. When no data is being sent, the data-transmission line remains in a logic 1 state. A 1-to-0 high-to-low transition on the line signifies that a character is being sent. The first bit is called a *start bit*. The

next 5 to 8 bits are data; these are followed by a parity bit. Finally, the end of transmission is defined by the addition of 1 or 2 stop bits at the end of the character. The start, stop, and parity bits are all added as part of the UART's function.

Meanwhile, the receiver section of the UART is continuously monitoring the input line for the start bit of a character. When the start bit comes, the following data bits are placed into a holding register and their parity is checked against the state of the parity bit. Completion is signaled by setting

a *data-available* flag. This flag, plus others defining *buffer status*, *parity*, and *overrun errors*, is read by the processor to determine when input data is ready or when another character can be transmitted. The individual pin functions of a typical UART are described in table 1.

RS-232C Interface Characteristics

So far, I have discussed only serialization of the data. I have said nothing about voltages or logic conventions associated with control of the information transmitted between

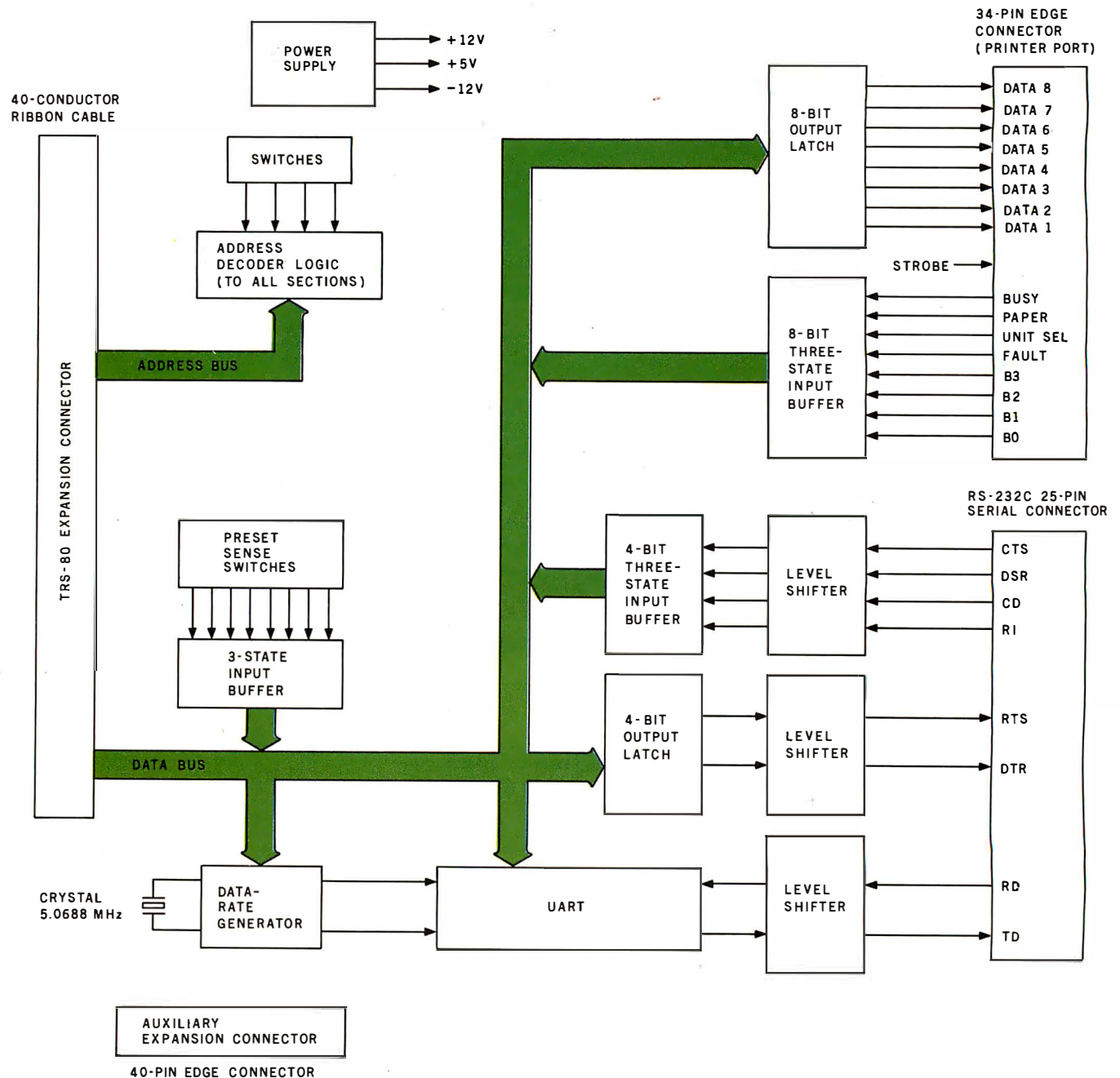

Figure 1: Block diagram of components and data flow in the COMM-80 serial and parallel interface for the Radio Shack TRS-80.



MODEL 800 - WITH SUNFLOWERS

A NEW MASTERPIECE IN PRINTERS

The MODEL 800 MST is certainly pleasing to look at, but its true beauty lies beneath the surface. A glimpse at its features reveals why it is rapidly becoming the most sought after printer in the world . . .

- Four standard interfaces:
 - RS-232 (15 baud rates)
 - Centronics compatible parallel
 - IEEE-488
 - 20ma current loop
- Six line densities: 64, 72, 80, 96, 120, 132
- 100 CPS at all six densities
- Unidirectional or bidirectional printing
- Sixteen horizontal and ten vertical tabs
- Elongated characters in all six densities
- 1920 character buffer
- Uses either perforated or roll paper
- Fully adjustable tractors to 9 1/2"
- Auto self-test
- Up to 10 character fonts
 - Standard 96 character ASCII
 - User defined character font
 - Provision for up to eight additional fonts
- Dot resolution graphics in six densities
- Variable line spacing control from 0 to 64 dots in half-dot increments
- Auto form-feed for any form length at any line spacing
- Heavy-duty all aluminum chassis
- 110vac or 220vac, 50/60Hz.
- 100 million character printhead
- Measures only 15" wide, 3" high, and 11" deep
- Weighs only 15 lbs.

. but maybe its most attractive feature is the price \$699.00.

equipment. The Electronic Industry Association (EIA) RS-232C electrical specification defines voltage levels and control signals: a logic level 1 is called a "mark" or "off" and is considered to be anything more negative than -3 V. A logic 0 is called a "space" or "on" and is considered to be anything more positive than +3 V. As a rule, designers tend to use +12 V and -12 V for the 0 and 1 logic states.

In addition to standardizing the serial format, the EIA also specifies that the connector for RS-232C be a 25-pin, D subminiature type (called a DB-25). The pin assignments and functions are shown in table 2.

The COMM-80 Hardware

The COMM-80 is driven only by signals present on the buses of the computer. All sections communicate with the processor as memory-mapped or directly addressed input/output ports. Figure 3 illustrates the complete schematic diagram of the COMM-80 interface in three sections.

There are two major sections: parallel printer port and serial port. They are joined together by a common address-decoding circuit and power supply.

Address Decoding

A standard TRS-80 expansion interface has an edge connector commonly called the Centronics printer port. It actually combines an 8-bit parallel output port and a 4-bit parallel input port. The addressing for this section is hardwired for hexadecimal memory location 37E8. Part of this same address decoder is used for the Radio Shack serial-interface board. Coincidentally, the Radio Shack serial interface is decoded to use I/O port addresses E8 thru EB for data-transfer and control functions.

The address-decoding section of the COMM-80, consisting of IC1 thru IC7, is designed to decode this set of

Pin Number	Name	Symbol	Function
1	V _{cc} Power Supply	V _{cc}	+5 V Supply
2	V _{cc} Power Supply	V _{cc}	-12 V Supply (Not connected on AY-5-1015)
3	Ground	V _{gr}	Ground
4	Received Data Enable	RDE	A logic 0 on the receiver-enable line places the received data onto the output lines.
5	Received Data Bits	RD8	These are the eight data output lines. Received characters are right justified; the least significant bit (LSB) always appears on RD1. These lines have three-state outputs.
6		RD7	
7		RD6	
8		RD5	
9		RD4	
10		RD3	
11		RD2	
12		RD1	
13	Parity Error	PE	This three-state line goes to a logic 1 if the received-character parity does not agree with the selected parity.
14	Framing Error	FE	This three-state line goes to a logic 1 if the received character has no valid stop bit.
15	Over-Run	OR	This three-state line goes to a logic 1 if the previously received character is not read (DAV line not reset) before the present character is transferred to the receiver-holding register.
16	Status Word Enable	SWE	A logic 0 on this three-state line places the status word bits (PE, FE, OP, DAV, TBMT) onto the output lines.
17	Receiver Clock	RCP	This line will contain a clock whose frequency is sixteen times the desired receiver data rate.
18	Reset Data Available	RDAV	A logic 0 will reset the DAV line.
19	Data Available	DAV	This three-state line goes to a logic 1 when an entire character has been received and transferred to the receiver holding register.
20	Serial Input	SI	This line accepts the serial bit input stream. A marking (logic 1) to spacing (logic 0) transition is required for initiation of data reception.
21	External Reset	XR	Resets shift registers. Sets SO, EOC, and TBMT to a logic 1. Resets DAV, and error flags to 0. Clears input data buffer. Must be tied to logic 0 when not in use.
22	Transmitter Buffer Empty	TBMT	The three-state transmitter buffer-empty flag goes to a logic 1 when the data bits holding register may be loaded with another character.

Table 1: Pin functions for the AY-5-1013, AY-5-1015, or COM2017 UARTs.

addresses as well as a range of other addresses. The range for the printer port is hexadecimal memory addresses 3708 to 37F8, and the serial range is hexadecimal I/O addresses 08 to F8. Figure 4 illustrates the switch settings for the different ranges.

There is a particular rationale for setting up the addresses this way. A user attaching a COMM-80 to his system would naturally set the switches for the range E8 thru EB, and the interface would then be completely compatible with standard TRS-80 software. Should an expansion-

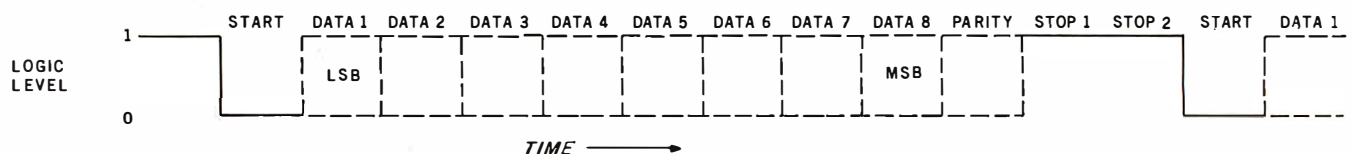

Figure 2: Logic levels plotted against time during the transmission of an 8-bit data word in asynchronous serial format.

Pin Number	Name	Symbol	Function		
23	Data Strobe	\overline{DS}	A strobe on this line will enter the data bits into the data-bits-holding register. Initial data transmission is initiated by the rising edge of \overline{DS} . Data must be stable during entire strobe.		
24	End of Character	EOC	This line goes to a logic 1 each time a full character has been transmitted. It remains at this level until the start of transmission of the next character.		
25	Serial Output	SO	The entire character is transmitted bit by bit (that is, serially) over this line. It will remain at logic 1 when no data is being transmitted.		
26	Data Bit Inputs	TD1	There are up to 8 data-bit-input lines available.		
27		TD2			
28		TD3			
29		TD4			
30		TD5			
31		TD6			
32		TD7			
33		TD8			
34	Control Strobe	CS	A logic 1 on this lead will enter the control bits (EPS, NB1, NB2, TSB, NP) into the control-bits-holding register. This line can be strobed or hardwired to a logic 1 level.		
35	No Parity	NP	A logic 1 on this lead will eliminate the parity bit from the transmitted and received character (no PE indication). The stop bit(s) will immediately follow the last data bit. If not used, this lead must be tied to a logic 0.		
36	Number of Stop Bits	TSB	This lead will select the number of stop bits (1 or 2) to be appended immediately after the parity bit. A logic 0 will insert 2 stop bits.		
37	Number of Bits Per Character	NB2	These two leads will be internally decoded to select either 5, 6, 7, or 8 data bits per character.		
38		NB1			
		NB2		NB1	bits/character
		0		0	5
		0		1	6
		1	0	7	
		1	1	8	
39	Odd/Even Parity Select	EPS	The logic level on this pin selects the type of parity which will be appended immediately after the data bits. It also determines the parity that will be checked by the receiver. A logic 0 will insert odd parity, and a logic 1 will insert even parity.		
40	Transmitter Clock	TCP	This line will contain a clock whose frequency is sixteen times the desired transmitter data rate.		

interface module be added to the system later, the user would merely flip a switch specified by table 3 to change the port address (the expansion interface is set only for 37E8). The switch circuit is shown in figure 4. The system could then accommodate two printers. As table 3 shows, there are sixteen possibilities, so there could be sixteen printers and sixteen serial ports. From this point on, however, I will refer only to the addressing range of E8 thru EB.

The Printer Port Is a Full 8 Bits

Since I explained parallel ports in detail last month, I will discuss the

printer port briefly. Initially my intention was to provide a general-purpose I/O port so that the user could connect some of my other projects and interface designs. As it worked out, however, I decided to combine efforts and configure the parallel port to serve as the printer port as well. The major difference is that the COMM-80 incorporates a full 8-bit input and a full 8-bit output port. Its address is nominally hexadecimal 37E8 in memory-address space. Writing to memory location 37E8 latches data onto IC14 and IC15 (both 74LS75 devices), and reading memory location 37E8 gates the

Once you have installed an RS-232 port, a whole new world of peripherals opens up.

printer status signals through the three-state buffer IC19 (a 74LS244 device).

Serial Port

The serial-port section requires four input and four output strobes to operate. As previously mentioned, the serial-port control addresses are nominally set for hexadecimal E8 thru EB. Figure 5 more explicitly illustrates the hardware derivation of these signals and lists their functions. These strobe signals coordinate the RS-232C handshaking, the sense switches, the data-rate generator, and the UART. All four subsections can be independently controlled in software by reading and writing to the appropriate port address.

The sense switches, for instance, are merely a convenience. It is a way for the user to present a frequently used combination of options. These switches, outlined in figure 6, allow selection of data rate, word length, parity condition, and number of stop bits. There is, however, no physical connection between these switches and the other sections. The software-driver routine coordinates the option selection.

First the routine determines the state of the switches by reading input port E9. It determines from the setting of switches SW6 thru SW8 what data rate the user wants. The particular code for that rate, selected from table 4, is written to output port E9. The remaining switch settings are written into the UART control register EA. Three bits of this output (b₀ thru b₂) and input port E8 are used for the RS-232C handshaking. The data-rate generator is presented in figure 7.

The sense switches are not absolutely necessary for operation of the serial interface. Most software drivers, such as the ST80 program written by Lance Micklus, offer a selection of the options through the keyboard. Separate data rates for the

Text continued on page 54

ALTOS COMPUTER SYSTEMS PROUDLY ANNOUNCES

SUN-SERIES

ACS8000-6



THE VERY FIRST

Double Density Z80 Micro-Computer
plus Twin 8" Floppies
plus 14.5Mb Winchester Disk
for under \$9,500!

And more! 4 user CP/M® for under \$12,000!

*CP/M is a registered trademark of Digital Research, Inc.

ALTOS COMPUTER SYSTEMS, LEADER IN SINGLEBOARD TECHNOLOGY
DOES IT AGAIN WITH ITS SINGLEBOARD ACS8000-6. TOTAL BUSINESS COMPUTER

HIGH TECHNOLOGY AGAIN

The new ACS8000-6 single board computer is packed with ultra-high technology: Z80 double-density computer, up to 208Kb of high speed RAM. Floppy-disk and Winchester Hard Disk controllers, DMA, up to 6 serial/2 Parallel I/O, optional 32 bit floating point processor . . . All on One Board, fully socketed, fully documented reliable and maintainable.

ADVANCED MULTI-USER SOFTWARE

Our new ALTOS Multi-User Executive (AMEX) supports four independent CP/M compatible programs in any of six languages: Basic, Fortran, Cobol, Pascal, APL, C, and a wealth of complete business application packages.

WINCHESTER MASS STORAGE

We're staying with Shugart for both floppies and Winchester hard disk. Why? Simple, low price, solid reliability and they're our next door neighbor. Our single board computer supports up to 4 Mbytes of floppies and 58 Mbytes of Winchester running under AMEX.

MINI PERFORMANCE FOR 1/2 COST

Prices you will love. Entry level ACS8000-6 Hard Disk System \$9,450
2 users \$10,670, 4 users \$11,960,
AMEX separate at \$250.

AVAILABLE NOW!

Call for your nearest Altos dealer. (408) 244-5766. Telex 171562 ALTOS SNTA.



COMPUTER SYSTEMS

2338-A Walsh Avenue
Santa Clara, Ca. 95050

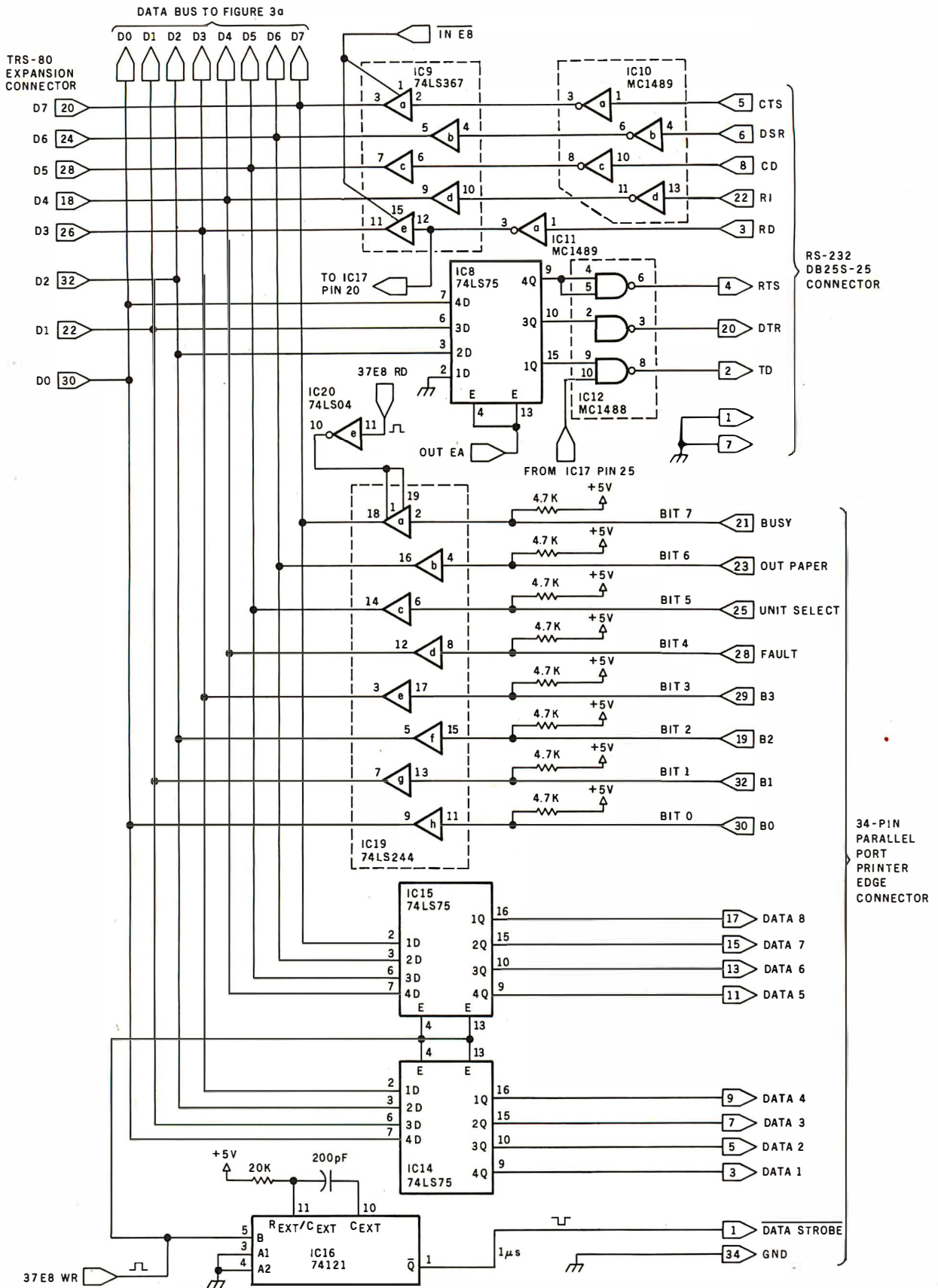

Figure 3b: Section of schematic diagram of COMM-80 interface. Connections to data buses and peripheral connectors are presented here. Some care must be exercised in connecting the COMM-80 to the expansion bus. It is best to use shielded ribbon cable. The production version of the COMM-80 includes two auxiliary expansion-bus edge connectors, which are like the one on the back of the keyboard/processor unit.

Now! North Star Application Software!

North Star now offers application software for use on the HORIZON! Now you have one reliable source for both hardware and software needs! The first packages available are:

NorthWord—

NorthWord is a simple-to-operate word processing system designed for use with the popular North Star HORIZON. NorthWord enables you to increase office efficiency and cut document typing time and cost. NorthWord incorporates the most sought-after word processing features: easy editing, on-screen text formatting, simultaneous document printing, and much more. NorthWord can be integrated with other North Star software packages to produce customized letters, labels and reports quickly and efficiently.

MailManager—

MailManager enables you to compile and maintain complete organized mailing lists. Lists are easily accessible and can be compiled with a great deal of flexibility. Entries, corrections and deletions are easily made. The North Star MailManager can print your list on individual envelopes, on mailing labels, or in compact summary form.

InfoManager—

InfoManager is a powerful list-oriented, data management system. It will accept up to 50 categories of information for each record and has the ability to select and sort before printing. The North Star InfoManager has power and flexibility for many applications: product inquiry, inventory, customer/client records, calendar reminders, and as an easy way to fill in often-used forms.

GeneralLedger—

General Ledger and Financial Reporting, two programs in one, maintains general ledger accounts based on such input as checks, bank deposits and journal entries, and uses the information in the general ledger to produce customized financial statements and financial reports.

NorthWord is the central building block for all the North Star application software to follow. Packages now being tested include other accounting and professional application packages. For more information or a demonstration, contact your local North Star dealer.

NorthStar 

North Star Computers, Inc.
1440 Fourth Street
Berkeley, CA 94710
(415) 527-6950
TWX/Telex 910-366-7001



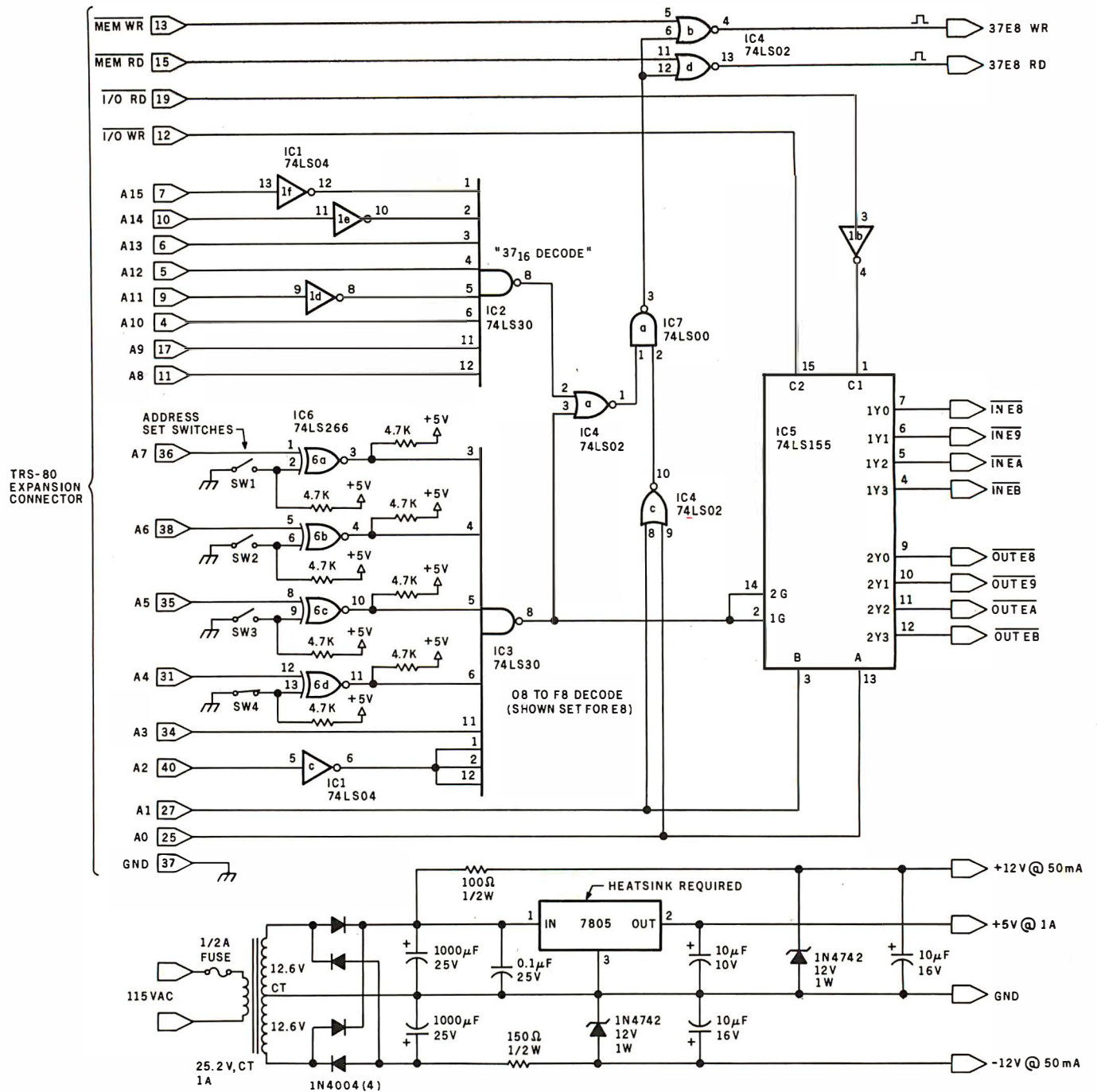

Figure 3c: Section of COMM-80 interface circuit, including power supply and address-selection circuitry. Power to the interface should not be cut off while the TRS-80 is in operation, lest programs be lost. Both units should be powered up and down simultaneously.

Text continued from page 49:
transmitter and receiver can also be established. This is easily accomplished by a direct output command to the data-rate generator using the codes from figure 6.

From this point on, serial communication proceeds by simply loading the UART with the data to be transmitted (using the Z80 instruction OUT EB) and reading the UART status register to see if the byte has

been completely sent or if there is a received data word available (with the IN EA instruction).

The software driver needed for this interface is too long to discuss in this
Text continued on page 58

Grrrrographics.

The Paper Tiger™ puts more bite into everything you do.

The Paper Tiger strikes again. With a DotPlot™ graphics option that lets you make the most of your Apple II,† TRS 80‡ or other personal computer.

With DotPlot and available software drivers, you can print screen graphics, draw illustrations, write block letters, plot charts. And DotPlot includes an expanded, 2K-byte buffer.

That's not all. Every Paper Tiger gives you 8 software-selectable character sizes. 80 and 132 column formats. Multi-part business forms handling. Forms control. Reliable stepper-motor paper drive. Adjustable width tractor feed. Continuous duty cycle operation. Plus lots more.

†Apple II is a trademark of Apple Computer Inc.

‡TRS-80 is a trademark of Radio Shack, a division of Tandy Corp.

The Paper Tiger costs only \$995. The DotPlot option only \$99 more. But don't let these low prices fool you. Because the Paper Tiger is rugged enough to stand up to the most demanding printer-plotter requirements.

For the name of the Paper Tiger dealer nearest you, call toll-free 1-800-343-6412 (except Massachusetts, Alaska, and Hawaii).

Integral Data Systems, 14 Tech Circle, Natick, MA 01760. (617) 237-7610.

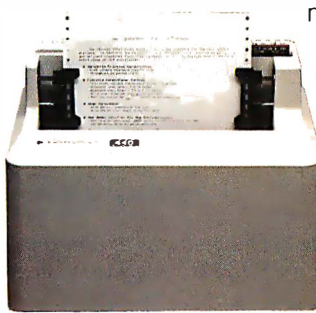

Circle 31 on inquiry card.

Integral Data Systems, Inc.



Hire a fast thinker.

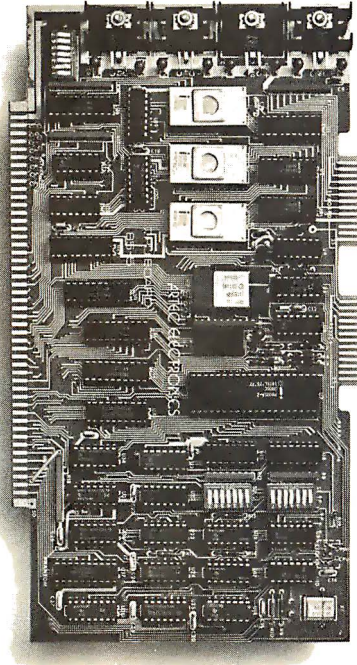

5 MHz CPU Card

- Intel 8085A-2 microprocessor
- Hardware floating point
- Performs calculations six times faster than other CPUs
- On-board monitor in PROM
- 1K RAM scratch pad
- Keyboard or RS232C terminal
- Variable clock frequency

PRICE—\$850

(California residents add 6% sales tax)

Call or write Artec for details.

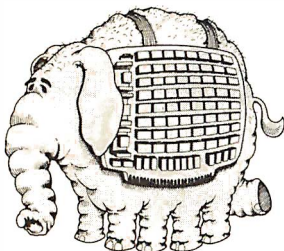

ARTEC ELECTRONICS, INC.

605 Old County Rd., San Carlos, CA 94070
Telephone (415) 592-2740

Pin 1	PGND — Protective Ground This is chassis or equipment ground. It may also be tied to signal ground.
Pin 2	TD — Transmit Data This is the serial data from the terminal to the remote receiving equipment. When no data is being sent it is in a marking (1) condition.
Pin 3	RD — Receive Data This is the serial data from the remote equipment which is transmitted to the terminal.
Pin 4	RTS — Request to Send Controls the direction of data transmission. In full-duplex operation an "on" sets transmit mode and an "off" sets non-transmit mode. In half-duplex operation an "on" inhibits the receive mode and an "off" enables it.
Pin 5	CTS — Clear to Send Signal from the modem to the terminal indicating ability to transmit data. An "on" is "Ready" and an "off" is "not ready."
Pin 6	DSR — Data Set Ready Signal from the modem to the terminal. An "on" condition indicates that the modem is ready.
Pin 7	SGND — Signal Ground
Pin 8	CD — Carrier Detect An "on" indicates reception of a carrier from the remote data set; "off" indicates no carrier is being received.
Pin 20	DTR — Data Terminal Ready: "on" connects the communication equipment to the communications channel; "off" disconnects the communications equipment from the communications channel.
Pin 22	RI — Ring Indicator An "on" indicates that a ringing signal is being received on the communications channel.

Table 2: Designations of pins on the DB-25 connector when used for communication with an RS-232C interface system and description of corresponding signals.

Address Range	SW1	SW2	SW3	SW4
08 thru 0B	Closed	Closed	Closed	Closed
18 thru 1B	Closed	Closed	Closed	Open
28 thru 2B	Closed	Closed	Open	Closed
38 thru 3B	Closed	Closed	Open	Open
48 thru 4B	Closed	Open	Closed	Closed
58 thru 5B	Closed	Open	Closed	Open
68 thru 6B	Closed	Open	Open	Closed
78 thru 7B	Closed	Open	Open	Open
88 thru 8B	Open	Closed	Closed	Closed
98 thru 9B	Open	Closed	Closed	Open
A8 thru AB	Open	Closed	Open	Closed
B8 thru BB	Open	Closed	Open	Open
C8 thru CB	Open	Open	Closed	Closed
D8 thru DB	Open	Open	Closed	Open
E8 thru EB	Open	Open	Open	Closed
F8 thru FB	Open	Open	Open	Open

Table 3: Use of the switch-selectable address decoder allows the I/O address range to be varied over the range shown here according to the switch positions specified. (See figure 4.) Radio Shack software uses the address range hexadecimal E8 thru EB.

Listing 1: Part of the output generated during a timesharing session on the Source, in which the TRS-80 equipped with the COMM-80 and a modem was used as a terminal. The Source is a service of the Source Telecomputing Corporation of McLean, Virginia. The hard copy was produced by an LA36 DECwriter connected to the TRS-80 through the COMM-80.

```

>DATA SYSCOM
***** SYSTEM COMMANDS *****

COMMAND      DESCRIPTION
-----
BASIC        PROGRAM IN THE BASIC LANGUAGE.
CHAT         TALK TO ANOTHER USER ON THE SYSTEM.
CRTLLST     DISPLAYS THE CONTENTS OF A FILE, STOPPING EVERY 24
              LINES TO GIVE YOU TIME TO CATCH UP. (TYPING A RETURN
              RESTARTS THE DISPLAY.)
    
```

Listing 1 continued on page 58

The Microsoft Z-80 SoftCard. Leading a Whole New Lineup for Your Apple II.

Plug the new Microsoft Z-80 SoftCard into your Apple II™ and start using all of the system and application software written for Z-80 based computers. Software that you could never use before on your Apple II.

The SoftCard actually contains a Z-80 processor and lets you switch between the Apple's 6502 and the Z-80 with simple commands, so you can use software written for either processor.

Starting with Two Software Standards. Versatile CP/M,* the most widely used microcomputer operating system ever, is included on diskette in the SoftCard package, ready to run on your Apple II.

You get Microsoft's 5.0 BASIC too, the most powerful version to date of our famous BASIC interpreter.

PRINT USING, 16-digit precision, CALL, and CHAIN and COMMON are just some of the major BASIC features you'll add. Applesoft's graphics extensions are still included.

More Power Down the Line. You can get even more programming power and versatility by adding Microsoft's FORTRAN, COBOL, BASIC Compiler and Assembly Language Development System. All are available separately to run with the SoftCard system.

And the whole host of CP/M-based business, scientific and educational applications can be easily transferred to your Apple with SoftCard.

The Microsoft Z-80 SoftCard is compatible with most every Apple product from the Apple II to the Apple II Plus, Language Card and peripherals. Independent peripherals for the Apple are supported, as well. The SoftCard package requires a system with 48K and a disk drive.

Line up a SoftCard demonstration at your Microsoft Consumer Products dealer today. They'll be glad to show you how the Z-80 SoftCard and your Apple computer combine to form a system that can't be beat for either practicality or pure pleasure by any personal computer available today. Or give us a call, 206/454-1315, for more information.

But act quickly. At the low price of \$349 for SoftCard, CP/M, Microsoft BASIC and complete documentation, you may have to stand in line to get one!

™ Apple II is a trademark of Apple Computer, Inc.

* CP/M is a registered trademark of Digital Research.

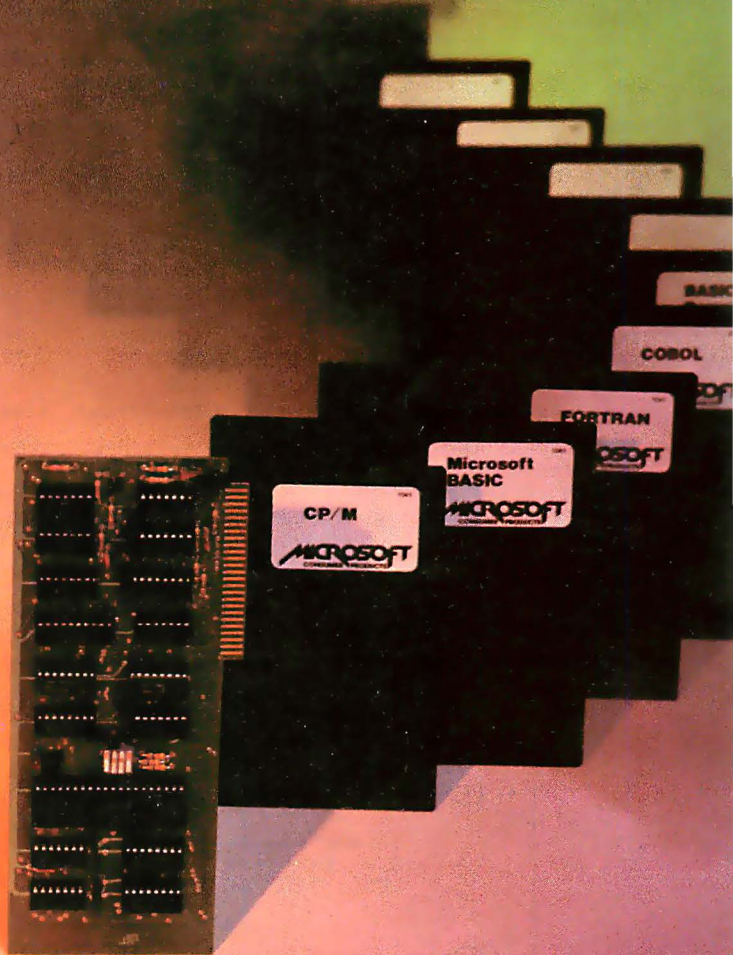

MICROSOFT

CONSUMER PRODUCTS

10800 Northeast Eighth, Suite 507
Bellevue, WA 98004
(206) 454-1315



Listing 1 continued:

```

DATA      DISPLAYS CERTAIN TCA LIBRARY PROGRAMS AND DATA BASES.
DATE      GIVES TIME AND DATE.
DEL       DELETES A FILE.
DELAY     AUTOMATICALLY DELAYS OUTPUT TO PRINTING TERMINALS
          WITH SLOWLY RETURNING CARRIAGES.

ED        TEXT EDITOR.
ENTER     TYPE IN A FILE.
FILES     PRINTS THE NAME OF ALL YOUR FILES.
FORTRN    COMPILES A FORTRAN PROGRAM.
ID        SYSTEM SIGN-ON COMMAND.
INFO      DISPLAYS CERTAIN OTHER LIBRARY PROGRAMS AND DATA BASES.
LOAD      LOADS A FORTRAN PROGRAM.

MAIL      INVOKES THE ELECTRONIC MAIL PROGRAM.
NSORT     SORTS A FILE.
OFF       SIGNS A USER OFF THE SYSTEM.
PLAY      PLAYS COMPUTER GAMES.
POST      INVOKES THE CLASSIFIED AD/BULLETIN BOARD PROGRAM.
R         RUNS A LIBRARY PROGRAM.
TIME      DISPLAYS THE TIME USED FOR THE CURRENT SESSION.
RUN       RUNS A LOADED FORTRAN PROGRAM.
TY        LIKE CRTLS, BUT DOES NOT STOP AFTER 24 LINES.
USAGE     SUMMARY OF YOUR SYSTEM USAGE THIS MONTH.
    
```

NOTE: A COMPLETE LIST OF SYSTEM DOCUMENTATION AND PROGRAMMING MANUALS MAY BE VIEWED BY TYPING DATA SYSDOC.

>ONLINE

```

CL0158    CL0619    TCA056    TCA088    TCA088    TCA290
TCA422    TCA434    TCA516    TCA569    TCA575    TCA612
TCA743    TCA766    TCA830    TCA914    TCB419    TCD011
TCD106    TCD140    TCD202    TCD248    TCD390    TCD419
TCD419    TCD437    TCD444    TCD459    TCD460    TCE052
TCE129    TCE201    TCE217    TCE274    TCE317
    
```

>DATA UFI

***** UNITED PRESS INTERNATIONAL *****

- 1) TO ACCESS THE UFI DATANEWS SYSTEM, SIMPLY TYPE "UFI" AND PRESS "RETURN".
- 2) THEN SELECT "NATIONAL", "REGIONAL" OR "STATE" NEWS OR "FEATURES". "FEATURES" INCLUDES MOST MAJOR NEWS SYNDICATES (NEW YORK TIMES, UNITED FEATURES, ETC.) AS WELL AS SYNDICATED COLUMNISTS. FOR A COMPLETE LIST OF FEATURES, INDEXED BY LOGICAL CONTENT, RETURN TO THE "COMMAND" LEVEL, AND TYPE.....UFI
- 3) SELECT FROM THE "GENERAL", "BUSINESS" OR "SPORTS" CATEGORIES; THE SYSTEM WILL THEN ASK YOU FOR ONE OR MORE "KEYWORDS".

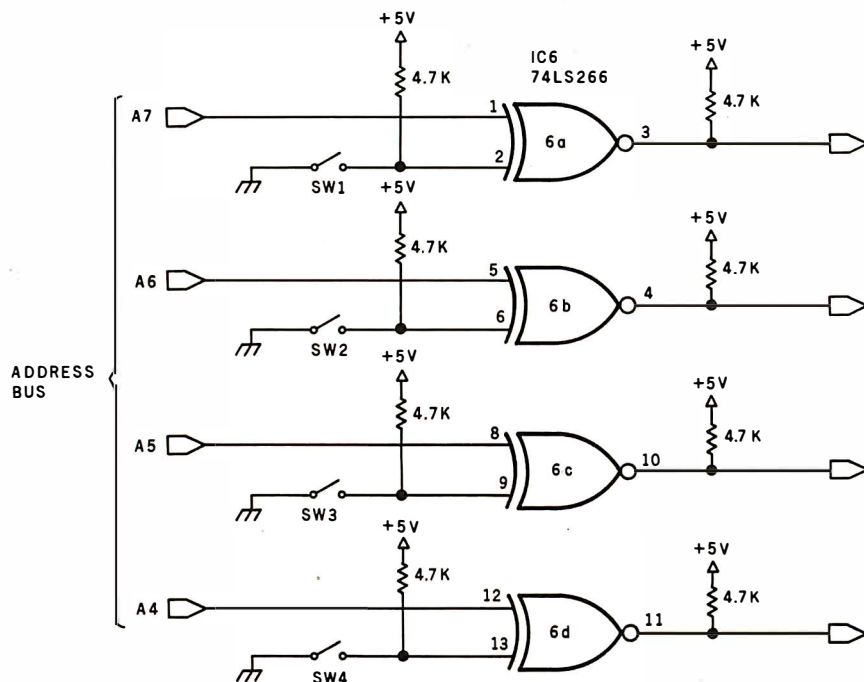

Figure 4: By closing the proper switches, one of sixteen possible address ranges in the I/O-address space can easily be selected. The switches are optional; the desired address range may be hardwired. For complete compatibility with standard TRS-80 software, the hexadecimal address range E8 thru EB should be chosen.

T _A	T _B	T _C	T _D	Data Rate	Clock Frequency
R _A	R _B	R _C	R _D		
0	0	0	0	50	800 Hz
1	0	0	0	75	1200 Hz
0	1	0	0	110	1760 Hz
1	1	0	0	134.5	2152 Hz
0	0	1	0	150	2400 Hz
1	0	1	0	300	4800 Hz
0	1	1	0	600	9600 Hz
1	1	1	0	1200	19.2 kHz
0	0	0	1	1800	28.8 kHz
1	0	0	1	200	32.08 kHz
0	1	0	1	2400	38.4 kHz
1	1	0	1	3600	57.6 kHz
0	0	1	1	4800	76.8 kHz
1	0	1	1	7200	115.2 kHz
0	1	1	1	9600	153.6 kHz
1	1	1	1	19200	316.8 kHz

Table 4: Chart to select data rates for the COM5016 data-rate generator. Transmission and reception rates may be set independently, according to the parameters specified here.

Text continued from page 54: article. Also, since this interface is software-compatible with existing TRS-80 hardware, there is no need to write your own driver routine. There are many sources, including the one listed with this article.

Using the COMM-80

Once you have an RS-232C port installed in your computer, a whole new world of peripherals opens up. The electronics industry has been turning out thousands of printers each year which use the RS-232C interface. For example, if you are interested in word processing, then you can attach a high-quality daisy-wheel printer to your TRS-80. Certain peripherals require a 20 mA current-loop interface; the required circuit is demonstrated in figure 8.

The most obvious application for the COMM-80 is to transform the TRS-80 from a mild-mannered personal computer into a full-fledged computer terminal. Photo 3 shows the system connected to a modem in actual use on the Source timesharing system. Listing 1 is a printout (from an LA36 DECwriter II also connected to the same serial interface) of typical user interaction on this national computer timesharing network. A look at

Text continued on page 62

OUR SOFTWARE MEANS BUSINESS - FOR YOU!

At last! An integrated set of business software ideal for you!

How often have you purchased software only to be disappointed by its features or frustrated by the inability of the different programs to work together? Are you tired of entering the same data into your Purchase Ordering System when a part is ordered, into Inventory when it arrives, Payables when it's invoiced and General Ledger when it's paid for? Does your Form Letter Merge utility easily work with Receivables to send Personalized Dunning Letters to past due clients? Does your Point of Sale Order Entry software also save a keyed file which may later be Sorted for over 60 customer characteristics and used to generate personalized sales literature?

If you don't like your answers to these questions, your accounting software is costing you money!

Packages from SoftwareHows™, a division of MicroDaSys, do all this and much more! These newest software products offer the perfect blend of performance, price and flexibility. Although each package can operate as a stand-alone module, all programs interact with common files. Every single transaction feeds your master records. This Data Base Integration™ approach organizes all your business' information so that every module is fully interactive. The result of this vast and easy to use data base is unique. You'll be amazed at how much better you'll understand the operation and cash flow of your business! And better understanding means better planning -- and higher profits for you!

Start with the basic four: General Ledger provides those all

important balance sheets and income statements, Accounts Receivable and Payable take care of invoice control in a jiffy, while Payroll with Cost Accounting does your payroll and provides cost effectiveness data. Next add the Order-Right™ order entry system and Inventory, and you have a complete sales management and material requirements system. Everything is prepared quickly and accurately: invoices, shipping labels, charge slips and COD tags. Orders are automatically fed into Inventory and Receivables. If your stock is too low, Inventory recommends the best sources of supply and approximate prices to pay. Upon verification, a purchase order is generated. The receiving department verifies receipt and the invoice is transferred to your Accounts Payable. SelectraSort™ pulls selected records from vendor, customer and maillist files on the basis of over 60 different sort criteria! Printing mailing labels and personalized form letters is a snap! Next, VersaSort™ sorts all files on any numeric or string data. Think how handy it would be to have client lists by ZIP, state, last name, or interests!

Each SoftwareHows™ package is just \$195! Plus, get one package absolutely free with every three you buy! Hundreds of pages of documentation are included, and getting them up and running on your system is a breeze. Best of all, complete CBASIC source code is included with every package. Current disk formats include 8" soft-sectored, 5" hard- and soft-sectored.

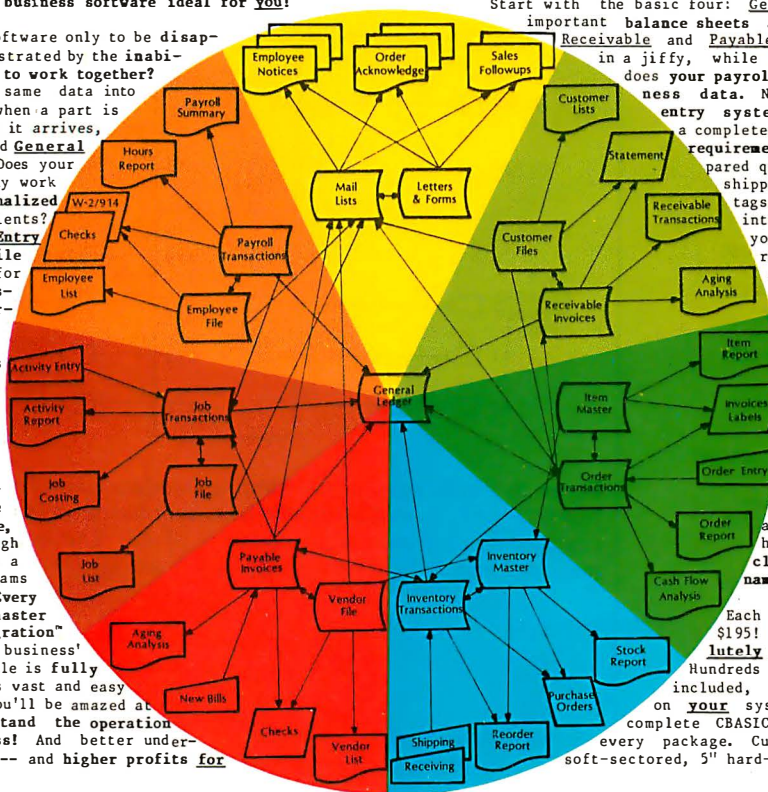

Call or Write now for the solution to your software needs!

- | | |
|--|---|
|  Payroll with Cost Accounting |  Order-Right™ |
|  Accounts Payable |  Inventory |
|  Accounts Receivable |  VersaSort™ |
|  General Ledger |  SelectraSort™ |

A complete 150 page overview of all eight packages is yours for \$25.

SOFTWARE HOWS™

A division of



MicroDaSys

Lucrative sales opportunities available.

Circle 34 on inquiry card.

SoftwareHows, VersaSort, SelectraSort, Order-Right, & Data Base Integration are trademarks of MicroDaSys.

P.O.Box 36275 , Los Angeles , CA 90036 USA (213) 731-0877 TWX: 910-321-2378

SEE CORVUS HIGH PERFORMANCE PERIPHERALS AT THESE SELECTED DEALERS

ARIZONA
Computerland
Phoenix 602/956-5727

CALIFORNIA
Computer Place
Carmel 408/624-7111
Computers Are Fun
Los Angeles 213/475-0566
Computer Merchant
San Diego 714/583-3963
Computerland
San Francisco 415/546-1592
Computer Emporium
San Jose 408/227-5414
Computer Plus
San Jose 408/735-1199
Computer City
Santa Ana 714/549-7749
The Computer Store
Santa Monica 213/451-0713
Future World
Stockton 209/952-2028

COLORADO
Colorado Computer Systems
Westminster 303/426-5880

CONNECTICUT
The Computer Store
Stamford 203/356-1920

DELAWARE
Computerland
Newark 302/738-9656

FLORIDA
Computer Village
Miami 305/266-5965
Gulf Coast Computer
Milton 904/994-8506

GEORGIA
Advanced Computer
Atlanta 404/255-8984

ILLINOIS
Farnsworth Computer
Aurora 372/851-3888
Computer Room
Chicago 312/337-6744
Capital Computer Systems
Springfield 217/544-4108

INDIANA
Digital Technology
Lafayette 317/423-2548

LOUISIANA
Microcomputers
New Orleans 504/821-0870

MASSACHUSETTS
The Computer Store
Cambridge 617/354-4599

MINNESOTA
Personal Business Systems
Minneapolis 612/929-4120

MISSOURI
Computer Country
Florissant 314/921-4433
Computers—ASP
Kansas City 816/741-8013

NEBRASKA
Computerland
Omaha 402/391-6716

NEW JERSEY
Computer Encounters
Princeton 609/924-8757

NEW MEXICO
South West Computer
Las Cruces 505/526-2842

NEW YORK
Byte Shop East
Levittown 516/731-8116
Computer Factory
New York 212/687-5001
McGraw-Hill
New York 212/997-4100
Computer Store
Rochester 716/244-5000

NORTH CAROLINA
Standard Computers
Charlotte 704/399-0228
Byte Shop
Raleigh 919/833-0210

OHIO
Byte Ohio
Fairfield Park 216/333-3261

OREGON
Computer Emporium
Portland 503/228-5242

SOUTH CAROLINA
Byte Shop
Columbia 803/771-7824

TEXAS
Computer Center
Amarillo 806/355-5618
Compushop
Dallas 214/234-3412
KA Computer Store
Dallas 214/634-7870
Computer Solutions
San Antonio 512/341-8851

UTAH
Inkley's
Salt Lake City 801/486-3921

VIRGINIA
The Computer Place
Roanoke 702/982-3661
Home Computer Center
Virginia Beach 804/340-1977

WASHINGTON
Computerland Store
Federal Way 206/927-8585

WISCONSIN
Blue Lake Computer
Madison 608/257-4424

INTERNATIONAL DISTRIBUTORS

CANADA
Corvus of Canada
705/474-5823

GREAT BRITAIN
Keen Computers
602/583254

FRANCE
Micrologie
331/6085560
Sonotec
331/610942

MEXICO
Electronica MYMSA
904/584-2347

WEST GERMANY
Basis D
0251/77023
MM Computer
08051/4523

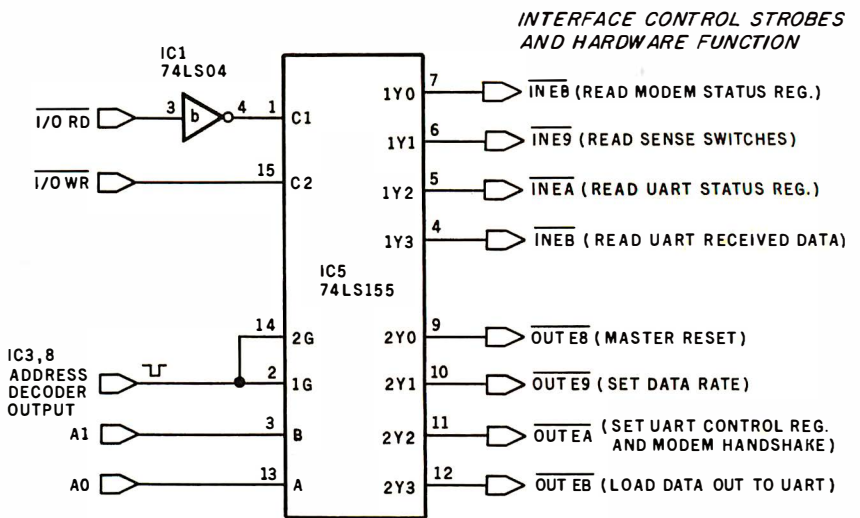

Figure 5: Detail figure demonstrating interface-control strobes. The address decoder (made up of IC3 and IC6) can be set within the range of hexadecimal 08 to F8. TRS-80 compatibility requires a low address of E8. The output-strobe address notations presented refer only to this setting. Switch settings for other addresses are given in table 3.

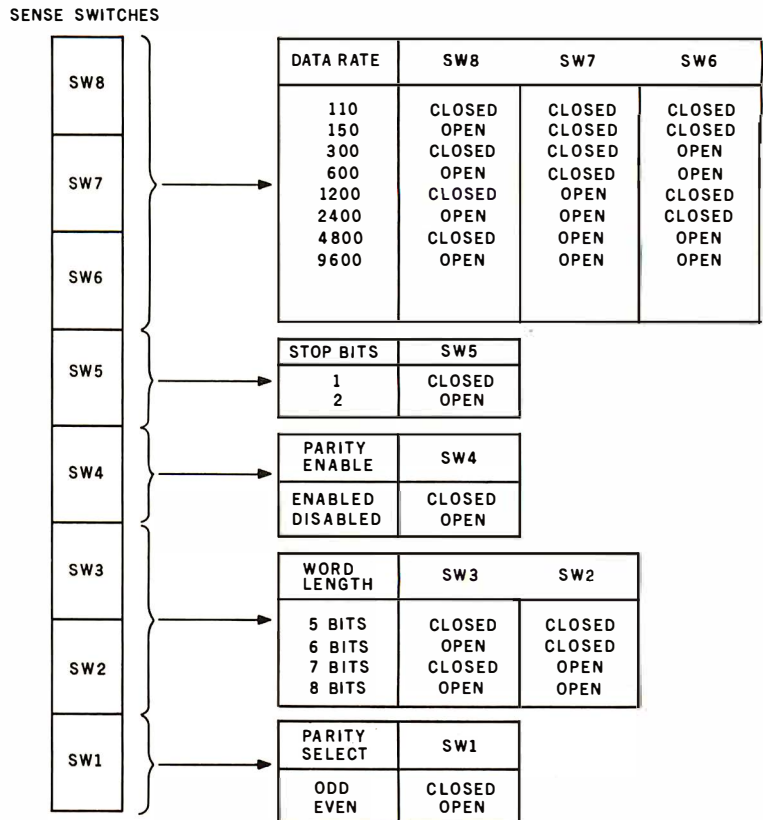

Figure 6: Programmable sense switches are read by the processor to allow preselection of UART options under program control. The correspondence of options and switches is illustrated here.

CORVUS SYSTEMS, Inc.

2029 O'Toole Ave, San Jose,
California 95131 (408) 246-0461

World leader in Winchester disk systems, Winchester
backups, and other intelligent peripherals.

← Circle 35 on inquiry card.

Circle 36 on inquiry card. →

The Imagination Machine™

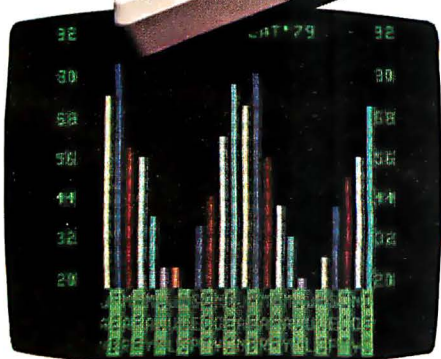

The Imagination Machine offers more at its price than any other personal computer on the market today.

Consider these features: 9K RAM, with 14K BASIC in ROM, 53-key typewriter keyboard. A fine resolution picture, generated on your television set or monitor in 8 colors!

The only computer with color, sound, user programmability and expandability at \$599.

A built-in, dual-track cassette tape deck with 1500 baud rate, for APF's digitally recorded, "saturated," tape programs. A built-in sound synthesizer. And two, built-in, game style controllers, with joysticks and numeric keypads.

When you want to go beyond APF's library of educational, home-and-personal management or entertainment programs... when you want to create your own programs... you can. The Imagination Machine is programmable in BASIC and 6800 machine language. The Imagination Machine

is also expandable. Just add our "Building Block", an optional, four-port expansion device, and you can hook up a printer, telephone modem, and additional memory cartridge or mini-floppy disk drive.

For the name of your nearest Imagination Machine dealer call, TOLL FREE: 1-800-223-1264. (New York residents call: (212) 758-7550) or write: APF Electronics, Inc. 444 Madison Avenue, N.Y., N.Y. 10022.

\$599. Manufacturer's suggested retail price.

APFelectronics inc.

"YOUR LIFE WILL NEVER BE THE SAME!"

Number	Type	+ 5 V	GND	- 12 V	+ 12 V
IC1	74LS04	14	7		
IC2	74LS30	14	7		
IC3	74LS30	14	7		
IC4	74LS02	14	7		
IC5	74LS155	16	8		
IC6	74LS266	14	7		
IC7	74LS00	14	7		
IC8	74LS75	5	12		
IC9	74LS367	16	8		
IC10	MC1489	14	7		
IC11	MC1489	14	7		
IC12	MC1488	7	7	1	14
IC13	COM5016	2	11		9
IC14	74LS75	5	12		
IC15	74LS75	5	12		
IC16	74121	14	7		
IC17	AY-5-1013A	1	3	2	
IC18	74LS244	20	10		
IC19	74LS244	20	10		
IC20	74LS04	14	7		
IC21	74LS244	20	10		

Table 5: Power supplies needed by the integrated circuits in the COMM-80.

Text continued from page 58:

some of the capabilities available through these networks might convince some people to use the network's facilities rather than spend thousands of dollars to build up an independent single-user system. At \$2.75 per hour of connect time, it seems a reasonable alternative. For those of you wishing to contact me via the Source, my electronic-mail identification is TCE317. I welcome questions on this or any other topics that I might possibly be able to answer. ■

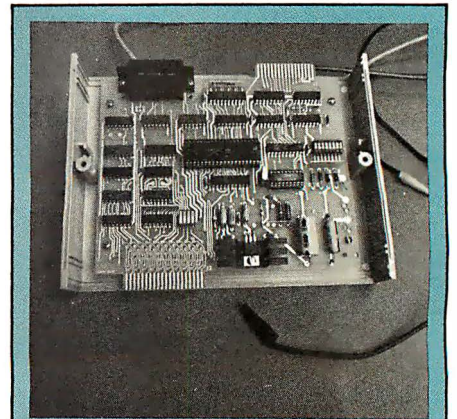

The COMM-80 is available assembled and tested in an attractive 20.95 by 15.24 by 6.35 cm (8.25 by 6 by 2.5 inch) enclosure, including expansion-bus connector and cable, an auxiliary 40-pin expansion-port edge connector, a 34-pin Centronics parallel printer port, RS-232C serial port with DB-25S connector, user's manual, power supply, and terminal software.

Price (including shipping):
\$179.95 (New York residents please add appropriate sales tax).

Order from:
The MicroMint Inc
917 Midway
Woodmere NY 11595
(516) 374-6793

Next Month

Handheld remote controls for the home-control system as described in the January 1980 Circuit Cellar.

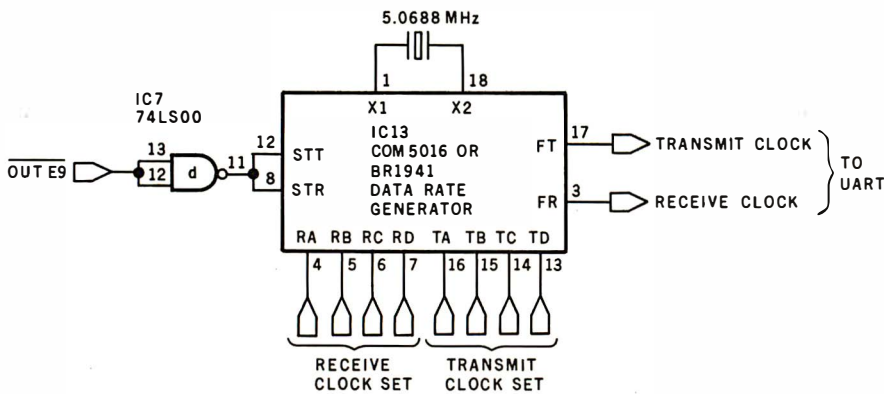

Figure 7: The data-rate generator determines how fast data is sent and received. Transmission and reception rates can be set independently. The specifications for setting up the various possible data rates on the COM5016 are presented in table 4.

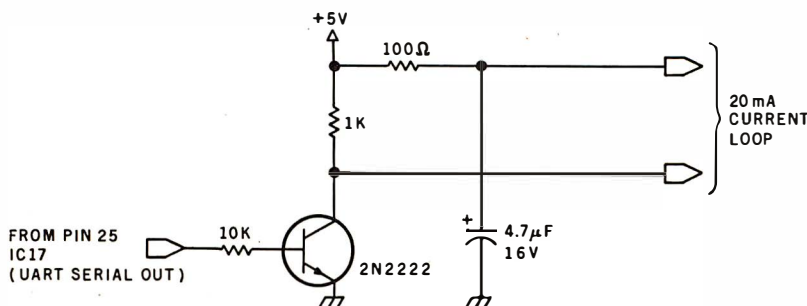

Figure 8: Some peripheral devices (ie: a Teletype ASR33) must be connected by means of a 20 mA current-loop circuit; such a circuit that can be attached to the COMM-80 is shown here.

Look to



for the...

BIG +

IEEE S-100 There's a BIG + in every interface that QT manufactures. That's because every one of our products is an improvement over any other on the market. And every one is an S-100-based unit that meets the exacting IEEE standards.

COMPATIBLE Most items in our BIG + line are available as bare boards, a kit or a completely assembled and tested unit. What's more, we have the S-100 mainframe available for all our boards.

EXPANDABLE + DYNAMIC MEMORY(16K to 64K)

- + Works With Cromenco Systems
- + Bank Selectable Write Protect
- + Uses 3242 Refresh Chip
- + Phantom Output Disable
- + 4 Layers Mean A Quiet Board
- + Switch Selectable Output Disable

Bare Board \$ 49.95	32K Kit \$369.95	48K A&T \$494.95
16K Kit \$295.95	32K A&T \$419.95	64K Kit \$519.95
16K A&T \$345.95	48K Kit \$444.95	64K A&T \$569.95

Z + 80 CPU

- + 1K Ram On Board + 2 Programmable Timers
- + Programmable Baud Rate Selection (110 to 9600)
- + Switch Selectable 2 or 4 MHZ
- + On-Board EPROM May be Used in Shadow Mode, Allowing Full 64K RAM to be Used
- + Power On Jump to On-Board 1K or 2K EPROM (2708-2716-2732) Can be Addressed on any 1K, 2K or 4K Boundary
- + On-Board USART for Synchronous or Asynchronous RS-232 Operation (On-Board Baud Rate Generator)

Bare Board \$ 45.00	A&T \$229.95
Kit \$169.95	1K Memory Kit \$ 12.00

CLOCK CALENDAR +

- + Time of Day in Hours, Minutes and Seconds
- + Simple Read Instructions Allow Simple Interface to Basic, CPM, Etc.
- + 24 Hour Time Format
- + Will Run With 4 MHZ Processors
- + Month and Day Date Function
- + Can be Located at any Group of 4 I/O Port Addressed

Bare Board \$45.00	Kit \$99.95	A&T \$149.95
--------------------	-------------	--------------

SILENCE + MOTHER BOARDS

- + No Need for Termination
- + Fits in Most Mainframes
- + Very High Crosstalk Rejection
- + 6, 12 and 18 Slots Available
- + LED Power Indicator

6-SLOT		12-SLOT		18-SLOT	
Bare Board	\$24.95	Bare Board	\$39.95	Bare Board	\$ 59.95
Kit	\$49.95	Kit	\$89.95	Kit	\$129.95
A&T	\$59.95	A&T	\$99.95	A&T	\$149.95

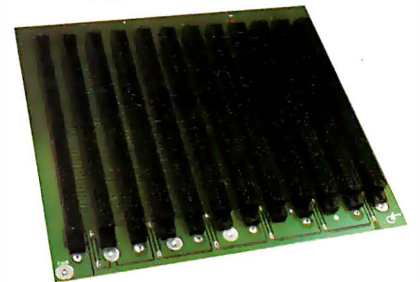
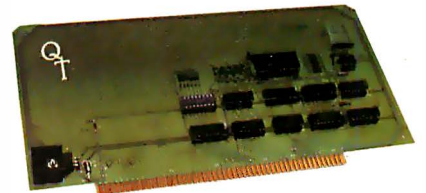
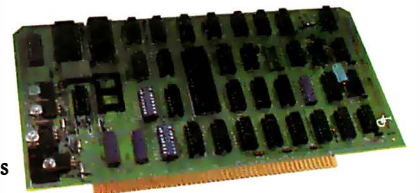
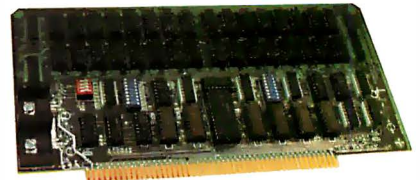

ASK FOR THE FOLLOWING NEW INTERFACES:

- I/O +
- Disk Controller +
- Video +
- Modem +
- EPROM Programmer +
- Mainframe +

Three of our newest dealers are:

DAL-COMP
2560 Electronic Lane
Suite 108
Dallas, TX 75220
214/350-6895

PRIORITY ONE (L.A. Area)
16723 Ro coe Blvd.
Sepulveda, CA 91343
213/894-8171
800/423-5633

**SANTA ROSA
COMPUTER CENTER**
604 7th Street
Santa Rosa, CA 95404
707/528-6480

Dealer Inquiries Invited

Circle 37 on inquiry card.



**COMPUTER
SYSTEMS
INC.**

15335 South Hawthorne Boulevard
Lawndale, California 90260
(213) 970-0952,
800/421-5150 (Continental U.S. Only)



"QUICK & TIMELY"

Z80 Op Codes for an 8080 Assembler

William T Powers
1138 Whitfield Rd
Northbrook IL 60062

If you have a Z80-based machine and an 8080 assembler, you are at a crossroad. You can do one of three things: dispose of your old assembler and purchase a full Z80 assembler; restrict your coding to the subset of the Z80 machine language that is equivalent to the 8080 machine language; or hand-assemble the non-8080 instructions within your Z80 source code. This article details a method I have devised that allows me to assemble all the Z80 instructions using an 8080 assembler without resorting to hand-assembling.

This is how the process works. Suppose you want to exchange the program status word (accumulator, A, and flag byte, F) and its duplicate. In Z80 assembly language, this instruction is:

(Hexadecimal Address)	(Instruction Mnemonic)	(Operand)
1000	EX	AF,AF'

which translates to a 1-byte instruction, hexadecimal 08, to be placed at location hexadecimal 1000. If we have an 8080 assembler that allows us to assign a symbolic name to a 1-byte or 2-byte constant, a 1-byte constant XAF ("exchange the AF pair") can be defined as hexadecimal 08 by a pseudo-operation statement like:

```
XAF DB 08H
```

(DB stands for "define byte," and this kind of pseudo-operation is called an *equivalence statement*.) Then, when we want to use this instruction in the same program, write

```
1000 DB XAF
```

which will cause the assembler to place a hexadecimal 08 in memory location 1000. True, this is a makeshift solution, but it is better than hand-assembling, and its merits become more obvious as more complex Z80 instructions are encoded.

(This article will concentrate on explaining the set of mnemonics I have put together; so I will assume that the reader is familiar with the Z80 instruction set.)

Mnemonic Conventions

Two main factors were considered while compiling the list of mnemonics. First, the mnemonics had to suggest the function they perform. Second, they had to avoid using up all the nice letter combinations I like to use in a program.

In general, I have used the following conventions. The letter "X" used in a mnemonic means either *extended* or *indexed*. The abbreviation for the destination comes first, then the source, wherever possible. "M" means *move*, "L" means *load*, "S" means *store to memory*, and "R" means *register*. Many of the mnemonics are preceded by the letter "Z" to keep them from duplicating variable names. For some mnemonics, however, I have abandoned the Z prefix, in the interest of either shortening the mnemonic, making its meaning obvious, or constructing an analog to a useful 8080-code mnemonic as a way to ease the burden on the user's memory.

16-Bit Loads and Stores

The Z80 has five instructions that are analogous to the 8080 load-HL-register-pair-direct (LHLD) instruction, five analogous to the store-HL-register-pair-direct (SHLD) instruction, and two analogous to the 16-bit immediate-load instruction (LXI). I will refer to the new mnemonics used here as the "Z-symbols."

The Z-symbols SBCD, SDED, SSPD, SIXD, and SIYD correspond to the SHLD instruction on the 8080. These instructions cause the BC registers, the DE registers, the stack pointer (SP), or one of the two index registers (IX and IY), respectively, to be loaded into the location whose address appears in the following 2 bytes. Notice that the middle two letters of the Z-symbol are an abbreviation for the registers to be stored.

The Z-symbols LBCD, LDED, LSPD, LIXD, and LIYD correspond to the LHLD instruction on the 8080. These instructions load the indicated registers from the memory location whose address is stored in the next 2 bytes.

LXIX and LXIY are immediate-mode instructions that coincide with the 8080 instruction LXI H,nn. Index register IX or IY is loaded with the number appearing in the following 2 bytes.

These previously mentioned Z-symbols compile into a 2-byte instruction followed by a 2-byte operand, for a

"We're building a computer family that grows as you do."

Alan Dziejma
Vice President Systems Division



"For years, we at ADDS have been the largest supplier of display terminals to computer giants. Now we're making an advanced small computer family for you. We call it ADDS Multivision™, because it gives you the ability to multiply your computing power as you grow.

"MULTIVISION 1 (top module) starts you off with a 5 MHz processor, 64K bytes of RAM and 700K bytes of mini disk storage. All for just \$3,785.

"MULTIVISION 2 (top and bottom) adds 5M or 10M bytes of hard-disk storage. It costs thousands less than other hard-disk systems.

"MULTIVISION 3 (entire stack) provides a multi-user system that supports up to four display terminals simultaneously. It costs less per user than Multivision 1.

"Only the most modern manufacturing facilities could enable such value. At ADDS, we've made a multi-million dollar commitment to high-volume tooling, rigid quality control, and the latest automation techniques. And our Multivision computer family clearly reflects the results."

Before you buy any small computer, find out about ADDS Multivision. Write: Systems Division, Applied Digital Data Systems Inc., 100 Marcus Boulevard, Hauppauge, N.Y. 11787. Dealer inquiries invited.

ADDS

SOMETHING EXTRA IN EVERYTHING WE DO

MULTIVISION

NEW

Traditional

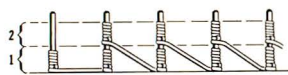

Wire-Wrapping

JUST WRAP



Wire-Wrapping

**WHY CUT?
WHY STRIP?
WHY NOT ...**

JUST WRAP™

WIRE WRAPPING TOOL

- AWG 30 Wire
- .025" Square Posts
- Daisy Chain or Point To Point
- No Stripping or Slitting Required
- JUST WRAP™
- Built In Cut Off
- Easy Loading of Wire
- Available Wire Colors:
- Blue, White, Red & Yellow

PATENTED U.S.A.

FOREIGN PATENTS PENDING

JUST WRAP TOOL WITH ONE 50 FT. ROLL OF WIRE		
COLOR	PART NO.	U.S. LIST PRICE
BLUE	JW 1 B	\$14.95
WHITE	JW 1 W	14.95
YELLOW	JW 1 Y	14.95
RED	JW 1 R	14.95
REPLACEMENT ROLL OF WIRE 50 FT.		
BLUE	R JW B	\$ 2.98
WHITE	R JW W	2.98
YELLOW	R JW Y	2.98
RED	R JW R	2.98
JUST WRAP-UNWRAPPING TOOL		
	JW 1	\$ 3.49

*Minimum billings \$25.00, add shipping charge \$2.00/New York State residents add applicable tax



OK Machine & Tool Corporation

3455 Conner St., Bronx, N.Y. 10475 U.S.A.
Tel. (212) 994-6600 Telex 125091



total of 4 bytes. Since the 8080 assembler cannot recognize the Z-symbols, they must appear in a program as pseudo-operations. On my assembler, the double-byte pseudo-operator is "define word" (DW), and the single-byte pseudo-operator is "define byte" (DB). For example, to load the IX register with the contents of memory location ADDRESS, we write:

```
1000    DW LIXD
1002    DW ADDRESS
```

The DW in each line is not pretty, but otherwise all these instructions look and act like normal assembly-language instructions. The second DW, which is simply a 2-byte address, can include computed offsets such as ADDRESS + 34H (hexadecimal 34 added to ADDRESS), or can be a literal such as 1FFFH (hexadecimal 1FFF). The LXIX and LXIY instructions (immediate load) work the same with the second DW being the 2-byte literal or mnemonic to be loaded.

In my opinion, two of the most useful instructions in this set are the Z-symbols LSPD and SSPD to load and store the stack pointer directly. As an example, if you want to use the stack pointer in a subroutine starting at hexadecimal 1000, start the subroutine with:

```
1000    DW SSPD
1002    DW STACK
```

This causes the stack pointer to be stored at the bytes at addresses STACK and STACK + 1. Just before the return statement, the original stack pointer should be restored:

```
101A    DW LSPD
101C    DW STACK
```

To summarize, here are the Z codes for the instructions just covered:

SBCD, SDED, SSPD, SIXD, SIYD:
store register or register pair in memory
LBCD, LDED, LSPD, LIXD, LIYD:

Z80 Mnemonic	Z-code Mnemonic	Function	Machine Code (Hexadecimal)
RLC	ZRLC	rotate left circular	ii CB dd 06
RRC	ZRRC	rotate right circular	ii CB dd 0E
RL	ZRL	rotate left (with carry)	ii CB dd 16
RR	ZRR	rotate right (with carry)	ii CB dd 1E
SLA	ZSLA	shift left arithmetic	ii CB dd 26
SRA	ZSRA	shift right arithmetic	ii CB dd 2E
SRL	ZSRL	shift right logical	ii CB dd 3E

Table 1: Z80 indexed rotate and shift instructions. The function of this table is to show the similarity of the machine codes for these instructions. The first byte of each instruction, listed here as "ii", is always hexadecimal DD for the IX register and hexadecimal FD for the IY register. The third byte, listed here as "dd", is the displacement required by the instruction. Note that the actual differentiation among the instructions occurs only in the fourth byte.



Z8000: SYBEX DELIVERS THE FUTURE!

16-bit microprocessors are now a reality. And PROGRAMMING THE Z8000 shows how the power of the Z8000 can be harnessed as simply as that of a PDP-11 or any 8-bit microprocessor.

Thorough yet concise, this book provides a comprehensive introduction to assembly level programming in the language of the Z8000—from basic concepts to advanced techniques. Exercises periodically check the reader's progress.

Comprehensive, with over 100 illustrations and an extensive index, PROGRAMMING THE Z8000 is an indispensable volume for engineers, students, PDP-11 users and anyone interested in learning machine language programming skills.

PROGRAMMING THE Z8000
by Richard Mateosian
312 pp., Ref C 281, \$15.95

TO ORDER:

By Phone: (415) 848-8233, Visa, MC, Am Ex
By Mail: Indicate quantity. Prepayment required
Shipping: Add \$1.50 per book (UPS) or 75¢ (4th Class)
Tax: In California please add tax



Dept. B6
2344 Sixth St.
Berkeley, CA.
94710

**AVAILABLE AT
BOOKSTORES AND
COMPUTER SHOPS EVERYWHERE**

MAIL TO: SYBEX, 2344 Sixth St., Berkeley, CA 94710

Send me _____ copy(s) of Programming the Z8000

Name _____

Company _____

Address _____

City _____ State _____ Zip _____

Amount enclosed _____ UPS 4th class

Charge my Visa Master Charge Am. Ex.

Card number _____

Expiration date _____

Signature _____

Send me your free detailed catalog 86C281

load register or register pair from memory
 LXIX: load IX register with immediate 2 bytes stored with instruction
 LXIY: load IY register with immediate 2 bytes stored with instruction

Relative and Indirect Jumps

The Z-symbols for the six relative jumps are:

JR unconditional jump
 JRNZ jump if zero flag = 0 (result not zero)
 JRZ jump if zero flag = 1 (result is zero)
 JRNC jump if carry flag = 0 (no carry)
 JRC jump if carry flag = 1 (carry)
 DJNZ decrement register B and jump if result not zero

These relative jumps require a single-byte pseudo-operation (DB, for define byte) defining the instruction, followed by a single-byte pseudo-operation containing the relative displacement (-128 to +127) measured from the next instruction. They cannot be combined into a single DW pseudo-operation because the byte describing the relative jump will be one of the defined Z-symbols, whereas the relative displacement will vary with each use.

For example, to jump on carry-clear to a location two addresses beyond the next instruction, we would write:

```
1000 DB JRNC
1001 DB 2H
```

If the relative jump is to a label, called LABEL, the displacement can be computed by a standard form involving the "\$", which is the symbol for the current beginning of the first instruction after the jump):

```
1000 DB JR
1001 DB LABEL-$-1
```

There are two indirect jumps in the Z80 that are analogous to the 8080 command PCHL, which puts the contents of the HL register pair into the program counter. This causes a jump to the number contained in the HL register pair. The same can be done with the following Z-code instructions:

JIX jump to the memory location contained in the IX register
 JIY jump to the memory location contained in the IY register

Input and Output

Now we begin to see instructions that are not simply direct substitutions of codes for symbols. Rather, the resulting instruction is the sum of several Z-symbol mnemonics (each of which represents an option available to a given instruction).

The input and output instructions refer to the data flow through the ports. Data flow between the port and the accumulator is covered by an 8080 assembler, but Z-symbols will have to be devised to generate instructions that initiate data flow between a port and either a

IMMEDIATE DELIVERY — FROM ORANGE MICRO

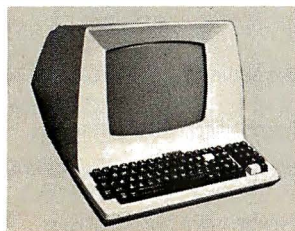

TELEVIDEO 912C
\$799⁰⁰

STANDARD FEATURES (partial list)

- Reverse video, Underline, Blinking, Reduced
- Protected fields, Security Blank fields.
- Block or Conversational modes.
- Editing: Line or Character; Insert / Delete.
- Tab, Backtab; Columnar tab.
- 14 key numeric pad with return key.
- RS232 Printer Port
- Deluxe Selectric® Keyboard

OPTIONAL:

- 2nd Page Memory: \$80⁰⁰
- 11 Special function keys and 8 edit keys: \$70⁰⁰

BASE 2 PRINTER
\$699⁰⁰

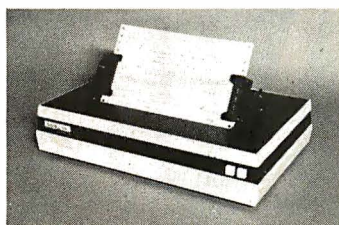

FEATURES:

- 72, 80, 96, 120 or 132 Columns per line.
- Bi-directional, 7 dot matrix, impact.
- Graphics Capability.
- RS232, Centronics®, IEEE-488, 20 ma.
- 60 LPM / Fast feed.
- User Programmable Character Fonts.
- 16 Baud Rates — to 19,200.
- Expanded Characters.

Interfaces to TRS80, Apple, Atari, PET and most other computers.



Digicom Coupler
 ORIGINATE
\$179⁰⁰



COMPARE QUALITY,
 FEATURES & DISCOUNT

QUME letter-perfect printer
 45CPS, receive only **\$2499⁰⁰**

TOLL FREE
(800) 854-8275
 CALIF. ONLY (714) 630-3322

**Orange
 Micro**



P.O. Box 2076, Yorba Linda, CA 92686



Phone orders WELCOME. Same day shipment for VISA and MASTER CHARGE. Personal checks require 2 weeks to clear. Add 3% for shipping and handling. CA residents add 6%. Manufacturer's warranty included. Prices subject to revision.



FLEX™

The Disk Operating System For 6800 and 6809 Users

FLEX™ is the most widely used disk operating system for the 6800 and 6809 microprocessors. Field proven for over two years, it has become an industry standard. FLEX is unparalleled in the amount of 6800/6809 support software being marketed. Two new versions are now available and each includes a disk editor and assembler:

FLEX for the EXORciser™ \$150.00

Runs on a Motorola EXORciser with EXORDisk™ II or III. Requires no hardware modifications with the possible exception of memory re-addressing. Uses the same boot as MDOS™.

FLEX for General Use \$150.00

Fully documented to allow a user to write his own terminal and disk I/O routines to adapt to most any hardware. Three system requirements are: (1) at least 12K of RAM at \$0000; (2) 8K of RAM at \$A000 for 6800 or \$C000 for 6809; (3) floppy disk drive capable of 256-byte, soft sectors. This package is not for beginners!

FLEX Support Software

Extended BASIC	\$100.00
Standard BASIC	65.00
6809 Diagnostics Package	75.00
Text Processing System	60.00
Sort/Merge	75.00
68000 Cross Assembler	250.00
6809 Cross Assembler	100.00
6809 FLEX Utilities	60.00
6800 FLEX Utilities	100.00
6809 Debug Package	75.00
6800 Debug Package	55.00
FLEX for SWTPc	90.00

Be sure to specify disk size and 6800 or 6809. All orders should include 3% postage and handling (10% on foreign orders). Mastercharge and Visa are welcomed. Write for a complete software catalog.

 **technical systems
consultants, inc.**

Box 2570, West Lafayette, IN 47906
(317) 463-2502 Telex 276143

FLEX is a trademark of Technical Systems Consultants, Inc. EXORciser, EXORDisk, and MDOS are trademarks of Motorola, Inc.

register or a memory location. When performing input to a register, the associated register is a destination register; on output, the associated register is a source register.

The Z-symbols that are used are:

- ZINP input to a register
- ZOUT output from a register
- INPI input to a register and increment HL register pair by 1
- OUTI output from a register and increment HL register pair by 1
- INPD input to a register and decrement HL register pair by 1
- OUTD output from a register and decrement HL register pair by 1

ZRPT add "repeat until register B equals 0" feature

These are all 2-byte (DW) mnemonics.

A ZINP or ZOUT is prepared for use by adding the mnemonic to it for the register being used (ZA1, ZB1, ZD1, ZE1, ZH1, ZL1, ZM1). For example, to get input into register D, write:

1000 DW ZINP+ZD1

(In this example, the instruction is to be assembled at memory location hexadecimal 1000.) The assembler will add the two constants together, put the low byte of the sum in hexadecimal 1000 and the high byte in hexadecimal 1001. Looking at the table of Z-symbol mnemonics (table 2), we see that ZINP is hexadecimal 40ED and that ZD1 is hexadecimal 1000. Their sum is 50ED, and, looking at a table of Z80 instructions, we find that the hexadecimal code for this instruction (named IN D,(C) in Z80 assembly language) is ED followed by hexadecimal 50. No port address is specified since the instruction requires that register C contains the port number.

The Z80 has four input and output instructions that transfer blocks of information to or from a range of memory, the start of which is pointed to by the HL register pair. The port address is still held in register C. This powerful set of instructions can load or output up to 256 times with a single instruction. Register B is used as an index counter, with the instruction repeating until the value in B is decremented to 0.

The Z codes OUTI and INPI perform output and input with the HL register pair being incremented by 1, and the B register being decremented by 1 after the data move. OUTD and INPD similarly involve decrementing the HL and B registers each time. If OUTI, INPI, OUTD, or INPD is used alone, only 1 byte of memory is moved (although the incrementing and decrementing still takes place). The automatic repetition occurs when the Z-code mnemonic ZRPT (repeat) is added to any of the four codes.

For example, to cause a block of memory starting at the location pointed to by the HL register pair to be sent to the port pointed to by register C (the number of bytes sent as output being the value in register B), we should write this instruction:

1000 DW OUTI+ZRPT

I should mention that here, and in all cases, the order of elements makes no difference because two quantities are just being added together. The previous instruction, for example, could just as well have read ZRPT+OUTI.

Block Moves and Searches

This section deals with four Z codes:

- BLMD block move in decreasing sequence
- BLMI block move in increasing sequence
- BLSD block search in decreasing sequence
- BLSI block search in increasing sequence

ZB1	0000	ZDAX	09DD	SBCD	43ED
ZC1	0800	ZDAY	09FD	SDED	53ED
ZD1	1000	ZDAC	4AED	SSPD	73ED
ZE1	1800	ZDSB	42ED	SIXD	22DD
ZH1	2000	ZXX	CBDD	SIYD	22FD
ZL1	2800	ZYY	CBFD	ZLXI	2100
ZM1	3000	ZRLC	00CB	LBCD	4BED
ZA1	3800	ZRRC	08CB	LDED	5BED
ZB2	0000	ZRL	10CB	LSPD	7BED
ZC2	0100	ZRR	18CB	LIXD	2ADD
ZD2	0200	ZSLA	20CB	LIYD	2AFD
ZE2	0300	ZSRA	28CB	POPX	E1DD
ZH2	0400	ZSRL	38CB	POPY	E1FD
ZL2	0500	ZRLD	6FED	PSHY	E5DD
ZM2	0600	ZRRD	67ED	PSHY	E5FD
ZA2	0700	ZBIT	40CB	ZNEG	44ED
ZSP	3000	ZRES	80CB	XTIX	E3DD
ZBC	0000	ZSET	C0CB	XTIY	E3FD
ZDE	1000	BIT0	0000	DJNZ	0010
ZHL	2000	BIT1	0800	*JR	0018
ZIX	2000	BIT2	1000	*JRNZ	0020
ZIY	2000	BIT3	1800	*JRZ	0028
ZX	00DD	BIT4	2000	*JRNC	0030
ZY	00FD	BIT5	2800	*JRC	0038
ZMXR	7000	BIT6	3000	JIX	E9DD
ZMRX	4600	BIT7	3800	JIY	E9FD
ZMXI	3600	ZINP	40ED	RETI	4DED
ZADD	8600	ZOUT	41ED	RTNM	45ED
ZADC	8E00	ZRPT	1000	I808	46ED
ZSUB	9600	OUTI	A3ED	I38	56ED
ZSBB	9E00	OUTD	ABED	IVECT	5EED
ZANA	A600	INPI	A2ED	*XAF	0008
ZXRA	AE00	INPD	AAED	*EXX	00D9
ZORA	B600	BLMI	A0ED	ZMAI	57ED
ZCMP	BE00	BLMD	A8ED	ZMIA	47ED
ZINR	3400	BLSI	A1ED	ZMAR	5FED
ZDCR	3500	BLSD	A9ED	ZMRA	4FED
ZINX	2300			ZXTI	E300
ZDCX	2B00				
KLUGE	0535				

Table 2: Z codes and their hexadecimal equivalents. This table of variable names (Z codes) and their hexadecimal values should be recreated in a given assembly-language program. This is done via the "define byte" (DB) and "define word" (DW) pseudo-operations (or the equivalent pseudo-operations on the user's 8080 assembler). For example, the first line might read, "ZB1 DB 0000H". All entries except those starred are to be defined as a 2-byte sequence (DW); the starred entries are single-byte sequences (DB).

Little Impact.

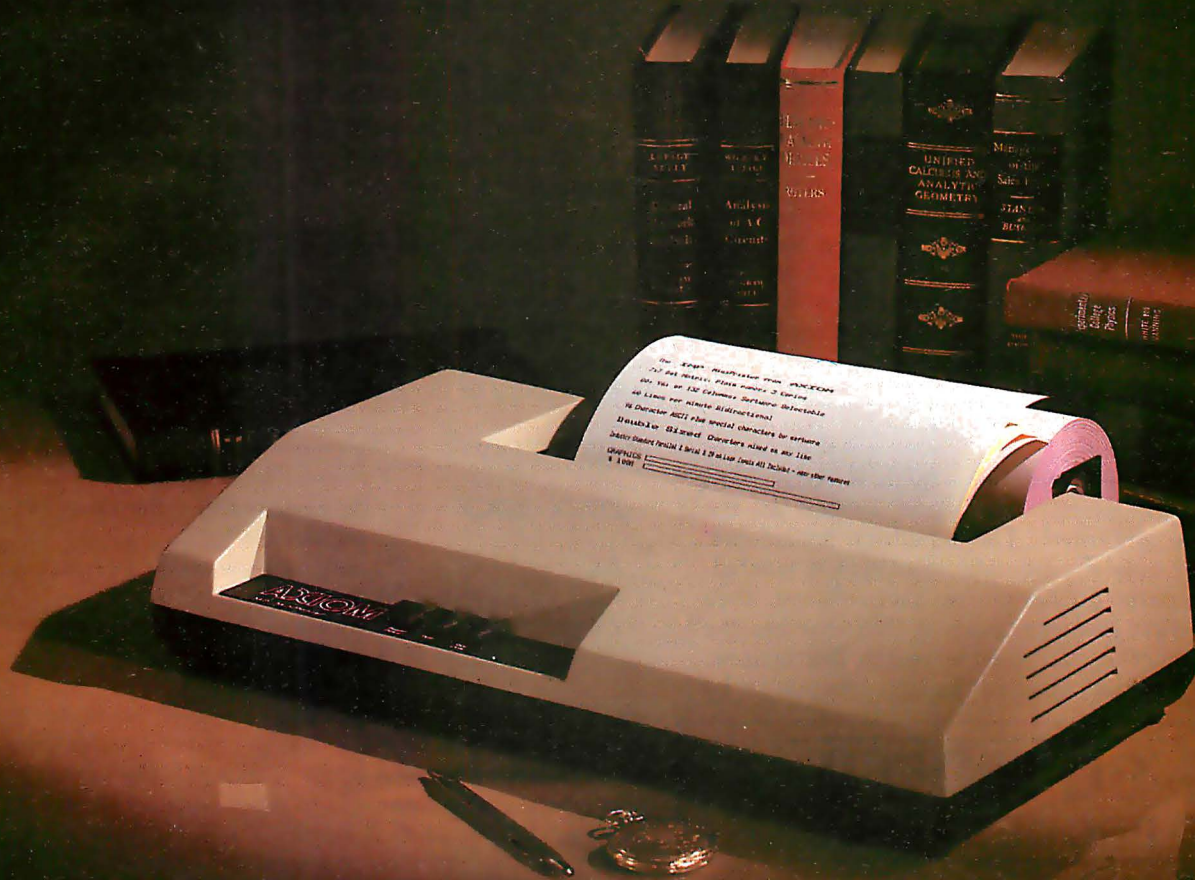

Meet the IMPs. A pair of stylish 3½ inch high impact printers that will look great on any desk.

Styled for desk top use, these sleek units stand just 3½ inches high, yet the unique fan-cooled printing system can knock out 80, 96 or 132 columns of crisp hardcopy with continuous throughput of one line per second.

A winning pair. IMP-1, with friction feed, can make multi-copies on plain 8½ inch wide paper, or on teletype rolls. In addition, IMP-2 has tractor feed and full forms control, with tractors adjustable from 1 inch to 9½ inches.

Interfaces abound. All IMPs have Centronics parallel and RS232C/20mA serial inputs as standard equipment. But if you need something different, then we make interfaces for just about any system—high speed serial, Apple, Pet, TRS-80, IEEE 488...

Versatile, too. 96 ASCII character set is standard. And you can select 6 character sizes, even graphics, under software control. Options include 2K buffering and special character sets.

Service — a big difference. No other printer manufacturer offers Axiom's combination of low cost and nation-wide service and distribution — in the USA and eighteen overseas countries.

Pssst — the price!!! It's low. \$695 for IMP-1. \$795 for IMP-2. And that's the single unit price.

Better phone, write or mail the bingo card today!

AXIOM

AXIOM CORPORATION

5932 San Fernando Road, Glendale, CA 91202
Tel: (213) 245-9244 • TWX: 910-497-2283

The two block-move Z codes, BLMI and BLMD, move data from the location specified by the HL register pair into the location specified by the DE register pair, using the BC register pair as a 16-bit countdown register. BLMI moves the memory block from bottom to top, while BLMD moves from top to bottom. As in the case of the input-block and output-block instructions, these repeat automatically only if the Z-code mnemonic ZRPT is added to the BLMI or BLMD mnemonic. Without the repeat Z code ZRPT, the move will execute only once with appropriate incrementing and decrementing done as usual but looping to be taken care of externally.

To move hexadecimal 1FFF bytes, for example, from the locations ascending from 0000 into the locations ascending from hexadecimal 2000, load register pair BC with hexadecimal 1FFF, register pair HL with hexadecimal 0000, and register pair DE with hexadecimal 2000. Then write:

```
1000 DW BLMI + ZRPT
```

The block-compare instructions (with Z codes BLSI and BLSA) work exactly the same as far as the mnemonics are concerned. The repetition mnemonic, ZRPT, is added only if automatic repetition is wanted. The block compares do not move data; instead, they search for the first memory location that matches the contents of register A. To use the search instructions, register pair HL is initialized to the first location to be

compared and register pair BC to the number of items to be examined.

An exit from an automatic search loop will occur if a match is found or if the counter in register pair BC runs down to 0. The difference in termination can be told by looking at the flags. If register pair BC made it to 0 without a match occurring, the parity flag is set to 0. If a match occurred and caused the exit, the Z flag is set to 1. Thus, a following JZ or JRZ (jump or jump relative on 0) instruction will cause a jump only if a match was found. In Z code, an automatic block-search instruction in the descending direction looks like:

```
1000 DW BLSA + ZRPT
```

Operations on Index Registers

The first two Z-code instructions that will be considered in this article are ZINX and ZDCX, which are the 16-bit analogs of the 8080 instructions INX and DCX:

ZINX, ZINY	increment either the IX or IY register by 1
ZDCX, ZDCY	decrement either the IX or IY register by 1
ZX	added to the above to select the IX register
ZY	added to the above to select the IY register

The ZINX and ZINY instructions are used to increment or decrement the 16-bit index registers. To designate which register, either ZX or ZY is added to one of the two mnemonics. (When referring to index registers IX and IY, the general mnemonics ZX and ZY will be used).

For example, to decrement register IX, write:

```
1000 DW ZDCX + ZX
```

Two more Z80 instructions are POP and PUSH. Since these may occur often, I have assigned an individual Z-code mnemonic to each:

POPX	move data from stack to index register X
POPY	move data from stack to index register Y
PSHX	move data from index register X to stack
PSHY	move data from index register Y to stack

These are 2-byte mnemonics. If you study the symbol table, you will see how to condense the table by defining ZPOP and ZPSH and adding ZX or ZY (which already exist) to them.

The Z-code mnemonics used to exchange the contents of the index registers X and Y with the contents of the location pointed to by the stack pointer are XTIX and XTIY, respectively. These can be condensed to ZXTI + ZX and ZXTI + ZY if desired. XTIX, XTIY, and ZXTI are all 2-byte instructions:

TRS-80 MOD II WORD PROCESSING



The best is now even better...

New Features
New Commands
New Capabilities
New Manual

SPECIAL PACKAGE INCLUDES:

- Wp Daisy™ word processor
- Mail Merge™ mailing list package
- I/OS operating system full CP/M™ & CDOS compatibility

Includes

- Diablo, Spinwriter and Qume support
- Printer spooling
- 30 programs

Contact your dealer of...

InfoSoft
SYSTEMS INCORPORATED
25 SYLVAN ROAD, SOUTH WESTPORT, CONN. 06880
(203) 276-1931

CP/M™
TM of Digital Research

We have the world communicating with **BISYNC-80** Communications Software

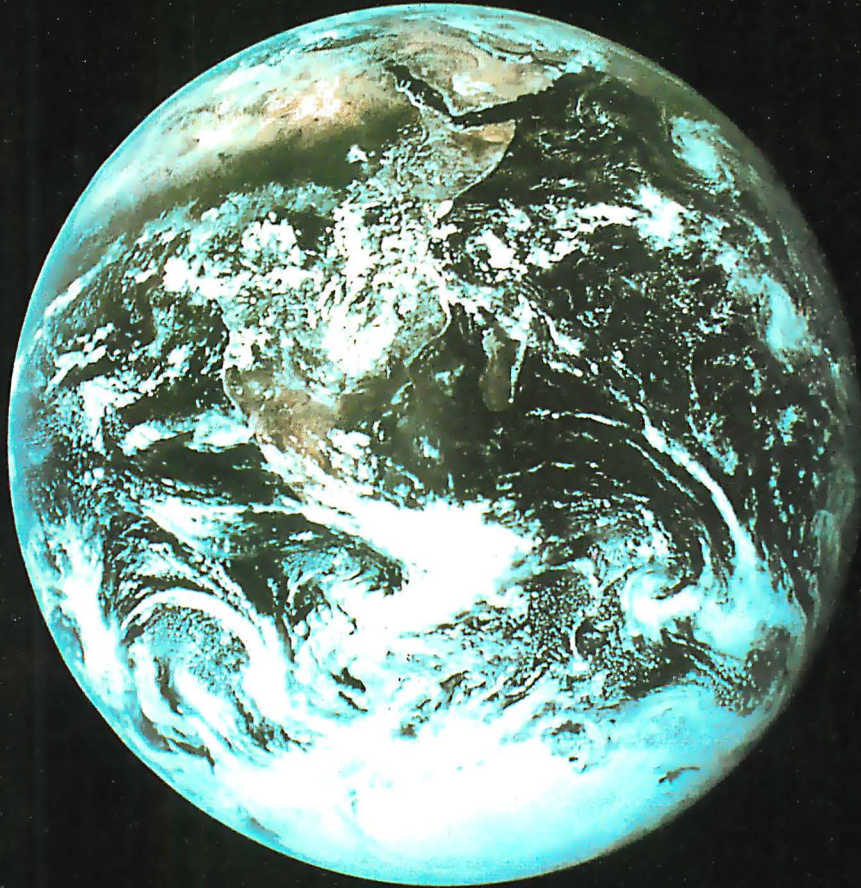

Integrate your 8080, 8085, or Z80 CP/M™ micro-computer into the world of distributed data processing. Communicate with IBM, DEC, HP, DG, or other mainframe in batch or interactive mode. Let your micro do the text editing, source data preparation, and local batch processing, then connect to a mainframe for number crunching and data base access. Imagine the powerful combination of your microcomputer and a large scale machine!

We have the communications software you need!

Batch Communications -

BISYNC-80/3780: A full function IBM 2780/3780 emulator that provides one of the most widely used communications protocols. This software will communicate with any 2780/3780 compatible terminal or mainframe (IBM, DEC, HP, DG, etc.) at up to 19.2K baud. Price - \$550 per license.

BISYNC-80/HASP: A full function Hasp Multi-leaving Workstation package. Supports real or disk file reader, punch, console, and up to two printers. Runs at up to 19.2K baud to drive high speed devices. Runs with any IBM operating system that

supports a Hasp Workstation. Available in July, 1980. Price - \$800 per license.

BISYNC-80/ASYN: An asynchronous communications package that uses the full error correcting BISYNC protocol. Uses inexpensive modems and runs 75 to 19.2K baud. Ideal for micro to micro communications where accurate, error correcting data transfer is required. Price \$95 per license.

Interactive Communications -

BISYNC-80/3270: A full function IBM 3275 or 3271/3277 terminal emulator that converts a "dumb" terminal into a very smart one. Ideally suited to matching transaction oriented IBM systems with the local processing power of a microcomputer. Price - \$550 per license.

Coming Products -

BISYNC-80/SDLC: Packages to support both interactive (3270) and batch (3770) communications using IBM SDLC line protocol will be available soon!

User manuals available separately - \$25 each.

CP/M is a trademark of Digital Research, Inc.



Micro-Integration, Inc.

104 Morris Avenue - P.O. Box 335 - Friendsville, MD 21531 - (301)746-5888

XTIX exchange IX with memory pointed to by stack pointer SP
 XTIY exchange IY with memory pointed to by stack pointer SP
 ZXTI same as XTIX if ZX added, same as XTIY if ZY added

As an example, the following sequence exchanges the top two 16-bit items in the stack (destroying the contents of the IX register):

```
1000 DW POPX
1002 DW XTIX
1004 DW PSHX
```

16-Bit Arithmetic

The Z codes used in this section are:

ZDAX add a register pair to the IX register
 ZDAY add a register pair to the IY register
 ZDAC 16-bit add with carry
 ZDSB 16-bit subtract with borrow
 ZBC added to select BC register pair as source register
 ZDE added to select DE register pair as source register
 ZHL added to select HL register pair as source register
 ZSP added to select the stack pointer as source register

The Z codes ZDAX and ZDAY are analogous to the 8080 instruction DAD. A 16-bit number is added to either the IX or IY register from the register itself, from the stack pointer, or from either the BC or DE register pair; one index register, however, cannot be added to the other, only to itself. As with the DAD instruction, the carry bit is not involved and no flags are affected. The following codes are added to either ZDAX or ZDAY to specify the register or register pair added to the IX or IY register: ZBC (add the BC register pair), ZDE, ZSP, ZIX (used with ZDAX only), ZIY (used with ZDAY only).

For example, to add without carry the DE register pair to the IY register, write:

```
1000 DW ZDAY+ZDE
```

The Z80 also permits 16-bit arithmetic with carry or borrow (ZDAC, ZDSB), limiting the destination register to the HL register pair only. It also limits the source register to the BC, DE, and HL register pairs and the stack pointer (use of the IX or IY register is not permitted).

To subtract the contents of the stack pointer from the contents of the HL register pair, with the carry acting as a borrow bit and all relevant flags affected by the operation, we can write:

```
1000 DW ZDSB+ZSP
```

8-Bit Indexed Arithmetic

The Z80 adds a new addressing mode to the normal

INSTEAD of a catalog, have you ever seen those dreaded words: I/O ERROR?

Track & Sector List™

Is all lost? NO! Now you may be able to save your disk. With this interactive assembly language utility program, which enables the disk to be directly accessed, you can "undelete" a deleted file, protect a bad sector from access, remove invisible control characters embedded in file names, and much more. Because the data

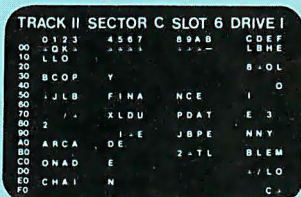

on an entire sector is displayed on one screen-page, it is possible to identify an I/O ERROR and recover from it. The 32-page tutorial manual begins with basic concepts of disk operation and progresses to detail the directory, the VTOC, track bit maps, etc. If you use Track & Sector List only once to recover a lost program, it is worth it! Disk only (32K) 29.95

AppleAids™

Form-It-Out™

A series of routines in Integer Basic and Applesoft containing detailed explanation and examples of programming techniques necessary to format your screen output. Included are cursor positioning and location, right and center justification, text windowing and error subroutines.

Disk (48K) 19.95

Scroll Control™

Have you ever wondered why you cannot list an Integer Basic or Applesoft program one screen-page at a time? So have we, and we did something about it! Our machine language Scroll Control, hidden in RAM so as not to "bump" into your program, can be engaged or disengaged at a flick of the keyboard. Why be frustrated when instead you can control the scroll?

Cassette 9.95 Disk 14.95

Little Tricks™

A series of carefully explained subroutines containing a potpourri of useful programming techniques in Integer Basic and Applesoft, such as specific key stroke identification, timing loops, simple sort, iterative solution, no return key entry, and many more.

Disk (32K) 19.95

Hex and Decimal Learning Tree™ Series

My ABC's and **Now I Can Rhyme** are both early learning Integer Basic programs requiring 48K, incorporating high resolution graphic letters and pictures in a drill-and-practice format. **My ABC's** is designed to develop identification of capital letters with pictures. **Now I Can Rhyme** is designed to develop rhyming skills. Score-keeping capabilities allow adult monitoring of progress. Child tested and teacher recognized. Each program: Cassette . . . 14.95 Disk 19.95

N.J. res. add 5% sales tax
 Add \$1.50/item, shipping and handling
 Apple II, Apple II plus and Applesoft are registered trademarks of Apple Computer, Inc.



software for the Apple II and Apple II plus

P.O. Box 774M
 Morristown, NJ 07960
 (201) 539-3770



MICROSOFT AND TRS-80™ MODEL II. RUNNING THE SHOW.

TRS-80 Model II is designed for professional business applications. Your ultimate goal for your Model II is probably a fast, turnkey system that's easy to use and easy to expand. To get there you need dependable, flexible system software to write the programs that run the whole show.

Microsoft's COBOL-80 and BASIC compilers are now available in versions fully compatible with Model II TRSDOS. You can have either of these universally popular programming languages plus all the advantages of a compiler: faster execution times, compact executable code, security for your programs.

With Microsoft's compiled languages you get a complete program development system, including our standard MACRO-80 Assembler and LINK-80 Linking Loader. Your compiled programs are relocatable modules that can be linked to each other or to Z80 assembly language subroutines.

COBOL-80 Compiler

Microsoft's COBOL-80 is an ANSI-74 standard COBOL that supports such advanced data manipulation verbs as COMPUTE, INSPECT, STRING, UNSTRING, and SEARCH. Plus three-dimension arrays, full COPY facility, compound and abbreviated conditions, and an optional packed decimal format that saves on mass storage by as much as 40%. In addition to Sequential and Relative files, COBOL provides Indexed files, allowing records to be retrieved with a user-specified key instead of a record number.

Interactive Screen Handling Most business applications require machine interaction, formatted screen displays, and the ability to insert and delete information as the machine prompts the user. The COBOL ACCEPT/DISPLAY verbs are implemented for this purpose—to DISPLAY formatted screens and ACCEPT operator input.

CHAIN and Segmentation Ideal for menu-driven application programs is COBOL-80's CHAIN feature. With

```

SHIP TO: ZAKS, ZEPHYRYM
COMPANY: ZAKSWIDG
ADDRESS:
*****
ITEM      QTY      AMOUNT
TOTAL
    
```

COBOL-80 formatted screen display

CHAIN, control is transferred from the menu program to any executable module as specified at runtime. COBOL-80 also supports Segmentation to make maximum use of memory when large programs are executing.

BASIC Compiler

The Microsoft BASIC Compiler has the fastest execution times of any BASIC available. It is language compatible with the Model II's interpreter so you can write and test your programs using the interpreter, then compile them for secure storage and efficient execution.

New BASIC Features In addition to those language features provided with the interpreter, the BASIC compiler supports all the latest features of Microsoft BASIC 5.1: WHILE conditional statement, CALL, long variable names, and ANSI compatibility. Plus the compiler has double precision transcendental functions (SIN, COS, TAN, ATN, LOG, EXP, SQR).

Secure Besides being an indispensable system software tool for developing your own utilities and application programs, the BASIC compiler is ideal for producing programs for resale. The machine code for any application program may be placed on a diskette, ROM, or other media, but the BASIC source program need not be distributed. Thus the original application program is protected from unauthorized alteration.

```

110 I = 4*J: K = (4*J-1) AND &H0FF0
**0025' L00110: LD HL,(J%)
**0028' ADD HL,HL
**0029' ADD HL,HL
**002A' LD (I%),HL
**002D' DEC HL
**002E' LD A,L
**002F' AND FO
**0031' LD L,A
**0032' LD A,H
**0033' AND OF
**0035' LD H,A
**0036' LD (K%),HL
    
```

BASIC compiler object code listing

Optimized Machine Code Compiled BASIC programs are fast and compact due to extensive optimizations performed during compilation:

1. Expressions are reordered to minimize temporary storage and eliminate common subexpressions
2. Constants are folded wherever possible
3. Peephole optimizations are performed
4. The code generator is template-driven, allowing optimal sequences to be generated for the most commonly used operations
5. String operations and garbage collection are extremely fast

Get Microsoft BASIC Compiler or Microsoft COBOL-80 and get serious with your Model II. After all, who's running this show?

Prices for COBOL-80 and BASIC Compiler include the MACRO-80 Assembler and LINK-80 Linking Loader and all documentation. Documentation purchased separately, \$20.

COBOL-80 \$750.
BASIC Compiler \$395.

**For TRS-80 Model II software,
contact Microsoft Consumer
Products.**

MICROSOFT

10800 NE 8th
Suite 819
Bellevue, WA 98004
(206) 455-8080
Telex 328945



We set the standard.

8080 arithmetic instruction. This mode is the calculation of the location in memory to be used as equal to the contents of the IX or IY register plus an 8-bit displacement stored with the instruction. The Z codes are:

ZADD	add contents of memory to accumulator, no carry
ZADC	add contents of memory to accumulator with carry
ZSUB	subtract contents of memory from accumulator, no borrow
ZSBB	subtract contents of memory from accumulator with borrow
ZANA	logical AND of memory with accumulator
ZORA	logical OR of memory with accumulator
ZCMP	compare accumulator to memory location
ZINR	increment contents of memory location by 1
ZDCR	decrement contents of memory location by 1

All the above Z codes, with the exception of ZINR and ZDCR, perform the given operation on the accumulator and the memory location pointed to, with the result being placed in the accumulator. ZINR and ZDCR are used to increment and decrement, respectively, the given memory location. All of the previously mentioned Z codes are completed by adding the Z code for the desired

register (ZX to use the IX register, ZY to use the IY register).

For all ten of these instructions, the DW containing the 2-byte hexadecimal code for the instruction must be followed by a DB containing the 1-byte displacement. To add to the accumulator, for example, a number located at 3 bytes beyond the location pointed to by IX, we write:

```
1000 DW ZADD+IX
1002 DB 3H
```

To increment the memory location 5 bytes beyond the location pointed to by the IY register, we write:

```
1000 DW ZINR+ZY
1002 DB 5H
```

Immediate Indexed Moves

Here, use only one Z code:

```
MVXI    move the immediate byte to the
         specified (indexed) location
```

This instruction causes the processor to move the byte that immediately follows to the memory location specified above by an index register plus a displacement. This instruction involves a total of 4 bytes: 2 for the op code itself, 1 for the immediate displacement, and 1 for the immediate byte to be moved (in that order). Again, the op code is completed by adding either ZX or ZY to the Z code MVXI. The displacement and immediate byte can

Call on JOHN D. OWENS for all of Your Computer Needs.

HAZELTINE 1500\$885
Outstanding reliability. Clearest video image in this price range. Excellent single & quantity pricing. Also available with 50Hz. and French, German, Swedish characters.

IBM CRT 3101\$1,295
9 x 16 dot matrix. Selectric-like keyboard. Works on 50Hz., 220V.

TELEVIDEO Smart CRTs.
Many edit features and remote commands. B models have TTY-like keyboard; C models have Selectric-like keyboards.
912B.....\$745 912C.....\$780
920B.....\$795 920C.....\$850

SOROC IQ 120.....\$865

4116 RAM CHIPS\$10

For Superbrain and TRS-80.
IMS 16K Memory, 250 ns\$340

CALIFORNIA COMPUTER SYSTEMS......\$270
16 K memory, Runs in 4MHz systems.

Call on us for product sheets.
Dealer inquiry invited.
(Prices subject to change without notice.)

IMS 5000 SYSTEM\$2,765
Z-80 CPU, S-100. Runs CPM.* Dual, double density 5/4 drives, 32K RAM.

IMS 8000\$4,185
Like 5000 system but with 8 inch drives. Double sided drives also available.

MARINCHIP 9900 16 BIT CPU\$700
Extensive software package included in price. Text editor and word processor worth over \$500 by itself! Manuals skillfully written.
CPU Kit.....\$550

DRIVES
SIEMENS\$450 **SHUGART** ..\$525
MPI B51\$275 **PER SCI 277**\$1,210
and the beautiful **INNOTRONICS** ..\$525
(John favors the INNOTRONICS for their construction and performance.)

TEI MAINFRAMES
12 slots\$500 22 slots\$670

TEXAS INSTRUMENTS PRINTERS
810\$1,695
820\$1,795 745\$1,075

PAPER TIGER\$945
with graphics\$100

TELETYPE MODEL 43\$985
with RS232.....\$1,085
220 v. transformer, installed\$100
tractor feeder mechanism.....\$100

DEC LA 34.....\$1,159
Plug compatible alternative to the TTY 43

DEC LA 35/36 UPGRADE ...\$750
Increases baud rate to 1200. Micro-processor controlled. Many features including TOF, tabs and margins control. Quantity pricing.

NEC SPINWRITER 5520 ...\$3,275
DIABLO 1640 KSR\$3,195

These prices include tractor
QUME SPRINT 5/55\$3,380

CONTROLLERS
KONAN Hard disk, S-100\$1,550
TELETEK Double density\$415
for 5/4 and 8 inch and single density
TARBELL Double density\$385

MODEM: The CAT from Novation \$179
Originate/answer

CODs accepted at no extra charge.
Shipping: \$13 for light printers and CRTs.
Credit cards add 4%. NY residents add tax.

WE EXPORT

Overseas Callers:

Phone 212 448-6298

or TWX 710 588 2844

or Cable: OWENSASSOC

JOHN D. OWENS Associates, Inc.

12 Schubert Street

Staten Island, New York 10305

212 448-6283 • 212 448-6298

We Are Known for Our Prompt and Courteous Service!

We have no reader inquiry number. Please call or write.



\$10,000.00 GIVE AWAY

SPONSORED BY THE MAKERS OF THE

BASIC SOFTWARE LIBRARY NOW ★ 10 ★ Volumes and Growing

And unlike others we are giving a portion in CASH that you Don't have to spend with us.

You are eligible NOW! Your name may already be entered.

First Prizes Awarded starting in mid September. More details in future advertisements. Our software is UN-EQUALLED in performance and excellence. If you are looking for compatible software to perform useful tasks you won't find a better deal Anywhere in the WORLD!!!

We have over 100,000 in circulation since 1975 and we are still around and That's more than Anyone else can say. We used to sell hundreds of programs individually, the programs in Volume X were sold for several years at over \$10,000, in Volume III for over \$6,000 but a few years ago we decided to promote software to the mass public and it was an instant success. We are still several years ahead of our time in our marketing concepts as well as our products and we are going to be making another major change in the market. We are going to offer our programs in cassette form. NOT just one of two programs like everybody else. But a book full of programs for just \$9.95.

For Homeowners, Businessmen, Engineers, Hobbyists, Doctors, Lawyers, Men and Women

Vol. I \$24.95	Vol. II \$24.95	Vol. III \$39.95	Vol. IV \$9.95	Vol. V \$9.95	Vol. VIII \$19.95	Vol. IX \$19.95	Vol. X \$69.95
Business & Personal Bookkeeping Programs	Animals Four Astronaut Bagel Bio Cycle Cannons Checkers Craps Dogflight Golf Judy Line Up Pony Roulette Sky Diver Tank Teach Me	Binomial Chi-Sq. Coeff. Confidence 1 Confidence 2 Correlations Curve Differences Dual Plot Exp-Distri Least Squares Paired Plot Plotpts Polynomial Fit Regression Stat 1 Stat 2 T-Distribution Unpaired Variance 1 Variance 2 XY.	Beam Conv. Filter Fit Integration 1 Integration 2 Intensity Lola Macro Max. Min. Navaid Optical Planet PSD Rand 1 Rand 2 Sphere Trian Stars Track Triangle Variable Vector	Billing Inventory Payroll Risk Schedule 2 Shipping Stocks Switch	Bingo Bonds Bull Enterprise Football Funds 1 Funds 2 Go-Moku Jack Life Loans Mazes Poker Popul Profits Qubic Rates Retire Savings SBA Tic-Tac-Toe	1040-Tax Balance Checkbook Instol 78 Deprec 2 APPENDIX C Favorites	Auto Cypher Hurrtrac ID Lorana Map Navigate Omega Payroll Bal Sh P/L Year End Data Base Tax Up Basic St.
Bond Building Compound Cyclic Decision 1 Decision 2 Depreciation Efficient Flow Installment Interest Investments Mortgage Optimize Order Perl Tree Rate Return 1 Return 2 Schedule 1 Games & Pictures	A. Newman J.F.K. Linus Ms. Santa Nixon Noel Noel Nude Peace Policeman Santa's Sleigh Snoopy Virgin	APPENDIX A	Vol. VI \$49.95 Mini-Ledger A/R Inventory Peprec. Ledger	Vol. VII \$39.95 Chess Medbil Wdproc Utility	APPENDIX B	APPENDIX C	

Available on TRS-80 Level II — 16K compatible cassette \$9.95
Volume III — Part 1 — Billing Inv. Pyrl.
Volume VII — Part 1 — Chess
Add \$1.00 per tape Post./Handling
Volume VI — Disk programs are compatible with TRS-80 disk basic
The disk programs in Volumes VI, VII and X are written in (CP/M) M Basic and Disk Extended Microsoft Basic. Other programs written in 8K Basic.

SELECTED PROGRAMS AVAILABLE ON CASSETTE

In addition to the \$10,000 Give Away we are going to celebrate July 4th by giving a Special Bonus to purchasers of an entire set of the Basic Software Library on a single order.

★ **SPECIAL BONUS** ★ 15% discounts on single purchase of full set by July 4th, 1980

Unconditional Money Back Guarantee.

Add \$1.50 per volume handling, all domestic shipments sent U.P.S. except APO and P.O. Box which go parcel post. Foreign orders add \$6.00/volume for air shipment and make payable in U.S. dollars only.

AVAILABLE AT MOST COMPUTER STORES

Master Charge and Bank Americard accepted.

Our Software is copyrighted and may not be reproduced or sold.

Unlike others we have NOT raised our prices in five years

Special Bonus Expires July 15, 1980

No PURCHASE Necessary, to enter send name & address on a 3 x 5 card. You are automatically entered every time you make a purchase from us. Void where prohibited by LAW.

KEMCO, LTD.

P.O. Drawer 2208L Petersburg, VA 23803
Sales HOT LINE 800-241-7131 ext. 440
In Georgia call 800-282-2686

IN GERMANY
Ing. W. Hofacker, GmbH
Holzkirchen, W. Germany

IN HOLLAND
Electronica Top Int'l
Den Dolder, Holland

OVER 116,000 IN USE TODAY

If sufficient demand we will make requested programs available for Apple, Atari, Pet, TRS-80, etc.

be represented as two DB pseudo-operations, especially if either or both are to be computed. If both are constants, they can be combined into a single DW word with a hexadecimal constant of nndd, where nn is the immediate byte and dd is the displacement byte. This is done because the DW pseudo-operation reverses the order of the bytes to ddnn before storage.

For example, to move a hexadecimal 80 to the memory location 6 bytes beyond the location pointed to by the IX register, we can say either:

```
1000 DW MVXI+ZX
1002 DB 6H
1003 DB 80H
```

or

```
1000 DW MVXI+ZX
1002 DW 8006H
```

Indexed Register Moves

There are two types of 8-bit move instructions peculiar to the Z80. Their Z codes are:

ZMRX move from register to indexed memory location

ZMXR move from indexed memory location to register

The indexed location is computed as before. The Z-code mnemonics ZMRX and ZMXR may seem confusing but

are consistent with the Z80 convention of listing moves in the order "destination, then source."

To complete these Z codes, both a n index-register symbol (ZX or ZY) and either a source-register or a destination-register symbol must be added. The problem is that the value to be added for the source or destination register differs with the function, necessitating two names for a given register.

Exchanges	DB XAF DB EXX DW XTI (X,Y)
16-bit Moves	DW S(BC,DE,SP,IX,IY)D; DW (ADDRESS) DW L(BC,DE,SP,IX,IY)D; DW (ADDRESS) DW LXI(X,Y); DW (CONSTANT) DW POP(X,Y) DW PSH(X,Y)
16-bit arithmetic	DW ZDA(X,Y) + Z(BC,DE,SP,IX*,IY*) DW ZD(AC,SB) + Z(BC,DE,HL,SP) DW Z(INX,DCX) + Z(X,Y) *: if X, do not use IY; if Y, do not use IX
Interrupt operations	DW I(8080,38,VECT) DW RETI DW RTNM
Input/output	DW Z(INP,OUT) + Zr1* DW (INPI,OUTI,INPD,OUTD) + ZRPT** *: r = A,B,C,D,E,H, or L **: use is optional
Block moves and searches	DW (BLMI,BLMD,BLSI,BLSD) + ZRPT* *: use is optional
Relative jumps	DB (DJNZ,JR,JRNZ,JRZ,JRNC,JRC); DB (DISPLACEMENT)
Indexed jumps	DW JI(X,Y)
Rotates and shifts (indexed)	DW Z(RLC,RRR,RL,RR,SLA,SRA,SRL) + Zs2** DW ZRLD DW ZRRD DW Z(XX,YY); DW Z(RLC,RRR,RL,RR,SLA,SRA,SRL) + KLUGE + (DISPLACEMENT) *: s = A,B,C,D,E,H,L, or M
Bit operations (indexed)	DW Z(BIT,RES,SET) + BITn* + Zs2** DW Z(XX,YY); DW Z(BIT,RES,SET) + BITn + KLUGE + (DISPLACEMENT) *: n = 0,1,2,3,4,5,6, or 7 **: s = A,B,C,D,E,H,L, or M
8-bit indexed arithmetic	DW Z(ADD,ADC,SUB,SBB,ANA,XRA,ORA, CMP,INR,DCR) + Zi*; DB (DISPLACEMENT) *: use ZX or ZY as appropriate
8-bit indexed moves	DW ZMRX + Zr1* + Z(X,Y) DW ZMXR + Z(X,Y) + Zr2* DW ZMXI + Z(X,Y) *: r = A,B,C,D,E,H, or L
8-bit moves	DW ZM(AI,IA,AR,RA)

Table 3: A summary of usage for the Z codes used in this article. Several abbreviations have been used. The terms in parentheses can be replaced with any one of the terms separated by commas. For example, the line "DW XTI (X,Y)" implies two instructions, "DW XTIX" and "DW XTIY".

TOLL FREE ORDERING



These Fine Products and More

NORTHSTAR	ASM	KIT	TERMINAL
HRZ-1-16K-D	1600.	1275.	SOROC IQ-120 760.
HRZ-1-32K-D	1995.	1580.	HAZELTINE 1400 760.
HRZ-2-32K-D	2300.	1900.	HAZELTINE 1500 940.
HRZ-1-32K-Q	2300.	1750.	HAZELTINE 1510 1050.
HRZ-2-32K-Q	2700.	2230.	TELEVIDEO912 700.
			TELEVIDEO920 750.
RAM-16K	365.	325.	PRINTERS
RAM-32K	565.	515.	BASE-2 450.
FPB-A	285.	220.	TI-810 1580.
MDS-A-D	710.	660.	CENTRONICS-799 970.
MDS-A-Q	880.	830.	NEC-5510 2550.
EXTRA DRIVE-D	—	350.	NEC-5520 2800.
EXTRA DRIVE-Q	—	525.	
HARD DISC SYSTEM	CALL		SOFTWARE—DISCS—MISC
Most NorthStar computers come standard with real wood cover, 2 serial ports, 1 parallel port, real time clock, disc operating system and NorthStar basic.			AUTOSCRIBE 325.
			VERBATUM DISCS (10) 28.
			5 FOOTRS-232 CABLE 20.
			10 FOOTRS-232 CABLE 25.

WE WILL TRY TO BEAT ANY ADVERTISED PRICE

A. E. I.

4341 W. Commonwealth Ave Suite D
Fullerton, Calif. 92633
(714) 739-4701 (800) 854-6003

INTRODUCING THE EMULATOR™

The trouble with video terminals today is that most of the low-cost models just don't have the performance to handle your tough applications. And the few that do are usually not compatible with your existing system. But now, Intertec has resolved this age old dilemma with the introduction of its new Emulator™ Video Terminal.

The \$895* Emulator™ performs exactly as you command. With the depression of just a few keys, Emulator users can select terminal control codes of any one of four popular video terminals. The Lear-Siegler ADM-3A. The Soroc 1Q-120. The DEC VT-52. Or the Hazeltine 1500. Incredible! It's like having four terminals for the price of one.

But, best of all, not only does the Emulator replace these terminals, it outperforms them by offering enhanced user-oriented features. Features that those other terminals just don't have - at any price.

Standard Emulator™ features include: a sharp, crisp 12" non-glare screen with a full 24 line by 80 column display. Twin RS232C serial ports - one for the host computer and one for your printer. Four separate cursor control keys. A separate 18 key numeric pad. Keyboard selectable baud rates and operating modes. And, a host of visual attributes.

No matter which dumb or smart terminal you're using today, don't buy another until you check out our new Emulator™. You'll get the

performance of four terminals for the price of one. And you'll probably save hundreds of dollars over the price you paid for your last terminal. Plus, you'll get unparalleled reliability, nationwide service and quick delivery. Call or write us today for all the details. Intertec terminals are distributed worldwide and may be available in your area now.

 **INTERTEC
DATA
SYSTEMS®**

2300 Broad River Rd, Columbia, SC 29210
(803) 798-9100 TWX: 810-666-2115



*Quantity one - Dealer inquiries invited.

For example, Z code ZA1 is added to ZMRX because the accumulator is being used as a destination register; but ZA2 is added to ZMXR because the accumulator is being used as a source register. Generally, we can say that the ZMRX Z code requires a Z code of the form Zr1, where r is one of the following symbols: A, B, C, D, E, H, or L. Similarly, the ZMXR Z code requires a Z code of the form Zr2. The ZX or ZY to be added is the same for both ZMRX and ZMXR.

To move a byte from the memory location that is hexadecimal 17 bytes past the address pointed to by IX to register E, write:

```
1000 DW ZMRX+ZE1+ZX
1002 DB 17H
```

Note that these instructions both require a following data byte for the displacement, which can be a literal (as shown here) or a computed value. One quick rule to tell whether to use Zr1 or Zr2 is as follows: look at the position of the "r" within the last two letters of the instruction mnemonic (ZMXR or ZMRX); if it is first (RX), use Zr1, but if it is second (XR), use Zr2.

Rotate and Shift Instructions

All the rotate and shift instructions, indexed or not, use the following basic Z-code instructions:

```
ZRLC rotate left circular (bit 7 goes into bit 0)
```

```
ZRRC rotate right circular (bit 0 goes into bit 7)
ZRL rotate left with carry (bit 7 goes into carry flag)
ZRR rotate right with carry (bit 0 goes into carry flag)
ZSLA arithmetic shift left, pad with zeros on right
ZSRA arithmetic shift right, pad with sign bit on left
ZSRL logical shift right, pad with zeros on left
```

For register-rotate instructions, we must add to one of the above the Z code named Zs2, where s is the register that is to be rotated or shifted (with value A, B, C, D, E, H, L, or M). The memory location pointed to by the HL register pair can be rotated or shifted by adding the Z code ZM2 to one of the above instructions.

To rotate-left-circular register D, for example, write:

```
1000 DW ZRLC+ZD2
```

When indexed rotates are used, a byte in memory is pointed to by the sum of the contents of an index register (either IX or IY) and a 1-byte displacement value stored with the instruction; it is this byte that is rotated or shifted. However, the structure of this 4-byte instruction does not lend itself easily to this method of using pseudo-operations to represent non-8080 instructions. A detailed explanation is followed by two solutions.

Table 1 contains the previous Z80 instructions in their indexed form. The first byte tells which index register is used for this instruction; it is hexadecimal DD for the IX register and hexadecimal FD for the IY register. The second byte is always hexadecimal CB. The third byte is the 8-bit displacement to be used by the instruction, and the fourth byte identifies the rotate or shift instruction.

The first method of building one of these 4-byte instructions (the method I am currently using) involves building two 2-byte groups with the define-word (DW) instruction. The first word is built by using either the ZXX or the ZYY Z code. This depends on whether the IX or IY register is used to help point to the byte to be operated on. Remember that the DW pseudo-operation reverses the order of bytes before storing them in memory.

The second word is built by creating a double-byte constant that is the sum of the Z-code mnemonic for the desired operation, the displacement, and a constant called KLUGE. This is an unattractive solution, but it is the only way to get the correct information into one line of assembly-language code. Basically, it zeros out the lower byte of the rotate or shift Z code to make room for the displacement byte.

To rotate right with carry the memory location 9 bytes beyond the location pointed to by the IY register, write:

```
1000 DW ZYY
1002 DW ZRR+KLUGE+9
```

A second solution involves building the last 2 bytes

BET, YOU DIDN'T KNOW!

OAE'S new PP-2708/16 PROM Programmer is the only programmer with all these features:

- Converts a PROM memory socket to a table top programmer: No complex interfacing to wire—just plug it into a 2708 memory socket*
- A short subroutine sends data over the address lines to program the PROM
- Programs 2 PROMS for less than the cost of a personality module. (2708s and TMS 2716s)
- Connect 2 or more in parallel—super for production programming
- Complete with DC to DC switching inverter and 10

turn cermet trimmers (for precision pulse width and amplitude alignment)

- All packaged in a handsome aluminum case

PP-2708/16 .. A & T \$325.

PP-2716 (Programs Intel's 2716) A & T \$295.

OAE

Oliver Advanced Engineering, Inc.
676 West Wilson Avenue
Glendale, Calif. 91203
(213) 240-0080

*Pat's Pending



Design-it-Yourself...

... an environment that really challenges your computer programming skills. You're a Systems Programmer and have great ideas that can pave the way for the future — if only you could use them.

How would you like to come to a place where innovation and creativity are not only encouraged but rewarded! A place where you can try your ideas, and where the only boundaries on growth and ambition are those you set yourself.

That place is National CSS, and there you'll find an environment where independent, creative thinkers make things happen ... and make a difference!

If you're a unique, high-performance Systems Programmer we'd like to hear from you. Mail in the coupon below and find out for yourself what National CSS has to offer. Where your new ideas today can pave the way for tomorrow. National CSS is an equal opportunity employer.

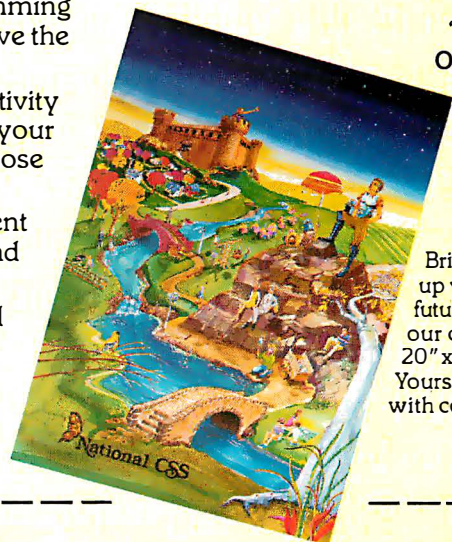

"Land of Opportunity" poster FREE

Brighten up your future with our colorful 20" x 28" poster. Yours free with coupon.

I'd like to know more about National CSS. Please send me your free brochure and poster.

Name: _____ Address: _____

City: _____ State: _____ Zip: _____

National CSS

Mail to: National CSS, Inc.
Dept. ADC 05061, P.O. Box 209,
West Haven, CT 06516

ONE PROGRAM THAT DOES IT ALL!

REPORT

CREATE

LABEL

High Tech's

DATA BASE MANAGEMENT SYSTEM

MODIFY

UPDATE

SORT

DELETE

SELECT

Now you can organize and manipulate large amounts of related data to meet YOUR application needs. DBMS's user-designed system layout and report format allows for wide-range flexibility and utility, making this a truly multi-purpose, highly individualized program.

All this, plus High Technology's unsurpassed combination of performance, clarity, and quality in an affordable program that does it all.

Software
with

HIGH TECHcitement

Exciting business solutions using the Apple II.™ See your dealer or write High Tech for details.



High Technology, Inc.™

P.O. Box 14665 · Oklahoma City, Oklahoma 73113
(405) 840-9900

using two define-byte (DB) pseudo-operations for the displacement and instruction Z code. First define a 1-byte Z code equal to the last byte of the instructions listed in table 1. (For example, set ZZRR equal to hexadecimal 1E for the rotate-right-with-carry instruction.) The previous example given would then take three lines of assembly-language code:

```
1000 DW ZYY
1002 DB 9
1003 DB ZZRR
```

In the first method, the only way I have found to handle negative displacements is to write the displacement as hexadecimal 100 minus the desired negative displacement; the added hexadecimal 100 takes care of the borrow that occurs when the negative-displacement byte is added in by 16-bit arithmetic. In the second method, putting a negative constant in the first DB pseudo-operation should do the trick.

Two unique instructions that belong with the rotate instructions have the following Z codes:

```
ZRLD rotate accumulator and memory location left, decimal
ZRRD rotate accumulator and memory location right, decimal
```

They use a define-word (DW) pseudo-operation and require no added Z codes.

Both instructions act on a byte pointed to by the HL register pair. Given a 16-bit number equivalent to the memory location followed by the accumulator, these instructions rotate left and right, respectively, the 16-bit number by 4 bits. If you consider both bytes as made of two 4-bit *nybbles* (as they are in, say, binary-coded decimal (BCD) arithmetic), the instructions have the effect of rotating 1 nybble within the 4-nybble number. These instructions are useful for BCD arithmetic, for programs dealing with hexadecimal numbers, and for shortening programs that use a large number of shifts or rotates together.

Bit Manipulation Instructions

All the bit instructions, indexed or not, use the following basic Z codes:

```
ZBIT test specified bit
ZRES clear specified bit to 0
ZSET set specified bit to 1
```

For register-bit instructions, two Z codes must be added to one of the above Z-code instructions: one specifies which register is affected (its Z code is Zs2, where s specifies register A, B, C, D, E, H, L, or M); the other specifies which bit is to be affected (its Z code is one of BIT0, BIT1, BIT2, . . . , BIT7). Also, the memory location pointed to by the HL register pair can be used by adding the Z code ZM2 to one of the above instructions.

To test bit 5, for example, in the D register, we write:

```
1000 DW ZBIT+ZD2+BIT5
```

The situation with the indexed version of these instruc-



free freight!



MICROWORLD

New Products

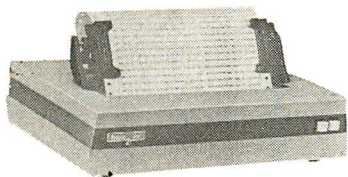

Base 2 Model 800

Lightweight, compact 80-column dot matrix printer with 60 lpm speed. Features 5 print densities and 15 baud rates up to 19,200 baud.

Call for Price!



Texas Instruments 99/4 Color Monitor

High quality 13" color monitor for high-resolution charts, graphs, animated displays, and more! Simple, sure hookup.

Call for Price!

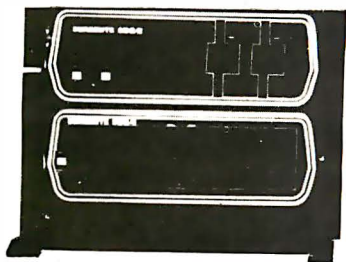

Dynabyte DB8/6

A multi-user, hard disk microsystem with expanded capabilities needed by a growing business! 32, 64 or 96 megabytes of storage.

Call for Price!

MicroWorld® Attacks Inflation With Free Freight, Low Pricing . . .

MicroWorld introduces the most attractive mail-order offer in the computer industry. *The nation's largest inventory*, plus our own automated order processing, allows us to pass along unrivaled cost savings. And now, as an additional measure to counter inflation, we offer *free freight* on any product featured on this page. We'll pay the surface freight on all pre-paid products in this ad, to any of 18,000 U.S. tariffed locations. *No handling charges*, add-on costs, insurance fees or credit card fees! Most items are *in stock* for fast delivery at exceptional discounts!

Call us before you buy anywhere else. Find out *their* total cost. Then compare with our low, freight-free price. Our industry-trained staff stands behind every order. We're *the source you can trust*. We grew up with the microelectronics revolution. We helped pioneer its growth. Our Free Freight program, our attractive pricing, and off-the-shelf delivery are our "thanks" to the thousands of satisfied computer users who made MicroWorld the *world's leading mail-order source* for micro-computers and peripherals!

Soroc IQ 120

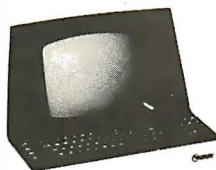

High quality; text editing terminal, 73-key board, built-in 2KRAM, RS232 interface.

\$789

Texas Instruments 99/4 Home Computer



Superior sound, 16-color graphics; low price includes 13" color monitor.

We will try to beat any advertised price!

Comprint GP

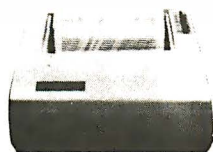

Low priced electrostatic matrix printer, 225 cps; ideal for personal computers, or professional applications requiring second printer.

Call for Price!

TI 810

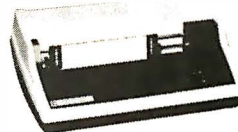

150 cps, RS232 tractors, 3" to 15" form width; bidirectional printing. Also have 820's and 825's.

\$1589

TeleVideo 920B



Low-cost terminal loaded with features: full-function keyboard, 24X80 display, blink, reverse, self-test!

Call for Price!

Okidata MicroLine 80

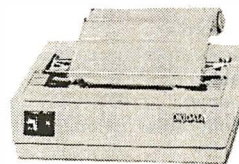

Compact, 80cps printer; 9x7 matrix, 132 col. w/-compressed print, graphics, and more!

Call for Price!

Atari 800



"Timeless" home computer system; expandable memory, full-software library.

Call for Price!

North Star Horizon



Quad- or double-density, while they last! Plus, hard disk drives for expansive storage requirements.

Call for Price!

TOLL-FREE 1-800-528-1418

1425 W. 12 Pl. • Tempe, AZ 85281 • 602-894-1193

Prices subject to change without notice; products subject to availability.

© Copyright 1980 The Phoenix Group, Inc.

tions is very similar to the indexed version for the shift and rotate instructions. However, due to the necessity of specifying a bit position, only the first solution, which uses two DW pseudo-operations to generate 4 bytes, will be discussed. The first DW is exactly the same as before, using the Z codes ZXX or ZYY to indicate use of the IX or IY register, respectively. The second DW is the sum of the Z-code instruction (above), the value of KLUGE, the BITn Z code (where n = 0 thru 7), and the displacement.

To clear bit 2 of the memory location 8 bytes past the location pointed to by the contents of the IX register, we write:

```
1000 DW ZXX
1002 DW ZRES+BIT2+KLUGE+8H
```

Miscellaneous Instructions

Here are some miscellaneous Z80 instructions and their corresponding Z codes:

RETI	return from interrupt
RETN	return from nonmaskable interrupt
I8080	8080-like interrupt (interrupt mode 0)
I38	interrupt to hexadecimal location 0038 (interrupt mode 1)
IVECT	vectored interrupt (interrupt mode 2)
ZMAI	move accumulator to interrupt register
ZMIA	move interrupt register to accumulator
ZMAR	move accumulator to refresh register
ZMRA	move refresh register to accumulator

EXX	exchange registers with alternate registers
XAF	exchange A and F registers with A' and F'
ZNEG	replace value in accumulator with its two's complement

RETI and RETN are the return-from-interrupt Z codes that stand for the Z80 instructions of the same name. I8080, I38, and IVECT are the Z codes for the Z80 instructions IM 0, IM 1, and IM 2, respectively, each corresponding to an interrupt mode available on the Z80.

The Z codes ZMAI, ZMIA, ZMAR, and ZMRA move between the accumulator and either the interrupt register or the refresh register in the Z80 as specified above. EXX changes the B, C, D, E, H, and L registers with their counterparts, B', C', D', E', H', and L'. The Z code XAF exchanges the A and F registers with their counterparts A' and F'. (The F register contains the Z80 flags.)

Finally, the Z code ZNEG replaces the contents of the accumulator with its two's complement.

The Z code EXX is a 1-byte (DB) instruction. All the others listed here are 2-byte (DW) instructions.

Final Remarks

A complete table of the Z codes employed in this article is given in table 2. A summary of the composite Z80 instructions that can be built using the Z codes is presented in table 3. The entire table (or, if you can keep track, only the Z codes you use) must be included with your assembly-language program. I assemble the program *without* the list of Z codes until I have found all the errors that are due to the absence of the Z-code equivalence statements. I then add the Z-code equivalence statements to the end of the program, do a complete assembly (creating the machine-language module), and stop the listing when I get to the Z codes (to save time and paper).

The Z80 microprocessor has a number of powerful instructions and instruction modes that are not on the 8080. I devised the method presented in this article to enable me to use these instructions without having to buy a Z80 assembler. I hope you have found this approach as useful as I have. ■

GENERAL LEDGER PAYROLL ACCOUNTS RECEIVABLE & PAYABLE

Flexible and sophisticated business software that is among the highest quality on the market. Originally developed by OSBORNE & ASSOCIATES and rapidly becoming a standard. Our service is support. We will send you these programs with the proper I/O and CRT specific subroutines for your hardware configuration. Get back to business and leave the programming to us. Include hardware description with order.

- Accounts Receivable and Payable 145.00
- Payroll (California) 145.00
- Non California state tax calculations (please inquire) 15-250.00
- General Ledger 145.00
- Multiple profit center option for G/L 25.00
- Manuals (each) 20.00

All programs in CBASIC under CP/M (includes source)

These programs are up and running on the following computer systems: Altos, TRS-80 MOD II (under CP/M), Northstar, Vector Graphics, Intertec Super Brain, Cromemco, and others.

Synergetic Computer Products

508 University Ave • Palo Alto, CA 94301
(415) 328-5391

Visa • Mastercharge • COD • Certified Check
CP/M is a trademark of Digital Research

BYTE's Bits

Computer Camp

Computer Camp is being held this summer at Rancho Oso, near Santa Barbara, California. Five 2-week sessions will begin June 22 for beginning and advanced students aged 10 thru 15. There will be 2 campers per computer and instruction will cover all aspects of per-

sonal microcomputers. Balancing the program will be Rancho Oso's facilities that include horseback riding, tennis, swimming, and more. For more information and application forms, contact Computer Camp, 1235 Coast Village Rd, Suite G, Santa Barbara CA 93108, (805) 965-7777.

The COMPUTER FACTORY

TO ORDER CALL (212) 687-5000

SUPERBRAIN™

INTERTEC
DATA
SYSTEMS
64K
ONLY
\$2995



32K \$2795

More than an intelligent terminal, the SuperBrain outperforms many other systems costing three to five times as much. Endowed with a hefty amount of available software (BASIC, FORTRAN, COBOL), the SuperBrain is ready to take on your toughest assignment. You name it! General Ledger, Accounts Receivable, Payroll, Inventory or Word Processing... the SuperBrain handles all of them with ease.

FEATURES INCLUDE:

- 2 dual-density minifloppies with 360K bytes of disk storage
- 64K of RAM to handle even the most sophisticated programs
- a CP/M Disk Operating System with a high-powered text editor, assembler and debugger.

NEW Model QD \$3895
With Dual Density/Double Sided Drives with 720K bytes disk storage and 64K RAM

NEW 1980/1981 80 COLUMN PET

Introducing Basic
4.0 Operating
System

- 80 column by 25 line display
- 12" CRT
- New screen editor
- Split screen processing
- Super fast string handling
- 15 additional basic commands
- Supports relative record processing

Model 8016 16K memory **\$1495**
Model 8032 32K memory **\$1795**

AND

NEW 8050 DUAL DISK

- 1 million bytes on-line storage and new DOS 2.0 operating system
- Supports relative record (Random Access)
 - Faster and more reliable

only **\$1695**

CENTRONICS 704



- 180 cps Bi-Directional • Up to 15" Paper Width • 9 x 9 Matrix
- Upper/Lower Case
- Tractor Feed
- RS-232 Serial Interface

\$1895
List \$2500

CENTRONICS 700-9

\$1295 List \$1895

- 60 cps • Up to 15" paper width
- Tractor Feed • Parallel Interface for Apple & TRS-80 • 2 channel vertical forms! • Top of Form!

CENTRONICS (Letter
737 Serial \$995 quality)
737 PARALLEL \$965

CENTRONICS

730 Serial \$845
730 Parallel \$795

Commodore Computer

These low cost Commodore PET Business Computers have virtually unlimited business capabilities. Accounts Receivable, Inventory Records, Payroll, and other accounting functions.

- PET 16N & 32N COMPUTERS**
- Full size keyboard
 - 16 or 32 000 Bytes Memory
 - Level III Operating System
 - Full Screen Editor
 - Upper lower case & 64 graphic characters



\$995



\$1295

- PET DUAL FLOPPY DISK**
- Stores 360 000 Bytes on-line
 - Microprocessor controlled
 - Uses single or dual sided floppies



\$695

- HI-SPEED PRINTER**
- 150 characters per second • Up to 4 copies 8" wide
 - Microprocessor Controlled • Prints All Graphics
 - Full Formatting Capability

PERIPHERALS FOR PET

- 24K Memory Expansion \$499
- 16K Memory Expansion 399
- PET to RS232 Serial 179
- 2 Way Serial/Communication 229
- Modem Board for PET 375
- Analog to Digital Board for 16 Devices 275
- Second Cassette Drive 95

Great PET Software

DATABASE MANAGEMENT SYSTEM—Six modules comprising 48K of programming allows you to: create, edit, delete, display, print, sort, merge, etc.—databases of up to 10,000 records. Printer routines included. 60 Pages of documentation for 16-32K PET and 2040 Dual Disk...
Cost \$125

KRAM—Keyed Random Access Method—The new, ultra-fast access method for the PET Disk, provides keyed retrieval/storage of data, in either direct or sequential mode, by either full or partial key values. 6502 coding
KRAM 1.0 (logical delete) \$79.95 for PET
KRAM 2.0 (physical delete) \$99.95

ANDERSON JACOBSON
841 I/O Terminal Ideal for word processing and small businesses.
Parallel \$1130
Serial \$1230

- ASCII Code
- 15 CPS Printout
- High Quality Electronic Printing
- Reliable heavy duty mechanism
- Completely Refurbished by A.J.
- Delivered FREE to nearest service center

11 Megabyte
Hard Disk
For Apple
\$ 4995



APPLE II PLUS ONLY \$1195

A complete self-contained computer system with APLESOFT floating point BASIC in ROM, full ASCII keyboard in a light weight molded carrying case.

Features Include:

- auto-start ROM • Hi-Res graphics and 15 color video output
 - Expandable to 48K.
- | | | | |
|-------------------------|-------|---------------------------|-------|
| Supertalker | \$279 | Micromodem | \$379 |
| Disk | 595 | Superterm (24 x 80) | 395 |
| Add-on Disk | 495 | Speech lab | 229 |
| Pascal Card | 495 | Communication Card | 225 |
| Business Software | 625 | Modem | 200 |
| Monitor | 159 | Graphics Printer | 595 |
| Printer Card | 180 | Graphics Tablet | 795 |

ATARI Computers & Disks



ATARI.800 **Now In Stock!** ATARI.400
Personal computer Personal Computer



TEXAS INSTRUMENTS
TI-99/4
HOME COMPUTER

Only **\$1095** Includes 13" Color Monitor!

Over 1000 software tapes, books, disks, on display. Come in and browse.

NEW

XYMEC 1000 with QUADRA-PITCH \$2495 • Automatic recall

10, 12, 15 Pitch & Proportional Spacing
The XYMEC HY-Q 1000 is "Tomorrow's Printer" - with virtually every advancement built in as standard. No other options are required. Its versatility matches your output format - and - it can be used as an off-line typewriter

RADIO SHACK • PET • SORCERER • APPLE • COMPCOLOR • ETC. PRINTERS • PRINTERS • PRINTERS

- The COMPUTER FACTORY'S extensive inventory and wide selection of computer printers assures you of finding the printer best suited for your needs and specifications. The following printers work well with all known personal computers.
- | | |
|-----------------------|--------|
| Centronics 779 | \$1095 |
| Centronics 730 | 795 |
| Eaton 7000 | 389 |
| Paper Tiger 440 | 1095 |
| Xerox 1740 | 2895 |

★ FREE

\$35 of Software with purchase of any computer on this page.



Min Credit Card Order \$75



Open Mon.-Fri. 10-6 Sat. 10-4

N.Y. residents add 8% sales tax
• Same day shipment on prepaid and credit card orders • Add \$5 shipping for computers, \$3 for boards, \$1 each cassette tape.

TO ORDER CALL (212) 687-5000

(46th St.)

The COMPUTER FACTORY

485 Lexington Avenue 750 Third Avenue New York, N.Y. 10017
Foreign order desk - Telex 640055

Ask BYTE

Conducted by Steve Ciarcia

Beginning this month Steve Ciarcia will answer questions on any area of microcomputing. The most representative questions received each month will be answered and published. Do you have a nagging problem? Send your inquiry to:

Ask BYTE
c/o Steve Ciarcia
POB 582
Glastonbury CT 06033

Or, if you are a Source subscriber, send your questions to or chat with Steve (TCE317) directly. Unfortunately, because of the high volume of inquiries, individual replies by mail cannot be given. Please clearly mark all such questions with the words "Ask BYTE."

Dear Steve,

I have constructed the remote-keyboard circuit you described in "Come Upstairs and Be Respectable" (May 1977 BYTE, page 50) for use in several instances, and it has been a great help to me. I am presently planning on installing a video terminal and keyboard in our barn (the computer is 3000 feet away, in the house). What type of cable is suitable for this type of project (I may want to bury the cable)?

Randall Busse

Well, I suggest that you bury a twisted-pair shielded cable and use a pair of differential line-drivers and receivers. I have had good results with Texas Instruments' 75107As and 75110As. I have seen lines spanning 10,000 feet that operate quite nicely.

Unfortunately, you did not mention whether you intend to use direct video to drive your monitor, or if you are trying to transmit serial-data logic levels. For a serial terminal, a communications link similar to the one in my article will suffice, but direct video is more difficult to transmit over that distance. You could use video-quality coaxial cable and a video amplifier for this project, or you might try modulating a radio-frequency carrier and use a standard television set at the end of your cable.

Either method will require some experimentation. . . . Steve

Dear Steve,

I enjoyed reading your article in the October 1979 BYTE on light-emitting diode (LED) graphics displays ("Self-Refreshing LED Graphics Display," page 58). If a display were built using optical fibers, how would the price compare with a LED-type display? Can you suggest any references? Can you suggest a circuit board (or a manufacturer) that provides high-resolution color graphics with at least a 256-by-256 pixel display?

Robert Ashworth

I am afraid, Bob, that you are trying to compare apples and bananas. Light-emitting diodes are actually light sources while optical fibers are light conductors. The latter have no self-illuminating capability. You could make my LED graphics display into a fiber-optics display. This would be done by "piping" the emitted light to a remote location using optical fibers. Since LEDs are used in both cases, the fiber optics do not make the display any cheaper.

I hesitate to recommend equipment because graphics depends heavily on the configuration of your computer

system. The personal computer market is so dynamic that any suggestion I might make could be out of date by the time it was published. . . . Steve

[Editor's Note: We are planning to publish articles on the subject of high-resolution color graphics in a future issue of BYTE. Watch for it. . . . CPF]

Dear Steve,

While sitting in my living room last summer watching Hurricane David whirl by, I wanted nothing more than to use my TRS-80 computer. Unfortunately, our power was out for several hours, and when it came back on, my work was complicated with several brief power interruptions. Has anyone developed a combination emergency and uninterruptible power supply suitable for home-computer systems?

My approach to this problem would start with a well-shielded transformer and regulated battery charger. A zener regulator would float-charge a sealed maintenance-free automobile battery at the manufacturer's recommended voltage to ensure long life. Rather than use a square-wave-type inverter, a crystal-controlled 60 Hz oscillator might be more appropriate, driving a 250 W amplifier that would produce a reasonable

approximation of standard AC power. This would provide electricity for my computer and several peripheral devices, including a light bulb.

R B Nottingham

I have been thinking about uninterruptible power quite a bit lately. I first mentioned it in my articles on computer-controlled security for the home in the January thru March 1979 issues of BYTE. (See "Build a Computer-Controlled Security System for Your Home" January 1979 BYTE, page 56; February 1979 BYTE, page 162; March 1979 BYTE, page 150.)

I hesitate to guess at the cost of a 250 W amplifier with a peak output voltage of 176 V. In my own system I have battery backup sufficient for a half hour. The battery is connected directly to the power-supply regulators, and the system shuts down automatically before the power runs out.

The dilemma I face is that everything in my house is electronically controlled, even the wood stove. (See "A Computer-Controlled Wood Stove" February 1980 BYTE, page 62.) My uninterruptible house requires that I walk out to the garage and start my 5 kW propane-fueled generator, while the computer is running under battery power. . . . Steve

Manufacturer

Device Number

Fujitsu	MB 8114
Intersil	7114
Mostek	4114
National Semiconductor	MM 5256
Nippon	μ PB 2114
Signetics	2614
Synertek	SY 2114
Texas Instruments	40L45

Dear Steve,

What programmable-memory parts have the same pinout specifications as Intel's 2114 device?

Edward Savage

According to the Texas

Instruments MOS

Databook, the static memory circuits listed above are pin-for-pin compatible with the Intel 2114. Please note that these devices are available in a variety of operating speeds. . . . Steve ■

People are switching to Boschert

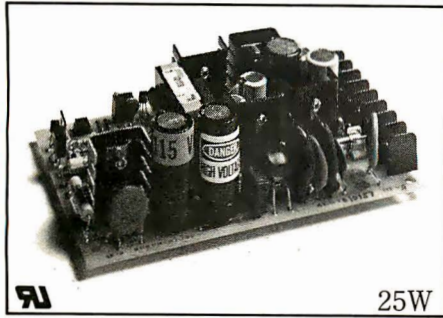

25W



65W

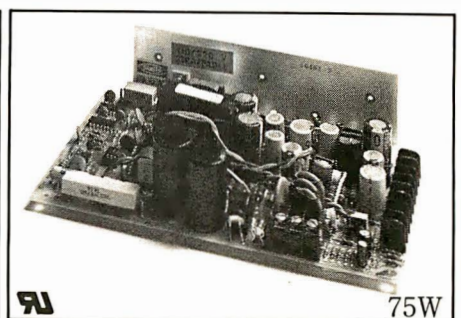

75W

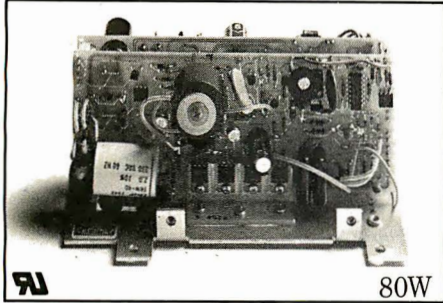

80W

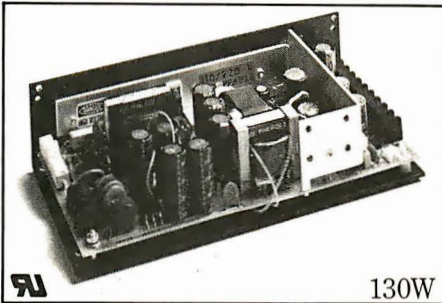

130W

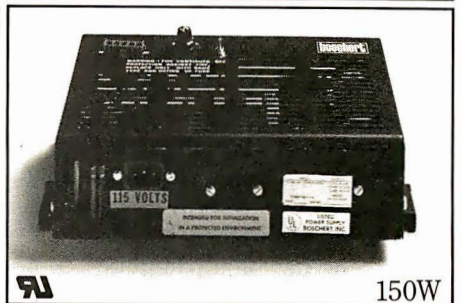

150W

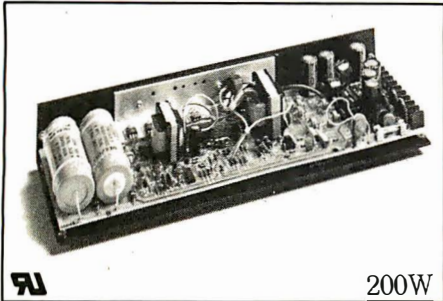

200W

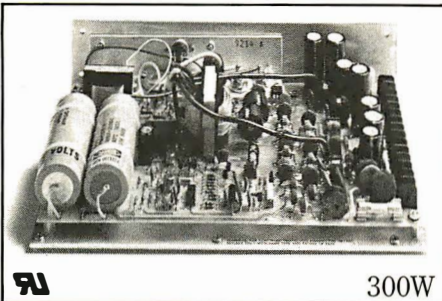

300W

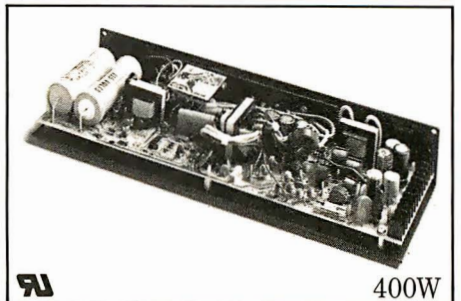

400W

because only Boschert offers a complete line of 25-400 watt switching power supplies.

When you want power, come to Boschert. We're the power leader with more standard 25-400 watt switching power supplies in production and in stock than any other manufacturer. Every one is UL-recognized. Each meets international input voltage requirements. And we offer the multiple output voltages you need to meet your particular system requirements.

Plus, when you switch to Boschert, you enjoy advantages only a leader can offer. Like high volume automated production capabilities to support your volume requirements. Off-the-shelf delivery when you need product fast. Custom tailoring. An up-to-date understanding of VDE requirements. Boschert even offers you an extensive European distribution network to support you overseas.

At Boschert we've been building off-line switching power supplies for almost a decade. Over 200,000 of

our multiple output power systems are now in operation. Isn't it time you made the switch to Boschert?

For more information on our full line of switching power supplies, contact your local Boschert representative, or write: Boschert Inc., 384 Santa Trinita Ave., Sunnyvale, CA 94086. Or call us direct, (408) 732-2440.



My TRS-80 Talks to My Cromemco Z-2

Rod Hallen
Road Runner Ranch
POB 73
Tombstone AZ 85638

Business computers communicate with each other all of the time. This is true whether they are located in adjacent rooms or halfway around the world from each other. You may ask, "Why can't personal computers communicate in the same manner?" Well, they can, and an intercomputer communications scheme is not really that difficult to implement.

I have owned as many as five personal computers at one time, but presently I'm concentrating on my Cromemco Z-2 and Radio Shack TRS-80. My Z-2 is used for word-processing and assembly-language program development; I bought the TRS-80 because it is the most popular machine on the market, and I want to write about the hardware and software for a large number of readers.

The Z-2 supports two ThinkerToys DISCUS 8-inch floppy disks, a fast Malibu 160 line printer, and a lot of other S-100 hardware, using software oriented to the CP/M operating system. The TRS-80 is a 16 K Level II machine with only one peripheral. That peripheral device is the Z-2, and therein lies my story.

Peripheral Devices

It doesn't take personal-computer enthusiasts long to find out that they will very quickly have more money invested in peripherals than in computers. In fact the computer itself is often the least expensive item. This is especially true for systems using printers and mass storage.

Good printers aren't cheap; neither are floppy-disk drives. And yet, the serious experimenter will want both. There are cases, such as mine, where peripherals are needed for two com-

puters. Duplication of peripherals is not a cost-effective solution.

Since the Z-2 already supported everything I needed for the TRS-80, my first thought was about some sort of switching arrangement. This would have allowed the flip of a switch to transfer control of the printer and disks between computers. This sounds like a reasonable solution until you consider the actual implementation. My printer uses two parallel input/output (I/O) ports, and the disk system is oriented for the S-100 bus. Obviously, this means that nearly one hundred signal lines must be controlled. If both ports had been serial RS-232 types, the task might have been possible.

My major need was for hard-copy printouts of TRS-80 programs. It didn't take long to arrive at the idea of simply sending the program listings to the Z-2 and letting the Cromemco machine handle the printing. This scheme turned out to be much simpler than I had anticipated.

Although what follows is a design to interface these two particular com-

puters, I have also included some hints about adapting this scheme to fit almost any situation.

Theory

Figure 1 shows how the two computers are tied together. At the present time, the RS-232 line works in only one direction, from TRS-80 to Z-2. This is because the TRS-80 serial port was originally intended to drive a printer and is not configured to receive. However, it does contain most of the receiver components, which suggests an interesting follow-up project.

First, let us look at the data transmission from the TRS-80. TRS-80 Level II BASIC has two statements, LPRINT and LLIST, which are designed to send information to a printer. Both are similar in operation to PRINT and LIST. The TRS-80 maps the printer I/O port into memory address space as hexadecimal location 37E8. When LLIST or LPRINT is used as a command, the information referred to will be sent to hexadecimal memory address 37E8.

The TRS-80 serial interface must accomplish two things. First, it must decode the printer port address and let the microprocessor know when the next character can be sent. In addition, it must provide parallel-to-serial conversion because I had decided that the communications between the two machines would use the RS-232 format.

Once I had temporarily interfaced an IBM Selectric typewriter and a Teletype Model 43 to the TRS-80, so I already had the required serial printer port. The Radio Shack RS-232 board, which mounts in the expansion inter-

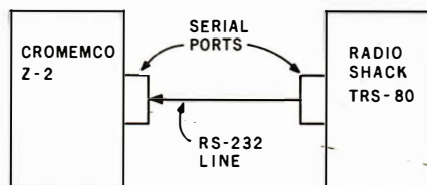

Figure 1: This block diagram of the inter-computer communications channel shows one-way data transfer from the TRS-80 to the Z-2. With the appropriate modifications, the same scheme can be used for other systems.

1. Outlasts every competitor—200,000,000 character head warranty
2. No duty cycle limitations—even in demanding business applications
3. Professional print quality—9 x 7 matrix
4. Rugged business use construction—metal chassis—two motors
5. 80 characters per second
6. Upper and lower case—full 96 character ASCII set
7. Double width characters
8. Connects directly to TRS-80™, APPLE® and other computers
9. Block graphics—64 shapes for charts, graphs, diagrams
10. Friction and pin feed
11. Plain paper—up to 3 parts
12. 6 and 8 lines per inch—program controlled paper savings
13. 80 and 132 columns—program controlled
14. Price—the best value in the industry. Call or write today for the name of your local Microline 80 dealer.



14 REASONS WHY TRS-80™ OWNERS CHOOSE THE MICROLINE 80

All fourteen are standard with every Microline 80. The only options are snap-on tractors and a buffered (up to 2000 characters) RS232 interface.

OKIDATA

Okidata Corporation
111 Gaither Drive, Mount Laurel, New Jersey 08054
Telephone: 609-235-2600

TRS-80 is a registered trade mark of Radio Shack, a division of Tandy Corp.

face, could be used instead.

I set the data-transfer rate at 2400 bps, which is the fastest that my port will run. I have also tried programming the Z-2 to display data as it is received. Unfortunately, 2400 bps is too fast to allow both storing and displaying of the data, so some characters are lost. I have written a routine for the Z-2 which sends incoming data directly to the printer, but I have found it preferable to make a disk file. This allows me to print as many copies as necessary.

Although no software changes of any kind are needed in the TRS-80, the Z-2 must be able to tell when characters are being sent to it and also what it should do with them. The program in listing 1, which I call TRSZ2, continually reads the input port which is being fed with data by the TRS-80. The characters thusly detected are stored in consecutive memory locations starting at hexadecimal 0100.

TRSZ2 is written in 8080 assembly language because it was originally intended for my computer which preceded the Z-2. It may be possible

to improve the efficiency of this routine by using some Z80 instructions, but the limiting factor is still the RS-232-channel transfer rate, so not much would be gained. I hope the 8080 code will be useful to a greater number of readers than any Z80 version.

The TRS-80 does not output a line-feed character after each carriage return because line feeds are inserted automatically by the Radio Shack line printer (ie: the Centronics 779). TRSZ2 must also monitor the data as it is received to add a line feed after each carriage return.

The Z-2 also needs some way to determine when the transmission is concluded. At the end of each TRS-80 program which is to be sent to the Z-2, I add a shift-@ character (hexadecimal 60). When the Z-2 reads the shift-@, the operation is terminated.

Since listing 1 was designed to be used in a CP/M environment, it also performs two other functions. First, a CP/M end-of-file (EOF) character must be added to mark the end of the program stored in memory. CP/M recognizes hexadecimal 1A as the

EOF. Second, CP/M requires that we tell it how many memory pages (ie: groups of 256 bytes) a program occupies before it is saved on disk.

This latter function is accomplished by converting the most significant byte of the storage pointer into two hexadecimal digits. As an example, suppose that the H and L registers contain hexadecimal 0A52 when listing 1 finds the end of the TRS-80 program. Since our storage area starts at hexadecimal address 0100, we have stored hexadecimal 0952 bytes of data ($0A52 - 100 = 0952$), which is more than nine pages and less than ten. CP/M does not consider partial pages, so we round up to the next integer. The H register contains hexadecimal 0A, which is decimal 10.

In the TRSZ2 routine, TEST and TABLE are used to convert the hexadecimal characters to ASCII, and the result is then sent to the screen one character at a time, followed by the message "H PAGES". At this point, in our example, the screen displays "0AH PAGES", and control is returned to CP/M. The transferred data may then be saved on disk by entering the proper CP/M commands.

Once a TRS-80 program has been stored on a CP/M disk, it is necessary only to call a print routine to get a hard copy. I have two ways to do this. If I type a control-P and then enter "TYPE FILENAME. TAB", the entire program will be listed on my printer. TYPE is a CP/M command which sends the specified file to the screen or to the screen and the printer, depending upon whether control-P has been toggled.

The TYPE command has one serious drawback: it does not take page length into account, and it prints continuously until the file has been completely listed. From the CP/M Users Group, I have obtained a program called PRINT which divides a listing up into pages of any desired length, and then titles and numbers each page. The address for the CP/M Users Group is given in a box near the end of this article.

Implementation

The procedure I usually follow is:

1. Write or load the TRS-80 program.

Text continued on page 94

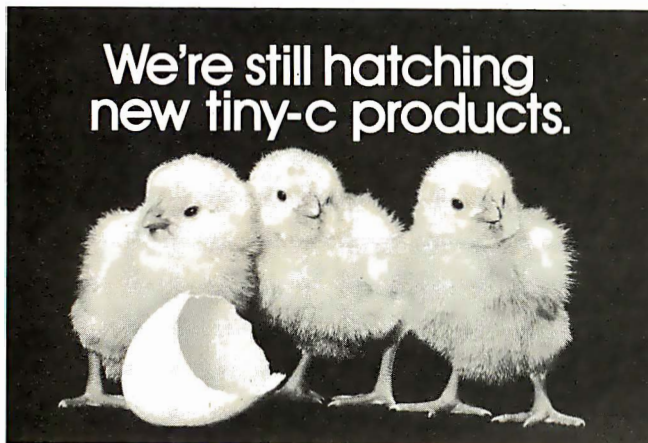

Yes, we're still feathering the tiny-c nest. The tiny-c structured programming language owner's manual (including 8080 and PDP-11 source code and tiny-c in C) is still just \$40. And these formats are now available (all 8080 unless noted): CP/M, PDP-11, H8/H89, HDOS, Flex 2.0 for 6800, Northstar and CDOS for Z80. In cassettes: TRS-80 for Z80, KIM for 6502, CUTS, Tarbell and K.C. Std. Plus we now sell a BDS C Compiler (for CP/M only). Order your tiny-c owner's manual today and get the whole story. Call or write tiny-c associates, P.O. Box 269, Holmdel, N.J. 07733. (201) 671-2296. You'll quickly discover tiny-c is still all it's cracked up to be.

New Jersey residents include 5% sales tax. Visa and MasterCard accepted. Include charge plate number with order.

tiny
C

The VP-111 hobby computer: Start programming for only \$99.

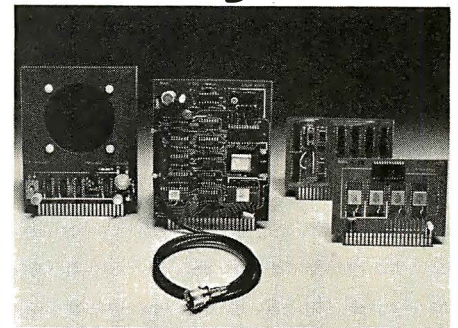
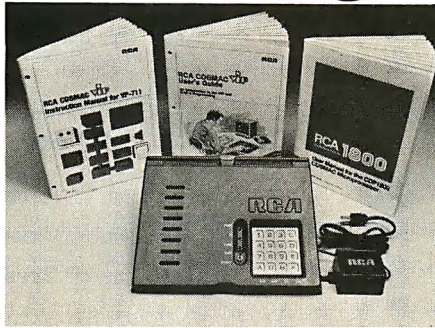
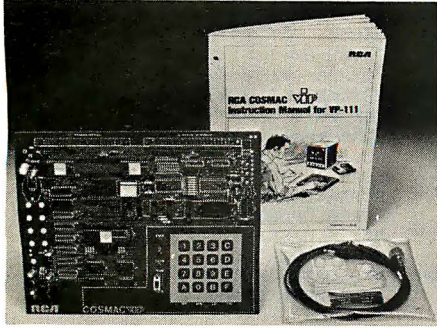

New! VP-111 Microcomputer \$99. Assembled* and tested.

Features:

- RCA 1802 Microprocessor.
- 1K Bytes static RAM.
- Expandable on-board to 4K.
- Expandable to 32K Bytes total.
- 512 Byte ROM operating system.
- CHIP-8 interpretive language or machine language programmable.
- Hexidecimal keypad.
- Audio tone generator.
- Single 5-volt operation.
- Video output to monitor or modulator.
- Cassette interface—100 Bytes/sec.
- Instruction Manual with 5 video game listings, schematics, CHIP-8, much more!

Ideal for low-cost control applications. Expandable to full VP-711 capability with VP-114 Kit.

*User need only connect cables (included), a 5-volt power supply and speaker.

New low price! \$199. VP-711, only..... Completely assembled and tested.

All the features of the VP-111 plus:

- A total of 2K Bytes static RAM.
 - Power supply.
 - 8 Bit input port.
 - 8 Bit output port.
 - I/O port connector.
 - System expansion connector.
 - Built-in speaker.
 - Plastic cover.
- Three comprehensive manuals:
- Instruction Manual—20 video game listings, schematics, much more.
 - User's Guide—operating instructions and CHIP-8 for the beginner.
 - RCA 1802 User's Manual (MPM-201B)—complete 1802 reference guide.

Add computer power a board at a time.

With easy-to-buy options, the versatile RCA hobby computer means even more excitement. More challenges in graphics, games and control functions. For everyone, from youngster to serious hobbyist.

Built around an RCA COSMAC microprocessor, our hobby computer is easy to program and operate. Powerful CHIP-8 interpretive language gets you into programming the first evening. Complete documentation provided.

Send the coupon now...

Complete the coupon below and mail to: RCA MicroComputer Customer Service, New Holland Ave., Lancaster, PA 17604.

Or call toll free (800) 233-0094 to place your Master Charge or VISA credit card order. In Pennsylvania, call (717) 397-7661, extension 3179.



Please send me the items indicated.

- VP-111** New low cost Microcomputer (See description above) \$ 99
- VP-114** Expansion Kit for VP-111—Includes 3K RAM, I/O Port and connectors \$ 76
- VP-711** The original VIP Microcomputer (See description above) \$199
- VP-44** RAM On-Board Expansion Kit—Four 2114 RAM ICs. Expands VP-711 memory to 4K Bytes \$ 36
- VP-590** Color Board—Adds color. Four background and eight foreground colors \$ 69
- VP-595** Simple Sound Board—Provides 256 programmable frequencies. For simple music or sound effects. Includes speaker \$ 30
- VP-550** Super Sound Board—Turns VP-111/711 into a music synthesizer! Two independent sound channels. Outputs to audio \$ 49
- VP-551** 4-Channel Super Sound—Includes VP-576 and demo cassette. Requires VP-550 and 4K RAM \$ 74
- VP-570** Memory Expansion Board—Plug-in 4K RAM memory \$ 95
- VP-580** Auxiliary Keypad—Adds two-player interactive capability. Connects to VP-590 or VP-585 \$ 20
- VP-585** Keypad Interface Board—Interfaces two VP-580 Auxiliary Keypads to VP-111/711 \$ 15
- VP-560** EPROM Board—Interfaces two 2716 EPROMS to VP-111/711 .. \$ 34

- VP-565** EPROM Programmer Board—Programs 2716 EPROMs. With software \$ 99
- VP-575** Expansion Board—Provides 4 buffered and one unbuffered expansion sockets \$ 59
- VP-576** Two-Board Expander—Allows use of 2 Accessory Boards in either I/O or Expansion Socket \$ 20
- VP-700** Tiny BASIC ROM Board—BASIC code stored in 4K of ROM \$ 39
- VP-701** Floating point BASIC for VP-711 on cassette. Requires 16K Bytes RAM (avail. 7/80) \$ 49
- VP-710** Game Manual—Listing for 16 exciting games \$ 10
- VP-720** Game Manual-II—More games .. \$ 15

ASCII keyboards.

- VP-601** Keyboard—128-character ASCII encoded alphanumeric 8-bit parallel output \$ 69
- VP-606** Keyboard—Same as VP-601. Asynchronous serial output \$ 99
- VP-611** Keyboard—Same as VP-601 plus 16-key numeric keypad \$ 89
- VP-616** Keyboard—Same as VP-606 plus 16-key numeric keypad \$119
- VP-620** Cable—Connects VP-601/611 to VP-111/711 \$ 20
- VP-623** Cable—Unterminated for VP-601/611 \$ 20
- VP-626** Connector—Male "D" mates to VP-606/616 \$ 7

Enclosed is \$_____ for items checked plus shipping & handling charge of \$3.00.

Add your state and local taxes \$_____ Total enclosed \$_____

I enclose check or money order. Or charge my VISA Master Charge.

Credit card account No. _____

Master Charge Interbank No. _____ Expiration date _____

Signature (required for credit orders): _____

Name (please type or print): _____

Street address: _____ City: _____

State & Zip: _____ Telephone:() _____

Make checks payable to RCA Corp. Prices and specifications are subject to change without notice.

The subLOGIC FS1 Flight Simulator*



is just one application of our fine graphic software.

Other applications can be yours!

Choose from a coordinated software and hardware collection to fit your graphic needs . . .

SOFTWARE

A23D1 animation package for the Apple II (\$45 on cassette, \$55 for disk).

8080/Z80 3D package for most S100 systems (\$41 on tarbell cassette or paper tape, \$51 on 5" North Star disk, or \$52 on 8" CPM disk).

HARDWARE (S100)

Matrox ALT-256 \$395
Matrox ALT-512 \$595

Write or call for an informative catalog describing these and other graphic products and their easy use in your applications.

Most subLOGIC software is at your dealer's. If he doesn't stock it, order direct from subLOGIC. Add \$1.25 for UPS or \$1.75 for first class mail. Visa and Mastercharge accepted.

*The FS1 Flight Simulator is available for Apple II and TRS-80 Level I & II for \$25 on cassette.

(217) 359-8482

subLOGIC

Box V, Savoy, IL 61874

The engineering and graphics experts.

Listing 1: This routine, called TRSZ2, allows the Cromemco Z-2 to continually read the serial RS-232 input port. Most transfers are completed in a short time.

```

;*****
;* Z-2 PROGRAM TO READ DATA FROM SERIAL *
;* PORT 9 (C1-B12) AND LOAD IT STARTING AT *
;* 100H FOR DISK SAVE. OBJECT: *
;* COMMUNICATIONS WITH THE TRS-80 ! *
;* *
;* ROD HALLEN BOX 73 TOMBSTONE, AZ 85638 *
;* REVISED SATURDAY 9 JUNE 1979 *
;*****

D700 = BEGIN EQU 0D700H ;LOAD ADDRESS OF PROC
0100 = SPSTAT EQU 100H ;STORAGE AREA
0008 = MASK EQU 8 ;SERIAL PORT STATUS
0040 = SPDATA EQU 40H ;BIT 6 MASK
0009 = SPDATA EQU 9 ;SERIAL PORT DATA
F803 = SCREEN EQU 0F803H ;VIO ENTRY POINT
0000 = BOOT EQU 0 ;CP/M WARM START

;
D700 210001 LXI H,BEGIN ;POINT TO STORAGE
D703 DB08 LOOP IN SPSTAT ;GET STATUS PORT
D705 E640 ANI MASK ;CHECK BIT 6
D707 CA03D7 JZ LOOP ;IF NO CHAR, DO AGAIN
D70A DB09 IN SPDATA ;GET DATA PORT
D70C E67F ANI 7FH ;RESET BIT 7
D70E FE60 CPI 60H ;IS IT THE END?
D710 CA21D7 JZ EXIT ;IF SO WE'RE DONE
D713 FE0D CPI 0DH ;IS IT A CR?
D715 C21CD7 JNZ LOAD ;IF NOT, STORE IT
D718 77 MOV M,A ;STORE CR
D719 23 INX H ;POINT NEXT STORAGE LOC
D71A 3E0A MVI A,0AH ;LOAD LF
D71C 77 MOV M,A ;STORE IT
D71D 23 INX H ;POINT NEXT STORAGE LOC
D71E C303D7 JMP LOOP ;GET ANOTHER CHAR

;
D721 360D EXIT MVI M,0DH ;STORE CR
D723 23 INX H ;POINT NEXT STORAGE LOC
D724 360A MVI M,0AH ;STORE LF
D726 23 INX H ;POINT NEXT STORAGE LOC
D727 361A MVI M,1AH ;STORE CP/M EOF

;
D729 3E0D ADDR MVI A,0DH ;LOAD CR
D72B CD03F8 CALL SCREEN ;OUT TO VIDEO
D72E 3E0A MVI A,0AH ;LOAD LF
D730 CD03F8 CALL SCREEN ;OUT TO VIDEO
D733 EB XCHG ;STORAGE POINTER TO DE
D734 7A MOV A,D ;GET MS BYTE
D735 E6F0 ANI 0FH ;RESET BITS 0-3
D737 0F RRC ;MOVE RIGHT 4 BITS
D738 0F RRC ;
D739 0F RRC ;
D73A 0F RRC ;
D73B CD55D7 CALL TEST ;FIG FIRST CHAR
D73E 7A MOV A,D ;GET MS BYTE AGAIN
D73F E60F ANI 0FH ;RESET BITS 4-7
D741 CD55D7 CALL TEST ;FIG SECOND CHAR
D744 2186D7 LXI H,MSG1 ;POINT TO MESSAGE
D747 0609 MVI B,9 ;MESSAGE LENGTH

;
D749 7E MSG MOV A,M ;GET CHARACTER
D74A CD03F8 CALL SCREEN ;OUT TO VIDEO
D74D 23 INX H ;INCREMENT MSG1 ADDRESS
D74E 05 DCR B ;DECREMENT CHAR COUNT
D74F C249D7 JNZ MSG ;GO GET ANOTHER

;
D752 C30000 JMP BOOT

;
D755 2166D7 TEST LXI H,TABLE ;POINT TO TABLE
D758 BE TEST1 CMP M ;DO THEY MATCH?
D759 23 INX H ;INCREMENT TABLE
D75A C262D7 JNZ TEST2 ;NZ=NO MATCH
D75D 7E MOV A,M ;CHAR TO A
D75E CD03F8 CALL SCREEN ;AND OUT TO SCREEN
D761 C9 RET
D762 23 INX H ;INCREMENT TABLE
D763 C358D7 JMP TEST1 ;NEXT CHAR

;
D766 00300131 TABLE DB 0,30H,1,31H ;CHARS IN ODD POSITIONS
D76A 02320333 DB 2,32H,3,33H ;ARE HEX AND THE EVEN
D76E 04340535 DB 4,34H,5,35H ;POSITIONS ARE THE
D772 06360737 DB 6,36H,7,37H ;ASCII EQUIVALENTS
D776 08380939 DB 8,38H,9,39H ;
D77A 0A410B42 DB 0AH,41H,0BH,42H ;
D77E 0C430D44 DB 0CH,43H,0DH,44H ;
D782 0E450F46 DB 0EH,45H,0FH,46H ;

;
D786 482050 MSG1 DB 48H,20H,50H ;H,SP,P
D789 414745 DB 41H,47H,45H ;A,C,E
D78C 530D0A DB 53H,0DH,0AH ;S,CR,LF

D78F END
    
```

"WHAT WOULD YOU SAY TO BIG COMPUTER PERFORMANCE FROM YOUR MICROCOMPUTER?"

"YOU'RE TALKING OUR LANGUAGE: PL/I-80.™"

New PL/I-80 from Digital Research Brings Big Computer Programming Power to Microcomputer Systems.

PL/I-80 is the biggest news for small system users and OEMs since we introduced CP/M® and MP/M. PL/I-80 is ANSI's General Purpose Subset of full PL/I, tailored into a language for 8080, 8085 and Z80 users who expect the software revolution they've seen in hardware—better results at lower cost. PL/I-80 works harder than any other general-purpose language for business, science, research and education.

The PL/I-80 software package includes a native code compiler, comprehensive subroutine library, linkage editor and relocating macro assembler. And it's backed by our CP/M and MP/M operating systems.

Best of all, **the complete PL/I-80 system diskette and documentation costs just \$500.**

PL/I-80: There's no better way to get big-machine results from your 8-bit processor.

Single- and Multi-User Operating Systems That Set Industry Standards.

CP/M is the industry standard operating system for small machines. With thousands of users throughout the world, it's the most popular and widely used. It's the original, hardware-independent 'bus' for users working with a broad array of languages, word-processing and applications software available from scores of suppliers at affordable prices.

Now we've made a great CP/M even better. CP/M 2.2 is the latest release of the efficient, reliable system that's truly universal, able to manage virtually any 8080, 8085 or Z80 micro and its floppy or hard-disk subsystems. Named to the 1979 Datapro Software Honor Roll, CP/M comes on a diskette with its own operating manual, for **just \$150 in unit quantity.**



MP/M provides big-computer power at small-computer cost. It provides multi-terminal access with multi-programming at each terminal. And it's CP/M compatible, so you can run many programming languages, applications packages and development software on your system.

Check these advanced capabilities. Run editors, translators, word processors and background print spoolers simultaneously. Use MP/M's real-time facilities to monitor an assembly line and schedule programs automatically, or control a network of micros. Even write your own system processes for operation under MP/M. The possibilities are endless, **yet MP/M costs just \$300 (unit price for diskette and manual).**

Utilities That Work For You.

Use our utilities. Thousands do. They're designed to make your small system work extra hard, yet they cost surprisingly little.:

- MAC™ (Macro Assembler)—\$90.
- SID™ (Symbolic Instruction Debugger)—\$75.
- ZSID™ (Z80 Symbolic Instruction Debugger)—\$100.
- TEX (Text Formatter)—\$75.
- DESPOOL™ (Background Print Utility)—\$50.

All are supplied on a diskette, with operating manual.

Circle 60 on inquiry card.

Digital Research
P.O. Box 579
801 Lighthouse Avenue
Pacific Grove, CA 93950
408 649-3896
TWX 910 360 5001

 **DIGITAL RESEARCH®**

Text continued from page 90:

2. Append shift-@ to the TRS-80 program.
3. Load TRSZ2 in the Z-2 and execute.
4. LLIST the TRS-80 program.
5. SAVE XX pages on Z-2.
6. PRINT resulting file.

The actual transfer happens very rapidly because of the speed of the RS-232 interface, the disks, and the printer.

Under CP/M, TRSZ2 can be loaded and executed in two different ways. After TRSZ2.ASM has been assembled, the file TRSZ2.HEX will reside on the disk. Typing "DDT TRSZ2.HEX" will load it starting at hexadecimal location D700, and then "GD700" will execute it. TRSZ2 loops continually until characters are detected at the input serial port.

As a preferred alternative, I have a utility routine from the CP/M Users Group called MOVDOWN which greatly simplifies this process. I have modified MOVDOWN so that any program which does not execute at the normal CP/M hexadecimal address of hexadecimal 0100 can be

loaded and executed in the same way as any CP/M command file. My modified routine is called MOVUP.

Other Computers

The basic principles discussed so far will work with other computers, but of course there are some detail changes that must be made. The most important consideration is the availability of a serial I/O port intended for a printer or other peripheral device. The main difference of using a serial port for inter-computer communications, when compared to the usual serial-port peripherals, is the high data-transfer rate possible.

For the receiving end, a great amount of flexibility is possible. When setting up the system, I picked hexadecimal D700 as the location for TRSZ2 because this is free memory outside of the CP/M operating area. I set my CP/M system size at 4 K bytes less than the available user memory to leave room for programs such as this, my printer-driver routine, and others that must run undisturbed during the normal operation of CP/M.

Note that in listing 1, BEGIN is

given the hexadecimal value 0100. This is the beginning of the text storage area, purely an arbitrary choice. I selected 0100 since it is the start of CP/M's disk-SAVE area.

SPSTAT is set to port 8 to indicate the status of my serial port. Whenever bit 6 is nonzero (tested by ANI MASK), a character is ready, and the next step is to read the serial data port (ie: SPDATA EQU 9). The received character is then stored in the memory location pointed to by the H and L registers. Bit masks and ports should be changed to match your particular configuration.

SCREEN defines the output port as my IMSAI VIO-C video interface board. Whenever location F803 is called, the character which is in the A register will appear on the screen. Finally, BOOT calls hexadecimal address 0000, which is the reentry point for CP/M. Substitute your monitor entry point if you are not running CP/M.

On non-CP/M systems you will, of course, need to use whatever tape- or disk-saving procedures are available to you. If this is difficult or undesirable, you might rewrite TRSZ2 so that it sends each character directly to the printer as it is received. In this case, the data-transfer rate must be adjusted to accommodate the slower peripheral device.

Flexibility

While the ability of the Cromemco Z-2 system to provide hard copy for the TRS-80 is a useful and economical feature, there are also many other advantages.

On the Z-2 I am using Microsoft Extended Disk BASIC which will accept TRS-80 Level II programs, except for a few statements. The reverse is also true. It is possible and desirable to write a program on one machine, then send it to the other for whatever modification is necessary. The Z-2 also runs a Z80 assembler and debugger, which could be used to generate assembly-language programs for the TRS-80. All of these will result in enormous flexibility of software design and utilization. ■

The Pascal Software Tool

OMSI PASCAL V1.2™

The value of Pascal in computer software design is becoming widely recognized. And our new V1.2 version contains significant enhancements in ease of operation and reliability. Consider the V1.2 Symbolic Debugger.

Pascal debugging should be performed in Pascal, not with assembler listings and memory maps. Our Debugger knows your data names and structures. Values are accepted and displayed in Pascal notation, including scalars, sets, arrays, records, and pointers.

Complete interactive control displays your original source lines, including embedded comments. Breakpoints give statement numbers and procedure names, rather than octal addresses. The Debugger can show the program execution history, including all stacked procedure calls. Should fatal errors occur, they are intercepted by the Debugger instead of ending your testing.

For more information on our approach, ask for the complete OMSI Pascal V1.2 Product Description.

Oregon Software

2340 S.W. Canyon Road • Portland, Oregon 97201 • (503) 226-7760 • TWX 910-464-4779

INTERNATIONAL DISTRIBUTORS

Australia: Sydney;
Network Computer Services
290-3677

Canada: Vancouver;
Valley Software
(604) 291-0651

England: Stafford;
Hoursds Computing Ltd.
0785-44221

Japan: Tokyo;
Rikei Corporation
03-345-1411

CP/M Users Group
2248 Broadway Suite 34
New York, NY 10024
Send \$4 for membership
and a catalog.

Time is precious Why lose it?

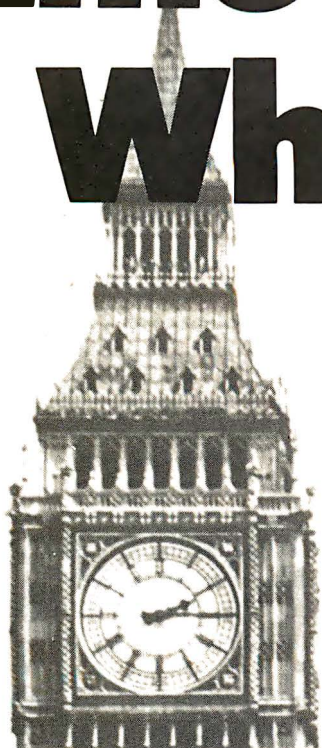

BATTERY SUPPORTED CALENDAR CLOCKS

PDP-11 ¹	TCU-100 • \$495
	TCU-150 • \$460
LSI-11/2 ¹	TCU-50D • \$325
Multi-Bus ²	TCU-410 • \$325
EXORcisor ³	TCU-68 • \$325
HP 2100	TCU-2100 • \$395
Lockheed SUE	TCU-200 • \$550
Naked Mini ⁴	TCU-310 • \$385

If automatic and accurate date and time entry is important to your system on power-up — you need a Digital Pathways battery supported calendar clock. All Digital Pathways' TCUs have on board NICAD batteries to maintain date and time during power down (typically up to



Serial Line Clock . . . SLC-1 • \$640
(RS 232 or 20mA) Microprocessor controlled. Auto message intercept and response. 10 Digit display option \$190.

three months). Timing is provided by a crystal controlled oscillator. Prices are U.S. domestic single piece. Quantity discounts available.

For more information on these timely products, contact:

Digital Pathways Inc.
4151 Middlefield Road
Palo Alto, CA 94306
Phone: (415) 493-5544

¹ Trademark of Digital Equipment Corp.

² Trademark of Intel Corp.

³ Trademark of Motorola Inc.

⁴ Trademark of Computer Automation Inc.



DIGITAL PATHWAYS

Communicating in Two Directions

Mark R Titchener
 40 Oxford St
 Room 230
 Harvard University
 Cambridge MA
 02138

With the prices of microcomputer components becoming ever more attractive, the temptation to sprinkle terminals and peripherals throughout the house is becoming more difficult to resist. Since a computer is more flexible than a telephone, it's not unreasonable to have a bedside terminal (that wakes you in the morning and reminds you of your appointment with the dentist), a terminal in the study for serious work, another remote terminal in the den for the kids to play with safely, and the main system residing in the basement workshop.

The simultaneous and independent transmission of signals in opposing directions through a single line, as

discussed here, has been done for years in communications systems (such as telephone links). I have not seen it applied to remote terminals or processors, so I present the idea along with some obvious applications.

Theory of Matching Bridges

In most systems the transmitters are simple current sources which, in the case of digital transmission, are switched *on* or *off*. Reception of the signals can be made by detecting the presence of a voltage across the nodes of a bridge, as shown in figure 1.

In order for the output signal to be unaffected by the local transmitter, the bridge must be balanced. For a transmission line to handle data

without reflection problems, the bridge network must *terminate* the line with an impedance that closely matches the line's impedance. By definition, the impedance of an ideal current source is infinite; but the receiver impedance must also be high. If the receiver draws too much current, it will affect the bridge balance and impedance.

From the two conditions shown along with figure 1, it is a simple matter to derive the values R_1 and R_2 , in terms of the characteristic impedance R_0 . The relations derived are:

$$R_2 = 2 R_0$$

$$R_1 = \frac{2}{3} R_0$$

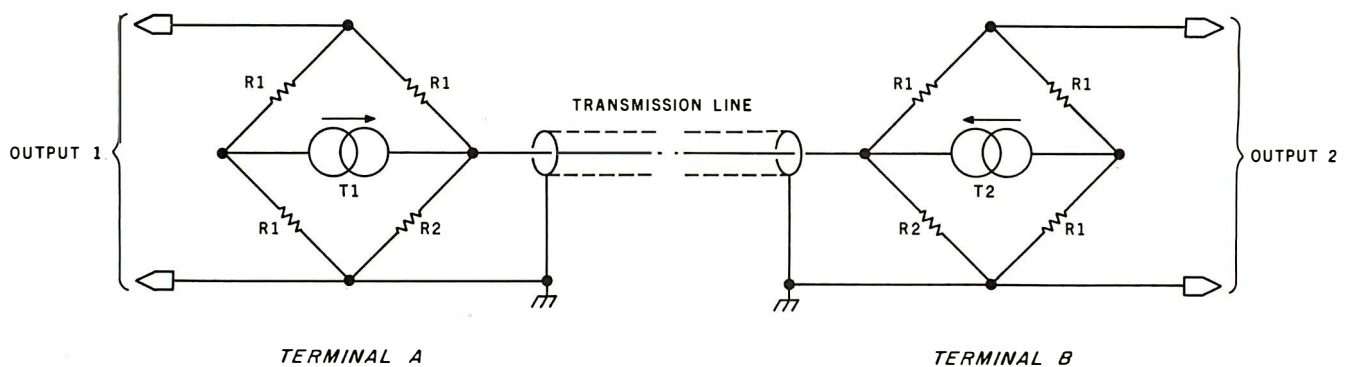

Figure 1: The fundamental transmission scheme. T_1 and T_2 are current sources (ie: transmitters) which may be either on or off. Proper termination of the transmission line is accomplished by the selection of bridge impedances to fit the equation:

$$\frac{1}{R_0} = \frac{1}{R_2} + \frac{1}{3 R_1}$$

where R_0 is the impedance of the transmission line. Solving this equation simultaneously with the bridge balancing equation:

$$\frac{1}{R_1} = \frac{1}{R_0} + \frac{1}{R_2}$$

gives the exact resistance values required.

Your micro-computer deserves the best in data base management

Get the most out of your micro-computer. Use an advanced and progressive data management system...one with many large-computer features...one designed to meet your present and future needs.

HDBS is an extended hierarchical data base system offering

1. fixed length records
2. file-level read/write protection
3. one-to-many set relationships

MDBS is a full network data base system offered as an upgrade from HDBS...or it may be ideal as your initial system. **Unique and versatile**, it adds these features:

4. full network CODASYL-oriented data structures
5. variable length records
6. multiple levels of read/write protection
7. one-to-one, many-to-one, and many-to-many sets
8. non-redundancy of data, easy updating
9. occurrences of a record type may own other occurrences of the same type
10. a single set may have multiple owner and member record types

MDBS-DRS. As an add-on to MDBS, the DRS system offers extraordinary flexibility in data base restructuring to meet new needs.

11. Item, record, and set types can be added, deleted, or renamed in an existing data base as well as other data base characteristics. You can redesign the data base after it is already on-line!

HDBS and MDBS Packages include:

- DDL data definition language analyzer/editor
- 260-page users manual
- DMS data management routines callable from host language
- Sample application program and DDL files
- Relocator to re-org all routines
- System specific manual for bringing up our software



Write or call for free copy of 54-page "primer" on data base systems for micro-computers.

Both HDBS and MDBS Systems...

- a. Run under CP/M (and similar derivatives) with Microsoft BASICs, FORTRAN or COBOL; under North Star DOS with North Star BASIC; under TRSDOS or NEWDOS with TRS Disk BASIC and with Apple DOS and Applesoft BASIC. Machine language callable forms also available.
- b. Up to 254 record-types definable in the data base; each record-type may contain up to 255 item-types; each item-type may be up to 9,999 bytes in length.
- c. Names of data items, records, sets, and files are wholly user definable.
- d. Command to add, delete, update, search, and traverse the data base.
- e. Straightforward use of ISAM-like structures.
- f. Records can be maintained in several sorted orders.
- g. Written in machine language for maximum execution efficiency and minimal memory usage.
- h. Independent of types and sizes of disk drives. Support data base spread over several disk drives (max. 8); disks may be mini- or full-sized floppies or hard disks.
- i. Available in versions Z80 (requires approx. 18K), 6502 (approx. 26K), and 8080 (approx. 22K).

Ordering and pricing information:

HDBS - Z80	\$250.00	MDBS - Z80	\$750.00
HDBS - 6502	325.00	MDBS - 6502	825.00
HDBS - 8080	325.00	MDBS - 8080	825.00
HDBS/MDBS Manual	35.00	MDBS/HDBS Manual	35.00
HDBS - Upgrade to MDBS	550.00	MDBS - DRS add-on	100.00
System Specific Manual (each)	5.00	MDBS - DRS Manual	5.00

For machine language callable forms, add \$75.00

We accept Visa and Master Charge.

When ordering, specify intended use with...

1. North Star DOS and BASIC
2. CP/M - Microsoft BASIC 4.XX
3. CP/M - Microsoft BASIC 5.XX
4. CP/M - Microsoft BASIC Compiler or FORTRAN-80

Add \$2.50 handling fee for non-cash order (\$5.00 outside U.S.).

Indiana residents add 4%.

5. CP/M - Microsoft COBOL-80
6. TRSDOS and TRS Disk BASIC
7. NEWDOS and TRS Disk BASIC
8. CP/M - machine language callable form
9. Apple DOS and Applesoft BASIC
10. (Other versions coming)

Name (please print)	Phone	
Company	Address	
City	State	Zip
Master Charge #	Bank #	
Visa #	Expr. date (either card)	

Finally, our software may cost a little more... but it's worth a lot more in quality and versatility.

Micro Data Base Systems, inc.



Box 248, Lafayette, Indiana 47902 / 317-742-7388

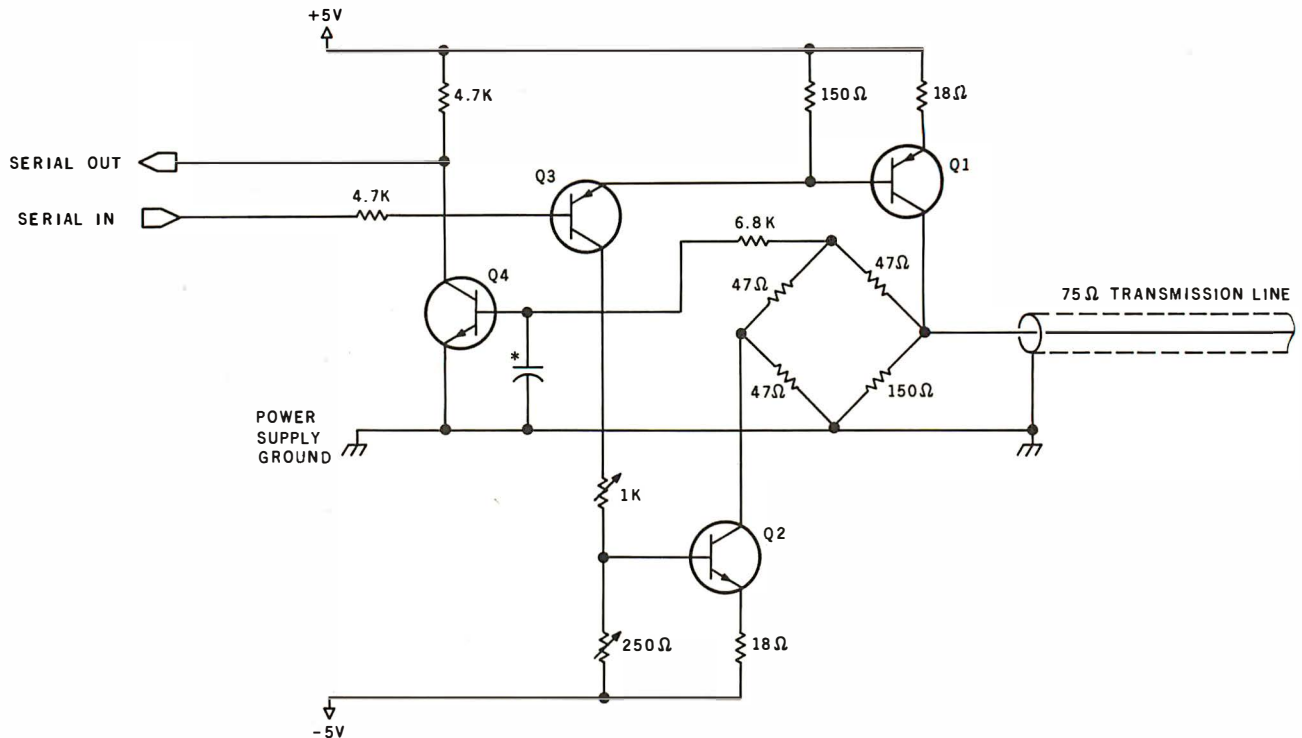

Figure 2: Typical bidirectional line-driver circuit designed for a 75-ohm transmission line. Capacitor marked with an asterisk has a value determined by the data-transfer rate. (See text.)

SUPERPASCAL PLUS!

New Features.
Relocatable Object Modules.
Reduced Compile Time. AND MORE!

Meet our new, improved Pascal/Z™. The true Z-80 compiler that's 5-10 times faster than P-code, and produces ROMable re-entrant code for true multi-tasking capability.

Our new compiler adds features like variant records, strings and random access. Also included are an improved macro-assembler that generates Microsoft-compatible relocatable object modules; a linker/loader and source on the full library. All six programs on a CP/M®-compatible disk, \$395. (Other formats and OEM licenses available.) For more information, call or write.

InterSystems™

Ithaca Intersystems, Inc., 1650 Hanshaw Road/P.O. Box 91,
Ithaca, NY 14850 • 607-257-0190/TWX: 510 255 4346

© 1980, Ithaca Intersystems Inc. CP/M registered trademark of Digital Research

For 75-ohm coaxial line, the values $R_2 = 150$ ohms and $R_1 = 47$ ohms would be about right. Slight imbalance in the bridge may be corrected as will be described later. The impedance of the bridge and cable combination is effectively 73 ohms. It is obvious that some variation may be introduced by the tolerance of the resistors, so you may have to choose the resistors carefully.

The Transmitter/Receiver Circuit

With this configuration in mind, some other arbitrary specifications of the circuit can be chosen. The components specified in figure 2 will be unsuitable for cable impedances other than 75 ohms. The supply voltages were selected as those most likely to be available from the processor or terminal with which the circuit is to be used. In electrically noisy environments, it may be necessary to use higher transmission voltages to hide the interference, in which case higher supply voltages will be required.

Using the 5 V supply, about 2 V is left as a suitable transmission voltage after biasing transistors Q1 and Q2. (The transmission voltage actually varies depending on whether both

SYNCHRO-SOUND

The ORIGINAL Computer People
who KNOW Computers
and offer EVERYTHING you need
in Small Computer Systems



TERMINALS

ADDS Regent 25

LEAR SIEGLER

ADM 3A
ADM 31
ADM 42

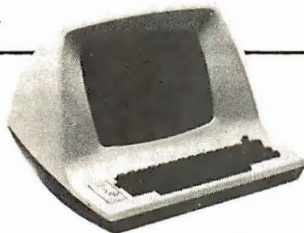

HAZELTINE

1400	1500	Mod 1
1410	1510	Edit
1420	1520	



PRINTERS

QUME Sprint

5/45 KSR
5/55

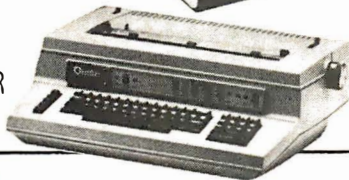

DECwriter IV
LA 34



TELETYPE
43

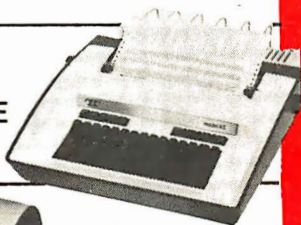

CENTRONICS

779-2 | 703-0
700-2 | 730



A PERFECT
SUPER SPECIAL MATCHED PAIR!



Texas Instrument
810 Multi Copy
Impact Printer
150 characters per sec.
bi-directional printing



Intertec
Super Brain
Computer Terminal
Dble. Density Dual Mini-
Floppies. CPM based
Development or Business System

ONLY \$3995.

COMPUTERS

DIGITAL SYSTEMS

DSC 2
Dble. Density
Dual Drive Disk

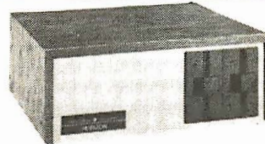
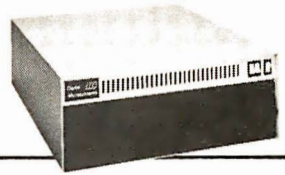

NORTHSTAR
HORIZON II
HORIZON II Quad

CROMEMCO
System 3

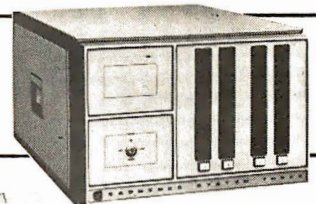

ATARI
400
800

MORE SPECIALS

Okidata SL125	\$2595.00	Livermore Acoustic Coupler	\$195.00
Okidata SL300	2995.00	Centronics Micro Printer	349.00
Persci 277	1395.00	5" Scotch Diskette Box	34.95
Integral Data Systems Paper Tiger Printer	895.00	8" Scotch Diskette Box	39.95
Imsai PCS 80/15	499.00		
Televideo 912, 920	CALL		

MANY OF OUR PRICES ARE TOO LOW
TO ADVERTISE. PLEASE CALL OR WRITE

We carry a full line of Alpha-Micro Products.
We have a full staff of Programmers and Computer
Consultants to design, configure and deliver a Turnkey
Computer System to meet your specific requirements.



SYNCHRO-SOUND

ENTERPRISES, INC.
THE COMPUTER PEOPLE

193-25 Jamaica Ave., Jamaica, New York 11423 • TWX 710-582-5886

PHONE ORDERS, CALL:
New York 212/468-7067
Los Angeles-213/628-1808
Chicago-312/641-3010
Dallas-214/742-6090

No. 13: Commodore

Software for most popular 8080/280* computer disk systems including NORTH STAR, iCOM, MICROPOLIS, DYNABYTE DB8/2 & DB8/4, EXIDY SORCERER, SD SYSTEMS, ALTAIR, VECTOR MZ, MECA, 8" IBM, HEATH H17 & H89, HELIOS, IMSAI VDP42 & 44, REX, NYLAC, INTERTEC SUPER-BRAIN, VISTA V80 and V200, TRS-80* MODEL I and MODEL II, ALTO, OHIO SCIENTIFIC, DIGI-LOG, KONTRON PS180, IMS 5000 diskette formats and CSSN BACKUP cartridge tapes.



CP/M® VERSION 2 FOR TRS-80 MODEL II NOW AVAILABLE

All Lifeboat programs require CP/M, unless otherwise stated.

- CP/M® FLOPPY DISK OPERATING SYSTEM** — Digital Research's operating system configured for many popular micro-computers and disk systems:
- | System | Version | Price |
|---------------------------------|---------|----------|
| North Star Single Density | 1.4 | 145/25 v |
| North Star Double Density | 1.4 | 145/25 |
| North Star Double/Quad | 2.x | 170/25 |
| iCOM Micro-Disk 2411 | 1.4 | 145/25 |
| iCOM 3712 | 1.4 | 170/25 |
| iCOM 3812 | 1.4 | 170/25 |
| Mis 3202/Altair 8800 | 1.4 | 145/25 |
| Heath H8 + H17 | 1.4 | 145/25 |
| Heath H89 | 1.4 | 145/25 |
| Heath H89 by Magnolia | 1.4 | 250/25 |
| TRS-80 Model I | 1.4 | 145/25 |
| TRS-80 Model II | 2.x | 170/25 |
| Processor Technology Helios III | 1.4 | 145/25 |
| Cromenco System 3 | 1.4 | 145/25 |
| Intel MDS Single Density | 1.4 | 145/25 |
| Intel MDS Single Density | 2.x | 170/25 |
| Intel MDS 800 Double Density | 2.x | 200/25 |
| Intel MDS 230 Double Density | 1.4 | 145/25 v |
| Micropolis Mod I | 1.4 | 145/25 v |
- The following configurations are scheduled for release during the first half of 1980:
- | | | |
|-------------------------------------|--------|-----------|
| North Star Double/Quad + Corvus 2.x | 250/25 | |
| North Star Horizon HD-1 | 200/25 | |
| Ohio Scientific C3 | 2.x | 250/25 |
| Ohio Scientific C3-B | 2.x | 250/25 |
| Ohio Scientific C3-C | 2.x | 250/25 |
| Micropolis Mod II | 2.x | 200/25 |
| Mostek MDX STD Bus System | 2.x | 350/25 ** |
| iCOM 3812 | 2.x | 225/25 * |
| iCOM 4511/Portec D3000 | 2.x | 375/25 * |
| TRS-80 Model II + Corvus | 2.x | 250/25 |
- Software consists of the operating system, text editor, assembler, debugger and other utilities for file management and system maintenance. Complete set of Digital Research's documentation and additional implementation notes included. Systems marked * and ** include firmware on 2708 and 2716. Systems marked @ include 5440 media charge. Systems marked @ restore the specific versions of software in this catalog. Systems marked v have minor variants available to suit console interface of system. @ includes hardware addition to allow our standard versions of software to run under it. Call or write for full list of options.
- MP/M* — Intel MDS single density only (Documentation includes CP/M 2.0 manuals) \$300/\$30
-
- Z80 DEVELOPMENT PACKAGE — Consists of: (1) disk file line editor with global and local macros; (2) Z80 relocating assembler, Ziog/Mostek mnemonics, conditional assembly and cross reference table capabilities; (3) linking loader producing absolute Intel hex disk file \$95/\$20
 - ZDT — Z80 Monitor Debugger to break and examine registers with standard Ziog/Mostek mnemonic disassembly displays. \$35 when ordered with Z80 development package \$50/\$10
 - XASM-68 — Non-macro cross-assembler with nested conditionals and full range of pseudo operations. Assembles from standard Motorola MC68000 mnemonics to Intel hex \$200/\$25
 - XASM-65 — As XASM-68 for MOS Technology MCS-6500 series mnemonics \$200/\$25
 - DISTEL — Disk based disassembler to Intel 8080 or TDLXitan Z80 source code, listing and cross reference files, Intel or TDLXitan pseudo ops optional. Runs on 8080 \$65/\$10
 - DISILOG — As DISTEL to Ziog/Mostek mnemonic files. Runs on Z80 only \$65/\$10
 - SMAL/80 Structured Macro Assembler Language — Package of powerful general purpose text macro processor and SMAL structured language compiler. LAMP is an assembler language with IF-THEN-ELSE, LOOP-REPEAT-WHILE, DO-END, BEGIN-END constructs \$75/\$15
 - tiny C — Interactive interpretive system for teaching structured programming techniques. Manual includes source file listings \$105/\$40
 - BDS C COMPILER — Supports most features of language, including Structures, Arrays, Pointers, recursive function evaluation, overlays. Includes linking loader, library manager, and library containing general purpose, file I/O, and floating point functions. Lacks initializers, statics, floats and longs. Documentation includes "The C PROGRAMMING LANGUAGE" by Kernighan and Ritchie \$125/\$20
 - WHITESMITHS C COMPILER — The ultimate in systems software tools. Produces faster code than a pseudo-code Pascal with more extensive facilities. Conforms to the full UNIX* Version 7 C language, described by Kernighan and Ritchie, and makes available over 75 functions for performing I/O, string manipulation and storage allocation. Linkable to Microsoft REL files. Requires 60K CP/M \$630/\$30

MICROSOFT

- BASIC-80 — Disk Extended BASIC, ANSI compatible with long variable names, WHILE/WEND, chaining, variable length file records \$325/\$25
 - BASIC COMPILER — Language compatible with BASIC-80 and 3-10 times faster execution. Produces standard Microsoft relocatable binary output. Includes MACRO-80. Also linkable to FORTRAN-80 or COBOL-80 code modules \$350/\$25
 - FORTAN-80 — ANSI 66 (except for COMPLEX) plus many extensions. Fully relocatable. Includes compiler, linking loader, library with manager. Also includes MACRO-80 (see below) \$425/\$25
 - COBOL-80 — Level 1 ANSI '74 standard COBOL plus most of Level 2. Full sequential, relative, and indexed file support with variable file names. STRING, UNSTRING, COMPUTE, VARYING/UNTIL, EXTEND, CALL, COPY, SEARCH, 3-dimensional arrays, compound and abbreviated conditions, nested IF. Powerful interactive screen-handling extensions. Includes compatible assembler, linking loader, and relocatable library manager as described under MACRO-80 \$700/\$25
 - MACRO-80 — 8080/Z80 Macro Assembler. Intel and Ziog mnemonics supported. Relocatable linkable output. Loader, Library Manager and Cross Reference List utilities included \$149/\$15
 - XMACRO-86 — 8086 cross assembler. All Macro and utility features of MACRO-80 package. Mnemonics slightly modified from Intel ASM86. Compatibility data sheet available \$275/\$25
 - EDIT-80 — Very fast random access text editor for text with or without line numbers. Global and intra-line commands supported. File compare utility included \$89/\$15
 - PASCAL/M* — Compiler generates P code from extended language, implementation of standard PASCAL. Supports overlay structure through additional procedure calls and the SEGMENT procedure type. Provides convenient string handling capability with the added variable type STRING. Untyped files allow memory image I/O. Specify 8080, Z80 or Cromenco when ordering. Requires 56K CP/M \$175/\$20
 - PASCAL/Z — Z80 native code PASCAL compiler. Produces compact, relocatable P code. All interfacing to CP/M is through the support library. The package includes compiler, Microsoft Compatible relocating assembler and linker, and source for all library modules. Variant record strings and string I/O are supported. Requires 56K CP/M and Z80 CPU \$395/\$25
 - PASCAL/MT — Subset of standard PASCAL. Generates ROMable 8080 machine code. Symbolic debugger included. Supports interrupt procedures, CP/M I/O and assembly language interface. Real variables can be BCD software floating point, or AMD 9511 hardware floating point. Version 3 includes Enumeration and Record data types. Manual explains BASIC to PASCAL conversion. Requires 32K \$250/\$30
 - ALGOL-60 — Powerful block-structured language compiler featuring economical run-time dynamic allocation of memory. Very compact (24K total RAM) system implementing almost all Algol 60 report features plus many powerful extensions including string handling, direct disk address I/O etc. Requires Z80 CPU \$199/\$20
 - CBASIC-2 Disk Extended BASIC—Non-Interactive BASIC with pseudo-code compiler and run-time interpreter. Supports full file control, chaining, integer and extended precision variables, etc. \$120/\$15
-
- ### MICRO FOCUS
- STANDARD CIS COBOL — ANSI '74 COBOL standard compiler fully validated by U.S. Navy used to ANSI level 1. Supports many features to level 2 including dynamic loading of COBOL modules and a full ISAM file facility. Also, program segmentation, interactive debug and powerful interactive extensions to support protected and unprotected CRT screen formatting from COBOL programs used with any dumb terminal \$850/\$50
 - FORMS 2 — CRT screen editor. Output is COBOL data descriptions for copying into CIS COBOL programs. Automatically creates a query and update program of indexed files using CRT protected and unprotected screen formats. No programming experience needed. Output program directly compiled by STANDARD CIS COBOL \$200/\$20
-
- ### EIDOS SYSTEMS
- KISS — Keyed Index Sequential Search. Offers complete Multi-Keyed Index Sequential and Direct Access file management. Includes built-in utility functions for 16 or 32 bit arithmetic, string/integer conversion and string compare. Delivered as a relocatable linkable module in Microsoft format for use with FORTRAN-80 or COBOL-80, etc. \$335/\$23

KBASIC

- KBASIC — Microsoft Disk Extended BASIC with all KISS facilities, integrated by implementation of nine additional commands in language. Package includes KISS REL as described above, and a sample mail list program \$555/\$45
 - To license KBASIC — Microsoft BASIC-80 (BASIC) \$435/\$45
 - XYBASIC Interactive Process Control BASIC — Full disk BASIC features plus unique commands to handle bytes, rotate and shift, and to test and set bits. Available in integer, extended and ROMable versions. Integer Disk or Integer ROMable \$295/\$25
 - Extended Disk or Extended ROMable \$395/\$25
-
- BASIC UTILITY DISK — Consists of: (1) CRUNCH-14 — Compacting utility to reduce the size and increase the speed of programs in Microsoft BASIC 4.51, BASIC-80 and TRS-80 BASIC. (2) DPFUN — Double precision subroutines for computing nineteen transcendental functions including square root, natural log, log base 10, sine, arc sine, hyperbolic sine, hyperbolic arc sine, etc. Furnished in source on diskette and documentation \$50/\$35
 - STRING/80 — Character string handling plus routines for direct CP/M BIOS calls from FORTRAN and other compatible Microsoft languages. The utility library contains routines that enable programs to chain to a COM file, retrieve command line parameters, and search file directories with full wild card facilities. Supplied as linkable modules in Microsoft format \$95/\$20
 - STRING/80 source code available separately \$255/NA
 - THE STRING BIT — FORTRAN character string handling. Routines to find, fill, pack, move, separate, concatenate and compare character strings. This package completely eliminates the problems associated with character string handling in FORTRAN. Supplied with source \$65/\$15
 - VSORT — Versatile sort/merge system for fixed length records with fixed or variable length fields. VSORT can be used as a stand-alone package or loaded and called as a subroutine from CBASIC-2. When used as a subroutine, VSORT maximizes the use of buffer space by saving the TPA on disk and restoring it on completion of sorting. Records may be up to 255 bytes long with a maximum of 5 fields. Upper/lower case translation and numeric fields supported \$175/\$20
 - CPM/374X — Has full range of functions to create or re-name an IBM 3741 volume, display directory information and edit the data set contents. Provides full file transfer facilities between 3741 volume data sets and CP/M files \$195/\$10
 - BSTAM — Utility to link one computer to another also equipped with BSTAM. Allows file transfers at full data speed (no conversion to hex), with CRC block control check for very reliable error detection and automatic retry. We use it! It's great! Includes expansion to send *COM, etc. 9600 baud with wire. 300 baud with phone connection. Both ends need one. Standard and @ versions can talk to one another. \$150/\$5
-
- WHATSI? — Interactive data-base system using associative tags to retrieve information by subject. Hashing and random access used for fast response. Requires CBASIC-2 \$179/\$20
 - SELECTOR III-C2 — Data Base Processor to create and maintain multi key data bases. Prints formatted sorted reports with numerical summaries or mailing labels. Comes with sample applications, including Sales Activity, Inventory, Payables, Receivables, Check Register, and Client/Patient Appointments, etc. Requires CBASIC-2. Supplied in source \$295/\$20
 - GLECTOR — General Ledger option to SELECTOR III-C2. Interactive system provides for customized COA. Unique chart of transaction types insure proper double entry bookkeeping. Generates balance sheets, P&L statements and journals. Two year record allows for statement of changes in financial position report. Supplied in source. Requires SELECTOR III-C2, CBASIC-2 and 52K system \$250/\$25
 - CBS — Configurable Business System is a comprehensive set of programs for defining custom data files and application systems without using a programming language such as BASIC, FORTRAN, etc. Multiple key fields for each data file are supported. Set-up program customizes system to user's CRT terminals, etc. Provides last and easy interactive data entry and retrieval with transaction processing. Report generator program does complex calculations with stored and derived data, record selection with multiple criteria, and custom formats. Sample inventory and mailing list systems included. No support language required \$295/\$40

all Micropro prices are discounted!

MICROPRO

- SUPER-SORT I — Sort, merge, extract utility as absolute executable program or linkable module in Microsoft format. Sorts fixed or variable records with data in binary, BCD, Packed Decimal, EBCDIC, ASCII, floating & fixed point, exponential, field justified, etc. Even variable number of fields per record! \$225/\$25
- SUPER-SORT II — Above available as absolute program only \$175/\$25
- SUPER-SORT III — As II without SELECT/EKON/UPZE \$125/\$25
- WORD-STAR — Menu driven visual word processing system for use with standard terminals. Text formatting performed on screen. Facilities for text pagination, page number, justify, center and underscore. User can print one document while simultaneously editing a second. Edit facilities include global search and replace, Read/Write to other text files, block move, etc. Requires CRT terminal with addressable cursor positioning \$449/\$40
- WORD-STAR Customization Notes — For sophisticated users who do not have one of the many standard terminal or printer configurations in the distributed version of WORD-STAR NA/\$95
- WORD-MASTER Text Editor — In one mode has super-set of CP/M's ED commands including global searching and replacing, forwards and backwards in file in video mode, provides full screen editor for users with serial addressable-cursor terminal \$149/\$20
- POLYVUE/80 — Full screen editor for any CRT or XY cursor positioning. Includes vertical and horizontal scrolling, interactive search and replace, automatic text wrap around for word processing, operations for manipulating blocks of text, and comprehensive 70 page manual \$135/\$15
- POLYTEXT/80 — Text formatter for word processing applications. Justifies and paginates source text files. Will generate form letters with custom fields and conditional processing. Support for Daisy Wheel printers to create variable plus justification and motion optimization \$85/\$15
- TEXTWRITER III — Text formatter to justify and paginate letters and other documents. Special features include insertion of text during execution from other disk files or console, permitting recipe documents to be created from variable plus justification on other files. Has facilities for sorted index, table of contents and footnote insertions. Ideal for contracts, manuals, etc. Now compatible with Electric Pencil* prepared files. \$125/\$20

Now applications software for Microsoft's BASIC interpreter!

PEACHTREE SOFTWARE

- GENERAL LEDGER — Records details of all financial transactions. Generates a balance sheet and an income statement. Flexible and adaptable design for both small businesses and firms performing client writeup services. Produced in source code for Microsoft BASIC \$990/\$30
- ACCOUNTS PAYABLE — Tracks current and aged payables and incorporates a check writing feature. Maintains a complete vendor file with information on purchase orders and discount terms as well as active account status. Produces reports as follows: Open Voucher Report, Accounts Payable Aging Report and Cash Requirements. Provides input to PEACHTREE General Ledger. Supplied in source code for Microsoft BASIC \$990/\$30
- ACCOUNTS RECEIVABLE — Generates invoice register and complete monthly statements. Tracks current and aged receivables. Maintains customer file including credit information and account status. The current status of any customer account is instantly available. Produces reports as follows: Aged Accounts Receivable, Invoice Register, Payment and Adjustment Register and Customer Account Status Report. Provides input to PEACHTREE General Ledger. Supplied in source code for Microsoft BASIC \$990/\$30

Prices and specifications subject to change without notice.

Everything on #13 runs on 64K TRS-80 Model II

CONDIMENTS

- PAYROLL** - Prepares payroll for hourly, salaried and commissioned employees. Generates monthly, quarterly and annual returns. Prepares employee W-2's. Includes tables for federal withholding and FICA as well as withholding for all 50 states plus up to 20 cities from pre-computed or user generated tables. Will print checks, Payroll Register, Monthly Summary and Unemployment Tax Report. Provides input to PEACHTREE General Ledger. Supplied in source code for Microsoft BASIC. \$990/\$30
- INVENTORY** - Maintains detailed information on each inventory item including part number, description, unit of measure, vendor and reorder data, item activity and complete information on current item costs, pricing and trends. Procedures reports as follows: Physical Inventory Worksheet, Inventory Price List, Departmental Summary Report, Inventory Status Report, The Reorder Report and the Period-to-Date and Year-to-Date reports. Supplied in source code for Microsoft BASIC. \$1190/\$30

GRAHAM-DORIAN SOFTWARE SYSTEMS

- GENERAL LEDGER** - An on-line system; no batching is required. Entries to GRAHAM-DORIAN accounting packages are automatically posted. User establishes customized C.O.A. Provides transaction register, record of journal entries, trial balances and monthly closing reports. Reports as follows: Provides comparison of current year with previous year. Requires CBASIC-2. Supplied in source \$995/\$35
- ACCOUNTS PAYABLE** - Maintains vendor list and check register. Performs cash flow analysis. Flexible - writes checks to specific vendor for certain invoices or can make automatic. Automatically posts to GRAHAM-DORIAN General Ledger or runs as stand alone system. Requires CBASIC-2. Supplied in source \$995/\$35
- ACCOUNTS RECEIVABLE** - Creates trial balance reports, prepares statements, ages accounts and records invoices. Provides complete information describing customer payment activity. Receipts can be posted to different ledger accounts. Entries automatically update GRAHAM-DORIAN General Ledger or runs as stand alone system. Requires CBASIC-2. Supplied in source \$995/\$35
- PAYROLL SYSTEM** - Maintains employee master file. Computes payroll withholding for FICA, Federal and State taxes. Prints payroll register, checks, quarterly reports and W-2 forms. Can generate ad hoc reports and employee form letters with mail labels. Requires CBASIC-2. Supplied in source \$590/\$35
- INVENTORY SYSTEM** - Captures stock levels, costs, sources, sales, ages, turnover, markup, etc. Transaction information may be entered for reporting by salesperson type of sale, date of sale, etc. Reports available both for accounting and decision making. Requires CBASIC-2. Supplied in source \$590/\$35
- JOB COSTING** - Designed for general contractors. To be used interactively with other GRAHAM-DORIAN accounting packages for tracking and analyzing expenses. User establishes customized cost categories and job phases. Permits comparison of actual versus estimated costs. Automatically updates GRAHAM-DORIAN General Ledger or runs as stand alone system. Requires CBASIC-2. Supplied in source \$995/\$35
- APARTMENT MANAGEMENT SYSTEM** - Financial management system for receipts and security deposits of apartment projects. Captures data on vacancies, revenues, etc. for annual trend analysis. Daily report shows late rents, vacancy notices, vacancies, income lost through vacancies, etc. Requires CBASIC-2. Supplied in source \$990/\$35
- CASH REGISTER** - Maintains files on daily sales. Files data by salesperson and item. Tracks sales, over-rings, refunds, payouts and total net deposits. Requires CBASIC-2. Supplied in source \$590/\$35
- POSTMASTER** - A comprehensive package for mail list maintenance that is completely menu driven. Features include: mail tracking and label production. A form letter program is included which provides neat letters on single sheet or continuous forms. Compatible with NAD files. Requires CBASIC-2 \$150/\$15

STRUCTURED SYSTEMS GROUP

- GENERAL LEDGER** - Interactive and flexible system providing proof and verification of each transaction of COA created interactively. Multiple branch accounting centers. Extensive checking performed at data entry for proof, COA correctness, etc. Journal entries may be batched prior to posting. Closing procedure automatically balances all accounts. Includes Statement of Changes in Financial Position. Requires CBASIC-2 \$1250/\$25
- ACCOUNTS RECEIVABLE** - Open item system with output for internal aged reports and customer-oriented statement and billing purposes. Online inquiry permits termination for Customer Service and Credit departments. Interface to General Ledger provided if both systems used. Requires CBASIC-2 \$1250/\$25
- ACCOUNTS PAYABLE** - Provides aged statements of accounts by vendor with check writing for labels and invoices. Can be used alone or with General Ledger and/or with NAD. Requires CBASIC-2 \$1250/\$25
- PAYROLL** - Flexible payroll system handles weekly, bi-weekly, semi-monthly and monthly payroll periods. Tips, bonuses, re-imbursments, advances, sick pay, vacation pay, and compensation time are all part of the payroll records. Prints government required periodic reports and will post to multiple SSG General Ledger accounts. Requires CBASIC-2 and 54K of memory \$1250/\$25
- INVENTORY CONTROL SYSTEM** - Performs control of functions of adding and deleting items, including new items and deleting old items. Tracks quantity of items on hand, on order and back-ordered. Optional hard copy audit trail is available. Reports include Master Item Legend, Customized Reports, Valuation and Re-order List. Requires CBASIC-2 \$1250/\$25
- ANALYST** - Customized data entry and reporting system. User specifies up to 75 data items per record. Interactive data entry, retrieval, and update facility makes information management easy. Sophisticated report generator provides customized reports using selected records with multiple level break-points for summarization. Requires a disk sort utility such as OSORT, SUPER-SORT or VSORT and CBASIC-2 \$250/\$15
- LETTERIGHT** - Program to create, edit and type letters and other documents. Has facilities to enter, display, delete and move text, with good video screen presentation. Designed to integrate with NAD for form letter mailings. Requires CBASIC-2 \$200/\$25
- NAD Name and Address Selection System** - Interactive mail list creation and maintenance program with output as full reports with reference data or restricted information for mail labels. Transfer system for extraction and transfer of selected records to create new files. Requires CBASIC-2 \$100/\$20
- OSORT** - Fast sort/merge program for files with fixed record length, variable field length information. Up to five ascending or descending keys. Full back-up or input files created \$100/\$20

- HEAD CLEANING DISKETTE** - Cleans the drive Read/Write head in 30 seconds. Diskette absorbs loose oxide particles. Fingerprints, and other foreign particles that might hinder the performance of the drive head. Lasts at least 3 months with daily use. Specify 5" or 8".
Single sided \$20 each/\$55 for 3
Double sided \$25 each/\$55 for 3
- FLOPPY DISK KIT** - Template and instructions to modify single sided 5 1/4" diskettes for use of second side in single sided drives \$12.50
- FLOPPY SAVER** - Protection for center holes of 5" and 8" floppy disks. Only 1 needed per diskette. Kit contains centering post, pressure tool and tough 7 mil mylar reinforcing rings for 25 diskettes. \$14.95
5", Rings only \$7.95
8", Kit \$16.95
8", Rings only \$8.95
- PASCAL USER MANUAL AND REPORT** - By Jensen and Wirth. The standard textbook on the language. Recommended for use by Pascal/Z, Pascal/M and Pascal/MT users \$10
- THE C PROGRAMMING LANGUAGE** - By Kernighan and Ritchie. The standard textbook on the language. Recommended for use by BDS C, Tiny C, and Whitesmiths C users \$12
- STRUCTURED MICROPROCESSOR PROGRAMMING** - By the authors of SMAL/80. Covers structured programming, the 8080/8085 instruction set and the SMAL/80 language \$20
- ACCOUNTS PAYABLE & ACCOUNTS RECEIVABLE** - CBASIC - By Osborne/McGraw-Hill \$20
- GENERAL LEDGER** - CBASIC - By Osborne/McGraw-Hill \$20
- LIFEBOAT DISK COPYING SERVICE** - Transfer data or programs from one media format to another at a moderate cost from \$25

Hearty Appetite.

*CP/M and MP/M are trademarks of Digital Research. Z80 is a trademark of Zilog, Inc. UNIX is a trademark of Bell Laboratories. WHATSIT? is a trademark of Computer Headware. Electric Pencil is a trademark of Michael Shayrer Software. TRS-80 is a trademark of Tandy Corp. Pascal/M is a trademark of Sorcim.

Recommended system configuration consists of 48K CP/M, 2 full size disk drives, 24 x 80 CRT and 132 column printer.

Modified version available for use with CP/M as implemented on Health and TRS-80 Model I computers.

User license agreement for this product must be signed and returned to Lifeboat Associates before shipment may be made.

This product includes/excludes the language manual recommended in Condiments.

Ordering Information

MEDIA FORMAT ORDERING CODES
When ordering, please specify format code.

Computer system	Format Code	Computer system	Format Code
Altair 8800 Disk	See MITS 3200	Processor Technology Helios II	A1
Altos	A1*	RAIR Single Density	R9
Apple + Microsoft SoftCard	R6	RAIR Double Density	RE
BIS/RAW Single Density	O5	Research Machines 5V 1/4"	RH
Blackhawk Micropolis Mod II	O2	Research Machines 5V 1/2"	OH
CDS Versatile 30	O1	REX	O3
CDS Versatile 30	O1	Sarcorer	A1*
COMPAL-80	O2	SD Systems 5V 1/4"	R3
Cromcom System 3	A1*	See Exidy Sarcorer	
Cromcom 212	R6	See Exidy Sarcorer	
CS5N BACUP (tape)	T1	Superbrain	See Intertec
Delta	A1*	Terbell	A1*
Delta 89 + Microtel CP/M	R0	TEI 8"	A1*
Digital Microsystems	A1*	TEI 6"	A1*
Discus	See Morrow Discus	Thinkertoy	See Morrow Discus
Durango F-85	R6	TRS-80 Model I	R2
Dynabyte DB8/2	R1	TRS-80 Model I + Micromaloc	A4*
Dynabyte DB8/4	A1*	TRS-80 Model I + Omikron 5V 1/4"	RM
Exidy Sarcorer + Lifeboat CP/M	O2	TRS-80 Model I + Omikron 8"	A1
Exidy Sarcorer + Exidy CP/M	O4	TRS-80 Model I + Shuttleboard 8"	A1
Health 89 + H17/H27	P4	TRS-80 Model II	A1
Health 89 + Lifeboat CP/M	P4	VDP-40/42/44/48	See IMSAI
Health 89 + Magnolia CP/M	P7	Vector MZ	O2
Helios II	See Processor Technology	Versatile	See CDS Versatile
Horizon	See North Star	Vista V85 5 1/4" Single Density	P5
ICOM 2411 Micro Floppy	R3	Vista V200 5 1/4" Double Density	P5
ICOM 3712	A1*	Zenith 289 Lifeboat CP/M	P7
ICOM 3812	A1*	Zenith 289 Magnolia CP/M	P7
ICOM 4511 5440 Cartridge CP/M 14 D1			
ICOM 4511 5440 Cartridge CP/M 22 D2			
IMS 3000	R4		
IMS 8000	A1*		
IMSAI VDP-40	R4**		
IMSAI VDP-42	R4**		
IMSAI VDP-40	R4**		
IMSAI VDP-42	R4**		
IMSAI VDP-80	A1**		
Intel MCS Single Density	A1		
Intertec Super-Brain DOS 0.1	R7		
Intertec Super-Brain DOS 0.6-2.X	RJ		
Intertec Super-Brain DOS 3.X	RK		
Kontron PSI-80	RF		
Meca	P6		
Micromation (Except TRS-80 below)	A1*		
Micropolis Mod I	O1		
Micropolis Mod II	O2		
MITS 3200/3202	R1		
Morroe Discus	A1*		
Mositek	A1		
MSD 5 1/4"	RC		
North Star Single Density	P1		
North Star Double/Dquad	P2		
Nylac Single Density	O3		
Nyvac Micropolis Mod. II	O2		
Ohio Scientific	A3		
Petec PCC 2000	A1*		

Prices F.O.B. New York. Shipping, handling and C.O.D. charges extra. Manual cost applicable against price of subsequent software purchase. The safe of each proprietary software package conveys a license for use on one system only.



transmitters T1 and T2 are in their on state.)

When a high input level causes Q3 to conduct, about 10 mA of current flows through the base resistors of Q1 and Q2. This biases each base at about 1.5 V with respect to the corresponding supply rails and defines the emitter resistor voltages at Q1 and Q2 to be 1 V. Thus, with a high input level, about 50 mA will be available from the collectors of Q1 and Q2. The two collectors of these transistors form the source and sink of the current transmitters, T1 and T2, shown in figure 1.

With the resistances given for R1 and R2, the voltage developed by the current source T1 is about 2 V at the cable. If the current sources at each end of the line are in the on state, this voltage rises to about 3.6 V. However, the voltage sensed by each receiver is about 1.2 to 1.3 V, with very little variation. When both T1 and T2 are on, no current flows in the transmission line.

The transistor Q4 is switched through a 6.8 k-ohm resistor which limits the base current to about 0.1 mA. This provides ample current for switching the output, and the 6.8 k-ohm resistor is of sufficiently high impedance to be ignored in the bridge balance and cable termination calculations. The output at the collector of Q4 is transistor-transistor-logic (TTL) compatible as is the input at the base of Q3.

The balance of the current source and current sink is crucial to good performance, and is adjusted using the 250-ohm potentiometer at the base of Q2. The 1 k-ohm bias-current control, used in setting up the base voltages of Q1 and Q2, should be adjusted to give 2 V at the cable connection. It will be found that this adjustment is not entirely independent of the balance adjustment; it may be necessary to readjust each to obtain proper operation.

Some immunity to noise and to the glitches produced by slight imbalance in the switching characteristics of Q1 and Q2 is given by the capacitor at the base of Q4. This value should be calculated to filter any frequencies greater than the third harmonic of the chosen data rate. The appropriate formula is:

$$c = \frac{1}{188f}$$

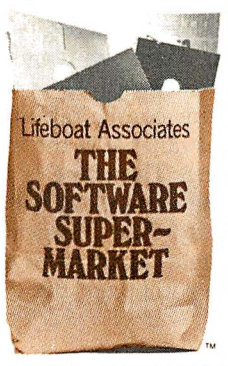

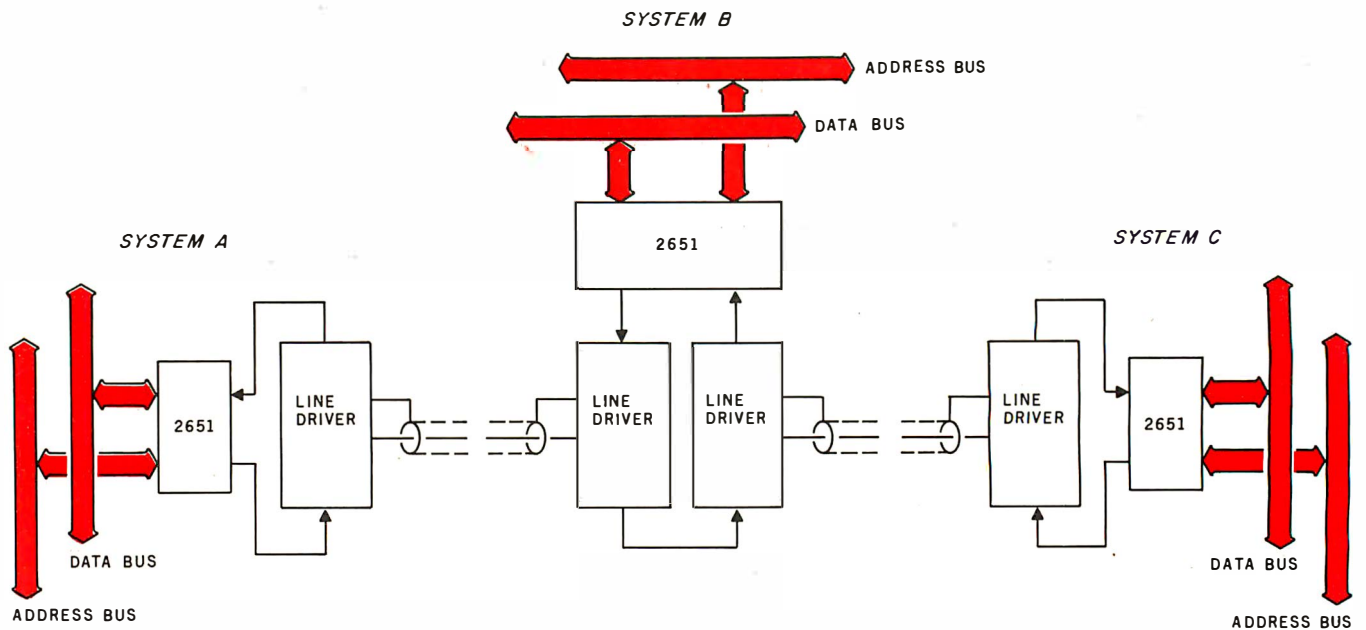

Figure 3: Simple-ring network of three systems.

where c is in farads and f is in bits per second.

Parallel-to-Serial Conversion

The output and input lines of this line driver may be directly coupled to the serial lines of a universal asynchronous receiver/transmitter (UART). Thus a simple link consisting of a single coaxial cable can connect a peripheral to the parallel port of the main system. This is possibly the simplest way to use such a scheme. However, in more sophisticated networks, some other arrangements are advantageous.

Ring Networks

The networks described next assume some degree of intelligence in each system, because the simplicity of the transmission system is reflected in the need for some software monitoring. The UART is not particularly well suited for these configurations, so interfacing may be better achieved with an integrated circuit such as the Signetics 2651 peripheral communications adapter (PCI). The features of this circuit include:

- simultaneous operation of transmitter and receiver
- synchronous or asynchronous transmission
- characters may be from 5 to 8 bits wide

- automatic, serial echo mode
- internal data-rate generator with sixteen common rates
- error detection
- single 5 V power supply required

In figure 3, the simple ring network of three systems is reduced to a linear configuration. The ring need not be limited to three systems, but may form the basis of a simple network where each office or room might be equipped with a terminal. Using this scheme, the data is shunted around the ring from one system to the next until its destination is reached. The 2651 then signals a flag to the system involved and the automatic echo mode is ceased. The incoming data block is diverted to the system's memory while fill characters (synchronous idle, SYN, or data-link escape, DLE) are substituted onto the ring, indicating that the line is free. When the block transfer has been completed, the 2651 will return to its automatic echo mode, thus allowing following data to circulate on the ring.

With this configuration, some flexibility is available in the initial wiring of the ring. The order of the systems within the network is not necessarily dictated by their physical locations. Each system, apart from the two end ones, may intercept the data passing

in either of two directions. Thus if certain pairs are more often in communication, their placement may be arranged for greatest efficiency.

In figure 4 (see page 106), a somewhat more sophisticated system is shown. This time the physical linking of the systems is continued until a loop has been formed. Each system is now connected to the loop via two 2651s and has access to data circulating in either of two directions. The performance of such a network will depend largely on the sophistication of the associated software, but the possibilities are exciting.

The network might be described as being a *reconfigurable dual-ring network*, which enables simultaneous conversations between two or more pairs of systems, depending on their relative placement on the loop. If we consider any two systems, we see that one of four different conversation loops may be chosen (see figure 5, page 106); either one of the two rings may be used independently, or one of the two possible loops formed as a combination of the two data rings may be used.

At this point I sense that we may be beyond the reasonable, in terms of the experimenter's immediate interests. However, I believe these ideas may in one form or another stimulate thoughts on the subject from fellow BYTE readers. ■

MicroQuote

Your personal computer becomes
a window on Wall Street.



MicroNET, the personal computer service of CompuServe, now offers MicroQuote, a comprehensive securities information system.

With MicroQuote you can gain information from a data bank of over 32,000 stocks, bonds and options from the New York, American, OTC and major regional markets plus Chicago options. MicroQuote contains price and volume data from January, 1974 with cumulative adjustment factors and dividend information from January, 1968.

You can determine indicated annual dividends, earnings per share, shares outstanding, BETA factors, open interest on options and amount outstanding on debt issues. MicroQuote can provide issue histories on a daily, weekly or monthly basis and even performs certain statistical analyses on the data. It's a vital tool for any investor.

It's just part of the MicroNET service

MicroNET also allows error-free downloading of software via the new software exchange and executive programs (now available for the TRS-80[®], Apple II[®] and CP/M[®] systems). It also provides electronic

mail service and can be accessed with a 300 baud modem via local phone calls in more than 175 U.S. cities. Write for full details on how your microcomputer can control one of the nation's largest and most sophisticated time-sharing computer centers for about 8 cents a minute!

TRS-80 is a registered trademark of Tandy Corporation.
Apple II is a registered trademark of Apple Computer, Inc.
CP/M is a registered trademark of Digital Research

Regional distributors and local dealers wanted.
Inquire to Dept. R

Software authors: MicroNET seeks to license quality programs for software exchange. Write to Dept. S

MicroNET

Mail to: **CompuServe** Dept: B
Personal Computing Division
5000 Arlington Centre Blvd.
Columbus, Ohio 43220

**“Percom Sells More
Microcomputer Disk
Systems Than Any
Other Peripherals
Manufacturer.
I’d like to
show you
why.”**



“Percom has been manufacturing mini-disk storage systems for microcomputers since 1977 when we introduced the 35-track, single-drive LFD-400™. Now we produce 1-, 2- and 3-drive systems in 40- and 77-track versions, a multi-density MEGABASE™ system and a host of accessories and software.

“Volume not only means experience in critical production and testing operations, it also means we can offer superior design features, extra testing and qualified backup support at very competitive prices.

“I know of no other microcomputer disk system manufacturer who even begins to offer the broad spectrum of disk equipment and programs available from Percom.”

“So before you buy a mini-disk system for your 6800, 6809 or TRS-80* computer, take a good look at what the people at Percom have to offer.”

*Harold Mauch
President, Percom Data Company*

Percom disk systems start at only \$399.00. Disk systems and other quality Percom products are available at computer dealers nationwide.
Call toll-free, 1-800-527-1592, for the locations of dealers in your area, or to order direct.

PERCOM

PERCOM DATA COMPANY, INC.
211 N. KIRBY GARLAND, TEXAS 75042
(214) 272-3421

PRICES AND SPECIFICATIONS SUBJECT TO CHANGE WITHOUT NOTICE.
TM trademark of Percom Data Company, Inc.

*trademark of Tandy Radio Shack Corporation which has no relationship to Percom Data Company.

"From an efficient 1K-byte control system DOS to high level languages such as FORTRAN and Pascal, no other microcomputer disk systems manufacturer provides the range and quality of development and application programs available from Percom."

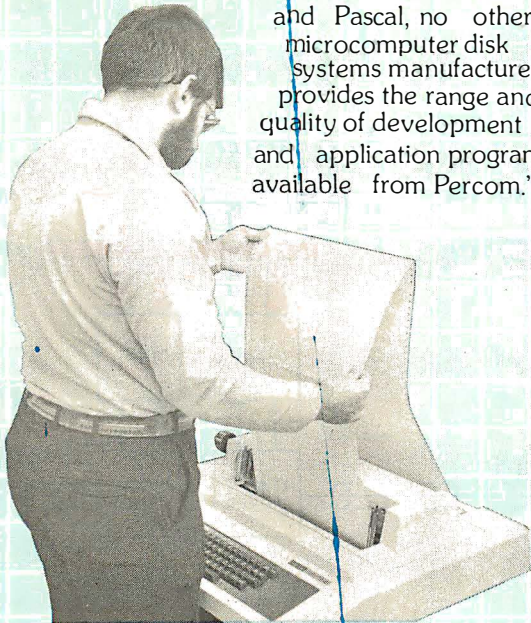

"Connie is running a 'cats eye' test on a mini-disk drive to check radial track alignment. Drive motor-speed timing and sensor alignment tests have already been performed. Disk formatting and format verification tests are next. These measurements are part of the 100% testing every single unit receives."

"Whether you call about a shipping date or ask a tough technical question, you get a competent courteous answer. Outstanding customer service is a hallmark of Percom."

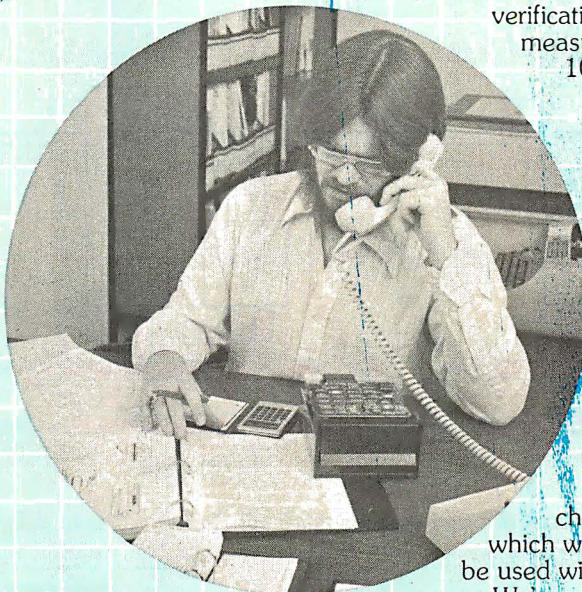

"Richard's making final changes to a disk controller which will allow Percom drives to be used with yet another computer. We're constantly developing and introducing new products that extend and enhance the value of Percom systems."

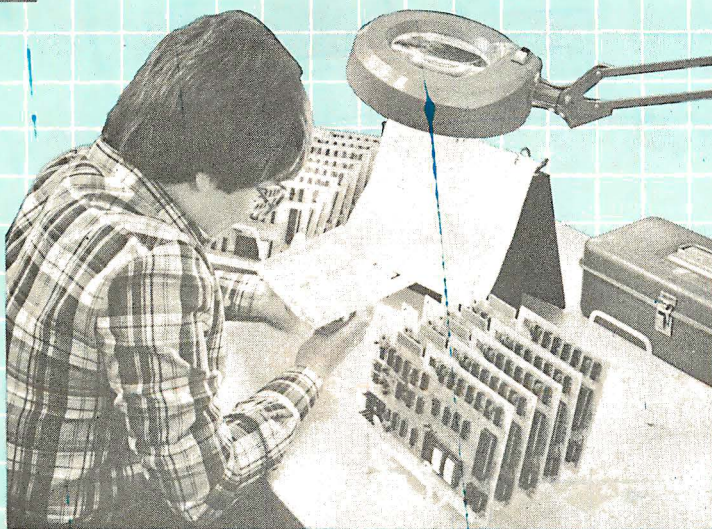

"Slipping a circuit board through the eye of a needle would be easier than slipping a cold solder joint past Beverly. These are four-drive LFD-400/800 disk system controllers she's inspecting."

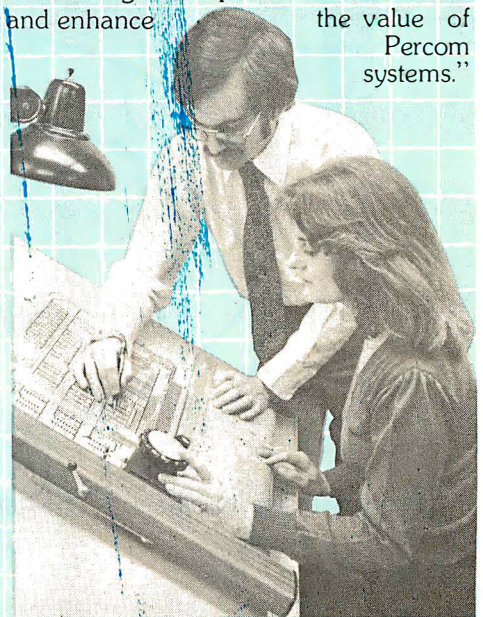

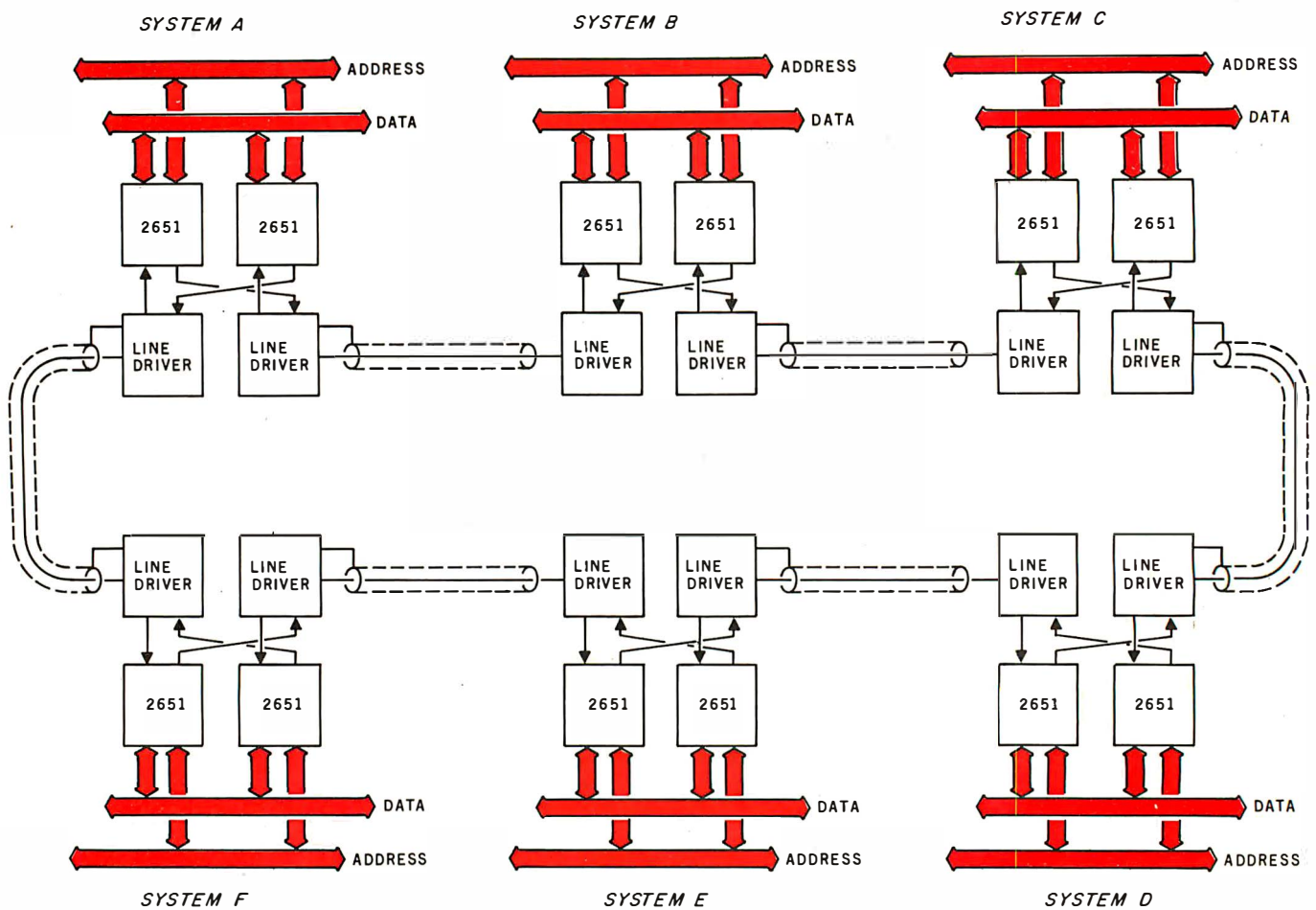

Figure 4: Dual-ring network of six systems. Each system has access to data which may circulate in either direction.

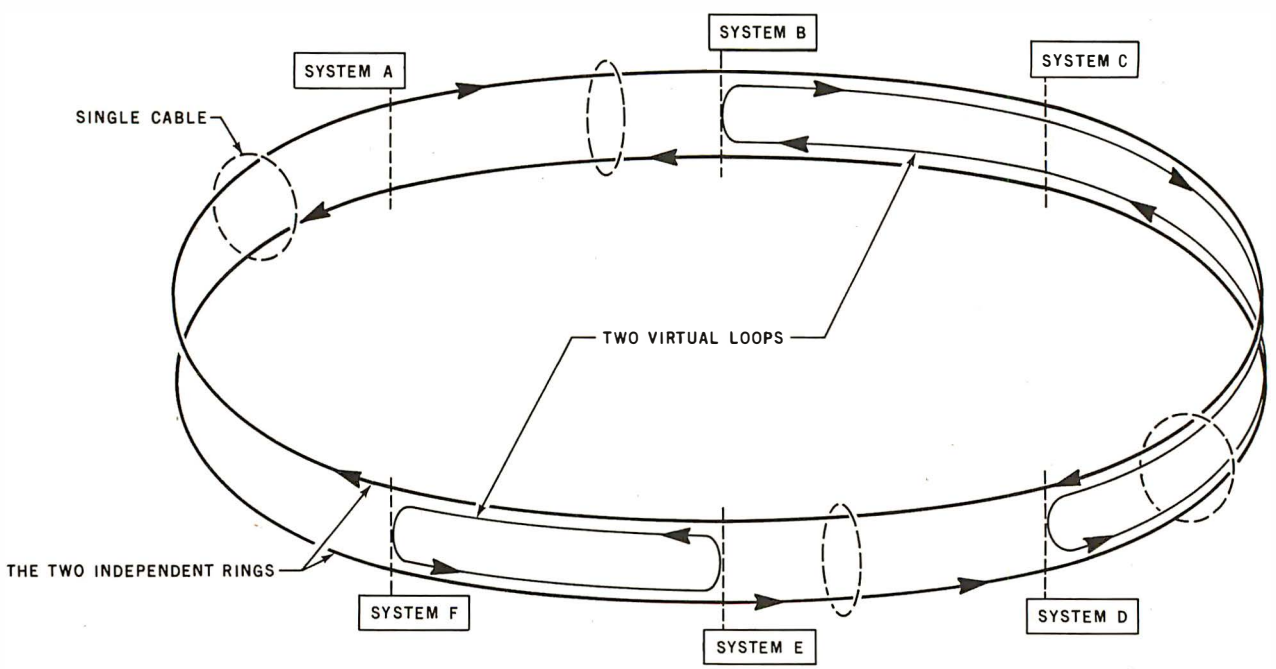

Figure 5: Possible communications links using the dual-ring network.

The Universal™ Intelligent Controller and the 5 Little Plugs

**This little pluggy
went to the S-100,
This little pluggy
stayed with fixed disks,
This little pluggy
had floppies,
This little pluggy
supported tape,
And this little pluggy
went all the way home,
to the Universal™ Controller.**

Five plug sets is all it takes for simultaneous, multi-device storage control. DML's Universal™ Intelligent Controller makes it possible.

- S-100 Bus, with CP/M* support
- Plug adaptable device support
- Control of up to 8 storage devices: 4 fixed disks, 4 floppy or tape cartridge drives
- IEEE DMA or port transfer

Call or write for full information. Data Management Labs, 2148 Bering Drive, San Jose, CA 95131 (408) 248-2104.

*CP/M is a trademark of Digital Research



DATA MANAGEMENT LABS

Understanding ISAM

Reginald D Gates
4244 Carfax
Lakewood CA 90713

More and more microcomputer systems are advertised as featuring ISAM files. The *indexed-sequential access method (ISAM)* permits rapid access to large amounts of data and is well suited to disk storage. However, ISAM does have some disadvantages. This article is intended to enable the personal-computer user to understand what ISAM is, how it works, and how to tell if the indexed-sequential access method is appropriate for a given application.

A brief look at two other access methods will be a helpful prelude to describing ISAM. *Sequential access* is the most common method for reading files, and it is easily understood. Records of a sequential file are accessed one after another in the order in which they are physically stored. The records are located adjacent to each other on the storage device.

In the *random-access* method, records are read or written via a unique *key* associated with each record. This key translates into a physical address—that is, the address in the storage device that contains both the specified key and its associated data. Here, the records are not necessarily located next to each other; they tend to be scattered over the storage area. Figure 1 shows the same file of three entries stored in both a random and a sequential manner.

The major problem with sequential files is speed. To obtain the one hundredth item from a sequential file, it is necessary to first read the preceding ninety-nine records. If the program makes a lot of unordered accesses to a sequential file, the response will be slow since the preceding records have to be read for each entry that is obtained. Events in the real world typically occur in an unordered manner.

This means that the slow response time of a sequential file often precludes its use in real-time systems.

On the other hand, the advantage of the random-access file is speed. If the key of a record is known, we know exactly where to look for it. The programs can obtain any record in a random-access file with just one input/output (I/O) operation.

ISAM represents a compromise between the random- and sequential-access methods.

The problem with the random-access method for files is related to the size and composition of the record's key. Since there is a one-to-one correspondence between a key and a physical location, the storage medium must have a space available for every possible key value. If the key is a four-digit integer, that implies 9999 slots. However, if the key is a Social Security number, storage for 999,999,999 records would have to be allocated. (There are various randomizing or *hashing* techniques available to deal with this problem. See "Making Hash With Tables" by Terry Dollhoff, January 1977 BYTE, page 18, reprinted in the book *Program Design* from BYTE Books.)

ISAM represents a compromise between the random- and sequential-access methods. ISAM access is faster than sequential access but not as fast as random access. An ISAM file takes less storage than a random file but more storage than a sequential file.

Records in an ISAM file are stored adjacent to each other as they are in a sequential file, but the storage location of the individual record is not tied directly to the key of the record. (See figure 2.) Instead, data records (called *prime records*) are grouped together and stored as a *physical record*. The size of the physical record is the largest number of logical, prime records that will fit into a fundamental unit of mass storage (in a disk, this unit is called a *sector*). Along with each physical record, an *index* record is built that contains a pointer (address) to the physical record and the highest key value of any record within that physical record. In other words, the ISAM index file provides a means of translating from the key of a record to that record's physical location. (In most cases, use of the ISAM index file is made solely by the operating system so that the use is *transparent* to (unnoticed by) the program that is accessing the record "randomly.")

To clarify the previous general discussion, observe the following example. Suppose you are asked to maintain the membership data for a local computer club. Each member is assigned a unique three-digit membership number that can be used as a key for your file. After studying the data to be kept on each member, you determine that four records will fill a sector on the storage device. Records are updated regularly as the members pay their dues, added fairly often as the club grows, and deleted infrequently. There are currently seventy-two members, with membership numbers from 001 to 072.

In order to compare the three access methods, look at the storage space and I/O processing necessary

Combine the **POWER** of **PASCAL**
with the **MUSCLE** of your **MICRO!**
Get the tool to do your job right:

PASCAL/MT[®] 3.0

Executes under
CP/M[®] in as little as
32K bytes.

Compiles directly to
Romable 8080
object code at up to
2000 lines per
minute.

Contains built-in mini
assembler for in-line
machine code.

Supports CP/M[®] files
including CP/M[®] 2.0
random access files.

Includes program
chaining facilities.

```
{HANDLE A/D CONVERSION EVERY SECOND FOR 3 HOURS}
PROGRAM SAMPLER;
{ * DEMONSTRATES THE POWER OF PASCAL/MT * }
CONST
  RTC__VECTOR=6; {FOR RTC__ISR}
TYPE
  TIME__OF__DAY=RECORD
    HOURS      : 0..24;
    MINUTES    : 0..60;
    SECONDS    : 0..60;
  END;
VAR
  NOW: TIME__OF__DAY;
  SAMPLE: INTEGER;

PROCEDURE INCREMENT__ TIME__OF__DAY;
BEGIN
  ... { * INCREMENTS NOW BY ONE SECOND * }
END;

PROCEDURE GET SAMPLE; {TALK TO A/D CONVERTER}
BEGIN
  SAMPLE:=INPUT {$B}; {GET I/O PORT DATA}
  OUTPUT {$FA} = SHR (SAMPLE, 3); {USE SHIFT RIGHT}
  WHILE TSTBIT (INPUT {$6C}, 2) <> TRUE DO; {WAIT}
  INLINE ("LOA / $FOCD / *STA / $309B); {JOB CODE}
  END;

PROCEDURE INTERRUPT (RTC__VECTOR) RTC__ISR;
BEGIN {INTERRUPT SERVICE ROUTINE}
  GET SAMPLE { * EVERY SECOND * }
  INCREMENT__ TIME__OF__DAY
  END;

BEGIN
  NOW. SECONDS:= 0; NOW. MINUTES:= 0; NOW. HOURS:= 0;
  INLINE ("MVI A, / $3E / *SIM {80B5}); {START CLOCK}
  GET SAMPLE; {TAKE FIRST SAMPLE}
  WHILE NOW. HOURS <> 3 DO; {SAMPLE FOR 3 HOURS}
  END. {AT END RETURN TO OPERATING SYSTEM}
```

Features a
SYMBOLIC debugger
which allows variable
display and
breakpoints.

Supports I/O port
access and interrupt
procedures.

Contains bit and byte
manipulation facilities.

Minimum overhead of
1.25K bytes.

Includes business and
scientific arithmetic.

Price: \$250 : Business & Scientific Compilers, Runtime Source, Debugger, User's Manual
\$ 30 : Manual Only, refundable with purchase of total package



MT micro SYSTEMS



1562 Kings Cross Drive
Cardiff, CA 92007 [714] 753-4856

We ship on 8" single density floppies

© PASCAL/MT tradename of MT MICROSYSTEMS, CP/M trademark of Digital Research
OTHER DISK FORMATS: LIFEBOAT [212] 580-0082, FMG [817] 294-2510

! SOUND EFFECTS !

**GUNSHOTS! PHASERS!
MUSIC! "OUTER SPACE
NOISES!" AND MUCH MORE...**

with

**THE ads
NOISEMAKER[®]
S-100 BUS**
and
**NOISEMAKER II[®]
APPLE II BUS[™]**

**BOARDS USE THE
GI AY 3-8910 TO PRODUCE
SOUND EFFECTS UNDER
SOFTWARE CONTROL**

- On board audio amp
- Breadboard area with +5, gnd
- Tone generators, noise source
- Envelope generator, I/O ports

FULL MANUAL INCLUDES:

Construction notes, software examples, full notes on AY 3-8910 schematic, parts list, etc. P.C. board soldermasked, gold contacts, parts silkscreen

NEW FEATURES!!!!

noisemaker (S-100 Bus)

Now, *TWO* on board audio amps for stereo, and on board wait state logic for 4MHz systems

ATTENTION APPLE II[™] USERS!

Assembled & tested noisemaker II now available at \$79.95! plus \$1.50 shipping & handling

noisemaker P.C. board & manual \$34.95 + 50¢ shipping

noisemaker II P.C. board & manual \$34.95 + 50¢ shipping

Please specify *which* version when ordering.

Illinois residents add sales tax
*Apple is trademark of Apple Computer, Inc.

Write for details on the new ADS sound effects interpreter, the "Sound Writer"



Ackerman Digital Systems, Inc.
110 N. York Rd., Suite 208
Elmhurst, Ill. 60126 (312) 530-8992

for the following functions:

- Store the membership file.
- Update record 57.
- Add new member number 108.
- Delete record 12.
- Print a membership list for the entire club.

If the access method is sequential, the file will occupy eighteen sectors of storage ($4 \times 18 = 72$). To read and then update record 57, the fifteenth sector must be obtained. When using a sequential-access method, the preceding fourteen sectors must be read, giving a total of fifteen read operations and one write operation.

Adding a record past the current end of file entails first reading the entire data set (eighteen reads) and then executing a write. Deleting record 12 implies rewriting every record from record 13 to the end of the file. Since the point of deletion has to be read first, every sector is read, and sectors 13 thru 18 are written. Finally, printing a membership list simply involves eighteen read operations. (This data is summarized in table 1.)

Suppose you choose to access the membership file using a random-access file. Since the I/O package reads *sectors* from the disk, it will make a one-to-one correspondence between the sector of a record and a

Sequential File			Random File		
Address	Record Key	Record Data	Address	Record Key	Record Data
001	003	DDDDDDDD	001	(empty)	
002	005	DDDDDDDD	002	(empty)	
003	007	DDDDDDDD	003	003	DDDDDDDD
004	(empty)		004	(empty)	
005	(empty)		005	005	DDDDDDDD
006	(empty)		006	(empty)	
007	(empty)		007	007	DDDDDDDD

Figure 1: Data organization in sequential-access and random-access files. In a sequential file, data records are stored physically adjacent to each other; this saves storage space, but the entire file must be rewritten if a new record is inserted. In a random file, data records are stored with respect to the record's key. This requires a larger initial investment in storage space but allows new records to be inserted without rewriting the entire file.

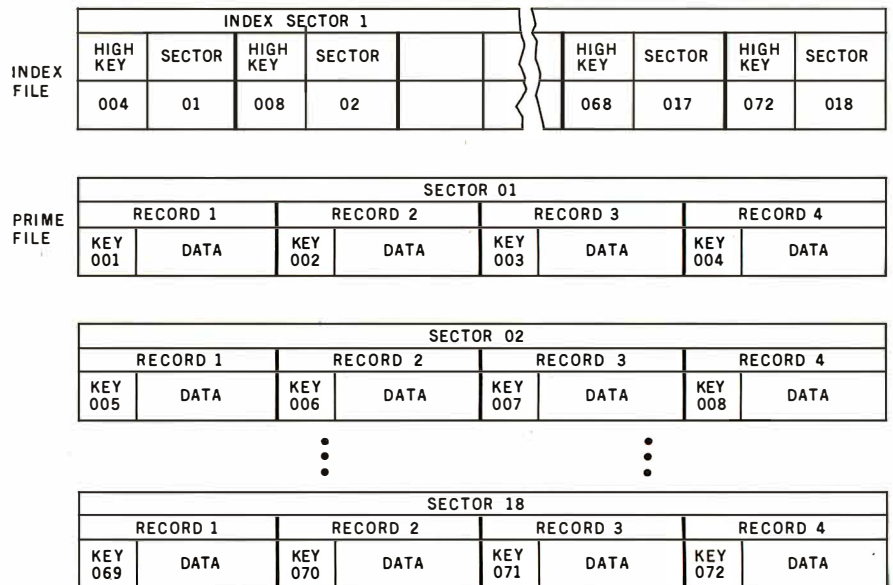

Figure 2: Structure of an ISAM file. The ISAM file presented is actually two files. The prime file contains a series of contiguous physical records, each of which contains a number of logical records. (Here, one physical record equals one disk sector.) All the logical records contained within one physical record are in ascending-key sequence for the file. The second file, the index file, provides an index of physical records in ascending-key sequence. Together, these two files allow the ISAM file to be in ascending-key sequence without the use of the random-access method.

ALMOST PERFECT.

The **MAGIC WAND**TM is the most powerful, most flexible, most reliable, *most usable* word processing software available for a CP/M[®]-based computer.

That's not bragging. That's just telling it like it is.

The MAGIC WAND *is* the best word processing software ever written for a microcomputer. It can do more work in less time with higher quality than any other product you can buy.

The MAGIC WAND is a rock solid piece of software. The command structure is simple and logical and complete. We have not tossed in features without thought to the overall design of the package. Nor have we included any feature that is not thoroughly implemented. The programs are crash-proof and completely reliable.

And the system is supported by what we are told is the best user's manual ever produced for microcomputer software. It contains a step-by-step instructional program designed for the novice. The trainee uses sample files from the system disk and compares his work to simulated screens and printouts in the manual.

Support doesn't stop when you buy the package. As a registered user, you receive our bi-monthly newsletter which answers questions, reports upgrades and teaches new applications of the MAGIC WAND.

It's through a lot of hard work that we are able to offer you a product that is "almost perfect," but we aren't about to stop working until we can say that the MAGIC WAND *is* perfect.

Full screen text editing

The MAGIC WAND has probably the most responsive and easy-to-use editor available for either a serial or DMA terminal. It uses only single stroke control keys to give command and takes advantage of the special function keys on your terminal whenever possible. In addition, you can set up library files with coded sections that you can merge by section name.

Full text formatting commands

The MAGIC WAND allows you to set the left, right, top and bottom margins, page length, indentation, paragraph indentation, (including "hanging" paragraphs), text left flush, right flush, justified (two ways), literal or centered, variable line and pitch settings, variable spacing (including half lines), bold face, underlining (solid or broken), conditional hyphenation, sub- and superscripting. You may change any of these commands at run-time *without reformatting the file*.

Merging with external data files

You may access any external data file, with either fixed length or sequential records. The MAGIC WAND converts the record into variables that you define and can use like any other variable. Of course, you may use the data for automatic form letter generation. But you can also use it for report generation.

Variables

You may define up to 128 variables with names of up to seven characters. The current value of a variable may be up to 55 characters, and you may print it at any point in the text without affecting the current format. Although the MAGIC WAND stores the variables as strings, you may also treat them as integer numbers or format them with commas and a decimal point. You may increment or decrement numeric variables or use them in formatting commands.

Conditional commands

You may give any print command based on a run-time test of a pre-defined condition. The conditional test uses a straightforward IF statement, which allows you to test any logical condition of a variable. You may skip over unneeded portions of the file, select specific records to print, store more than one document in a single file, etc.

True proportional printing

The MAGIC WAND supports proportional print elements on NEC, Diablo and Qume printers. Other formatting commands, including justified columns, boldface, underline, etc., are fully functional while using proportional logic.

Available on 8" soft-sectored and 5 1/4" Northstar or Micropolis (hard or soft sectored) diskettes, as well as ONYX hard disk. Terminals supported include—ADDS, Beehive, Croniemco, Dynabyte, Hazeltine, Heath, Imsai, Intertec, Lear Siegler, Microterm Act V, Perkin Elmer, Sol VDM1, Soroc, TEC, TEI, Televideo, TRS80 Mod II, Vector Graphics, plus a variety of video boards.

Also available in OASIS

small business applications, inc.

3220 Louisiana • Suite 205 • Houston, Texas 77006 • 713-528-5158

CP/M is a registered trademark of Digital Research Corp.

person's membership number. This means that the random-access method will start by costing 999 sectors of storage, one sector for each possible membership number. Multiple records per sector are not possible with this addressing scheme, so 75% of each sector is unused (one sector could hold four records).

Once this price has been paid, the rest seems fairly simple. Reading record 57 costs the user one I/O operation, as does writing to update the record. The addition of record 108 takes just one write operation since the disk space is already there.

A deletion, though, raises some interesting questions for a random-access file. The sector cannot be eliminated from the disk, so it must be written over with a standard pattern to indicate that the slot is empty. This implies that the I/O package (or program) must recognize the pattern that indicates an empty record. Because all records are empty before the file is created, a formatting program must be run to create 999 empty records before the first real record can be added to the random file.

The use of random access also sets a physical limit to the size of the file — that is, to a maximum of 999 entries. Will the club ever grow beyond 999 members? If it does not, this approach is fine. But if there is a possibility of having more than 999 members in the club, the key size must be changed and the allocation for the random-access file must be increased to 9999 sectors.

Producing a membership list from this random file means that every sector in the data set must be read unless you know the highest key currently assigned. Even if you know that the highest key is 108, you will have to execute a minimum of 108 read operations. Again, these figures are given in table 1.

If ISAM is chosen as the access method, the records can be stored four to a sector (the content of a sector is sometimes called a *block*). However, you must build an index file to tie the record's key to its physical location. (A good I/O package will create the index file automatically.) Records in the index file will consist of the highest key from the records in a given sector and the physical address (or sector number) of that sector. There are

only eighteen index records, since only eighteen sectors are needed to save seventy-two records. These eighteen sectors are called *prime blocks*. The index records are small enough to fit in one sector of the storage device.

Getting back to the evaluation questions in table 1, an update of record 57 involves reading the index (which can be done with one read operation), searching the index records until there is a high or equal compare, then reading the prime sector that corresponds to the sector number from the index. The sector from the prime file is then rewritten, but it is not necessary to update the index sector (which stays the same). Adding record 108 involves reading the index sector and updating it as well as writing a new prime sector. Record 12 is deleted by locating the logical record, writing over it with a predetermined pattern, and updating the corresponding index record so that it contains a high key value of

11. Printing a membership list calls for accessing the index and reading each of the eighteen prime sectors. A summary of these results for an ISAM file are given in table 1.

Most readers will notice that a situation where a new record is added between two existing records has not yet been discussed. This was done deliberately so that ISAM's basic features could be reviewed. Now we must look at *overflow*.

Overflow processing is unique to ISAM files and can cause a tremendous increase in the number of I/O operations necessary to access ISAM records. Since fast response time is one of the attractive features of ISAM, overflow will be discussed in some detail. (Please note that there are several ways to implement ISAM, all of which involve overflow processing of some kind. Although the guidelines that will be developed are based on a detailed consideration of one implementation, the general prin-

Characteristic	Sequential Access Method	Random Access Method	ISAM (Indexed-Sequential Access Method)
Number of sectors used for storage	18	999	19
Number of I/O operations to update record 57	16	2	3
Number of I/O operations to add record 108	19	1	3
Number of I/O operations to delete record 12	34	1	4
Number of I/O operations to print memberships lists	18	108	19
Software must be able to recognize a deleted record?	no	yes	yes
Must run disk formatting program?	no	yes	no
Maximum file size	device limit	999	device limit

Table 1: Comparison of disk-access methods. Using the example of a file containing seventy-two records, the characteristics listed here point up the relative strengths and weaknesses of each method.

Action	I/O Count
Read Index file	1
Read Overflow Block 019	2
Read Overflow Block 017	3
Read Overflow Block 009	4
Read Overflow Block 001	5
(Key 266 in overflow block 1 is high)	
Write 252 as Overflow Block 020	6
Read Overflow Block 009 again	7
(Change Block 9 Link Field to 020)	
Write Updated Overflow Block 009	8

Table 2: Processing a record that is in the overflow file of an ISAM file. Given the problem of writing a new record with a key of 252 to an ISAM file as represented in figure 6, this table lists the sequence of events necessary to add the new record, which will go into the overflow file between the records with keys 250 and 266.

a new star is born!



a better computer system
any way you look at it.

The facts speak for themselves. The QUAY 500 SERIES offers more for the money than North Star Horizon computers.

MORE TECHNICAL FEATURES. A single board computer instead of a backplane with multiple boards, means fewer parts, fewer interconnections and fewer problems □ additional disk capacity for more program storage □ DMA controlled disk transfers for increased system performance □ on-board expansion capabilities for additional parallel and serial ports, and EPROM □ AC convenience outlets □ a more compact design.

IMMEDIATE DELIVERY. The 500 SERIES is available off the shelf for virtually immediate delivery. No waiting for far off delivery dates for this one.

LOWER PRICE. The advanced technology engineered into Quay computers actually lowers our cost to manufacture. The price of the 500 SERIES is about 20% lower than the Horizon-2-32K-D — and our 520 SERIES also offers significant savings over the Horizon-2-32K-Q.

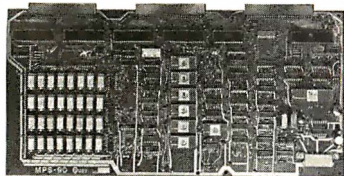

Advanced single board modular design.

The bottom line is simple. There is a new star in the computer field. The 500 SERIES by Quay. It outshines all of the competition.

COMPARE FOR YOURSELF:

SPECIFICATION	QUAY 500	HORIZON-2-32K-D
Architecture	Single Board	S100 bus
CPU	Z80A, 4MHz.	Same
Dynamic RAM (std/max)	32/64 Kb.	Same
Disk drive type	Double density	Same
No. of drives (std/max)	2/4	Same
Capacity per drive (on-line)	200 Kb.	180 Kb.
Direct Memory Access (DMA)	Yes	No
CP/M® disk operating system	Standard	Optional
Unit Price	\$2,500.	\$3,095.

SPECIFICATIONS	QUAY 520	HORIZON-2-32K-Q
Disk drive type	Quad density	Same
Capacity per drive (on-line)	400 Kb.	360 Kb.
Unit Price	\$3,200.	\$3,595.

The QUAY 500 offers technical superiority—availability—a \$2,500 price!

CP/M* is a registered trademark of Digital Research

QUAY CORPORATION

P.O. Box 386, Freehold, New Jersey 07728 ■ (201) 681-8700
Factory: Route 34, Wall Township, New Jersey 07719

DISTRIBUTOR AND REPRESENTATIVE INQUIRIES WELCOME

ciples will apply to all ISAM implementations.)

One of the advantages of ISAM is that records whose keys differ greatly may occupy physically adjacent locations in the storage medium. For example, it is perfectly proper to have the ISAM prime block illustrated in figure 3. The index entry for this sector would carry 266 as the highest key entry.

Suppose that record 200 is to be added. If this record is written in its normal place, something must be done with record 266, as there can be only four records in a block. If 266 is relocated to the next block, the highest record in that block will be bumped, and so on. Bumping records in this manner would increase the access time significantly by necessitating the rewriting of the entire prime file from the point of addition on (as in a sequential file). Because access speed is one of the reasons for considering ISAM, this approach is usually avoided by writing bumped records into an *overflow file*. In addition, the format of the ISAM index record is modified to indicate the presence and address of any overflow entries. Figure 4 presents the disk file example with the extensions necessary to add record 200 to an overflow file.

The pointer in the overflow field of the index is the address of the sector in the overflow file that contains the next record with a key that is higher than the prime block high key. In figure 4, the next record higher than 250 is found in overflow sector 1; apparently record 266 was the first overflow to occur for the prime file.

Each record in the overflow file consists of the key of the record, its data, and a *link field*. The link field contains a pointer to the next higher record in overflow associated with this particular disk sector. If more records are added to the original sector, the link fields in the overflow file form a chain of records displaced from the prime file. Suppose records with keys of 210 and 218 are added to the ISAM file on different days. Figure 5 shows how the blocks in the three files would appear.

The overflow pointer in the index record has changed to a value of 017, while the overflow key remains at 266. This shows three things: that there is an overflow chain for this set of prime records; that the highest key

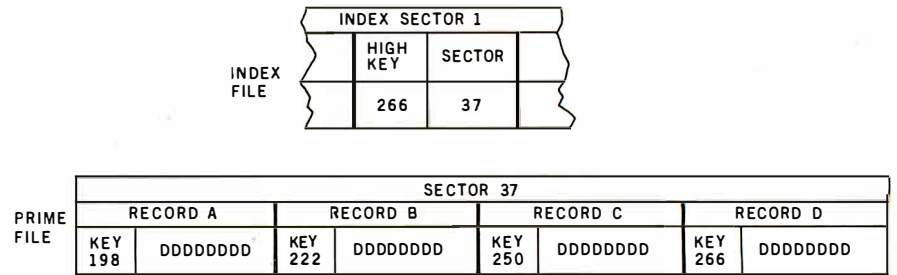

Figure 3: A valid physical record in an ISAM file. Since an ISAM file does not require saving disk space for every possible key, records with nonadjacent keys can be adjacent in the file. If, for example, the record with key 252 were to be added to this file, this physical record would be rewritten with record 252 in the place of record 266. Record 266 would then be written in the overflow area for this physical record.

in the chain is 266; and that the chain starts with overflow block 017. In this example, the overflow chain has three entries.

If a record is added whose key is greater than the highest key currently in the prime area, then that record is written at the end of the overflow file. The index and overflow link values are altered to put the new record in its proper place. For example, if record 220 is added, the prime block remains unchanged while the overflow and index blocks are modified as shown in figure 6.

The overflow records have three distinct characteristics. First, they are *not* in key sequence. Second, the records are *not* blocked. Third, the overflow records do *not* have the same format as the non-overflow

records (link fields are present). Although there is only one overflow chain for each prime block, the chain may have multiple entries.

In order to access an ISAM record, the program may have to "walk" along an overflow chain until it finds the desired record. Any such overflow processing adds tremendously to the number of I/O operations executed during a retrieval. If the files looked like those in figure 6, it would take just two I/O operations to read record 198 (one read of the index file and a read of the prime file). However, retrieving record 266 takes five read operations, four of which are overflow reads. The processing necessary to add record 252 near the end of the overflow chain is listed in table 2.

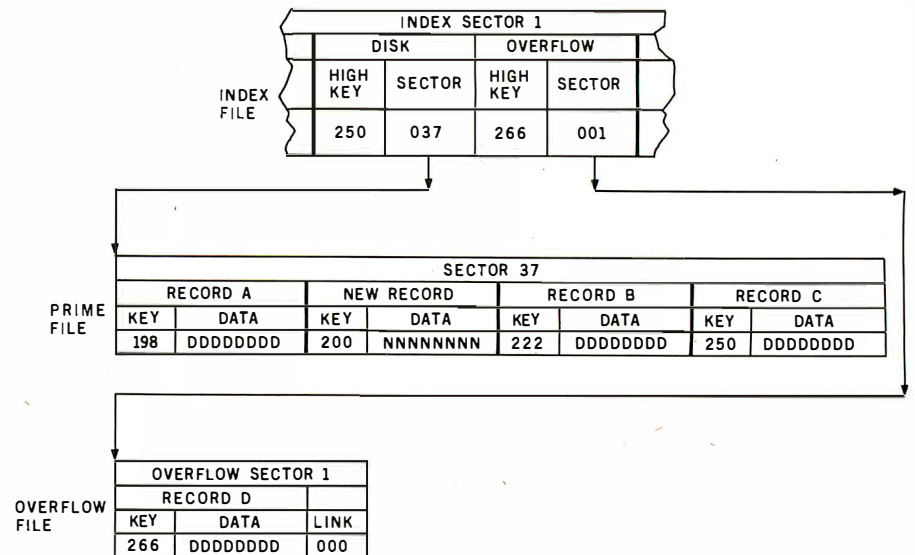
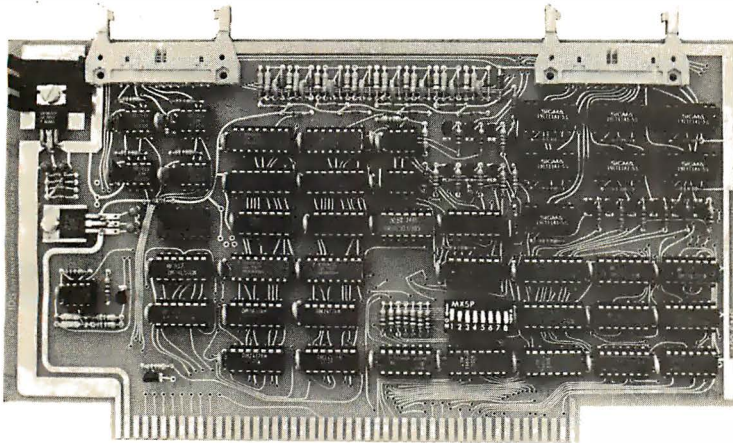

Figure 4: Index entry for a given physical record in an ISAM file. Along with the pointer to the physical record (here, a disk sector), a pointer must be established to the first record in the overflow area that belongs to the current physical record. When record 200 is added to the file here, it bumps record 266 out of the same physical record. Record 266 is placed in the overflow file with a pointer to it from the index entry.

IDS Announces S-100 Energy Management Module

The 100-EMM Energy Management Module provides temperature measurement at four separate locations indoors or out; monitors eight (8) doors, windows, or fire sensors; controls six external devices via relay or optoisolator; and provides an intrusion alarm with battery backup (alarm operates even during primary power outages). Put the 100-EMM to use in your home or business and claim a 30% tax credit for the cost of your S-100 computer system including the 100-EMM. (Purchasing the 100-EMM can actually save you several times its cost in tax credits. Full instructions for filing are included in the 100-EMM manual.)



**BUY THIS S-100 BOARD
AND GET UP TO A 30%
TAX CREDIT BASED ON
THE COST OF YOUR
COMPUTER SYSTEM!**

**100-EMM Energy Management Module
Assembled and Tested \$395.00
Kit \$345.00**

Options for 100-EMM:

CP-52 Cable Panel - Terminates two 26-conductor flat cables in 26 screwplugs. Use it for convenient interconnection of the 100-EMM to the "outside world". **\$45.00**

CABL-26-STD 26-Conductor Flat Ribbon Cable - Four feet in length with connectors for 100-EMM and CP-52 above. **\$35.00** Other lengths available on special order. Add **\$1.00** per foot.

OTHER PRODUCTS FROM IDS. The most complete source of S-100 compatible modules for process control, data acquisition, energy management, and data communications.

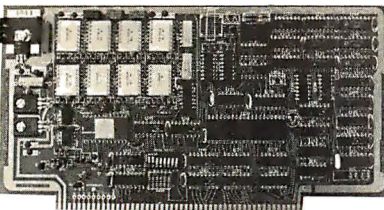

88-MODEM S-100 ORIGINATE/ANSWER MODEM WITH AUTO-DIALER. Software selectable baudrate provides any baudrate from 66-600 baud. Provides 1.5 stop bits when operated in 5-bit code mode. Auto-answer programs available for CROMEMCO CDOS, CP/M, North Star Horizon and MDS, and Alpha Micro.

Assembled and Tested \$395.00 Kit \$245.00

88-UFC UNIVERSAL FREQUENCY COUNTER

Four software selected inputs. Measure frequency from 0-650 MHz and period from .1µs to 1 Second. Extensive software included.

Assembled and Tested \$299.00 Kit \$199.00 Temperature-Compensated Crystal Oscillator option **\$145.00**

88-SAI SYNCHRONOUS/ASYNCHRONOUS INTERFACE

The most versatile serial interface on the market. Computer access/control of all data and handshake lines and provision for masked interrupts, inversion of any input or output signal, and onboard baudrate generation for 110, 134.5, 150, 300, 600, 1200, 2400, 4800, 9600, and many other baud rates. Many more features.

Assembled and Tested \$299.00 Kit \$199.00

88-SPM TIME OF DAY CLOCK with battery backup. Set the clock with three out instructions: no delays! Programs included in North Star BASIC, CBASIC, and 8080 assembly language.

Assembled and Tested with crystal option \$199.00 Kit less crystal option \$99.00 Crystal Option Kit \$25.00

88-RCB RELAY CONTROL BOARD

16 Relays on one board. Control appliances, production equipment, or even musical instruments (See BYTE Magazine Sept 1977 page 12)

Assembled and Tested \$299.00 Kit \$199.00

**INTERNATIONAL
DATA SYSTEMS, INC.**

Mailing Address:

Post Office Box 17269
Dulles International Airport
Washington, DC 20041
Telephone (703)661-8442

Shipping Address:

400 West Service Road, Suite 130
Dulles International Airport
Washington, DC 20041 USA
TELEX 901112 IDS CTLY

This brief description of the I/O operations associated with processing overflow chains indicates why ISAM overflow processing must be avoided at all costs. There is no more certain way of slowing down a program than to force it to process long overflow chains.

Each record in the overflow file consists of the key of the record, its data, and a link field.

Since it is fairly common to add new records to an existing file, some overflow is bound to occur. How can this overflow be removed? Many ISAM I/O packages provide a utility program that will *reorganize* an ISAM file — that is, rewrite the entire file so that all records are written into the prime disk file. After reorganization, the overflow file is empty and all delay associated with overflow records is eliminated. If such a utility is not available, a program to do the reorganization may have to be created.

The obvious next question is, "When should an ISAM file be reorganized?" Unfortunately, there is no precise answer. One guideline used in the past by this author is as follows: an ISAM file should be reorganized whenever the file response time increases by more than 30%, or whenever more than 20% of the records in the file are stored in overflow.

The first part of this guideline implies that there must be some way of measuring response time, even if it is subjective. There also must be someone assigned to a monitoring function. The second part suggests that there should be another utility program that will give certain information about an ISAM file. It must at least show the ratio of prime to overflow storage, and it might also tell the number of blocks that have overflow chains and the number of entries in each chain.

Now some criteria may be established for judging whether ISAM is appropriate for a given application. First, you must be certain that reorganization and diagnostic utilities are available (or that the user

is willing to create them). It is difficult to see how ISAM files can be considered without such utilities unless very few records will ever be added to the file.

Next, see if the other two access methods can be eliminated. Is the sequential access method really too slow? What kind of response is required (not just desired) for this application? If rapid response (less than 1 second) to the user is a requirement, then sequential files are probably eliminated. Of course, this judgement has to be made on an application by application basis: if an inventory system is being designed, it is reasonable to require a reasonably prompt response to an inventory question. On the other hand, the need for immediately answered inquiries to a membership file for the computer club is less obvious.

To evaluate the random-access method, the keys to the file should be examined. Can a unique key be assigned that will translate to a physical address? If this key is alphanumeric and of any length, the number of possible key values may easily exceed the storage capacity.

Even if the key is numeric, the range may be larger than the storage. In either case, the pure random-access approach is usually impractical.

If both sequential and random files are impractical, consider ISAM files. First, establish the approximate size and growth rate for the file. Once the system is fully operational, how many records are expected to be stored in this file? How often are records added to the file? Are they added uniformly with respect to time, or is there a particular period when there will be rapid growth for this file? For example, you expect a marked difference in the growth pattern for an inventory file for an auto parts store as opposed to an inventory file for a toy store, especially during the Christmas season. Rapid, irregular growth of an ISAM file indicates rapid growth of the overflow file; if computer time is limited, there may be potential problems with scheduling the file's reorganizations.

In connection with reorganizing the file, two questions must be asked. How long will it take to reorganize the full file? Can the user permit this file to be unavailable to him for the

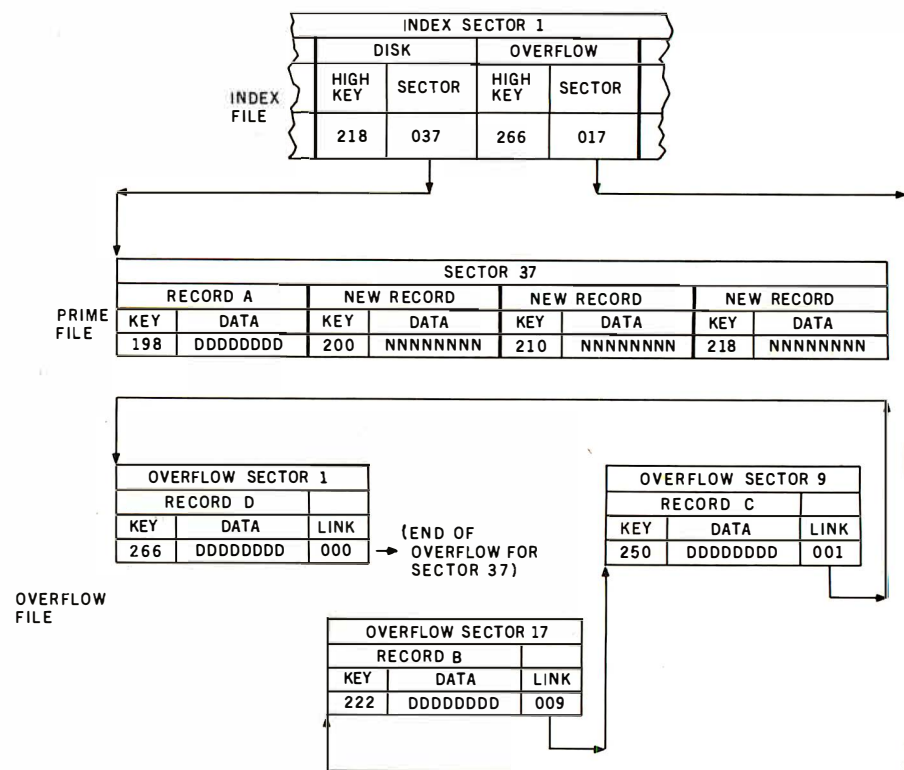
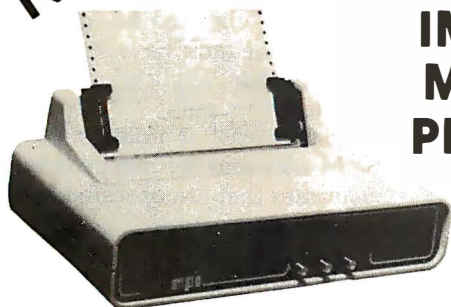

Figure 5: Multiple-overflow records associated with a physical record. When more than one logical record originally from a given physical record is pushed into overflow, the records are threaded together in ascending-key sequence as presented. The overflow index points to the first overflow record. Each overflow record points to its successor, with a pointer of 000 indicating the end of the string of records.

NEU!

MPI MODEL 88T IMPACT MATRIX PRINTER



The first of a series of new, full-capability, low cost, high performance printers designed by MPI to meet the requirements of the general use computer market - hobbyist or professional.

SPECIFICATIONS

- Impact Bidirectional
- 7 x 7 Dot Matrix
- 100 Characters Per Second
- 80, 96 and 132 Column
- 10 Lines Per Second
- Tractor and Friction Feed
- Normal Paper, Roll, Fan-fold or Cut Sheets
- 115/230 VAC \pm 10%, 50/60 Hz.
- 96 ASCII Upper and Lower
- RS232C, 20 ma Current Loop
- 110-1200 BAUD
- 2 Line Buffer: 1 or 2 K Optional
- Centronics Parallel
- 41 x 27 x 16 cm; 7 Kg

Sigma International, Inc. is master international distributor for MPI and seeks dealers/distributors worldwide. Please write us on your letterhead at the following address:

SIGMA INTERNATIONAL, INC.
 P.O.Box 1118 SCOTTSDALE, AZ 85252 USA
 Tel. (602) 994-3435 Tlx. 165-745 Sigma Cable: SIGMAS

MICROCOMPUTERHÄNDLER WIR LADEN EIN!

Handeln Sie als Wiederverkäufer mit Microcomputer-systemen und Peripheriegeräten und sehen sich daher gezwungen, mit den immer noch überhöhten Preisen Ihrer jetzigen Lieferanten zu kalkulieren? Dann wählen Sie doch den einfacheren Weg und beziehen direkt aus den USA!

Sigma ist weltweiter Lieferant führender amerikanischer Hersteller und offeriert Preise und Service, wie sie Ihnen keine andere Quelle bieten kann.

Unter anderem verkaufen wir Geräte der Firmen:

Base 2	Impact Data	North Star
Centronics	Industrial Micro	Ohio Scientific
Century Data	Integral Data	PerSci
Control Data	Konan	Qume
Exidy	LRC Eaton	Soroc
Hazeltine	Micro Peripherals	Televideo
Houston Inst.	N.E.C.	Texas Instruments

Wir laden Sie daher ein, kostenlos unsere neueste Preisliste anzufordern, und Sie werden feststellen, dass Sie wesentlich günstiger kaufen können. Bitte schreiben Sie - auf Kopfbogen - an folgende Adresse:



SIGMA INTERNATIONAL, INC.
 P.O.Box 1118 SCOTTSDALE, AZ 85252 USA
 Tel. (602) 994-3435 Tlx. 165-745 Sigma Cable: SIGMAS



LRC EATON MODEL 7000+ IMPACT PRINTER

NEW

- Simple Design
- Simple Maintenance
- Simple Interfacing to:
 - Apple
 - Pet
 - TRS-80
 - Exidy
 - OSI
 and many other personal computers

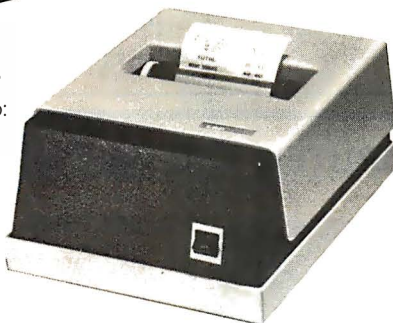

The 7000+ was designed to provide the personal computer user with an inexpensive, yet reliable printer. Take a look - you won't regret it!

SPECIFICATIONS

- Impact Unidirectional
- 125 LPS; 50 CPS
- 40 or 64 Column
- 5 x 7 Dot Matrix
- Standard Paper Rolls
- 100 Million Character Printhead Life (minimum)
- 6 LPI Line Spacing

Substantial Dealer Discounts are Available.

OEM inquiries are invited. Please contact:

SIGMA INTERNATIONAL, INC.
 P.O. Box 1118 SCOTTSDALE, AZ 85252 USA
 Tel. (602) 994-3435 Tlx. 165-745 Sigma Cable: SIGMAS

IMPACT DATA MODEL 801

THE HEAVY DUTY WORKHORSE AT THE AFFORDABLE PRICE.

- 7 x 7 Impact Dot Matrix
- 132 CPS (max.)
- 96 Character Upper/Lower ASCII
- 8.0 in. (203 cm) Line Length
- 80 or 96 Columns
- 6 LPI Line Spacing
- Tractor or Friction Feed
- 127 Character Buffer - 2 K Optional
- Feed at 50 LPM Printing - 560 LPM Slewing
- Continuous Loop Ribbon with Re-inking Roller - 5 Million Character Life
- Paper is Standard Fan-fold, Multi-copy Computer Forms up to 9-5/8" (24.45 cm)
- 8-bit Parallel (Centronics Compatible) RS232 or 20 ma. Current Loop Interfaces. 110/1200 BAUD. Switch Selectable
- 115 VAC, 3A, 60 Hz or 220 VAC, 1.5A, 50 Hz
- 12"H x 18"W x 14"D (30 x 45 x 35 cm)

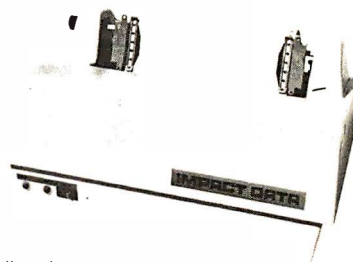

High Quality • High Technology • Low Price

Substantial Dealer/Distributor
Discounts Available

SIGMA INTERNATIONAL, INC.
 P.O. Box 1118 SCOTTSDALE, AZ 85252 USA
 Tel. (602) 994-3435 Tlx. 165-745 Sigma Cable: SIGMAS

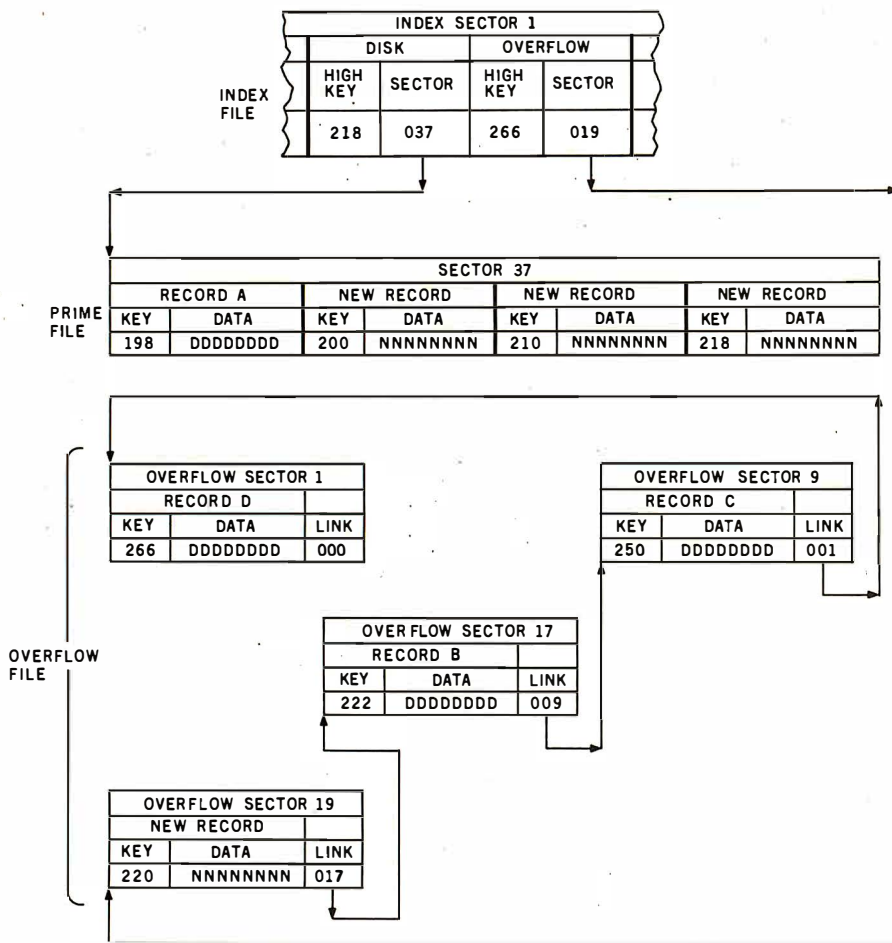

Figure 6: Comparison of record-access times for overflow and non-overflow records. It takes two disk-read operations to access any record that is in the disk file: one to read the index entry, and one to read the physical record. Since an overflow record is read by chaining through the overflow records associated with a given index entry, retrieving an overflow record may take many disk-read operations. It will take five disk-read operations to read record 266: one to read the index entry, and four to read through records 220, 222, and 250, before arriving at record 266.

length of time necessary for the reorganization? In particular, if the answer to the second question is "no," the file must be redesigned (and probably the application as well). Although this point may seem trivial at the very least, it indicates that large ISAM files may be inappropriate for businesses that are operated 24 hours a day, 7 days a week.

Now it is necessary to determine roughly how often the file must be reorganized. How long will it take the file to grow by 20%? If the answer is 90 days, you have 3 months to reorganize the file. If the answer is only 9 days, you may have a bit more of a problem in scheduling the processing necessary to do the reorganization.

In addition to the number of new records being added, also consider the relative activity of those records. Is a new record more likely to be accessed than an old record? If this is the case, then it is possible that the new record might be placed in overflow; this would cause either longer access time when the record is being referenced or time lost in reorganizing the file.

The indexed sequential-access method has many advantages, but it should not be selected without a thorough examination. When provided with a basic understanding of ISAM files and the questions suggested in this article, the personal computer user can determine if the ISAM method of data access is the best choice for his application. ■

S-100 USERS: GIVE YOUR COMPUTER THE GIFT OF SIGHT!

The DS-80 Digisector® is a random access video digitizer. It works in conjunction with a TV camera (either interlaced or non-interlaced video) and any S-100 computer conforming to the IEEE standards. Use it for:

- Precision Security Systems
- Moving Target Indicators
- Computer Portraiture
- Fast To Slow Scan Conversion
- Robotics
- Reading UPC Codes, schematics, paper tape, musical scores



● IMAGE PROCESSED BY DS-80 ●

CHECK THESE FEATURES:

- High resolution** — a 256 x 256 picture element scan
- Precision** — 64 levels of grey scale
- Speed** — Conversion time of 14 microseconds per pixel
- Versatility** — scanning sequences user programmable
- Economy** — a professional tool priced for the hobbyist; comes fully assembled, tested and burned in, with fully commented portrait printing software.

Price: \$349.95 MasterCharge and Visa

THE **MICRO
WORKS**

P.O. BOX 1110, DEL MAR, CA 92014 714-756-2687

Diablo introduces the first printer that runs on four wheels.

The Diablo 630 printer is the most versatile printer you can get.

It's the only one that gives you a choice of 4 different interchangeable print wheels and over 100 different type styles.

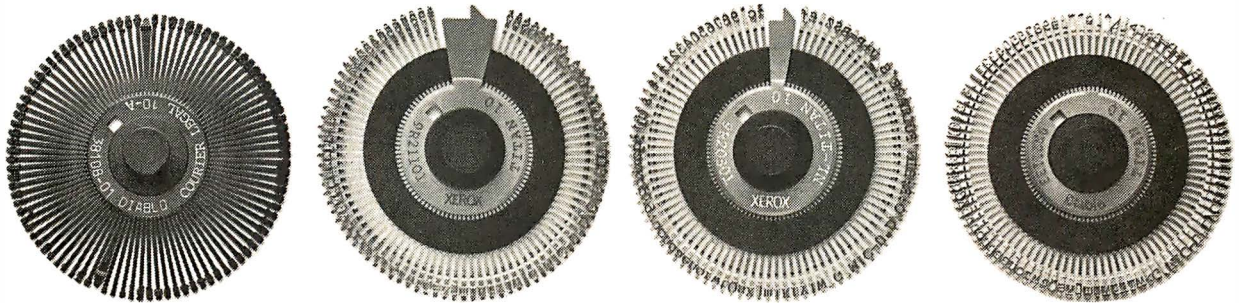

Every 630 works just as well with a 96-character plastic daisy print wheel as it does with an 88, 92, or 96-character metal daisy print wheel.

The 630 also has fewer moving parts than competitive printers, which makes it exceptionally reliable.

This new addition to our line offers unsurpassed print quality. Compatibility with existing Diablo supplies. And automatic bi-directional printing.

The Diablo 630 printer.

Probably the best thing to happen to printing since we re-invented the wheel.

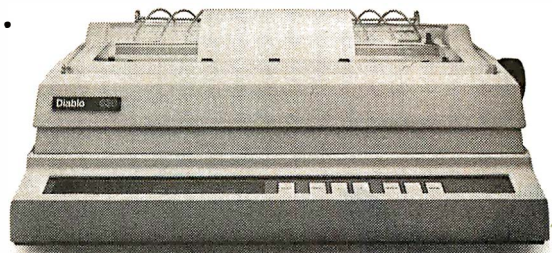

Diablo Systems

FOLLOW

DataStar.™ A general purpose key to disk data entry software package that's way ahead of the pack.

DataStar has two distinct phases. One allows you to actually design on the CRT the exact form you need. The other allows you to store and retrieve data. Quickly. And accurately. So, when it comes to data entry and verification, go with the leader.

Go with DataStar.

WordStar.™ The world leader in microcomputer word processing.

With so many advanced features, isn't it quite obvious? WordStar is a born leader. In fact, more than seven thousand people have purchased WordStar from over 300 dealers around the world. In just the first year! Proof positive that WordStar is *the* word processing software package for Z-80, 8085 and 8080 microcomputers.



THE LEADER.

SuperSort.™ It makes sorting so simple, it's simply in a class by itself.

There you are. With a *mountain* of tedious tasks. But don't panic. Here comes SuperSort to the rescue! SuperSort is faster, more powerful and able to sort 560 records in a single minute. Hooray for SuperSort. It makes molehills out of mountains.

WordMaster.™ It's everything you've ever wanted in a video text editor. And more.

WordMaster is so powerful and flexible it can actually double as a word processor. Yet it has all the capabilities you need to enhance your file management needs on a small budget. No wonder it's the path most programmers wish to take.

I/O Master.™ The economic route to quality printing.

Now you can get better input/output performance for less money because I/O Master's S-100 board

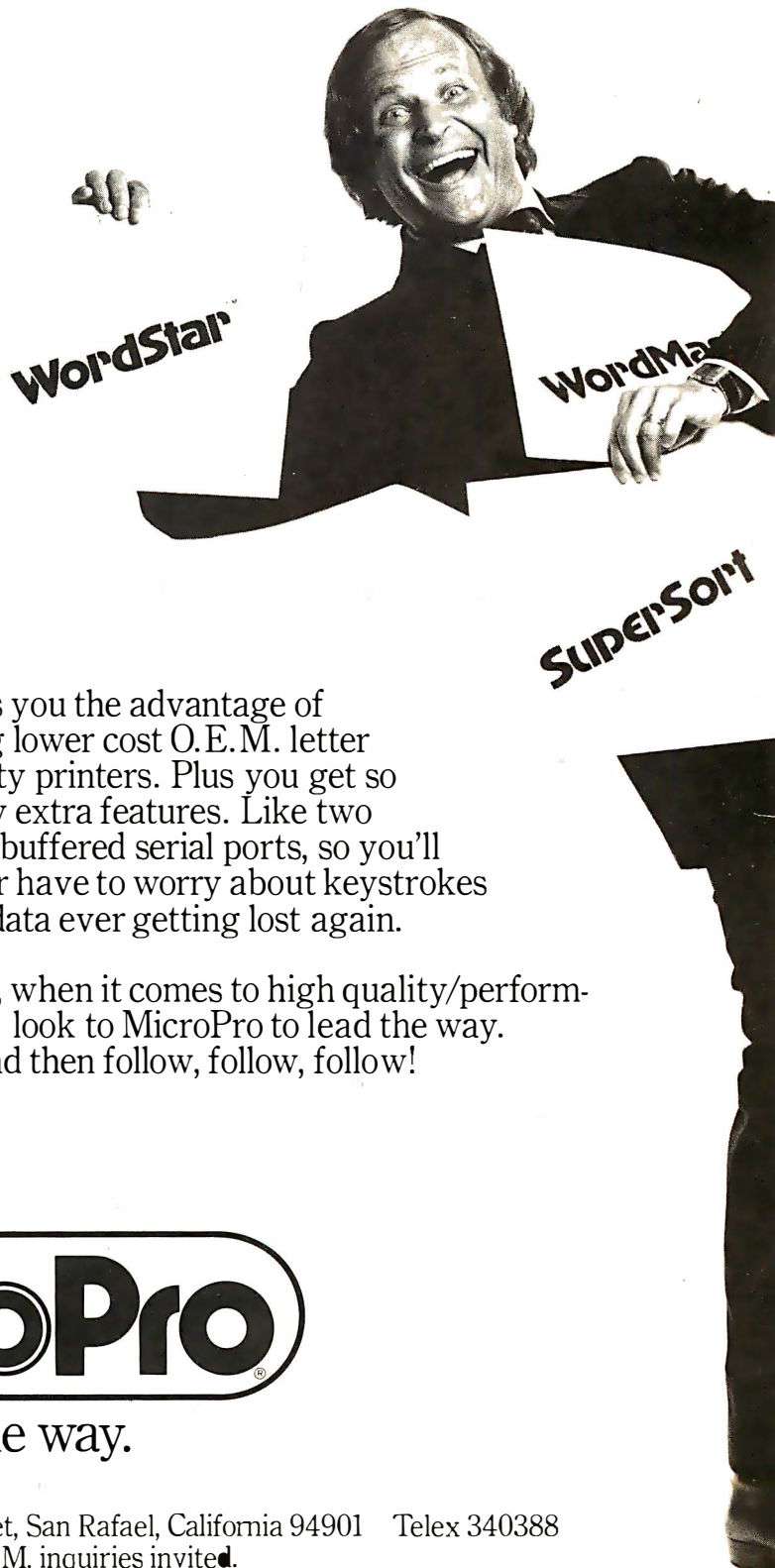

gives you the advantage of using lower cost O.E.M. letter quality printers. Plus you get so many extra features. Like two fully-buffered serial ports, so you'll never have to worry about keystrokes and data ever getting lost again.

So, when it comes to high quality/performance, look to MicroPro to lead the way. And then follow, follow, follow!

MicroPro

Leads the way.

A Time-Sharing/Multi-User Subsystem for Microprocessors

Don Kinzer
19972 NW Metolius Dr
Portland OR 97229

Now that the personal computer has become firmly established, many users are developing an appetite for more complex and sophisticated systems. Disk-based systems, quite rare among users several years ago, are now commonplace.

Among the concepts being investigated and implemented by advanced experimenters are: real-time operating systems; multiprocessor systems (eg: resource sharing); advanced disk-operating systems; multitasking systems; parallel processing; and time-sharing/multi-user systems. Indeed, almost every feature of large computer systems is being considered for implementation on microcomputers. This article will explain some of the problems, techniques, advantages, and disadvantages of time-sharing/multi-user microprocessor systems. For the most part, the techniques are applicable to all currently popular microprocessors (eg: 6800, 8080, 6502). However, the exact implementation and circuitry required may differ depending upon the microprocessor.

The impetus for time-sharing or multi-user systems is to allow for more efficient use of processor time and to allow several people to share the processor. A microprocessor can do only one thing at a time: the trick

is to make it *appear* to be doing more than one thing simultaneously. In most home computer applications, the processor is input/output (I/O) bound — that is, the processor spends much of its time waiting for I/O.

The only time the processor "wastes" is the overhead time required to change users.

The idea, then, is to let the processor execute the next user's job while the I/O interface handles the time-consuming serial I/O. This may lead to the false proposition that we need complicated I/O interfaces. But all serial I/O devices, such as the universal asynchronous receiver/transmitter (UART), or the asynchronous communications interface adapter (ACIA), are I/O processors. After they get the character to transmit, for example, they are processor independent, allowing the processor to do something else (usually a loop to wait for the device to come to a ready state, as in single-user systems).

Imagine two programs, both in memory, two I/O routines, and two terminals. Program A (Spaceflight,

for example) uses I/O routine A that drives terminal A. Program B, a BASIC interpreter, uses I/O routine B that drives terminal B. Each I/O routine has the flowchart shown in figure 1. One program executes until it needs its I/O device and the device is busy. At that time, control is transferred to the other program after first saving the contents of the processor registers. When the other program meets the same condition with its I/O device, control switches back again.

But what happens if program A gets caught in a loop or if program B doesn't do any I/O? The answer is, of course, that the multi-user system fails. What we need is some way to insure that each user gets a share of the processor time. To accomplish this, we can adopt a whole new philosophy that gives each user equal time. The clock circuitry shown in figure 2 will interrupt the processor at regular intervals. The interrupt routine will consist of saving one user's registers, restoring the next user's register contents, and beginning execution. This solution is much more foolproof. No user can hang up the system unless interrupts are masked or disabled. However, this returns to the same problem we started out to solve: if user A is doing

SMOKE SIGNAL BROADCASTING

Presents

3 Powerful New SS-50/SS-50C Boards

DCB-4
Disk Master
Double Density Controller Board
and DOS68D Double Density DOS
\$449.00

The new DCB-4 is a truly state-of-the-art development which allows up to 366K bytes to be stored on a single 5¼" disk and has these outstanding features:

- Up to four 5¼" and four 8" drives can be handled in the same system with a user definable logical unit table. (DOS68D will be compatible with future hard disk systems).
- Under software control, the user can select the following for any drive:
 - ☆ Single sided or double sided operation.
 - ☆ Single density or double density data.
 - ☆ 5¼" or 8".
 - ☆ Stepping Rate.
 - ☆ 40 track or 35 track density on double sided 5¼" drives.
 - ☆ User can select the system boot configuration.
- Occupies only 16 bytes of memory space (F760-F76F standard). User selectable to any 16 byte address space.
- Can read and write a single sector by itself. On-board buffer memory allows full interrupt capability in interrupt driven systems. Once data transfer has been initiated, no more processor time is required.
- Contains extended decoding circuitry for extended addressing per SS-50C bus which can be enabled by an option jumper.
- SSB provides a means for copying software written by older versions of DOS68 to be read by DOS68D. All new media formatted by DOS68D can be read by all older versions of DOS68. DOS68 is SSB's 6800 disk operating system.
- Track Ø of side Ø is recorded in single density per IBM standard.
- Phase-locked-loop assures highest data integrity attainable.

All of these features are available for immediate delivery on one standard 5½" x 9" 50 pin SS-50/SS-50C card for only \$449.00. The price includes DOS68D version 5.1, MONITOR object code on diskette, and a manual with the source listing.

SCB-69
Super Computer Board
6809CPU Board
\$299.00

The most versatile 6809 CPU Board on the market is now available from Smoke Signal Broadcasting and has the following features:

- Standard 2 MHz operation.
- 20 bit address generation for up to 1 Mbyte of memory. Uses an improved address translation RAM which is compatible with present extended addressing schemes yet requires much less overhead when used in multi-user systems.
- All on-board devices can be switch selected to occupy any or all extended pages. Any on-board device may be disabled and its memory space is then available for external memory.
- Standard real-time clock (time-of-day, day-of-week, day-of-month) with battery back up capable of generating programmable interrupts.
- Up to 20K of EPROM can be installed on the CPU Board.
- Standard 1K of RAM on board.
- Includes improved 6809 Monitor (and source listing).
- Contains an FPLA for decoding EPROM address and optional devices. Switches are used to select 2K/4K EPROM and Fast/Slow I/O.
- Contains provision for optional 9511/9512 floating point processor.
- NMI line is user selectable to work with either SS-50 or SS-50C busses.

Price for the new SCB-69 is only \$299.00 for an assembled, burned-in fully tested board.

M-32-X
32K
Memory Board
\$539.00 \$439.00

The first and best 32K Static Ram Board on standard size (5½" x 9") SS-50/SS-50C Bus Circuit Card is made by Smoke Signal.

- Switch selectable to any 4K boundary.
- Any 4K block may be switch enabled or disabled.
- Fully compatible with SS-50C extended addressing (allows memory decoding up to 1 Mbyte).
- Extended addressing capability may be switched off for compatibility with SS-50 systems.
- Gold Bus Connectors for high reliability.
- Guaranteed 2MHz operation (tested at 2.2 MHz).
- Low power consumption — 8 volts at 2.4 amps typical.

M-32-X 32K Memory Board is priced at \$539.00.

M-24-X 24K Memory Board expandable to 32K, is \$439.00.

And our M-16-X 16K board is back to the old price of \$299.00.

Circle 77 on inquiry card.

SMOKE SIGNAL



BROADCASTING®

31336 Via Colinas, Westlake Village, CA 91361, (213) 889-9340

I/O and his device is not ready, processor time is wasted waiting for it.

The obvious solution is to use the best parts of both systems and eliminate the disadvantages of each: allow each user a timeslice, and when the time has expired, move to the next user. Furthermore, if a user needs his I/O device and the device is busy, truncate (ie: terminate) his time slice and move to the next user. With this system, a user's program will execute until the allotted time runs out or an

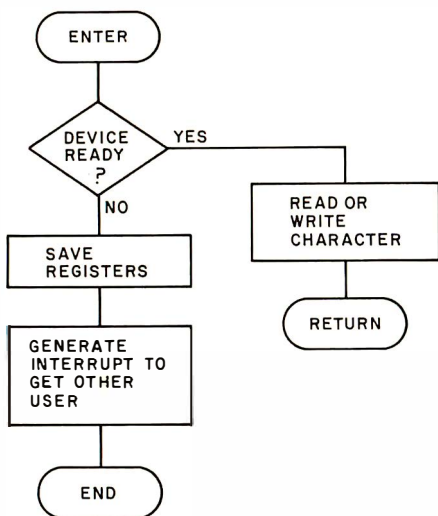

Figure 1: Flowchart of I/O routines in a multi-user system. The software controlling both programs leaves the control with one until that program requires the use of an I/O device that is not currently available. This scheme is too simple to be used in a practical situation.

I/O request receives a busy response. Hence, the processor is always doing something useful, and the only time it wastes is the overhead time required to change users.

The efficiency of the system, in terms of *processor time efficiency* (PTE), is defined as:

$$PTE = \frac{\text{execution time}}{\text{execution} + \text{overhead time}}$$

Although the system can never be 100% efficient, it will be the system designer's goal to make the processor time efficiency as high as possible. This is subject to other constraints to be discussed later.

It is clear that we need some means to terminate a time cycle and concurrently generate an interrupt to the processor. Furthermore, we want to insure that when the current user prematurely terminates, the next can still get his full time allotment. The circuit in figure 3 will implement this for a 6800 microprocessor. An 8080 implementation might use IN or OUT instructions instead of memory-mapped I/O.

SEL is a signal that comes from a memory-mapped bit and indicates that we are addressing the interrupt circuitry, while VMA indicates a valid address on the bus. Normally, IC1a will time out (ie: Q output will drop low) after a certain period of time set by its resistor/capacitor combination. It will trigger IC1b for a 1 μs pulse. This pulse is fed to the inter-

rupt line of the processor through the open-collector inverter IC2. Furthermore, when IC1b times out, it triggers IC1a and starts the cycle over again. However, when VMA and SEL are true and the processor is doing a write (ie: R/W false), IC1a will be cleared early. This action fires IC1b which then interrupts the processor and also triggers IC1a to start a new cycle. We now have a means for the processor to interrupt itself!

In general, when the system is first powered up, we do not want these interrupts occurring all over. Unless the system is in read-only memory, we must first load in the software including the interrupt handler. Furthermore, back-to-back one-shots usually have startup problems so that the circuit of figure 3 may not always run.

We can fix both of these problems simultaneously as shown in figure 4. Upon power-up or pressing the reset button, the RESET line becomes active and sets the RS flip-flop formed by IC4a and IC4b. Through IC5, IC4b holds IC1a cleared and IC4a holds the A input of IC1b high. Because IC1a is cleared, the B input of IC1b remains high as well. When VMA and SEL are true and the processor is executing a read operation, the RS flip-flop is reset. This removes the CLEAR signal from IC1a, thus triggering IC1b, which causes the processor to be interrupted. When IC1b times out, it triggers IC1a and then the cycle is the same as before. As you can see, when the system powers up, the interrupt timer is disabled until the processor reads a particular location (ie: the memory-mapped bit SEL), which then starts the timer. Furthermore, pressing the reset button will also disable the timer.

Memory management is important in such systems. For example, if we have a sixteen-user system and the users will never be running the same program, we can merely assemble all the programs so that they fit in the memory space available. Additionally, we need to set aside a *separate* temporary storage area for each user. With the 8080 this is no great disadvantage, but with the 6800 or 6502, there is the 256-word page 0 which is most efficiently used as temporary storage. With large programs requiring large amounts of storage, there

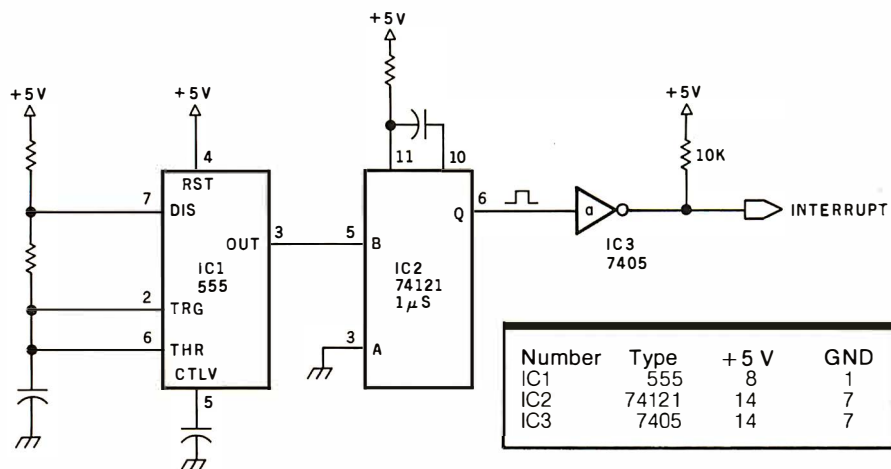

Figure 2: Schematic diagram of a time-slicing interrupt clock. This circuit generates a periodic pulse that is used to interrupt the processor. When coupled with the appropriate software, the circuit can be used to divide processor time equally among all the running programs.

You Know Tarbell



But, do you know all the components Don Tarbell has ready for you?

When someone says "Tarbell" there's no doubt what's meant . . . the cassette interface whose reliability and solid engineering made it an industry standard.

Since that first breakthrough-product, Don Tarbell has expanded his list of useful, dependable components . . . components to meet your needs of today, and keep you prepared for tomorrow.

Check this partial list of quality components Don Tarbell has ready for you. You're probably ready for them, right now.

- When it comes to RAM memory, Tarbell means reliability. 16K and 32K static memory that offers you easier trouble shooting, and far easier maintenance. Remember that.
- Tarbell BASIC brings simplicity and sophistication to your programs. Our BASIC is easier to program, and offers unique commands and statements not found in regular BASICS under any name.
- CP/M® disk operating system is, of course, the standard for software exchange. At Tarbell we provide our own approved CP/M system modified for all Tarbell floppy disk interfaces. Note. We also have MP/M® for those interested in multi user systems.
- The Tarbell VDS line comes as a complete package . . . or, as separate units. For example, the Tarbell mainframe can be ordered with 1 or 2 Shugart or Siemens drives, or no drives. Whichever way you go, you get the reliability of Tarbell tested components.
- With the Tarbell Double Density floppy disk interface, storage capacity, speed and versatility are greatly increased. Under our DD CP/M, single and double density disks may be intermixed with no penalty. The system automatically determines which is in place.

We also still have our Single Density floppy disk interface. It's specifically designed to operate with many different and unusual drives. Naturally, they're Tarbell tested.

Tarbell
Electronics

950 Dovlen Place, Suite B
Carson, California 90746
(213) 538-4251 / 538-2254

*CP/M & MP/M are products of Digital Research Corp.

may not be enough page 0 memory to go around.

Further problems are encountered when we try to let all users run the same program at the same time. One approach is to have one copy of the program in memory for each of the users: sixteen users and sixteen copies. The amount of memory used may rule out multiple copies.

A second, more desirable approach is to overlay memory from the disk. Under this scheme, when we change users, we write memory out to the disk and load in the next user's memory. This is fine for extremely fast disks or very small programs, but the overhead time mentioned earlier becomes extremely large.

Hardware paging, a more reasonable solution, is very similar to disk-overlay paging. Using this technique, we set out to fool the processor by manufacturing our own address bits. Figure 5 shows a 16 K-byte memory system attached to a sixteen-user time-sharing system. As far as the processor is concerned, the 16 K bytes of memory occupy only 1 K bytes of memory. A 16 K-byte memory requires 14 address bits, A_{13} thru A_0 , and the lower 10 bits are supplied by the processor with IC2 enabling the memory for hexadecimal addresses

0000 to 03FF (1 K bytes of memory). The other four address lines are supplied by IC1, a 4-bit binary counter.

Conveniently, we have sixteen blocks of memory, each of which is effectively the first 1 K-byte block in

memory. The processor has no idea which 1 K-byte block it is and couldn't care less. If we have sixteen users, each has his own 0000-thru-03FF block of memory to use for temporary storage. Now, if every time we go to another user, we increment

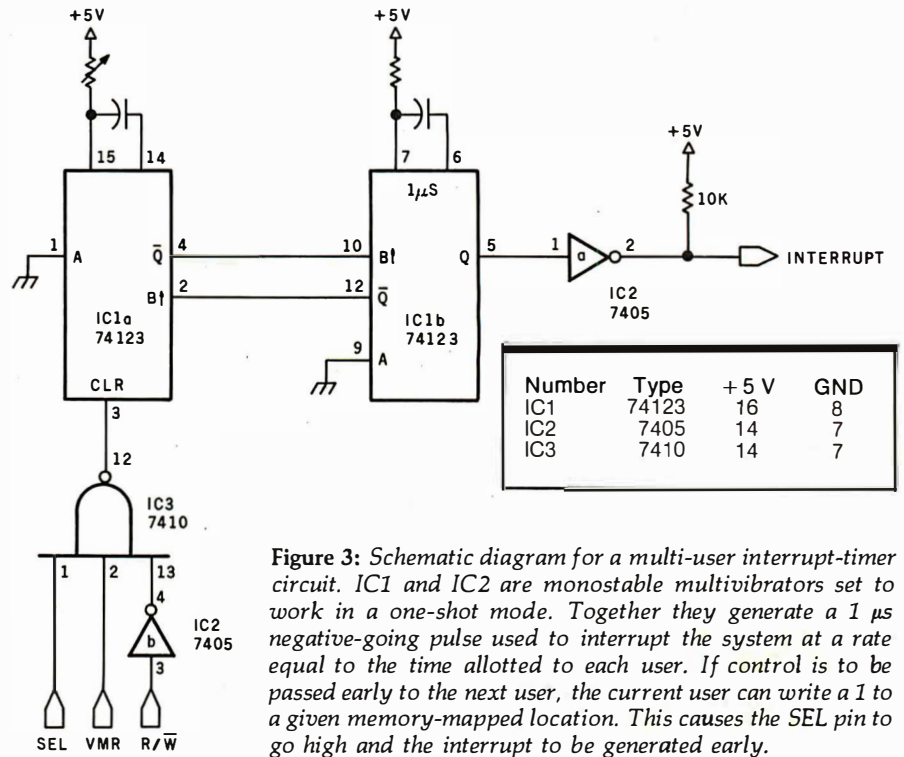

Figure 3: Schematic diagram for a multi-user interrupt-timer circuit. IC1 and IC2 are monostable multivibrators set to work in a one-shot mode. Together they generate a 1 µs negative-going pulse used to interrupt the system at a rate equal to the time allotted to each user. If control is to be passed early to the next user, the current user can write a 1 to a given memory-mapped location. This causes the SEL pin to go high and the interrupt to be generated early.

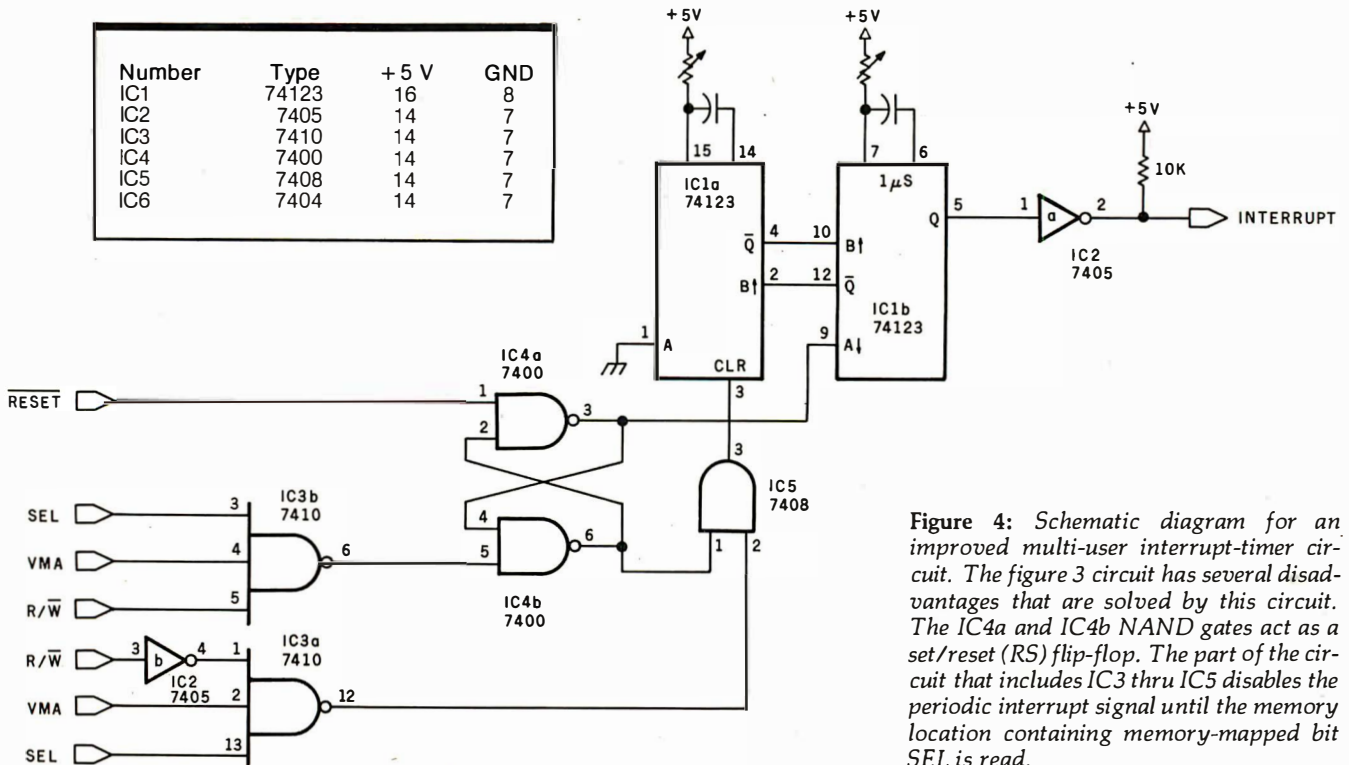

Figure 4: Schematic diagram for an improved multi-user interrupt-timer circuit. The figure 3 circuit has several disadvantages that are solved by this circuit. The IC4a and IC4b NAND gates act as a set/reset (RS) flip-flop. The part of the circuit that includes IC3 thru IC5 disables the periodic interrupt signal until the memory location containing memory-mapped bit SEL is read.



Please send your free software catalog.

(Check which software is of particular interest)

C COMPILER. Optimized native code for VAX 11/780, PDP-11, LSI-11, Z80, 8085, 8080. Full C language as defined in Kernighan and Ritchie, with comprehensive portable library. Cross compilers available. Runs under VMS, IAS, RSX-11D, RSX-11M, RSTS/E, RT-11, UNIX, Idris, CDOS, CP/M. From \$500.

IDRIS OPERATING SYSTEM. System calls and file system identical to UNIX V6, including pipelines. Utilities include shell, editor, assembler, loader, archiver, compare, copy, grep, etc., plus system utilities for file system maintenance. Runs on LSI-11, PDP-11. From \$1000.

PASCAL COMPILER. Optimized native code for VAX 11/780, PDP-11, LSI-11, Z80, 8085, 8080. Full Pascal language as defined in Jensen and Wirth, with standard library. Includes C compiler and portable library, permitting intermixed C and Pascal. Cross compilers available. Runs under VMS, IAS, RSX-11D, RSX-11M, RSTS/E, RT-11, UNIX, Idris, CDOS, CP/M. From \$750.

Idris is a trademark of Whitesmiths Ltd.
UNIX is a trademark of Bell Laboratories.
CP/M is a trademark of Digital Research Co.

VMS, RSX-11, RT-11, RSTS/E, VAX,
PDP-11, LSI-11 are trademarks of Digital
Equipment Corporation.

Name _____

Company _____

Street _____

City _____ State _____ Zip _____

Whitesmiths, Ltd.
Software for grownups.
(212) 799-1200

P.O.B. 1132 Ansonia Station, New York, N.Y. 10023

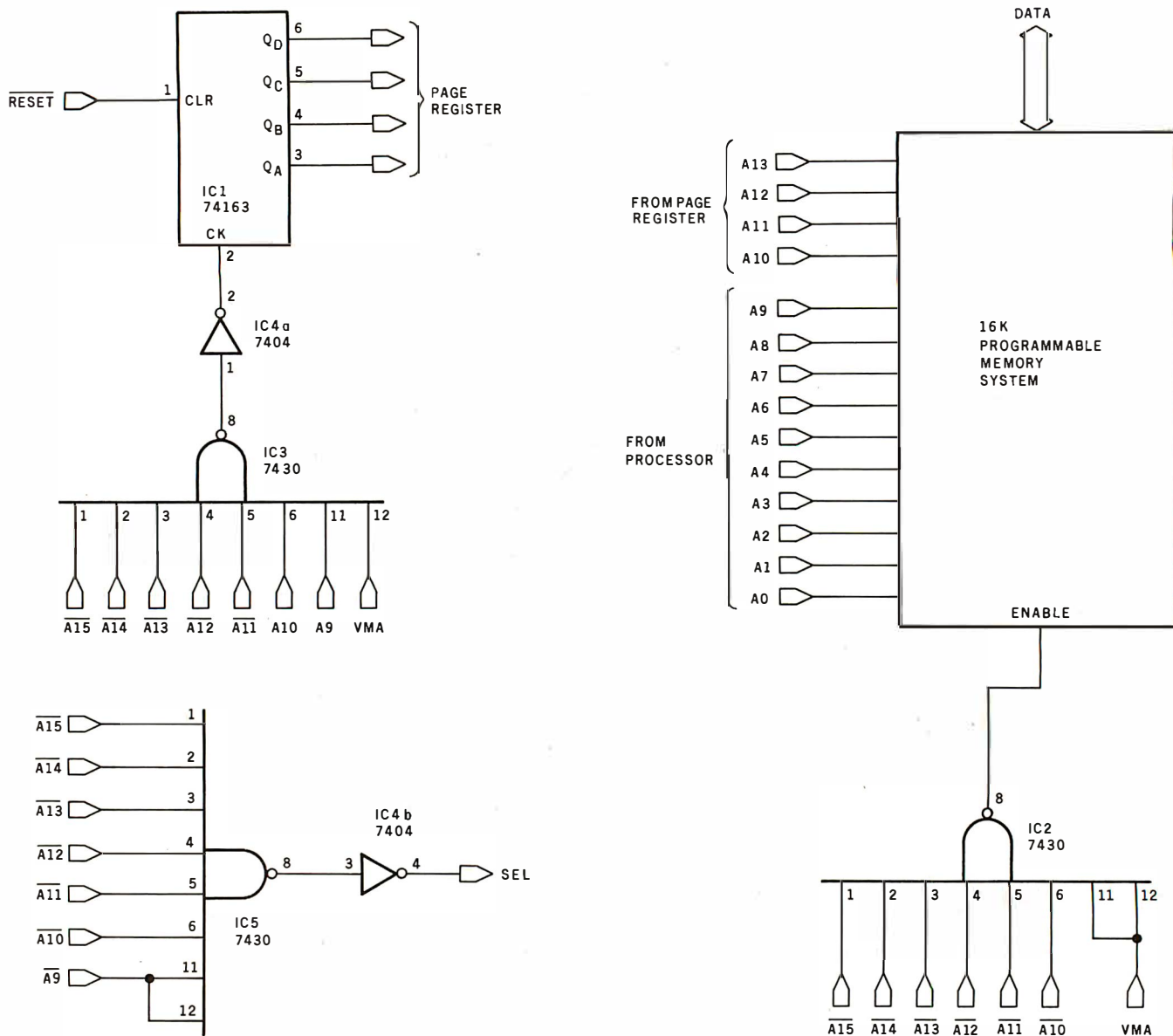

Figure 5: Overview of a 16 K-byte hardware-paged memory design. The 16 K-byte block of memory shown appears to the computer as a 1 K block with hexadecimal addresses 0000 thru 3FFF. The block of memory is enabled when IC2 goes low, which occurs when address bits A15 thru A10 are low (that is, when an address of hexadecimal 03FF or lower is seen on the address bus). The 4-bit binary counter IC1 is incremented when IC3 goes low. This occurs when a hexadecimal address of 06xx (or 07xx) appears on the address bus; the software in listing 1 uses the hexadecimal address 0600. The SEL line goes high and causes an early interrupt in the circuitry of figure 4 when a hexadecimal address of 04xx (or 05xx) occurs on the address bus. The software in listing 1 uses the address 0400 in two different contexts.

the page register (IC1), we have changed the physical memory which responds to addresses 0000 thru 03FF. This operation will take at most 6 μ s, so we keep overhead low.

Since the circuit that first increments the page register and later increments the interrupt circuitry must be memory-mapped to an address outside the 1 K-byte memory space, the whole system occupies a 2 K-byte block. An 8080 would not need to waste this extra memory if IN

and OUT instructions were used. Also note that RESET sets the page register to user 0.

The paging scheme, while having separate storage areas with identical addresses, will allow us to have only one copy of each program. This, of course, rules out the use of self-modifying code, unless that code modified is in the first 1 K of memory allotted to each user. On the other hand, code should not be written to modify itself.

Now that the hardware description is complete, I can discuss the software. Since my experimentation was done on a 6800, it will be used as an example. Implementation for a 6502 will be similar and that for an 8080 only slightly more involved. General flow for initialization, interrupt, and I/O routines is shown in figure 6. The 6800 machine code used to implement the flowcharts is given in listing 1. It is assumed that all users

Text continued on page 134

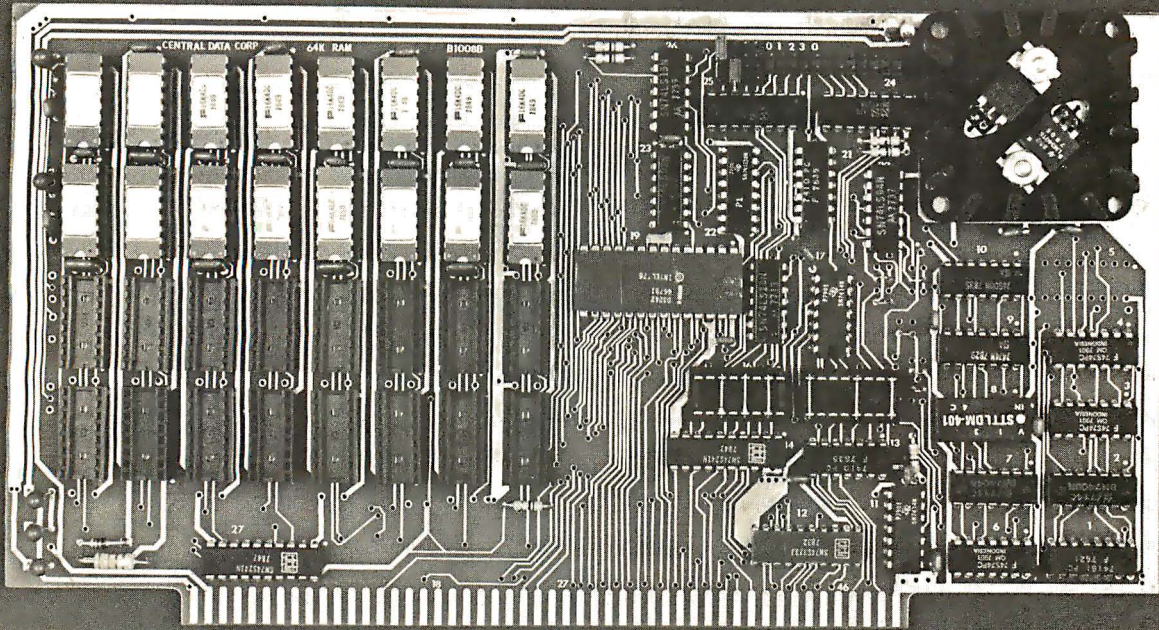

32K Board Pictured Above

Why Not the Best?

From The Dynamic RAM Company.

2MHz	4MHz
16K—\$249	\$259
32K—\$375	\$395
48K—\$500	\$530
64K—\$625	\$665

We have now been shipping our 2MHz dynamic RAM boards for over two years. Hundreds of 4MHz boards have been going out every month since early 1979. Our reliability is proven in the thousands of systems which contain our board. Many quality-minded systems houses across the country and overseas are using our boards for their equipment.

Our prices still beat all. Despite rising 16K memory chip prices (at least from reputable suppliers), Central Data continues to give you the best buy in memory today. Nobody offers a board with a capacity of 64K, assembled, tested, and guaranteed for a full year at the price we do.

Deselect around PROMs. Our boards have the important deselect feature which lets you overlap any fixed memory in your system with no interference.

Our features make the board easily used and expanded. You address our boards on 16K boundaries with mini-jumps (small shorting plugs that slide over wire-wrap pins) near the top of the board for easy access. If you want to expand your board after you have purchased it, all that you need to do is add memory. We can supply you with expansion packages (\$150-2MHz, \$160-4MHz) which include eight RAMs that you can depend on as well as two mini-jumps for addressing. And of course, our board **never** generates wait states.

Low power consumption keeps your computer running cool and reliable. The total power consumption of our 16K board is typically less than 4 watts (+8V @ 300ma, +16V @ 150ma and

–16V @ 20ma). Boards with additional memory typically increase power consumption only 1 watt per 16K!

Standard S-100 Interface. Our board is designed to interface with any standard S-100 CPU. All of the timing of the board is independent of the processor chip, and the board is set up for different processors by changing two plugs on the board.

Call or write us today. That will guarantee a fast response with more information on the board. Or make an order — you'll probably have the board in two weeks! **If you're interested, also ask for a catalog on our Z8000 16-bit processor board designed for the MULTIBUS.** All of these products are available to your local dealer, also.

Central Data Corporation, 713 Edgebrook Drive, PO Box 2530, Station A, Champaign, IL 61820. (217) 359-8010

Central Data

Listing 1: Software routines for the author's 6800-based multi-user system. INIT is an initialization routine called just after power-up or reset. INTERR is the interrupt routine that saves the status of a given user and prepares the system for the next user in line. OUTCH is the output routine used by the system. This software is assumed to work with the circuitry of figures 4 and 5. In INIT, reading TIMER causes SEL line of figure 5 to go high and the interrupt system in figure 4 to be enabled for the first time. In INTERR, writing to NUSER causes the page register in figure 5 to increment, causing the next user's block of memory to be immediately enabled. In OUTCH, writing to FORCE causes the SEL line in figure 5 to go high, causing an early interrupt to occur.

Hexadecimal Address	Hexadecimal Code	Label	Instruction Mnemonic	Operand	Commentary
		*			
		* TIME SHARING SOFTWARE			
		*			
03F2			ORG	\$3F2	
03F2		STACK	RMB	8	
03FA		ACIAH	RMB	1	
03FB		ACIAL	RMB	1	
03FC		XSAVE	RMB	2	
03FE		SP	RMB	2	
		*			
		*			
0400		FORCE	EQU	\$400	FORCED INTERRUPT ADDR
0400		TIMER	EQU	\$400	START TIMER ADDR
0600		NUSER	EQU	\$600	NEXT USER ADDRESS
		*			
		*			
		*			
2000			ORG	\$2000	
2000	0F	INIT	SEI		DISABLE INTERRUPTS
2001	5F		CLR B		SET USER 0
2002	CE 03 F2	INITLP	LDX	#STACK	
2005	FF 03 FE		STX	SP	SET STACK POINTER
2008	CE 08 00		LDX	#\$800	LOAD PROGRAM ADDRESS
200B	FF 03 F8		STX	STACK+6	SET USERS PC
200E	86 80		LDA A	#\$80	
2010	B7 03 FA		STA A	ACIAH	SET ACIA HIGH ADDR
2013	F7 03 FB		STA B	ACIAL	SET ACIA LOW ADDR
2016	F7 06 00		STA B	NUSER	SET NEXT USER
2019	5C		INC B		
201A	5C		INC B		GET NEXT USER ID
201B	C1 20		CMP B	#16.2	CHECK DONE
201D	26 E3		BNE	INITLP	LOOP TILL DONE
201F	C6 10		LDA B	#16	SET USER COUNT
2021	FE 03 FA	STACIA	LDX	ACIAH	GET USERS ACIA ADDR
2024	86 03		LDA A	#3	
2026	A7 00		STA A	0,X	RESET ACIA
2028	86 15		LDA A	#\$15	
202A	A7 00		STA A	0,X	SET CHARACTERISTICS
202C	B7 06 00		STA A	NUSER	SET NEXT USER
202F	5A		DEC B		COUNT DOWN
2030	26 EF		BNE	STACIA	LOOP TILL DONE
2032	8E 03 F9		LDS	#STACK+7	SET USER 0 STACK
2035	B6 04 00		LDA A	TIMER	START INTERRUPTS
2038	0E		CLI		ENABLE INTS
2039	7E 08 00		JMP	\$800	GO TO USERS PROGRAM
		*			
		*			
		*			
203C	BF 03 FE	INTERR	STS	SP	SAVE USERS SP
203F	B7 06 00		STA A	NUSER	SET NEXT USER
2042	FE 03 FE		LDX	SP	GET THIS USERS SP
2045	3B		RTI		START PROCESSING HIM
		*			
		*			
		*			
2046	FF 03 FC	INCH	STX	XSAVE	SAVE X
2049	FE 03 FA		LDX	ACIAH	GET USERS ACIA ADDR
204C	A6 00	CHECKR	LDA A	0,X	GET STATUS
204E	47		ASR A		
204F	24 08		BCC	NOTRED	BRANCH IF NOT READY

Listing 1 continued on page 132

The Place To Buy Computers

CROMEMCO Z-2H HARD DISK



• Full 11-megabyte hard disk system • fast Z80A 4 MHz processor • two floppy disk drives • 64K RAM memory • RS-232 special interface • printer interface • extensive software available
List \$9995 . . . **OUR PRICE ONLY \$8489**

CROMEMCO HDD

11/22 megabyte hard disk for use with existing systems. DMA controller, transfer rate of 5.6 megabytes/sec.
HDD-11, List \$6995 . . . **OUR PRICE \$ 5,939**
HDD-22, List \$11,995 **10,189**

NORTH STAR HORIZON



HORIZON 1 KITS

16K, Double Density, List \$1599 . . . \$1474
32K, Double Density, List \$1849 . . . 1684
32K, Quad Density, List \$2049 1869

HORIZON 1 ASSEMBLED & TESTED*

32K, Double Density, List \$2695 . . . \$2279
32K, Quad Density, List \$2995 2539

HORIZON 2 KITS

16K, Double Density, List \$1999 . . . \$1824
32K, Double Density, List \$2249 . . . 2034
32K, Quad Density, List \$2629 2359

HORIZON 2 ASSEMBLED & TESTED*

32K, Double Density, List \$3095 . . . \$2619
32K, Quad Density, List \$3595 . . . \$3049
48K, Double Density, List \$3590 . . . 3039
48K, Quad Density, List \$4090 3469
64K, Double Density, List \$3830 . . . 3239
64K, Quad Density, List \$4330 3669

SUPERBRAIN® By INTERTEC

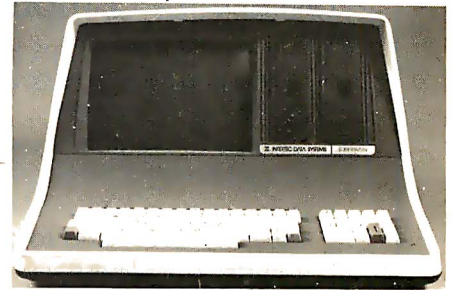

Available with 32K, 48K & 64K

Totally self-contained in a single box; 32K, 48K, or 64K Version; Uses two Z-80 CPU's; Commercial-type terminal with 12" monitor (like the Intertube); Dual double-density minifloppies w/360 Kilobytes of storage capacity; I/O ports included; Expandable (if needed) with an external S-100 bus interface; Comes with CP/M™ operating system; extensive software support.
w/32K of RAM, List \$2995 . . . **ONLY \$2685**
w/64K of RAM **\$2883**

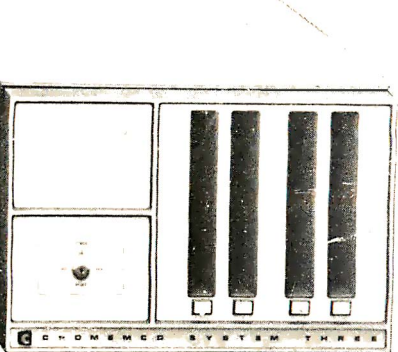

CROMEMCO SYSTEM 3 — NOW DOUBLE THE CAPACITY! —

Features 4 MHz CPU, 64K of RAM, dual-sided PerSci 299B floppy disk drive (provision for installing a second 299B), RS232C interface, printer interface. All Cromemco systems are assembled and tested, ready to use.
With 64K of RAM, List \$6990 . . . **\$5890**

CROMEMCO SYSTEM 2 NOW DOUBLE THE CAPACITY (with double-sided drives)

With 64K of RAM, two minifloppy disk drives, RS232 interface and printer interface board.
System 2 w/64K RAM, List \$3990 **\$3390**

CROMEMCO Z-2

Can be rack mounted. Z-80 processor, 21 slots, power supply, front cover panel. Includes fan and all edge connectors. Assembled and tested.
Z-2W, Assem., List \$995 **\$845**

WRITE FOR FREE CATALOG

Above prices reflect a 2% cash discount (prepaid prior to shipment). Add 2% to these prices for credit cards, C.O.D., etc. Prices are f.o.b. shipping point. Prices are subject to change and offers subject to withdrawal without notice.
Circle 80 on inquiry card.

VECTOR MZ



Now 64K with Bank Select — Complete Peachtree Business Software Package also available — Call for details.

INTER SYSTEMS (formerly ITHACA AUDIO)



The new series II CPO Board features a 4 MHz Z-80A CPU and a full feature front panel. 20-slot actively terminated motherboard, with 25-amp power supply (50/60 HZ operation, incl. 68 cfm fan).
DPS-1, List \$1495 **OUR PRICE \$1299**

SD SYSTEMS

SDS-100, w/32K RAM, \$6995: **ONLY \$5945**
SDS-200, List \$8995 **7645**

DYNABYTE

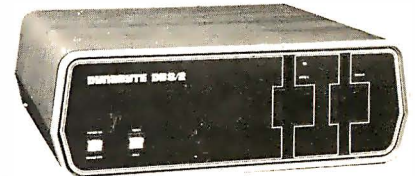

48K and 64K models, single and double density, dual mini disk (77 track), standard 8" and dual-sided 8" systems . . . **SAVE 15%**

HEATH

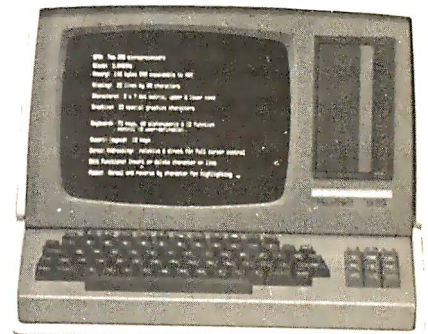

WH-89 — All-in-one computer. Features two Z-80's, 16K to 48K. Call or write for prices.

RADIO SHACK TRS-80™ 10% OFF

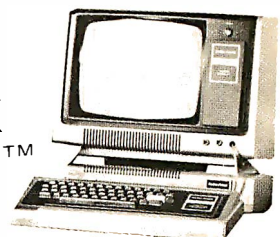

MiniMicroMart, Inc.

1618 James Street, Syracuse NY 13203 (315) 422-4467 TWX 710-541-0431

Anti-Static Dust Covers

Protect your computer and accessories.

- Anti-static vinyl helps prevent static from damaging sensitive components and causing faulty operation.
- Double-fold stitching will not rip out and is unmatched for strength and long life.
- Heavy gauge textured vinyl blends with any decor and folds easily for convenient storage.
- Over 1000 custom designs guaranteed to fit precisely.
- 100% satisfaction guarantee means we stand behind our product.

Yes, there are differences in Dust Covers. Differences which can be vitally important to the proper functioning of your system.

At Cover Craft we've manufactured the highest quality Dust Covers for the electronics industry for more than six years. We've been selected by major equipment manufacturers to make covers for their products. Our covers are in use in every state and in more than 50 countries. We know what it takes!

THE BEST
DUST COVERS
AT ANY PRICE

MOST PRICED
\$7.95 to \$11.95
PLUS POSTAGE AND
HANDLING
VISA-MasterCharge



So visit your dealer or contact Cover Craft for our latest catalog and list of over 200 dealers.

COVER CRAFT
P.O. BOX 555 • AMHERST, NH 03031 • (603) 889-6811

Listing 1 continued:

2051	A6	01			LDA A	1,X	ELSE GET DATA
2053	84	7F			AND A	#\$7F	MASK OFF PARITY
2055	FE	03	FC		LDX	XSAVE	RESTORE X
2058	39				RTS		
2059	B7	04	00	NOTRED	STA A	FORCE	FORCE INTERRUPT
205C	20	EE			BRA	CHECKR	GO CHECK AGAIN
				*			
				*			
				*			
205E	36			OUTCH	PSH A		SAVE CHARACTER
205F	FF	03	FC		STX	XSAVE	SAVE X
2062	FE	03	FA		LDX	ACIAH	GET USERS ACIA ADDR
2065	A6	00		CHECKD	LDA A	0,X	GET STATUS
2067	47				ASR A		
2068	47				ASR A		
2069	24	07			BCC	NOTDON	BRANCH IF BUSY
206B	32				PUL A		GET CHARACTER BACK
206C	A7	01			STA A	1,X	SEND IT
206E	FE	03	FC		LDX	XSAVE	RESTORE X
2071	39				RTS		DONE
2072	B7	04	00	NOTDON	STA A	FORCE	FORCE INTERRUPT
207C	20	EE			BRA	CHECKD	GO CHECK AGAIN
				*			
				*			
				*			

END

NO ERROR(S) DETECTED

SYMBOL TABLE:

ACIAH	03FA	ACIAL	03FB	CHECKD	2065	CHECKR	204C
FORCE	0400	INCH	2046	INIT	2000	INITLP	2002
INTERR	203C	NOTDON	2072	NOTRED	2059	NUSER	0600
OUTCH	205E	SP	03FE	STACIA	2021	STACK	03F2
TIMER	0400	XSAVE	03FC				

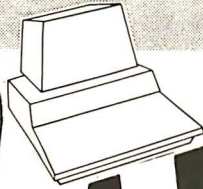

APPLE/PET BREAKTHROUGHS

"Precise, humanized, well documented an excellent value" are the applauds now being given to United Software's line of software. These are sophisticated programs designed to meet the most stringent needs of individuals and business professionals. Every package is fully documented.

APPLE WORLD

By Paul Lutus

3-D ANIMATED GRAPHICS

The Program made famous on National TV!

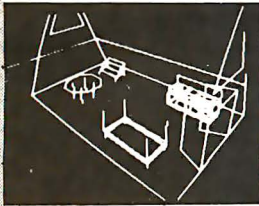

FOR APPLE II COMPUTERS

APPLE WORLD turns your Apple into a sophisticated graphics system capable of creating animated three-dimensional color images, projecting them in true perspective on the screen, rotate them, move them closer, further away, and many other exciting and imaginative things.

A powerful screen-oriented text editor is included to facilitate image formation. This program was recently featured on Tom Snyder's Prime Time Saturday TV Show and is now available for sale.

APPLE WORLD'S powerful editor is so easy to use that children will love it. You can now "sketch" your dream house, boat, car, or fantasy empire. Then view it as it would be seen from 10,000 feet, or you can ZOOM in until the screen is filled with a doorknob. You could then go inside and move from room to room examining furniture placement as your screen rotates within the room. Images or specific parts of images can easily be saved to disk or printer.

Does all this sound like science fiction? You won't think so after you have visited Apple World.

Introductory Price \$59.95

36 page manual included

Look for the RED-WHITE-BLUE United Software Display at your local computer dealer, or send check or moneyorder, plus \$3.00 shipping to:

USA UNITED SOFTWARE OF AMERICA

750 3RD Avenue,
New York NY 10017
(212) 682-0347

Telex 640055

DEALER INQUIRIES INVITED

KRAM

By Ken Germann

KEYED RANDOM ACCESS METHOD

Many times more powerful and efficient than the primitive "relative record" method used by Apple & Commodore.

FOR APPLE II & COMMODORE PET

KRAM is the FASTEST and MOST POWERFUL keyed access method available for the Apple & Commodore CBM (Pet) Computers. Written entirely in 6502 machine code, KRAM is extremely fast, comprehensive in scope, very compact, and easy to use. KRAM function calls are invoked via a single instruction.

Using the sophisticated capabilities of KRAM the Apple & CBM (Pet) can now fully meet the requirements of information management applications, such as: Accounts Receivable/Payable, Inventory Control, General Ledger, Payroll, Mailing lists, and Database Management. Programs can now be 30% to 90% shorter and run many times faster! Less experienced users can now create powerful programs!

KRAM Release 2.0 Functions:

- Create/Open a dataset
- Put record by Key
- Add & delete records by Key
- Get any record by Full/Partial key in 4/10ths of a second (2/10ths with Corvus Disk)
- Read next or previous record
- Dynamic space allocation
- Dynamic space reclamation
- Dynamic index compression
- Never needs file reorganization!

An 87 page manual fully documents KRAM 2.0 detailing KRAM functions and illustrating with programming samples. KRAM architecture is fully explained and a sample mailing list application program is included.

PET & Apple Requirements

KRAM is designed to work with both Apple's Disk II, or Corvus Systems 10 Megabyte Winchester Disk, and Commodores 2040, 3040, and 8050 Disk units. KRAM 2.0 requires an integer Apple or Apple Plus with integer card and at least one disk drive. KRAM works on any 40/80 column 16K/32K PET.

Introductory Special \$99.95

FOR COMMODORE 16K/32K COMPUTERS

DATABASE MANAGEMENT SYSTEM — A comprehensive, interactive system like those run on mainframes! Six modules comprising 42K of programming allow you to: create, edit, delete, display, print, sort, merge, etc., etc. - databases of up to 10,000 records. Printer routines automatically generate reports and labels on demand. 60 pages of concise documentation are included. Requirements - 16-32K PET and 2040 Dual Disk (printer optional) **COST \$125**

OTHER UNITED SOFTWARE PRODUCTS

APPLE COMPUTERS

Super Space Wars.....	\$ 9.95
States & Capitals.....	9.95
Moving Point	
Average.....	19.95
Stock Options.....	24.95
Finance.....	12.95
Bonds.....	12.95
Stock Analyzer.....	22.95
Mortgage.....	15.95

COMMODORE PET

Space Intruders	
("Best Game of 1979") ..	\$19.95
Jury/Hostage.....	9.95
Kentucky Derby/Roulette	9.95
Alien I.Q./Tank.....	9.95
Tunnelvision/Maze Chase	14.95
Submarine Attack.....	9.95
Battle of Midway.....	7.95
Laser Tank Battle.....	9.95
Swarm.....	14.95
Baseball.....	9.95
Super Startrek.....	14.95
PET Music Box.....	29.95

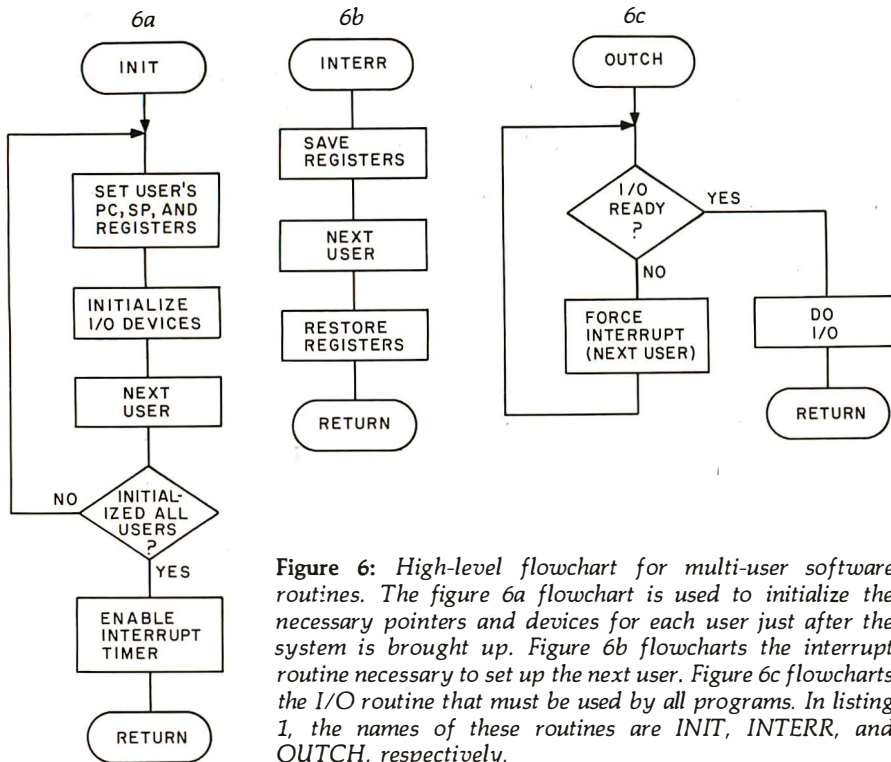

Figure 6: High-level flowchart for multi-user software routines. The figure 6a flowchart is used to initialize the necessary pointers and devices for each user just after the system is brought up. Figure 6b flowcharts the interrupt routine necessary to set up the next user. Figure 6c flowcharts the I/O routine that must be used by all programs. In listing 1, the names of these routines are INIT, INTERR, and OUTCH, respectively.

Text continued from page 128:

are running the same program (for example, BASIC) that starts at hexadecimal 0800. Furthermore, it is assumed that ACIAs are used for the I/O interface and are located contiguously at hexadecimal 8000, with each one occupying two memory locations. No pointer initializations are shown for any programs that require them. If you are going to run BASIC, you will need to set pointers in user areas to indicate the memory area to be used as source-code storage for that particular user.

The overhead in the interrupt handler is a mere 36 μ s, including the time to respond to the interrupt, assuming that you have 1 MHz system clock. The interrupt rate, or time-slice length, depends on several factors and must be selected according to the software being run. If the I/O devices are running at 1200 bps, the character time is 8.33 ms. Continuing our example of sixteen users, a good starting point would be 1/16 of this time. This would allow each user to output at full speed, but would have 93% efficiency (ie: PTE). A more efficient system could be realized by lengthening the time slice at the expense of slowing effective output speed. The trade-off here

depends on the computing-to-I/O ratio to be encountered in the application.

The apparent efficiency perceived by a single user also depends on the amount of I/O being encountered. If no users are doing I/O, then the speed reduction factor (SRF) for each user will be:

$$SRF = \frac{PTE}{16}$$

where 16 is the number of users. As a worst-case example, if a certain operation takes $N \mu$ s to execute on a single-user system, it will now take $N/SRF \mu$ s to execute. However, if some or all other users are doing nothing but I/O, the apparent speed rises considerably.

This is how a sixteen-user time-sharing system can be implemented. The technique can be applied to a greater or smaller number of users by changing minor points. Furthermore, the system requires little hardware and a small amount of software. In fact, the 16 K user storage, paging hardware, and interrupt circuitry can all be placed on one printed-circuit board at a modest cost. The only additional hardware necessary is the extra I/O ports and terminals. ■

Backup: A complete hardware/software solution designed to be functionally compatible with the entire spectrum of S/100 hard disk systems.

- Cromemco
- Micromation
- Thinker Toys
- North Star
- Vector Graphics
- XCOMP
- Konan
- others, as available

'Security....for your S-100 hard disk data'

BAC←UP

Don't let a hard disk be
the soft spot in your
data security

The availability of fast, reliable, high capacity hard disk storage for the S-100 computer market has created a wave of excitement. It has also underscored the somber necessity for a reliable means of backup. No serious application is practical without a dependable, economical method for backup and archival of critical on-line data.

Now, CSSN breaks the barriers to hard disk applications by offering the complete hardware and software solution for data security. . .



*Put your valuable data on-line with a hard disk . . .
Save it off-line with our Back-Up Solution*

Software provides:

- File by file save and restoral operation using standard CP/M file naming conventions
- Tape files are totally O.S. independent
- Read after write with vertical and horizontal error check ensures data integrity
- Files may be grouped in logical savesets
- Selective restore can key off of save date
- Includes command file and log file facilities
- Runs under CP/M compatible operating systems on 8080, 8085 and Z80 microprocessors
- All Lifeboat software now available on CSSN Backup cartridges

Hardware provides:

- 6400 BPI cartridge tape drive with power supply
- Up to 13.4 megabytes per tape
- S/100 interface card
- Available as either a panel rack mount unit or in a deluxe table top/rack mount enclosure
- Uses EMCA/ANSI standard 3M tape cartridges

CSSN

COMPUTER SERVICE SYSTEMS NETWORK

120 BOYLSTON STREET • FOURTH FLOOR • BOSTON, MASSACHUSETTS 02116 • (617) 482-2343 • TWX (710) 321-1913 INCORPORATED

SAVE ON ADD-ONS FOR APPLE® AND TRS-80®

NEWDOS/80

Powerful Disk Operating System for the TRS-80® designed for the sophisticated user and professional programmer. NEWDOS/80 is not meant to replace the present version of NEWDOS 2.1 which satisfies most users, but is a carefully planned upward enhancement.

- New BASIC Commands with variable record lengths up to 4095.
- Mix or match drives, 35, 40, 77TK.
- Security boot-up for BASIC or machine code application programs.
- Improved editing commands.
- Enhanced RENUMBER that allows relocation.
- Device handling for routing to display and printer simultaneously.
- CDE function: striking of C, D, and E keys allows user to enter a mini-DOS.
- Compatible with NEWDOS and TRSDOS 2.3.
- Superzap 3.0 and 2.1 utilities.

LIMITED UPGRADE OFFER

NEWDOS owners up-grade to NEWDOS/80. Contact Apparat or MTI for information.

\$149

NEW DOS FOR APPLE® "APEX"

The complete APEX package with operating system, assembler, editor and user manuals. The package also includes a complete set of utilities to maintain files on single or multiple drive systems. (Specify 5 inch Apple disk or 8 inch disk.)

\$99

RELATED SOFTWARE

XPLO \$79
FOCAL™ \$59

TRS-80® SOFTWARE

NEW DOS+ 35 track \$99
AJA Word Processor \$89
AJA Business Program \$289
Disk Drive Alignment Program \$109
Radix Data Base Program \$99.95

MOD I "8" DISK SYSTEM

- One SA800R DOS and Cable
- 2 Drive Chassis and Power Supply

\$1095

TRS-80® DISK DRIVES

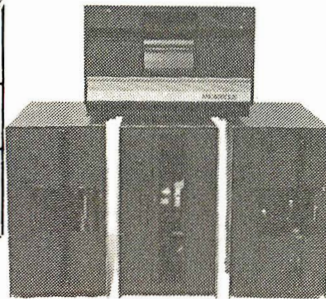

DISK DRIVE SYSTEM

- 2 Shugart SA400
- with power/chassis
- Cable
- Interface 32K
- 1 35-Track DOS+

\$1249

SPECIAL PRICE ONLY

★ BARE DRIVES FOR ANY MICROCOMPUTER ★

Pertec FD200	\$282	FD250	\$359
Shugart SA400 (unused) ..	\$282	SA800	\$479
MPI B52	\$349	B51	\$282

OKIDATA PRINTER

LIST \$1009
OUR PRICE **\$799**

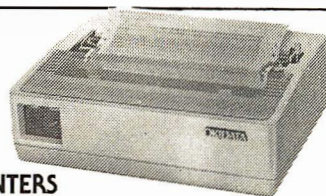

PRINTERS

Centronics 779	\$1069	ANADEX	\$ 950
Centronics 737	\$ 950	700-1	\$1195
Centronics 701-1	\$1795	702-2	\$1995
Spinwriter-NEC	\$2599		
Base 2 Printer 80, 132 col. graphics / tractor	\$ 599		



3304 W. MacArthur
Santa Ana, CA 92704
(714) 979-9923

Telex #678401TABIRIN

ALL PRICES CASH DISCOUNTED • FREIGHT FOB FACTORY



7310 E. Princeton Ave.
Denver, CO 80237
(303) 741-1778

ASK FOR FREE CATALOGUE

Book Reviews

The Network Nation: Human Communications via Computer

by S R Hiltz and M Turoff
Addison-Wesley, 1978
hardcover \$29.50
softcover \$17.50

One of the most promising areas in personal computing is public-information utilities, which can bring people into communication with each other and open doors to vast information resources. One aspect of the new computer communications media is computer conferencing. A computer conference is a structured town meeting where all the discussants may "speak" and "listen" simultaneously without being present at the same times and places. A computer conferencing facility monitors the progress of the discussion and provides a complete and constantly available verbatim transcript of the entire conference.

The Network Nation is a comprehensive treatment of this new electronic communications medium, written by two professionals very much involved with its genesis. Murray Turoff is a computer scientist who is one of the pioneers in computer conferencing. Starr Roxanne Hiltz is a sociologist who, in collaboration with Turoff, has made careful studies of the psychological and sociological dynamics of computer conferences. This book treats you to an overview of what a computer conference is, what it is like to participate, and how the new medium is different from conventional face-to-face conference situations. Examples are drawn from the historical antecedents of

present systems and the most important existing programs. Applications of these systems in high-level planning and decision making, scientific conferencing, etc are presented. Future applications for mass public use are predicted along with speculation on the psychological, sociological, and cultural implications that may be expected from the widespread availability of computer conferencing.

The Network Nation is an entertaining, informative, and thought-provoking book that should appeal to a wide range of readers. It is unusual in its technical excellence as well as its emphasis on human and cultural issues. It should be read by everyone interested in the direction that our technology is taking us and particularly by those interested in personal computing. The authors summarize best the impact of their subject in the following quotation drawn from the preface of the book.

"Computerized conferences [are] a new form of human communication utilizing the computer. We believe that it will eventually be as omnipresent as the telephone and as revolutionary, in terms of facilitating the growth and emergence of vast networks of geographically dispersed persons who are nevertheless able to work and communicate with one another at no greater cost than if they were located a few blocks from one another." ■

Glen A Taylor
19 June 81
Matawan NJ 07747

SOFTSIDE MAGAZINES the fun way to learn programming ...

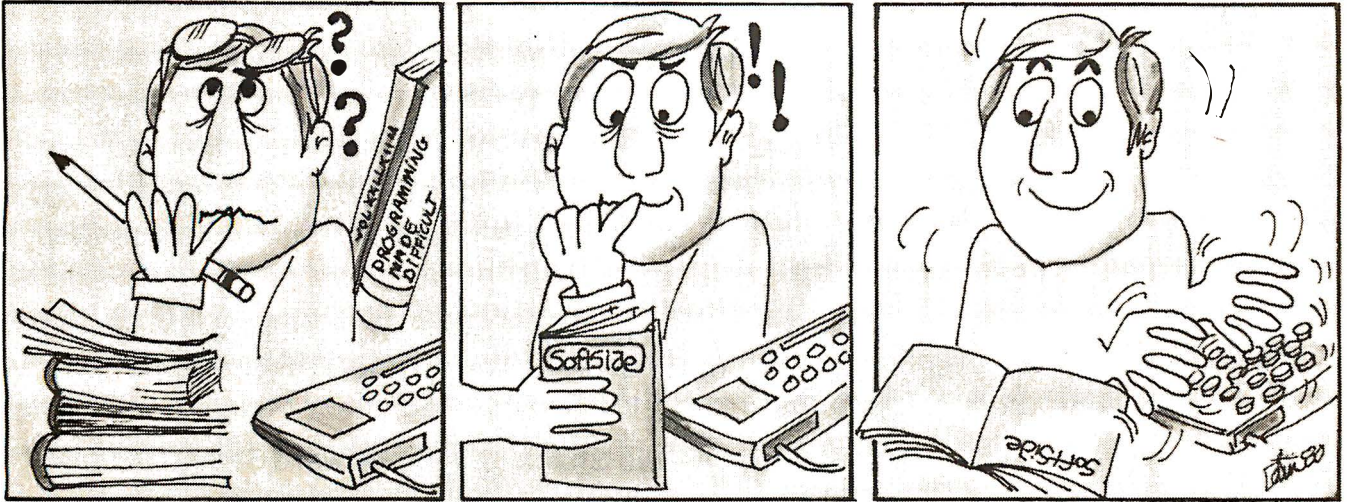

The easiest and most entertaining way to learn to program is by entering games into your computer. You get to see how other programmers accomplish certain tasks, gain experience with new BASIC instructions, and the reward of playing the game when you finish serves as constant encouragement.

That is what SoftSide is all about. To make it even easier, we include lots of programming hints, and occasionally take programs apart completely and describe what each part does.

Our games are very good. Many of the games we have published have sold individually for \$8, \$10, or even \$15 each! One issue is normally worth the price of a years subscription for the game value alone.

For example, our May Issue of the S-80 Edition for the TRS-80 and Video Genie computers is a special Star Trek Issue. We include two complete Star Trek games, including one for which over 2000 people paid \$14.95 each. We include 8K of remark statements not included in the commercial version so you can understand how it works and make your own modifications. There is a ten page article and flight manual lavishly illustrated with examples from the actual play of the game. You can even subscribe on cassette or diskette if you don't want to type in the line listings. The game issue also includes an article on Star Trek, the Motion Picture, including five programs developed on a 4K Level I TRS-80 to be used as displays in the movie! Another program included is an uncopyrighted day of the week routine that you can use in your own programs.

The May issue of our Apple Edition includes a high speed, colorful, challenging version of the space invaders game that is so popular in the arcades. Other features include the second installment of the book, "Intimate Instructions in Integer BASIC", Right/Left — a game for very young children, Small Marquee — a word guessing game, Black Box — a game of deduction, Magic Cave — a game seeking treasure in a hazardous dungeon, plus a disk catalog program and a method for protecting your program against copying.

Atari owners will soon have their own SoftSide! SoftSide: Atari is now accepting charter subscriptions, and the first issue will come this summer.

SoftSide: S-80

Bulk rate \$18 year
 First Class \$25
 Cassette \$39.50, 6 months
 Diskette \$69.50, 6 months

SoftSide: Apple

\$15 year
 \$22
 (not available)
 \$69.50, 6 months

SoftSide: Atari

\$15 year
 \$22
 (not available)
 (not available)

Call toll free **1-800-258-1790** and use your Visa or Master Charge
 (in N.H. call 603-673-5144)

SoftSide™ Or send your check and the version you desire to
 P.O. Box 68 Milford, N.H. 03055

Also from SoftSide Publications

Unlock the
 hidden power
 of your computer!

PATHWAYS THROUGH THE ROM

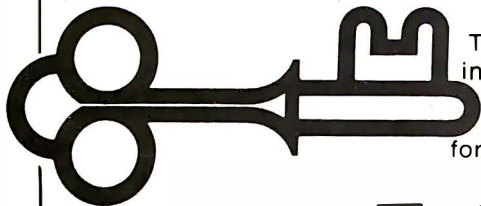

The guide to using machine language routines from Level II BASIC (TRS-80) in your own programs. Contains comments on the complete code of Level II BASIC, several programs to explore and use the subroutines in read only memory, and explanations of how to use the material. Includes line listing for a complete monitor and Z-80 disassembler. This book includes Supermap and the TRS-80 Disassembled Handbook, independently published at \$30.

The Software Exchange
 6 South Street, Box 68, Milford, NH 03055 603-673-5144

Only \$19.95 plus \$1 shipping
1-800-258-1790
 (in NH call 673-5144)

WHERE CAN YOU FIND...



Descriptions of hundreds of the best programs from...

The Software Exchange, The Programmers Guild, Quality Software, Radio Shack, Automated Simulations, Personal Software, Apparat, Adventure International, Synergistic Software, Peripherals Unlimited, Michael Shrayer Software, Small Business Systems Group, Racet Computes, Broderbund Software, Ramware, Level IV, Instant Software, Acorn Software, Atari, Hayden, Microsoft, Small Systems Software, Softtape, Muse, Personal Finance Systems, Lance Micklus, Inc., SoftSide, Web Associates, Strategic Simulations, 80-US...



Computer systems, peripherals, printers, floppy and hard disk drives, modems, power supplies, memories and other accessories for the TRS-80, Apple, and Atari computers at discount prices...



Books about your computer from Radio Shack, Scelbi, Howard Sams, Hayden, Compusoft, and SoftSide Publications...



A catalog of computer magazines for the Apple, Atari, and TRS-80...

IN A SINGLE CATALOG?

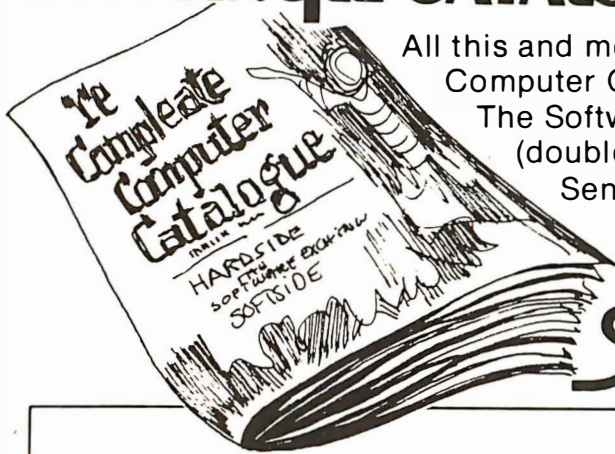

All this and more can be found in the Complete Computer Catalogue from HardSide, SoftSide, and The Software Exchange! 136-page catalogue only \$1 (double credit on your first order).

Send \$1 and your name and address today to:

The Complete Computer Catalogue,
P.O. Box 68, Milford, N.H. 03055

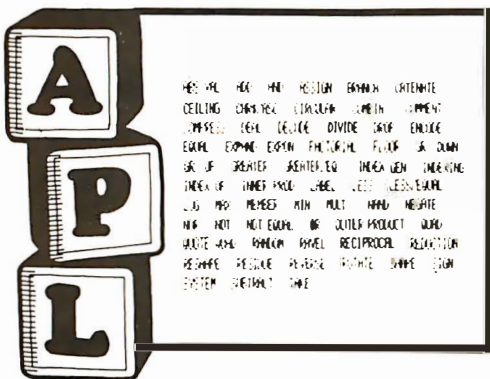

APL is a powerful and elegant computer language yet it is easy to learn. It is ideal for the engineer, scientist, mathematician, artist, designer, or for the person who just wants to learn a new language.

Due to the absence of the special character set for APL on the TRS-80, APL 80 uses shifted letters, which are identified on the screen with a lighted graphic black before the letter. If you have a modified TRS-80 (Electric Pen or Modulator), a lower case driver is included to display the shifted letters on the screen.

Special features of APL 80 include the ability to save and load workspace on disk, return to DOPS for directory or commands without losing your workspace or variables, and send output to a line printer. Four workspaces are included with lessons on the use of APL operators, commands, and functions, with many examples.

All of this plus manual and the book **APL: An Interactive Approach**, for only \$49.95 plus \$1.00 shipping. (2 1/2 disk required, 40K recommended)

Reduced featured: TRS-80 Level II tape version, no lessons, no book, 100 capacity, \$14.95, with book \$49.95 plus \$1.00 shipping

APL: An Interactive Approach, Separately, \$15.50 plus \$1.00 shipping

The Lazy Man's Shortcut to Machine Language!



by Dave Bohlke

A BASIC Compiler in BASIC! Run your source program in BASIC, compile it into FAST Z80 Code, and execute the compiled version, all without retyping 26 integer variables, GOTO, GOSUB, END, REM, RND, L, . . . IF, THEN, ELSE, <, >, INKEYS, C1S, PRINT, CHR\$, PEEK, POKE. Compiled programs may be saved via TAPE-DISK.

Supplied with game program, "3D TIC TAC TOE", which uses all of the TINY COMP Statement set and is ready to compile.

Manual includes several sample programs as well as thorough documentation of the Compiler for those who like to know "how things work", and for those who might even wish to EXPAND on TINY COMP's capabilities.

Tape version: **\$19.95**
Disk version: **\$24.95**

COMM-80

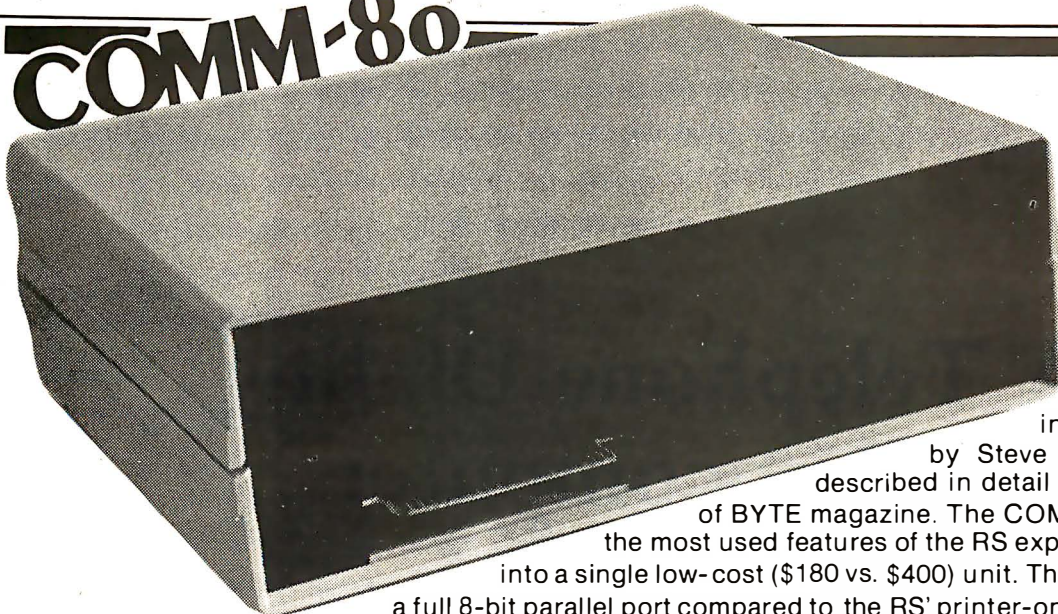

HARDSIDE in conjunction with MICROMINT has solved the TRS-80 I/O bottle-neck. This new expansion interface, designed

by Steve Ciarcia, is described in detail in the June issue of BYTE magazine. The COMM-80 provides the most used features of the RS expansion interface into a single low-cost (\$180 vs. \$400) unit. The COMM-80 has a full 8-bit parallel port compared to the RS' printer-only port. There is also a built-in RS-232-C interface (no extra board to purchase). A BUS connector is provided for future expansion. And to really clean up the I/O bottle-neck, up to 16 of these units can be chained together and addressed separately. The unit connects, with the cable supplied, directly to the CPU/Keyboard or expansion interface. This is the only interface you need to turn your TRS-80 into a time-sharing terminal with provisions for a printer.

Terminal software is included. COMM-80 \$179.95
DEALER INQUIRIES INVITED

TO ORDER TOLL-FREE
1-800-258-1790

(in NH call 673-5144)



6 South Street, Milford, NH 03055 (603) 673-5144

	LIST PRICE	OUR PRICE
TRS-80 COMPUTERS:		
Level II, 4K	\$619.00	\$559.00
Level II, 16K, no keypad		669.00
Level II, 16K, w/keypad	849.00	749.00
EXPANSION INTERFACES:		
COMM-80 Interface		179.95
Expansion Interface, no RAM	299.00	269.00
Expansion Interface, 16K RAM (NEC)	448.00	369.00
Expansion Interface, 32K RAM, (NEC)	597.00	459.00
DISK DRIVES:		
Percom, TFD-100, 40-track	399.00	389.00
Percom, Dual TFD-100's	795.00	775.00
Percom, TFD-200, 77-track	675.00	650.00
Percom, Dual TFD-200's	1350.00	1300.00
CompuThink, Dual Drive, Dual Sided		1295.00
DISK DRIVE ACCESSORIES:		
2-Drive cable for TRS-80	29.95	29.00
4-Drive cable for TRS-80	39.95	39.00
Percom Data Separator		29.95
Extender Card	15.95	15.00
PRINTERS:		
Centronics 730	795.00	719.00
Centronics 737	995.00	895.00
Centronics 753-2	3196.00	2695.00
Centronics 779-2	1559.00	995.00
RS Quick Printer II	219.00	209.00
RS Line Printer III	1960.00	1813.00
NEC 5530 SpinWriter	2995.00	2595.00
LRC 7000+	389.00	369.00
LRC 7000+ (64 column)	405.00	389.00

PRINTER CABLES:

QPII to Expansion Interface Cable	19.95	19.00
LRC to TRS-80 cable		20.00
LRC to APPLE cable		20.00
LRC to EXIDY cable		20.00
LRC to PET, IEEE cable		59.00
LRC to RS232C male, cable		65.00
LRC to RS232C female, cable		65.00
730 or 737 to TRS-80 cable		29.00
779 or 753 to TRS-80 cable		35.00

PERIPHERALS:

Novation CAT Modem	189.95	179.00
UDS 103-LP		195.00
RS-232-C Interface Board	99.00	89.00
TRS-232 Printer Interface		39.95
DATA Dubber		49.95
16K Memory Kit, Keyboard		99.00
16K Memory Upgrade Kit, E.I.		95.00
Percom Electric Crayon, w/cable		279.00
Busy Box, TRS-80		109.95
Busy Box, APPLE		114.95
BSR X-10, Starter Kit		124.95

ATARI COMPUTERS:

ATARI 800 Computer System	1080.00	875.00
ATARI 400 Computer	630.00	499.00
ATARI 410 Program Recorder	89.95	65.00
ATARI 810 Disk Drive	699.95	565.00
ATARI 820 Printer	599.95	470.00
Joystick Controllers	19.95	18.95
Paddle Controllers	19.95	18.95

*TRS-80 is a trademark of Tandy Corp.

*Apple is a trademark of Apple Computer Co.

A Telephone-Dialing Microcomputer

John Renbarger
Moore School of Electrical Engineering
University of Pennsylvania
Philadelphia PA 19104

Introduction

This article describes an application of computers to personal control of communication facilities. I have added some simple hardware to my KIM-1 microcomputer and have successfully dialed local and long-distance numbers on my home telephone. Although I made use of an expanded KIM to develop the programs listed here, the final program and data tables fit into the standard KIM memory.

In the form presented here, the system accepts a single telephone number from the KIM keypad, dials it, and stores it for redialing. In my system, only one number is stored in the computer at a time, but the routines could be used by a supervisory program to select and dial from a list of several stored numbers.

Two methods of dialing are available. One method uses pulses to control a solenoid that interrupts the telephone connection. The other method, which is faster, generates dual-tone, multiple-frequency signals that are acoustically coupled to the telephone receiver.

How to Use the Program

After loading into KIM, the dialer program is started at address hexa-

Touch Tone is a registered trademark of the Bell System for its dual-tone, multiple-frequency signaling equipment.

decimal 0200. The program will accept any telephone number up to eleven digits long from KIM's keypad. As the number is entered, the last six digits appear in the display, rolling earlier digits off the left edge of the display. All eleven digits are stored in the computer's memory. If you make a mistake, pressing the GO key clears the number, puts six Fs in the display, and lets you start over.

You can generate higher frequencies by using a larger increment to step through the waveform table.

When the number has been entered correctly, there are two options for dialing. The first option is to push KIM's AD key. The system will produce data for a digital-to-analog (D/A) converter to generate a pair of audio tones for each of the stored digits. These tones are the same ones produced by push-button telephones. The tones will operate the telephone switching circuits if the sound is coupled to the receiver mouthpiece by a speaker held nearby.

The second option is to push KIM's DA key. The system will briefly break the telephone connection the proper number of times and at the correct rate, the way a rotary-dial telephone does. A solenoid must be connected to the cradle button of the

telephone receiver to operate the telephone switching circuits.

After the number has been dialed, it remains stored in the computer, ready to be dialed again. A new number can be entered by first pressing the clear (GO) key and then using the keypad to enter the new number. Since the present system can store and recall only one number, the primary usefulness of the device is to eliminate reentering a number when repeatedly calling a line that is busy.

If your telephone line to the central office is not set up to accept the Touch-Tone frequencies, you will be limited to the pulse-dialing method, using a solenoid to depress the cradle button. On the other hand, if you have a push-button telephone, your computer will be able to use both methods to dial.

Telephone System Basics — Tones

Push-button telephones dial other telephones by sending pairs of audio frequency tones over the telephone voice channel each time the user holds down a key on the telephone set. The telephone company selected the particular tones that are employed so they could be easily decoded, but we need only know what the frequencies are. Table 1 lists the frequencies generated by the various buttons.

Central-office switching facilities decode the tones and connect the desired circuits based on the sequence of tone pairs received. Each tone pair must last long enough to be recog-

Hexadecimal Offset	Hexadecimal Data	Telephone Digit	KIM-1 Key	Frequencies (Hz)
00	08 0C	0	0	941, 1336
02	02 0A	1	1	697, 1209
04	02 0C	2	2	697, 1336
06	02 0E	3	3	697, 1477
08	04 0A	4	4	770, 1209
0A	04 0C	5	5	770, 1336
0C	04 0E	6	6	770, 1477
0E	06 0A	7	7	852, 1209
10	06 0C	8	8	852, 1336
12	06 0E	9	9	852, 1477
14	08 0A	*	A	941, 1209
16	08 0E	#	B	941, 1477
18	00 00	none	C	silence

Table 1: Dual-tone, multiple-frequency (ie: Touch-Tone) signals and tables within the DIAL program. Each Touch-Tone digit is composed of two frequencies, with a total of eight basic frequencies producing the tones for the twelve valid Touch-Tone keys. (See table 2.) The numbers necessary to produce each of the eight frequencies are contained in the table FRQINC (at 2 bytes per frequency). The two numbers in the DATA column point to the appropriate numbers in the FRQINC table necessary to make the two frequencies used by this key. These same numbers (the contents of the DATA column) are in the table TONTAB (see listing 1), and the number pairs are pointed to by the number in the OFFSET column.

nized as a digit by the switching equipment, and there must be enough separation between tone pairs to distinguish separate digits. Experimentally, a tone pair duration of about 150 ms and a separation of about 75 ms seem to work with my telephone.

Telephone System Basics — Dial Pulses

When you pick up the receiver on a telephone, an electrical connection is made to the lines leading to the central office. When you replace the receiver on the cradle the connection is broken or interrupted. This applies to both push-button and rotary-dial telephones.

The rotary dial on a telephone is a mechanical device which periodically breaks the connection leading to the central office. As you place your finger in a numbered hole and rotate the dial to the stop, the connection is still maintained. When you release the dial, as it travels back to its resting position it breaks the connection at the rate of about ten times per second, thus dialing that digit.

A number of interruptions equal to the value of the digit you dialed will occur each time you release the dial, with the exception that 0 (ie: the digit zero) causes a total of ten interruptions. If you dial a 7, for example, seven interruptions will occur when you release the dial.

The central-office circuitry counts the number of interruptions to determine which digit was dialed. The longer pause between digits is interpreted as evidence that one digit is complete and that another may begin.

Numbers can also be dialed by pushing the cradle switch button at the rate of ten times per second. This means that a solenoid plunger can be mounted to depress and release the cradle switch on the telephone set.

Since the telephone company prohibits the installation of unapproved equipment on the telephone lines, the only method of interrupting the phone line to be considered here is that of using a solenoid to push the cradle button rather than the method of making any direct connection to the line. Jules Gilder's book *Telephone Accessories You Can Build* (see References) contains solenoid installation suggestions.

There is no problem with using the dual-tone, multiple-frequency method of dialing as long as the coupling is done through the microphone of the handset and not by direct connection to the lines leading to the telephone.

If you are interested in learning more about the operation of the telephone system in general, the References include other sources, such as Peter Luff's *Scientific American* article.

Software Required — Pulses

For generating interrupting pulses, an output bit on one of the KIM's in-

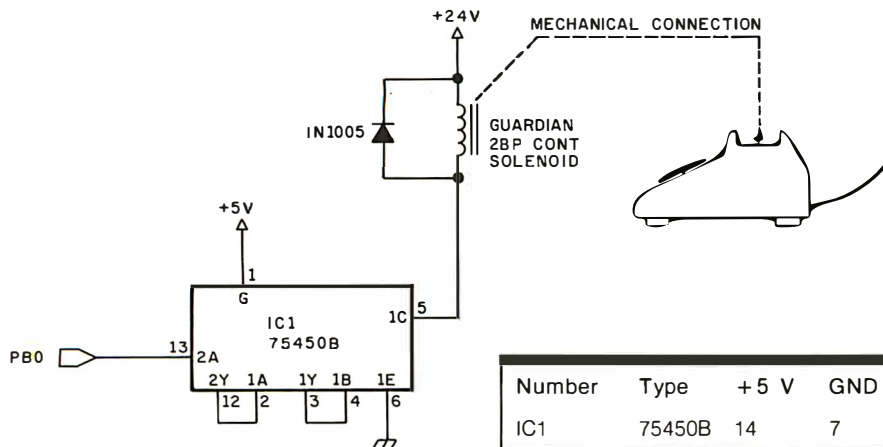

Figure 1: Schematic diagram for solenoid interface to the computer. In this method, the computer interrupts the phone line by pressing and releasing the cradle switch button on the body of the telephone set. IC1 is a TTL-compatible peripheral driver capable of switching up to 300 mA at 30 V. A logical 0 at the output bit PBO leaves the push-type solenoid unenergized, and a logical 1 energizes the solenoid, pushing the cradle switch button down and interrupting the telephone line.

put/output (I/O) lines connected to a solenoid driver can be used. KIM's programmable interval timer can help to simplify the programming to control the duration of the solenoid on and off periods. The on time for a pulse (ie: the length of the interruption) seems to be about 35 ms and the

off time (ie: the time between interruptions) seems to be about 65 ms.

When a telephone number is entered to the program for dialing, each digit must cause a corresponding number of pulses to be output (eg: one pulse for a 1 digit, two pulses for a 2 digit, and so on). Ten pulses are

sent for the 0 digit.

The program must generate these pulses at the rate of ten per second and pause for about 1/2 second between digits, thus allowing the telephone system to distinguish between digits. For the program in this article, pulses on the KIM output line PB0 control a solenoid connected as shown in figure 1.

Hexadecimal Offset	Hexadecimal Integer, Fraction	Frequency (Hz)
00	00,00	0 (silence)
02	0B,3E	697
04	0C,6B	770
06	0D,BE	852
08	0F,2D	941
0A	13,80	1209
0C	15,8C	1336
0E	17,D2	1477
10	1A,56	1633

Table 2: The basic frequencies used in the Touch-Tone system and their relation to the FRQINC table. The sound-producing routine SOUND creates the digital values that will become an analog audio signal by lookup in a table containing a sine wave "template." The frequency of the sine wave is varied by changing the number of values of the template skipped over before releasing the next digital value. The values in FRQINC are the increment values necessary to generate the given frequency, expressed as a hexadecimal integer-and-fraction pair.

Software Required — Tones

One method of generating tone pairs for the telephone network is to produce two square waves of the correct frequencies using just two computer output bits, combining the resulting tones by filters and a resistive network. This would give a waveform with much distortion, but it might be adequate for the telephone system.

I have chosen to generate low-distortion sine waves by using the computer to shuffle data and send values to a digital-to-analog converter. I generate audio waveforms in real time by transmitting a byte to an 8-bit converter at a rate that is more than triple the frequency of my highest tone. This technique, described below, uses a table that holds the values for the shape of a sine waveform. The idea is based on Hal Chamberlin's work. (See References.)

The sine waveform table occupies exactly 256 bytes and starts at the beginning of a page boundary. So that I need deal only with positive values, and to avoid overflow with addition, the values stored in the table range from a minimum of 0 to a maximum of hexadecimal 7F. See the SINTAB table which starts at hexadecimal 0300 in listing 1 for the values stored in the table. Since exactly one cycle is stored, going from the last entry in the table to the first entry will give a smooth transition to the next cycle of a continuous waveform. My table is stored in page 03 of memory.

Waveform Generation

To give you an idea of how the real-time waveform generation works, I will use an example. Starting at the first table location, I get a value from the table and convert that value to a voltage. Later, after a fixed interval, I will go to the next table location, get the value stored there, and

Text continued on page 160

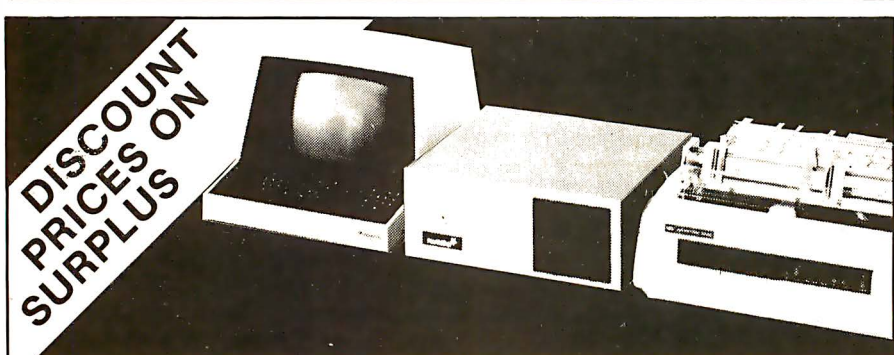

Great Selection! Great Prices! Great Deliveries
Master Charge! Visa! C.O.D.! No Risk!

	List Price	OUR PRICE		List Price	OUR PRICE
TI 99/4 Computer Console	950	859	Osborne GL, AR & AP, PR	69 ea.	
Horizon-2-64K-Quad	4330	3695	Hazeltine 1500	1225	1089
Horizon-2-32K-Double	3095	2595	Hi-Plot Plotter	1085	929
Horizon-2-64K-Double	3830	3195	Hi-Pad Digitizer	795	669
Northstar 32K RAM	739	599	T1810 w/CP,FLC,FUL	2195	1989
North Star 16K RAM	499	399	Thinkertoys Discus-2	1199	1099
North Star 18MB Hard Disk	...	Call	Thinkertoys 26 MB Hard Disk	...	Call
NEC 5515 Serial Printer	2850	2499	ATARI 800 8K	1080	899
NEC Tractor Feed	220	199	PET 8K Graphics, Lg KB	795	695
Soroc IQ120	995	889	Word Star Word Processor	500	350
Hazeltine 1420	995	899	Magic Wand Word Processor	400	350

CIRCLE COMPUTER SALES
 700 Larkspur Landing Circle
 Larkspur, CA 94939
 (415) 461-2616

Prices subject to change.
 Delivery subject to availability.
 We pay shipping on prepaid orders.

NEECO
PROUDLY
INTRODUCES

Zenith Data Systems

Z89 "Integrated Microcomputer"



- CPU with 16K user RAM expandable to 48K RAM.
- Integrated CRT, Disk & Keyboard.
- 100K Bytes of storage on one 5.25 Floppy Disk
- External Dual Drive available via Z87 peripheral drive.
- 2 serial RS232 Ports
- CP/M now available
- Z87 Dual Floppy Disk \$1195

Z19 "Intelligent Data Terminal"

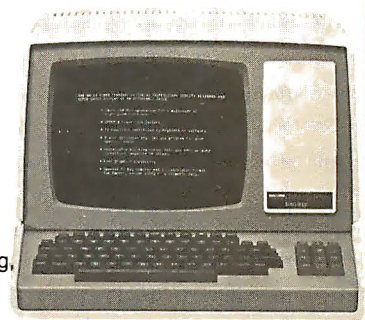

- 12" display with 80 column screen
- RS232 with up to 9600 Baud
- Ansi and DECVT52 compatible
- Full Duplex or half duplex modes
- Cursor addressing, edit functions, and much more.

Purchase a 48K Z89 and you will receive HDOS and MBasic5 for only \$100.

16K Model **\$2595** 48K **\$2895**
HDOS - \$100, MicrosoftBASIC - \$150, Call for information

\$995 includes interface cable

CALL FOR COMPLETE INFO ON ANY ZENITH PRODUCTS

SUPERBRAIN SOFTWARE

(Business Packages written in MicrosoftBASIC)

Trial Tested Osborne Business Packages on the Superbrain

- Accounts Receivable \$250.00
 - General Ledger \$250.00
 - Accounts Payable \$250.00
 - Payroll Package \$250.00
- Complete 4 Module Package \$795**
MicrosoftBASIC \$325

SUPERBRAIN

32K RAM **\$2795**
64K RAM **\$2995**
FORTRAN **\$ 450**

SPECIAL OFFER!

Purchase a 64K Superbrain at \$2995 and will include MBASIC5 for only \$250! (regularly \$350)

SPECIAL OFFER! - Purchase

a Centronics 704-9 (RS232, 180 CPS, retail \$2380) printer and a 64K Superbrain together for only \$4595 - cash price only.

"The Superbrain is ideal for use as an intelligent terminal or stand alone microcomputer system for OEM's, commercial customers, and other sophisticated computer users."



\$2995 The Honor Graduate

SUPERBRAIN™

NEECO

679 Highland Ave.
Needham, MA
02194

Mon-Fri 9:30-5:30
MasterCharge &
Visa Accepted

(617) 449-1760
Telex: 951021

MICROAMERICA DISTRIBUTING

"Nationwide distributors of Computer Equipment"
21 Putnam Street
Needham, MA
02194

(617) 449-4310

Listing 1: Program listing for the main program, which includes the telephone number entry, audio-tone dialing, and pulse-dialing routines. The main routine, DIAL, starts at hexadecimal 0200. The sine wave table starts at hexadecimal 0300; it can be moved if the new beginning address starts on a page boundary and if the byte at PAGE1 points to that page number. The program uses routines SCANDS and GETKEY of the KIM monitor.

LINE	ADDRESS	OBJECT CODE	LABEL	INSTRUCTION MNEMONIC	OPERAND	COMMENTARY
1	0000			*=\$00		
2	0000		INC1F	*=++1		
3	0001		INC1I	*=++1		
4	0002		PNT1F	*=++1		
5	0003		PNT1I	*=++1		
6	0004	03	PAGE1	.BYTE \$03		PNT1I AND PAGE1 TOGETHER POINT TO A LOCATION IN
7	0005		INC2F	*=++1		SINTAB. THIS ENABLES USE OF INDIRECT ADDRESSING
8	0006		INC2I	*=++1		
9	0007		PNT2F	*=++1		
10	0008		PNT2I	*=++1		
11	0009	03	PAGE2	.BYTE \$03		
12	000A		TEMPX	*=++1		
13	000B	0B	NDIGIT	.BYTE \$0B		
14	000C			*=\$10		
15	0010	00 00	FRQ INC	.DBYTE \$0C00,\$0B3E,\$0C6B,\$0DBE,\$0F2D		VALUES FOR INC#I, INC#F (NOTE ORD
15	0012	0B 3E				
15	0014	0C 6B				
15	0015	0D BE				
15	001B	0F 2D				
16	001A	13 8D		.DBYTE \$138D,\$158C,\$17D2,\$1A56		
16	001C	15 8C				
16	001E	17 D2				
16	0020	1A 56				
17	0022	08 0C	TONTAB	.DBYTE \$080C,\$020A,\$02CC,\$020E		HOLDS PAIRS OF OFFSETS FROM START
17	0024	02 0A				
17	0026	02 0C				
17	002B	02 0E				
18	002A	04 0A		.DBYTE \$040A,\$040C,\$040E,\$060A		OF FRQINC. EACH BYTE FOR ONE TON
18	002C	04 0C				
18	002E	04 0E				
18	0030	06 0A				
19	0032	06 0C		.DBYTE \$060C,\$060E,\$080A,\$080E		TONTAB WITH DIGIT NUMBER FROM 00
19	0034	06 0E				
19	0036	08 0A				
19	0038	08 0E				
20	003A	00 00		.DBYTE \$0000		
21	003C		DIGTAB	*=++NDIGIT		SPACE FOR THE DIGITS OF THE TELEPHONE NUMBER
22	0047			*=++1		LOCATION FOR LAST KEYCODE
23	0048		MAXKEY	=\$0C		HIGHEST DIGIT ALLOWED IN TELEPHONE NUMBER
24	0048		INH	=\$F9		KIM DISPLAY VARIABLES
25	0048		POINTH	=\$FB		
26	0048		DAC	=\$1700		
27	0048		DACDIR	=\$1701		
28	0048		PORTB	=\$1702		
29	0048		PBDIR	=\$1703		
30	0048		T1024	=\$1707		
31	0048		TSTAT	=\$1707		
32	0048		DUMMY	=\$194B		
33	0048		SCANDS	=\$1F1F		
34	0048		GETKEY	=\$1F6A		
35	0048			*=\$0100		
36	0100	A2 00	TONES	LDX # \$0C		
37	0102	86 0A	TONES1	STX TEMPX		SAVE X, IT WILL BE ALTERED BY SETUP
38	0104	B5 3C		LDA DIGTAB,X		
39	0106	20 11 01		JSR SETUP		GET READY AND THEN MAKE THE TONES
40	0109	A6 0A		LDX TEMPX		
41	010B	E8		INX		
42	010C	E4 0B		CPX NDIGIT		DONE ALL DIGITS OF NUMBER?
43	010E	30 F2		BMI TONES1		
44	0110	60		RTS		
45	0111	C9 0C	SETUP	CMP #MAXKEY		KEYS ABOVE MAXKEY NOT ALLOWED
46	0113	10 2A		BPL SETUP1		
47	0115	0A		ASL A		
48	0116	A8		TAY		
49	0117	B9 22 00		LDA TONTAB,Y		GET OFFSET INTO FRQINC FOR FIRST TONE
50	011A	AA		TAX		
51	011B	B5 10		LDA FRQINC,X		GET FREQ INCR FOR FIRST TONE
52	011D	85 01		STA INC1I		INTEGER PART
53	011F	B5 11		LDA FRQINC+1,X		
54	0121	85 00		STA INC1F		FRACTIONAL PART
55	0123	B9 23 00		LDA TONTAB+1,Y		GET OFFSET INTO FRQINC FOR SECOND TONE
56	0126	AA		TAX		
57	0127	B5 10		LDA FRQINC,X		
58	0129	85 06		STA INC2I		
59	012B	B5 11		LDA FRQINC+1,X		

Listing 1 continued on page 146

SIEMENS

4 OF A KIND

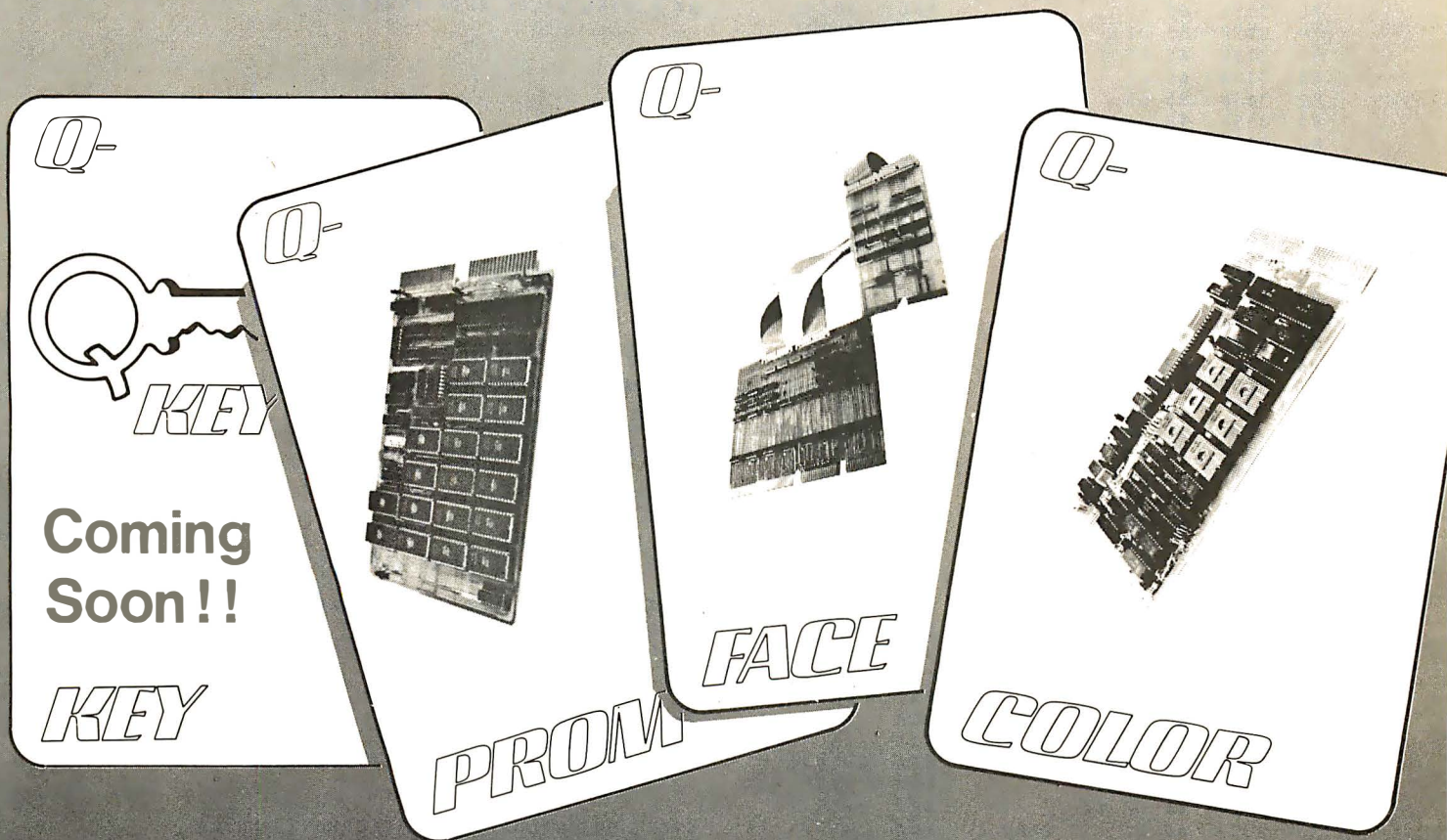

When you are looking for efficient, cost-effective ways to develop your LSI - 11* product, turn to SIEMENS for answers. We deal winning hands starting with Q-Face, the Q-Bus*-Unibus* translator that lets your PDP-11* act as a development system or use LSI-11* peripherals on your PDP-11*. Need Color displays? Q-Color is plug-compatible with the LSI-11* and generates user-defined character sets in 8 colors, without CPU overhead.

If you have lots of program, but minimal space in your backplane, the 16K x 16 bit Q-Prom is for you.

All that memory density on a dual board for your LSI-11* costs only a medium density price.

So, for a complete hand on the deal, come to SIEMENS for the right cards the first time.

For more information contact:

Digital Systems

Siemens Electric Limited

9829 - 45 Avenue

Edmonton, Alberta, Canada T6E 5C8

Tel: (403) 436-6640

Tlx: 027-2300 TWX: 610-831-1566

Q-KEY
Model 11

Q-PROM
Model 816

Q-FACE
Model 54

Q-COLOR
Model 45

Listing 1 continued:

```

60 012D 85 05          STA  INC2F
61 012F 20 40 01     JSR  SOUND
62 0132 A9 4A          LDA  #$4A
63 0134 8D 07 17     STA  T1024
64 0137 8D 07 17     STA  T1024
65 013A AD 07 17     DLY  LDA  TSTAT          PAUSE BETWEEN SENDING OF TONE PAIRS
66 013D 10 FB          BPL  DLY
67 013F 60           SETUP1 RTS
68 0140 A0 00          SOUND LDY  #$00          THIS SUBROUTINE GENERATES THE TONE PAIRS
69 0142 A9 92          LDA  #$92
70 0144 8D 07 17     STA  T1024
71 0147 8D 07 17     STA  T1024
72 014A 18           SOUND1 CLC
73 014B B1 03          LDA  (PNT11),Y     THIS LOOP TAKES 63 STATES TO EXECUTE
74 014D 71 08          ADC  (PNT21),Y     GET VALUE FROM SINTAB WITH INDIRECT ADDRESSING
75 014F 8D 00 17     STA  DAC          Y=0. PNT#1, PAGE# CONTAINS THE ADDRESS
76 0152 18           CLC
77 0153 A5 02          LDA  PNT1F         INCREASE THE POINTER TO SINTAB
78 0155 65 00          ADC  INC1F         BY ADDING VALUE FROM FRQINC
79 0157 85 02          STA  PNT1F
80 0159 A5 03          LDA  PNT11
81 015B 65 01          ADC  INC11
82 015D 85 03          STA  PNT11
83 015F 18           CLC
84 0160 A5 07          LDA  PNT2F
85 0162 65 05          ADC  INC2F
86 0164 85 07          STA  PNT2F
87 0166 A5 08          LDA  PNT21
88 0168 65 06          ADC  INC21
89 016A 85 08          STA  PNT21
90 016C AD 07 17     LDA  TSTAT          CHECK IF TIMER OUT YET (NEGATIVE)
91 016F 10 D9          BPL  SOUND1       LOOP AGAIN IF NOT
92 0171 60           RTS
93 0172                *=$0200
94 0200 A2 FF          DIAL  LDX  #$FF          EXECUTION STARTS HERE
95 0202 9A           TXS          INITIALIZE STACK POINTER
96 0203 20 23 02     JSR  INIT
97 0205 20 1F 1F     LOOK JSR  SCANDS       LIGHT DISPLAY FOR A WHILE
98 0209 20 6A 1F     JSR  GETKEY       LOOK FOR KEY CLOSURE
99 020C A6 0B          LDX  NDIGIT
100 020E D5 3C         CMP  DIGTAB,X     CHANGED FROM LAST CODE?
101 0210 95 3C         STA  DIGTAB,X
102 0212 F0 F2         BEQ  LOOK          NO, LOOK AGAIN
103 0214 C9 15         CMP  #$15         LOOK AGAIN IF IT JUST SAYS KEY RELEASED
104 0216 F0 EE         BEQ  LOOK
105 0218 20 63 02     JSR  CMND         IT IS A NEW KEY, LET CMND HAVE IT
106 021B B0 E9         BCS  LOOK         IF CARRY SET, CMND TOOK IT
107 021D 20 3D 02     JSR  DIGIT       ELSE GIVE IT TO DIGIT
108 0220 B8           CLV
109 0221 50 E3         BVC  LOOK
110 0223 A9 FF          INIT  LDA  #$FF         SET DIRECTION REGISTERS
111 0225 8D 01 17     STA  DACDIR       OUTPUTS
112 0228 8D 03 17     STA  PBDIR       OUTPUTS
113 022B A9 00          LDA  #$00
114 022D 8D 02 17     STA  PORTB
115 0230 A9 0F          ZERO  LDA  #$0F         STORE $0F VALUES INTO TELEPHONE NUMBER
116 0232 A6 0B          LDX  NDIGIT
117 0234 CA           ZERO1 DEX
118 0235 95 3C         STA  DIGTAB,X
119 0237 D0 FB         BNE  ZERO1
120 0239 20 4C 02     JSR  SHIFT2       PUT F'S IN DISPLAY
121 023C 60           RTS
122 023D C9 0C          DIGIT CMP  #MAXKEY      KEYS ABOVE MAXKEY NOT ALLOWED
123 023F 10 21         BPL  DIGIT1
124 0241 A2 00          SHIFT LDX  #$00       SHIFT NEW DIGIT INTO TELEPHONE NUMBER
125 0243 B5 3D          SHIFT1 LDA  DIGTAB+1,X
126 0245 95 3C         STA  DIGTAB,X
127 0247 E8           INX
128 0248 E4 0E         CPX  NDIGIT
129 024A 30 F7         BMI  SHIFT1
130 024C A2 41          SHIFT2 LDX  #DIGTAB+5    SETUP LOOP
131 024E A0 FB         LDY  #POINTH
132 0250 B5 00          SHIFT3 LDA  00,X         THIS LOOP SHIFTS DIGITS THRU DISPLAY VARIABLES
133 0252 0A           ASL  A
134 0253 0A           ASL  A
135 0254 0A           ASL  A
136 0255 0A           ASL  A
137 0256 15 01         ORA  $01,X
138 0258 99 00 00     STA  $00,Y
139 025B E8           INX

```

Listing 1 continued on page 148

Now Graphics for your computer

\$680

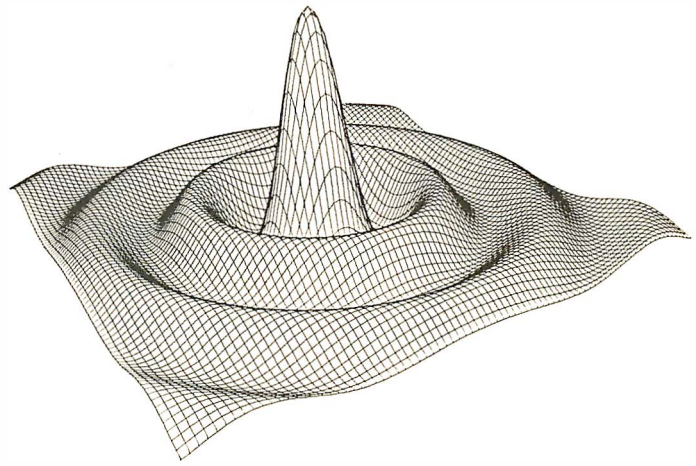

Expand your computer's capabilities with this easy-to-use drum plotter. The Strobe Model 100 interfaces to any computer to generate professional quality graphics.

OFFERING High Resolution Graphics Output * Outstanding Performance * Assembler Coded Drivers for High Speed Plotting * Precise Operator Controls * Interactive Coordinate Input

ALSO AVAILABLE Hardware Interfaces for — TRS-80 · APPLE II · PET · S-100.

Applications Software Package providing vector plotting and variable size alphanumeric for: TRS-80 Level II BASIC, Applesoft BASIC, Northstar BASIC, CBASIC, Microsoft BASIC & FORTRAN.

*TRS-80, APPLE II, and PET are trademarks of Tandy Corp. Apple Computer Co. and Commodore Business Machines, respectively.

Circle 91 on inquiry card.

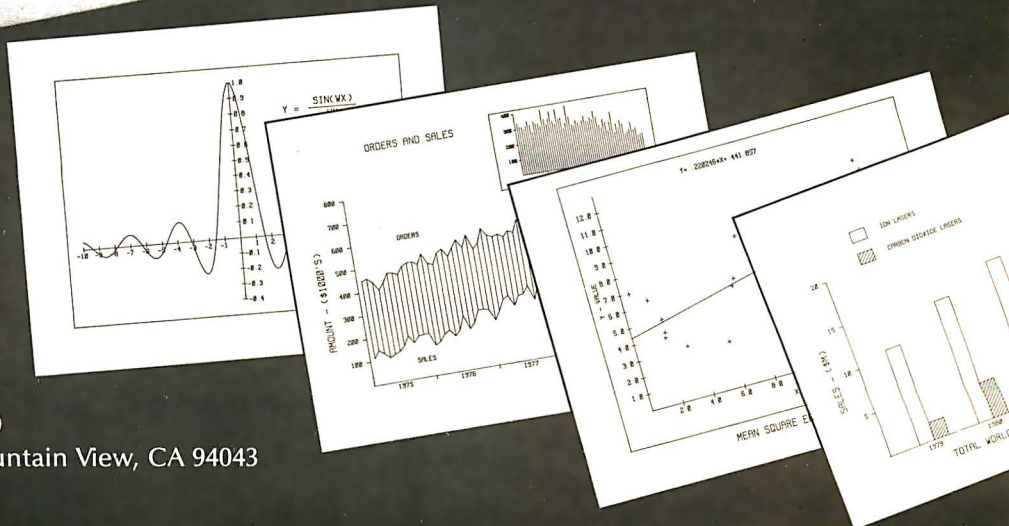
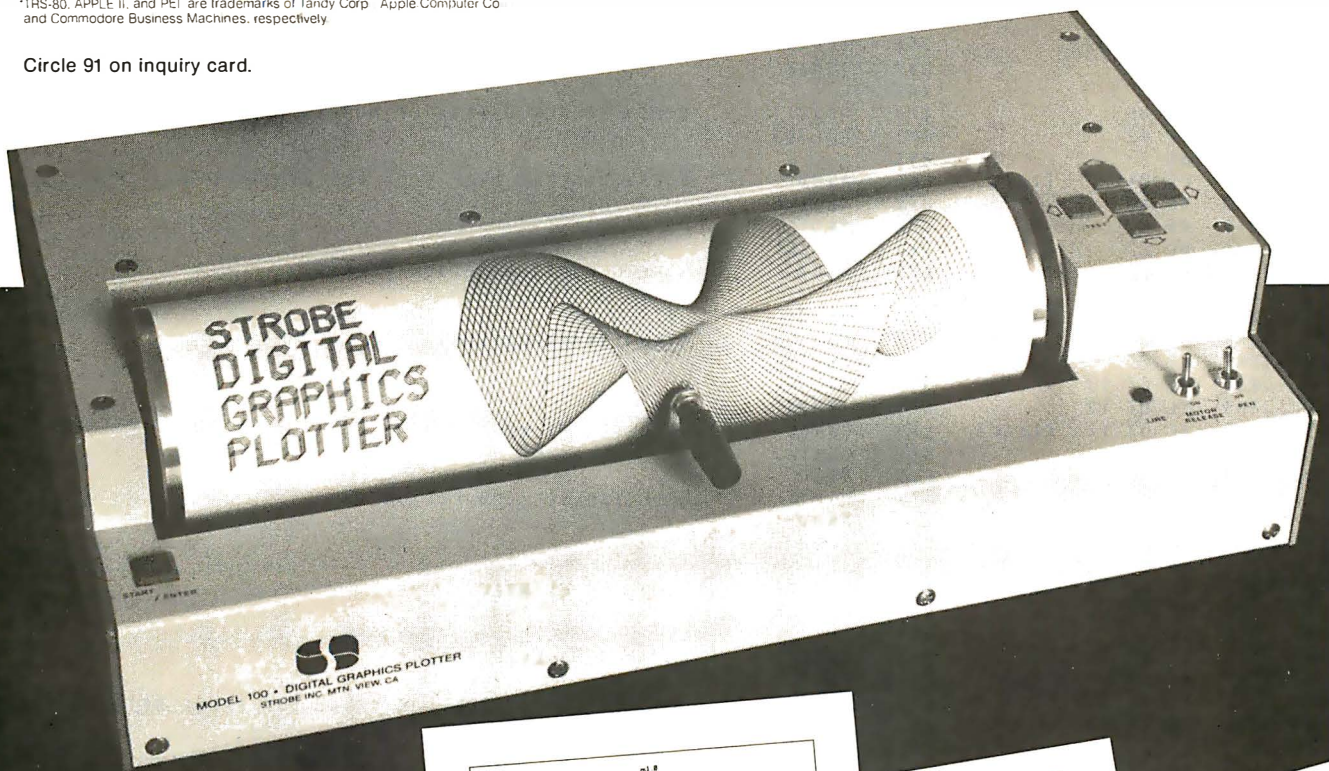

STROBE INCORPORATED

897-5A Independence Avenue, Mountain View, CA 94043
(415) 969-5130

Listing 1 continued:

```

140 025C E8          INX
141 025D 88          DEY
142 025E C0 F9      CPY #INH          DOWN TO LOWEST LOCATION YET?
143 0260 10 EE      BPL SHIF13
144 0262 60          DIGIT1  RTS
145 0263 18          CMND   CLC
146 0264 C9 10      CMP #S10
147 0265 10 01      BPL CMND1
148 0268 60          RTS          RETURN IF KEYCODE IS $00 TO $0F
149 0269 C9 10      CMND1  CMP #S10      AD KEY GENERATES TONES
150 026B D0 05      BNE CMND2
151 026D 20 00 01   JSR TONES
152 0270 38          SEC
153 0271 60          RTS
154 0272 C9 13      CMND2  CMP #S13      GO KEY RESETS EVERYTHING
155 0274 D0 05      BNE CMND3
156 0276 20 30 02   JSR ZERO
157 0279 38          SEC
158 027A 60          RTS
159 027B C9 12      CMND3  CMP #S12      + KEY AVAILABLE FOR USER
160 027D D0 05      BNE CMND4
161 027F 20 4B 19   JSR DUMMY
162 0282 38          SEC
163 0283 60          RTS
164 0284 C9 11      CMND4  CMP #S11      DA KEY GENERATES PULSES
165 0285 D0 04      BNE CMND5
166 0288 20 8D 02   JSR PULSE
167 028B 38          SEC
168 028C 60          CMND5  RTS
169 028D A2 00      PULSE  LDX #S00
170 028F 86 0A      PULSE1 STX TEMPX     SAVE X, CLICK MODIFIES X
171 0291 B5 3C          LDA DIGTAB,X  GET NEXT DIGIT OF TELEPHONE NUMBER
172 0293 20 9E 02   JSR CLICK
173 0296 A6 0A          LDX TEMPX
174 0298 E8          INX
175 0299 E4 0B      CPX NDIGIT    CHECK IF ALL DIGITS OF NUMBER HAVE BEEN PASSED TO CLI
176 029B 30 F2      BMI PULSE1
177 029D 60          RTS
178 029E C9 0A      CLICK  CMP #S0A      PULSE DIALING ONLY GOOD FOR DIGITS 0-9
179 02A0 10 40      BPL CLICK5
180 02A2 C9 00      CMP #S00
181 02A4 D0 02      BNE CLICK1
182 02A6 A9 0A          LDA #S0A      MAKE 0 DIGIT HAVE TEN PULSES
183 02A8 A8          CLICK1 TAY
184 02A9 A2 01      CLICK2 LDX #S01
185 02AB 8E 02 17   STX PORTB     START INTERRUPTION
186 02AE A2 25      LDX #S25
187 02B0 8E 07 17   STX T1024
188 02B3 8E 07 17   STX T1024
189 02B5 AE 07 17   CLICK3 LDX TSTAT     HOLD FOR 35 MSEC
190 02B9 10 FB      BPL CLICK3
191 02BB A2 00      LDX #S00
192 02BD 8E 02 17   STX PORTB     RE-ESTABLISH CONNECTION
193 02CD A2 3D      LDX #S3D
194 02C2 8E 07 17   STX T1024
195 02C5 8E 07 17   STX T1024
196 02C8 AE 07 17   CLICK4 LDX TSTAT     HOLD FOR 65 MSEC
197 02C9 10 FB      BPL CLICK4
198 02CD 88          DEY
199 02CE D0 D9      BNE CLICK2    ANY MORE PULSES TO GO?
200 02D0 A0 01      LDY #S01
201 02D2 A2 FF      DLY1  LDX #SFF      DO THIS LOOP TWICE FOR A 0.5 SEC PAUSE BETWEEN DIGITS
202 02D4 8E 07 17   STX T1024
203 02D7 8E 07 17   STX T1024
204 02DA AE 07 17   DLY2  LDX TSTAT
205 02DD 10 FB      BPL DLY2
206 02DF 88          DEY
207 02E0 10 F0      BPL DLY1
208 02E2 60          CLICK5 RTS
209 02E3          *=$0300
210 0300 40          SINTAB .BYTE 64,65,67,68,70,71,73,74
210 0301 41
210 0302 43
210 0303 44
210 0304 46
210 0305 47
210 0306 49
210 0307 4A
211 0308 4C          .BYTE 76,77,79,80,82,83,85,86
211 0309 4D
211 030A 4F

```

Listing 1 continued on page 150

SuperSoft announces a complete line of CP/M* compatible software

ACCOUNTING

SuperSoft offers a complete, interactive accounting system at an affordable price. We started with the Osborne accounting system, the standard of the industry, and made it even better. Since either the General Ledger and the Accounts Payable/Receivable can stand alone, you do not need to purchase the entire system at once. This means that you can start with what you need and up-grade later. Look for a compatible Payroll package in the future.

ACCOUNTS PAYABLE/RECEIVABLE: A complete, user oriented package which features:

- automatic postings to general ledger (optional)
- accounts payable: • check printing with invoice • invoice aging
- accounts receivable: • progress billing • customer statements
- partial invoice payments • invoice aging

The entire package is menu driven and easy to learn and use. It incorporates error checking and excellent user displays. This package can be used stand alone or with the General Ledger below. Requires: 48K CP/M, terminal with cursor positioning and clear screen, one 8" disk or Two 5" disks. CBASIC2 required.

Supplied with extensive user manual: \$200.00. Manual alone: \$20.00.

GENERAL LEDGER: A complete, user oriented package which features:

- Accepts postings from external programs (i.e. AP/AR above)
- Accepts directly entered postings
- Maintains account balances for current month, quarter, and year and previous three quarters
- Financial reports: trial balance, income statement balance sheet, and more. Completely menu driven and easy to learn and use. Excellent displays and error checking for trouble free operation. Can be used stand alone or with Accounts Payable/Receivable above. Minimal requirements: 48K CP/M, terminal with cursor positioning, home and clear screen, one 8" disk or Two 5" disks. CBASIC2 required.

Supplied with extensive user manual: \$200.00. Manual alone: \$20.00.

TEXT PROCESSING

TFS—Text Formatting System: An extremely powerful formatter. More than 50 commands. Features include:

- left & right margin justification
- headers and footers
- page numbering
- chaptering
- dynamic insertion from disk file
- extended & indented paragraphs
- works with any printer or CRT
- tabbing
- auto paragraphing
- auto list numbering
- centering
- user defined macros
- underlining and backspace
- much, much more

TFS lets you make multiple copies of any text. For example: Personalized form letters complete with name & address & other insertions from a disk file. Text is not limited to the size of RAM making TFS perfect for reports, manuals or any big job.

Text is entered using CP/M standard editor or most any CP/M compatible editor. TFS will link completely with Super-M-List making personalized form letters easy.

Requires: 24K CP/M.

Supplied with extensive user manual: \$85.00. Manual alone: \$20.00.

Source to TFS in 8080 assembler (can be assembled using standard CP/M assembler) plus user manual: \$250.00.

MAILING LIST

SUPER-M-LIST: A complete, easy to use mailing list program package. Allows for two names, two address, city, state, zip and a three digit code field for added flexibility. Super-M-List can sort on any field and produce mailing labels direct to printer or disk file for later printing or use by other programs. Super-M-List is the perfect companion to TFS. Handles 1981 Zip Codes!

Requires: 24K CP/M.

Supplied with complete user manual: \$75.00. Manual alone: \$10.00

UTILITIES

Utility pack #1: A collection of programs that you will find useful and maybe even necessary in your daily work (we did!). Includes:

- CMP:** Compare two files for equality.
- ARCHIVER:** Compacts many files into one, useful when you run out of directory entries.
- SORT:** In core sort of variable length records.
- XDIR:** Extended, alphabetical directory listing with groupings by common extension.
- PRINT:** Formatted listings to printer.
- PG:** Lists files to CRT a page at a time. ... plus more ...

Requires: 24K CP/M.

Supplied with instructions on discette: \$50.00.

SYSTEM MAINTENANCE

DIAGNOSTICS I: Easily the most comprehensive set of CP/M compatible system check-out programs ever assembled. Finds hardware errors in your system, confirms suspicions, or just gives your system a clean bill of health. Tests:

- Memory • CPU (8080/8085/Z80) • Terminal
- Disk • Printer

To our knowledge the CPU test is the first of its kind anywhere. Diagnostics I can help you find problems before they become serious. A good set of diagnostic routines are a must in any program library.

Minimal requirements: 24K CP/M. Supplied with complete user manual: \$50.00 Manual alone: \$15.00.

SOFTWARE SECURITY

ENCODE/DECODE: A complete software security system for CP/M. Encode/Decode is a sophisticated coding program package which transforms data stored on disk into coded text which is completely unrecognizable. Encode/Decode supports multiple security levels and passwords. A user defined combination (One billion possible) is used to code and decode a file. Uses are unlimited. Below are a few examples:

- data bases • general ledger • inventory
- payroll files • correspondence • accounts pay/rec
- programs • tax records • mailing lists

Encode/Decode is available in two versions:

Encode/Decode I provides a level of security suitable for normal use. Encode/Decode II provides enhanced security for the most demanding needs. Both versions come supplied on discette and with a complete user manual.

Encode/Decode I: \$50.00

Encode/Decode II: \$100.00 Manual alone: \$15.00

PROGRAMMING LANGUAGES

ENHANCED 'TINY' PASCAL: We still call it 'Tiny' but it's bigger and better than ever! This is the Famous Chung/Yuen 'Tiny' Pascal with more features added. Features include:

- recursive procedures/functions • integer arithmetic • CASE
- FOR (loop) • sequential disk I/O • one dimensional arrays
- IF ... THEN ... ELSE • WHILE • 'PEAK' & 'POKE'
- READ & WRITE • REPEAT ... UNTIL • more

'Tiny' Pascal is fast. Programs execute up to ten times faster than similar BASIC programs.

SOURCE TOO! We still distribute source, in 'Tiny' Pascal, on each discette sold. You can even recompile the compiler, add features or just gain insight into compiler construction.

'Tiny' Pascal is perfect for writing text processors, real time control systems, virtually any application which requires high speed. Requires: 36K CP/M. Supplied with complete user manual and source on discette: \$85.00.

Manual alone: \$10.00.

INTERCOMPUTER COMMUNICATIONS

TERM: a complete intercommunications package for linking your computer to other computers. Link either to other CP/M computers or to large timesharing systems. TERM is comparable to other systems but costs less, delivers more and source is provided on discette!

With TERM you can send and receive ASCII and Hex files (COM too, with included conversion program) with any other CP/M computer which has TERM or compatible package. Allows real time communication between users on separate systems as well as acting as timesharing terminal.

- Engage/disengage printer • error checking and auto retry
- terminal mode for timesharing between systems • conversational mode
- send files • receive files

Requires: 32K CP/M.

Supplied with user manual and 8080 source code: \$100.00

Manual alone: \$15.00.

formats: CP/M 8" SOFT SECTORED, NORTHSTAR CP/M

All Orders and General Information:

SUPERSOFT ASSOCIATES

P.O. BOX 1628

CHAMPAIGN, IL 61820

(217) 344-7596

Technical Hot Line: (217) 384-0847
(answered only when technician is available)

*CP/M REGISTERED TRADEMARK DIGITAL RESEARCH

SuperSoft

First in Software Technology



Circle 93 on inquiry card.



**OPTIMIZED SYSTEMS
SOFTWARE
PRESENTS**

CONTROL PROGRAM/APPLE
the DOS you have been waiting for

OSS CP/A is an all new, disk-based operating system which provides commands and utilities similar to CP/M®. CP/A has byte and block I/O, a simple assembly language interface, and direct access via Note and Point. And it's easy to add your own commands or device handlers. CP/A is expandable, flexible, consistent, easy-to-use and available now with compatible program products:

BASIC — Some of the features of OSS BASIC are syntax checking on program entry, true decimal arithmetic (great for money applications), 32K byte string sizes, flexible I/O, long variable names (up to 255 significant characters), and the ability to get and put single bytes.

BUSINESS BASIC WITH PRINT USING— This is virtually the only basic available on the Apple that has PRINT USING. It also has record I/O statements and all the features of our standard BASIC.

EDITOR/ASSEMBLER/DEBUG — OSS EASMD is a total machine language development package. The editor provides functions like FIND, REPLACE, etc. The assembler uses standard 6502 mnemonics, can include multiple files in one assembly, and can place the object code in memory or to a disk file.

Prices of CP/A with:

BASIC	\$ 69.95
Business BASIC	84.95
EASMD	69.95
BASIC + EASMD	109.95
Business BASIC + EASMD	124.95

Requires 48K RAM and DISK

Add \$3.50 for shipping and handling in continental USA. California residents add 6%. VISA/Master Charge welcome. Personal checks require two weeks to clear.

SEE YOUR DEALER or ORDER TODAY

OPTIMIZED SYSTEMS SOFTWARE
is a product of

Shepardson Microsystems, Inc.
20395 Pacifica Dr., Suite 108B
Cupertino, CA 95014
(408) 257-9900

Listing 1 continued:

211	030B	50
211	030C	52
211	030D	53
211	030E	55
211	030F	56
212	0310	58
212	0311	59
212	0312	5B
212	0313	5C
212	0314	5D
212	0315	5F
212	0316	60
212	0317	61
213	0318	63
213	0319	64
213	031A	65
213	031B	67
213	031C	68
213	031D	69
213	031E	6A
213	031F	66
214	0320	6C
214	0321	6D
214	0322	6F
214	0323	70
214	0324	71
214	0325	72
214	0326	73
214	0327	73
215	0328	74
215	0329	75
215	032A	76
215	032B	77
215	032C	78
215	032D	78
215	032E	79
215	032F	7A
216	0330	7A
216	0331	7B
216	0332	7E
216	0333	7C
216	0334	7C
216	0335	7D
216	0336	7D
216	0337	7D
217	0338	7E
217	0339	7E
217	033A	7E
217	033B	7F
217	033C	7F
217	033D	7F
217	033E	7F
217	033F	7F
218	0340	7F
218	0341	7F
218	0342	7F
218	0343	7F
218	0344	7F
218	0345	7F
218	0346	7E
218	0347	7E
219	0348	7E
219	0349	7D
219	034A	7D
219	034B	7D
219	034C	7C
219	034D	7C
219	034E	7B
219	034F	7B
220	0350	7A
220	0351	7A
220	0352	79
220	0353	78
220	0354	78
220	0355	77
220	0356	76
220	0357	75
221	0358	74
221	0359	73
221	035A	73
221	035B	72

.BYTE 88, 89, 91, 92, 93, 95, 96, 97

.BYTE 99, 100, 101, 103, 104, 105, 106, 107

.BYTE 108, 109, 111, 112, 113, 114, 115, 115

.BYTE 116, 117, 118, 119, 120, 120, 121, 122

.BYTE 122, 123, 123, 124, 124, 125, 125, 125

.BYTE 126, 126, 126, 127, 127, 127, 127, 127

.BYTE 127, 127, 127, 127, 127, 127, 126, 126

.BYTE 126, 125, 125, 125, 124, 124, 123, 123

.BYTE 122, 122, 121, 120, 120, 119, 118, 117

.BYTE 116, 115, 115, 114, 113, 112, 111, 109

Listing 1 continued on page 152

QUASAR DATA PRODUCTS

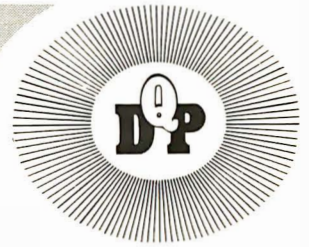

You can have it all

UNIX for Z-8000
Available soon

Z-80 OR Z-8000

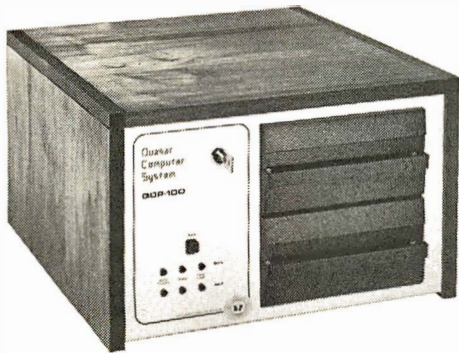

With a

Quasar Computer System

QDP - 100
Z-80 Computer

Z-80 Emulator - allows Z-8000
to run Z-80/8080 Programs

QDP-8100
Z-8000 Computer

- Z-80 4 Mhz CPU
- 64 K Memory
- Two 8" Double Sided
Double Density Floppies
- Smart CRT Terminal
- Four Ports - 2 Serial - 2 Parallel
- Disk Controller - Double Sided
Double Density - up to 4 M.B.
- Monitor in Prom
- CP/M 2.2 DOS
- S-100 (I-EEE) Motherboard
- Basic Language Included
- Real Time Clock
- Upgradable to QDP-8100

\$4995

30 Day ARO

- Z-8000 4 Mhz CPU I-EEE-100
- 64 K Memory
- Two 8" Double Sided
Double Density Floppies
- Smart CRT Terminal
- Three Ports - 2 Serial - 1 Parallel
- Disk Controller - Double Sided
Double Density - up to 4 M.B.
- CP/M 2.2 DOS
- Z-80 Software Emulator
- I-EEE 100 Motherboard
- Basic Language Included
- Z-8000 Pascal Available

\$6395

Unix™ - Bell Lab CP/MTM - Digital Research

Checks, money orders accepted

Add \$2.50 freight charges on orders under 10 lbs. Over 10 lbs. F.O.B. Cleveland

QUASAR DATA PRODUCTS

25151 Mitchell Dr., No. Olmsted, Ohio 44070 (216)779-9387



CP/M[®] SOFTWARE

DATEBOOK™ NEW! for NorthStar, Micropolis, TRS-80 Mod II, & any other CP/M based operating system. End paging through an appointment book forever! Easy to learn & use CP/M program.

- ★ Replaces your office appointment book
- ★ Searches for openings that fit
 - time of day
 - day of week
 - day of year constraints
- ★ Appointments made, modified, or cancelled by a few key strokes
- ★ Copies of day's appointments can be quickly printed
- ★ Schedule appointments 4 months in advance - plus

\$295. Manual alone -\$25.

PASCAL/M™

New Features! THE CP/M compatible language for 8" 8080/Z80 CPU's, Northstar 2D, Cromemco COOS & TRS-80 Mod II

- ★ Random access files
- ★ Otherwise clause on Case statement
- ★ Runtime debug support
- ★ Over 45 extensions to Standard Pascal

**NEW PRICE! \$175.
Manual alone - \$10.**

TEXTWRITER™

New Features! a text formatting program for NorthStar & TRS-80 DOS, Micropolis MDOS; & any CP/M based system.

- ★ Proportional spacing & enhanced printing for
 - Diablo • Gume • NEC printers
- ★ Enhanced printing includes ribbon color change, dual pitch, reverse line feed,
 - **UNDERScore**
 - **BOLDFACE**
 - **DOUBLE STRIKE**
 - **STRIKEOUT**
 - **SUPERSCRIPT**
 - **SUBSCRIPT**

- ★ Allows for optional left justified page headings on even numbered pages & right justified on odd numbered pages

\$125. Manual alone - \$25.

DATEBOOK & TEXTWRITER are trademarks of Organic Software
 PASCAL/M is a trademark of Sorcim
 CP/M is a trademark of Digital Research
 TRS-80 is trademark of Radio Shack
 Outside USA add \$10. for shipping & handling

DIGITAL MARKETING
 2670 Cherry Lane
 Walnut Creek, CA 94596
 (415) 938-2880

Listing 1 continued:

221	035C	71	
221	035D	70	
221	035E	6F	
221	035F	6D	
222	0360	6C	.BYTE 108,107,106,105,104,103,101,100
222	0361	6B	
222	0362	6A	
222	0363	69	
222	0364	68	
222	0365	67	
222	0366	65	
222	0367	64	
223	0368	63	.BYTE 99,97,96,95,93,92,91,89
223	0369	61	
223	036A	60	
223	036B	5F	
223	036C	5D	
223	036D	5C	
223	036E	5B	
223	036F	59	
224	0370	58	.BYTE 88,86,85,83,82,80,79,77
224	0371	56	
224	0372	55	
224	0373	53	
224	0374	52	
224	0375	50	
224	0376	4F	
224	0377	4D	
225	0378	4C	.BYTE 76,74,73,71,70,68,67,65
225	0379	4A	
225	037A	49	
225	037B	47	
225	037C	46	
225	037D	44	
225	037E	43	
225	037F	41	
226	0380	40	.BYTE 64,62,60,59,57,56,54,53
226	0381	3E	
226	0382	3C	
226	0383	3B	
226	0384	39	
226	0385	38	
226	0386	36	
226	0387	35	
227	0388	33	.BYTE 51,50,48,47,45,44,42,41
227	0389	32	
227	038A	30	
227	038B	2F	
227	038C	2D	
227	038D	2C	
227	038E	2A	
227	038F	29	
228	0390	27	.BYTE 39,38,36,35,34,32,31,30
228	0391	26	
228	0392	24	
228	0393	23	
228	0394	22	
228	0395	20	
228	0396	1F	
228	0397	1E	
229	0398	1C	.BYTE 28,27,26,24,23,22,21,20
229	0399	1B	
229	039A	1A	
229	039B	18	
229	039C	17	
229	039D	16	
229	039E	15	
229	039F	14	
230	03A0	13	.BYTE 19,18,16,15,14,13,12,12
230	03A1	12	
230	03A2	10	
230	03A3	0F	
230	03A4	0E	
230	03A5	0D	
230	03A6	0C	
230	03A7	0C	
231	03A8	0B	.BYTE 11,10,9,8,7,7,6,5
231	03A9	0A	
231	03AA	09	
231	03AB	08	
231	03AC	07	

Listing 1 continued on page 154

By Netronics

ASCII/BAUDOT, STAND ALONE

Computer Terminal

COMPLETE FOR ONLY \$149.95



The Netronics ASCII/BAUDOT Computer Terminal Kit is a microprocessor-controlled, stand alone keyboard/terminal requiring no computer memory or software. It allows the use of either a 64 or 32 character by 16 line professional display format with selectable baud rate, RS232-C or 20 ma. output, full cursor control and 75 ohm composite video output.

The keyboard follows the standard typewriter configuration and generates the entire 128 character ASCII upper/lower case set with 96 printable characters. Features include onboard regulators, selectable parity, shift lock key, alpha lock jumper, a drive capability of one TTY load, and the ability to mate directly with almost any computer, including the new Explorer/85 and ELF products by Netronics.

The Computer Terminal requires no I/O mapping and includes 1k of memory, character generator, 2 key rollover, processor controlled cursor control, parallel ASCII/BAUDOT to serial conversion and serial to video processing—fully crystal controlled for superb accuracy. PC boards are the highest quality glass epoxy for the ultimate in reliability and long life.

VIDEO DISPLAY SPECIFICATIONS

The heart of the Netronics Computer Terminal is the microprocessor-controlled Netronics Video Display Board (VID) which allows the terminal to utilize either a parallel ASCII or BAUDOT signal source. The VID converts the parallel data to serial data which is then formatted to either RS232-C or 20 ma. current loop output, which can be connected to the serial I/O on your computer or other interface, i.e., Modem.

When connected to a computer, the computer must echo the character received. This data is received by the VID which processes the information, converting to data to video suitable to be displayed on a TV set (using an RF modulator) or on a video monitor. The VID generates the cursor, horizontal and vertical sync pulses and performs the housekeeping relative to which character and where it is to be displayed on the screen.

Video Output: 1.5 P/Pinto 75 ohm (EIA RS-170) • **Baud Rate:** 110 and 300 ASCII • **Outputs:** RS232-C or 20 ma. current loop • **ASCII Character Set:** 128 printable characters—

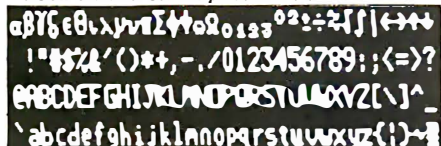

BAUDOT Character Set: A B C D E F G H I J K L M N O P Q R S T U V W X Y Z - ? * # \$ % () , . / 0 1 2 3 4 5 6 7 8 9 ; < = > ? ! " # \$ % ' () * + , - . / 0 1 2 3 4 5 6 7 8 9 : ; < = > ? @ A B C D E F G H I J K L M N O P Q R S T U V W X Y Z [\] ^ _ ` a b c d e f g h i j k l m n o p q r s t u v w x y z { | } ~ `

Continental U.S.A. Credit Card Buyers Outside Connecticut

CALL TOLL FREE 800-243-7428

To Order From Connecticut Or For Technical Assistance, Etc. Call (203) 354-9375

Netronics R&D Ltd., Dept. PE-9
333 Litchfield Road, New Milford, CT 06776

Please send the items checked below—

- Netronics Stand Alone ASCII Keyboard/Computer Terminal Kit, \$149.95 plus \$3.00 postage & handling.
- Deluxe Steel Cabinet for Netronics Keyboard/Terminal in Blue/Black Finish, \$19.95 plus \$2.50 postage and handling.
- Video Display Board Kit alone (less keyboard), \$89.95 plus \$3 postage & handling.
- 12" Video Monitor (10 MHz bandwidth) fully assembled and tested, \$139.95 plus \$5 postage and handling.
- RF Modulator Kit (to use your TV set for a monitor), \$8.95 postpaid.
- 5 amp Power Supply Kit In Deluxe Steel Cabinet (± 8VDC @ 5 amps, plus 6-8 VAC), \$39.95 plus \$2 postage & handling.

Total Enclosed (Conn. res. add sales tax) \$ _____

- By—
- Personal Check Cashiers Check/Money Order
 - Visa Master Charge (Bank # _____)

Acct. # _____
Signature _____ Exp. Date _____

Print Name _____

Address _____

City _____

State _____ Zip _____

Send Me More Information

Start Computing For Just \$129.95 With An 8085-Based Professional Computer Kit—

Explorer/85

100% compatible with all 8080A and 8085 software & development tools!

No matter what your future computing plans may be, Level "A"—at \$129.95—is your starting point.

Starting at just \$129.95 for a Level "A" operating system, you can now build the exact computer you want. Explorer/85 can be your beginner's system, OEM controller, or IBM-formatted 8" disk small business system... yet you're never forced to spend a penny for a component or feature you don't want and you can expand in small, affordable steps!

Now, for just \$129.95, you can own the first level of a fully expandable computer with professional capabilities—a computer which features the advanced Intel 8085 cpu, thereby giving you immediate access to all software and development tools that exist for both the 8085 and its 8080A predecessor (they are 100% software compatible)—a computer which features onboard S-100 bus expansion—plus instant conversion to mass storage disk memory with either 5-1/4" diskettes or standard IBM-formatted 8" disks.

For just \$129.95 (plus the cost of a power supply, keyboard/terminal and RF modulator, if you don't have them already), Explorer/85 lets you begin computing on a significant level... applying the principles discussed in leading computer magazines... developing "state of the art" computer solutions for both the industrial and leisure environment.

Level "A" Specifications

Explorer/85's Level "A" system features the advanced Intel 8085 cpu, an 8355 ROM with 2k deluxe monitor/operating system, and an 8155 ROM-I/O—all on a single motherboard with room for RAM/ROM/PROM/EPROM and S-100 expansion, plus generous prototyping space.

(Level "A" makes a perfect OEM controller for industrial applications and is available in a special Hex Version which can be programmed using the Netronics Hex Keypad/Display.)



Level "A" at \$129.95 is a complete operating system, perfect for beginners, hobbyists, or industrial controller use.

...cassette tape recorder output... speaker output... LED output indicator on SOD (serial output) line... printer interface (less drivers)... total of four 8-bit plus one 6-bit I/O ports • Crystal Frequency: 6.144 MHz • Control Switches: reset and user (RST 7.5) interrupt... additional provisions for RST 5.5, 6.5 and TRAP interrupts onboard • Counter/Timer: programmable, 14-bit binary • System RAM: 256 bytes located at F800, ideal for smaller systems and for use as an isolated stack area in expanded systems... RAM expandable to 64k via S-100 bus or 4K on motherboard.

System Monitor (Terminal Version): 2k bytes of deluxe system monitor ROM located at F900 leaving 0000 free for user RAM/ROM. Features include tape load with labeling... tape dump with labeling... examine/change contents of memory... insert data... warm start... examine and change all registers... single step with register display at each break point, a debugging/training feature... go to execution address... move blocks of memory from one location to another... fill blocks of memory with a constant... display blocks of memory... automatic baud rate selection... variable display line length control (1-255 characters/line)... channelized I/O monitor routine with 8-bit parallel output for high speed printer... serial console in and console out channel so that monitor can communicate with I/O ports.

System Monitor (Hex Version): Tape load with labeling... tape dump with labeling... examine/change contents of memory... insert data... warm start... examine and change all

Netronics R&D Ltd., Dept. RE 10
333 Litchfield Road, New Milford, CT 06776

Please send the items checked below—

- Explorer/85 Level "A" Kit (ASCII Version), \$129.95 plus \$3 p&h.
- Explorer/85 Level "A" Kit (Hex Version), \$129.95 plus \$3 p&h.
- 8k Microsoft BASIC on cassette tape, \$64.95 postpaid.
- 8k Microsoft BASIC in ROM Kit (requires Levels "B," "D," and "E"), \$99.95 plus \$2 p&h.
- Level "B" (S-100) Kit, \$49.95 plus \$2 p&h.
- Level "C" (S-100 6-card expander) Kit, \$39.95 plus \$2 p&h.
- Level "D" (4k RAM) Kit, \$69.95 plus \$2 p&h.
- Level "E" (EPROM/ROM) Kit, \$5.95 plus 50¢ p&h.
- Deluxe Steel Cabinet for Explorer/85, \$49.95 plus \$3 p&h.
- ASCII Keyboard/Computer Terminal Kit (features a full 128 character set, upper & lower case, full cursor control, 75 ohm video output convertible to baudot output, selectable baud rate, RS232-C or 20 ma. I/O, 32 or 64 character by 16 line formats, and can be used with either a CRT monitor or a TV set (if you have an RF modulator), \$149.95 plus \$2.50 p&h.
- Hex Keypad/Display Kit, \$69.95 plus \$2 p&h.
- Deluxe Steel Cabinet for ASCII Keyboard/Terminal, \$19.95 plus \$2.50 p&h.
- Power Supply Kit (± 8V @ 5 amps) in deluxe steel cabinet, \$39.95 plus \$2 p&h.
- Gold Plated S-100 Bus Connectors, \$4.85 each, postpaid.
- RF Modulator Kit (allows you to use your TV set as a monitor), \$8.95 postpaid.
- 16k RAM Kit (S-100 Board expands to 64k), \$199.95 plus \$2 p&h.
- 32k RAM Kit, \$329.95 plus \$2 p&h.
- 48k RAM Kit, \$459.95 plus \$2 p&h.
- 64k RAM Kit, \$589.95 plus \$2 p&h.
- 16k RAM Expansion Kit (to expand any of the above up to 64k), \$139.95 plus \$2 p&h each.
- Intel 8085 cpu User's Manual, \$7.50 postpaid.
- Special Computer Grade Cassette Tapes, \$1.90 each or 3 for \$5, postpaid.
- 12" Video Monitor (10 MHz bandwidth), \$139.95 plus \$5 p&h.
- North Star Double Density Floppy Disk Kit (One Drive) for Explorer/85 (includes 3 drive S-100 controller, DOS, and extended BASIC with per-

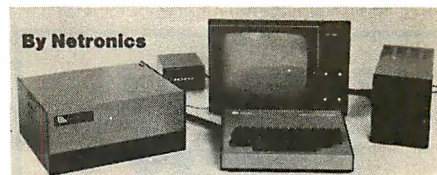

registers... single step with register display at each break point... go to execution address. Level "A" in the Hex Version makes a perfect controller for industrial applications and can be programmed using the Netronics Hex Keypad/Display.



Hex Keypad/Display Specifications

Calculator type keypad with 24 system defined and 16 user defined keys. 6 digit calculator type display which displays full address plus data as well as register and status information.

Explorer/85 with Level "C" card cage.

Level "B" Specifications

Level "B" provides the S-100 signals plus buffers/drivers to support up to six S-100 bus boards and includes: address decoding for onboard 4k RAM expansion select-able in 4k blocks... address decoding for onboard 8k EPROM expansion select-able in 8k blocks... address and data bus drivers for onboard expansion... wait state generator (jumper select-able), to allow the use of slower memories... two separate 5 volt regulators.



Level "C" Specifications

Level "C" expands Explorer's motherboard with a card cage, allowing you to plug up to six S-100 cards directly into the motherboard. Both cage and cards are neatly contained inside Explorer's deluxe steel cabinet.

Level "C" includes a sheet metal superstructure, a 5-card gold plated S-100 extension PC board which plugs into the motherboard. Just add required number of S-100 connectors

Level "D" Specifications

Level "D" provides 4k or RAM, power supply regulation, filtering decoupling components and sockets to expand your Explorer/85 memory to 4k (plus the original 256 bytes located in the 8155A). The static RAM can be located anywhere from 0000 to EFFF in 4k blocks.

Level "E" Specifications

Level "E" adds sockets for 8k of EPROM to use the popular Intel 2716 or the TI 2516. It includes all sockets, power supply regulator, heat sink, filtering and decoupling components. Sockets may also be used for soon to be available RAM IC's (allowing for up to 12k of onboard RAM).

Order A Coordinated Explorer/85 Applications Pak!

Experimenter's Pak (SAVE \$12.50)—Buy Level "A" and Hex Keypad/Display for \$199.90 and get FREE Intel 8085 user's manual plus FREE postage & handling!

Student Pak (SAVE \$24.45)—Buy Level "A," ASCII Keyboard/Computer Terminal, and Power Supply for \$319.85 and get FREE RF Modulator plus FREE Intel 8085 user's manual plus FREE postage & handling!

Engineering Pak (SAVE \$41.00)—Buy Levels "A," "B," "C," "D," and "E" with Power Supply, ASCII Keyboard/Computer Terminal, and six S-100 Bus Connectors for \$514.75 and get 10 FREE computer grade cassette tapes plus FREE 8085 user's manual plus FREE postage & handling!

Business Pak (SAVE \$89.95)—Buy Explorer/85 Levels "A," "B," and "C" (with cabinet), Power Supply, ASCII Keyboard/Computer Terminal (with cabinet), 16k RAM, 12" Video Monitor, North Star 5-1/4" Disk Drive (includes North Star BASIC) with power supply and cabinet, all for just \$1599.40 and get 10 FREE 5-1/4" minidiskettes (\$49.95 value) plus FREE 8085 user's manual plus FREE postage & handling!

Continental U.S.A. Credit Card Buyers Outside Connecticut

CALL TOLL FREE 800-243-7428

To Order From Connecticut Or For Technical Assistance, Etc. Call (203) 354-9375

sonalized disk operating system—just plug it in and you're up and running!), \$699.95 plus \$5 p&h.

Power Supply Kit for North Star Disk Drive, \$39.95 plus \$2 p&h.

Deluxe Case for North Star Disk Drive, \$39.95 plus \$2 p&h.

Experimenter's Pak (see above), \$199.90 postpaid.

Student Pak (see above), \$319.85 postpaid.

Engineering Pak (see above), \$514.75 postpaid.

Business Pak (see above), \$1599.40 postpaid.

Total Enclosed \$ _____ (Conn. res. add sales tax) By—

Personal Check M.O./Cashier's Check Visa Master Charge

(Bank # _____) Acct. # _____ Signature _____ Exp. Date _____ Print Name _____ Address _____ City _____ State _____ Zip _____

Send Me Information

UTILITY MEANS *help...*

APPLESOFT UTILITY PROGRAMS (Gilder)

helps you calculate the decimal address of your machine language program, renumber the program in any increment, join two or more programs together, and more. Contains 9 subroutines, among them 3 statement formatters: REM, PRINT, and Poke writer. #03504, Apple II, \$29.95

REVIVE (Gilder)

helps recover "lost" programs. When a program is accidentally erased, REVIVE searches through memory and finds the information that enables it to restore the pointers that have been changed. Can be loaded at any time, even after you have accidentally erased the program. #03604, Apple II, \$19.95

SLOW LIST/ STOP LIST (Gilder)

helps start, stop, and control the speed of your program with Apple II's game paddles. Control the speed at which the disk catalog appears and terminate CATALOG operation in the middle. The program can be enabled and disabled under software control. #03904, Apple II, \$10.95

**...And All That Help
Comes From Hayden —
Your Software Publisher!**

At computer stores
everywhere!

Call (201) 843-0550, ext. 307
TO CHARGE YOUR ORDER TO
Master Charge or BankAmericard!

Minimum order is \$10.00; customer
pays postage and handling.

Hayden Book Company, Inc.

50 Essex Street, Rochelle Park, NJ 07662

Listing 1 continued:

231	03AD	07	
231	03AE	06	
231	03AF	05	
232	03B0	05	.BYTE 5,4,4,3,3,2,2,2
232	03B1	04	
232	03B2	04	
232	03B3	03	
232	03B4	03	
232	03B5	02	
232	03B6	02	
232	03B7	02	
233	03B8	01	.BYTE 1,1,1,0,0,0,0,0
233	03B9	01	
233	03BA	01	
233	03BB	00	
233	03BC	00	
233	03BD	00	
233	03BE	00	
233	03BF	00	
234	03C0	00	.BYTE 0,0,0,0,0,0,1,1
234	03C1	00	
234	03C2	00	
234	03C3	00	
234	03C4	00	
234	03C5	00	
234	03C6	01	
234	03C7	01	
235	03C8	01	.BYTE 1,2,2,2,3,3,4,4
235	03C9	02	
235	03CA	02	
235	03CB	02	
235	03CC	03	
235	03CD	03	
235	03CE	04	
235	03CF	04	
236	03D0	05	.BYTE 5,5,6,7,7,8,9,10
236	03D1	05	
236	03D2	06	
236	03D3	07	
236	03D4	07	
236	03D5	08	
236	03D6	09	
236	03D7	0A	
237	03D8	0B	.BYTE 11,12,12,13,14,14,16,18
237	03D9	0C	
237	03DA	0C	
237	03DB	0D	
237	03DC	0E	
237	03DD	0E	
237	03DE	10	
237	03DF	12	
238	03E0	13	.BYTE 19,20,21,22,23,24,26,27
238	03E1	14	
238	03E2	15	
238	03E3	16	
238	03E4	17	
238	03E5	18	
238	03E6	1A	
238	03E7	1B	
239	03E8	1C	.BYTE 28,30,31,32,34,35,36,38
239	03E9	1E	
239	03EA	1F	
239	03EB	20	
239	03EC	22	
239	03ED	23	
239	03EE	24	
239	03EF	26	
240	03F0	27	.BYTE 39,41,42,44,45,47,48,50
240	03F1	29	
240	03F2	2A	
240	03F3	2C	
240	03F4	2D	
240	03F5	2F	
240	03F6	30	
240	03F7	32	
241	03F8	33	.BYTE 51,53,54,56,57,59,60,62
241	03F9	35	
241	03FA	36	
241	03FB	38	
241	03FC	39	
241	03FD	3B	

Listing 1 continued on page 156

IT'S HERE . . . AND CPU BOARDS WILL NEVER BE THE SAME AGAIN.

The CompuPro Dual Processor Board gives true 16 bit power with an 8 bit bus, is downward compatible with the vast library of 8080 software, is upward compatible with hardware and software not yet developed, accesses 16 Megabytes of memory, meets all IEEE S-100 bus specifications, runs 8085 and 8086 code in your existing mainframe as well as Microsoft 8086 BASIC and Sorcim PASCAL/M™, and runs at 5 MHz for speed as well as power.

The Dual Processor Board has two CPUs that "talk" to each other; the 8088 CPU is an 8 bit bus version of the 8086 16 bit CPU, while the 8085 is an advanced 8 bit CPU that can run existing software such as CP/M.

Amazingly enough, all this flexibility won't break your budget: introductory prices are \$385 unkit, \$495 assembled, and \$595 qualified under the Certified System Component high-reliability program. Don't need 16 bit power yet? Then select our single processor version which does not include the 8088 for \$235 unkit, \$325 assembled, and \$425 CSC.

The Dual Processor Board is built to the same stringent standards that have established our leadership in S-100 system components . . . and starting June 1st, you'll be able to plug it into your mainframe to experience computing power that, until now, you could only dream about. CPU boards will truly never be the same again.

THINKING GRAPHICS? THINK "SPECTRUM" COLOR GRAPHICS BOARD.

The CompuPro Spectrum board is actually three sophisticated products in one: a fast (5 MHz), low power 8Kx8 IEEE compatible memory board with extended addressing; an I/O board with full duplex bidirectional parallel port (including latched data along with attention, enable, and strobe bits), capable of interfacing with keyboards, joysticks, or similar parallel peripherals; and a 6847-based graphics generator board that can display all 64 ASCII characters. Put these together, and you've got 10 modes of operation — from alphanumeric/semi-graphics in 8 colors to ultra-dense 256x192 full graphics. Includes a 75 Ohm RS-170 compatible line output and video output for use with FCC approved video modulators. **Introductory pricing is \$339 unkit, \$399 assembled, and \$449 qualified under the high-reliability CSC program. Looking for graphics software? Sublogic's 2D Universal Graphics Interpreter (normally \$35) is yours for \$25 with the purchase of a Spectrum board in any configuration.**

No longer must you settle for B&W graphics, or stripped down color graphics boards; starting June 1st, you'll be able to plug one of the industry's most cost-effective and full-feature color graphics boards into your S-100 system.

OUTSTANDING COMPUTER PRODUCTS: MEMORY

All boards are static, run in 5 MHz systems, meet all IEEE standards, include a 1 year limited warranty, and feature low power consumption. Choose from unkit (sockets, bypass caps pre-soldered in place), assembled, or boards qualified under our high-reliability Certified System Component (CSC) program (200 hour burn-in, 8 MHz operation, and extremely low power consumption).

Name	Bus & Notes	Unkit	Assm	CSC
8K Econoram* IIA	S-100	\$169	\$189	\$239
16K Econoram XIV	S-100 (1)	\$299	\$349	\$429
16K Econoram X-16	S-100	\$329	\$379	\$479
16K Econoram XIII A-16	S-100 (2)	\$349	\$419	\$519
16K Econoram XV-16	H8 (3)	\$339	\$399	n/a
24K Econoram XIII A-24	S-100 (2)	\$479	\$539	\$649
32K Econoram X-32	S-100	\$599	\$689	\$789
32K Econoram XIII A-32	S-100 (2)	\$649	\$729	\$849
32K Econoram XV-32	H8 (3)	\$649	\$749	n/a
32K Econoram XI	SBC/BLC	n/a	n/a	\$1050

* Econoram is a trademark of Bill Godbout Electronics.

- (1) Extended addressing (24 address lines). Addressable on 4K boundaries.
- (2) Compatible with all bank select systems (Cromemco, Alpha Micro, Etc.); addressable on 4K boundaries.
- (3) Bank select option for implementing memory systems greater than 64K.

SPECIAL PRICE! TRS-80* -I or -II MEMORY EXPANSION CHIP SET: \$69!

We've done it again . . . 8 low power, 250 ns 16K dynamic RAMs at a trendsetting price. Don't be impressed with fancy packaging or four color ads; our chip set gives all the performance you want at a price you can afford. Offer good while supplies last. Add \$3 for TRS-80 compatible DIP shunts and complete installation instructions.

*TRS-80 is a trademark of the Tandy Corporation.

TERMS: Cal res add tax. Allow 5% for shipping, excess refunded. VISA®/Mastercharge® call our 24 hour order desk at (415) 562-0636. COD OK with street address for UPS. Sale prices good through cover month of magazine; other prices are subject to change without notice.

MOTHERBOARDS

Meet or exceed all IEEE S-100 specs; with true active termination, grounded Faraday shield, edge connectors for all slots. Unkits have edge connectors and termination resistors pre-soldered in place for easy assembly.

6 slot: \$89 unkit, \$129 assm.

12 slot: \$129 unkit, \$169 assm.

19 slot: \$174 unkit, \$214 assm.

GODBOUT COMPUTER BOX \$289 desktop, \$329 rack mount. With quiet fan, dual AC outlets and fuseholder, line filter, card guide, etc.

S-100 2708 EROM BOARD \$85 unkit. 4 independently addressable 4K blocks. Includes support chips and manual, but no EROMs.

S-100 ACTIVE TERMINATOR BOARD \$34.50 kit. Plugs into older, unterminated motherboards to improve performance.

S-100 MEMORY MANAGER BOARD \$59 unkit, \$85 assm, \$100 CSC. Adds bank select and extended addressing to older S-100 machines to dramatically increase the available memory space.

25 "INTERFACER I" S-100 I/O BOARD \$199 unkit, \$249 assm, \$324 CSC. Dual RS-232 ports with full handshake. On-board crystal timebase, hardware UARTS, much more.

3P PLUS S "INTERFACER II" I/O BOARD \$199 unkit, \$249 assm, \$324 CSC. Includes 1 channel of serial I/O (RS-232 with full handshake), along with 3 full duplex parallel ports plus a separate status port.

PASCAL/M™ + MEMORY SPECIAL PASCAL can give a microcomputer with CP/M more power than many minis. You can buy our totally standard Wirth PASCAL/M™ 8" diskette, with manual and Wirth's definitive book on PASCAL, FOR \$150 with the purchase of any memory board. Specify Z-80 or 8080/8085 version. PASCAL/M™ available separately for \$350.

Z-80A CPU BOARD \$225 unkit, \$295 assm, \$395 CSC. Full compliance with IEEE S-100 bus standards, provision for adding two EROMs, on-board fully maskable interrupts, power on jump and clear, selectable automatic wait state insertion, IEEE extended addressing, much more.

CompuPro™ from **GODBOUT**
ELECTRONICS
Bldg. 725, Oakland Airport, CA 94614

Many of these products are stocked by finer computer stores world-wide, or write us for further information if there's no dealer in your area.

Circle 100 on inquiry card.



400

A Warner Communications Company

PERSONAL COMPUTER SYSTEM

List \$630 **ONLY \$499**



ATARI® 800™ PERSONAL COMPUTER SYSTEM.

List \$1080 **ONLY \$849**

ATARI® 820 PRINTER, List \$599.95 .. \$499

810 DISK DRIVE, List \$699.95 \$589

APPLE II PERSONAL COMPUTERS

16K, List \$1195 \$ 989

32K, List \$1395 1169

48K 1259

COMMODORE PET *Call Us!*

EXIDY SORCERER COMPUTERS

16K RAM, List \$1295 \$ 999

32K RAM, List \$1395 1099

48K RAM, List \$1495 1199

Texas Instruments

TI-99/4 Home Computer

List \$1150

OUR PRICE

\$995



Prices do not include shipping by UPS. All prices and offers are subject to change without notice.

Personal PC Systems



609 Butternut Street
Syracuse, N.Y. 13208
(315) 478-6800

Listing 1 continued:

```
241 03FE 3C
241 03FF 3E
242 0400
```

•END

END OF MOS/TECHNOLOGY 650X ASSEMBLY VERSION 5.1
NUMBER OF ERRORS = 0, NUMBER OF WARNINGS = 0

SYMBOL TABLE

SYMBOL	VALUE	LINE	DEFINED	CROSS-REFERENCES
CLICK	029E	178	172	
CLICK1	02A8	183	181	
CLICK2	02A9	184	199	
CLICK3	02B6	189	190	
CLICK4	02C8	196	197	
CLICK5	02E2	208	179	
CMND	0263	145	105	
CMND1	0269	149	147	
CMND2	0272	154	150	
CMND3	027B	159	155	
CMND4	0284	164	160	
CMND5	028C	168	165	
DAC	1700	26	75	
DACDIR	1701	27	111	
DIAL	0200	94	****	
DIGIT	023D	122	107	
DIGIT1	0262	144	123	
DIGTAB	003C	21	38	100 101 118 125 126 130 171
DLY	013A	65	66	
DLY1	02D2	201	207	
DLY2	02DA	204	205	
DUMMY	1948	32	161	
FRQINC	0010	15	51	53 57 59
GETKEY	1F6A	34	98	
INC1F	0000	2	54	78
INC1I	0001	3	52	81
INC2F	0005	7	60	85
INC2I	0006	8	58	88
INH	00F9	24	142	
INIT	0223	110	96	
LOOK	0206	97	102	104 106 109
MAXKEY	000C	23	45	122
NDIGIT	000B	13	21	42 99 116 128 175
PAGE1	0004	6	****	
PAGE2	0009	11	****	
PBDIR	1703	29	112	
PNT1F	0002	4	77	79
PNT1I	0003	5	73	80 82
PNT2F	0007	9	84	86
PNT2I	0008	10	74	87 89
POINTH	00FB	25	131	
PORT3	1702	28	114	185 192
PULSE	028D	169	166	
PULSE1	028F	170	176	
SCANDS	1F1F	33	97	
SETUP	0111	45	39	
SETUP1	013F	67	46	
SHIFT	0241	124	****	
SHIFT1	0243	125	129	
SHIFT2	024C	130	120	
SHIFT3	0250	132	143	
SINTA3	0300	210	****	
SOUND	0140	68	61	
SOUND1	014A	72	91	

SYMBOL	VALUE	LINE	DEFINED	CROSS-REFERENCES
TEMPX	000A	12	37	40 170 173
TONES	0100	36	151	
TONES1	0102	37	43	
TONTA3	0022	17	49	55
TSTAT	1707	31	65	90 189 196 204
T1024	1707	30	63	64 70 71 187 188 194 195 202 203
ZERO	0230	115	156	
ZERO1	0234	117	119	

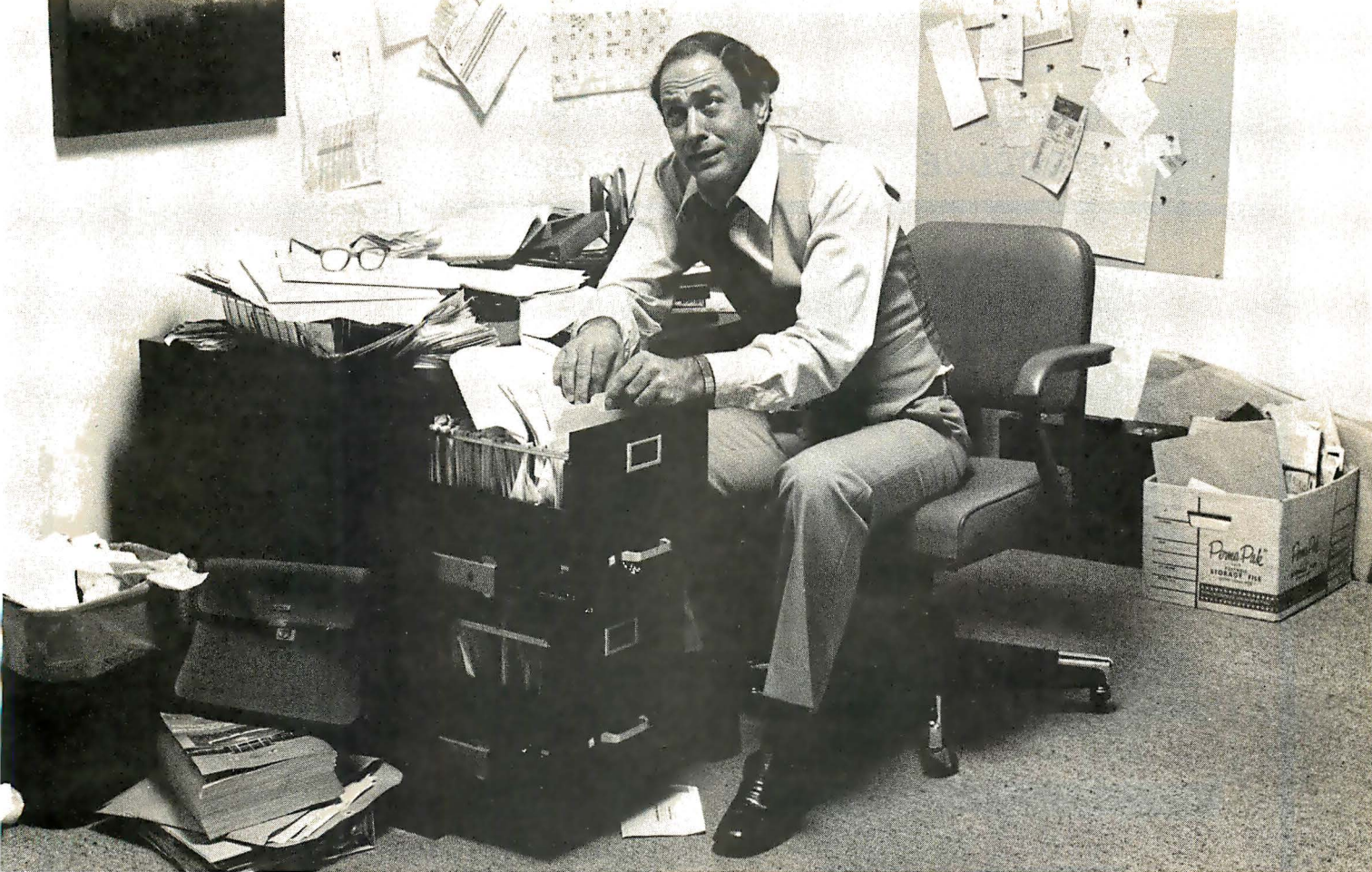

Record keeping problems? Our CCA Data Management System solves them easily.

Having information at your fingertips can make your job a whole lot easier. And that's what the CCA Data Management System is all about.

With this Personal Software™ package and an Apple II™ or TRS-80™ disk system, it will be far easier to keep inventories, customer lists, accounts receivable and payable records, patient histories and many more items.

In fact, you can use the CCA DMS for all of your data management needs, rather than buying (expensive) or writing (time consuming) separate programs for each application. That's because DMS lets you create your own filing systems, adapting itself to the types of records you keep. You specify the number and names of each data field—without any programming.

With DMS keeping all of your records, you only have to learn how to use one system. That's easier, too. It's menu driven, with plenty of prompts to help you create files and add, update, scan, inspect, delete, sort, condense and print data. Our comprehensive 130-page step-by-step instruction manual even provides complete "how to" inventory and mailing list applications so you can start processing immediately.

DMS is a very powerful system, with more file and record storage capacity than other data base programs on the market.

And it also gives you greater data handling flexibility. To customize DMS, write add-on BASIC programs that read or write DMS files and perform any kind of processing you want.

You can sort and print your data in nearly any form of report and mailing label you want. Sort data by up to 10 fields for zip code, balance due, geographic location or whatever. And print reports with subtotals and totals automatically calculated.

The CCA Data Management System, written by Creative Computer Applications, has two years of field testing on other microcomputers. Now Personal Software makes DMS available on the TRS-80 Level II and Apple II and II Plus 48k disk systems. And at under \$100, DMS is also easy to afford.

Apple DMS has two additional and exclusive features. Its ISAM search method finds any item on a diskette within 10 seconds. And its Data Interchange Format Program moves DMS files into our Apple VisiCalc™ program — the "electronic worksheet" — for powerful, flexible calculating.

Ask your Personal Software dealer to show you how easy computerized record keeping is. To locate the nearest dealer, contact Personal Software Inc., (408) 745-7841, 1330 Bordeaux Drive, Sunnyvale, CA 94086.



**PERSONAL
SOFTWARE**

*Apple is a trademark of Apple Computer, Inc.; TRS-80 is a trademark of the Radio Shack Div. of Tandy Corp.

NEECO
PROUDLY
INTRODUCES

COMMODORE'S NEW 8000 SERIES (80 column) COMPUTERS



\$1695 (available May/June '80)

CBM™ 8050 DUAL DRIVE FLOPPY DISK

The CBM 8050 Dual Drive Floppy Disk in an enhanced version of the intelligent CBM 2040 Disk Drive. The CBM 8050 has all of the features of the CBM 2040, and provides more powerful software capabilities, as well as nearly one megabyte of online storage capacity. The CBM 8050 supplies relative record files and automatic diskette initialization. It can copy all the files from one diskette to another without copying unused space. The CBM 8050 also offers improved error recovery and the ability to append to sequential files.

HARDWARE SPECIFICATIONS

Dual Drives
Two microprocessors
974K Bytes storage on two 5.25" diskettes (ss)
Tracks 70
Sectors 17-21
Soft sector format
IEEE-488 interface
Combination power (green) and error (red) indicator lights
Drive Activity indicator lights
Disk Operating System Firmware (12K ROM)
Disk Buffer (4K RAM)

FIRMWARE

DOS version 2.0
Sequential file manipulation
Sequential user files
Relative record files
Append to sequential files
Improved error recovery
Automatic diskette initialization
Automatic directory search
Command parser for syntax validation
Program load and save

CBM™ 8000 SERIES BUSINESS COMPUTERS

The new Commodore 8000 series computers offer a wide screen display to show you up to 80-character lines of information. Text editing and report formatting are faster and easier with the new wide-screen display. The 8000 series also provides a resident Operating System with expanded functional capabilities. You can use BASIC on the 8000 computers in both interactive and program modes, with expanded commands and functions for arithmetic, editing, and disk file management. The CBM 8000 series computers are ideally suited for the computing needs of the business marketplace.

SCREEN

2000 character display, organized into twenty-five 80-column lines
64 ASCII, 64 graphic characters
3 x 8 dot matrix characters
Green phosphor screen
Brightness control
Line spacing: 1½ in Text Mode
1 in Graphics Mode

KEYBOARD

73-key typewriter style keyboard with graphic capabilities
Repeat key functional with all keys

MEMORY

CBM 8016: 16K (15359 net) random access memory (RAM)
CBM 8032: 32K (31743 net) random access memory (RAM)

POWER REQUIREMENTS

Volts: 110V
Cycles: 60 Hz
Watts: 100

SCREEN EDITING

CAPABILITIES
Full cursor control (up, down, right, left)
Character insert and delete
Reverse character fields
Overstriking
Return key sends entire line to CPU regardless of cursor position

INPUT/OUTPUT

Parallel port
IEEE-488 bus
2 cassette ports
Memory and I/O expansion connectors

FIRMWARE

24K or ROM contains:
BASIC (version 4.0) with direct (interactive) and indirect (program) modes
9-digit floating binary arithmetic
Tape and disk file handling software

The 8000 Series will be available May/June '80

Model 8016	Model 8032	2040 Dual Floppy
	Available Now	
\$1495	\$1795	\$1295

commodore

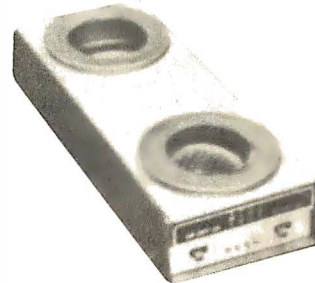

CBM™ IEEE MODEM

SPECIFICATIONS

- *Full or half duplex operation
- *300 bits per second
- *Standard IEEE 488 interface
- *Switch selectable originate, off, answer-full duplex, test, half duplex
- *Visible indicators are transmit data, receive data, carrier ready, test
- *Frequency shifted modulation
- *Bell 103/113 compatible

Available June/July

\$395

"Exceptional performance - even on noisy phone lines"

VISICALC FOR CBM \$150 (Available June)

*CBM is a registered trademark of Commodore. All prices and specifications are subject to change without notice.

NEECO
679 Highland Ave.
Needham, MA
02194

Mon-Fri 9:30-5:30
MasterCharge &
Visa Accepted

(617) 449-1760
Telex: 951021

MICROAMERICA DISTRIBUTING
"Dealer and OEM inquiries invited"
21 Putnam Street
Needham, MA
02194
(617) 449-4310



NEECO
PROUDLY
INTRODUCES

MULTI-CLUSTER

"Multi User Management System for
Commodore CBM/PET* Computers"

UP TO 8 CBM/PETS MAY NOW SIMULTANEOUSLY ACCESS ONE 2040!



Channel Module
CM-800



- Up to 8 Channel (3 Standard) for CBM/PET Computers.
- Up to 8 CBM/PETS can multi-use one Commodore 2040 dual disk drive simultaneously with equal access.
- Multi-Cluster supports all 2040 disk O/S commands including sequential, random access, and user files.
- Multi-Cluster does not utilize any RAM or ROM from the 2040 or host CBM/PET units.
- Multi-Cluster is compatible with all known software that utilize the IEEE port.
- Multi-Cluster can be fully implemented on 8 PETS, completely ready to use, in less than 15 minutes.
- Simply plug the Multi-Cluster unit into the IEEE port of the 2040 Disk Drive, then attach a Channel Module, #CM800, (3 Channel Modules are standard with unit), to the IEEE port of each PET.

Multi-Cluster
Model MC-800A
Standard 3 Channels)

\$995

THE MULTI-CLUSTER SYSTEM HAS BEEN USED AND FULLY-TESTED BY NEECO

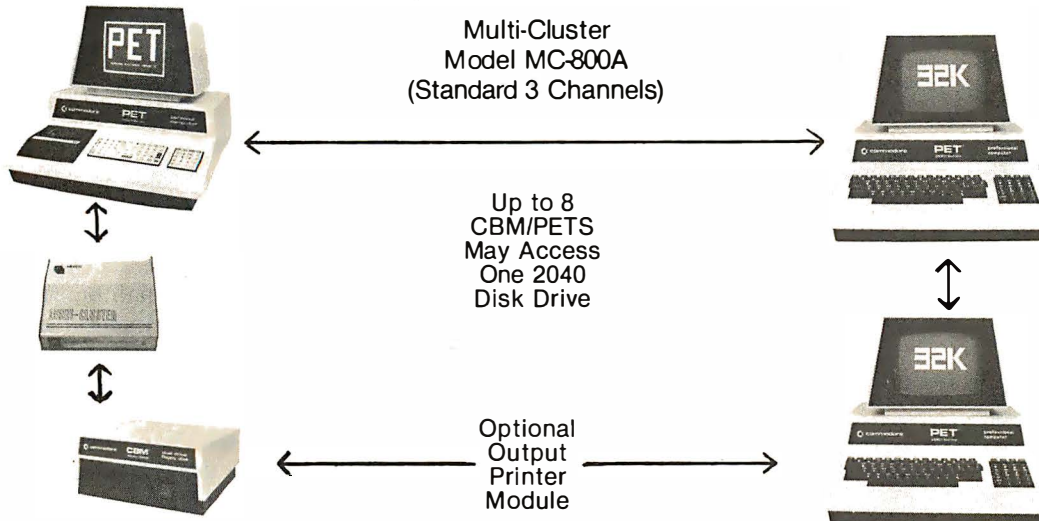

Multi-Cluster is ideal for industrial, OEM, Vertical Markets, and Educational Institutions. Multi-Cluster allows you to make full use of the Commodore 3 units for the price of 2 educational programs.

Output Printer Module allows
1 CBM/PET to scan 2040 Disk
and print flagged files.

Standard Components:

- 1 Multi-Cluster #MC800A
- 3 Channel Modules #CM-100
- 3 6' Ribbon Cables #RC6

Optional Component Prices:

- Each additional CM-100 \$250
- Each 12' Ribbon Cable (RC12) \$ 40
- Each 18' Ribbon Cable (RC18) \$ 60
- Output Printer Module (PM200) \$200
(For Centronics Protocol Printers)

*PET is a registered trademark of Commodore Business Machines. Small Keyboard PETS require a ROM Retrofit Kit for Multi-Cluster system operation.

Multi-Cluster is available in Canada from BMB Compu Science, Milton, Ontario, (416) 878-7277



NEECO

679 Highland Ave.
Needham, MA
02194

Dealer Sales:

Microamerica Distributing
21 Putnum St., Needham, MA 02194
(617) 449-4310 **Telex: 951021**

Circle 105 on inquiry card.

Customer Sales:

NEECO

679 Highland Ave., Needham, MA 02194
(617) 449-1760

Circle 104 on inquiry card.

Text continued from page 142:

convert it. After going through all 256 table locations, I will return to the beginning of the table for the next value, continuing to go through the table for as long as I want a tone to be produced.

The fixed interval between output samples is $63 \mu\text{s}$ for my program when it is run on a KIM-1 with a 1 MHz clock. Using this time for the example, it will take 256 steps/cycle multiplied by $63 \mu\text{s}/\text{step} = 16.1 \text{ ms}$ to go through the sine table once (one cycle of the waveform). As I continue to increment through the table for

subsequent cycles, I am producing a continuous sine waveform with a period of 16.1 ms, or a frequency of $1/16.1 \text{ ms} = 62 \text{ Hz}$.

If I skip every other table location — that is, add 2 instead of 1 to get the next location — then it will take me half the time to step all the way through a complete cycle ($(128 \text{ steps/cycle}) \times (63 \mu\text{s}/\text{step}) = 8.1 \text{ ms/cycle}$) and the frequency of the tone will be doubled ($1/8.1 \text{ ms/cycle} = 124 \text{ Hz}$). You can generate higher frequencies by using a larger increment to step through the waveform table. However, there is a

practical and theoretical) upper limit to the increment size: it should not be more than one third (practical) to one half (theoretical) of the length of the table itself. This means that the practical frequency upper limit is $5300 \text{ Hz} ((3 \text{ steps/cycle}) \times (63 \mu\text{s}/\text{step}) = 189 \mu\text{s}/\text{cycle})$.

So far, the important points are that I use a fixed sample rate to step through a waveform table, using a small increment size for a low frequency and a large increment size for a high frequency. The increment sizes up to now have been exact integers, restricting me to discrete frequencies (62 Hz, 124 Hz, 248 Hz, etc). How can I get all of the frequencies in between?

The control program in this case was made very simple.

I will use a 2-byte increment and a 2-byte pointer. These have both an integer part and a fractional part. As I step through the table I will add both the integer part and the fractional part to the 2-byte table pointer, but will ignore the fractional part when I use the pointer as an offset from the beginning of the waveform table. Thus I will maintain a table pointer with both integer and fractional parts, but I will index into the table with just the integer part. For example, with 2.5 as the increment size used to choose successive samples within the 256-entry table, the program will take (on the average) not 256 but $256/2.5 = 102.4$ steps to create one cycle of the sine wave. With each step taking $63 \mu\text{s}$, the waveform has a period of 6.45 ms, which is equivalent to a frequency of 155 Hz.

Combining two tones could be done by using two digital-to-analog converters and combining the audio frequency tones with a resistive network. However, I can let the computer add the instantaneous waveform values before sending the results out to the digital-to-analog converter. The resulting waveform is the same.

My program keeps track of two increment sizes and two table pointers. When the processor has both values for a single sample instant, it performs an ADC (ie: add) instruction and sends the result to the digital-to-

COMMODORE

MAKES GOOD BUSINESS SENSE!



PROFESSIONAL PET 2001 (MODEL N)
Terminal styled keybd./numeric pad/graphics keys/40 column by 25 line display. (Basic 3.0 OS)

8K IN only \$ 795 + FREE SOFTWARE VALUED AT \$50
16K (Specify N or B) \$ 995 + FREE SOFTWARE VALUED AT \$100

BUSINESS CBM 2001 (MODEL B)
Typewriter styled keybd./numeric pad/40 column by 25 line display. (Basic 3.0 OS)

32K (Specify N or B) \$1,295 + FREE SOFTWARE VALUED AT \$100

CBM MODEL 8000
Typewriter styled keybd./numeric pad/80 column by 25 line display/new screen edit (Basic 4.0 OS)

8016 \$1,495 + FREE SOFTWARE VALUED AT \$100
8032 \$1,795 + FREE SOFTWARE VALUED AT \$100



CBM 2022 PRINTER
80 column dot matrix/plain paper or forms/tractor feed/full PET graphics/variable line spacing/programmable character (CBM 2023 Printer is friction feed)

2022 Printer \$ 795 + FREE SOFTWARE VALUED AT \$50
2023 Printer \$ 695 + FREE SOFTWARE VALUED AT \$50



CBM 2040 DUAL DRIVE FLOPPY DISK
Intelligent 5 1/4" mini-floppy disk system with 343K net user storage (DOS 1.0)

2040 Dual Floppy \$1,295 + FREE SOFTWARE VALUED AT \$100

CBM 8050 DUAL DRIVE FLOPPY DISK
Intelligent 5 1/4" mini-floppy disk system with over 950K net user storage. (DOS 2.0)

8050 Dual Floppy \$1,695 + FREE SOFTWARE VALUED AT \$100

CBM C2N CASSETTE DRIVE C2N CASSETTE DR. \$95

CBM MODEM MODEM \$365

QUALIFIED EDUCATIONAL INSTITUTIONS RECEIVE 3 COMPUTERS FOR THE PRICE OF 2!
This is a limited duration special by COMMODORE. Software specials do not apply.

TO ORDER: Certified checks or money orders receive FREE INSURED SHIPPING BY UNITED PARCEL SERVICE!
C.O.D. shipments require a 15% deposit — freight collect.

Arizona residents: Add 5% sales tax. Credit cards welcome. There are no handling charges.

1. MICRO-COMPUTER BROKERS is a COMMODORE AUTHORIZED SALES CENTER.
2. SOFTWARE OFFER IS CUMULATIVE! Example: Order of 1 CBM 2001, 1 Printer 2022, 1 Dual Drive 2040 qualifies for \$250 in FREE SOFTWARE.
3. Great savings also on Industrial Micro, Leedex, N.E.C., Televideo, Texas Instruments



MICRO-COMPUTER BROKERS

MAIL ORDER DIVISION

6819-P, N. 21st Ave. • Phoenix, AZ 85015

TELEPHONE ORDERS WELCOME (602) 242-9966 TELEX: (0) 668382

DATASPEED INC.

S-100 BUS PRODUCTS

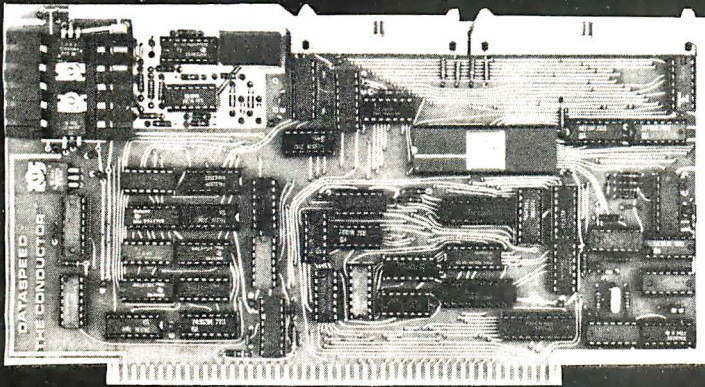

THE CONDUCTOR™

A versatile dual density floppy disk controller. Works with most popular drives such as SHUGART, MPI, SIEMENS, PERSCI, etc., and guaranteed to work with virtually all leading CPU boards and RAM cards. Backed up with dual density CP/M 2.2 (\$150) and available NOW!!!

\$325 assembled

5 AND 8 INCH SINGLE-AND DOUBLE-DENSITY CONTROLLER ON ONE BOARD

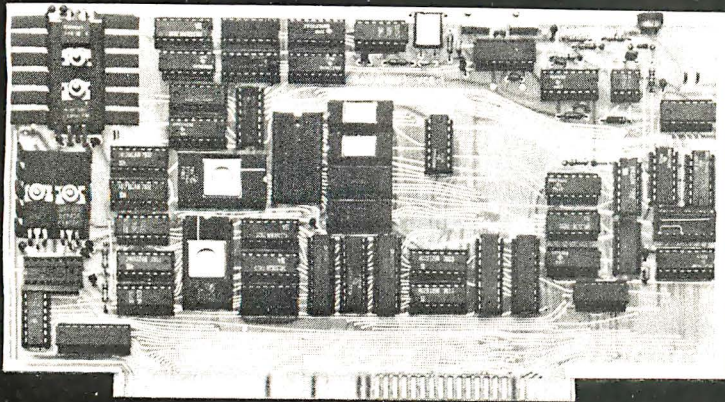

VCB-1™ VIDEO CONTROLLER

Memory mapped 80 x 24 with dual character sets (PROGRAMMABLE!) parallel port, 1K user ROM and HARDWARE SCROLLING. Firmware available.

\$349 assembled

THE PERFECT I/O COMPANION TO THE CONDUCTOR

We feature SHUGART drives. Each drive system includes the CONDUCTOR dual density controller, cabinet, power supply and cables. EVERYTHING you need for a solid dual-density system at solid savings.

DOUBLE-DENSITY MINI-FLOPPY SYSTEMS

Single-Sided System	(SA-400)	\$795
Double-Sided System	(SA-450)	\$895

8" DRIVE SYSTEMS

	single-sided	double-sided
Single Drive System	(one SA-800) . . . \$1149	(one SA-850) . . . \$1349
Dual Drive System	(two SA-800) . . . \$1849	(two SA-850) . . . \$2049

DISK SYSTEMS

Let DATASPEED package your disk system. All the hardware you need for a complete floppy disk system. Just add CP/M and a computer. PLUS-FREE Osborne Accounting software.

complete systems from **\$795**

DATASPEED INC. IS NOT AFFILIATED WITH ANY BELL SYSTEM COMPANY OR PRODUCT.

Canada:
ARDEX DISTRIBUTING CO., LTD.
31 PROGRESS CT., UNIT 12
SCARBOROUGH
ONTARIO

Exclusive European Distributor:
TRANS AM COMPONENTS
12 CHAPEL STREET
LONDON
ENGLAND

DATASPEED, INC.
1300 NOE STREET
SAN FRANCISCO, CA 94131
(415) 641-8947

VISA AND
MASTER CHARGE
ACCEPTED

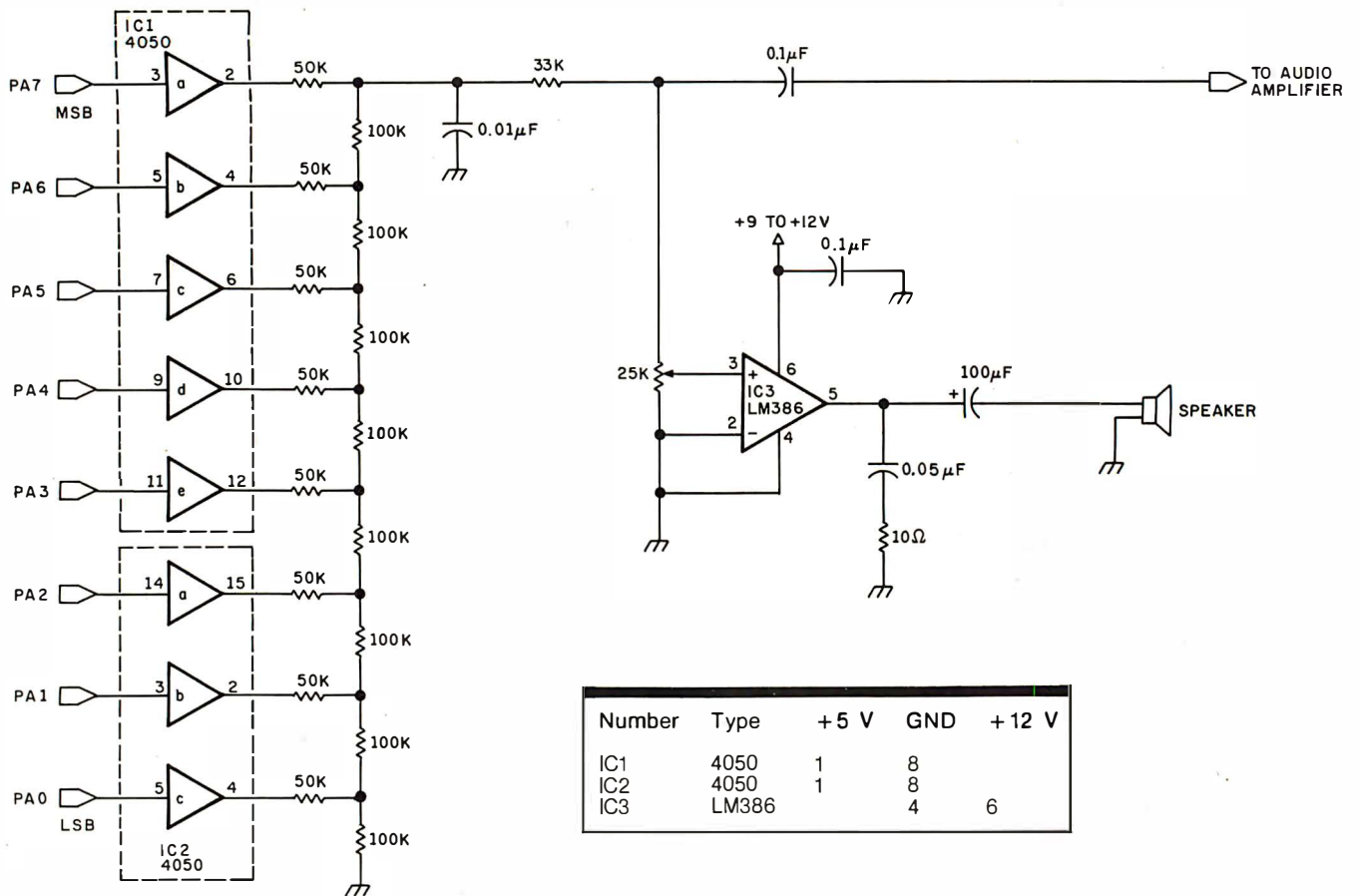

Figure 2: Schematic diagram of circuit for audio dialing. The tones used for dual-tone, multiple-frequency (ie: Touch-Tone) dialing are generated by the conversion of an 8-bit digital quantity to an analog signal. Here, a resistive ladder converts the 8-bit value to an analog voltage, and a resistor-capacitor pair acts as a low-pass filter with a cutoff frequency of about 3 kHz. The signal can either be sent to an external amplifier, or it can be amplified by the circuit centering around IC3.

analog converter. The maximum value of the sum must never exceed the 8-bit range of a single byte, so the waveform values themselves must all be less than one half of hexadecimal FF. (This gives the previously stated value of hexadecimal 7F.)

The waveform produced is a staircase approximation to the superposition of two frequencies. The sharp transitions in the voltage levels produced by this method are full of high-frequency harmonics. Filtering will be required to get rid of these unwanted frequencies.

Hardware Required — Tones

Hardware required to generate tone pairs consists of a simple 8-bit digital-to-analog converter, a low-pass filter, an amplifier, and a small speaker. (See figure 2 for a schematic diagram of the circuit I used.)

The 8-bit latched output from the computer is applied to a ladder-network digital-to-analog converter using complementary metal-oxide semiconductor (CMOS) buffers. This

is unsigned binary conversion: a code of hexadecimal FF produces close to 5 V output and a code of hexadecimal 00 produces close to 0 V output.

A similar ladder network could be constructed using transistor-transistor logic (TTL) integrated circuits, but CMOS buffers give more accurate results (even though the quality of conversion is not too important in this application). For each of the 50 k-ohm resistors shown, I used two 100 k-ohm resistors in parallel.

The output of the digital-to-analog converter goes through a single-pole, low-pass filter with a cutoff frequency of about 3 kHz. The output of the filter can be fed to an amplifier and speaker system. Use a capacitor in series (as shown in figure 2) to block the DC voltage offset from the converter. Make your connection at the wiper of the potentiometer if your amplifier lacks a volume control of its own. The volume-control potentiometer I used a 25 k-ohm linear

trimmer, but almost anything from 20 k thru 100 k should work fine.

I found it convenient to use an integrated-circuit audio amplifier to drive my speaker (one side of a pair of headphones). The manufacturer of the LM386 suggested the simple circuit I used. The input is direct coupled (ie: the DC offset voltage potential from the converter will be maintained through the amplifier stage). The output capacitor blocks direct current to the speaker; it must be of a value of at least 100 µF to produce a sound loud enough to work with my system.

Another factor in loudness is the supply voltage for the LM386. A 5 V supply will produce tones that are clearly audible but which are not loud enough to work the telephone circuits when I use the headphone speaker. The headphones work fine using a 9 V or a 12 V supply. If a speaker lower in impedance than mine is used, the 5 V power supply may be sufficient.

My circuits were constructed on an

NEW!



PRB-1 DIGITAL LOGIC PROBE

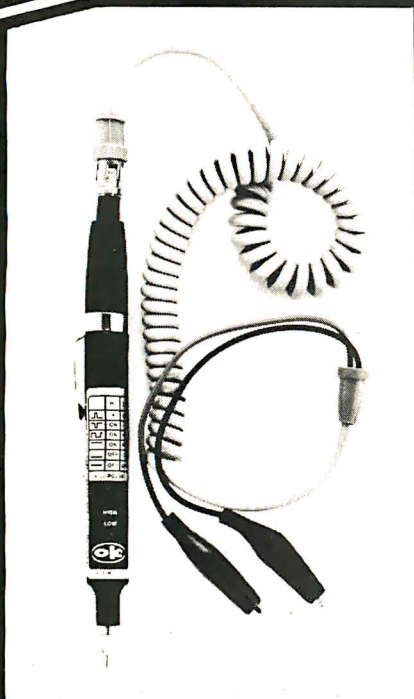

Compatible with DTL, TTL, CMOS, MOS and Microprocessors using a 4 to 15V power supply. Thresholds automatically programmed. Automatic resetting memory. No adjustment required. Visual indication of logic levels, using LED's to show high, low, bad level or open circuit logic and pulses. Highly sophisticated, shirt pocket portable (protective tip cap and removable coil cord).

\$36⁹⁵*

- DC to > 50 MHz
- 10 Nsec. pulse response
- 120 K Ω impedance
- Automatic pulse stretching to 50 Msec.
- Automatic resetting memory
- Open circuit detection
- Automatic threshold resetting
- Compatible with all logic families 4-15 VDC
- Range extended to 15-25 VDC with optional PA-1 adapter
- Supply O.V.P. to \pm 70 VDC
- No switches/no calibration

* ADD \$2.00 FOR SHIPPING (N. Y. CITY AND STATE RESIDENTS ADD TAX)

OK MACHINE & TOOL CORPORATION

3455 Conner St., Bronx, N.Y. 10475 (212) 994-6600 / Telex 125091

MR. PROGRAMMER

Are you finding programming the most tedious pursuit you've ever engaged in?

MR. DEALER

Would you find your hardware sales increased 100 fold if your prospective purchasers could create their own programs immediately?

MR. HOBBYIST

How about you? Spending lots and lots of time debugging?

MR., MRS., MS.

Who ever you are - if programming has become unpalatable or if you've bitten off more than you can chew

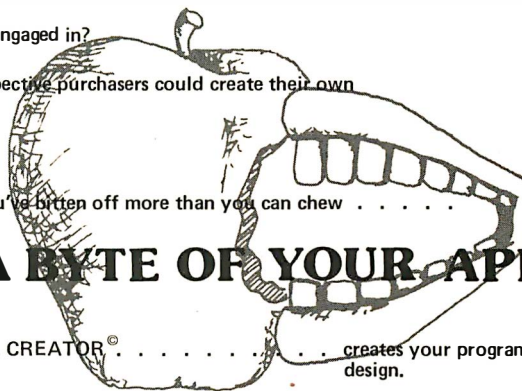

LET THE CREATOR® TAKE A BITE OF YOUR APPLE

THE CREATOR® does the work! You answer the simple direct questions and THE CREATOR® creates ... all in Basic language.

THE CREATOR® makes complete running programs that are modular and fully documented.

THE CREATOR® cuts programming time up to 90 %

THE CREATOR® requires **NO** (none) prior programming knowledge or skills

THE CREATOR® creates your programs to your design.

THE CREATOR® is presently available for Apple II

THE CREATOR® is presently available for TRS 80 Model I
TRS 80 Model II
Tandy 10

THE CREATOR® will soon be available for CP/M systems

Enclosed is my check (or money order) in the amount of \$250.00. Please send me my serial numbered, registered copy of THE CREATOR® as soon as my check clears. (No wait for Certified checks, bank checks or money orders.) Sorry, no credit cards accepted.

Please Print
 Name _____
 Address _____ Apt. No. _____
 City _____ State _____ Zip _____
 Computer make _____ Model _____

We are seeking qualified dealers and distributors to handle our growing software lines. Address inquires, on your company letterhead, to: Complete Business Systems, Inc., Software Division, 9420 W. Foster Ave., Chicago, Illinois 60656.

ANNOUNCING PASCAL FOR CONNOISSEURS, FROM JRT.

The advantages of PASCAL are well recognized and accepted. Now, JRT Systems makes a good thing even better.

JRT PASCAL is a compiler and run-time package with extensions. Not a subset, it is a complete PASCAL and is fully CP/M* compatible —because it's specifically designed for CP/M. It gives you all the standard PASCAL benefits—all data types, (records, arrays, sets, user defined types, etc.); 14 digit BCD floating point package

PLUS extensions to support commercial applications and reduce programming effort.

Powerful dynamic storage management system / dynamic variable allocation procedures NEW & DISPOSE are fully implemented / automatic dynamic storage compression / user assigned pointer variables allow access to any part of storage—example: a memory mapped video display could be accessed as an array of characters. External procedures / functions may be separately compiled and disk-stored in relocatable format / allows development of large programs, not limited by main storage size / automatic loading into dynamic storage when procedure is referenced / automatic purging from dynamic storage by a least-recently-used algorithm. Powerful disk I/O facilities / data may be stored in ASCII text or space-saving binary format / random access by relative byte address, perfect for index file structures and data base systems / random access by relative record number. String and structured variables / entire arrays and records, strings of different lengths may be assigned, compared, input or output with simple statements / function return values may be string, array, record. CASE statement with ELSE clause / CASE labels may be full expressions. More readable identifiers / up to 32 characters / may contain underline characters. Assembler routine interface. Hex constants.

JRT PASCAL User Manual, Diskette, and PASCAL User Manual & Report by Jensen & Wirth: \$225. Manuals only: \$25. (VISA/MC accepted. California residents add sales tax. Dealer inquiries invited.)
Order today from:

JRT SYSTEMS, INC.
P.O. Box 22365
San Francisco
CA 94122
Telephone
415/566-4240

*CP/M is a registered trademark of Digital Research.

PASCAL FOR CONNOISSEURS

integrated-circuit breadboard without much attention paid to component layout and wire lengths. The 0.05 μ F capacitor and 10-ohm resistor on the amplifier output were recommended by the manufacturer for

stability, but they were not required in my system.

When you run the program to generate tones, adjust the volume control to give an output as loud as possible without clipping distortion. If you have an efficient speaker, perhaps you can set the volume control lower than would otherwise be necessary. Try dialing some local numbers to test correct operation. I have found that (in my local telephone system) dialing my own number will give a busy signal if everything is working properly. If a dial tone remains after the system has produced the tones, or if there is silence, I know the system needs adjustment.

Software Required — Control

There must be an overall controlling mechanism to accept user commands and digits and to execute the proper routines. The control program in this case was made very simple, relying on calls to subroutines to execute desired operations. The KIM monitor routines are used to collect input data from the keypad and to put information into the display. Other routines are called to set up I/O registers, to enter a digit from the keypad into memory as part of the telephone number, and to interpret and execute a command key when pressed.

The remainder of this article is a discussion of the individual routines used in the dialer program. Refer to the flowcharts in figures 3 and 4 for a general idea of the program's logic. I shall first describe the overall software structure and then each of the subroutines in more detail.

Listing 1 shows the main routine of the program. I kept it very short and relied on subroutines to do the work so that I could concentrate on getting the basic program flow to work before I tried out the more complicated and error-prone subroutines.

When I was testing the main routine, I changed the subroutine addresses to call KIM location hexadecimal 194B, which contains hexadecimal 60, a return instruction. Each such subroutine call is a dummy providing an immediate return. When the main routine worked to my satisfaction, I began writing the subroutines and one by one replaced the dummy calls with calls to a new routine to be tested.

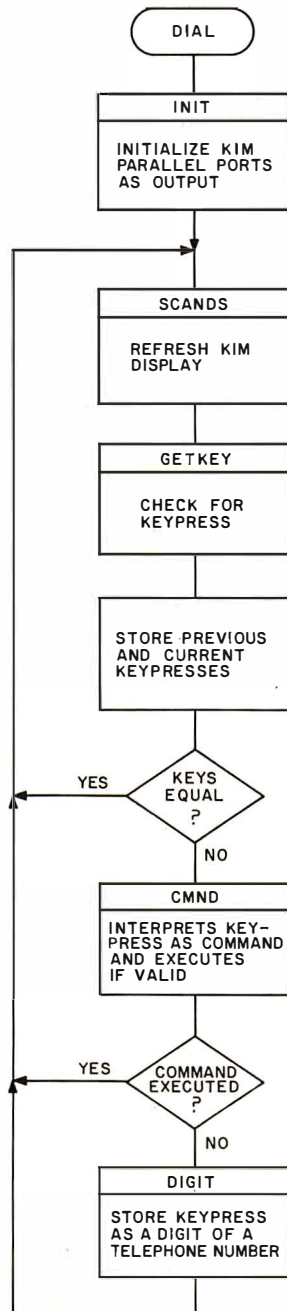

Figure 3: Flowchart for DIAL, the main loop of the program used to store and dial a telephone number. SCANDS and GETKEY are KIM monitor routines to display data on the KIM readout and to check for a keypress, respectively. CMND executes the most recent keypress if it is a valid command, and DIGIT stores and displays the digit key just pressed during the process of entering the number to be dialed.

FINALLY!

PASCAL for the price of BASIC

SORCIM's \$175.00 PASCAL/M^{T.M.}

Sorcim delivers all the advantages of PASCAL — from ease of learning to sophistication of application — in a totally CP/M* compatible software package for 8080 or Z80 based systems. And, the features are as impressive as the price:

- Built-in error checking (PASCAL/M's unique runtime debug support)
- Runs under both CP/M 1.4 and 2.2
- Optional updating service protects your investment
- Extensions chosen for compatibility with other popular PASCALS
- Console cursor controls for word processing-like editing capabilities
- Complete random file and longer integer (32 bit, 9 digit) support
- Case statement includes otherwise clause
- Full Wirth implementation
- All I/O totally compatible with CP/M file structure
- Special version (at no extra cost) for Z80 + 9511 math chip based systems
- Comprehensive 90 page manual describing PASCAL/M implementation
- Full access to CP/M data files written in other languages and stored under CP/M
- Assembly code external support for added flexibility . . . and there's more.

Find out why Sorcim's \$175 PASCAL/M is the choice of companies such as Digital Marketing, FMG Corporation, Godbout Electronics/CompuPro, and Lifeboat Associates . . . and why it should be yours. Still need convincing? The 90 page manual is available separately for \$10, and tells all about PASCAL/M's implementation. Need more background? Jensen and Wirth's definitive book on PASCAL is available from us for \$7.90.

You may never go back to BASIC again.

PASCAL/MTM is a trademark of Sorcim
 *CP/M is a trademark of Digital Research



2273 CALLE DE LUNA
 SANTA CLARA, CALIFORNIA 95050

ORDER FORM	PASCAL/M requires 56K of RAM and one floppy disk. All disks are shipped on single-sided/single density, soft-sectored CP/M compatible media.	
	TERMS: We accept UPS COD, Mastercard®, VISA®, personal checks (allow time to clear), and certified checks. Price good through cover month of magazine.	
	Send the indicated items to:	
	Name _____	
	UPS address _____	
	Town _____ State _____ Zip _____	
	Mastercard® _____ date _____	
	VISA® _____	
	8080 PASCAL/M	<input type="checkbox"/>
	Z80 PASCAL/M	<input type="checkbox"/>
Z80 + 9511 PASCAL/M	<input type="checkbox"/>	
PASCAL/M manual	<input type="checkbox"/>	
Jensen & Wirth book	<input type="checkbox"/>	
CA sales tax	<input type="checkbox"/>	
Add \$10 outside US	<input type="checkbox"/>	
Enclosed is	<input type="checkbox"/>	

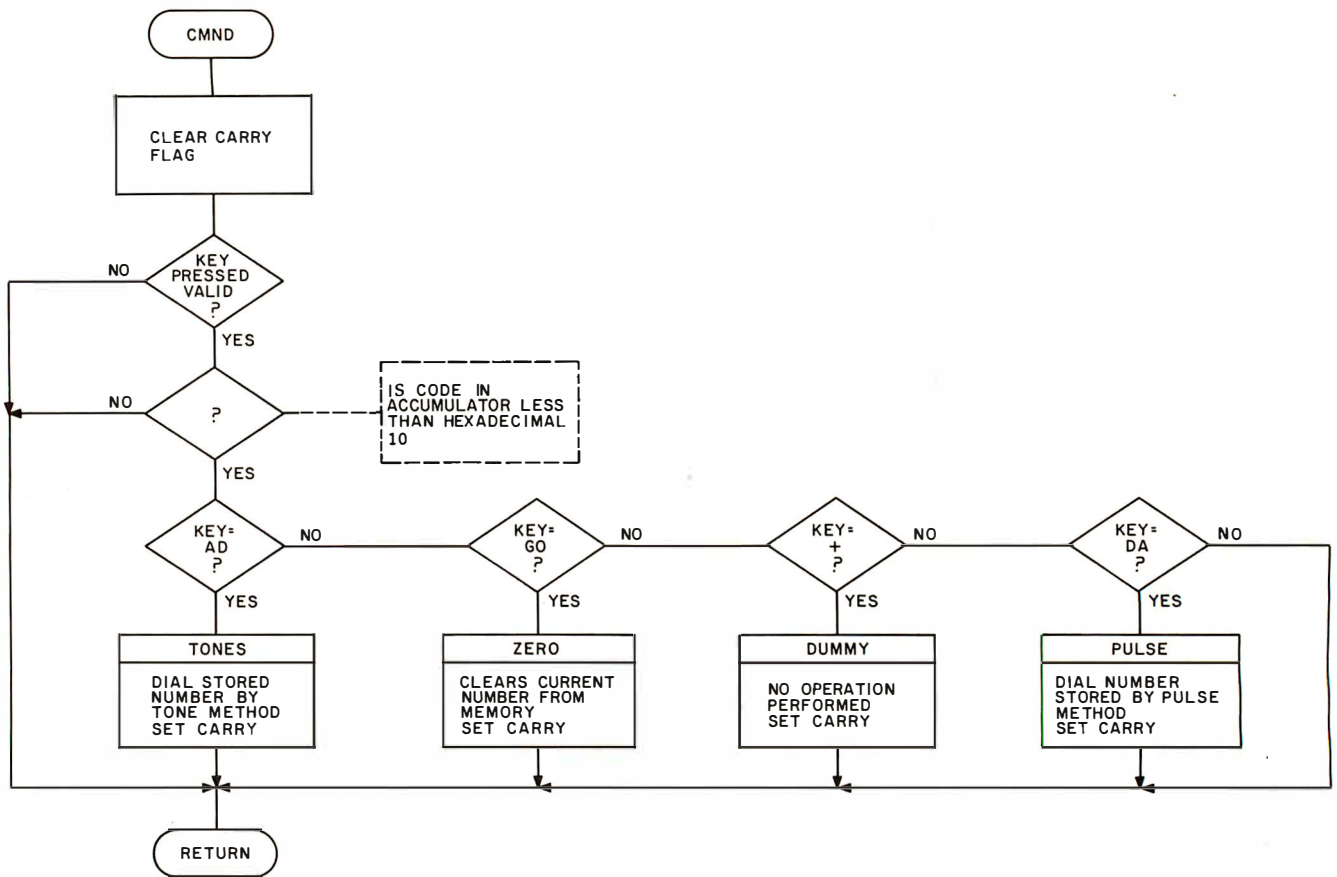

Figure 4: Flowchart for CMND, a command decoding subroutine. TONES and PULSE cause the telephone number currently in memory to be dialed by the audio-tone and pulse-dialing methods, respectively. ZERO clears the current number from memory, and DUMMY is a trivial subroutine used to test the calling routines. The CMND subroutine returns with the status of the carry flag denoting whether or not the last keypress is a valid command (set) or a digit (cleared).

The logic of the main program is not too complicated. First, a call to an initialization routine is made to set up

Key Pressed	Code Returned
none	15
0	00
1	01
2	02
3	03
4	04
5	05
6	06
7	07
8	08
9	09
A	0A
B	0B
C	0C
D	0D
E	0E
F	0F
AD	10
DA	11
+	12
GO	13
PC	14

Table 3: Codes returned by the KIM monitor subroutine GETKEY. These values must be known in order to decode a keypress in the CMND subroutine.

data-direction registers of the I/O devices and to load variables with starting values. I then use two KIM routines to put data in the display (SCANDS) and to check for a key closure on the KIM keypad (GETKEY).

If no key is pressed, the GETKEY routine returns with a value of hexadecimal 15 in the accumulator. If one of the keys (except for reset and stop) is pressed, a hexadecimal code from 00 to 14 will be stored in the accumulator. (See table 3 for the key names and the codes returned by GETKEY.) The main routine waits for a hexadecimal 15 from GETKEY between separate closures on the keypad. In this way, the program can distinguish between an old key still held down and a second closure of the same key.

Further processing of a key will determine whether the key is a command (GO, AD, DA, PC, +) or a digit (0 thru 9 and A thru C). If the key is a command, then the action called for will be carried out by invoking the appropriate subroutine.

The keycode is passed to the CMND subroutine in the accumulator. If that routine returns with the carry flag set, then a command was carried out and no further processing need be done. If the carry flag is cleared (=0) when the subroutine returns, then it was not a valid command keycode and processing will be done in the DIGIT subroutine.

The DIGIT routine also checks for valid digit codes and returns immediately if the code is out of range. If the code is a digit, then the DIGIT subroutine will take that code and store it into memory as the next digit of the telephone number. The display will also show the new digit, as I will show later. When digit processing is over, the program makes an unconditional relative jump to service the keyboard and the display.

Subroutine INIT loads the I/O control registers with data-direction information, making all bits of application port A and B into outputs (although only lines PA0 thru PA7 and PB0 are used in this application).

PET TWO-WAY RS-232 and PARALLEL OUTPUT INTERFACE



SADI - The microprocessor based serial and parallel interface for the Commodore PET. SADI allows you to connect your PET to parallel and serial printers, CRT's, modems, acoustic couplers, hard copy terminals and other computers. The serial and parallel ports are independent allowing the PET to communicate with both peripheral devices simultaneously or one at a time. In addition, the RS-232 device can communicate with the parallel device.

- Special Features for the PET interface include:
- Conversion to true ASCII both in and out
 - Cursor controls and function characters specially printed
 - Selectable reversal of upper and lower case
 - PET IEEE connector for daisy chaining
 - Addressable - works with other devices
- Special Features for the serial interface include:
- Baud rate selectable from 75 to 9600
 - Half or full duplex
 - 32 character buffer
 - X-ON, X-OFF automatically sent
 - Selectable carriage return delay
- Special Features for the parallel interface include:
- Data strobe - either polarity
 - Device ready - either polarity
 - Centronics compatible

Complete with power supply, PET IEEE cable, RS-232 connector, parallel port connector and case. Assembled and tested.

SAD1a (110VAC) \$295
SAD1e (230VAC) \$325

Order direct or contact your local computer store.

CONNECTICUT microCOMPUTER, Inc.
150 POCONO ROAD
BROOKFIELD, CONNECTICUT 06804
TEL: (203) 775-9659 TWX: 710-456-0052

VISA AND M/C ACCEPTED - SEND ACCOUNT NUMBER, EXPIRATION DATE AND SIGN ORDER.
ADD \$3 PER ORDER FOR SHIPPING & HANDLING - FOREIGN ORDERS ADD 10% FOR AIR POSTAGE.

SPECIALIZING IN QUALITY MICROCOMPUTER HARDWARE

INDUSTRIAL • EDUCATIONAL • SMALL BUSINESS • PERSONAL

BUILDING BLOCKS FOR MICROCOMPUTER SYSTEMS, CONTROL & TEST EQUIPMENT

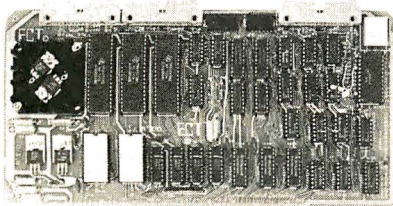

R² I/O
2K ROM
2K RAM
3 Serial Ports
1 Parallel Port
WIRED: \$295.00

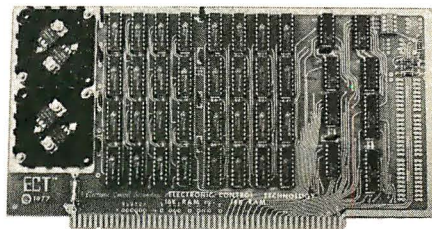

16 K RAM
FULLY STATIC
MEMORY
KIT: \$279.00
WIRED: \$310.00

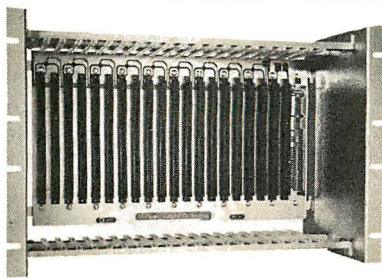

ECT-100-F
RACKMOUNT
CARD CAGES
KIT: \$200.00
WIRED: \$250.00

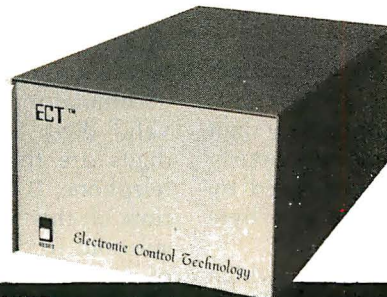

TT-10
TABLE TOP
MAINFRAMES
KIT: \$340.00
WIRED: \$395.00

POWER SUPPLIES, CPU's, MEMORY, OEM VARIATIONS

763 RAMSEY AVE.
HILLSIDE, N.J. 07205

ELECTRONIC CONTROL TECHNOLOGY (201) 686-8080

Location	Contents	Name	Description
00 01	XX XX	INC1F, INC1I	Frequency increment value for current note 1.
02 03	XX XX	PNT1F, PNT1I	Pointer to SINTAB for note 1.
04	03	PAGE1	SINTAB is page 03.
05 06	XX XX	INC2F, INC2I	As above for note 2.
07 08	XX XX	PNT2F, PNT2I	
09	03	PAGE2	SINTAB is page 03.
0A	XX	TEMP0	Temporary storage
0B	XX	TEMP1	Temporary storage
0C	0B	NDIGIT	Maximum number of digits in telephone number

Table 4: Definitions and locations for variables and constants within the DIAL program. There are pointers (PNTxx) and increment values (INCxx) to two frequencies (xxx1x and xxx2x), each of which has a fractional (xxxxF) and an integer (xxxxI) byte. PAGE2 points to the page boundary that contains the beginning of the sine wave table SINTAB. The increment values are valid only if the KIM-1 board is running at 1 MHz.

The entry point labeled ZERO can be called as a subroutine by other parts of the program. It clears out the digits stored in memory by replacing them all with hexadecimal 0F. Then subroutine SHIFT2 (part of subroutine DIGIT) is called to update the display variables (INH, POINTL, POINTH) to show all Fs.

The CMND subroutine examines the keycode and passes control to the correct subroutine to carry out the action required. The CMND routine initially clears the carry flag. If the keycode in the accumulator from the DIAL routine does not match with a valid command code, then the routine will return with the carry flag still cleared.

Otherwise, the keycode is compared with each valid command code. If a match is found, the command is carried out by calling a subroutine. When that subroutine returns, the carry flag is set to 1, and control is returned to the main program, which must examine the carry flag to see if a command was executed. If this is the case, then no further processing of the keycode is required.

The DIGIT subroutine also examines the keycode and appends it to the telephone number if it is a valid digit key. The routine first checks to see if the keycode is within the proper range to be a valid digit (hexadecimal 00 thru 0C). If so, then the new digit is shifted into the string of previously entered digits. This is facilitated by storing the keycode in the next byte beyond the string of old digits.

The KIM display contents, which are held in locations 00F9 (INH, the two rightmost digits of KIM's display), 00FA (POINTL, the next two digits), and 00FB (POINTH, the

two leftmost digits), are also changed to reflect the six most recent digits entered. At the start (or whenever the GO key is pressed), the display shows "FFFFFF", and the memory also contains all hexadecimal 0F bytes to act as a flag that no digit is to be dialed.

Be aware of telephone company restrictions concerning direct connection to the telephone circuits.

The PULSE subroutine is called by the CMND subroutine when the keycode for solenoid dialing of the stored number is processed. It steps through the stored-digit table one digit at a time, passing each digit, through the accumulator, to the CLICK subroutine that pulses the solenoid to dial the digit. As the program is currently set up, the number of digits stored is eleven. This number can be changed by modifying hexadecimal location 000C (NDIGIT) to some number other than hexadecimal 0B (11 decimal). After calling CLICK eleven (NDIGIT) times, control is passed back to the CMND routine.

The CLICK subroutine pulses the output bit that controls the button-pressing solenoid. The keycode in the accumulator is checked to see if it is a valid digit. In this case, the valid digits are those of a standard dial telephone, 0 thru 9. The basic function of this routine is to cause the solenoid to close the correct number of times for the digit which was passed to it. The user must make sure that the length of line interruptions caused by the solenoid actuation and the separation in time between inter-

ruptions is within phone company tolerances; the values given here will work for a KIM-1 running at the standard 1 MHz frequency.

One catch is that a dialed digit 0 is not zero interruptions but ten. The zero must be tested for and the value in the accumulator changed to ten if a match is found. The CLICK routine times the interruption for approximately 35 ms and waits approximately 65 ms between interruptions. Furthermore, after the last click for any digit, the routine delays an additional half second before returning. This is to simulate the pause taken between digits when a person uses a rotary-dial telephone.

Notice that each time I use the timer, I load the initial value twice. This is to avoid improper timer operation that occurs when the timer is loaded just as it times out from the countdown in progress (and it is always counting down). (See Timothy Martin's letter in *KIM-1/6502 User Notes*.)

The operation of the TONES subroutine is similar to that of PULSE. It is called by the CMND routine to count the eleven digits passed to the subroutines SETUP and SOUND, which do the dialing — in this case the sounding of tone pairs. A code for the digit to be dialed is passed to SETUP in the accumulator.

Subroutine SETUP prepares data for use by the tone-generating routine, SOUND. The subroutine checks the accumulator for a valid digit (in this case, anything between hexadecimal 00 and 0F). Only 00 thru 0B actually produce tone pairs, 0C produces a pause, and 0D thru 0F cause an immediate return.

The code in the accumulator is first multiplied by two (via a shift left

**MARKET YOUR HARD-
WARE AND SOFTWARE
PRODUCTS IN THE
RAPIDLY EXPANDING
U.K. AND EUROPEAN
MARKET THROUGH**

**Sun Computing Services
60 Broad Lane
Hampton
Middlesex
London
England**

**Tel: 01 979 9824
TWX: 8954428 SUNCOM G**

LONG ESTABLISHED IN THE COMPUTER INDUSTRY WE GIVE FULL HARDWARE AND SOFTWARE DISTRIBUTOR SUPPORT, NATIONAL ADVERTISING IN ALL RELEVANT PERIODICALS, AND CAREFULLY VET DEALER APPLICATIONS. TWX OR PHONE PAUL DOCKERILL TODAY WITH CONFIDENCE AND OPEN UP A WHOLE NEW MARKET.

**At last...the
Typewriter Interface!**

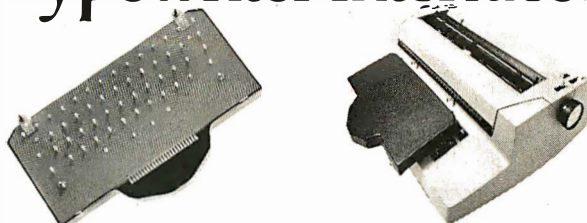

Turn your electric typewriter into a low cost, high quality hard copy printer. 1 Year Warranty

The patented* RDI-I/O Pak is fast becoming the industry standard for typewriter output. Why? Because:

1. It takes 2 minutes to initially install and 5 seconds to remove or replace.
2. You *do not* have to modify your typewriter. All factory warranties and maintenance agreements on your typewriter will be honored.
3. You can use it with *all* powered carriage return typewriters that have U.S. keyboard. Our Model I works with all *non* Selectrics and our Model II works with Selectrics. Conversion between models takes 2 minutes and the kit (26 plungers) is available for a nominal charge.
4. You don't have to lug around a bulky printer when you travel. If there is a typewriter at your destination, you can install the light (3 lbs.) I/O Pak in just 2 minutes.
5. Same interface for TRS-80, Apple and GPIB. Centronics and Pet compatible interfaces are available in third quarter 1980. Electric pencil available.
6. Delivery: stock to 2 weeks. Price: \$639.50, FOB Rochester, Domestic.

See your local distributor or call Bob Giese, 716 385-4336. We have the only "clean" approach to the typewriter/printer market.

*Patent Pending

ROCHESTER DATA

3100 Monroe Avenue, Rochester, New York 14618 incorporated

**Put your computer
in touch with the world.**

**AJ makes it possible for only \$185 with
the A 242 acoustic data coupler.**

Experts call it "the best acoustic coupler ever made." Thousands are in use by major companies all over the U.S. And now the A 242 from AJ, refurbished at the factory, can connect to *your* terminal or personal computer, putting you in touch with every other compatible terminal or computer. If you can telephone the site, you can send or receive data.

The originate-mode A 242 can interface to either EIA or TTY terminals and operates at speeds up to 450 bits per second. At just \$185—about half the original price—it's a tremendous bargain. We're so confident you'll agree, we're offering a 10-day money-back guarantee.*

Call toll-free for details:
(800) 538-9721.
California residents call:
(408) 263-8520.

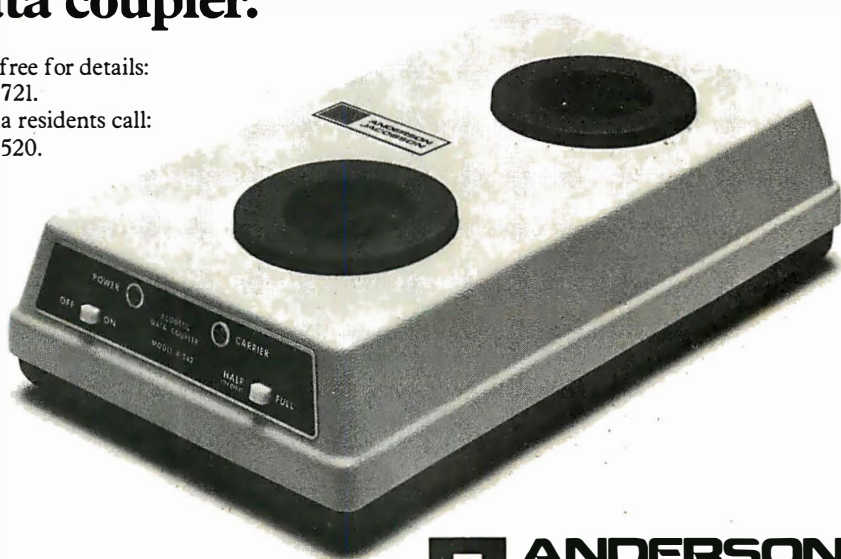

**ANDERSON
JACOBSON**

*Details on request.

Prices subject to change without notice.

(ASL) instruction) and used as an offset from the beginning of data table TONETAB. The reason for multiplying by two is that the table contains value pairs.

Two-tone or frequency-identifier codes are obtained from the table. These two identifiers are each used as indices into another data table, FRQTAB. From this table, we get increment values (both integer and fractional parts) that are used by SOUND to step through the waveform table.

SOUND will produce the dual tones for a fixed length of time. When control returns to SETUP, a delay of

approximately 75 ms is inserted before returning to TONES. The purpose of this delay is to allow the telephone company equipment to distinguish between individual digits.

The purpose of subroutine SOUND is to produce a waveform at the output of the digital-to-analog converter that is the superposition of two sine waves of different frequency. The routine actually computes the composite waveform by adding instantaneous values for two tones.

Data for a single cycle of a pure sine wave is stored in hexadecimal locations 0300 thru 03FF, filling all of

page 03 of memory. A loop in the SOUND routine is repeatedly executed for 150 ms, determined by a value loaded into the interval timer (T1024). It is very important to remember that the loop always takes 63 μ s to execute once. Each time through the loop, a new value of the waveform (the instantaneous voltage out of the digital-to-analog converter) is determined by adding together values from the table for the two frequencies. The waveform values are obtained by using only the integer part of a 2-byte pointer (PNT1I, PNT1F or PNT2I, PNT2F) kept for each tone as an offset into the sine-wave table.

After one instantaneous value has been output to the digital-to-analog converter, the pointers are increased by adding both integer (INCR1I and INCR2I) and fractional (INCR1F and INCR2F) parts of an increment value. The carry out from the fractional addition must be added in with the integer part. If the sum of the integer parts for the pointer goes above 255, the carry is ignored, and the table reference will wrap around to the beginning of page 03. A continuous sine wave will be produced.

Summary

Additional hardware needed to add to a microcomputer for controlling the dialing of numbers with a telephone receiver is minimal. The software shown here is complex, but it has been written in modular form to enhance its usefulness in customized applications. Be aware of telephone company restrictions concerning direct connection to the telephone circuits; do not use any method of connection that destroys the electrical integrity of the telephone system. ■

References

- Chamberlin, H, "A Sampling of Techniques for Computer Performance of Music," BYTE, volume 2, number 9, September 1977, page 62.
- Chamberlin, H, "Advanced Real-Time Music Synthesis Techniques," BYTE, volume 5, number 4, April 1980, page 70.
- Gilder, J H, *Telephone Accessories You Can Build*, Hayden Book Co, Rochelle Park NJ, 1976.
- Luff, P P, "The Electronic Telephone," *Scientific American*, volume 238, number 3, March 1978, page 58.
- Martin, T, Letter in *KIM-1/6502 User Notes*, number 12, page 11.

Future World-Today

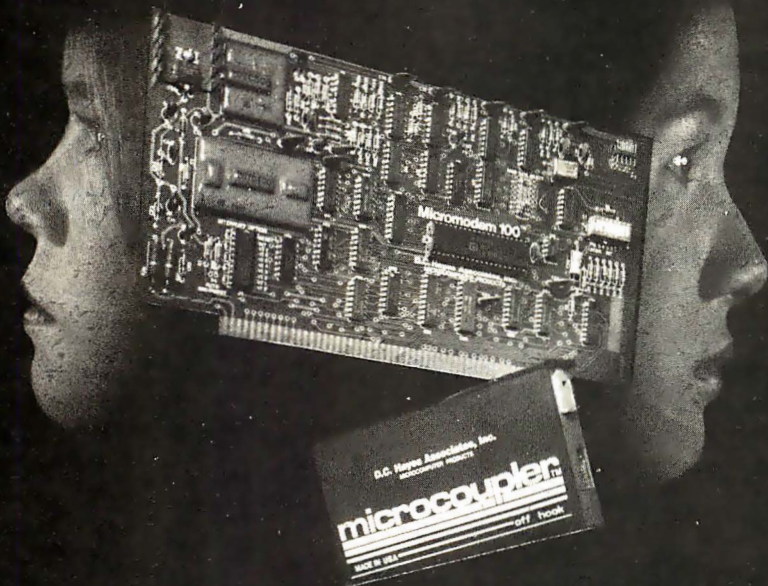

Instant Nationwide Communications

A Micromodem 100 in your S-100 bus adds: Automatic Time Sharing, Nationwide Communications, Remote Data Base Access, TWX Simulation, Branch Office Communications, and much, much more. The D.C. Hayes Associates Micromodem 100 is compatible with 300 baud modems and the proposed IEEE S-100 bus standard. It is built to the highest quality standards and tested with automated equipment to assure reliability. Whether built-in to original equipment, or added on from your local computer store, the Micromodem 100 adds new communications capabilities to every S-100 bus computer.

D.C. Hayes Associates, Inc.
MICROCOMPUTER PRODUCTS

10 Perimeter Park Drive, Atlanta, Georgia 30341 (404) 455-7663

*Registered trademark of Apple Computer, Inc. Micromodem 100 is a trademark of D. C. Hayes Associates, Inc.

NEW FROM LOBO:

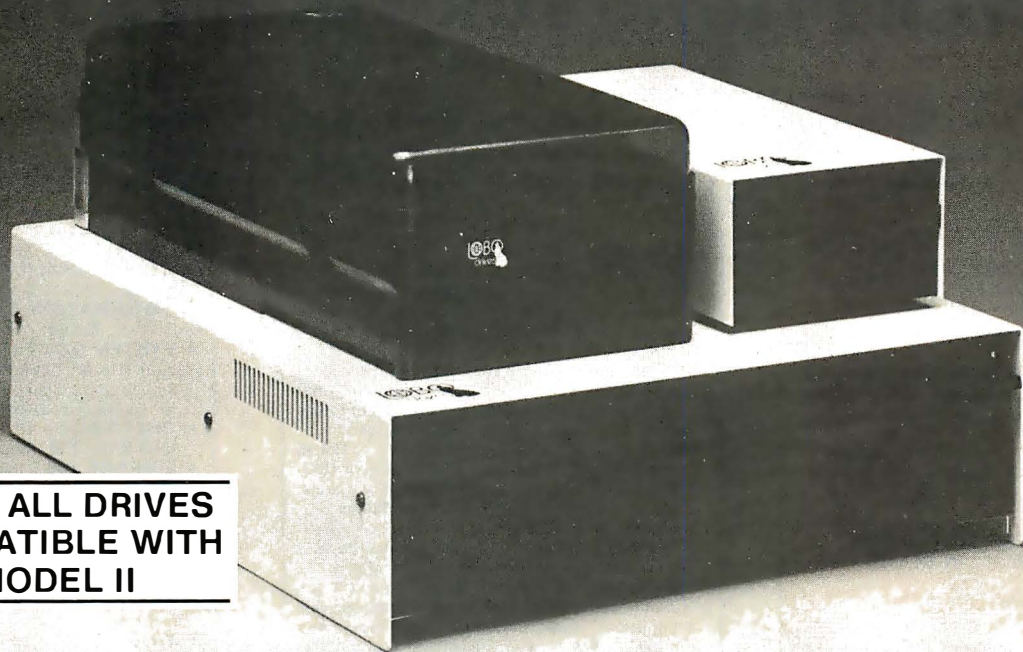

**NOW! ALL DRIVES
COMPATIBLE WITH
MODEL II**

An Entire Family of Disk Drives for APPLE, TRS-80*, and S-100 Computers

Only LOBO DRIVES offers you an entire family of fully-compatible disk drives to select from. Whatever computer you're using, APPLE, TRS-80, or S-100, you can add a LOBO drive now, with the peace-of-mind of knowing there's a whole family of drives available when you're ready to expand.

And every drive you order comes complete with chassis and high reliability power supply. Each drive is 100% calibrated, burned-in, and performance tested on either an APPLE, TRS-80, or S-100 computer before it's shipped. We are so proud of our drives . . . our quality, reliability, and performance, that we back-up every drive with a one year, 100% parts/labor warranty.

400 SERIES FLOPPY DISK DRIVES

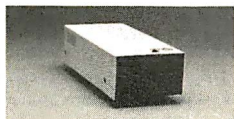

Meet our low-cost 5.25-inch mini drive that records data in either hard or soft sectored format. It is available in single or double

density configurations, with a total storage capacity of 220K bytes.

800/801 SERIES FLOPPY DISK DRIVES

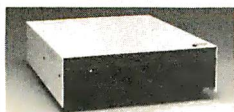

Here is our dual 8-inch Floppy disk memory unit. It records and retrieves data on standard 8-inch diskettes to provide 800K

bytes of data storage unformatted, or 512K bytes

in IBM format per drive. It is also available with double-sided, double-density capabilities, for a maximum storage capacity of 1.6 Megabytes.

7000 SERIES HARD DISK DRIVES

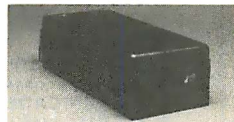

The latest member of our drive family, the Series 7000 is an 8-inch, 10 Mega-byte Winchester Technology, hard disk drive. It is fully

hardware/software compatible and comes complete with disk controller. Now you can have the convenience, speed, reliability, and all the storage capacity you need.

Call or write for the complete LOBO DRIVES story. Find out just how competitively priced a quality drive can be.

Quantity discounts available --
Dealer inquiries invited.

Yes, I want to know more about LOBO Drives and what they can do. Send me information on:

TRS-80 APPLE S-100

5 1/4-in. Floppy drive

8-in. Winchester hard disk, 10 Mbyte drive

8-in. Floppy drive
Single sided
Double sided

Double density expansion interface

Name _____

Company _____

Address _____

City _____ State _____ Zip _____

Phone No. _____

If dealer, provide resale no. _____



935 Camino Del Sur
Goleta, California 93017
(805) 685-4546

"CAN YOU REALLY AFFORD
TOPAYLESS?"

*TRS-80 is a registered trademark of Radio Shack, a Tandy Company.

H & E COMPUTRONICS INC.

...EVERYTHING FOR YOUR TRS-80™...

TRS-80 is a trademark of the Radio Shack Division of Tandy Corporation

★ All Orders processed within 24-Hours

★ Free Shipping within U.P.S. areas (add \$3 for orders outside of the U.S.A. or U.P.S. areas).

★ 30-Day Money Back Guarantee on all Software (less a \$3 penalty for handling).

★ 10-Day Money Back Guarantee on Disk Drives and Printers **PLUS** 120-Days Free Service.

• **LEARNING LEVEL II** by David Lien
The Original Author Of The Level Manual
A Step By Step approach to Learning Level II
especially geared to new TRS-80™ Owners
\$15.95

• **TRS-80 DISK AND OTHER MYSTERIES**
\$19.95 (\$22.95 after 2/1/80). Over 100 pages
of indispensable information for disk owners
Learn to recover information from bad disks,
how to make Basic programs unlistable and 12
more chapters of never published tips and infor-
mation. Written by H.C. Pennington (For all
Disk Owners)

NEW SBSG BUSINESS SYSTEM FOR MODEL I OR MODEL II - IN STOCK

- General Ledger
- Accounts Receivable
- Accounts Payable
- Payroll
- Inventory Control With Invoicing
- Each module can be operated individually
or as a coordinated **SYSTEM**. Turn-Key error
catching operation for beginners
- Complete manual and documentation
accompany each program
- Minimum System requirements 2-Disk
Drives for Model I...1-Disk Drive for Model II
- Each module can be formatted to span data
on Up to 4-Disk Drives
- Free 30-Day telephone consultation
- Call for complete specifications
- Model I Version \$125 per module
\$495 per System
- Model II Version \$225 per module
\$995 per System

DATA MANAGEMENT SYSTEMS

- DMS replace index cards or any data
requiring long lists of information.
- TBS In-Memory Information System
(for cassette systems) \$24.50
- TBS Disk Data Manager (requires 1 or more
disk drives)...Set up fast random access
files in minutes. Stores up to 320K of
information on 4 Drives. Up to 10 fields
and 255 characters per record. Supports
upper and lower case RS-232 or TRS-232...
Features complete editing \$49.50
- Personal Software CCA Data Management
System...Completely user oriented, menu
drive, 130 page Step by Step Manual...
capable of inventory control, sorting data,
reporting data in nearly any form (for reports
and mailing labels). Sorts data by up to 10
fields for zip code, balance due, geographic
location or whatever. Prints reports with
subtotals and totals automatically calculated.
Fast random access \$75.00

FROM RACET COMPUTES

- **REMODEL-PROLOAD** - Renumbers pro-
gram lines, combines programs. The only re-
number program that will renumber the middle
of a program. Specify 16K, 32K or 48K. Works
with Cassette or Disk... **\$34.95**
- **GSF** - Use in your Basic Programs for Instant
Sorting (will sort 1000 items in 9 seconds). Other
commands include Compress and Uncompress
Data, Duplicate Memory, Display Screen
Controls and Fast Graphic Controls... **\$24.95**
(For Cassette or Disk, specify 16K, 32K or 48K)
- **DOSORT** - All G S F. commands plus special
Multiple Disk Sorting Routines... **\$34.95**
(Specify 32K or 48K)
- **INFINITE BASIC** - Adds 70 commands to
your TRS-80 including Instant Sort, Matrix
Commands, String Commands, Left and Right
Justification, String Centering, Simultaneous
Equations, Upper and Lower Case Reverse and
more... **\$49.95** (For Cassette or Disk)
- **INFINITE BUSINESS** (Requires Infinite Basic) -
Eliminate Round-off error. 127-Digit Calculation
Accuracy. Insert New Elements in Sorted
Arrays, Automatic Page Headings, Footings,
and Pagination, Multiple Precision Arithmetic
and more... **\$29.95** (For Cassette or Disk)
- **COPSYS** - Copy Machine Language
Programs... **\$14.95** (For Cassette only)

FROM SMALL SYSTEM SOFTWARE

- **RSM-2** Machine Language Monitor... **\$26.95**
- **RSM-2D** Disk Version of RSM-2... **\$29.95**
- **DCV-1** Converts Machine Language Programs
from tape to disk... **\$9.95**
- **AIR RAID** - The ultimate TRS-80 game con-
verts your TRS-80 into a real time shooting
gallery... **\$14.95**
- **BARRICADE** - A fast pong style game... **\$14.95**
- **CPM** - \$150 (for Disk only)
- **TRS-232 INTERFACE** - Interface with Soft-
ware driver RS-232 printers to your
TRS-80... **\$49.95**
- **TRS-232 FORMATTER** - Additional
(optional) Software for TRS-232 owners. Adds
many printer commands to your
TRS-80... **\$14.95** (\$9.95 with purchase of
TRS-232)

- **MAIL PAC** - For Model I or Model II Disk
Systems only... **\$99.95**. Quick-sorting full user
control over mailing list from Galactic Software.

FROM ADVENTURELAND INTERNATIONAL

- **ADVENTURE #1 - #8** by Scott Adams .
\$14.95 each available on Cassette or Disk

SARGON II
THE CHESS CHAMP
\$29.95

FROM APPARAT
NEW DOS + \$99.95
35, 40 and 77 Track Versions available

FROM THE BOTTOM SHELF

- **CHECKBOOK II** (for Cassette or Disk) . .
\$18.50
- **INFORMATION SYSTEM** (for Cassette or
Disk . . . **\$24.50**
- **SYSTEM DOCTOR** (a complete diagnosis of
your TRS-80 checks memory, video, cassette,
disk, ROM and all other parts of your system) -
for Cassette or Disk . . . **\$28.50**
- **CHECKBOOK REGISTER ACCOUNT-**
ING SYSTEM (requires 2 disk drives) . . **\$49.50**
- **LIBRARY 100** - 100 established business,
game and educational programs plus **FREE** Tiny
Pilot all for . . . **\$49.50**
- **BASIC TOOL KIT** - lists all variables, GOTO's
and GOSUB's in your program . . . **\$19.80**

- **SOUNDWARE** - Adds sound to your TRS-80.
Just plus it in . . . **\$29.95**. Sample programs
included
- **TING TONG** - Can be used with Soundware
for a **Sound** version of pong . . . **\$9.95**.

- **VIC-The Carta Visual Instructional \$19.95**
Computer Program
The Level II 16K Cassette is designed to teach
beginners the Basics of Machine Language and
Assembly Language Programming. See every
Machine Language Instruction Display on
your Video
VIC includes a Step By Step 55 page manual

VISTA V80 DISK DRIVE
110 K OF STORAGE
\$395

Add \$29.95 for Cable
(Free with Purchase of Two Disk Drives)
— 10 Day Money Back Guarantee —

FROM HOWE SOFTWARE

- **MON-3** - Machine Language Programming for
Beginners. **MON-3** is a Complete
System Monitor with Users
Manual . . . **\$39.95**
- **MON-4** - Disk Version of **MON-3** . . . **\$49.95**

LEVEL III BASIC . . . \$49.95 FROM

MICROSOFT - Now Cassette owners can add
Disk Commands to their TRS-80 without owning
a Disk Drive.

- **BRAND NEW OLIVETTI PRINTER** . . . **\$2495**
Business Letter quality print, Automatic Line
Justification (on request), Quick Printing, can
be used as a Memory Typewriter, plugs right
into your TRS-80 without any modification or
software

THE ELECTRIC PENCIL
Cassette . . . **\$99.95**
Disk . . . **\$150.00**

- **HORSE SELECTOR II** by Dr. Hal Davis . . .
\$50. The TRS-80 version updated for the TRS-80
and originally reviewed in Systems and
Methods

COMPUTRONICS
MATHEMATICAL APPLICATIONS SERVICE™

Box 149 New City, New York 10956

48-Page Catalog \$2 **FREE** With Any Order

Order by Phone or Mail

No Shipping Charge

Add \$3 for C.O.D.

Add \$3 for all Foreign and non-UPS shipments

Add \$3 for UPS Blue Label



24
HOUR ORDER LINE
(914) 425-1535



THE ORIGINAL MAGAZINE FOR OWNERS OF THE TRS-80™* MICROCOMPUTER

SOFTWARE FOR TRS-80™ OWNERS

H & E COMPUTRONICS INC.

MONTHLY NEWSMAGAZINE FOR TRS-80™ OWNERS

MONTHLY NEWSMAGAZINE Practical Support For Model I & II

- PRACTICAL APPLICATIONS
- BUSINESS
- GAMBLING • GAMES
- EDUCATION
- PERSONAL FINANCE
- BEGINNER'S CORNER
- NEW PRODUCTS
- SOFTWARE EXCHANGE
- MARKET PLACE
- QUESTIONS AND ANSWERS
- PROGRAM PRINTOUTS
- AND MORE

PROGRAMS AND ARTICLES PUBLISHED IN OUR FIRST 12 ISSUES INCLUDE THE FOLLOWING:

- A COMPLETE INCOME TAX PROGRAM (LONG AND SHORT FORM)
- INVENTORY CONTROL
- STOCK MARKET ANALYSIS
- WORD PROCESSING PROGRAM (FOR DISK OR CASSETTE)
- LOWER CASE MODIFICATION FOR YOUR VIDEO MONITOR OR PRINTER
- PAYROLL (FEDERAL TAX WITHHOLDING PROGRAM)
- EXTEND 16-DIGIT ACCURACY TO TRS-80™ FUNCTIONS (SUCH AS SQUARE ROOTS AND TRIGONOMETRIC FUNCTIONS)
- NEW DISK DRIVES FOR YOUR TRS-80™
- PRINTER OPTIONS AVAILABLE FOR YOUR TRS-80™
- A HORSE SELECTION SYSTEM***ARITHMETIC TEACHER
- COMPLETE MAILING LIST PROGRAMS (BOTH FOR DISK OR CASSETTE SEQUENTIAL AND RANDOM ACCESS)
- RANDOM SAMPLING***BAR GRAPH
- CHECKBOOK MAINTENANCE PROGRAM
- LEVEL II UPDATES***LEVEL II INDEX
- CREDIT CARD INFORMATION STORAGE FILE
- BEGINNER'S GUIDE TO MACHINE LANGUAGE AND ASSEMBLY LANGUAGE
- LINE RENUMBERING
- AND CASSETTE TIPS, PROGRAM HINTS, LATEST PRODUCTS COMING SOON (GENERAL LEDGER, ACCOUNTS PAYABLE AND RECEIVABLE, FORTRAN-80, FINANCIAL APPLICATIONS PACKAGE, PROGRAMS FOR HOMEOWNERS, MERGE TWO PROGRAMS, STATISTICAL AND MATHEMATICAL PROGRAMS (BOTH ELEMENTARY AND ADVANCED) ... AND

WORD PROCESSING PROGRAM (Cassette or Disk)

For writing letters, text, mailing lists, etc., with each new subscriptions or renewal.

LEVEL II RAM TEST (Cassette or Disk)

Checks random access memory to ensure that all memory locations are working properly.

DATA MANAGEMENT SYSTEM (Cassette or Disk)

Complete file management for your TRS-80™

CLEANUP (Cassette or Disk)

Fast action Maze Game.

* TRS-80™ IS A TRADEMARK OF TANDY CORP

FREE
↳

FREE
↳

SEND FOR OUR NEW 48 PAGE SOFTWARE CATALOG (INCLUDING LISTINGS OF HUNDREDS OF TRS-80™ PROGRAMS AVAILABLE ON CASSETTE AND DISKETTE). \$2.00 OR FREE WITH EACH SUBSCRIPTIONS OR SAMPLE ISSUE.

COMPUTRONICS INC.

MATHEMATICAL APPLICATIONS SERVICE™

Box 149 New City, New York 10956

ONE YEAR SUBSCRIPTION \$24

TWO YEAR SUBSCRIPTION \$48

SAMPLE OF LATEST ISSUE \$ 4

START MY SUBSCRIPTION WITH ISSUE

(#1 - July 1978 • #7 - January 1979 • #12 - June 1979 • #18 - January 1980)

NEW SUBSCRIPTION RENEWAL



24 HOUR ORDER LINE
(914) 425-1535



CREDIT CARD NUMBER _____ EXP. DATE _____

SIGNATURE _____

NAME _____

ADDRESS _____ STATE _____ ZIP _____

*** ADD \$6/YEAR (CANADA, MEXICO) - ADD \$12/YEAR AIR MAIL - OUTSIDE OF U.S.A., CANADA & MEXICO ***

BYTE LINES

NEWS AND SPECULATION ABOUT PERSONAL COMPUTING

Conducted by Sol Libes

New IBM Micro-computer. More On The Way? IBM is not sitting by idly in the microcomputer revolution. It has introduced a new desktop computer, the model 5120, which sells for \$13,500 and features 16 K bytes of programmable memory and either BASIC or APL in read-only memory. But *Electronics* magazine, a McGraw-Hill publication, recently reported the prediction of a \$4500 IBM computer. The IBM 5105 microcomputer was predicted by Creative Strategies Inc of San Jose, California, an industry analysis firm. The 5105 will be made in Japan, and it will be designed to interface with the S-100 bus. Creative Strategies predicts that the desktop machine will have, among other features, at least 16 K bytes of programmable memory, a high-speed magnetic tape cartridge for mass storage, and a small thermal printer. They also predict the introduction of the 5130, a multiterminal version of the 5105 machine.

Smalltalk For Microcomputers: Rosetta Inc, a company located in Houston, Texas, has been working for the past year on an original interactive language called "Rosetta Smalltalk." The language, inspired by but not connected with Xerox Corporation's Smalltalk language, can be expanded to include

new features and has been designed to run on a Z80 system. For evaluation purposes, Rosetta Inc is privately offering a prototype version of the language to several selected owners of Z80-based systems.

IMSAI Back In Business: IMSAI is back in operation as the IMSAI Computer Division of Fischer-Freitas Corporation. IMSAI declared bankruptcy last summer. Its manufactured stock, trademarks, software, etc, were purchased by Fischer-Freitas. The company is now selling the complete line of IMSAI products and will continue to support all IMSAI hardware and software products.

Will Your Copilot Be A Computer? A research project at the University of Illinois, Urbana-Champaign, is working on an experimental computer system that will determine the correct procedures for airplane pilots to follow in unexpected situations. The system will monitor the flight plan and airframe stress; it will also adjust control settings in response to changing environmental conditions, detect malfunctions, and predict failures. Thus the computer will apply its data, analyze the problem, compute the solution, warn the pilot, and

provide instructions through a synthesized voice. The pilot will be able to request assistance from the computer via voice input. The research group expects to have an operational model within three years.

Zenith To Produce Home Computer: Zenith Radio Corporation is the first television manufacturer to plunge into the home-computer market. Actually, Zenith entered this market in a limited way last year with the acquisition of Heath and the formation of Zenith Data Systems. Zenith now plans to produce an under-\$1000 home computer on its color television production line. The unit will compete with the Radio Shack TRS-80 and other computers.

National Introduces New 16-Bit Micro-processors: National Semiconductor will soon be shipping samples of its 16-bit microprocessors. There is the 16008, a 16-bit microprocessor with 8-bit input/output (I/O), the 16016 microprocessor with 16-bit I/O, and the 16032 16-bit microprocessor with 24-bit memory addressing (8 megabytes). Furthermore, the 16008 and 16016 are "bilingual" (ie: they execute two instruction sets, their own and the 8080's instruction set).

IBM Testing Josephson-Junction-Based Computer: IBM's Research Division is currently testing a prototype computer that uses 4000 circuits employing Josephson-junction logic devices. These devices operate in the 35 to 40 picosecond range. This project could lead to a tiny computer (1 or 2 cubic inches) with a projected cycle time of 2.5 ns. This is eighty times faster than IBM's System 370/168.

Josephson-junction technology uses the phenomenon of superconductivity occurring at temperatures near absolute zero (0° K). In a Josephson-junction device, a magnetic field is used to turn the electron flow on or off. This technology provides a big leap forward in miniaturization and will result in reduced costs.

Video Cassette To Be Used For Winchester Backup: Pixel Corporation of Burlington, Massachusetts, plans to manufacture 500-megabyte data-storage systems that use video-cassette recorders (VCRs).

Corvus Systems Inc of San Jose, California, a maker of Winchester hard-disk drives, is presently field-testing an interface to its disk controller that enables it to be attached to a consumer VCR. Corvus claims a data-storage capacity of 100 megabytes for the system. Corvus

Advance Your H8® into the 80's

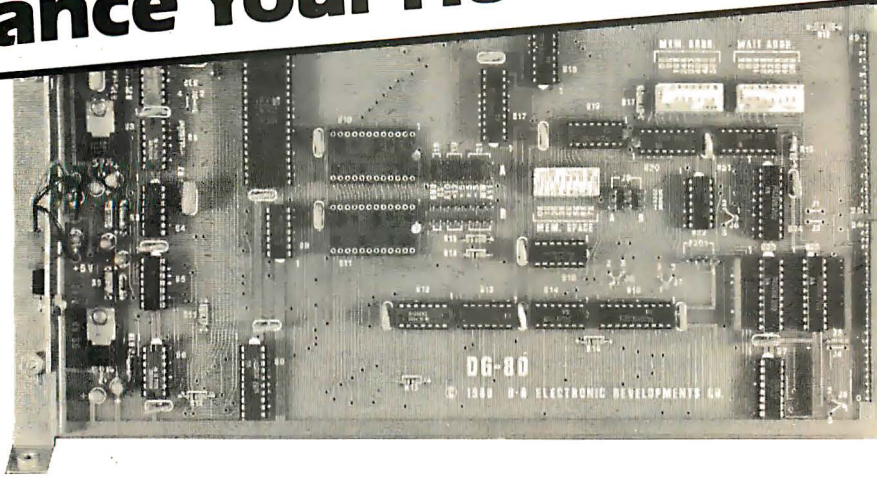

Introducing the **DG-80 Z80 CPU!**

Hardware Features:

- ✓ Compatible with Heath H8® hardware and software and DG-32D*
- ✓ Z80 CPU Enhanced Instruction Set
- ✓ Operational at 2 MHz or 4 MHz
- ✓ Jump on Reset to any 1K boundary
- ✓ On board provisions for up to 8K PROM and/or 4K RAM
- ✓ Wait States available for any or all 8K Memory blocks for 4 MHz operation using slow memory
- ✓ Interrupt acknowledge (INTA) and dynamic RAM refresh signals (RFS) available on bus
- ✓ Au-gold machined sockets for PROM and RAM
- ✓ Many advanced features are included to enable future expansion and flexibility
- ✓ Frequently selected options are switch selectable.

The **Z80 CPU** has finally arrived for the H8®. All the features you have wanted with power to spare. The **DG-80** is packed with feature after feature that allows you expansion and versatility options to do almost anything. The **DG-80**, using the powerful Z80 microprocessor, upgrades the H8® to levels never before possible. The full complement of advanced features available on the Z80 microprocessor are available on the **DG-80 CPU** for those who wish to utilize the full potential of their system. The **DG-80** is fully compatible with all Heath H8® hardware and software. * The **DG-80** is assembled, tested, and ready to plug-in. (Heath® ROM must be installed prior to use.) Complete documentation includes the Mostek® Z80 programming manual and is supplied with each board.

DG-80 CPU... \$249 (Documentation only: \$25.)

* Not all advanced features compatible with H8® (hardware and/or software)

SPECIAL INTRODUCTORY OFFER!



OUR POPULAR DG-32D

Dynamic RAM Board

(fully populated only) Regularly \$479.00

OUR POWERFUL NEW DG-80 CPU

..... Regularly \$249.00

Regularly Total ~~\$728.00~~

NOW through June, 1980, both for only **\$625.00**



16K CHIP SETS (8-4116 Type Dynamic RAMS) for DG-32D, Apple®, TRS-80®, H88/89® and PET® (Tested) **\$64.00**

(Programming jumpers available at additional cost)

32K/DG-32D **\$479.00**

HALF POPULATED 16K/DG-32D **\$415.00**

DOCUMENTATION ONLY (DG-32D) **\$12.00**

Heath, H8, TRS-80, Apple, Mostek and Pet are Registered Trademarks.

D·G ELECTRONIC DEVELOPMENTS CO.

Ordering Information: Products listed available from DG Electronic Developments Co., P.O. Box 1124, 1827 South Armstrong, Denison, Tx. 75020. Check, Money Order, VISA or Master Charge accepted. Phone orders (charge only) call (214) 465-7805. No COD's. Freight prepaid. Allow 3 weeks for personal checks to clear. Texas residents add 5%. Foreign orders add 30%.

expects to sell its interface controller for \$790. Added to the cost of \$1000 to \$1500 for the video recorder, this gives a total cost of \$1800 to \$2300 for the disk backup system.

Development of video recorders proceeds apace. BASF, the German maker of floppy-disk drives and media, recently established the BASF Video Corporation in Fountain Valley, California. BASF Video will soon produce a consumer video-cassette recorder. BASF showed a 72-track recorder at a recent electronic show. The unit stores 94.6 megabytes using a longitudinal-scan method, rather than the more common helical-scan technique. The longitudinal method is preferable for random-access applications. Some Japanese manufacturers may introduce low-cost longitudinal-scan video recorders that can be used for data storage.

In comparison with competing data-storage techniques, the VCR-based systems provide a good price/performance ratio. For instance, the 3M 1/2-inch cartridge tape drive with controller stores 75 megabytes of data at a list price of \$21,150.

8-Inch Winchester Disk Standard Being Developed:

An American National Standards Institute (ANSI) committee is nearing adoption of a standard interface for the 8-inch Winchester fixed-disk drives. Such a standard would hasten acceptance of such drives by original-equipment manufacturers (OEMs), and large-scale integration (LSI) chips would be quickly developed to carry out the standard. The interface should support concurrent device operations, unidirectional data pass, nonreturn-to-zero (NRZ) data transmission, and should be able to handle variable data rates up to 10 megabytes/second

over cables up to 8 meters in length. Cost will also be considered. Final adoption of the standard should be reached in mid-1980.

UCSD Pascal News: The University of California, San Diego (UCSD) has arbitrarily revoked licenses to distribute UCSD Pascal. These licenses were previously granted to and paid for by a number of computer clubs. The clubs had paid \$250 for the license and they, in turn, had allowed club members to copy the software package at costs ranging from \$5 to \$50. A user now must pay \$250 to obtain a copy of the UCSD package....A newsletter for UCSD Pascal users is being published by Jim McCord, 330 Vereda, Legenda CA 93017. Send Jim \$2 to get on the mailing list. The first issue of the newsletter was 9 pages long and full of information....An international Pascal Users Group (PUG) has been formed. To join, send \$6 to PUG, c/o Dick Shaw, Digital Equipment Corporation, 5775 Peachtree Dunwoody Rd, Atlanta GA 30342. Your effort will get you an occasional newsletter that is several hundred pages long....

Economic Woes Of The Personal-Computer Industry:

The current rocketing interest rates on business loans are said to be cutting profits and curtailing the growth of personal-computer manufacturers, distributors, and dealers. Some smaller businesses may collapse, while throughout the field decreasing inventories are prolonging customer waiting time. In some instances, finance charges and interest rates run as high as 24 to 30 percent, when money is available. Retail stores are finding it difficult to finance small-business systems, and distribution of new pro-

ducts is curtailed. ComputerLand Corporation of San Leandro, California, reports that potential store owners are having trouble buying franchises.

Motorola Introduces 32-Bit Microcomputer Bus:

Motorola has introduced a new microcomputer-development system with address and data buses that are 32 bits wide. The system can support 8-bit, 16-bit, and the forthcoming 32-bit microprocessors. (Most experts feel, however, that 32-bit microprocessors are still about five years away from production.) Called the "Versabus," it allows direct addressing of up to four billion words of memory. Motorola has published a specification for the bus, which can be obtained by contacting the Motorola engineering offices.

Memory News: Intel Corporation has announced a new 16 K-by-1-bit metal-oxide semiconductor (MOS) static programmable memory with a 40 ns access time. Known as the 2167, it will draw about 500 mW from a single +5 V supply and will be transistor-transistor-logic (TTL) compatible on all pins. The estimated date of availability has not been set; however, it will probably be the final quarter of 1980....Several manufacturers are in the initial production phases of 64-K bit dynamic memory devices. Included are Texas Instruments and Motorola.

256 K-Byte Programmable-Memory Devices Announced: Nippon Telephone and Telegraph and NEC-Toshiba have announced that 256 K-byte programmable-memory devices are under development by the two companies.

The devices have been constructed in prototype form, and speculation is that production is still a couple of years away.

This announcement has great significance because it is one indication that leadership in the high-density, integrated circuit technology has passed from the US to Japan.

Bell Laboratories Licenses UNIX For Microcomputer Systems: Bell Laboratories, via the AT&T Western Electric Company subsidiary, has licensed Onyx Systems Inc of Cupertino, California, for implementation of UNIX on a Z8000-based microcomputer system. The system will be introduced this month.

Random Rumors And News Bits: Several toy manufacturers are working on electronic toys with voice output for the Christmas season. However, most manufacturers are reluctant to divulge any details. But you can expect the rage of Christmas 1980 to be talking toys....Radio Shack is very secretive about the sales volume of the TRS-80 computers. But one top executive recently revealed that, as of March 1, 1980, Radio Shack had manufactured 370,000 TRS-80s. That means that since 1979 Radio Shack has been producing 600 to 700 TRS-80s per day....Contrary to predictions, 8-inch Winchester disks are meeting with resistance from potential purchasers. Most OEMs are adopting a "wait and see" attitude. One problem is that backup storage for the nonremovable disks that have a capacity of greater than 10 megabytes is still lacking. Furthermore, the prices for the larger 14-inch drives are very competitive with the larger 8-inch drives. The greatest demand for hard 8-inch

ANNOUNCING AN APPLE II® COMPATIBLE
SYNTHESIZER THAT PRODUCES
MUSIC
plus
SOUND EFFECTS

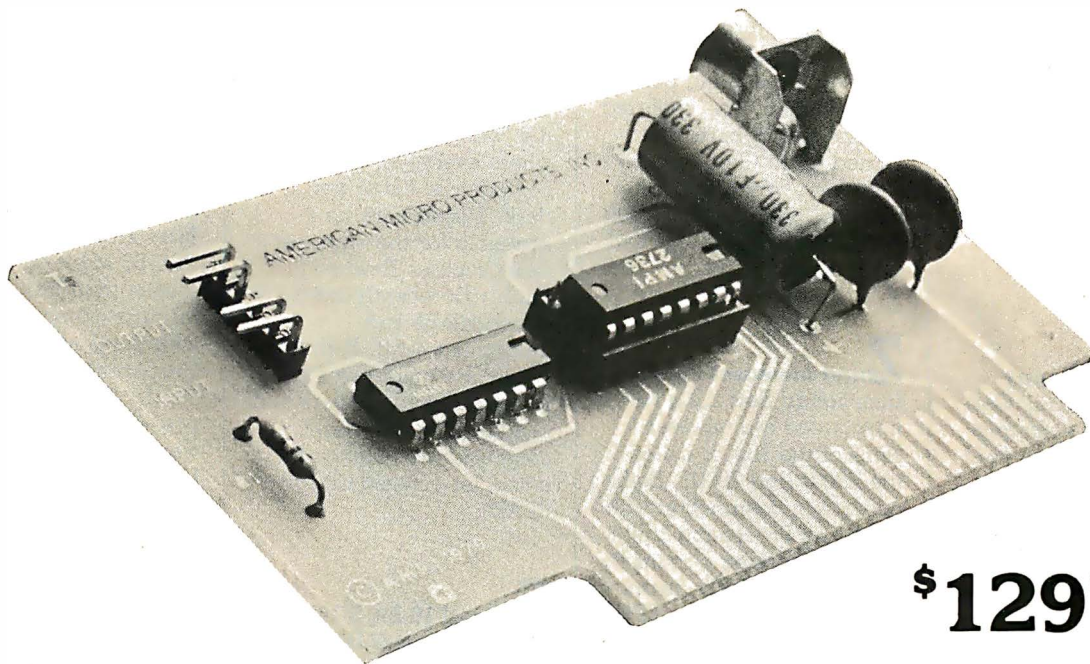

\$ 129⁹⁵

HARDWARE FEATURES of the Juke Box Synthesizer

- Three simultaneous programmable voices and one programmable white noise generator
- Five octave range starting at 55 Hz (the A below bass clef) to 1760 Hz (the second A above the treble clef)
- On board amplifier capable of directly driving an eight ohm speaker. (no external amp needed)
- Up to six synthesizers can be installed to create stereophonic, quadraphonic, and polyphonic operation

SOFTWARE FEATURES of the KIS Music Editor

- Three part interactive program consisting of a play mode, a composition mode and an edit mode
- Play mode displays low resolution color graphics of each voice while the song is playing
- Composition mode enables the user to hear and see, in high resolution graphics, each note as it's input
- Edit mode sounds and displays, in high resolution graphics, each note as the user single steps through the song
- Notes can be inserted, deleted and changed

SOFTWARE FEATURES of the Sound Effects Program

- Uses the channel of white noise to create a vast array of sounds. Some of these are as follows: explosions, steam engine, whistle, phasers, gun shots, race cars, sirens, chimes and jet engines
- Modular so that any one sound can easily be patched into an existing program
- Detailed instructions illustrate how to generate unusual sounds

AVAILABILITY

- All Juke Box synthesizers are shipped with the KIS Music Editor and are available at most computer stores for \$129.95
- The Flash & Crash sound effects program is available separately for \$39.95

*Apple II is the registered trademark of Apple Computer Co.



705 N. Bowser
Richardson, Texas 75080
(214) 238-1815

disks is expected to be for drives with a capacity of less than 10 megabytes....Initial sales reports for the Texas Instruments (TI) 99/4 personal computer indicate a "ho-hum" response to the unit. Sales have not been up to expectations. TI will start shipping the unit without a color monitor (as is done with the Apple and Atari computers) and will reduce the price to \$950 in an effort to improve the lagging sales....Diablo printer and service prices are due to be raised by 8.5 percent this month. Labor and material costs were cited as reasons for the increases.

Tandy Signs Floppy-Disk Supplier: Tandy Corporation (parent company of Radio Shack) has signed an agreement with Data-point Corporation for the latter to manufacture 8-inch and 5-inch floppy-disk drives. Radio Shack currently purchases drives from Shugart, Control Data, and Tandem Magnetics.

Robot Hand Developed: The Research Institute of Industrial Safety of the Japanese Ministry of Labor has announced development of a manipulator that operates like a human hand. It has 12 degrees of freedom, three joints, and can apply 10 newtons of force. It uses the Winslow-effect clutch, which is based on an instantaneous, reversible, and substantial change in apparent viscosity when a fluid is subjected to an external electric field.

Integrated Circuit Black Market Emerges: Apparently a black market exists for integrated circuits. Intel Corporation reported in January that 10,000 unmarked

integrated circuits, mostly type-2732 erasable programmable read-only memories (EPROMs) valued at one million dollars, were stolen. One black-market dealer has already been arrested for illegal possession of integrated circuits manufactured by Intel, Signetics, and National Semiconductor. All the devices were cosmetic rejects. Two former Intel employees have been arrested for stealing parts. Last summer, Intel reported a large loss of parts that turned up in Germany. In February, Wang Laboratories disclosed that \$750,000 worth of Intel EPROMs had been stolen.

Zilog Increases Z8000 Instruction Set: Zilog has introduced two new versions of the Z8000, called the Z8001 and Z8002. Both operate in conjunction with Extended Processing Unit (EPU) integrated circuits to expand the Z8000's instruction set. One or more EPUs may be added to a system; the EPU uses previously undefined op codes to provide floating-point arithmetic, data-base search and maintenance operations, network interfaces, and graphics-support operations. This is a concept similar to Intel's 8087 mathematical coprocessor for the 8086. The standard Z8000 will not operate with the EPU. Six instructions have been added to the Z8001/2 to allow these versions to work with the EPU.

Machine-Independent Language Offered: Systems Consultants Inc of San Diego, California, has introduced what they describe as the first universal high-level compiler language for microcomputers. Called PLMX, the language system contains a library of compiled programs, an I/O interface, and code generator. PLMX syntax is identical to that of

Intel's PL/M language. Currently versions of PLMX are available for TEKDOS (Tektronix) and CP/M operating systems. Code can be generated for 8080, 8085, Z80, 6800, TMS 9900, and CDP 1802 systems. A single license for PLMX costs \$1000.

Office Of The Future To Include Personal Computers: Computer manufacturers are working hard on the "office of the future" where everyone will have a computer at his or her desk. Systems are now available for the engineer's desk, such as Hewlett-Packard's recently introduced HP-85 and Tektronix's 4050. Both computers are chiefly designed for electrical engineers and can function as a desktop computer work-station for computer-assisted design (CAD).

Several 16-Bit S-100 Microcomputers Debut: Several manufacturers have announced 16-bit processor boards for S-100 systems. I know of the following so far: Ithaca Intersystems and National Multiplex Corporation are introducing boards that use the Z8000; Ackerman Digital Systems, the 68000; Godbout Electronics, a dual-processor board using the 8085A and 8088 (which is a 16-bit 8086 with 8-bit input/output); DigiComp Research Corporation, a dual-processor system (two boards) with Z80 and Pascal Microengine.

Videotext Test To Be Conducted in Ohio: OCLC Inc, which furnishes on-line catalog services to more than 2000 libraries in the US and Canada, will conduct a three-month test in Columbus, Ohio, of a home videotext system starting in October. The potential user will need a \$500 terminal

that attaches to a television set and holds information in an amount equivalent to ten full television screens, down-loaded from a central data base. Applications will include banking services, community information, catalog listings, and encyclopedia data. Users will be able to pay bills, transfer funds, and obtain financial data. The goal is to ultimately provide the terminal for less than \$100 with a typical \$10 monthly service fee.

More Random News Bits: You can now lease the TRS-80 Model II computer system from Radio Shack, through an arrangement with the A and A Financial Corporation. The leases run for thirty-six months, preceded by a ninety-day warranty period....Percom Data Corporation has secured a contract with Texas Instruments to supply floppy-disk drives.

CORRECTION: The April BYTE News column contained an item reporting that Motorola was shipping samples of an erasable programmable read-only memory (EPROM) part that is organized as "8 K by 8 bytes." The EPROMs are really organized as 8 K by 8 bits. [We apologize for this error....RSS]

MAIL: I receive a large number of letters each month, as a result of this column. If you wish a response, please include a stamped, self-addressed envelope.

**Sol Libes
Amateur Computer
Group of New Jersey
(ACG-NJ)
1776 Raritan Rd
Scotch Plains NJ 07076**

"THE ORIGINAL"

Personal Computing[®] 80

Presents: Personal Computing and Small Business Computer Show

The Largest Personal Computing Show in 1980

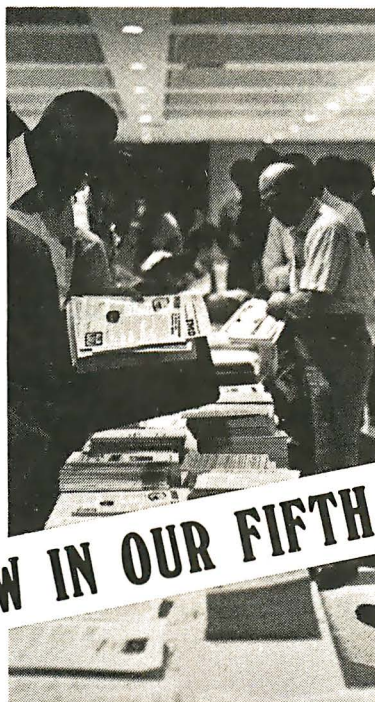
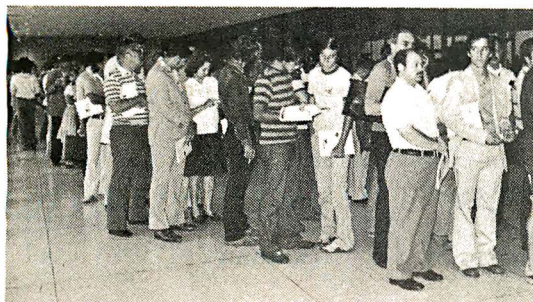

August 21, 22, 23, 24th at the Philadelphia Civic Center

- Major exhibits by the industries leading companies
- Thursday, Aug. 21st, Dealer Day — 12 Noon to 6 P.M.
- Friday and Saturday, Aug. 22, 23rd — 9 A.M. to 6 P.M.
- Sunday, Aug. 24th — 10 A.M. to 5 P.M.
- Free Seminars ● Robotics Contest ● Antique Computer Display
- Special Seminars and Tutorials about Computer Music, Saturday, Aug. 23rd
- 3rd Annual Computer Music Festival, Saturday Evening, Aug. 23rd
(Computer Music Festival is sponsored by the Philadelphia Area Computer Society-Tickets on sale at show)
- Computer Visual Arts Festival, Sunday, Aug. 24th

Advanced Registration Saves Time & Money

Send _____ Dealer-Retailer (4 days) Registrations at \$10. each, \$12. at door for Thursday-Sunday, Aug. 21, 22, 23, 24

Send _____ Regular Registrations (3 days) at \$8. each, \$10. at door for Friday-Sunday, Aug. 22, 23, 24 only.

Advanced Registrations will be mailed late July - early August. No Advanced Registrations accepted after Aug. 8th.

Send Exhibitor information or Phone 609-653-1188

COMPANY NAME _____

NAME _____

STREET _____

CITY _____ STATE _____ ZIP _____

PHONE _____

Send To:

PERSONAL COMPUTING 80

Rt. 1, Box 242, Warf Rd., ● Mays Landing, NJ 08330

DO IT

University Software gives you



these programs were designed to work right — the first time — on your machine.

What's more, they're programs you can use. The Small Business text contains programs to help you look at interest rates every possible way, a materials inventory program, a touch typing course and a small business accounting system. But that's only the beginning. Among the Education and Scientific programs, you'll find a speed reading course, a President's quiz, a math education program, and programs to help you learn English and build your vocabulary. The two vol-

Canned Programs are Only a Beginning. Pre-programmed disks and cassettes are a terrific way to get started in micros. But they're just a start. The best thing about owning a computer is programming it. Yourself.

University Software makes it easy. Using compact, easy-to-understand Microsoft BASIC, *University Software* has selected the best work of scores of different authors to create this spiral-bound, five-volume set of the programs you most want to have. All you have to do is sit down at the keyboard and enter them.

Software for People. The problem with BASIC as a language is that it was developed on timeshare and other large capacity computers. But Microsoft BASIC was specifically designed to run on micros; it's fast, it's simple, and memory requirements are minimal.

All the programs in the *University Software* set were written on micros, for micros. If you own a TRS-80, Apple, Texas Instruments, Atari, Commodore PET, Sorcerer, or Ohio Scientific micro,



A University Software Sampler

Here is a small sample of the programs you'll get in each of the five University Software volumes.

HOME & ECONOMICS—\$24.95

Text Editor: Compose and correct your notes, letters, invoices.

Utilities: Electric, water, phone, gas and trash bills control.

Temperature Conversion: Lets you convert different temperature units.

Eternal Calendar: Returns the day of the week for a given date.

Recipes Book: Sets up recipes on cassette tape.

Checking Account: Checkbook analysis. ... **Plus 9 more!**

Battlestar Galactica: You have to reach Earth passing many Cylon stations. ... **Plus 17 more!**

EDUCATION & SCIENTIFIC—\$34.95

Astronomical Computations: Compute the positions of the planets; draw orbits.

Pythagorean Theorem: Review geometry theorems.

Word Search: Spelling puzzle.

Quantum Chemistry: Compute quantum numbers of an atom.

Program Manager: Load and run multiple programs. ... **Plus 21 more!**

FUN & GAMES Volume I—\$14.95

Space Race: You command Federation Trading Ships in the Asteroid Belt.

Mastermind: Players attempt to figure out one another's combinations.

Combat: Battle game employing numbered board on screen.

Biorhythm: Physical, emotional and intellectual patterns.

Merchant of Venus: Make money in outer space. ... **Plus 10 more!**

SMALL BUSINESS—\$49.95

Mortgage Analysis: Outputs loan tables.

Distributions Mapping: Maintains library of distribution functions.

Billing System: Creates and manages data base containing bills.

Investment Management: Analysis of stocks, funds, debentures, real estate.

Small Business Accounting: Posts income and expenses, prints trial balance; chart of accounts.

Tax: Federal Income and F.I.C.A. taxes. ... **Plus 22 more!**

FUN & GAMES Volume II—\$14.95

Blackjack: The famous card game.

World War III: War game.

Bridge: Deals four hands on screen.

Act now for your FREE BOOK

You can order each of these volumes separately NOW through Folio Books. But if you call today and order the entire set, we'll include *Microsoft BASIC*, a standard introductory guide to the use of the language by Ken Knecht absolutely FREE.

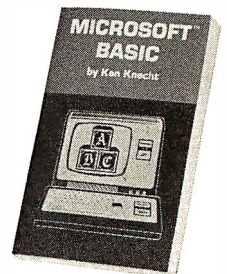

Offer expires June 30, 1980

YOURSELF.

105 Microsoft programs. For less than a buck and a half apiece.

umes of Fun & Games programs offer a total of 35 games and graphics to challenge every level of skill. Finally, the Home & Economics text contains the programs you need to help you manage your life more efficiently—an appointments calendar, metric conversions, and programs to help you balance your checking account and budget the family income.

Do Your Pocketbook a Favor. It's this simple: if you input your own programs, you save money. Lots of money. Preprogrammed cassettes and disks nowadays cost anywhere from \$10 to upwards of \$50. And if the program you want is not available in a format for your computer, you're just flat out of luck.

If you buy the entire set of *University Software* programs, on the other hand, you get 105 programs for \$139.75—about \$1.33 each. Plus, there's a conversion appendix in the back of *each* volume to help you convert any Microsoft BASIC program written on one computer to run on yours.

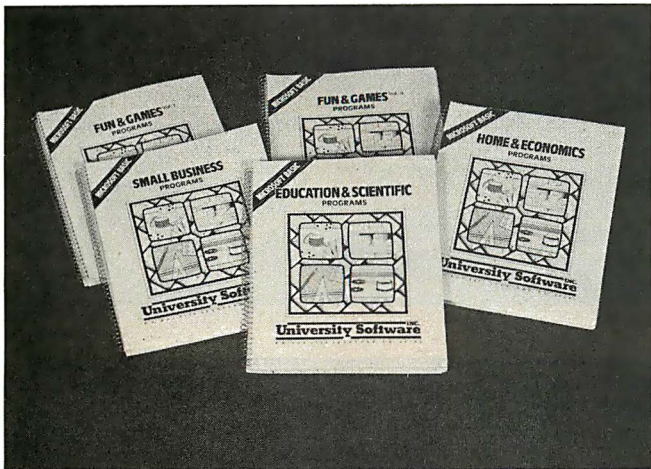

Do Yourself a Favor. To really master and understand your computer, you can't be content to sit back and let *it* do all the work. You've got to roll up your sleeves and accept the challenge to your own creativity. *University Software* programs will help you run your life. And they'll help you grow.

You can order any of the *University Software* volumes separately, but if you *act now* and order the entire set, we'll include Ken Knecht's *Microsoft BASIC*, a complete introduction and tutorial book on programming in Microsoft BASIC, **FREE!** It's yours—a \$10 value—just for ordering the whole *University Software* set at one time.



We'll jump right on your order. There's only one place you can get the entire *University Software* set shipped directly to you almost as soon as you call: Folio Books. We are specialists in computer books for micro and mini computers, and honestly believe that *University Software* is the finest set of application Microsoft programs available to the general public.

Call us today. Do it for yourself.

ORDERING INFORMATION: Call toll-free (800) 423-4864, M-F 9-5 p.m. Pacific Time. Mail order: include name, address and telephone. M/C and Visa customers include: your name as it appears on your card, card number, expiration date. All orders add \$1.00 per volume for shipping and handling. California residents add 6% sales tax. We ship UPS or Parcel Post. Introductory offer: order 3 or more volumes and receive a 10% discount; order all 5 and we also pay shipping anywhere in U.S.A.

(800) 423-4864

In California call collect: (213) 795-5224

University Software is available from

Folio Books

P.O. Box 4100-H, Los Angeles, California 90041

University Software Also Available at Leading Computer Stores Everywhere.

BYTE's Bugs

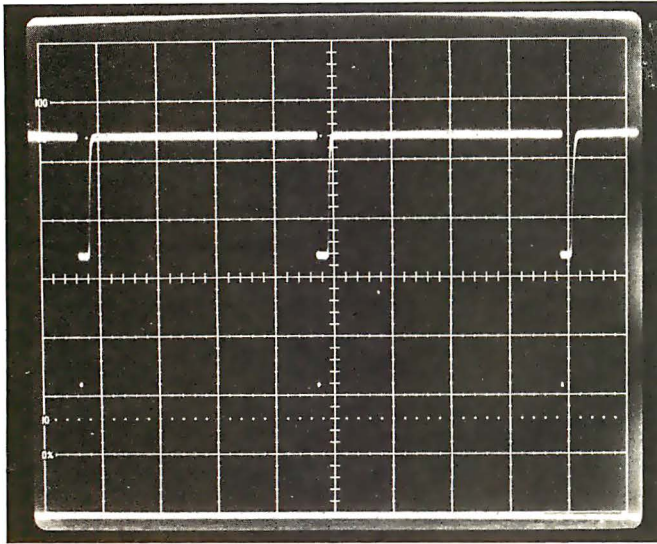

a

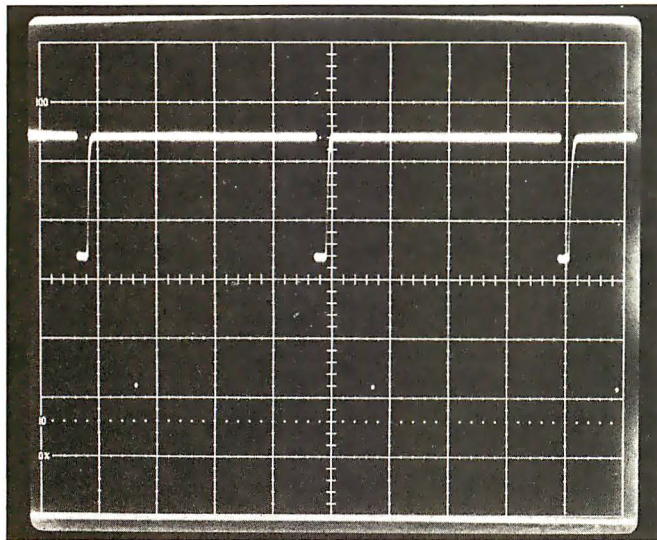
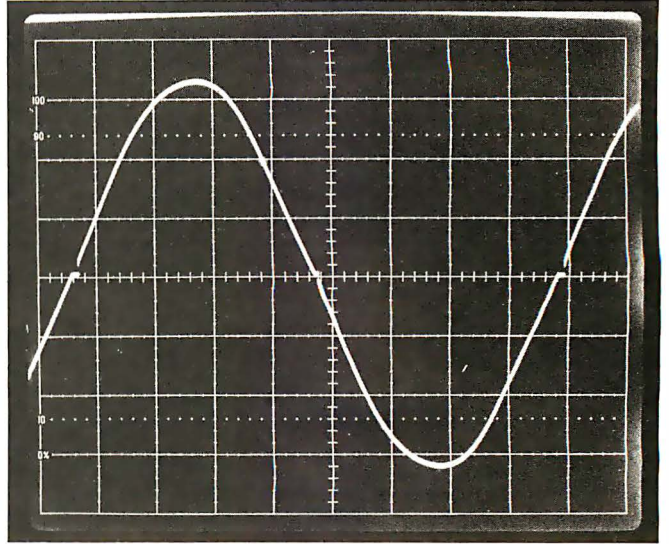

b

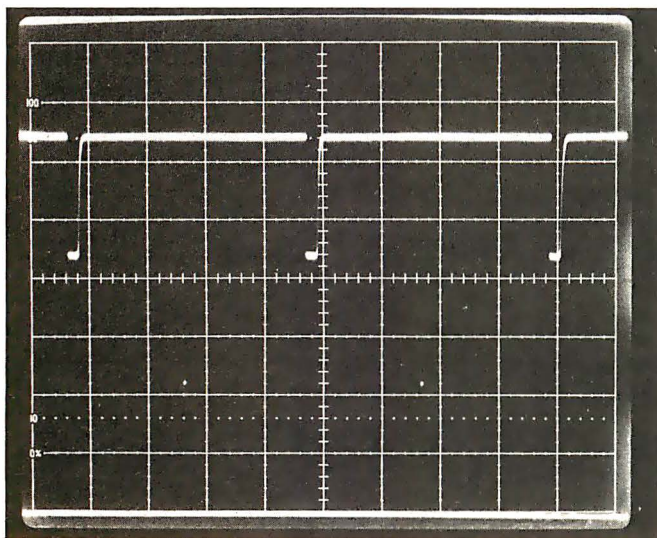
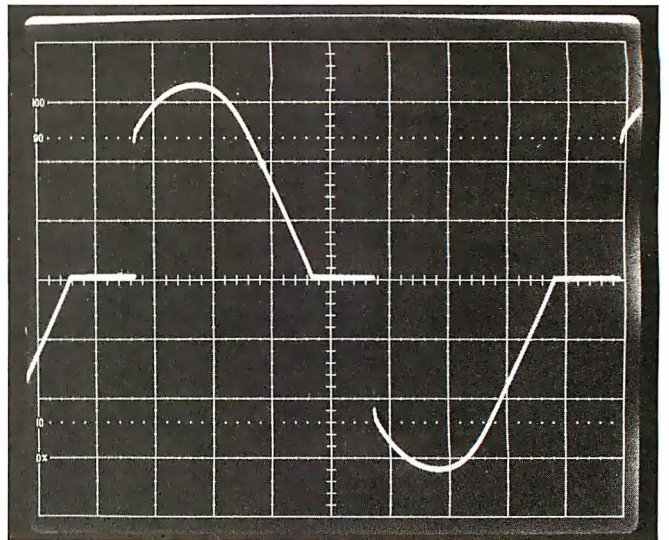

c

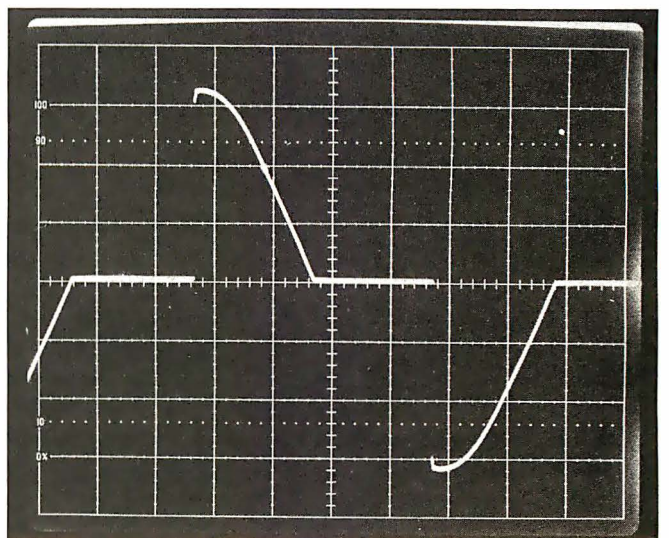

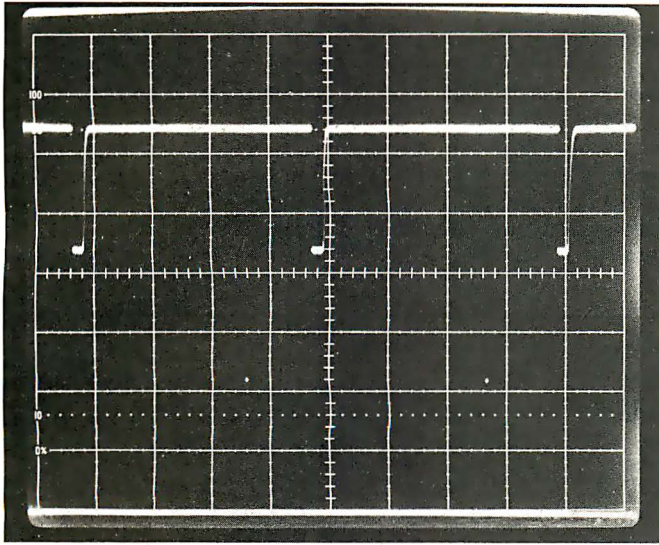

d

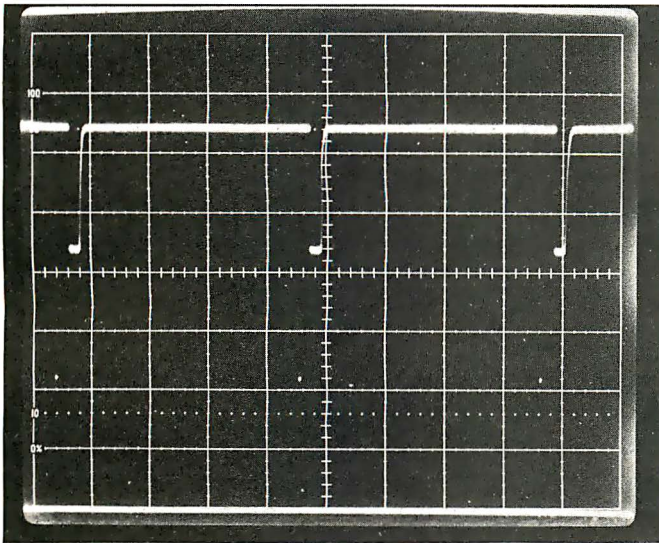
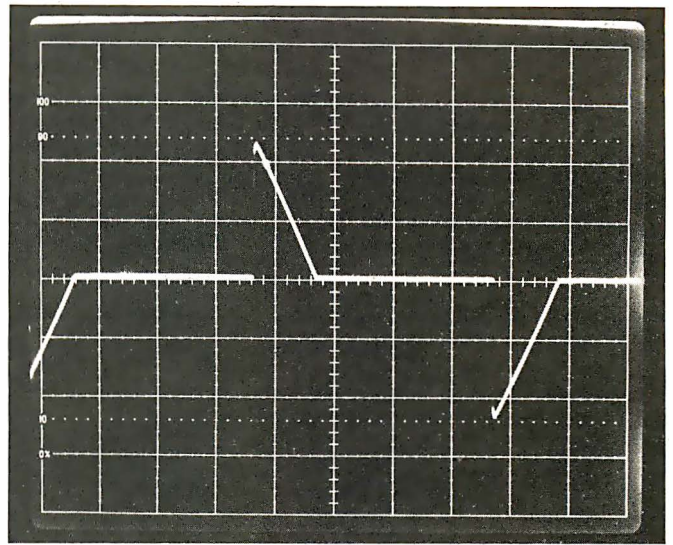

e

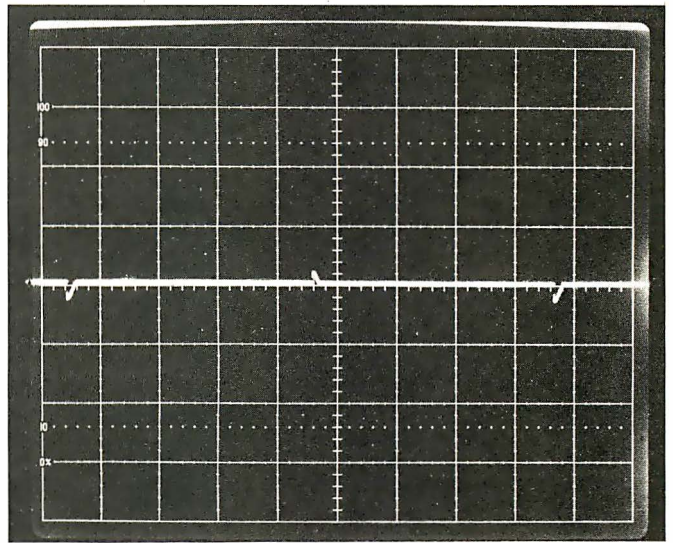

Taking a Dim View of Photographs

A series of photos in the article "A Computer-Controlled Light Dimmer, Part 1: Design," by John H Gibson (January 1980 BYTE, pages 56 thru 72) was in-

advertently printed upside down. The series of pictures found in photo 2 on page 66 were inverted. The oscilloscope traces in the top row that appear to be positive pulses are in fact *negative* pulses from the timing-reference syn-

chronizer. The positive output pulses at the bottom from the timer, mentioned in the photo caption, did not reproduce sufficiently well in print to be seen. The sections of sine curves in the bottom row of photos were also upside down, and

therefore were meant to indicate opposite polarities from those implied.

To correct this error, we now present the series of photos here in the correct orientation, as they should have appeared in the January BYTE.

Bugs in the Data Cartridge

Gremlins struck the BYTE editorial department recently during the preparation of the article "Hewlett-Packard's New Personal Computer, The HP-85" (March 1980 BYTE, page 60). At the bottom of the left-hand column of page 62, the storage capacity of the data cartridge for the HP-85 should have been given as 780 program records con-

sisting of 256 bytes each for a *total* of 192 K bytes, or 850 data records of 256 bytes each for a *total* of 210 K bytes. In addition, the procedure for printing the information on the screen is to simply press the COPY key. Our thanks to Jerry Fisher of Hewlett-Packard for pointing out these errors.

Dropping Balloons Reliably

I thoroughly enjoyed the

balloon game in the article "Writing Animated Computer Games," by Tony Estep (November 1979 BYTE, page 152). I do not have a Sol computer, so I had to make a few patches to the program. I also added a drop counter, which may interest other readers.

The game as published drops balloons unreliably. To make the balloons drop consistently, change the code at hexadecimal location 01F6 to

```
CA 26 02 JZ BALN
```

The FINAL SCORE message is not centered. Change the code at location 04DE to

```
21 98 CD
LXI H, VDMBAS + 410
```

to center the message.

Many video terminals can clear the screen after receiving a form-feed character (hexadecimal 0C). If this works on your terminal, you can change the code at

locations 0103 and at 0126
to
CD F0 06 CALL CLSNFF
and add the code as follows
06F0 0E 0C MVI C, 0CH
06F2 CD 09 F0 CALL

06F5 C9 RET VIDEO
RET
The game as published
allows an unlimited number
of balloons to be dropped.
While this is interesting, in a
way, it can lead the player
to engage in real block-

bombardment, dropping
balloons without aiming at
anything below. I have add-
ed a limit to the number of
balloons available and a
counter to tell how many
balloons are left, to
discourage waste of valuable
resources. I have found that

thirty-five balloons is a fair
number. The code to pro-
vide this feature is shown in
listing 1.

Olli Urrila
SF-44800
Pihtipudas
FINLAND ■

Address	Object Code	Label	Mnemonics	Commentary	
0291	C3 10 06		JMP TITLE	Jump to add more titling	
0610	CD 64 05	TITLE	CALL PRINT	Send the previous message	
0613	21 19 CD		LXI H, VDMBAS + 119H	Load new message destination	
0616	11 63 06		LXI D, MSG	Load start address	
0619	CD 64 05		CALL PRINT	Send it	
061C	C3 94 02		JMP INI	JUMP back	
0497	CD 20 06		CALL BALLS	Prepare to send "balloons left" message	
0620	CD AB 04	BALLS	CALL SCOUT	Send the previous message	
0623	21 1A CC		LXI H, VDMBAS + 1AH	Load new message address	
0626	11 72 06		LXI D, MSG	Load start address	
0629	CD 64 05		CALL PRINT	Send it	
062C	C9		RET		
062D	00 00 00		NOP; NOP; NOP		
0137	CD 30 06		CALL INIT	Initialize balloon counter	
0630	E5	INIT	PUSH H		
0631	21 7D 06		LXI H, COUNTB	Counter, 'tens' address	
0634	36 33		MVI M, 033H	Put decimal 3 to tens counter	
0636	23		INX H	Move to units counter	
0637	36 35		MVI M, 035H	Put decimal 5 to units counter	
0639	E1		POP H		
063A	C9		RET		
01F6	CA 40 06		JZ DROP	Call counter if a drop was made	
0640	21 7E 06	DROP	LXI H, COUNTL	Load units counter	
0643	35		DCR M	Decrease by one	
0644	3E 2F		MVI A, 02FH	First 'digit' below 030H	
0646	BE		CMP M	Is counter below zero?	
0647	C2 26 02		JNZ BALN	If not, go back to game	
064A	36 39		MVI M, 039H	If yes, replace it with decimal 9	
064C	2D		DCR L	Move to tens counter	
064D	35		DCR M	Decrease by one	
064E	3E 2F		MVI A, 2FH		
0650	BE		CMP M	Is tens counter below zero?	
0651	CA 57 06		JZ WASTE	If yes, go to end game	
0654	C3 26 02		JMP BALN	Else go back to game	
0657	21 8E CC	WASTE	LXI H, VDMBAS + 8EH	Load message destination	
065A	11 80 06		LXI D, MSG	Load message start address	
065D	CD 64 05		CALL PRINT	Send message	
0660	C3 DE 04		JMP OVER	Jump to game over	
0663	2A 2A 20 33				
0667	35 20 42 41			35 BALLS (balloons)	
066B	4C 4C 53 20				
066F	2A 2A 00				
0672	42 41 4C 4C				
0676	53 20 4C 45			BALLS LEFT . .	
067A	46 54 20 20				
067E	20 00				
0680	2A 2A 20 59				
0684	4F 55 20 48				
0688	41 56 45 20			YOU HAVE WASTED	
068C	57 41 53 54				
0690	45 44 20 41			ALL YOUR BALLS!	
0694	4C 4C 20 59				
0698	4F 55 52 20				
069C	42 41 4C 4C				
06A0	53 20 21 20				
06A4	2A 2A 00				
TITLE	0610	BALLS	0620	INIT	0630
DROP	0640	WASTE	0657	COUNTB	067D
COUNTL	067E				

One small word about computers.

Osborne

The Leader In Microcomputer Books

The 8089 I/O Processor Handbook,
by Adam Osborne

Intel is developing the co-processor concept; the 8089 is the first of the Intel co-processors. **The 8089 I/O Processor Handbook** provides a fully detailed description of this innovative device, its operation, and use in 8086 systems. This Osborne Handbook contains complete discussions of pins, signals, timing, the instruction set, and programming and configuration guidelines. Also describes the 8289 Bus Arbiter.

#39-X \$5.95

The 8086 Book

by Russell Rector and George Alexy

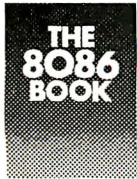

A handbook for all 8086 microcomputer users, it includes 8086 programming instruction, a thorough analysis of the 8086 instruction set, and detailed hardware

and interfacing guides which reveal the full power of the 8086 multiprocessing capabilities.

#29-2 \$15.00

Z8000 Assembly Language Programming

by Lance Leventhal et al.

The first in this popular series of books to have the combined authorship of Dr. Leventhal, Dr. Adam Osborne, and Charles Collins. The Z8000 processor instruction set is described in detail, and the discussion of assembly language programming techniques makes the book an invaluable teaching tool, programming manual, and Z8000 reference book.

Available July. #36-5 \$12.50

An Introduction to Microcomputers: Vol. 1, Basic Concepts, 2nd Ed.

by Adam Osborne

Since this book first appeared in 1976, more than 200,000 copies in four different languages have been sold, making it the best selling book on microprocessors ever written. Now it has been completely revised to reflect changes in this dynamic field. Basic Concepts, 2nd edition contains the most current information on microprocessor fundamentals to be found in any publication.

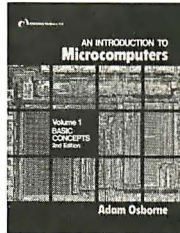

#34-9 \$12.50

6809 Assembly Language Programming

by Lance Leventhal

Another book in the popular series of assembly language programming texts, this for the powerful 6809 processor. In a comprehensive style and format, Dr. Leventhal describes the 6809 instruction set, provides numerous sample programs, and discusses the merits of assembly language programming techniques.

Available this fall. #35-7 \$12.50

PET Personal Computer Guide

by Carroll Donahue and Janice Enger

For all users of the Commodore PET, this step-by-step guide offers advice on operating and equipment maintenance, how to cope with PET peculiarities and make the most of PET graphics. It gives instruction on PET programming techniques along with a complete PET BASIC command reference.

#30-6 \$15.00

PET and the IEEE 488 Bus (GPIB)

by Eugene Fisher and C. William Jensen

The only complete reference available on interfacing the Commodore PET computer to any I/O device using the IEEE 488 interfacing port.

It includes a list of the available IEEE 488 Bus-compatible instruments.

#31-4 \$15.00

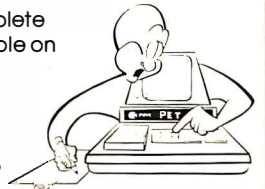

Practical BASIC Programs

edited by Lon Poole

A collection of 40 BASIC programs for office and home use. Programs include Home Budgeting, Critical Path Method, and Income Averaging.

#38-1 \$15.00

NEW and Upcoming Titles



To order, return coupon with check or money order. Include 75¢ per item for 4th class mail, \$1.25 per book UPS, or \$2.50 per book air mail in the U.S.

California residents also include local sales tax. To place an order by phone call 415/548-2805.

Notify me when available: Z8000 ALP
 6809 ALP

 **OSBORNE/McGraw-Hill**

630 Bancroft Way Dept. B5
Berkeley, CA 94710

Book	Price	Quantity	Amount

Name _____ Tax

Address _____ Shipping

City _____ State _____ ZIP _____

Phone _____ HOW TO SHIP _____ TOTAL

FREE CATALOGS

Software (over 400 programs for Apple, Pet, TRS-80, Sorcerer, Sol, Challenger and CP/M systems)

Books (over 100 titles on personal, recreational and educational applications of small computers.)

Peripherals (ALF music synthesizer and VersaWriter for the Apple II)

Peripherals Plus

119 Maple Avenue
Morristown, NJ 07960

Circle 281 on inquiry card.

779 UPPERCASE/lowercase "CONVERSION KIT I"

Expand the capabilities of your 779 line printer to include WORD PROCESSING! Service Technologies is now offering our new "Conversion Kit I" for the TRS 80/ Centronics 779 line printer. This is a full 96 ASCII UPPERCASE/lower case character set with the option of changing slash zero to a standard zero, if you desire.

The "Conversion Kit I" comes complete with easy to follow instructions, no etch cuts or soldering is needed. *Installation can be achieved in minutes with a screwdriver.* No program modification or additional interface is required. The "Conversion Kit I" can be removed in a matter of seconds should any warranty repairs on your printer be required.

Price \$125.00

To order please send Check or Money Order to



Service Technologies, Inc.

32 Nightingale Road
Nashua, N.H. 03062

*Visa and Master Charge accepted. Service Technologies will pay all shipping and handling.
*Charge orders please include expiration date, signature, and phone number.

Inquiries and Phone Orders Welcome (603) 883-5369

Circle 282 on inquiry card.

STATIC RAM CHIPS

FACTORY PRIME From the same shipment we use in our professional quality boards.

2114L 450 ns. \$5.90 200 ns. \$6.90
4044 450 ns. \$5.90 250 ns. \$6.90
Add \$5.00 Handling on Orders Under \$200.00

32K STATIC RAM BOARD

FOR THE SS50 AND SS50C BUS (SWTP etc.)

- SS50C Extended Addressing (can be disabled).
- 4 separate 8K blocks.
- Low power 2114L RAMS
- Socketed for 32K
- Write Protect
- Gold Bus Connectors

16K \$328.12
24K \$438.14
32K \$548.15

Phone, write, or see your dealer for details and prices on our broad range of Boards and Systems for the SS50/SS50C bus including our UNIQUE 80x24 VIDEO BOARD, and our AC Power Control Products for all computers.

GIMIX inc.

1337 W. 37th Place • Chicago, IL 60609
(312) 927-5510 • TWX 910-221-4055

The Company that delivers.
Quality Electronic products since 1975.
GIMIX® and GHOST® are Registered Trademarks of GIMIX INC.

Circle 59 on inquiry card.

BYTE's Bits

Bills Introduced in Congress

The Congress of the United States is beginning to take notice of personal computers. Two bills dealing with personal computers have been introduced in the House of Representatives. We believe that many of our readers will be interested in these bills, so we are printing the text of the bills here.

One bill, HR 3822, was introduced by the Honorable Thomas J Downey, Representative from New York. This bill would establish a National Center for Personal Computers in Education.

The other bill, HR 4326, was introduced by the Honorable James H Scheuer, also a Representative from New York. HR 4326, which is less directly concerned with personal computers, would establish a National Commission on the Scientific and Technological Implications of Information Technology in Education.

Presently both bills are sitting in committees. HR 3822 was sent to the Subcommittee on Elementary, Secondary, and Vocational Education of the Committee on Education and Labor. Both the committee and subcommittee are chaired by the Honorable Carl D Perkins of Kentucky. As of mid-March 1980, hearings have not been held nor any other action taken.

HR 4326 was referred jointly to the Committee on Education and Labor and to the Committee on Science and Technology. The Committee on Education and Labor has not referred HR 4326 to a subcommittee. However, the bill has been referred by the Committee on Science and Technology to the Subcommittee on Science, Research, and Technology, which is chaired by the Honorable George E Brown Jr from

California. A hearing on HR 4326 was held for one day, on October 9, 1979. No further action has been taken.

H.R. 3822

96th CONGRESS
1st Session

To amend title III of the Elementary and Secondary Education Act of 1965 to establish a National Center for Personal Computers in Education.

IN THE HOUSE OF
REPRESENTATIVES
MAY 1, 1979

Mr. Downey introduced the following bill; which was referred to the Committee on Education and Labor

A BILL

To amend title III of the Elementary and Secondary Education Act of 1965 to establish a National Center for Personal Computers in Education.

Be it enacted by the Senate and House of Representatives of the United States of America in Congress assembled, That title III of the Elementary and Secondary Education Act of 1965 (20 U.S.C. 2941 et seq.) is amended by adding at the end thereof the following new part:

"Part N—Computers in Education

"Program Authorized

"Sec. 393. (a) The Commissioner shall award grants to one applicant for the establishment and operation of a National Center for Personal Computers in Education (hereinafter in this part referred to as the 'Center') to instruct students in the use of personal computers and to develop programs designed to utilize personal computers and microcomputers as educational tools at all educational levels. The Center shall be operated during the fiscal years ending September 30, 1980,

September 30, 1981, and September 30, 1982.

"(b) The responsibilities of the Center shall be to—

"(1) identify sources of courseware materials and provide information about such materials to interested parties;

"(2) develop courseware materials for use in areas in which available courseware materials are inadequate;

"(3) identify and develop curriculum materials for instructing students at all educational levels in the uses of computers;

"(4) provide special teacher training and demonstration computer systems to schools at all educational levels that have a large proportion of minority students;

"(5) develop methods for enabling handicapped individuals to use computers for communication and educational purposes;

"(6) conduct programs demonstrating the various educational uses of computers which shall include, but not be limited to—

"(A) the provision of computers in the classroom for student use which may include as many as one computer per four students,

"(B) the establishment of a laboratory that uses computers to simulate live experiments, and

"(C) the establishment of a computer library that would allow students to borrow personal computers for use outside the classroom;

"(7) assess the relative quality and merits of commercially available microcomputers and disseminate such assessments to educators;

"(8) monitor new developments in educational technology, including microcomputers and video disk systems, and disseminate information about such developments to educators;

"(9) develop teacher training materials, including computer programs, films, slides, pamphlets, and audio and video cassettes, that will—

"(A) instruct educators about personal computers and their uses to enable them to determine the amount of financial resources and personnel to commit to the use of computers in their educational system,

"(B) instruct educators in the methods of using computers to enhance the learning experiences of their students in the classroom, in laboratories, and at home, and

"(C) instruct teachers in computer programming and in the development of courseware materials;

"(10) establish a demonstration laboratory to exhibit examples of personal computer systems and courseware materials to enable educators to personally observe the operation of such computers and courseware materials;

"(11) publish a periodic newsletter to disseminate information on computers, computer training programs, and courseware materials;

"(12) assist Congress and interested Federal agencies in developing a program for establishing Regional Centers for Personal Computers in Education, that shall include, but not be limited to, appropriate goals and designs for such centers;

"(13) solicit from subscribers to the newsletter established under paragraph (11) of this section information concerning their computer education needs;

"(14) assist Congress and Federal agencies in identifying areas in which Federal funding will accelerate the educational impact of emerging computer technologies;

"(15) undertake any studies requested by Congress or Federal agencies relating to educational uses of computer technology;

"(16) establish a mechanism to inform the computer industry of the computer needs of the Nation's educational system and to receive from the computer industry information concerning recent developments in computers;

The Working Analyst.



If you would like to put a computer to work collecting, organizing, and summarizing the information you need to make better decisions, take a look at Analyst.

Analyst is a software package designed to let you store and analyze virtually any information involving numbers, dollars, dates, and descriptions. Simply tell Analyst what kind of information

you want to store. Analyst creates a computerized file for that information. And Analyst creates an information entry program for your file that asks you for each entry, and checks your data for errors. (You can create any number of different files.)

Then tell Analyst what reports you want from your data file. There are all sorts of record selection and report formatting options, so you can design an unlimited variety of reports to focus on different aspects of the same data file.

Analyst is so flexible, you'll find a million ways to use it. It is easy to use, so you don't need to be a programmer to make your computer really work for you. If this bit of information intrigues you, find out the rest. You'll like what you see.

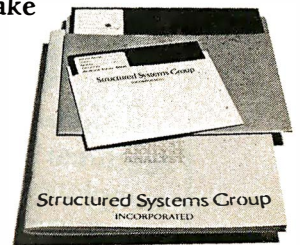

Analyst is a part of a full line of working software solutions from Structured Systems Group, all ready to run on any CP/M[®] microcomputer system. For more information, see your computer retailer, or call us.

[®]CP/M is a trademark of Digital Research.

Circle 125 on inquiry card.

Structured Systems

5204 Claremont Oakland, Ca. 94618 (415) 547-1567

June 1980 © BYTE Publications Inc 187

"(17) monitor developments in the area of intercommunication among users of personal computers and devise means of utilizing intercommunication to inform educators of the potential uses of personal computers;

"(18) assist interested local libraries in establishing programs to provide personal computers and video disk systems to the public; and

"(19) establish a model Community Personal Computer Center in one local shopping mall which shall—

"(A) provide a site for field trips by groups of local students,

"(B) provide demonstrations of the educational uses of personal computers to patrons of the mall,

"(C) conduct courses for community residents on the operation of personal computers, and

"(D) provide com-

puter programs and books, magazines, and other information about computers on loan to the public.

"APPLICATION

"Sec. 394. The grants provided under section 393 of this title shall be awarded to one applicant from among those who have submitted an application to the Commissioner. Each application for such grants shall be submitted at such time, in such form, and containing such information as the Commissioner shall prescribe by regulation. An application shall not be approved unless it—

"(1) provides that the Center will be administered by, or under the supervision of, the applicant;

"(2) provides for the performance of the responsibilities described in section 393(b) of this title;

"(3) sets forth policies and procedures that will insure adequate evaluation of the performance of the

Center;

"(4) provides for such fiscal control and fund accounting procedures as may be necessary to assure proper disbursement of and accounting for Federal funds paid to the applicant under this part; and

"(5) provides for making an annual report and such other reports in such form and containing such information as the Commissioner may reasonably require and for keeping such records and affording such access thereto as the Commissioner may find necessary to assure the correctness and verification of such reports.

"REPORT

"Sec. 395. The recipient of the grants provided under this part shall transmit a final report to the President not later than January 1, 1983. The final report shall contain a detailed statement of the activities of the Center and the recommen-

dations of the recipient for using personal computers to improve the educational system of the United States.

"DEFINITIONS

"Sec. 396. For purposes of this part—

"(1) the term 'courseware materials' means educational materials for use with personal computers and includes, but is not limited to, computer programs and student-teacher workbooks that provide—

"(A) simulated laboratory experiences in the natural and social sciences,

"(B) discovery learning in mathematics,

"(C) drill and practice in communications, mathematics, and science,

"(D) educational games that provide learning experiences, and

"(E) materials to develop problem-solving skills in mathematics and science;

"(2) the term 'microcomputer' means a digital computer constructed primarily of microelectronic components;

"(3) the term 'personal computer' means a microcomputer that is portable, costs less than \$2,000, and needs only an electrical outlet for use; and

"(4) the term 'computer' means a microcomputer or a personal computer.

"AUTHORIZATION OF APPROPRIATIONS

"Sec. 397. There is authorized to be appropriated to carry out the provisions of this part \$750,000 for the fiscal year 1980, \$1,250,000 for the fiscal year 1981, and \$2,000,000 for the fiscal year 1982."

H.R. 4326

96th CONGRESS
1st Session

To establish a national commission to study the scientific and technological implications of information technology in education.

IN THE HOUSE OF REPRESENTATIVES

What is it?...



It is InterThink, Inc.

It offers Osborne/McGraw-Hill accounting packages ready to slip into your CP/M-SOROC with CBASIC machine.

Features: fully initialized files • sample company data • turnkey complete documentation • step by step instruction by example • BASIC and INT programs

The Osborne/McGraw-Hill accounting programs are excellent but their disks are far from a turnkey package. Our implementation of the package for CP/M systems with SOROC terminals is complete with sample data which leads you through step by step use of the programs. Order one of the books and we'll send free step by step implementation instructions.

Programs on 8" disks including books:
Accounts Receivable\$145.00
Accounts Payable\$145.00
Payroll with Cost Accounting\$195.00

CP/M is a registered trademark of Digital Research
SOROC is a registered trademark of Soroc
Technology, Inc.
CBASIC is a registered trademark of Software Systems

General Ledger\$195.00
All four for\$550.00
Books: \$20 each: (A/R & A/P) are one book

InterThink Inc.
3301 N.W. 82nd Ave. Miami, Fla. 33122
(305) 591-8767
(800) 327-3374

```

REM MERGE SORT USING LINK () FOR INDEX
FUNCTION MERGE (I,J=INTEGER)=INTEGER
VAR T,KM,M=INTEGER
IF ARRAY (I) < ARRAY (J) THEN
BEGIN
M=I
I=J
J=M
END
T=J
KM=T
I=LINK (I)
WHILE K>0,DO
BEGIN
IF ARRAY (I) < ARRAY (J) THEN
BEGIN
M=I
I=J
J=M
END
LINK(KM)=I
KM=I
I=LINK(I)
END
LINK(KM)=J
END=T
FUNCTION SORT (IS,JS=INTEGER)=INTEGER
VAR KS,II,JJ=INTEGER
IF IS=JS THEN
BEGIN
LINK(IS)=0
RETURNED.VALUE=IS
GOTO OEND
END
KS=IS+(JS-IS)/2
II=SORT (IS,KS)
JJ=SORT (KS+1,JS)
RETURNED.VALUE=MERGE(II,JJ)
OEND
END=RETURNED.VALUE

```

Now there's no need to switch

This new Structured Basic™ language offers all the power you've been waiting for.

The language produces chainable (passing common variables), relocatable .COM files in the CP/M* world. It uses CP/M 2.xx capabilities while remaining 1.4x compatible.

It gives you: fully defined user functions and procedures (both recursive); local and global variables, functions and procedures; REPEAT - UNTIL, WHILE - DO, IF - THEN - ELSE, BEGIN - END, CASE - OF structure techniques; single and double precision floating point, fixed point packed BCD, integer, string and character data types; packed binary disk storage (requiring no memory / disk type

*CP/M is a trademark of Digital Research.

conversions); and much, much more... **and still retains the flexibility of BASIC.**

As a software house always looking for that great, powerful, new language... we're excited about making **Structured BASIC™** available to the software community.

Order your copy now at an introductory price of \$250.. from...

MICRO•AP, INC.

9807 Davona Drive

San Ramon, CA 94583

Telephone (415) 828-6697

MICRO•AP

*Structured BASIC is a trademark of Topaz Programming.

June 5, 1979

Mr. Scheuer introduced the following bill; which was referred jointly to the Committees on Education and Labor and Science and Technology

A BILL

To establish a national commission to study the scientific and technological implications of information technology in education.

Be it enacted by the Senate and House of Representatives of the United States of America in Congress assembled,

POLICY

Section 1. It is the policy of the United States that—

(1) the capability of the Nation's education system to prepare young people for the developing information-based society should be improved, with emphasis on achieving widespread development of computer skills; and

(2) computer-based techniques should be applied to the learning processes at

all levels of education, whenever qualitative improvements can be demonstrated.

ESTABLISHMENT

Sec. 2. To carry out the purposes of this Act, there is established a commission to be known as the National Commission on the Scientific and Technological Implications of Information Technology in Education (hereafter in this Act referred to as the "Commission").

DUTIES OF THE COMMISSION

Sec. 3 (a) For the purpose of furthering the policy stated in section 1(1) of this Act, the Commission shall conduct studies that include, but are not limited to—

(1) a forecast of changes in information technology during the period from 1981 to 2000, with emphasis on the effect of such technology on education and lifestyles;

(2) a forecast of the need for individuals with computer skills during the period from 1981 to 2000,

with emphasis on the need in the service sector of the Nation's economy for individuals skilled in information processing;

(3) a forecast of the effect of increased use of computers in education on school financing and local taxation during the period from 1981 to 2000;

(4) an investigation of incentives for increasing private sector involvement in the research and development, demonstration, dissemination, and utilization of computers for education purposes; and

(5) an investigation of the costs and benefits of alternative methods of training teachers in the use and application of information technologies and computer-based instructional materials.

(b) For the purpose of furthering the policy stated in section 1(2) of this Act, the Commission shall conduct studies that include, but are not limited to—

(1) an investigation of

the status and effectiveness of existing computer-based instructional techniques;

(2) an investigation of research in the application of cognitive psychology and artificial intelligence to computer-based learning; and

(3) an investigation of institutional mechanisms for development of exemplary computer-based learning techniques.

MEMBERSHIP

Sec. 4. (a) The Commission shall consist of twelve members appointed by the President with the advice and consent of the Senate.

(b)(1) At least one member of the Commission shall be appointed from each of the following three categories:

(A) Individuals who are engaged in the professions of teaching, education administration, or education research.

(B) Individuals who are developers of computer-based instructional materials and computer equipment.

(C) Individuals who are enrolled in school or parents of such individuals.

(2) Not more than three members of the Commission shall be officers or employees of the United States.

(c) Members of the Commission shall be appointed for the duration of the Commission.

(d) The President shall designate the Chairman and the Vice Chairman of the Commission. The Vice Chairman of the Commission shall act as Chairman in the absence or disability of the Chairman or in the event of a vacancy in that office.

(e) The Commission shall not transact any business until a member has been appointed by the President and confirmed by the Senate for each of the twelve positions on the Commission.

(f) Seven members of the Commission shall constitute a quorum.

(g) Any vacancy in the Commission shall not affect the powers of the Commission and shall be filled in the

DIGITAL SPEECH
is now a
two-way street.

Input/Output Speech Digitizer. Permits talking programs. I/O capability allows interactive teaching programs and speech-prompted data input formats. Use output for speech directed activities in business systems, announcements in a control-room, or sound effects in entertainment programs. Easy to use because input as well as output is under user control with special software operating system.

Available at Apple Dealers worldwide.

SUPER TALKER SD200

Mountain Hardware
LEADERSHIP IN COMPUTER PERIPHERALS
A Division of Mountain Computer, Inc.
300 Harvey West Blvd., Santa Cruz, CA 95060 (408) 429-8600

TRS-80® CP/M® & CBASIC® BUSINESS SOFTWARE

LOW-COST MOD II DISK EXPANSION

... over 610,000 bytes/disk with our
CP/M... plus many other features.

Find out why ours is the **Better Business Buy!**

Model II CP/M (rel. 2.0) \$250.00
Model I CP/M (re. 1.5) 150.00
CBASIC 95.00

APH (Automated Patient History) 175.00

RESIDENTIAL PROPERTY ANALYSIS

system 300.00

MAGIC WAND® Word Processor 400.00

RM COBOL® (Z80 code) 750.00

Osborne & Assoc. CBASIC source programs—

O&A **Payroll w/Cost Accounting** \$250.00

O&A **Accts. Rec./Accts. Payable** ... 250.00

O&A **General Ledger w/Cash Journal** 250.00

O&A CBASIC books for above (each) ... 20.00

Send 30¢ SASE for CP/M Users Group software list & free "CP/M Primer".

- ® MAGIC WAND is a registered trademark of Small Business Applications, Inc.
- ® RM COBOL is a registered trademark of Ryan McFarland Corp.
- ® TRS-80 is a registered trademark of Kikusui Shokai, Ltd. and company.
- ® CP/M is a registered trademark of Digital Research.
- ® CBASIC is a registered trademark of Software Systems.



(714) 848-1922

8041 NEWMAN AVENUE • SUITE 208 • HUNTINGTON BEACH, CALIFORNIA 92647

Disc/3 MART, INC.

DO IT YOURSELF

LOW-LOW PRICES

ANADEX PRINTER, DP-8000 \$ 825.00
ANADEX PRINTER, DP-9500 1,425.00
BASE II Printer (complete with options) 645.00
CENTRONICS 730 Matrix Printer 745.00
(with 4 free zip pack)
HAZELTINE 1520 1,319.00
NEC Spinwriter 5510 (RO) 2,643.00
SOROC IQ 120 750.00
SOROC IQ 140 Assembled 1,225.00
TI 810 Basic (upper & lower case) 1,669.00
TI 994 Personal Computer 1,150.00
LA 34 DEC Writer Teleprinter 1,195.00

CARTRIDGES • DISKETTES • MAG TAPE • ACCESSORIES

**ADDS, CENTRONICS, HAZELTINE, IMSAI, LEAR SIEGLER,
TECHTRAN, TI, VECTOR GRAPHICS AND OTHERS**

STORE HOURS: 9 A.M. - 5:30 P.M. Mon. through Fri.

Call or write for quotes or information.

Circle 129 on inquiry card.

Disc/3 MART, INC.

1840 LINCOLN BLVD.,
SANTA MONICA, CA 90404
(213) 450-5911

DATA DISK SYSTEMS

PROFESSIONAL SOFTWARE FOR NORTH STAR SYSTEMS

DIGITAL RESEARCH

CP/M 2.0 — Digital Research's latest disk operating system for 8080/8085/Z80 based microcomputers, not specially tailored for the North Star disk systems. Includes ED text editor, DDT debugger, ASM assembler, additional utility programs and complete documentation. CP/M 2.0 is upward compatible with earlier releases and makes a wealth of professional software available to your system. \$150/\$25

TEX — A powerful text formatter. Produces finished copy with automatic page numbering, left and right margin justification, indentation, page headers, line centering and other quality features. Output may be vectored to printer, disk or console. \$70/\$15

MAC — 8080 Macro assembler. Allows use of library programs, greatly increasing programming efficiency. Uses Intel macro conventions. Assembly toggles allow listing, hex and symbol table outputs to be directed to disk, printer, console or combination. A tremendous development aid. \$85/\$15

SID — Symbolic Instruction Debugger for the 8080. Allows multiple break points with user set pass counter. Displays user labels during debugging when used with MAC. Greatly reduces hard-copy listing requirements. Includes back-trace and histogram utilities. A must for serious software development. \$85/\$15

ZSID — Same as SID except incorporates complete Z80 instruction set and uses Z-80 mnemonics. \$95/\$15

QESPOOL — Allows simultaneous printing of disk files and user access to other programs. No need to stop production while lengthy printouts are in progress. \$45/\$5

SOFTWARE SYSTEMS

CBASIC-2 — A commercially oriented, compiler-interpret extended disk BASIC. Self-documenting, using full length variable labels without penalizing speed. Compiler permits distribution of software without releasing source code. \$105/\$15

California residents add 6% sales tax.
Specify single, double or quad capacity.
Additional formats available soon.
Structured Systems Group programs require CP/M and CBASIC-2.

*CP/M is a registered trademark of Digital Research.
†Software and documentation/documentation only.

Datadisk Systems, P.O. Box 195, Poway, CA 92064, (714) 578-3831

BUSINESS SOFTWARE FROM

STRUCTURED SYSTEMS GROUP

GENERAL LEDGER — A comprehensive applications package for business accounting or CPA firm client write up. Produces financial reports to user defined specifications. Interactive posting, balance sheet, income statement, general and cash disbursement journals, sort, multiple profit centers, accounts distribution and much more. Outstanding package. \$895/\$25

ACCOUNTS RECEIVABLE — A complete open item or balance forward system. Operates alone, or interfaces with General Ledger. Produces customer statements, aged trial balance, on-line inquiry, sales reports, reminder notices and more. \$695/\$25

ACCOUNTS PAYABLE — A powerful cash management system. Aged account statements, writes checks, cash requirements projection, General Ledger update and more included. Stand alone operation or interfaces with General Ledger and OSORT. \$695/\$25

NAD — Name and Address System — Stores mailing lists on disk. Prints mailing labels or lists additional references information. Selective data extraction. \$75/\$10

QSORT — A generalized, full disk sort/merge package. Fast and flexible. Multiple key sorting. \$95/\$15

LETTERRIGHT — Word processing for the business office. Produces professional correspondence, letters, envelopes, and more. High speed production with minimal training. Multiple personalized letters produced when used with list formed by NAD. \$175/\$20

ANALYST — Generalized data base management program. Stores and retrieves disk data producing user formatted reports. Interactive input. Easy to use. Tremendous versatility. \$225/\$20

INVENTORY — Complete inventory control program limited in capacity only by your disk size. On-line inquiry, average valuation, reorder and activity reports with report range option. Menu driven and fully auditable, the system uses full screen formatting and permits user defined record numbers. \$795/\$25

NOW—AN AFFORDABLE HARD DISK
Ask about our 13.2 megabyte Winchester technology hard disk business system. Uses all above listed software. Price varies with software configuration.

DIGITAL DATA RECORDER MODEL CC-9B

For five years now, the CC series recorders have been the industry NRZ Asynchronous recorder standard. Now the B model sets a new standard in stability and reliability with its tachometer feedback LC stabilized motor circuit.



CC-9B Model

Price \$275.00

CC-9 Model

Price \$225.00

- 4800 or 9600 Baud (3" or 6" per second)
- 10⁻⁸ Error Rate RS232 or TTL In and Out
- RTS motor start
- CTS Data start
- DB 25 or special connector optional
- 110/220 - 50/60 Hz
- Wow & Flutter ± .3%
- Speed Stability (long term) ± .1%

NATIONAL MULTIPLEX CORPORATION

260 Lackland Drive East
Middlesex, New Jersey 08846
Tel. (201) 356-9200 TWX 710-997-9530

same manner in which the original appointment was made.

COMPENSATION

Sec. 5. (a)(1) Except as provided in paragraph (2) of this subsection, members of the Commission shall receive \$150 for each day (including travel time) during which they are engaged in the actual performance of duties vested in the Commission.

(2) Members of the Commission who are full-time officers or employees of the United States shall receive

no additional pay on account of their services on the Commission.

(b) While away from their homes or regular places of business in the performance of services for the Commission, members of the Commission shall be allowed travel expenses, including per diem in lieu of subsistence, in the same manner as individuals employed intermittently in the Government service are allowed expenses under section 5703 of title 5, United States Code.

ADMINISTRATION

Sec. 6. (a)(1) Within sixty days after the date on which the member appointed by the President for the twelfth position on the Commission is confirmed by the Senate, the Commission shall appoint an Executive Director and shall fix the rate of compensation for such position at a rate not to exceed the maximum rate of basic pay currently payable for GS-18 of the General Schedule under section 5332 of title 5, United States

Code.

(2) With the approval of the Commission, the Executive Director may appoint such additional personnel as the Executive Director deems advisable and shall fix the rate of compensation for such personnel at a rate not to exceed the maximum rate of basic pay currently payable for GS-18 of the General Schedule under section 5332 of title 5, United States Code.

(3) Except as provided in paragraphs (1) and (2) of this subsection, the Executive Director and the personnel appointed under paragraph (2) of this subsection may be appointed without regard to the provisions of title 5, United States Code, governing appointments in the competitive service, and may be paid without regard to the provisions of chapter 51 and subchapter III of chapter 53 of such title relating to classification and General Schedule pay rates.

(b) With the approval of the Commission, the Executive Director may procure temporary and intermittent services to the same extent authorized by section 3109(b) of title 5, United States Code, but at rates not to exceed \$150 per individual per day.

(c) The Commission is authorized to negotiate and enter into contracts with private organizations and educational institutions to carry out such studies and reports as the Commission deems necessary to carry out its duties under this Act.

(d) Under section 1862 of title 42, United States Code, the National Science Foundation was given a special mandate to foster computer technology for research and education. Therefore, the National Science Foundation is hereby directed to provide administrative support and services to the Commission.

COOPERATION WITH FEDERAL AGENCIES

Sec. 7 (a) Each department, agency, and instrumentality of the Federal Government is authorized

D
E
S
K

T
O
P



C
O
M
P
U
T
E
R

Chrislin is First !!!

with deliveries of DEC's Desk Top Computers. Available with LSI 11/2 or LSI 11/23 CPU. Complete system totally enclosed within VT100 Video Terminal. Price **\$4,500** with LSI 11/2 and 64K bytes or **\$8,995** with LSI 11/23 and 256K bytes.

NOW Available — PDP 11/23 with 256 KB Memory **\$8,900.**

SPECIAL — LSI 11/2 and 32K x 16 Memory **\$1,095.**

10 MEGA BYTE Cartridge Disk System with Controller, RT11 compatible **\$6,100.**

1 MEGA BYTE RX02 Floppy Disc System **\$3045.**



Chrislin Industries, Inc.

Computer Products Division

31352 Via Colinas • Westlake Village, CA 91361 • 213-991-2254

ANNOUNCING COLLECTOR EDITION BYTE COVERS

SIGNED AND NUMBERED
EDITIONS OF 100.
\$15 EACH

Robert Tinney Graphics is now issuing limited editions of selected Byte Covers, each signed and numbered by the artist, Robert Tinney. The first four Collector Edition covers are shown at right. Unlike previously published Byte covers, these magazine-size prints are made from the original Byte color separations, and can be offered at a substantially lower price.

Collector Edition Byte Covers offer the following features:

- o THE PRINT—Each Collector Edition Byte Cover is 11"x14", including 1 1/2" borders at top and sides, and a 1 3/4" border at bottom. The paper stock is a smooth finish, 65 lb. antique cover weight. This heavy, very white sheet reproduces the depth and brilliance of the original art.
- o THE EDITION—All Collector Editions are strictly limited to 100 prints, and the printing plates are destroyed after the run. Mr. Tinney

inspects and approves the quality of each print before personally affixing the individual number and signature at bottom. A Certificate of Authenticity accompanies each print and certifies the number of the edition as well as the destruction of the printing plates. Each certificate is also signed and numbered by Mr. Tinney.

- o SHIPMENT—Collector Edition prints are packed flat between heavy binder boards to avoid rolling and to assure undamaged shipment. However, should any damage occur, your print will be immediately replaced. Shipment, of course, is always first class.
- o PRICE—The price of each Collector Edition Byte Cover is \$15, plus \$3 for postage and handling (\$6 for orders outside the U.S. and Canada). **If all 4 covers are ordered, the price is only \$50 plus postage and handling.**

If you would like to order one or more of these beautiful Collector Edition Byte Covers, please use the convenient coupon below.



THE SEVEN BRIDGES OF KÖNIGSBERG

February 1980



FUN AND GAMES

November 1979

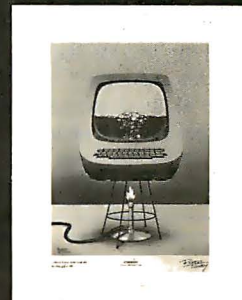

HOME BREW

March 1980

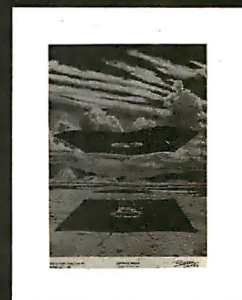

SOFTWARE MIRAGE

May 1980



"The Seven Bridges of Königsberg" shown mounted in a standard 12"x16" frame. Frame not included.

Please send me the following Collector Edition Byte Covers and Certificates of Authenticity.

Qty.	Cover	Amount
	The Seven Bridges of Königsberg	\$
	Fun and Games	\$
	Homebrew	\$
	Software Mirage	\$
<input type="checkbox"/>	All 4 - only \$50	\$
Post. & hand. (\$3 in US & Can., \$6 overseas)		\$
Total		\$

- I have enclosed check or money order to Robert Tinney Graphics.
- Visa Mastercharge
- Card # _____
- Expiration Date _____
- Signature _____

Send my print(s) to:

Name _____
Address _____
City _____
State _____ Zip _____

Mail this coupon to:

robert tinney graphics

P.O. Box 45047
Baton Rouge, LA 70895
Ph. (504) 357-5500



and directed to furnish to the Commission, upon request, such data, reports, and other information not otherwise prohibited by law as the Commission deems necessary to carry out its duties under this Act.

(b) The head of each department or agency of the Federal Government is authorized to provide to the Commission such services as the Commission requests on such basis, reimbursable or otherwise, as may be agreed between the department or agency and the Chairman or Vice Chairman of the Commission. All such requests shall be made by the Chairman or Vice Chairman of the Commission.

POWERS OF THE COMMISSION

Sec. 8. (a) For the purpose of carrying out its duties under this Act, the Commission, or at its direction, any subcommittee or member thereof, may hold such hearings, sit and act at such

times and places, take such testimony, and receive such evidence as the Commission, or such subcommittee or member, may deem advisable. Any member of the Commission may administer oaths or affirmations to witnesses appearing before the Commission, or before such subcommittee or member.

(b)(1) The Commission may require by subpoena the attendance and testimony of any witness and the production of any evidence that relates to any matter that the Commission is empowered to investigate by this Act. Such attendance of witnesses and production of evidence may be required from any place within the United States at any designated place of hearing within the United States. Subpoenas may be issued under the signature of the Chairman or the Vice Chairman and may be served by any person designated by

the Chairman or Vice Chairman. The subpoenas of the Commission shall be served in the manner provided for subpoenas issued by a United States district court under the Federal Rules of Civil Procedure for the United States district courts.

(2) If a person who has been issued a subpoena under paragraph (1) of this subsection is guilty of contumacy or refuses to obey such subpoena, any United States district court within the judicial district within which the hearing is to be conducted or within the judicial district within which such person is found, resides, or transacts business may, upon application by the Attorney General of the United States, order such person to appear before the Commission, or any subcommittee or member thereof, to produce evidence or to give testimony related to the matter under inquiry. Any person who disobeys such

order of the court may be punished by the court as in contempt thereof.

(3) Notwithstanding paragraphs (1) and (2) of this subsection, a person shall be excused from testifying or from producing evidence in obedience to a subpoena issued under this subsection if such person states in writing to the court ordering such person to testify or to produce evidence that the required testimony or evidence may tend to incriminate such person or subject such person to a criminal penalty.

(4) Any witness subpoenaed by the Commission shall be reimbursed for reasonable and necessary travel expenses, including per diem in lieu of subsistence.

REPORTS

Sec. 9. (a) The Commission shall transmit a final report to the President and to each House of Congress not later than one year after the date on which the Executive Director of the Commission is appointed. The final report shall contain the results of the studies conducted under section 3 of this Act, the Commission's recommendations for improving computer-based education, and proposals for such legislative and administrative actions as the Commission deems necessary to accomplish its recommendations.

(b) The Commission may publish such interim statements as it deems advisable, including consultants' reports, transcripts of testimony, and Commission findings.

TERMINATION

Sec. 10. The Commission shall cease to exist thirty days after submitting its final report pursuant to section 9(a) of this Act.

AUTHORIZATION OF APPROPRIATIONS

Sec. 11. There is authorized to be appropriated for fiscal years beginning after September 30, 1980, not to exceed \$2,000,000 to carry out this Act. ■

OPAMPTICS

REMOTE TEMP DRIVER—

provides the drive and amplification for our sensors below. You get output covering 0 to 50 degrees centigrade. Zero point is adjustable and you may mount up to 4 active sensors within 1200' via 2 conductor shielded cable \$59.00

MOISTURE SENSOR—

design a probe from wire, rods or surfaces then use this card to detect changes in resistivity. The output is TTL compatible, with a LED indicator. Trip resistivity is adjustable between 1K and 100K ohms \$39.00

ABSOLUTE OR GAGE PRESSURE SENSOR—

run your 1/4" tubing to our solid state pressure transducer. 0 to 5 or 0 to 15 psi ranges feature stability, low hysteresis and millisecond response time \$97.00

ONE CHANNEL A TO D CONVERTER—

converts a 0 to 1 volt analog level to an 8 bit digital word, with output buffering. Conversion rate is 5/second and input scaling resistors can be added. See your converted data on the 3 digit display. An easy to use, CMOS design \$82.00

REMOTE TEMP SENSOR—

only 1 1/4" x 1 1/2" yet this semiconductor device outputs +10 mv per degree C. and works from any 9 to 30 volt DC source. Trimable 0 C. output of 2.782 volts \$14.75

Prices include assembly, testing and UPS shipping.

IMPULSE ELECTRONICS, INC.

P.O. BOX 40481
PORTLAND, OREGON 97240

PHONE 1-503-645-1469
TWX 1-910-467-8760

A Race-Car Monitoring Program

Jeff Johnson, POB 2289, Socorro NM 87801

A computer-controlled racetrack was the final project in our computer science class in Real-Time Data Acquisition and Control Theory. Three of us assembled a Tyco two-lane track with lane-changing capabilities. We set photoresistors into the track as sensors and wrote FORTRAN code that displayed the status of a race in real time on a graphics display system owned by the New Mexico Institute of Mining and Technology Computer Science Dept.

Our system included the following components: PDP-11/34 computer with 80 K words (160 K bytes) of memory; an RX01 dual single-sided floppy-disk drive (256 K bytes per drive); a VT11 vector graphics display (1024 by 1024 resolution); an LA36 DECwriter; an AR11 16-channel analog-to-digital (A/D) converter; a DZ11 8-channel RS-232 interface, which also connects our com-

puter lab with the DEC-20 main computer; and a disk-operating system (including two text editors, a macro-assembler, and a FORTRAN compiler).

Originally, the computer was to control the lane-switching capabilities and the speed of one of the race cars. Our digital-to-analog (D/A) converter was never implemented, so we settled for merely keeping track of the cars, with the computer continually monitoring the analog-to-digital (A/D) conversion channels connecting the sensors in the track. This may not sound very useful, but the computer actually performed functions that cannot easily be performed manually: keeping track of laps completed, determining the winning car, and timing the racers.

On a lane-switching track, there is no simple mechanical way to count laps, because the cars can exchange lanes during any lap. Therefore, "serious" racing is not practical without an observer to referee the race. Our observer is the computer.

Smart move.



Take stock in America.
Buy U.S. Savings Bonds.

Listing 1: Race-car-monitor program written as a structured pseudocode algorithm.

```
BEGIN RACE CAR PROGRAM:
  WHILE NOBODY OBJECTS TO RACING CARS DO:
    BEGIN
      INITIALIZATION:
        RECOGNIZE DATA OF TRACK CONFIGURATION, TYPICAL READINGS OF A/D CHANNELS
          WHEN DIFFERENT SENSORS SHADED.(IN FORTRAN, THESE ARE DATA STATEMENTS).
        CALIBRATE SENSORS;
        DETERMINE AMBIENT SENSOR VALUES AND CORRESPONDING NOISE
        INITIALIZE VELOCITIES, LOCATIONS, LAPS, TIME TO APPROPRIATE VALUES
        CREATE DISPLAY;
        DISPLAY TRACK
        DISPLAY TEXT, NUMBERS(SEE FIGURE 2), REMEMBERING LOCATION OF
          TEXT, NUMBERS TO BE CHANGED LATER
        READ IN NUMBER OF CARS, DISPLAY CORRESPONDING CARS, REMEMBERING
          THEIR LOCATIONS WHICH WILL BE CHANGED LATER.
      WAIT FOR START SIGNAL.
      START ELAPSE TIME.
      WHILE NO CAR HAS COMPLETED 25 LAPS DO:
        FOR EACH CAR DO:
          MONITOR A/D CHANNEL OF NEXT TRACK/ IF READING IS NOT WITHIN
            NOISE LIMITS, WAIT THE TIME REQUIRED FOR CAR TO GET FULLY
            OVER THE SENSOR, THEN CALL PROCEDURE DETECT, PASSING THE
            PARAMETERS CAR#, AND A/D CHANNEL.
          /* HERE WOULD NORMALLY GO THE COMPUTER ACTION PROCEDURE CALL */
        END FOR
        MONITOR EMERGENCY TERMINATE CHANNEL, IF FOUND, GO TO BEGINNING.
        UPDATE ELAPSED TIME.
      END WHILE
      DECLARE WINNER, MONITOR REMAINING CARS UNTIL THEY FINISH, ALSO MONITORING
        EMERGENCY TERMINATION CHANNEL.
    END WHILE;
  PROCEDURE DETECT(CAR#,CHANNEL)
    BEGIN
      IF THIS PROCEDURE HAS JUST PREVIOUSLY BEEN CALLED UNDER THE SAME CONDITIONS,
        THEN RETURN /* CAR HAS NOT YET LEFT THE SENSOR AREA */
      FIND SENSOR WITH READING CORRESPONDING TO PRESENT READING ON CHANNEL.
      PLACE CAR ON CORRESPONDING POSITION OF DISPLAYED TRACK.
      DETERMINE CURRENT, AVERAGE VELOCITY, DISPLAY THESE, AND THE TRACK# AND
        LANE CORRESPONDING TO THIS SENSOR.
      IF THIS SENSOR IS ON THIS CAR'S STARTING TRACK, INCREMENT THE NUMBER
        OF LAPS FOR CAR#.
    RETURN
  END PROCEDURE DETECT
END PROGRAM.
```

S-100, 6-PORT COMMUNICATIONS

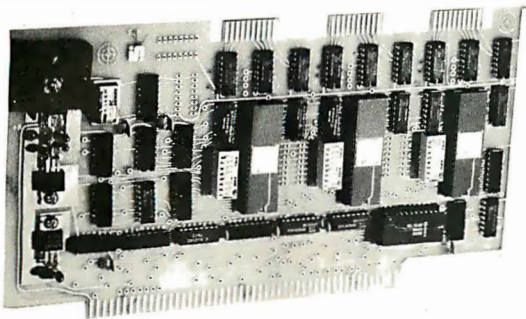

- INTERFACES MULTI TERMINALS, COMPUTERS, PRINTERS, MODEMS, ETC.
- 2, 4, OR 6 CHANNELS; 2 OPTIONAL RTC'S
- SELECTABLE I/O ADDRESS
- PROGRAMMABLE SYNC. CHARACTERS
- SYNC AND ASYNC
- HARDWARE ERROR CHECKING (CRC-16, CCITT)
- COMPLIES WITH: EIA RS-232C STANDARD; IEEE PROPOSED S-100 BUS STANDARD

FULL 6-PORT CONFIGURATION (ASSEMBLED AND TESTED) \$895.00

For information, contact: Dianne Polk (703) 893-4330 x 100



Inco, Inc.

7916 Westpark Drive □ McLean, Virginia 22102



compas
microsystems

There is nothing like a

DAIM



A complete disk system for the Rockwell Aim 65. Uses the Rockwell Expansion Motherboard. Base price of \$850 (U.S.) includes controller with software in Eprom, disk power supply and one packaged Shugart SA400 Drive.

224 SE 16th St.
P.O. BOX 687

AMES, IA 50010
(515) 232-8187

NEW FROM MICROWARE.

OS-9

THE ULTIMATE 6809 OPERATING SYSTEM

Here's an all-new, state-of-the-art operating system that let's you use the 6809 to its fullest capability. Pick the configuration you need: tape or disk-based, single-or multiuser. It's also easy to modify or expand. Here are some features:

- **Interrupt-Driven Multidevice I/O**
- **Hierarchical Disk File Structure**
- **Unix*-Type I/O Calls**
- **Full Memory Management Capability**
- **System Executive on ROM**
- **Highly Hardware - Independent**

Versions are available off-the-shelf for most popular CPU's such as SWTPC, GIMIX, PERCOM, Motorola, etc.

*UNIX is trademark of Bell Telephone Laboratories

OS-9 System Software

We also offer a new generation of interactive software development tools for fast, efficient application programming.

- **Minimum-Keystroke Text editor**
- **OS-9 Assembler**
- **Microsoft Basic**
- **Interactive debug module**
- **Expansion device driver modules**
- **OS-9 Level 2 Multuser**
- **Motorola BASIC09**

And Coming Soon . . .

Call or write today for information.

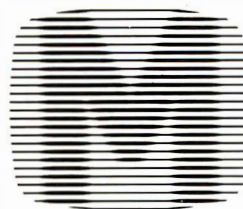

MICROWARE®

5835 Grand Ave., P.O. Box 4865, Des Moines, IA 50304
515/279-8844

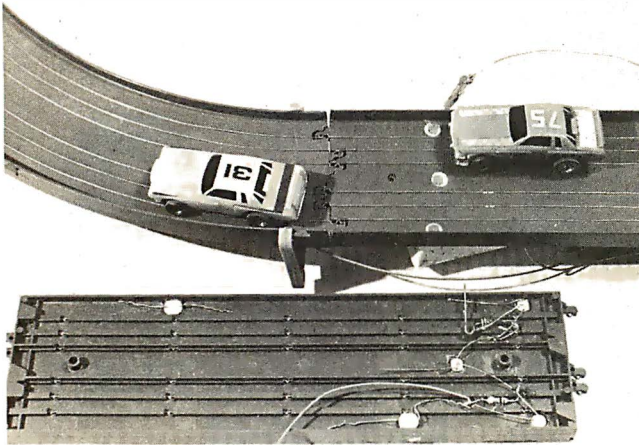

Photo 1: A look at the racetrack showing the positioning of the light sensors.

After assembly of the hardware, we wrote a racetrack monitoring program. This program creates a graph of the track and causes the location of the cars on the graph and relevant data such as the current and cumulative average speed, the lane, the number of laps, the current track section for each car, and the elapsed time to appear on the graphics display (see photo 2). The algorithm for the program is given in listing 1.

The program keeps track of the first 25 laps of each

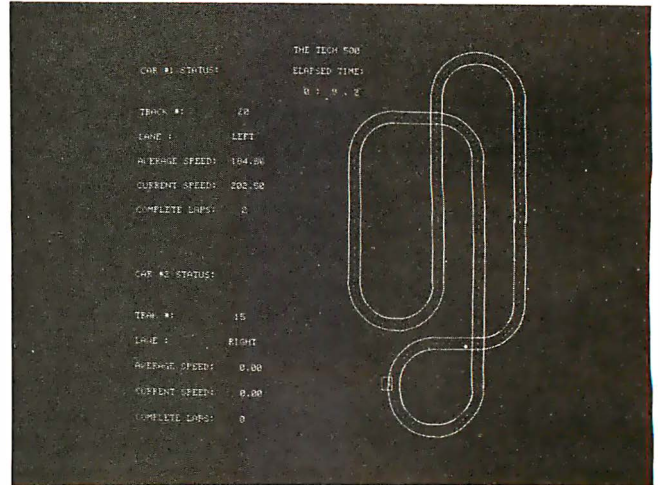

Photo 2: Display on Digital Equipment Corporation VT11 vector graphics unit showing the layout of the racetrack and the position of the one car that is racing. The display resolution is 1024 pixels by 1024 pixels.

car; 25 laps are one race. The computer can distinguish between the cars until one overtakes the other, whereupon a number of problems arise.

Generally, when a car attempts to pass another, there is a pile-up. We decided to make it easier. The cars start in two different locations, about half a lap apart, and finish the race after 25 laps or when one car catches up to another.

Why pay more ... and get less? Sirius gives you lower prices and higher quality!

**Remex RFD 4000/4001
8" Floppy Disc Drives
Double sided ...
Double density!!**

\$549⁹⁵

RFD 4001, \$564.95

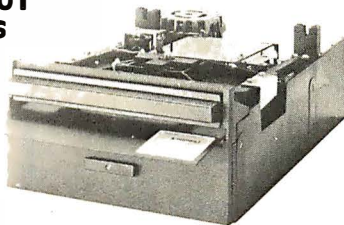

Offers quality and features found in drives costing much more! ■ Single or Double Density ■ Double-Sided Drive ■ Door Lock INCLUDED ■ Write-Protect INCLUDED ■ 180 Day Warranty ■ Compatible with Shugart 850/851 ■ Low Power Operation ensures LONGER LIFE!! ■ Model RFD 4001 offers Data and Sector Separator

AVAILABLE OPTIONS/ACCESSORIES

- Single Drive Power Module, \$119.95
- RFD4000 Manual, \$.95
- Drive Cabinet, \$29.95
- Dual Drive Power Module, \$139.95
- Interface Manual, \$2.95

**Remex 1000B ... If you've been looking
for a less expensive floppy disc drive,
but not wanting to sacrifice quality —
this is it!**

\$419⁹⁵

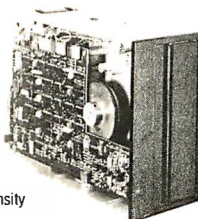

You get both in the Remex 1000B! For only \$419.95 look at what you get: ■ 8" Floppy Drive ■ Single or Double Density ■ Hard or Soft Sectoring ■ Media Protection Feature ■ Single Density Data Separator ■ 180 Day Factory Warranty

AVAILABLE OPTIONS/ACCESSORIES

- Door Lock, \$19.95
- Connectors, \$9.95
- Interface Manual, \$2.95
- Write-Protect, \$19.95
- Drive Cabinet, \$29.95
- 1000B Technical Manual, \$.95
- Interface Adapter (Remex to Shugart), \$12.95

**SIRIUS 80plus Series ...
perfect add-ons for your
TRS-80*!**

- Comes complete ready to plug in and run!
- 5ms track to track
- SIRIUS 80+1 and 80+2 — up to 102,000 bytes
- SIRIUS 80+3 and 80+4 — 240K and 480K bytes

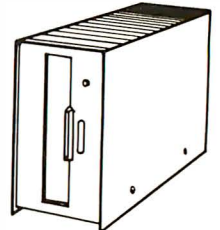

SIRIUS 80+1 (Single Head) **\$349⁹⁵**

SIRIUS 80+2 (Dual Head) **\$419.95**

SIRIUS 80+3 (Single Head) **\$439.95** SIRIUS 80+4 (Dual Head) **\$539.95**

MPI 51/52 ... A Great Reliable Mini-Drive!

- Fast! 5ms track to track access
- Exclusive Pulley-Band Design
- Unique Door/Ejector Mechanism
- Reliable 1½% Speed Stability

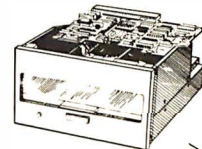

MPI-51 (Single Head) **\$259.95**

MPI-52 (Dual Head) **\$349.95**

**MPI 91/92 ... More
Drive For Your Money!
240K/480K!**

MPI-91 (Single/240K) **\$349.95**

MPI-92 (Dual/480K) **\$449.95**

*TRS-80© Tandy Corp.

**SIRIUS
SYSTEMS**



(615) 693-6583

P.O. Box 9748, Knoxville, TN 37920

Phone Orders accepted 9AM-7PM (EST)

VOLUME DISCOUNTS AVAILABLE

CAT-100 FULL COLOR GRAPHICS

The original 256-color imaging system with high resolution video FRAME GRABBER for the S-100 bus.

Capture and digitize a video frame in 1/60 of a second. Select the best resolution for your application, from 256 to 1280 pixels per TV line. Display your digitized or computer processed image with 256 gray levels or 256 colors on standard B&W, NTSC or RGB color TV monitors.

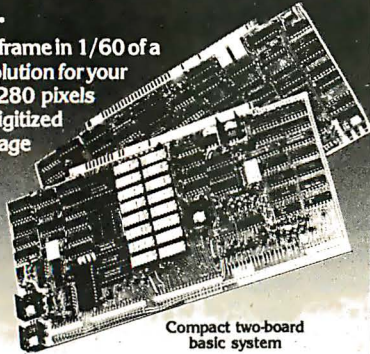

Compact two-board basic system



240x256 Digitized image, 16 levels

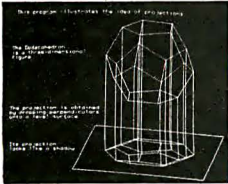

480x512 Computer-generated

Features:

- Highest possible quality 480x512x8 digital video image presently available on the market
- Input capability from TV camera or other sources
- Variety of synchronization choices
- 2 selectable video A/D conversion circuits
- Choice of 1, 2, 4, 8, 16 or 32 bits per pixel
- 32K-byte image memory on the basic system
- 32, 64, 128 & 256K byte system capacity
- Lightpen input
- Photographic trigger control input
- Software selectable system parameters
- Interfaces for TRS-80 and other processors
- Comprehensive line of accessories, monitors and support software

SEND FOR FREE CATALOG



DIGITAL GRAPHIC SYSTEMS

441 California Ave., Palo Alto, CA 94306 415/494-6088

THE ESSENCE of output quality

- Any IBM SELECTRIC® can be converted to produce high quality output at an affordable price!
- Interfaces directly to S100, Parallel, RS-232 or IEEE-488.
- Compatible with TRS-80, Sorcerer, Pet, Apple, Horizon, etc.
- Why be printer bound? Prices from \$496 to \$675.

Call today.



Backspace and Tab Available NOW!



Escon Products, Inc.
171 Mayhew Way, Suite 204
Pleasant Hill, Ca., 94523
(415) 935-4590

Order the professional's choice.

UCSD Pascal.™

The Pascal everyone is talking about is UCSD Pascal... with over 10,000 users and growing. The fully developed Pascal is available with support from a professional software company. Implemented on most major microprocessors.

Not just another compiler, but complete development software — from operating system to screen-oriented editor. Language extensions for systems development and commercial applications programming.

Program portability that allows programs written on one microcomputer to run without recompilation on different microcomputers. This protects your software investment... without restricting your hardware options.

If you have CP/M® visit your local computer store or order below. System supplied on single-density, soft-sectored, 8" floppy disks and requires 48K of contiguous RAM. For other systems call us or write for more information. Telephone orders accepted with Master Charge or VISA.



9494 Black Mountain Road • San Diego • CA • 92126
TEL: (714) 578-6105 • TWX: 910-335-1594

CP/M is a registered trademark of Digital Research Corporation. LSI-11 is a trademark of Digital Equipment Corporation. UCSD Pascal is a trademark of the Regents of the University of California.

- Yes! Rush me a complete UCSD Pascal system for my CP/M® based microcomputer. A check or money order for \$300.00 is enclosed. I have a _____ computer.
- Send me more information about UCSD Pascal. Versions are available for systems using the following microprocessors: LSI-11,™ 6502, 6800, 6809, 9900, Z80 and 8080/8085.
- Send me only the complete set of documentation for UCSD Pascal. A check or money order for \$37.00 is enclosed.
- Send distributor information.

Name _____

Company _____

Address _____

City _____

State/Zip _____

M/C or VISA # _____ Exp. Date _____

Mass. and Calif. residents enclose applicable sales tax.

B-6

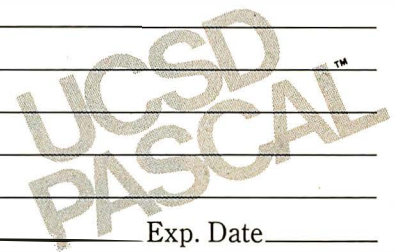

Teratek's



Tomorrow's mail system. Today.

One package does it ALL.
Postmaster offers the most powerful and flexible
mail-management system available.

Batch Entry: Entering names and addresses to a mailing list is simple. Repeated elements of a record need only be entered once.

Powerful Record Extraction: Used in conjunction with the **Optional Reference Field**, this feature allows simple creation of user specified "target-files."

Dedicated Record Editor: List, modify or delete records. Allows intact or extracted backup of original file.

Automatic "ID" Field Insertion: (optional) Key in a name, and a unique 10 character record identifier will be entered automatically to the Reference area.

Envelopes: Postmaster prepares single or continuous envelopes.

Mailing Labels: Standard or user-specified formats up to five across are supported by Postmaster. User may specify any number of labels per name.

Form Letters: Prepare and edit form letters in a variety of formats, on either single or continuous forms. Optional capability of allowing text or salutation "Inserts" for some or all letters in any print run.

Dedicated Record Sorting: Sorted files are re-written to disk. The sort may be in either ascending or descending order. Uses the FAST Shell-Metzner sorting algorithm.

Attractive Reports: Neat, paginated reports on either 80 or 132 column paper. The 80 column option allows your CRT to provide an attractive report display.

Clear, Complete Documentation: The manual will explain in simple English how to get started right away. Sample data and form-letter files are included on the disk to allow new users to experiment (learn) quickly.

Quality That's Affordable and Available: The Postmaster programs are available in a variety of 5" and 8" disk formats (40k of RAM, CP/M and CBASIC2 are required). Among the formats supported are TRS-80, North Star, Heath H8 and H89, standard 8" IBM, Vector MZ and other CP/M derivatives capable of running CBASIC.

It's terrific!
We use it ourselves!

Prices reflect distribution on 8" single density diskettes. If a format is requested which requires additional diskettes, a surcharge of \$8. per additional diskette will be added.

*Inquire
about
additional
features!*

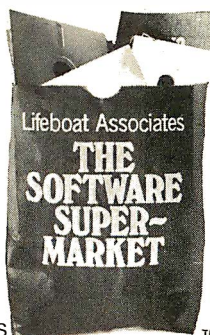

COMPLETE
PACKAGE:

\$150.

MANUAL
ALONE:

\$15.

(Credited toward
subsequent purchase)

*CP/M is a trademark
of Digital Research

LIFEBOAT ASSOCIATES
2248 Broadway, New York, N.Y. 10024 ☐ (212) 580-0082 ☐ Telex: 220501

The most popular event at our track is running an individual car for time, and keeping track of the best time.

Construction

The system was very simple to put together, taking about 20 man-hours. Three holes were drilled in the left, middle, and right lanes of each section of track (see photo 1).

Masking tape was placed on the top surface over each hole, the tracks were then turned upside down, and the photoresistors were placed in the holes. The holes were then filled with epoxy.

Since we had more sensors than analog-to-digital converter channels, we had to input several sensors into one channel. We decided to use six sensors per channel. To avoid confusion, resistors of various specific values were put in parallel with the photoresistors, evenly dividing the voltages. Since the analog-to-digital converter could read from 0 to 60, a car going over one sensor would give a value that was an integer multiple of 10, and the particular multiple uniquely determined that sensor.

After we had installed the appropriate resistors, we wired everything together. The wires were attached to a terminal-strip extension cord going to the analog-to-digital converter.

The final step was to place an incandescent lamp over the assembled track, because the only other illumination was provided by mercury lamps. Mercury lamps give sufficient 60 Hz noise to be detected by the photoresistors.

The problems encountered were as follows. Because the analog-to-digital converter channels were spread over more than one track, the motion of one car could conceivably affect the other's status. Two cars going over sensors connected to the same channel at the same time would give faulty information or none at all. There was a problem with race cars bouncing around and not keeping to their designated lane (especially around curves). This sensor restriction causes the difficulty in keeping track of passing.

Possible Improvements

Because each track had its own channel, the greatest difficulty was in determining which lane each car was in, since a car often tripped two of the sensors. This difficulty could be resolved by using two channels (and only two, better-spaced sensors) per track. The ambiguity of track identification could be resolved with one sensor per channel. However, with twenty-five track sections, we would need fifty analog-to-digital conversion channels.

Sophisticated software might resolve this problem. By treating each car through a process that monitors both ahead and behind each car for two track lengths, a correct status could be found after at least every two track sections, since there are no more than two track sections per channel.

A higher-quality model race-car set would greatly help, and I hope that in the future toy manufacturers will make available higher-quality racing sets. Toy companies might even come up with something similar to our system, using a microprocessor and light-emitting diode display. Such a system could have not only circuits along the track to bring power to the cars, but also circuits connecting sensors built into the track, so that the tangle of

DEC LSI-11 Components

Dependable service
at discount prices
Domestic
and Export

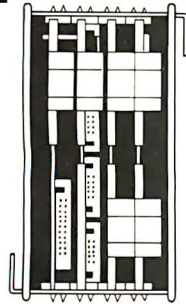

Mini
Computer Suppliers, Inc.

25 Chatham Rd., Summit, N.J. 07901
Since 1973
(201) 277-6150 Telex 13-6476

©Mini Computer Suppliers, Inc.
1979

ANNOUNCING:

NEW!

MICROSTAT

A complete statistics package for business, scientific, education and research work. No other package has the features of MICROSTAT. For example:

- File oriented with COMPLETE editing
- A Data Management Subsystem for editing, sorting, ranking, lagging, data file transfers PLUS 11 data transformations (e.g., linear, reciprocal, exponential, etc.)
- Frequency distributions
- Simple and multiple regression
- Time series (including exponential smoothing)
- 11 Non-parametric tests
- Crosstabs/Chi-square
- Factorials (up to 1,000,000!), permutations, combinations
- 8 Probability distributions
- Scatterplots
- Hypothesis test (Mean, proportion)
- ANOVA (one and two-way)
- Correlation
- Plus many other unique features

Users manual: \$10.00 (credited towards purchase) and includes sample data and printouts. Uses

NORTH STAR BASIC 32K of memory, one or two disk drives (2 recommended). Printer optional. Price: \$200.00



ECOSOFT

P.O. Box 68602
Indianapolis, IN 46268

Phone orders:
(317) 253-6828

A REFURBISHED "SELECTRIC" ASCII TERMINAL
FOR THE SMALL BUSINESSMAN OR SERIOUS HOBBYIST.

The AJ 841 I/O terminal. Now available from dealers nationwide.

Demand for our AJ 841 I/O computer terminal has been great. And now it's getting even greater. So call your local computer shop dealer right away. Supply is limited! You may never have another opportunity like this one to buy your own *professional* terminal.



The AJ 841 features:

- Choice of serial RS 232 or parallel interface
- ASCII code
- 14.9 cps printout
- High quality Selectric printing
- Heavy-duty Selectric mechanism
- Off-line use as typewriter
- Documentation included
- 30-day warranty on parts and labor (details available on request)

Call toll-free now

For location of your nearest AJ dealer, call toll-free:

800/538-9721

California residents call 408/263-8520.

 **ANDERSON
JACOBSON**

Diagnostics I

for CP/M* & TRSDOS*

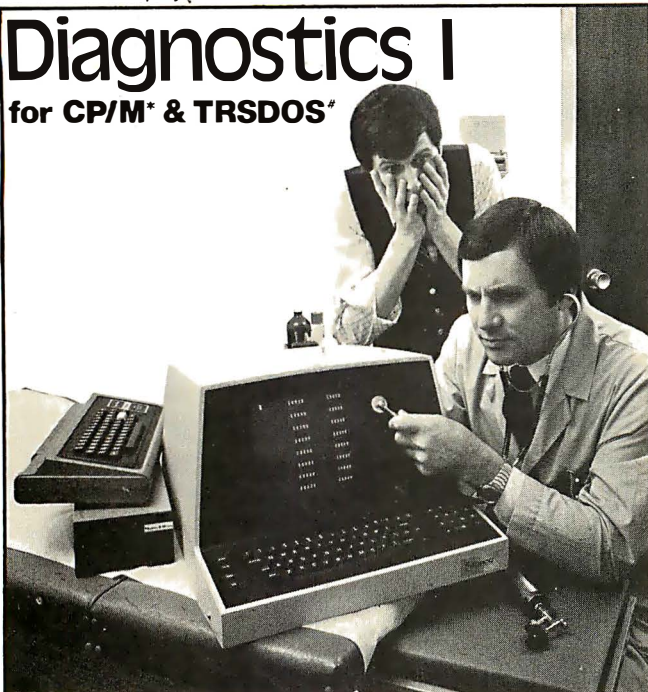

Someday your computer is going to break; even the most reliable computer systems "go down". Often, finding exactly what is wrong can account for the most time consuming part of repairing the system, and the longer the system is down, the more money you lose.

DIAGNOSTICS I is a complete program package designed to check every major area of your computer, detect errors, and find the cause of most common computer malfunctions, often before they become serious. For years, large installations have run daily or weekly diagnostic routines as a part of normal system maintenance and check-out procedures.

DIAGNOSTICS I is designed to provide that kind of performance testing for 8080/Z80 micro computers.

DIAGNOSTICS I will really put your system through its paces. Each test is exhaustive and thorough. The tests include:

- Memory Test • CPU Test (8080/8085/Z80) • Printer Test
- Disk Test • CRT Test

To our knowledge, this is the first CPU test available for 8080/Z80 CPU's. Many times transient problems, usually blamed on bad memory, are really CPU errors.

A good set of diagnostics is an indispensable addition to your program library even if your system is working fine. Hours have been wasted trying to track down a "program bug" when actually hardware was to blame!

DIAGNOSTICS I also allows you to be confident of your system. This can be critical when file merges or sorts and backups are involved. You want to be as sure of your computer as possible during these critical times. Running DIAGNOSTICS I prior to these and other important functions helps to insure that your system is operating at peak performance.

DIAGNOSTICS I is supplied on discette with a complete users manual.

DIAGNOSTICS I: \$60.00 Manual only: \$15.00

Requires: 24K CP/M; 16K disc for TRS-80

formats: CP/M 8" SOFT SECTORED, NORTHSTAR CP/M AND TRS-80 DOS



**All Orders and General Information:
SUPERSOFT ASSOCIATES
P.O. BOX 1628
CHAMPAIGN, IL 61820
(217) 359-2112**

**Technical Hot Line: (217) 359-2691
(answered only when technician is available)**

*CP/M REGISTERED TRADEMARK DIGITAL RESEARCH
#TRSDOS TRS 80 TRADEMARKS TANDY CORP

wires that we encountered can be avoided.

The Computer Science Dept also has two LSI-11 systems that will someday be connected to the PDP-11/34 system through RS-232 lines. On these, programs could be used in a multiprocessing mode to monitor and control one particular car.

We determined that one output channel can control both the speed and the lane of the computer car. Should we be suitably inspired by the advent of a high-quality race-car set, we shall resume our original plan of racing against the computer. Our ultimate goal: having two computer programs race against each other. ■

Acknowledgements

I received advice and assistance in this project from Tom Nartker, Greg Freiberg, Russ Calvery, and Dick Carlson. A listing of the FORTRAN program to monitor the cars may be obtained by writing to me. Please include a self-addressed envelope with \$0.28 US postage affixed.

Computing Time Between Dates

**Paul E Condon, Staff Scientist, Lawrence Berkeley Laboratory
Bldg 90, Room 3078, University of California,
Berkeley CA 94720**

There is an easier way to find the elapsed time between two dates than the one given by W B Agocs in the Programming Quickie "Day of Week and Elapsed Time Program" (September 1979 BYTE, pages 126 and 129). Zeller's congruence as given by Agocs is a specialized version of a formula for the elapsed time in days since February 28, 0000 AD:

$$N = [(13 \times M - 1) / 5] + K + 365 \times Y + [Y / 4] + 36524 \times C + [C / 4]$$

M is the month number minus 2, except it is 11 or 12 of the previous year for January or February. K is the day of the month. Y is the year (modulo 100), and C is the century (ie: [(the year AD)/100]). The square brackets indicate the integer part of the enclosed expression. To find the elapsed time between two dates, evaluate N for each date and subtract.

If this leads to numerical overflow on a small system, one can replace C by (C-16). Then the formula will still work for all pairs of dates after the fifteenth century.

Also, Agocs should avoid so many GOTOs in coding the Zeller formula. Instead of lines 35 thru 115 of his listing 1, why not have:

```

35 LET M1 = M
40 LET Y1 = Y
45 LET MX = INT ((M + 9) / 12)
50 LET M = M - 2 + 12 * MX
55 LET Y = Y - 1 + MX
60 LET C = INT (Y / 100)
65 LET Y = Y - 100 * C
70 LET D1 = INT ((13 * M - 1) / 5) + D + Y - 2 * C
80 LET D1 = D1 + INT (C / 4) + INT (Y / 4)
    
```

The variable MX is equal to 0 for January or February, and is 1 otherwise. ■

DYNACOMP

Quality software for: PET
Apple II Plus
TRS-80 (Level II)
North Star

All software is supplied with complete documentation which includes clear explanations and examples. Each program will run with standard terminals (32 characters or wider) and within 16K program memory space. Except where noted, all software is available on PET cassette, North Star diskette (North Star BASIC), TRS-80 cassette (Level II) and Apple cassette (*AppleSoft* BASIC). These programs are also available on *PAPER TAPE* (Microsoft *BASIC*).

FLIGHT SIMULATOR

(as described in SIMULATION, Volume II)

Price: \$17.95 postpaid

A realistic and extensive mathematical simulation of take-off, flight and landing. The program utilizes aerodynamic equations and the characteristics of a real airfoil. You can practice instrument approaches and navigation using radials and compass headings. The more advanced flyer can also perform loops, half-rolls and similar aerobatic maneuvers.

SIMULATION, Volume II (BYTE Publications): \$6.00

VALDEZ

Price: \$14.95 postpaid

A simulation of supertanker navigation in the Prince William Sound and Valdez Narrows. The program uses an extensive 256X256 element radar map and employs physical models of ship response and tidal patterns. Chart your own course through ship and iceberg traffic. Any standard terminal may be used for display.

BRIDGE 2.0

Price: \$17.95 postpaid

An all-inclusive version of this most popular of card games. This program both BIDS and PLAYS either contract or duplicate bridge. Depending on the contract, your computer opponents will either play the offense OR defense. If you bid too high the computer will double your contract! BRIDGE 2.0 provides challenging entertainment for advanced players and is an excellent learning tool for the bridge novice.

HEARTS 1.5

Price: \$14.95 postpaid

An exciting and entertaining computer version of this popular card game. Hearts is a trick-oriented game in which the purpose is not to take any hearts or the queen of spades. Play against two computer opponents who are armed with hard-to-beat playing strategies.

DATA SMOOTHER

Price: \$14.95 postpaid

This special data smoothing program may be used to rapidly derive useful information from noisy business and engineering data which are equally spaced. The software features choice in degree and range of fit, as well as smoothed first and second derivative calculation. Also included is automatic plotting of the input data and smoothed results.

FOURIER ANALYZER

Price: \$14.95 postpaid

Use this program to examine the frequency spectra of limited duration signals. The program features automatic scaling and plotting of the input data and results. Practical applications include the analysis of complicated patterns in such fields as electronics, communications and business.

MAIL LIST I

Price: \$18.95 postpaid (available for North Star only)

A many-featured mailing list program which searches through your customer list by user-defined product code, customer name or Zip Code. Entries to the list can be conveniently added or deleted and the printout format allows the use of standard size address labels. Each diskette can store more than 1000 entries.

CHESS MASTER

Price: \$19.95 postpaid (available for North Star and TRS-80 only)

This complete and very powerful program provides five levels of play. It includes casting, en passant captures, and the promotion of pawns. Additionally, the board may be preset before the start of play, permitting the examination of "book" plays. To maximize execution speed, the program is written in assembly language (by SOFTWARE SPECIALISTS of California). Full graphics are employed in the TRS-80 version, and two widths of alphanumeric display are provided to accommodate North Star users.

TEXT EDITOR I (Letter Writer)

Price: \$14.95 postpaid

An easy to use, line-oriented text editor which provides variable line widths and simple paragraph indexing. This text editor is ideally suited for composing letters and is quite capable of handling much larger jobs.

GAMES PACK I

Price: \$10.95 postpaid

Seven entertaining games for less than a dollar a kilobyte! Play CATAPULT, CRAPS, SWITCH, HORSERACE, SLOT MACHINE, BLACKJACK and LUNAR LANDER. This is an excellent and economical way to start your games library.

All orders are processed within 48 hours. Please enclose payment with order. If paying by MASTER CHARGE or VISA, include all numbers on card. Foreign orders add 10% for shipping and handling.

Write for detailed descriptions of these and other programs available from DYNACOMP.



DYNACOMP
P.O. Box 162

Webster, New York, 14580
(716) 586-7579

New York State residents please add 7% NYS sales tax.



Event Queue

JUNE 1980

June

Laboratory Short Courses, Virginia Polytechnic Institute and State University, Blacksburg VA. Dr Peter Rony will conduct three short courses for scientists and engineers. For information, contact Dr Peter R Rony, Course Director, Virginia Polytechnic Institute, Blacksburg VA 24061, (703) 961-6370.

June

Software International Seminars. These seminars cover the use of Software International business software. The courses are being held in the US and Canada. For a schedule, contact Software International Corp, 2 Elm Sq, Andover MA 01810, (617) 475-5040.

June and July

Zilog Courses on Hardware and Software Products, Cupertino CA. A series of technical courses for engineers who use Zilog components and systems is being offered at Zilog headquarters and Zilog's US sales offices. Special emphasis will be placed on the Z80 and Z8000 microprocessors. Contact Zilog, 10460 Bubb Rd, Cupertino CA 95014, (408) 446-4666.

June 2-4

Improving Productivity and Distributed Data Entry, Sheraton Center, New York NY. The conference and seminar schedule includes discussions on word processing, data processing, the future directions of data entry, improving data-entry productivity, automated offices, installing a data-entry incentive system, and more. Contact Data Entry Management Association, POB 3231, Stamford CT 06905.

June 2-5

The Ninth Annual Symposium on Incremental Motion-Control Systems and Devices, Ramada Inn, Champaign IL. Exhibition space is available for this conference. Contact Professor B C Kuo, POB 2772, Station A, Champaign IL 61820.

June 4-5

Microprocessors: Hardware, Software, and Application, Holiday Inn, Boston MA. This course is recommended for technical professionals who need an understanding of microprocessors in relation to their corporate and business careers. Contact Office of Continuing Education, Worcester Polytechnic Institute, Worcester MA 01609.

June 4-6

Salon de l'Ordinateur Computer Show, Place Bonaventure, Montreal, CANADA. This exhibition will feature over eighty manufacturers' hardware and software. For more information, contact Industrial Trade Shows of Canada, 36 Butterick St, Toronto, Ontario M8W 3Z8 CANADA.

June 9-13

Microcomputer Workshop, Carnegie-Mellon University, Pittsburgh PA. Engineers, research scientists, educators, and managers will benefit from this course. It covers all aspects of microcomputers and software. Hands-on training will be provided. The tuition is \$585 and housing can be arranged. Contact the Post College Professional Education, Carnegie-Mellon University, Pittsburgh PA 15213.

June 10-13

Pascal Computer Programming, George Washington University, Washington DC.

Event Queue

Laboratory sessions and hands-on experience are two aspects of this course. For details of this and other courses being offered by the University, contact The Director of Continuing Engineering Education, George Washington University, Washington DC 20052, (202) 676-6106 or toll free (800) 424-9773.

June 14

Microcomputers in Business and the Professions: Systems Selection, Butler University, 4600 N Sunset Ave, Indianapolis IN. This seminar will cover various types of hardware and software, how to evaluate the kinds and performances of computers, and their applications in business and the home. The registration fee is \$75. For information, contact College of Business Administration, Butler University, 4600 N Sunset Ave, Indianapolis IN 46208.

June 14-25

Introduction to Microcomputer Interfacing, Virginia Military Institute (VMI), Lexington VA. This hands-on course will feature the TRS-80 Level II system with one station for every two participants. The tuition is \$450. Contact Dr Philip B Peters, Dept of Physics, VMI, Lexington VA 24450, (703) 463-6225.

June 15-18

International Summer Consumer Electronics Show, McCormick Place, McCormick Inn, and the Pick-Congress Hotel, Chicago IL. The Consumer Electronics Show (CES) will feature exhibits from many companies and seminars and discussions. Items to be displayed will range from televisions, tape recorders, telephones, and translators, to computers, component

systems, auto sound systems, and electronic games. Attendance is limited to dealers and the press. Contact Consumer Electronics Show, Two Illinois Center, Suite 1607, 233 N Michigan Ave, Chicago IL 60601.

June 16-17

The BYTE Conference on Languages and Tools for Microcomputing, McGraw-Hill, 1221 Avenue of the Americas, New York NY 10020. The program covers block-structured languages and software systems, Pascal, Ada, C, LISP, FORTH, background context of traditional assembly-language tools, and more. Some of the speakers are Carl Helmers Jr, Editorial Director of BYTE magazine; Dr Ken Bowles, Dr Peter Grogono, Dr Fred Martin, Dr Henry Baker, and John Morse. For more information, contact McGraw-Hill Conference and Exposition Center, 1221 Avenue of the Americas, Rm 3677, New York NY 10020 (212) 997-4930.

June 16-19

The Thirteenth Annual Association of Small Computer Users in Education (ASCUE) Conference, University of Tennessee, Martin TN. Conference sessions will include presentations of papers and demonstrations of computers. Tutorials on structured programming, database management systems, programming in Pascal, and computer graphics will be included. Contact James Westmoreland, Computer Center, University of Tennessee at Martin, Martin TN 38238, (901) 587-7891.

June 16-20

Data Flow Concepts in Computer Language and Architecture, Massachusetts Inst-

Discover Savings and Service with

EBS

MAIL ORDER DIVISION

ORDER TOLL FREE



Cromemco

incorporated
Tomorrow's Computers Today



ALL CROMEMCO SYSTEMS NOW HAVE DOUBLE CAPACITY!

SYSTEM 3	1 Mbyte	5990.
SYSTEM 2		3190.
Z-2H	11 Mbyte	8995.
HDD-11	11 Mbyte	5945.
HDD-22	22 Mbyte	9995.
3102 CRT		1695.
3779 PRINTER		1270.
3703 PRINTER		2545.
3355 PRINTER		2715.
SCC		380.
BYTESAVER II		210.
ZPU		335.
4FDC		420.
64KZ		1510.
TU-ART		250.
Z3-SDSK		335.
Z3-MDSK		590.
COBOL		90.
FORTAN IV		90.
MACRO ASSEMBLER		90.
16K BASIC		90.
32K BASIC		275.
DBMS		90.
WORD PROCESSING		90.
RATFOR		180.
TRACE		90.

SOFTWARE

CBASIC2 ver 2.05 85.

EBS G/L

ACCOUNTING SYSTEM

GENERAL LEDGER	400.
ACCTS. PAYABLE	500.
ACCTS. RECEIVABLE	500.
PAYROLL (Calif.)	600.
INVENTORY	200.
ORDER ENTRY	200.
MAILING LIST	100.
Manuals included	
Requires dual disk/48K 24x80 CRT with curs addr CBASIC2 and CP/M or CDOS	

11 MEGABYTE HARD DISK BUSINESS SYSTEM

ONLY

CROMEMCO Z-2H
CROMEMCO 3102 CRT
CROMEMCO 3703 PRINTER
EBS G/L ACCT. SYSTEM
10 DISKETTES
1 BOX FANFOLD PAPER
ALL CABLES
CBASIC2

\$15,500

Over \$17,600 List Price

TERMINALS

SOROC IQ120	750.
SOROC IQ140	1150.
TELEVIDEO 912B	780.
TELEVIDEO 912C	830.
TELEVIDEO 920B	805.
TELEVIDEO 920C	855.
ADDS REGENT 25	925.
PERKIN ELMER 550	785.

PRINTERS

BASE-2	499.
with tractor	599.
CENTRONICS 704-1	1795.
CENTRONICS 703-2	2375.
CENTRONICS 779-1	995.
CENTRONICS 779-2	1095.
QUME SPRINT 5 RO	2650.
includes power supply	

PERSCI 277	1195.
with eject options	1345.

TEK COM COUPLER	175.
acoustic, originate only	

WE ALSO OFFER:

- Complete analysis of your system needs
- Installation, training, support & maintenance
- Custom applications software

AT OUR REGULAR CONSULTING RATES
Phone inquiries welcome

EXECUTIVE BUSINESS SYSTEMS

20457 E. Valley Blvd., Walnut, CA 91789

(714) 594-5736

TO ORDER: COLLECT PHONE ORDERS welcome or send check or M.O. Please include phone number. Personal or Co. checks require two weeks to clear. Items in stock will be shipped next business day upon receipt of certified funds. Within Calif. add 6% sales tax. All prices and offers subject to change without notice.

SHIPPING: We ship freight collect by UPS when possible. Larger items shipped by motor freight. Air and express delivery available.

CDOS[®] Cromemco, Inc.CP/M[®] Digital ResearchCBASIC[™] Compiler Systems

BUSINESS - PROFESSIONAL - GAME SOFTWARE FOR APPLE II

HOME FINANCE PAK I: Complete package \$49.95

BUDGET: The heart of a comprehensive home finance system. Allows user to define up to 20 budget items. Actual expense input can be by keyboard or by automatic reading of CHECKBOOK II files. Costs are automatically sorted and compared with budget. BUDGET produces both monthly actual/budget/variance report and a year-to-date by month summary of actual costs. Color graphics display of expenses by month. \$24.95

CHECKBOOK II: This extensive program keeps complete records of each check/deposit. Unique check entry system allows user to set up common check purpose and recipient categories. Upon entry you select from this pre-defined menu to minimize keying in a lot of data. Unique names can also be stored for completeness. This system produces rapid access to check files. Check register display incorporates unique up/down scrolling system for the ultimate in flexibility. 40 column printout of check register. Up to 100 checks per month storage. Files accessible by BUDGET program. \$19.95

SAVINGS: Allows user to keep track of deposits/withdrawals for up to 10 savings accounts. Complete records shown via screen or 40 column printer. \$14.95

CREDIT CARD: Keep control of your cards with this program. Organizes, stores and displays purchases, payments and service charges. Screen or 40 column printer display. Up to 10 separate cards. \$14.95

THE UNIVERSAL COMPUTING MACHINE: \$39.95

A user programmable computing system structured around a 15 row by 30 column table. User defines row and column names and equations forming a unique computing machine. Table elements can be multiplied, divided, subtracted or added to any other element. User can define repeated functions common to a row or column greatly simplifying table setup. Hundred of unique computing machines can be defined, used, stored and recalled, with or without old data, for later use. Excellent for sales forecasts, engineering design analysis, budgets, inventory lists, income statements, production planning, project cost estimates-in short for any planning, analysis or reporting problem that can be solved with a table. Unique cursor commands allow you to move to any element, change its value and immediately see the effect on other table values. Entire table can be printed by machine pages (user-defined 3-5 columns) on a 40 column printer. Transform your computer into a UNIVERSAL COMPUTING MACHINE.

COLOR CALENDAR: HI-RES color graphics display of your personal calendar. Automatic multiple entry of repetitive events. Review at a glance important dates, appointments, anniversaries, birthdays, action dates, etc. over a 5 year period. Graphic calendar marks dates. Printer and screen display a summary report by month of your full text describing each day's action item or event. Ideal for anyone with a busy calendar. \$19.95

BUSINESS SOFTWARE SERIES: Entire package \$159.95

MICROACCOUNTANT: The ideal system for the small cash business. Based on classic T-accounts and double-entry bookkeeping, this efficient program records and produces reports on account balances, general ledger journals, revenue and expenses. Screen or 40 column printer reports. Handles up to 500 journal entries per period, up to 100 accounts. Program instructions include a short primer in Financial Accounting. \$49.95

UNIVERSAL BUSINESS MACHINE: This program is designed to SIMPLIFY and SAVE TIME for the serious businessman who must periodically Analyze, Plan and Estimate. The program was created using our Universal Computing Machine and it is programmed to provide the following planning and forecasting tools.

CASH FLOW ANALYSIS	SALES FORECASTER
PROFORMA PROFIT & LOSS STATEMENT	SOURCE AND USE OF FUNDS
PROFORMA BALANCE SHEET	JOB COST ESTIMATOR

Price, including documentation and a copy of the base program, Universal Computing Machine. \$89.95

BUSINESS CHECK REGISTER: Expanded version of the Checkbook II program. Handles up to 500 checks per month with complete record keeping. \$29.95

BUSINESS BUDGET: As described above and companion program to Business Check Register. Handles 500 transactions per month, up to 20 cost categories. Accesses BCR files for actual costs. \$29.95

ELECTRICAL ENGINEERING SERIES: Both programs \$159.95

LOGIC SIMULATOR: SAVE TIME AND MONEY. Simulate your digital logic circuits before you build them. CMOS, TTL, or whatever, if it's digital logic, this program can handle it. The program is an interactive, menu driven, full-fledged logic simulator capable of simulating the bit-time by bit-time response of a logic network to user-specified input patterns. It will handle up to 1000 gates, including NANDS, NORs, INVERTERS, FLIP-FLOPS, SHIFT REGISTERS, COUNTERS and user-defined MACROS. Edge triggered or 2 phase clocks. Up to 40 user-defined, random, or binary input patterns. Simulation results displayed on CRT or printer. Accepts network descriptions from keyboard or from LOGIC DESIGNER for simulation. Specify 1000 gate version (48K required) or 500 gate version (32K required). Price including manual and demos. \$89.95

LOGIC DESIGNER: Interactive HI-RES Graphics program for designing digital logic systems. A menu driven series of keyboard commands allows you to draw directly on the screen up to 15 different gate types, including 10 gate shape patterns supplied with the program and 5 reserved for user specification. Standard patterns supplied are NAND, NOR, INVERTER, EX-OR, T-FLOP, JK-FLOP, D-FLOP, RS-FLOP, 4 BIT COUNTER and 4 BIT SHIFT REGISTER. User interconnects gates just as you would normally draw using line or graphics commands. Network descriptions for LOGIC SIMULATOR generated simultaneously with the CRT diagram being drawn. Drawing is done in pages of up to 20 gates. Up to 50 pages (10 per disc) can be drawn, saved and recalled. Lines crossing pages can be interconnected using any of the 50 page connectors. The ideal interactive LOGIC DESIGN SYSTEM. Specify 1000 gate (48K) or 500 gate (32K) system. \$89.95

MATHEMATICS SERIES: Complete Package \$49.95

NUMERICAL ANALYSIS: HI-RES 2-Dimensional plot of any function. Automatic scaling. At your option, the program will plot the function, plot the INTEGRAL, plot the DERIVATIVE, determine the ROOTS, find the MAXIMA and MINIMA and list the INTEGRAL VALUE. For 16K. \$19.95

MATRIX: A general purpose, menu driven program for determining the INVERSE and DETERMINANT of any matrix, as well as the SOLUTION to any set of SIMULTANEOUS LINEAR EQUATIONS. The program will handle up to 55 equations in 55 unknowns in 55 (48K Ram). Matrix parameters can be saved and retrieved using the program DISC I/O. Specify 55 set (48K), or 35 set (32K). \$19.95

3-D SURFACE PLOTTER: Explore the ELEGANCE and BEAUTY of MATHEMATICS by creating HI-RES PLOTS of 3-dimensional surfaces from any 3-variable equation. Disc save and recall routines for plots. Menu driven to vary surface parameters. Demos include BLACK HOLE gravitational curvature equations. Specify Disc (32K) or no disc (16K) version. \$19.95

ACTION ADVENTURE GAMES SERIES: Entire series \$49.95

RED BARON: Can you outfly the RED BARON? This fast action game simulates a machine-gun DOG-FIGHT between your WORLD WAR I BI-PLANE and the baron's. You can LOOP, DIVE, BANK or CLIMB in any one of 8 directions - and so can the BARON. In HI-RES graphics (16K). \$19.95

BATTLE OF MIDWAY: You are in command of the U.S.S. HORNETS' DIVE-BOMBER squadron. Your targets are the Japanese carriers, Akagi, Soryu and Kaga. You must fly your way through ZEROS and AA FIRE to make your DIVE-BOMB run. In HI-RES graphics (16K). \$19.95

SUB ATTACK: It's April, 1943. The enemy convoy is headed for the CORAL SEA. Your sub, the MORAY, has just sighted the CARRIERS and BATTLESHIPS. Easy pickings. But watch out for the DESTROYERS - they're fast and deadly. In HI-RES graphics (16K). \$19.95

SEND FOR FREE CATALOG - All programs run on Apple II with Disc and Applesoft ROM Card and require 32K RAM unless otherwise noted. Detailed instructions included. Orders shipped within 48 hours. Card users include card number. Add \$1.50 postage and handling with each order. California residents add add 6 1/2% sales tax. Make checks payable to:



SPECTRUM SOFTWARE

DEALER INQUIRIES WELCOMED P.O. BOX 2084 - SUNNYVALE, CALIFORNIA 94087 FOR PHONE ORDERS - 408-245-1415

stitute of Technology (MIT), Cambridge MA. MIT's program will cover principles of data-flow computer organization and programming language design and applications. Certain architectures will be covered and techniques discussed. Familiarity with languages and architecture is a prerequisite. The tuition is \$750. Living arrangements can be made through the school. Contact the Office of the Summer Session, Room E19-356, MIT, Cambridge MA 02139.

June 17-19

Data Comm, Palais des Expositions, Geneva, SWITZERLAND. Data communications and distributed-data processing are the main themes of this conference and exhibition. Software development and tools; computer languages; managing data-communications systems; and definitions, concepts, and applications of data communications and distributed-data processing are among the topics that will be covered in the conference.

For more information, contact Industrial and Scientific Conference Management Inc, 222 W Adams St, Suite 999, Chicago IL 60606.

June 16-27

Designing Microprocessor-Based Systems, Massachusetts Institute of Technology (MIT), Cambridge MA. This course is intended to give individuals with a technical background the ability to create cost-effective designs using microprocessors. Software techniques and hardware structures will be covered along with lab projects. Contact Francis F Lee, Professor of Electrical Engineering and Computer Science, Summer Session Office, MIT, Cambridge MA 02139, (617) 253-2598.

June 18-21

Association for Computational Linguistics, University

of Pennsylvania, Philadelphia PA. The meeting will cover theoretical and methodological problems of computational linguistics, speech acts, analysis of multisentence texts, dialogue, machine translation, and computational semantics. For further information contact Don Walker, Artificial Intelligence Center, SRI International, 333 Ravenswood Ave, Menlo Park CA 94025.

June 20-22

The Fifth Annual Computerfest, Franklin University, Columbus OH. Sponsored by the Midwest Affiliation of Computer Clubs, this is a gathering of interested hobbyists, professionals, and business-oriented computer users. Workshops and discussions are the main features of the conference. Contact James Crowley, 4008 Rickenbacker Ave, Columbus OH 43213.

June 23-27

The First World Conference on Transborder Data Flow Policies, Rome, ITALY. Legal and social implications, economic dimensions, regulatory environment, interdependence caused by global communications, and assessing the status of data flow developments are some of the topics that will be covered in this forum. Write to the Intergovernmental Bureau for Informatics, POB 10253, 00144 Rome, ITALY.

June 30-July 3

Electronic Music Workshop, New England Conservatory, Boston MA. A combination of demonstrations and hands-on workshops are part of this course involving synthesizers, computers, and related materials. Arp, Moog, Buchla, and EML synthesizers will be available. Studio techniques will be discussed and demonstrations offered. Contact Robert L Annis, Summer School 1980—Electronic Music, New England

Buy By Mail and Save!

COMPUTERS

INTERTEC SuperBrain®
 32K RAM \$2995 . . . \$2495
 64K RAM \$3345 . . . \$2695
 64K Quad, \$3995 . . . \$3395

NORTH STAR Horizon® 1
 32K Kit, List \$1999 . . . \$1579
 32K Assembled \$2695 \$2149

Horizon 2
 32K DD, Kit, \$2399 . . . \$1885
 32K DD, Assm, \$3095 \$2439
 32K QD, Kit \$2779 . . . \$2359
 32K QD, Assm, \$3595 \$2859

CROMEMCO
 System 3, 64K, \$6990 . \$5479
 System 2, 64K, \$3990 . \$3179
 Z-2, List \$995 . . . \$ 829

COMMODORE PET 16K \$849
APPLE 16K, List \$1195 \$979
TI-99/4, List \$1150 . . . \$985

ALTARI® 400, List \$630 \$489
 800 List \$1080 . . . \$839

DISK SYSTEMS

THINKER TOYS®
 Discus 2D, \$1149 . . . \$ 939
 Discus 2 + 2, \$1549 . . . \$1288

PRINTERS/TERMINALS

ANADEX DP-8000 . . . \$799
T.I. 810 \$1575

CENTRONICS 730-1 . . . \$639
 737, List \$995 . . . \$849

PAPER TIGER IDS-440 \$849
 with Graphics Option . \$949

INTERTUBE II, \$995 . . . \$729
P-E Bantam 550 \$789
SOROC 120 \$745
TELEVIDEO 912 \$789

FLOPPY DISKS, 5¼"
 box of 10 **SPECIAL \$29.95**

Most items in stock for immediate delivery, factory-sealed cartons, with full factory warranty. N.Y.S. residents add appropriate sales tax. Prices do not include shipping. VISA and Master Charge add 3%. COD orders require 25% deposit. Prices subject to change and offers subject to withdrawal without notice.

Computers Wholesale



P.O. Box 144
 Camillus, NY 13031
 (315) 472-2582



GRAND OPENING SALE

We've moved to a new location to better serve you
 (ALL ITEMS ARE IN STOCK NOW!)

NORTHSTAR DISCOUNTS!

	SALE	reg.
Quad Drive—Orig. Mfr. NEW	\$550	\$725
Dbl. Dens Drive—Orig. Mfr.—NEW	\$325	\$500
Horizon 32K 2 dbl. dens. drives (asmb.)	\$2750	\$3095
Horizon 32K 2 quad drives (asmb.)	\$3250	\$3595
Northstar T-SHIRTS (Blue, Orange, S,M,L,XL)	\$5	\$7

Full service facilities on our premises — service contracts available

DYSAN MINIDISKS FOR NORTHSTAR

107/1D 10 sector dbl. dens. 1 side	\$30	\$37
107/2D 10 sector dbl. dens. 2 side (Quad)	\$33	\$40

ANADEX PRINTERS The ultimate in reliability at affordable prices

DP-8000 80 column dot matrix, 115 cps.	\$825	\$995
DP-9500 132 column dot matrix, 115 cps.	\$1350	\$1650

Northstar Users Group now forming — call for details!

Prices good until July 15, but subject to change due to manufacturer increases to us — All items are new, with factory warranty.

DATEK Systems, Inc.

RETAIL STORE: 4786 Lee Highway, Arlington, Virginia 22207
 MAIL ORDERS: Box 4146, Arlington, Virginia 22204
 PHONE ORDERS AND INFORMATION: 703/243-3770
 VISA AND MASTERCARD ACCEPTED!

Call now for a quotation
 (312) 733-0497

U.S. ROBOTICS, INC.

1035 W. LAKE ST.

CHICAGO, ILL. 60607

The 550 BANTAM from Perkin-Elmer



\$799

All the features of the Hazeltine 1400 & LSI ADM-3A plus

- Upper/Lower Case
- 7x10 Character Matrix
- White or Black Characters
- Transparent Mode
- Addressable Cursor
- Tab Function
- Backspace Key
- Shiftlock Key
- Print Key
- Integrated Numeric Pad
- Editing Functions
- Extremely Compact: 15" W x 19" D x 14" H
- Silent fan-free operation

All products in stock!

LA34 DECwriter IV



\$1199

- Tabs
- 132 columns
- 10, 12, 13.2, 16.5 characters/inch
- 2, 3, 4, 5, 8 or 12 lines/inch
- Optional tractor feed
- 110 or 300 baud
- RS232C/ASCII
- Friction feed/up to 15" wide paper
- 9x7 dot matrix, impact printing
- Upper/lower case

Teletype Model 43 KSR \$1049

- 110 or 300 baud
- RS232C/ASCII
- Pin feed/8½" H x 11" W paper is perfect for filing and copying.

PENRIL 300/1200 MODEM Originate/Auto-Answer



\$799

- 0-300 or 1200 baud
- Bell 212A & 103/113 compatible
- 1 year warranty
- Stand alone
- RS232
- Full duplex over voice grade phone lines
- FCC certified for direct connection to phone lines via RJ11C voice jack (standard extension phone jack)



- 132 columns
- Upper/lower case, true descenders
- Dot matrix, impact printing

Connect your TRS-80, Apple or ANY other computer to the phone lines with the...

USR-330 Originate/Auto-Answer Modem



\$339

FCC certified for direct connection to phone lines via standard extension phone jack

- 0-300 Baud
- Bell 103/113 compatible
- Stand Alone
- RS232
- 1 Year Warranty
- Crystal Controlled
- State of the Art LSI circuitry
- 5 stage active filters

USR-310 Originate Acoustic Coupler



\$159

Conservatory, 290 Huntington Ave, Boston MA, (617) 262-1120.

JULY 1980

July

TRS-80 Interfacing and Application for Scientific Instrumentation and Motorola 6801 Single Chip Microcomputer Design, Interfacing and Applications, Virginia Tech Facility, Dulles Airport. These are hands-on workshops sponsored by Virginia Polytechnic Institute and State University. For more information, contact Dr Linda Leffel, CEC, Virginia Tech, Blacksburg VA 24061, (703) 961-5241.

July 1

IEEE Indy Microcomputer Show, Sheraton Motor Inn East, Indianapolis IN. There will be exhibits, demonstrations, and technical seminars

addressing all the applications of microcomputer systems. Contact Publicity Chairman, IEEE Indy Microcomputer Show, Naval Avionics Center, D/810, 6000 E 21 St, Indianapolis IN 46218, (317) 353-3047.

July 7-11

Computers and Related Products, Hyatt Regency Hotel, Seoul, SOUTH KOREA. This show is limited to approximately forty firms for exhibition. For details, contact Robert Wallace, Rm 6015A, US Dept of Commerce, Industry and Trade Commission, Washington DC 20230.

July 14-16

Diagnostic Software: Planning and Design, Sheraton-Lexington Motor Inn, Lexington MA. The seminar is for design, test, and diagnostic engineers. Design

examples, lectures, informal sessions, and programming are part of the course. The fee is \$450. Contact Professor Donald French, Institute for Advanced Professional Studies, One Gateway Center, Newton MA 02158.

July 14-18

SIGGRAPH '80, Seattle Center, Seattle WA. Panel discussions and readings will be included in this conference. The topics will include graphic displays, animation/dynamics, cartography, input techniques, video and color hardware, and more. For general information, write to SIGGRAPH '80, POB 88203, Seattle WA 98188.

July 22-24

Microcomputer Show, Wembley Center, London, ENGLAND. New products will be exhibited, along with presentations of papers. For information contact TMAC, 680 Beach St, Suite 428, San Francisco CA 94109.

August 12-14

Computer Graphics '80, Birmingham, ENGLAND. Computer Graphics '80 will bring together experienced users and specialists to present applications experiences and research findings. In addition to the conference, there will be an equipment exhibition and an animated film festival. To register, contact Paula Stockham, Online, Cleveland Rd, Uxbridge UB8 2DD, ENGLAND, phone Uxbridge (0895) 39262.

August 14-24

Electronics/China 80, Guangzhou (Canton), CHINA. This is the first exhibition of US electronic companies in the People's Republic of China. The United States-China Trade Consultants are the sponsors of the show. Products demonstrated will include circuit components, system elements, test instrumentation, product equipment, and materials. Details are available through Expoconsul Inc, Clapp and Poliak Inc, Princeton-Windsor Office Park, POB 277, Princeton Junction NJ 08550.

TERMINALS FROM TRANSNET

PURCHASE FULL OWNERSHIP AND LEASE PLANS

DESCRIPTION	PURCHASE PRICE	PER MONTH		
		12 MOS.	24 MOS.	36 MOS.
LA36 DECwriter II	\$1,695	\$162	\$ 90	\$ 61
LA34 DECwriter IV	1,295	124	69	47
LA120 DECwriter III KSR	2,495	239	140	90
LA180 DECprinter I	2,095	200	117	75
VT100 CRT DECscope	1,895	182	101	68
VT132 CRT DECscope	2,295	220	122	83
DT80/1 DATAMEDIA CRT	1,895	182	101	68
TI745 Portable Terminal	1,595	153	85	57
TI765 Bubble Memory Terminal	2,795	268	149	101
TI810 RO Printer	1,895	182	101	68
TI820 KSR Printer	2,195	210	117	79
TI825 KSR Printer	1,695	162	90	61
ADM3A CRT Terminal	875	84	47	32
QUME Letter Quality KSR	3,195	306	170	115
QUME Letter Quality RO	2,795	268	149	101
HAZELTINE 1410 CRT	875	84	47	32
HAZELTINE 1500 CRT	1,195	115	64	43
HAZELTINE 1552 CRT	1,295	124	69	47
DataProducts 2230 Printer	7,900	757	421	284
DATAMATE Mini Floppy	1,750	168	93	63

FULL OWNERSHIP AFTER 12 OR 24 MONTHS • 10% PURCHASE OPTION AFTER 36 MONTHS

ACCESSORIES AND PERIPHERAL EQUIPMENT

ACOUSTIC COUPLERS • MODEMS • THERMAL PAPER RIBBONS • INTERFACE MODULES • FLOPPY DISK UNITS

PROMPT DELIVERY • EFFICIENT SERVICE



TRANSNET CORPORATION

1945 ROUTE 22, UNION, N.J. 07083

201-688-7800

TWX 710-985-5485

AUGUST 1980

August 4-6

Data-Entry Management and Supervision Seminar, Chicago IL. Data-entry managers and supervisors will benefit from the techniques provided in this seminar. Topics will range from data-entry control techniques and improving data-entry operator productivity, to personnel communications and motivation. Contact MIC, 140 Barclay Center, Cherry Hill NJ 08034, (609) 428-1020.

August 23-24

Personal Computer Arts Festival, Philadelphia Civic Center, Philadelphia PA. Tutorials, seminars, musical performances, and graphic extravaganzas will be featured in this show. Computer musicians and artists have until July 1 to submit material for presentation. Contact PCAF '80, c/o Philadelphia Area Computer Society, POB 1954, Philadelphia PA 19105. ■

In order to gain optimum coverage of your organization's computer conferences, seminars, workshops, courses, etc, notice should reach our office at least three months in advance of the date of the event. Entries should be sent to: Event Queue, BYTE Publications, 70 Main St, Peterborough NH 03458. Each month we publish the current contents of the queue for the month of the cover date and the two following calendar months. Thus a given event may appear as many as three times in this section if it is sent to us far enough in advance.

A MCGRAW-HILL PUBLICATION

onComputing™

GUIDE TO PERSONAL COMPUTING

GETTING STARTED
What You Need And What It Will Cost

EQUIPMENT REVIEWS
TRS-80, Apple, Sorcerer and PET

Best-Selling Author
JERRY FOURNELLE
"Writing With A Microcomputer"

THE BINARY WORLD

Also...
**A PERSONAL
COMPUTER DIRECTORY**
**COMPUTER CLUBS:
WHO NEEDS THEM?**

Plus much much more
for the new computer user

When will the Personal Computer Explosion touch YOU?

Are you prepared for the explosive transformation? Right in your own home? Electronic mail. Personalized investment analysis. Foreign language tutorial. Home energy management. Robots. Computer music. Secretarial service. Diet and menu planning. And more, more, more.

onComputing™ the new McGraw-Hill quarterly, prepares you for the enormous changes coming during the

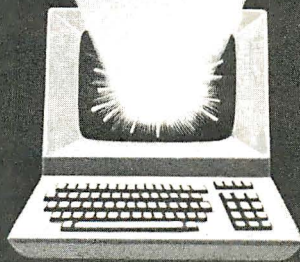

1980's (Some are already here), **onComputing™** explains in nontechnical language what personal computers are, how they work, and how you can use them at home, for fun and profit.

Don't let the personal computer explosion catch you off guard. Know what's happening and help make it happen! Prepare now for the exciting future with a subscription to **onComputing™!**

Call Toll-Free
800-258-5485

Start your
subscription today.

onComputing™ Subscription Dept. P.O. Box 307, Martinsville, NJ 08836

DOMESTIC subscription rate:

U.S. 1 yr. (4 issues) @ \$8.50 Canada & Mexico, 1 yr. (4 issues) @ \$10.00

FOREIGN (to expedite service, please remit in U.S. funds drawn on a U.S. bank.)

Europe (and all other countries, except above), 1 yr. @ \$12.00 — surface delivery.

Bill Visa Bill Master Charge Bill me (North America only)

Card Number

Expiration

Signature

Name (please print)

Street/Apartment Number

City

State/Province/Country Code

7B60

Please allow 6-8 weeks for processing.

Clubs and Newsletters

Southeastern Michigan Computer Organization (SEMCO)

The objective of SEMCO is to share ideas on programming, troubleshoot problems, and review new products. Meetings are held on the second Sunday of the month at the Ford Automotive Safety Center Auditorium at 7 PM in Detroit, Michigan. SEMCO's newsletter, *Data Bus*, is a monthly publication. Membership is \$10 per year. Contact SEMCO, POB 02426, Detroit MI 48202.

Rochester Area Microcomputer Society (RAMS)

RAMS, which has been in existence for nearly four years, meets on the second Thursday of each month in

room 1250 of the Science Building on the Rochester Institute of Technology campus. A RAMS' monthly meeting features a speaker plus reviews of products and news of interest. Their newsletter, *Memory Pages*, is published monthly. Membership in RAMS runs from October to September, and the dues are \$7.50. For details, write RAMS, POB 90808, Rochester NY 14609.

Homebrew Computer Club

This pioneering personal-computer club is based in Mountain View, California. They meet monthly on the second Thursday at the Sherman Fairchild Medical Center Auditorium in Stanford, California. Their newsletter contains reviews of products, programs in

different languages for all types of systems, bulletin board news, and more. To obtain information, contact Homebrew Computer Club, POB 626, Mountain View CA 94042.

Long Island Computer Association

The Long Island Computer Association is open to all computer users with interests in programming, applications, or related subjects. Dues are \$10 per year; members receive a newsletter called *The Stack*. There are groups for 8080 users, TRS-80 users, and 6502 users. The meetings feature guest speakers and reports on individual members' projects. *The Stack* includes reports of the meetings, want ads, computer store listings, pro-

grams, and more. Contact the club at 3788 Windsor Dr, Bethpage NY 11714.

Delaware Valley Computer Society

The Delaware Valley Computer Society (DVCS) is dedicated to the development and improvement of its members' programming and hardware skills on the TRS-80. Meetings are held at 8 PM on the third Thursday of each month at the Bristol Township Municipal Building, near Levittown, Pennsylvania. Recent meetings have included discussions of fast graphics programming in Level II BASIC, interfacing with the real world, assembly-language programming, and beginner's BASIC programming. DVCS publishes a newsletter six times a year.



**10%
DISCOUNT
Off
List**

64K 1 Drive
\$3499.00

AUTHORIZED

Radio Shack® DEALER A301

COMPUTER SPECIALISTS

Popular 16K Level II System	\$ 722.00
26-1145 RS-232 Board	84.00
26-1140 "O" K Interface	254.00
26-1160 Mini Disk	424.00
26-1171 Telephone Modem	169.00
Fast 100 CPS Centronics 730 Printer	750.00
Highly Reliable Lobo 5 1/4" Drives	375.00
Versatile Lobo Interface, 8" Drives and IMI Hard Drives.....	Call For Prices

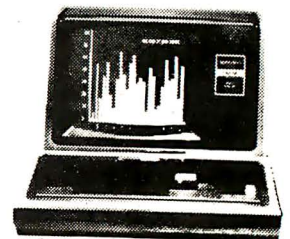

**15%
DISCOUNT
Off
List**

4K Level II
\$527.00

No Taxes on Out Of
State Shipments

Immediate Shipment
From Stock.

MICRO MANAGEMENT SYSTEMS, INC.
DOWNTOWN PLAZA SHOPPING CENTER
115 C SECOND AVE. S.W.
CAIRO, GEORGIA 31728
912-377-7120

Circle 157 on inquiry card.

Full Factory Warranty
on All Items Sold.

VISA, Master Charge
and COD's, Add 3%

**TRS-80
LEVEL II**

\$675 COMPLETE SYSTEM

Limited quantity in stock

The world's most popular microcomputer, with 16K of memory and Level 11 basic for only \$675, complete with full 90 day Radio Shack warranty. We accept check, money order or phone orders with Visa or MasterCard. (Shipping costs added to charge orders).

Disk drives, printers, peripherals, software and games . . . you name it, we've got it (Both Radio Shack & other brands). Write or call for our complete price list.



Shown is Level I. Level II includes Alphanumeric keypad.

**C&S
ELECTRONICS MART** Ltd.

AUTHORIZED DEALERSHIP **Radio Shack**

32 E. Main Street • Milan Michigan 48160 • (313) 439-1400

6809 S-100 ads™
SINGLE BOARD COMPUTER

- MEETS I.E.E.E. S-100 STANDARD
 - 10 addressing modes
 - 24 indexed sub modes
 - auto increment/decrement
 - constant indexing from PC
- 4K/8K/16K ROM • 2K RAM
ROM/RAM relocatable on 4K boundary
- ACIA; PIA; 8080 SIMULATED I/O
- 20 PARALLEL I/O LINES • 256 I/O PORTS
ACIA provides RS-232 lines for asynchronous communications with limited modem control at 8 selectable baud rates; I/O locatable at any 4K boundary
- COMPREHENSIVE MANUAL WITH SOFTWARE LISTINGS
- P.C. BOARD: SOLDERMASKED WITH PARTS LEGEND
P.C. Board & Manual \$69.95* + shipping
- adsMON: ADS MONITOR SUPPORTS BREAKPOINTS
User definable interrupt service & more.

Available in PROM, write for prices.
Illinois residents add sales tax. *add \$1.00 for shipping & handling

Ackerman Digital Systems, Inc.
110 N. York Rd., Suite 208, Elmhurst, Ill. 60126 (312) 530-8992

New Produced and widely used in England and U.S.A.
COMPLETE BUSINESS PACKAGE

INCLUDES EVERYTHING FROM INVENTORY TO SALES SUMMARY PROMPTS USER, VALIDATES EACH ENTRY, MENU DRIVEN

Approximately 60-100 entries/inputs require only 2-4 hours weekly and your entire business is under control.

PROGRAMS ARE INTEGRATED-

- 01 = ENTER NAMES/ADDRESS, ETC
- 02 = ENTER/PRINT INVOICES
- 03 = ENTER PURCHASES
- 04 = ENTER A/C RECEIVABLES
- 05 = ENTER A/C PAYABLES
- 06 = ENTER/UPDATE INVENTORY
- 07 = ENTER/UPDATE ORDERS
- 08 = ENTER/UPDATE BANKS
- 09 = EXAMINE/MONITOR SALES LEDGER
- 10 = EXAMINE/MONITOR PURCHASE LEDGER
- 11 = EXAMINE/MONITOR (INCOMPLETE RECORDS)
- 12 = EXAMINE PRODUCT SALES

SELECT FUNCTION BY NUMBER-

- 13 = PRINT CUSTOMER STATEMENTS
- 14 = PRINT SUPPLIER STATEMENTS
- 15 = PRINT AGENT STATEMENTS
- 16 = PRINT TAX STATEMENTS
- 17 = PRINT WEEK/MONTH SALES
- 18 = PRINT WEEK/MONTH PURCHASES
- 19 = PRINT YEAR AUDIT
- 20 = PRINT PROFIT/LOSS ACCOUNT
- 21 = UPDATE END MONTH FILES MAINTENANCE
- 22 = PRINT CASH FLOW FORECAST
- 23 = ENTER/UPDATE PAYROLL (NOT YET AVAILABLE)
- 24 = RETURN TO BASIC

WHICH ONE? (ENTER 1-24)

01 SUB. MENU EXAMPLE: 01 = EXAMINE: 02 = INSERT: 03 = AMEND: 04 = DELETE
05 = PRINT (1,2,3): 06 = NUMERIC COMBINATIONS: 07 = SORT
VERY FLEXIBLE. ADD YOUR OWN FUNCTIONS. EASY TO INTEGRATE.

All programs in BASIC for CP/M. PET. 6800

G. W. COMPUTERS LTD, the producers of this beautiful package in U.K.

WE EXPORT TO ALL COUNTRIES:
BARCLAYCARD ACCEPTED
CBM APPROVED

CALLERS BY APPOINTMENT ONLY
89 Bedford Court Mansions
Bedford Avenue
London WC1, U.K.

CONTACT TONY WINTER 01-636-8210
BARCLAYCARD ACCEPTED
CBM APPROVED

CP/M Ver. 9.00 is one 16 K core program using random access releasing both drives for data storage, and 250 word vocabulary is translatable in any foreign language.

CP/M Ver. 9.00 is one 16 K core program using random access releasing both drives for data storage, and 250 word vocabulary is translatable in any foreign language.

PRICES: Programs 1-23 EXC (19,20,22,23) £475

£575 Stock Integrated Option + £100 Bank Integrated Option + £100

SORCERER* SOFTWARE!

All programs on cassette. Only 8K of memory required.

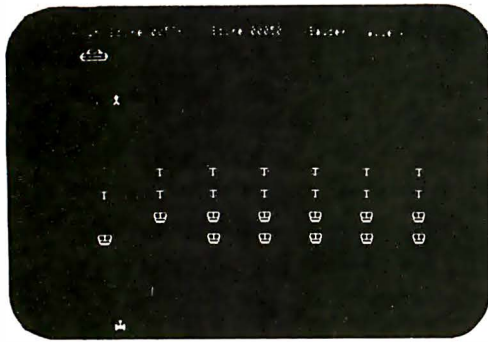

MARTIAN INVADERS™ by James Albanese. How long can you hold out against a persistent invasion force from Mars? Zap all the members of the landing party and another group comes after you. The longer you hold out, the higher your score. The Sorcerer's programmable graphics make this game look great, plus we've added special keyboard routines to really zip it up. Written in machine language. **\$14.95**

NIKE II™ by Charles Finch and Bob Broffel. You may never get your computer back from your kids once they start playing Nike II. The object is to destroy enemy bombers by firing Nike missiles at them. If you miss the bombers, they bomb your factories and return for a second pass. Nine levels of play make this game a challenge for everyone. Written in machine language. **\$11.95**

TANK TRAP by Don Ursem. An action game that combines skill, strategy, and luck. A rampaging tank tries to run you down. You are a combat engineer, building concrete barriers in an effort to contain the tank. Four levels of play make this animated game fun for everyone. Written in BASIC with machine language subroutines. **\$11.95**

DPX™ (Development Pac Extension) by Don Ursem. Serious Z80 program developers will find this utility program to be invaluable. Move the line pointer upward. Locate a word or symbol. Change a character string wherever it occurs. Simple commands allow you to jump directly from EDIT to MONITOR or DDT modes and automatically set up the I/O you want for listings. Built-in serial printer driver. Stop and restart listings. Abort assembly with the ESC key. Save backup files on tape at 1200 baud. Load and merge files from tape by file name. Versions for 8K, 16K, 32K, and 48K Sorcerer. Requires Exidy Development Pac. **\$29.95**

QS SMART TERMINAL by Bob Pierce. Convert your Sorcerer to a smart terminal. Used with a modem, this program provides the capability for you to communicate efficiently and save connect time with larger computers and other microcomputers.

The program formats incoming data from time-sharing systems such as The Source for the Sorcerer Video. Incoming data can be stored (downloaded) into a file in RAM. Files, including programs, may be saved to or loaded from cassette, listed on the video, printed, transmitted out through your modem, or edited with an onboard text editor. The text editor includes commands to delete and insert lines and to find or change character strings. Many other features are included, and all features are thoroughly documented. **\$49.95**

PLOT by Vic Tolomei. High res and low res modes. **\$14.95**

SHAPE MAKER™ by Don Ursem. An on-screen character maker. **\$14.95**

DEBUG by Bob Pierce. Debug machine language programs. **\$14.95**

Z80 DISASSEMBLER by Vic Tolomei. Decode machine language programs. **\$14.95**

FASTGAMMON™ by Bob Christiansen. A fast backgammon opponent. **\$19.95**

MAGIC MAZE™ by Vic Tolomei. A challenging maze game. **\$11.95**

SOFTWARE INTERNALS MANUAL FOR THE SORCERER by Vic Tolomei. A must for anyone writing software for the SORCERER. Seven chapters. Indexed. Includes diagrams and software routines. 64 pages. **\$14.95**



QUALITY SOFTWARE

6660 Reseda Blvd., Suite 103, Reseda, CA. 91335
Telephone 24 hours, seven days a week: (213) 344-6599

WHERE TO GET IT: Ask your nearest Sorcerer dealer to see *Quality Software's* Sorcerer programs. Or, if you prefer, you may order directly from us. MasterCard and Visa cardholders may telephone their orders and we will deduct \$1 from orders over \$19 to compensate for phone charges. Or mail your order to the address above. California residents add 6% sales tax. *Shipping Charges:* Within North America orders must include \$1.50 for first class shipping and handling. Outside North America the charge for airmail shipping and handling is \$5.00 — payable in U.S. currency.

*The name "SORCERER" has been trademarked by Exidy, Inc.

Membership dues are \$12 per year. For information, contact DVCS, POB 651, Levittown PA 19058.

Apple's Contact 6 Newsletter

This newsletter is published by Apple Computer Inc, 10260 Bandy Dr, Cupertino CA 95014. It contains articles on programs, hardware, and other related items produced by the company. There is an editorial section and letters from Apple II owners and users. The newsletter also has product reviews of equipment for the Apple that is manufactured by other companies. Every issue includes valuable program listings for the Apple.

New York Amateur Computer Club

The New York Amateur Computer Club is an organization to promote the exchange of information about computers for personal use and to encourage fellowship among those interested in computing. General meetings are held once a month, normally on the second Thursday. Several specialized user groups also meet on a monthly basis. Club dues are \$10 per year which includes a newsletter. For information, write to the club at POB 106, Church St Sta, New York NY 10007.

Newsletter for Texas Instruments' Programmable Calculator Users

The Texas Instruments Personal Programmable Calculator Club and its newsletter, *TI PPC Notes*, will continue coverage of all TI programmable calculators formerly covered by *52-Notes*. The new format will be mainly concerned with practical programming aids and routines. Active member participation is encouraged. Write TI PPC

Club, Maurice E T Swinnen, 9213 Lanham Severn Rd, Lanham MD 20801.

Software Management Newsletter

Salt 'n' Pepper is a quarterly newsletter dealing with software management issues. An article in a recent issue entitled "Cost Effectiveness: A Challenge for OEMs" suggests that a higher degree of specialization and creativity will characterize successful original equipment manufacturers (OEMs) in the 1980s. Another article gives reasons for software products firms to consider offering a processing service. Other topics have included industry trends in software maintenance and software pricing. Subscriptions are \$35 per year from Culpepper and Associates Inc, 4922 Heatherdale Ln, Atlanta GA 30360. ■

BYTE's Bits

An Othello Tournament for Humans and Computers

An Othello tournament is going to be held at Northwestern University on June 19. A one-day competition of three rounds is planned. There will be eight players: two or three humans and five or six computer programs. David Levy's program will run on a Commodore PET. Professor Peter W Frey of Northwestern University is sponsoring the event. He will be running his second-generation Othello program on either an Apple or a TRS-80 personal computer. Fidelity Electronics has been invited to enter their new Reversi Challenger. The Carnegie-Mellon program, as described in *Scientific American*, will be entered by Hans Berliner. Jonathan Cerf, the US national

Othello champion, may also compete in the event. BYTE magazine is going to co-sponsor the event. Contact Professor Peter W Frey, Cresap Neuroscience Laboratory, 2021 Sheridan Rd, Evanston IL 60201, (312) 492-7405.

Call for Papers on Computer Simulation

Papers are being solicited for the 1981 Summer Computer Simulation Conference to be held July 21 to 23, 1981, in Washington DC. The conference theme is "Simulation: Foundations and the Future." A 500-word summary or complete drafts of original papers must be submitted by November 15, 1980 to L G Culhane, The Mitre Corp, 1820 Dolley Madison Blvd, McLean VA 22102, (703) 827-6447.

The major areas of interest include simulation methodology, chemical sciences, biomedical systems, energy, system engineering, and special topics. Some other areas of special interest are government applications; simulation applications in sports, television, games, and movies; and microcomputer applications.

Call for Papers, Industrial Control

Papers are being solicited for the 1981 International Conference on the Application of Microcomputers to Industrial Control in the area of general systems to be held in Calcutta, INDIA. Hardware, software, and operational experience should be covered. A 300- to 600-word abstract is required by August 22, 1980. The full paper should not exceed twelve 8½- by 11-inch double-spaced pages. Three copies of the abstracts and papers are required. The deadline for the paper is September 26, 1980. Address material to Dr Sushil Dasgupta, Professor and Head of the Electrical

Engineering Dept, Jadavpur University, 40B, Southern Ave, Calcutta-700029, INDIA.

The 1981 International Conference on Microcomputer Applications to Industrial Control will be held February 14 to 16 at Jadavpur University in Calcutta.

The First Annual National Conference on Artificial Intelligence

Recently we received a letter from Louis G Robinson, the conference coordinator of the American Association for Artificial Intelligence (AAAI). He wanted BYTE readers to know that the First Annual National Conference on Artificial Intelligence will be held at Stanford University August 19, 20, and 21st, 1980.

The AAAI is headed up by professor Allen Newell of Carnegie-Mellon University and professor Edward A Feigenbaum of Stanford University. The AAAI is intended to serve as a vehicle for communication among researchers in the US artificial intelligence community. This communication will be accomplished through two means. One means will be a magazine-format publication produced by the organization and the other will be an annual US artificial intelligence conference.

The first of these conferences is the 1980 Conference this August. The activities during the conference will include a one-day tutorial examining the current state of the art of US artificial intelligence to be held on August 18th at Stanford University. We are sure that many of our readers will be interested in attending this tutorial, to say nothing of the formal conference sessions on August 19, 20, and 21. We know that the AAAI will be an important, vital organization within the computer-science community during the years to come. ■

More Printing Terminals From MICROMAIL



DIABLO 1650

- Prints at 40 cps, using 88, 92, or 96 char. metalized printwheels.
- Vertical resolution 1/48"; Horizontal 1/120". Capable of proportional spacing, bidirectional printing, and graphics under software control.
- Bidirectional normal and direct tabs. Left, right, top and bottom margins.

**R.O. \$2890.00
KSR \$3285.00**

DIABLO 1640

- Uses plastic printwheel and prints at 45 cps. Otherwise, shares identical features with 1650 including:
 - Friction or tractor feed, up to 15" wide.
 - Cartridge ribbon, fabric or carbon.

**R.O. \$2745.00
KSR \$3140.00**

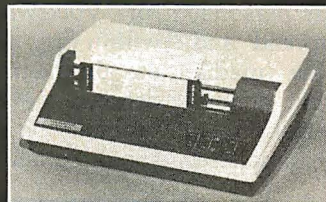

T.I. 810

- Includes upper/lower case option.
- Bidirectional printing at 150 cps.
- Tractor-feed forms, 3" to 15" wide.

\$1599.00

- Options:
- Forms length control — \$100.00
 - Vertical Format Control with Compressed Print — \$125.00

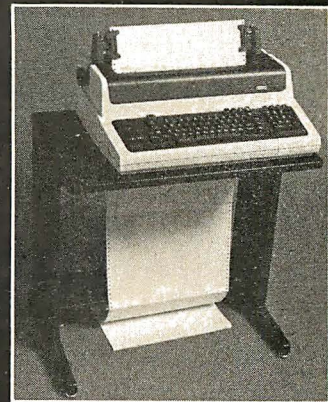

DEC LA 34

(Shown with optional forms tractor and numeric keypad).

- Prints 10, 12, 13.2, or 16.5 characters per inch, upper/lower case.
- 2, 3, 4, 6, 8, or 12 lines per inch.
- Friction feed, paper width to 15 inches.

\$999.00

- Options:
- Numeric keypad — \$80.00
 - Adjustable forms tractor — \$130.00

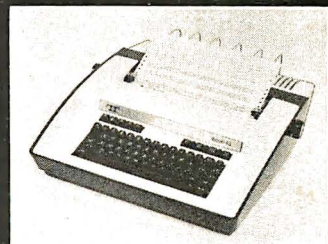

TELETYPE 43

- Prints 132 columns, upper/lower case with true descenders.
- 30 character/second print speed. 110-300 baud.
- Uses 12" wide by 8.5" pinfeed paper.
- Print position scale, paper guide and supply rack.

\$999.00

We Also Represent the Following Manufacturers:

SOROC TEC GTC

Write or Call In for Our Free Catalogue!



TO ORDER: Send check or money order to: MICROMAIL, P.O. Box 3297, Santa Ana, CA 92703. Personal or company checks require two weeks to clear. Terminals in stock are shipped the business day after receipt of certified funds. All equipment includes factory warranty.

SHIPPING: We ship freight collect by UPS when possible. Larger terminals are shipped by motor freight. Air and express delivery is available on all products.

Circle 162 on inquiry card. →

Interpersonalized Media: What's News?

James A Levin
The Communications Program
University of California, San Diego
La Jolla CA 92093

We are in the midst of a major change in the ways that we communicate. This change will affect many areas of our lives—the ways we are informed, educated, and entertained; the ways we interact with friends, organizations, and the world. New communication media are arising from the grass roots as personal computers become widespread and are interconnected. These media allow new possibilities for interactive, personalized communication, so I will call them interpersonalized media.

Already there are small-scale efforts to interconnect personal computers via telephone lines. There are several national personal-computer networks and many local computer "bulletin board" systems, five in the San Diego area alone. These developments will lead to such radically modified institutions as personalized news, classroomless education, and interactive soap operas. In this article, I will focus on the influence of these new media on the interchange of information that constitutes news.

About the Author

Jim Levin is a cognitive scientist interested in the implications of computer-mediated communications for the people involved. He teaches in The Communications Program and pursues research in the Laboratory of Comparative Human Cognition at the University of California, San Diego.

Personalized News

Imagine your own personal news staff, preparing a report every day on only those topics that you have expressed interest in: political news concerning Ghana, reports of advances in alternate energy sources, sports news about certain teams, want ads for Volkswagen Rabbits for sale within fifty miles for less than \$3000, etc. By the time you specified a fairly detailed news profile, you would probably be receiving a unique, personalized news report.

If the current decrease in the cost of computation and data storage continues, a system for distributing personalized news will soon be economically feasible.

Is this concept of personalized news a notion for some distant time in the future? No. The requirements for such a system are quite minimal and well within current capability. A prototype for parts of such a system exists at the Artificial Intelligence Laboratory at Stanford University, where the daily Associated Press wire contents are stored by a computer, and users are notified of stories that match their specified news profile.

The details of storing, indexing, and retrieving large amounts of text have been worked out well. (However, the retrieval techniques are not foolproof. One user at Stanford, interested in dolphin research, asked to see all stories containing the word "dolphin." He was then puzzled that he was being notified of all the Monday morning football-score summaries, until he noticed the stories had the scores for the Miami Dolphins!)

The barrier to such systems has been economic—the costs of storage, computation, and communication have been too high to challenge the existing mass-distributed media of television, radio, and newspaper news. However, the cost of all three factors is rapidly dropping, and if the current decreases continue, a system for distributing personalized news will soon be economically feasible. (See the economic analysis by Panko in reference 11 for first-class business mail, for instance.) This development is especially likely when the interactive information system is integrated into a broader system for entertainment, education, and commercial interactions.

Electronic Mail

Electronic mail is an almost accidental development of interactive computer networks, but it may become the most significant use of computers in our everyday lives. It

8088 S100 CPU

Want to upgrade your 8 bit system to a 16 bit system? Don't want to discard your 8 bit boards? The **LDP88** offers 10 to 20 times the processing power of your present CPU while retaining compatibility with your 8 bit memory and peripherals. The **LDP88** is a single board computer with complete **IEEE S100** bus compatibility. The board has the following features:

- Up to 8K bytes of ROM/EPROM
- 1K bytes static RAM
- 8 vectored interrupts
- Serial I/O port
- 16 bit instruction set
- **8086** software compatibility
- Address up to 1 Megabyte of memory

PRICE: \$399.99 (assembled and tested)

Serial monitor for CRT or TTY: \$79.99
(Mass. residents add 5% sales tax)

See your March and April **BYTE** for Steve Ciarcia's articles about the 8088.

To order send check or money order to:

Lomas Data Products
11 Cross Street
Westborough, MA 01581
Telephone: (617) 366-4335

813-485-3559

**NEED IT FAST?
AT A FAIR PRICE?
WITH SUPPORT?**

	LIST PRICE	OUR PRICE
Cromemco System II (64K. Two 160K disks)	\$3995	\$3292
Vector Graphic 64KZ	975	796
Dynabyte DB8/4-22	4195	3499
Nec 5515 Spinwriter	3200	2550
Thinker Toys		
16K Memory Master	399	345
Zenith WH 19	995	895
Word-Star	445	375
Microsource Timekeeper	595	499
Invmaster—Inventory w/A/R	1595	995

Send ad for free catalog.

SARA TECH
P.O. Box 692 • Venice, FL 33595

BUILD YOUR COMPUTER BREADBOARDS & INTERFACES FASTER AND EASIER WITH NEW VECTOR PLUGBORDS

EASY TO USE!

COST EFFECTIVE!

CLEAN HOLES!

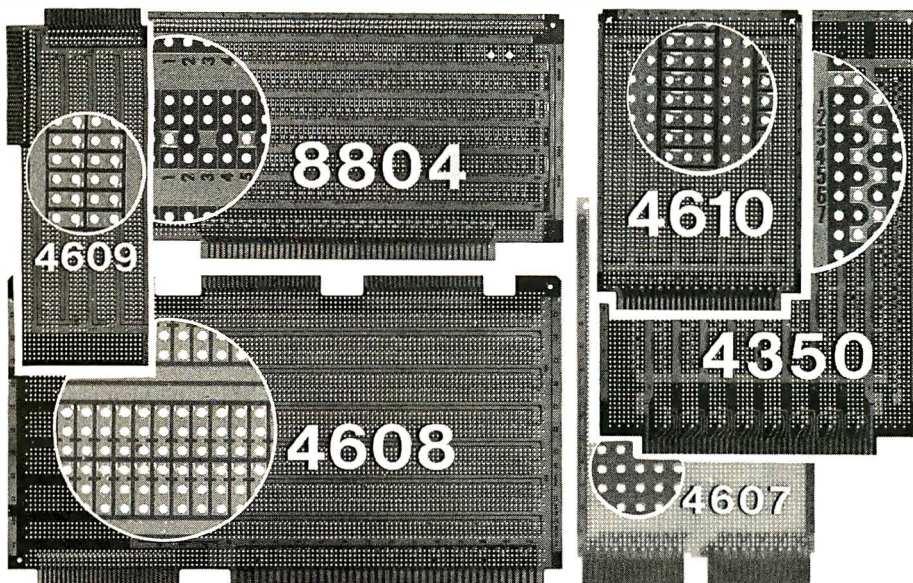

4610 Series - For STD-BUS-WW, solderable and unpatterned models

4608 Series - For Intel/National SBC/BLC 80-WW/ solderable, or unpatterned

8804 Series - For S100 - 5 models available

4607 - For DEC LSI 11/ PDP8-11, Heath H-11

4609 - For Apple II, SuperKim, Pet Commodore with Expandamem

4350 - For TI 980 Computer



Vector Electronic Company INCORPORATED

12460 Gladstone Ave., Sylmar, CA 91342 (213) 365-9661 TWX (910) 496-1539
Available through Distributors or Factory Direct if not available locally.

74801

FREE THE HOSTAGES!

Ten humans, including the beautiful Delilah, are being held hostage by the High Tollah. Who are the High Tollah? They're fiends who are secreted in a moon base, in the star system of Rigel, on the fringe of human-occupied space. Their leader, Sha Tollah, was deposed. And rather than face the Tollah's revenge for his excesses while in power, he took refuge in the Stellar Union. In a fit of vengeful fury, the Tollah grabbed the humans off the planet of Ultima Thule and are holding out for an exchange—return the Sha Tollah or the humans will die, including Delilah.

You'll rescue the hostages and have Delilah for your very own in this exciting REALTIME computer game from Automated Simulations. You'll destroy armed aliens and hostile creatures in an unexplored environment—60 chambers in the convoluted layers of the Tollah moon base. Find the rooms in which each hostage is held. Find Delilah.

But HURRY! Your vital powerpack is being depleted and you still have to beam each hostage up to your gunboat in orbit.

If you have a PET, TRS-80 or an APPLE, you can play "RESCUE AT RIGEL". You'll destroy the Tollah, and Delilah will be yours.

Ask your dealer or rush \$19.95 (for cassette) or \$24.95 (for TRS-80 or APPLE disk) to us. Please add \$1.00 shipping and handling. California residents add 6% sales tax. Be sure to tell us if you have a PET 32K, TRS-80 16K or APPLE 48K (APPLESOFT). Or, call our FANTASY LINE toll free, 800-824-7888, Operator 861 to order and to tell us what other fantasies you would like to touch. (California, 800-852-7777, Operator 861).

Automated Simulations, Dept. CT3
P.O. Box 4232, Mountain View,
CA 94040.



GUARANTEE:

If not completely satisfied,
send "RESCUE AT RIGEL"
back in 10 days for a full refund.

Game includes 32-page illustrated
game booklet, command card and
program and data file on cassette
or disk.



began as interactive users of large computers needed ways to communicate with other users. Initially, mechanisms were developed to allow one person to type text that immediately appeared on the terminal of another user. However, these communication mechanisms could be used only if the other person was using the computer system at the same time.

Computer-mail systems were the next development, through which one user could type an entire message, to be seen by the other user whenever he or she next used the system. Since then, computer-mail systems have grown in power (and thus in convenience of usage) until they are now used even by people unable or unwilling to use computers for programming.

In the few organizations where they have been available for general use, electronic-mail systems have become a major communication medium. They are assuming much of the load previously carried by written memos and telephone calls, and even some of the interaction previously carried out face to face. For example, I have been using an electronic-mail system at the University of California, San Diego (UCSD) called MSG (which will be described in more detail later). Over the course of the five days before I wrote this, I received fourteen messages on this system. Two of these were directed specifically to me; two had been written to another person with a copy sent to me. Two more were directed to me as a member of a defined group of nine people, all concerned with a particular problem. This ability to send messages to a defined group of people easily allows these mail systems to be used for *teleconferencing* (described later).

The remaining eight messages were addressed to a group called "all," a group consisting of all thirty-seven users of this computer system. We can say that such messages are posted on an *electronic bulletin board*. But such use also leads to a potential problem, especially for systems involving a large number of people—the widespread distribution of electronic junk mail.

EVERY TRS-80* MODEL II NEEDS

DataBank

Data Management & Reporting System

Configure it ... to what YOU want to do!

Inventory/Accounting Data
Mailing/Membership lists
School/Student Records
Patient/Client Files

DataBank includes:

1. Configuration Utilities
2. File Management Program
3. Report Generator
4. User Subroutines
5. Complete Documentation

Call or write:

DATA ACCESS CORPORATION

4221 Ponce De Leon Blvd.
Coral Gables, FL 33146
(305) 446-0669



*TRS-80 is a registered trademark of Radio Shack

DISCOUNT SOFTWARE

CP/M®

OSBORNE AND ASSOC.
business software in CBASIC-2

# General Ledger	} \$59/\$19 each
# Acct. Rec./Acct. Pay.	
# Payroll w/Cost Acct.	
Buy 2 get 1 free	\$118/\$57
All 3 plus CBASIC-2	\$199/\$71

CBASIC-2® \$89/\$14

DIGITAL RESEARCH
CP/M® 2.2 for TRS-80® Model II \$149/\$24
CP/M® 2.2 for Northstar \$149/\$24

WORDSTAR by MicroPro \$399/\$24

WHITESMITHS
**"C" Compiler \$600/\$29
*Pascal (includes **"C") \$750/\$44

*SELECTOR III-C2 \$269/\$19

PEACHTREE business software
in Microsoft BASIC source code.

† General Ledger	} \$399/\$65 each
† Acct. Rec.	
† Acct. Pay.	
† Payroll	
† Inventory	\$1995/\$349
All 5 plus WORDSTAR	

TRS-80® MODEL II

CP/M® 2.2
Latest Version \$149

ELECTRIC PENCIL II
Standard Printer \$249
Diablo, Qume, NEC \$279

APPLE II®

VISICALC® by Personal Systems... \$122

VISA • MASTERCHARGE
ORDERS ONLY — CALL TOLL FREE
1-800-854-2003 ext. 823A
Calif. 1-800-522-1500 ext. 823A

For information write or call:

THE DISCOUNT SOFTWARE GROUP
1610 Argyle Ave., Bldg. 102
Los Angeles, CA 90028
(213) 461-3127

CP/M users: specify disk systems and formats.
Most formats available.

Add \$2.50 postage and handling per each item.
California residents add 6% sales tax.
Allow 2 weeks on checks. C.O.D. ok

Prices subject to change without notice.
All items subject to availability.

* — Special Bonus with order † — Requires CBASIC-2
‡ — Requires Microsoft BASIC ® — Mfgs. Trademark

P.S. — We want to be your software source. Give us the opportunity to beat any nationally advertised price!

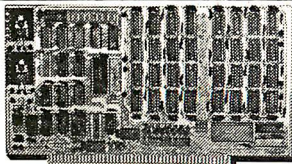

64K BYTE EXPANDABLE RAM

DYNAMIC RAM WITH ON BOARD TRANSPARENT REFRESH GUARANTEED TO OPERATE IN NORTHSTAR, CROMEMCO, VECTOR GRAPHICS, SOL, AND OTHER 8080 OR Z-80 BASED S100 SYSTEMS *4MHZ Z-80 WITH NO WAIT STATES.

- * SELECTABLE AND DESELECTABLE IN 4K INCREMENTS ON 4K ADDRESS BOUNDARIES.
- * LOW POWER—8 WATTS MAXIMUM.
- * 200NSEC 4116 RAMS.
- * FULL DOCUMENTATION.
- * ASSEMBLED AND TESTED BOARDS ARE GUARANTEED FOR ONE YEAR AND PURCHASE PRICE IS FULLY REFUNDABLE IF BOARD IS RETURNED UNDAMAGED WITHIN 14 DAYS.

	ASSEMBLED / TESTED
64K RAM	\$595.00
48K RAM	\$529.00
32K RAM	\$459.00
16K RAM	\$389.00
WITHOUT RAM CHIPS	\$319.00

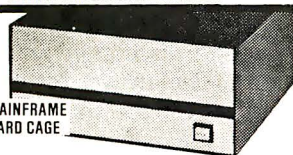

S100 MAINFRAME
AND CARD CAGE

- * W/ SOLID FRONT PANEL \$239.00
- * W/ CUTOUTS FOR 2 MINI-FLOPPIES \$239.00
- * 30 AMP POWER SUPPLY \$119.00
- * 8 SLOT MOTHERBOARD \$149.00
- * 19 SLOT MOTHERBOARD \$199.00



VISTA V-200 MINI-FLOPPY SYSTEM

- * S100 DOUBLE DENSITY CONTROLLER
 - * 204 KBYTE CAPACITY FLOPPY DISK DRIVE WITH CASE & POWER SUPPLY
 - * MODIFIED CPM OPERATING SYSTEM WITH EXTENDED BASIC
- \$695.00
* EXTRA DRIVE, CASE & POWER SUPPLY \$395.00

16K X 1 DYNAMIC RAM

- THE MK4116-3 IS A 16,384 BIT HIGH SPEED NMOS, DYNAMIC RAM. THEY ARE EQUIVALENT TO THE MOSTEK, TEXAS INSTRUMENTS, OR MOTOROLA 4116-3.
- * 200 NSEC ACCESS TIME, 375 NSEC CYCLE TIME.
 - * 16 PIN TTL COMPATIBLE.
 - * BURNED IN AND FULLY TESTED.
 - * PARTS REPLACEMENT GUARANTEED FOR ONE YEAR.
- \$8.50 EACH IN QUANTITIES OF 8

BETA COMPUTER DEVICES

1230 W. COLLINS AVE.
ORANGE, CA 92668
(714) 633-7280

Calif. residents please add 8% sales tax. Mastercharge & Visa accepted. Please allow 14 days for checks to clear bank. Phone orders welcome. Shipping charges will be added to all shipments.

32K BYTE MEMORY RELIABLE/COST EFFECTIVE EXPANDABLE RAM FOR 6502 AND 6800 SYSTEM—AIM 65-KIM*SYM*PET*544-BUS

- * PLUG COMPATIBLE WITH THE AIM-65/SYM EXPANSION CONNECTOR BY USING A RIGHT ANGLE CONNECTOR (SUPPLIED) MOUNTED ON THE BACK OF THE MEMORY BOARD.
- * MEMORY BOARD EDGE CONNECTOR PLUGS INTO THE 6800 S 44 BUS.
- * CONNECTS TO PET OR KIM USING AN ADAPTOR CABLE.
- * RELIABLE—DYNAMIC RAM WITH ON BOARD INVISIBLE REFRESH—LOOKS LIKE STATIC MEMORY BUT AT LOWER COST AND A FRACTION OF THE POWER REQUIRED FOR STATIC BOARDS.
- * USES +5V ONLY, SUPPLIED FROM HOST COMPUTER.
- * FULL DOCUMENTATION, ASSEMBLED AND TESTED BOARDS ARE GUARANTEED FOR ONE YEAR AND PURCHASE PRICE IS FULLY REFUNDABLE IF BOARD IS RETURNED UNDAMAGED WITHIN 14 DAYS.

ASSEMBLED WITH 32K RAM	\$419.00
& WITH 16K RAM	\$349.00
TESTED WITHOUT RAM CHIPS	\$279.00
HARD TO GET PARTS (NO RAM CHIPS)	
WITH BOARD AND MANUAL	\$109.00
BARE BOARD & MANUAL	\$49.00

PET INTERFACE KIT—CONNECTS THE 32K RAM BOARD TO A 4K OR 8K PET. CONTAINS: INTERFACE CABLE, BOARD STANDOFFS, POWER SUPPLY MODIFICATION KIT AND COMPLETE INSTRUCTIONS. \$49.00

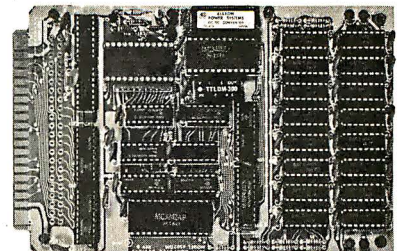

GET IT OFF THE FLOOR

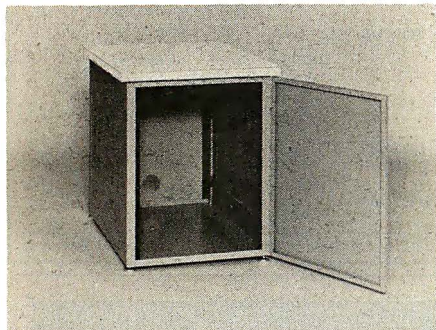
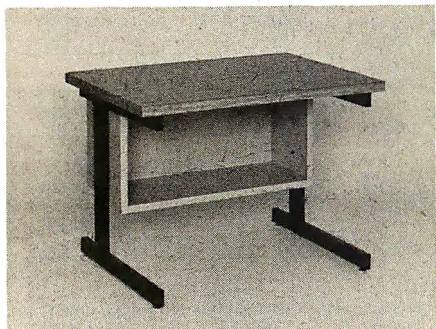

Now that you have a shiny new computer terminal, what are you going to put it on? Computer Furniture and Accessories makes a variety of furniture for a wide range of computer applications. In combinations of six widths, three depths, and three heights. With "L" shaped returns, Micro shelves, data shelves, RETMA mounting, and printer stands. With optional drawers, doors, CRT turntables, and casters. Sizes, shapes and colors designed to fit your office or computer room environment. Reasonably priced and shipped from stock.

Call CF&A. We'll get your system up where you can really put it to use.

CF&A

Computer Furniture and Accessories, Inc.
1441 West 132nd Street
Gardena, CA 90249
(213) 327-7710

One unexpected property of text teleconferences is the tendency for multiple streams of conversation to form and flow in parallel.

Electronic Bulletin Boards

The use of electronic bulletin boards has already spread through the personal-computing community. A student of mine, Mary Loughran, discovered five electronic bulletin-board systems in operation in the San Diego area as of June 1979; two local "nodes" of nationwide bulletin-board systems, and three systems set up by individuals.

Electronic Junk Mail

The problem of electronic junk mail is a major issue for these bulletin-board systems, one that becomes critical for a widespread electronic-mail system. People get upset if they get a lot of junk mail. Fortunately, personal computers give us a direct way to deal with this problem—we can design and use electronic junk-mail "filters," programs that preprocess our electronic mail and systematically discard recognized junk mail. For example, if every message I have ever received from Bill Smith has not been worth reading, I can program my mail filter to automatically discard any messages from him.

As such junk-mail filters become widely used, general announcements (advertisements) will become more sophisticated, so that announcements are targeted only to people that are genuinely interested in them (or else are disguised as interesting messages). We can predict several rounds of action and counteraction like this within an electronic-mail system—beyond that, the system is likely to evolve into novel, currently unpredictable forms.

Teleconferences

Another mode of electronic interaction is the *teleconference*, which draws an analogy to more conventional, face-to-face meetings. Early computer teleconferencing systems had a chairman who assigned the

floor to a speaker (who was then allowed to type in text that everyone else in the teleconference saw, until either he or she relinquished the floor or the chairman reclaimed it).

However, it was soon discovered that this new medium does not require a "floor" since many people can enter text simultaneously. More important, the participants do not even have to be simultaneously involved—the "tele-" aspect was then extended to mean "remote in time" as well as "remote in space." In this way, the non-real-time teleconference was born.

You may ask, "Why bother with computer-text conferences if you can just arrange a meeting or even a conference phone call?" First of all, anyone who has tried to arrange a meeting time for even a small number of busy people knows how difficult it is to find a common free time. This problem is aggravated by differing time zones; in arranging a conference telephone call that includes people from both the east coast and the west coast of the United States, you have only four hours during which both sets of people are normally available during the working day. Between London and Los Angeles there is only a one-hour window, and for much of the world there is no overlap at all.

Even when there is a considerable overlap, even a normal two-person phone call is not easy to conduct. You call the other person; she is in a meeting, so you leave a message; she returns the call an hour later only to find that you are in a meeting, and so on. I have gone as many as five rounds like this to establish communication, even when I have known I was not getting a "tele-runaround." In addition, the interruption of another phone call is amazingly disruptive—have you ever been able to finish a coherent thought when your phone rings?

But you might wonder, "Isn't a non-real-time teleconference a stilted, artificial, and ineffective way of conducting discussion or decision making?" The answer to this seems to be (1) yes, at the start, and (2) no, not after the participants acquire some experience with this new medium. A number of transcripts from different types of text teleconferences that seemed to work for the participants quite smoothly and effectively are

CP/M® SOFTWARE TOOLS

NEW ED-80 TEXT EDITOR

ED-80 offers a refreshing new approach for the creation and editing of program and data files conversationally—and it saves you money. Its powerful editing capabilities will satisfy the most demanding professional—yet it can still be used by the inexperienced beginner.

Look at These Outstanding Features:

- FULL SCREEN window displays with forward and backward scrolling for editing your data a page-at-a-time, rather than line-by-line.
- Provides you with all the features found on the large mainframe and minicomputer editors, such as IBM, UNIVAC, CDC, and DEC.
- Commands include forward or backward LOCATE, CHANGE, and FIND; and INSERT, DELETE, REPLACE, APPEND, SAVE, PRINT, WINDOW, MACRO, TABSET, SCALE, DUMP, and others.
- Compatible with existing CP/M edit and textformatted files, with CBASIC, and with Microsoft's MBASIC, FORTRAN, COBOL, and ASSEMBLER.
- CHANGE commands allow you to make conditional changes and to use variable length strings.
- Designed for CP/M and derivative operating systems, including LIFEBOAT, CDOS, IMDOS, DOS-A, ADOS, etc.
- GET and PUT commands for concatenating, moving, duplicating, and merging your edit files on the same or different diskettes.
- Provides you with fast memory-to-memory COPY commands, and an intermediate buffer for copying lines over-and-over.
- Saves your last LOCATE, CHANGE, FIND, and APPEND command for easy re-execution.
- Simple line-oriented commands for character string editing.
- Safeguards to prevent catastrophic user errors that result in the loss of your editfile.
- INLINE command for your character-oriented editing.
- Designed for today's CRT's, video monitors, and teletypewriter terminals.
- Thoroughly field tested and documented with a comprehensive User's Manual and self-instructional tutorial.

And remember — in today's interactive programming environment — your most important software tool is your text editor. ED-80 is already working in industry, government, universities, and in personal computing to significantly cut program development time and to reduce high labor costs. Why not let ED-80 begin solving your text editing problems today? ED-80 is protected by copyright and furnished under a paid-up license for use on a single computer system. Single Density Diskette and Manual: \$99.00, or the Manual alone: \$20.00 (credited with purchase of the Diskette). Specify Disk make/model, 5" or 8", hard or soft sectored. ORDER NOW and we'll pay the postage!

SOFTWARE DEVELOPMENT & TRAINING, INC.
Post Office Box 4511 — Huntsville, Alabama 35802

Dealer Inquiries Welcomed

© CP/M is a trademark of Digital Research

TWICE THE BYTE!

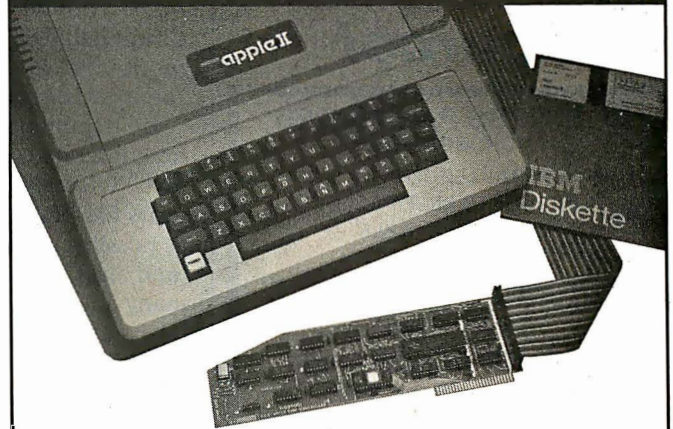

8" DISK CONTROLLER NOW—DOUBLE SIDED OPTION!

- DOUBLES APPLE II STORAGE
- APPLE DOS COMPATIBLE
- SHUGART 800 OR 850 COMPATIBLE
- IBM 3740 DATA ENTRY CAPABILITY
- CP/M, UCSD PASCAL CAPABILITY

Available at your local APPLE Dealer: \$400.



SORRENTO VALLEY ASSOCIATES
11722 SORRENTO VALLEY RD.
SAN DIEGO, CA 92121

INFINITE BASIC

For MOD I TRS-80™ Tape and Disk Systems

Extensions to Level II and Disk BASIC \$49.95

Full MATRIX Functions — 30 BASIC commands!!
Mathematical and common matrix functions. Change arrays in mid-program. Complete array handling. Tape array read and write, including strings. Common subroutine calls.

Over 50 more STRING Functions as BASIC commands!! String manipulation, translation, compression, copying, search, screen control, pointer manipulation and utility functions. Includes multikey multivariable machine language sorts. Load only machine language functions that you want! Where you want in memory! Relocating linking loader! More than you ever expected!!

∞ **BUSINESS (Requires Infinite BASIC) \$29.95**

20 Business oriented functions including:
Printer Automatic Pagination with headers and footers!
Packed Decimal Arithmetic (+, -, *, /) 127 digits!
Binary array searches and hash code generator!

COMPROC Command Processor for Disk Systems \$19.95

Auto your disk to perform any sequence of DOS commands, machine language loads, BASIC, memory size, run program, respond to input statements, etc. Single BASIC command file defines execution! Includes auto key-debounce, screen print and lower case software driver.

REMODEL + PROLOAD Specify 16, 32, or 48K Memory \$34.95

RNumber any portion or all of BASIC program. MOver any portion of program from one location to another. DELete program lines. MERGE all or any portion from tape. Save and verify portion or all of combined merged programs to tape.

GSF (Specify 16, 32, or 48K) \$24.95

18 Machine language routines. Includes RACET sorts.

CHECK, VISA, M/C, C.O.D.
Calif. Residents add 6%

Telephone Orders Accepted (714) 637-5016

TRS-80 ISA REGISTERED TRADEMARK OF TANDY CORPORATION

DEALER INQUIRIES INVITED

WHEN ORDERING PLEASE
ADVISE PUBLICATION SOURCE

DISK SORT MERGE 'DSM'

For MOD I and MOD II TRS-80™

FAST — Now you can sort an 85K diskette in less than 3 minutes* — **FAST**

Perfect for your multi-diskette RANDOM file mailing lists, inventory, etc. Ideal for specialized report generation. Sort, merge or combination. All machine language stand-alone package — Efficient and easy to use. No separate key files required! Physical records are rearranged on diskette! Supports multiple sub records per sector including optional sector spanning. Sorts on one or more fields — ascending or descending. Sort fields within records may be character, integer, and floating-point binary. Provides optional output field deletion, rearrangement, and padding.

*Sort timings shown below are nominal times. Times will vary based on sort and system configurations. Nominal times based on Mod I 48K 4-drive configuration, 64 byte records, and 5 sort keys.

TYPE	FILE SIZE (Bytes)	SORT TIME (Sec)	TYPE	FILE SIZE (Bytes)	SORT TIME (Sec)
SORT	16K	33	SORT	340K	1081
SORT	32K	49	SORT	680K	2569
SORT	85K	173	SORT and 85K SORT +		1757
SORT	170K	445	MERGE	1275K Merge	

DSM for Mod I (Minimum 32K, 2-drives) \$75 On-Disk
DSM for Mod II (Minimum 64K, 1-drive) \$150 On-Disk

Mod II Development Package \$100

Machine Language SUPERZAP, plus Editor/Assembler and Disassembler patches.

Mod II Generalized Subroutine Facility 'GSF' \$50

RACET COMPUTES
702 Palmdale, Orange CA 92665

Your Discount Software Source!

BUSINESS PACKAGES in MICROSOFT BASIC

- GENERAL LEDGER
- ACCOUNTS RECEIVABLE
- ACCOUNTS PAYABLE
- PAYROLL

Extremely well documented with source code. BEST VALUE ON THE MARKET!
Support limited.

ONLY \$99 per package
All four: **ONLY \$399**

CBASIC-2

Disk Extended BASIC \$89.95

MICROSOFT

BASIC-80 \$269
BASIC COMPILER 325
FORTRAN-80 389

MICROPRO

SUPER-SORT III \$120
WORD-STAR 395
WORD-STAR/MAIL-MERGE 525

STRUCTURED SYSTEMS

GENERAL LEDGER (requires CBASIC-2) \$749
ACCTS. RECEIVABLE (req. CBASIC-2) . 749
ACCTS. PAYABLE (req. CBASIC-2) . . . 749
PAYROLL (req. CBASIC-2) 749
INVENTORY CONTROL SYS. (requires
CBASIC-2) \$449
ANALYST (req. CBASIC-2) 199
LETTERRIGHT (req. CBASIC-2) \$169
NAD (requires CBASIC-2) 89
QSORT 89

PEACHTREE

GENERAL LEDGER, List \$1000 \$749
ACCOUNTS PAYABLE, List \$1000 749
ACCOUNTS RECEIVABLE, List \$1000 . . 749
PAYROLL, List \$1000 749
INVENTORY, List \$1200 799
MAILING ADDRESS, List \$800 599

OSBORNE

Business Software

Only \$89 per Package

All 4 for only \$289

General Ledger, Accounts Receivable, Accounts Payable, and Payroll (with Cost Accounting). Available in the following BASICs: CBASIC2, Cromemco 16K, NorthStar, Microsoft, and TRS-80

All packages available in 8" CP/M™ and 5 1/4" CP/M™ for North Star, Micropolis, Vector Graphic, SuperBrain, and others.

SHIPPING AND INSURANCE: Add \$2.50 per order. All prices subject to change and all offers subject to withdrawal without notice. Prices in this ad are for prepaid orders. Slightly higher prices prevail for other-than-prepaid orders, i.e., C.O.D., credit card, etc.

— WRITE FOR FREE CATALOG —

MiniMicroMart

1618 James Street,
Syracuse, NY 13088 (315) 422-4467

recorded in the book *Network Nation: Human Communication via Computer* by Hiltz and Turoff. [See the review by Glen Taylor on page 136 of this issue....RSS]

Isn't spontaneity lost without real-time interaction? My experience with text teleconferences over several years has been that spontaneity is just as possible as in face-to-face meetings (and just as problematic—in how many meetings have you felt free to be spontaneous in your participation?).

One property of text teleconferences that is unexpected (and a bit disconcerting at first encounter) is the tendency for multiple streams or threads of conversation to form and flow in parallel. Multiple streams are disruptive in a face-to-face meeting, but are easily accommodated by many text-teleconferencing systems. In my experience, a new conversational thread does not appear out of the blue, but instead starts as a response to a message that branches from the main, continuing stream. Some participants follow the main stream; others follow the new branch. Many participants follow both, especially in non-real-time conferences where the urgency of real time is lacking.

Open News Networks: Being Your Own Editor and Reporter

We can now return to the general issues concerning the effect of new interpersonalized media on the ways that we exchange information. I started out with a discussion of personalized news. In effect, personalized news allows everyone to become his or her own news editor, since each person specifies which items he or she wants to see from the much larger pool of information.

Once editorial capability has become distributed, the restrictions on input and on transmission of information can be relaxed. Broadcast media structurally require strong central control of information, since the same few items are sent out to a large audience. Such restrictions are not needed for "narrowcast" media like personal letters, phone calls, personal conversation, or interpersonalized media.

Everyone can thus serve as a reporter of whatever he or she defines to be news and then act as editor,

again defining the small part of a vast information pool which is considered news. The structure of information flow can change from the current "hourglass" form to that of an open network; the constriction in flow can be removed.

What Is News?

The kinds of changes discussed here may have a major impact on the ways we circulate information about the world. The general notion of what constitutes news will be challenged. Currently, "news" is information that is sufficiently interesting to a broad enough section of an audience to be judged worthy of being broadcast or otherwise disseminated by a commercial or governmental organization.

If a Little League baseball team in Peoria, Illinois, wins a local championship, that is generally not news for a San Diego, California, newspaper. However, if your nephew is playing on that team, then the result of the game is news to you (even if you live in San Diego). If you personalize the information you receive, then you are redefining what is news. Thus, news as information of general interest to a broad audience is replaced by news as information of specific interest to each particular individual.

There will still remain a role for news mediators in an open information network. Given a complex world and a large body of information about it, people will still depend on other people to collect, evaluate, and condense information. I will return to this issue of mediators after I consider a more general way to view these interactive information networks.

Mixed-Intelligence Information Networks

The examples we have explored of new forms of news networks are particular cases of general systems for sending and receiving information. You can picture yourself as part of a vast network, branches going in all directions, with you at one of the many places where branches converge, a *node* of the net. Each of the branches entering and leaving your node represents a way in which you receive and transmit information: by television, by newspaper, by phone call, or by word of mouth. The

THE BEST OF BOTH WORLDS NORTH STAR BASIC — CP/M

The Fabulous North Star Basic Meets
The Industry Standard CP/M Operating System

Not all perfect marriages are made in heaven; this one was made in SoHo! The software professionals at the SoHo group present The MATCHMAKER, an easy-to-use conversion kit which enables North Star owners who also own the CP/M operating system to gain the full power of their North Star Basic, running under CP/M.

You'll have dynamic file allocation, automatic file creation and extension, and automatic reuse of deleted files, all under the control of the powerful instruction set of the outstanding North Star Basic interpreter with its byte-access or random files, multiline functions, and extensive library of software. 32K memory is all you need. No relocation or modification of Basic is necessary. And all your existing North Star programs will run without modification!

The installation takes about 30 minutes and involves no disassembly or machine coding. Every powerful feature of both systems is maintained with this professional piece of software. And the instructions are COMPLETE and easy to follow.

The SoHo Group
140 Thompson St.
Suite 4-B
New York, NY 10012

The MATCHMAKER
\$89.95 ppd.
Manual only, \$9.95
applicable
against purchase

NY residents include sales tax

Note: CP/M and North Star are registered trademarks of Digital Research and North Star computers, respectively.

CATCH THE S-100 INC. BUS!



	LIST PRICE	OUR SPECIAL CASH PRICE
Godbout, Econoram XIV 16K Static Ram w/Extended Addressing 4 MHz Assembled & Tested	349.00	298.00
Godbout Econoram X 32K 4 MHz Static Memory Board — "Unkit"	599.00	512.00
S.D. Systems VDB 80x24 Video Board Kit	370.00	309.00
S.D. Systems Z-80 Starter Kit w/PIO	340.00	275.00
Sanyo Video Monitor 9"	240.00	160.00
Intertec Intertube Terminal U/L Case 80x25	995.00	779.00

Subject to Available Quantities • Prices Quoted Include Cash Discounts. Shipping & Insurance Extra.

We carry all major lines such as
S.D. Systems, Cromemco, Ithaca Intersystems, North Star, Sanyo, ECT, TEI, Godbout, Thinker Toys, Hazeltine, IMC
For a special cash price, telephone us.

Hours:
Mon.-Fri.
10 A.M.-6 P.M.

Bus **S-100, inc.**
Address **7 White Place**
Clark, N.J. 07066
Interface **201-382-1318**

The Mainframe.

(or how to get a good night's sleep)



There is no other mainframe that compares with the performance and reliability of a TEI mainframe. Its unique design enhances substantially the reliability of any S-100 computer system by providing high efficiency power, brown out protection, line noise rejection and a sophisticated high-speed bus packaged in a durable enclosure.

TEI manufactures the broadest selection of S-100 mainframes . . . 8, 12 and 22 slot, desk top and rackmount models. Whether your requirements are standard or custom, TEI's extensive manufacturing capacity and know-how can solve your mainframe problems today!

Successful OEM's, system integrators and computer dealers worldwide rely on TEI mainframes and enjoy a good night's sleep knowing that their systems are still running. Call TEI today . . . you too can enjoy a good night's sleep!

TEI More than a decade
of reliability.

5075 S. LOOP E., HOUSTON, TX. 77033
(713) 783-2300 TWX. 1 910-881-3639

SAVE MORE THAN 20%
NORTH STAR—INTERTUBE—MICROTEK
ZENITH—HEATH—ITHACA
THINKER TOYS—GODBOUT—SOFTWARE

The smartest computers at the smartest price

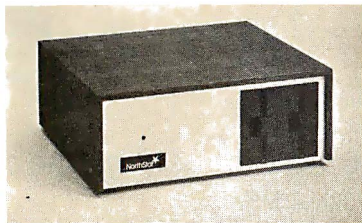

FACTORY ASSEMBLED & TESTED	LIST	ONLY
HORIZON-1-16K-DOUBLE DEN KIT	SPECIAL	\$1269
HORIZON-1-32K-DOUBLE DEN KIT		\$1999 1575
HORIZON-2-32K-DOUBLE DEN KIT		2399 1879
HORIZON-1-32K-DOUBLE DEN		2695 2129
HORIZON-2-32K-DOUBLE DEN		3095 2435
HORIZON-2-32K-QUAD DENSITY		3595 2839
HORIZON-2-64K-QUAD+HARD DISK		9329 7229
HORIZON MEMORY 16K 389	32K	579
NORTH STAR HARD DISK 18 Mb		4999 3949
PASCAL FOR NORTH STAR ON DISK		199 190
Powerful NORTH STAR BASIC..The Best.....		FREE
2 NORTH STAR SOFTWARE DISKS w/HORIZON.....		FREE
NORTH STAR BUSINESS PROGRAMS & NORTHWORD,PHONE		PHONE
COLOR! RAINBOW-2000 & CAT-100		PHONE
ITHACA FRONT PANEL COMPUTER 64K	2885	2449
Z-8000 CPU CARD 16-bit ITHACA S-100		PHONE
ITHACA MEMORY 8/16-bit		PHONE
8086 CPU 16 bit 10xfaster SEATTLE COMPUTER		PHONE
SEATTLE COMPUTER MEMORY		PHONE
SSM Z-80 CPU, VIDEO BOARD, MEMORY		PHONE
MEASUREMENT MEMORY 64K A & T 4mHz		650
JAWS MEMORY 64K A & T 4mHz		PHONE
GODBOUT MEMORY - Static, Super Selection & Price		
THINKER TOYS DISCUS/2D A & T	1199	975
THINKER TOYS HARD DISK 26 Mb	4995	4149
DISCUS/2+2 1.2 Mbytes A & T	1545	1285
THINKER TOYS SUPERRAM		PHONE
DELTACOMPUTER & DISK DRIVES		PHONE
TARBELL COMPUTERS & DISK DRIVES		PHONE
INTERTUBE II SMART TERMINAL	995	725
ZENITH-HEATH SMARTTERMINAL Z-19 A & T		795

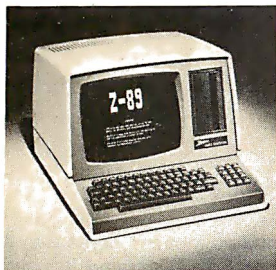

ZENITH COMPUTER-TERMINAL-DISK Z-89	2595	2195
CAT NOVAION MODEM	179	169
MICROTEK PRINTER	795	725
AXIOM PRINTER	795	695
ANADFX PRINTER	995	865
NEC PRINTER Fast Typewriter Quality	2915	2799
SECRETARY WORD PROCESSOR The Best!	85	77
TEXTWRITER III Book Writing Program	125	112
GOFAST NORTH STAR BASIC Speeder Upper	79	71
PDS Super Z-80 ASSEMBLER & More	99	89
COMPILER FOR NORTH STAR \$150	w/PDS & HDS	90
EZ-80 MACHINE LANGUAGE TUTORIAL \$25	HDS	40
EZ-CODER Translates English to BASIC	79	71
ECOSOFT FULL ACCOUNTING PKG	350	315
DATABASE, THE SOURCE 90, CROSS ASSEMBLERS-CALL		
BOX OF DISKETTES 29	IN PLASTIC CASE	30
Which Computers are BEST? BROCHURE.....		FREE
North Star Documentation refundable w/HRZ		20
ORDER 2 or more COMPUTERS....		BIGGER DISCOUNTS
FACTORY ASSEMBLED & FACTORY WARRANTY		

AMERICAN
SQUARE COMPUTERS
KIVETT DR. JAMESTOWN NC 27282
(919)-889-4577

possibilities discussed above are steps toward a *mixed-intelligence information network*, where some of the nodes are human (as in our current information networks) and some of the nodes are computers.

Let us look at the simplest case, in which you and your personal computer are sending and receiving electronic mail from a friend (and her personal computer). You type a message; your personal computer transmits it, placing a telephone call to your friend's personal computer (trying repeatedly if the line is busy). Your friend reads the message the next time she checks her mail, perhaps entering a reply message to be sent back to you. This network has four nodes: two human nodes and two computer nodes. By expanding the number of people involved, we can develop much more complex mixed-intelligence networks for sending and receiving information.

Dispatcher Mediators

Imagine that you want to send a message to all people who are interested in a certain topic, but you do not know who they are. You can broadcast a general message to everyone and let everyone decide whether he or she is interested, but that would be extremely expensive. Instead, you can send the message to a single person who keeps a list of people interested in the topic and ask that person to send the message on to the appropriate people. This single person can thus serve as a *dispatcher*, mediating the distribution of messages.

If a human dispatcher grows tired of forwarding the same kinds of messages to the same list of people, he can program his personal computer to automatically distribute these well-defined group messages. Thus, both human and computer dispatchers are likely to emerge in interactive information networks, with computers handling the routine cases and humans called upon to handle difficult cases.

A dispatcher lowers the cost of reaching a desired audience, raising the efficiency of the whole network. The dispatcher can then charge for the service provided according to the amount saved. Therefore, dispatchers will have incentive to develop accurate knowledge of which nodes in the net are interested in receiving

what information.

Standing Answers

In any information network, people come to have different kinds of knowledge. Experts in different areas emerge, and others go to these experts to ask questions in the area of expertise. Expert advice can be expensive, as anyone who has gone to an auto mechanic lately can testify. One function of this high cost is to control access, so that the experts are not overwhelmed by demands on their time. (Another function is to make the experts rich.) In situations where the cost of accessing experts is kept low (as in Great Britain's system of socialized medicine), other kinds of barriers arise (difficulty in getting appointments, long waits in office waiting rooms, and other problems).

How can access to expert knowledge be handled in mixed-intelligence networks? Say that you are an expert member of such a system, on the topic of backpacking in San Diego County. You receive questions from all over, which you answer for a small fee. After a while, since you give good answers, questions pour in. Worse, most of the questions are the same. You get tired of answering the same old questions again and again.

What can you do? You can program your personal computer to scan through the incoming messages. Any that the computer can identify as a "standard" question, it answers with your "standard" answer. You have thus specified a *standing answer*, which is to be given to any incoming question matching your specification for the standing answer.

Slowly, you build up a computer data base of your specialized knowledge that is readily available to other people. You can easily add new information and remove incorrect or obsolete information. Questions that do not fit any standard pattern are automatically passed on for your expert human judgment, and any question that even *you*, the expert, cannot handle can be forwarded to another expert.

From the point of view of the question, it bounces around the network, with each node it visits attempting to answer it. Both computer and human nodes in this net can easily face the possibility of being unable to handle a question, since it is easy to pass the

At Last! HIGH RESOLUTION S-100 GRAPHICS

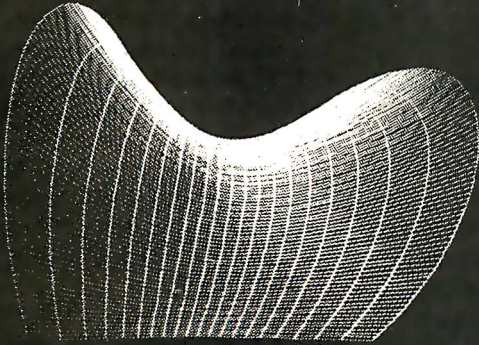

Unretouched photograph

\$925

Complete interface
Assembled and tested
On-board memory
Standard video output
Monitor extra
FOB Cambridge

- LIGHT PEN
- HIGH RESOLUTION
- 512 X 640 MATRIX
- S-100 PLUG-IN
- HIGH SPEED
- SOFTWARE

Send for brochure and data

CAMBRIDGE DEVELOPMENT LAB

44 Brattle Street, Cambridge, MA 02138
Call (617) 547-3894



What TECO* does for minis, TED will do for your micro.

Like TECO*, TED is a character-oriented editor that gives you everything you'd expect. Plus, you get many things you wouldn't expect.

- ▶ 36 command/text buffers
- ▶ 32-entry push-down stack
- ▶ Sophisticated macros
- ▶ Conditional & iterative command execution
- ▶ Conditional & absolute branching
- ▶ Multiple open files

TED and user manual \$90
Manual alone \$20
Coupon furnished with manuals purchased separately worth \$20 towards purchase of TED.

You'll also find some elegant enhancements among TED's 90-plus commands.

TED's compatible with Z-80*-based systems supporting standard CP/M*. We recommend at least 24K bytes RAM. TED's supplied on CP/M*-compatible 8-inch disks.

SEND FOR FREE COMMAND SUMMARY

small system design

P.O. BOX 4546 MANCHESTER, NEW HAMPSHIRE 03108
TELEPHONE: 603-432-7929

*TECO® Digital Equipment Corp.; Z-80® Ziilog Inc.; CP/M® Digital Research Inc.

SOFTWARE FOR

NORTH STAR®

TRS-80*

TEXT PROCESSORS

TFS - Text Formatting System. At last a full featured text processor for NorthStar that you can rely on! TFS has left & right margin justification, page numbering, chaptering, page headings, centering, paged output & MORE. Supports powerful text manipulation including: global & local search and change, file merges and block moves. This means that you can restructure your text file at any time to look the way you want it to, you can even 'chain' files together from disk for documents larger than your current memory.

TFS is completely 'load and go' therefore you can start using it at once. You get two (2) user's manuals: one is a Quick Start manual to get you going in minutes, the other is an in depth study of TFS. (TFS requires RAM from 0000H to 2000H) \$75.00 (Manual only: \$20.00)

PROGRAMMING LANGUAGES

'Tiny' Pascal—This is famous Chung/Yuen 'tiny' Pascal. FAST - ELEGANT - STRUCTURED. Local and global variables plus procedure and function independence make 'tiny' Pascal great for high speed applications. Compiles to 8080 code that executes up to 25 times faster than BASIC. You also receive SOURCE to 'tiny' Pascal written in Pascal. This means that you can compile the compiler! Add features, relocate, etc. (you will need 36K to do this) \$50.00

UTILITIES

D E B E —(Does Everything But Eat!) This is a must for NorthStar users. You can: COMPACT & EXPAND BASIC programs. Compacting removes unnecessary spaces and remarks. This saves money and makes programs run faster. Expanding puts them back again.

Cross-reference BASIC programs by variables and transfer statements.

Global substitutions of variables and transfer statements
Formatted print outs of BASIC programs as well. \$40.00

All Orders and General Information:

SUPERSOFT ASSOCIATES

P.O. BOX 1628

CHAMPAIGN, IL 61820

(217) 359-2112

Technical Hot Line: (217) 359-2691

(answered only when technician is available)

SPEECH SYNTHESIZER SOFTWARE

'ANGLOPHONE': At last you can take complete advantage of your TRS-80 voice synthesizer. Forget about cumbersome phonetic codes. With 'Anglophone' you can simply use ordinary English. Completely interfaces with BASIC, or just about any other programming language. 'Anglophone' applies sophisticated pronunciation rules to transform normal English spelling into speech using the TRS-80 Voice Synthesizer. Minimum hardware: Level II, 16K, Voice Synthesizer. Comes complete with user's manual and test program. \$45.00

SYSTEM MAINTENANCE

DIAGNOSTICS I: Easily the most comprehensive set of CP/M compatible system check-out programs ever assembled. Finds hardware errors in your system, confirms suspicions, or just gives your system a clean bill of health.

Tests:

- Memory
- CPU (8080/8085/Z80)
- Terminal
- Disk
- Printer

To our knowledge the CPU test is the first of its kind anywhere. Diagnostics I can help you find problems before they become serious. A good set of diagnostic routines are a must in any program library.

Minimal requirements: 24K CP/M. Supplied with complete user manual: \$60.00
Manual alone: \$15.00

SOFTWARE SECURITY

ENCODE/DECODE: A complete software security system for CP/CP/M. Encode/Decode is a sophisticated coding program package which transforms data stored on disk into coded text which is completely unrecognizable. Encode/Decode supports multiple security levels and passwords. A user defined combination (One billion possible) is used to code and decode a file.

Encode/Decode is available in two versions.

Encode/Decode I provides a level of security suitable for normal use.
Encode/Decode II provides enhanced security for the most demanding needs.

Both versions come supplied on discette and with a complete user manual.

Encode/Decode I: \$50.00

Encode/Decode II: \$100.00

Manual alone: \$15.00



SuperSoft

First in Software Technology

* TRS-80 TRADEMARK: TANDY CORP.

question on to some other node if the current node cannot answer it.

To keep the network from filling up with unanswerable questions, any question that is unanswered after traversing enough nodes can be sent back to the asker with the answer of "unknown." In fact, if a small "handling charge" is added to a question at each step, then the asker can specify exactly how hard the system as a whole should work in trying to answer a question by specifying a maximum cost for a question. A question judged by the asker to be unimportant would either be answered in the first few steps or returned unanswered, while an important question would keep circulating on to new experts for consideration.

Any question can be answered differently by different experts. A mixed-intelligence information network easily handles this kind of conflict by sending *all* answers back to the asker.

The asker may not want to deal with multiple conflicting answers. This situation provides for another kind of mediator in these interactive networks: one that collects divergent

If a given piece of expertise is in great demand, then it will spread through the network, becoming common knowledge.

answers to a question and selects one. This "sifter" role is similar to that played by editors and other gatekeepers in the current mass-media systems. The flexibility of these new interpersonalized media is illustrated here by the fact that a person can choose to have his or her answers edited or not, and can directly select the mediator.

Standing Questions

We started this exploration of interactive information systems by considering the possibilities for personalized news. I discussed the possibility for each person to specify his or her own "news filter." A more active way to view this personalization is that each participant in a mixed-intelligence network can for-

mulate *standing questions*. These questions can reside in one or more of the nodes of the net, and any information arriving at that node which answers the standing question will be sent to the asker. For example, you might set up as a standing question, "What is the score of the most recent Pittsburgh Steelers' football game?" or "Has Fermat's Last Theorem been proven?" or "What will the weather be tomorrow?" Whenever the answer to any of these questions crosses a node containing the corresponding standing question, that node will send you that information.

Diffusion of Knowledge in a Mixed-Intelligence Network

Expertise can spread through these interpersonalized-media information networks in a way directed by the demand of the participants. Each node in the net can keep a record of how often it has asked a given question of a given expert. If the question is asked and answered often enough, then the node in question can store the answer received to be then used as its *own* standing answer, thereby moving that bit of knowledge one step outward through the net.

The decision at each node can be individually determined, but presumably would be based on the trade-off between the cost of contacting the expert and the cost of storing the information locally. This trade-off is conditioned on the likelihood of needing that information in the future, which can be judged by the need in the recent past. If a given piece of expertise is in great demand, it will spread through the network, becoming common knowledge.

In an area of knowledge that is rapidly changing, each node can guarantee the integrity of its own knowledge by leaving behind, with the experts consulted, standing questions that request any *updated* answers to those questions. In special cases, experts may want to selectively disseminate corrections to those nodes that had previously received answers to questions. In this way, knowledge among participants of an interpersonalized-media network can be flexibly and efficiently distributed and updated.

Feasibility Issues

Are the kinds of interpersonalized media I have described so far possible

2 STEP COLOR GRAPHICS

STEP 1:
The RAINBOW 2000 Color Video Board

Includes: Standard RS 232 Interfacing, up to 192 x 256 Resolution, 8 colors plus two-color alpha-numeric characters, 38.4 K baud with crystal clock, 6K RAM Memory, complete ROM software included, microprocessor on-board. Ideal for OEM Product Incorporation, Dealer-Distributors and Advanced Hobbyists. Cost-effective and made to Industrial Specifications.

7" Monitor \$393.00

10" Monitor \$357.00

13" Monitor \$393.00

19" Monitor \$495.00



Digitus CORPORATION

**For orders or information
CALL TOLL-FREE
1-800-638-1473**

In Maryland:
Call 467-3223

FANTASTIC MAIL ORDER DISCOUNTS!!!

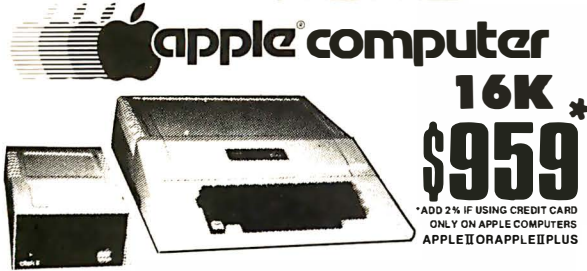

apple computer
16K*
\$959

*ADD 2% IF USING CREDIT CARD
ONLY ON APPLE COMPUTERS
APPLE II OR APPLE III PLUS

APPLE II 32K \$1040* APPLE II 48K \$1100*

APPLE II ACCESSORIES

CORVUS 10 MEGABYTE DISK DRIVE.....\$4650	SUPERTALKER SPEECH SYNTHESIZER.....259
PASCAL LANGUAGE SYSTEM.....445	ROMPLUS CARD w/KEYBD. FLTR.....179
GRAPHICS INPUT TABLET.....875	HEURISTICS SPEECH LINK 2000.....225
DISK II with CONTROLLER CARD.....495	DC HAYES MICROMODEM II.....335
DISK II without controller.....440	ALF MUSIC SYNTHESIZER.....245
APPLES OF TII FIRMWARE CARD.....155	SSM A10 CARD (KIT).....129
INTEGER FIRMWARE CARD.....155	NOVATION CAT MODEM.....159
PARALLEL INTERFACE CARD.....155	SSM A10 CARD (ASSEMBLED).....170
SERIAL INTERFACE CARD.....160	CCS GPIB IEEE INTERFACE.....289
COMMUNICATIONS CARD.....190	MICROSOFT Z-80 SOFT CARD w/CP/M.....349
SUP-R-MOD RF TV MODULATOR.....25	MICROWORKS DS-85 DIGISECTOR.....349
SUP-R-TERM 80 col. CARD.....349	ROMWRITER.....159
DAN PAYMAR Lowercase kit.....45	SYNTEC LIGHT PEN CARD.....229
SVA 8" DISK CONTROLLER CARD.....349	CCS PROGRAMMABLE TIMER MODULE.....159
CCS ARITHMETIC PROCESSOR CARD.....349	CENTRONICS PRINTER INT. CARD.....190
CLOCK/CALENDAR CARD.....239	SLIENTYPE PRINTER W/INT. CARD.....529
INTRLOX-10 SYSTEM.....239	

SOFTWARE

PASCAL LANGUAGE SYSTEM.....\$445	APPLEWRITER WORD PROCESSOR.....69
FORTRAN LANGUAGE PACKAGE.....175	VISI-CALC.....125
THE CONTROLLER GEN. BUS. SYSTEM.....529	SARGON II on Disk.....35
THE CASHIER RETAIL MGT. & INV.....209	SUPER INVADER On Disk.....25
APPLEPOST MAILING LIST SYSTEM.....45	

WE WILL GLADLY PERFORM WARRANTY REPAIR ON ALL APPLE COMPUTER PRODUCTS.



COMPUTER SPECIALTIES

MONITORS

LEEDEX VIDEO 100

- 12" BLACK & WHITE MONITOR
- VIDEO BANDWIDTH 12 MHz±3db
- COMPOSITE VIDEO INPUT

\$139 SOROC IQ 120 \$739
SOROC IQ 140 \$1295



SANYO 9" B/W Monitor \$169 • SANYO 15" B/W Monitor \$259 • ZENITH 13" Color Monitor \$429

PRINTERS

PAPER TIGER ITS 440 w/Graphics.....\$1050	NEC SPINWRITER.....2695
TRENDCOM T-200.....559	AXIOM EX-801.....495
CENTRONICS 737.....850	AXIOM EX-820.....750
CENTRONICS 700 9.....1149	COMPRINT 9 12S.....599
ANADEX DP-8000 OR AP.....850	COMPRINT 9 12P.....559
MP18-T.....725	TRENDCOM T-100.....349

THE AMAZING SORCERER™ II 16K

The SORCERER is a Z80 CPU based micro-computer internally expandable to 48K 4K ROM resident monitor. I/O connector for S-100 expansion. Parallel and serial interface. Dual cassette I/O. Graphic resolution of 240 x 512, 30 lines of 64 characters, 8 x 6 dot matrix. Full ASCII set (upper and lower case), plus standard graphic symbols. User may define up to 128 characters. Keyboard is 63-key data processing type, plus a 16 key numeric input pad.

\$995



32K 1,145.00 48K 1,295.00

ATARI 800

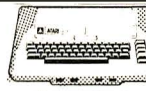

\$799

A Warner Communications Company

ATARI 400 COMPUTER.....\$449	BASKETBALL.....30
ATARI 820 PRINTER.....489	VIDEOSL.....30
ATARI 810 DISK DRIVE.....579	SUPER BREAKOUT.....30
ATARI 410 PROGRAM RECORDER.....69	MUSIC COMPOSER.....45
ATARI 16K RAM MODULE.....149	COMPUTER CHESS.....30
ATARI 8 RAM MODULE.....99	3D TIC TAC TOE.....30
ATARI BASIC ROM.....45	STAR RAIDERS.....45
ASSEMBLER/EDITOR.....45	PERSONAL FINANCE.....45
*High resolution COLOR Graphics	*Built-in RF TV modulator
*10K Basic in ROM	*High speed serial I/O port
*8K user RAM expandable to 48K	*Includes ATARI 41 D program recorder
*57 key full stroke keyboard	

• TO ORDER •

Phone orders invited, using credit cards. Or send cashiers check or money order that draws on a U.S. bank. Please add 3% (\$5.00 Minimum) for handling, shipping (air service) and insurance, or equipment will be shipped freight collect. California residents add 6% sales tax. All equipment is in factory cartons with the manufacturers warranty. Equipment is subject to price change and availability without notice.



6363 EL CAJON BLVD., SUITE 205,
SAN DIEGO, CA. 92115 • (714) 579-0330

MICAH

OSBORNE BUSINESS SOFTWARE

in CBASIC2 or CROMEMCO 16K BASIC

* features *

- Four Complete Packages---
 - General Ledger
 - Accounts Receivable
 - Accounts Payable
 - Payroll with Cost Accounting
- Strong support from Osborne Manuals
- CBASIC2 runs under CP/M or under CDOS version 1.07 on Cromemco computers
- 16K BASIC runs on Cromemco computers
- Cursor addressing routines for Hazeltine, Lear Siegler and Cromemco (Beehive) Terminals
- Source Codes and Installation Instructions provided along with disks
- Automatic Command Start-up
- Easy to apply to all of your business and systems needs

* hardware required *

- One or more 8" or 5" Floppy Drives
- CRT with cursor addressing
- 132-Column Printer

\$95 per package

TO ORDER
Add \$5 for shipping.
Call: add 6-1/2% Sales Tax
CREDIT CARDS ACCEPTED

• DEALER INQUIRIES INVITED •

MICAH'S PRODUCTS OF DISTINCTION

• OSBORNE BUSINESS SOFTWARE (in CBASIC2 & 16K)	• DUP1 (Disk Utilities for CP/M and CDOS)	• EXPAND (Run Cromemco Software on CP/M)
• CBIOS (CP/M for Cromemco Computers)	• DUP2 (Disk Utilities for Cromemco)	• BLACKJACK (Tutorial Casino Action)
• MICROPLOT (Versatile Printer Graphics)	• DUP3 (DUP2 Expanded)	• DRIVE (Customized Printer Drivers)
	• SPOOL (Cromemco Format Utility)	• DBMS Conversion to NAD

• Call or Write for Free Catalogue and More Information •

* We will Customize any of our programs at our Standard Consulting Rates *

Ah! MICAH . . . Satisfyin' Software

That turns your system on!
MICRO Applications and Hardware

• CONSULTANTS and SOFTWARE DEVELOPERS •

MICAH Box 22212 San Francisco, California 94122 USA phone: 415/664-0778



TEXAS INSTRUMENTS INCORPORATED

ONLY
\$228.99 TI-59
\$157.99 PC-100C

CALL TOLL FREE
TEX 1-800-692-1313, ext. 60
USA 1-800-858-4567, ext. 60



TI-59
Programmable

Advanced programmable, magnetic card storage.

PC-100C
Printer/plotter for TI-59.

Speak & Spell™ ONLY
\$59.95

Talking learning aid. Additional word modules available. Suggested Retail \$20. U.C. \$14.99

Special Bonus for Ordering Now!

Order your T.I. 59, PC-100C or Speak & Spell by Sept. 1, and receive a T.I. Joggers Watch Model 562-10—retail value \$17.00, for only \$11.25.

MAKE CHECKS PAYABLE TO: U.C. PRODUCTS
1516 53rd Lubbock, Tx 79412

NAME _____
ADDRESS _____
CITY _____ STATE _____ ZIP _____

TI-59 \$228.99 TI Jogger \$11.25 PC-100C \$157.99 Speak & Spell \$59.95 Check Enclosed \$ VISA MASTER CHARGE

PRICE POST PAID
Sub Total _____
(Tex. Residents Add 5% Tax) _____
Grand Total _____
 More Information.

INTERBANK NO _____ Expires _____ / _____
Signature _____

Offer expires Sept. 30, 1980.

New **E-AS-E!** 1M SUPER-MICRO™

Executes Pascal 13x faster than an LSI-11!

The SUPER-MICRO™ series of X-pert Systems,* designed by Computex, combine high performance with low cost. The X9000 system line features the Pascal MICROENGINE™—16-bit CPU and is now available for delivery.

*Trademark Western Digital Corp

SYSTEM X9020 (CPU Manual \$19.95)



\$4195* READY TO RUN

SYSTEM FEATURES (partial list)

Pascal MICROENGINE™ X9000

- 16 bit P-code CPU
- 64K bytes RAM/Full DMA
- Floppy disk controller (SS or DS)
- Floating point hardware (IEEE standard)
- System software with enhancements
- 2 serial, 2 parallel ports
- Pascal compiler, text editors, file manager, CPU & memory diagnostics, symbolic Pascal debugger, linker, utilities and more.

Floppy Disk Drives (2)

- 1M combined memory
- Double density, single sided
- Standard 8" diskettes
- 6 ms track to track

SYSTEM X9023

\$5095*

SYSTEM FEATURES
(same as above)

PLUS...

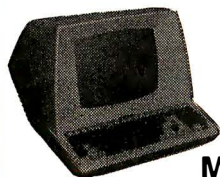

MODEL X-920 DISPLAY/EDIT TERMINAL

X-920 FEATURES (partial list)

- Microprocessor controlled
- Serial RS232C and 20 ma current loop
- 10 baud rates—75 to 19,200
- 24 lines x 80 characters
- 12 x 10 character resolution
- Dual intensity display
- Programmable reverse video & underline
- 14 key numeric pad with decimal
- 16 special function keys
- 8 edit function keys
- 2 block transmission keys
- Block, protect & self-test modes
- 80 storable tabbing
- Insert/delete character and line
- Addressable cursor
- A host of other features, including cursor controls and remote commands such as: clear to nulls, spaces, end of line, end of screen; set hi, low, zero intensity; set blink, etc.

*LIMITED TIME cash price. 10% DOWN guarantees priority. Master Charge & VISA cards accepted.

Customer satisfaction is guaranteed.

Full refund with the return of any product within 10 days. Prices: X9000 CPU \$2995. Manual \$19.95. X-920 CRT \$920. Manual \$10. Perkin-Elmer "Bantam" CRT \$799. X-800 disk drive \$495. Hardware F.O.B. Chicago. Manuals postpaid. Custom systems are also available. We service what we sell. Written hardware warranty. Nationwide service contracts. Custom software. We provide expert technical support.

(312) 684-3183

COMPUTEX
Microcomputer Systems
"The Computer Experts"
5710 Drexel, Chicago, IL 60637

Listing 1: A typical message sent using the electronic-mail system called MSG at the University of California, San Diego. This particular message was sent to two recipients, the author (Levin) and Hutchins.

To: hutchins levin
From: dan
Date: Thu Nov 15 17:42:31 1979
Subject: wednesday at 3 pm
cc:
Message:

I have put the two of you down for 3 PM, Wednesday. OK?

My office.

dn

Listing 2: The procedure for generating a message under the MSG electronic-mail system. All input by the user is shown underlined. The caret (^) indicates use of a control character, in this case a control-D.

```
<—sndmsg
To: hutchins
Subject: tomorrow meeting with dan
cc: levin
cc:
Type message, end with ^D
Should we get together shortly before 3 to go over what we'll cover with dan?
^D
```

now? If not, what capabilities are needed to make them feasible? These kinds of information networks depend heavily on distributed processing and storage, features that are optionally available with relatively inexpensive off-the-shelf personal computers. The existence of computer-based community bulletin boards demonstrates the feasibility of using current microcomputers (for example, the Apple II and Radio Shack TRS-80).

The physical interconnection can be provided by the dialed-telephone network (as in existing bulletin-board systems), by a combination of dialed and leased lines (as in existing nationwide packet-switched networks), by cable television lines, or by radio transmission.

The simplest format for message transmission is to transmit straight ASCII (American Standard Code for Information Interchange) characters through an acoustic-coupler modem. With noisy lines (generated by all of the physical interconnections described above), you lose characters, but for many purposes this is acceptable (the English language is considerably redundant). However, a protocol called Dialnet is currently being developed at Stanford University for personal computers (see

Dialnet Protocol by M Crispin and I Zabala, Stanford Artificial Intelligence Laboratory, Palo Alto CA, 1979). This protocol, which sends information in error-resistant blocks called *packets*, and ones like it, can allow personal computers to use noisy lines to send noise-free messages.

In many cases, users are not overly concerned about the possibility that some unknown person might look at their electronic mail. Yet most often we prefer to know that nobody else is reading our mail. In some cases, this need for privacy is critical. There are many simple encoding/decoding algorithms that provide some security; unfortunately, these simple algorithms are relatively easy to decipher. (As an example of such a system, you can encode a message by calculating the exclusive-OR of text segments with a secret key, then have the receiver decode it by another exclusive-OR operation with the same key.)

Recently, a series of *trap-door* encoding/decoding algorithms have been developed, at Stanford by Diffie and Hellman in 1976 and later at the Massachusetts Institute of Technology (MIT) by Rivest, Shamir, and Adleman in 1977 (see references 4 and 12). Trap-door algorithms prom-

FOR SERIOUS USERS OF 8080, 8085, OR Z80 COMPUTERS

PRINTER WIZARD — Now add powerful capabilities to your printer. Free your computer for use while simultaneously printing backlogged output on a first-in-first-out basis. Transparent operation without noticeable slowing of the computer. Allows continuous computer and printer operation on programs having sporadic output. Will backlog up to 100 pages when used with a disk system. Adds optional automatic paging with numbers, adjustable margins on 4 sides, indented overflow lines. Occupies less than 2½ K.

	EX80M103	\$45.00
Documentation only	EX80M103D	\$ 7.50

DISASSEMBLER — Disassemble machine code into standard source language. Modify or relocate existing programs such as DOS or BASIC using your existing assembler (not included). Disassembles any 8080, 8085, or Z80 code, including embedded data blocks and "trick" codes. Generates symbol and label tables.

	EX80M217	\$75.00
Documentation only	EX80M217D	\$12.50

ALL EXCOM products are fully supported and warranted indefinitely against original defects. Available on single or double density NORTHSTAR 5¼" diskettes, 300 or 1200 baud cassettes (specify). Washington residents add 5.3% tax.

EXCOM

P.O. Box 1802 Bellevue, Washington 98009 U.S.A.
Telephone (206) 641-6577

Main/Frames from \$200

- 14 Basic Models Available
- Assembled & Tested
- Power Supply:
8v@15A, ± 16v@3A
- 15 Slot Motherboard (connectors optional)
- Card cage & guides
- Fan, line cord, fuse, power & reset switches, EMI filter
- 8v@30A, ± 16v@10A option on some models

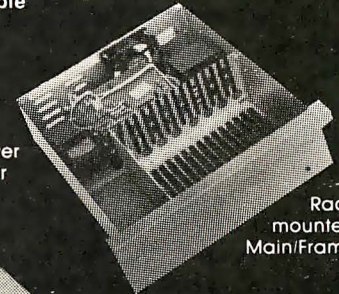

Rack mounted Main/Frame

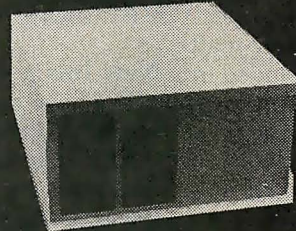

8" Floppy Main/Frame (includes power for drives and main/frame)

Write or call for our brochure which includes our application note:
'Building Cheap Computers'
INTEGRAND

8474 Ave. 296 • Visalia, CA 93277 • (209) 733-9288
We accept BankAmericard/Visa and MasterCard

READ AMERICA'S NUMBER 1 NON-SELLER.

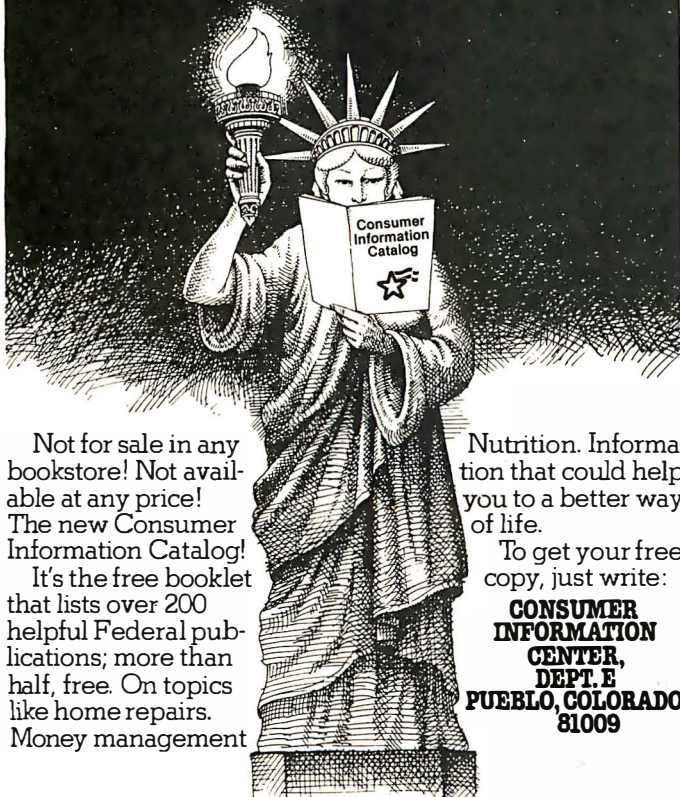

Not for sale in any bookstore! Not available at any price! The new Consumer Information Catalog! It's the free booklet that lists over 200 helpful Federal publications; more than half, free. On topics like home repairs. Money management

Nutrition. Information that could help you to a better way of life.

To get your free copy, just write:

CONSUMER INFORMATION CENTER, DEPT. E PUEBLO, COLORADO 81009

APPLE II PARALLEL INTERFACE CARD

John Bell Engineering is announcing an Apple II Parallel Interface Card. There are four I/O ports with handshaking logic. The board has two 6522 versatile interface adapters and a 74LS74 for addressing and timing. Each 6522 has two interval timers. This will interface your Apple II to printers, speech synthesizers, keyboards, and other John Bell Engineering products. Inputs and outputs are TTL and CMOS compatible.

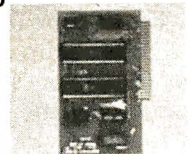

Prices:
79-295 Complete kit \$69.95
79-295 Assembled \$79.95

SOLID STATE SWITCH

Now you can control the World! Switch lights on and off for home security, computer controlled disco light shows. Turn your printer on only when needed. The Switch can handle 720 watts (120 VAC 6 AMPS). Its input is TTL compatible (5V-2MA), isolation 1500VDC. The circuit board is 2" square on the one channel kit and 2"x 8" on the 4 channel unit.

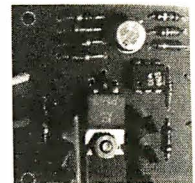

Prices:
1 Channel kit \$9.95 assm. \$12.50
4 Channel kit \$34.95 assm. \$44.95

A to D D to A CONVERTER

John Bell Engineering now has available an Analog to Digital and Digital to Analog Converter Board. Features low cost medium speed (50,000 conversions per second) for applications such as speech recording and music synthesizing. Single power (+5) required. Parallel inputs and outputs include 8 data bits, strobe lines, and latches. Analog inputs and outputs are medium impedance zero to five volt range.

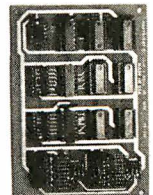

Prices:
79-287 Kit \$49.95
79-287 Assembled \$69.95

PRODUCTS AVAILABLE FROM:

JOHN BELL ENGINEERING
P.O. BOX 338
DEPT. 4
REDWOOD CITY, CA 94064
(415) 367-1137

ADD 6% SALES TAX IN CALIFORNIA AND \$1.00 SHIPPING & HANDLING FOR ORDERS LESS THAN \$20. ADD 4% FOR VISA OR M.C.

J B ENGINEERING

ise an extremely high degree of security for even everyday use. A clear description of these cryptic functions is provided by Martin Gardner in the August 1977 issue of *Scientific American* (reference 5).

MSG: A Usable Electronic-Mail System

Many different software approaches have been tried for sending and receiving electronic mail. However, certain features are common to many existing electronic-mail systems. These have been included in a system called MSG. Every message is structured in a way illustrated in listing 1.

One command that is needed is S (an abbreviation for *sndmsg*), which automatically puts in the "From" and "Date" parts of the message header and assists in entering the rest of the message. For example, a message-generation sequence is shown in listing 2 (user input is underlined).

On the UNIX operating system, the MSG program announces the arrival of new mail to you with the following message:

From levin: tomorrows meeting
with dan

Two commands are used to read mail. The H (for *header*) command allows you to skim over mail, since it prints out only the sender and subject headers of the message. The T (for *type*) command then prints out the messages specified. The D (for *delete*) command is used to delete messages.

A command that seems to add significantly to the utility of the mail system is the A (for *answer*) command, which quickly sends a reply to the originator of a message. When the A command is used, the MSG system automatically fills in the entire header, so that the user can easily compose a quick response.

The ability in MSG to define a *group* of people to receive messages allows this message system to be used

for teleconferencing. With the MSG system, a user can type a list of names into a text file, then send one or more messages to all of these people simply by supplying the name of the text file.

The particular MSG system described here has other nice features, such as a *forward* command and the ability to keep several different mail files. But the capabilities described above seem to be the ones that make the system valuable enough to be used widely.

New Images of News

We have explored a new world—a world in which "news" is defined by each individual. Everyone serves as his or her own editor of news through the establishment of a set of standing questions. Everyone also serves as a reporter of news by submitting standing answers to the information network. These standing questions and standing answers bounce around the net until they are appropriately matched, possibly through the assistance of various kinds of mediators. Knowledge spreads through the net, following the heavily traveled paths to where it is needed.

This new kind of information network has major implications for us and for our society. I have touched on some of these issues here; I am also exploring the effects of this kind of interactive media on education and on entertainment (see references 8 and 9). These other uses of interpersonalized media will affect the information-interchange uses, since the educational and entertaining uses are likely to carry personal computers into homes, thus bringing about widespread use. Costs are dropping substantially, but even so, not many people are likely to invest several hundred dollars to improve their information access. However, they are likely to invest that amount for entertainment. So the educational and informational uses may well follow interactive entertainment.

For More Information

If you are concerned with developing new forms of interactive communication, I urge you to contact me and my associates by whatever medium you select. Our mailing address is given at the beginning of this article; our telephone number is (714) 452-4410. We are located at Third College, Media Center Communica-

tion Building, and my address for electronic mail is "catt:levin" for those with access to UCSD's word-processing system. ■

REFERENCES

1. Christensen, W and R Suess, "Hobbyist Computerized Bulletin Board," *BYTE*, November 1978, pages 150 thru 157.
2. Crispin, M and I Zabala, *Dialnet Protocols*, Stanford Artificial Intelligence Laboratory, Palo Alto CA, 1979.
3. Costas, J, "Cryptography in the Field, Part 1: An Overview," *BYTE*, March 1979, pages 56 thru 64; "Part 2: Using the Pocket Calculator," *BYTE*, April 1979, pages 144 thru 165.
4. Diffie, W and M Hellman, "New Directions in Cryptography," *IEEE Transactions on Information Theory*, November 1976.
5. Gardner, M, "Mathematical Games," *Scientific American*, August 1977, page 120.
6. Hiltz, S R and M Turoff, *The Network Nation: Human Communication via Computer*, Addison-Wesley Publishing Co, Reading MA, 1978.
7. Johansen, R, J Vallee, and K Spangler, "Electronic Meetings: Utopian Dreams and Complex Realities," *The Futurist*, December 1978, pages 313 thru 319.
8. Levin, J A, *Computers and Education*, Laboratory of Comparative Human Cognition at University of California, San Diego, La Jolla CA, 1979.
9. Levin, J A, *InterPersonalized Media: Interactive Entertainment*, The Communications Program of the University of California, San Diego, La Jolla CA, in preparation.
10. Meushaw, R, "The Standard Data Encryption Algorithm, Part 1: An Overview," *BYTE*, March 1979, pages 66 thru 74; "Part 2: Implementing the Algorithm," *BYTE*, April 1979, pages 110 thru 126.
11. Panko, R R, "The Outlook for Computer Mail," *Telecommunications Policy*, 1977, volume 1, pages 242 thru 253.
12. Rivest, R L, A Shamir, and L Adleman, *A Method for Obtaining Digital Signatures and Public-Key Cryptosystems*, MIT Laboratory for Computer Science, Cambridge MA, 1977.

BYTE's Bits

Fixing the Fee

A Bits item in the March 1980 *BYTE* ("Real-Time BASIC Available Free," page 174) reported that the LLL BASIC system developed at the Lawrence Livermore Laboratory was available for just the duplication fee from the National Software Center in Argonne, Illinois. One of our readers called the Center and learned that the duplication fee for LLL BASIC is \$159. ■

I want to thank the many Communications students at UCSD who participated in the development of these ideas, and Yaakov Kareev for helpful comments on earlier versions of this paper. My thanks to the many people across the country who participated in the evolutionary development of the MSG electronic-mail system, including Martin Yonke, John Vittal, and others at BBN, and Greg Haerr at UCSD.

Reliable Business Bookkeeping Software

ORDER ENTRY

MICROSOFT CP/M_R, PET, APPLE II, MICROPOLIS: \$350/ea.

GL, A/P, A/R, INVENTORY, PAYROLL

TRS-80 MOD I: \$100/ea.
 CBASIC-CP/M_R: \$200/ea.
 ATARI, PET, APPLE II, TRS-80 MOD II, MICROPOLIS, VECTOR, EXIDY, DYNABYTE, CROMEMCO, MICROSOFT CP/M_R: \$140/ea.

They all work together!

Buy simple, effective programs designed specifically for your machine. Call us once for same week delivery on a product you can use the day you receive it, and two years from now when your company is twice as big.

Order today by U.P.S. COD. We'll pay postage and handling on Am.Ex., Visa, Mastercharge, or pre-paid orders.

COMPUMAX

467 HAMILTON AVE. PALO ALTO, CA. 94301

Micro Computer **Your One Stop For...Quality and Huge Savings**

DISCOUNT Company

COMPARE PRICE *QUALITY *DELIVERY *SERVICE
 you'll know why you don't have to look anywhere else!

APPLE		COMPUCOLOR	
16K Apple II or Plus	\$ 995	16K	1595
48K Apple II or Plus	1159	32K	1695
Disk w/Controller	539	CROMEMCO	
Disk	450	System 3	\$ 5445
Pascal	505	Z-2H	9445
ATARI		HAZELTINE	
400	\$ 495	1210	\$ 825
800	865	1500	1095
Disk	639	INTEGRAL DATA	
APF ELECTRONICS		440 (Paper Tiger)	\$ 880
APF Computer	\$ 495	440-Graphics	945
CENTRONICS PRINTERS		INTERTEC	
730-1 Parallel	\$ 730	SuperBrain 32K	\$ 2495
730-1 Serial	759	32K memory upgrade with purchase	\$19.95
*779-2 Tractor	1035	SuperBrain 64K	2695
*704 Serial	1795	NEC SPINWRITER	
*753-1	2595	*5530 RO	\$ 2695
COMMODORE PET		*5520 KSR	2990
8K "N"	\$ 795	*5510 RO	2795
Plus \$100 Free Merchandise		Tractor add	200
16K "N" or "B"	995	TEXAS INSTRUMENTS	
Plus \$150 Free Merchandise		99/4 Computer	\$ 995
32K "N" or "B"	1295	810 Printer	1695
Plus \$200 Free Merchandise		XEROX TERMINALS	
2040 Floppy	1295	*1740RO	\$ 2619
Plus \$200 Free Merchandise		*1740 KSR	3000
2022 Printer (Tractor)	795	*1750 RO	2800
Plus \$100 Free Merchandise		*1750 KSR	3170
C2 "N" Cassette	add \$89.90	Tractors add	235
MAIL ORDER ONLY		PHONE (212) 986-7690	
Send Certified Check (Personal or Company Checks require 2 weeks to clear.)		We pay all shipping and insurance charges except items marked with asterisk.	
VISA, MasterCharge add 4% N.Y.S. Residents add appropriate sales tax.		Micro Computer Discount Co	(DENOTES ITEMS SHIPPED F.O.B. NYC)
		60 E. 42nd St., Suite 411, New York, N.Y. 10017	

BYTE BACK ISSUES FOR SALE

The following issues are available:

- 1976: July
- 1977: March, May thru December
- 1978: February thru October, December
- 1979: January thru December except March
- 1980: January and March

Cover price for each issue thru August 1977 is \$1.75 Domestic; \$2.75 Canada and Mexico; \$3.75 Foreign. September 1977 through October 1979 issues are \$2.50 Domestic; \$3.25 Canada and Mexico; \$4.00 Foreign. November 1979 to current is \$3.00 Domestic; \$3.75 Canada and Mexico; \$4.50 Foreign.

Send requests with payment to:

BYTE Magazine

70 Main St, Peterborough, NH 03458
 Attn: Back Issues



WANTED

**A Hot New Market
 Looking for a Systems House!
 Retail Pharmacy Computerization**

- New approach that assures patentability.
- Simple, flexible functioning plus pharmacy management and accounting.
- Efficient "third party" billing.
- Eliminates time consuming pharmaceutical chores.
- Applicable to any pharmacy situation or size.

Expected Period of Development
 Approximately 6 Weeks

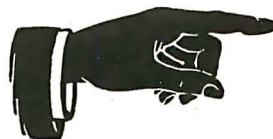

Write or call:

Art Bennett

1000 Pine Ave., Apt. 177
 Redlands, CA 92373
 (714) 792-6676

Fifteen: A Game of Strategy

(or Tic-Tac-Toe Revisited)

John Rheinstein
10 Gould Rd
Lexington MA 02173

Most of us lost interest in the game of tic-tac-toe by the age of ten or twelve. By this time we had learned the strategy, and the game presented no further challenge. Upon casting the game in a different format, though, the strategy is no longer so obvious and a new, more challenging game may be developed. The game of Fifteen, described in Robert Teague's *Computing Problems for FORTRAN Solution*, is such a game.

Listing 1: *The game of Fifteen, written in Digital Group MaxiBASIC. The program can be easily modified to run in other versions of BASIC. Fifteen is a two player game. Players alternate picking numbers between 1 and 9, using each number only once. The object is to select numbers so that the sum of three of them is 15, while at the same time preventing the opponent from achieving the sum with three numbers.*

```

10  # " -----"
20  # " F I F T E E N - A G A M E O F S T R A T E G Y "
30  # " -----"
40  # " D O Y O U W A N T I N S T R U C T I O N S ( Y O R N ) " ;
50  INPUT A$
60  IF A$ <> "Y" THEN 160
65  # ""
70  # " YOU AND THE Z-80 ALTERNATE PICKING NUMBERS BETWEEN"
80  # " (INCLUDING) 1 AND 9 - YOU START. THE OBJECT IS TO"
90  # " PICK THREE NUMBERS THAT SUM TO 15, AND TO KEEP THE"
100 # " Z-80 FROM DOING THIS. "
110 # " IF YOU PLAY PERFECTLY YOU MAY WIN OR FORCE A TIE. "
120 # " IF YOU GOOF - THE Z-80 MAY WIN. "
160 DIM C (11) ,D (11)
170 FOR K=1 TO 11
180 READ C (K) ,D (K) :NEXT K
190 FOR K = 1 TO 9
200 READ A1 (K) ,B1 (K) :NEXT K
230 DIM B (9) ,A (3,3)
250 # ""
260 # " N E W G A M E S T A R T S N O W . . . "
270 FOR J=1 TO 3
280 FOR I=1 TO 3
290 LET A (I,J)=0
300 NEXT I
310 NEXT J
320 LET Z=0
330 # "" : # " Y O U R M O V E " ,
340 INPUT C1
345 # ""
350 IF C1 > 9 THEN 620
360 IF C1 < 1 THEN 620
370 R = A1 (C1) :C = B1 (C1)

```

Listing 1 continued on page 232

The game of Fifteen is a two player game. The players alternate picking numbers between 1 and 9, using each number only once. The object is to select numbers such that the sum of three of them is 15, and at the same time to prevent the opposing player from achieving a sum of 15 with three numbers. For example, assume that the two players are A and B. If the first player, A, picks the number 5, the status of the game may be indicated as shown below:

```

1 2 3 4 5 6 7 8 9
          A

```

If the second player, B, then picks the number 3, we have:

```

1 2 3 4 5 6 7 8 9
      B  A

```

Continuing, we might have:

```

1 2 3 4 5 6 7 8 9
      B A A B

```

Neither player can now achieve a sum of 15 in the next move, which might look as shown here:

```

1 2 3 4 5 6 7 8 9
      B  B A A B  A

```

On the next turn A can win by picking 2 as follows:

```

1 2 3 4 5 6 7 8 9
      B A B A A B  A

```

since the sum of 2 + 5 + 8 is 15.

The relationship between tic-tac-toe and the game of Fifteen, as described above, is based upon the 3 by 3 magic square:

6	1	8
7	5	3
2	9	4

CP/M SOFTWARE

Word Processing For CP/M

FMT Text Formatter \$75

Use FMT and your text editor to convert your CP/M system to a powerful word processor. FMT features include automatic page headings and footings, page numbering, centering, underscoring, external file merging, and in-line console input. FMT works with any video, CRT, or hardcopy terminal and printer combination. Added capabilities for daisy-wheel printers: superscripting, subscripting, and half-line spacing.

Run Cromemco Software Under CP/M

ADAPT Software Interface \$50

Now you can get Cromemco software to run on your CP/M system. ADAPT interfaces those powerful Cromemco packages (except for Multi-User BASIC) to any Z-80 based CP/M system without patching. ADAPT works without changes for any memory size.

Fast RATFOR

RATFOR (RATional FORtran) \$95

RATFOR lets you write structured code that translates to Microsoft or Cromemco FORTRAN. TSW's RATFOR (RATional FORtran) precompiler runs at more than 1000 statements per minute. Documentation includes "Software Tools" book by Kernighan and Plauger. (ADAPT and RATFOR packages combined \$125)



THE SOFTWARE WORKS
8369 Vickers
San Diego, CA 92111
(714) 569-1721

VISA and MasterCard accepted
* CP/M is a trademark of Digital Research.

Marymac Industries Inc

Radio Shack®

AUTHORIZED SALES CENTER

**Save 10% 15%
OR MORE**

DELIVERED TO YOUR DOOR

Owned and operated by Marymac Industries Inc. Houston's only independent Radio Shack® dealer. Warranties will be honored by all company owned Radio Shack® stores and most franchise and dealer authorized sales centers. Store open Mon.-Sat. 10-7. We pay freight and insurance. Save state sales tax. Texas residents add only 5% sales tax. Brand new in factory sealed cartons. Reference: Katy National Bank. Call us for a customer reference near your city. Offered exclusively by Radio Shack® Authorized Sales Center 21969 Katy Fwy., Katy (Houston) Texas 77450

Telephone 1-713-392-0747

TRS-80[®] FOR BUSINESS, LEARNING AND ENTERTAINMENT

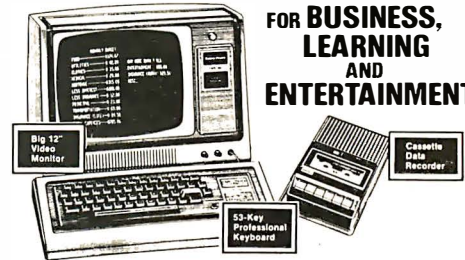

Meet TRS-80's Big Brother! The New TRS-80 Model II



We are located just 5 hours from the giant Tandy Computerware House in Ft. Worth, Texas.

Call
Joe McManus
Today

We've added a bigger, more powerful "brother" to the TRS-80 family. It's TRS-80 Model II — a completely new microcomputer for business applications.



CHARGE IT



A Message to our Subscribers

From time to time we make the BYTE subscriber list available to other companies who wish to send our subscribers promotional material about their products. We take great care to screen these companies, choosing only those who are reputable, and whose products, services, or information we feel would be of interest to you. Direct mail is an efficient medium for presenting the latest personal computer goods and services to our subscribers.

Many BYTE subscribers appreciate this controlled use of our mailing list, and look forward to finding

information of interest to them in the mail. Used are our subscribers' names and addresses only (no other information we may have is ever given).

While we believe the distribution of this information is of benefit to our subscribers, we firmly respect the wishes of any subscriber who does not want to receive such promotional literature. Should you wish to restrict the use of your name, simply send your request to BYTE Publications Inc, Attn: Circulation Department, 70 Main St, Peterborough NH 03458. Thank you.

IBM + CP/M + OSM = CP/M Compatible Distributed Processing Multi-User Computer System

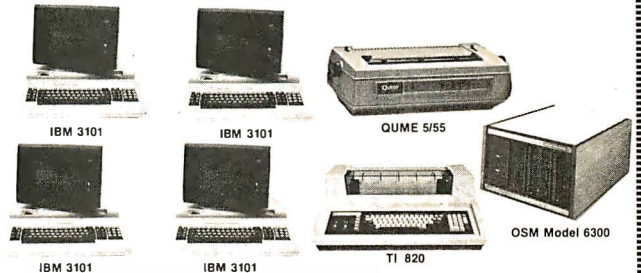

O S M Computer Corporation is introducing a true multi user, multi tasking computer system.

Hardware features

1. IBM 3101 terminals.
2. Each user has its own complete system consisting of CPU, memory, console, and printer (optional).
3. Unlike MP/M system there is no speed degradation as you add users.
4. All users share common data base disk storage and host printer.
5. Users can select either host or local printer.
6. Dual floppy and up to 128 mega byte hard disk storage.
7. Up to 128 user terminals.
8. Each user has a hardware CPU reset button. If any of the users "crash" he can reset his CPU without affecting other users.

Software Features

1. Use of CP/M 2.2 allows any CP/M compatible software to be used.
2. DPOS/2 multiuser supervisor executive
3. 2 file protect modes (in addition to CP/M's) prevent "fatal embrace" and "interleaved update sequences".
4. Automatic system printer spooling.
5. Messages can be passed among users.

Prices

Single user Mainframe (Z80, 64K memory, 2 serial 3 parallel I/O, 1.2 M Byte 8 inch dual disk) . . . \$5,195.00
Two user Mainframe . . . \$7,790.00
Each additional user (CPU, 64K memory, I/O) . . . \$1,295.00
IBM 3101 terminal . . . \$1,250.00
Texas Instrument 820 RO . . . \$1,695.00
QUME 5/45 RO . . . \$2,550.00
27 Mega Byte Hard Disk . . . \$4,995.00

OSM Computer Corporation

2364 Walsh Ave.
Santa Clara, CA 95051 (408) 496-6910

Dealer Inquiries Invited

It may be seen that the sum of any horizontal row, any vertical column, or any diagonal is 15. In addition, no other combination of three of these numbers sums to 15. Thus playing the game of Fifteen is the same as playing the game of tic-tac-toe if the relationship indicated in the magic square is known. If this relationship is not known, then derivation of the strategy, except by enumeration of all cases, is not trivial.

The accompanying listing was written in MaxiBASIC for a Digital Group Z-80 micro-computer. With minor changes it should run on any computer with BASIC. If your version of BASIC does not have an EXIT statement, then just leave this statement out of any lines in which it appears. The symbol # is a short form of the command PRINT. The program is based upon a modified version of the game of tic-tac-toe in David Ahl's *101 Basic Games*. As listed here, the computer will make a random move on its first or second move, after which it will play perfectly. If you play perfectly, you will either win or force a tie, each of these outcomes having roughly an equal probability of occurrence.

If you are playing the game of tic-tac-toe as listed in Ahl's book, inserting the following statement will make the game much more interesting by eliminating some less than optimal moves:

$$1915 B(8) = A(3,1) + A(2,2) + A(1,3)$$

I have found that friends who evidence no interest in playing the game of tic-tac-toe will play the game of Fifteen with great interest and find it to be challenging. As soon as I indicate the magic square relationship with tic-tac-toe, the interest quickly wanes after just a few more games. I hope you'll find the game interesting, too. ■

Listing 1 continued:

```

380 IF A (R,C) <>0 THEN 620
390 LET A (R,C) = -1
400 GOSUB 1660
410 IF Z=1 THEN 490
420 REM MACHINE MOVE
430 GOSUB 1100
440 REM TEST FOR GAME WIN
450 GOSUB 1660
460 IF Z=0 THEN 650
490 # ""
500 FOR K = 1 TO 9
510 B = A (A1 (K) ,B1 (K) )
520 # TAB (20) ;K;
530 IF B <> 0 THEN 550
540 # ""
545 GOTO 575
550 IF B > 0 THEN 570
560 # " Y O U " ;
565 GOTO 571
570 # " Z - 8 0 " ;
571 IF ABS (B) > 1 THEN # " * " ;
573 # ""
575 NEXT K
580 # ""
590 IF Z <> 0 THEN 2070
600 GOTO 330
620 # " I L L E G A L M O V E , T R Y A G A I N "
630 # ""
640 GOTO 330
650 LET T2 = 0
660 FOR J=1 TO 3
670 FOR I=1 TO 3
680 IF A (I,J) <>0 THEN 700
690 LET T2=T2+1
700 NEXT I
710 NEXT J
720 IF T2 > 0 THEN 270
730 GOSUB 1340
740 GOTO 490
750 IF T2>1 THEN 490
760 FOR J=1 TO 8
770 IF B (J) = -2 THEN EXIT 800
780 NEXT J
790 GOTO 730
800 GOSUB 2000
810 GOTO 490
900 FOR J = 1 TO 9
910 B (J) = 0
920 NEXT J
930 FOR J = 1 TO 3
940 FOR I = 1 TO 3
950 B (J) = B (J) + A (J,I)
960 B (J+3) = B (J+3) + A (I,J)
970 NEXT I
980 NEXT J
990 B (7) = A (1,1) + A (2,2) + A (3,3)
1000 B (8) = A (1,3) + A (2,2) + A (3,1)
1010 RETURN
1100 FOR I = 2 TO 3
1110 C (I) = INT (2.99*RND (0) ) + 1
1120 D (I) = INT (2.99*RND (0) ) + 1
1130 NEXT I
1200 FOR I = 1 TO 8
1210 IF B (I) >1 THEN EXIT 1370
1220 NEXT I
1230 FOR I=1 TO 8
1240 IF B (I) <-1 THEN EXIT 1370
1250 NEXT I
1270 FOR K=1 TO 11
1280 LET I=C (K)
1290 LET J=D (K)
1300 IF A (I,J) <>0 THEN 1330
1310 LET A (I,J) = 1
1320 GOTO 1360
1330 NEXT K
1340 # " . . . T I E G A M E . . . "
1350 LET Z=3
1360 RETURN
1370 IF I>3 THEN 1440
1380 FOR J=1 TO 3
1390 IF A (I,J)=0 THEN EXIT 1420
1400 NEXT J
1410 GOTO 1360
1420 LET A (I,J)=1
1430 GOTO 1360
1440 IF I>6 THEN 1510
1450 FOR J=1 TO 3
1460 IF A (J,I-3) =0 THEN EXIT 1490
1470 NEXT J
1480 GOTO 1360
1490 LET A (J,I-3) =1
1500 GOTO 1360
1510 IF I>7 THEN 1550
1520 FOR J=1 TO 3
1530 IF A (J,J) =0 THEN EXIT 1590
1540 NEXT J
1550 IF A (1,3) =0 THEN 1610
1560 IF A (3,1) =0 THEN 1630
1570 LET A (2,2) =1
1580 GOTO 1360
1590 LET A (J,J) =1
1600 GOTO 1360
1610 LET A (1,3) =1
1620 GOTO 1360
1630 LET A (3,1) =1
1640 GOTO 1360
1660 LET T1=0
1700 FOR J = 1 TO 3
1710 IF A (J,1) <>A (J,2) THEN 1750
1720 IF A (J,1) <>A (J,3) THEN 1750
1730 T1 = A (J,1)

```

Listing 1 continued on page 234

MAKE YOUR BASIC BETTER FOR BUSINESS

Developing business applications without keyed file support is like producing a play without the right cast — you can expend needless time and money, and end up giving an inadequate performance

Enter MAGSAM™

MAGSAM picks up where your BASIC leaves off by providing it with a powerful Keyed File Management System that's quick and easy to use. The result is applications that do exactly what you want them to — instead of only what BASIC allows you to.

Supporting Cast

MAGSAM's advanced features and capabilities include:

- Random, sequential, and generic access by key
- Secondary indexing with any number of keys
- Key and record deletes with automatic space reclamation
- Dynamic file allocation and extension
- Complete compatibility with BASIC files
- Interactive tutorial program
- One year update service

The versatile MAGSAM file management is now available in two major versions. MAGSAM IV, the new high performance assembler version, is ideal for business applications in which response time is critical. Complete with an interface for CBASIC, MAGSAM IV is \$295. MAGSAM III is the standard version and is in use world wide. Written in BASIC, it is available for CBASIC, Microsoft BASIC, or Micropolis BASIC for \$145. The MAGSAM manual alone is \$25.

You're the Star

MAGSAM is available immediately — off the shelf. So you can begin saving time and money now while providing your customers and clients with applications that truly meet their needs. Send for a free brochure telling the full story on MAGSAM, or see a demonstration at your computer dealer today.

Another Business Solution from:

MAG MICRO APPLICATIONS GROUP
7300 Caldas Avenue, Van Nuys, CA 91606

Multi-User North Star Horizon Hard Disk Computer Systems

Interrupt-driven, bank-switching timesharing, developed by Micro Mike's, Inc. for the North Star Horizon computer, has been mated to Micro Mike's hard disk operating system.

As many as *four* 26.5 megabyte (formatted) Winchester-type, sealed-media Shugart hard disk units can provide users access to as much as 106 megabytes (formatted) of stored information *in a flash*. Micro Mike's timesharing/hard disk operating system, **TIMESHAVER**,[®] allows as many as *seven* users per timesharing computer system, each user *simultaneously* running a different program.

The programming staff of Micro Mike's has written a wide variety of comprehensive business application programs in North Star BASIC, based around a set of defined Common SUBroutines (CSUB). Most programs are available separately or are included in Micro Mike's Program Library.

IN STOCK:

North Star Horizon computers

Zenith Z 19 intelligent (Z80-based) terminals

Printers: NEC Spinwriter, Texas Instruments TI 810, IDS-440 Paper Tiger

Shugart 26.5 megabyte (formatted) hard disk units with S-100 controller card for North Star* systems

Call or write for details and descriptive literature.

Mike's **Micro Mike's, Inc.**
905 South Buchanan
Amarillo, Texas 79101 *USA*
telephone: 806-372-3633

making technology uncomplicated... for People

Copyright 1980 Micro Mike's, Inc. All Rights Reserved Worldwide.

To further improve service to our customers we have installed a toll-free WATS line in our Peterborough, New Hampshire office.

BYTE's Toll-free Subscriber W.A.T.S. Line

(800) 258-5485

We thank you and look forward to serving you.

If you would like to order a subscription to BYTE, or if you have a question related to a BYTE subscription, you are invited to call* (800)258-5485 between 8:00 AM and 4:30 PM Eastern Time. (Friday 8 AM - Noon). *Calls from continental U.S. only.

9178

WHY PAY MORE? Compare our prices and service

SOROC

IQ 120..... \$ 790.
IQ 140..... \$1190.

CENTRONICS PRINTERS

Prices too low to advertise. Call for best price.

LIVERMORE DATA MODEMS

300 BAUD..... \$170.
RS-232, 2 yr. uncond. guarantee

BASF DISKETTES

5 1/4" 10/\$30.
8" 10/\$30.

CABLES

IEEE to Centronics..... \$100.
RS-232..... \$ 25.

COMMODORE SPECIALS FREE*

PET32K (N&B)..... 1295... 175.
PET 16K (N&B)..... 995... 135.
PET 8K..... 795... 100.
PET 2040 Disk Drive..... 1295... 175.
PET 2022 Tractor Printer..... 795... 100.
PET C2N Cassette Deck..... 95... 12.

*Free merchandise with purchase of CBM item.

BPI GENERAL LEDGER

Accounting System for Apple II Computers—Special... \$399.

CDS SERIES 80 IPS-100

- Main Frame
- Key Switch (ON/OFF)
- 8085 Processor
- 630,000 Byte Disks
- 10 Slot S-100 Buss
- 32K Ram
- 2 Independent RS-232 I/O Ports
- Up to Four Users
- 110 Volts 60 HZ
- 220 Volts Available
- List Price \$3295.
- Sale Price \$2700.

TO ORDER:

Send check or money order. VISA/Master Charge/C.O.D.

COMPUTER PRODUCTS INTERNATIONAL

P.O. Box 17675 Washington, D.C. 20041
703-573-9633



5280 Trail Lake Drive Suite 14 Ft. Worth, Texas 76133 (817) 294-2510

CP/M is a registered trademark of Digital Research Corp.
TRS-80 is a registered trademark of RadioShack.



FROM THE ORIGINATOR OF THE TRS-80 PROJECT

**FMG Corporation — for
HIGH LEVEL LANGUAGES**
• FORTRAN • BASIC
• PASCAL • COBOL

Microcomputer software for business applications, engineers, consumers, hobbyists and others who have a serious interest in computers.



**SEND FOR
FREE
SOFTWARE
CATALOG**

- CP/M — Industry Standard Operating System
- USCD PASCAL PACKAGE
- GENERAL LEDGER; PAYROLL; ACCOUNTS RECEIVABLE and ACCOUNTS PAYABLE
- FORTRAN-80 PACKAGE — New Capabilities for TRS-80 Users
- FMG's MICRO COBOL — For TRS-80 and TRS-80 Model II
- CP/M Z80 — Macro Assembler
- ZSID — Symbolic Debugger
- Custom Programming, Service, Installation and Training are Available at Additional Cost

FMG Corporation is an Independent Software Company — from the ORIGINATOR OF THE TRS-80 PROJECT and the AUTHOR OF THE FIRST CP/M FOR THE TRS-80.

M-452

Listing 1 continued:

```

1740 A (J, 1) = 3*A (J, 1)
1745 A (J, 2) = A (J, 1) :A (J, 3) = A (J, 1)
1750 NEXT J
1760 FOR J = 1 TO 3
1770 IF A (1, J) <> A (2, J) THEN 1810
1780 IF A (1, J) <> A (3, J) THEN 1810
1790 T1 = A (1, J)
1800 A (1, J) = 3*A (1, J)
1805 A (2, J) = A (1, J) : A (3, J) = A (1, J)
1810 NEXT J
1820 IF A (1, 1) <> A (3, 3) THEN 1860
1830 IF A (1, 1) <> A (2, 2) THEN 1860
1835 T1 = A (2, 2)
1840 A (1, 1) = 3*A (1, 1)
1845 A (2, 2) = A (1, 1) : A (3, 3) = A (1, 1)
1860 IF A (1, 3) <> A (3, 1) THEN 1910
1870 IF A (1, 3) <> A (2, 2) THEN 1910
1880 T1 = A (2, 2)
1890 A (1, 3) = 3*A (1, 3)
    
```

```

1900 A (2, 2) = A (1, 3) : A (3, 1) = A (1, 3)
1910 IF T1 > 0 THEN 2030
1915 IF T1 < 0 THEN 2000
1920 GOTO 900
2000 # . . . Y O U W I N - T H I S T I M E . . . "
2010 LET Z=1
2020 RETURN
2030 # " . . . Z - 8 0 W I N S T H I S T I M E . . . "
2040 LET Z=2
2050 RETURN
2070 # " DO YOU WISH TO PLAY AGAIN (Y OR N) " ;
2080 INPUT XS
2090 IF XS="Y" THEN 250
2120 # ""
2130 # " THANKS FOR THE GAME. HOPE YOU HAD FUN!! "
2135 # ""
2140 GOTO 9999
2150 DATA 2, 2, 1, 1, 3, 3, 1, 1, 3, 3, 1, 3, 3, 1, 1, 2, 3, 2, 2, 3, 2, 1
2160 DATA 2, 3, 3, 1, 1, 2, 1, 1, 2, 2, 3, 3, 3, 2, 1, 3, 2, 1
9999 END
READY
    
```

UCSD Pascal* for TRS-80† Model II

The Standard Package: Operating System □ Compiler □ Screen Editor □ Filer □ Library □ Z-80 Assembler □ Patch Utility Program □ 280 page User Manual □ Jensen & Wirth Pascal Reference Manual □ Bowles' Beginners Guide To UCSD Pascal □ tutorial disk.

Plus:

- Single or double density diskettes in one or more standard formats. **\$350 Complete**
- Disk Formatting program. **\$300 without manuals or tutorial disk**
- Configuration program for serial I/O.

Optional Utility Programs:

- File conversion—
CP/M† to Pascal \$50.00
TRSDOS† to Pascal \$50.00
- Z-80 Disassembler/Dump Program \$50.00

PCD SYSTEMS

P. O. Box 143 • Penn Yan • New York 14527 • 315-536-3734

*Trademark of the Regents of the University of California

†Trademark of Tandy Corp.

‡Trademark of Digital Research Corp.

JINSAM™ Data Manager

- ★ CUSTOM DATA FILES
- ★ FAST/EASY/MENU DRIVEN
- ★ HELP COMMANDS
- ★ KEYED RANDOM ACCESS
- ★ MULTIPLE SEARCH KEYS
- ★ PRIVACY ACCESS CODES
- ★ WILD CARD SEARCH

For 16K-32K PET, Dual Disk, and Printer

FREE: LABEL PRINTER MODULE
FREE: REPORT GENERATOR MODULE

Specify CBM 2040 or COMPU/THINK

Package \$150 User's Guide only \$25
Introductory Demo Tape \$5 Disk \$ 8

Check or Money Order plus \$2 Shipping

(NY residents add 8% Sales Tax)

- DEALER INQUIRIES WELCOMED -

JINI MICRO-SYSTEMS, Inc.
P.O. Box 274-B • Bronx, NY 10463

Circle 198 on inquiry card.

MEMOREX Floppy Discs

Lowest prices. **WE WILL NOT BE UNDERSOLD!!** Buy any quantity 1-1000. Visa, Mastercharge accepted. Call free (800)235-4137 for prices and information. All orders sent postage paid.

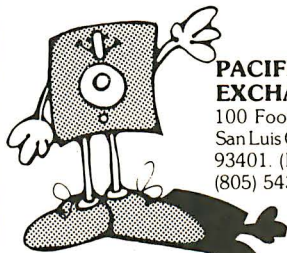

PACIFIC EXCHANGES
100 Foothill Blvd.
San Luis Obispo, CA
93401. (In Cal. call
(805) 543-1037.)

Circle 199 on inquiry card.

DISCOUNT PRICES

NORTH STAR
APPLE II
MICROTEK
ANADIX
TREND/COM
CENTRONICS
SOROC
INTERTUBE
THINKER TOYS
SOLID STATE MUSIC
& OTHERS

Call for Prices
(301) 694-8884

FREDERICK COMPUTER PRODUCTS

Municipal Airport
Frederick, MD. 21701

MAGIC WAND™

Word Processing System

\$400

Starburst Computer Group, Inc.

Route 2 Box 183
Afton Virginia 22920

(Authorized Dealer)

Magic Wand works on any CP/M® system with all major CRT's. Ask for our free point-by-point comparison of Magic Wand and two popular word processing systems.

Magic Wand is a Trademark of Small Business Applications Inc.

"CP/M is a registered Trademark of Digital Research"

(804) 361-1180

Circle 201 on inquiry card.

DISK DRIVE/CRT

★SALE★

Shugart SA801R
for RS MOD. II
ONLY

\$489

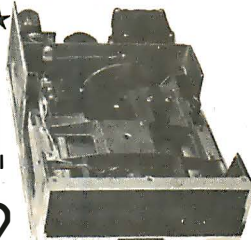

Hazeltine 1000 (unused)..... \$ 599
Shugart SA400 282
Percetec FD200..... \$282 — FD250 ... 399
MPI 851 \$279 — 852 399
SA801 R w/PS/Cab 799
Dual Drives w/PS/Cab 1645

LIMITED QUANTITIES

MTI 3304 W. MacArthur Blvd.
Santa Ana, CA 92704
(714) 979-9923

Circle 202 on inquiry card.

H9 OWNERS!

Upgrade your video terminal with one of these long overdue kits:

GRAFIX — Graphical display capabilities assembled and tested \$69.95. Kit \$59.95.

CURSOR CONTROL — A total of 8 functions assembled and tested \$34.95. Kit \$29.95.

FLICKER FREE — 4800 baud operation assembled and tested \$79.95. Kit \$69.95.

All have a full 6 month warranty.

NORTHWEST COMPUTER SERVICES, INC.

8503 N.E. 30th Avenue
Vancouver, WA 98665

Circle 203 on inquiry card.

80X24 VIDEOTERM™

7X9 MATRIX DISPLAY FOR

LOWER CASE W/ DESCENDERS **APPLE II®**



REGISTERED TRADE MARK OF APPLE COMPUTER INC.

80 columns by 24 lines with easy to read 7x9 dot matrix, upper and lower case with descenders using shift lock feature • 1K firmware incorporates PASCAL and BASIC protocols so user is not required to enter machine language programs or change PASCALS. Misc. info. or Gotoxy files • Compatible with all APPLE II peripherals so user won't need new software patches for future software products • Crystal controlled dot clock for excellent character stability • VIDEOTERM is the same size as the Apple language card and power consumption is held to a minimum through the use of CMOS and lower power devices • Character set can be user definable up to a maximum of 128 symbols of 8x16 dot matrix font • Display control character mode and four standard display formats controlled by escape sequences • Built in light pen capability • Inverse display mode • 50/60 HZ operation • Sockets on all IC's.

PRICE: Without graphic EPROM \$345

OPTIONS: Graphics EPROM line w/g \$25

VIDEO SWITCH PLATE inserts

In case slot to choose between

APPLE II® and VIDEOTERM S12

MANUAL: \$15

VIDEX 3060 N.W. Thistle Pl., Corvallis, OR 97330 Phone (503) 758-0521



Circle 204 on inquiry card.

SURPLUS ELECTRONICS

ASCII

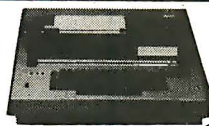

ASCII

**IBM SELECTRIC
BASED I/O TERMINAL
WITH ASCII CONVERSION
INSTALLED \$645.00**

- Tape Drives • Cable
- Cassette Drives • Wire
- Power Supplies 12V15A, 12V25A, 5V35A Others, • Displays
- Cabinets • XFMRs • Heat Sinks • Printers • Components

Many other items, SEND \$1.00 FOR CATALOG
REFUNDABLE FIRST ORDER

WORLDWIDE ELECT. INC.
130 Northeastern Blvd.

Nashua, NH 03060

Phone orders accepted using

VISA or MC

Call 603-889-7661

Circle 205 on inquiry card.

DISBURSEMENTS & CASH RECEIPTS JOURNALS

In stock & ready to go to work, ready to ship...no waiting

- a.) Co-authored, debugged and used by a licensed, practicing CPA.
- b.) A copyrighted document balance routine provides for no-fault entries.
- c.) As many as 4 Gen. Ledger postings for each document, can all be different.
- d.) Document types supported by programs: DJ-1001 Cash/Checks/Payroll CJ-2001 Deposits/R.O.A/Credit Memo
- e.) Complete audit trails for analysis.
- f.) Concise, ready-to-use printouts.
- g.) No special training. Programs use live-cueing at every step.
- h.) Fully Documented, with listings, & supplied on 5 1/4" diskette, written in TRS-80 Basic.
- i.) Also available in MOD II format.
- j.) Total support-for 1-year from date-of-purchase.

DISBURSEMENTS JOURNAL DJ-1001 \$95.00

CASH RECEIPTS JOURNAL CJ-2001 \$75.00
SPECIAL...BOTH PROGRAMS ONLY \$145.00

Complete software packages, and computer supplies at competitive prices.

Checks O.K. **S & A DATA SYSTEMS**

Master Charge/Visa P O BOX 39

NO COD'S Craig, CO 81625

NO CHARGE 1-800-854-2003 (ext 804) TOLL

In Calif. 1-800-522-1500 (ext 804) FREE

Circle 206 on inquiry card.

Take the mystery out of programming

with the latest from *BYTE Books*tm

The BYTE Book of Pascal

Edited by Blaise W. Liffick

Based on the growing popularity of Pascal as a programming language, numerous articles, language forums and letters from past issues of *BYTE* magazine have been compiled to provide this general introduction to Pascal. In addition, this book contains several important pieces of software

including two versions of a Pascal compiler - one written in BASIC and the other in 8080 assembly language; a p-code interpreter written in both Pascal and 8080 assembly languages; a chess playing program; and an APL interpreter written in Pascal. **\$25.00 Hardcover pp. 342 ISBN 0-07-037823-1**

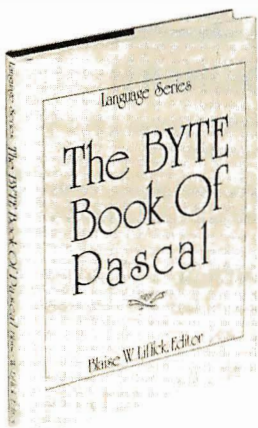

Beginners Guide for the UCSD Pascal System

by Kenneth Bowles

Written by the originator of the UCSD Pascal System, this highly informative book is designed as an orientation guide for learning to use the UCSD Pascal System. For the novice, this book steps through the System bringing the user to a sophisticated level of expertise. Once familiar with the System, you will find the guide an invaluable reference tool for creating advanced applications. This book features tutorial examples of programming tasks in the form of self-study quiz programs. The UCSD Pascal Software Systems, available from SofTech Microsystems Inc, 9494 Black Mountain Road, San Diego CA 92126, is a complete general purpose software package for users of microcomputers and minicomputers. The package offers several interesting features including:

- Programs which may be run without alteration on the General Automation or DEC PDP-11 minicomputers, or an 8080, 8085, Z80, 6502, 6800, or 9900 based microcomputers.
 - Ease of use on a small, single-user computer with display screen and one or more floppy disk drives.
- \$11.95 ISBN 0-07-006745-7**

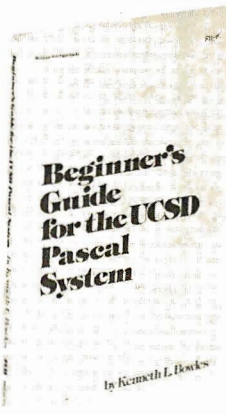

These and other *BYTE*/McGraw-Hill books are available from *BYTE Books* or your local computer store.

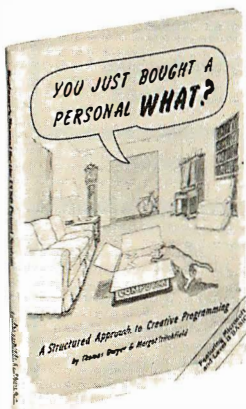

YOU JUST BOUGHT A PERSONAL WHAT?

by Thomas Dwyer and Margot Critchfield

Whether you are a novice programmer or an experienced computer user, this book is filled with practical ideas for using a personal computer at home or work. It will take you through the steps necessary to write your own computer programs, and then show you how to use structured design techniques to tackle a variety of larger projects. The book contains over 60 ready-to-use programs written in Microsoft and Level II BASIC in the areas of educational games, financial record keeping, business transactions, disk-based data file and word processing. **\$11.95 pp. 256 ISBN 0-07-018492-5**

Please send

- _____ copies of *The BYTE Book of Pascal*
 _____ copies of *You Just Bought a Personal What?*
 _____ copies of *Beginner's Guide for the UCSD Pascal System*

Add 75¢ per book to cover postage and handling.

Name _____ Title _____ Company _____

Street _____ City _____ State/Province _____ Code _____

- Check enclosed in the amount of \$ _____
 Bill Visa Bill Master Charge
 Card No. _____ Exp. Date. _____



BYTE BOOKS Division • 70 Main Street
 Peterborough, NH 03458

B6

CARD FAMILY

68000 Industries

For MULTIBUS*:

MIKUL 68000 CPU CARD
 Motorola 8 MHz 16 bit processor
 4 channel DMA . . . PTM . . . ACIA
 7 vectored interrupts

MIKUL 68001 MEMORY CARD
 6/12K x 16 PROM . . . 16/32/48K x 16 RAM
 68000 a-sync cycle support
 *Intel-TM

ALSO
 6809 cards and custom design
 TL Industries, Inc., 2573 Tracy Road
 Northwood, OH 43619, 419-666-8144
16-BIT CARD FAMILY

Circle 207 on inquiry card.

Dial: 402-987-3771

HOTLINE

YOU NEED CRISP, HIGH CONTRAST BLACK-WHITE and VIVID COLOR ALPHA-NUMERICS/GRAPHICS CAPABILITIES FROM YOUR VIDEO MONITOR IF YOU WANT REALLY SUPER-LOOKING IMAGES FROM YOUR COMPUTER!!

AS SPECIALISTS IN VIDEO IMAGING...we think we have the right monitor or modulator for your system. Our product line includes the popular "Micro-Verter" (OSI and Apple Inc. approved UHF color modulator), a variety of color and B-W monitors, color cameras, B-W cameras, Audio subcarrier kits and parts. **FREE CATALOG UPON REQUEST.** Dealers welcomed. Well established program with over 400 dealers.

GET FREE DETAILS VIA OUR HOTLINE!!!

ATV Research 13-B BROADWAY DAKOTA CITY, NE. 68731

UC 2000 system A

The best choice in mainframes !

- S100 CARD FRAME
- AXIAL BLOWER
- 22MM±12" CRT MONITOR
- ASSEMBLED & TESTED
- 18 AMP POWER SUPPLY
- READY FOR YOUR CARDS
- UPPER & LOWER CASE
- \$895.00 OEM QUANT. ONE ASCH KEY BOARDS

INFINITE
 incorporated TM

Celebrating Our 13th Year
 819 E. STRAWBRIDGE, MELBOURNE, FL 32901 - (305) 724-1588

Circle 209 on inquiry card.

HP-85 IN STOCK

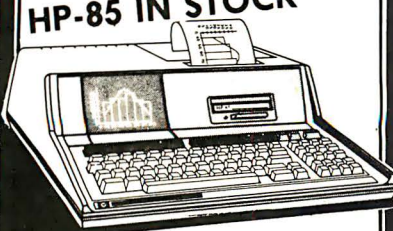

HEWLETT PACKARD

15% off Hewlett-Packard's Series E Calculators
 HP41C, 38C, 34C, 33C in stock

FARNSWORTH COMPUTER CENTER
 1891 N. Farnsworth & E-W Tollway
 Aurora, Il. 60505 (312)851-3888
 Weekdays 10-8; Sat. 10-5

Circle 210 on inquiry card.

C-10 SHORT CASSETTES 50 FT.

Qty.	Price
1	\$1.00
10	\$0.75
50	\$0.65

Premium tape and cassettes acclaimed by thousands of repeat order microcomputer users. Price includes labels, cassette box and shipping in U.S.A. VISA and M/C orders accepted. California residents add sales tax. Phone (415) 968-1604.

MICROSETTE CO.
 475 Ellis Street
 Mt. View, CA 94043

Circle 211 on inquiry card.

NORTH STAR BUSINESS SOFTWARE

Very comprehensive software now available in BASIC.

- Job costing
- Payroll
- General Ledger
- Accounts Payable
- Inventory
- Interfaces to GL
- Veterinarian
- Questionnaire: Survey/Polling
- Other Misc. Software
- Also Corvus Hard Disc

WE ACCEPT MASTER CHARGE/VISA

THE COMPUTER PLACE INC.
 2718 COLONIAL AVENUE S.W.
 ROANOKE, VA. 24015
 (703)982-3661

Circle 212 on inquiry card.

GET Paid for using your Computer

FUN! Easy

RUSH COUPON FOR FREE FACTS

GREAT SPARETIME

Send today to — DAR-B6
 3110 Fulton Ave, Sacramento CA 95821

CASH

NAME _____
 STREET _____
 CITY _____
 STATE _____ ZIP _____

Circle 213 on inquiry card.

OHIO SCIENTIFIC SYSTEMS

CALL TOLL FREE (800) 558-0870

OR

WRITE FOR CATALOG

FARAGHER & ASSOCIATES

7635 BLUEMOUND
 MILWAUKEE, WI 53213
 (414) 258-2588
 In Wisconsin

Circle 214 on inquiry card.

MICRO MART

16K UPGRADE KIT FOR TRS-80, APPLE, PET, SORCERER \$70
 MICROPOLIS 8" Hard Disk DRIVE with

Power, S-100 controller
 9 Megabyte \$3995
 27 Megabyte \$4495
 45 Megabyte \$4995

TI 994 \$1050.00
 Without Monitor \$895.00

DISCOUNTS on EXIDY SORCERER, PET, most other systems, peripherals, and software.

MICROCOMPUTERS, PERIPHERALS AND SOFTWARE

1015 NAVARRO SAN ANTONIO, TEXAS 78205
 512/222 1427

Circle 215 on inquiry card.

Comment and Correction for Mouse

Tom Lane, 612 W Laurel, Ft Collins CO 80521

I enjoyed Peter Grogono's article on Mouse (July 1979 BYTE, page 198). It demonstrates that an interesting and powerful language can be implemented with very little effort, if carefully designed. The decision to express the program in a machine-independent form such as Pascal was especially commendable; it makes the program easier to understand and useful to a wider range of readers. I hope that other authors will follow this example.

A major benefit of a high-level program is that it is more easily understood and debugged than the equivalent assembly-language program. I hope to graphically demonstrate this claim by reporting on several bugs which I found in the Mouse interpreter program.

First off, there were several typographical errors in the listing. Line 42 should have read "CAL := CAL - 1", not "CAL := CAL = 1". This kind of syntax error would be caught by an assembler as well as a compiler, so Pascal is not ahead here. Line 176 should have been "PARAM: PARBAL := PARBAL + 1;" (a plus sign not a minus). In order to catch this error, one must understand the logic of the loop on lines 172 thru 179. The equivalent assembler code would be much more than eight lines long, and would contain a lot of extraneous detail (eg: how to access the STACK data structure); the incrementing and decrementing of PARBAL would not stand out at all.

The next problem I found was in the SKIP routine. It fails if it has to skip over a quoted string containing one of the bracketing characters. For example, consider the program fragment:

```
A. [ "PRINT A BRACKET ] HERE" ]
```

If $A \leq 0$, SKIP will be invoked to skip over the conditional clause. In its present form it will only skip to the first right bracket; the interpreter then tries to evaluate the rest of the quoted string. When the closing quote is reached, control takes off looking for a matching quote, which is never found. We can fix this by rewriting SKIP as follows:

```
CNT := 1;
repeat
  GETCHAR;
  if CH = '"' then
    repeat GETCHAR until CH = '"'
  else if CH = LCH then CNT := CNT + 1
  else if CH = RCH then CNT := CNT - 1
until CNT = 0
```

This bug looks like a simple oversight. Such oversights

are probably more common in assembler programs, simply because there is more code and thus there are more opportunities to forget something.

The same problem exists in the loop on lines 182 thru 190, which searches for the desired actual parameter in a macroinstruction call. Furthermore, this loop will fail when an actual parameter being skipped over contains two adjacent macroinstruction calls, as in:

```
#A, #B, 1; #C, 2; , 34;
```

Here, after skipping over "#B, 1;" by calling SKIP at line 187, the GETCHAR on the same line advances CH to the following "#". But since this is already past the test for CH = '#', the second macroinstruction call is not recognized as such. If we were looking for the second parameter of A, "2" would be found instead of "34". What is really needed, following the call to SKIP, is to return to the GETCHAR call at line 183. With both problems fixed, the loop becomes:

```
repeat
  GETCHAR;
  if CH = '"' then
    repeat GETCHAR until CH = '"'
  else if CH = '#' then SKIP('#',';')
  else if CH = ';' then PARNUM := PARNUM - 1
  else if CH = ':' then PARNUM := 0
until PARNUM = 0;
```

Notice that we have to modify the loop exit logic so that it will not exit after returning from SKIP (for we are not done scanning, even though CH=';'). I suspect that the original code did exit the loop in this case, and that this bug arose as a result of trying to fix the SKIP code rather than the exit condition. This particular bug would never have occurred in assembler code, since after the call to SKIP one would merely jump back to the top of the loop; it illustrates that "GOTO-less programming" has its own pitfalls.

Finally, there is a subtle problem with the allocation of local variables for macroinstructions. Consider the program:

```
#A, #B; ;
$A Q1 = %A Q.! @
$B Q33 = @
$$
```

When A is invoked it sets its local variable Q to 1, then evaluates its parameter, which results in B being invoked. B sets its local variable Q to 33. Since A and B have independent local variables, this should not change A's Q, so when A finally prints out the value of Q it should print 1.

With the interpreter as published, it prints 33. This can be seen by following the manipulations of OFFSET. Initially OFFSET=0, signifying that the main program's variables A thru Z occupy DATA locations 1 thru 26.



SOFTWARE BY KEY-TRONICS FOR TRS-80



LEVEL II COMPUTERS

***Earn \$\$\$\$\$ with COMPUTER DATING**
single disc holds 1000 entries
disc #1 — \$49.00 disc #2 — \$39.00

***GASOLINE ENGINE SERIES**
4 cycle and 2 cycle engines
3 cassetts — \$9.95 each or all 3—\$19.95
EDUCATIONAL

***STATIC DISCHARGE KIT**
Helps eliminate accidental disc start up
easy installation
a must for computer buffs
just \$16.95

KEY-TRONICS

P.O. BOX 1097
HAGERSTOWN, MARYLAND 21740
301-790-0547

TRS-80 is a product
of the TANDY corporation

SUPPLIES



- 3M DISKETTES, MINI OR STANDARD
 - 3M DATA CARTRIDGES, CASSETTES, DISK PACKS
 - RIBBONS, PRINT WHEELS, ELEMENTS, PAPER
- ZAPP**
STATIC PROBLEMS???

CALL US ON 3M VELOSTAT®
ANTISTATIC FLOOR MATS

5555 Magnatron Blvd. #J
San Diego, CA 92111
(714) 565-4505



Circle 217 on inquiry card.

OHIO SCIENTIFIC

..... With This Ad

HAZELTINE 1420 \$780
CENTRONICS 779 W/TRACTOR \$969
NEC SPINWRITER \$2250

..... Get the Catalog
&
Our Low Prices



9460 Telstar Avenue (213) 573-5991
El Monte, CA 91731 (714) 994-4180

Circle 218 on inquiry card.

APPLE II™

A/D INTERFACE BOARD

- 8 CHANNELS
 - 8 BITS
 - 65 μ S CONVERSION
 - ON BOARD REFERENCE
- \$99.50 + \$2.50 SHIPPING
(\$5.00 SHIPPING FOREIGN)

TRENDCOM 100™

GRAPHICS UPGRADE KIT

- TGU1 - FOR PRINTERS WITH SELF-TEST JUMPER
 - TGU2 - FOR PRINTERS WITH SELF-TEST SWITCH
 - APPLE II HIRES DUMP SOFTWARE
- \$59.95 + \$2.50 SHIPPING
(\$5.00 SHIPPING FOREIGN)



8900 SW BURNHAM. #F9
TIGARD, OR 97223 (503) 620-2713

Circle 219 on inquiry card.

ALL CP/M & CROMEMCO SYSTEMS

INVENTORY CONTROL (for Manufacturers & Retailers) \$250
Parts explosions for finished goods & assemblies
Parts requirements forecasting & ull Sheets
Economic Order Quantities & Reorder Reports
1500 items per S.D. 8" disk side

ACCOUNTS PAYABLE/RECEIVABLE \$175/\$175
Replaces all your hand written ledgers
Prints Monthly Ledger Sheets, Checks, Vouchers & Stubs
Aged Trial Balances & Statements
Handles Discounts, Partial Payments, Credits, Etc.

APARTMENT MANAGEMENT SYSTEM \$250
Prints all your Monthly Rent Bills
Reports Late Payments, Vacancies, and Lease Expirations
Links with Accounts Receivable Program

PAYROLL SYSTEM \$175
300 Employees per S.D. 8" disk side
Federal, State and Local Taxes
Quarterly & Yearly Reports (inc. 941's & W-2's)
Prints Payroll Registers, Checks & Vouchers

MAILING LIST \$99
Maintains your list up to 1700 customers per S.D. 8" disk side
Prints the list by Customer Type, City, State or Zip
Can be used to send Personalized Form Letters
These programs run **FASTER & BETTER** than ones costing up to 5 times more. All used over 1 1/2 years by several large corporations.
Hardware Required: 48 KRAM, dual floppy disks, 132 col. printer.
Written in Cromemco 16 K EXTENDED BASIC (runs under CP/M)

FEITH SOFTWARE

Cedarbrook A-1103
Wycoke, Pa. 19095
(215) 887-9780

Circle 220 on inquiry card.

DOUBLE YOUR LA36 DECWRITER'S SPEED TO 60 CPS

The ACCELEWRITER converter enables you to convert the LA36 Decwriter from 10/15/30 to 10/30/60 CPS.

- Utilizes Decwriter's own built-in 60 CPS. speed
- Plugs into logic board
- Compatible with Decwriter option boards
- Decwriter reconverts to "stock" in seconds
- Thousands sold
- In use for over 3 years
- Full one-year warranty
- \$115 includes shipping



Brochure sent promptly at your request.
Write or call us.

LARKS ELECTRONICS & DATA

P.O. Box 22, Skokie, IL 60077
(312) 677-6080

Circle 221 on inquiry card.

INTEL SBC 8010 CENTRAL PROCESSING UNIT \$225 ea.

Complete computer on a multi-bus P.C.B. includes 8080 CPU, system clock, 1K bytes of ram memory, sockets for 4K bytes of E prom's allowing customized firmware 48 programmable I/O lines, a USART, RS232C and TTY drivers and receivers, sockets for I/O line drivers and terminators, and 6 interrupt lines.

PROGRAMMABLE KEYBOARD \$100 ea. KEYTRONICS 65-01641-01 PCB-002A. KEYTRONICS custom programmable keyboard, 10 programmable function keys, numeric keypad (ASCII) encoded alphabet, 1K bytes of read only memory.

BOSCHERT POWER SUPPLY

\$100 ea.
115/230v AC, outputs +5v \pm 1%; -5 \pm 5%; +12v \pm 5%; -12v \pm 5%; +15v \pm 5%; -15v \pm 5%.

Contact Ernest at Exeter Int'l.
52 Church St., Boston, MA 02116
(617) 357-5223

Circle 222 on inquiry card.

STRUCTURAL ANALYSIS SOFTWARE

For TRS-80 and North Star Computers

SPACE FRAME (Finite Element — Stiffness Method)
includes Space Frame, Plane Frame, Space Truss & Floor Grids
Disk Version \$150.00 Casette Version \$50.00
TRS-80 Model II \$200.00 Documentation Only \$25.00
plus postage

TRUSS FORCE (Method of joints solution of Common Trusses)

Disk Version \$50.00 Casette Version \$25.00
Documentation Only \$5.00 plus postage

LINEAR PROGRAMMING (Simplex Method)
Disk Version \$80.00 Casette Version \$25.00
Documentation Only \$5.00 plus postage

ENGINEERING ANALYSIS SOFTWARE

P.O. Box 26206
Fort Worth, Texas 76116
Phone (214) 298-1248

In California Contact:

MICOPS INC.
421 Royale Park Dr.
San Jose, Ca. 95136
Phone (408) 629-5716

Circle 223 on inquiry card.

MINI FLOPPY SALE

TRS-80 OWNERS

SINGLE SIDED \$365.00
DOUBLE SIDED \$485.00
READY TO GO-CABINET-
POWER SUPPLY-CABLE
ASSEMBLED & TESTED

ADD ON DRIVES

SINGLE SIDED \$225.00
DOUBLE SIDED \$ 345.00

INTERFACE, INC.
20932 CANTARA STREET
CANOGA PARK, CA. 91304
(213) 341-7914

MASTER CHARGE & VISA

Circle 224 on inquiry card.

When macroinstruction A is invoked, OFFSET is set to 26 (see line 160 in the interpreter), so that A's variables occupy 27 thru 52; in particular, Q occupies 43. When we start to evaluate A's actual parameter, OFFSET is reset to 0 (see line 181). This is essential since variable names within the text of the actual parameter should refer to main program variables. When the call to B is processed, OFFSET is set to 26 (line 160 again), so B's variables are allocated on top of A's variables. Hence, when B stores into its Q, A's Q gets changed.

The problem essentially is that the variable OFFSET is used for two incompatible purposes. One is to keep track of the current context (ie: the set of locations to which the names A thru Z refer). The other is to remember how much of the DATA array is in use, so that fresh locations can be allocated when a macroinstruction is called. These uses are obviously incompatible because the total storage allocation changes only at macroinstruction call and return, while the context changes at macroinstruction call/return and when accessing actual parameters.

Once the problem is phrased this way, the fix is simple. I chose to retain OFFSET for indicating context, and to introduce a new variable LASTUSED for keeping track of free space. The required changes are:

In line 17, add LASTUSED to the list of global integer variables.

In line 88, add "LASTUSED := 26;"

Replace line 160 with "OFFSET := LASTUSED; LASTUSED := LASTUSED + 26;"

In line 166, add "LASTUSED := LASTUSED - 26;"

OFFSET is still saved and restored in the control stack; LASTUSED need not be, since it can only change as shown above.

All these bugs were found during two evenings of studying the interpreter listing, with no machine use whatever. The fixes were invented in the same period. I was later able to test the fixes on a Pascal machine; they all worked correctly the first time. I am sure you will agree that equivalent problems in an assembler program would not have been detected so easily nor fixed so readily.

The approach recommended by Mr Grogono, namely coding the algorithm in a high-level language and then translating to assembler, has great merit. It is capable of

producing bug-free programs in a shorter time than the conventional methods. However, to achieve best results one must spend time examining the high-level program before plunging into assembler coding. (It helps a lot if you can actually run the program in that form.) As I hope I have demonstrated, it is much easier and quicker to remove bugs at this stage than later on.

Peter Grogono Replies:

First of all, I would like to commend Mr Lane for so carefully reading and checking the Mouse interpreter before rushing off to the nearest computer and attempting to implement it. If more programmers behaved likewise, there might not be a "software crisis" in industry today.

The proof copy of listing 6 that I received was a poor photocopy, hence the typographical errors in the program. The proof of the article was very clear, so I have no excuse for the error in the right-hand column on page 205; the definition of F should read:

```
$F N%A=1 (N.† N.* NN. 1- =) @
```

I have little to say about Mr Lane's other points. The problems that he identifies are all genuine bugs, and his corrections are simple and elegant. I would like to take this opportunity to apologize to other readers who have been inconvenienced by them.

As I mentioned in the article, Mouse is based on a language that I first implemented several years ago. The bugs are, perhaps, partly due to my confusion between the old and new versions of the language. This confusion also appears in the design. I now feel that I should have made % a postfix operator with a numerical operand, like the other unary operators. The formal parameters are then 1%, 2%,... rather than %A, %B,... In general, % may be preceded by any expression that has a positive value. This extends the power of the language, as can be seen from the following program, which prints 15:

```
#S, 1, 2, 3, 4, 5, 0; !
$$ NO= 0 ( NN.1+= N.%† N.% + ) @
$$
```

The changes required to the interpreter are very small; in line 170 change

```
GETCHAR: PARNUM: = NUM (CH);
```

to

```
PARNUM: = POPCAL;
```

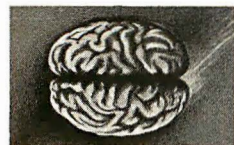

S-100 8086

CPU with \$450.
Vectored Interrupts

PROM-I/O \$495.

RAM \$395.

8K x 16/16K x 8

Parallel I/O \$350.
and Timer

S-100 ANALOG

A/D 16 Channel, \$495.

12 Bit, High Speed

D/A 4 Channel, \$395.

12 Bit, High Speed



S-100 VIDEO DIGITIZATION

Real Time Video \$850.

Digitizer and Display

Computer Portrait

System \$4950.

S-100 Boards

Video and/or Analog
Data Acquisition
Microcomputer Systems



The High Performance S-100 People

TECMAR, INC.

23414 Greenlawn • Cleveland, OH 44122
(216) 382-7599

FOR SALE BY OWNER:

Mini-Computer, Vector,
Z-80 Based, 48K,
8"-Dual Disc Drive.
Guaranteed Perfect
Condition, 2 years old —
Cost \$6,000.00
Asking \$3,000.00.
Also Centronics 700
Printer — \$700.00.

B. KLEIMAN
7600 Osler Drive,
Baltimore, MD 21204
PHONE: (301) 821-0764.

Circle 226 on inquiry card.

CRANIAL LABS

BASEBALL & FOOTBALL
the 2 most exciting non-
graphics games yet.

plus **CLEAR THE SKIES**
Pure Graphics, call your plays
or test your reactions.

Order # 102 \$11.00
Post Paid

Created for TRS-80, 16K
LEVEL II SYSTEMS.

Games played
with friend or computer.

CRANIAL LABS
168 Villa Avenue
Buffalo, NY 14216

Circle 227 on inquiry card.

FAST A/D FOR MICROS



At last: Scientific quality data acquisition in real time
for microcomputers. A/D Section: 12 bits (1 part in
4096 resolution) in 25 microseconds, 5 channels input
(expandable to 21) unipolar or bipolar, software
selected full-scale range for each channel. D/A Section:
2 (up to 6) 12 bit double-latched fast analog
outputs, selectable ranges.

Rugged, modular construction with internal supplies.
Ready to operate, includes extensive software pack-
age. Customized to your needs, applications consult-
ing. Interface card for Apple II and TRS-80. Please
write for information.

das

DATA ACQUISITION SYSTEMS, INC.
1534 Cambridge Street, Suite 2
Cambridge, Massachusetts 02139

Circle 228 on inquiry card.

MEMOREX Floppy Discs

Lowest prices. **WE WILL NOT
BE UNDERSOLD!** Buy any
quantity 1-1000. Visa. Mastercharge
accepted. Call free (800)235-4137
for prices and information. All
orders sent postage paid.

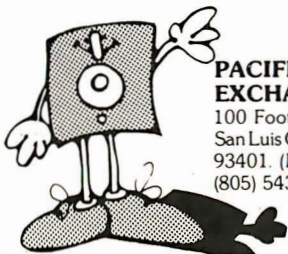

**PACIFIC
EXCHANGES**
100 Foothill Blvd.
San Luis Obispo, CA
93401. (In Cal. call
(805) 543-1037.)

Circle 199 on inquiry card.

BUSINESS SOFTWARE — FOR — MICROPOLIS MOD II

Now available, the business software
that is becoming a standard. General
Ledger, Payroll, Accounts Receivable
& Payable originally developed by
OSBORNE & ASSOCIATES have been
converted by M-SOFTWARE to
MBASIC using MDOS. All programs
are shipped on 5 1/4" floppy disk.

Payroll w/Cost Accounting \$125
Accts. Rec./Accts. Payable \$125
General Ledger w/Cash Journal .. \$125

— CALIF. RESIDENTS ADD 6% SALES TAX —

M-SOFTWARE
21215 Merridy
Chatsworth, CA 91311

Circle 229 on inquiry card.



- Animation Compiler and Graphics Editor Package
- Add smooth, fast action to basic programs
- Create ad layouts, newsletter covers, posters

\$14.95 Write or call for complete catalog

MACROTRONICS, Inc.

1125 N. Golden State Blvd. / Suite G
Turlock, CA 95380 (A)
(209) 667-2888 / 634-8888

We are experiencing telephone difficulties,
please keep trying.

California residents add 6% tax

VISA or MC

Circle 230 on inquiry card.

PROVEN CP/M AND NORTHSTAR SOFTWARE

is always available from
The Software Review. This
months offerings include:

OSBORNE BASIC BUSINESS PROGRAMS—Com-
plete set (A/R, A/P, G/L, Payroll) in most CP/M
formats (Documentation separate) \$100
SUPER-PILOT 4.1—The definitive education lan-
guage for Northstar Systems. Includes tutorials on
disk \$49.95.
KRIS STEWART'S "SCRUNCH"—San Diego State
College Master's Project puts state-of-art FOR-
TRAN numerical analysis routines into structured
Northstar BASIC. Includes documented source
code and thesis \$29.95
YVGAMES VOL. 1—Games for Northstar w/VDM.
Real-time action games for VDM/Flashwriter video
displays. Hot stuff \$21.50
COPY—Single density single drive copy utility for
CP/M systems. The best way to copy programs
from one disk to another on a single drive system
(specify format and diskette size desired) .. \$21.50
**BUSINESS ADDRESS AND TELEPHONE DIREC-
TORY**—For Northstar systems, the best mailing
list/phonebook database system we've found. Lots
of features \$79.95
MSSE DISKS 14-22 & P01—Just released and
available from the Software review. Set of 10
diskettes
ORDER FROM
The Software Review
704 Salano Ave., Albany, CA 94706
(415) 527-7730

Circle 231 on inquiry card.

2716's \$19.95

ANY QUANTITY

\$5 per order for shipping
handling & insurance

floppy drives \$1550

including two Siemens 8"
drives, cabinet & power

Intelligence Systems, Ltd.
124 South Delaware, Indianapolis, IN
(317) 631-5514

Circle 232 on inquiry card.

NorthStar

HORIZON II Computer

With 32K RAM

FULLY TESTED & ASSEMBLED

\$2150.

IN STOCK FOR IMMEDIATE DELIVERY
C.O.D. OR CASH IN ADVANCE



**CUSTOM
BUSINESS COMPUTERS**

LYNBROOK, N.Y. 11563
103 ATLANTIC AVE. (516) 887-3340

AUTHORIZED DEALER
FOR

MAGIC WAND™

WORD PROCESSING
\$400.

Circle 233 on Inquiry card.

What's New?

PERIPHERALS

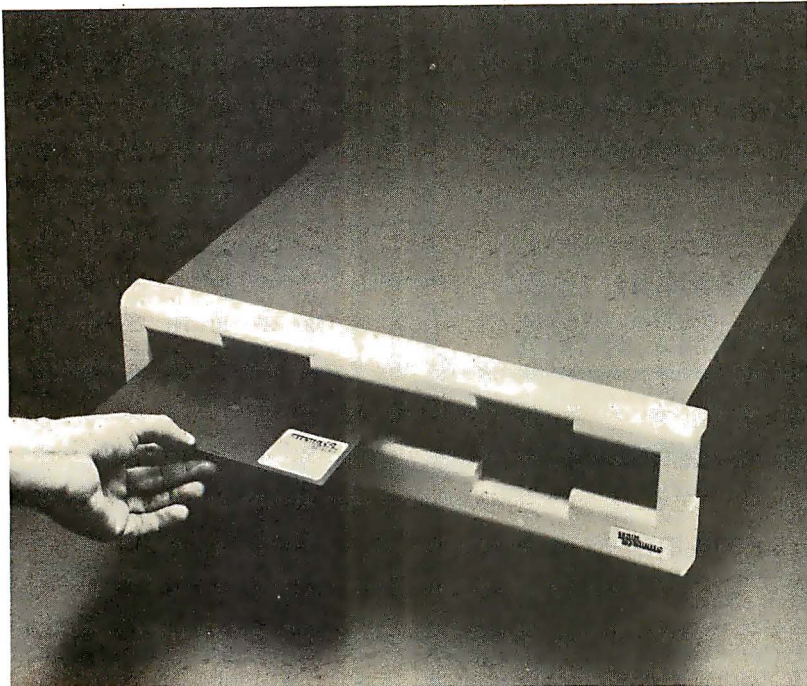

Floppy-Disk Drive Compatible with DEC and IBM Formats

This floppy-disk drive system is compatible with all Digital Equipment Corporation (DEC) and IBM disk formats, including the IBM double-density, double-sided format. The DSD 480 system reads and writes on both sides of 8-inch disks for a formatted capacity of 1 megabyte per disk or 2 megabytes of on-line storage. The system is fully com-

patible with DEC LSI-11 and PDP-11 computers. It is possible to transfer data and applications programs written for IBM machines directly to DEC computers, and vice versa. The DSD 480 features hardware bootstrap, off-line disk formatting, and "Hyperdiagnostics"—a library of routines that perform system self-tests. Priced at \$4495, the DSD 480 is available from Data Systems Design, 3130 Coronado Dr, Santa Clara CA 95051.

Circle 595 on inquiry card.

Light Pen for the Apple II

A self-contained light pen which plugs directly into the Apple has been announced by the 3-G Co, Rt 3, POB 28A, Gaston OR 97119. The light pen bypasses the keyboard and interacts directly with the information displayed on the video screen. A menu can be displayed on the screen and the user can

make a selection from that menu by using the light pen. By elimination of the need to use the keyboard, children can use computers with the pen for educational purposes. A demonstration cassette, sample program, and complete programming instructions are included with the pen. The package sells for \$32.95.

Circle 596 on inquiry card.

Where Do New Products Items Come From?

The information printed in the new products pages of BYTE is obtained from "new product" or "press release" copy sent by the promoters of new products. If in our judgement the information might be of interest to the personal computing experimenters and homebrewers who read BYTE, we print it in some form. We openly solicit releases and photos from manufacturers and suppliers to this marketplace. The information is printed more or less as a first in first out queue, subject to occasional priority modifications. While we would not knowingly print untrue or inaccurate data, or data from unreliable companies, our capacity to evaluate the products and companies appearing in the "What's New?" feature is necessarily limited. We therefore cannot be responsible for product quality or company performance.

Modem for Digital Devices



The Bell-compatible model 103 LP modem enables digital devices (computers and/or interactive terminals) to communicate with each other via the analog facilities of the telephone network. The model 103 LP allows full-duplex data communication at speeds of up to 300 bits per second (bps). All necessary operating power is taken directly from the telephone line. Only three snap-in connections are required to set up the unit. Connectors for RS-232 and current loop interfaces are featured. A talk/data switch enables the user to return the telephone to the voice communication mode without disturbing cable connections. The model 103 LP is less than 3.2 cm (1.25 inches) thick and fits under an ordinary telephone. The price is under \$200. For details, contact UDS, 5000 Bradford Dr, Huntsville AL 35805, (205) 837-8100.

Circle 597 on inquiry card.

Lobo Drives Offers Expansion Interface for TRS-80

Lobo Drives International, 935 Camino Del Sur, Goleta CA 93017, announced the addition of an enhanced expansion interface for the Radio Shack TRS-80 personal computer.

The model LX80 can expand memory storage capacity up to 40 megabytes. It provides facilities for up to 32 K bytes of programmable memory and offers a second serial port. The keyboard read-only memory (ROM) can be overridden for booting in diagnostics and customized operating systems. There is a bidirectional parallel port exclusively for Lobo Drives' model 7710T Winchester hard-disk drive. Other features include a parallel Centronics printer port, screen printer port, two microprocessor-controlled bidirectional serial ports, and a crystal-controlled real-time clock. The model LX80 expansion interface is priced at \$525.

Circle 598 on inquiry card.

What's New?

SYSTEMS

6809 SS-50 Microprocessor Card Is Also Stand-Alone Microcomputer

The SBC/9 card can be used as a stand-alone control computer or as an upgrade processor card for SS-50 bus microcomputers. It includes its own operating system; 1 K of programmable memory; 1 K bytes of read-only memory; and a full-duplex, RS-232C serial interface. The card is completely compatible with the SS-50 bus and requires no modification. The SBC/9 hardware features include a port for 8-bit bidirectional data lines, a multilevel data bus, extended address line capability to accommodate up to 16 megabytes of memory, a serial interface for use with cassette recorders, and more. The SBC/9 with the operating system and a manual sells for \$199.95 from Percom Data Co, 211 N Kirby, Garland TX 75042.

Circle 599 on inquiry card.

Mainframe for PC/M's 12-bit, PDP-8-Compatible Microcomputer

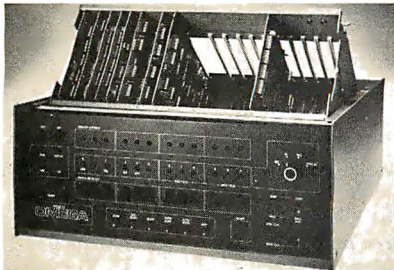

The PCM-12 Omega mainframe is compatible with Digital Equipment Corporation's PDP-8 series minicomputers. The PCM-12 is based on the 6100 microprocessor and is software-compatible with all PDP-8 systems. The mainframe includes connectors for 18 plug-in cards (enough for 32 K words of memory), and up to 14 peripheral interfaces and input/output (I/O) devices. The power supply is over-voltage protected and fold-back current limited. Operation is from 100 to 240 V, 50 or 60 Hz. The front panel structure provides real-time operational display and includes all PDP-8/E functions, plus built-in bootstraps for paper tape, RX01 and RX02 floppy disks, RK05 hard disk, and TU-58 DECtape. The Omega mainframe is priced at \$889. Contact PC/M Inc, 6800 Dublin Blvd, Dublin CA 94566, (415) 829-8700.

Circle 601 on inquiry card.

R2E Introduces a Single Board Microcomputer

The model 80-20 is a small-business microcomputer system. The single board system includes a Z80 microprocessor; 32 K bytes of programmable memory, expandable to 64 K bytes; two single-sided, double-density, 5-inch floppy-disk drives with 140 K bytes of storage on each; an ASCII (American Standard Code for Information Interchange) keyboard; parallel Centronics printer

interface; cabinet and power supply. The system also has a 1024-character uppercase and lowercase video display. Software for the model 80-20 includes R2E's BAL Language (Business Oriented BASIC) with sequential, indexed sequential, and random access file management, plus a macroassembler. Optional are FORTRAN, COBOL, Pascal, APL, CBASIC, and MBASIC (compiler and interpreter). These operate under CP/M. The 80-20 is priced under \$3000. For more information, contact R2E of America, 47 Bedford St S E, Minneapolis MN 55414.

Circle 600 on inquiry card.

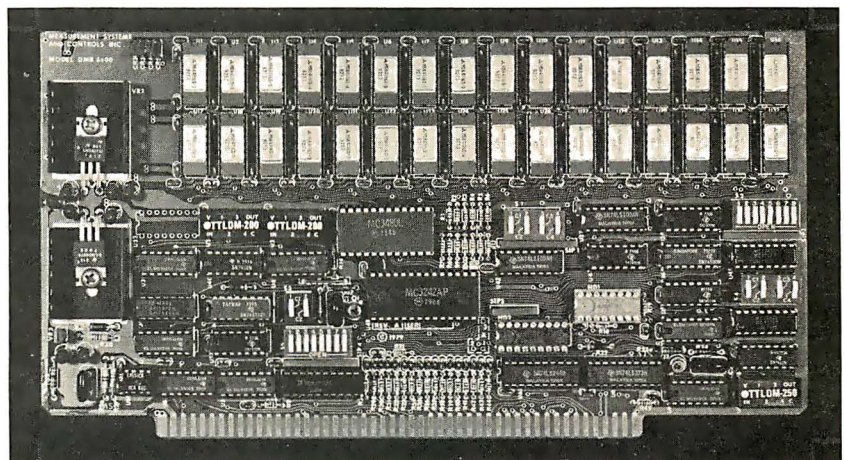
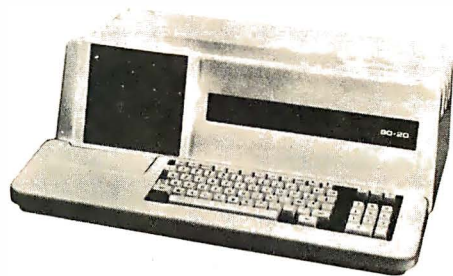

64 K-Byte Board Compatible with S-100 Bus Systems and MP/M

The DMB6400, a 64 K bank-selectable, dynamic-memory board, is compatible with Alpha Micro, Cromemco, North Star Horizon, and other S-100 bus computers, as well as MP/M systems. The memory board uses output-port addressing for the bank-select feature and is configured as 4 independent 16 K-byte banks of memory. Any of the 256 ports can be decoded, and 8 banks of memory are

possible for each port. Each memory bank can be turned on or off at system reset, and phantom addressing can be used by any of the 4 banks. The memory board will run with all 8080 processors, 8085s at 3 MHz, and most Z80As at 4 MHz. In addition, it will run with the Marin M9900 processor. The boards come with documentation and are guaranteed for 1 year. Contact Measurement Systems and Control Inc, 867 N Main St, Orange CA 92668, for original equipment manufacturers and dealer pricing information.

Circle 602 on inquiry card.

What's New?

MISCELLANEOUS

8-Inch Floppy-Disk Controller

Disk 2+2 is a single-density, 8-inch floppy-disk controller for the Apple II computer. It increases the data on line, increases the individual file size, and reduces the number of disks handled by the user. The board operates under the Apple disk operating system 3.1 or 3.2. It will control up to 4 standard 8-inch floppy-disk drives. The card uses a 1771 LSI controller integrated circuit that allows exchange from the Apple to IBM 3740 format. Disk 2+2 costs \$400 and is available from Apple dealers. For more information, contact Sorrento Valley Associates, 11722 Sorrento Valley Rd, San Diego CA 92121.

Circle 603 on inquiry card.

Sink the Bismarck

Computer Bismarck is an historical simulation game of the British attempt to seek and destroy the German battleship Bismarck in 1941. The game is played on an Apple II with Applesoft read-only memory (ROM) or an Apple II Plus. The game requires 48 K bytes of programmable memory and a floppy-disk drive. It features high-resolution

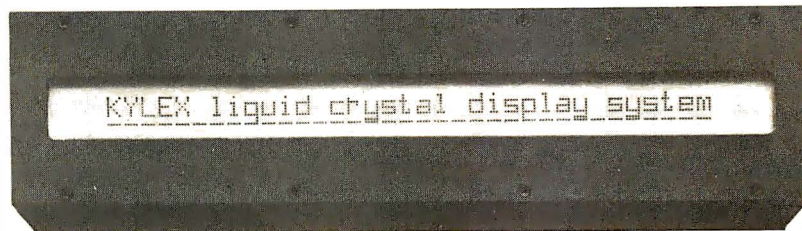

One-Line, 40-Character, Dot-Matrix Liquid-Crystal Display (LCD)

Kylex Inc, 420 Bernardo Ave, Mountain View CA 94043, has introduced a one-line, 40-character, 5-by-10 dot-matrix LCD with integral electronics that can interface directly with microprocessors through a single peripheral parallel interface device. The LX140 is aimed at electronic typewriter, word processing, and terminal printer

applications. It includes integral drive, refresh, temperature compensation, and power supply electronics. The LCD is designed for use in high ambient light conditions to reduce eye strain. The 5-by-10 dot matrix for each character provides display capability for the full ASCII (American Standard Code for Information Interchange) set, with each dot addressable.

Price for the LX140 in quantities of 100 and up is \$199.

Circle 604 on inquiry card.

color graphics and can be played by one or two players. Players take turns moving their vessels and aircraft across the North Atlantic. Only enemy units which are spotted are revealed to the players. Rules cover all of the critical aspects of the naval campaign, from weather to ship fuel capacities. Combat

occurs when opposing units have spotted each other. Computer Bismarck comes with a program disk, rule book, and 7 player-aid charts for \$59.95 from Strategic Simulations Inc, POB 5161, Stanford CA 94305.

Circle 605 on inquiry card.

64 K-Byte Dynamic Programmable Memory Board

The ST4203, a 64 K-byte dynamic programmable-memory board, is compatible with any processor in the STD BUS environment, and will operate at any microprocessor speed, up to and including 4.0 MHz. The onboard refresh

controller feature allows the processor to synchronize to external events, or use peripheral controllers which require multiple WAIT states without regard to refresh timing. The ST4203 can take the place of four 16 K static programmable-memory cards, and it can make available 3 slots in the STD BUS card cage. Memory expansion for bank-selection and phantom-memory opera-

tions are selectable. A number of WAITRQ options are also available. Prices range from \$220 for a card without memory to \$700 for a complete 64 K-byte unit in the 2.5 MHz version. For more information, contact Applied Micro Technology, POB 3042, Tucson AZ 85702.

Circle 606 on inquiry card.

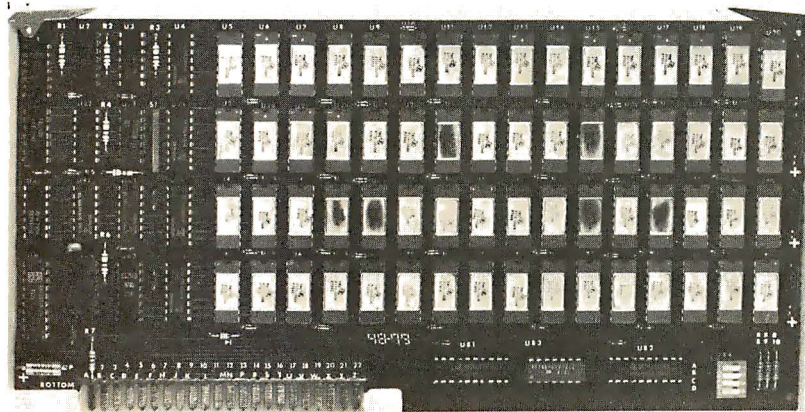

Memory Board for Hewlett-Packard 9845B/T Computer

Eventide Clockworks, 265 W 54th St, New York NY 10019, is manufacturing and marketing a board which adds 128 K bytes of programmable memory to the Hewlett-Packard (HP) 9845B/T computer. The Eventide WMAP-1 has identical capabilities to those of the HP part #09845-66526, but it costs half as much. The WMAP-1 board carries a full 1-year parts and labor warranty. Complete schematics, field installation instructions, and troubleshooting data are provided.

Circle 607 on inquiry card.

What's New?

MISCELLANEOUS

Catalog for Micah Software

A four-page foldout catalog lists software from Micah, POB 22212, San Francisco CA 94122. Micah software

products include Expand, which expands CP/M to run Cromemco software; Spool, a spooler for CP/M or Cromemco; CBIOS, CP/M for Cromemco computers; and DUP/1, disk utilities for

CP/M and CDOS. Micah also has Osborne business software and graphics software. Contact the company for a copy of the catalog.
Circle 608 on inquiry card.

Tabletop Winchester Tape Cartridge Add-On for DEC PDP-11

ABC Computers Inc, 500 Tonopah, POB 7529, Tahoe City CA 95730, (916)

583-5562, is offering a tabletop, 20-megabyte add-on Winchester system with a tape-cartridge backup unit for the Digital Equipment Corporation PDP-11 Series. The Winchester is the Marksman 14 drive from Cal Comp, a division of

Xerox. The 17-megabyte tape cartridge is produced by DEI. The entire system is delivered in a 27.5 cm (10.5 inch) high cabinet complete with power supply and controller for \$8600.
Circle 609 on inquiry card.

A New Software Vendor Directory

The Software Vendor Directory, a listing of microcomputer software vendors, is available from Micro-Serve Inc, POB 482, Nyack NY 10960. The publication lists over 700 vendors within 35 categories of hardware and operating

systems. Software is classified into personal (games, etc), programming (operating systems, utilities, languages, etc), general business, and industry business (insurance, medical, etc). Vendors of books and other publications have also been included. The directory is designed for hardware and software vendors, computer stores, consultants,

programming services, sales and marketing people; in short, those who need information on software products for microcomputers. *The Software Vendor Directory* is priced at \$37.95. A quarterly update service is also offered at a price of \$9.95 per issue.

Circle 610 on inquiry card.

12-Inch Monitor for Under \$200

Leedex Corp, 2300 E Higgins Rd, Elk Grove Village IL 60007, has introduced a 12-inch black and white monitor, the Video 100-80. Built for industrial use, the monitor includes a metal cabinet and a removable face plate that provides mounting space for a floppy-disk drive. There is also space inside the cabinet for an 11-by-14 printed circuit board for custom-designed electronics. The 90-degree deflection picture tube allows an 80-character by 24-line display, and the unit features a 12 MHz bandwidth.

The Video 100-80 is plug compatible with Apple, Atari, Radio Shack, OSI, Microterm, and Exidy computers. It is priced under \$200.

Circle 611 on inquiry card.

Light Pen for Apple II Users

The Lipson Light Pen is now available for the Apple II. The pen is packaged with 12 BASIC programs on cassette, a manual, cable, and a connector to PDL(0) on the Apple II. The demonstration programs are designed to be incorporated into programs created by the user. The pen utilizes a cadmium selenide cell for light detection, enabling the user to detect and measure varying intensities of light. High-resolution graphics, sound, and color are implemented in the demonstration programs. The Lipson Light Pen is available exclusively from ARESKO, POB 1142, Columbia MD 21044, for \$24.95.

Circle 612 on inquiry card.

Floppy-Disk Head-Cleaning Kits from 3M

Scotch head-cleaning disks use a wet and dry method by which a cleaning solution is applied to the porous cleaning fabric in the disk envelope. The cleaning disk is then run in a normal manner for 30 seconds. Two-sided systems may be cleaned with the same technique. Each kit contains two disks and a bottle of fluid. A maximum of 30 cleanings is possible. Each 5- or 8-inch floppy-disk kit costs \$30. Further details concerning the Scotch 7400 and 7440 head-cleaning disk kits may be obtained by writing to 3M, Dept DR80-1, POB 33600, St Paul MN 55133, (612) 733-9572.

Circle 613 on inquiry card.

PROPERTY MANAGEMENT SOFTWARE

This is professional software designed to meet the exacting requirements of the Institute of Real Estate Management. This software is user engineered and has been thoroughly developed in actual nationwide use managing all types of income properties. The software is written in CBASIC, requiring dual drives and 48K of memory (also TRS-80, Pet, Apple compatible). We feel this is the most extensive property management software written for a microcomputer. The system includes:

- Full General Ledger
- Checkwriter
 - manual check can also be used
- Budgeting
- Tenant Information
- Rent Roll
- Delinquency List
- Vacancy List
- Lease Expiration Report
- Lost Rent Report
- Vendor Report
- Full Audit Trail
- Real Estate Support
- Plus much, much more

Demonstration diskettes with manual is \$35.00 and can be applied toward full software price of \$650.00. MasterCard, Visa and COD orders welcome. Dealer inquiries invited.

A-T Enterprises 221 No. Lois, La Habra, CA 90631 (213) 947-2762

What's New?

MISCELLANEOUS

Upgrade TRS-80 to Emulate Z80 CP/M System

The "Freedom Changes" are upgrades for the Radio Shack TRS-80 Model I personal computer. The Freedom Option reorganizes memory to emulate a standard Z80 machine that responds to CP/M software. The extended memory adds programmable memory to the Model I, bringing it up to 64 K bytes. Part of it is available in normal TRS-80 mode.

The Freedom Option consists of a board, system disk, and instructions. The board configures programmable memory at the bottom and the memory-mapped areas on top. The disk has the T8 operating system and the software to utilize the switch to make the system compatible with CP/M software. The disk format is changed to read and write in the IBM-compatible 128-byte sector convention. The system will recognize 35- or 40-track disk configurations. The extended memory puts certain unusable address locations into operation, thus adding 2560 bytes of programmable memory under normal TRS-80 operation. This space is ideal for programs

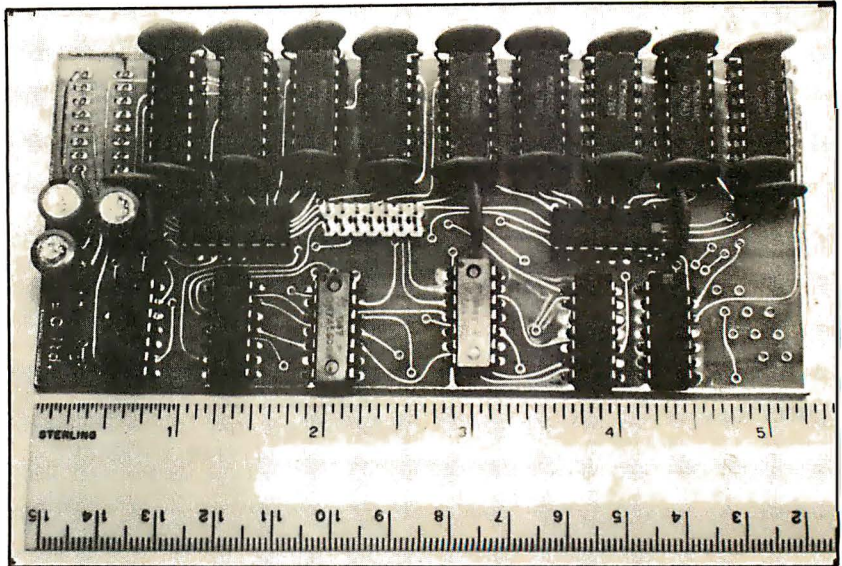

such as RS-232 communication, debounce, lowercase, and more. In the Freedom mode, the extended memory allows the machine to function on programmable memory only.

Both changes require a 48 K-byte disk system. Only the extended memory

requires minor hardware changes. The Freedom Option is priced at \$245 and the extended memory is \$295. Contact Field Engineering Consultants Ltd, POB 2368, Woburn MA 01888, (617) 944-5329.

Circle 614 on inquiry card.

Card File Consolidates AIM-65 with Expansion File

The MTU K-1005A-A card file integrates the AIM-65 computer, keyboard, and a series of expansion boards into a single compact unit. Drawing no power, the unbuffered motherboard utilizes the AIM bus structure to carry expansion connector signals to up to 4 additional boards. A fifth undedicated position is provided for a board not on the bus. The card file features a U-shaped black-anodized aluminum frame measuring 39.5 by 29.5 by 11.5 cm (15.5 by 11.5 by 4.5 inches). Other card files are offered for the PET, KIM-1, and SYM-1 computers.

The MTU K-1005A-A card file is

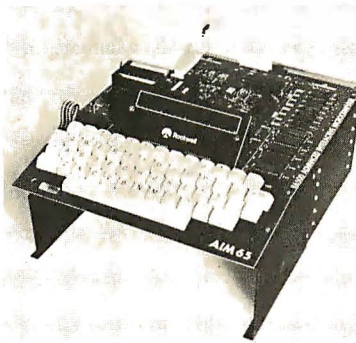

priced at \$95, including manual. For additional information, write Micro Technology Unltd, 841 Galaxy Way, POB 4596, Manchester NH 03108.

Circle 615 on inquiry card.

AC Remote-Control System for the PET

Honders Inc offers a complete AC remote-control system for the Commodore PET or CBM. Most electrical devices can be switched on or off and lamps can be dimmed or brightened under computer control. No additional wiring is needed. Up to 256 points can be controlled. This system is useful for security- and energy-control systems. The basic package includes a plug-in module to the PET's second port, 3 remote power controllers, and a cassette software package for demonstration and applications. The package may be ordered for \$179 from Honders Inc, Kennel Rd, Cuddebackville NY 12729.

Circle 616 on inquiry card.

Sound Generator for the Apple II

Symtec Inc has introduced a sound-synthesizer card for the Apple II. The Super Sound Generator, or SSG, uses 13 programmable registers to control three voices. The SSG is provided with an output cable and RCA phono plug for hook-up to stereo systems. It features separate 8-bit parallel input and output

(I/O) ports for connection to accessories, such as an alphanumeric keyboard, an organ keyboard interface, or a parallel printer driver. SSG control is accomplished with a series of 4 POKES to 3 memory locations. The SSG card may be programmed in any language available for the Apple. The music composing software provides for entry and editing of the entire music score using keyboard commands. The

score can be copied by a graphics printer. Stereo effects and orchestrations can be produced using multiple cards. Up to 21 voices can be accessed by the user with a complete complement of SSG cards. The Symtec SSG is available for \$159.95 from Symtec Inc, POB 462, Farmington MI 48024.

Circle 617 on inquiry card.

What's New?

MISCELLANEOUS

Datagrid II Computer-Aided Drafting Systems Brochure

The Datagrid II series of computer-aided drafting systems is described in a brochure from Summagraphics Corporation. The Datagrid II series are used by engineers, draftsmen, and others to create designs and drawings. The brochure is free from Summagraphics Corp., Dept MS-80, 35 Brentwood Ave, Fairfield CT 06430, (203) 384-1344.

Circle 618 on inquiry card.

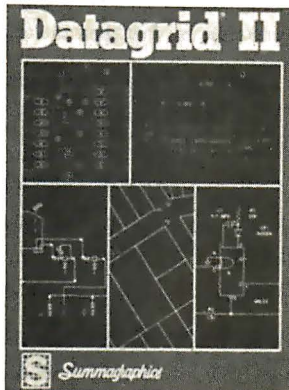

High-Resolution Video Display with a Refresh Rate of 60 Hz

A black and white high-resolution video display which refreshes at 60 Hz (eliminating the flicker of many high-resolution displays) has been introduced by Calma, 527 Lakeside Dr, Sunnyvale CA 94086. The RB1000 uses an internal graphics processor with its own raster memory that controls all display func-

tions. This allows the refresh rate of 60 times per second. The high resolution of the 1280-by-1024 video monitor eliminates the "stair-stepping" appearance of nonorthogonal lines. Separate video screens for graphic displays and for nongraphic alphanumeric data are provided. The unit features selective erase, on-screen menus, and multiport views. The Calma RB1000 is available on Calma interactive-graphics systems as an extra item.

Circle 619 on inquiry card.

Anniversary Catalog from V R Data

V R Data has introduced its eighth anniversary catalog. The complete Centronics and Apple line of equipment and supplies from MPI, Pertec, Nashua, NEC, Memorex, Maxell, and Dysan are

featured. V R Data also includes its disk head-cleaning kit for 5- and 8-inch floppy-disk drives, for \$12.95. For a catalog, call toll free, (800) 345-8102, or write V R Data Corp, 777 Henderson Blvd, Folcroft Industrial Park, Folcroft PA 19032.

Circle 620 on inquiry card.

Letter-Quality Printer Interface from MicroPro

The I/OMaster S-100 interface board allows use of lower cost letter-quality printers and/or high-speed line printers within the same microcomputer configuration. The I/OMaster interfaces with less expensive versions of the NEC, Diablo, and Qume letter-quality printers, and can also be used with high-speed Centronics printers for draft and nonletter-quality applications. The board features two serial and two parallel ports, and 8-level interrupt-control and dual-interval timer circuitry. The two 8251-based serial ports have built-in 32-character first-in, first-out (FIFO) buffers to prevent loss of data during switching operations. The I/OMaster costs \$400 from MicroPro International Corp, 1299 Fourth St, San Rafael CA 94901, (415) 457-8990.

Circle 621 on inquiry card.

Report on the Warnier-Orr Diagram

A Powerful Structured Tool: Warnier-Orr Diagram is a report providing a strong introduction to the Warnier-Orr diagram. The report includes an overview of system and program design and documentation tools; the need for proper logical tools; how to read a Warnier-Orr diagram; benefits of the diagram; the use of the diagram to develop the mini-specs of structured analysis and to document existing systems; and more. The report includes an annotated bibliography containing 20 entries, a capsule description of a software package to automate the diagram, and 5 illustrations. The Warnier-Orr report is available for \$12 (prepaid) from Shetal Enterprises, Dept 2, 1787 B W Touhy, Chicago IL 60626.

Circle 622 on inquiry card.

16 K RAMS & RAM CONTROLLERS

- 16 K X 1 DYNAMIC RAMS MK4116P3
- 200 NSEC ACCESS/375 NSEC CYCLE TIMES
- 16 PIN/TTL COMPATIBLE
- ALL CHIPS BURNED IN AND FULLY TESTED
- PRICE WITH DATA SHEET \$68.00 IN QTY OF 8/THAT'S \$8.50 EACH

6800/6502 64K BYTE RAM & CONTROLLER SET

- MAKE 64K BYTE MEMORY FOR YOUR 6800 OR 6502 THIS SET INCLUDES:
- 32 MSK 4116-3 16K X 1 200 NSEC RAMS
 - 1 MC3480 MEMORY CONTROLLER
 - 1 MC3242A MEMORY ADDRESS MULTIPLEXER AND COUNTER
 - DATA & APPLICATION SHEETS. PARTS TESTED AND GUARANTEED.

\$295.00 PER SET

- #### DYNAMIC MEMORY CONTROLLER MC3480L
- GENERATES RAS/CAS & REFRESH TIMING FOR 16K TO 64K BYTE MEMORIES
 - PRICE WITH DATE SHEET: \$13.95 EACH

- #### MEMORY ADDRESS MUX/COUNTER MC3242AP
- MUX ADDRESS & REFRESH COUNTER FOR 16K TO 64K BYTE MEMORIES
 - PRICE WITH DATA SHEET: \$12.50 EACH

QUANTITY DISCOUNTS AVAILABLE

ALL ORDERS POSTPAID. U.S. FUNDS ON INTERNATIONAL ORDERS. CHECK OR MONEY ORDER, VISA/BANK. ALSO AC CREDIT. SEND ACCT. NO. EXPIRATION DATE & INTERBANK NO. WITH SIGNED ORDER. CALIF. RESIDENTS PLEASE ADD 6% SALES TAX. PHONE ORDERS: 714/633-4460.

MEASUREMENT SYSTEMS & CONTROLS, INC.

MEMORY DEVICES DIVISION
867 NORTH MAIN ST., ORANGE, CA 92666

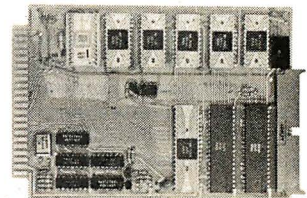

SINGLE BOARD COMPUTER \$99.50*

with 6800 MPU, 6850 serial I/O, 2 6820 parallel I/O (32 lines), 512 RAM, socket for 2708, 2716, EROM. Interface modules for industrial control, data acquisition, lab instrumentation, on 44 pin 4 1/2"x6 1/2" PCB's. RAM, ROM, CMOS RAM/battery, A/D, D/A, Driver/Sensor, Serial I/O, Parallel I/O, Counter/Timer, IEEE 488 GPIB, floppy controller.

*OEM (500 piece) price

WINTER Corp.
1801 South Street
Lafayette, IN 47904
Phone (317) 742-8428

Circle 237 on inquiry card.

TEXAS INSTRUMENT 99/4 COMPUTER	\$ 989
TI 810 PRINTER	\$1590
CENTRONIC PRINTERS:	
730-1 PARALLEL PRINTER	\$ 749
SAVE ON ALL OTHER MODELS	
SPINWRITERS FROM NEC	
5510 R/O SERIAL INTERFACE	\$2690
5520 KSR SERIAL WITH KEYBOARD	\$2890
5530 PARALLEL INTERFACE	\$2690
COMPRINT 912 APPLE, TRS-80, PET	\$ 559
912 SERIAL	\$ 599
APPLE II PLUS 48K RAM	\$1340
COMMODORE BUSINESS MACHINES:	
PET 2001-8K COMPUTER	\$ 695
PET 2001-16K	\$ 895
PET 2001-32K	\$1090
PET 2022 TRAC. FEED PRINTER	\$ 699
PET 2023 FRIC. FEED PRINTER	\$ 679
PET 2040 DUAL FLOPPY DISK DRIVE	\$1090
ATARI 800	\$ 889
400	\$ 495
INTEC SUPERBRAIN(32K)	\$2595
NORTH STAR COMPUTER AND ACC.	
** SAVE \$ SAVE \$ **	
DISPLAY TERMINALS:	
INTERTUBE II	\$ 775
HAZELTINE 1410	\$ 785
SAVE ON COMPLETE HAZELTINE LINE	
IMMEDIATE DELIVERY FROM STOCK.	

MULTI-BUSINESS COMPUTER SYSTEMS
28 MARLBOROUGH STREET
PORTLAND, CONN. 06480
(203) 342-2747



Circle 238 on inquiry card.

What's New?

SOFTWARE

Word Processing for the UCSD Pascal Operating System

Renaissance Systems Inc, 11760 Sorrento Valley Rd, Suite M, San Diego CA 92121, has announced two software packages for the UCSD Pascal operating system. PROFF is a program to format and print text files. The PROFF package features adjustable margins; filling, centering, and adjusting; automatic

pagination; text underscoring and printing. An "include" command allows reading from files other than the original input file.

The FORML package aids the user in document generation. Multiple copies of a form letter, each addressed to a different individual, can be produced. FORML requires a PROFF source file to perform textual substitution, then it calls PROFF to produce the modified copy of the document. The packages currently

support output to a Diablo Hytype II printer, a disk file, the system console, or the system printer. The packages are available in machine-readable form on an 8-inch soft-sectored, single- or double-density floppy disk. Manuals are included with the package or purchased separately for \$25. The PROFF package costs \$425 and the PROFF and FORML package is \$500.

Circle 623 on inquiry card.

Space Shuttle Landing Simulator for the Apple II

Modeled after the National Aeronautics and Space Administration (NASA) Shuttle Mission Simulator in Houston, Texas, this program is a real flight simulator (except for roll motion) with a visual display of the sky and ground. High-resolution color graphics show the shuttle's forward view using animation, projective geometry, and machine language to depict the runway, sky, ground, and distant scenery. Flight data, messages, and warnings are printed on the screen. Functional features are angle of attack control, speed brakes, full stall capability, landing gear, wheel brakes, eject, variable pitch rate control, and more. Runway stripes on rollout give a visual indication of motion. The program requires 48 K bytes of memory. Version A is for Applesoft read-only memory (ROM) and version B for Applesoft program-mable memory. The price is \$17 for the cassette and \$21 for the floppy disk. It is available from Harvey's Space Ship Repair, POB 3478, University Park, Las Cruces NM 88003, (505) 522-1482 (evenings).

Circle 624 on inquiry card.

Keyboard Expander

This hardware and software modification transforms Apple II microcomputers into complete uppercase and lowercase systems. Cap and shift locks are included; all Apple characters and monitor editing functions are maintained. Software is transparent to the user and compatible with the Apple disk operating system. Uppercase and lowercase can be used in text files, in PRINT and REM statements within BASIC programs, in disk operating system file names, and in immediate mode. The software runs in 250 bytes of memory. It costs \$20 and is available from C and H Micro, POB 249, Clifton Park NY 12065.

Circle 628 on inquiry card.

Software for Music Board on CP/M-Compatible Disk

Software support for the Newtech Model 6 music board is available on CP/M-compatible disks. The MV80 Multivoice Music Interpreter allows the user to enter four-voice music in a simple notation. The waveforms for each voice can be individually controlled to create the impression of an instrumental quartet. MV80 requires CBASIC2 and a 40 K-byte or larger 8080, Z80, or 8085 CP/M system. MV80 is available on 8-inch floppy disks for \$29.95 including a manual. Contact Newtech Computer Systems Inc, 230 Clinton St, Brooklyn NY 11201.

Circle 625 on inquiry card.

Atari and Texas Instruments Software

Image Computer Products Inc, 615 Academy Dr, Northbrook IL 60062, has introduced a series of programs for the Atari 400 and 800 series and the Texas Instruments 99/4 microcomputers. The programs include Baseball, Wall Street Challenge, Mind Master, Strategy Pack, Skill Builder, and Tournament Brick Bat. There are two copies of each program, which arrive on cassette. Some of the simulation games allow users to save the program on tape in the middle of a game, so that play can be resumed later. The prices for the programs are \$19.95 and \$29.95.

Circle 626 on inquiry card.

68' FORTH for 6809

68' FORTH is a 6809 implementation of the FORTH language, which is a combination operating system, interpreter, and compiler. It is well suited for situations where it is necessary to be able to quickly test and modify routines or data, especially in the development of algorithms, graphics, data collection and analysis, and instrument control. 68' FORTH consists of full FORTH Interest Group standard vocabulary to 31 characters, 16- and 32-bit integer mathematics, compiler error checking,

and a source text editor. The system is supplied with additional vocabulary to simulate disk in memory, to use the disk for virtual memory, to interface with FLEX 9.0 text files, and to perform standard FORTH disk-block read and write. It is supplied on 5-inch floppy disks configured for SwTPC MF-68 systems. The minimum memory requirement is 8 K bytes for FLEX plus 12 K bytes of programmable memory. The disk plus documentation is \$39.95 from Talbot Microsystems, 2433 Dorrington St, Houston TX 77030.

Circle 627 on inquiry card.

Four-Part Music System for PET

A B Computers, 115 E Stump Rd, Montgomeryville PA 18936, has announced a system that enables PET users to create and play musical compositions of up to four parts. The KL-4M board includes an 8-bit digital-to-analog (D/A) converter, a low-pass filter, and an audio amplifier. No additional hardware other than a speaker is required. Connection is made via the PET parallel and cassette ports. The KL-4M is compatible with any of the four-part music

monitors. The Visible Music Monitor is written in 6502 machine language and displays the musical staff and notes for all four voices on the PET screen. It includes edit capabilities, successive piece loading without intervention, user-definable keyboard, tempo flexibility, transpose capability, and waveform modification capability. Music can be played with or without note display. The entire system is \$59.90. The KL-4M board is \$34.90 and the Visible Music Monitor is \$29.90.

Circle 629 on inquiry card.

What's New?

SOFTWARE

I/OS Disk Operating System for Microcomputers

InfoSoft Systems Inc has introduced its I/OS disk operating system for 8080, 8085, and Z80 disk-based systems. The system is designed for use with hard and

floppy disks and has a file capacity exceeding 268 megabytes. It features printer spooling, supports up to 15 disk units, includes a symbolic debugger, text editor, directory status, disk-copy and file-transfer programs, disk and memory diagnostics, and a printout formatting facility.

I/OS Version 3.0 is compatible with the CDOS 02.00 from Cromemco Inc. I/OS is also compatible with CP/M versions 2.0 and earlier. The price of the package is \$150 plus a dealer configuration fee. Contact InfoSoft Systems Inc, 25 Sylvan Rd S, Westport CT 06880. Circle 630 on inquiry card.

Home Improvements Program for the Imagination Machine

APF Electronics Inc, 444 Madison Ave, New York NY 10022, (212) 758-7550, has announced the Space, Size, and Surface program for its personal computer, The Imagination Machine. The program assists

homeowners with home improvements involving maintenance, covering surfaces, and materials required. It calculates the necessary materials for lawn projects, wall papering, painting, panelling, tiling, and more. The program asks for dimensions and areas to be covered or left uncovered, and then tabulates the amount of materials required to complete the job. The program

also compares the costs of different products and computes various percentage margins to allow for extra materials due to patterns and fittings around doors and windows. The price for Space, Size, and Surface Guide program is between \$19.95 and \$29.95, depending on the format. Circle 631 on inquiry card.

Educational Programs for the PET

This series of documented programs will run in 8 K bytes of programmable memory and requires no peripherals. One series is entitled "Mathematical Enrichment." Programs such as "Symmetry" and "Third-Dimension" suit themselves to planned curriculum or experimentation. A second series features cooperative games for various ages; many are based on the ideas of Jim Deacove of Family Pastimes. Prices range from \$10 to \$20 per documented cassette. For complete information, contact Go:Forth Microcomputing, 329-22 St E, Prince Albert, Saskatchewan, S6V 1N3 CANADA.

Circle 632 on inquiry card.

Lifeboat Puts CP/M on Altair Disk

The Lifeboat implementation of the CP/M operating system on the Altair and MITS 3202 series of floppy-disk systems takes advantage of the 300 K bytes of memory capacity per disk and the error-free characteristics of the equipment. No changes of any kind are required. With the use of CP/M on the Altair disk, users will have access to the broad range of systems and applications software available. Languages such as C, COBOL, FORTRAN, Pascal, and BASIC are available, as are applications from word processing to accounting. The price for the CP/M system is \$145. Contact Lifeboat Associates, 2248 Broadway, New York NY 10024.

Circle 633 on inquiry card.

North Star BASIC SCAN Command

Scan is a machine-language utility program that can be added to North Star BASIC. It allows the user to scan a BASIC line from a single character or variable to complete sentences or key words. The SCAN command operates like LIST except that it lists only those lines that contain the item being scanned for. In the debug mode, it will find all references to any line number such as in GOSUB or GOTO statements. Scan works with single-, double-, or quad-density versions of North Star BASIC. It is available for \$27.50 from Electronic Technicians Software Services, 1072 Casitas Pass Rd, Carpinteria CA 93013, (805) 684-6049.

Circle 634 on inquiry card.

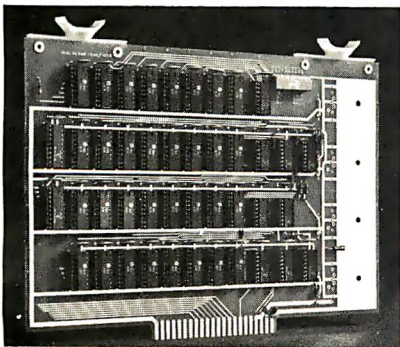

VAK-4 DUAL 8K-RAM ~~\$270.00~~ \$325.00 plus shipping
VAK-2 8K-RAM (1/2 populated) \$239.00

VAK-4 16K STATIC RAM BOARD

- Designed specifically for use with the AIM-65, SYM-1, and KIM-1 microcomputers
- Two separately addressable 8K-blocks with write protect.
- Designed for use with the VAK-1 or KIM-4* motherboards
- Has provisions for mounting regulators for use with an unregulated power supply
- Made with 1st quality 2114 static ram chips
- All IC's are socketed
- Completely assembled, burned-in, and tested

We manufacture a complete line of high quality expansion boards. Use reader service card to be added to our mailing list, or U.S. residents send \$1.00 (International send \$3.00 U.S.) for airmail delivery of our complete catalog.

*Product of MOS Technology

 **ENTERPRISES**
INCORPORATED

2967 W. Fairmount Avenue • Phoenix, AZ 85017 • (602) 265-7564

What's New?

PUBLICATIONS

UCSD Pascal Newsletter

This newsletter is addressed to those using UCSD Pascal on LSI-11 computers. The first issue contains a detailed article on the situation regarding UCSD and Softech and the licensing problems. It also includes a precise report on the different versions of UCSD Pascal and the anomalies that exist in versions. The publisher is using 8-inch floppy-disk drives with his system and includes articles on the use of the drives and text formatting with the system. There are items of interest concerning new products for the system and letters from users. To get on the mailing list, send \$2 to Jim McCord, 330 Vereda Leyenda, Goleta CA 93017.

Circle 635 on inquiry card.

Computer Careers Magazine

Computer Careers Magazine is dedicated to the computer job market. The audience is made up of systems analysts, programmers, data processors, and technicians. The magazine contains news and information directed to the computer professional, with an emphasis on career development. Feature articles in this twice monthly magazine cover career goals, communicating more effectively, preparing resumes, and choosing the right company. Other areas covered are company profiles, supportive editorials, and classifieds. Contact *Computer Careers Magazine*, 3901 MacArthur Blvd, Newport Beach CA 92660.

Circle 636 on inquiry card.

Catalogs for Printers and Punched Paper-Tape Readers

Design literature and catalogs for printers and punched paper-tape readers are now available. Printers are numeric and limited-alphanumeric and are largely used for data logging. The readers read punched paper-tape prepared to American National Standards Institute (ANSI) standards for levels five to eight at up to 150 characters per second (cps) asynchronously, and are used for computer entry, numerical control, data transmission, and programmable read-only memory (PROM) programmers. For more information, contact Admstar Corp, 416 Junipero Serra Dr, San Gabriel CA 91776, (213) 285-1121

Circle 637 on inquiry card.

Dataguide

Dataguide is a 500-page purchasing guide to original equipment manufacturers computer hardware, software, supplies, and accessories. It is published in the spring and fall; the subscription rate is \$38 per year. *Dataguide* features a manufacturers directory and a product

directory. The manufacturers directory contains over 1500 listings of companies with detailed information on each company. The product directory lists nearly 6000 companies organized under categories which include computers and microprocessors, memory systems, disk drives, tape drives, video displays, printers, and plotters, and more.

Subscription order forms may be obtained by contacting Sentry Publishing Co, 5 Kane Industrial Dr, Hudson MA 01749, (617) 562-9308.

Circle 638 on inquiry card.

Z-80
*
\$1250

APPLE GAME PORT REMOTE PLUG-IN EXPANDER with SELECTOR!

Allows continuous connection of any three of the Apple game port options.

\$3995

80-COLUMN IMPACT PRINTER
LOWEST IN PRICE—HIGHEST IN PERFORMANCE
*Compact Size
*50 Lines per Minute
*118/200AC, 50 or 80 Hz.
*72, 96, 120 or 132 Characters Line
*Half and Switch
*Auxiliary User Defined Character Set
*RS-232, 20ma, IEEE 488 and Centronics I/O
*18 Bond Rates to 18,200



\$599.00

base2, inc.

8038C
VCO Waveform Gen.
w/sine \$265

78H05
\$595

4116
Dynamic RAM
MEMORY ADD-ON FOR THE TRS-80 OR APPLE II+ to 450ms
8 for \$4995

video 100

12" BLACK & WHITE LOW COST VIDEO MONITOR \$129.00



LOGIC PROBE KIT
\$1795

I.C. MASTER

NEW "1980" \$5995

2708
1024 X 8 EPROM
\$745
450ns AMD, SGS



SOROC IQ120
\$74900

Dust Cover for Apple
keyboard \$895
disk \$395

8216 \$199
BUS DRIVER
T.I./M.M.I.
74LS240
74LS241
74LS243
74LS244
74LS373
74LS374
\$245
LIMIT 10 EACH
IN STOCK

2716 16K EPROM
\$2795
450ns single+5V
T.I., HIT., INT., SGS

8212
I/O PORT
3.95

ULN2001
High-current Drivers.
Darlingtons 69c

RESISTOR NETWORKS
values
270, 4.7K, & 15K
OHMS
1.5K & 10K
\$89 EA
100/49c

MH0026CJ
DUAL CLOCK DRIVER \$100

74S373
74S374
\$325

S-100 16K ADD-ON BARE BOARD
WITH DOCUMENTATION AND DETAILED INSTRUCTION BOOK. \$2895

2114L
1024x4 Static RAM
450 ns \$475

16K STATIC RAM
S-100 MEMORY ADD-ON

** FULLY STATIC OPERATION
** USES 2114 TYPE STATIC RAMS
** +8 VDC INPUT AT LESS THAN 2 AMPS
** BANK SELECT AVAILABLE BY BANK PORT AND BANK BYTE
** PHANTOM LINE CAPABILITY
** ADDRESSABLE IN 4K BLOCKS IN 4K INCREMENTS
** LED INDICATORS FOR BOARD/BANK
** SOLDER MASK ON BOTH SIDES OF BOARD

EPROM ERASER BY SPECTOLINE
UP TO 6 EPROMS IN 19 MINUTES
6000 HOUR BULB LIFE
\$4995

CONCORD COMPUTER COMPONENTS

1971 SOUTH STATE COLLEGE * ANAHEIM, CA. 92806
VISA - MASTER CHARGE (714) 937-0637 MINIMUM ORDER - \$10.00
CHECK OR M.O. ADD \$1.50 FOR FRT.
NO C.O.D. We stock and sell over 12,000 types of semi-conductors CAL. RES. ADD 6%

ASSEMBLED & TESTED
\$26900
California Computer Systems

America's Largest Mail-Order Computer Store

HOBBYWORLD[®] ELECTRONICS, INC.

ATARI[®] Home Video System

Call Toll-Free: USA (800) 423-5387
In Calif: (800) 382-3651
Local & Outside USA:
(213) 886-9200



Backgammon Challenger \$115.50

You will be challenged and intrigued by this game. Uses all strategies of the game, including a running game, hit and run, blocking and bear off games. YOU handle the dice! Choose offense or defense. Computer responses vary every game. Weight 3 lbs. Cat No. 2411

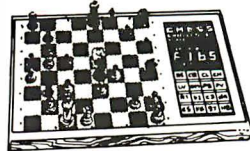

Chess Challenger "7" Chess "VOICE" Challenger

If you're into chess you will love Chess Challenger! 7 levels of play. "Mate in Two" and "Chess by Mail". Like to have your opponent call out the moves? Try "Voice" Chess Challenger. 96,000 Bits of Read Only Memory, and over 8,000 bits of Random Access Memory. Can be used by the blind as the game will audibly call every move, capture, and repeat board position.

Cat No. 2399 Chess Challenger "7"
Cat No. 2398 Chess Voice Challenger

Wt. 3 lbs. 117.95
Wt. 4 lbs. 353.95

STAR TREK III

One of the most advanced Star Trek games ever. Locate the 5 Class M Planets, battle Klingons, but watch out for black holes and pulsars. This version is 3 dimensional, not flat like other versions. Watch the Enterprise phasers hit and explode the Klingons! Extensive use of graphics throughout. At the end, return to Star Fleet command, where the data in the ships computer evaluates and rates your performance. Takes about 2 hours to play a game.
Cat No. 1041 TRS-80 level III/16K \$15.75

16K Memory Add-On Kit \$65.00

Everything needed to upgrade your TRS-80, Apple or Exidy! An additional 16K includes illustrated instructions, RAMS, and preprogrammed jumpers. No Special tools required. Wt. 4 oz.

CAT NO.	DESCRIPTION
1156	TRS-80 Keyboard Unit
1156-A	TRS-80 Exp. Interface (prior to 4/1/79)
1156-B	TRS-80 Exp. Interface (after 4/1/79)
1156-C	for APPLE II
1156-D	for EXIDY

The nation's best selling home video entertainment center is here! Currently supports a library of 23 video game cartridges with over 1300 variations and options. Comes with interchangeable joystick and paddle controllers, special circuits to protect home TV, realistic sound effects and produces crisp, bright colors on your TV screen. Also includes ATARI's "Combat" game with 108 variations and options.

CAT NO.	DESCRIPTION	WT.	PRICE
2375	ATARI Video Computer System	8 lb.	\$188.95
2206	Driving Controller-Pair	2 lb.	\$ 20.95
2207	Paddle Controller-Pair	2 lb.	\$ 20.95
2208	Joystick Controller-Pair	2 lb.	\$ 20.95

ATARI Game Cartridges

CAT NO.	DESCRIPTION	WT.	PRICE
2376	Starship	6 oz.	\$16.75
2377	Black Jack	6 oz.	\$16.75
2378	Space War	6 oz.	\$16.75
2379	Surround	6 oz.	\$16.75
2380	Slot Machine	6 oz.	\$16.75
2381	Outlaw	6 oz.	\$18.95
2382	Slot Racer	6 oz.	\$18.95
2383	Video Olympics	6 oz.	\$18.95
2384	Breakout	6 oz.	\$18.95
2385	Canyon Bomber	6 oz.	\$20.95
2386	Street Racer	6 oz.	\$20.95
2387	Homerun	6 oz.	\$20.95
2388	Basketball	6 oz.	\$20.95
2389	Football	6 oz.	\$20.95
2390	Bowling	6 oz.	\$20.95
2391	Skydiver	6 oz.	\$20.95
2392	Fun With Numbers	6 oz.	\$20.95
2393	Brain Game	6 oz.	\$20.95
2394	Superman	6 oz.	\$28.50
2395	Casino	6 oz.	\$28.50
2396	Backgammon	6 oz.	\$47.25
2397	Video Chess	6 oz.	\$47.25
2500	Space Invaders	6 oz.	\$29.95

**NOTE: Not for use with
ATARI Programmable
Computers**

NOVATION "CAT" ACOUSTIC MODEM

The FIRST compact modem designed for the small computer user. Transmits data over standard telephone lines... Exchange data or programs with other systems. Data transfer rate up to 30 char/sec. Complete and ready to use. Requires 110 VAC, 60 Hz.

Cat No. 1480 Weight 3 lbs. Price: \$189.00



EMAKO 22 MICROPRINTER

The EMAKO 22 microprinter is a dependable, low cost, addition for your personal computer system. It features a 9X7 dot-matrix character format, bi-directional printing at 125 CPS and sprocket feed paper mechanism. Line length is select-

able at 40, 80, or 132 characters per line. Forms may be loaded either from the bottom or the rear. Available with parallel or asynchronous serial interfacing.

Cat No.	Description	Weight	Price
2455	Parallel Interface Model	22 lb.	\$834.75
2456	RS232-C Serial Model	22 lb.	\$894.00

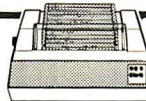

VERBATIM 5 1/4" DISKETTES 10 per box

CAT NO.	TYPE	DESCRIPTION	PRICE
1147	525-01	soft sector, TRS-80, Etc.	\$33.00
1148	525-10	10 hole, hard, Apple, North star	\$33.00
1149	525-16	16 hole, hard, micropolis	\$33.00
2330	577-01	soft sector certified	\$49.95
2331	577-10	10 hole, hard, certified	\$49.95
2332	577-16	16 hole, hard, certified	\$49.95

Fuller Electronics TRS-80 LPRINT/LLIST PLUG

Many users are faced with the problem of running programs with LPRINT or LLIST, but they do not want a print out. In this case, all LPRINTS have to be removed from the program before it will run, and this takes time and ties up your keyboard. But there is an alterna-

tive! Simply connect the TRS-80 LPRINT/LLIST plug to your line printer port, and the program will run just as if there was a printer connected to your machine. Easy installation and detailed instructions. Wt. 2 oz. **\$11.95**
Cat No. 2480



MATCHLESS MS-80 TRS-80 MINI DISK DRIVE

Plugs into the expansion interface. Complete factory tested drive includes installation instructions and software listing to

access 3 times faster than Radio Shack drives. 40 tracks instead of 35. Existing 35 track software completely compatible.

Cat No.	Description	Weight	Price
1375	MS-80 Disk Drive	8 lbs.	\$464.25
2964	2 Drive Cable	8 oz.	\$ 25.75
1396	4 Drive Cable	8 oz.	\$ 41.95
1938	Accessing Software, tracks 36-40	4 oz.	\$ 10.50
1485 D	MS-80 MPI 51 Manual	2 oz.	\$ 1.75
1147	Verbatim Diskettes, (box of 10)	8 oz.	\$ 33.00

CCS 7811B ARITHMETIC PROCESSOR

Assembled & tested, adds advanced arithmetic power to your Apple II. AMD AM 9511 based, 16 and 32 bit fixed point, 32 bit floating point operation. Float to fixed and fixed to float conversions. Trig and inverse functions, square roots, logs, exponentiation. Interrupt daisy chain, DMA daisy chain, and much more. Weight 2 lbs. Cat No. 1635 **\$419.95**

DISKETTE DRIVE HEAD CLEANING KIT

Diskette drive heads, like your 8 track car stereo cassette heads, need periodic maintenance to assure efficient and error-free operation. Unlike other peripheral devices, the read/write head(s) on diskette drives are extremely difficult to clean without partially disassembling the drive. The unique concept of the diskette head cleaning kit allows the user to clean the drive heads without disassembly in just minutes. Available for 8" or 5 1/4", both single and double sided disk drives. Kit contains 2 cleaning diskettes, a 4 oz. bottle of CS-85 cleaning solution and easy-pour dispenser. Weight 12 oz.

Cat No.	Description	Price
2499	8" Disk Drive Cleaning Kit	\$30.75
2534	5 1/4" Disk Drive Cleaning Kit	\$30.75

SEND FOR FREE FLYER FEATURING:

Page after page of exciting products. Computerized toys and games, personal computers, disk drives, integrated circuits, semi conductors. Add new dimension to your Apple, Atari, TRS-80, etc. with our special application boards and comprehensive software library. Hundreds of products available at terrific Hobbyworld prices. Circle our reader service number or write/phone for your free illustrated flyer today.

HOW TO ORDER

Pay by check, Mastercharge, Visa, or C.O.D. Charge card orders please include expiration date. Payment in U.S. dollars only. Order by phone, mail or at our retail store. MINIMUM ORDER \$10.00. Please include phone number and magazine issue you are ordering from. Prices valid thru last day of cover date. SHIPPING: USA: Add \$2.00 for first 2 lbs., 35c each add'l lb. for ground. For AIR add \$3.00 first 2 lbs., 75c each add'l lb. FOREIGN: surface: \$3.00 first 2 lbs., 60c each add'l lb. AIR: \$11.00 first 2 lbs., \$5.00 each add'l lb. COOs: add \$1.25 add'l. Not responsible for typographical errors. Some items subject to prior sale or quantity limitations. 120 day guaranteed satisfaction. Exception: partially assembled kits.

19511 Business Center Drive Dept. B6 Northridge, Ca. 91324

HEX ENCODED KEYBOARD

Four onboard LEDs indicate the HEX code generated for each key depression. The board requires a single +5 volt supply. Board only \$15.00 Part No. HEX-3, with parts \$49.95 Part No. HEX-3A. 44 pin edge connector \$4.00 Part No. 44P.

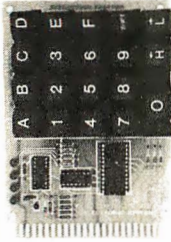

ASCII TO CORRESPONDENCE CODE CONVERTER

This bidirectional board is a direct replacement for the board inside the Trendata 1000 terminal. The on board connector provides RS-232 serial in and out. Sold only as an assembled and tested unit for \$249.95. Part No. TA 1000C

ASCII KEYBOARD

53 Keys popular ASR-33 format • Rugged G-10 P.C. Board • Tri-mode MOS encoding • Two-Key Rollover • MOS/DTL/TTL Compatible • Upper Case lockout • Data and Strobe inversion option • Three User Definable Keys • Low contact bounce • Selectable Parity • Custom Keycaps • George Risk Model 753. Requires +5, -12 volts. \$59.95 Kit.

ASCII KEYBOARD

TTL & DTL compatible • Full 67 key array • Full 128 character ASCII output • Positive logic with outputs resting low • Data Strobe • Five user-definable spare keys • Standard 22 pin dual card edge connector • Requires +5VDC, 325 mA. Assembled & Tested. Cherry Pro Part No. P70-05AB. \$119.95.

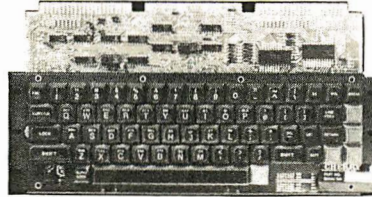

COMPRINT PRINTER

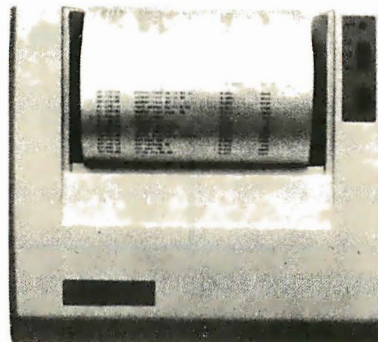

Printing Characteristics: 225 characters/second (170 lines/minute) throughput • 9 horizontal x 12 vertical matrix • 96 ASCII character set with upper and true lower case • 80 characters/line • 5.8 lines/inch
Buffer Memory: standard 256 bytes; optional; 2,048 bytes (buffer memory option designated as Model 912-2K), add \$149.95.
Paper Requirements: electrosensitive type (aluminum coated) • 8-1/2 inch width • 3.7 inch max. (300 ft.) roll diameter.
Model 912-S Interfacing: serial interface RS232 and 20 mA current loop • BAUD rates 110, 150, 300, 600, 1200, 2400 and 4800 are strap selectable.
Model 912-P Interfacing: parallel interface, IEEE-488 and 8 bit parallel (strobe/acknowledge). Model 912-S, Part No. CPIA, 3211B, \$579.95. Model 912-P, Part No. CPIA, 32117, \$559.95.

T.V. INTERFACE

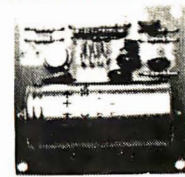

• Converts video to AM modulated RF, Channels 2 or 3. So powerful almost no tuning is required. On board regulated power supply makes this extremely stable. Rated very highly in Doctor Dobbs' Journal. Recommended by Apple • Power required is 12 volts AC C.T., or +5 volts DC • Board only \$7.60 part No. 107, with parts \$13.50 Part No. 107A

TAPE INTERFACE

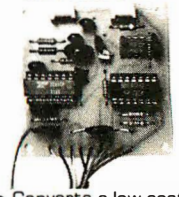

• Converts a low cost tape recorder to a digital recorder • Works up to 1200 baud • Digital in and out are TTL serial • Output of board connects to mic. in of recorder • Earphone of recorder connects to input on board • No coils • Requires +5 volts, low power drain • Board only \$7.60 Part No. 111, with parts \$29.95 Part No. 111A

T.V. TYPEWRITER



• Stand alone TVT • 32 char/line, 16 lines, modifications for 64 char/line included • Parallel ASCII (TTL) input • Video output • 1K on board memory • Output for computer controlled cursor • Auto scroll • Non-destructive cursor • Cursor inputs: up, down, left, right, home, EOL, EOS • Scroll up, down • Requires +5 volts at 1.5 amps, and -12 volts at 30 mA • All 7400, TTL chips • Char. gen. 2513 • Upper case only • Board only \$39.00 Part No. 106, with parts \$145.00 Part No. 106A

UART & BAUD RATE GENERATOR

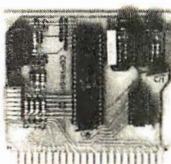

• Converts serial to parallel and parallel to serial • Low cost on board baud rate generator • Baud rates: 110, 150, 300, 600, 1200, and 2400 • Low power drain +5 volts and -12 volts required • TTL compatible • All characters contain a start bit, 5 to 8 data bits, 1 or 2 stop bits, and either odd or even parity. • All connections go to a 44 pin gold plated edge connector • Board only \$12.00 Part No. 101, with parts \$35.00 Part No. 101A, 44 pin edge connector \$4.00 Part No. 44P

SOROC IQ 120



Upper/lower case display • Numeric keypad & cursor keys • Protected fields, 1/2 intensity display • RS 232 interface & aux. port. IQ120—\$799.95 • IQ140 Detachable keyboard—\$1199.95

MODEM



• Type 103 • Full or half duplex • Works up to 300 baud • Originate or Answer • Serial TTL input and output • connect 8 Ω speaker and crystal mic. directly to board • Requires +5 volts • Board only \$7.60 Part No. 109, with parts \$29.95 Part No. 109A.

44 BUS MOTHER BOARD



Has provisions for ten 44 pin (.156) connectors, spaced 3/4 of an inch apart. Pin 20 is connected to X, and 22 is connected to Z for power and ground. All the other pins are connected in parallel. This board also has provisions for bypass capacitors. Board cost \$15.00 Part No. 102. Connectors \$3.00 each Part No. 44WP.

RS-232/20mA INTERFACE



This board has two passive, opto-isolated circuits. One converts RS-232 to 20mA, the other converts 20mA to RS-232. All connections go to a 10 pin edge connector. Requires +12 and -12 volts. Board only \$9.95, part no. 7901, with parts \$14.95 Part No. 7901A.

RS-32/TTL INTERFACE

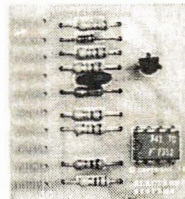

• Converts TTL to RS-232, and converts RS-232 to TTL • Two separate circuits • Requires -12 and +12 volts • All connections go to a 10 pin edge connector, kit \$9.95 Part No. 232A 10P, edge connector \$3.00 part No. 10P.

COMPCOLOR II



With reg. keyboard MOD3 8K \$1595.95 MOD4 16K \$1695.95 MOD5 32K \$1995.95 Now includes \$250 more, worth of software and accessories with 101 key option add \$134.95 with 117 key option add \$179.95

DC POWER SUPPLY

• Board supplies a regulated +5 volts at 3 amps., +12, -12, and -5 volts at 1 amp. • Power required is 8 volts AC at 3 amps., and 24 volts AC C.T. at 1.5 amps. • Board only \$12.50 Part No. 6085, with parts excluding transformers \$42.50 Part No. 6085A



To Order: Mention part no. description, and price. In USA shipping paid by us for orders accompanied by check or money order. We accept C.O.D. orders in the U.S. only, or a VISA or Master Charge no., expiration date, signature, phone no., shipping charges will be added. CA residents add 6.5% for tax. Outside USA add 10% for air mail postage and handling. Payment must be in U.S. dollars. Dealer inquiries invited. 24 hour order line (408) 448-0800

Send for FREE Catalog ... a big self-addressed envelope with 41¢ postage gets it fastest!

ELECTRONIC SYSTEMS Dept. B P. O. Box 21638, San Jose, CA USA 95151

Apple II Or APPLE II PLUS



16K \$975.95, Extra 16K E.S. RAM installed \$74.95, extra 32K E.S. RAM installed \$148.95.

APPLE II HOBBY/PROTOTYPING CARD
Part No. 7907 \$14.95

REAL TIME 100,000 DAY CLOCK

MT. HARDWARE Double the utility of your S-100 bus computer with a real-time clock that keeps time in 100µs increments for over 273 years. Program events for the entire period with real time interrupts...without derailing the system. Maintain a log of computer usage, time and date transaction printouts, call up lists...virtually any activity where time is a factor. On-board battery backup. MHPX004—\$249.95

SUPER MODEM



Originate, RS-232 and 20 mA compatible. Full duplex, and half duplex, direct connect or acoustic coupled, on board power supply, carrier detect light, DB25 plug, 300 BAUD, Type 103 compatible frequencies, Bare board Part No. 2000, \$19.95, Kit Part No. 2000A, \$99.95.

16K EPROM



Uses 2708 EPROMS, memory speed selection provided, addressable anywhere in 65K of memory, can be shadowed in 4K increments. Board only \$24.95 part no. 7902, with parts less EPROMs \$49.95 part no. 7902A.

PET COMPUTER



With 16K & monitor - \$795. Dual Disk Drive - \$10.95

OPTO-ISOLATED PARALLEL INPUT BOARD FOR APPLE II

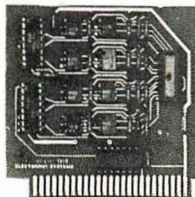

There are 8 inputs that can be driven from TTL logic or any 5 volt source. The circuit board can be plugged into any of the 8 sockets of your Apple II. It has a 16 pin socket for standard dip ribbon cable connection. Board only \$15.00, Part No. 120, with parts \$69.95, Part No. 120A.

VIDEO TERMINAL



16 lines, 64 columns • Upper and lower case • 5x7 dot matrix • Serial RS-232 in and out with TTL parallel keyboard input • On board baud rate generator 75, 110, 150, 300, 600, & 1200 jumper selectable • Memory 1024 characters (7-21L02) • Video processor chip SFF96364 by Neculonic • Control characters (CR, LF, →, ←, ↑, ↓, non destructive cursor, CS, home, CL) • White characters on black background or vice-versa • With the addition of a keyboard, video monitor or TV set with TV interface (part no. 107A) and power supply this is a complete stand alone terminal • also S-100 compatible • requires +16, & -16 VDC at 100mA, and BVDC at 1A, Part No. 1000A \$199.95 kit.

PARALLEL TRIAC OUTPUT BOARD FOR APPLE II



This board has 8 triacs capable of switching 110 volt 6 amp loads (660 watts per channel) or a total of 5280 watts. Board only \$15.00 Part No. 210, with parts \$119.95 Part No. 210A.

APPLE II* SERIAL I/O INTERFACE

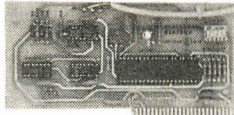

Baud rate is continuously adjustable from 0 to 30,000 • Plugs into any peripheral connector • Low current drain. RS-232 input and output • On board switch selectable 5 to 8 data bits, 1 or 2 stop bits, and parity or no parity either odd or even • Jumper selectable address • SOFTWARE • Input and Output routine from monitor or BASIC to teletype or other serial printer • Program for using an Apple II for a video or an intelligent terminal. Also can output in correspondence code to interface with some electrics. • Also watches OTR • Board only \$15.00 Part No. 2, with parts \$42.00 Part No. 2A, assembled \$62.00 Part No. 2C

8K EPROM PIGEON

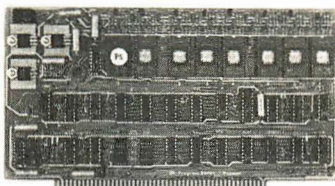

• Programs 2708's address relocation of each 4K of memory to any 4K boundary • Power on jump and reset jump option for "turnkey" systems and computers without a front panel • Program saver software in 1 2708 EPROM \$25. Bare board \$35 including custom coil, board with parts but no EPROMS \$139, with 4 EPROMS \$179, with 8 EPROMS \$219.

WAMECO PRODUCTS

With ELECTRONIC SYSTEMS parts

- FDC-1** FLOPPY CONTROLLER BOARD will drive shugart, pertek, remex 5" & 8" drives up to 8 drives, on board PROM with power boot up, will operate with CPM (not included). PCBD \$42.95
- FPB-1** Front Panel. (Finally!) IMSAI size hex displays. Byte or instruction single step. PCBD \$42.95
- MEM-1A** 8Kx8 fully buffered, S-100, uses 2102 type RAMS. PCBD \$24.95, \$168 Kit
- QMB-12** MOTHER BOARD, 13 slot terminated, S-100 board only \$34.95
- CPU-1** 8080A Processor board S-100 with 8 level vector interrupt PCBD \$89.95 Kit
- RTC-1** Realtime clock board. Two independent interrupts. Software programmable. PCBD \$25.95, \$60.95 Kit
- EPM-1** 1702A 4K EPROM card PCBD \$25.95
- \$49.95 with parts less EPROMS
- EPM-2** 2708/2716 16K/32K EPROM card PCBD \$24.95
- \$49.95 with parts less EPROMS
- QMB-9** MOTHER BOARD. Short Version of QMB-12. 9 Slots PCBD \$30.95
- \$67.95 Kit
- MEM-2** 16Kx8 Fully Buffered 2114 Board PCBD \$25.95, \$269.95 Kit

D.C. HAYES MICROMODEM

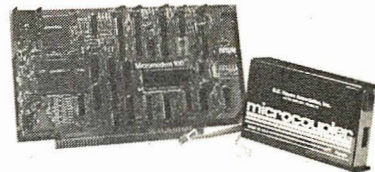

Fully S-100 bus compatible including 16-bit machines and 4 MHz processors. • Two software selectable Baud rates—300 Baud and a jumper selectable speed from 45 to 300 Baud. (110 standard). Supports originate and answer modes. • Direct-connect Microcoupler. This FCC-registered device provides direct access into your local telephone system, with none of the losses or distortions associated with acoustic couplers and without a telephone company supplied data access arrangement. • Auto-Answer/Auto-Call. The MICROMODEM 100 can automatically answer the phone and receive input; it can also dial a number automatically. • Automatic Reset and Disconnect. • Software compatible with the D.C. Hayes Associates 80-103A Data Communications Adapter. Micromodem-DCHA32625—\$379.95

TIDMA



Tape Interface Direct Memory Access • Record and play programs without bootstrap loader (no prom) has FSK encoder/decoder for direct connections to low cost recorder at 1200 baud rate, and direct connections for inputs and outputs to a digital recorder at any baud rate • S-100 bus compatible • Board only \$35.00 Part No. 112, with parts \$110.00 Part No. 112A.

SYSTEM MONITOR

8080, 8085, or Z-80 System monitor for use with the TIDMA board. There is no need for the front panel. Complete with documentation \$12.95.

RS-232/TTY INTERFACE



This board has two active circuits, one converts RS-232 to 20 mA, the other converts 20 mA to RS-232. Requires +12 and -12 volts. \$9.95 Part No. 600A Kit.

SERIAL I/O



Four Serial I/O RS-232 ports. S-100 Bus, Software or jumper selectable baud rate (110, 300, 600, 1200, 2400, 4800, 9600, 19.2K), on board Xtal baud rate generator, Addressing, switch selectable, Parity or no parity (odd or even) switch selectable, 1 or 2 stop bits, 5 to 8 bits/character. Board only \$29.95, Part No. 7908 With parts (kit) \$199.95, Part No. 7908A.

S-100 BUS ACTIVE TERMINATOR



Board only \$14.95 Part No. 900, with parts \$24.95 Part No. 900A

To Order:

Mention part no. description, and price. In USA shipping paid by us for orders accompanied by check or money order. We accept C.O.D. orders in the U.S. only, or a VISA or Master Charge no., expiration date, signature, phone no., shipping charges will be added. CA residents add 6.5% for tax. Outside USA add 10% for air mail postage and handling. Payment must be in U.S. dollars. Dealer inquiries invited. 24 hour order line (408) 448-0800



Send for FREE Catalog... a big self-addressed envelope with 41¢ postage gets it fastest!

ELECTRONIC SYSTEMS

 Dept. B P. O. Box 21638, San Jose, CA USA 95151

TRS-80 SERIAL I/O

- Can input into basic
- Can use LIST and LPRINT to output, or output continuously
- RS-232 compatible
- Can be used with or without the expansion bus
- On board switch selectable baud rates of 110, 150, 300, 600, 1200, 2400, parity or no parity odd or even, 5 to 8 data bits, and 1 or 2 stop bits. D.T.R. line
- Requires +5, -12 VDC
- Board only \$19.95 Part No. 801Q, with parts \$59.95 Part No. 8010A, assembled \$79.95 Part No. 8010C. No connectors provided, see below.

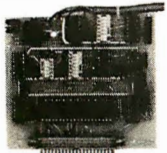

EIA/RS-232 connector Part No. DB25P \$5.00 with 9' B conductor cable \$10.95 Part No. DB25P9.



3' ribbon cable with attached connectors to fit TRS-80 and our serial board \$19.95 Part No. 3CA84Q.

COMPUCRUISE



\$129.95; with cruise control \$169.95

THE TELESIS VAR-80 INTERFACE UNIT

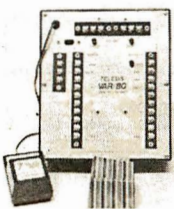

For the TRS-80 with Level II Basic • Provides 8 outputs • Provides 8 inputs • 2 ft. of interconnecting cable w/ connector • Plugs directly into TRS-80 • Power supply provided • Assembled and tested. Part No. VAR80, Introductory price \$109.95.

GAME PADDLES & SOUND



Includes: 2 game paddles, interface, software, speaker, power supply, full documentation including: schematics, theory of operation, and user guide; plus 2 games on cassette (Pong and Starship War). \$79.95 Complete Part No. 7922C

DIGICOM DATA PRODUCTS INC. Series 312 Acoustic Coupler



300 BAUD Originate, Part No. AC3122, \$219.95. 300 BAUD Answer, Part No. AC3122, \$219.95. 300 BAUD Answer/Originate, Part No. AC3123, \$229.95.

LIGHT-PEN For Your TRS-80



Your TRS-80 Light-Pen is a carefully engineered instrument and with the proper care will give satisfactory use and many years of service. Part No. TRSBOLP \$24.95.

SYSTEM EXPANSION from LNW Research

- Serial RS232C/20 mA I/O
- Floppy controller
- 32K bytes memory
- Parallel printer port
- Dual cassette port
- Real-time clock
- Screen printer bus
- Onboard power supply
- Software compatible
- Solder mask, silk screen, PC board and user manual, Part No. LNW80, \$69.95.

DISKETTES



Box of 10, 5" \$29.95, 8" \$39.95. Plastic box, holds 10 diskettes, 5" - \$4.50, 8" - \$6.50.

16K RAMS

For the Apple, TRS-80 or Pet \$8 each Part No. 4116/2117.

LEEDEX MONITOR

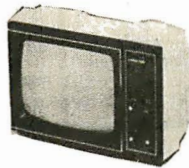

12" Black and White • 12 MHz Bandwidth • Handsome Plastic Case • \$139.00

S-100 INTERFACE

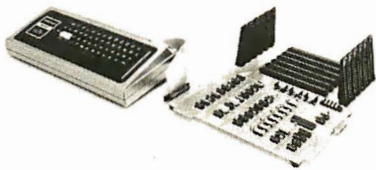

AN S-100 bus Adapter—Motherboard for the TRS-80. Kit, Part No. HUH81 DLXK, \$295.95. Assembled, Part No. HUH81 DLXA, \$375.95.

NOW! A FULL SUPPORT SYSTEM FOR TRS-80

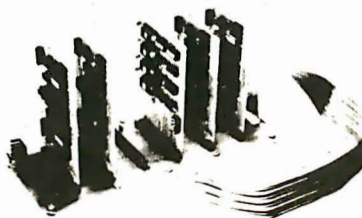

- 32K of RAM
- EPROM firmware
- Disk control
- Data acquisition
- Parallel I/O
- Serial I/O
- Plug into GPA's Motherboard. GPA's quality design includes: 6-44 pin edge connectors • +5V, -5V, +12V, -12V external power supply required
- Active termination. The Motherboard, Part No. GPA80, is only \$149.95.

TAKE ADVANTAGE OF GPA-EXPANSION CARDS FOR THE GPA80

Memory cards: Now with Fortran compilers available for your TRS-80, additional expansion memory is a must! Card with sockets only, Part No. GPA801, \$119.95. Card with 16K of 4116 Dynamic Ram, Part No. GPA802, \$224.95. Card with 32K of 4116 Dynamic Ram, Part No. GPA803, \$329.95. All cards come equipped with sockets to accommodate 32K of Ram.

EPROM firmware card. Put those valuable subroutines in firmware. Don't waste time loading and unloading tapes and disks. For 2708 or 2716 EPROMS, Part No. GPA806, \$79.95.

Serial I/O card. Here's what you've been asking for, a full serial terminal interface, with RS-232C or 20 mA. Current loop. Input/output capabilities. Part No. GPA807, \$79.95.

Parallel I/O Card. Control functions in the outside world, monitor and store real time events. Two parallel output ports. Dip switches select ports (0-254). Part No. GPA808, \$79.95.

FLOPPY DISK STORAGE BINDER

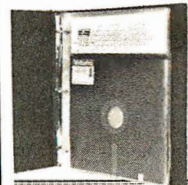

Three-ring binder comes with ten transparent plastic sleeves which accommodate either twenty, five-inch or ten, eight-inch floppy disks. Binder & 10 holders \$14.95 Part No. 8800; Extra holders 95¢ each. Part No. 800.

DIGITAL CASSETTE



5 min. each side. Box of 10 \$9.95. Part No. C-5.

DISK JACKET™

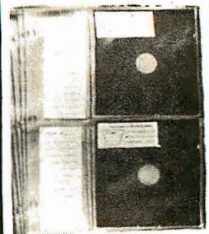

Holds two 5-1/4 inch diskettes and will fit any standard three ring binder. \$9.95/10 Pack.

TRENDCOM PRINTER



- 40 characters per second
- 4-7/16 inch wide thermal paper
- Graphics (TRENDCOM 100): 480 sevendot print positions per line. TRENDCOM 100, Part No. TRC0100, \$495.95. TRENDCOM 200, Part No. TRC0200, \$375.95.
- Interface for TRS-80.** Part No. TBOA \$45.95. For Apple II, Part No. TRCAII, \$75.95. For PET, NO. TRCP2, \$79.95. For Scocerer, TRCSR1 \$45.95.

SARGON: A Computer Chess Program

Features the complete program that won the 1978 West Coast Computer Faire Tournament. Part No. 00603 — TRS-80 Level II; Part No. 00604 — Apple II (24K). \$19.95

SOUND EFFECTS AND MUSIC FOR YOUR COMPUTER



SOUNDWARE is a complete system. It includes a speaker/amplifier unit with volume control, earphone jack, and connectors. It boasts excellent tone quality yet is small and convenient to use. Add batteries, plug it in, and play. One year warranty. **SOUNDWARE** package includes **INTRO to SOUNDWARE** (programs) PET (BK), Part No. 20003, \$29.95. TRS-80 Level II (16K), Part No. 20002, \$29.95. **CompuColor II** (BK), Part No. 20001, \$39.95. **INTRO to SOUNDWARE** programs only PET and TRS-80, Part No. 20005, \$14.95. **CompuColor II** Part No. 20006, \$19.95.

To Order: Mention part no. description, and price. In USA shipping paid by us for orders accompanied by check or money order. We accept C.O.D. orders in the U.S. only, or a VISA or Master Charge no., expiration date, signature, phone no., shipping charges will be added. CA residents add 6.5% for tax. Outside USA add 10% for air mail postage and handling. Payment must be in U.S. dollars. Dealer inquiries invited. 24 hour order line (408) 448-0800



Send for FREE Catalog . . . a big self-addressed envelope with 41¢ postage gets it fastest!

ELECTRONIC SYSTEMS Dept. B P. O. Box 21638, San Jose, CA USA 95151

DIGITAL RESEARCH COMPUTERS

(214) 494-1505

16K EPROM CARD-S 100 BUSS

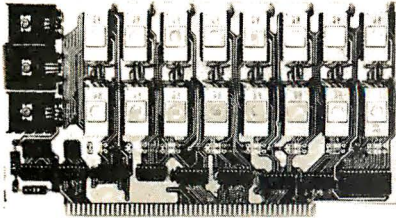

\$59.95
KIT

FIRST TIME OFFERED!
BLANK PC BOARD - \$28

USES 2708's!

Thousands of personal and business systems around the world use this board with complete satisfaction. Puts 16K of software on line at **ALL TIMES!** Kit features a top quality soldermasked and silk-screened PC board and first run parts and sockets. Any number of EPROM locations may be disabled to avoid any memory conflicts. Fully buffered and has WAIT STATE capabilities.

OUR 450 NS 2708'S
ARE \$8.95 EA. WITH
PURCHASE OF KIT

ASSEMBLED
AND FULLY TESTED
ADD \$30

8K LOW POWER RAM KIT-S 100 BUSS SALE

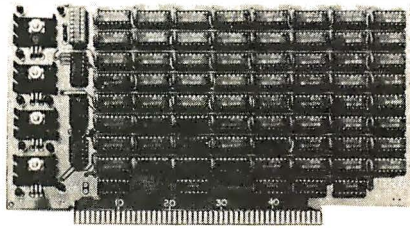

PRICE
CUT!

\$119.50
KIT

21L02
(450 NS RAMS!)

Thousands of computer systems rely on this rugged, work horse, RAM board. Designed for error-free, NO HASSLE, systems use.

Blank PC Board w/Documentation
\$29.95

Low Profile Socket Set...**13.50**

Support IC's (TTL & Regulators)
\$9.75

Bypass CAP's (Disc & Tantalums)
\$4.50

ASSEMBLED AND FULLY
BURNED IN ADD \$35

ALL ASSEMBLED BOARDS
ARE TESTED AT 4MHZ.

16K STATIC RAM KIT-S 100 BUSS

PRICE CUT!

\$225
KIT

FOR 4MHZ
ADD \$10

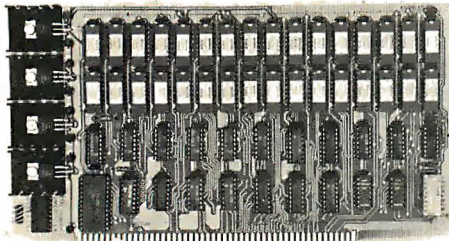

KIT FEATURES:

1. Addressable as four separate 4K Blocks.
2. ON BOARD BANK SELECT circuitry. (Cromemco Standard!). Allows up to 512K on line!
3. Uses 2114 (450NS) 4K Static Rams.
4. ON BOARD SELECTABLE WAIT STATES.
5. Double sided PC Board, with solder mask and silk screened layout. Gold plated contact fingers.
6. All address and data lines fully buffered.
7. Kit includes ALL parts and sockets.
8. PHANTOM is jumpered to PIN 67.
9. LOW POWER: under 1.5 amps TYPICAL from the +8 Volt Buss.
10. Blank PC Board can be populated as any multiple of 4K.

BLANK PC BOARD W/DATA-\$33

LOW PROFILE SOCKET SET-\$12

SUPPORT IC'S & CAPS-\$19.95

ASSEMBLED & TESTED-ADD \$35

OUR #1 SELLING
RAM BOARD!

16K STATIC RAM SS-50 BUSS

PRICE CUT!

\$229
KIT

FULLY STATIC
AT DYNAMIC
PRICES

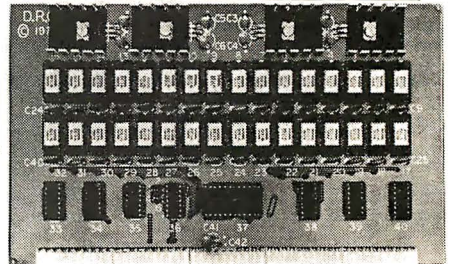

FOR SWTPC
6800 BUSS!

ASSEMBLED AND
TESTED - \$35

BLANK PC BOARD-\$26

KIT FEATURES:

1. Addressable on 16K Boundaries
2. Uses 2114 Static Ram
3. Runs at Full Speed
4. Double sided PC Board. Solder mask and silk screened layout. Gold fingers.
5. All Parts and Sockets included
6. Low Power: Under 1.5 Amps Typical

COMPLETE SOCKET SET-\$12
SUPPORT IC'S AND CAPS-\$19.95

NEW! STEREO! S-100 SOUND COMPUTER BOARD NEW!

At last, an S-100 Board that unleashes the full power of two unbelievable General Instruments AY3-8910 NMOS computer sound IC's. Allows you under total computer control to generate an infinite number of special sound effects for games or any other program. Sounds can be called in BASIC, ASSEMBLY LANGUAGE, etc.

KIT FEATURES:

- * TWO GI SOUND COMPUTER IC'S.
- * FOUR PARALLEL I/O PORTS ON BOARD.
- * USES ON BOARD AUDIO AMPS OR YOUR STEREO.
- * ON BOARD PROTO TYPING AREA.
- * ALL SOCKETS, PARTS AND HARDWARE ARE INCLUDED.
- * PC BOARD IS SOLDERMASKED, SILK SCREENED, WITH GOLD CONTACTS.
- * EASY, QUICK, AND FUN TO BUILD. WITH FULL INSTRUCTIONS.
- * USES PROGRAMMED I/O FOR MAXIMUM SYSTEM FLEXIBILITY.

Both Basic and Assembly Language Programming examples are included.

SOFTWARE:

SCL Interpreter coming soon! Our new Sound Command Language interpreter along with the Register Examine/Modify (REM) routines and Sound Effects Library (SEL) will be available soon in EPROM. SCL makes sound effects programming generally easier and quicker than that written in Basic or Assembly Language. An SCL users group will be formed, and the best new SCL programs submitted will be added to the Sound Effects Library in EPROM.

COMPLETE KIT!
\$84.95

(WITH DATA MANUAL)

BLANK PC
BOARD W/DATA
\$31

FOR SALE!
4MHZ

LOW POWER - 300NS
2114 RAM SALE!

8 FOR
\$44

4K STATIC RAM'S. MAJOR BRAND, NEW PARTS.

These are the most sought after 2114's, LOW POWER and 300NS FAST.
8 FOR \$44

Digital Research Computers

(OF TEXAS)

P.O. BOX 401565 • GARLAND, TEXAS 75040 • (214) 494-1505

Perfect for
OEM's

S-100 Z80 CPU CARD

\$169.95

WIRED!
NOT A KIT!

4 MHZ

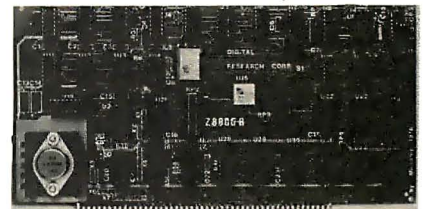

ASSEMBLED AND TESTED! READY TO USE! Over 3 years of design efforts were required to produce a TRUE S-100 Z80 CPU at a genuinely bargain price!

BRAND NEW!

FEATURES:

- * 2 or 4 MHZ Operation.
- * Generates MWRITE, so no front panel required.
- * Jump on reset capability.
- * 8080 Signals emulated for S-100 compatibility.
- * Top Quality PCB. Silk Screened. Solder Masked. Gold Plated Contact Fingers.

NEW! G.I. COMPUTER SOUND CHIP

AY3-8910. As featured in July, 1979 BYTE! A fantastically powerful Sound & Music Generator. Perfect for use with any 8 Bit Microprocessor. Contains: 3 Tone Channels, Noise Generator, 3 Channels of Amplitude Control. 16 Bit Envelope Period Control, 2-8 Bit Parallel I/O. 3 D to A Converters, plus much more! All in one 40 Pin DIP. Super easy to interface to the S-100 or other busses.

SPECIAL OFFER: \$14.95 each Add \$3 for 60 page Data Manual.

TERMS: Add \$1.00 postage. We pay balance. Orders under \$15 add 75¢ handling. No C.O.D. We accept Visa and MasterCharge. Tex. Res. add 5% Tax. Foreign orders (except Canada) add 20% P & H. 90 Day Money Back Guarantee on all items. Orders over \$50. add 85¢ for insurance.

NOT ASSOCIATED WITH DIGITAL RESEARCH OF CALIFORNIA, THE SUPPLIERS OF CPM SOFTWARE.



CALIFORNIA COMPUTER SYSTEMS

16K RAM BOARD. Fully buffered addressable in 4K blocks. IEEE standard for bank addressing 2114's. PCB\$27.95 Kit 450 NSEC\$249.95

PT-1 PROTO BOARD. Over 2,600 holes 4" regulators. All S-100 buss functions labeled, gold fingers. PCB\$26.95

PT-2 PROTO BOARD. Similar to PT-1 except set-up to handle solder tail sockets. PCB\$26.95

CCS MAIN FRAME. Kit (S-100)\$339.95

APPLE EXTENDER. Kit\$22.95

APPLE IEEE INSTRUMENTATION INTERFACE KIT 7490. Kit\$275.00

ARITHMETIC PROCESSOR FOR APPLE 7811A. Kit\$350.00

APPLE ASYNCHRONOUS SERIAL INTERFACE 7710A. Kit\$89.95

APPLE SYNCHRONOUS SERIAL INTERFACE 7712A. Kit\$89.95

ALL OTHER CCS PRODUCTS AVAILABLE



PB-1 2708 & 2716 Programming Board with provisions for 4K or 8K EPROM. No external supplies required. Textool sockets. Kit\$129.95

CB-1A 8080 Processor Board. 2K of PROM 256 BYTE RAM power on/rest Vector Jump Parallel port with status. Kit\$129.95 PCB\$27.95

VB-3 80 x 55 VIDEO BOARD. Graphic included. 4 MHz\$379.95

IO-4 Two serial I/O ports with full handshaking 20/60 ma current loop: Two parallel I/O ports. Kit\$130.00 PCB\$27.95

VB-1B 64 x 16 video board, upper lower case Greek composite and parallel video with software, S-100. Kit\$125.00 PCB\$27.95

CB-2 Z80 CPU BOARD. Kit\$185.95

AIO APPLE SERIAL/PARALLEL\$125.95

ALL OTHER SSM PRODUCTS AVAILABLE

WMC inc. WAMECO INC.

FDC-1 FLOPPY CONTROLLER BOARD will drive shugart, pertek, remic 5" & 8" drives up to 8 drives, on board PROM with power boot up, will operate with CPM™ (not included). PCB\$42.95

FPB-1 Front Panel. IMSAI size, hex displays. Byte, or instruction single step. PCB\$47.50

MEM-1A 8K x 8 fully buffered, S-100, uses 2102 type rams. PCB\$25.95

QM-12 MOTHER BOARD, 13 slot, terminated, S-100 board only\$38.95

CPU-1 8080A Processor board S-100 with 8 level vector interrupt. PCB\$27.95

RTC-1 Realtime clock board. Two independent interrupts. Software programmable. PCB\$24.95

EPM-1 1702A 4K Eprom card. PCB\$25.95

EPM-2 2708/2716 16K/32K EPROM CARD. PCB\$25.95

QM-9 MOTHER BOARD. Short Version of QM-12. 9 Slots. PCB\$32.95

MEM-2 16K x 8 Fully Buffered 2114 Board. PCB\$27.95

PTB-1 POWER SUPPLY AND TERMINATOR BOARD. PCB\$27.95

IOB-1 SERIAL AND PARALLEL INTERFACE. 2 parallel, one serial and cassette. PCB\$27.95

2708\$ 9.49 2114L 450 NSEC\$5.99

2716\$35.95 2114L 200 NSEC\$6.99

JUNE SPECIAL SALE ON PREPAID ORDERS
(Charge cards not included on this offer)

JUNE SPECIAL 5% off on all CCS, WAMECO and SSM PCB and kits. Also included are MIKOS parts assortments.

MIKOS PARTS ASSORTMENT WITH WAMECO AND CYBERCOM PCBDS

MEM-2 with MIKOS #7 16K ram with L2114 450 NSEC\$249.95

MEM-2 with MIKOS #13 16K ram with L2114 250 NSEC\$279.95

CPU-1 with MIKOS #2 8080A CPU\$ 94.95

QM-12 with MIKOS #4 13 slot mother board\$ 95.95

RTC-1 with MIKOS #5 real time clock\$ 59.95

EMP-1 with MIKOS #10 4K 1702 less EPROMS\$ 49.95

EPM-2 with MIKOS #11 16-32K EPROMS less EPROMS\$ 59.95

QM-9 with MIKOS #12 9 slot mother board\$ 89.95

FPB-1 with MIKOS #14 all parts for front panel\$144.95

MIKOS PARTS ASSORTMENTS ARE ALL FACTORY MARKED PARTS. KITS INCLUDE ALL PARTS LISTED AS REQUIRED FOR THE COMPLETE KIT LESS PARTS LISTED. ALL SOCKETS INCLUDED.

MIKOS

NOTE:
NEW ADDRESS AND PHONE (415) 726-7593
P. O. Box 955 • El Granada, CA 94018
Please send for IC, Xistor and Computer parts list

VISA or MASTERCARD. Send account number, interbank number, expiration date and sign your order. Approx. postage will be added. Check or money order will be sent post paid in U.S. If you are not a regular customer, please use charge, cashier's check or postal money order. Otherwise there will be a two-week delay for checks to clear. Calif. residents add 6% tax. Money back 30-day guarantee. We cannot accept returned IC's that have been soldered to. Prices subject to change without notice. \$10 minimum order. \$1.50 service charge on orders less than \$10.00.

UP TO **30% OFF** AND IMMEDIATE DELIVERY

TRS 80™ \$3626.00
MODEL II 64K IN-STOCK FULLY GUARANTEED

ORDER NOW (1) 800-345-8102

DISK DRIVES \$350.00
OVER \$149.00 LESS THAN RADIO SHACK

Fully compatible with Radio Shack's operating system TRSDOS™ and drives. Just plug in and run!

- One, two, three or four drive configurations, 102k to 408k bytes.
- All systems include a patch program to upgrade your TRSDOS™ to 40 tracks.
- Cases are furnished in gray to match your system.

ORDER NOW (1) 800-345-8102

	LIST PRICE	OUR PRICE		LIST PRICE	OUR PRICE
TRS-80 4 K LEVEL I SYSTEM	\$499.00	\$464.10	CENTRONICS 730	\$995.00	\$695.00
TRS-80 4 K LEVEL II SYSTEM	\$619.00	\$575.70	CENTRONICS 737		
TRS-80 16 K LEVEL II SYSTEM	\$849.00	\$789.60	• 100 CPS		
EXPANSION INTERFACE (D K Memory)	\$299.00	\$278.10	• LETTER QUALITY DOT MATRIX	\$950.00	
TELEPHONE MODEM	\$199.00	\$185.10	• TRUE DESCENDERS		
			NEC SPINWRITER 5530 (with Tractor)	3195.00	2950.00

V R DATA CORPORATION
777 HENDERSON BOULEVARD N-6
FOLCROFT INDUSTRIAL PARK
FOLCROFT, PA. 19032 (215) 461-5300

V R DATA'S TRS-80™ SWEEPSTAKES

Celebrating V. R. DATA's 8th Anniversary
OVER \$1700.00 in PRIZES
GRAND PRIZE - 16K LII TRS-80
TWO SECOND PRIZES - DISK DRIVES
FOUR THIRD PRIZES - \$50.00 Gift Certificates

SWEEPSTAKES RULES

1. ALL ENTRIES MUST BE SUBMITTED ON ORIGINAL ENTRY BLANK.
2. ONE ENTRY PER PERSON.
3. WINNERS SELECTED BY RANDOM DRAWING, NOTIFIED BY MAIL.
4. ENTRIES MUST BE RECEIVED BY 10/31/80.
5. VOID WHERE PROHIBITED BY LAW, NO PURCHASE NECESSARY.

MAIL NOW TO ENTER V. R. DATA'S SWEEPSTAKES

NAME _____
ADDRESS _____
CITY _____ STATE _____ ZIP _____
TELEPHONE _____ OCCUPATION _____
COMPUTER EQUIPMENT OWNED _____
INTENDED USE _____

SEND FOR CATALOG

Now get OHIO SCIENTIFIC personal computer products with guaranteed, quick, mail order delivery.

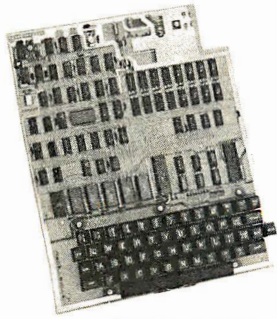

ONLY \$299

Ohio Scientific Superboard II

The first complete computer system on a board. Includes keyboard, video interface and audio cassette interface. BK BASIC-in-ROM; 4K RAM. Requires power supply +5V at 3 Amp.

"We heartily recommend Superboard II for the beginner who wants to get into microcomputers with a minimum cost. A real computer with full expandability."

POPULAR ELECTRONICS, MARCH, 1979

"The Superboard II is an excellent choice for the personal computer enthusiast on a budget."

BYTE, MAY, 1979

Ohio Scientific C4P Series.



The Challenger 4P. A 4-slot computer with one open slot. Highly sophisticated 16 color video interface. 32 rows x 64 columns, upper and lower case. BK BASIC-in-ROM, BK RAM. 200-20KHz programmable tone generator. AC remote interface. Expandable to 32K RAM and two mini-floppy drives. **\$750.**

The Challenger 4P MF. Mini-floppy version of the 4P. Two to three times faster than competitors. More I/O built-in than any other in its class. 24K RAM. Real time clock. Modem interface. Printer interface. Foreground/Background operation and much, much more. **\$1795.**

Ohio Scientific C1P Series.



The Challenger 1P. The best bargain in personal computer anywhere! BK BASIC-in-ROM. 4K RAM. Cassette based with 53-key keyboard. B&W video interface, 30 rows x 30 columns. Upper and lower case. **\$399.**

Ohio Scientific C1P MF. Mini-floppy version of the C1P. BK BASIC-in-ROM. 20K RAM and OS-65D software. Fully expandable. **\$1250.**

Accessories

AC-3P 12" B/W monitor, TV	\$ 125
AC-15P 12" Color monitor	\$ 450
AC-16P 2-8 Axis Joysticks with cable	\$ 39
AC-11P Answer/Originate 300 baud modem with cable	\$ 199
AC-17P Home Security Starter Set. 1 fire detector, 2 window alarms, 1 door unit.	\$ 249
AC-18P 8 1/2" aluminized paper printer. Upper/lower case.	\$ 695
AC-9TP Centronics 799 110cps tractor feed, business printer with interface	\$ 1250
AC-12P AC-Remote starter set. Console. 2 lamp modules, 2 appliance modules, OS 65D home control operating system	\$ 175
Disk Drives	
CD 3P Single 5" mini floppy	\$ 499
CD 2P Dual 8" Disk with interface and OS-65D DOS	\$ 1599
Power Supplies	
PS 1. 5-volt @ 3 amps regulated. For use with Superboard II	\$ 29
Boards (Assembled and tested)	
CM 9P. 24K Static.	\$ 399
610. BK Static. Expandable to 24K and dual mini-floppy controller.	\$ 298
CA-14A. Votrax® voice synthesizer.	\$ 399
CA-15 Universal Telephone Interface, rotary or touch tone	\$ 499
CA-15V UTI with Votrax®	\$ 799
CM-6 48K Dynamic memory board.	\$ 499
4KP. 4K static RAM chip set	\$ 69
CA12. 96 line parallel I/O	\$ 175
Books:	
How to Program Microcomputers, By William Barden	\$ 8.95
Basic and Personal Computer By Dwyer & Critchfield	\$ 12.95
Howard Sams C1P Service Manual	\$ 7.95
Howard Sams C4P Service Manual	\$ 15.95

SOFTWARE

Cassettes	MOMS Checking and Savings Account	\$29.00
Add Game	\$ 6.00	
BASIC Tutor Series		\$29.00
Torpedo	\$ 6.00	
Address Book		\$ 8.00
Programmable Calculator	\$12.00	
Savings Account		\$ 6.00
Breakout	\$ 6.00	
Battleship	\$ 6.00	
Bowling	\$ 6.00	
Destroyer	\$ 6.00	
Space War	\$ 6.00	
Star Trek	\$ 6.00	
Tiger Tank		\$12.00
	MOMS Personal Calendar/Address Book	\$29.00
	Home Control II	\$29.00
	DAC I Music Generation	\$39.00
	Baseball I & II, Golf, Bowling, Hockey	\$39.00
	Poker, Black Jack, Spades, Hearts, more	\$29.00
	Tiger Tank, Space Attack, Etch-A-Sketch, more	\$29.00
Disks	Star Wars, Zulu 9, High Noon, more	\$29.00
When ordering, specify Challenger 1P, 4P or 8P	Monster, Kite, Three Little Pigs, Humpty Dumpty and more	\$29.00
MOMS Education System	(2 Disk Set)	\$29.00

Many, many more software systems are available to you. See our catalog for complete listings.

Freight Policies

All orders of \$100 or more are shipped freight prepaid. Orders of less than \$100 please add \$4.00 to cover shipping costs. Ohio Residents add 5.5% Sales Tax.

Guaranteed Shipment

Cleveland Consumer Computers & Components guarantees shipment of computer systems within 48 hours upon receipt of your order. **Our failure to ship within 48 hours entitles you to \$35 of software, FREE.**

Ohio Scientific 8P Series.

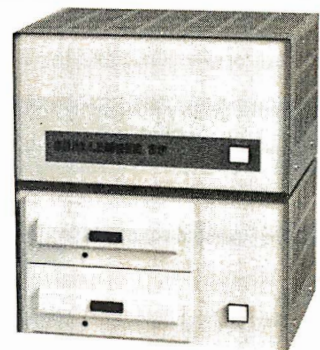

Challenger 8P. Ohio Scientific's mainframe-class. Personal computer. 8 slots with 6 open. Cassette based with BK BASIC-in-ROM. BK static RAM, expandable to 32K RAM, and dual 8-inch floppy disk drive. **\$950.**

Challenger 8P DF. A top of the line personal and small business computer. 32K RAM, expandable to 48K. Features dual 8" floppy disk drives. Audio output 200 20KHz. DAC for voice generation. Keypad interfaces. Joystick (2) interfaces. AC Remote. Real Time Clock. Printer & Modem interfaces. And more. **\$2895.**

To Order:

Dr to get our free catalog
CALL 1-800-321-5805 TOLL FREE.
Charge your order to your **VISA** or **MASTER CHARGE** ACCOUNT
Ohio Residents Call: (216) 464-8047.
Or write, including your check or money order, to the address listed below.



Hours:

Call Monday thru Friday
8:00 AM to 5:00 PM E.S.T.

CLEVELAND CONSUMER COMPUTERS & COMPONENTS
P.O. Box 46627
Cleveland, Ohio 44146

TO ORDER: CALL
1-800-321-5805
TOLL FREE



FREE! Up to \$170 in merchandise with purchase of one of following PET-CBM items!!!

- Axiom EX-801 PET Printer(withgraphics)\$ 475.00
- Axiom EX-820 PET Plotter \$ 749.00
- Anderson Jacobson 841 Selectric ... \$1015.00
- Leedex Video 100 12" Monitor \$ 119.00
- Heath WH19 Terminal(factory asm.) ... \$ 770.00
- Heath WH 14 Printer(factory asm.) ... \$ 735.00
- IEEE-RS 232 Printer Adaptor for PET ... \$ 88.00

- BETSI PET to S-100 Interface \$ 119.00
- PET Connectors-Parallel or IEEE \$ 1.95
- Cassette Port \$ 1.45
- Hands on Basic with a PET \$ 10.15
- Programming the 6502 (Zaks) \$ 10.45
- 6502 Applications Book (Zaks) \$ 10.45
- 6500 Manuals (MOS Technology) \$ 6.50
- Programming a Microcomputer: 6502 . \$ 7.75
- 6502 Assembly Language (Osborne) NEW! \$ 9.90

PET SPECIALS

***FREE**

- PET 16N 16K full size graphics keyboard \$ 995 **\$130**
- PET 16B 16K full size business keyboard \$ 995 **\$130**
- PET 32N 32K full size graphics keyboard \$1295 **\$170**
- PET 32B 32K full size business keyboard \$1295 **\$170**
- PET 8N 8K full size graphics keyboard \$ 795 **\$100**
- PET2040 DUAL DISK DRIVE-343,000 bytes \$1295 **\$170**
- PET 2022 Tractor Feed Printer \$ 795 **\$100**
- PET 2023 Pressure Feed Printer \$ 695 **\$ 70**
- PET C2N External Cassette Deck \$ 95 **\$ 12**
- Used 8K PETs (limited quantities) \$ 495

★ **EDUCATIONAL DISCOUNTS** ★
Buy 2 PET Computers, get 1 FREE ★

*Free Merchandise with Purchase of PET-CBM Item.

- KIM-1 \$159 (add \$30 for power supply) SYM-1 \$209
- BAS-1 Microsoft ROM Basic for SYM \$ 85
- Memory Plus (KIM, SYM, AIM) \$195
- SYM Assembler in ROM \$ 85
- KIM 16K Static RAM \$284
- Seawell Motherboard - 4K RAM Space ... \$139
- KTM-2/80 Synertek (Video Board) \$349
- S-100 16K Static RAM Kit **SALE** \$198
- TIS PET Workbooks - set of 6 \$ 21.50
- Dust Cover for PET \$ 7.45

All Book and Software Prices are Discounted
PET Personal Computer Guide (Osborne) ... \$ 12.75
PET and the IEEE-488 Bus (Osborne) \$ 12.75
6502 Software Cookbook (Scelbi) \$ 9.45

Cassettes (all tapes guaranteed) AGFA PE611
Premium quality, high out put low noise in 5 screw housing with labels:

- C-10 10/5.65 50/25.00 100/48.00
- C-30 10/6.90. 50/30.00 100/57.00

- 2716 EPROM (5 volt) ... \$29.00 5@ 27.00 10@ 25.00
- 4116 RAM 16K x 1 \$7.50 8 @ 7.10
- 2114 L 450 \$5.35 20 @ 4.95 80 @ 4.45
- 2114 L 300 \$6.10 20 @ 5.65 80 @ 5.05
- 6502 \$8.35 10 @ 7.85 40 @ 7.35
- 6522 \$7.15 10 @ 6.95 40 @ 6.45
- 6520 \$5.15 10 @ 4.90 40 @ 4.45
- 6532 \$7.90 10 @ 7.40 40 @ 6.85
- 6502A \$9.50
- 6504 \$7.95
- 21L02 \$.90
- 6550 RAM (PET 8K) \$12.70
- S-100 Wire Wrap \$2.85 10 @ 2.65
- S-100 Solder Tail \$2.35 10 @ 2.15

ATARI - INTRODUCTORY SPECIAL

ATARI 400, Atari 800 and all Atari Modules 20% OFF.

- Programmers Toolkit - PETROM Utilities. \$ 44.90
- Sargon II (TRS-80 or Apple) NEW! \$ 24.90
- Microchess for PET (Peter Jennings) \$ 17.90
- Visible Music Monitor (4 Voice) for PET ... \$ 29.90
- KL-4M 4 Voice Music Board (PET) \$ 34.90
- CmC Word Processor (8K \$25) (16K \$34)
- Adventures by Scott Adams 15% Off

SALE

(write for quantity prices)



- Scotch 8" Disks ... 10/\$31.00
- Scotch 5 1/4" Disks . 10/\$31.50
- Verbatim 5 1/4" Disks 10/\$26.50
- Diskette Storage Pages 10/\$ 3.95
- Disk Library Cases 8" - \$2.95 5" - \$2.15
- BASF 5 1/4" Disks 10/\$28.00
- BASF 8" Disks 10/\$29.00



MINIMAX
by COMPU/THINK

MINIMAX I (.8 Megabyte Disks) \$3395

MINIMAX II (2.4 Megabyte Disks) \$4495

SPECIAL - MINIMAX prices include Compu/

Think PAGEMATE Database and Report Writer at no charge.

115 E. Stump Road
Montgomeryville, PA 18936

(215) 699-8386
699-5826

A B Computers

WRITE FOR COMPLETE CATALOG

Add \$1.00 per order for shipping.
We pay balance of UPS surface charges on all prepaid orders.

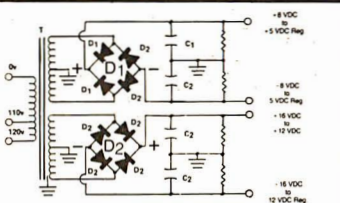

**BUILD YOUR OWN LOW COST
MICRO-COMPUTER
POWER SUPPLIES
FOR S-100 BUS, FLOPPY DISCS, ETC.**

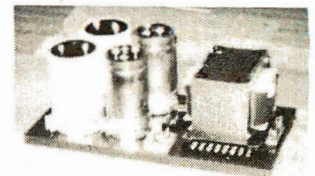

POWER TRANSFORMERS (WITH MOUNTING BRACKETS)

ITEM NO.	USED IN KIT NO.	PRI. WINDING TAPS	SECONDARY WINDING OUTPUTS			SIZE W x D x H	UNIT PRICE
			2x8 Vac	2x14 Vac	2x24 Vac		
T1	1	0V, 110V, 120V	2x7.5A	2x2.5A	—	3 3/4" x 3 5/8" x 3 1/8"	21.95
T2	2	0V, 110V, 120V	2x12.5A	2x3.5A	—	3 3/4" x 4 3/8" x 3 1/8"	27.95
T3	3	0V, 110V, 120V	2x9A	2x2.5A	2x2.5A	3 3/4" x 4 3/8" x 3 1/8"	29.95
T4	4	0V, 110V, 120V	2x4A	—	2x3A	3 3/4" x 3 5/8" x 3 1/8"	21.95

POWER SUPPLY KITS (OPEN FRAME WITH BASE PLATE, 3 HRS. ASSY. TIME)

ITEM	USED FOR	@ +8 Vdc	@ -8 Vdc	@ +16 Vdc	@ -16 Vdc	@ +28 Vdc	SIZE W x D x H	UNIT PRICE
KIT 1	15 CARDS SOURCE	15A	—	2.5A	2.5A	—	12" x 6" x 4 7/8"	51.95
KIT 2	SYSTEM SOURCE	25A	—	3A	3A	—	12" x 6" x 4 7/8"	58.95
KIT 3	DISC SYSTEM	15A	1A	2A	2A	4A	14" x 6" x 4 7/8"	66.95
KIT 4	DISC SOURCE	8A	1A	—	—	5A	10" x 6" x 4 7/8"	49.95

EACH KIT INCLUDES: TRANSFORMER, CAPACITORS, RESIS., BRIDGE RECTIFIERS, FUSE & HOLDER, TERMINAL BLOCK, BASE PLATE, MOUNTING PARTS AND INSTRUCTIONS.

DISC DRIVE POWER SUPPLY "R3" ASSY. & TESTED, OPEN FRAME, SIZE: 9" (W) x 5" (D) x 5" (H) 64.95

SPECS: +5V @ 5A REGULATED, -5V @ 1A REG., +24V @ 5A REG., SHORTS PROTECT.

IDEAL FOR 2 SHUGART 801/851 OR SIEMANS FDD 100-8/200-8 DISK DRIVES & ROCKWELL AIM-65.

SHIPPING FOR EACH TRANSFORMER: \$4.75. FOR EACH POWER SUPPLY: \$5.00 IN CALIF. \$7.00 IN OTHER STATES. CALIF. RESIDENTS ADD 6% SALES TAX. OEM WELCOME.

SUNNY INTERNATIONAL

(TRANSFORMERS MANUFACTURER)

Telephone: (213) 633-8327

STORE:

7245 E. ALONDRA BLVD.
PARAMOUNT, CA 90723
STORE HOURS: 9 AM - 6 PM



MAIL ORDER:
P.O. BOX 4296
TORRANCE, CA 90510



MICRO BUSINESS WORLD™ MAIL ORDER

Immediate response to your orders (verbal or written). Phone (213) 371-1660

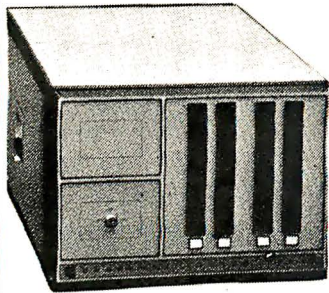

Cromemco System Three FEATURES . . .

- Z-80A Micro Processor • 64K RAM
- Dual 8" Double Sided Disk Drive easily expandable to 4 Drives • RS232 and Printer Interface.

CALL FOR OUR PRICE

Cromemco System Two FEATURES . . .

- Z-80A Micro Processor • 64K RAM
- Wangco Drives • RS232 and Printer Interface.

CALL FOR OUR PRICE

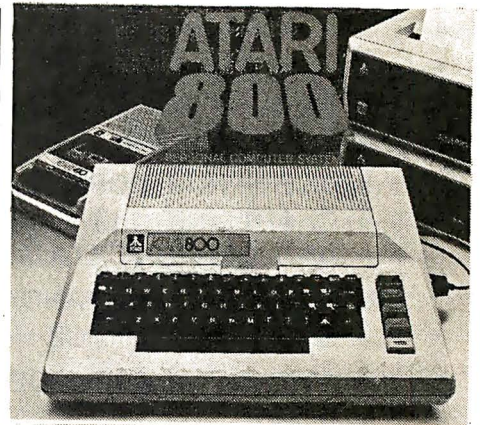

ATARI 800 Personal Computer System

Packed with: Computer Console, Basic Language Card, Education System Master Cartridge, Cassette Recorder, TV Modulator, 8K Memory (expandable to 48K), Power Supply & all Books and Manuals

\$799.95

ATARI 400 Personal Computer System for less

Packed with: Computer Console, Basic Language Cartridge, Power Supply, TV Modulator, and all Books and Manuals

\$499.95

ATARI Program Recorder 69.99

ATARI Software, Roms, Cassettes 25% off list price

ATARI Expansion Memory 8K Module 99.99

16K Module 169.99

SANYO 9" MONITOR

A Superb Black and White TV Monitor that can be used with most Computers

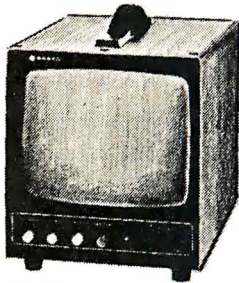

OUR PRICE \$185

Apple II personal computer.

We have a Complete stock of different Software for the Apple II

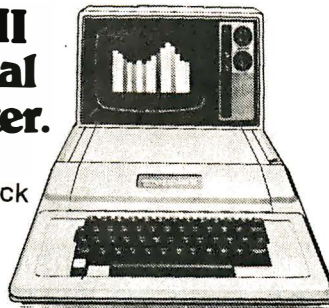

All Apple and Apple related products...
15-25% OFF list price

Texas Instruments TI-99/4 Home Computer

The TI-99/4 gives you an unmatched combination of features, including: • Powerful TI-BASIC—built-in 13-digit, floating point BASIC. • Up to 72K total memory capacity — 16K RAM (Random Access Memory), 26K ROM (Read Only Memory), plus up to 30K ROM in TI's Solid State Command Modules. • 13" color monitor included. • Revolutionary Solid State Speech™ \$999 Synthesizer (optional) without monitor \$699

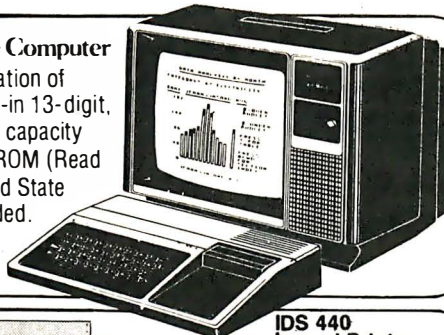

ZENITH DATA SYSTEMS: Smart Video Terminal

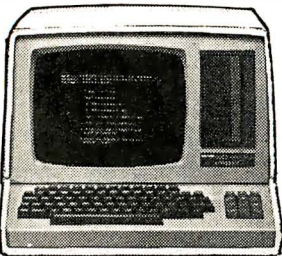

Z-89 Computer System:

includes: Z19 Display, a built in 5 1/4" Floppy Disk, 2 serial ports, and 16K of memory. 2295.00
48K Memory version 2595.00

Z-19 has a Z80 Microprocessor, Numeric Keypad and 8 function key \$895.00

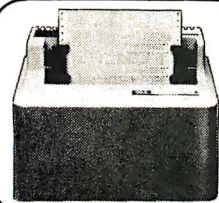

IDS 440 Impact Printer

The Paper Tiger

This low-cost printer has the capability of printers twice its price. Ideal for use with small computers w/graphics **OUR PRICE \$995.00**

DYSAN DISKETTES

THE CADILLAC OF THE FLOPPY DISKS
AT LOW LOW PRICES

8" (Box of 10) 3740/1/1 sgl side/sgl density \$4.50 ea.

8" (Box of 10) 3740/1/D sgl side/dbl density \$6.95 ea.

5" (Box of 5):

104/1 Soft Sector or 107/1 10 Sectors or 105/1 16 Sectors \$4.50

Plastic Floppy Disk Holder (up to 10) 8" \$3.95

Plastic Floppy Disk Holder (up to 10) 5" \$3.25

The Vector MZ Microcomputer

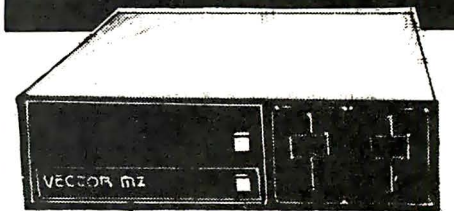

System B is a Z-80 based microcomputer with over 630,000 characters of on-line storage and is capable of handling standard accounting or special computations of any small business or large company department — even scientific calculations in a technical environment.
Call for Our Price

16K RAM set of 8 4116's 250 ns or better \$59.00

Prices subject to change without notice. VISA and MASTER CHARGE WELCOME. Allow 2 weeks for cashiers check to clear, 4 weeks for personal checks. Add 2% for shipping and handling. Calif. residents add 6% sales tax. (Sorry, no C.O.D.)

U.S. and International dealer inquiries invited.

Copyright 1980 • MICRO Business WORLD Circle 251 on inquiry card.



MICRO BUSINESS WORLD™

15818 Hawthorne Boulevard
Lawndale, California 90260 (213) 371-1660

WAMECO

THE COMPLETE PC BOARD HOUSE EVERYTHING FOR THE S-100 BUSS

INTRODUCTORY SPECIAL

IOB-1 SERIAL/PARALLEL INTERFACE BOARD

- * TWO PARALLEL DATA PORTS PROGRAMMABLE USING AN 8255 WITH SEPARATE HANDSHAKING.
 - * ONE SERIAL PORT USING AN 8251 WITH PROVISIONS FOR PARITY, STOP BIT AND CHARACTER LENGTH. BAUD RATES 110 TO 9600 BAUD. OUTPUTS RS232, TTL AND CURRENT LOOP.
 - * KANSAS CITY STANDARD CASSETTE INTERFACE, 300 BAUD FOR USE WITH THE SERIAL INTERFACE.
 - * STATUS MAY BE POLLING SOFTWARE OR VECTURED INTERRUPTS.
- PCBD\$31.95
KIT TO BE ANNOUNCED LATER.

FUTURE PRODUCTS: 80 CHARACTER VIDEO BOARD.

Z-80 CPU BOARD WITH ROM, 8 PARALLEL PORT I/O BOARD.

**DEALER INQUIRIES INVITED, UNIVERSITY DISCOUNTS AVAILABLE
AT YOUR LOCAL DEALER**

MOST PRODUCTS FOR IMMEDIATE SHIPMENT. NO 4-8 WEEK DELAYS REQUIRED FOR OTHERS.

NOTE:
NEW ADDRESS AND PHONE



WAMECO, INC., P. O. BOX 877 • 455 PLAZA ALHAMBRA • EL GRANADA, CA 94018 • (415) 726-6378



**NO ONE CAN GIVE YOU A BETTER
DEAL ON TRS-80 COMPUTERS!!**

OUR Radio Shack® Merchandise is New and covered by Radio Shack® Warranties

WE PAY Domestic U.P.S. Shipping & Insurance on minimum orders

NO TAXES are collected on out-of-state Shipments

TOLL FREE Order Number

OPEN 8:00 a.m. to 6:00 p.m., Central Time, Monday through Friday; 9:00 a.m. to 6:00 p.m., Saturday

on computers, peripherals, software and other Radio Shack® products.

Offered Exclusively By

Pan American Electronics

INCORPORATED

A

Radio Shack®

AUTHORIZED SALES CENTER

1117 CONWAY MISSION, TEXAS 78572

TOLL FREE ORDER NUMBER 800/531-7466

TEXAS AND MAIN TELEPHONE NUMBER 512/581-2765



IMSAI CONN.
100 PIN GOLD
SOLDERTAIL
\$2.60 ea.
or
10 for \$2.45 ea.

CAPACITORS
1 @ 12 Volts
CERAMIC
11¢ ea.
or
100/\$10⁰⁰

MICROBYTE

4116's - 200NS

Add-On Memory for:
Apple, TRS-80, Heath, Exidy,
SD Expandoram, etc.

8 for \$55⁰⁰
16 for \$105⁰⁰

LO-PRO SOCKETS

	1-99	100 UP
14 PIN	.10	.09
16 PIN	.12	.11
18 PIN	.15	.13
20 PIN	.23	.21
24 PIN	.26	.24
28 PIN	.30	.28
40 PIN	.42	.40

LOBO INT'L

SA800

Shugart 8''
Single-Sided/
Double Density
Floppy Disk
Drive, Cabinet &
Power Supply
(1) Drive Installed
\$775⁰⁰
(2) Drives Installed
\$1250⁰⁰

16K STATIC RAM BOARD

- S-100 Compatible
- 4K Bank Addressable
- Extended Memory Management
- No DMA Restrictions
- Assembled & Tested
- 4MHz Operation

\$250⁰⁰

MICROBYTE

CATALOG
AVAILABLE
CALL
OR
WRITE

32K STATIC RAM BOARD

- IEEE/S-100
- 4K Bank Addressable to any 4K Slot within a 64K Boundary
- On-board 8-Bit Output Port
- No DMA Restrictions
- Assembled & Tested
- 4MHz Operation

\$500⁰⁰

ATARI 400 & 800

MODEL 400

- Computer Console
- Basic Language Cartridge
- Basic Language Programming Manual
- Operators Manual
- Power Supply
- TV Switch Box

MODEL 800

- Computer Console
- Basic Language Cartridge
- Education System Master Cartridge
- Basic Language Programming Manual
- Operators Manual
- Atari 410 Program Recorder
- Guide to Basic Programming Cassette
- 8K Ram Module
- Power Supply
- TV Switch Box

CALL FOR PRICE

AVAILABLE FROM STOCK

74LS244

\$175 ea.

QTY. PRICES AVAILABLE

8080A

CERAMIC
\$250^{ea.}

2716's

5-VOLT ONLY
(450 NS)

\$300^{ea.}

TEXAS INST., FUJITSU

STATIC & DYNAMIC RAM CHIPS

2104 (4K Dynamic) \$225^{ea.}

4108/4115 (8K Dynamic) \$450^{ea.}

5257-3L (4K Static) \$600^{ea.}
250 NS

INTEL's \$3200^{ea.}

2708's

(450 NS)

\$800^{ea.}

or

8/\$58⁰⁰

SHUGART

SA801R

Bare Drives
Single Sided/
Sgl/Dbi Density

CALL FOR PRICE AND DELIVERY

SANYO

B & W
MONITORS

9" MODEL
\$175⁰⁰

15" MODEL
\$250⁰⁰

CENTRONICS PRINTERS

(MODEL # 703)

- 180 CPS B1-Directional
- Logic Seeking Printer
- 132 Column Carriages
- VFU & Centronics Standard Parallel Interface

\$1995⁰⁰

MODEL #704 (Serial) \$1895⁰⁰

SHUGART SA400

- Enclosed in Metal Case
- Cutouts for Data Cable, Switch, Fuse & Pwr Cord

\$315⁰⁰

LINEAR COMPONENTS

LM 348	75
LM 377	90
LM 555	35
LM 3900	42

COMMODORE

SOFTWARE

- Basic/Basic
- Mortgage
- Stock Portfolio
- Basic Finance
- Statistics Pkg.
- Checkbook
- Basic Math
- Alphabetizing
- Guess A Sentence
- Spelling

CALL FOR PRICES

TRS-80 DISK DRIVES

REGULATORS

Shugart SA400, Single or Double Density, Soft Sector, up to 218K Bytes, 25 MSec. Access Time, Software Compatible.

\$395⁰⁰

320T-5	90
320T-12	80
340T-5	75
340T-12	65
78HO5	5.25

ORDERING INFO

Name, Address, Phone
Ship by: UPS or Mail
Shipping Charges, Add
\$2.00 up to (5) lbs.

TERMS

We Accept Cash,
Check, Money Order,
Visa & Master Charge.
C.O.D.'s on Approval.
(U.S. Funds Only)
Tax: 6% Calif. Res.

Circle 255 on inquiry card.



apple computer

\$975 16K

APPLE II OR APPLE II PLUS

The APPLE II is a completely assembled and tested computer system. The system includes a rugged molded case, typewriter-style keyboard with N-key rollover, high-efficiency switching power supply, two hand controllers, demonstration programs on tape cassettes, AC power cord, cassette cable, reference manuals.

APPLE II has ROM-resident Integer BASIC interpreter, monitor, mini-assembler and disassembler & BASIC Programming Manual.

APPLE II PLUS has ROM-resident Applesoft Extended BASIC interpreter, Auto-Start ROM, disassembler & Applesoft Tutorial Manual.

32K \$1050	48K \$1125				
DISK II-DRIVE ONLY \$429	PROGRAMMABLE TIMER MODULE No 7440A 145	M&R SUP-R-TERMINAL 80 COLUMN BOARD 339	APPLE II & APPLE II PLUS SOFTWARE	FORTH II by PROGRAMMA SOFTWARE 45	SINGLE DISK COPY ROUTINES 17
DISK II-DRIVE & CONTROLLER CARD 489	3+1-DIGIT BCDANALOG TO DIGITAL CONVERTER 135	MICROSOFT 2.80 SOFTCARD SYSTEM W/CP/M 299	PASCAL with LANGUAGE SYSTEM \$429	APPLEBUG ASSEMBLER/ DISASSEMBLER 79	APPLEBUG DEBUGGER 79
MODEM II B W/INTERFACE 339	GPIB IEEE-488 (1978) INTERFACE No. 7490A 259	MICROWORKS OS-65 DIGISECTOR 339	FORTRAN for use with LANGUAGE SYSTEM 169	APPLEBUG DEBUGGER 79	APPLEBUGS DEBUGGER 79
MODEM II B only (Novation Cat.) 159	ASYNCHRONOUS SERIAL INTERFACE No. 7710A 145	MOUNTAIN HARDWARE	CP/M for use with MICROSOFT 2.80 SOFTCARD 299	APPLEBUGS UTILITY PROGRAMS by HAYDEN 27	
GRAPHICS TABLET 659	PARALLEL SERIAL INTERFACE NO. 7712A 145	APPLE CLOCK/CALENDAR CARD 229	THE CONTROLLER General Business System 519		
SILENTYPE PRINTER W/Apple Interface 519	ARITHMETIC PROCESSOR CARD NO. 7811B 339	SUPER TALKER SPEECH SYNTHESIZER SYSTEM 249	THE CASHIER Retail Management & Inventory 199	PRINTERS, TERMINALS & MONITORS	
APPLE COMPUTER INTERFACE CARDS	WIRE WRAP BOARD 20	ROMPLUS - w/KEYBOARD FILTER 169	APPLEWRITER Word Processor 65	PRINTERS, TERMINALS & MONITORS	
PROTOTYPING/HOBBY CARD \$22	SOLDER TAIL BOARD 20	ROMPLUS - w/KEYBOARD FILTER INTROL X-10 REMOTE CONTROL SYSTEM 249	APPLEPOST Mailing List System 45	ANAEXD 0P8000 or 0P8004P \$795	
PARALLEL PRINTER INTERFACE CARD 145	EXTENDER BOARD 24	INTROL X-10 CONTROLLER ONLY 169	APPLEPLOT Graph & Plot System 85	ANAEXD 0P9500 or 0P9501 1395	
COMMUNICATION CARD & DB25 Connector Cable 185	PCB ETCH BOARD 20	ROMWRITER SYSTEM 159	DOW JONES PORTFOLIO EVALUATOR 45	BASE 2 w/TRACTOR & BUFFER 599	
HI-SPEED SERIAL INTERFACE CARD 155	CORVUS	PROGRAMMA APPLE JOYSTICK SEE-THRU CLEAR PLASTIC TOP FOR APPLE II 23	CONTRIBUTED VOLUMES 1 THRU 5 w/ MANUALS 35	CENTRONICS 700-7 1099	
LANGUAGE SYSTEM WITH PASCAL CENTRONICS PRINTER 429	CORVUS 10 MEGABYTE HARD DISK DRIVE SYSTEM \$4495	SSM A10 SERIAL/PARALLEL I/O CARO(KIT) 129	VISI-CALC by PERSONAL SOFTWARE DESKTOP/PLAN by DESKTOP COMPUTERS 85	CENTRONICS 737 849	
INTERFACE CARD 185	CORVUS MIRROR (VTR Required) 695	SSM A10 ASSEMBLED & TESTED SYMTEC 169	PIMS Personal Information Management System 23	CENTRONICS 709-9 699	
APPLESOFT II FIRMWARE CARD W/Auto-Start ROM 149	CORVUS MIRROR (VTR Required) 795	APPLE LIGHT PEN SYSTEM 219	ADVENTURE by MICROSOFT 27	PAPER TIGER IDS 440 895	
INTEGER BASIC FIRMWARE CARD W/Mon. & Prog. Aid ROMS 149	CORVUS CONSTITUTION 595	SUPER SOUND GENERATOR (MONO) 139	SUB-LOGIC FS-1 Flight Simulator 23	W/GRAPHICS OPTION 995	
ADD-ONS	DC DAYTIME LOW-COST ADAPTER 44 319	SUPER SOUND GENERATOR (STEREO) 229	Bill Budgets TRILOGY (Cass.) 27	NEC SPINWRITER 5530 or 5510 2595	
16K MEMORY UPGRADE (RS-80, Apple, Sorcerer) \$69	HUERISTICS	SV&8 INCH DISK DRIVE CONTROLLER CARD 339	SARGON II Chess on Diskette 32	TRENDCOM 100 329	
ABT NUMERIC INPUT KEYPAD (Old or New Keyboard) 119	SPEECHLINK 2000(64 Word Vocabulary) 219	VERSA WRITER DIGITIZER DRAWING SYSTEM 219	Bill Budgets SPACE GAME ALBUM 32	TRENDCOM 200 529	
ALF MUSIC SYNTHESIZER 239	SPEECHLAB 20A (Cassette) 169	VIDEO XTERM 80 COLUMN CARD 319	SPACE INVADER on Cassette 18	LEODEX VIDEO 100 139	
ALF TIMING MODE INPUT BOARD 19	SPEECHLAB 20A (Diskette) 169	VIDEO XTERM W/GRAPHICS EPROM 339	SPACE INVADER on Diskette 23	SANYO 9 INCH B&W MONITOR 159	
BRIGHTEN LIGHTPEN from SOFAPAC CALIFORNIA COMPUTER SYSTEMS 32	MODEL 70 CONTROLLER 75		SYBEX APPLER-80 8080 SIMULATOR 17	SANYO 15 INCH MONITOR 249	
12K ROM/PROM ASSEMBLED BOARD NO 7114A \$69	M&R SUP-R-MOD TV MODULATOR ADAPTER 27			TI 13 INCH-COLOR MONITOR 429	

ORDERING INFORMATION: Phone orders may be placed using Visa Mastercard or bank wire transfer. Mail orders may send charge card number (include expiration date). Cashiers check, money order or personal check (allow 2 weeks to clear). Please include telephone number with all orders. Foreign orders (excluding Military, PO's) add 10% for shipping and funds must be in U.S. dollars. Shipping, handling and insurance in US is 50¢ per lb surface, \$1.00 per lb for air. No COD's or purchase orders. All prices subject to change and availability. Equipment is new and complete with manufacturer warranty.

"WE WILL NOT BE UNDER SOLD!"

BUDGET COMPUTER PRODUCTS

4878 RONSON COURT, SUITE A
SAN DIEGO, CA. 92111 (714) 698-0260

PRINTED CIRCUIT BOARD 4" x 6" DOUBLE SIDED EPOXY BOARD 1/16" thick \$6.00 ea. \$592.60 EPOXY glass vector board 1/16" thick with 1/10" spacing \$1.95 74500 - 30 74S32 - 40 74S151 - 1.25 74502 - 30 74S151 - 40 74S157 - 1.25 74508 - 40 74S86 - 65 74S158 - 1.25 74S11 - 35 74S112 - 85 74S174 - 1.40 7 WATT LD-65 LASER DIODE IR \$8.95 25 watt Infra Red Pulse (SG 2006 equiv.) Laser Diode (Spec sheet included) \$24.95 MINIATURE MULTI-TURN TRIM POTS 100K, .5K, 10K, 20K, 250K, 1 Meg, \$.75 each 3/2.00 2N3820 FT \$.45 2N5457 N FET \$.45 2N2646 UJT \$.45 ER 900 TRIGGER DIODES 4/61.00 2N 6028 PROG. UJT \$.65 FP 100 PHOTO TRANS. \$.50 RED, YELLOW, GREEN LARGE LED'S, 2" 6/61.00 RED/GREEN BIPOLAR LED'S, 2" \$.95 TIL-118 OPTO-ISOLATOR \$.75 MCT-6 OPTO-ISOLATOR \$.80 1 WATT ZENERS: 3.3, 4.7, 5.1, 5.6, 9.1, 10, 12, 15, 18, or 22V 6/61.00 TTL REED RELAY - SPST 5V 20ma \$1.00 Silicon Power Rectifiers <table border="1"> <tr> <td>PRV</td> <td>1A</td> <td>3A</td> <td>12A</td> <td>50A</td> <td>125A</td> <td>240A</td> </tr> <tr> <td>100</td> <td>.06</td> <td>.14</td> <td>.35</td> <td>.90</td> <td>3.70</td> <td>5.00</td> </tr> <tr> <td>200</td> <td>.07</td> <td>.20</td> <td>.40</td> <td>1.30</td> <td>4.25</td> <td>6.50</td> </tr> <tr> <td>400</td> <td>.09</td> <td>.25</td> <td>.65</td> <td>1.50</td> <td>6.50</td> <td>9.60</td> </tr> <tr> <td>600</td> <td>.11</td> <td>.30</td> <td>.80</td> <td>2.00</td> <td>8.50</td> <td>12.50</td> </tr> <tr> <td>800</td> <td>.15</td> <td>.35</td> <td>1.00</td> <td>2.50</td> <td>10.50</td> <td>16.50</td> </tr> <tr> <td>1000</td> <td>.20</td> <td>.45</td> <td>1.25</td> <td>3.00</td> <td>12.50</td> <td>20.00</td> </tr> </table> SILICON SOLAR CELLS 4" diameter .4V at 1 AMP \$10.00 IN 4148 (IN914) \$151.00 .1 or .01 of 25V ceramic disc. caps. 16/61.00, 100/650.00 RS232 CONNECTORS DB 25P male \$2.95 DB 25F female \$3.50 HOODS \$1.50 REGULATORS 323K - 5V/3A \$5.75 309K \$1.60 723 - 5.1V or 15V \$5.50 320T - 5.1V or 15V \$1.30 LM305H 75 320M5 \$.75 340K - 12, 15 or 24V \$1.50 340T - 5, 6, 8, 12, 15, 18 or 24V \$1.30 340V - 5, 6, 8, 12, 15, 18 or 24V \$1.30 79M \$1.30 320M5 \$.75		PRV	1A	3A	12A	50A	125A	240A	100	.06	.14	.35	.90	3.70	5.00	200	.07	.20	.40	1.30	4.25	6.50	400	.09	.25	.65	1.50	6.50	9.60	600	.11	.30	.80	2.00	8.50	12.50	800	.15	.35	1.00	2.50	10.50	16.50	1000	.20	.45	1.25	3.00	12.50	20.00	TRANSISTOR SPECIALS 2N1303 PNP GE TO-5 3/61.00 2N1613 PNP SIL TO-18 3/61.00 2N6 1.75 MFR-8004 C B 8K Transistor NPN \$.75 2N1772 NPN SIL TO-3 \$1.00 2N4008 PNP SIL TO-3 \$1.00 2N2907 NPN SIL TO-18 4/61.00 2N3137 NPN SIL RF \$1.50 2N3919 NPN SIL TO-3 RF \$1.50 2N3638 NPN SIL TO-3 \$1.50 2N3767 NPN SIL TO-6 \$.70 2N2922 NPN SIL TO-18 5/61.00 2N2905 NPN SIL TO-3 \$1.50 2N3904 NPN SIL TO-3 6/61.00 2N 9069 NPN SIL TO-92 6/61.00 2N3626 NPN SIL TO-220 \$1.50 2N1548 PNP GERM TO-3 \$.95 2N1309 PNP TO-5 \$.40 TIP-31 NPN SIL TO-220 \$.60 TIP-3 B PNP SIL TO-220 \$.65 2N1307 PNP GE TO-5 \$.40 TTL IC SERIES 7400 - 17 7448 - 75 74161 - 80 7401 - 17 7472 - 35 74162 - 120 7402 - 17 7473 - 35 74163 - 82 7403 - 24 7474 - 42 74165 - 85 7404 - 33 7476 - 45 74166 - 105 7406 - 33 7478 - 45 74170 - 60 7408 - 27 7483 - 60 74173 - 30 7409 - 24 7485 - 75 74175 - 75 7410 - 17 7486 - 42 74174 - 85 7411 - 22 7489 - 1.60 74176 - 75 7412 - 22 7490 - 50 74180 - 75 7413 - 42 7491 - 50 74181 - 1.50 7414 - 90 7492 - 50 74181 - 1.50 7416 - 33 7493 - 50 74190 - 1.20 7417 - 37 7494 - 60 74191 - 1.20 7420 - 17 7495 - 60 74192 - 79 7425 - 35 7496 - 60 74193 - 79 7426 - 33 74107 - 35 74194 - 85 7427 - 35 74121 - 35 74195 - 65 7438 - 27 74126 - 42 74196 - 65 7440 - 17 74145 - 75 74197 - 87 7441 - 85 74148 - 1.10 74229 - 75 7442 - 50 74150 - 1.10 74235 - 2.50 7445 - 70 74151 - 65 74267 - 80 7446 - 75 74153 - 65 74492 - 65 7447 - 75 75154 - 1.10 75492 - 1.05 8798 - 1.10 14 pin headers 3/61.00 16 pin headers \$4.60 MM5387AA \$5.95 MM5314 \$4.75 NO. 30 WIRE WRAP WIRE SINGLE STRAND \$1.40 ALCO MINIATURE TOGGLE SWITCHES MTA 106 SPST \$1.05 MTA 206 DPDT \$1.70 MTA 206 DPDT CENTER OFF \$1.85 MSD 206 P DPDT CENTER OFF LEVER SWITCH \$1.85	Full Wave Bridges <table border="1"> <tr> <th>PRV</th> <th>2A</th> <th>6A</th> <th>25A</th> </tr> <tr> <td>100</td> <td>.80</td> <td>1.40</td> <td>1.40</td> </tr> <tr> <td>200</td> <td>.80</td> <td>1.30</td> <td>2.20</td> </tr> <tr> <td>400</td> <td>1.00</td> <td>1.65</td> <td>3.30</td> </tr> <tr> <td>600</td> <td>1.30</td> <td>1.90</td> <td>4.40</td> </tr> </table> DIP SOCKETS 8 PIN 17 14 PIN 20 16 PIN 22 28 PIN 40 40 PIN 60 SANKEN AUDIO POWER AMPS SI 100 G 10 WATTS \$ 7.50 SI 102 G 20 WATTS \$13.75 SI 105 G 50 WATTS \$26.90 22UF35 V 5/61.00 47UF35 V 5/61.00 68UF35 V 5/61.00 1UF 35V 5/61.00 2.2UF20V 5/61.00 3.3UF20V 4/61.00 4.7UF15V 5/61.00 6.8UF35V 4/61.00 22UF25V \$.40 30UF6V 5/61.00 33UF20V \$.60 100UF15V \$.70 150UF15V \$.95	PRV	2A	6A	25A	100	.80	1.40	1.40	200	.80	1.30	2.20	400	1.00	1.65	3.30	600	1.30	1.90	4.40
PRV	1A	3A	12A	50A	125A	240A																																																																		
100	.06	.14	.35	.90	3.70	5.00																																																																		
200	.07	.20	.40	1.30	4.25	6.50																																																																		
400	.09	.25	.65	1.50	6.50	9.60																																																																		
600	.11	.30	.80	2.00	8.50	12.50																																																																		
800	.15	.35	1.00	2.50	10.50	16.50																																																																		
1000	.20	.45	1.25	3.00	12.50	20.00																																																																		
PRV	2A	6A	25A																																																																					
100	.80	1.40	1.40																																																																					
200	.80	1.30	2.20																																																																					
400	1.00	1.65	3.30																																																																					
600	1.30	1.90	4.40																																																																					

Terms: FOB Cambridge, Mass. Send Check or Money Order. Inclusive Postage, Minimum Telephone, C.O.D. Purchase Order or Charge \$20.00. Minimum Mail Order \$5.00.

Send \$5 for our catalog featuring Transistors and Rectifiers 145 Hampshire St., Cambridge, Mass.

SOLID STATE SALES

P.O. BOX 748
SOMERIDGE, MASS. 02143 TEL. (617) 547-7053

WE SHIP OVER 95% OF OUR ORDERS THE DAY WE RECEIVE THEM

DELTA IS READY . . .

WITH SYSTEMS AND SOFTWARE!

. . . Feel Free to Mix and Match

SYSTEM 1



Twin Mini W/32K

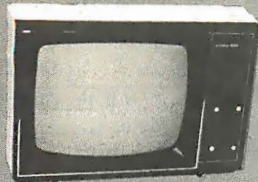

Leadex Monitor



Keyboard

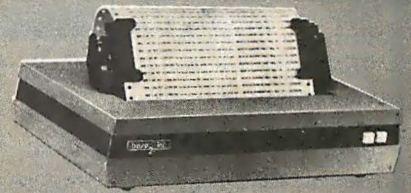

Base 2

SYSTEM 2

MULTIUSER CAPABLE



32K S-100 Mainframe



T/V 912 Terminal

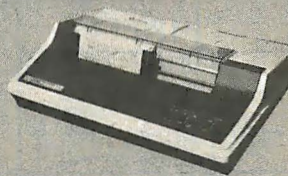

TI 810

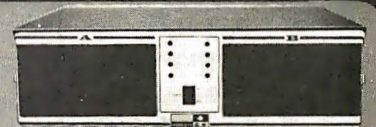

1 Megabyte
Double Density Storage

SYSTEM 3

MULTIUSER CAPABLE



64K S-100 Mainframe



T/V 920 Terminal



Diablo 1620

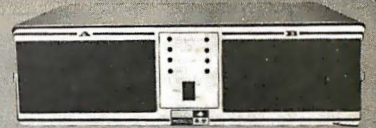

2 Megabyte
Quad Density Storage

SYSTEM 4

MULTIUSER

† (Dealers Only)



Desk Enclosure

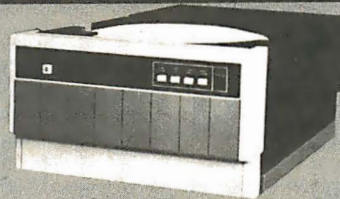

32 Megabyte Disk



AT&T Model 300

Software:

CPM 1.4	\$115.00
CPM 2.0	\$150.00
MPM MULTI-USER	\$350.00

CBASIC	\$115.00
MBASIC	\$300.00
FORTRAN	\$395.00
COBAL	\$625.00
PASCAL	\$265.00

WORDSTAR	\$495.00
ACCTS. PAYABLE	\$699.00
ACCTS. RECEIVABLE	\$699.00
GENERAL LEDGER	\$899.00
SUPERSORT	\$225.00

DATABASE	\$150.00
INVENTORY	\$440.00
QSORT	\$ 95.00
NAD	\$ 79.00
LETTERRIGHT	\$180.00

West:

DELTA PRODUCTS
15392 Assembly Lane
Unit A, Huntington Beach
Calif. 92649
Tel: (714) 898-1492
Circle 257 on inquiry card.



Telex: 182-126 DELTMAR SGHL

East:

DELTA PRODUCTS
1254 South Cedar Road
New Lenox, Illinois 60451
Tel: (815) 485-9072

DIGITAL MULTIMETERS Sinclair PDM35 Hickok LX303 Reg. \$69.95 \$49.95 Reg. \$89.95 \$69.50 	MURAPHONE Cordless Telephone System Reg. \$89.95 \$74.95 	Portable VOM Multitester Model VM520 Reg. \$19.95 20 KΩ VDC = 10 KΩ VAC 	100 MHz 8-Digit Counter Model MAX100 Reg. \$150.00 20 Hz to 100 MHz range LED display Fully automatic \$127.50 	6" x 9" 3-Way Speaker 20 oz. ceramic magnet Model BP2000-69TR \$14.95 ea.
3 1/2-Digit Portable DMM Model 2800 Beckman TECH310 \$130. 	GTE Flip-Phone \$37.95 	HICKOK Digital CB In-Line Tester Model 388 Reg. \$399.00 \$169.95 	Logic Monitor Model LM-1 Reg. \$349.95 \$59.95 Automatically displays static and dynamic logic Works with DTL, HTL, TTL, and CMOS 16 LED display 	CODE-A-PHONE Telephone Answering Model 1500 \$249.95 Call Control Reg. \$349.95 Model 1400 \$199.95
Portable Oscilloscopes 15 MHz Dual Trace Triggered Miniscope Model MS-15 Reg. \$435.00 \$369.95 	Function Generator Model 2001 Reg. \$185.95 \$157.95 Sine-, square-, triangle- and separate TTL square wave output Frequency range: 1Hz-100KHz 	Attache Style Tool Case Model TC100/ST Reg. \$471 \$279.95 	Weller Xcelite Meter Model 820 Measures capacitance from 0.1pF to 1 Farad Resolves to 0.1pF 10 ranges for accuracy and resolution 4 digit easy-to-read LED display 0.5% accuracy \$29.95 	FREE 8 pc. Tool Set (value \$14.95) with \$200.00 purchase from this ad.
15 MHz Triggered Miniscope Model MS-15 Reg. \$319.00 \$269.95 	Service Master Tool Kit Model 99-SM Reg. \$69.95 \$47.50 	Weller Xcelite Proto Board with Built-in Power Supplies Model PB-104 Fully assembled breadboard contains four QT-59S sockets, seven QT-59B bus strips and four 5-way binding posts Reg. \$154.95 \$129.95 	3 1/2-Digit 0.1% Digital Capacitance Meter Model 3001 9 ranges from 1999 pF to 199.9 μF 0.1% of reading accuracy Reg. \$190.00 \$170 	Miniature High Fidelity 3-Way Stereo Speakers Model HF-9 Reg. \$149.95 \$69.50 PR
Logic Probe Model LP-1 Compact circuit powered Detects pulses as short as 50 μsec DTL/TTL/HTL/CMOS compatibility \$44.95 	RC Circuit Box 36 resistors (15 Ω to 10 MΩ) 18 capacitors (100 pF to 0.22 μF) Reg. \$49.95 \$42. Includes test leads VIZ Model WC 412A 	30 MHz Dual Trace Triggered Miniscope Model MS-230 Reg. \$559.00 \$479.95 	DIGITAL MULTIMETER Simpson 461 Complete with nickel-cadmium batteries, AC charger/adaptor, test leads \$149.95 	In-Dash Car Stereos 8-Track Tape Player with AM/FM/MPX Radio Model C-777 \$52.50
RC Circuit Box 36 resistors (15 Ω to 10 MΩ) 18 capacitors (100 pF to 0.22 μF) Reg. \$49.95 \$42. Includes test leads VIZ Model WC 412A 	Magnifier Lamp Precision ground and polished magnification lens Model MG10A \$49.95 	30 MHz LEADER Dual Trace with Delay Line Model L80-520 Reg. \$77.50 \$89.95 	BSR X-10 Remote Control for Lights & Appliances 4 Pc Standard Starter Kit Console • Two (2) Lamp Modules • One (1) Appliance Reg. \$87.95 \$79.50 5 Pc Ultrasonic Starter Kit Console • One (1) Hand Held Remote Unit • Two (2) Lamp Modules • One (1) Appliance Unit Reg. \$112.95 \$99.95 Lamp Modules \$14.50 Standard Command Console \$36.00 Appliance Modules \$14.50 Ultrasonic Command Console \$59.95 Wall Switch Modules \$14.50 with Hand Held Remote 	Cassette Tape Player with AM/FM/MPX Radio Model CAS-888 \$57.50
Chess Challenger 7 Reg. \$110.00 \$79.95 Model BBC 	Weller Controlled Output Soldering Station Model WTCPN Reg. \$77.50 \$49.95 	Portable Frequency Counter Model 1827 Reg. \$130.00 \$65. 	Stereo Power Booster Model POW-40 40W stereo \$24.95 	FORDHAM 855 Conklin St. Farmingdale, N.Y. 11735 ADD FOR SHIPPING AND INSURANCE \$ 250.00 \$ 5.00 \$251.00 to 500.00 5.00 \$501.00 to 750.00 7.50 \$751.00 to 1000.00 10.00 over 1000.00 12.50 COD's extra TOLL FREE (800) 645-9518 in N.Y. State call (516) 752-0050

Dual Trace Oscilloscope
HITACHI 30 MHz

- TV sync-separator circuit
- High-sensitivity 1mV/div (5MHz)
- 5weep-time magnifier (10 times)
- Z-axis input (Intensity modulation)
- Signal delay line
- X-Y operation
- Trace Rotation

\$945.00

More sensitive to your input

SD Systems KITS

27001	ExpandRAM Kit - Expandable RAM Board Kit (No RAMs)	\$220
27002	Versat floppy Flexible Disk Drive Controller Kit	250
27003	SBC-100 Single Board Computer Kit	295
27004	Z80 Starter Kit	340
27007	ExpandEPROM Kit	175
27010	Add-on RAM (16K Devices) 4118 (250ns)(package of eight devices)	165
27011	VDB-8024 Video Display Board Kit	370
27012	ExpandRAM II Expandable RAM Board Kit (16K RAM)	460
27013	Versat floppy II Flexible Disk Drive Controller Kit	350
27014	PROM-100 PROM Programmer Board Kit	200
27015	MPB-100 Z80 Central Processing Unit Board Kit	250
27017	Add-on RAM (8K Devices) 4118 (200ns)	250
27018	SBC-200 Single Board Computer Kit	320
27024	ExpandRAM II Expandable RAM Board Kit (No RAMs)	230

SD Systems ASSEMBLED

38001	ExpandRAM (16K on-board RAM)	\$ 480
38002	ExpandRAM (32K on-board RAM)	620
38003	ExpandRAM (48K on-board RAM)	760
38004	ExpandRAM (84K on-board RAM)	900
38005	Versat floppy Flexible Disk Drive Controller	335
38006	SBC-100 Single Board Computer	350
38007	Z80 Starter System	450
38010	ExpandEPROM	245
38011	Cable for 8" Disk Drives	80
38013	VDB-8024 Video Display Board	470
38016	Cable, 6ft., 28 Pin Edge Connector (see mod)	50
38017	Cable for SD-100/SD-200 to Radio Shack Instruments 810 Printer	80
38018	Cable, same as above (Internal)	120
38019	Cable, same as above (External)	80
38020	ExpandRAM II (16K Population)	610
38021	ExpandRAM II (32K Population)	840
38022	ExpandRAM II (48K Population)	1070
38023	ExpandRAM II (84K Population)	1300
38024	Versat floppy II Double Density Flexible Disk Drive Controller	430
38025	PROM-100 PROM Programmer	265
38026	MPB-100 Z80 Microprocessor Board	325
38028	SBC-200 Single Board Computer	400

NEW HICKOK LX 304

DIGITAL MULTIMETER

Compact Accurate Dependable

\$89.95

Universal Oscilloscope Probe

\$36.00

SWITCHABLE X1 and X10 ATTENUATION FACTOR

KEY ADDITIONAL FEATURES:

- 100 MHz bandwidth
- Heavy duty tip
- Break resistant center conductor
- Slender, flexible cable
- 6 ft. length
- Wide compensation range
- Fits all scopes
- Ground reference can be activated at tip
- Includes SPRUNG HOOK, I.C. TIP, BNC ADAPTOR, INSULATING TIP and TRIMMER TOOL accessories

Function Generator XR-2206KB KIT

\$19.95

MICRO-PROCESSOR 8080A \$5.95

POWER SUPPLY 5 Volt 3 Amp

APS 5-3

1-9 \$37.25
 10 up \$35.55
 25 up \$34.05

Two Color Light Emitting Diode ED95

Red-Orange and Green

Color mixing possible due to separate anode terminals.

ONLY \$1.60

Flasher LED FRL-4403

Red LED and Flasher IC chip **92¢ ea.** in One Package

EPROM 2708 \$10.50

EPROM (5 Volt) 2716 \$29.90

Vacuum Vise

Vacuum based light duty vise for precision handling of small components and assemblies. Rugged ABS construction. 1 1/2 in. wide jaws, 1 1/4 in. travel for maximum versatility. Also features screw legs for permanent installation.

VV-1 \$3.49

★ 15% DISCOUNT COUPON ★

Bring this COUPON into one of our stores or mail to our Mail Order address shown below and receive a **15% DISCOUNT** on purchases from this Ad of \$100.00 or more.

Offer EXPIRES on June 31, 1980

NAME.....
 ADDRESS.....
 CITY..... STATE.....
 ZIP..... PHONE NO.....

Coupons accepted only with full name and address filled in.

ANCORNA

Send check or Money Order to: P.O. Box 22087, Culver City CA 90230. California residents add 6% sales tax. Minimum Order: \$10.00. Add \$1.00 to cover postage and handling. Master Charge and Visa welcomed. Please include your charge card number, Interbank number and expiration date. **PHONE ORDERS: (213) 641-4064**

MAIL ORDER P.O. Box 22087 Culver City, CA 90230 (213) 641-4064	PORTLAND 1125 N.E. 82nd Ave. Portland, OR 97220 (503) 254-5541	SANTA ANA 1300 E. Edinger Ave. Santa Ana, CA 92705 (714) 547-8424	CULVER CITY 11080 Jefferson Blvd. Culver City, CA 90230 (213) 390-3595
TUCSON 4518 E. Broadway Tucson, AZ 85711 (602) 881-2348	HOUSTON 2649 Richmond Houston, TX 77098 (713) 529-3489	ATLANTA 3330 Piedmont Rd. N.E. Atlanta, GA 30305 (404) 261-7100	SUNNYVALE 1054 E. El Camino Real Sunnyvale, CA 94087 (408) 243-4121

CIRCUIT BREAKER PRICE SLASHING

16K MEMORY UPGRADE KITS

for TRS-80*, Apple II, Sorcerer (specify)

\$59

PRINTERS

NEC Spinwriter

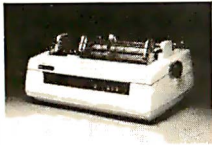

Letter Quality High Speed Printer

Includes TRS-80* interface software, quick change print fonts, 55 cps, bidirectional, high resolution plotting, graphing, proportional spacing

\$2998

With Tractor Feed **\$3198**

DIABLO 1650

Letter Quality High Speed Printer

Prints at 40 cps, using 88, 92 or 96 char. Metalized printwheels. Vertical resolution 1/48"; Horizontal 1/20". Capable of proportional spacing, bidirectional printing, and graphics under software control. Bidirectional normal and direct tabs. Left, right, top and bottom margins. Friction and tractor feed.

R.O. **\$2890**

KSR **\$3285**

779 CENTRONICS TRACTOR FEED PRINTER

Same as Radio Shack line printer

\$969

737 CENTRONICS FRICTION & PIN FEED PRINTER

Text quality matrix, proportional spacing

\$849

730 CENTRONICS FRICTION & PIN FEED PRINTER

7 x 7 matrix

\$639

P1 CENTRONICS PRINTER

Same as Radio Shack quick printer

\$339

PAPERTIGER (IP440)

Includes 2K buffer and graphics option

\$949

TI-810

Parallel and serial w/ TRS-80* interface software with upper and lower case and paper tray

\$1575

\$1665

OKIDATA Microline 80 Friction and pin feed

Tractor Feed, friction, and pin feed

\$795

\$920

EATON LRC 7000 + 64 columns, plain paper

\$349

LEEDEX MONITOR Video 100

\$135



DISK DRIVES

\$299

More capacity than Radio Shack 35 Track (80 K Bytes) drives. Fully assembled and tested. Ready to plug-in and run the moment you receive it. Can be intermixed with each other and Radio Shack drive on same cable. TRS-80* compatible silver enclosure.

90 DAY WARRANTY. ONE YEAR ON POWER SUPPLY.

FOR TRS-80*

CCI-100 5 1/4", 40 Track (102K Bytes) for Model I **\$299**

CCI-200 5 1/4", 77 Track (197K Bytes) for Model I **\$549**

CCI-800 8" Drive for Model II (1/2 Meg Bytes) **\$795**

For Zenith Z89

CCI-189 5 1/4", 40 Track (102K Bytes) add-on drive **\$394**

Z-87 Dual 5 1/4" add-on drive system **\$1095**

DISKETTES — Box of 10 (5 1/4") **\$24.95**

— 8" double density for Model II (Box of 10) **\$36.49**

DISK OPERATING SYSTEMS

PATCHPAK #4 by Percom Data **\$ 8.95**

NEWDOS Plus — with over 200 modifications 35 Track **\$ 89.00**

and corrections to TRS-DOS 40 Track **\$ 99.00**

CP/M for Model I, Zenith **\$145.00**

CP/M for Model II, Altos **\$170.00**

COMPLETE SYSTEMS

TRS-80* LEVEL II-16K with keypad **\$699**

TRS-80* Expansion Interface **\$249**

ZENITH Z89, 16K expands to 48K, all-in-one computer **\$1949**

ZENITH Z19 **\$740**

ATARI 400 \$524 ATARI 800 \$849

MATTEL INTELLIVISION **\$249**

TI 99/4 **\$979**

NORTH STAR  **Call for prices**

CAT MODEM Originate and answer same as **\$157.50**

Radio Shack Telephone Interface II

SOFTWARE FOR THE TRS-80*

SBSG

Free enhancements and upgrades to registered owners for the cost of media and mailing. 30-day free telephone support from vendor. User references supplied upon request. SBSG maintains a time-sharing computer where you can dial-up and leave your problems, 24 hours, 7 days a week.

KVP: Allows use of serial printer with TRS-80*. Lower case. Keyboard debounce. Direct entry of graphics and control characters from the keyboard. **\$29.95**

Fullly Interactive Accounting Package: Requires 2, 3, or 4 drives. Includes General Ledger, Accounts Payable, Accounts Receivable, and Payroll. Report generating. Well documented and fully tested by accountants. Complete Package: **\$389.00**

Individual Modules: **\$99**

AJP, AJR, G/L, Payroll for Model II

Individual Modules: **\$129**

Inventory II: Requires 2 or 3 drives. Handles up to 1000 items per disk drive. Reports include complete activity, inventory, listing, and minimum quantity search. **\$95.00**

Mailing List Name & Address II System: Requires 2 drives. Use with Electric Pencil files for automatic insertion of name, address and greetings in letters. Has ability to print envelopes. Menu driven. Includes enter, delete, update, search, extract, merge and print. Up to 1250 names per diskette. Will sort up to 600 names in 7 minutes. 40 page manual. Zip code sort is excellent for bulk mail applications. **\$99.00**

Intelligent Terminal System St-80 III: Enables a TRS-80* to act as a dial-up terminal on any standard time sharing network. Provides a TRS-80* with control key, ESC Key, Repeat Key, Rub Out Key, Break Key, full upper and lower case support, selectable printer output and program selectable transmission rates. **\$149.00**

Stock and Bond Portfolio Management System: Designed for the stock investor to track individual buys and sells of assets and to examine the total buy/sell portfolio with a minimum of time and effort. Supports up to 999 clients, 500 assets and 3,000 outstanding transactions. This system has the advantage of maintaining all open information on file by specific transaction. Both YTD Unit and \$ amount of purchase/sales are summarized for each client in the Client Master. Current total stock levels for each stock is available in the Asset Master. **\$189.00**

Client Billing System: Designed for CPA and law firms to track time and activities (or services) performed for clients. Supports up to 999 clients, 99 employees, 99 pre-coded activities and 3000 outstanding transactions. This system has the advantage of maintaining all information on file by specific transaction. Available information include personnel/expense reports for each client, YTD hours and \$ amount for clients, employees and activities, reports of employee in-house activities, and work-in-progress summaries. **\$299.00**

File Management System: For specialized storage needs. Sorts files in ascending or descending order on 3 separate fields. Scannable. Some applications have been fixed assets, phone numbers, names, slides, albums. Selectively totals numeric and dollar fields. Display and print capability. **\$49.00**

S & M SYSTEMS

INSEQ-80™ - Indexed Sequential Access Method (ISAM) for the TRS-80* Model I. Four machine language programs that can be called from your BASIC program via USR functions to access records either sequentially or randomly. The INSEQ-80 programs maintain all indexes and chains for you. Includes reorganization utility to consolidate files. **\$49.95.**

DIGITAL RESEARCH

MAC - 8080 Macro Assembler. Full Intel macro definitions. Pseudo Ops include RPC, IRP, REPT, TITLE, PAGE and MACLIB. Z80 library included. Produces intel absolute hex output plus symbols file for use by SID (see below). **\$120/\$15**

SID - 8080 Symbolic debugger. Full trace, pass count and break-point program testing system with backtrace and histogram utilities. When used with MAC, provides full symbolic display of memory labels and equated values. **\$105/\$15**

ZSID - As above for Z80. Requires Z80 CPU. **\$130/\$25**

TEX - Text formatter to create paginated, page-numbered and justified copy from source text files, directable to disk or printer. **\$105/\$15**

DESPOOL - Program to permit simultaneous printing of data from disk while user executes another program from the console. **\$80/\$5**

MICROSOFT Basic-80: Disk Extended BASIC, ANSI compatible with long variable names, WHILE/WEND, chaining, variable length file records. **\$300/\$25**

Basic Compiler: Language compatible with BASIC-80 and 3-10 times faster execution. Produces standard Microsoft relocatable binary output. Includes MACRO-80. Also linkable to FORTRAN-80 or COBOL-80 code modules. **\$350/\$25**

MICROPRO WORD-STAR: Menu driven visual word processing system for use with standard terminals. Text formatting performed on screen. Facilities for text paginate, page number, justify, center and underscore. User can print one document while simultaneously editing a second. Edit facilities include global search and replace. Read/Write to other text files, block move, etc. Requires CRT terminal with addressable cursor positioning. **\$445/\$40**

S & M SYSTEMS

Fullly Interactive Accounting Package: Includes General Ledger, Accounts Payable, Accounts Receivable, and Payroll. Individual Modules: **\$99/\$15**

Inventory: **\$125/\$20**

ACCESSORIES

HEAD CLEANING DISKETTE: Cleans drive head. Read/Write head in 30 seconds. Diskette absorbs loose oxide particles, fingerprints, and other foreign particles that might hinder the performance of the drive head. Lasts at least 3 months with daily use. Specify 5 1/4" or 8". **\$20 ea/\$45 for 3**

FLOPPY SAVER: Protection for center holes of 5 1/4" floppy disks. Only 1 needed per diskette. Kit contains centering post, pressure tool, tough 7-mil mylar reinforcing rings. Installation tools and rings for 25 diskettes. **\$14.95**

Re-orders of rings only: **\$7.95**

Send for FREE Catalogue

The CPU SHOP

TO ORDER CALL TOLL FREE 1-800-343-6522

Massachusetts residents call (617) 242-3361

For detailed technical information, call 617/242-3350

Hours: 10AM-6PM (EST) M-F (Sat. till 5)

*TRS-80 is a Tandy Corporation Trademark

5 Dexter Row, Dept. B6M
Charlestown, Massachusetts 02129

Massachusetts residents add
5% sales tax

Quantities on some items are limited



Precision Engineered Drives...

Power supply guaranteed for one year.

More Capacitance: Insures stable operation over greater line voltage variations (105-125 Vac.)

Scratch resistant steel cover: Primed and baked enamel finish. Virtually eliminates video interference. Color compatible with Radio Shack or Zenith Z89.

Increased ventilation for additional cooling: Top, side and bottom vents mean lower operating temperatures for longer life.

Switch designed with high current ratings (10 AMP)

Transformer designed as integral part of system for best line regulation. Not separately encased to avoid heat build-up providing longer life.

Designed to UL specifications. Wide operating temperature range (0°C to 50°C) Tested to 1500 volts input to output isolation for enhanced power surge protection.

Easy access to terminating resistor for easy field conversion from drive 0 to drive 1, 2, or 3.

Simpler, more reliable circuitry.

Extender: Easy plug-in access

3-wire grounded line cord for added operator safety.

With the number of disk drives on the market increasing, more and more people are beginning to ask what's underneath that cover.

The CCI™ series of disk drives have been designed for long life and ease of operation. The features shown above are what set our CCI drives apart from the rest. With a CCI drive you get an integrated professional design!

If you're still not convinced that you get the most for your money with a CCI drive, just ask for our complete specifications sheet. Then, compare our disk drives to anyone else's.

5 1/4" DRIVES

CCI-100 40 Track (102K Bytes) for TRS-80* Model I \$399.00
 CCI-189 40 Track (102K Bytes) for Zenith Z89 \$499.00
 CCI-200 77 Track (197K Bytes) for TRS-80* Model I \$675.00

8" DRIVES

CCI-800 77 Track (1/2 Meg Bytes) for TRS-80* Model II \$895.00
 All CCI drives are also available for 220 Vac (50Hz) operation.

Operating Systems

NEWDOS Plus for 5 1/4", 40 and 77 Track Drives—with over 200 modifications and corrections to TRSDOS \$110.00
 CP/M for Model I, Zenith \$150.00
 CP/M for Model II, Altos \$250.00

Software by S&M Systems

INSEQ-80™—Indexed Sequential Access Method (ISAM) for the TRS-80 Model I.

Four machine language programs that can be called from your BASIC program via USR functions to access records either sequentially or randomly. The INSEQ-80 programs maintain all indexes and chains for you. Includes reorganization utility to consolidate files. \$49.95

Professional Business Software using INSEQ-80 for the TRS-80* Model I and Zenith Z89.

Accounts Payable, Accounts Receivable, General Ledger, Payroll per package \$99.00
 Inventory per package \$125.00

ComputerCity™

TO ORDER CALL TOLL FREE 1-800-343-6522
 TWX: 710-248-1796
 Massachusetts residents call 617/242-3350

175 Main Street, Dept. B-6 Charlestown, MA 02129
 Hours: 10AM-6PM (EST) Mon.-Fri. (Sat. till 5).

For detailed technical information, call 617/242-3350.
 Freight Collect, F.O.B. Charlestown.
 *TRS-80 is a trademark of the Tandy Corporation

Products also available from: Radio Shack, NEC, Centronics, Paper Tiger, TI, Altos, MPI, Zenith, Mattell, ATARI, PET, OKIDATA, Apple, Eaton/LRC.

FRANCHISE AND DEALER (NATIONAL/INTERNATIONAL) INQUIRIES INVITED

Retail Stores: MA: Burlington, Charlestown, Framingham, Hanover NH: Manchester RI: Providence



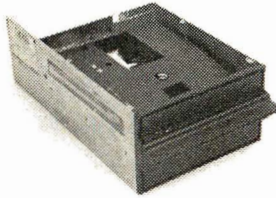

Qume Datatrak 8

Double sided floppy with NO HEADACHES. Although many think this an impossibility, seeing is believing, and this drive is really something! Shugart compatible, fully optioned, reliable, and rapidly becoming the standard in double-sided diskdom.

\$599. Two/\$549.

Cal Disk 142 M

A sleeper in the floppy drive industry: built like the proverbial tank and

chosen for use by Motorola and DEC, this drive features single/double density, write protect and much more. With Electrolabs' special cabling, it magically becomes Shugart compatible. . . . \$439 Two/\$419

The following 5 1/4" mini-floppies share most features with their 8" cousins, so without further ado...

Siemens FDD 100-5D. \$279.
Cal Disk Mini 279.
Qume Datatrak 5 (double sided). . . . 399.
BASF Mini mini 279.
SA 400 299.

All the above mini-floppies are fully SA400 compatible.

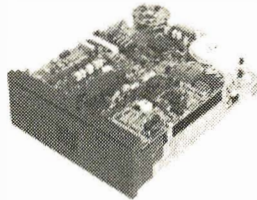

Disk Accessories

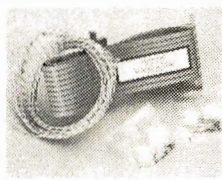
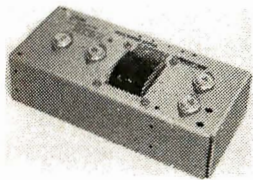

Cable kits for 8" drives with 10' 50 cond. flat cable, power cable, and all connectors. Assembled if desired. One drive 27.50, two 33.95, three 38.95 for mini floppies (34 cond): one 24.95, two, 29.95

CP-206 Power-one power supply. Powers two drives more than adequately, top quality. 2.8A/24V, 2.5A/5V, 5A/-5V. \$99.

Delta Products double density disk controller
Operate at 2 or 4MHZ, with 8 or 5" drives \$399
Micromation doubler w/programmable UART
RS-232 port \$495
Sorrento Valley single density for Apple \$399
Again, purchase price of manuals (\$5) is applicable towards future purchase price.

Subtract 15% OFF any Controller with Purchase of 2 Drives

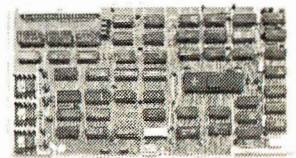

Electrolabs

POB 6721, Stanford, CA 94305

415-321-5601 800-227-8266

Telex: 345567 (Electrolab Pla)

Visa MC Am. Exp.

Tarbell floppy disk controller, A & T \$325
Tarbell floppy disk controller, A & T \$225
Tarbell double density, DMA A & T \$425
Tarbell double density, DMA, kit \$325

Hard Disk



CII HB 10 MBY fully REMOVEABLE cartridge drive. Complete with controller, personality card, media, power supply, cabling, connectors and documentation. Highlighted by stylish & modern cabinetry. \$6995.

Shugart SA4008 20MBY fixed disk system. S-100, includes controller, power supply, and all that is necessary to run \$6995.

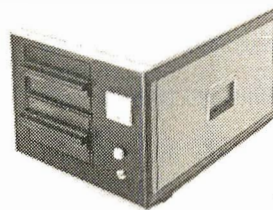

ENCLOSURES

Rackmount Mainframe MT-200. This gorgeous beast is so appealing that it can easily function also as stand-alone mainframe. Very modern styling with fully actively terminated S-100 bus. With two 8" single-sided disk drives. . . \$1899. With two 8" double sided disk drives in place of single-sided variety. \$2499.

Manuals for all drives are \$10, refundable against future purchase of drives. Also, all 8" drives can be ordered with 220 v/50 hz for world-wide use. Moving on to the realm of floppy disk controllers... although we still feel that single density is more reliable, there are many excellent double density disk controllers available, so choose your weapons carefully.

Desktop Mainframe MT-100. Contemporary styling, a handsome cabinet coated with durable epoxy finish colors (blue, beige, off-white & silver). Easy to fit into an office environment. The proper way to start your system.

Above plus two 8" single sided disk drives \$1599.
Above with two 8" double sided disk drives in place of single-sided variety \$2199.

Media



8"\$39.93/10 single-sided/single density
8"\$55.00 single sided/double density
8"\$55.00 double sided/single density
8"\$60.00 double sided
8"specify hard or soft
5 1/4"\$34.95 single sided
5 1/4"\$60.00 double sided
Verbatim, Memorex, Scotch, or equivalent name brand
Diskette head cleaning kit for 5 1/4" or 8" \$28.75 includes everything for 1 drive for 1 year. Alignment Diskette for Floppy Drives \$39.00

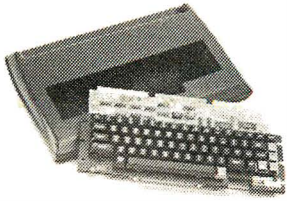

Keyboard Special 1 !!

CHERRY "PRO" Keyboard
..... \$119.00
Streamlined Custom Enclosure
..... 34.95
BOTH only \$134.95

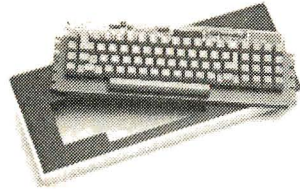

Keyboard Special 2 !!

Keytronics 1660 \$149.00
Hard Plastic enclosure 49.00
BOTH only \$152.00

June Bonanza!!

4116 dynamic RAM, 16K

Set of 8, 16K, for Apple, TRS-80, Exidy, Heath & more. 200 Ns, prime parts, at the unheard of \$49/8.

Large discounts available for quantity & dealers (500 & up). Offer limited while supply lasts, as these will vanish quickly!!!

Daisy Wheel Printers

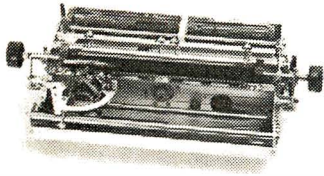

Qume Sprint 3\45

PRINTER (factory warr.) \$1499.
POWER SUPPLY (Borschert) 349.
(Shown mounted on rear of printer)
COMBINATION SPECIAL 1699.
Cases available 200.
S-100 interface card 149.
SPRINT 5/45 RO, RS-232
Complete, assembled, in case, plug-in &
print, hence, no muss & no fuss \$2699.
NEC Spinwriter \$2899,

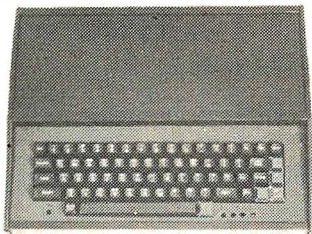

ESAT 200B

BI-LINGUAL 80x24 Communicating Terminal

Scrolling, full cursor, bell, 8x8 matrix, 110-19,200 baud, Dual Front Applications.
Arabic & Hebrew, Multilingual Data Entry
Forms Drawing, Music, & Switchyards.
Alone \$279.
with Cherry Pro keyboard &
custom metal case \$399.

Disk Subsystem

Matchmaker Technology TURNKEY DISK SUBSYSTEMS

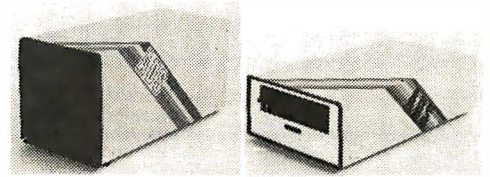

APPLE Single density disk controller. Expanded Apple DOS
TRS-80 Single or double density. Expansion interface necessary. Space for 48K dynamic RAM on controller card RS232 port
SORCERER .. Full RS-232 Interface. One S-100 slot for memory expansion. Single or double density
All above units come as follows: Complete, assembled and tested, with two 8" floppy disk drives (Apple available in one drive model). Includes all cabling, connectors and documentation in a stunning color coordinated cabinet with power supply. Ready to go, plug in and run!!!

When ordering specify single or double sided drives

Software available for above disk add-ons

TRS-80 & Sorcerer operate on all CP/M compatible software

Data Display Monitors

Please call us for particulars

Electrolabs

POB 6721, Stanford, CA 94305
415-321-5601 800-227-8266
Telex: 345567 (Electrolab Pla)
Visa MC Am. Exp.

Software

CP/M 1.4 \$ 99
CP/M 2.0 149
OS-1 (incl. 1st yr. update) .. 249
Spellbinder (Exc. secretarial type
word-processor) 350

Peripheral Sale!!

Hiplot Plotter	\$875.
Hipad Digitizer	715.
Televideo 912C	760.
Televideo 920C	860.
IDS 440 Paper tiger	899.
SD Expandoram II (A&T, 64K)	560.
Imsai 65K dynamic RAM III	399.
DC Hayes Micromodem 100 ..	399.
Super switcher power for hard disk & more	349.
CII HB 10 MBY	3300.
SA 4008	2799.
<hr/>	
C-Basic	99.
Fortran Compiler	100.
C Compiler	600.
Basic compiler	350.

NEW "UNIX-like" Operating System for Z-80

OS-1

OS-1 is truly a breakthrough in the micro world! OS-1 is NOT a "control program for micros" but is, instead a large, professional operating system designed to lower the cost and improve the quality of programming efforts. OS-1 provides a "friendly" human interface for both system programmers and users. Finally, with OS-1, the capability of a Z-80 system is vastly expanded.

OS-1 appears exactly like UNIX to the user, and includes virtual i/o, "set tty" and "login" commands, a shell, a hierarchical "tree" type file structure with 16Mby file size and an unlimited no. of files and devices. OS-1 allows the extremely useful "pipes" and "filters" to be implemented. OS-1 also provides for up to 1024 users and 64 groups and security for users, groups, files and devices. OS-1 occupies 12Kby and comes with a 4Kby "enhanced" cp/m adapter which runs ALL cp/m and most CDOS programs. Source code is supplied with adapter.

OS-1 (Including Debugger, "UNIX-type" editor, Linker-Loader & 1 Yr. update)

\$249

"C" Compiler (Whitesmiths') \$600

Microsoft Compiler Interface (Interfaces MS Fortran & Cobal compilers directly to OS-1. This allows compiler output to "Command" OS-1 Routines. The Electrolabs' Software Group considers this interface indispensable. Contains over 100 separate routines) \$49

Manuals:

(price applies to OS-1 purchase)

Introduction to OS-1 (60pg)	\$15
OS-1 Users' Guide (150pg)	\$35
Sys-Gen Manual for OS-1 (40pg)	\$10
SET	\$45

California Digital

Post Office Box 3097 B • Torrance, California 90503

FREE Paper Tiger



With Purchase of The INTEGRAL DATA 440

Your Choice, \$200 Value

- 1) Graphics Option Package
 - 2) Interface for APPLE II
 - 3) TRS-80 Printer Interface
- California Digital has recently researched the complete low cost printer market. It is our opinion that the IDS 440 Paper Tiger is, without doubt, the most versatile and offers the best value of any printer costing under \$1,000.

This quality dot matrix printer incorporates such features as software selectable character size to allow print densities upto 132 characters per line. Full forms handling capabilities and tractor feed mechanism adjustable to 9.5". The Paper Tiger is engineered to accept either parallel or RS232 serial ASC11. 110/220V.50/60Hz.

***** \$95.00 plus shipping *****

S-100 Mother Board

Quiet™ Buss

\$2995
8803-18
18 slot
MSAI

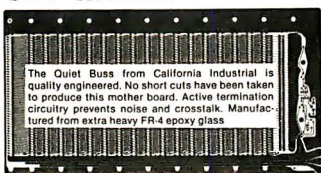

The Quiet Buss from California Industrial is quality engineered. No short cuts have been taken to produce this mother board. Active termination circuitry prevents noise and crosstalk. Manufactured from extra heavy FR-4 epoxy glass

\$149



MOTOROLA

New factory surplus. M3000/3211 Motorola CRT monitors. 20 MHz bandwidth Electronics terminate into single ten pin (.156") edge connector. Requires DC power supply

TELETYPE MODEL 43

4320 KEYBOARD

TTL AAA \$1050
RS232.... AAK 1150
Friction... AAE 1100
183 Modem AAB 1575



FREE PLASTIC LIBRARY CASE with purchase of each box of Memorex mini-diskettes. \$5 value.

\$24.95

BOX of 10 DISKETTES

HARD TO FIND 74LS

Not cheap... But available examples

00	.39	123	1.29	161	1.79
02	.49	125	.69	163	2.19
04	.39	138	1.79	174	1.49
08	.39	139	1.39	175	1.09
74	1.49	148	240	1.95
75	.89	151	.89	244	1.95
06	.95	153	.89	245
90	.95	157	.89	387	.95

Minimum purchase 100 each

Edge Connectors



GOLD 100 PIN MSAI/ALTAIR
Imsal solder .125x.250 \$2.95 3/\$ 7.50
Imsal w/w .125centers \$4.95 3/\$413.00
Altair solder tail.140row \$5.95 3/\$415.00

SPECIALS
22/44 Km eyelet.156" \$1.95 3/\$ 45.00
25/50 solder tab .156" \$1.09 3/\$ 42.00
36/72 wide post w/w.156 \$1.95 3/\$ 45.00

COMPUTERS

Apple II 128K/16K	1988
Apple Plus 75K	988
Atari 800	430
Atari 800	850
Texas Instruments 99/4	895
Northern Quest 32k Horiz.	2995
Vector M2	1395
Compucon II Model 3	1395
Rockwell Alm 65(1K)	375

CRT TERMINALS

ADDS Regent 25 (ten key pad)	850
ADDS Regent 40	1185
ADDS Regent 80	1450
Hazeltine 1420	850
Hazeltine 1500	995

MONITORS

Sanyo 9" black & white monitor	179
Leeds Video 100 12"	125
Leeds Video 100-80 12"	179

PRINTERS

HS404G Tiger with Graphics	5995
Printonix P-300 (300 1.25) 4900	988
Printonix P-600	1150
Teletype Model 43 (RS232)	1150
Teletype Model 40(122 col.)	895
NEC Spewriter 5510 R/O	2595
Texas Instrument 810	1850
Centronics 120 fraction	695
Centronics 179-2 tractor	995
Centronics 704	1950
Andes UP9000	885
Andes UP9500	885
Andes UP9501	885
Diablo 1540 R/O plastic wheel	2750
Diablo 1540 KSR plastic wheel	3150

MODEMS

Universal Data Systems I.P.300	179
Direct coupled V.F.C. Approved powered from phone line.	169
Novation Cat Acoustic	169

DISK DRIVES

Shugart SABOR 8" floppy	\$449
Shugart SABOR 8" hard disk	479
LoBo 2 Two Shugart 801's with power supply and enclosure	1195
One Shugart 801 with power supply and enclosure	795
LoBohard drive for Apple	3995
10 megabyte T11A	3995
LoBohard drive for TRS80	3995
LoBo 4084 5 1/4" for TRS80	398
Vista V-80 for TRS80 (40k) 388	388
Corvus Systems hard drive	885

APPLE COMPATIBLE PRODUCTS

Apple disk drive with controller	580
Apple drive without controller	495
Apple Parallel interface	179
Ten Key Data Pad for Apple	119
Mountain Hardware SuperTalk	279
Mountain / Intro X-10 for IBM 230	230
**** Microrex Special ****	27
8" soft sector diskette (10)	27
8" double density for TRS80	30

S-100 PRODUCTS

Goobot Back Enclosure	\$289
Goobot Desk Top Enclosure	329
Electronic Controls ECT 100F	250
Cal Digital 18 slot motherboard	30
S-100 BOARDS	
Think/Toys Switchboard I/O	219
Goobot Econorm Pro/ica	329
Mullin TP-2 Extnd. Altdig	49
Artec WW100 WireWrap Pro	25
SD 64k. Expandomem Memory	49
8 bit 5-100 BOARDS	
Cal. Digital CAL-86	650
Trenar 8086	650
Seattle Computers 8085	650
Goobot 8086/8085	650
Itasca InterSystems Z-8000	329
MICROELANCO J.S.	329
Cherry Pro ASCII Keyboard	129
Maxiwatch HEX Keyboard	49
UV Keuser 1141	65
Super Mod I.I.R. Modulator	30

Authorized Distributor

Scotch Data Products



740-0	IB M soft format.	10 Pak	\$30.00	\$3.50
740/2	D double side soft		65.00	6.00
741-0	Double density		53.00	1.90
743-0	D double/D double		70.00	6.60
740-32	8" Hard sector		39.00	3.50
744-(0)10(16)5 1/4" mini	Library case for any above:	Add \$3.00		
834 A	Data Cassette		5.50	
D C100	Mini Cartridge		16.00	
D C300	Data Cartridge		20.00	
920()	Disk Cartridge		39.30	

Shugart Associates

SA800-R Floppy Disk Drive

The most cost effective way to store data processing information, when random recall is a prime factor. The SA800 is fully compatible with the IBM 3740 format. Write protect circuitry, low maintenance & Shugart quality.

\$449.50

XEROX 800 WORD PROCESSING KEYBOARD ASCII ENCODED



This 77 key word processing keyboard was manufactured by Microswitch for use in the Xerox 800 word processing system. The keyboard outputs a seven bit ASCII code along with an eighth bit that allows most keys to shift and double function as special characters. Extra large "Tab & Return" keys are designed into the layout of the keyboard to emulate the IBM Selectric. 17 illuminated keys serve for special word processing codes. The keyboard is equipped with two thumbwheel switches for defining line width. Original Xerox acquisition over \$400.00. California Digital USED price only \$49.00. Excellent cond. Documentation included.

MEMORY

TRS-80 \$59
APPLE II 59
16k memory (8) 4116's



Installation is simple. Anyone who has ever changed a spark plug should be able to up-grade his microcomputer. How can California Digital offer these memory up-grade sets at 25% below our competition? Simple, we buy in volume, wholesale to dealers and sell the balance directly to owners of personal micro-systems. These 16K dynamic memory circuits are factory prime and unconditionally guaranteed for one full year. NOW, before you change your mind, pick up the telephone and order your up-grade memory from California Digital. Add \$3 for TRS80 jumpers.

STATIC	1-31	32-99	100-5C	-999	1K+
21L02 450nS.	1.19	.99	.95	.90	.85
21L02 250nS.	1.49	1.39	1.25	*	*
2114 1Kx4 450	5.95	5.50	5.25	4.75	4.50
2114 1Kx4 300	8.95	8.50	8.00	*	*
4044 4Kx1 450	5.95	5.50	5.25	*	*
4044 4Kx1 250	9.95	9.50	9.00	*	*
4045 1Kx4 450	8.95	8.50	8.00	*	*
4045 1Kx4 250	9.95	9.50	9.00	*	*
5257 low pow.	5.95	5.50	5.00	4.80	4.60

SPECIAL CIRCUITS

Z80A 4MHz.	24.95	AY5-1013A UART	4.95
8080A CPU	9.95	Floppy Disc Controllers	
8085	22.50	WD 1771 single D.	39.95
8086 Intel 16 bits	85.00	WD 1781 Double D	65.00
TMS9900 16 bits	49.95	WD 1791 D/D 3740	*

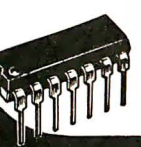

EPROMS	1-15	16-63	64+
1702A 2K	4.95	4.50	4.00
2708 8K	9.95	9.50	9.00
2716 5v16K	29.95	27.50	*
2716 T I	24.88	20.00	*
2532	85.00	*	*

MICROCOMPUTER POWER SUPPLY

This regulated supply is powered by an 8 Amp center-tapped industrial transformer. 36,000 MFD of filtering and dual pass transistor regulation make this power supply a must for any micro-computer workshop. Triple outputs. 5, 7.2, 6.5 Volt D.C.



\$29

direct connect MODEM Universal Data 103

Connects directly to the new modular phone jack. Fully powered from your existing telephone line. No need to locate external AC power. Crystal control prevents frequency drift. Direct connect feature eliminates loss of information due to carbon compression that is associated with acoustic modems. Runs circles around those other "Domesticated" modems.



\$169



PORTABLE DATA ENTRY SYSTEM

These used data terminals were originally designed for chain store inventory control and order entry systems. The operator enters the inventory control number, merchandise so hand and the unit price. After all pertinent data has been entered into the recorder, the main warehouse is telephoned, the handset is placed in the acoustic coupler and all the recorded information is transmitted back to the master computer. With a little imagination and one of these portable entry systems, you should be able to exchange programs and computer information with associates across the country. All units were removed from service in working condition. Original cost \$2,500. Each system comes complete with:

\$139.50

- Portable Cassette Drive Unit
- Removable Entry Keyboard with LED Display
- Five Gould "D" MCards
- Acoustical Coupler
- Battery Charger
- #1925 Cable
- Shoulder Strap
- Full Documentation



\$850

Regent 25

Through years of research the ADDS Corporation has evolved a low maintenance, extremely durable CRT terminal capable of withstanding an abusive 24 hour duty cycle. The Regent 25 features Intel 8085 microprocessor controlled circuitry along with the Cherry Switch long-life capacitance keyboard. 18 key cursor and numeric pad doubles to allow for user definable special functions. True descending lower case characters along with a fully addressable cursor make the Regent 25 the ideal word processing terminal. 18 key cursor and numeric pad doubles to allow for user definable special functions. True descending lower case characters along with a fully addressable cursor make the Regent 25 the ideal word processing terminal. High-resolution screen is capable of displaying 96 upper and lower case ASCII characters and 22 control codes. This terminal is switch selectable to display via European languages. At \$850 (plus shipping) the Regent 25 offers the best value in today's CRT terminals market. Additional stock upon request.

MINIATURE SWITCHES

your choice

\$.98 10 50 100 1k
\$.88 .81 .73 .66

SPDT Miniature Toggles

7101 CAK ON-NONE-ON
7107 jbt ON-OFF(mt. ON)
7108 CK ON-(moment ON)
7193 CK ON OFF ON
Rotary 3P-4-Pos.
Rotary 3P-6-Pos.
Push B (N.O.) \$.39ea. 4/\$1

DIP Switch

\$1.29 10 25 100 1k
\$1.19 .109 .97 .83

specify 4 for 8pos.

DISCOUNT Wire Wrap Center

IC SOCKETS

pin	Wire wrap ea.	low profile 25 50	25 50
8		17: 16 15	
14	37: 36 35	18 17 16	
16	38 37 36	19 18 17	
24	99 93 85	36 35 34	
40	169 155 139	63 60 58	

50ft. KYNAR WIRE WRAP \$98 \$500 1,000 11,000 \$9. \$15. \$105.

ON HOBBY WRAP-30 wire wrap & strip tool \$545

(213) 679-9001

All merchandise sold by California Digital is premium grade. Most orders shipped same day as received. Shipping: first five pounds \$2.00 \$.40 for each additional pound. Foreign orders add 10%. Access will be refunded. California Res. add 6%. Open accounts offered to Stat. supported educational institutions and companies with "Strong" Dunn & Bradstreet. COD's discouraged.

page

DEAL #1

Hobby Wire Wrap Starter Package



BW2630 WW Tool	\$19.95
BT30 #30 Bit	3.95
BC1 Batteries & Charger		14.95
*Kit #1 Wire Kit	9.95
Regular Price	\$48.80

\$39⁹⁵

*Kit #1 Contains 900 pcs. of precut wire in asst. sizes.

Choose from Red, Blue, White, Black, Green, Orange, Violet, Yellow, or assortment.

DEAL #2

Industrial Wire Wrap Starter Package



BW928BF WW Tool	\$52.95
BT30I #30 Bit & Sleeve	..	29.50
BC1 Batteries & Charger		14.95
*Kit #3 Wire Kit	32.95
Regular Price	...	\$130.35

\$119⁹⁵

*Kit #2 Contains 4000 pcs. of precut wire in asst. sizes.

Choose from Red, Blue, White, Black, Green, Orange, Violet, Yellow or assortment.

★ ★ BIG DEAL ★ ★

RN IC Sockets by the Tube

RN HIGH RELIABILITY eliminates trouble. "Sidewipe" contacts make 100% greater surface contact with the wide, flat sides of your IC leads for positive electrical connection.

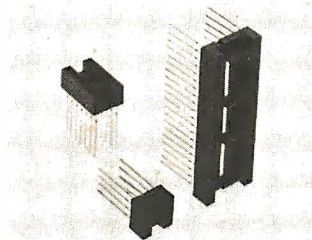

WIRE WRAP SOCKETS

Size	Quantity/Tube	Price ea.*	Price/Tube
08 pin	52	.39	\$20.28
14	30	.46	\$13.80
16	26	.50	\$13.00
3-level Gold			
Closed Entry	18	.23	\$15.64
Design	20	.21	\$17.85
	22	.18	\$16.56
	24	.17	\$15.95
	28	1.15	\$18.45
	40	1.60	\$16.00

*Sockets sold at these prices by the tube only.
Above prices include gold up to \$800/oz.

SOLDER TAIL

Low Profile Tin
Closed Entry
Design

1¢/pin
(over 5 tubes)

3/4¢/pin
(over 100 tubes)

*Sockets sold at these prices by the tube only.

See tube quantities above.

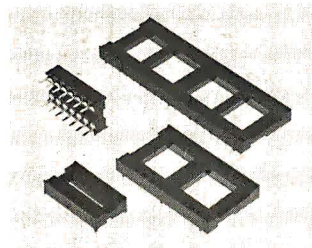
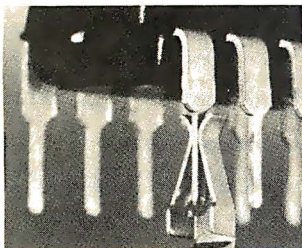

ORDERING INFORMATION

- Orders under \$25 include \$2 handling
- All prepaid orders shipped UPS Ppd.
- Visa, MC & COD's charged shipping
- All prices good through cover date
- Most orders shipped next day.

Limited to products Page Dittigal stocks. All discounts are off of list price.
Call or write for list prices.

- 10% off on all OK hobby products!**
- 10% off on all Bishop Graphics products!**
- 5% off on all Vector products!**

page

135 E. Chestnut Street 5A, Monrovia, California 91016 Phone (213) 357-5005

JADE. INFLATI FOR THE 80's.

OPENING BOUT

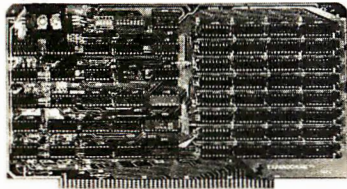

EXPANDORAM

Expandable to 64K Using 4116 RAMS

Interfaces with most popular S-100 boards
Bank selectable; PHANTOM provision
Draws only 5 watts fully populated
Designed to work with Z-80, 8080, and 8085 systems
No wait states required
16K boundaries & protect via dip switches
Kits come with sockets for full 64K
Invisible refresh

MEM-16130K (16K KIT)	\$199.95
MEM-16130A (16K A&T)	\$249.95
MEM-32131K (32K KIT)	\$254.95
MEM-32131A (32K A&T)	\$304.95
MEM-48132K (48K KIT)	\$309.95
MEM-48132A (48K A&T)	\$359.95
MEM-64133K (64K KIT)	\$364.95
MEM-64133A (64K A&T)	\$414.95

Sale Price \$475.00

32K STATIC RAM

Expandable 8K/32K, 2/4MHz, KIT/A&T

Switchable 2 or 4 MHz

THE JADE BIG Z

Z-80A CPU with Serial I/O Port

This CPU can accommodate a 2708, 2716, or 2732 EPROM in SHADOW mode, allowing you to use a full 64K of RAM. The MWRITE signal is generated automatically if you use the board without a front panel. There's also an independent on-board USART to control the RS232 serial port at baud rates from 75 to 19,200.

We've sold thousands of these high quality S-100 CPU boards at \$159.95; but now, in a brief fit of financial insanity, we're offering them to you for only \$135.00! Don't pass this one up!

CPU-30201K (KIT)	\$135.00
CPU-30201A (A&T)	\$199.00
CPU-30200B (BARE BOARD)	\$ 35.00

S D Systems

EXPANDORAM II

4 MHz RAM Board Expandable to 256K

S-100 bus compatible, up to 4 MHz operation
Expandable memory from 16K to 256K
Dip switch selectable boundaries
Page-mode allows up to 8 boards on the same bus
Invisible refresh; PHANTOM output disable
Designed to operate in Z-80 based systems

MEM-16630K (16K KIT)	\$279.95
MEM-16630A (16K A&T)	\$329.95
MEM-32631K (32K KIT)	\$349.95
MEM-32631A (32K A&T)	\$399.95
MEM-48632K (48K KIT)	\$419.95
MEM-48632A (48K A&T)	\$469.95
MEM-64633K (64K KIT)	\$489.95
MEM-64633A (64K A&T)	\$539.95

Circle 267 on inquiry card.

Solid State Music

PB-1

EPROM Programmer for 2708 or 2716

MEM-99510K (KIT)	\$125.00
MEM-99510A (A&T)	\$175.00

JADE DOUBLE-D

Double Density Disk Controller

Read/write single or double density, 8" or 5 1/4" drives
On board Z-80 insures reliable operation
CP/M compatible in either single or double density
Density is software selectable
Up to 4 single or double sided, single or double density drives may be mixed on the same system
EIA level serial printer interface on board-up to 9600 baud (perfect for despooling operations)
All the hard work of disk access is done by the on board Z-80A and 2K memory, leaving your host CPU free for its normal duties
Uses IBM standard formats for proven reliability
THIS BOARD REALLY WORKS!!!!
IOD-1200K (DOUBLE-D KIT)

IOD-1200K (DOUBLE-D KIT)	\$295.00
IOD-1200A (DOUBLE-D A&T)	\$395.00
IOD-1200D (MANUAL ONLY)	\$ 15.00

Televideo

SMARTER TERMINAL

Lower Price, More Features

TELEVIDEO MODEL 912

Microprocessor controlled, 7 x 10 upper and lower case characters, underlining, reverse video, dual intensity, blinking fields, protected fields, self test, block and conversation modes, auxiliary RS-232 port, all standard baud rates from 75 to 9600 baud, 10 key numeric pad, 115/230 VAC, 50/60 Hz, nationwide field service through General Electric Corporation.

912B (TTY KEYBOARD)	\$825.00
912C (TYPEWRITER KEYBOARD)	\$875.00

TELEVIDEO MODEL 920

All the features of the 912 plus 11 special function keys, 6 editing keys, 2 transmission keys, making the 920 a perfect mate to a word processing or business computer.

920B (TTY KEYBOARD)	\$895.00
920C (TYPEWRITER KEYBOARD)	\$995.00

JADE

Memory Expansion Kits TRS-80 APPLE EXIDY

Everything you need to add 16K of memory to your computer. Your kit comes neatly packaged with easy to follow instructions. In just minutes your computer is ready to tackle more advanced software.

\$59.95

JADE DISKETTES Magnificent Magnetic Media™

5 1/4" single sided, single density, box of 10	
MMD-5110103 (SOFT SECTOR)	\$29.95
MMD-5111003 (10 SECTOR)	\$29.95
MMD-5111603 (16 SECTOR)	\$29.95
5 1/4" double sided, double density, box of 10	
MMD-5220103 (SOFT SECTOR)	\$39.95
8" single sided, single density, box of 10	
MMD-8110103 (SOFT SECTOR)	\$34.95
8" single sided, double density, box of 10	
MMD-8120103 (SOFT SECTOR)	\$55.95
8" double sided, double density, box of 10	
MMD-8220103 (SOFT SECTOR)	\$57.95

S D Systems

VERSAFLOPPY

Versatile Floppy Disk Controller

IBM 3740 soft sectored format
S-100 Z-80 or 8080 compatible
Controls up to 4 single or double sided drives
Compatible with all popular disk drives
CP/M compatible
Listings for control software included
IOD-1150K (KIT)

IOD-1150K (KIT)	\$239.00
IOD-1150A (A&T)	\$289.00

S D Systems

Z-80 STARTER

Complete Z-80 Microcomputer

On-board keyboard, display, EPROM programmer, cassette interface and S-100 interface
Wire-wrap area and room for 2 S-100 connectors
Two 8-bit parallel I/O ports, 4 channel CTC, 5 programmable breakpoints
Examine & change memory, I/O ports, or register
CPS-30010K (KIT)

CPS-30010K (KIT)	\$299.95
CPS-30010A (A&T)	\$369.95

TITLE MATCH

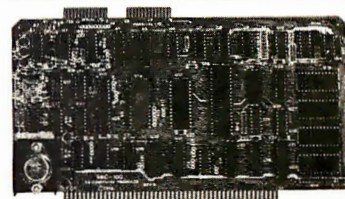

S D Systems

SBC-100/200

2 or 4 MHz Single Board Computer

S-100 bus compatible Z-80 CPU
1K of on-board RAM
4 EPROM sockets accommodate 2708, 2716, or 2732
One parallel and one serial I/O port
4-channel counter timer chip (Z-80 CTC)
Software programmable serial baud rates
CPC-30100K (2 MHz KIT)

CPC-30100K (2 MHz KIT)	\$259.95
CPC-30100A (2 MHz A&T)	\$309.95
CPC-30200K (4 MHz KIT)	\$289.95
CPC-30200A (4 MHz A&T)	\$339.95

Coming Soon

NEW JADE P/S I/O

Parallel Serial Interrupt Board

Z-80 SIO, PIO, 2 CTCs, expands to 2 SIOs, 4 CTCs
4 serial ports (async, sync, bisync, SDLC/HDLC)
2 parallel ports with full handshake
Software baud rate generators, interval timers, counters, and generates 32 vectored interrupts
Designed especially for MP/M multi-user multi-tasking operating systems. For use with Z-80 only
IOI-1045B (BARE BOARD)

IOI-1045B (BARE BOARD)	\$ 59.95
IOI-1045K (KIT)	\$199.95
IOI-1045A (A&T)	\$279.95

Solid State Music

I/O-4

2 Serial & 2 Parallel I/O Ports

IOI-1010K (KIT)	\$149.95
IOI-1010A (A&T)	\$199.95

ON FIGHTER ROUND #3.



Special Package Price

RS-232 SET
 1 Male DB-25,
 1 Female DB-25,
 1 Cover
\$6.50

Jade's New
Motherboards
ISO-BUS

Silent, Simple and On Sale!

6 SLOT	
BB	\$ 19.95
KIT	\$ 39.95
A&T	\$ 49.95
12 SLOT	
BB	\$ 29.95
KIT	\$ 69.95
A&T	\$ 89.95
18 SLOT	
BB	\$ 49.95
KIT	\$ 99.95
A&T	\$139.95

PLACE ORDERS
TOLL FREE

Inside California Continental U.S.
 800-262-1710 800-421-5500

For customer service
 or technical inquiries call 213-973-7707

Write for our **FREE** 1980 catalog

JADE
COMPUTER PRODUCTS
 4901 W. Rosecrans, Hawthorne, CA 90250

TERMS OF SALE: Cash, checks, credit cards money orders or from recognized institutions. Purchase orders accepted. Minimum order \$10.00. California residents add 6% sales tax. Minimum shipping and handling charge \$2.50. Prices are for U.S. and Canadian delivery only and are subject to change without notice. For export prices and information send for a **JADE INTERNATIONAL CATALOG**.



Circle 267 on inquiry card.

S D Systems

VERSAFLOPPY II

Double Density Disk Controller

Single or double density floppy disk controller
 985600 bytes on 8" double sided diskettes
 259840 bytes on double sided 5 1/4" diskettes
 S-100 bus (IEEE) standard compatible
 IBM 3740 format in single density
 8" and 5 1/4" drives controlled simultaneously
 Operates with Z-80, 8080, and 8085 CPU's
 Controls up to 4 drives
 Vectored interrupt operation optional
IOD -1160K KIT \$299.95
IOD -1160A A&T \$349.95

TKO CHAMPS

Special Package Price

ROCKWELL AIM-65

The Head-Start in Microcomputers

KIM-1 compatible
 On-board printer
 Full ACSII keyboard
 AIM-65 w/1K RAM. \$395.00
 AIM-65 w/4K RAM. \$439.95
 8K BASIC ROM. \$100.00
 POWER SUPPLY. \$59.95
 CASE for AIM-65. \$49.95
 4K Assembler/Editor. \$85.00
Special Package Price \$599.00
 4K AIM-65, 8K BASIC ROM, Power Supply, and Case.



Lobo Drives

DUAL DISK SPECIAL

Double Density, Single or Double Sided
 Two double density certified 8" Shugart disk drives mounted in an attractive metal enclosure.
MSF-12800R (SINGLE SIDED) \$ 995.00
MSF-125202 (DOUBLE SIDED) \$1495.00

We Think It's Superior

SDOS

A New Disk Operating System

SDOS is a disk operating system which will run any program that runs under CP/M*. It is designed specifically for use with the SBC-100/Versafloppy (I or II) board set by S.D. Systems. SDOS actually has more functions than CP/M, including file attributes, disk label, and read/write logical blocks. It provides additional protection features and is expandable to a multi-user realtime system. And if all that doesn't impress you, SDOS also contains S.D.'s ASSEMBLER/EDITOR/LINKER package and CBASIC 2!
SFX-55001002M (5 1/4" W/MAN) \$150.00
SFX-55001006F (8" W/MAN) \$150.00
SFX-55001000D (MANUAL ONLY) \$ 15.00
 *CP/M is a trademark of Digital Research

Textool

ZIP* DIP II SOCKETS



16 PIN ZIP* DIP II	\$ 5.50
24 PIN ZIP* DIP II	\$ 7.50
40 PIN ZIP* DIP II	\$ 10.25

* ZERO INSERTION PRESSURE

RAMS	
21L02 (2 MHz) ...	\$ 1.25
21L02 (4 MHz) ...	\$ 1.50
2114L (2 MHz) ...	\$ 5.75
2114L (4 MHz) ...	\$ 5.95
4116	\$ 8.95
4127 (70ns)	\$ 39.95
4164 (64K x 1)	\$175.00
5257 (2 MHz)	\$ 6.75
5257 (4 MHz)	\$ 7.25

SUPPORT DEVICES	
8212	\$ 4.95
8214	\$ 4.65
8216	\$ 2.95
8224	\$ 3.25
8224-4	\$10.95
8226	\$ 3.85
8228	\$ 4.95
8238	\$ 4.95
8243	\$ 8.00
8250	\$14.95
8251	\$ 6.50
8253	\$13.95
8255	\$ 6.50
8257	\$19.95
8259	\$17.95
8275	\$49.95
8279	\$15.95

Z80 SUPPORT	
3881 (PIO)	\$ 9.50
3881-4	
(PIO-4 MHz)	\$14.50
3882 (CTC)	\$ 9.50
3882-4	
(CTC-4MHz)	\$14.95
3883 (SIO)	\$29.50
3884 (SIO)	\$49.50

BAUD RATE GENERATORS	
MC14411	\$10.00
CRYSTAL	\$ 4.95
UARTS	
AY5-1013A	\$5.25
AY3-1014A	\$8.25
TR1602B	\$5.25
TMS6011	\$5.95
IM6403	\$9.00

6800 SUPPORT	
6821P	\$ 5.95
6828P	\$11.95
6834P	\$12.95
6840P	\$18.75
6850P	\$ 4.80
6852P	\$ 5.79
6875L	\$ 7.40
68488P	\$25.00

PROMS	
2708 (450ns)	\$ 8.95
2716 (450ns)	\$34.95
2716 (5v)	\$34.95
2732 (5v)	\$95.00
2758 (5v)	\$34.95

MICROPROCESSORS	
Z-80	\$10.95
Z-80A	\$14.95
6502	\$11.50
6800	\$11.95
6802	\$17.95
6809	\$39.95
8035	\$24.00
8035-8	\$24.00
8080A	\$ 6.59
8085	\$15.95
TMS9900JL	\$39.95

Special Price for

NOVATION CAT

Acoustic Coupler/Modem

\$149.95



Let your computer talk to other computers!
 Bell Systems 103 compatible
 300 baud, answer or originate
IOM-5200A (SALE PRICED)..... \$149.95

Get Down to Business

8" DISK FOR APPLE

Special **JADE** Package

Almost 5 times more capacity than the standard Apple 2 Drive System. Special package price includes: Sorrento Valley Associates interface and controller, 2 Shugart 8" disk drives, cabinet and power supply, software and cables.
List \$1,995.00 \$1495.00

Integral Data Systems

THE PAPER TIGER

132 Column Dot Matrix Printer

Up to 198 CPS
 1.75 to 9.5 inch adjustable tractor.
 Parallel and serial interface.
 98 character ASCII set.
 80 to 132 columns.
 6 or 8 lines per inch.
 Eight software selectable character sizes.
 110, 300, 600, or 1200 baud.
PRM-33440 \$950.00
PRM-33441 (GRAPHICS & 2K BUFFER) . \$1050.00



PRIORITY ONE ELECTRONICS

RN ROBINSON NUGENT, INC.

GOLD 3 LEVEL
WIRE WRAP SOCKETS

AND OTHER LEADING MANUFACTURERS

ICY SERIES GOLD 3 LEVEL WIRE WRAP SOCKETS

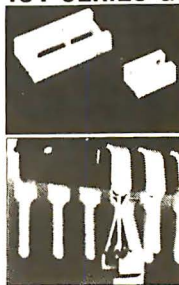

- Deep Chamfered Closed Entry Contacts
- RN Side Wipe Contact Design
- Terminal Barbs Allow Self-lock into PC Board
- Rugged Socket Body Design

PRICE*

PART NO.	PINS	1-9	10-24	25-99	100-249	250-999
RNS-08WWG	8	.50	.42	.40	.37	.33
RNS-14WWG	14	.60	.49	.47	.45	.42
RNS-16WWG	16	.65	.52	.50	.47	.44
RNS-18WWG	18	.65	.75	.70	.65	.60
RNS-20WWG	20	1.00	.90	.80	.75	.70
RNS-22WWG	22	1.25	1.15	1.10	1.05	1.00
RNS-24WWG	24	1.25	1.15	1.10	1.05	1.00
RNS-28WWG	28	1.60	1.50	1.40	1.30	1.20
RNS-40WWG	40	1.85	1.65	1.55	1.45	1.35

*Price based on gold not exceeding \$500 per oz.
Sockets purchased in multiples of 50 per type may be combined for best price.

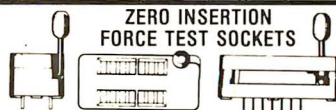

ZERO INSERTION FORCE TEST SOCKETS

- ZIP-16DIP \$5.50
- ZIP-24DIP \$7.50
- ZIP-40DIP \$10.25



Texas Instruments FACE GRIP LOW PROFILE SOLDER TAIL DIP SOCKETS C85 SERIES



- *Face grip design provides maximum retention force
- *Anti-wicking feature
- *Redundant contact points

PART NO.	PINS	1-9	PRICE				
			10-49	50-99	100-499	500-999	1,000 +
TIS-08LP	08	N/A	.15	.10	.08	.07	.06
TIS-14LP	14	N/A	.18	.15	.14	.12	.11
TIS-16LP	16	N/A	.20	.18	.16	.13	.12
TIS-18LP	18	.30	.25	.22	.18	.15	.13
TIS-20LP	20	.30	.25	.23	.20	.17	.145
TIS-22LP	22	.35	.30	.25	.22	.19	.17
TIS-24LP	24	.40	.35	.30	.24	.20	.18
TIS-28LP	28	.45	.40	.35	.28	.24	.21
TIS-40LP	40	.50	.45	.42	.40	.35	.31

*MINIMUM ORDER \$1.00 Per Line Item
Sockets purchased in multiples of 100 per type may be combined for best price

DIP PLUGS



PART NO.	PINS	PRICE			
		1-9	10-24	25-99	100-249
KNX-08DP	8	.50	.45	.43	.40
KNX-14DP	14	.65	.60	.58	.55
KNX-16DP	16	.70	.65	.62	.58
KNX-24DP	24	1.15	1.05	.90	.85
KNX-40DP	40	1.90	1.70	1.60	1.50



WINCHESTER ELECTRONICS

D-Subminiature Connector

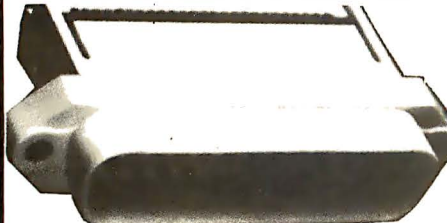

P = Plug-Male
S = Socket-Female
C = Cover-Hood

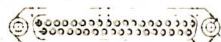

PART NO.	NO. OF PINS	PRICE		
		1-9	10-24	25-99
IDC-DE9P	9	4.00	3.60	3.20
IDC-DE9S	9	4.20	3.80	3.40
IDC-DE9C	9	1.10	1.00	
IDC-DA15P	15	4.20	3.75	3.40
IDC-DA15S	15	4.85	4.35	3.90
IDC-DA15C	15	1.25	1.10	.95
IDC-DB*25P	25	6.00	5.20	4.70
IDC-DB*25S	25	6.35	5.60	5.00
IDC-DB*25C	25	1.50	1.35	1.20
IDC-DC37P	37	8.00	7.20	6.40
IDC-DC37S	37	10.25	9.20	8.20
IDC-DC37C	37	2.00	1.80	1.60

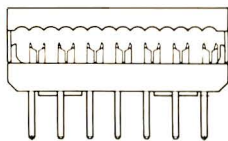

Dip Plugs

PART NO.	NO. OF PINS	PRICE		
		1-9	10-24	25-99
IDC-14DP	14	1.40	1.25	1.10
IDC-16DP	16	1.60	1.45	1.30
IDC-24DP	24	2.20	2.00	1.80

FLEX-COM

Edgecard Connector



PART NO.	NO. OF PINS	PRICE		
		1-9	10-24	25-99
IDC-20CE	10/20	4.15	3.75	3.30
IDC-26CE	13/26	4.75	4.30	3.80
IDC-34CE	17/34	5.70	5.10	4.50
IDC-40CE	20/40	6.50	5.80	5.25
IDC-50CE	25/50	7.00	6.30	5.40

RIBBON CABLE



Color Coded Laminated Cable for Insulation Displacement 28 Gauge, 7 Strand

PART NO.	NO. OF CONDUCTORS	PRICE PER SPOOL	
		10 Ft.	100 Ft.
IDC-09CC	9	N/A	26.20
IDC-14CC	14	4.60	36.65
IDC-16CC	16	5.20	42.00
IDC-25CC	25	N/A	68.15
IDC-26CC	26	8.50	68.15
IDC-34CC	34	11.00	89.10
IDC-40CC	40	N/A	104.85
IDC-50CC	50	16.00	131.05

GRAY LAMINATED CABLE FOR INSULATION DISPLACEMENT 28 Gauge 7 Strand

PART NO.	NO. OF CONDUCTOR	PRICE PER SPOOL	
		10 Ft.	100 Ft.
IDC-09GY	9	N/A	18.05
IDC-14GY	14	N/A	26.20
IDC-16GY	16	4.00	30.20
IDC-20GY	20	N/A	38.50
IDC-25GY	25	N/A	50.32
IDC-26GY	26	5.00	50.32
IDC-34GY	34	8.10	65.25
IDC-40GY	40	N/A	76.85
IDC-50GY	50	11.00	93.10

IDC System

Socket Connector

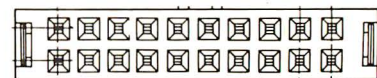

PART NO.	NO. OF PINS	PRICE		
		1-9	10-24	25-99
IDC-20SKT	10/20	2.50	2.25	2.00
IDC-26SKT	13/26	3.20	2.85	2.30
IDC-34SKT	17/34	4.20	3.75	3.30
IDC-40SKT	20/40	5.00	4.50	3.90
IDC-50SKT	25/50	6.00	5.40	4.75

Header Connector

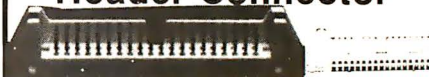

Right Angle Solder Tail G0L0 Header

PART NO.	1-9	10-24	25-99
IDC-RAH 26STG	2.00	1.80	1.60
IDC-RAH 34STG	2.60	2.35	2.10
IDC-RAH 40STG	3.00	2.70	2.40
IDC-RAH 50STG	3.60	3.25	2.90

Right Angle Wire Wrap Gold Header

PART NO.	1-9	10-24	25-99
IDC-RAH 26WWG	4.30	3.90	3.50
IDC-RAH 34WWG	5.00	4.75	4.50
IDC-RAH 40WWG	6.00	5.40	4.80
IDC-RAH 50WWG	6.80	6.20	5.50

INSTALLATION/ASSEMBLY TOOLS are available call for prices & information.



FOR MORE INFORMATION SEE OUR 52 PAGE AD IN JANUARY BYTE OR SEND \$1.00 FOR CATALOG

• Sale Prices are for prepaid orders only • Quantities are limited, subject to prior sale • CREDIT CARD ORDERS WILL BE CHARGED APPROPRIATE FREIGHT



PRIORITY ONE ELECTRONICS

16723K Roscoe Blvd. Sepulveda, CA 91343

Terms: Visa, MC, BAC, Check, Money Order, U.S. Funds Only. CA residents add 6% sales tax. Minimum order \$10.00 Prepaid U.S. orders less than \$75.00 include 5% shipping and handling. MINIMUM \$2.50. Excess refunded. Just in case ... please include your phone no. Prices subject to change without notice. We will do our best to maintain prices thru JUNE 1980

*SOCKET and CONNECTOR prices based on GOLD, not exceeding \$500 per oz.

*Sale Prices are for prepaid orders only credit card orders will be charged appropriate freight

ORDER TOLL FREE
1-800-423-5633
except CA., AK., HI., CALL
(213) 894-8171

ORDER TOLL FREE (800) 423-5633

PRIORITY ONE ELECTRONICS

CENTRONICS 730 Dot Matrix Printer

SAVE \$100.00

STANDARD FEATURES: • 50 Characters/second • Characters/line • 10 characters/inch • 3-way paper handling system • 7 x 7 dot matrix • 96 character ASCII • microprocessor electronics • unidirection print at 50 ips • high speed return approximately 10 ips • 21 lpm with 80 columns printed • 50 lpm with 20 columns printed • 80 character buffer • 6 lpi vertical • Centronics Colors and logo

FORMS HANDLING: Roll Paper: 8.5 in. x 5.0 dia. with 1 in. core maximum dimension 3.5 in. wide with .38 in. core minimum dimension Fan Fold: 9.0 in. (22.9 cm. wide pin to pin 9.5 in. (24.1 cm wide overall. Up to 3 ply paper with 2 carbons (total thickness not to exceed .012 inches) Cut Sheet: Maximum width 8.5 inches.

RIBBON SYSTEM: Continuous ribbon 9/16" (14mm) wide, 20 yards (18.3 meters) long. Mobius Loop allows printing on upper and lower portion on alternate passes

OPERATOR CONTROLS: Power on/off Reset Switch - allows disabling of printer without dropping AC.

DATA INPUT: 7 or 8 bit ASCII parallel, TTL levels with strobe. Acknowledge pulse indicates that data was received.

PHYSICAL DIMENSIONS: Weight: less than 10 lbs./5 kg. Width: 14.5 inches/37 cm Depth: 11.0 inches/28cm Height: 4.89 inches/13cm Dimensions exclusive of roll paper holder.

SHIPPING WEIGHT: 14 lbs.



WOW
PRICE
\$695.00
WOW

CEN-730-1 (Parallel Int.) LIST PRICE: \$795.00

TRS-80/APPLE MEMORY EXPANSION KITS

4116's RAMS
(from Leading Manufacturers)
(16Kx1 200/250ns)

100% GUARANTEED

1,000's SETS SOLD

8 for \$55.00

ADD \$3.00 FOR PROGRAMMING JUMPERS FOR TRS-80 KEYBOARD

4116's 100 pcs & UP \$5.50 each
1000 pcs & UP \$5.00 each

4 MHZ EXPANDORAM II KIT The S-100 Memory Board for the 80's

SD SYSTEMS' ExpandoRAM II is a state-of-the-art dynamic RAM board with capacities from 16K bytes (4116) to 256K bytes (4164). It operates on the industry S-100 Bus. The ExpandoRAM II's design allows eight boards to operate from the same S-100 Bus. Page mode operation provides the system with the capability of servicing multiple users without RAM interference. Invisible refresh and synchronization with wait states provide greater reliability, and processing speeds up to 4 Mhz.

- S-100 Bus Compatible
- Up to 4Mhz Operation
- Expandable Memory from 16K to 256K
- DIP Switch Selectable Boundaries
- Uses 16K (4115) or 64K (4164) Memory Devices
- Page Mode Operation Allows up to 8 Memory Boards on Bus
- Operates with Z80 CPU's
- Phantom Output Disable
- Invisible Refresh (Synchronized with Wait States)

The ExpandoRAM II is compatible with some S-100 CPU's based on the Z80 microprocessor. When other SD SYSTEMS 200 series boards are combined with the ExpandoRAM II, they create a microcomputer with exceptional capabilities and features.

NEW

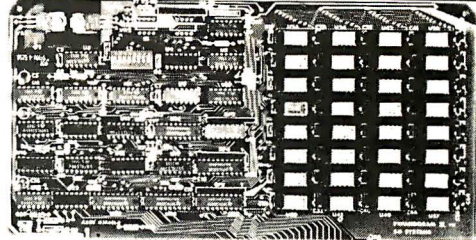

SDS - EXPANDOPRAM II KIT (4116)

Sale Price

16K ...	\$280.00	48K ..	\$399.00
32K ...	\$340.00	64K ..	\$459.00

LOBO 8" DISK DRIVE CABINET

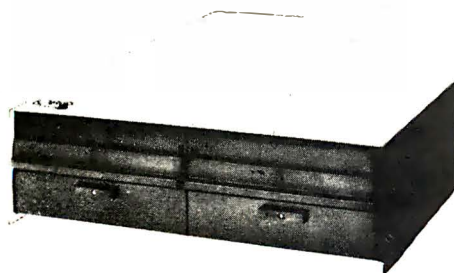

New from Lobo, a dual Cabinet with power supply, and internal data cable hook-up.

- Cabinet accepts 2 801R, 800R, FD120, or FD200 style disk drives.
- Power Supply for 2 drives.
- Assembled, tested and guaranteed by Lobo Drives.
- Shipping Weight 30 lbs.

LBO - DUAL 8 PCS \$329.00

BUY CABINET AND DRIVES AND SAVE

WITH 1 DRIVE \$775.00
WITH 2 DRIVES \$1250.00

LBO-801R-1PSC \$775.00
LBO-801R-2PSC \$1250.00

DISC DRIVE ONLY

SHU-801R.....\$499.00

EXTERNAL DATA CABLES
CARDEDGE TO CARDEDGE \$19.95
CARDEDGE TO SOCKET \$19.95

RS232 and "D" SUB-MINIATURE CONNECTORS

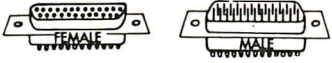

P = Plug, Male Type - S = Socket, Female Type - C = Cover, Hood

PART NO.	DESCRIPTION	PRICE		
		1-9	10-24	25-99
CND-DE9P	9 Pin Male	1.70	1.50	1.40
CND-DE9S	9 Pin Female	2.35	2.10	2.00
CND-DE9C	9 Pin Cover	1.50	1.35	1.20
CND-DA15P	15 Pin Male	2.45	2.25	2.10
CND-DA15S	15 Pin Female	3.35	3.20	3.00
CND-DA15C	15 Pin Cover	1.60	1.45	1.30
CND-DB25P	25 Pin Male	2.90	2.70	2.50
CND-DB25S	25 Pin Female	3.75	3.65	3.35
CND-DB51212-1	1 pc Grey Hood	1.50	1.30	1.10
DB-P258C	2 pc Grey Hood	1.45	1.25	1.00
DB1226-1A	2 pc Black Hood	1.90	1.65	1.45
CND-DC37P	37 Pin Male	4.40	4.20	3.90
CND-DC37S	37 Pin Female	6.20	5.95	5.70
CND-DC37C	37 Pin Cover	2.25	2.00	1.75
CND-OD50P	50 Pin Male	5.75	5.45	5.00
CND-OD50S	50 Pin Female	9.65	8.85	8.25
CND-OD50C	50 Pin Cover	2.40	2.20	2.00
D20418-S	Hardware Set 2 pr.	1.00	.80	.70
CND-RS232-8FT	RS232, DB25P, EIA class 1 cable 8 con. 8 ft. long Centronics 700 Series printer connector	18.00	16.00	14.00
CND-57-30360		9.00	7.50	6.00

NOVATION CAT ACOUSTIC COUPLER/MODEM

List - \$199.00 Sale \$156.00

MEMORY MEMORY

2102LIPC
Low Power 450ns in lots of 20 \$1.10

2102AL-2
Low Power 250ns in lots of 20 \$1.25

2114-3L
1Kx4 300ns Low Power 8/\$50.00

5257-3L
4Kx1 300ns Low Power 8/\$55.00

2708
8K 450ns EPROM 8/\$60.00-\$8.50 ea.

2716
16K 5 Volt only EPROM \$24.00 ea.
10/\$200.00



Part No	Sectoring	Application	Pk. of 2	Box of 10
VRB-MD 525-01	Soft Sector	TRS-80 Apple	\$ 8.95	\$29.95
VRB-MD 525-10	Hard 10 Sector	North Star	\$ 8.95	\$29.95
VRB-MD 525-16	Hard 16 Sector	Microtops	\$ 8.95	\$29.95
VRB-FD32-1000	Hard Sector	Shugart 801R	\$11.95	\$37.00
VRB-FD34-1000	Soft Sector	IBM 3740	\$11.95	\$37.00

BE SURE TO ORDER YOUR KASSETTE/10 LIBRARY CASE BELOW

KASSETTE/10 LIBRARY



Part No	Color	Size	Price
MMM-KS-10	GREY	8" DISKETTE HOLDER	\$4.50 or 3/\$10.00
MMM-KM-10	GREY	5 1/4" DISKETTE HOLDER	\$4.25 or 3/\$10.00

ORDER TOLL FREE 1-800-423-5633

except CA., AK., HI., CALL
(213) 894-8171

THE FAMOUS
GODBOUT
ECONORAM II
8K 450ns RAM
UNKIT CLOSE OUT
\$109.00ea. 2/\$200.00

NEW MS-230 DUAL TRACE MINISCOPE 30 MHz BANDWIDTH

1 NLS MS-230 30 MHz Scope ... \$598.15
2 NLS 41-141 10 to 1 Combo Probe \$54.00
1 NLS 41-180 Deluxe Leather Case \$45.00

LIST PRICE \$697.15
MS 230 COMBO PRICE \$547.15
SAVE \$150.00

ORDER TOLL FREE
1-800-423-5633
except CA., AK., HI., CALL
(213) 894-8171



PRIORITY ONE ELECTRONICS
16723K Roscoe Blvd. Sepulveda, CA 91343

Terms: Visa, MC, BAC, Check, Money Order, U.S. Funds Only. CA residents add 6% sales tax. Minimum order \$10.00 Prepaid U.S. orders less than \$75.00 include 5% shipping and handling. MINIMUM \$2.50. Excess refunded. Just in case ... please include your phone no. Prices subject to change without notice. We will do our best to maintain prices thru JUNE 1980.
*SOCKET and CONNECTOR prices based on GOLD, not exceeding \$500 per oz.

*Sale Prices are for prepaid orders only credit card orders will be charged appropriate freight

FOR MORE INFORMATION SEE OUR \$2 PAGE AD IN JANUARY BYTE OR SEND \$1.00 FOR CATALOG
• Sale Prices are for prepaid orders only • Quantities are limited, subject to prior sale • CREDIT CARD ORDERS WILL BE CHARGED APPROPRIATE FREIGHT

SD SYSTEMS

FACTORY REBATE SALE



When you purchase any S.D. SYSTEMS Computer Board, either kit or A&T from PRIORITY 1 ELECTRONICS you will receive a COUPON FOR A \$25.00 CASH REBATE Direct from the Manufacturer SD SYSTEMS. Combine the Rebate with our already low prices, and you can hardly afford to pass up this special offer.

SD EXPANDORAM The Ultimate S-100 Memory

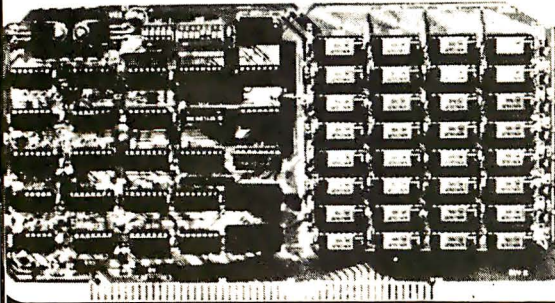

EXPANDO 64 KIT (4116)

	List Price	Sale Price
16K	385.00	189.00
32K	550.00	244.00
48K	715.00	298.00
64K	880.00	349.00

The EXPANDORAM is available in versions from 16K up to 64K, so for a minimum investment you can have a memory system that will grow with your needs. This is a dynamic memory with the invisible on-board refresh, and IT WORKS!

- Interfaces with Altair, IMSAI, SOL-8, Cromenco, SBC-100, and others.
- Bank Selectable
- Phantom
- Power 8VDC, ± 16VDC, 5 Watts
- Lowest Cost Per Bit
- Uses Popular 4116 RAMS
- PC Board is doubled solder masked and has silk-screen parts layout.
- Extensive documentation clearly written
- Complete Kit includes all Sockets for 64K
- Memory access time: 375ns, Cycle time: 500ns.
- No wait states required
- 16K boundaries and Protection via Dip Switches
- Designed to work with Z-80, 8080, 8050 CPU's

VERSAFLOPPY II

DOUBLE DENSITY, DOUBLE SIDED, DISC CONTROLLER

GENERAL DESCRIPTION
Versafloppy II is a flexible disk drive controller that incorporates a wide range of capabilities into one board. It operates with double density soft sector format which provides 985,600 bytes of storage on a double sided 8 inch diskette and 128,000 bytes per side on a five inch mini diskette. The Versafloppy II directly controls many popular disk drives. These include Shugart SA400 and SA450, Shugart SA800 and SA850, Mayflower MF520 and MF700, Per Se 70 and 277, and Siemens 851 105.

NEW

- S-100 Bus IEEE Standard Compatible
- IBM 3740 Compatible Soft Sector Format for Single Density Drives
- Operates with both Standard 8" and Mini 5 1/4" Drives Simultaneously
- Provides Control for Double Sided Operation
- Operates with Z80, 8080 and 8085 Central Processing Unit
- Controls up to four drives
- Vectored Interrupt Operation Optional
- Control and Diagnostic Software Available in PROM
- SDSOS Disk Operating System Compatible

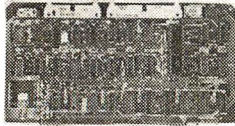

SDS-VERSAFLOPPY II KIT.....\$335.00
SDS-VERSAFLOPPY II KIT.....\$425.00

DISC CONTROLLER

SD "VERSAFLOPPY" KIT
The Versatile Floppy Disk Controller



FEATURES IBM 3740 Soft Sector Compatible S-100 BUS Compatible for Z80 or 8080 Controls up to 4 Drives (single or double sided) Directly controls the following drives:
1. Shugart SA400/SA450 Mini Floppy
2. REOSC 10 and 277
3. MF 70/740
4. MF 70/740
5. CDC 940/940E
6. CDC (same as F201208)
34 Pin Connector for Mini Floppy 50 Pin Connector for Standard Floppy Operates with modified CP/M operating system and C Basic Computer. The new Versafloppy from S.D. Computer Products provides complete control for many of the available floppy disk drives. Both Mini and Full Size FD1718 I Single Density Controller Chip Listings for CP/M10/SD Versafloppy \$100.00

DISC CONTROLLER
SD "VERSAFLOPPY" KIT
The Versatile Floppy Disk

\$235.00

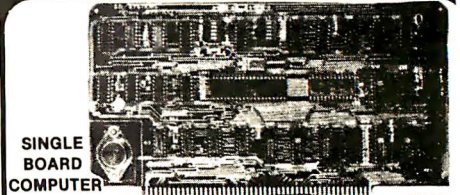

SINGLE BOARD COMPUTER

With On-Board RAM, PROM, CTC

- S-100 Bus Compatible
- Z80 Central Processing Unit
- 1024 Bytes of Random Access Memory
- 8K Bytes of PROM using 2716
- Parallel Input and Output Ports
- Four Channel Counter/Timer (Z80-CTC)
- Software Programmable Baud Rate Generator
- No Front Panel Required for Operation

SDS-SBC-100 2MHZ KIT.....\$280.00
SDS-SBC-100 2MHZ A&T.....\$350.00
SDS-SBC-200 4MHZ KIT.....\$299.00
SDS-SBC-200 4MHZ A&T.....\$369.00

Sale Price

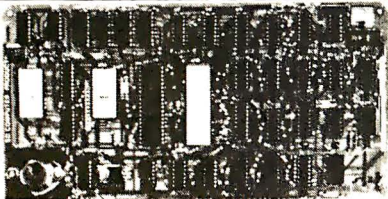

VDB-8024 VIDEO DISPLAY BOARD
With on-board Z80 Microprocessor

- S-100 bus Compatible
- Full 80 Characters by 24 Lines Display
- Characters Displayed by High Resolution 7 x 10 Matrix
- Composite or TTL Video Output
- Keyboard Power and Interface
- Forward and Reverse Scrolling Capability
- Blinking, Underlining, Field Reverse, Field Protect and Combinations
- Full Cursor Control
- 96 Upper and Lower Case Characters
- 32 Special Character Set
- 128 Additional User Programmable Characters (Optional)
- On-Board Z80 Microprocessor
- 2K Bytes Independent On-Board RAM Memory Display
- Glitch-Free Display

SDS-VDB-8024 KIT.....\$335.00
SDS-VDB-8024 A&T.....\$469.00

Sale Price

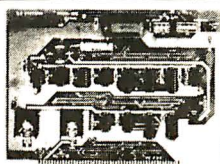

PROM-100
Programming Board
for PROM Development

NEW

SD SYSTEMS' PROM-100 is a versatile PROM programming board offering complete EPROM programming capability. The board operates on the industry standard S-100 Bus. Support software verifies the erasure of EPROM and verifies the loaded program. SD SYSTEMS' PROM-100 offers a support-software listing with its operations manual.

- S-100 Bus Compatible
- Programs the Following EPROM's: 2708, Intel 2758, 2716, 2732 and Texas Instruments 2516
- Dip Switch Selection of EPROM type
- 25 VDC Programming Pulse Generated On Board
- Maximum Programming time: 16,384 Bits in 100 Seconds
- Power Requirement: +8VDC at 300 ma.; +16 VDC at 100 ma.; -16 VDC at 60 ma.
- TTL compatible
- Software Provides for Reading of Object File from SDSOS, CP/M or PROM and Programming into EPROM
- Program Verification • Verification of Erasure of Object File
- Zero Insertion Force Socket

SDS-PROM-100 KIT.....\$175.00
SDS-PROM-100 A&T.....\$225.00

Sale Price

Z80 STARTER KIT
A Complete Microcomputer On A Board

- Z80 CPU with 158 Instructions
- On-Board Keyboard and Display
- On-Board PROM Programmer for Single Voltage PROMS (2716, 2758, TI2516)
- Kansas City Standard Cassette Interface
- Simple Key Controlled Audio Cassette Load and Dump
- Expansion Provision for Mounting Two S-100 Connectors (Sockets Not Included)
- Wire Wrap Area for Custom Circuitry
- Single Step through RAM or PROM
- Memory Examine and Change
- Port Examine and Change
- Z80 CPU Register and Change
- 2K Byte ZBUG Monitor in ROM
- 1K Bytes of RAM (Expandable to 2K Bytes)
- A 4 Channel Hardware Counter/Timer (Z80-CTC)
- Two Bi-Directional 8-Bit I/O Ports (Z80-P10)
- Up to 5 Programmable Breakpoints
- Switch Selectable PROM or Monitor Restart
- Vectored Interrupts provided by Z80-CTC and

SDS-Z80 STARTER KIT.....\$299.00
SDS-Z80 STARTER A&T.....\$439.00

Sale Price

ORDER TOLL FREE
1-800-423-5633
except CA, AK, HI, CALL
(213) 894-8171



PRIORITY ONE ELECTRONICS
16723K Roscoe Blvd. Sepulveda, CA 91343

Terms: Visa, MC, BAC, Check, Money Order, U.S. Funds Only. CA residents add 6% sales tax. Minimum order \$10.00 Prepaid U.S. orders less than \$75.00 include 5% shipping and handling. MINIMUM \$2.50. Excess refunded. Just in case... please include your phone no. Prices subject to change without notice. We will do our best to maintain prices thru JUNE 1980.
*SOCKET and CONNECTOR prices based on GOLD, not exceeding \$500 per oz.



FOR MORE INFORMATION SEE OUR 52 PAGE AD in JANUARY BYTE OR SEND \$1.00 FOR CATALOG

• Sale Prices are for prepaid orders only • Quantities are limited, subject to prior sale • CREDIT CARD ORDERS WILL BE CHARGED APPROPRIATE FREIGHT

ORDER TOLL FREE (800) 423-5633

DAL - COMP



**MODEL 550
"BANTUM" CRT**

Interactive CRT terminal with high resolution 12" diagonal 24x80 display and a 7x10 character matrix. All 128 ASCII characters, highlighted numeric pad, RS-232C interface with eleven switchable baud rates (110 to 9600). Inverse video and transparent modes, switchable parity, full or half duplex and stop bits, absolute and relative cursor control from host computer. 115V, 60 Hz.

\$799.00

DYNAMIC RAMS 4116 — 250 NS OR BETTER 8 FOR \$55.00

STATIC RAMS

2114 — 450 NS	4.50
2114L — 450 NS	5.25
2114L — 300 NS	5.50

8080/8085 SUPPORT

8212	\$3.75	8251	6.95
8214	4.50	8253	19.50
8216	2.50	8253-5	6.25
8224	3.50	8255	20.25
8228	5.95	8257	17.95
8238	6.25	8279-5	18.50
8243	7.95	8295	16.50

3881 PIO 2 MHz **8.75**

DIP SWITCHES

3 Pos.	\$1.00	6 Pos.	\$1.10
4 Pos.	1.00	7 Pos.	1.15
5 Pos.	1.00	8 Pos.	1.20

ZIP DIP II SOCKETS

16 Pin	\$5.50
24 Pin	7.50
40 Pin	10.25

RS-232 CONNECTORS

DB25P — Male Plug	\$2.95
DB25S — Female Socket	3.60
DB25C — Cover	1.50

PROMS

1702	\$4.95
2708	6.25
2716 — 5 Volt	21.95
2716 — TI +5 -5 +12V	17.00
2732	85.00

USRT

S 2350	\$7.95
--------	---------------

UARTS

TR 1602 B	\$3.95
TR 1863/AY5 1015	5.95

DISC CONTROLLER

1771	\$26.95
1791	37.95

MICROPROCESSORS

Z80A	\$13.95	8035	4.95
6502	11.95	8080A	4.95
8008	15.95	8085A	21.95
8008-1	15.95	8086	89.95

CHARACTER GENERATOR

2513 (2140) Upper	9.95
2513 (3021) Lower	9.95

LO-PRO SOCKETS

14 PIN	.15	16 PIN	.17
18 PIN	.19	20 PIN	.26
24 PIN	.33	28 PIN	.37
40 PIN	.45		

(ALL SOCKETS ARE TIN)

MOTHER BOARDS

6 Slot Bare Board	\$22.45
6 Slot Kit	47.45
12 Slot Bare Board	37.45
12 Slot Kit	87.45
18 Slot Bare Board	57.45
18 Slot Kit	127.45



**THE STAR MODEM
FROM LIVERMORE**

0 to 300 baud data rate. Compatible with Bell 103 and 113. CCITT. Answer/Originate. Full/Half Duplex. Special self test features.

\$169.00



EPROM ERASER

Compact, durable quality UV Lamp for erasing EPROM's. Features a special safety lock to prevent accidental exposure. Erases up to four devices (2708, 2716, 2732, 1702A, 5203Q, 5304Q, etc.) simultaneously.

UVS-11E \$68.95

CMOS

LIMITED QUANTITIES — NOT BUFFERED

4000	.15	4018	.86
4001	.19	4019	.43
4002	.20	4023	.22
4006	.90	4024	.72
4007	.25	4025	.20
4010	.40	4027	.45
4011	.23	4028	.80
4012	.20	4030	.43
4013	.37	4035	.95
4014	1.00	4049	.40
4015	.97	4050	.43
4016	.43	4528	.75
4017	1.00	74C151	1.55



EDGE CONNECTOR

.125 IMSAI
WIRE WRAP GOLD
LIMITED QUANTITIES
\$3.25

SD SYSTEMS EXPANDORAM I & II

SD SYSTEMS VERSAFLOPPY I & II

SD SYSTEMS SBC-100 & SBC-200

SD SYSTEMS VDB-8024 VIDEOBOARD

PRICES TOO LOW TO PUBLISH — CALL TOLL FREE FOR BARGAIN QUOTES

I04 2 PARALLEL & 2 SERIAL I/O BOARD

SSM — I04 — KIT	\$124.95
SSM — I04 — A&T	\$197.95

VB3 80 CHARACTER VIDEO BOARD

SSM — VB3 — KIT	\$297.95
SSM — VB3 — A&T	\$387.95

PB1 2708/2716 PROGRAMMER & 4K/8K EPROM BOARD

SSM — PB1 — KIT	\$124.95
SSM — PB1 — A&T	\$174.95

CB2 Z-80 CPU BOARD

SSM — CB2 — KIT	\$184.95
SSM — CB2 — A&T	\$249.95

AIO APPLE SERIAL/PARALLEL INTERFACE

KIT	\$115.00
ASSEMBLED & TESTED	\$155.00

VB2 I/O MAPPED VIDEO INTERFACE

KIT	\$150.00
ASSEMBLED & TESTED	\$195.00

I02 PARALLEL I/O INTERFACE

KIT	\$59.00
ASSEMBLED & TESTED	\$89.00

XB1 EXTENDER BOARD

KIT (W/CONNECTOR)	\$19.95
ASSEMBLED & TESTED	\$29.95

CALL TOLL FREE 800-527-5310

**TEXAS RESIDENTS
CALL COLLECT (214) 350-6898**

DAL - COMP
MAIL ORDER DIV.

TERMS OF SALE: Cash, checks, money orders, VISA, Master Charge. Minimum Order \$10.00. Texas residents add 5% sales tax. Minimum shipping and handling charge \$3.00. COD orders add \$2.00 COD fee. U.S. funds only. PRICES SUBJECT TO CHANGE WITHOUT NOTICE. SOME ITEMS SUBJECT TO PRIOR SALE. WE RESERVE THE RIGHTS TO LIMIT QUANTITIES. GUARANTEED SATISFACTION FOR 90 DAYS OR YOUR MONEY BACK.

DAL-COMP M/O DIV. 2560 ELECTRONIC LANE, SUITE 108, DALLAS, TEXAS 75220 • (214) 350-6895

MINIATURE SCREWDRIVER

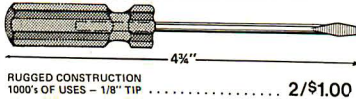

RUGGED CONSTRUCTION
1000's OF USES - 1/8" TIP 2/\$1.00

MAGNETIC RETRIEVER TOOL



Picks up elusive metal parts or tools in hard-to-reach places.
EXTENDS TO 26 3/4" - ROTATES 360° STRONG, LIFETIME MAGNET
MRT-2281 \$3.95

CONTINENTAL SPECIALTIES

LOGIC PROBE KIT



SPECIFICATIONS

Input Impedance: 300,000 Ohms.
Thresholds: "Lo" 30%Vcc - "Hi" 70%Vcc
Maximum Speed: 300 nsec., 1.5MHz
Input Protection: ±150VDC continuous 117VAC for 15 sec.
Power: 30mA @ 5V - 40mA @ 15V - 25V max. reverse voltage protected; 36" cable with color coded clips included.
Operating Temp.: 0-50°C.
Dimensions: 5.8" x 1.0W x 0.7D in. (147 x 25 x 18mm)
Weight: 30 oz. (85 gm)
LPK-1 \$21.95/Kit

Proto Clips

14-PIN CLIP	PC-14 \$ 4.50
16-PIN CLIP	PC-16 \$ 4.75
24-PIN CLIP	PC-24 \$10.00
40-PIN CLIP	PC-40 \$16.00

Proto Boards

PB-6 \$17.95
PB-100 19.95
PB-101 22.95
PB-102 26.95
PB-103 44.95
PB-104 55.95
PB-203 99.95
PB-203A 155.00
PB-203A-Kit 131.00

Jumbo 6-Digit Clock Kit

- Four .630" ht. and two .300" ht. common anode displays
- Uses MM5314 clock chip
- Switches for hours, minutes and hold functions
- Hours easily viewable to 30 feet
- Simulated walnut case
- 115VAC operation
- 12 or 24 hour operation
- Includes all components, case and wall transformer
- Size: 6 1/2" x 3 3/4" x 1 1/4"

JE747 \$29.95



- Bright .300 ht. comm. cathode display
- Uses MM5314 clock chip
- Switches for hours, minutes and hold modes
- Hrs. easily viewable to 20 ft.
- Simulated walnut case
- 115 VAC operation
- 12 or 24 hr. operation
- Incl. all components, case & wall transformer
- Size: 6 3/4" x 3-1/8" x 1 3/4"

JE701

6-Digit Clock Kit \$19.95

Regulated Power Supply

Uses LM309K. Heat sink provided. PC board construction. Provides a solid 1 amp @ 5 volts. Can supply up to ±5V, ±9V and ±12V with JE205 Adapter. Includes components, hardware and instructions. Size: 3 1/2" x 5" x 2 1/4"

JE200 \$14.95

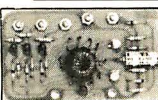

ADAPTER BOARD - Adapts to JE200 - ±5V, ±9V and ±12V

DC/DC converter with +5V input. Toroidal hi-speed switching XMFR. Short circuit protection. PC board construction. Piggy-back to JE 200 board. Size: 3 1/2" x 2" x 9/16" H

JE205 \$12.95

MICROPROCESSOR COMPONENTS

8080A/8080A SUPPORT DEVICES		MICROPROCESSOR MANUALS	
8080A	CPU	M-280	User Manual
8212	B-Bit Input/Output	M-C91802	User Manual
8214	Priority Interrupt Control	M-2650	User Manual
8216	8-Bit Internal Bus Driver		
8224	Clock Generator/Driver		
8226	Bus Driver		
8228	System Controller/Bus Driver		
8238	System Controller		
8242	Prog. Contn. 1/0 (USART)		
8253	Prog. Interval Timer		
8255	Prog. Periph. 1/0 (PPI)		
8257	Prog. DMA Control		
8259	Prog. Interrupt Control		
8000/8000 SUPPORT DEVICES		ROM'S	
MC6800	MPU	2513(140)	Character Generator(Lowercase)
MC6802CP	MPU with Clock and Ram	2513(302)	Character Generator(upper case)
MC6801API	128X8 Static Ram	2516	Character Generator
MC6821	Periph. Inter. Adapt (MC6820)	MM5230N	2048-Bit Read Only Memory
MC6828	Priority Interrupt Controller		
MC6830LB	1024X8 Bit ROM (MC68A30-B)		
MC6850	Asynchronous Comm. Adapter		
MC6852	Synchronous Serial Data Adapt.		
MC6860	0-800 bps Digital MODEM		
MC6862	2400 bps Modulator		
MC6880A	Quad 3-State Bus. Trans. (MC68T26)		
MICROPROCESSOR CHIPS - MISCELLANEOUS		RAM'S	
Z80(780C)	CPU	1101	256X1 Static
Z80A(780-1)	CPU	1103	1024X1 Dynamic
CDP1802	CPU	2101(8101)	256X4 Static
2650	MPU	2102	1024X1 Static
6502	CPU	2112	256X4 Static
8035	8-Bit MPU w/clock, RAM, 1/0 lines	2114	1024X4 Static 450ns low power
8985	CPU	2116	1024X4 Static 300ns
TMS9901JL	16-Bit MPU w/hardware, mu/fiply & divide	2118	1024X4 Static 300ns low power
		2119	1024X4 Static 450ns
		2120	1024X4 Static 300ns
		2121	1024X4 Static 300ns low power
		2122	1024X4 Static 450ns
		2123	1024X4 Static 300ns
		2124	1024X4 Static 300ns
		2125	1024X4 Static 300ns
		2126	1024X4 Static 300ns
		2127	1024X4 Static 300ns
		2128	1024X4 Static 300ns
		2129	1024X4 Static 300ns
		2130	1024X4 Static 300ns
		2131	1024X4 Static 300ns
		2132	1024X4 Static 300ns
		2133	1024X4 Static 300ns
		2134	1024X4 Static 300ns
		2135	1024X4 Static 300ns
		2136	1024X4 Static 300ns
		2137	1024X4 Static 300ns
		2138	1024X4 Static 300ns
		2139	1024X4 Static 300ns
		2140	1024X4 Static 300ns
		2141	1024X4 Static 300ns
		2142	1024X4 Static 300ns
		2143	1024X4 Static 300ns
		2144	1024X4 Static 300ns
		2145	1024X4 Static 300ns
		2146	1024X4 Static 300ns
		2147	1024X4 Static 300ns
		2148	1024X4 Static 300ns
		2149	1024X4 Static 300ns
		2150	1024X4 Static 300ns
		2151	1024X4 Static 300ns
		2152	1024X4 Static 300ns
		2153	1024X4 Static 300ns
		2154	1024X4 Static 300ns
		2155	1024X4 Static 300ns
		2156	1024X4 Static 300ns
		2157	1024X4 Static 300ns
		2158	1024X4 Static 300ns
		2159	1024X4 Static 300ns
		2160	1024X4 Static 300ns
		2161	1024X4 Static 300ns
		2162	1024X4 Static 300ns
		2163	1024X4 Static 300ns
		2164	1024X4 Static 300ns
		2165	1024X4 Static 300ns
		2166	1024X4 Static 300ns
		2167	1024X4 Static 300ns
		2168	1024X4 Static 300ns
		2169	1024X4 Static 300ns
		2170	1024X4 Static 300ns
		2171	1024X4 Static 300ns
		2172	1024X4 Static 300ns
		2173	1024X4 Static 300ns
		2174	1024X4 Static 300ns
		2175	1024X4 Static 300ns
		2176	1024X4 Static 300ns
		2177	1024X4 Static 300ns
		2178	1024X4 Static 300ns
		2179	1024X4 Static 300ns
		2180	1024X4 Static 300ns
		2181	1024X4 Static 300ns
		2182	1024X4 Static 300ns
		2183	1024X4 Static 300ns
		2184	1024X4 Static 300ns
		2185	1024X4 Static 300ns
		2186	1024X4 Static 300ns
		2187	1024X4 Static 300ns
		2188	1024X4 Static 300ns
		2189	1024X4 Static 300ns
		2190	1024X4 Static 300ns
		2191	1024X4 Static 300ns
		2192	1024X4 Static 300ns
		2193	1024X4 Static 300ns
		2194	1024X4 Static 300ns
		2195	1024X4 Static 300ns
		2196	1024X4 Static 300ns
		2197	1024X4 Static 300ns
		2198	1024X4 Static 300ns
		2199	1024X4 Static 300ns
		2200	1024X4 Static 300ns
		2201	1024X4 Static 300ns
		2202	1024X4 Static 300ns
		2203	1024X4 Static 300ns
		2204	1024X4 Static 300ns
		2205	1024X4 Static 300ns
		2206	1024X4 Static 300ns
		2207	1024X4 Static 300ns
		2208	1024X4 Static 300ns
		2209	1024X4 Static 300ns
		2210	1024X4 Static 300ns
		2211	1024X4 Static 300ns
		2212	1024X4 Static 300ns
		2213	1024X4 Static 300ns
		2214	1024X4 Static 300ns
		2215	1024X4 Static 300ns
		2216	1024X4 Static 300ns
		2217	1024X4 Static 300ns
		2218	1024X4 Static 300ns
		2219	1024X4 Static 300ns
		2220	1024X4 Static 300ns
		2221	1024X4 Static 300ns
		2222	1024X4 Static 300ns
		2223	1024X4 Static 300ns
		2224	1024X4 Static 300ns
		2225	1024X4 Static 300ns
		2226	1024X4 Static 300ns
		2227	1024X4 Static 300ns
		2228	1024X4 Static 300ns
		2229	1024X4 Static 300ns
		2230	1024X4 Static 300ns
		2231	1024X4 Static 300ns
		2232	1024X4 Static 300ns
		2233	1024X4 Static 300ns
		2234	1024X4 Static 300ns
		2235	1024X4 Static 300ns
		2236	1024X4 Static 300ns
		2237	1024X4 Static 300ns
		2238	1024X4 Static 300ns
		2239	1024X4 Static 300ns
		2240	1024X4 Static 300ns
		2241	1024X4 Static 300ns
		2242	1024X4 Static 300ns
		2243	1024X4 Static 300ns
		2244	1024X4 Static 300ns
		2245	1024X4 Static 300ns
		2246	1024X4 Static 300ns
		2247	1024X4 Static 300ns
		2248	1024X4 Static 300ns
		2249	1024X4 Static 300ns
		2250	1024X4 Static 300ns
		2251	1024X4 Static 300ns
		2252	1024X4 Static 300ns
		2253	1024X4 Static 300ns
		2254	1024X4 Static 300ns
		2255	1024X4 Static 300ns
		2256	1024X4 Static 300ns
		2257	1024X4 Static 300ns
		2258	1024X4 Static 300ns
		2259	1024X4 Static 300ns
		2260	1024X4 Static 300ns
		2261	1024X4 Static 300ns
		2262	1024X4 Static 300ns
		2263	1024X4 Static 300ns
		2264	1024X4 Static 300ns
		2265	1024X4 Static 300ns
		2266	1024X4 Static 300ns
		2267	1024X4 Static 300ns
		2268	1024X4 Static 300ns
		2269	1024X4 Static 300ns
		2270	1024X4 Static 300ns
		2271	1024X4 Static 300ns
		2272	1024X4 Static 300ns
		2273	1024X4 Static 300ns
		2274	1024X4 Static 300ns
		2275	1024X4 Static 300ns
		2276	1024X4 Static 300ns
		2277	1024X4 Static 300ns
		2278	1024X4 Static 300ns
		2279	1024X4 Static 300ns
		2280	1024X4 Static 300ns
		2281	1024X4 Static 300ns
		2282	1024X4 Static 300ns
		2283	1024X4 Static 300ns
		2284	1024X4 Static 300ns
		2285	1024X4 Static 300ns
		2286	1024X4 Static 300ns
		2287	1024X4 Static 300ns
		2288	1024X4 Static 300ns
		2289	1024X4 Static 300ns
		2290	1024X4 Static 300ns
		2291	1024X4 Static 300ns
		2292	1024X4 Static 300ns
		2293	1024X4 Static 300ns
		2294	1024X4 Static 300ns
		2295	1024X4 Static 300ns
		2296	1024X4 Static 300ns
		2297	1024X4 Static 300ns
		2298	1024X4 Static 300ns
		2299	1024X4 Static 300ns
		2300	1024X4 Static 300ns
		2301	10

Buy Direct From CompuMart

COMPUMART NOW OFFERS THE ENTIRE DEC LSI-11 PRODUCT LINE - CALL FOR PRICES & DELIVERY.



Buy Direct from the Largest Commodore Dealer in the Country - NCE/CompuMart.

8K-Keyboard N	\$795
16K-Keyboard B	\$995
16K-Keyboard N	\$995
32K-Keyboard B	\$1,295
32K-Keyboard N	\$1,295
B - large keyboard (graphics not on keys)	
N - large keyboard with graphics symbols	

SUPER SAVER. Thanks to Commodore their printer prices have been drastically reduced:

Commodore Printer (tractor feed)	was \$995 NOW \$795
Commodore Printer (friction feed)	was \$849 NOW \$695

NEW FROM EXIDY THE SORCERER II 48K COMPUTER

Z-80 Microprocessor, Full-sized keyboard • ROM PAC Programs • Microsoft BASIC • Powerful Graphics • Serial and Parallel I/O • Dual Cassette I/O Memory Internally Expandable • S-100 Expansion Options.
48K Sorcerer II

CENTRONICS PRINTERS



The 779-2 is a tractor feed printer designed for small business systems. Uses a 5x7 dot matrix to produce all 64 upper case ASCII characters. Centronics is the biggest name in printers and this is their most popular model.
List: \$1,245

The New 730-1 parallel matrix printer is ideally suited for all personal and microcomputer systems. Standard Features include: 100 cps • 80 char./line • 3-way paper handling system • 7x7 dot matrix • 96 character ASCII • List \$995

To meet our Centronics' quotas we are offering these great specials on their printers!
753-9 9 x 9 Data Processing Printer. List: \$2,995 SALE! \$2,395

704-9 9 x 9 180 CPS. List: \$1,995 SALE! \$1,750
701-9 9 x 9 Matrix. List: \$1,595 SALE! \$1,395
730-3 Serial 730. List: \$895 SALE! \$745

Brand New, Centronics Model 737, the first printer in its class capable of offering print quality suitable for text processing, plus the performance & application flexibility required for data processing. Unbelievable quality of type.

737-3 Serial Word Processor Printer \$1,045
737-1 Parallel Word Processor Printer \$995

Perfect Printer for Small Business Systems

2 Good reasons for buying your PET™ from CompuMart:

(1) \$100 IN FREE ACCESSORIES WITH 16K or 32K PET.

When you buy a 16K or 32K PET, apply \$100 toward PET accessories. FREE. Choose from the accessories listed below and indicate on your order that you have reduced the cost of your accessories by \$100

(2) FREE WITH PURCHASE OF ANY PET (Offer extended until June 15, 1980)

A Texas Instruments Hex/Octal Calculator (\$60 Value), and a set of 6 PET Workbooks (Worth \$36).

PET Accessories

Commodore Dual Floppy Disk Drive	\$1,295.00
Second Cassette—from Commodore	\$95.00
Commodore PET Service Kit	\$30.00
Beeper—Tells when tape is loaded	\$24.95
Petunia—Play music from PET	\$29.95
Video Buffer—Attach another CRT	\$29.95
Combo—Petunia abd Video Buffer	\$49.95
TNW Bi-Dir. RS-232 printer S-face	\$229.00
KIM 1 (A Single Board Computer from Commodore)	\$179.00
PET TO IEEE Cable	\$39.95
IEEE TO IEEE Cable	\$49.95
KIM1 & Power Supply Package Special ..	\$200.00

Commodore's 3 for 2 is Back! SPECIAL OFFER TO EDUCATORS - GET A FREE PET COMPUTER

For a limited time only, when your school buys any 2 PET's at the regular list (see our PET's prices listed above), Commodore will include another PET in the deal, absolutely FREE! Call CompuMart TOLL-FREE for complete details.

The Paper Tiger Printer From Integral Data ROAR!



Standard features include: 4 character 8.3 to 16.5 cpi • 56 cps at 10 char. per in. • Selectable line spacing • 8 switch-selectable form sizes.

The IDS Graphics Option for the Paper Tiger allows full dot pattern control and includes an expanded 2048-byte buffer (a 256-byte buffer is standard).

IDS Paper Tiger Printer

IDS Graphics Paper Tiger Printer \$1,094

SANYO MONITORS

9-inch reg. \$199
SALE! \$169

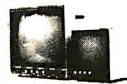

15-inch reg. \$299
SALE! \$269

Perfect for Apple users... Sanyo Cassette Recorder \$55



We have a complete inventory of Apple computers, peripherals, & software In-Stock for immediate delivery - Call us for prices.

\$200 in FREE accessories with the purchase of a 48K Apple II reg. or Apple II plus.

16K Apple reg. or plus - \$1,195 (\$100 in free acces.)
32K Apple reg. or plus - \$1,395 (\$150 in free acces.)
48K Apple reg. or plus - \$1,495 (\$200 in free acces.)

Apple Accessories

PASCAL	\$495
Micromodem	\$379
VisiCalc	\$150
The Controller (Business Package)	SALE! \$550
The Cashier (POS System)	SALE! \$200
Integer BASIC ROM Card	\$200
Centronics Printer Interface	\$225
Disk and Controller	\$595
Parallel Printer Card	\$180
Communications Card	\$225
Hi-Speed Serial Card	\$195
Firmware Card	\$200
NEW! AppleWriter Text Editor	\$75
Apple Graphics Tablet	\$795

NOVATION CAT™ ACCOUSTIC MODEM

- Answer Originate • Bell 108
- 300 Baud • Low Profile Design

Looks good, works great! \$179.00



ZENITH

EXCLUSIVE FROM COMPUMART!

COLOR VIDEO MONITOR

Beautiful Display Capabilities. Excellent for use with Apple, Atari, & Sorcerer Computers. This 13-inch monitor is Zenith's first color video display designed specifically for computers. Features include color and degaussing circuits.
Zenith Color Monitor

\$499.00

HAZELTINE TERMINALS AT SPECTACULAR SAVINGS!

Hazeltine 1410-TTY-style keyboard, 8 baud rates from 110 to 9600, 12" screen, 24x80 display, 5x7 dot Matrix Upper Case ASCII character set, 12-key numeric keypad. List Price \$895

SALE! \$779

Hazeltine 1500 - 8 baud rates from 110 to 19,200, and ANSI Standard Keyboard, EIA RS-232, All 94 Upper/Lower Case characters in a high resolution 7x10 matrix display. Much more. List Price \$1,145

SALE! \$995

Hazeltine 1520 - Take advantage of this \$310 savings while it lasts! The Hazeltine 1520 is a powerful multi-processor terminal. List Price \$1,585

SALE! \$1,275



THE SINGLE BOARD DEVELOPMENT SYSTEM ROCKWELL AIM 65

6502 Microprocessor • 20-character, alpha-numeric LED display • Full-size 54-key keyboard with 3 user-defined functions • Fast, on-board 20-column thermal printer • 8K Advanced Interactive Monitor program • Dual cassette interface board • On-board timer • On-board ROM expansion to 12K • 4K on-board RAM • On-board TTY interface • 16 parallel I/O lines • One serial I/O port • KIM-compatible edge connectors for even further memory or I/O expansion.

The CompuMart AIM System combines all of our options for the AIM to give you the capabilities of development systems costing 5 to 10 times as much. This system includes a 4K AIM 65 with BASIC and Assembler, an MTU power supply, a Sanyo tape recorder and an EGI Enclosure for the AIM.

CompuMart AIM System	\$785.00
4K AIM-65	\$450.00
Power for the AIM	\$4.75

CompuMart

We've Had a Reputation for Dependability Since 1971.

DEPT. BY60, 270 THIRD ST., CAMBRIDGE, MA. 02142

To Order: 1 (800) 343-5504

In Mass: 1 (617) 491-2700

Member Computer Dealers Assoc.



10-DAY FREE TRIAL

SEND FOR OUR
FREE CATALOG

Lear Siegler Terminals & Printers at Tremendous Savings

ADM-3A. Industries' favorite dumb terminal for some very smart reasons. 12" diagonal screen • Full or half duplex operation at 11 selectable data rates • 1,920 easy-to-read characters in 24 rows of 80 letters • RS-232C interface extension port • Direct cursor addressing. Reg. Price. \$895 **Sale!**



Call us for sale prices.

ADM-31. A terminal that's too smart to be considered dumb. Comes complete with keyboard, control logic, character generator, refresh memory & interface • Displays two pages of text instead of one • Field protect mode • Factory installed selected parameters. Reg. Price. \$1,450 **Sale!**

We Stock Lear Siegler
Accessories —
Call For Details.



The remarkable TI-99/4 Home Computer. Compare it. Dollar for dollar. Feature for feature.

Superior color, music, sound & graphics - and a powerful extended BASIC - all built in. Plus a unique new Solid State Speech™ Synthesizer and TI's special Solid State Software.

Comes complete with the Features you want:

- Powerful TI-BASIC
 - Up to 72K total memory capability - 16K RAM, 26K ROM plus up to 30K ROM in TI's Solid State Software Command Modules.
 - 16 - color graphics capability
 - Music & sound effects
 - Built-in equation calculator
 - High quality 13" color monitor
- Call our Sales Dept. for Complete Description & Specs.
- TI-99/4 Home Computer w/Monitor \$1,050.
 - TI-99/4 Home Computer w/o Monitor \$895.
 - TI User Reference Manual \$9.95.

TI CALCULATORS - Three of the finest from the first.

- TI Programmable 59 \$245.00
- TI-58C Programmable Calculator (w/continuous memory) \$104.00
- TI Programmer \$59.00

Add convenient versatile printing capabilities to your TI Programmable 58C or 59 calculator with the PC-100C thermal printer, plotter. TI PC-100C 168.00

TI Talking Translator. The translator that actually speaks! \$300.00 Language Modules for the TI Translator \$49.95 Ea. Available in: Spanish, French, English & German.

SPEAK & SPELL™ - TI's remarkable learning aid with electronic voice & brain. &69.95 Modules for Speak & Spell \$17.95 Ea: Super Stumpers (grades 4-6), Vowel Power (Ages 7 & up), Super Stumpers (Grades 7 & 8)

ADDITIONAL TI-99/4 ACCESSORIES

- Speech Editor \$99.95
 - Demonstration \$69.95
 - Diagnostic \$29.95
 - Joysticks \$29.95
 - Speech Box \$149.95
 - Dual Cassette Cable \$19.95
 - Math Dictionary \$29.95
 - Beginners Basic \$9.95
- SOLID STATE SOFTWARE COMMAND MODULES**
- Entertainment:
- Football \$29.95
 - Video Chess \$69.95
 - Video Graphs \$19.95
- Home Management/Personal Finance:
- Home Financial Decisions \$22.95
 - Household Budget Mgt. \$44.95
- Education:
- Early Learning \$29.95
 - Physical Fitness \$29.95
 - Number Magic \$13.95
 - Beginning Grammar \$29.95

300 Series Ballistic Printers. This application-oriented matrix printer is built to last. Features include: Ballistic Printing • Positive 180 cps • Bi-directional Printing • A character buffer that is optionally expandable to 2,048 characters • 512 character buffer standard.

ADM-42 Ballistic Printer (Serial/Parallel)

Reg. Price \$2,045 **Sale! Call**

ADM-42 with Keyboard. Reg. Price \$1,795 **Sale!**

ADM-42 without Keyboard. Reg. Price \$1,595 **Sale! Call**

ADM-42. The semi-intelligent terminal that provides you with flexibility of format, security, editing, interface, and transmission. Two-page display standard (Originally expandable to eight!) • Blanking, blinking, and reverse fields • three ways to TAB • 16 Function keys do the work of 32 • Detachable keyboard.

A Calculator, A System, A Whole New Standard.

The finest calculators available for Science, Engineering, & Business.

HEWLETT-PACKARD'S HP-41C

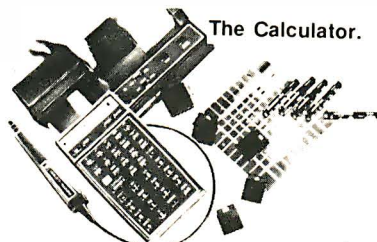

The Calculator.

Features over 130 functions and offers up to 400 lines of program memory or 63 data storage registers — expandable to 319 registers or up to 2,000 lines. RPN Logic. Alpha-numeric capabilities let you communicate with the calculator in English. Customization features allow you to totally reassign the keyboard functions. Continuous memory HP-41C Calculator \$288.00

The System.

Memory Modules. For storing programs or up to 2,000 lines of program memory \$45.00

"Extra Smart" Card Reader. Records programs and data back onto blank mag-cards \$179.00

The Printer. Upper and Lower case. High resolution plotting. Portable. Thermal operation \$320.00

Application Modules \$45.00 EACH.

Standard pac. Statistics, Math, Financial, & Surveying.

HP SERIES E CALCULATORS

HP-31E — Scientific. Trigonometric, exponential & math functions \$49.95

HP-32E — Advanced Scientific with Statistics. All HP-31E functions plus hyperbolics and comprehensive statistics. \$66.95

HP-33E — Programmable Scientific. A programmable science, math and statistical calculator \$79.95

Also available with continuous memory... 86.40

HP-37E — Business Management. Best choice for a business/finance calculator \$69.95

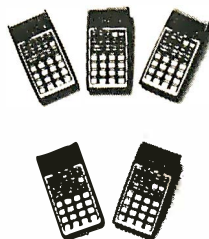

HP-38E — Advanced Financial with Programmability. All the features of the HP-37E plus a lot more power. \$108.00

Also available with continuous memory \$144.95

THE ALL NEW HP-34C. Advanced Continuous Memory Scientific Programmable with an impressive array of programming features. \$144.95

CompuMart STOCKS THE COMPLETE LINE OF MATROX PRODUCTS. CALL FOR SPECS.

CompuMart

Dept. BY60,
270 Third St.,
Cambridge, Mass.
02142

TO ORDER CALL:
1-800-343-5504
IN MASS. CALL: (617) 491-2700

IMPORTANT ORDERING INFORMATION

All orders must include 4% shipping and handling. Mass. residents add 5% sales tax. Mich. residents 4% for sales tax.

Phones open from 8:30 a.m. to 5:30 p.m. EST. Mon.-Fri. • P.O.'s accepted from D&B rated companies — shipment contingent upon receipt of signed purchase order • All prices are subject to change without notice • Most items in stock for immediate shipment — call for delivery quotation • In the Ann Arbor area? Our retail store is open 11:00 a.m. to 7:00 p.m. Tues.-Fri., 10:00 a.m. to 5:00 p.m. Saturdays (closed Sun. and Mon.)

IF NOT SATISFIED RETURN PURCHASE WITHIN 10 DAYS FOR A FULL REFUND.

Based on our policy of offering our customers only the finest in micro-computers, CompuMart is pleased to announce that we now carry the new generation of Personal Computers by Atari.™



INTRODUCTORY SPECIALS

To celebrate our commitment to Atari, we are offering the following Atari Specials: note: (You must buy an Atari.)

(1) Buy additional memory for your computer, 8K or 16K, and we will double the amount of memory FREE! (A potential savings of \$200.)

(2) Buy the Atari 800 Computer and take \$100 off the purchase price of the Atari 810 Disk Drive or the Atari 820 printer.

ATARI 800™

PERSONAL COMPUTER SYSTEM

Comes with:

- Computer Console
- BASIC Language Cartridge
- Education System Master Cartridge
- BASIC Language Programming Manual
- 800 Operator's Manual
- ATARI 810 Program Recorder
- Invitation to Programming™ Cassette
- 8K RAM Memory Module™
- 10K ROM Operating System

- Power Supply
- TV Switch Box

SPECIFICATIONS:

High resolution color graphics
57 key full stroke keyboard
Built-in RF modulator for channel 2/3 operation with standard TV set
Composite video output for use with monitor
Internal Speaker
Two cartridge slots for rapid program insertion
Four internal slots for expansion up to 48K RAM
6502B Microprocessor
High speed serial I/O port

Atari 800 Computer System \$995.95

ATARI 820™ PRINTER

High resolution dot matrix impact printer
Uses standard 3/8 inch roll paper and ribbon
40 characters per line
Speed: 40 characters per second
UL approved

Atari 920 Printer \$599.95

ATARI 810™ PRINTER

Uses standard 5 1/4 inch diskettes
88K bytes storage per diskette
Up to four disk drive units can operate with the system
Average data access time: 236 milliseconds
Power: AC adapter; UL approved

Atari 810 Disk Drive \$699.95

Upgrade your computer with additional memory. (Note that the Atari 800 Computer comes with 8K of RAM memory and will accept up to 48K.)

Atari 8K RAM Memory Module \$124.95
Atari 16K RAM Memory Module \$199.95



COMPUTER SYSTEMS INC.

15335 South Hawthorne Boulevard
Lawndale, California 90260
(213) 970-0952

QUICK & TIMELY

Look to QT for the BIG +

S D SYSTEMS

EXPANDORAM I

EXPANDABLE TO 64K USING 4116 RAMS

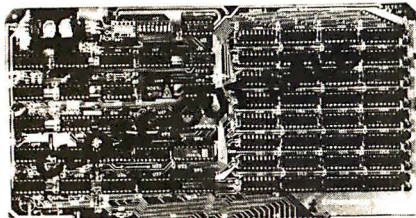

Interfaces with most popular S-100 boards
Bank selectable; PHANTOM provision
Draws only 5 watts fully populated
Designed to work with Z-80, 8080 and 8085 systems
No wait states required
16K boundaries & protect via dip switches
Kits come with sockets for full 64K
Invisible refresh

MEM-16K (16K KIT)	\$205.00
MEM-16AT (16K A&T)	\$289.00
MEM-32K (32K KIT)	\$260.00
MEM-32AT (32K A&T)	\$359.00
MEM-48K (48K KIT)	\$315.00
MEM-48AT (48K A&T)	\$429.00
MEM-64K (64K KIT)	\$370.00
MEM-64AT (64K A&T)	\$499.00

SPECIAL

NOVATION CAT

ACOUSTIC COUPLER/MODEM

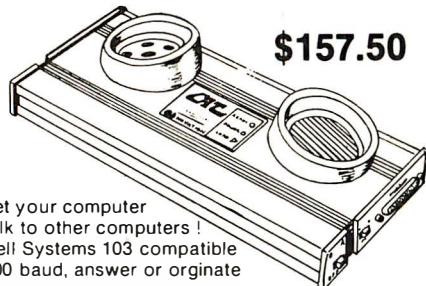

\$157.50

Let your computer talk to other computers!
Bell Systems 103 compatible
300 baud, answer or originate

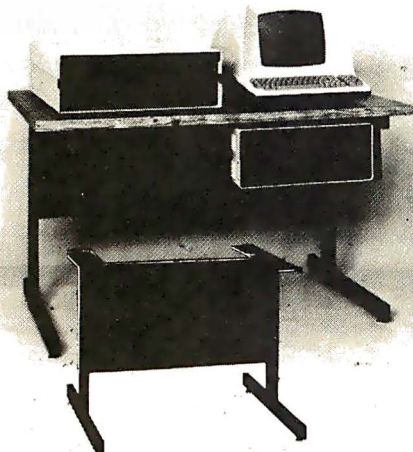

QT SYSTEMS FURNITURE +

DS4830 48" w X 30" d X 26" h Pecan or white finish avail	\$149.95
DS4830-1 48" w X 30" d X 26" h with Micro-Shelf, Pecan finish	\$224.95
DS4830-2 48" w X 30" d X 26" h with Return, Pecan or white finish avail	\$249.95
DS-810 Printer Stand for TI 810	\$120.00

S D SYSTEMS

VERSAFLOPPY II

DOUBLE DENSITY DISK CONTROLLER

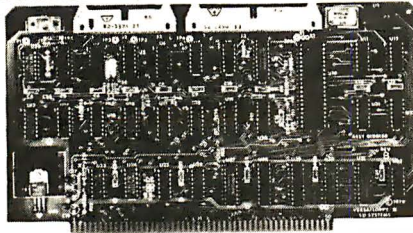

Single or double density floppy disk controller
985600 bytes on 8" double sided diskettes
259840 bytes on double sided 5 1/4" diskettes
S-100 bus (IEEE) standard compatible
IBM 3740 format in single density
8" and 5 1/4" drives controlled simultaneously
Operates with Z-80, 8080, and 8085 CPU's
Controls up to 4 drives
Vectored interrupt operation optional
VF-2K (KIT)

\$335.95

\$385.95

EPROMS

1702A	\$ 4.95
2708	\$ 6.75
2516	\$22.00
2716 (TI) (5V-12V)	\$20.00
2716 (5 VOLT)	\$22.00
2758	\$27.00
2532	\$70.00
2732	\$70.00

TEXTOL ZIP* DIP II SOCKETS



16 PIN ZIP* DIP II	\$5.50
24 PIN ZIP* DIP II	\$7.50
40 PIN ZIP* DIP II	10.25

* ZERO INSERTION PRESSURE

5 1/4" DISK DRIVES

MPI B-51	\$295.00
SHUGART SA400	\$295.00

8" DISK DRIVES

SHUGART 8" 801R	\$495.00
REMAX RFD 4000	\$595.00

HARD DISK

LOBO 10 MEGABYTE For Apple with controller	\$4295.00
LOBO 10 MEGABYTE For S-100 with controller	\$4795.00

QT DISKETTES

SOFT SECTOR	
5 1/4" single sided, single density box of 10	\$29.95
SOFT SECTOR	
8" single sided, single density box of 10	\$34.95

S D SYSTEMS

Z-80 STARTER KIT

COMPLETE Z-80 MICROCOMPUTER

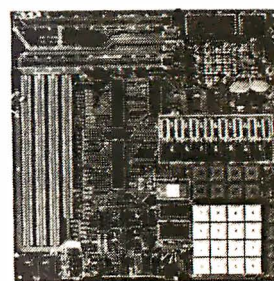

On-board keyboard, display, EPROM programmer, and cassette interface
On-board S-100 interface
Wire-wrap area and room for 2 S-100 connectors
Two 8-bit parallel I/O ports, 4-channel CTC, 5 programmable breakpoints
Examine and change memory, I/O ports, or register
Z-80K (KIT)

\$310.00

\$369.95

TV-1 ONLY \$7.95

R.F. MODULATOR KIT

S D SYSTEMS

SBC-100/200

OR 4 MHz SINGLE BOARD COMPUTER

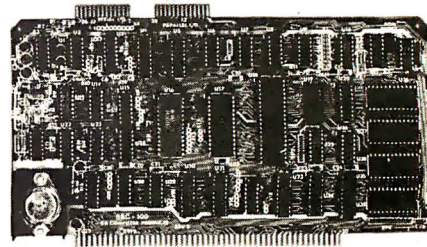

S-100 bus compatible Z-80 CPU
1K of on-board RAM
4 EPROM sockets accommodates 2708, 2716, or 2732
One parallel and one serial I/O port
4-channel counter timer chip (Z-80 CTC)
Software programmable serial baud rates

SBC-100K (2 MHz KIT)	\$280.00
SBC-100AT (2 MHz A&T)	\$340.00
SBC-200K (4 MHz KIT)	\$299.00
SBC-200AT (4 MHz A&T)	\$359.00

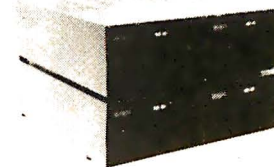

TRS-80 DISK DRIVE (CABLES INCLUDED)

TRS-80 I (5 1/4")	\$395.00
TRS-80 II (8")	\$1095.00
APPLE II	\$1550.00

DISK DRIVE SYSTEMS S-100

MS-800-1 (Drive with case, cables & power supply)	\$1095.00
MS-800-2 (2 Drives with case, cables & power supply)	\$1595.00

PAPER TIGER

- 132/80 Columns; 6 or 8 lines per inch
- 1.75" -9.5" Adjustable Tractor and Friction Feed
- Parallel and Serial Interface
- 98 Character ASCII Set
- 8 Software Selectable Character Sizes
- 110, 300, 600 or 1200 Baud

QT PRICES

PT-132	\$950.00
PT-132G (Graphics & 2K Buffer)	\$1050.00

Look at these QT Values . . .

APPLE PRODUCTS

APPLE KITS & ASSEMBLED BOARDS

(Apple is a TM of Apple Computers, Inc.)

MICRO-MODEM II	\$350.00
WIZARD CONTROLLER for 8" Disk Drive	\$360.00
SORRENTO CONTROLLER for 8" Apple Disk Drive	\$360.00
INTRLO X-10 SYSTEM (turns appliances on/off)	\$275.00
MICRO-MUSIC (Software)	\$180.00
AIO/Serial-Parallel Board Kit	\$115.00
AIO/Serial-Parallel Board A&T	\$155.00
INTEGR Firmware Card	\$179.00
PARALLEL INTERFACE CARD	\$90.00
VISICALC(Business Software Package)	\$124.95
SUPER-MOD II (connects Apple to TV) ..	\$25.00
ROM WRITER (Epromburner) Mountain Hardware (order)	\$175.00
PROGRAMMER AID #1	\$50.00
APPLE CLOCK	\$280.00
SANYO 15" MONITOR	\$295.00

MODEL 920B TELEVIDEO SMART (CRT) TERMINAL

- Reverse Video
- Blinking/blank fields
- Upper/lower case character
- Protected fields
- Non-glare screen
- Underlining
- 12x10 character resolution
- Single stroke editing keys
- Function keys
- Blinking cursor
- TTY keyboard
- Numeric pad
- 9 Baud rates (75-9600 Baud)
- Self-test
- Printer port

SALE PRICE
\$889.00

OPTION:	
2nd Page Memory	\$ 24.95
912B Sale Price	\$789.00
Freight Charge	\$ 20.00

Nationwide Field Service available from General Electric Instrumentation and Communication Equipment Service Shops.

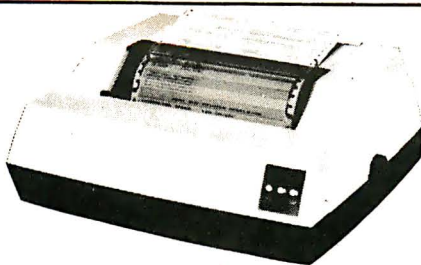

MATCHLESS PRINTER

FEATURES:

- 132/80 Columns, 63 LPM, Bi-Directional, Nominal Thruput
- 100% Heavy Duty Cycle - High Reliability, 100 Million Character Print Head Life
- Sprocket Feed, Variable Forms Width, 4.5" - 9.5"
- Double Width Characters
- 9 x 7 Dot Matrix Character Font
- 12-Channel Electronic Vertical Format Unit

SALE PRICE WITH CABLE

FOR TRS-80 I	\$795.00
FOR TRS-80 II	\$795.00
FOR APPLE	**\$849.00
FOR S-100 (parallel interface)	\$795.00

*Includes parallel interface with documentation. Add freight \$20.00

ESM PRODUCTS

S-100 BARE BOARDS

CB1A 8080 CPU	\$30.95
VB1B Memory Mapped Video Interface ..	\$26.95
VB2 I/O Mapped Video Interface	\$29.95
I02 Parallel I/O Interface	\$34.00
I04 2P + 2S I/O Interface	\$26.95
SB1 Music Synthesizer	\$39.95
OB1 Vector Jump & Prototyping Board ..	\$29.95
MB6B 8K Static RAM	\$25.95
MB7 Low Power 16K Static RAM	\$26.95
MB8 4K 1702 EPROM Board	\$29.95
MB8A 16K 2708 EPROM Board	\$34.95
T1 Terminator	\$26.00
MT1 15 Slot Motherboard	\$45.00
XB1 Extender Board	\$13.50

ESM SOFTWARE, FIRMWARE, MANUALS, MISC.

SMM 8080 Monitor (on two 2708s or eight 1702s)	\$50.00
AIO Apple Parallel Interface Firmware ..	\$25.00
AIO Apple Pascal Patcher Disk	\$25.00
SB1 Music Synthesizer Software	
Paper Tape of MUS-X1 Interpreter	\$ 9.00
CP/M Compatible 8" Disk, containing	
• MUS-X1 Music Interpreter	
• Test Program	
• 18 Encoded Music Selections	\$25.00
SB1 Booklet (with 21 Encoded Music Selections)	\$10.00
Manuals	
SB1 Music Synthesizer Manual	\$10.00
All Other Manuals	\$ 5.00
100 Pin edge connector (short st)	\$ 3.00
100 Pin edge connector (standard ww) ..	\$ 4.00
Card Guides	\$.15

S-100 KITS & ASSEMBLED BOARDS

I04 2P + 2S I/O Interface	
Kit	\$129.95
Assembled & Tested	\$199.95
PB1 2708/2716 EPROM Programmer	
Kit with Textool sockets	\$124.95
Assembled & Tested with Textool sockets	\$174.95
VB1B Memory Mapped Video Interface	
Kit	\$125.00
Assembled & Tested	\$180.00

QT MEMORY EXPANSION KITS FOR TRS-80 APPLE EXIDY 4116-200 ns

Expansion Kit (8 pcs)	\$55.00 ea.
100 pcs	\$5.50 ea.
1,000 pcs	5.00 ea.

MICROPROCESSORS

Z80 (2 MHz)	\$10.95
Z80A (4 MHz)	\$12.95
6502	\$11.25
6800	\$12.50
6802	\$19.50
8035	\$20.00
8035-8	\$20.00
8080A	\$ 3.95
8085A	\$20.00
8086-4	\$60.00
8748-8	\$70.00

STATIC RAMS

21L02 (450 ns)	64/ea./\$1.20 ea.
.....	100 ea./\$1.10 ea.
.....	1,000 ea./\$.95 ea.
2102-1	\$1.35
2114L (450 ns)	\$5.25 ea.
.....	100 ea./\$4.50 ea.
2114L (250 ns)	\$5.50 ea.
.....	100 ea./\$4.75 ea.

UARTS

TR1602B	\$ 3.75
---------------	---------

BAUD RATE GENERATOR

MC14411P	\$10.00
----------------	---------

CHARACTER GENERATORS

2513 (Upper case)	\$10.95
2513 (Lower case)	\$10.95
2513 Upper (5 v)	\$ 9.75
2513 Lower (5 v)	\$10.95
2516 (Sig)	\$13.00
6571	\$13.00
6571AP	\$10.95

VB2 I/O Mapped Video Interface

Kit	\$150.00
Assembled & Tested	\$195.00

VB3 80 Character Video Interface

80x24 Display, 2 MHz	
Kit	\$299.95
Assembled & Tested	\$389.95

80x24 Display, 4 MHz

Kit	\$324.95
Assembled & Tested	\$410.00

Upgrade Kit for 80x24 Display

2 MHz	\$ 69.00
4 MHz	\$ 89.00

I02 Parallel I/O Interface

Kit	\$ 59.00
Assembled & Tested	\$ 89.00

CB1A 8080 CPU

Kit	\$129.95
Assembled & Tested	\$189.95

SB1 Music Synthesizer (4)

Kit	\$199.00
Assembled & Tested	\$279.00

OB1 Vector Jump & Prototyping Board

Kit	\$ 55.00
Assembled & Tested	\$ 85.00

MB6B 8K Static RAM

450 ns RAM	
Kit	\$129.95
Assembled & Tested	\$149.95

250 ns RAM

Kit	\$159.95
Assembled & Tested	\$224.95

MB7 Low Power 16K Static RAM

Kit	\$269.96
Assembled & Tested	\$375.00

CB2 Z-80 CPU

Kit	\$185.95
Assembled & Tested	\$250.00

MB3 4K 1702 EPROM Board

Kit - without EPROMs	\$ 65.00
Assembled & Tested	\$125.00

MB8A 16K 2708 EPROM Board

Kit - without EPROMs	\$ 85.00
Assembled & Tested	\$139.00

T1 Active Terminator

Kit	\$ 34.00
Assembled & Tested	\$ 64.00

MT1 15 Slot Motherboard

Kit (with Connectors)	\$129.95
Assembled & Tested	\$149.95

XB1 Extender Board

Kit (with Connector)	\$ 19.95
Assembled & Tested	\$ 29.95

PLACE ORDERS TOLL FREE
1-800-421-5150
(CONTINENTAL U.S. ONLY)
(EXCEPT CALIFORNIA)

TERMS OF SALE: Cash, checks, money orders, credit cards accepted. Also C.O.D. orders under \$100.00. Minimum order \$10.00. California residents add 6% sales tax. Minimum shipping and handling charge \$2.50. Prices subject to change without notice. International sales in American dollars only.



COMPUTER SYSTEMS INC.

15335 South Hawthorne Boulevard
Lawndale, California 90260
(213) 970-0952



7400 74LS00

SN7400N	19	SN74123N	59	74LS00N	35	74LS164N	119
SN7401N	22	SN74125N	39	74LS01N	26	74LS165N	89
SN7402N	22	SN74126N	44	74LS02N	26	74LS166N	248
SN7403N	22	SN74127N	59	74LS03N	26	74LS167N	189
SN7404N	22	SN74132N	69	74LS04N	39	74LS168N	189
SN7405N	23	SN74136N	95	74LS05N	26	74LS170N	89
SN7406N	23	SN74139N	95	74LS06N	39	74LS173N	89
SN7407N	23	SN74141N	69	74LS07N	39	74LS174N	99
SN7408N	26	SN74142N	295	74LS08N	26	74LS175N	99
SN7409N	23	SN74143N	295	74LS11N	39	74LS181N	220
SN7410N	22	SN74144N	295	74LS12N	39	74LS190N	115
SN7411N	29	SN74145N	62	74LS13N	47	74LS191N	115
SN7412N	29	SN74147N	195	74LS14N	125	74LS192N	98
SN7413N	39	SN74148N	120	74LS15N	26	74LS193N	98
SN7414N	59	SN74150N	99	74LS20N	26	74LS194N	115
SN7416N	29	SN74151N	67	74LS21N	38	74LS195N	89
SN7417N	29	SN74152N	67	74LS22N	38	74LS196N	89
SN7420N	22	SN74153N	67	74LS26N	39	74LS197N	89
SN7421N	35	SN74154N	119	74LS27N	39	74LS210N	524
SN7422N	29	SN74155N	82	74LS28N	39	74LS240N	299
SN7423N	29	SN74156N	89	74LS30N	26	74LS241N	249
SN7425N	29	SN74157N	69	74LS32N	39	74LS242N	229
SN7426N	29	SN74158N	165	74LS37N	79	74LS243N	229
SN7427N	29	SN74160N	95	74LS38N	39	74LS244N	235
SN7429N	45	SN74161N	95	74LS40N	26	74LS245N	89
SN7430N	23	SN74162N	89	74LS42N	79	74LS247N	110
SN7432N	29	SN74163N	87	74LS47N	79	74LS248N	110
SN7437N	29	SN74164N	97	74LS48N	79	74LS249N	169
SN7438N	29	SN74165N	120	74LS51N	26	74LS251N	179
SN7439N	29	SN74166N	97	74LS52N	26	74LS253N	98
SN7440N	24	SN74167N	195	74LS55N	35	74LS257N	98
SN7441N	79	SN74170N	169	74LS73N	45	74LS258N	98
SN7442N	57	SN74172N	595	74LS74N	59	74LS259N	295
SN7443N	79	SN74173N	79	74LS75N	68	74LS260N	69
SN7444N	79	SN74174N	89	74LS76N	45	74LS261N	49
SN7445N	79	SN74175N	89	74LS78N	65	74LS266N	59
SN7446N	79	SN74176N	85	74LS83AN	99	74LS273N	175
SN7447N	59	SN74177N	85	74LS85N	119	74LS275N	449
SN7448N	79	SN74179N	180	74LS86N	45	74LS279N	59
SN7450N	29	SN74180N	215	74LS90N	75	74LS283N	110
SN7451N	23	SN74181N	175	74LS92N	75	74LS290N	129
SN7453N	23	SN74182N	75	74LS93N	75	74LS293N	195
SN7454N	23	SN74184N	195	74LS95N	88	74LS295N	110
SN7455N	29	SN74185N	195	74LS96N	98	74LS298N	129
SN7456N	29	SN74186N	95	74LS107N	45	74LS324N	175
SN7457N	39	SN74188N	390	74LS109N	45	74LS347N	195
SN7472N	34	SN74190N	115	74LS112N	49	74LS348N	195
SN7473N	38	SN74191N	115	74LS113N	49	74LS352N	165
SN7474N	36	SN74192N	85	74LS114N	55	74LS353N	165
SN7475N	36	SN74193N	89	74LS115N	71	74LS358N	149
SN7476N	36	SN74194N	85	74LS123N	119	74LS359N	99
SN7479N	460	SN74195N	85	74LS124N	135	74LS366N	99
SN7480N	59	SN74196N	85	74LS125N	89	74LS367N	99
SN7481N	110	SN74197N	85	74LS126N	89	74LS368N	99
SN7482N	110	SN74198N	139	74LS127N	79	74LS373N	275
SN7483N	55	SN74199N	139	74LS132N	89	74LS375N	69
SN7485N	65	SN74221N	139	74LS138N	89	74LS375N	69
SN7486N	39	SN74225N	95	74LS139N	89	74LS377N	195
SN7489N	175	SN74273N	105	74LS145N	125	74LS385N	195
SN7490N	29	SN74279N	89	74LS146N	149	74LS386N	65
SN7491N	65	SN74283N	215	74LS151N	79	74LS393N	195
SN7492N	52	SN74284N	390	74LS153N	79	74LS393N	195
SN7493N	49	SN74285N	390	74LS154N	249	74LS395N	175
SN7494N	72	SN74290N	125	74LS155N	119	74LS399N	290
SN7495N	65	SN74296N	65	74LS156N	99	74LS424N	229
SN7496N	79	SN74355N	95	74LS158N	75	74LS670N	295
SN7497N	310	SN74366N	68	74LS158N	75	74LS670N	295
SN74100N	99	SN74367N	79	74LS160N	89	81LS95N	199
SN74107N	32	SN74368N	79	74LS161N	115	81LS96N	199
SN74109N	53	SN74380N	190	74LS162N	98	81LS97N	199
SN74110N	190	SN74382N	190	74LS163N	98	81LS99N	199
SN74112N	29	SN74490N	190				
SN74122N	39						

BECKMAN Digital Multimeters

MODELS TECH 800 AND TECH 500

AS LOW AS \$100.00

TECH 300 Digital Multimeter \$100
 TECH 310 Digital Multimeter \$130
 VC-200 Vinyl Carrying Case \$10
 DC-202 Deluxe Carrying Case \$24
 HV-211 High Voltage Probe \$36
 RP-221 PIP Probe \$35
 PC-201 AC Current Clamp \$42
 DL-241 Deluxe Test Lead Kit \$10
 TL-242 Square Test Leads \$5

Circle 2 on Models - The TECH 310 has auto-zero feature's functions. 29 ranges and 0.5% Vdc accuracy. The TECH 300 has 0.5% Vdc accuracy and all the above features, but without auto-zero's "continuity function" of the TECH 310.

PROTECTION AGAINST TRANSIENT OVER VOLTAGE SAVINGS ON ENERGY COSTS

URGONICS

POWER-SENTRY™ INT ERCEPTOR SURGE-LESS SOCKET™

The Power-Sentry and Intceptor Surge-Less Socket protect protection of all electronic appliances by absorbing an 120 Vdc surge (up to 50 Hz power line). The unit's consist of a two stage solid state circuit board protected by a 3 amp fuse.

Power-Sentry \$150
 Intceptor Surge-Less Socket \$180

THE BONE FONE

• SKIERS
 • JOGGERS
 • SKATERS
 • CYCLERS

You must hear it and feel it to believe it!

AM/FM stereo surrounds and fills your body with sound. No earplugs. You wear it!

\$65.95

FLOPPY DISK DRIVES

MPJ B51-51/40 tracks	279.00
Shugart SA4005/35 tracks	299.00
Shugart 800-801R B5	475.00
Siemens Shugart Compatible Model	
FDD-120-B0	429.00
WANG/SIEMENS Dual 5 1/4" Drive	1,295.00
MPI B52 5 1/4" Dual	395.00
WANG/SIEMENS 82 Dual 5 1/4"	395.00
WANG/SIEMENS 82	290.00

MONITORS

Sanyo 9" \$169.95	
Sanyo 12" 279.00	
Leeceex 12" 139.95	
Motrolara 12" High Resolution, 22 MHz, QEM Model	
#M-3000-340 219.00	
Zenith 13" Color Monitor 499.00	
MGA 13" Color TV 349.00	
VAMP 15" Color Monitor 575.00	
VAMP 15" Color Monitor 449.00	

CONTINENTAL SPECIALTIES

Model 3001 Digital Capacitance Meter	275.00
Model 333 Tri-Mode Comparator	295.00
Model LM-3 40-channel Logic Monitor	585.00
Model LM-1 Logic Monitor	60.00
Model LP-2 Logic Monitor	147.00
Model 2001 Switchable Function Generator	185.00
Model 5001 Universal Counter-Timer	3600.00
Model 6001 50MHz Frequency Counter	3850.00
MAX-100 100 MHz Portable Frequency Counter	1450.00
PS-500 500 MHz Decade Prescaler	7000.00
MAX-50 50 MHz Handheld Frequency Counter	1450.00
MAX-550 550 MHz Handheld Frequency Counter	7700.00
Model 4001 Pulse Generator	8350.00
Model DP-1 Digital Puffer	8300.00
Logic Probes	
Model LP-1 Digital Logic Probe	5000.00
Model LP-2 Economy Logic Probe	1470.00
Model LP-3 High Speed Logic Probe	7700.00
Model LPK-1 Logic Probe Kit	2195.00
Logic Probe Accessories	21.00
Model LTC-1, LTC-2 Logical Analysis Kits	220.250

ADVANCED COMPUTER PRODUCTS

Apple II 16K or Apple II. Plus \$990

16K Apple Upgrade Kit \$62.95

Hi-Speed Serial I/O	\$174.95	OS65 Digi-Sector	\$349.00	Integer ROM Card	\$175.00
Centronics Printer I/O	199.95	Apple Graphics Tablet	79.00	Proto Card	21.95
Applesoft II Firmware	174.95	DC Hayes Modem II	349.95	M & R Modulator	29.95
Apple Clock	189.95	Disk II w/Controller	475.00	Sanyo Cassette	54.95
Intro X-10 System	269.95	Disk III	575.00	16K Upgrade Kit	62.95
Intro X-10 Controller	179.95	Parcal Lang System	475.00	Apple Radio Car	159.00
All Music Synthesizer	259.95	Parcal Printer Card	165.00	8" Floppy Controller	350.00
16 Ch Analog Input	249.95	Communications Card	210.00	Heuristics SpeechLab	179.00
2 Ch Analog Output	164.95	Business Software Pkg	625.00	Romplus +	169.00
13-Key Keypad	119.95	Conus 10 Megabyte Drive		SuperTalker	279.00
Vis-Calc	149.95		4625.00	Cashier	2500.00

ATARI® 800 & 400 Personal Computer System

ATARI 800 \$899.00
ATARI 400 \$499.00

ATARI 800 Includes: Computer Console, BASIC Lang. Cartridge, Education System Master Cartridge, BASIC Language Programming Manual, 800 Operator's Manual w/Notebook, Atari 410 Program Recorder, 8K RAM Module, Power Supply, TV Switch Box.

Peripherals		Education System Cassette Programs	35.00	Spelling	35.00
Disk Drive	599.00	US History	35.00	Basic Electricity	35.00
Printer	499.00	US Government	35.00	Basic A/B/C	35.00
Program Recorder	499.00	Supervisory Skills	35.00	Basic Math & Program Cassette	35.00
Software - ROM Cartridges		World History (Western)	35.00	Guide to BASIC Programing	19.00
Education System Laser Cartridge	2800	Business Dictionary	35.00	BASIC Game Programs	1800
Mathematics	5500	Accounting Procedures	35.00	Math Review	175.00
Assembler Debug	5500	Principles of Accounting	35.00	8K RAM Memory Module	1100
Life Science	4200	Physics	35.00	16K RAM Memory Module	2125.00
Life Science	4200	Great Classics/English	35.00	Flashdisk	3500
Super Breakout™	4200	Bus.ess Communications	35.00	Blank Disks/ettes	500
Music Composer	5500	Basic Psychology	35.00	Disk II Cartridge	5.00
Super Rug™	4200	Electronics	35.00	Assembly Cartridges	35.00
Computer Chess	3500	Auto Mechanics	35.00	Driving Controller Par	1800
Home/Inmate	5500	Principles of Economics	35.00	Joystick Controller Par	1800

TEXAS INSTRUMENTS INCORPORATED

99/4 PERSONAL COMPUTER

Superior Color, Music, Sound and Graphics - and a Powerful Extended Basic - All Built In.

\$1099.00

Commodore PET AS \$775.00

DISCOUNT PRICES

2001-BK	775.00	2023 B0-Cat Plain Paper Printer	695.00
2001-16KN	975.00	2040 Dual Max Disk Drive	1250.00
2001-16KB w/ep	990.00	Pet IEEE Cable	39.95
2001-32KN	1250.00	IEEE to EEE Cable	49.95
2001-32KB Reg	1250.00	C2N External Cassette Deck	95.00
2001-85-Cat Max Printer	795.00		

COMPUWRITE Zemco, Inc.

Model 44 with cruise control **\$174.95**

Model 41 without cruise control **\$154.95**

An onboard navigational computer for automobiles, trucks and recreational vehicles. Features cruise control, fuel management system, trip computer, multifunctioned quartz crystal time source, plus many other functions.

TEXAS INSTRUMENTS LANGUAGE TRANSLATOR THAT SPEAKS

FREE Language Module with purchase til June 30.

The world's first handheld electronic translator to pronounce and display words, phrases and sentences.

Sugg. Ret. 300.00 **\$279.95** ACP Price

LANGUAGE MODULES Sugg. Ret. 60.00 each

ENGLISH • SPANISH **\$54.95**
 FRENCH • GERMAN

TEXAS INSTRUMENTS ELECTRONIC DIGITAL THERMOSTAT

The Intelligent Way To Cut Energy Costs Year-Round

Use Only The Energy You Really Need - With The Touch Of A Button

The Texas Instruments Electronic Digital Thermostat is the intelligent way to cut energy costs year-round. A fully automatic, 24-hour, set and forget comfort system for the home. It can actually pay for itself in less than one season.

Sugg. Ret. \$160.00 ACP Price **\$104.95**

SINGLE BOARD COMPUTER SELECTION GUIDE

BOARD	PROCESSOR	ACP PRICE	ENCLOSURE
KIM-1	6502	169.00	Add 29.95
SYM-1	6502	239.00	Add 39.95
Cromemco	Z80	409.00	N/A
SD-SBC100	Z80	239.00	N/A
AIM 65	6502	375.00	Add 49.95
Cosmac Vip	1802	199.00	Inc.

CMOS

CD4000	29	CD4093	95
CD4001	22	CD4094	295
CD4002	22	CD4098	95
CD4006	139	CD4099	225
CD4007	29	MC14408	1295
CD4008	139	MC13409	1295
CD4009	59	MC14410	1295
CD4010	59	MC14412	1295
CD4011	29	MC14415	895
CD4012	29	MC14419	495
CD4013	49	CD4501	39
CD4014	139	CD4502	165
CD4015	139	CD4503	125
CD4016	59	CD4505	895
CD4017	119	CD4506	75
CD4018	119	CD4507	95
CD4019	49	CD4508	395
CD4020	139	MC14412	1295
CD4021	149	CD4511	139
CD4022	129	CD4512	139
CD4023	38	CD4515	395
CD4024	79	CD4516	169
CD4025	39	CD4518	39

The Supermarket for TRS-80* Add-on Components (and other computers, too)

In stock now. Immediate delivery.

The VISTA V-80 Disk Drive System

- 23% more storage capacity than TRS-80
- 120 day warranty
- 40 track patch at NO CHARGE

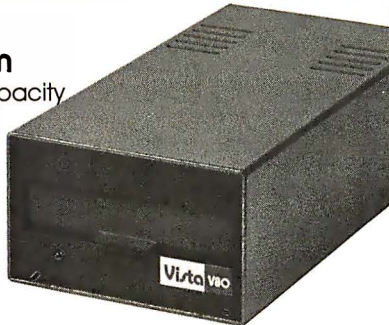

Single drive system \$ 395.00
 Two drive system \$ 770.00
 Four drive system \$ 1450.00
 Two drive cable \$ 29.95
 Four drive cable \$ 39.95

The VISTA V-80 Expansion Module

- Provides double density modification to your current Radio Shack interface (lets you format diskettes in either single or double density).
- Increases storage capacity up to 204K bytes (on single 40 track drive).
- Includes all hardware and software.

\$239.00

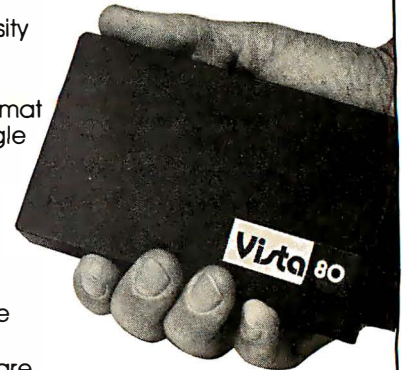

The VISTA Model II

- Provides one, two or three drives.
- Adds up to 1.5 million bytes of on-line storage.
- 120 day warranty
- Does everything Radio Shack's expansion system will do...for less!



\$1000.00 Single drive Expansion System
\$1550.00 Two drive Expansion System
\$2100.00 Three drive Expansion System
\$ 525.00 Additional drives alone

The TRS-80 Printers

Centronics 730... **\$945.00**
 7x7 dot matrix-80 column

Anadex DP8000... **\$895.00**
 9x7 dot matrix-80 column

VISTA Printer... **\$745.00**
 5x7 dot matrix-80 column

Cables **\$27.50 each**



Other Products

1. VISTA Verbatim diskettes (hard or soft sector) Certified 40 track **\$ 38.95**
2. 16K RPM upgrade kits, guaranteed for 120 days.
PRIME PRODUCT **\$ 74.50**
3. NEW! DOS + **\$ 110.00**
4. LNW expansion bare board **\$ 66.95**
5. H.C. Pennington book, **TRS-80 Disk and Other Mysteries** **\$ 18.95**
6. DDT Disco-Tech disk drive timer **\$ 19.95**
7. Cryptext (An Encryption Module) **\$299.00**

Add On Drives

- | | | |
|---------|---------------------------------------|-----------------|
| MPI B51 | 40 Track, Double Density-204K | \$275.00 |
| MPI B52 | Dual Head, Double Density-408K | \$375.00 |
| Siemens | FDD100-5 40 Track Double Density 204K | \$275.00 |
| Siemens | FDD100-5 Flippy, records both sides | \$290.00 |
| Siemens | FDD100-8 8" Single Sided Drive | \$448.00 |

The VISTA V-200 for Exidy

- Completely packaged system, tested and ready to plug in, includes: power supply, two 40 track drives, case, controller, all cabling and total CPM documentation.
 - Storage capacity from 400K to 1.2 meg.
 - System software-VISTA CP/M Disk Operating System and BASIC-E Compiler recorded on 5-1/4" diskettes.
- Price: Starting as low as **\$1199.00**

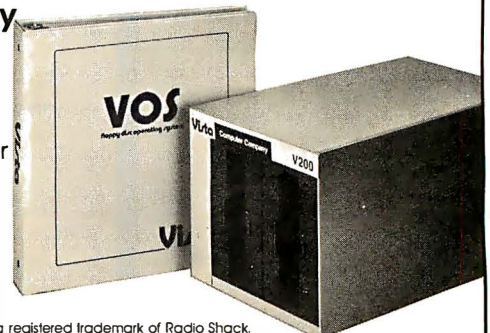

CALL TOLL-FREE 800-854-8017

The Vista Computer Company 1401 Borchard Street • Santa Ana, California 92705 • 714/953-0523

*TRS-80 is a registered trademark of Radio Shack.

Unclassified Ads

FOR SALE: Ohio Scientific Challenger 2P, Sup'r mod II TV interface, and cassette recorder ready to hook up to your TV or monitor. Original cost \$750, will sacrifice for \$575. First certified check or money order gets system, manuals, and programs. R A Post, 9111 Pawnee Ln, Leawood KS 66206.

FOR SALE: Expando Black Box printer with base and cover, \$385. Also, ESP-I on disk, \$20. Paul G Kutty, Old County Rd, Frankestown NH 03043, (603) 547-2777.

WANTED: TRS-80 programs wanted to swap; Level 2. Write or send tape to G M Fuller, 16 Maryburn Rd, Twizel, NEW ZEALAND.

SORCERER USERS: I am a games fanatic and have many games programs. Will trade one for one. Send cassette with game and receive another. I am specially interested in graphics and machine-language programs. I will also help with or exchange ideas on any other original programs. I have university degrees in computing and math. Send program (preferably airmail) to Paul Balin, 19 Starkey St, Forestville, NSW 2087, AUSTRALIA.

WANTED: Correspondence with people using systems based on Intel's SBC 80/10; specifically those interfacing the SBC with a floppy disk and/or using CP/M and Pascal. J Scott Nintzel, 3843 Granada Ln N, Oakdale MN 55109, (612) 770-6926.

FOR SALE: Set of BYTE magazine from first issue to present; complete except for issue number 11, August 1976. Peter Ricke, 1383 Rockland, POB 546, Calumet MI 49913, (906) 337-0180.

FOR SALE: PET 8 K computer with keyboard, video display, and cassette interface storage. Brand-new condition. Must sell. \$350. Bruce Tempone, (215) 446-8693 after 6 PM ET.

WANTED: I would like any free booklets, pamphlets, catalogs, or brochures on computers and electronics. Anthony Atella, 269 Beckwith St, Cranston RI 02910.

FOR SALE: TRS-80 computer. Level II/16 K with numerical keyboard. Includes game tapes for blackjack, backgammon, and Microchess. Also, a tape which allows the computation of elliptical and parabolic orbits from three positions, elliptical orbit from four positions, and elliptical and parabolic positions from elements. Instructions included. \$650. You pay shipping. Brian Warner, Rt 3, POB 803, Mullins SC 29574

FOR SALE: KIM-1 with cassette recorder, power supply, and all documentation. Includes Microchess and other game software on cassette. Works perfectly. \$140 or best offer. Jeff Thompson, 1700 Washington Creek Ln, Dayton OH 45459, (513) 435-3169.

FOR SALE: Benrus video display module. 7 by 5 by 17 inch module contains 6 by 10 cm high-frequency video display, X and Y amplifiers (sensitivity .1 V/cm), z-axis modulation, and high-voltage supplies. Completely transistorized, operates from 110 VAC. High-frequency response extends beyond 30 MHz. Excellent for computer graphics or for construction of a high-frequency scope; used, excellent condition, \$100. Also, have limited number of 4027, 250 ns 4 K by 1 dynamic programmable memories equivalent to 4096 and 2104A; \$1.50 each. M Bickerton, 2631 Wharton St, Philadelphia PA 19146, (215) 467-3549.

FOR SALE: Apple II computer with 48 K, 250 ns programmable memory, disk with controller, three boxes of diskettes, all original manuals, and programs in original container. Less than three months old, barely used, in perfect condition. A lot of software included. Original cost over \$1800. Will sacrifice at \$1500. Chase Roh, 1803 Old Maple Ln, Savoy IL 61874, (217) 356-1900 or 398-0700.

WANTED: Back issues of the *Radio Shack TRS-80 Microcomputing Newsletter*. I will pay \$0.50 an issue plus postage. Send information on the issues you have. David Fischer, Branch POB 1394, Rome NY 13440, (315) 339-1037 days.

FOR SALE: ELF II system with full BASIC and 12 K programmable memory. Also included: ASCII keyboard, video display board, Giant Board, 5 A power supply, cassette recorder, and full documentation. Plus cabinets for ELF II and ASCII keyboard. \$825 for complete system, plus shipping. Will throw in Tiny BASIC and Short Course programming manuals, plus game cassette package. Kevin Mast, 308 Jackson Ave, De fiance OH 43512, (419) 782-6147.

FOR SALE: Cromemco multichannel microcomputer analog interface kit (new, unassembled in original packing) Model D-7A/I/O. Original price \$145; first offer over \$40 gets it. I will pay postage. V Roningen, 4707 9th St S, Arlington VA 22204, (703) 521-1451.

FOR SALE: Heathkit H8 with 16 K of memory and serial input/output (I/O). Also includes Info 2000 dual 8-inch disk drives and controller. Disk controller upgrades system to a Z80 and runs under CP/M. By flipping a switch, system will run under Heath cassette software (two cassette drives included). Includes many extras, too. \$1000 takes all plus a bonus of an H10 paper-tape reader/punch free. R Nicosia, 234 41st St, Lindenhurst NY 11757.

FOR SALE: AIM-65 microcomputer system. 4 K programmable memory. Assembler/Editor read-only memory. Standard enclosure. Extra paper. Excellent condition. Hardly used. \$480 or best offer. David Kusek, POB 24, Storrs CT 06268, (203) 429-0600.

FOR SALE OR SWAP: Okidata CP110 matrix bidirectional printer. Upper and lowercase with Centronics-type interface. Takes Teletype-style roll paper. Comes complete with service manual, thirteen extra ribbons, and about \$90 extra paper rolls. Printer itself sells new for about \$1800. Will sell all for \$500 FOB Berkeley. Or will swap for heavy-duty (Model B i/O writer?) IBM Selectric. Dick Blumenstein, 202 Stanford Ave, Kensington CA 94708, (415) 524-5666.

WANTED: People in the San Francisco Bay Area interested in creating an outstanding, alternative computer network and information resource—user owned and run. Billy Smith, 2325½ Howe St, Berkeley CA 94705, (415) 848-0884.

WANTED: Word processor in good working condition. Will consider Wang, CPT, Ty-Data Series 3600, Quintype 70, or others. Also, need Friden Justewriter and Flex-o-riter. Give price, age, all pertinent details. Albert Pile, R 1, Box 67, Bardstow KY 40004.

FOR SALE: IBM Selectric Model 735 input/output writer. Can be used as a typewriter or computer terminal. Excellent condition—recently refurbished by IBM. Uses Correspondence Code (easily converted to BCD or ASCII in hardware or software). Includes user manual and complete computer-interface instructions. \$425 plus shipping. Video monitor: Ultronic Videomaster 12-inch high-resolution (15 MHz) raster display. Excellent condition, with circuit diagram. \$60. Joe Blau, 2344 Evergreen St, Yorktown Hts NY 10598, (914) 245-1015.

FOR SALE: 4 K programmable-memory circuits. Thirty-two UPD414D (Mostek MK4015N) from converting two Exidy Sorcerers from 8 K to 32 K. Make me an offer for some or all. Steven Larky, 2423 Nottingham Rd, Bethlehem PA 18017.

WANTED: Dental software for the Apple II. Anything that can be used in a dental office. Interesting games, too. Dr Kahn, 51 Upper Sheep Pasture Rd, Setauket NY 11733.

FOR SALE: TRS-80, Level 2.2 with 32 K, expansion interface, Radio Shack disk, power supply, keyboard, cassette unit, manuals. Software includes Invasion Force, Business Income Tax Package, and eleven diskettes all in perfect condition. Shipped prepaid. \$1850. Jim Handy, 2102 Courtland Cir, Carrollton TX 75007, (214) 492-3670.

WANTED: Software in the scientific, business, engineering, and technical fields that has been written, adapted, purchased, and/or tested to run on the new HP-85 in 16 K or 32 K. I am a new owner and would like to trade information about using various peripherals with the HP-85. Dan Berkeley, POB 2972, Littleton CO 80161, (303) 781-0320.

FOR SALE: ASR33 Teletype keyboard-printer terminal with tape reader-punch. Fully operational with documentation and could be interfaced to any computer. With stand, \$450, or without stand, \$400. Shipping extra. Patel, 418 Guild Hall Dr, Columbia SC 29210, (803) 781-5647.

FOR SALE: Ohio Scientific Challenger 1P, 8 K of programmable memory. Javelin video display monitor. Cassette recorder and twelve programs included. \$450 for the entire system. Ben Galewsky, 1035 Dowlen Rd, Beaumont TX 77706.

FOR SALE: Programmable memory for S-100 bus systems. Ithaca Audio 8 K programmable memory; \$100. Also, an 8 K programmable-memory board by Quantronics Problem Solvers, with phantom line; \$125. A 2708 programmable read-only memory programmer by Optimal Technology; \$40. Hal Skurnick, 14 LeRoy Pl, Chappaqua NY 10514, (914) 238-4961.

FOR SALE: Brand-new microcomputer. Commodore PET 2001-8 with 32 K and video display. Best reasonable offer. John W Cook, 8670 Tanglewood Trl, Chagrin Falls OH 44022, (216) 543-7785.

FOR SALE: KIM-1 with power supply, 1 K programmable memory, 2 K read-only memory, user manual, wall-size schematic, hardware manual, programming manual plus *Programming a Microcomputer: 6502*. Asking \$125 or best offer. Ed, (617) 544-2207 in PM.

FOR SALE: Tektronix 4051. 32 K programmable memory. All manuals included. \$3000. Jay Ross, POB 247, Ortonville MN 56278, (612) 839-6181.

March BOMB Ciarcia Wins With Ease

"Ciarcia's Circuit Cellar" continued as the best-liked feature in the BOMB voting, as Steve Ciarcia won again with his article "Ease into 16-Bit Computing" (page 17). It placed 2.30 standard deviations above the mean. Steve will take home another \$100 first-place prize. Second place in the tally went to Editor-in-Chief Chris Morgan for his article "Hewlett-Packard's New Personal Computer, The HP-85" (page 60), which had a standard deviation of 0.91 above the mean. Third place was taken by James R Lewis for "TRS-80 Performance, Evaluation by Program Timing" (page 84), and fourth place was taken by D Martin Harrell for "Operation Codes for 8080, 8085, and Z80 Processors" (page 194.) ■

UNCLASSIFIED POLICY: Readers who are soliciting or giving advice, or who have equipment to buy, sell or swap should send in a clearly typed notice to that effect. To be considered for publication, an advertisement must be clearly noncommercial, typed double spaced on plain white paper, contain 75 words or less, and include complete name and address information.

These notices are free of charge and will be printed one time only on a space available basis. Notices can be accepted from individuals or bona fide computer users clubs only. We can engage in no correspondence on these and your confirmation of placement is appearance in an issue of BYTE.

Please note that it may take three or four months for an ad to appear in the magazine.

Reader Service

To get further information on the products advertised in BYTE, fill out the reader service card with your name and address. Then circle the appropriate numbers for the advertisers you select from the list. Add a 15-cent stamp to the card, then drop it in the mail. Not only do you gain information, but our advertisers are encouraged to use the marketplace provided by BYTE. This helps us bring you a bigger BYTE. *Correspond directly with company.

Inquiry No.	Page No.	Inquiry No.	Page No.	Inquiry No.	Page No.	Inquiry No.	Page No.
249	AB Computers 258	263	Electrolabs 268, 269	238	Multi-Business Comp Sys 247	90	Siemens Electr 145
70	Ackerman Digital 110	113	Electronic Control Tech 167	51	National CSS Inc 81	74	Sigma Int'l 117
159	Ackerman Digital 211	242	Electronic Systems 252, 253	131	National Multiplex Corp 191	139	Sirius Sys 198
274	Adv Computer Prod 284, 285	243	Electronic Systems 254	88	NEECO 143	71	Small Business
29	Altos 51	223	Engineering Analysis Software 239	102	NEECO 158		Appl 111
121	American Micro Prod Inc 177	141	Escon 199	104	NEECO 159	178	Small Sys Design 223
176	American Square Comp 222	24	Essex Publishing 40	9	Netronics 16	77	Smoke Signal Broadcasting 123
259	Ancrona Corp 264	185	Excom 227	96	Netronics 153	46	Softag 74
18	Anadex Inc 27	151	Executive Busi Sys 205	25	Netronics 153	142	Softech 199
114	Anderson Jacobson 169	222	Exeter Int'l Corp 239	30	North Star 41	169	Software Devel & Training 219
145	Anderson Jacobson 201	214	Faragher & Assoc 237	203	North Star 53	85	The Software Exchange 137
36	APF Electronics Inc 61	210	Farnsworth Computer 237	120	Northwest Computer Serv 235	86	The Software Exchange 138
84	Apparat 136	220	Feith Software 239	56	Ohio Scientific Instr CV IV	231	The Software Review 241
6	Apple Computer 13	196	FMG Corp 234	26	Okidata Corp 89	190	Software Works 231
38	Applied Digital Data Sys (ADDS) 65	123	Folio Books 180, 181	39	OK Machine & Tool 43	173	The SoHo Group 221
32	Artex Electronics 56	258	Fordham Radio 264	108	OK Machine & Tool 163	256	Solid State Sales 262
254	ASAP Comp Prod Inc 261		Frederick Computer Prod 235	192	Oliver Adv Eng (OAE) 80	111	Sorcim 165
235	A-T Enterprises 245	59	Gimix 186	*	OnComputing 209	170	Sorrento Valley Assoc 219
*	ATV Research 237	99	Godbout 155	41	Orange Micro 68	10	Southwest Tech Prod Corp CV II
166	Automated Simulations 216	61	Graham Dorian 15	61	Oregon Software 94	152	Spectrum Software 206
49	Avionic Enterprises Inc (AEI) 78	160	GW Computers Ltd 211	124	Osborne/McGraw-Hill 185	201	Starburst Comp Grp Inc 235
43	Axiom 71	117	H & E Computronics 172	216	OSM Computer Corp 231	219	Start Electronics 239
28	Base 2 Inc 47	118	H & E Computronics 173	199	Owens Associates 76	91	Strobe Inc 147
188	John Bell 227	87	Hardside 139	289	Pacific Exchanges 235, 241	125	Structured Sys Grp 187
*	Art Bennett 229	98	Hayden Book Co Inc 154	199	Page Digital 271	4	SSM 11
217	Beta Business Sys Inc 239	115	D C Hayes Associates Inc 170	253	Pan American Electr 260	180	SubLOGIC 92
*	Beta Computer Devices 217	27	Hewlett-Packard 45		(A Radio Shack Auth Sales Ctr)	208	Sun Comp Serv Ltd 169
17	BIZCOMP 26	52	High Tech Inc 82	197	PCD Systems Inc 234	250	Sunny Int'l 258
55	Boschert 87	241	Hobbyworld Electronics 251	67	Percom Data 23	92	SuperSoft 149
255	Budget Comp Prod 262	133	Impulse Electronics Inc 194	281	Pericom Data 104, 105	146	SuperSoft 202
*	BYTE Back Issues 229	136	Inco Inc 197	100	Peripherals Plus 186	179	SuperSoft 223
*	BYTE Books 236	276	Industrial Micro Systems CV III	100	Personal Comp Sys 156	40	Sybox 67
134	BYTE Seminar 195	209	Infinite Inc 237	*	Personal Computing '80, 179	22	Symtec Inc 37
*	BYTE Subscriber 231	44	Infosoft Systems Inc 72	101	Personal Software 157	65	Synchro Sound 99
*	BYTE WATS 233	31	Integral Data Systems Inc 55	11	Power One Inc 17	54	Synergetic Comp Prod 84
158	C & S Electronics 211	186	Integrand 227	268	Priority One 274, 275	78	Tarbell Electr 125
14	California Computer Sys 20, 21	426	Intel insert (between pp 16 & 17)	278	Priority One 276	42	Tech Sys Consultants (TSC) 69
270	California Digital 270	232	Intelligence Systems Ltd 241	37	QT Computer Sys 63	225	Tec-Mar Inc 240
177	Cambridge Develop Labs 223	224	Interface Inc 239	273	QT Computer Sys 282, 283	175	Texas Electr Instr (TEI) 221
79	Centrai Data 129	73	Int'l Data Sys (IDS) 115	161	Quality Software 212	20	3 M Company 31
7	Chrislin Industries 14	23	Intertec Data Sys 39	94	Quasar Data Products 151	57	Robert Tinney Graphics 193
132	Chrislin Industries 192	50	Intertec Data Sys 79	72	Quay Corp 113	207	Tiny C 90
236	Circle Computer Sales 142		InterThink Inc 188	260	Quest 265	156	TL Industries 237
248	Cleveland Consumer Computers & Components 257	64	Ithaca Intersystems 9	171	Racet Computes 219	206	TransNet 208
137	Compas Microsystems 197	267	Ithaca Intersystems 98	12	RCA Solid State 18	183	UC Products 225
109	Complete Business Systems 163	271	Jade Comp Prod 272, 273	58	RCA Solid State 91	*	United Software 133
272	CompuMart 280, 281	198	Jameco Electronics 278, 279	3	RITAM Int'l 8	155	US Robotics 207
189	CompuMax 229	110	Jini Microsystems 235	239	RNB Enterprises 249	165	Vector Electronics 215
66	CompuServe (MicroNET) 103	48	JRT Sys Inc 164	277	Rochester Data 169	204	Videx 235
262	ComputerCity 267	* KEY-TRONICS 239	48	174	S-100 Inc 221	275	Vista Computer 286
247	Computer Enhancements Co (CECO) 6	226	B. Kleiman 241	206	S & A Data Sys 235	246	VR Data 256
*	Computer Factory 85	15	Konan Corp 22	164	Sara-Tech 215	252	Wameco 260
168	Computer Furniture & Access 218	221	Larks Electr & Data 239	282	Scion Corp 5	*	Whitesmith's Ltd 127
*	Computer Hardware 34	221	Lifboat 100, 101, 200	93	Service Tech 186	237	Wintek Corp 247
212	The Computer Place 237	116	Lobo Drives 171	292	Shepardson Micro Sys 150	205	Worldwide Electronics 235
181	Computer Specialties 225	163	Lomas Data Products 215	*	Shugart 7	149	Zilog Inc 203
195	Computer Prod Int'l 233	229	M-Software 241			147	ZS Systems 203
153	Computers Wholesale 207	5	Macrotronics 12				
184	Computex 226	230	Macrotronics 241				
240	Concord Computer Components 250	*	Markline 25				
35	Corvus Systems 60	148	Marketline 203				
81	Cover Craft 132	191	Marymac Industries Inc 231				
261	The CPU Shop 266	*	Meas Sys & Controls 33, 247				
227	Cranial Labs 241	182	MICAH 225				
1	Cromemco 1, 2	223	Micops Inc 239				
82	CSSN (Computer Serv Sys Network) 134, 135	89	Microamerica Distributing 143				
233	Custom Business Computers 241	103	Microamerica Distributing 158				
112	CT MicroCOMPUTER Inc 167	105	Microamerica Distributing 159				
*	Cybernetics Inc 191	127	Micro Ap 189				
266	Dai-Comp 277	193	Micro Appl Grp (MAG) 233				
213	DAR Sales 237	251	Micro Business World 259				
*	Data Access 217	106	Micro-Computer Brokers 160				
228	Data Acquisition Sys Inc 241	*	Micro Computer Discount 229				
130	Datadisk Systems 191	83	Microcomputer Tech Inc 136				
68	Data Management Labs 107	202	Microcomputer Tech Inc. 235				
218	Data Prod Maintenance Corp 239	34	MicroDaSys 59				
107	Data Speed 161	63	Micro Data Base Sys 97				
154	Datek Sys Inc 207	45	Micro-Integration Inc 73				
257	Delta Products 263	162	Micromail 213				
119	DG Electronics 175	157	Micro Management Sys 210				
76	Diablo (Div of Xerox) 119	215	Micro Mart 237				
140	Digital Graphic Systems 199	194	Micro Mike's Inc 233				
95	Digital Marketing 152	*	Micro Pro Int'l 120, 121				
122	Digital Pathways 95	211	Microsette 237				
244	Digital Research: Comp 255	47	Microsoft 75				
60	Digital Research Corp (CA) 93	33	Microsoft (Cons Prod Div) 57				
280	Digitus Corp 224	21	Microtek 35				
167	Discount Software Group 217	138	Microware Sys 197				
129	Disc/3 Mart Inc 191	75	The Micro Works 118				
150	Dynacomp 204	53	Micro World 83				
187	Ecosoft 201	245	Mikos 256				
		143	Mini Computer Suppliers 201				
		80	Mini Micro Mart 131				
		17	Mini Micro Mart 220				
		19	Morrow/Thinker Toys 29				
		13	Mountain Hardware 19				
		128	Mountain Hardware 190				
		69	MT Microsystems Inc 109				

BOMB

BYTE's Ongoing Monitor Box

Article #	Page	Article	Author
1	24	An Answer/Originate Modem	Parsons
2	42	I/O Expansion for the TRS-80, Part 2: Serial Ports	Ciarclia
3	64	Z80 Op Codes for an 8080 Assembler	Powers
4	88	My TRS-80 Talks to My Cromemco Z-2	Hallen
5	96	Communication in Two Directions	Tichener
6	108	Understanding ISAM	Gates
7	122	A Time-Sharing/Multi-User Sub-system for Microprocessors	Kinzer
8	140	A Telephone-Dialing Microcomputer	Renbarger
9	214	Interpersonalized Media: What's News?	Levin
10	230	Fifteen: A Game of Reversi (or, Tic-Tac-Toe Revisited)	Rheinstein

Bomb results on previous page

For fastest service transfer mailer label from wrapper to coupon provided at the right. Requests cannot be honored unless zip code is given. This card valid for 90 days only.

NOTE—If label is missing or defaced fill out coupon carefully —PLEASE PRINT—this is only way to get requested material to you.

Name _____
 (Title) _____
 (Company) _____
 Address _____
 City _____ State _____ Zip _____

1 21 41 61 81 101 121 141 161 181 201 221 241 261 281 301 321 341 361 381 401 421 441 461 481 501 521 541 561 581 601 621 641
 2 22 42 62 82 102 122 142 162 182 202 222 242 262 282 302 322 342 362 382 402 422 442 462 482 502 522 542 562 582 602 622 642
 3 23 43 63 83 103 123 143 163 183 203 223 243 263 283 303 323 343 363 383 403 423 443 463 483 503 523 543 563 583 603 623 643
 4 24 44 64 84 104 124 144 164 184 204 224 244 264 284 304 324 344 364 384 404 424 444 464 484 504 524 544 564 584 604 624 644
 5 25 45 65 85 105 125 145 165 185 205 225 245 265 285 305 325 345 365 385 405 425 445 465 485 505 525 545 565 585 605 625 645
 6 26 46 66 86 106 126 146 166 186 206 226 246 266 286 306 326 346 366 386 406 426 446 466 486 506 526 546 566 586 606 626 646
 7 27 47 67 87 107 127 147 167 187 207 227 247 267 287 307 327 347 367 387 407 427 447 467 487 507 527 547 567 587 607 627 647
 8 28 48 68 88 108 128 148 168 188 208 228 248 268 288 308 328 348 368 388 408 428 448 468 488 508 528 548 568 588 608 628 648
 9 29 49 69 89 109 129 149 169 189 209 229 249 269 289 309 329 349 369 389 409 429 449 469 489 509 529 549 569 589 609 629 649
 10 30 50 70 90 110 130 150 170 190 210 230 250 270 290 310 330 350 370 390 410 430 450 470 490 510 530 550 570 590 610 630 650
 11 31 51 71 91 111 131 151 171 191 211 231 251 271 291 311 331 351 371 391 411 431 451 471 491 511 531 551 571 591 611 631 651
 12 32 52 72 92 112 132 152 172 192 212 232 252 272 292 312 332 352 372 392 412 432 452 472 492 512 532 552 572 592 612 632 652
 13 33 53 73 93 113 133 153 173 193 213 233 253 273 293 313 333 353 373 393 413 433 453 473 493 513 533 553 573 593 613 633 653
 14 34 54 74 94 114 134 154 174 194 214 234 254 274 294 314 334 354 374 394 414 434 454 474 494 514 534 554 574 594 614 634 654
 15 35 55 75 95 115 135 155 175 195 215 235 255 275 295 315 335 355 375 395 415 435 455 475 495 515 535 555 575 595 615 635 655
 16 36 56 76 96 116 136 156 176 196 216 236 256 276 296 316 336 356 376 396 416 436 456 476 496 516 536 556 576 596 616 636 656
 17 37 57 77 97 117 137 157 177 197 217 237 257 277 297 317 337 357 377 397 417 437 457 477 497 517 537 557 577 597 617 637 657
 18 38 58 78 98 118 138 158 178 198 218 238 258 278 298 318 338 358 378 398 418 438 458 478 498 518 538 558 578 598 618 638 658
 19 39 59 79 99 119 139 159 179 199 219 239 259 279 299 319 339 359 379 399 419 439 459 479 499 519 539 559 579 599 619 639 659
 20 40 60 80 100 120 140 160 180 200 220 240 260 280 300 320 340 360 380 400 420 440 460 480 500 520 540 560 580 600 620 640 660

MENTION **BYTE** WHEN WRITING TO ADVERTISERS

BYTE SUBSCRIPTIONS

4160

For a subscription to BYTE, please complete this card.

Name _____
 Address _____
 City _____
 State _____ Zip _____ Country _____

USA **Canada**
Mexico

- 1 year \$18 \$20
- 2 years \$32 \$36
- 3 years \$46 \$52

- \$32 Europe (air freight) payment enclosed
- \$32 Elsewhere (surface mail) payment enclosed
 (Air mail rates available upon request)

*Please remit in US funds drawn on a US bank.
Thank you.*

- Check enclosed (**Bonus:** one EXTRA issue
— receive 13 issues for the price of 12)

  Bill me (North America only)

Card No. _____
 Expiration date _____
 Four digits above name — Master Charge only _____
 Signature _____ Date _____

Please allow eight weeks for processing.

Thank you

BOMB: BYTE's Ongoing Monitor Box 4160

BYTE's BOMB is your direct line to the editor's desk. Each month, the two top rated authors receive bonuses based on your votes. To use this card, refer to the list of authors, titles, and corresponding BOMB article numbers on the opposite page. Then rate each article on a scale from 0 to 10 below by circling the appropriate rating number to the right of each BOMB article number. Your feedback helps us produce the best possible magazine each month.

BOMB Article Number Rating										
	Poor	Fair	Good	Very Good	Excellent	Wow!					
1	0	1	2	3	4	5	6	7	8	9	10
2	0	1	2	3	4	5	6	7	8	9	10
3	0	1	2	3	4	5	6	7	8	9	10
4	0	1	2	3	4	5	6	7	8	9	10
5	0	1	2	3	4	5	6	7	8	9	10
6	0	1	2	3	4	5	6	7	8	9	10
7	0	1	2	3	4	5	6	7	8	9	10
8	0	1	2	3	4	5	6	7	8	9	10
9	0	1	2	3	4	5	6	7	8	9	10
10	0	1	2	3	4	5	6	7	8	9	10
11	0	1	2	3	4	5	6	7	8	9	10
12	0	1	2	3	4	5	6	7	8	9	10
13	0	1	2	3	4	5	6	7	8	9	10
14	0	1	2	3	4	5	6	7	8	9	10
15	0	1	2	3	4	5	6	7	8	9	10
16	0	1	2	3	4	5	6	7	8	9	10
17	0	1	2	3	4	5	6	7	8	9	10
18	0	1	2	3	4	5	6	7	8	9	10
19	0	1	2	3	4	5	6	7	8	9	10
20	0	1	2	3	4	5	6	7	8	9	10

Comments _____

PLACE
STAMP
HERE

BYTE

READER SERVICE

PO Box 2114 GPO
New York NY 10001
USA

PLACE
STAMP
HERE

BYTE

SUBSCRIPTIONS

PO Box 590
Martinsville NJ 08836
USA

PLACE
STAMP
HERE

BYTE

Publications Inc

70 Main St
Peterborough NH 03458
USA

BOMB
—
BYTE's Ongoing Monitor Box



More than meets the eye.

The new Series 5000 is mighty for its size. In more than several thousand ways!

In fact, it's the first small system offering over a megabyte of integrated mini-floppy capacity. And with its super memory management, you can have better than 300k of RAM in desk or desktop versions. But hardware is just the beginning of the story.

It's the wide selection of software that really makes this system mighty.

Operating systems? Choose CP/M* with CBASIC†—the most widely accepted small computer operating system ever. Or MVT-FAMOS,** a multi-user, multi-tasking operating system with file management like the big guys, Or MICROCOBOL,††

also for multiple users, but implemented in COBOL, familiar to commercial users the world over.

And applications programs for these operating systems number in the thousands. From real estate to accounting, taxes to inventory control, they're all available at low cost—ready to run.

When you add these software and hardware features to Industrial Micro Systems' reputation for rugged, reliable quality products you'll begin to see it all. A lot more systems than your first glance reveals.

See even more at your dealer. Call us to find out the name of your nearest dealer. He'll tell you everything you need to know. And really open your eyes!

*Trademark of Digital Research Inc.

**Trademark of MVT Microcomputer Systems Inc.

†Trademark of Software Systems

††Product of CAP:CPP

INDUSTRIAL MICRO SYSTEMS

628 N. Eckhoff St., Orange, CA 92668, (714) 978-6966
2800 Lockheed Way, Carson City, NV 89701

Circle 276 on inquiry card.

The Microcomputers you should take seriously.

The Challenger III Series is the micro-computer family with the hardware features, high level software and application programs that serious users in business and industry demand from a computer system, no matter what its size.

Since its introduction in August, 1977, the Challenger III has become one of the most successful microcomputer systems in small business, educational and industrial development applications. Tens of thousands of Challenger III's have been delivered and today hundreds of demonstrator units are set up at systems dealers around the country.

The Challenger III systems offer features which make their performance comparable with today's most powerful mini-based systems. Some of these features are:

Three processors today, more tomorrow.

The Challenger III Series is the only computer system with the three most popular processors—the 6502A, 68B00 and Z-80. This allows you to take maximum advantage of the Ohio Scientific software library and programs offered by independent suppliers and publishers. And all Challenger III's have provisions for the next generation of 16 bit micros via their 16 bit data BUS, 20 address bits, and unused processor select codes. This means you'll be able to plug a CPU expander card with two or more 16 bit micros right in to your existing Challenger III computer.

Systems Software for three processors.

Five DOS options including development, end user, and virtual data file single user systems, real time, time share, and networkable multi-user systems.

The three most popular computer languages including three types of BASIC plus FORTRAN and COBOL with more

languages available from independent suppliers. And, of course, complete assembler, editor, debugger and run time packages for each of the system's microprocessors.

Applications Software for Small Business Users.

Ready made factory supported small business software including Accounts Receivable, Payables, Cash Receipts, Disbursements, General Ledger, Balance Sheet, P & L Statements, Payroll, Personnel Files, Inventory and Order Entry as stand alone packages or integrated systems. A complete word processor system with full editing and output formatting including justification, proportional spacing and hyphenation.

OS-DMS, the software star.

Ohio Scientific offers an Information Management system which provides end user intelligence far beyond what you would expect from even the most powerful mini-systems. Basically, it

allows end users to store any collection of information under a Data Base Manager and then instantly obtain information, lists, reports, statistical analysis and even answers to conventional "English" questions pertinent to information in the Data Base. OS-DMS allows many applications to be computerized without any programming!

The "GT" option yields sub-microsecond microcomputing.

Ohio Scientific offers the 6502C microprocessor with 150 nanosecond main memory as the GT option on all Challenger III Series products. The system performs an average of 1.5 million instructions per second executing typical end user applications software (and that's a mix of 8, 16 and 24 bit instructions!).

Mini-system Expansion Ability.

Challenger III systems offer the greatest expansion capability in the microcomputer industry, including a full line of over 40 expansion accessories.

Networking and Distributed Processing

OS-65U level 3 now provides networking capabilities as well as time sharing ability allowing Challenger III based systems to be expanded to meet the most demanding business applications.

Prices you have to take seriously.

The Challenger III systems have phenomenal performance-to-cost ratios. The C3-S1 with 48K static RAM, dual 8" floppies, RS-232 port, BASIC and DOS has a suggested retail price of under \$4000. 80 megabyte disk based systems start at under \$13,000. Our OS-CP/M software package with BASIC, FORTRAN and COBOL is only \$600, and other options are comparably priced.

For literature and the name of your local dealer, CALL 1-800-321-6850 TOLL FREE.

Circle 120 on inquiry card.

C3-B wins Award of Merit at WESCON '78 as the outstanding microcomputer application for Small Business.

The Challenger III Series from Ohio Scientific.

C3-B



C3-S1



C3-OEM



OHIO SCIENTIFIC
1333 SOUTH CHILLICOTHE ROAD
AURORA, OH 44202 • (216) 831-5600